



Operator's Manual
C-Class Sedan



Mercedes-Benz



2035842071

Order No. 6515 0142 13 Part No. 203 584 20 71 USA Edition B 2005

C 230 Kompressor Sport

C 240

C 240 4MATIC

C 320

C 320 4MATIC

C 320 Sport

Our company and staff congratulate you on the purchase of your new Mercedes-Benz.

Your selection of our product is a demonstration of your trust in our company name. Furthermore, it exemplifies your desire to own an automobile that will be as easy as possible to operate and provide years of service.

Your Mercedes-Benz represents the efforts of many skilled engineers and craftsmen. To help assure your driving pleasure, and also the safety of you and your passengers, we ask you to make a small investment of time:

- Please read this manual carefully, then return it to your vehicle where it will be handy for your reference.
- Please follow the recommendations contained in this manual. They are designed to acquaint you with the operation of your Mercedes-Benz.
- Please pay attention to the warnings and cautions contained in this manual. They are designed to help improve the safety of the vehicle operator and occupants.

We extend our best wishes for many miles of safe, pleasurable driving.

Mercedes-Benz USA, LLC
A DaimlerChrysler Company

Contents

Introduction	9	At a glance	21	Getting started	31
Product information	9	Cockpit	22	Unlocking	32
Operator's Manual	10	Instrument cluster	24	Unlocking with the SmartKey	32
Service and warranty information ..	10	Multifunction steering wheel	26	Starter switch positions	33
Important notice for California		Center console	27	Adjusting	35
retail buyers and lessees of		Upper part	27	Seats	35
Mercedes-Benz automobiles	11	Lower part	28	Steering wheel	39
Maintenance	12	Overhead control panel	29	Mirrors	41
Roadside Assistance	12	Door control panel	30	Driving	43
Change of address or ownership	12			Fastening the seat belt	43
Operating your vehicle outside				Starting the engine	46
the USA or Canada	13			Switching on headlamps	49
Where to find it	14			Turn signals	50
Symbols	15			Windshield wipers	51
Operating safety	16			Problems while driving	53
Proper use of the vehicle	16			Parking and locking	54
Problems with your vehicle	17			Parking brake	54
Reporting safety defects	18			Switching off headlamps	55
Reporting Safety Defects	18			Turning off engine	56
Vehicle data recording	19				
Information regarding electronic					
recording devices	19				

Contents

Safety and Security	57	Controls in detail	93	Lighting	117
Occupant safety.....	58	Locking and unlocking.....	94	Exterior lamp switch	117
Air bags	59	SmartKey	94	Combination switch	121
Seat belts	64	Opening the doors from the		Cornering fog lamps* (All models	
Children in the vehicle.....	68	inside	98	with Bi-Xenon* headlamps,	
Blocking of rear door window		Opening the trunk	99	except C 230 Kompressor Sport	
operation.....	80	Closing the trunk.....	101	and C 320 Sport)	122
Panic alarm*	81	Trunk lid emergency release	102	Hazard warning flasher	123
Activating	81	Automatic central locking	103	Interior lighting	124
Deactivating	81	Locking and unlocking from		Door entry lamps	125
Driving safety systems.....	83	the inside	104	Trunk lamp.....	125
ABS	83	Seats	106	Instrument cluster	126
BAS	84	Easy-entry/exit feature*	106	Instrument cluster illumination ...	126
ESP.....	85	Removing and installing front		Coolant temperature gauge	127
Four wheel electronic traction		seat head restraints	107	Trip odometer	127
system (4MATIC) with the ESP	88	Rear seat head restraints	109	Tachometer.....	128
Anti-theft systems.....	89	Multicontour seats*	112	Outside temperature indicator	128
Immobilizer.....	89	Seat heating*	113	Control system	129
Anti-theft alarm system*	89	Memory function*	114	Multifunction display.....	129
Tow-away alarm*	91	Storing positions into memory	115	Multifunction steering wheel.....	130
		Recalling positions from memory	115	Menus.....	132
		Storing exterior rear view mirror		Standard display menu	134
		parking position	116	AUDIO menu	135
				NAV* menu.....	138

Contents

Vehicle status message memory menu.....	138	Adjusting air distribution and volume.....	182	Audio system.....	201
Settings menu.....	140	Defrosting.....	183	Audio and telephone, operation....	201
Trip computer menu.....	156	Air recirculation mode.....	184	Operating safety.....	201
TEL menu*.....	158	Air conditioning.....	185	Operating and display elements ...	202
Manual transmission.....	162	Rear passenger compartment adjustable air vents.....	187	Button and soft key operation.....	204
Shifting into reverse.....	163	Automatic climate control*.....	188	Operation.....	204
Automatic transmission*.....	164	Deactivating the automatic climate control system.....	191	Radio operation.....	209
One-touch gearshifting.....	166	Setting the temperature.....	191	Introduction to satellite radio* (USA only).....	214
Gear ranges.....	167	Adjusting air distribution.....	192	CD mode.....	219
Gear selector lever position.....	168	Adjusting air volume.....	193	GSM network phones.....	226
Automatic shift program.....	169	Defrosting.....	194	TDMA or CDMA network phones..	232
Driving tips.....	170	Maximum cooling MAXCOOL.....	194	Emergency calls "911".....	239
Emergency operation (Limp Home Mode).....	171	Air recirculation mode.....	195	Power windows.....	241
Good visibility.....	172	Charcoal filter.....	196	Opening and closing the windows.....	241
Headlamp cleaning system*.....	172	Air conditioning.....	198	Synchronizing power windows.....	244
Rear view mirrors.....	172	Residual heat and ventilation (available on automatic climate control panel design A only).....	199	Power tilt/sliding sunroof*.....	245
Sun visors.....	175	Rear passenger compartment adjustable air vents.....	200	Opening and closing the power tilt/sliding sunroof.....	245
Rear window sunshade*.....	176			Synchronizing the power tilt/sliding sunroof.....	248
Rear window defroster.....	177				
Climate control.....	178				
Deactivating the climate control system.....	181				
Setting the temperature.....	181				

Contents

Driving systems	249			
Cruise control.....	249			
Loading.....	252			
Roof rack*	252			
Ski sack* (Canada only)	252			
Split rear bench seat*	255			
Loading instructions.....	257			
Cargo tie-down rings*	258			
Useful features	259			
Storage compartments.....	259			
Ashtrays	263			
Cigarette lighter	265			
Electrical outlet in the rear passenger compartment	265			
Telephone*	266			
Tele Aid*	267			
Garage door opener*	274			
Operation	281			
The first 1 000 miles (1 500 km).....	282			
Driving instructions.....	283			
Drive sensibly – save fuel.....	283			
Drinking and driving	283			
Pedals	283			
Power assistance	283			
Brakes.....	284			
Driving off	285			
Parking.....	285			
Tires	286			
Hydroplaning.....	286			
Tire traction.....	287			
Tire speed rating	287			
Winter driving instructions	288			
Standing water	289			
Passenger compartment	290			
Driving abroad.....	290			
Control and operation of radio transmitters	290			
Catalytic converter	291			
Emission control	291			
Coolant temperature	292			
At the gas station	293			
Refueling.....	293			
Check regularly and before a long trip.....	295			
Engine compartment	296			
Hood	296			
Engine oil	297			
Transmission fluid level.....	300			
Coolant level	301			
Battery	302			
Windshield washer system and headlamp cleaning system*	303			
Tires and wheels.....	304			
Important guidelines	304			
Tire care and maintenance.....	305			
Direction of rotation.....	307			
Loading the vehicle	307			
Recommended tire inflation pressure.....	313			
Checking tire inflation pressure ...	315			
Tire labeling	317			
Load identification	321			
DOT, Tire Identification Number (TIN)	322			

Contents

Maximum tire load	323		
Maximum tire inflation pressure ..	324		
Uniform Tire Quality Grading Standards (U.S. vehicles)	325		
Tire ply material	327		
Tire and loading terminology	327		
Rotating tires	331		
Winter driving	332		
Winter tires	332		
Block heater (Canada only)	333		
Snow chains	333		
Maintenance	334		
Clearing the maintenance service indicator	335		
Maintenance service term exceeded	335		
Calling up the maintenance service indicator	335		
Resetting the maintenance service indicator	336		
Vehicle care	337		
Cleaning and care of the vehicle ..	337		
		Practical hints	343
		What to do if	344
		Lamps in instrument cluster	344
		Lamp in center console	350
		Vehicle status messages in the multifunction display	352
		Where will I find ...?	377
		First aid kit	377
		Vehicle tool kit	377
		Minispare wheel	380
		Spare wheel bolts	382
		Unlocking/locking in an emergency ...	383
		Unlocking the vehicle	383
		Locking the vehicle	384
		Fuel filler flap	385
		Manually unlocking the transmission gear selector lever ...	386
		Opening/closing in an emergency	387
		Power tilt/sliding sunroof*	387
		Replacing SmartKey batteries	388
		SmartKey	389
		Replacing bulbs	390
		Bulbs	390
		Replacing bulbs for front lamps	393
		Replacing bulbs for rear lamps	397
		Replacing wiper blades	398
		Removing wiper blades	398
		Installing wiper blades	398
		Flat tire	399
		Preparing the vehicle	399
		Mounting the Minispare wheel	399
		Battery	404
		Disconnecting the battery	405
		Removing the battery	405
		Charging and reinstalling the battery	405
		Reconnecting the battery	406
		Jump starting	407
		Towing the vehicle	409
		Installing towing eye bolt	412
		Fuses	413
		Aids for changing fuses	413
		Main fuse box in passenger compartment	414
		Fuse box in engine compartment	414
		Fuse box in trunk	416

Contents

Technical data	417	Weights.....	430	Technical terms	441
Parts service	418	Fuels, coolants, lubricants, etc.	431		
Warranty coverage.....	419	Capacities	431	Index	447
Loss of Service and Warranty		Engine oils.....	433		
Information Booklet.....	419	Engine oil additives	433		
Identification labels.....	420	Air conditioning refrigerant	433		
Layout of poly-V-belt drive	421	Brake fluid.....	433		
C 230 Kompressor (all models)	421	Premium unleaded gasoline	434		
C 240 (all models)/		Fuel requirements	434		
C 320 (all models).....	421	Gasoline additives	435		
Engine	422	Flexible Fuel Vehicles.....	435		
Rims and Tires	424	Coolants.....	437		
Same size tires	425	Windshield washer and			
Mixed size tires	426	headlamp cleaning system*	439		
Minispare wheel	427				
Electrical system.....	428				
Main dimensions.....	429				

▼ **Product information**

Please observe the following in your own best interest:

We recommend using genuine Mercedes-Benz parts as well as conversion parts and accessories explicitly approved by us for your vehicle model.

We have tested these parts to determine their reliability, safety and special suitability for Mercedes-Benz vehicles.

We are unable to make an assessment for other products and therefore cannot be held responsible for them, even if in individual cases an official approval or authorization by governmental or other agencies should exist. Use of such parts and accessories could adversely affect the safety, performance or reliability of your vehicle. Please do not use them.

Genuine Mercedes-Benz parts as well as conversion parts and accessories approved by us are available at your authorized Mercedes-Benz Center where you will receive comprehensive information, also on permissible technical modifications, and where proper installation will be performed.

Introduction

Operator's Manual

This Operator's Manual contains a great deal of useful information. We urge you to read it carefully and familiarize yourself with the vehicle before driving.

For your own safety and longer service life of the vehicle, we urge you to follow the instructions and warnings contained in this manual. Ignoring them could result in damage to the vehicle or personal injury to you or others. Vehicle damage caused by failure to follow instructions is not covered by the Mercedes-Benz Limited Warranty.

Your vehicle may have some or all of the equipment described in this manual. Therefore, you may find explanations for optional equipment not installed in your vehicle. If you have any questions about the operation of any equipment, your authorized Mercedes-Benz Center will be glad to demonstrate the proper procedures.

We continuously strive to improve our product, and ask for your understanding that we reserve the right to make changes in design and equipment. Therefore, information, illustrations and descriptions in this Operator's Manual might differ from your vehicle.

Optional equipment is also described in this manual, including operating instructions wherever necessary. Since they are special-order items, the descriptions and illustrations herein may vary slightly from the actual equipment of your vehicle.

If there are any equipment details that are not shown or described in this Operator's Manual, your authorized Mercedes-Benz Center will be glad to inform you of correct care and operating procedures.

The Operator's Manual and Maintenance Booklet are important documents and should be kept with the vehicle.

Service and warranty information

The Service and Warranty Information Booklet contains detailed information about the warranties covering your Mercedes-Benz, including:

- New Car Limited Warranty
- Emission System Warranty
- Emission Performance Warranty
- California, Maine, Massachusetts, and Vermont Emission Control System Warranty (California, Maine, Massachusetts, and Vermont only)
- State Warranty Enforcement Laws (Lemon Laws)

Important notice for California retail buyers and lessees of Mercedes-Benz automobiles

Under California law you may be entitled to a replacement of your vehicle or a refund of the purchase price or lease price, if Mercedes-Benz USA, LLC and/or its authorized repair or service facilities fail to fix one or more substantial defects or malfunctions in the vehicle that are covered by its express warranty after a reasonable number of repair attempts. During the period of 18 months from original delivery of the vehicle or the accumulation of 18000 miles (approx. 29000 km) on the odometer of the vehicle, whichever occurs first, a reasonable number of repair attempts is presumed for a retail buyer or lessee if one or more of the following occurs:

- (1) the same substantial defect or malfunction results in a condition that is likely to cause death or serious bodily injury if the vehicle is driven, that defect or malfunction has been subject to repair two or more times, and you have directly notified Mercedes-Benz USA, LLC in writing of the need for its repair,
- (2) the same substantial defect or malfunction of a less serious nature than category (1) has been subject to repair four or more times and you have directly notified us in writing of the need for its repair, or
- (3) the vehicle is out of service by reason of repair of the same or different substantial defects or malfunctions for a cumulative total of more than 30 calendar days.

Written notification should be sent to us, not a dealer, at Mercedes-Benz USA, LLC, Customer Assistance Center, One Mercedes Drive, Montvale, NJ 07645-0350.

Introduction

Operator's Manual

Maintenance

The Maintenance Booklet describes all the necessary maintenance work which should be performed at regular intervals.

Always have the Maintenance Booklet with you when you take the vehicle to your authorized Mercedes-Benz Center for service. The service advisor will record each service in the booklet for you.

Roadside Assistance

The Mercedes-Benz Roadside Assistance Program provides factory-trained technical help in the event of a breakdown. Calls to the toll-free Roadside Assistance number

1-800-FOR-MERCEdes (in the USA)
1-800-387-0100 (in Canada)

will be answered by Mercedes-Benz Customer Assistance Representatives 24 hours a day, 365 days a year.

For additional information refer to the Mercedes-Benz Roadside Assistance Program brochure in your vehicle literature portfolio.

Change of address or ownership

If you change your address, be sure to send in the "Change of Address Notice" found in the Service and Warranty Information Booklet, or simply call the Mercedes-Benz Customer Assistance Center (in the USA) at 1-800-FOR-MERCEdes, or Customer Service (in Canada) at 1-800-387-0100. It is in your own interest that we can contact you should the need arise.

If you sell your Mercedes, please leave all literature with the vehicle to make it available to the next operator.

If you bought this vehicle used, be sure to send in the "Notice of Purchase of Used Car" found in the Service and Warranty Information Booklet, or call the Mercedes-Benz Customer Assistance Center (in the USA) at 1-800-FOR-MERCEdes, or Customer Service (in Canada) at 1-800-387-0100.

Operating your vehicle outside the USA or Canada

If you plan to operate your vehicle in foreign countries, please be aware that

- service facilities or replacement parts may not be readily available,
- unleaded gasoline for vehicles with catalytic converters may not be available; the use of leaded fuels will damage the catalyts,
- gasoline may have a considerably lower octane rating, and improper fuel can cause engine damage.

Certain Mercedes-Benz models are available for delivery in Europe under our European Delivery Program. For details, consult an authorized Mercedes-Benz Center or write to:

In the USA:

Mercedes-Benz USA, LLC
European Delivery Department
One Mercedes Drive
Montvale, NJ 07645-0350

In Canada:

Mercedes-Benz Canada, Inc.
European Delivery Department
98 Vanderhoof Avenue
Toronto, Ontario M4G 4C9

Introduction

Where to find it

This Operator's Manual is designed to provide comprehensive support information for you, the vehicle operator. Each section has its own reference color so you can find information quickly.

At a glance

Here you will find an overview of all the controls that can be operated from the driver's seat.

Getting started

Here you will find all the information you need for your first drive. You should read this section first if this is your first Mercedes-Benz vehicle or if you are renting or borrowing this vehicle.

Safety and Security

Here you will find descriptions of the safety features of your vehicle.

Controls in detail

Here you will find detailed information about the equipment installed in your vehicle. This section expands on the "Getting started" section and also describes technical innovations. If you are already familiar with the basic functions of your vehicle, this section will be of particular interest to you.

Operation

Here you will find all the information you need for the proper operation of your vehicle.

Practical hints

This section provides fast assistance for dealing with problems you may encounter.

Technical data

All important technical data for your vehicle can be found in this section.

Indexes

The glossary provides explanations of the most important technical terms.

The table of contents and the index are designed to help you find information quickly and easily.

The following publications are part of your vehicle documentation:

- this Operator's Manual
- the Maintenance Booklet

Separate operating instructions will be provided as required depending on the equipment options installed in your vehicle.

▼ Symbols

The following symbols are found in this Operator's Manual:

- * Optional equipment is identified with an asterisk. Since standard equipment varies between models, the descriptions and illustrations in this manual may differ slightly from the actual equipment of your vehicle.

Warning!



Warning notices draw your attention to hazards that may endanger your health or life, or the health or life of others.



Highlights hazards that may result in damage to your vehicle.



Helpful hints or further information you may find useful.

- ▶ This symbol points to instructions for you to follow.
- ▶ A number of these symbols appearing in succession indicates a multiple-step procedure.
- ▷ Page This symbol tells you where to look for further information on a topic.
- ▷▷ This continuation symbol marks an interrupted procedure which will be continued on the next page.
- > In the glossary of technical terms, this symbol is used to indicate cross-references to term definitions.
- Display Words appearing in the multi-function display are printed in the type shown here.

Introduction

Operating safety

Warning!



Work improperly carried out on electronic components and associated software could cause them to cease functioning. Because the vehicle's electronic components are interconnected, any modifications made may produce an undesired effect on other systems. Electronic malfunctions could seriously impair the operating safety of your vehicle.

See an authorized Mercedes-Benz Center for repairs or modifications to electronic components.

Other improper work or modifications on the vehicle could also have a negative impact on the operating safety of the vehicle.

Some safety systems only function while the engine is running. You should therefore never turn off the engine while driving.

Warning!



Heavy blows against the vehicle underbody or tires/wheels, for example when running over an obstacle, road debris or a pothole, may cause serious damage and impair the operating safety of your vehicle. If you feel a sudden significant vibration or ride disturbance, or you suspect that damage to your vehicle has occurred, you should turn on your hazard warning flashers, carefully slow down, and drive with caution to an area which is a safe distance from the road.

Inspect the vehicle underbody and tires/wheels for possible damage. If the vehicle appears unsafe, have it towed to the nearest authorized Mercedes-Benz Center or other qualified maintenance or repair facility for further inspection or repairs.

Proper use of the vehicle

Proper use of the vehicle requires that you are familiar with the following information and rules:

- the safety precautions in this manual
- the “Technical data” section in this manual
- traffic rules and regulations
- motor vehicle laws and safety standards

Warning!



Various warning labels are attached to your vehicle. These warning labels are intended to make you and others aware of various risks. You should not remove any of these warning labels unless explicitly instructed to do so by information on the label itself. Removal of any of these labels may cause you and others to be unaware of certain risks which may result in an accident and/or personal injury.

▼ **Problems with your vehicle**

If you should experience a problem with your vehicle, particularly one that you believe may affect its safe operation, we urge you to immediately contact an authorized Mercedes-Benz Center to have the problem diagnosed and corrected if required. If the matter is not handled to your satisfaction, please discuss the problem with the Mercedes-Benz Center management, or if necessary contact us at one of the following addresses:

In the USA:

Customer Assistance Center
Mercedes-Benz USA, LLC
One Mercedes Drive
Montvale, NJ 07645-0350

In Canada:

Customer Relations Department
Mercedes-Benz Canada, Inc.
98 Vanderhoof Avenue
Toronto, Ontario, M4G 4C9

Introduction

Reporting safety defects

For the USA only:

The following text is published as required of manufacturers under Title 49, Code of U.S. Federal Regulations, Part 575 pursuant to the “National Traffic and Motor Vehicle Safety Act of 1966”.

Reporting Safety Defects

If you believe that your vehicle has a defect which could cause a crash or could cause injury or death, you should immediately inform the National Highway Traffic Safety Administration (NHTSA) in addition to notifying Mercedes-Benz USA, LLC.

If NHTSA receives similar complaints, it may open an investigation, and if it finds that a safety defect exists in a group of vehicles, it may order a recall and remedy campaign. However, NHTSA cannot become involved in individual problems between you, your dealer, or Mercedes-Benz USA, LLC.

To contact NHTSA, you may either call the Auto Safety Hotline toll-free at 1-888-327-4236 (or 366-0123 in Washington, D.C. area) or write to: NHTSA, U.S. Department of Transportation, Washington, D.C. 20590. You can also obtain other information about motor vehicle safety from the Hotline.

▼ Vehicle data recording**Information regarding electronic recording devices**

(Including notice pursuant to California Code § 9951)

Please note that your vehicle is equipped with devices that can record vehicle systems data and, if equipped with the Tele Aid system, may transmit some data in certain accidents.

This information helps, for example, to diagnose vehicle systems after a collision and to continuously improve vehicle safety. DaimlerChrysler may access the information and share it with others

- for safety research or vehicle diagnosis purposes
- with the consent of the vehicle owner or lessee
- in response to an official request by law enforcement or other government agency
- for use in dispute resolution involving DaimlerChrysler, its affiliates or sales/service organization and/or
- as otherwise required or permitted by law.

Please check the Tele Aid subscription service agreement for details regarding the information that may be recorded or transmitted via that system.





At a glance

Cockpit

Instrument cluster

Multifunction steering wheel

Center console

Overhead control panel

Door control panel

At a glance

Cockpit

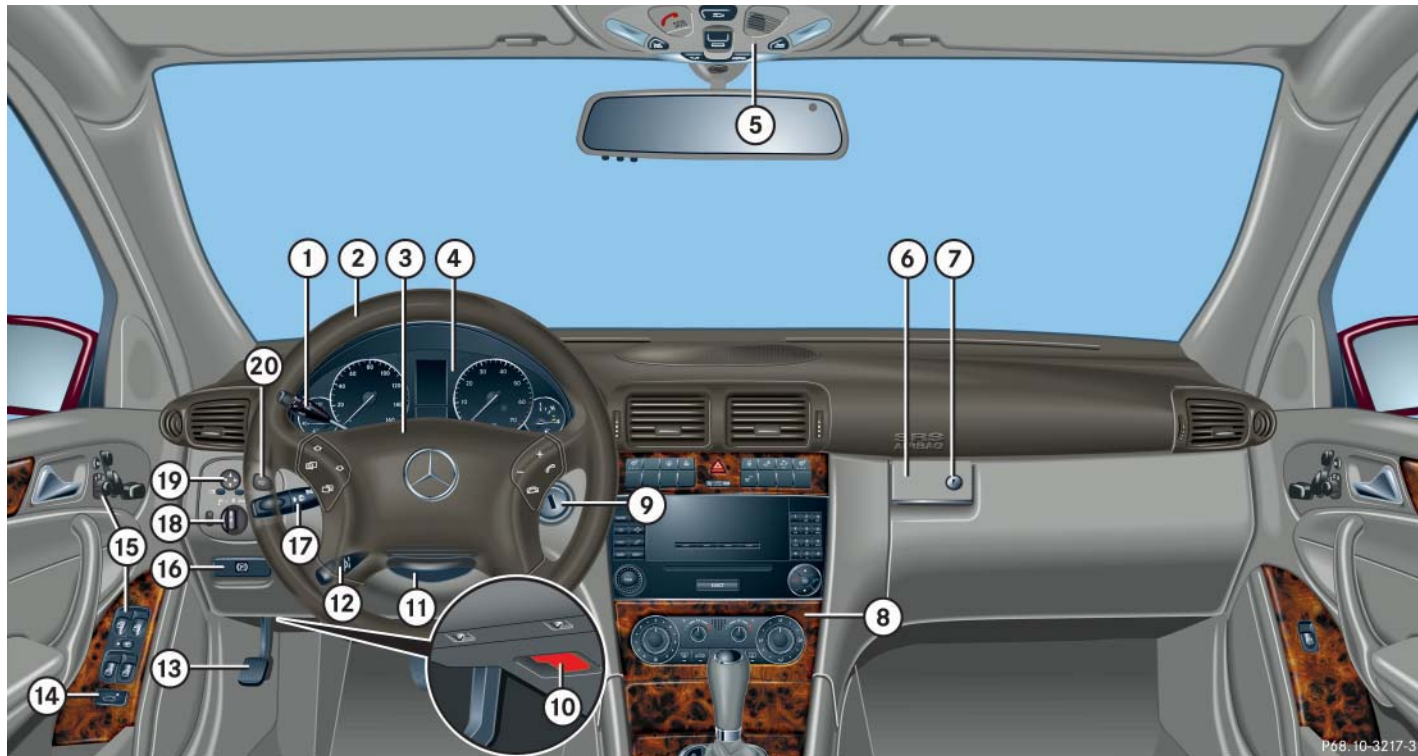

At a glance

Cockpit

	Item	Page
①	Cruise control lever	249
②	Multifunction steering wheel	26, 130
③	Horn	
④	Instrument cluster	24, 126
⑤	Overhead control panel	29
⑥	Glove box lid release	259
⑦	Glove box lock	259
⑧	Center console	27

	Item	Page
⑨	Starter switch	33
⑩	Hood lock release	296
⑪	Steering wheel adjustment handle (manual)	40
⑫	Steering wheel adjustment stalk (electrical)*	40
⑬	Parking brake pedal	48, 54
⑭	Remote trunk lid switch	100
⑮	Door control panel	30
⑯	Parking brake release	48

	Item	Page
⑰	Combination switch	
	• Turn signals	50
	• Windshield wipers	51
	• High beam	50
⑱	Exterior lamp switch	49, 117
⑲	Exterior rear view mirror adjustment	41, 116
⑳	Headlamp washer switch*	172





At a glance





Instrument cluster





At a glance

Instrument cluster

	Item	Page
①	Speedometer with:	
	 Electronic Stability Program (ESP) warning lamp	85, 348
	 Brake warning lamp, USA only	48, 54, 345
	 Brake warning lamp, Canada only	48, 54, 345
	 Low beam headlamp indicator lamp	49, 117
②	 Left turn signal indicator lamp	50
③	Multifunction display with:	129
	Trip odometer	127
	Main odometer	129
	Gear selector lever position	47, 129, 168

	Item	Page
	Program mode	169
	Status indicator (outside temperature/digital speedometer)	128, 144
	Digital clock	129
④	 Right turn signal indicator lamp	50
⑤	Tachometer with:	128
	 Antilock Brake System (ABS) indicator lamp	83, 344
	 Engine malfunction indicator lamp, USA only	346, 347
	 Engine malfunction indicator lamp, Canada only	346, 347
	 Supplemental restraint system indicator lamp	58, 349

	Item	Page
	 Seat belt telltale	64, 349
	 High beam headlamp indicator lamp	50, 121
⑥	Fuel gauge with:	
	Fuel reserve warning lamp	349
	 Fuel filler cap location indicator: The fuel filler cap is on the rear right-hand side.	
⑦	Coolant temperature gauge	127
⑧	Reset button for:	126
	• Resetting trip odometer	127
	• Resetting individual settings	141
	• Instrument cluster illumination	126

At a glance

Multifunction steering wheel

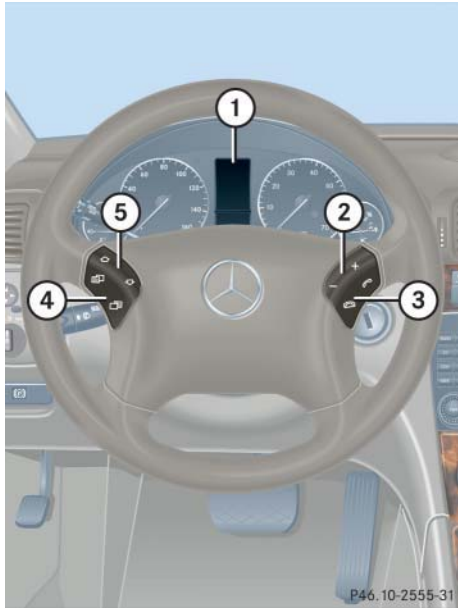

Item	Page
① Multifunction display	129
Operating control system	130
② Selecting the submenu or setting the volume: Press button	
up/to increase	
down/to decrease	
③ Telephone*: Press button	
to take a call	
to end a call	

Item	Page
④ Menu systems: Press button	
for next menu	
for previous menu	
⑤ Moving within a menu: Press button	
for next display	
for previous display	



C 230 Kompressor Sport, and C 320 Sport:
Steering wheel in these vehicles will vary from steering wheel shown. However, multifunction steering wheel symbols and feature description apply to Sport models as well.

At a glance

Center console

▼ Center console

Upper part



P68, 20-3000-31

Item	Page
① Seat heating*, driver's side	113
② Rear window sunshade switch*	176
③ ESP control switch	85
④ Hazard warning flasher switch - switching on/off	123
⑤ Central locking switch	104
Central unlocking switch	104
⑥ Switch for folding back rear seat head restraints	110
⑦ Tow-away alarm switch*	91
Anti-theft alarm system indicator lamp*	90

Item	Page
⑧ Seat heating*, passenger side	113
⑨ Front passenger front air bag off indicator lamp	75, 350, 351
⑩ Audio system, or COMAND* (see separate operating instructions)	201
⑪ Climate control	178
Automatic climate control*	188
Rear window defroster	177

At a glance

Center console

Lower part



	Item	Page
①	Ashtray	263
	Cigarette lighter	265
②	Gear selector lever for automatic transmission*	47, 168
	Gearshift lever for manual transmission	46, 162
③	Cup holders	261
④	Armrest	260
⑤	Program mode selector switch for automatic transmission*	169

At a glance

Overhead control panel

▼ Overhead control panel



Item	Page
① Rear interior lighting on/off	125
② Power tilt/sliding sunroof*	245
③ Right reading lamp on/off	125
④ Interior lighting control	124
⑤ Hands-free microphone for Tele Aid* (emergency call system) and telephone*	158, 226, 267

Item	Page
⑥ Interior rear view mirror	41, 172
⑦ Garage door opener*	274
⑧ Left reading lamp on/off	125
⑨ Tele Aid* (emergency call system) button	267

At a glance

Door control panel



	Item	Page
①	Door handle	98
②	Memory function* (for storing seat, exterior mirror and steering wheel settings)	114
③	Switches for seat adjustment*	35, 106
④	Switches for opening/closing front door windows	241
⑤	Switch for rear door window override	80
⑥	Switches for opening/closing rear door windows	241
⑦	Remote trunk lid switch	100

Getting started

Unlocking

Adjusting

Driving

Parking and locking

Getting started

Unlocking



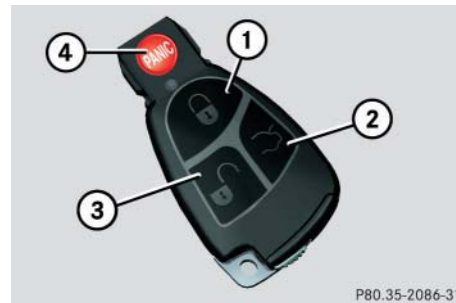

The “Getting started” section provides an overview of the vehicle’s most basic functions. First-time Mercedes-Benz owners should pay special attention to the information given here.

If you are already familiar with the basic functions described here, the “Controls in detail” section will provide you with further information. The corresponding page references are located at the end of each segment.

Unlocking with the SmartKey



SmartKey with remote control

- ①  Lock button
- ②  Opening button for the trunk lid
- ③  Unlock button
- ④  Panic button* (▷ page 81)



Canada only:
Only vehicles equipped with an anti-theft alarm system* have SmartKeys with integrated panic button* ④.

Warning!



When leaving the vehicle, always remove the SmartKey from the starter switch, take it with you, and lock the vehicle. Do not leave children unattended in the vehicle, or with access to an unlocked vehicle. Unsupervised use of vehicle equipment may cause an accident and/or serious personal injury.

- ▶ Press unlock button  on the SmartKey.
All turn signal lamps flash once. The locking knobs in the doors move up. The anti-theft alarm system* is disarmed.
- ▶ Get in the vehicle and insert the SmartKey in the starter switch.

For more information, see “Locking and unlocking” (▷ page 94).

Starter switch positions

Warning!



When leaving the vehicle, always remove the SmartKey from the starter switch, take it with you, and lock the vehicle. Do not leave children unattended in the vehicle, or with access to an unlocked vehicle. Unsupervised use of vehicle equipment may cause an accident and/or serious personal injury.

SmartKey

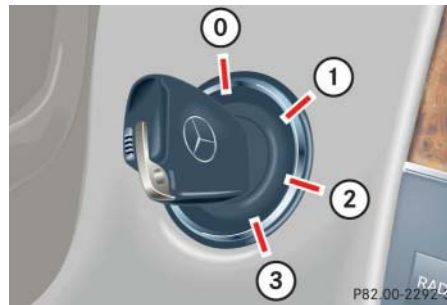

Starter switch

- 0** For removing SmartKey
The steering is locked when the SmartKey is removed from the starter switch. If necessary, move steering wheel slightly to allow the locking mechanism to engage.
- 1** Power supply to some electrical consumers, such as seat adjustment

- 2** Ignition (power supply for all electrical consumers) and driving position.
All lamps (except low beam headlamp indicator lamp, high beam headlamp indicator lamp, and turn signal indicator lamps unless activated) in the instrument cluster come on. If a lamp in the instrument cluster fails to come on when the ignition is switched on, have it checked and replaced if necessary. If a lamp in the instrument cluster remains on after starting the engine or comes on while driving, refer to “Lamps in instrument cluster” (▷ page 344).
- 3** Starting position

Getting started

Unlocking



When you switch on the ignition, the indicator and warning lamps (except low beam headlamp indicator lamp, high beam headlamp indicator lamp, and turn signal indicator lamps unless activated) in the instrument cluster come on. This indicates that the respective systems are operational. The indicator and warning lamps (except low beam headlamp indicator lamp, high beam headlamp indicator lamp, and turn signal indicator lamps if activated) should go out when the engine is running.



Vehicles with automatic transmission:
The SmartKey can only be removed from the starter switch with the gear selector lever in position **P**.



If the SmartKey cannot be turned in the starter switch, the battery may not be sufficiently charged.

- Check the battery and charge it if necessary (▷ page 404).
- Get a jump start (▷ page 407).

To prevent accelerated battery discharge and a possible dead battery, always remove the SmartKey from the starter switch when the engine is not in operation.

▼ Adjusting

Warning!



All seat, head restraint, steering wheel, and rear view mirror adjustments, as well as fastening of seat belts, must be done before the vehicle is put into motion.

Seats

The seats can be adjusted either manually or electrically, depending on the vehicle's equipment.

Warning!



Do not adjust the driver's seat while driving. Adjusting the seat while driving could cause the driver to lose control of the vehicle.

Never ride in a moving vehicle with the seat back in an excessively reclined position as this can be dangerous. You could slide under the seat belt in a collision. If you slide under it, the belt would apply force at the abdomen or neck.

That could cause serious or fatal injuries. The seat back and seat belts provide the best restraint when the wearer is in a nearly upright position and belts are properly positioned on the body. Your seat must be adjusted so that you can correctly fasten your seat belt (▷ page 43).

Never place hands under the seat or near any moving parts while a seat is being adjusted.

Warning!



When leaving the vehicle, always remove the SmartKey from the starter switch, take it with you, and lock the vehicle.

Even with the SmartKey removed from the starter switch, the power seats* can be operated when the respective door is open. Therefore, do not leave children unattended in the vehicle, or with access to an unlocked vehicle. Unsupervised use of vehicle equipment may cause an accident and/or serious personal injury.

Getting started

Adjusting

Warning!



According to accident statistics, children are safer when properly restrained in the rear seating positions than in the front seating position. Thus, we strongly recommend that children be placed in the rear seats whenever possible. Regardless of seating position, children 12 years old and under must be seated and properly secured in an appropriate infant, or toddler restraint, or booster seat recommended for the size and weight of the child. For additional information, see "Children in the vehicle" (▷ page 68).

A child's risk of serious or fatal injuries is significantly increased if the child restraints are not properly secured in the vehicle and/or the child is not properly secured in the child restraint.

Getting started

Adjusting

Manual seat adjustment

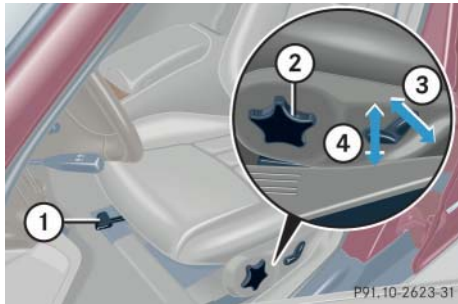

- ① Seat fore and aft adjustment
- ② Seat cushion tilt
- ③ Seat backrest tilt
- ④ Seat height

Seat fore and aft adjustment

- ▶ Lift handle ①.
- ▶ Slide seat to the desired position.
- ▶ Allow handle ① to reengage.
- ▶ Check for proper engagement before driving.

Adjust seat to a comfortable seating position that still allows you to reach the accelerator/brake pedal safely. The position should be as far rearward as possible, consistent with ability to properly operate controls.



When moving the seat, make sure that there are no items in the footwell or behind the seat. Otherwise you could damage the seat.

Seat cushion tilt

- ▶ Turn handwheel ② forward or backward until your upper legs are lightly supported.

Seat backrest tilt

- ▶ Switch on ignition (▷ page 33).
- ▶ Press switch ③ in direction of arrow until your arms are slightly angled when holding the steering wheel.

Seat height

- ▶ Switch on ignition (▷ page 33).
- ▶ Press switch ④ in direction of arrow until your legs are lightly supported.

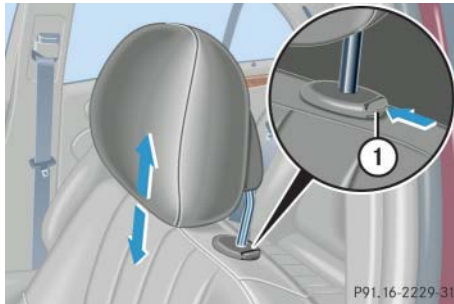
Head restraint height

① Release button

Raising:

- ▶ Manually adjust the height of the head restraint by pulling it upward.

Lowering:

- ▶ To lower head the restraint, push release button ① and push down on the head restraint.

Warning!

For your protection, drive only with properly positioned head restraints.

Adjust head restraint so that the center of the head restraint supports the back of the head at eye level. This will reduce the potential for injury to the head and neck in the event of an accident or similar situation.

Do not drive the vehicle without the seat head restraints. Head restraints are intended to help reduce injuries during an accident.

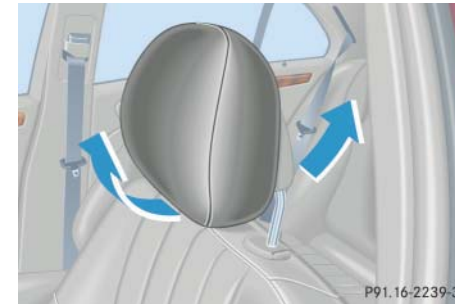

Adjust the head restraint in such a way that it is as close to the head as possible.

Head restraint tilt

Manually adjust the angle of the head restraint.

- ▶ Push or pull on the lower edge of the head restraint cushion.

For more information, see “Seats” (▷ page 106).

Getting started

Adjusting

Power seat* adjustment

The seat adjustment switches are located in each front door.

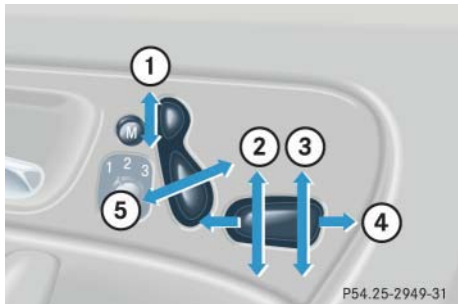

- ① Head restraint height
- ② Seat height
- ③ Seat cushion tilt
- ④ Seat fore and aft adjustment
- ⑤ Seat backrest tilt

▶ Switch on ignition (▷ page 33).

or

▶ Open the respective door.

Seat fore and aft adjustment

▶ Press switch forward or backward in direction of arrow ④.

Adjust seat to a comfortable seating position that still allows you to reach the accelerator/brake pedal safely. The position should be as far rearward as possible, consistent with ability to properly operate controls.



When moving the seat, make sure that there are no items in the footwell or behind the seat. Otherwise you could damage the seat.



The memory function* (▷ page 114) lets you store the setting for the seat position together with the settings for the steering wheel and exterior rear view mirrors.

Seat cushion tilt

▶ Press switch up or down in direction of arrow ③ until your upper legs are lightly supported.

Seat backrest tilt

▶ Press switch forward or backward in direction of arrow ⑤ until your arms are slightly angled when holding the steering wheel.

Seat height

▶ Press switch up or down in direction of arrow ②.

Head restraint height

▶ Press switch up or down in direction of arrow ①.



Adjust the head restraint in such a way that it is as close to the head as possible.

Warning!



For your protection, drive only with properly positioned head restraints.

Adjust head restraint so that the center of the head restraint supports the back of the head at eye level. This will reduce the potential for injury to the head and neck in the event of an accident or similar situation.

Do not drive the vehicle without the seat head restraints. Head restraints are intended to help reduce injuries during an accident.

Head restraint tilt



Manually adjust the angle of the head restraint.

- ▶ Push or pull on the lower edge of the head restraint cushion.

For more information, see “Seats” (▷ page 106).

Steering wheel

Warning!



Do not adjust the steering wheel while driving. Adjusting the steering wheel while driving, or driving without the adjustment locked could cause the driver to lose control of the vehicle.

When leaving the vehicle, always remove the SmartKey from the starter switch, take it with you, and lock the vehicle.

Even with the SmartKey removed from the starter switch, the electrical steering wheel adjustment feature* can be operated when the driver's door is open. Therefore, do not leave children unattended in the vehicle, or with access to an unlocked vehicle. Unsupervised use of vehicle equipment may cause an accident and/or serious personal injury.

Getting started

Adjusting

Steering wheel adjustment, manual

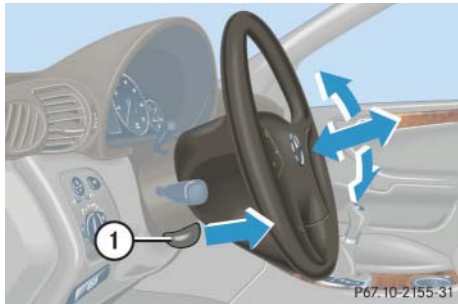

① Handle

- ▶ To unlock the steering column, pull handle ① out to its stop limit.
- ▶ Move steering wheel to the desired position.
- ▶ To lock the steering column, push handle ① all the way in until it engages.

The steering wheel is once again locked into position.

- ▶ Make sure the steering wheel is securely locked by trying to move it up and down, and in and out before driving off.

Warning!



Only adjust the steering wheel with the vehicle at a standstill and make sure the steering wheel is securely locked in place before driving off.

Driving without the steering wheel adjustment locked may cause an unexpected steering wheel movement which could cause the driver to lose control of the vehicle. Make sure the steering wheel is securely locked by trying to move it up and down, and in and out before driving off.

Steering wheel adjustment, electrical*

The stalk for steering wheel adjustment is located on the steering column (lower left).

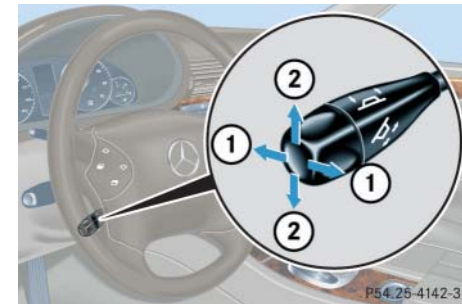

- ① Adjusting steering column, in or out
- ② Adjusting steering column, up or down

- ▶ Switch on ignition (▷ page 33).
- or
- ▶ Open the driver's door.

Adjusting steering column in or out

- ▶ Move stalk forward or back in the direction of arrow ① until a comfortable steering wheel position is reached with your arms slightly bent at the elbow.

Adjusting steering column up or down

- ▶ Move stalk up or down in the direction of arrow ②.

Make sure your legs can move freely and that all the displays (incl. malfunction and indicator lamps) on the instrument cluster are clearly visible.



The memory function* (▷ page 114) lets you store the setting for the steering wheel together with the settings for the seat position and exterior rear view mirrors.

Mirrors

Adjust the interior and exterior rear view mirrors before driving so that you have a good view of the road and traffic conditions.

Warning!

In the case of an accident, liquid electrolyte may escape the mirror housing if the mirror glass breaks.

Electrolyte has an irritating effect. Do not allow the liquid to come into contact with eyes, skin, clothing, or respiratory system. In case it does, immediately flush affected area with water, and seek medical help if necessary.



Electrolyte drops coming into contact with the vehicle paint finish can only be completely removed while in their liquid state and by applying plenty of water.

Interior rear view mirror

- ▶ Manually adjust the interior rear view mirror.

For more information, see “Rear view mirrors” (▷ page 172).

Exterior rear view mirrors**Warning!**

Exercise care when using the passenger-side exterior rear view mirror. The mirror surface is convex (outwardly curved surface for a wider field of view). Objects in mirror are closer than they appear. Check your interior rear view mirror or glance over your shoulder before changing lanes.

Getting started

Adjusting

The buttons are located above the exterior lamp switch.

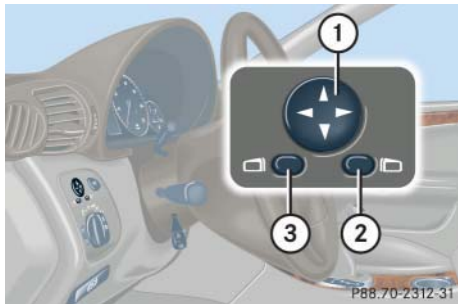

- ① Adjustment button
 - ② Passenger-side exterior rear view mirror button
 - ③ Driver's side exterior rear view mirror button
- ▶ Switch on ignition (▷ page 33).

- ▶ Press button ③ for the driver's side exterior rear view mirror or button ② for passenger-side exterior rear view mirror.
- ▶ Push adjustment button ① up, down, left, or right according to the desired setting.



If an exterior rear view mirror was forcibly pushed forward (hit from the rear) or forcibly pushed rearward (hit from the front), reposition it by applying firm pressure until it snaps into place. The mirror housing is now properly positioned and you can adjust the mirror normally.



The memory function* (▷ page 114) lets you store the setting for the exterior rear view mirrors together with the settings for the steering wheel and seat position.



At low ambient temperatures, the exterior rear view mirrors will be heated automatically.

For more information, see "Rear view mirrors" (▷ page 172).

▼ **Driving**

Warning!



Do not lay any objects in the driver's footwell. Be careful that floor mats or carpets in the driver's footwell have sufficient clearance for the pedals.

During sudden driving or braking maneuvers the objects could get caught between the pedals. You could then no longer brake or accelerate.

Fastening the seat belt

Warning!



Always fasten your seat belt before driving off. Always make sure your passengers are properly restrained, even those sitting in the rear and pregnant women.

Failure to wear and properly fasten and position your seat belt greatly increases your risk of injuries and their likely severity in an accident. You and your passengers should always wear seat belts.

If you are ever in an accident, your injuries can be considerably more severe without your seat belt properly buckled. Without your seat belt buckled, you are much more likely to hit the interior of the vehicle or be ejected from it. You can be seriously injured or killed.

In the same crash, the possibility of injury or death is lessened if you are wearing your seat belt. The air bags can only provide the protection they were designed to afford if the occupants are using their seat belts (> page 64).

Warning!



According to accident statistics, children are safer when properly restrained in the rear seating positions than in the front seating position. Thus, we strongly recommend that children be placed in the rear seats. Regardless of seating position, children 12 years old and under must be seated and properly secured in an appropriate infant or toddler restraint, or booster seat recommended for the size and weight of the child. For additional information, see "Children in the vehicle" (> page 68).

A child's risk of serious or fatal injuries is significantly increased if the child restraints are not properly secured in the vehicle and/or the child is not properly secured in the child restraint.

Getting started

Driving

Warning!



Never let more people ride in the vehicle than there are seat belts available. Be sure everyone riding in the vehicle is correctly restrained with a separate seat belt. Never use a seat belt for more than one person at a time.

Warning!



Never ride in a moving vehicle with the seat backrest in an excessively reclined position as this can be dangerous. You could slide under the seat belt in a collision. If you slide under it, the belt would apply force at the abdomen or neck. That could cause serious or even fatal injuries. The seat backrest and seat belt provide the best restraint when the wearer is in a nearly upright position and the belt is properly positioned on the body.

Warning!



Read and observe the additional warning notices printed in the “Safety and Security” section (▷ page 62) and (▷ page 64).

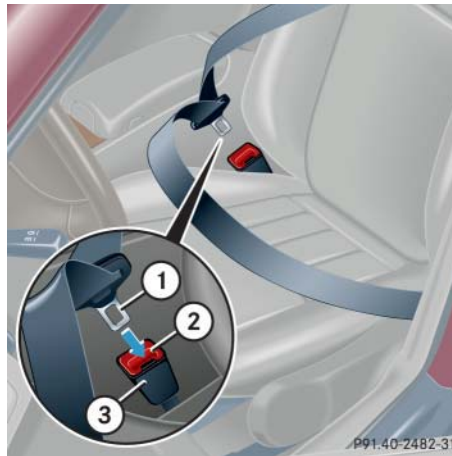

- ① Latch plate
- ② Release button
- ③ Buckle

- ▶ With a smooth motion, pull the belt from the belt outlet.
- ▶ Place the shoulder portion of the belt across the top of your shoulder and the lap portion across your hips.
- ▶ Push latch plate ① into buckle ③ until it clicks.
- ▶ If necessary, tighten the lap portion to a snug fit by pulling shoulder portion up.

Belt outlet height adjustment

Adjust seat belt so that shoulder portion is located as close as possible to the middle of your shoulder (it should not touch the neck or pass under the arm).

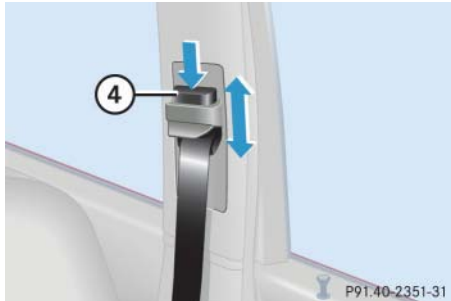

Belt outlet, front seats

- ④ Release button

Raising

- ▶ Slide belt outlet upward.

Lowering

- ▶ Press button ④ and slide belt outlet downward.

Proper use of seat belts

- Do not twist the belt when fastening.
- Adjust seat belt so that the shoulder portion is located as close as possible to the middle of the shoulder (it should not touch the neck). Never pass the shoulder portion of the belt under your arm. For this purpose, you can adjust the height of the belt outlet.
- Position the lap belt as low as possible on your hips (over hip joint) and not across the abdomen.
- Place the seat backrest in a nearly upright position.
- Never use a seat belt for more than one person at a time.
- Do not fasten a seat belt around a person and another object at the same time. When using a seat belt to secure infant or toddler restraints or children in booster seats, always follow the child seat manufacturer's instructions.

- Check your seat belt periodically during travel to make sure that it is properly positioned.
- Make sure that the seat belt is always fitted snugly. Take special care of this when wearing loose clothing.

Warning!



Do not pass belts over sharp edges. They could tear.

Do not allow the belt to get caught in the door or in the seat adjustment mechanism. This could damage the belt.

Never attempt to make modifications to seat belts. This could impair the effectiveness of the belts.

Do not bleach or dye seat belts as this may severely weaken them. In a crash, they may not be able to provide adequate protection.

Damaged seat belts or belts that were highly stressed in an accident must be replaced. Contact an authorized Mercedes-Benz Center.

Getting started

Driving

Starting the engine

Warning!



Inhalation of exhaust gas is hazardous to your health. All exhaust gas contains carbon monoxide, and inhaling it can cause unconsciousness and lead to death.

Do not run the engine in confined areas (such as garage) which are not properly ventilated. If you think that exhaust gas fumes are entering the vehicle while driving, have the cause determined and corrected immediately. If you must drive under these conditions, drive only with at least one window fully open.

Manual transmission

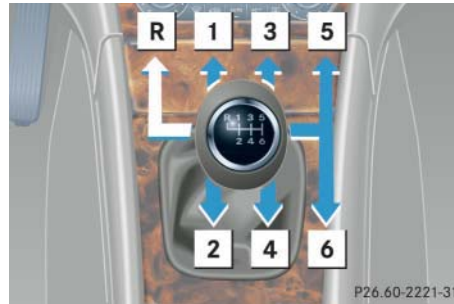

Gearshift pattern for manual transmission

For more information, see “Manual transmission” (▷ page 162).

Starting

- ▶ Depress brake pedal.
 - ▶ Make sure the gearshift lever is in neutral position (no gear selected).
 - ▶ Fully depress clutch pedal.
- Otherwise the engine cannot be started due to the integrated safety interlock.
- ▶ Do not depress the accelerator.
 - ▶ Turn the SmartKey in the starter switch to position **3** and hold until the engine starts (▷ page 33).

For information on turning off the engine, see “Turning off engine” (▷ page 56).

Automatic transmission***Gearshift pattern for automatic transmission**

- P** Park position with gear selector lever lock
- R** Reverse gear
- N** Neutral
- D** Drive position

For more information, see “Automatic transmission*” (▷ page 164).

Starting

- ▶ Make sure the gear selector lever is set to **P**.
- ▶ Do not depress the accelerator.
- ▶ Turn the SmartKey in the starter switch to position **3** and hold until the engine starts (▷ page 33).



You can also use the “touch-start” function. Turn the SmartKey in the starter switch to position **3** and release it again immediately. The engine then starts automatically.

- ▶ Depress the brake pedal.

The gear selector lever lock is released.

For information on turning off the engine, see “Turning off engine” (▷ page 56).

Starting difficulties

If the engine does not start as described, carry out the following steps:

- ▶ Turn the SmartKey in the starter switch to position **0** and repeat starting procedure (▷ page 46).
Remember that extended starting attempts can drain the battery.
- ▶ Get a jump start (▷ page 407).

If the engine does not start after several starting attempts, there could be a malfunction in the engine electronics or in the fuel supply system.

- ▶ Notify an authorized Mercedes-Benz Center.

Getting started

Driving

Parking brake

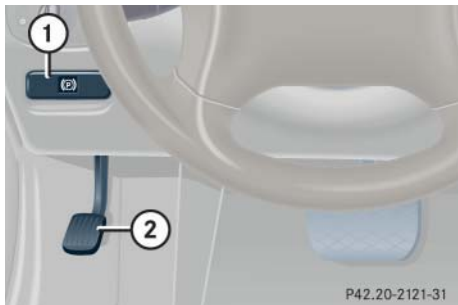

- ① Release handle
- ② Parking brake

Warning!



When leaving the vehicle, always remove the SmartKey from the starter switch, take it with you, and lock the vehicle. Do not leave children unattended in the vehicle, or with access to an unlocked vehicle. Children could release the parking brake, which could result in an accident and/or serious injury.

- ▶ Release parking brake by pulling on handle ①.

The warning lamp **BRAKE** (USA only) or **(P)** (Canada only) in the instrument cluster goes out.

Driving

- ▶ Depress the brake pedal.
- ▶ Move gear selector lever to position **D** or **R** (manual transmission: first or reverse gear).



Vehicles with automatic transmission: Wait for the gear selection process to complete before setting the vehicle in motion.

- ▶ Release the brake pedal.
- ▶ Carefully depress the accelerator.

Once the vehicle is in motion, the automatic central locking system engages and the locking knobs drop down.



You can open a locked door from the inside. Open door only when conditions are safe to do so.

You can deactivate the automatic locking using the control system (> page 153).



Simultaneously depressing the accelerator pedal and applying the brake reduces engine performance and causes premature brake and drivetrain wear.



If you hear a warning signal when driving off, you have forgotten to release the parking brake.

Release the parking brake.

After a cold start, the automatic transmission shifts at a higher engine revolution. This allows the catalytic converter to reach its operating temperature earlier.

Warning!



On slippery road surfaces, never downshift in order to obtain braking action. This could result in drive wheel slip and reduced vehicle control. Your vehicle's ABS will not prevent this type of loss of control.



Vehicles with automatic transmission: Place the gear selector lever in position **P** or **R** only when the vehicle is stopped in order to avoid damaging the transmission.



Do not run cold engine at high engine speeds. Running a cold engine at high engine speeds may shorten the service life of the engine.

Warning!



Vehicles with automatic transmission: It is dangerous to shift the gear selector lever out of **P** or **N** if the engine speed is higher than idle speed. If your foot is not firmly on the brake pedal, the vehicle could accelerate quickly forward or in reverse. You could lose control of the vehicle and hit someone or something. Only shift into gear when the engine is idling normally and when your right foot is firmly on the brake pedal.

For more information on driving, see “Driving instructions” (▷ page 283).

Getting started

Driving

Switching on headlamps

For more information on headlamps, see “Lighting” (▷ page 117).

Low beam headlamps

The exterior lamp switch is located on the dashboard to the left of the steering wheel.



Exterior lamp switch

- ① Off
- ② Low beam headlamps on

Getting started

Driving

- ▶ Turn exterior lamp switch to position .

The low beam headlamp indicator lamp  in the instrument cluster comes on (▷ page 24).

High beam

The combination switch is located on the left of the steering column.



Combination switch

- ① High beam
- ② High beam flasher

- ▶ Push combination switch in direction of arrow ①.

The high beam headlamp indicator lamp  in the instrument cluster comes on (▷ page 24).

Turn signals



The combination switch is located on the left of the steering column.



Combination switch

- ① Turn signals, right
- ② Turn signals, left

- ▶ Press combination switch in direction of arrow ① or ②.

The corresponding turn signal indicator lamp  or  in the instrument cluster flashes (▷ page 24).

The combination switch resets automatically after major steering wheel movements.

i

To signal minor directional changes such as changing lanes, press combination switch only to point of resistance and release. The corresponding turn signals will flash three times.

Windshield wipers

The combination switch is located on the left of the steering column.

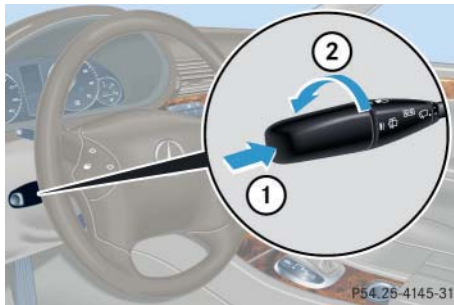

Combination switch

- ① Single wipe
 - ② Switching on windshield wipers
- Switch on ignition (► page 33).

Switching on windshield wipers

- Turn the combination switch to the desired position depending on the intensity of the rain.

- 0 Windshield wipers off
- I Intermittent wiping
- II Normal wiper speed
- III Fast wiper speed



Vehicles without rain sensor:
When the vehicle is standing still, the wiper speed returns to next lower setting.

Vehicles with rain sensor*:
Intermittent wiping interval is dependent on wetness of windshield. After the initial wipe, pauses between wipes are automatically controlled by the rain sensor.



Vehicles with rain sensor*:
Do not leave windshield wipers in intermittent setting when the vehicle is taken to an automatic car wash or during windshield cleaning. Wipers will operate in the presence of water sprayed on the windshield, and wipers may be damaged as a result.

The switch should not be left in intermittent setting as the wipers will wipe the windshield once every time the engine is started. Dust that accumulates on the windshield might scratch the glass and/or damage the wiper blades when wiping occurs on a dry windshield.

Getting started

Driving

Intermittent wiping

- ▶ Set the wiper switch to position I.



Intermittent wiping is interrupted when the vehicle is at a standstill and a front door is opened.

Single wipe

- ▶ Press combination switch briefly in direction of arrow ①.

The windshield wipers wipe one time without washer fluid.

Wiping with windshield washer fluid

- ▶ Push combination switch in direction of arrow ① past the resistance point.

The windshield wipers operate with washer fluid.

For information on filling up the washer reservoir, see “Windshield washer system and headlamp cleaning system*” (▷ page 303).



If anything blocks the windshield wipers (leaves, snow, etc.), switch them off immediately.

- For safety reasons, withdraw SmartKey from starter switch before attempting to remove any blockage.
- Remove blockage.
- Turn the windshield wipers on again.

If windshield wipers fail to function at all in switch position I,

- set the combination switch to the next highest wiper speed
- have the windshield wipers checked at the nearest authorized Mercedes-Benz Center

Problems while driving

The engine runs erratically and misfires

- An ignition cable may be damaged.
- The engine electronics may not be operating properly.
- Unburned gasoline may have entered the catalytic converter and damaged it.
- ▶ Give very little gas.
- ▶ Have the problem repaired by an authorized Mercedes-Benz Center as soon as possible.

The coolant temperature is above 248°F (120°C)

The coolant is too hot and is no longer cooling the engine.

- ▶ Stop the vehicle as soon as possible and turn off the engine. Allow engine and coolant to cool.
- ▶ Check the coolant level and add coolant if necessary (▷ page 301).

In case of accident

If the vehicle is leaking gasoline:

- ▶ Do not start the engine under any circumstances.
- ▶ Notify local fire and/or police authorities.

If the extent of the damage cannot be determined:

- ▶ Notify an authorized Mercedes-Benz Center.

If no damage can be determined on the

- major assemblies
- fuel system
- engine mount:
- ▶ Start the engine in the usual manner.

Getting started

Parking and locking

You have now completed your first drive. You have properly stopped and parked your vehicle. End your drive as follows.

Warning!



Vehicles with manual transmission: Wait until the vehicle is stationary before removing the SmartKey from the starter switch. The vehicle cannot be steered when the SmartKey is removed.

Warning!



With the engine not running, there is no power assistance for the brake and steering system. In this case, it is important to keep in mind that a considerably higher degree of effort is necessary to brake and steer the vehicle.

Warning!



Do not park this vehicle in areas where combustible materials such as grass, hay or leaves can come into contact with the hot exhaust system, as these materials could be ignited and cause a vehicle fire.

To reduce the risk of personal injury as a result of vehicle movement, before turning off the engine and leaving the vehicle always:

- Keep right foot on brake pedal.
- Firmly depress parking brake pedal.
- Move the gear selector lever to position **P** (manual transmission: first or reverse gear).
- Slowly release brake pedal.
- When parked on an incline, turn front wheels towards the road curb.
- Turn the SmartKey in the starter switch to position **0** and remove the SmartKey from the starter switch.
- Take the SmartKey with you and lock the vehicle when leaving.

Parking brake

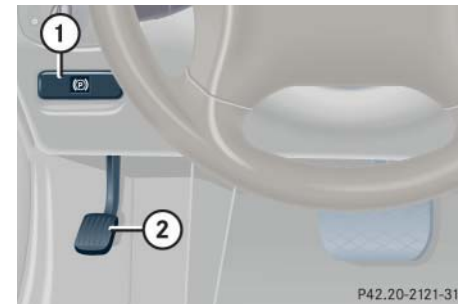

- ① Release handle
- ② Parking brake

- Step firmly on parking brake pedal ②.

When the engine is running, the warning lamp **BRAKE** (USA only) or  (Canada only) in the instrument cluster will be illuminated.

Warning!



When leaving the vehicle, always remove the SmartKey from the starter switch, take it with you, and lock the vehicle. Do not leave children unattended in the vehicle, or with access to an unlocked vehicle. Children could release the parking brake and/or move the gear selector lever from position **P**, either of which could result in an accident and/or serious injury.

Warning!



Getting out of your vehicle with the gear selector lever not fully engaged in position **P** is dangerous. Also, when parked on an incline, position **P** alone may not prevent your vehicle from moving, possibly hitting people or objects.

Always set the parking brake in addition to shifting to position **P** (manual transmission: first or reverse gear).

When parked on an incline, turn front wheel towards the road curb.

Switching off headlamps

- ▶ Turn the exterior lamp switch to **0** (▷ page 49).

For more information on headlamps, see “Lighting” (▷ page 117).

Getting started

Parking and locking

Turning off engine

- ▶ Place the gear selector lever in position **P** (manual transmission: first or reverse gear).



Always set the parking brake in addition to shifting to position **P** (manual transmission: first or reverse gear).

On slopes, turn the front wheels towards the road curb.

- ▶ Turn the SmartKey in the starter switch to position **O** and remove the SmartKey from the starter switch. The immobilizer is activated.



Vehicles with automatic transmission: The SmartKey can only be removed from the starter switch with the gear selector lever in position **P**.

- ▶ Press the seat belt release button (▷ page 44).

Allow the retractor to completely rewind the seat belt by guiding the latch plate.



With the SmartKey removed and the driver's door open, a warning sounds if the vehicle's exterior lamps are not switched off.

Warning!



To prevent possible personal injury, always keep hands and fingers away from the door openings when closing the doors. Be especially careful when small children are around.

Before closing doors, make sure there is no possibility of someone getting caught in a door during closing.

- ▶ After exiting the vehicle, press the lock button  on the SmartKey (▷ page 32).

All turn signal lamps flash three times. The locking knobs in the doors move down. The anti-theft alarm system* is armed.

Warning!



When leaving the vehicle, always remove the SmartKey from the starter switch, take it with you, and lock the vehicle. Do not leave children unattended in the vehicle, or with access to an unlocked vehicle. Unsupervised use of vehicle equipment may cause an accident and/or serious personal injury.

For more information, see “Locking and unlocking” (▷ page 94).

Safety and Security

Occupant safety

Panic alarm*

Driving safety systems

Anti-theft systems

Safety and Security

Occupant safety

In this section you will learn the most important facts about the restraint system components of the vehicle.

- Seat belts (▷ page 64)
- Child restraints (▷ page 77)
- Lower anchors and tethers for children (LATCH) (▷ page 78)

Supplemental Restraint System (SRS) with

- Air bags (▷ page 59)
- Air bag control unit (with crash sensors)
- Emergency tensioning device (ETD) for seat belts (▷ page 67)

Air bag system components with

-  indicator lamp (▷ page 75)
- Front passenger seat with Occupant Classification System (OCS) (▷ page 71)

As independent systems, their protective functions work in conjunction with each other.



For information on infants and children traveling with you in the vehicle and restraint systems for infants and children, see “Children in the vehicle” (▷ page 68).

The SRS system conducts a self-test when the ignition is switched on and in regular intervals while the engine is running. This facilitates early detection of malfunctions. The **SRS** indicator lamp in the instrument cluster comes on when the ignition is switched on and goes out no later than a few seconds after the engine has been started.

The SRS components are in operational readiness if the **SRS** indicator lamp is not lit when the engine is running.

A malfunction in the system has been detected if the **SRS** indicator lamp:

- fails to go out after approximately four seconds after the engine was started
- does not come on at all.
- comes on after the engine was started or while driving.

Safety and Security

Occupant safety

Warning!



In the event that the **SRS** indicator lamp comes on during driving or does not come on at all, the SRS self-check has detected a malfunction. For your safety, we strongly recommend that you visit an authorized Mercedes-Benz Center immediately to have the system checked; otherwise the SRS may not deploy when needed in an accident, which could result in serious or fatal injury, or it might deploy unexpectedly and unnecessarily which could also result in injury.

In addition, improper work on the SRS creates a risk of rendering the SRS inoperative or causing unintended air bag deployment. Work on the SRS must therefore only be performed by qualified technicians. Contact an authorized Mercedes-Benz Center.

If it is necessary to modify an air bag system to accommodate a person with disabilities, contact your local authorized Mercedes-Benz Center or call our Customer Assistance Center at 1-800-FOR-MERcedes (1-800-367-6372) for details.

Air bags

Warning!



Air bags are designed to reduce the potential of injury and fatality in certain frontal impacts (front air bags) or side impacts (side impact air bags and head protection window curtain air bags). However, no system available today can totally eliminate injuries and fatalities.

The deployment of the air bags temporarily releases a small amount of dust from the air bags. This dust, however, is neither injurious to your health, nor does it indicate a fire in the vehicle. The dust might cause some temporary breathing difficulty for people with asthma or other breathing trouble. To avoid this, you may wish to get out of the vehicle as soon as it is safe to do so. If you have any breathing difficulty but cannot get out of the vehicle after the air bag inflates, then get fresh air by opening a window or door.

Safety and Security

Occupant safety

Warning!



To reduce the risk of injury when the front air bags inflate, it is very important for the driver and front passenger to always be in a properly seated position and to wear their respective seat belts.

For maximum protection in the event of a collision always be in normal seated position with your back against the backrest. Fasten your seat belt and make sure that it is properly positioned on your body.

Since the air bag inflates with considerable speed and force, a proper seating and hands on steering wheel position will help to keep you at a safe distance from the air bag. Occupants who are unbelted, out of position or too close to the air bag can be seriously injured by an air bag as it inflates with great force in the blink of an eye:

- Sit properly belted in a nearly upright position with your back against the seat backrest.

- Adjust the driver seat as far as possible rearward, still permitting proper operation of vehicle controls. The distance from the center of the driver's breastbone to the center of the air bag cover on the steering wheel must be at least 10 in (25 cm) or more. You should be able to accomplish this by a combination of adjustments to the seat and steering wheel. If you have any problems, please see an authorized Mercedes-Benz Center.
- Do not lean your head or chest close to the steering wheel or dashboard.
- Keep hands on the outside of steering wheel rim. Placing hands and arms inside the rim can increase the risk and potential severity of hand/arm injury when driver front air bag inflates.
- Adjust the front passenger seat as far as possible rearward from the dashboard when the seat is occupied.

- Occupants, especially children, should never place their bodies or lean their heads in the area of the door where the side impact air bag inflates. This could result in serious injuries or death should the air bag be triggered. Always sit nearly upright, properly use the seat belts and use an appropriately sized infant or toddler restraint or booster seat recommended for the size and weight of the child.

Failure to follow these instructions can result in severe injuries to you or other occupants.

If you sell your vehicle, it is important that you make the buyer aware of this safety information. Be sure to give the buyer this Operator's Manual.

Safety and Security

Occupant safety

Warning!



Accident research shows that the safest place for children in an automobile is in the rear seat.

It should be noted that with respect to both front and rear side impact air bags there is a possibility for a side impact air bag related injury if occupants, especially children, are not properly seated or restrained when next to a side impact air bag which needs to deploy rapidly in a side impact in order to do its job.

To help avoid the possibility of injury, please follow these guidelines:

- (1) Occupants, especially children, should never place their bodies or lean their heads in the area of the door where the side impact air bag inflates. This could result in serious injuries or death should the side impact air bag be deployed.

- (2) Always sit nearly upright, properly use the seat belts and for children 12 years old and under, use an appropriately sized infant or toddler restraint or booster seat recommended for the size and weight of the child.

- (3) Always wear seat belts properly.

If you believe that, even with the use of these guidelines, it would be safer for your rear seat occupants to have the rear mounted side impact air bags deactivated, then deactivation can be accomplished upon your written request to do so at an authorized Mercedes-Benz Center at an additional cost.

Please contact your local authorized Mercedes-Benz Center or call our Customer Assistance Center at 1-800-FOR-MERCEdes (1-800-367-6372) for details.



Air bags are designed to deploy only in certain frontal impacts (front air bags) and in side impacts (side impact and head protection window curtain air bags) which exceed preset thresholds. Only during these events will they provide their supplemental protection.

The driver and passengers should always wear their seat belts. Otherwise it is not possible for air bags to provide their supplemental protection.

Safety and Security

Occupant safety

In case of other types of impacts and impacts below air bag deployment thresholds, air bags will not deploy. The driver and passengers will then be protected to the extent possible by a properly fastened seat belt. A properly fastened seat belt is also needed to provide the best possible protection in a rollover.

We caution you not to rely on the presence of the air bags in order to avoid wearing your seat belt.

It is important to your safety and that of your passengers that you replace deployed air bags and repair any malfunctioning air bags to make sure that the vehicle will continue to provide supplemental crash protection for occupants.

Safety guidelines for the seat belt, emergency tensioning device and air bag

Warning!



- Damaged seat belts or belts that were highly stressed in an accident must be replaced and their anchoring points must also be checked. Only use belts installed or supplied by an authorized Mercedes-Benz Center.
 - Air bags and emergency tensioning devices (ETDs) are designed to function on a one-time-only basis. An air bag or ETD that is deployed must be replaced.
 - Do not pass belts over sharp edges. They could tear.
 - Do not make any modification that could change the effectiveness of the belts.
 - Do not bleach or dye seat belts as this may severely weaken them. In a crash they may not be able to provide adequate protection.
- No modifications of any kind may be made to any components or wiring of the SRS. This includes changing or removing any component or part of the SRS, the installation of additional trim material, badges, etc. over the steering wheel hub, passenger front air bag cover, door trim panels, or door frame trims, and installation of additional electrical/electronic equipment on or near SRS components and wiring. Keep area between air bags and occupants free from objects (e.g. packages, purses, umbrellas, etc.).
 - Do not hang items such as coat hangers from the coat hooks or handles over the door. These items may turn into projectiles and cause head and other injuries when curtain air bag is deployed.
 - Never place your feet on the instrument panel, dashboard, or on the seat. Always keep both feet on the floor in front of the seat.
 - Air bag system components will be hot after an air bag has inflated. Do not touch.

- In addition, improper repair work on the SRS creates a risk of rendering the SRS inoperative or causing unintended air bag deployment. Work on the SRS must therefore only be performed by qualified technicians. Contact an authorized Mercedes-Benz Center.
- For your protection and the protection of others, when scrapping the air bag unit or emergency tensioning device, our safety instructions must be followed. These instructions are available from your authorized Mercedes-Benz Center.
- Given the considerable deployment speed, required inflation volume, and the textile structure of the air bags, there is the possibility of abrasions or other more significant injuries resulting from air bag deployment.

When you sell your vehicle we strongly urge you to give notice to the subsequent owner that it is equipped with an SRS by alerting them to the applicable section in the Operator's Manual.

Front air bags



- ① Driver's air bag
- ② Passenger front air bag

Driver and front passenger air bags are deployed:

- in the event of certain frontal impacts
- if impact exceeds a preset deployment threshold
- independently of the side impact air bags

i

The front air bags in this vehicle have been designed to inflate in two stages. This allows the air bag to have different rates of inflation that are based on the rate of relevant vehicle deceleration as assessed by the air bag control unit.

On the front passenger side, the front air bag deployment is additionally influenced by the passenger's weight category as identified by the Occupant Classification System (OCS) (▷ page 71).

The lighter the front passenger side occupant, the higher the vehicle deceleration rate required for the second stage inflation of the air bag.

Safety and Security

Occupant safety

The air bags will not deploy in impacts which do not exceed the system's deployment thresholds. You will then be protected by the fastened seat belts.

The passenger front air bag will only be deployed if:

- the system, based on OCS weight sensor readings, senses that the front passenger seat is occupied
- the  indicator lamp in the center console is not lit (▷ page 75)
- the impact exceeds a preset deployment threshold

Side impact air bags, window curtain air bags

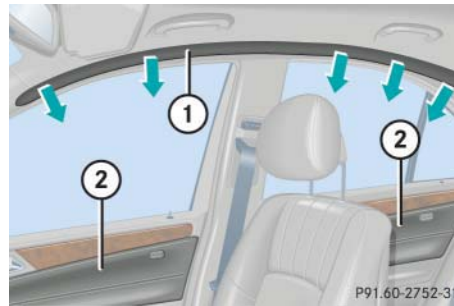

- ① Window curtain air bag
- ② Side impact air bags

The side impact air bags and window curtain air bags are deployed:

- on the impacted side of the vehicle
- in impacts exceeding a preset deployment threshold
- independently of the front air bags

The side impact air bags and window curtain air bags are not deployed in impacts which do not exceed the system's deployment threshold.

Seat belts

When the engine is started, the seat belt telltale  illuminates to remind you and your passengers to fasten your seat belts.

If the driver's seat belt is not fastened before the engine is started, the seat belt telltale  illuminates and a warning chime sounds for approximately six seconds when the engine is started.

The use of seat belts and infant and child restraint systems is required by law in all 50 states, the District of Columbia, the U.S. territories and all Canadian provinces.

Even where this is not the case, all vehicle occupants should have their seat belts fastened whenever the vehicle is in motion.

For more information, see “Fastening the seat belt” (▷ page 43).



For information on infants and children traveling with you in the vehicle and restraint systems for infants and children, see “Children in the vehicle” (▷ page 68).

Warning!



Always fasten your seat belt before driving off. Always make sure all of your passengers are properly restrained, even those sitting in the rear and pregnant women.

Failure to wear and properly fasten and position your seat belt greatly increases your risk of injuries and their likely severity in an accident. You and your passengers should always wear seat belts.

If you are ever in an accident, your injuries can be considerably more severe without your seat belt properly buckled. Without your seat belt buckled, you are much more likely to hit the interior of the vehicle or be ejected from it. You can be seriously injured or killed.

In the same crash, the possibility of injury or death is lessened if you are properly wearing your seat belt. Air bags can only protect as they are designed if the occupants are properly wearing their seat belts.

Safety and Security

Occupant safety

Warning!



Never ride in a moving vehicle with the seat backrest in an excessively reclined position as this can be dangerous. You could slide under the seat belt in a collision. If you slide under it, the belt would apply force at the abdomen or neck. That could cause serious or even fatal injuries. The seat backrest and seat belt provide the best restraint when the wearer is in a nearly upright position and the belt is properly positioned on the body.

Warning!



Never let more people ride in the vehicle than there are seat belts available. Be sure everyone riding in the vehicle is correctly restrained with a separate seat belt. Never use a seat belt for more than one person at a time.

Safety and Security

Occupant safety

Warning!



Damaged seat belts or belts that were highly stressed in an accident must be replaced and their anchoring points must also be checked.

Only use seat belts which have been approved by Mercedes-Benz.

Do not make any modifications to the seat belts. This can lead to unintended activation of the ETDs or to failure.

Do not bleach or dye seat belts as this may severely weaken them. In a crash they may not be able to provide adequate protection.

Have all work carried out only by qualified technicians. Contact an authorized Mercedes-Benz Center.

Warning!



USE SEAT BELTS PROPERLY

- Seat belts can only work when used properly. Never wear seat belts in any other way than as described in this section, as that could result in serious injuries in case of an accident.
- Each occupant should wear their seat belt at all times, because seat belts help reduce the likelihood of and potential severity of injuries in accidents, including rollovers. The integrated restraint system includes SRS (driver air bag, passenger front air bag, side impact air bags, head protection window curtain air bags for side windows), ETD (seat belt emergency tensioning device), and front seat knee bolsters.

The system is designed to enhance the protection offered to properly belted occupants in certain frontal (front air bags and ETD) and side (side impact and window curtain air bags and ETD) impacts which exceed preset deployment thresholds.

- Never wear the shoulder belt under your arm, against your neck or off your shoulder. In a frontal crash, your body would move too far forward. That would increase the chance of head and neck injuries. The belt would also apply too much force to the ribs or abdomen, which could severely injure internal organs such as your liver or spleen.

Safety and Security

Occupant safety

- Never wear belts over rigid or breakable objects in or on your clothing, such as eyeglasses, pens, keys, etc., as these might cause injuries.
- Position the lap belt as low as possible on your hips and not across the abdomen. If the belt is positioned across your abdomen, it could cause serious injuries in a crash.
- Never use a seat belt for more than one person at a time. Do not fasten a seat belt around a person and another person or other objects.
- Belts should not be worn twisted. In a crash, you wouldn't have the full width of the belt to distribute impact forces. The twisted belt against your body could cause injuries.

- Pregnant women should also use a lap-shoulder belt. The lap belt portion should be positioned as low as possible on the hips to avoid any possible pressure on the abdomen.
- Never place your feet on the instrument panel, dashboard, or on the seat. Always keep both feet on the floor in front of the seat.
- When using a seat belt to secure infant or toddler restraints or children in booster seats, always follow the child seat manufacturer's instructions.

Emergency tensioning device (ETD), seat belt force limiter

The seat belts for the front and rear outer seats are equipped with emergency tensioning devices and belt force limiters.

The ETD is designed to activate in the following cases:

- in frontal or rear-end impacts exceeding a preset severity level.
- if the restraint systems are operational and functioning correctly, see **SRS** indicator lamp (▷ page 58).



The ETDs for the front seats will only activate if the front seat belts are fastened (latch plate properly inserted into buckle).

The ETDs for the rear outer seats will activate with or without the respective seat belts fastened.

Safety and Security

Occupant safety

In an impact, emergency tensioning devices remove slack from the belts. Belt force limiters reduce the force exerted by the seat belts on occupants during a crash.

Warning!



An emergency tensioning device (ETD) that was activated must be replaced.

When disposing of the emergency tensioning device, our safety instructions must be followed. These are available at your authorized Mercedes-Benz Center.

Children in the vehicle

If an infant or child is traveling with you in the vehicle:

- Secure the child using an infant or child restraint appropriate to the age and size of the child.
- Make sure that the infant or child is properly secured at all times while the vehicle is in motion.

Infant and child restraint seats and information on choosing an appropriate restraint system can be obtained from any Mercedes-Benz Center.

Infant and child restraint systems

We recommend all infants and children be properly restrained at all times while the vehicle is in motion.

All lap-shoulder belts except the driver's seat belt have special seat belt retractors for secure fastening of child restraints.

To fasten a child restraint, follow child restraint instructions for mounting. Then pull the shoulder belt out completely and let it retract. During seat belt retraction, a ratcheting sound can be heard to indicate that the special seat belt retractor is activated. The belt is now locked. Push down on child restraint to take up any slack.

To deactivate, release seat belt buckle and let seat belt retract completely. The seat belt can again be used in the usual manner.

Safety and Security

Occupant safety



Information on child seats with mounting fittings for tether anchorages (▷ page 77).

For information on LATCH-type child seat mounts (▷ page 78).



The use of infant or child restraints is required by law in all 50 states, the District of Columbia, the U.S. territories and all Canadian provinces.

Infants and small children should be seated in an appropriate infant or child restraint system, properly secured by a lap/shoulder belt or, if so equipped, a top tether anchorage point and a child restraint lower anchorage system that complies with U.S. Federal Motor Vehicle Safety Standards 213 and 225 and Canadian Motor Vehicle Safety Standards 213 and 210.2.

Warning!



Never release the seat belt buckle while the vehicle is in motion, since the special seat belt retractor will be deactivated.



A statement by the child restraint manufacturer of compliance with this standard can be found on the instruction label on the restraint and in the instruction manual provided with the restraint.

When using any infant, or toddler restraint, or booster seat, be sure to carefully read and follow all manufacturer's instructions for installation and use.

Please read and observe warning labels affixed to the inside of the vehicle and to infant or child restraints.

Warning!



According to accident statistics, children are safer when properly restrained in the rear seating positions than in the front seating position. Thus, we strongly recommend that children be placed in the rear seats whenever possible. Regardless of seating position, children 12 years old and under must be seated and properly secured in an appropriate infant or child restraint recommended for the size and weight of the child.

The infant or child restraint must be properly secured with the vehicle's seat belt, the seat belt and top tether strap, or lower anchors and top tether strap, fully in accordance with the child seat manufacturer's instructions.







Safety and Security

Occupant safety



Children can be killed or seriously injured by an inflating air bag. Note the following important information when circumstances require you to place a child in the front passenger seat:

- Your vehicle is equipped with air bag technology designed to turn off the front passenger front air bag in your vehicle when the OCS senses the weight of a typical 12-month-old child or less along with the weight of a standard appropriate child restraint on the front passenger seat.
 - A child in a rear-facing child restraint on the front passenger seat will be seriously injured or even killed if the front passenger front air bag inflates in a collision which could occur under some circumstances, even with the air bag technology installed in your vehicle. The only means to completely eliminate this risk is to never place a child in a rear-facing child restraint in the front seat. We therefore strongly recommend that you always place a child in a rear-facing child restraint in the back seat.
- If you must install a rear-facing child restraint on the front passenger seat because circumstances require you to do so, make sure that the  indicator lamp is illuminated, indicating that the front passenger air bag is deactivated. Should the  indicator lamp not illuminate or go out while the restraint is installed, please check installation. Periodically check the  indicator lamp while driving to make sure the  indicator lamp is illuminated. If the  indicator lamp goes out or remains out, do not transport a child on the front passenger seat until the system has been repaired. A child in a rear-facing child restraint on the front passenger seat will be seriously injured or even killed if the front passenger front air bag inflates.
 - If you have to place a child in a forward-facing child restraint on the front passenger seat, move the seat as far back as possible, use the proper child restraint recommended for the age, size and weight of the child, and secure child restraint with the vehicle's seat belt according to the child seat manufacturer's instructions. For children larger than the typical 12-month-old child, the front passenger air bag may or may not be activated ([▷ page 73](#)).

Safety and Security

Occupant safety

Warning!



Infants and small children should never share a seat belt with another occupant. During an accident, they could be crushed between the occupant and seat belt.

A child's risk of serious or fatal injuries is significantly increased if the child restraints are not properly secured in the vehicle and/or the child is not properly secured in the child restraint.

Children too big for a toddler restraint must ride in seats using regular seat belts. Position shoulder belt across chest and shoulder, not face or neck. A booster seat may be necessary to achieve proper belt positioning for children from 41 lbs until they reach a height where a lap/shoulder belt fits properly without a booster.

When the child restraint is not in use, remove it from the vehicle or secure it with the seat belt to prevent the child restraint from becoming a projectile in the event of an accident.

Do not leave children unattended in the vehicle, even if the children are secured in a child restraint system. Unsupervised children in a child restraint system may use vehicle equipment and may cause an accident and/or serious personal injury.

Occupant Classification System

The Occupant Classification System (OCS) automatically turns the front passenger front air bag on or off based on the classified occupant weight category determined by weight sensor readings from the front passenger seat.



The system does not deactivate the front passenger side impact air bag, the window curtain air bag and the emergency tensioning device.

Occupants must sit properly belted in a nearly upright position with their back against the seat backrest and feet on the floor to be correctly classified. If the occupant's weight is transferred to another object in the vehicle (e.g. by leaning on armrests), the OCS may not be able to properly approximate the occupant's weight category.

Safety and Security

Occupant safety





If your seat, including your trim cover and cushion needs to be serviced in any way, take the vehicle to your authorized Mercedes-Benz Center.

Only seat accessories approved by Mercedes-Benz may be used.

Both driver and the front passenger should always use the  indicator lamp as an indication of whether or not the front passenger is properly positioned.

Warning!



If the  indicator lamp illuminates when an adult or someone larger than a small individual is in the front passenger seat, have the front passenger re-position himself or herself in the seat until the  indicator lamp goes out.

More information about air bag display messages (▷ page 354).



In the event of a collision, the air bag control unit will not allow front passenger front air bag deployment when the OCS classified the front passenger seat occupant as being up to or less than the weight of a typical 12-month-old child in a standard child restraint or if the front passenger seat is sensed as being empty.

When the OCS senses that the front passenger seat occupant is classified as being up to or less than the weight of a typical 12-month-old child in a standard child restraint, the  indicator lamp will illuminate when the engine is started and remain illuminated, indicating that the front passenger front air bag is deactivated.

When the OCS senses that the front passenger seat is classified as being empty, the  indicator lamp will illuminate when the engine is started and remain illuminated, indicating that the front passenger front air bag is deactivated.

Safety and Security

Occupant safety

When the OCS senses that the front passenger seat occupant is classified as being heavier than the weight of a typical 12-month-old child seated in a standard child restraint or as being a small individual (such as a young teenager or a small adult), the  indicator lamp will illuminate for approximately six seconds when the engine is started and then, depending on occupant weight sensor readings from the seat, remain illuminated or go out. With the  indicator lamp illuminated, the front passenger front air bag is deactivated. With the  indicator lamp out, the front passenger front air bag is activated.

When the OCS senses that the front passenger seat occupant is classified as an adult or someone larger than a small individual, the  indicator lamp will illuminate for approximately six seconds when the engine is started and then go out, indicating that the front passenger front air bag is activated.

If the  indicator lamp is illuminated, the front passenger front air bag is deactivated and will not be deployed.

If the  indicator lamp is not illuminated, the front passenger front air bag is activated and will be deployed:

- in the event of certain frontal impacts
- if impact exceeds a preset deployment threshold
- independently of the side impact air bags.

If the front passenger front air bag is deployed, the rate of inflation will be influenced by:

- the rate of relevant vehicle deceleration as assessed by the air bag control unit
- front passenger's weight category as identified by the Occupant Classification System (OCS).

Warning!



According to accident statistics, children are safer when properly restrained in the rear seating positions than in the front seating position. Thus, we strongly recommend that children be placed in the rear seats whenever possible. Regardless of seating position, children 12 years old and under must be seated and properly secured in an appropriate infant or child restraint recommended for the size and weight of the child.

The infant or child restraint must be properly secured with the vehicle's seat belt, the seat belt and top tether strap, or lower anchors and top tether strap, fully in accordance with the child seat manufacturer's instructions.







Safety and Security

Occupant safety



Children can be killed or seriously injured by an inflating air bag. Note the following important information when circumstances require you to place a child in the front passenger seat:

- Your vehicle is equipped with air bag technology designed to turn off the front passenger front air bag in your vehicle when the system senses the weight of a typical 12-month-old child or less along with the weight of a standard appropriate child restraint on the front passenger seat.
 - A child in a rear-facing child restraint on the front passenger seat will be seriously injured or even killed if the front passenger front air bag inflates in a collision which could occur under some circumstances, even with the air bag technology installed in your vehicle. The only means to completely eliminate this risk is to never place a child in a rear-facing child restraint in the front seat. We therefore strongly recommend that you always place a child in a rear-facing child restraint in the back seat.
- If you must install a rear-facing child restraint on the front passenger seat because circumstances require you to do so, make sure that the  indicator lamp is illuminated, indicating that the front passenger front air bag is deactivated. Should the  indicator lamp not illuminate or go out while the restraint is installed, please check installation. Periodically check the  indicator lamp while driving to make sure the  indicator lamp is illuminated. If the  indicator lamp goes out or remains out, do not transport a child on the front passenger seat until the system has been repaired. A child in a rear-facing child restraint on the front passenger seat will be seriously injured or even killed if the passenger front air bag inflates.
 - If you have to place a child in a forward-facing child restraint on the front passenger seat, move the seat as far back as possible, use the proper child restraint recommended for the age, size and weight of the child, and secure child restraint with the vehicle's seat belt according to the child seat manufacturer's instructions. For children larger than the typical 12-month-old child, the front passenger front air bag may or may not be activated (▷ page 73).

Safety and Security

Occupant safety



Deployment of the driver front air bag does not mean that the front passenger front air bag also should have deployed.

The Occupant Classification System (▷ page 71) may have determined:

- that the seat was empty or occupied by the weight up to or less than that of a typical 12-month-old child seated in a standard child restraint - both instances where the system suppresses deployment of the front passenger front air bag even though the impact met the criteria and was of sufficient severity to deploy the driver front air bag.

- that the seat was occupied by a small individual (such as a young teenager or a small adult) or a child weighing more than the weight of a typical 12-month-old child in a standard child restraint - instances where the system may suppress deployment of the front passenger front air bag even though the impact met the criteria and was of sufficient severity to deploy the driver front air bag.

The  indicator lamp is located in the center console.



- ① Front passenger front air bag off indicator lamp

The  indicator lamp will be illuminated, except with the SmartKey removed or in starter switch position 0.

Safety and Security

Occupant safety

Warning!





If the **SRS** indicator lamp and the  indicator lamp are lit at the same time, there is a malfunction in the Occupant Classification System. The front passenger front air bag will be deactivated in this case.

In order to ensure proper operation of the air bag system and OCS:

- Have the system checked as soon as possible by qualified technicians. Contact an authorized Mercedes-Benz Center.
- Sit properly belted in a nearly upright position with your back against the seat backrest.
- Do not lean on the armrests or lift yourself from the seat by using the handle over the door as this may cause the OCS to be unable to correctly approximate the occupant weight category.

- Only have the seat repaired or replaced by an authorized Mercedes-Benz Center.
- Read and observe all warnings in this chapter.

Self-test Occupant Classification System

After turning the SmartKey in the starter switch to position **1** or **2**, the  indicator lamp located in the center console illuminates. If an adult occupant is properly sitting on the front passenger seat and the system senses the occupant as being an adult, the  indicator lamp will illuminate and go out after approximately six seconds.

If the seat is not occupied and the system senses the front passenger seat as being empty, the  indicator lamp will illuminate and not go out.

Warning!



If the  indicator lamp should not illuminate, the system is not functioning. You must see an authorized Mercedes-Benz Center before seating any child on the front passenger seat.

More information can be found in the “Practical hints” section (▷ page 350).

Warning!



Never place anything between seat cushion and child seat (e.g. pillow), since it reduces the effectiveness of the Occupant Classification System. The bottom of the child seat must make full contact with the passenger seat cushion. An incorrectly mounted child seat could cause injuries to the child in case of an accident, instead of increasing protection for the child.

Follow the manufacturer’s instructions for installation of child seats.

Installation of infant and child restraint systems

This vehicle is equipped with tether anchorages for a top tether strap at each of the rear seating positions.

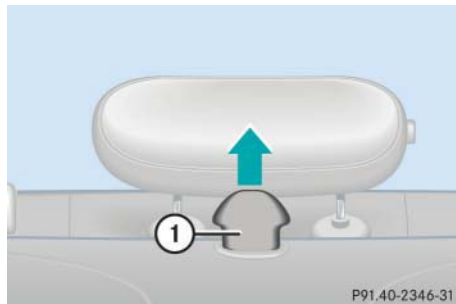

① Cover of top anchorage ring

- ▶ Make sure the rear backrest is locked in its upright position (▷ page 257).

Warning!



Always lock backrest in its upright position when rear seat bench is occupied by passengers, or the extended cargo area is not in use. Check for secure locking by pushing and pulling on the backrest.

- ▶ Remove cover ① from anchorage ring ③.
- ▶ Guide tether strap between head restraint and top of seat back.

Head restraint must be positioned such that the top tether strap can pass freely between the head restraint and top of seat back.

Make sure the tether strap is not twisted.

Safety and Security

Occupant safety



② Hook

③ Anchorage ring

- ▶ Securely fasten hook ②, which is part of the tether strap, to anchorage ring ③.

Once the top tether anchorage hook is attached, the child restraint itself can be secured. Tighten the top tether strap according to the child restraint manufacturer's instructions.



Safety and Security

Occupant safety



For safety, make sure the hook ② has attached to the ring ③ beyond the safety catch, as illustrated.

- ▶ Reinstall cover ① after removing the tether strap.

Child seat anchors – LATCH-type

This vehicle is equipped with two LATCH- (Lower Anchors and Tethers for Children) type anchors (at each of the outer rear seats) for the installation of a LATCH-type child seat with the matching mounting fittings.

To fold anchors out

The foldable LATCH-type anchors are located between the seat cushion and the backrest.

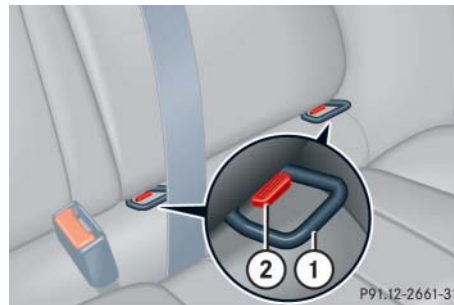

- ① Anchors
- ② Release button

- ▶ Grip inner side of anchors ① and fold forward until they audibly lock in place.
- ▶ Install child seat according to the manufacturer's instructions.



If a child seat is not installed, the LATCH-type anchors can be folded back between the seat cushion and the backrest (▷ page 79).



The child seat must be firmly attached in the right and left side anchors ①.

With a child seat installed in the left rear seat, the seat belt for the center seat occupied by a passenger must operate freely. Guide seat belt between its seat cushion mount and backrest mount along outside of right side child seat anchor.

Safety and Security

Occupant safety

To fold anchors back

- ▶ Press down button ② on each anchor and return anchor ① to its catch.



Non-LATCH-type child seats may also be used and can be installed using the vehicle's seat belt system. Install child seat according to the manufacturer's instructions.

Warning!



Children too big for a toddler restraint must ride in seats using regular seat belts. Position shoulder belt across chest and shoulder, not face or neck.

A booster seat may be necessary to achieve proper belt positioning for children from 41 lbs until they reach a height where a lap/shoulder belt fits properly without a booster.

Before installing the child seat, make sure anchors ① are folded out and locked in place.

Install child seat according to manufacturer's instructions.

The child seat must be firmly attached in the right and left side anchors ①.

An incorrectly mounted child seat may come loose during an accident which could result in serious injury or death to the child.

Damaged or impact damaged child seats or child seat mounting fittings must be replaced.

Do not leave children unattended in the vehicle, even if the children are secured in a child restraint system.

Safety and Security

Occupant safety

Blocking of rear door window operation

You can block the rear door window operation (for instance when you have children riding in the rear passenger compartment).

The override switch is located on the door control panel of the driver's door.



- ① Deactivating override switch
- ② Activating override switch
- ③ Override switch

Activating override switch

- ▶ Slide override switch ③ to the right.

The rear door windows can no longer be operated using the respective switch located in the rear doors.



Operation of the rear door windows with the switches located on the door control panel of the driver's door is still possible.

Deactivating override switch

- ▶ Slide override switch ③ to the left.

The rear door windows can be operated again using the respective switch located in the rear doors.

Warning!



Activate the override switch when children are riding in the back seats of the vehicle. The children may otherwise injure themselves, e.g. by becoming trapped in the window opening.

When leaving the vehicle, always remove the SmartKey from the starter switch, take it with you, and lock the vehicle. Do not leave children unattended in the vehicle, or with access to an unlocked vehicle. Unsupervised use of vehicle equipment can cause an accident and/or serious personal injury.

For more information, see "Power windows" (▷ page 241).

▼ Panic alarm*

An audible alarm and flashing exterior lamps will operate for approximately 2¹/₂ minutes.



① PANIC button



Canada only:
Only vehicles equipped with an anti-theft alarm system* have SmartKeys with integrated panic button ①.

Activating

- ▶ Press and hold button ① for at least one second.

Deactivating

- ▶ Press button ① again.
- or
- ▶ Insert SmartKey in starter switch.



USA only:

This device complies with Part 15 of the FCC Rules. Operation is subject to the following two conditions:

- (1) This device may not cause harmful interference, and
- (2) this device must accept any interference received, including interference that may cause undesired operation.

Any unauthorized modification to this device could void the user's authority to operate the equipment.

Safety and Security

Panic alarm*



Canada only:

This device complies with RSS-210 of Industry Canada. Operation is subject to the following two conditions:

- (1) This device may not cause interference, and
- (2) this device must accept any interference received, including interference that may cause undesired operation of the device.

Any unauthorized modification to this device could void the user's authority to operate the equipment.

▼ Driving safety systems

In this section you will find information on the following driving safety systems:

- ABS (Antilock Brake System)
- BAS (Brake Assist System)
- ESP (Electronic Stability Program)
- 4MATIC (Four Wheel Electronic Traction System)



In winter operation, the maximum effectiveness of the ABS, ESP, and 4MATIC (if so equipped) is only achieved with winter tires (M+S tires), or snow chains as required.

Warning!



The following factors increase the risk of accidents:

- Excessive speed, especially in turns
- Wet and slippery road surfaces
- Following another vehicle too closely

The ABS, BAS, ESP, and 4MATIC (if so equipped) cannot reduce this risk.

Always adjust your driving style to the prevailing road and weather conditions.

ABS

Warning!



Do not pump the brake pedal. Use firm, steady brake pedal pressure instead. Pumping the brake pedal defeats the purpose of the ABS and significantly reduces braking effectiveness.

The Antilock Brake System (ABS) regulates the brake pressure so that the wheels do not lock during braking. This allows you to maintain the ability to steer your vehicle.

The ABS is functional above a speed of approximately 5 mph (8 km/h) independent of road surface conditions.

On slippery road surfaces, the ABS will respond even to light brake pressure.

The  indicator lamp in the instrument cluster (▷ page 24) comes on when you switch on the ignition. It goes out when the engine is running.

Safety and Security

Driving safety systems

Braking

At the instant one of the wheels is about to lock up, a slight pulsation can be felt in the brake pedal, indicating that the ABS is in the regulating mode.

- ▶ Keep firm and steady pressure on the brake pedal while experiencing the pulsation.

Continuous steady brake pedal pressure yields the advantages provided by the ABS, namely braking power and ability to steer the vehicle.

The pulsating brake pedal can be an indication of hazardous road conditions and functions as a reminder to take extra care while driving.

Emergency brake maneuver

- ▶ Keep continuous full pressure on the brake pedal.

Warning!



The ABS cannot prevent the natural laws of physics from acting on the vehicle, nor can it increase braking or steering efficiency beyond that afforded by the condition of the vehicle brakes and tires or the traction afforded. The ABS cannot prevent accidents, including those resulting from excessive speed in turns, following another vehicle too closely, or hydroplaning. Only a safe, attentive, and skillful driver can prevent accidents. The capabilities of an ABS equipped vehicle must never be exploited in a reckless or dangerous manner which could jeopardize the user's safety or the safety of others.

For more information, see "Practical hints" (▷ page 344) and (▷ page 358).

BAS

The Brake Assist System (BAS) operates in emergency situations. If you apply the brakes very quickly, the BAS automatically provides full brake boost, thereby potentially reducing the braking distance. Apply continuous full braking pressure until the emergency braking situation is over. The ABS will prevent the wheels from locking.

When you release the brake pedal, the brakes function again as normal. The BAS is then deactivated.

Warning!



If the BAS is malfunctioning, the brake system is still functioning normally, but without the additional brake boost available that BAS would normally provide in an emergency braking maneuver. Therefore, the braking distance may increase.

Safety and Security

Driving safety systems

Warning!



The BAS cannot prevent the natural laws of physics from acting on the vehicle, nor can it increase braking efficiency beyond that afforded by the condition of the vehicle brakes and tires or the traction afforded. The BAS cannot prevent accidents, including those resulting from excessive speed in turns, following another vehicle too closely, or hydroplaning. Only a safe, attentive, and skillful driver can prevent accidents. The capabilities of a BAS equipped vehicle must never be exploited in a reckless or dangerous manner which could jeopardize the user's safety or the safety of others.

For more information, see “Practical hints” (▷ page 359).

ESP

The Electronic Stability Program (ESP) is operational as soon as the engine is running and monitors the vehicle's traction (force of adhesive friction between the tires and the road surface) and handling.

The ESP recognizes when a wheel is spinning or if the vehicle starts to skid. By applying brakes to the appropriate wheel and by limiting the engine output, the ESP works to stabilize the vehicle. The ESP is especially useful while driving off and on wet or slippery road surfaces. The ESP also stabilizes the vehicle during braking maneuvers.

The ESP warning lamp  in the speedometer flashes when the ESP is engaged.

The ESP warning lamp  in the speedometer comes on when you switch on the ignition. It goes out when the engine is running.

Warning!



Never switch off the ESP when you see the ESP warning lamp  flashing in the speedometer. In this case, proceed as follows:

- While driving off, apply as little throttle as possible.
- While driving, ease up on the accelerator.
- Adapt your speed and driving style to the prevailing road conditions.

Failure to observe these guidelines could cause the vehicle to skid.

The ESP cannot prevent accidents resulting from excessive speed.

Safety and Security

Driving safety systems

Warning!



The ESP cannot prevent the natural laws of physics from acting on the vehicle, nor can it increase the traction afforded. The ESP cannot prevent accidents, including those resulting from excessive speed in turns or hydroplaning. Only a safe, attentive, and skillful driver can prevent accidents. The capabilities of an ESP equipped vehicle must never be exploited in a reckless or dangerous manner which could jeopardize the user's safety or the safety of others.



The ESP will only function properly if you use wheels of the recommended tire size (▷ page 424).



Vehicles without 4MATIC:
Because of the ESP's automatic operation, the engine must be shut off (SmartKey in starter switch position **0** or **1**) when

- the parking brake is being tested on a brake test dynamometer
- the vehicle is being towed with the front axle raised

Active braking action through the ESP may otherwise seriously damage the brake system.

For information on vehicles with 4MATIC, see "Four wheel electronic traction system (4MATIC) with the ESP" (▷ page 88).

For more information, see "Practical hints" (▷ page 348) and (▷ page 360).

Switching off the ESP

Warning!



The ESP should not be switched off during normal driving other than in the circumstances described below. Disabling of the system will reduce vehicle stability in standard driving maneuvers.

To improve the vehicle's traction, turn off the ESP in driving situations where it would be advantageous to have the drive wheels spin and thus cut into surfaces for better grip such as:

- starting out on slippery surfaces and in deep snow in conjunction with snow chains
- in sand or gravel



Turn on the ESP immediately if the aforementioned circumstances do not apply anymore.

When you switch off the ESP

- the ESP does not stabilize the vehicle
- the engine output is not limited, which allows the drive wheels to spin and thus cut into surfaces for better grip
- the traction control will still brake a spinning wheel
- the ESP continues to operate when you are braking



When the ESP is switched off and one or more drive wheels are spinning, the ESP warning lamp  in the speedometer flashes. However, the ESP will then not stabilize the vehicle.

The switch is located on the center console.



① ESP switch (off/on)

- ▶ Press switch ①.

The ESP warning lamp  in the speedometer comes on.

The ESP is deactivated.

Safety and Security

Driving safety systems

Warning!



When the ESP warning lamp  is illuminated continuously, the ESP is switched off.

Adapt your speed and driving to the prevailing road conditions and to the non-operating status of the ESP.



Avoid spinning of a drive wheel for an extended period with the ESP switched off. This may cause serious damage to the drivetrain which is not covered by the Mercedes-Benz Limited Warranty.

Switching on the ESP

- ▶ Press switch ① again.

The ESP warning lamp  in the speedometer goes out.

You are now again in normal driving mode with the ESP switched on.

Safety and Security

Driving safety systems

Four wheel electronic traction system (4MATIC) with the ESP

Models with all-wheel-drive only.

The 4MATIC improves vehicle's ability to use available traction, e.g. during winter operation in mountains under snowy conditions, by applying power to all four wheels.

Warning!



If you see the ESP warning lamp  flashing in the speedometer, proceed as follows:

- While driving off, apply as little throttle as possible
- While driving, ease up on the accelerator
- Adapt your speed and driving style to the prevailing road conditions

Failure to observe these guidelines could cause the vehicle to skid.

The ESP cannot prevent accidents resulting from excessive speed.



Do not tow with one axle raised.

Otherwise the transfer case can be damaged, which is not covered by the Mercedes-Benz Limited Warranty.



Performance testing must only be conducted on a two-axle dynamometer.

Otherwise the transfer case can be damaged, which is not covered by the Mercedes-Benz Limited Warranty.



Because of the ESP's automatic operation, the engine must be shut off (SmartKey in starter switch position **0** or **1**) when the parking brake is being tested on a brake test dynamometer.

Active braking action through ESP may otherwise seriously damage the front or rear axle brake system.

Operational tests with the engine running can only be conducted on a two-axle dynamometer.



At highly demanding operating conditions, the electronic traction system may temporarily switch off to prevent overheating of the drive wheel brakes.

The message `unavailable`

See Operator's Manual will then appear in the multifunction display while the ESP warning lamp  is flashing. The ESP is still functioning normally.

▼ Anti-theft systems

Immobilizer

The immobilizer prevents unauthorized persons from starting your vehicle.

Activating

- ▶ Remove the SmartKey from the starter switch.

Deactivating

- ▶ Switch on ignition (▷ page 33).



Starting the engine will also deactivate the immobilizer.

In case the engine cannot be started (yet the vehicle's battery is charged), the system is not operational. Contact an authorized Mercedes-Benz Center or call 1-800-FOR-MERCEdes (in the USA), or 1-800-387-0100 (in Canada).

Anti-theft alarm system*

Once the alarm system has been armed, a visual and audible alarm is triggered when someone opens

- a door
- the trunk lid
- the hood

The alarm system will also be triggered when

- someone attempts to raise the vehicle (▷ page 91)
- opening the vehicle with the mechanical key



The alarm will stay on, even if the activating element (a door, for example) is immediately closed.



If the alarm stays on for more than 30 seconds, a call to the Response Center is initiated automatically by the Tele Aid system* (▷ page 267) provided Tele Aid service was subscribed to and properly activated, and that necessary cellular service and GPS coverage are available.

Safety and Security

Anti-theft systems

Arming the alarm system

The indicator lamp is in the switch for the tow-away alarm* in the center console.



① Indicator lamp

- ▶ Lock the vehicle with the SmartKey.

The turn signal lamps flash three times to indicate that the alarm system is activated. Indicator lamp ① begins to flash after approximately 30 seconds after arming the alarm system.



If the turn signal lamps do not flash three times, one of the following elements may not be properly closed:

- a door
- the trunk lid
- the hood

Close the respective element and lock the vehicle again.

Disarming the alarm system

- ▶ Unlock your vehicle with the SmartKey.



The turn signal lamps flash once to indicate that the alarm system is deactivated.



The alarm system will rearm automatically after approximately 40 seconds if no door or the trunk lid was opened.

Canceling the alarm

To cancel the alarm:

- ▶ Press the  or  button on the SmartKey.

or

- ▶ Insert the SmartKey in the starter switch.

Safety and Security

Anti-theft systems

Tow-away alarm*

Once the tow-away alarm is armed, a visual and audible alarm will be triggered when someone attempts to raise the vehicle.



The tow-away protection alarm is triggered, for example, if the vehicle is lifted on one side.

If the alarm stays on for more than 30 seconds, a call to the Response Center is initiated automatically by the Tele Aid system* (▷ page 267) provided Tele Aid service was subscribed to and properly activated, and that necessary cellular service and GPS coverage are available.

Arming tow-away alarm

- ▶ Lock your vehicle with the SmartKey.

The tow-away alarm is automatically armed after about 30 seconds.



When you unlock your vehicle, the tow-away protection disarms automatically. The tow-away alarm remains disarmed until you lock the vehicle again.

Disarming tow-away alarm

To prevent triggering the tow-away alarm, switch off the tow-away alarm feature before towing the vehicle, or when parking on a surface subject to movement, such as a ferry or auto train.

The switch is located on the center console.



- ① Tow-away alarm off switch
- ② Indicator lamp

- ▶ Switch off ignition.



You cannot disarm the tow-away alarm while the ignition is switched on. ▷▷

Safety and Security



Anti-theft systems

- ▷▷ Press switch ①.
Indicator lamp ② in switch comes on briefly.
- ▶ Exit and lock your vehicle with the SmartKey.

The tow-away alarm remains disarmed until you lock your vehicle again.

Canceling the alarm

To cancel the alarm:

- ▶ Press the  or  button on the SmartKey.
- or
- ▶ Insert the SmartKey in the starter switch.

Controls in detail

Locking and unlocking

Seats

Memory function*

Lighting

Instrument cluster

Control system

Manual transmission

Automatic transmission*

Good visibility

Climate control

Automatic climate control*

Audio system

Power windows

Power tilt/sliding sunroof*

Driving systems

Loading

Useful features

Controls in detail

Locking and unlocking

In the “Controls in detail” section you will find detailed information on how to operate the equipment installed on your vehicle. If you are already familiar with the basic functions of your vehicle, this section will be of particular interest to you.

To quickly familiarize yourself with the basic functions of the vehicle, refer to the “Getting started” section of this manual. The corresponding page numbers are given at the beginning of each segment.

For more information on locking and unlocking, see “Getting started” (▷ page 32) and (▷ page 54).

SmartKey

Your vehicle comes supplied with two SmartKeys, each with remote control and a removable mechanical key.

The locking tabs for the mechanical key portion of the two SmartKeys are a different color to help distinguish each SmartKey unit.

The SmartKey provides an extended operating range. To prevent theft, however, it is advisable to only unlock the vehicle when you are in close proximity to it.

The SmartKey centrally locks and unlocks:

- the doors
- the trunk
- the fuel filler flap

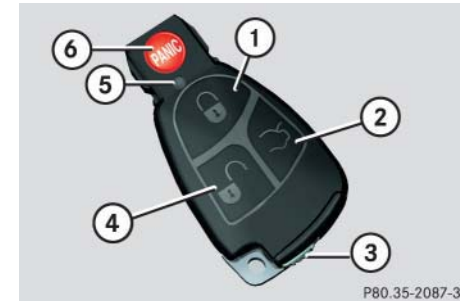

SmartKey with remote control

- ① Lock button
- ② Opening button for the trunk lid
- ③ Mechanical key locking tab
- ④ Unlock button
- ⑤ Battery check lamp
- ⑥ PANIC button* (▷ page 81).

i

Canada only:

Only vehicles equipped with an anti-theft alarm system* have SmartKeys with integrated panic button ⑥.

Warning!



When leaving the vehicle, always remove the SmartKey from the starter switch, take it with you, and lock the vehicle. Do not leave children unattended in the vehicle, or with access to an unlocked vehicle. It is possible for children to open a locked door from the inside, which could result in an accident and/or serious injury.



To prevent possible malfunction, avoid exposing the SmartKey to high levels of electromagnetic radiation.



USA only:

This device complies with Part 15 of the FCC Rules. Operation is subject to the following two conditions:

- (1) This device may not cause harmful interference, and
- (2) this device must accept any interference received, including interference that may cause undesired operation.

Any unauthorized modification to this device could void the user's authority to operate the equipment.



Canada only:

This device complies with RSS-210 of Industry Canada. Operation is subject to the following two conditions:

- (1) This device may not cause interference, and
- (2) this device must accept any interference received, including interference that may cause undesired operation of the device.

Any unauthorized modification to this device could void the user's authority to operate the equipment.



You can also open and close the power windows (▷ page 243) and power tilt/sliding sunroof* (▷ page 247) from outside using the SmartKey.

Controls in detail

Locking and unlocking

Controls in detail

Locking and unlocking

Factory setting

Global unlocking

- ▶ Press button .

All turn signal lamps flash once. The locking knobs in the doors move up. The anti-theft alarm system* is disarmed.

The vehicle will lock again automatically and reactivate the anti-theft alarm system* within approximately 40 seconds of unlocking if:

- neither door nor trunk is opened
- the SmartKey is not inserted in the starter switch
- the central locking switch is not activated



Global locking

- ▶ Press button .

All turn signal lamps flash three times. The locking knobs in the doors move down. The anti-theft alarm system* is armed.

Selective setting

If you frequently travel alone, you may wish to reprogram the SmartKey so that pressing  only unlocks the driver's door and the fuel filler flap.

- ▶ Press and hold buttons  and  simultaneously for about five seconds until battery check lamp  flashes twice.

The SmartKey will then function as follows:

Unlocking driver's door and fuel filler flap

- ▶ Press button  once.

All turn signal lamps flash once. The locking knob in the driver's door moves up. The anti-theft alarm system* is disarmed.

Global unlocking

- ▶ Press button  twice.



All turn signal lamps flash once. The locking knobs in the doors move up. The anti-theft alarm system* is disarmed.

Global locking

- ▶ Press button .

All turn signal lamps flash three times. The locking knobs in the doors move down. The anti-theft alarm system* is armed.

Restoring to factory setting

- ▶ Press and hold buttons  and  simultaneously for about six seconds until battery check lamp  flashes twice.



If you can no longer lock or unlock the vehicle with the SmartKey, then either the batteries in the SmartKey are discharged, the SmartKey is malfunctioning or the vehicle battery is drained.



- Check the batteries in the SmartKey (▷ page 97) and replace them if necessary (▷ page 389).
- Use the mechanical key to unlock the driver's door (▷ page 383) and the trunk lid (▷ page 384).
- Use the mechanical key to lock the driver's door (▷ page 384).
- Have the vehicle battery and the battery connections checked (▷ page 404).

If the SmartKey is malfunctioning, contact an authorized Mercedes-Benz Center.

Controls in detail

Locking and unlocking

Checking the batteries

- ▶ Press button  or .

Battery check lamp  comes on briefly to indicate that the SmartKey batteries are in order.





If battery check lamp  does not come on briefly during check, then the SmartKey batteries are discharged.

Replace the batteries (▷ page 389).

You can obtain the required batteries at any authorized Mercedes-Benz Center.



If the batteries are checked within signal range of the vehicle, pressing the  or  button will lock or unlock the vehicle accordingly.

Controls in detail

Locking and unlocking

Unlocking and opening the trunk lid

You can unlock and open the trunk separately.

A minimum height clearance of 5.71 ft (1.74 m) is required to open the trunk lid.

- ▶ Press button  until trunk lid unlocks and begins to open.



The trunk lid swings open upwards automatically. Always make sure there is sufficient overhead clearance.

Loss of SmartKey or mechanical key

If you lose a SmartKey or mechanical key, you should do the following:

- ▶ Have the SmartKey deactivated by an authorized Mercedes-Benz Center.
- ▶ Report the loss of the SmartKey or the mechanical key immediately to your car insurance company.
- ▶ If necessary, have the mechanical lock replaced.

Your authorized Mercedes-Benz Center will be glad to supply you with a replacement.

Opening the doors from the inside

You can open a locked door from the inside. Open door only when conditions are safe to do so.





- ① Locking knob
- ② Inside door handle



If the vehicle has previously been locked from the outside with the SmartKey, opening a door from the inside will trigger the anti-theft alarm system*.

To cancel the alarm, do one of the following:

- Press button  or  on the SmartKey.
- Insert the SmartKey in the starter switch.

Front doors

- ▶ Pull on door handle ② on the respective front door to open door.

If door was locked, locking knob ① will move up.

Rear doors

- ▶ Pull up locking knob ① on the respective rear door to unlock door.
- ▶ Pull on door handle ② on the respective rear door to open door.

Controls in detail

Locking and unlocking

Opening the trunk

Opening the trunk from the outside

A minimum height clearance of 5.71 ft (1.74 m) is required to open the trunk lid.

The handle is located above the rear license plate recess.

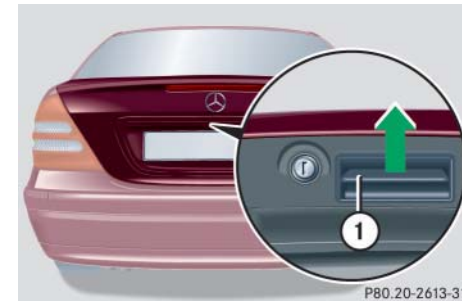

① Handle

Controls in detail

Locking and unlocking

The vehicle must be unlocked.

- ▶ Pull on handle ①.

The trunk lid unlocks and begins to open.



The trunk lid swings open upwards automatically. Always make sure there is sufficient overhead clearance.

The trunk can also be opened using button  on the SmartKey or from its inside in an emergency, see “Trunk lid emergency release” (▷ page 102).

Opening the trunk from the inside

You can open the trunk from the inside if the vehicle is stationary.

A minimum height clearance of 5.71 ft (1.74 m) is required to open the trunk lid.

The remote trunk lid switch is located on the driver's door.



- ① Remote trunk lid switch with indicator lamp

- ▶ Press remote trunk lid switch ① until the trunk begins to open.

The indicator lamp in the switch remains lit as long as the trunk is open.



The trunk lid swings open upwards automatically. Always make sure there is sufficient overhead clearance.

The trunk can also be opened using button  on the SmartKey or from its inside in an emergency, see “Trunk lid emergency release” (▷ page 102).

Closing the trunk

Depending on production date, your vehicle is equipped with either trunk design A or B.



Trunk design A

- ① Handle
- ▶ Lower trunk lid by pulling firmly on handle ①.
- ▶ Close trunk lid with hands placed flat on the trunk lid.

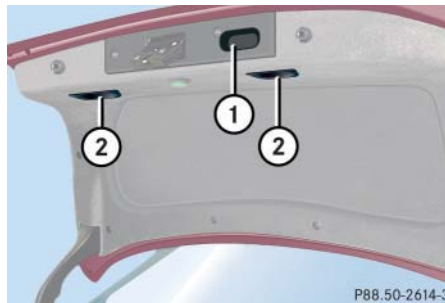

Trunk design B

- ① Handle
- ② Handles
- ▶ Lower trunk lid by pulling firmly on handle ① or handles ②.
- ▶ Close trunk lid with hands placed flat on the trunk lid.

Controls in detail

Locking and unlocking

Warning!



To prevent possible personal injury, always keep hands and fingers away from the trunk opening when closing the trunk. Be especially careful when small children are around.

When leaving the vehicle, always remove the SmartKey from the starter switch, take it with you, and lock the vehicle. Do not leave children unattended in the vehicle, or with access to an unlocked vehicle. Unsupervised use of vehicle equipment may cause an accident and/or serious personal injury.

Warning!



Only drive with the trunk closed as, among other dangers such as visibility blockage, exhaust fumes may enter the vehicle interior.

Controls in detail

Locking and unlocking



Do not place the SmartKey in the open trunk. You may lock yourself out.



If the vehicle was previously centrally locked, the trunk lid will lock automatically after closing it. The turn signals will flash three times to confirm locking.

Trunk lid emergency release

The emergency release button is located on the inside of the trunk lid.

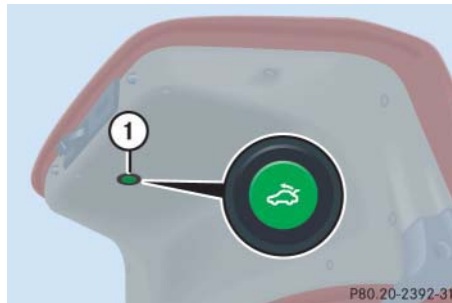

① Emergency release button

- ▶ Briefly press emergency release button ①.

The trunk lid unlocks and the trunk lid opens.



The trunk lid swings open upwards automatically.

Illumination of the emergency release button:

- The button will flash for 30 minutes after opening the trunk.
- The button will flash for 60 minutes after closing the trunk.



The emergency release button unlocks and opens the trunk while the vehicle is standing still or in motion.





The emergency release button does not open the trunk lid if the vehicle battery is discharged or disconnected.



If the vehicle has previously been locked from the outside with the SmartKey, opening the trunk from the inside using the emergency release button will trigger the anti-theft alarm system*.

To cancel the alarm, do one of the following:

- Press button  or  on the SmartKey.
- Insert the SmartKey in the starter switch.

Automatic central locking

The doors and the trunk automatically lock when the ignition is switched on and the wheels are turning at vehicle speeds of approximately 9 mph (15 km/h) or more.

You can open a locked door from the inside. Open door only when conditions are safe to do so.

Controls in detail

Locking and unlocking



The doors unlock automatically after an accident if the force of the impact exceeds a preset threshold.

To prevent the vehicle door locks from locking, deactivate the automatic central locking when the vehicle

- is pushed or towed
- is on a test stand

You can deactivate the automatic locking mode using the control system, see “Setting automatic locking” (> page 153).

Controls in detail

Locking and unlocking

Locking and unlocking from the inside

You can lock or unlock the doors and the trunk from inside using the central locking or unlocking switch. This can be useful, for example, if you want to lock the vehicle before starting to drive.

You cannot lock or unlock the fuel filler flap with the central locking or unlocking switch.

Warning!



When leaving the vehicle, always remove the SmartKey from the starter switch, take it with you, and lock the vehicle. Do not leave children unattended in the vehicle, or with access to an unlocked vehicle. Unsupervised use of vehicle equipment may cause an accident and/or serious personal injury.

Depending on production date, your vehicle is equipped with either switch design A or B.

The switches are located in the center console.

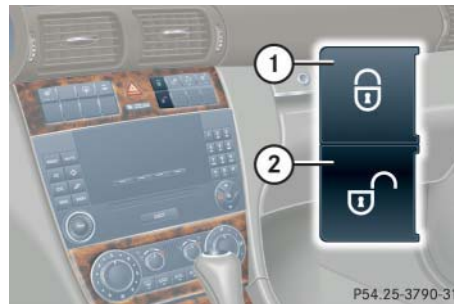

Switch design A

- ① Central locking switch
- ② Central unlocking switch

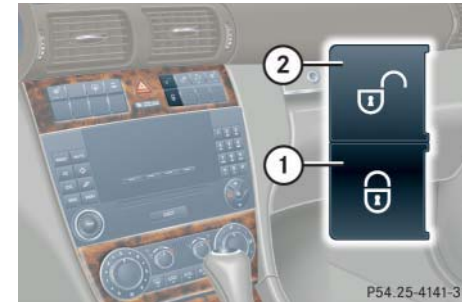

Switch design B

- ① Central locking switch
- ② Central unlocking switch



You can open a locked door from the inside. Open door only when conditions are safe to do so.

If the vehicle was previously centrally locked using the SmartKey, it will not unlock using the central unlocking switch ②.

If the vehicle was previously locked with the central locking switch ①

- while in the selective remote control mode, only the door opened from the inside is unlocked.
- while in the global remote control mode, the complete vehicle is unlocked when a door is opened from the inside.

Locking

- ▶ Press central locking switch ①.

If all doors are closed, the vehicle locks.

Unlocking

- ▶ Press central unlocking switch ②.

The vehicle unlocks.

Controls in detail

Seats

For information on seat adjustment, see “Adjusting” (▷ page 35).

Easy-entry/exit feature*

This feature allows for easier entry into and exit from the vehicle.

The easy-entry/exit feature can be activated or deactivated in the Convenience submenu of the control system (▷ page 154).

Warning!



You must make sure no one can become trapped or injured by the moving steering wheel and driver's seat when the easy-entry/exit feature is activated.

To cancel seat/steering wheel movement, do one of the following:

- Press seat adjustment switch* (▷ page 30).
- Move steering column stalk* (▷ page 40).
- Press memory position switch* (▷ page 115).

Do not leave children unattended in the vehicle, or with access to an unlocked vehicle. Children could open the driver's door and unintentionally activate the easy-entry/exit feature, which could result in an accident and/or serious personal injury.

When exiting the vehicle, with the easy-entry/exit feature activated and depending on your selection, the steering wheel tilts upwards and/or the driver's seat moves a few inches to the rear when you:

- remove the SmartKey from the starter switch,
or
- open the driver's door with the SmartKey in starter switch position **0** or **1**.



If the current position for the steering wheel is in the uppermost tilt position, the steering wheel will no longer be able to move upward when the easy-entry/exit feature is activated.

If the current seat position falls into a factory-set position range and the system recognizes the current seat position to be rearward enough for easy entry and exit, the driver's seat will not move to the rear when the easy-entry/exit feature is activated.

When entering the vehicle, with the easy-entry/exit feature activated, the steering wheel or, depending on your selection, the steering wheel and driver's seat will return to their last set position or a factory-set maximum forward position when you:

- close the driver's door with the ignition switched on
- insert the SmartKey into the starter switch with the driver's door closed.



For safety reasons, the driver's seat will not return to its last set position with the easy-entry/exit feature activated if the system recognizes the last set position as an extreme forward position. Instead, the driver's seat will remain at or move to a factory-set maximum forward position. To again fully return the driver's seat to your last set position or to memory position, adjust the seat to the desired position or press and hold the respective memory position switch* (> page 115).

Controls in detail

Seats

Removing and installing front seat head restraints

For information on head restraint adjustment, see "Seats" (> page 35).



Adjust the head restraint in such a way that it is as close to the head as possible.

Warning!



For your protection, drive only with properly positioned head restraints.

Adjust head restraint so that the center of the head restraint supports the back of the head at eye level. This will reduce the potential for injury to the head and neck in the event of an accident or similar situation. >>

Controls in detail

Seats

- ▷▷ Do not drive the vehicle without the seat head restraints. Head restraints are intended to help reduce injuries during an accident.

Do not interchange head restraints from front and rear seat.



Tilt the backrest to the rear for easier removal and installation of the head restraints.

Front seat head restraints, manual seat

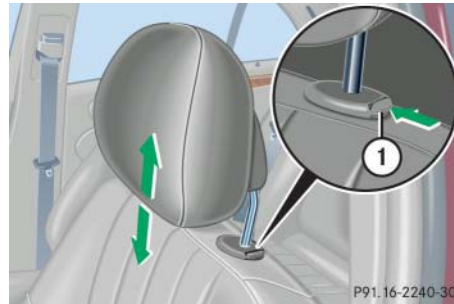

- ① Release button

Removing front seat head restraints

- ▶ Pull head restraint to its highest position.
- ▶ Push release button ① and pull out head restraint.

Installing front seat head restraints

- ▶ Insert head restraint and push it down until it engages.
- ▶ Push release button ① and adjust head restraint to desired position.

Front seat head restraints, power seat*

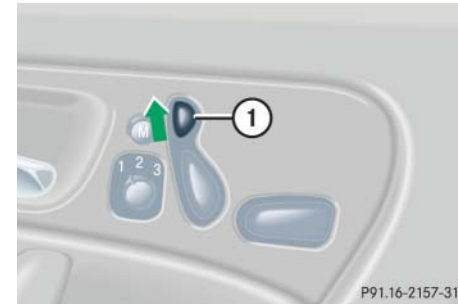

- ① Head restraint switch

- ▶ Switch on ignition (▷ page 33).

Removing front seat head restraints

- ▶ Press switch ① upwards and hold until head restraint is fully extended.
- ▶ Pull out head restraint.

Installing front seat head restraints

- ▶ Press switch ① upwards and hold for about five seconds.
- ▶ Push head restraint down until it engages.
- ▶ Adjust head restraint to desired position (▷ page 38).

Rear seat head restraints

Warning!



For safety reasons, always drive with the rear head restraints in the upright position when the rear seats are occupied.

Keep the area around head restraints clear of articles (e.g. clothing) to not obstruct the folding operation of the head restraints.

Head restraint height (rear outer seats)

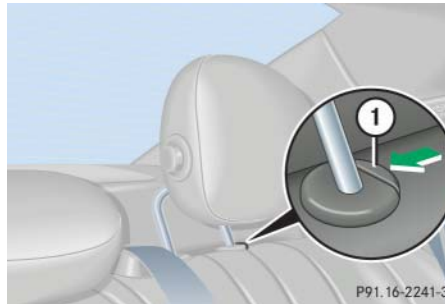

① Release button

Raising:

- ▶ Manually adjust the height of the head restraint by pulling it upward.

If the head restraint is fully retracted, push release button ① and pull the head restraint out.

Lowering:

- ▶ To lower the head restraint, push release button ① and push down on the head restraint.



Adjust the head restraint in such a way that it is as close to the head as possible.

Warning!



For your protection, drive only with properly positioned head restraints.

Adjust head restraint so that the center of the head restraint supports the back of the head at eye level. This will reduce the potential for injury to the head and neck in the event of an accident or similar situation.

Do not drive the vehicle without the seat head restraints. Head restraints are intended to help reduce injuries during an accident.

Controls in detail

Seats

Folding head restraints back with release button

The rear seat head restraints can be folded backward for increased visibility.

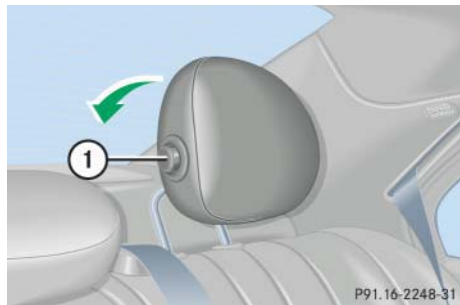

① Release button

- ▶ Push release button ①.

The head restraint will fold backward.



You can also fold the rear outer seat head restraints back using the switch in the center console (> page 110).

Folding head restraints back with switch in the center console (rear outer seats)



① Switch for rear seat head restraints

- ▶ Start the engine (> page 46).
- ▶ Press switch ①.

The rear seat head restraints will fold backward.

Placing head restraints upright

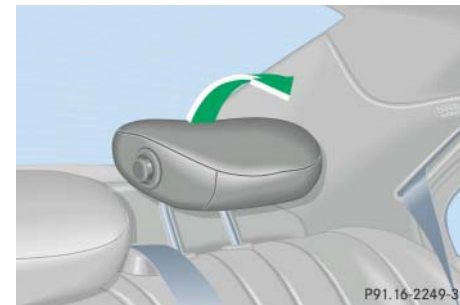

- ▶ Pull the head restraint forward until it locks into position.

Warning!



Make sure the head restraints engage when placing them upright. Otherwise their protective function cannot be assured.

Head restraint tilt (rear outer seats)

Two different head restraint angle positions are available:

- ▶ Press the release button (▷ page 110) and tilt the head restraint to the desired position.

Removing and installing rear seat head restraints (rear outer seats)



Adjust the head restraint in such a way that it is as close to the head as possible.



The rear center seat head restraint cannot be removed.

Warning!



For your protection, drive only with properly positioned head restraints.

Adjust head restraint so that the center of the head restraint supports the back of the head at eye level. This will reduce the potential for injury to the head and neck in the event of an accident or similar situation.

Do not drive the vehicle without the seat head restraints. Head restraints are intended to help reduce injuries during an accident.

Do not interchange head restraints from front and rear seat.

Controls in detail

Seats

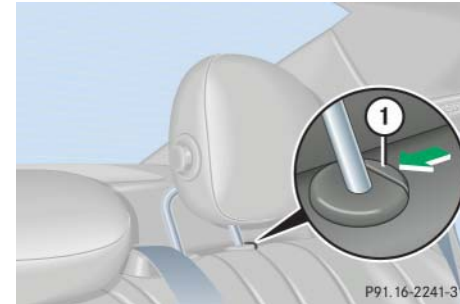

- ① Release button

Removing rear seat head restraints

- ▶ Fold back head restraint (▷ page 110).
- ▶ Pull head restraint to its highest position.
- ▶ Push release button ① and pull out head restraint.

Installing rear seat head restraints

- ▶ Insert head restraint and push it down until it engages.
- ▶ Push button ① and adjust head restraint to desired position.

Controls in detail

Seats

Multicontour seats*

This multicontour seat has a movable seat cushion and inflatable air cushions built into the backrest to provide additional lumbar and side support.

The seat cushion movement, backrest cushion height and curvature can be continuously varied with switches on the side of the seat after switching on ignition.

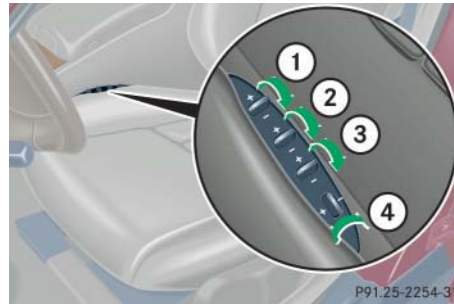

- ① Seat cushion depth
- ② Backrest bottom
- ③ Backrest center
- ④ Backrest side bolster adjustment

- ▶ Switch on ignition (▷ page 33).

Seat cushion depth

- ▶ Adjust the seat cushion depth to the length of your upper leg using switch ①.

Backrest contour

- ▶ Adjust the contour of the backrest to the desired position using switches ② and ③.

Backrest side bolsters

- ▶ Adjust the backrest side bolsters so that they provide good lateral support using switch ④.

Seat heating*

The switches for the front seats are located in the center console.



- ① Seat heating switch
- ② Indicator lamps

The red indicator lamps ② in the switch show the heating level selected.

Level	
3	Three indicator lamps on. After approximately five minutes, seat heating is automatically switched to level 2.
2	Two indicator lamps on. After approximately ten minutes, seat heating is automatically switched to level 1.
1	One indicator lamp on. After approximately 20 minutes, seat heating is automatically switched off.
off	No indicator lamp on.

- ▶ Switch on ignition (▷ page 33).

Switching on seat heating

- ▶ Press switch ① twice.
Three red indicator lamps ② in the switch come on.
- ▶ Continue pressing switch ① until desired seat heating level is reached.

Switching off seat heating

- ▶ Press switch ① repeatedly until all indicator lamps ② go out.



If one or all of the indicator lamps ② on the seat heating switch are flashing, there is insufficient voltage due to too many electrical consumers are turned on. The seat heating switches off automatically.

The seat heating will switch back on again automatically as soon as sufficient voltage is available.

Controls in detail

Memory function*



Prior to operating the vehicle, the driver should check and adjust the seat height, seat position fore and aft, and seat backrest angle if necessary, to ensure adequate control, reach and comfort. The head restraint should also be adjusted for proper height. See also the section on air bags (> page 59) for proper seat positioning.

In addition, adjust the steering wheel to ensure adequate control, reach, operation and comfort. Both the interior and exterior rear view mirrors should be adjusted for adequate rear vision.

Fasten seat belts. Infants and small children should be seated in a properly secured restraint system that complies with U.S. Federal Motor Vehicle Safety Standards 213 and 225 and Canadian Motor Vehicle Safety Standards 213 and 210.2.

You can store up to three different settings for each SmartKey.

The following settings are stored when using the buttons on the driver's door:

- Driver's seat, backrest and head restraint position
- Steering wheel position
- Exterior rear view mirror positions

These key-dependent memory settings can be deactivated if desired. For information on key-dependent memory settings, see "Setting key-dependency" (> page 155).

The following settings are not key-dependent. They are stored when using the buttons on the front passenger door:

- Front passenger seat, backrest and head restraint position

Warning!



Do not activate the memory function while driving. Activating the memory function while driving could cause the driver to lose control of the vehicle.

Controls in detail

Memory function*

The memory button and memory position switch are located on the door.

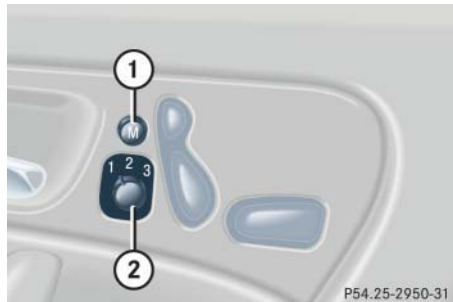

- ① Memory button
- ② Memory position switch

▶ Switch on ignition (▷ page 33).

or

▶ Open the respective door and insert the SmartKey in the starter switch.

Storing positions into memory

- ▶ Adjust the seat, steering wheel and exterior rear view mirrors to the desired position (▷ page 35).
- ▶ Turn memory position switch ② to the selected memory position.
- ▶ Press memory button ①.
- ▶ Release memory button ① and press memory position switch ② within three seconds.

All settings are stored to the selected position.

Recalling positions from memory



Do not operate the power seats using the memory button if the seat backrest is in an excessively reclined position. Doing so could cause damage to front or rear seats.

- ▶ Turn memory position switch ② to the selected memory position.
- ▶ Press and hold memory position switch ② until the seat, steering wheel and exterior rear view mirrors have completely moved to the stored positions.



Releasing the memory position switch stops movement to the stored positions immediately.

Controls in detail

Memory function*

Storing exterior rear view mirror parking position

For easier parking, you can adjust the passenger-side exterior rear view mirror so that you can see the right rear wheel as soon as you engage reverse gear **R**.

For information on activating the parking position feature, see “Activating exterior rear view mirror parking position*” (▷ page 174).



You can store a parking position for the passenger-side exterior rear view mirror for each SmartKey.



- ① Memory button
- ② Adjustment button
- ③ Passenger-side exterior rear view mirror button

- ▶ Stop the vehicle.
- ▶ Switch on ignition (▷ page 33).

- ▶ Press button ③.
The passenger-side exterior rear view mirror is selected.
- ▶ Adjust the exterior rear view mirror with button ② so that you see the rear wheel and the road curb.
- ▶ Press memory button ①.
- ▶ Within three seconds, press bottom of adjustment button ②.

The parking position is stored if the mirror does not move.



If the mirror does move, repeat the above steps. After the setting is stored, you can move the mirror again.

▼ Lighting

For information on how to switch on the headlamps and use the turn signals, see “Switching on headlamps” (▷ page 49) and “Turn signals” (▷ page 50).



If you drive in countries where vehicles drive on the other side of the road than the country where the vehicle is registered, you must have the headlamps modified for symmetrical low beams. Relevant information can be obtained at your authorized Mercedes-Benz Center.

Exterior lamp switch

The exterior lamp switch is located on the dashboard to the left of the steering wheel.



Exterior lamp switch

Controls in detail

Lighting

- 0** Off
Daytime running lamp mode (▷ page 119)
- AUTO** Automatic headlamp mode
Daytime running lamp mode (▷ page 119)
- ☰** Parking lamps (also tail lamps, license plate lamps, side marker lamps, instrument panel lamps)
- ☷** Low beam headlamps (or high beam headlamps when the combination switch is pushed forward) and parking lamps
- P↔** Standing lamps, right (turn left one stop)
- ↔P** Standing lamps, left (turn left two stops)
- ☷** Indicator lamp for front fog lamps
- ☷** Indicator lamp for rear fog lamp

Controls in detail

Lighting



With the SmartKey removed from the starter switch and the driver's door open, a warning sounds if the parking lamps or low beam headlamps are switched on.

The message *Switch off lights.* appears in the multifunction display

Manual headlamp mode

The low beam headlamps and the parking lamps can be switched on and off with the exterior lamp switch.

Automatic headlamp mode

The following lamps switch on and off automatically depending on the brightness of the ambient light:

- Low beam headlamps
- Tail and parking lamps
- License plate lamps
- Side marker lamps



Warning!



If the exterior lamp switch is set to **AUTO**,

- the headlamps may switch off unexpectedly when the system senses bright ambient light, for example light from oncoming traffic.
- the headlamps will not be automatically switched on under foggy conditions.

To minimize risk to you and to others, activate headlamps by turning exterior lamp switch to  when driving or when traffic and /or ambient lighting conditions require you to do so.

In low ambient lighting conditions, only switch from position **AUTO** to  with the vehicle at a standstill. Switching from **AUTO** to  will briefly switch off the headlamps. Doing so while driving in low ambient lighting conditions may result in an accident.

The automatic headlamp feature is only an aid to the driver. The driver is responsible for the operation of the vehicle's lights at all times.

- ▶ Turn the exterior lamp switch to position **AUTO**.

With the SmartKey in starter switch position **1**, only the parking lamps will switch on and off automatically.

When the engine is running, the low beam headlamps, the tail and parking lamps, the license plate lamps, and the side marker lamps will switch on and off automatically.

Daytime running lamp mode

- ▶ Turn the exterior lamp switch to position **0** or **AUTO**.

When the engine is running, the low beam headlamps are switched on.

In low ambient light conditions, the following lamps will switch on additionally:

- Tail and parking lamps
- License plate lamps
- Side marker lamps

For nighttime driving you should turn the exterior lamp switch to position **HD** to permit activation of the high beam headlamps.



With the daytime running lamp mode activated and the exterior lamp switch in position **0**, the high beam headlamps cannot be switched on.

The high beam flasher is available at all times.

Canada only:

The daytime running lamp mode is mandatory and therefore in a constant mode.

Vehicles with automatic transmission*: When the engine is running, and you shift from a driving position to position **N** or **P**, the low beam headlamps will switch off with a three-minute delay.

When the engine is running, and you

- turn the exterior lamp switch to position **PL**, the parking lamps switch on additionally.
- turn the exterior lamp switch to position **HD**, the manual headlamp mode has priority over the daytime running lamp mode.

The corresponding exterior lamps switch on (▷ page 117).

USA only:

By default, the daytime running lamp mode is deactivated. Activate the daytime running lamp mode using the control system, see “Setting daytime running lamp mode (USA only)” (▷ page 150).

When the engine is running, and you turn the exterior lamp switch to position **PL** or **HD**, the manual headlamp mode has priority over the daytime running lamp mode.

The corresponding exterior lamps switch on (▷ page 117).

Controls in detail

Lighting



Locator lighting and night security illumination

The locator lighting and the night security illumination are described in the “Control system” section, see “Setting locator lighting” (▷ page 151) and “Setting night security illumination” (▷ page 151).

Fog lamps

Warning!



In low ambient lighting or foggy conditions, only switch from position **AUTO** to  with the vehicle at a standstill. Switching from **AUTO** to  will briefly switch off the headlamps. Doing so while driving in low ambient lighting conditions may result in an accident.



Fog lamps will operate with the parking lamps and/or the low beam headlamps on. Fog lamps should only be used in conjunction with low beam headlamps. Consult your State or Province Motor Vehicle Regulations regarding permissible lamp operation.



Fog lamps cannot be switched on with the exterior lamp switch in position **AUTO**. For switching on the fog lamps, turn the exterior lamp switch to position  first.

Front fog lamps

- ▶ Switch on the low beam headlamps (▷ page 117).
- ▶ Pull out the exterior lamp switch to first stop.

The front fog lamps switch on.



The green indicator lamp  in the exterior lamp switch comes on (▷ page 117).

- ▶ Push in the exterior lamp switch.

The front fog lamps switch off.

The green indicator lamp  in the exterior lamp switch goes out.

Rear fog lamp (driver's side only)

- ▶ Switch on the front fog lamps (▷ page 120).
- ▶ Pull out the exterior lamp switch to second stop.
The rear fog lamp switches on.
The yellow indicator lamp  in the exterior lamp switch comes on (▷ page 117).
- ▶ Push in the exterior lamp switch to first stop.
The rear fog lamp switches off.
The yellow indicator lamp  in the exterior lamp switch goes out.
The front fog lamps remain lit.

Combination switch

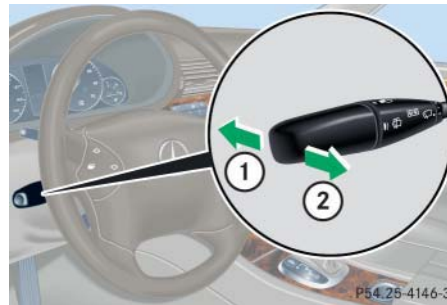

The combination switch is located on the left of the steering column.



Combination switch

- ① High beam
- ② High beam flasher

High beam

- ▶ Turn the exterior lamp switch to position  or **AUTO** (▷ page 117).
- ▶ Push the combination switch in direction of arrow ① to switch on the high beam.
The high beam headlamp indicator lamp  in the instrument cluster comes on (▷ page 24).

- ▶ Pull the combination switch in direction of arrow ② to its original position to switch off the high beam.

The high beam headlamp indicator lamp  in the instrument cluster goes out.

High beam flasher

- ▶ Pull the combination switch briefly in direction of arrow ②.

Controls in detail

Lighting

Cornering fog lamps* (All models with Bi-Xenon* headlamps, except C 230 Kompressor Sport and C 320 Sport)

The cornering fog lamps improve illumination of the road into which you are turning.

Cornering fog lamps will operate with the engine running and with

- the exterior lamp switch in position  (▷ page 117)
or
- the exterior lamp switch in position **AUTO** (▷ page 117)
or
- the daytime running lamp mode activated (▷ page 119)



Cornering fog lamps will only come on in low ambient lighting conditions.

The cornering fog lamps function is not available at a vehicle speed above 25 mph (40 km/h).

Driving forward

Switching on cornering fog lamps

- ▶ Depending on whether you are turning left or right, switch on the left or right turn signal (▷ page 50).

The respective front fog lamp comes on and illuminates the road into which you are turning.



The cornering fog lamps will come on automatically depending on the steering angle, even if you did not switch on either turn signal. If the cornering fog lamps came on automatically, they will also go out automatically depending on the steering angle.

Switching off cornering fog lamps

The combination switch for the turn signal resets automatically after major steering wheel movements. This will switch off the cornering fog lamps if they were activated by switching on the left or right turn signal.

If the turn signal should stay on after making the turn, the turn signal and cornering fog lamp can be switched off by returning the combination switch to its original position.

Driving rearward

Switching on cornering fog lamps

- ▶ Place the gear selector lever (manual transmission: gearshift lever) in position **R**.

The inverse front fog lamp comes on automatically depending on the steering direction and steering angle.

Switching off cornering fog lamps

- ▶ Place the gear selector lever (manual transmission: gearshift lever) out of position **R**.

The respective front fog lamp goes out.

Hazard warning flasher

The hazard warning flasher can be switched on at all times, even with the SmartKey removed from the starter switch.

The hazard warning flasher switches on automatically when an air bag deploys.

The hazard warning flasher switch is located on the upper part of the center console.



① Hazard warning flasher switch

Controls in detail

Lighting

Switching on hazard warning flasher

- ▶ Press hazard warning flasher switch ①.

All turn signals are flashing.



With the hazard warning flasher activated and the combination switch set for either left or right turn, only the respective turn signals will operate when the ignition is switched on.

Switching off hazard warning flasher

- ▶ Press hazard warning flasher switch ① again.



If the hazard warning flasher has been activated automatically, press hazard warning flasher switch ① once to switch it off.

Controls in detail

Lighting

Interior lighting

The controls are located in the overhead control panel.



- ① Rear interior lights
- ② Right front reading lamp
- ③ Rocker switch for automatic control system
- ④ Left front reading lamp

Activating automatic control

- ▶ Press rocker switch ③ to center position.

Interior lamps are switched on in darkness, even when you:

- unlock the vehicle
- open a door
- remove the SmartKey from the starter switch

The interior lamps are switched off after a preset time, see “Setting interior lighting delayed shut-off” (▷ page 153).



If the door remains open, the interior lamps switch off automatically after approximately five minutes, when the SmartKey is removed or in starter switch position 0.

An interior lamp switched on manually does not go out automatically.

Deactivating automatic control

- ▶ Press the  symbol on rocker switch ③.

The interior lighting remains switched off, even when you:

- unlock the vehicle
- open a door
- remove the SmartKey from the starter switch

Manual control



Switching all front interior lights on and off

- ▶ Press the  symbol on rocker switch ③.



The front interior lights come on.

- ▶ Press rocker switch ③ to center position to activate the automatic control.



Switching rear interior lights on and off

- ▶ Press button .
The lights in the rear passenger compartment come on.
- ▶ Press button  again.
The lights in the rear passenger compartment go out.

Switching right front reading lamp on and off

- ▶ Press right button .
The right reading lamp comes on.
- ▶ Press right button  again.
The right reading lamp goes out.

Switching left front reading lamp on and off

- ▶ Press left button .
The left reading lamp comes on.
- ▶ Press left button  again.
The left reading lamp goes out.

Door entry lamps

The appropriate door entry lamp switches on if a door is opened in darkness and if the interior lighting is switched to automatic function.

The entry lamp switches off automatically when the door is closed.



If you turn the SmartKey in the starter switch to position **0** and switch off the exterior headlamps, the door entry lamps will remain lit for approximately five minutes.

Trunk lamp

The trunk lamp switches on if the trunk lid is opened.

If you leave the trunk open for an extended period of time, the trunk lamp will switch off automatically after approximately ten minutes.

Controls in detail

Instrument cluster

For a full view illustration of the instrument cluster, see “At a glance” (▷ page 24).



① Reset button

The instrument cluster is activated when you

- open a door
- switch on ignition
- press reset button ①
- switch on the exterior lamps

You can change the instrument cluster settings in the Instrument cluster submenu of the control system (▷ page 143).

Instrument cluster illumination

Use reset button ① to adjust the illumination brightness for the instrument cluster.



The instrument cluster illumination is dimmed or brightened automatically to suit ambient light conditions.

The instrument cluster illumination will also be adjusted automatically when you switch on the vehicle's exterior lamps.

To brighten illumination

- ▶ Turn reset button ① clockwise.
The instrument cluster illumination will brighten.

To dim illumination

- ▶ Turn reset button ① counterclockwise.
The instrument cluster illumination will dim.

Coolant temperature gauge

The coolant temperature gauge is on the left side in the instrument cluster (▷ page 24).

Warning!





- Driving when your engine is badly overheated can cause some fluids which may have leaked into the engine compartment to catch fire. You could be seriously burned.
- Steam from an overheated engine can cause serious burns and can occur just by opening the hood. Stay away from the engine if you see or hear steam coming from it.

Turn off the engine, get out of the vehicle and do not stand near the vehicle until the engine has cooled down.

During severe operating conditions, e.g. stop-and-go traffic, the coolant temperature may rise close to 248°F (120°C).

The engine should not be operated with the coolant temperature above 248°F (120°C). Doing so may cause serious engine damage which is not covered by the Mercedes-Benz Limited Warranty.

Trip odometer

- ▶ Make sure you are viewing the trip odometer and main odometer in the multifunction display (▷ page 129).
- ▶ If it is not displayed, press button  or  on the multifunction steering wheel (▷ page 130) until the trip odometer appears in the multifunction display.
- ▶ Press and hold the reset button in the instrument cluster (▷ page 126) until the trip odometer is reset.

Controls in detail

Instrument cluster

Tachometer

The red marking on the tachometer (▷ page 24) denotes excessive engine speed.



Avoid driving at excessive engine speeds, as it may result in serious engine damage that is not covered by the Mercedes-Benz Limited Warranty.

To help protect the engine, the fuel supply is interrupted if the engine is operated within the red marking.

Outside temperature indicator

Warning!



The outside temperature indicator is not designed to serve as an ice-warning device and is therefore unsuitable for that purpose.

Indicated temperatures just above the freezing point do not guarantee that the road surface is free of ice. The road may still be icy, especially in wooded areas or on bridges.

The outside temperature is indicated in the multifunction display (▷ page 129). For information on how to select the unit of the indicated temperature, i.e. degrees Celsius (°C) or degrees Fahrenheit (°F), see “Selecting temperature display mode” (▷ page 143).

The temperature sensor is located in the front bumper area. Due to its location, the sensor can be affected by road or engine heat during idling or slow driving. This means that the accuracy of the displayed temperature can only be verified by comparison to a thermometer placed next to the sensor, not by comparison to external displays (e.g. bank signs, etc.).

When moving the vehicle into colder ambient temperatures (e.g. when leaving your garage), you will notice a delay before the lower temperature is displayed.

A delay also occurs when ambient temperatures rise. This prevents inaccurate temperature indications caused by heat radiated from the engine during idling or slow driving.

▼ Control system

The control system is activated as soon as the SmartKey in the starter switch is turned to position **1**. The control system enables you to

- call up information about your vehicle
- change vehicle settings

For example, you can use the control system to find out when your vehicle is next due for service, to set the language for messages in the instrument cluster display, and much more.



The displays for the audio systems (radio, CD player) will appear in English, regardless of the language selected.

Warning!



A driver's attention to the road and traffic conditions must always be his/her primary focus when driving.

For your safety and the safety of others, selecting features through the multifunction steering wheel should only be done by the driver when traffic and road conditions permit it to be done safely.

Bear in mind that at a speed of just 30 mph (approximately 50 km/h), your vehicle is covering a distance of 44 feet (approximately 14 m) every second.

The control system relays information to the multifunction display.

Controls in detail

Control system

Multifunction display

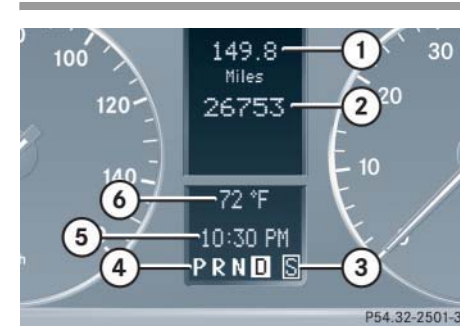

- ① Trip odometer
- ② Main odometer
- ③ Current program mode
- ④ Current gear selector lever position/gear range
- ⑤ Digital clock
- ⑥ Status indicator (outside temperature/digital speedometer)







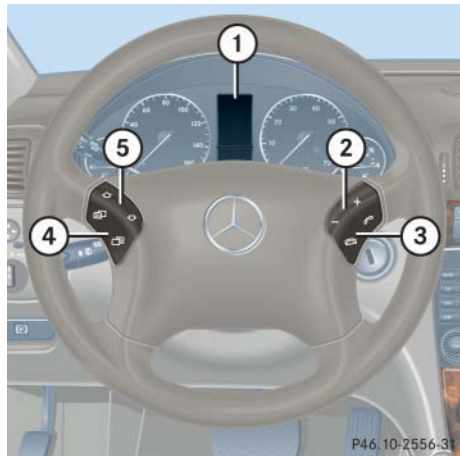

Controls in detail

Control system

Multifunction steering wheel

The displays in the multifunction display and the settings in the control system are controlled by the buttons on the multifunction steering wheel.



- ① Multifunction display
Operating the control system
- ② Selecting the submenu or setting the volume:
Press button
 up/to increase
 down/to decrease
- ③ Telephone*:
Press button
 to take a call
 to end a call
- ④ Menu systems:
Press button
 for next menu
 for previous menu
- ⑤ Moving within a menu:
Press button
 for next display
 for previous display

Pressing any of the buttons on the multifunction steering wheel will alter what is shown in the multifunction display.

The information available in the multifunction display is arranged in menus, each containing a number of functions or sub-menus.





The individual functions are then found within the relevant menu (radio or CD operations under **AUDIO**, for example). These functions serve to call up relevant information or to customize the settings for your vehicle.



C 230 Kompressor Sport, and
C 320 Sport:

Steering wheel in these vehicles will vary from steering wheel shown. However, multifunction steering wheel symbols and feature description apply to Sport models as well.

It is helpful to think of the menus, and the functions within each menu, as being arranged in a circular pattern.

- If you press button  or  repeatedly, you will pass through each menu one after the other.
- If you press button  or  repeatedly, you will pass through each function display, one after the other, in the current menu.

In the **Settings** menu, instead of functions you will find a number of submenus for calling up and changing settings. For instructions on using these submenus, see “Submenus in the Settings menu” (▷ page 141).

The number of menus available in the system depends on which optional equipment is installed in your vehicle.

The menus are described on the following pages.

Controls in detail

Control system

Menus

This is what you will see when you scroll through the menus.

The table on the next page provides an overview of the individual menus.

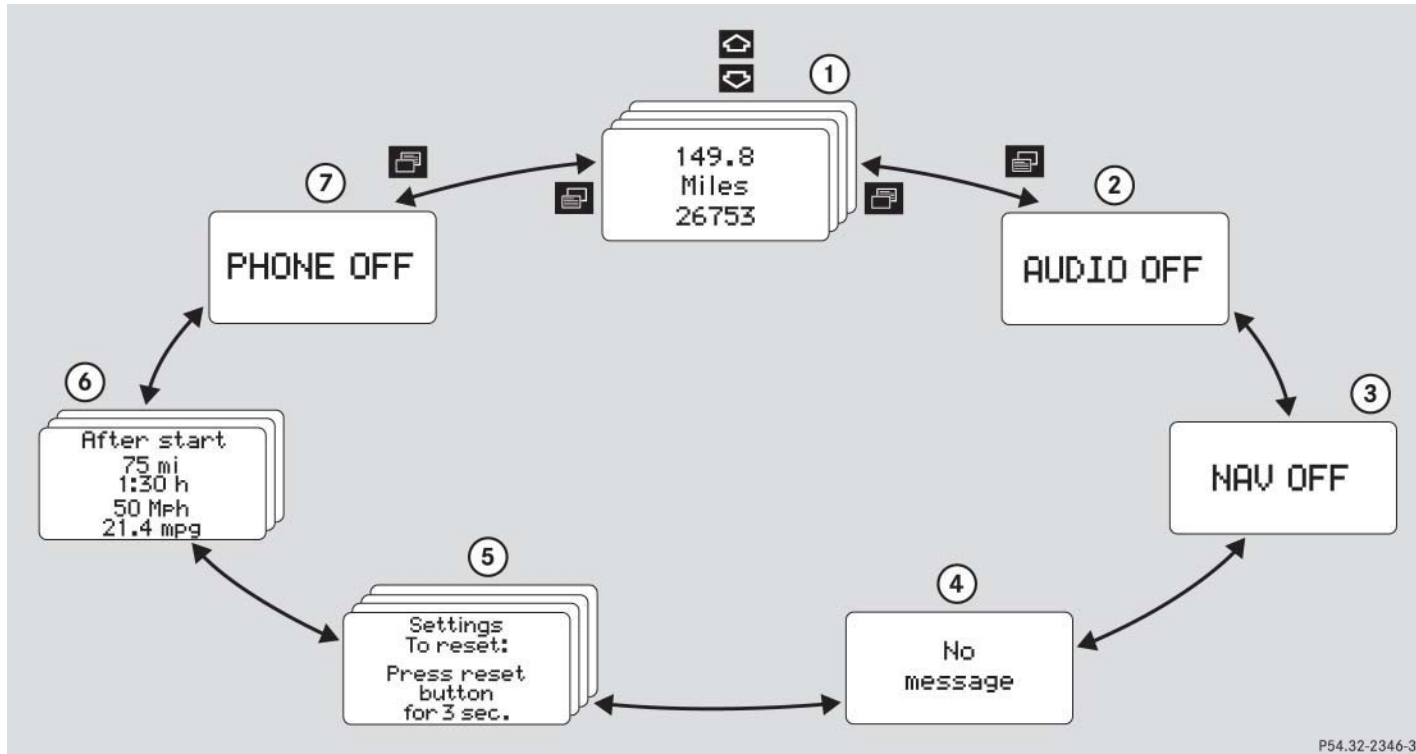

Menus, submenus and functions

	Menu ① Standard display (▷ page 134)	Menu ② AUDIO (▷ page 135)	Menu ③ NAV* (▷ page 138)	Menu ④ Vehicle status message memory (▷ page 138)	Menu ⑤ Settings (▷ page 140)	Menu ⑥ Trip computer (▷ page 156)	Menu ⑦ Telephone* (▷ page 158)
Commands/ submenus	Digital speedometer or outside temperature	Select radio station	Activate route guidance	Call up vehicle malfunction, warning and system status messages stored in memory	Reset to factory settings	Fuel consumption statistics after start	Load phone book
	Call up maintenance service display	Select satellite radio station* (USA only)			Instrument cluster submenu	Fuel consumption statistics since the last reset	Search for name in phone book
	Check engine oil level	Operate the CD player*			Time/Date submenu Lighting submenu Vehicle submenu Convenience submenu	Call up range	

Controls in detail

Control system



The headings used in the menus table are designed to facilitate navigation within the system and are not necessarily identical to those shown in the control system displays.

The first function displayed in each menu will automatically show you which part of the system you are in.

Standard display menu

In the standard display, the main odometer and the trip odometer are shown in the multifunction display.



- ① Trip odometer
- ② Main odometer



If you see another display, press button or repeatedly until the standard display appears.

You can select the functions in the standard display menu with button or .

The following functions are available:

Function	Page
Display digital speedometer or outside temperature	135
Calling up maintenance service display	334
Checking engine oil level	298

Display digital speedometer or outside temperature

- ▶ Press button  or  repeatedly until the digital speedometer appears in the multifunction display.

The current vehicle speed is shown in the multifunction display.

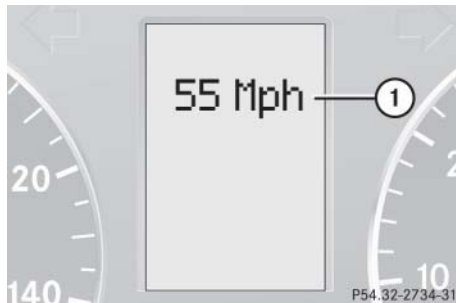

① Digital speedometer



You can have the outside temperature displayed instead of the digital speedometer. You can select the setting in the submenu *Instr.Cl.* via the function *Status line display* (▶ page 144).

AUDIO menu

The functions in the *AUDIO* menu operate the audio equipment which you currently have turned on.

If no audio equipment is currently turned on, the message *AUDIO OFF* appears in the multifunction display.



The following functions are available:

Function	Page
Select radio station	136
Select satellite radio station* (USA only)	136
Operate the CD player*	137

Controls in detail

Control system

Select radio station

- ▶ Turn on the radio (▷ page 204).
Vehicles with COMAND*:
Refer to separate operating instructions.
- ▶ Press button  or  repeatedly until the currently tuned station appears in the multifunction display.

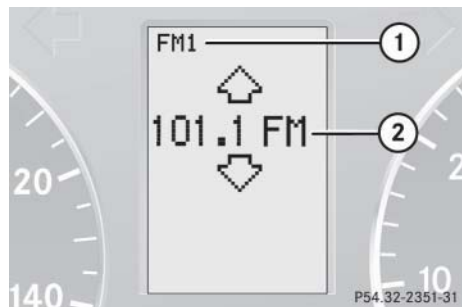

- ① Waveband setting
- ② Station frequency

- ▶ Press button  or  repeatedly until the desired station is found.



You can only store new stations using the corresponding feature on the radio (▷ page 212).

Vehicles with COMAND*:
Refer to separate operating instructions.

You can also operate the radio in the usual manner.



Select satellite radio station* (USA only)

The satellite radio is treated as a radio application.

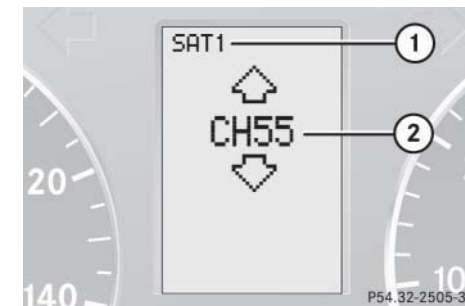
- ▶ Select satellite radio with the corresponding soft key (SAT) in the radio menu.



- ① SAT mode and preset number
- ② Channel name or number



- ▶ Press button  or  repeatedly until the desired channel is found.



For more information on satellite radio operation, see “Introduction to satellite radio* (USA only)” (▷ page 214).

Vehicles with COMAND*:
Refer to separate operating instructions.

Operate the CD player*

- ▶ Turn on the radio and select the CD player (▷ page 219).
Vehicles with COMAND*:
Refer to separate operating instructions.
- ▶ Press button  or  repeatedly until the settings for the CD currently being played appear in the multifunction display.

Controls in detail

Control system

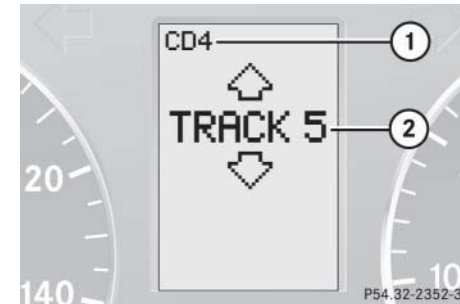

- ① Current CD (for CD changer*)
- ② Current track

- ▶ Press button  or  repeatedly until the desired track is selected.





To select a CD from the magazine, press a number on the audio system or the COMAND* system key pad located in the center dashboard.

Controls in detail

Control system

NAV* menu

The NAV menu contains the functions needed to operate your navigation system.

- ▶ Press button  or  repeatedly until the message NAV appears in the multifunction display.
- If the navigation system is switched off, the message NAV OFF appears in the multifunction display.
- If the navigation system is on, different messages, depending on the current state of the navigation system, appear in the multifunction display.

Please refer to the COMAND* manual for instructions on how to activate the route guidance system*.



Vehicle status message memory menu

Use the vehicle status message memory menu to scan malfunction and warning messages that may be stored in the system. Such messages appear in the multifunction display and are based on conditions or system status the vehicle's system has recorded.

Warning!



Malfunction and warning messages are only indicated for certain systems and are intentionally not very detailed. The malfunction and warning messages are simply a reminder with respect to the operation of certain systems and do not replace the owner's and/or driver's responsibility to maintain the vehicle's operating safety by having all required maintenance and safety checks performed on the vehicle and by bringing the vehicle to an authorized Mercedes-Benz Center to address the malfunction and warning messages (> page 352).

- ▶ Press button  or  repeatedly until the vehicle status message memory appears in the multifunction display.

No vehicle status messages



If no conditions are recorded in memory, the message in the multifunction display is: No message

Vehicle status messages have been recorded

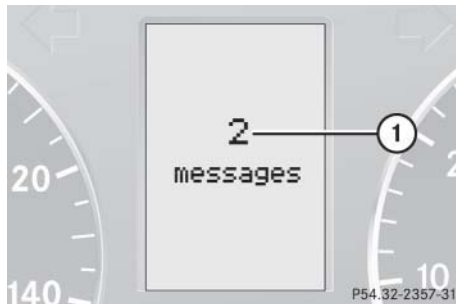
If conditions have occurred causing status messages to be recorded, the number of messages appears in the multifunction display:



① Number of messages

► Press button  or .

The stored messages will now be displayed in the order in which they have occurred. For malfunction and warning messages, see “Vehicle status messages in the multifunction display” (▷ page 352).

Should the vehicle’s system record any conditions while driving, the number of messages will reappear in the multifunction display when the SmartKey in the starter switch is turned to position **0** or removed from the starter switch.

Controls in detail

Control system





The vehicle status message memory will be cleared when you turn the SmartKey in the starter switch to position **1** or **2**. You will then only see high-priority messages in the multifunction display (▷ page 352).

Controls in detail

Control system

Settings menu

In the Settings menu there are two functions:

- The function **Reset to factory settings**, with which you can reset all the settings to the original factory settings.
 - A collection of submenus with which you can make individual settings for your vehicle.
- ▶ Press button  or  repeatedly until the Settings menu appears in the multifunction display.

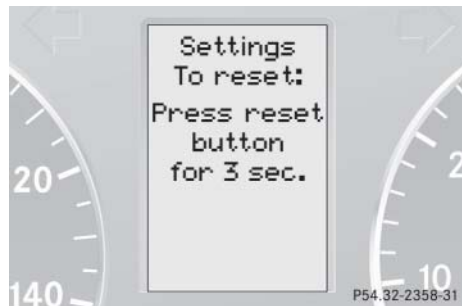

Resetting all settings

You can reset all the functions of all submenus to the factory settings.

- ▶ Press the reset button in the instrument cluster (▷ page 126) for approximately three seconds.

The request to press the reset button once more to confirm appears in the multifunction display.

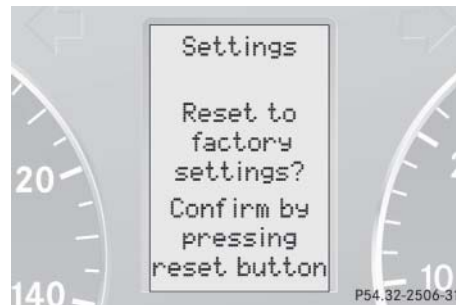

- ▶ Press the reset button once more.

The functions of all the submenus will reset to factory settings.



The settings you have changed will not be reset unless you confirm the action by pressing the reset button a second time. After approximately five seconds, the Settings menu reappears in the multifunction display.

For safety reasons, the following functions are not reset while driving:

- the Hd lamp mode function in the Lighting submenu
- the Key dependency function in the Convenience submenu

Submenus in the Settings menu



- ▶ Press button  or .

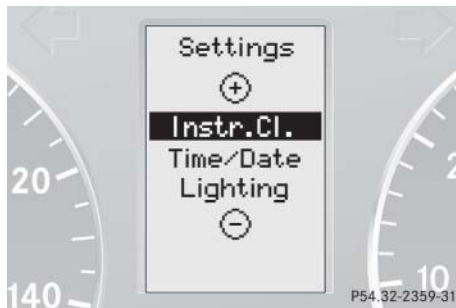

The collection of the submenus appears in the multifunction display.





- ▶ Press button .

The selection marker moves to the next submenu.

The submenus are arranged by hierarchy. Scroll down with button , scroll up with button .

Move within the submenus with button  or  to the individual functions.

The settings themselves are made with button  or .

Resetting the functions of a submenu

For each submenu you can reset all the functions to the factory settings.

- ▶ Move to a function in the submenu.
- ▶ Press the reset button (> page 126) in the instrument cluster for approximately three seconds.

The request to press the reset button once more to confirm appears in the multifunction display.

- ▶ Press the reset button once more.

All functions of the submenu will reset to factory settings.



The settings you have changed will not be reset unless you confirm the action by pressing the reset button a second time. After approximately five seconds, the Settings menu reappears in the multifunction display.

Controls in detail

Control system

The table below shows what settings can be changed within the various menus.

Detailed instructions on making individual settings can be found on the following pages.

Instrument cluster	Time/Date	Lighting	Vehicle	Convenience
Selecting temperature display mode	Time synchronization with head unit*	Setting daytime running lamp mode (USA only)	Setting automatic locking	Activating easy-entry/exit feature
Selecting speedometer display mode	Setting the time (hours)	Setting locator lighting		Setting key-dependency
Selecting language	Setting the time (minutes)	Setting night security illumination		Setting parking position for exterior rear view mirror
Selecting display (speed display or outside temperature) for status indicator	Selecting time display mode	Setting interior lighting delayed shut-off		
	Selecting automatic time change (Daylight Saving Time (DST) summer/Standard time winter)			
	Setting the date (month)			
	Setting the date (day)			
	Setting the date (year)			

Instrument cluster submenu

Access the Instr.Cl. submenu via the Settings menu. Use the Instr.Cl. submenu to change the instrument cluster display settings.

The following functions are available:

Function	Page
Selecting temperature display mode	143
Selecting speedometer display mode	143
Selecting language	144
Selecting display (speed display or outside temperature) for status indicator	144

Selecting temperature display mode

- ▶ Move the selection marker with button **+** or **-** to the Instr.Cl. submenu.
- ▶ Press button **↶** or **↷** repeatedly until the message Temperature indicator appears in the multifunction display.

The selection marker is on the current setting.

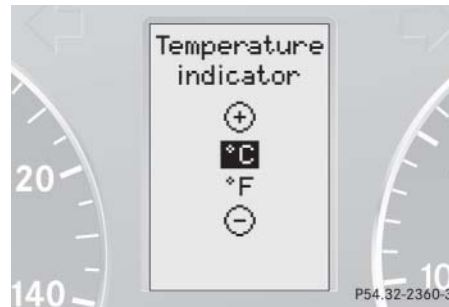

- ▶ Press button **+** or **-** to set temperature unit to °C (degrees Celsius) or °F (degrees Fahrenheit).

Selecting speedometer display mode

- ▶ Move the selection marker with button **+** or **-** to the Instr.Cl. submenu.
- ▶ Press button **↶** or **↷** repeatedly until the message Disp.Unit Speed/odo appears in the multifunction display.

The selection marker is on the current setting.



- ▶ Press button **+** or **-** to set speedometer unit to km or Miles.

Controls in detail

Control system

Selecting language

- ▶ Move the selection marker with button **+** or **-** to the Instr.Cl. submenu.
- ▶ Press button **▲** or **▼** repeatedly until the message Language appears in the multifunction display.

The selection marker is on the current setting.



- ▶ Press button **+** or **-** to select the language to be used for the multifunction display messages.

Available languages:

- German
- English
- French
- Italian
- Spanish

Selecting display (digital speedometer or outside temperature) for status indicator

- ▶ Move the selection marker with button **+** or **-** to the Instr.Cl. submenu.
- ▶ Press button **▲** or **▼** repeatedly until the message Status line display appears in the multifunction display.

The selection marker is on the current setting.

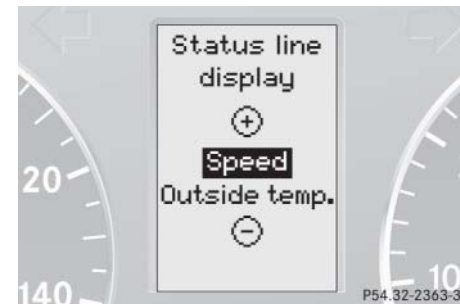

- ▶ Press button **+** or **-** to select the desired setting.

The selected display is then shown continuously in the lower display.

The other display now appears in the menu of the standard display:

- Digital speedometer
or
- Outside temperature

Time/Date submenu

Access the Time/Date submenu via the Settings menu. Use the Time/Date submenu to change the instrument cluster display settings.

The following functions are available:

Function	Page
Time synchronization with head unit*	145
Setting the time (hours)	145
Setting the time (minutes)	146
Selecting time display mode	147
Selecting automatic time change (Daylight Saving Time (DST) summer/Standard time winter)	147
Setting the date (month)	147
Setting the date (day)	148
Setting the date (year)	149

Time synchronization with head unit*

This function can only be seen on vehicles with COMAND* and navigation module*.

- ▶ Move the selection marker with button **+** or **-** to the Time/Date submenu.
- ▶ Press button **▲** or **▼** repeatedly until the message Time synchro. w/Head Unit appears in the multifunction display.

The selection marker is on the current setting.



- ▶ Press button **+** or **-** to select the desired setting.

Setting the time (hours)

This function can only be seen with audio system.



Vehicles with COMAND*:
For information on setting the time, refer to the separate COMAND operating instructions.

- ▶ Move the selection marker with button **+** or **-** to the Time/Date submenu.
- ▶ Press button **▲** or **▼** repeatedly until the message Time Hours appears in the multifunction display. ▷▷

Controls in detail

Control system

- ▷▷ The selection marker is on the hour setting.



- ▶ Press button **+** or **-** to set the hour.

Setting the time (minutes)

This function can only be seen with audio system.



Vehicles with COMAND*:
For information on setting the time, refer to the separate COMAND operating instructions.

- ▶ Move the selection marker with button **+** or **-** to the Time/Date submenu.
- ▶ Press button **↕** or **↕** repeatedly until the message *Time Minutes* appears in the multifunction display.

- The selection marker is on the minute setting.



- ▶ Press button **+** or **-** to set the minutes.

Selecting time display mode

- ▶ Move the selection marker with button **+** or **-** to the Time/Date submenu.
- ▶ Press button **↶** or **↷** repeatedly until the message **Clock display** appears in the multifunction display.
The selection marker is on the current setting.



- ▶ Press button **+** or **-** to set the 12h or 24h time display mode.

Selecting automatic time change (Daylight Saving Time (DST) summer/Standard time winter)

- ▶ Move the selection marker with button **+** or **-** to the Time/Date submenu.
- ▶ Press button **↶** or **↷** repeatedly until the message **Change-over Summer / Winter time** appears in the multifunction display.

The selection marker is on the current setting.



Controls in detail

Control system

- ▶ Press button **+** or **-** to select if the changeover between summer and winter time should be automatic or manual.

Setting the date (month)

This function can only be seen with audio system.



Vehicles with COMAND*:
For information on setting the date, refer to the separate COMAND operating instructions.

- ▶ Move the selection marker with button **+** or **-** to the Time/Date submenu.
- ▶ Press button **↶** or **↷** repeatedly until the message **Date Set MM** appears in the multifunction display. ▷▷

Controls in detail

Control system

- ▷▷ The selection marker is on the month setting.



- ▶ Press button **+** or **-** to set the month.

Setting the date (day)

This function can only be seen with audio system.



Vehicles with COMAND*:
For information on setting the date,
refer to the separate COMAND
operating instructions.

- ▶ Move the selection marker with button **+** or **-** to the Time/Date submenu.
- ▶ Press button **↶** or **↷** repeatedly until the message Date Set day appears in the multifunction display.

- The selection marker is on the day setting.

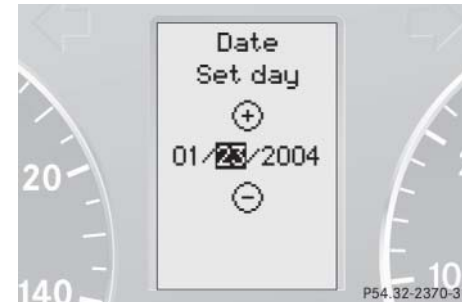

- ▶ Press button **+** or **-** to set the day.

Setting the date (year)

This function can only be seen with audio system.



Vehicles with COMAND*:
For information on setting the date, refer to the separate COMAND operating instructions.

- ▶ Move the selection marker with button **+** or **-** to the Time/Date submenu.
- ▶ Press button **↶** or **↷** repeatedly until the message Date Set YY appears in the multifunction display.

The selection marker is on the year setting.

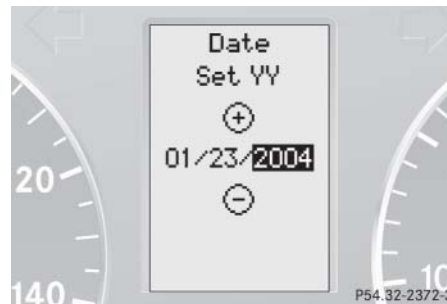

- ▶ Press button **+** or **-** to set the year.

Lighting submenu

Access the Lighting submenu via the Settings menu. Use the Lighting submenu to change the lamp and lighting settings on your vehicle.

The following functions are available:

Function	Page
Setting daytime running lamp mode (USA only)	150
Setting locator lighting	151
Setting night security illumination	151
Setting interior lighting delayed shut-off	153

Controls in detail

Control system

Setting daytime running lamp mode (USA only)



This function is not available in countries where the daytime running lamp mode is mandatory and therefore in a constant mode.

- ▶ Move the selection marker with button **+** or **-** to the Lighting submenu.
- ▶ Press button **↶** or **↷** repeatedly until the message Hd lamp mode appears in the multifunction display.

The selection marker is on the current setting.

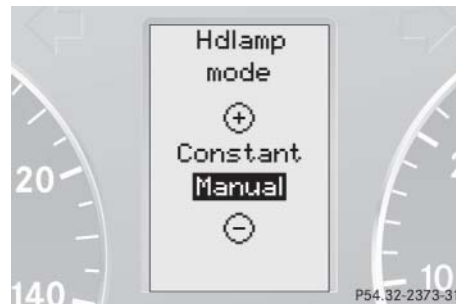

- ▶ Press button **+** or **-** to select manual operation (Manual) or daytime running lamp mode (Constant) activated.

With daytime running lamp mode activated and the exterior lamp switch in position **0** or **AUTO**, the low beam headlamps are switched on when the engine is running.

In low ambient light conditions the following lamps will switch on additionally:

- Parking lamps
- Tail lamps
- License plate lamps
- Side marker lamps

For more information on the daytime running lamp mode, see “Lighting” (▷ page 117).



For safety reasons, resetting the Lighting submenu to factory settings (▷ page 141) while driving will not deactivate the daytime running lamp mode.

The following message appears in the multifunction display:

Lighting - Cannot be completely reset to factory sets. while driving.

Setting locator lighting

With the locator lighting feature activated and the exterior lamp switch in position **AUTO**, the following lamps will switch on when the vehicle is unlocked with the SmartKey during darkness:

- Parking lamps
- Tail lamps
- License plate lamps
- Side marker lamps
- Front fog lamps

The locator lighting switches off when the driver's door is opened.

If you do not open a door after unlocking with the SmartKey the lamps will switch off automatically after approximately 40 seconds.

- ▶ Move the selection marker with button **+** or **-** to the Lighting submenu.

- ▶ Press button **↶** or **↷** repeatedly until the message Surround lighting appears in the multifunction display.

The selection marker is on the current setting.



- ▶ Press button **+** or **-** to switch the locator lighting function On.
- ▶ Turn the exterior lamp switch to position **AUTO** when exiting the vehicle (▷ page 117).

The locator lighting feature is activated.

Setting night security illumination (Headlamps delayed shut-off)

Use this function to set whether and how long you would like the exterior lamps to illuminate during darkness after exiting the vehicle and all doors closed.

With the delayed shut-off feature activated and the exterior lamp switch in position **AUTO** before the engine is turned off, the following lamps will switch on after you have removed the SmartKey from the starter switch:

- Parking lamps
- Tail lamps
- License plate lamps
- Side marker lamps
- Front fog lamps

If you do not open a door after removing the SmartKey from the starter switch, the lamps will switch off automatically after approximately 60 seconds.

Controls in detail

Control system



You can reactivate this function within ten minutes by opening a door.

- ▶ Move the selection marker with button **+** or **-** to the Lighting submenu.
- ▶ Press button **↶** or **↷** repeatedly until the message Hdlamp delay off appears in the multifunction display.

The selection marker is on the current setting.

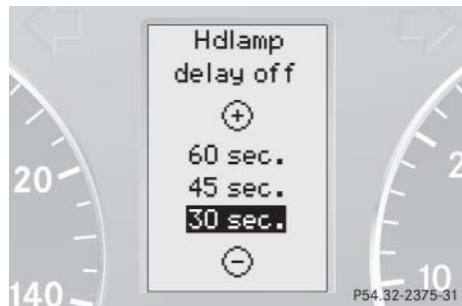

- ▶ Press button **+** or **-** to select the desired lamp-on period.

You can select:

- 0 sec., the delayed shut-off feature is deactivated.
- 15 sec., 30 sec., 45 sec. or 60 sec., select the desired lamp-on period.
- ▶ Turn the exterior lamp switch to position **AUTO** before turning off the engine (▷ page 117).

The headlamps delayed shut-off feature is activated.

You can temporarily deactivate the delayed shut-off feature:

- ▶ Before exiting the vehicle, turn the SmartKey in the starter switch to position **0**.
- ▶ Then turn it to position **2** and back to position **0**.

The delayed shut-off feature is deactivated. It will reactivate as soon as you reinsert the SmartKey in the starter switch.

Setting interior lighting delayed shut-off

Use this function to set whether and how long you would like the interior lighting to remain lit during darkness after you have removed the SmartKey from the starter switch.

- ▶ Move the selection marker with button **+** or **-** to the Lighting submenu.
- ▶ Press button **↕** or **↘** repeatedly until the message Int. light delay off appears in the multifunction display.

The selection marker is on the current setting.

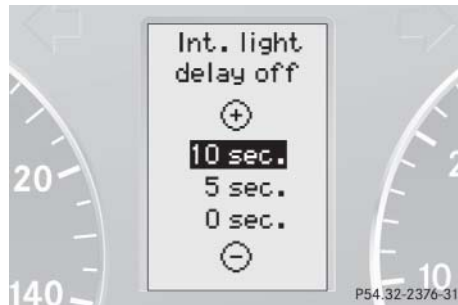

- ▶ Press button **+** or **-** to select the desired lamp-on period.

You can select:

- 0 sec., the delayed shut-off feature is deactivated.
- 5 sec., 10 sec., 15 sec. or 20 sec., the interior lighting delayed shut-off feature is activated with the desired lamp-on period.

Vehicle submenu

Access the Vehicle submenu via the Settings menu. Use the Vehicle submenu to make general vehicle settings.

The following function is available:

Function	Page
Setting automatic locking	153

Setting automatic locking

Use this function to activate or deactivate the automatic central locking. With the automatic central locking system activated, the vehicle is centrally locked at vehicle speeds of approximately 9 mph (15 km/h).

- ▶ Move the selection marker with button **+** or **-** to the Vehicle submenu.
- ▶ Press button **↕** or **↘** repeatedly until the message Automatic door lk. appears in the multifunction display. ▷▷

Controls in detail

Control system

- ▷▷ The selection marker is on the current setting.



- ▶ Press button **+** or **-** to switch the automatic central locking On or Off.

Convenience submenu

Access the Convenience submenu via the Settings menu. Use the Convenience submenu to change the settings for a number of convenience features.

The following functions are available:

Function	Page
Activating easy-entry/exit feature*	154
Setting key-dependency	155
Setting parking position* for exterior rear view mirror	156

Activating easy-entry/exit feature *

Use this function to activate and deactivate the easy-entry/exit feature (▷ page 106).

Warning!



You must make sure no one can become trapped or injured by the moving steering wheel and driver's seat when the easy-entry/exit feature is activated.

To cancel seat/steering wheel movement, do one of the following:

- Press seat adjustment switch* (▷ page 30).
- Move steering column stalk* (▷ page 40).
- Press memory position switch* (▷ page 115).

Do not leave children unattended in the vehicle, or with access to an unlocked vehicle. Children could open the driver's door and unintentionally activate the easy-entry/exit feature, which could result in an accident and/or serious personal injury.

- ▶ Move the selection marker with button **+** or **-** to the Convenience submenu.
- ▶ Press button **↕** or **↘** repeatedly until the message Easy-entry feature appears in the multifunction display.
The selection marker is on the current setting.



- ▶ Press button **+** or **-** to change the easy-entry/exit setting.

The following settings are available for the easy-entry/exit feature:

Off	The easy-entry/exit feature is deactivated
Steer. Column	Only the steering column is moved
St.col.+seat	Both the steering column and the seat are moved

Setting key-dependency

Use this function to set whether the memory settings for the seats, the steering wheel and the mirrors should be stored separately for each SmartKey (▷ page 114).

- ▶ Move the selection marker with button **+** or **-** to the Convenience submenu.
- ▶ Press button **↕** or **↘** repeatedly until the message Key dependency appears in the multifunction display.
The selection marker is on the current setting.



Controls in detail

Control system

Controls in detail

Control system

- ▶▶ Press button **+** or **-** to set key-dependency On or Off.

Setting parking position* for exterior rear view mirror

Use the Mirror set. parking aid function to select whether the passenger-side exterior rear view mirror should be turned downward during parking maneuvers when reverse gear **R** is engaged. For additional information, see “Activating exterior rear view mirror parking position*” (▷ page 174).

- ▶ Move the selection marker with button **+** or **-** to the Convenience submenu.

- ▶ Press button **↕** or **↔** repeatedly until the message Mirror set. parking aid appears in the multifunction display.

The selection marker is on the current setting.



- ▶ Press button **+** or **-** to switch function On or Off.





Trip computer menu

Use the trip computer menu to call up statistical data on your vehicle.

The following information is available:

Function	Page
Fuel consumption statistics after start	157
Fuel consumption statistics since last reset	157
Calling up range (distance to empty)	158

Fuel consumption statistics after start

- ▶ Press button  or  repeatedly until the first function of the Trip computer menu appears in the multifunction display.
- ▶ Press button  or  repeatedly until the message *After start* appears in the multifunction display.

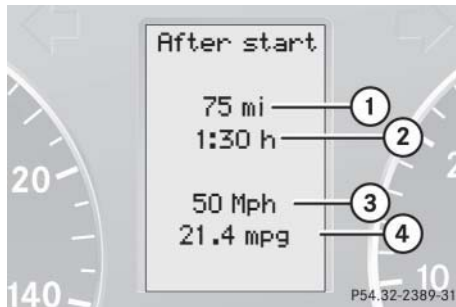

- ① Distance driven since start
- ② Time elapsed since start
- ③ Average speed since start
- ④ Average fuel consumption since start







All statistics stored since the last engine start will be reset approximately four hours after the SmartKey in the starter switch is turned to position **0** or removed from the starter switch.

Resetting will not occur if you turn the SmartKey back to position **1** or **2** within this time period.

Controls in detail

Control system

Fuel consumption since last reset

- ▶ Press button  or  repeatedly until the first function of the Trip computer menu appears in the multifunction display.
- ▶ Press button  or  repeatedly until the message *After reset* appears in the multifunction display.

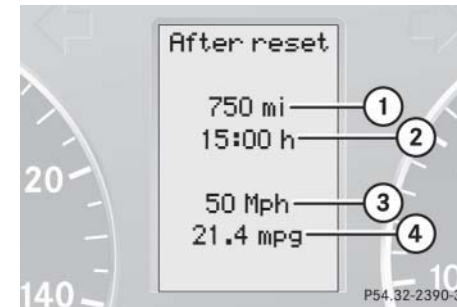





- ① Distance driven since last reset
- ② Time elapsed since last reset
- ③ Average speed since last reset
- ④ Average fuel consumption since last reset





Controls in detail

Control system

Resetting fuel consumption statistics

- ▶ Press button  or  repeatedly until the first function of the Trip computer menu appears in the multifunction display.
- ▶ Press button  or  repeatedly until the reading that you want to reset appears in the multifunction display.
- ▶ Press and hold the reset button in the instrument cluster (▷ page 126) until the value is reset to 0.

Calling up range (distance to empty)

- ▶ Press button  or  repeatedly until the first function of the Trip computer menu appears in the multifunction display.
- ▶ Press button  or  repeatedly until the message *Distance* appears in the multifunction display.

The calculated range based on the current fuel tank level appears in the multifunction display.



TEL menu*

Warning!





A driver's attention to the road must always be his/her primary focus when driving. For your safety and the safety of others, we recommend that you pull over to a safe location and stop before placing or taking a telephone call. If you choose to use the telephone while driving, please use the hands-free device and only use the telephone when weather, road and traffic conditions permit.

Some jurisdictions prohibit the driver from using a cellular telephone while driving a vehicle.

Bear in mind that at a speed of just 30 mph (approximately 50 km/h), your vehicle is covering a distance of 44 feet (approximately 14 m) every second.

Never operate radio transmitters equipped with a built-in or attached antenna (i.e. without being connected to an external antenna) from inside the vehicle while the engine is running. Doing so could lead to a malfunction of the vehicle's electronic system, possibly resulting in an accident and personal injury.

You can use the functions in the TEL menu to operate your telephone, provided it is connected to a hands-free system and switched on.

- ▶ Switch on the telephone and Audio or COMAND*.
- ▶ Press button  or  on the steering wheel repeatedly until the message TEL appears in the multifunction display.

Which messages will appear in the multifunction display depends on whether your telephone is switched on or off:

- If the telephone is off, the message PHONE OFF appears in the multifunction display.
- If the telephone is on:
The telephone will then search for a network. During this time the multifunction display is empty.
As soon as the telephone has found a network, the message READY appears in the multifunction display.



This standby message indicates that your telephone is ready for use and you can operate it using the control system.

Controls in detail

Control system

Answering a call

When your telephone is ready to receive calls, you can answer a call at any time. In the multifunction display you will then see the message:



- ▶ Press button .

You have answered the call. The duration of the call appears in the multifunction display.

Controls in detail

Control system



Ending a call

- ▶ Press button .

You have ended the call. The standby message appears in the multifunction display.

Dialing a number from the phone book



If your telephone is ready to receive calls, you may select and dial a number from the phone book at any time.

- ▶ Press button  or  repeatedly until the message TEL appears in the multifunction display.

- ▶ Press button  or .

The control system reads the phone book which is stored in the telephone. This may take up to 30 seconds. The message *Please wait* appears in the multifunction display.

When the message *Please wait* disappears, the phone book has been loaded.

- ▶ Press button  or  repeatedly until the desired name appears in the multifunction display.

The stored names are displayed in ascending or descending alphabetical order.

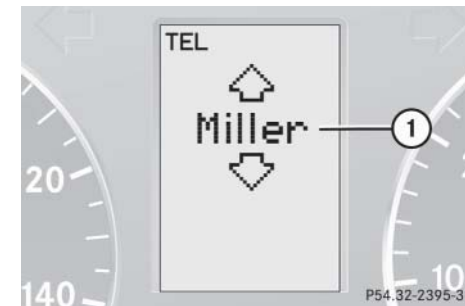



- ① Name from the phone book

Controls in detail

Control system



If you press and hold button  or  for longer than one second, the system scrolls rapidly through the list of names until you release the button again.

Cancel the quick search mode by pressing button .

- ▶ Press button .

The system dials the selected phone number.



- If the connection is successful, the name of the party you called and the duration of the call will appear in the multifunction display.



- If no connection is made, the control system stores the dialed number in the redial memory.



Redialing

The control system stores the most recently dialed phone numbers. This eliminates the need to search through your entire phone book.

- ▶ Press button  or  repeatedly until the message TEL appears in the multifunction display.

- ▶ Press button .

The first number in the redial memory appears in the multifunction display.

- ▶ Press button  or  repeatedly until the desired name appears in the multifunction display.

- ▶ Press button .

The control system dials the selected phone number.

Controls in detail

Manual transmission

Manual transmission is standard equipment on select models and not available on all models.

For information on driving with a manual transmission, see “Manual transmission” (▷ page 46).

Warning!



For vehicles equipped with a manual transmission, getting out of your vehicle with the gearshift lever not engaged in first or reverse gear and parking brake engaged is dangerous.

Also, when parked on an incline, an engaged first or reverse gear alone may not prevent your vehicle from moving, possibly hitting people or objects.

Always set the parking brake in addition to engaging first or reverse gear (▷ page 54).

When parked on an incline, turn front wheels towards the road curb.

Do not park this vehicle in areas where combustible materials such as grass, hay or leaves can come into contact with the hot exhaust system, as these materials could be ignited and cause a vehicle fire.

Warning!



When leaving the vehicle, always remove the SmartKey from the starter switch, take it with you, and lock the vehicle. Do not leave children unattended in the vehicle, or with access to an unlocked vehicle. Children could move the gearshift lever, which could result in an accident and/or serious injury.

Warning!



On slippery road surfaces, never downshift in order to obtain braking action. This could result in drive wheel slip and reduced vehicle control. Your vehicle's ABS will not prevent this type of loss of control.



Gearshift pattern for manual transmission



When you are shifting into the **5th** or **6th** gear, make sure that you press the gearshift lever to the right. Otherwise, you could accidentally shift into the **3rd** or **4th** gear and damage the transmission.

Downshifting gears leading to overrevving the engine can result in engine damage that is not covered by the Mercedes-Benz Limited Warranty.

Never hold the vehicle stopped on a hill by using the clutch pedal. The clutch may be damaged which is not covered by the Mercedes-Benz Limited Warranty.

Do not exceed the engine speed limits. Refer to tachometer (▷ page 128) for engine speeds.

Controls in detail

Manual transmission

Shifting into reverse



Only shift into reverse gear **R** when the vehicle is stationary, as the transmission could otherwise be damaged.

- ▶ Stop the vehicle completely.
- ▶ Fully depress clutch pedal.
- ▶ Move the gearshift lever to neutral position (no gear selected).
- ▶ Move the gearshift lever to the left until you feel a certain resistance.
- ▶ Push the gearshift lever past this resistance.
- ▶ Then move the gearshift lever forward into position **R**.

Controls in detail

Automatic transmission*

Automatic transmission is standard equipment on select models and available as optional equipment on select other models.

For more information on driving with an automatic transmission see “Automatic transmission*” (▷ page 47).

Your vehicle’s transmission adapts its gear shifting process to your individual driving style by continually adjusting the shift points up or down. These shift point adjustments are performed based on current operating and driving conditions.

If the operating conditions change, the automatic transmission reacts by adjusting its shift program.



During the brief warm-up, transmission upshifting is delayed. This allows the catalytic converter to heat up more quickly to operating temperature.



Gearshift pattern for automatic transmission

The automatic transmission selects individual gears automatically, depending on:

- the gear selector lever position **D** (▷ page 168) with gear ranges **4, 3, 2, 1** (▷ page 167)
- the selected program mode (**C/S**) (▷ page 169)
- the position of the accelerator pedal (▷ page 170)
- the vehicle speed

Controls in detail

Automatic transmission*

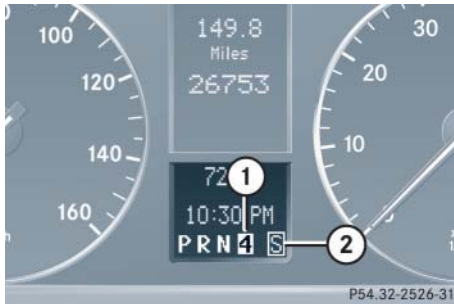

- ① Current gear range/gear selector lever position
- ② Current program mode

The current gear range/gear selector lever position and program mode (C/S) appear in the multifunction display.

An additional indication of the current gear selector lever position can be found on the cover of the shifting-gate.

The indicators come on when you activate a switch (e.g. unlocking the vehicle or opening a door) and go out after approximately 15 minutes.

Warning!



It is dangerous to shift the gear selector lever out of **P** or **N** if the engine speed is higher than idle speed. If your foot is not firmly on the brake pedal, the vehicle could accelerate quickly forward or reverse. You could lose control of the vehicle and hit someone or something. Only shift into gear when the engine is idling normally and when your right foot is firmly on the brake pedal.



Allow engine to warm up under low load use. Do not place full load on the engine until the operating temperature has been reached.

Shift into reverse gear **R** or parking position **P** only when the vehicle is stopped.

Avoid spinning of a drive wheel for an extended period when driving off on slippery road surfaces. This may cause serious damage to the drivetrain which is not covered by the Mercedes-Benz Limited Warranty.

When the gear selector lever is in position **D**, you can influence transmission shifting by:

- limiting the gear range
- changing gears manually

Controls in detail

Automatic transmission*

One-touch gearshifting

Even with an automatic transmission you can change the gears manually when the gear selector lever is in position **D**.

Downshifting

- ▶ Briefly press the gear selector lever to the left in the **D-** direction.

The transmission will shift from the current gear to the next lower gear as permitted by the shift program. This action simultaneously limits the gear range of the transmission (▷ page 167).

Warning!



On slippery road surfaces, never downshift in order to obtain braking action. This could result in drive wheel slip and reduced vehicle control. Your vehicle's ABS will not prevent this type of loss of control.



To avoid overrevving the engine when the gear selector lever is moved to the **D-** direction, the transmission will not shift to a lower gear if the engine's max. speed would be exceeded.

Upshifting

- ▶ Briefly press the gear selector lever to the right in the **D+** direction.

The transmission will shift from the current gear to the next higher gear as permitted by the shift program. This action simultaneously extends the gear range of the transmission.

Canceling gear range limit

- ▶ Press and hold the gear selector lever in the **D+** direction until **D** reappears in the multifunction display.

The transmission will shift from the current gear range directly to gear range **D**.

Shifting into optimal gear range

- ▶ Press and hold the gear selector lever in the **D-** direction.

The transmission will automatically select the gear range suited for optimal acceleration and deceleration. This will involve shifting down one or more gears.

Gear ranges

With the gear selector lever in position **D**, you can limit the transmission's gear range by pressing the gear selector lever to the left (**D-**), and reverse the gear range limit by pressing the gear selector lever to the right (**D+**).

The selected gear range appears in the multifunction display (▷ page 165). If you press on the accelerator when the engine has reached its rpm limit, the transmission will upshift beyond any gear range limit selected.

	Effect
4	The transmission shifts through fourth gear only.
3	The transmission shifts through third gear only. With this selection you can use the braking effect of the engine.

Controls in detail

Automatic transmission*

	Effect
2	The transmission shifts through second gear only. Allows the use of engine's braking power when driving: <ul style="list-style-type: none">• on steep downgrades• in mountainous regions• under extreme operating conditions
1	The transmission operates in first gear only. For maximum use of engine's braking effect on very steep or lengthy downgrades.

Controls in detail

Automatic transmission*

Gear selector lever position

	Effect
P	Park position Gear selector lever position when the vehicle is parked. Place gear selector lever in position P only when vehicle is stopped. The park position is not intended to serve as a brake when the vehicle is parked. Rather, the driver should always set the parking brake in addition to placing the gear selector lever in position P to secure the vehicle.

	Effect
	The SmartKey can only be removed from the starter switch with the gear selector lever in position P . With the SmartKey removed, the gear selector lever is locked in position P . If the vehicle's electrical system is malfunctioning, the gear selector lever could remain locked in position P (▷ page 386).
R	Reverse gear Place gear selector lever in position R only when vehicle is stopped.

	Effect
N	Neutral No power is transmitted from the engine to the drive axle. When the brakes are released, the vehicle can be moved freely (pushed or towed). To avoid damage to the transmission, never engage N while driving. If the ESP is deactivated or malfunctioning: Move gear selector lever to N only if the vehicle is in danger of skidding, e.g. on icy roads.
D	Drive The transmission shifts automatically. All five forward gears are available.



Coasting the vehicle, or driving for any other reason with gear selector lever in **N** can result in transmission damage that is not covered by the Mercedes-Benz Limited Warranty.

Warning!



Getting out of your vehicle with the gear selector lever not fully engaged in position **P** is dangerous. Also, position **P** alone is not intended to or capable of preventing your vehicle from moving, possibly hitting people or objects.

Always set the parking brake in addition to shifting to position **P** (▷ page 54).

When parked on an incline, turn the front wheels towards the road curb.

Do not park this vehicle in areas where combustible materials such as grass, hay or leaves can come into contact with the hot exhaust system, as these materials could be ignited and cause a vehicle fire.

Warning!



When leaving the vehicle, always remove the SmartKey from the starter switch, take it with you, and lock the vehicle. Do not leave children unattended in the vehicle, or with access to an unlocked vehicle. Children could move the gear selector lever from position **P**, which could result in an accident and/or serious personal injury.

Controls in detail

Automatic transmission*

Automatic shift program

The program mode selector switch is located on the lower part of the center console.

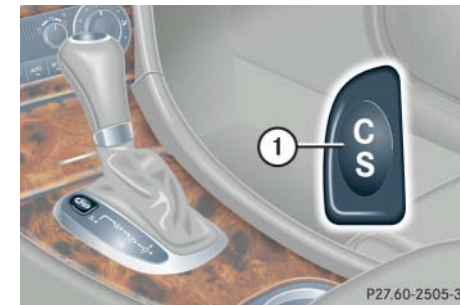

① Program mode selector switch

C Comfort For comfort driving

S Sport For standard driving

The current gear selector lever position and the selected program mode (C/S) are indicated in the multifunction display (▷ page 165).

Controls in detail

Automatic transmission*



Never change the program mode when the gear selector lever is out of position **P**. This could result in a change of driving characteristics for which you may not be prepared.



The last selected program mode (**C** or **S**) is switched on when the engine is restarted.

- ▶ Press program mode selector switch ① repeatedly until the letter of the desired program mode appears in the multifunction display.

Select **C** for comfort driving:

- The vehicle starts out in second gear (both forward and reverse) for gentler starts. This does not apply if full throttle is applied or gear range **1** is selected.
- Traction and driving stability are improved on icy roads.
- Upshifts occur earlier even when you give more gas. The engine then operates at lower rpms and the wheels are less likely to spin.

Driving tips

Accelerator position

Your driving style influences the transmission's shifting behavior:

Less throttle	Earlier upshifting
More throttle	Later upshifting

Kickdown

Use kickdown when you want maximum acceleration.

- ▶ Press the accelerator past the point of resistance.
The transmission shifts into a lower gear.
- ▶ Ease on the accelerator when you have reached the desired speed.
The transmission shifts up again.

Stopping

When you stop briefly, e.g. at traffic lights:

- ▶ Leave the transmission in gear.
- ▶ Hold the vehicle with the brake.

When you stop longer with the engine idling or on an uphill gradient:

- ▶ Move the gear selector lever to position **P**.
- ▶ Set the parking brake.

Maneuvering

When you maneuver in tight areas, e.g. when pulling into a parking space:

- ▶ Control the vehicle speed by gradually releasing the brakes.
- ▶ Accelerate gently.
- ▶ Never abruptly step on the accelerator.

Working on the vehicle

Warning!



When working on the vehicle, set the parking brake and move gear selector lever to position **P**. Otherwise the vehicle could roll away.

Emergency operation (Limp Home Mode)

If vehicle acceleration worsens or the transmission no longer shifts, the transmission is most likely operating in limp home (emergency operation) mode. In this mode only second gear and reverse gear can be activated.

- ▶ Stop the vehicle.
- ▶ Move gear selector lever to **P**.
- ▶ Turn off the engine.
- ▶ Wait at least ten seconds before restarting.
- ▶ Restart the engine.
- ▶ Move gear selector lever to position **D** (for second gear) or **R**.
- ▶ Have the transmission checked at an authorized Mercedes-Benz Center as soon as possible.

Controls in detail

Good visibility

For information on the windshield wipers, see “Windshield wipers” (▷ page 51).

Headlamp cleaning system*

The switch is located on the left side of the dashboard.

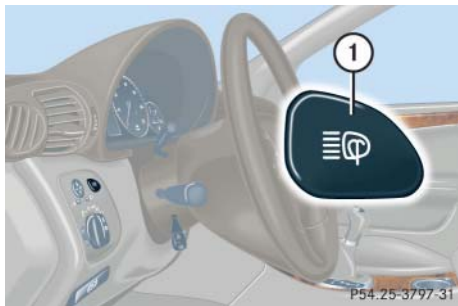

① Headlamp washer switch

- ▶ Switch on ignition (▷ page 33).

- ▶ Press switch ①.

The headlamps are cleaned with a high-pressure water jet.

For information on filling up the washer reservoir, see “Windshield washer system and headlamp cleaning system*” (▷ page 303).

Rear view mirrors

For more information on setting the rear view mirrors, see “Mirrors” (▷ page 41).

Interior rear view mirror, antiglare position

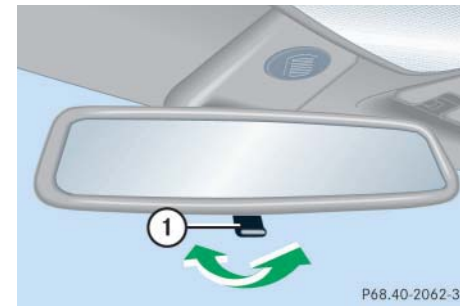

① Lever

- ▶ Tilt the mirror to the antiglare night position by moving lever ① towards the windshield.

The interior rear view mirror is dimmed.

Auto-dimming rear view mirrors*

The reflection brightness of the exterior rear view mirror on the driver's side and the interior rear view mirror will respond automatically to glare when

- the ignition is switched on and
- incoming light from headlamps falls on the sensor in the interior rear view mirror.

The rear view mirror will not react if

- reverse gear **R** is engaged
- the interior lighting is turned on

Warning!



The auto-dimming function does not react if incoming light is not aimed directly at sensors in the interior rear view mirror.

The interior rear view mirror and the exterior rear view mirror on the driver's side do not react, for example, if the rear window sunshade* is in raised position.

Glare can endanger you and others.

Warning!



In the case of an accident liquid electrolyte may escape from the mirror housing if the mirror glass breaks.

Electrolyte has an irritating effect. Do not allow the liquid to come into contact with eyes, skin, clothing, or respiratory system. In case it does, immediately flush affected area with water, and seek medical help if necessary.

Controls in detail

Good visibility



Electrolyte drops coming into contact with the vehicle paint finish can be completely removed only while in the liquid state and by applying plenty of water.

Warning!



Exercise care when using the passenger-side exterior rear view mirror. The mirror surface is convex (outwardly curved surface for a wider field of view). Objects in mirror are closer than they appear. Check your interior rear view mirror or glance over your shoulder before changing lanes.

Controls in detail

Good visibility

Activating exterior rear view mirror parking position*

Follow these steps to activate the mirror parking position so that the passenger-side exterior rear view mirror will be turned downward to the stored position.

The buttons are located above the exterior lamp switch.

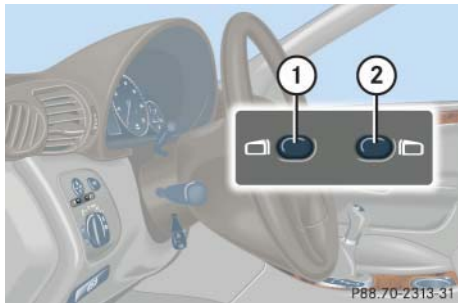

- ① Driver's side exterior rear view mirror button
- ② Passenger-side exterior rear view mirror button

- ▶ Make sure you have stored a parking position for the passenger-side exterior rear view mirror (▷ page 116).
- ▶ Make sure the **Mirror set. parking aid function** in the **Convenience** submenu of the control system is switched to **On** (▷ page 156).
- ▶ Switch on ignition (▷ page 33).
- ▶ Press button ② for the passenger-side exterior rear view mirror.
- ▶ Place the gear selector lever in reverse gear **R**.

The passenger-side exterior rear view mirror will be turned downward to the stored position.

The exterior rear view mirror returns to its previously stored driving position:

- ten seconds after you put the gear selector lever out of position **R**
- immediately once your vehicle exceeds a speed of approx. 6 mph (10 km/h)
- immediately when you press button ① for the driver's side exterior rear view mirror

Sun visors

The sun visors protect you from sun glare while driving.

Warning!



Do not use the vanity mirror while driving. Keep the mirrors in the sun visors closed while vehicle is in motion. Reflected glare can endanger you and others.

- Swing sun visors down when you experience glare.

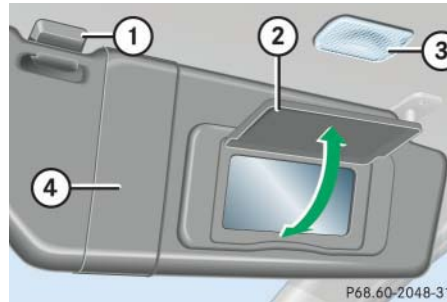

- ① Mounting
- ② Mirror cover
- ③ Mirror lamp
- ④ Sun visor

- To use illuminated mirror, lift up cover ②.

Controls in detail

Good visibility

i

If sunlight enters through a side window, disengage sun visor from mounting ① and pivot to the side.

The mirror lamp ③ will switch off.

Controls in detail

Good visibility

Rear window sunshade*

The switch is located in the center console.



① Rear window sunshade switch



Make sure that the movement of the rear window sunshade is not restricted by objects on the rear window shelf. Otherwise, the sunshade or the objects could be damaged.

- ▶ Switch on ignition (▷ page 33).

Always raise the sunshade fully for its support against the window frame.

Raising the sunshade

- ▶ Press switch ① briefly.
The sunshade is raised completely.

Stopping the raising procedure

- ▶ Press switch ① again.
The sunshade stops.

Lowering the sunshade

- ▶ Press switch ① briefly.
The sunshade is lowered completely.

Stopping the lowering procedure

- ▶ Press switch ① again.
The sunshade stops.

Warning!



When operating the rear window sunshade, make sure there is no danger of anyone being harmed by the raising or lowering procedure.

The raising or lowering procedure can be immediately halted by briefly pressing the switch.

Briefly press switch again to raise or lower the rear window sunshade completely.

Warning!





When leaving the vehicle, always remove the SmartKey from the starter switch, take it with you, and lock the vehicle. Do not leave children unattended in the vehicle, or with access to an unlocked vehicle. Unsupervised use of vehicle equipment can cause an accident and/or serious personal injury.

Rear window defroster

The rear window defroster uses a large amount of power. To keep the battery drain to a minimum, switch off the defroster as soon as the rear window is clear. The defroster is automatically deactivated after approximately 6 to 17 minutes of operation depending on the outside temperature.

Activating

- ▶ Press button  or  in the climate control panel (▷ page 179) or automatic climate control panel* (▷ page 189).

The indicator lamp on the button comes on.

Deactivating

- ▶ Press button  or  again.

The indicator lamp on the button goes out.

Controls in detail

Good visibility

Warning!



Any accumulation of snow and ice should be removed from the rear window before driving. Visibility could otherwise be impaired, endangering you and others.



If the rear window defroster switches off too soon and the indicator lamp starts flashing, this means that too many electrical consumers are operating simultaneously and there is insufficient voltage in the battery. The system responds automatically by deactivating the rear window defroster.

As soon as the battery has sufficient voltage, the rear window defroster automatically turns itself back on.

Controls in detail

Climate control

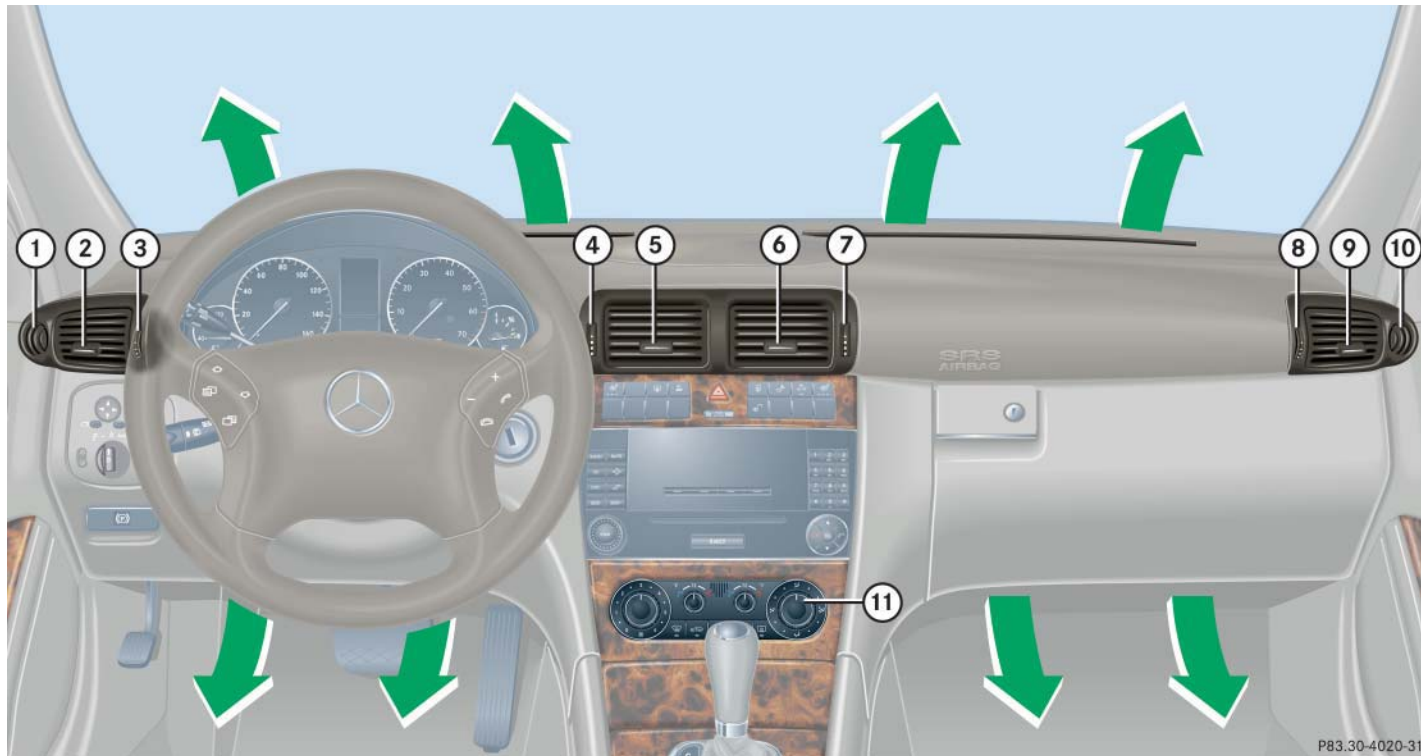

Item
① Left side defroster vent, fixed
② Left side air vent, adjustable
③ Thumbwheel for air volume control for left side air vent
④ Thumbwheel for air volume control for left center air vent
⑤ Left center air vent, adjustable
⑥ Right center air vent, adjustable
⑦ Thumbwheel for air volume control for right center air vent
⑧ Thumbwheel for air volume control for right side air vent
⑨ Right side air vent, adjustable
⑩ Right side defroster vent, fixed
⑪ Climate control panel



For draft-free ventilation, move the sliders for the air vents ②, ⑤, ⑥, and ⑨ to the middle position.

Depending on production date, your vehicle is equipped with either climate control panel design A or B.



Climate control panel design A



Climate control panel design B

Controls in detail

Climate control

Item
① Air volume control
② Left side temperature control
③ Right side temperature control
④ Air distribution control
⑤ Rear window defroster
⑥ AC cooling on/off (AC^{OFF} or A/C)
⑦ Air distribution and air volume (automatic mode)
⑧ Air recirculation
⑨ Defrosting

Controls in detail

Climate control

The climate control is operational whenever the engine is running. You can operate the climate control system in either the automatic or manual mode. The system cools or heats the interior depending on the selected interior temperature and the current outside temperature.

Warning!



When operating the climate control, the air that enters the passenger compartment through the air vents in the footwell can be very hot or very cold (depending on the set temperature). This may cause burns or frostbite on unprotected skin in the immediate area of the air vents. Always keep sufficient distance between unprotected parts of the body and the footwell air vents. If necessary, change the air flow using the air distribution controls to direct the air away from the footwell air vents (▷ page 182).

Nearly all dust particles, pollutants and odors are filtered out before outside air enters the passenger compartment through the air distribution system.

The air conditioning will not engage (no cooling) if mode **AC^{OFF}** is activated or mode **A/C** is deactivated (▷ page 185).

Warning!



Follow the recommended settings for heating and cooling given on the following pages. Otherwise the windows could fog up, impairing visibility and endangering you and others.



Severe conditions (e.g. strong air pollution) may require replacement of the filter before its scheduled interval. A clogged filter will reduce the air volume to the interior.

If the vehicle interior is hot, ventilate the interior before driving off, see “Opening (Summer opening feature)” (▷ page 247).

Keep the air intake grille in front of the windshield free of snow and debris.

Do not obstruct air flow by placing objects on the air flow-through exhaust slots below the rear window.

Deactivating the climate control system

Deactivating

- ▶ Set air volume control ① (▷ page 179) to position **0**.



When the air conditioning is switched off, the outside air supply and circulation are also switched off. Only choose this setting for a short time. Otherwise the windows could fog up.

Reactivating

- ▶ Set air volume control ① (▷ page 179) to any speed.

Setting the temperature

Use temperature controls ② and ③ (▷ page 179) to separately adjust the air temperature on each side of the passenger compartment. You should raise or lower the temperature setting in small increments, preferably starting at 72°F (22°C).



When operating the climate control system in automatic mode, you will only rarely need to adjust the temperature, air volume and air distribution.

Increasing

- ▶ Turn temperature control ② or ③ (▷ page 179) slightly to the right.

The climate control system will correspondingly adjust the interior air temperature.

Decreasing

- ▶ Turn temperature control ② or ③ (▷ page 179) slightly to the left.





The climate control system will correspondingly adjust the interior air temperature.

Controls in detail

Climate control

Adjusting air distribution and volume

Use air distribution control ④ (▷ page 179) to adjust the air distribution. The following symbols are found on the controls:

Symbol	Function
	Directs air to the windshield and the side defroster vents
	Directs air into the entire vehicle interior
	Directs air to the footwells
	Directs air through the center, side and rear passenger compartment air vents

Use the air volume control ① (▷ page 179) to adjust the air volume. You can select between six air volume speeds.

Adjusting manually

- ▶ Press button **AUTO** (▷ page 179).

The indicator lamp on the button goes out.



- ▶ Select any of the six air volume speeds and the air distribution.

Adjusting automatically

- ▶ Press button **AUTO** (▷ page 179).

The indicator lamp on the button comes on. The temperature, air distribution and volume are adjusted automatically.

Windshield fogged on the outside



- ▶ Switch the windshield wipers on (▷ page 51).
- ▶ Switch to manual mode.
- ▶ Turn air distribution control ④ to  or  (▷ page 179).

Defrosting



These settings should only be selected for a short time.

Activating

- ▶ Press button  or  (▷ page 179).

The indicator lamp on the button comes on.



The air conditioning switches automatically to the following functions:

- maximum blowing and heating power
- air flows onto the windshield and the front side windows
- the air recirculation mode is switched off

Controls in detail

Climate control

Deactivating

- ▶ Press button  or  (▷ page 179).

The indicator lamp on the button goes out. Defrosting is turned off.

Controls in detail

Climate control

Air recirculation mode

Switch to air recirculation mode to prevent unpleasant odors from entering the vehicle from the outside. This setting cuts off the intake of outside air and recirculates the air in the passenger compartment.

Warning!



When the outside temperature is below 41°F (5°C), only switch to air recirculation mode for short periods to prevent window fogging.

Window fogging may impair visibility and endanger you and others.

Activating

- ▶ Press button  (▷ page 179).

The indicator lamp on the button comes on.



If you keep button  pressed the side windows and tilt/sliding sunroof* will close.

Warning!



Never operate the side windows and the tilt/sliding sunroof* if there is the possibility of anyone being harmed by the closing procedure.

In the event that the closing procedure causes potential danger, the closing of the side windows can be immediately halted by pressing or pulling the respective window switch. The closing of the tilt/sliding sunroof* can be immediately halted by moving the tilt/sliding sunroof* switch in the overhead control panel in any direction.

The closing of the side windows and tilt/sliding sunroof* can be reversed by again pressing and holding the  button.



The air recirculation mode is activated automatically at high outside temperatures.

The indicator lamp on the  button is not lit when the air recirculation mode is automatically switched on.

After approx. 30 minutes, outside air is added to the air inside the vehicle.

If you have turned off the air conditioning (▷ page 185) or the outside temperature is below 41°F (5°C), the air recirculation mode will not switch on automatically.

Deactivating

- ▶ Press button  (▷ page 179).

The indicator lamp on the button goes out.



If you keep button  pressed the side windows and tilt/sliding sunroof* will return to their previous position.

The air recirculation mode is deactivated automatically:

- after five minutes if the outside temperature is below approximately 41°F (5°C)
- after five minutes if the air conditioning is turned off
- after 30 minutes if the outside temperature is above approximately 41°F (5°C)

At outside temperatures above 79°F (26°C) the system will not automatically switch back to outside air. A quantity of outside air is added after approximately 30 minutes.

Controls in detail

Climate control

Air conditioning

The air conditioning is operational while the engine is running and cools the interior air to the temperature set by the operator.



Condensation may drip out from underneath the vehicle. This is normal and not an indication of a malfunction.

Warning!



If you turn off the cooling function, the vehicle will not be cooled when weather conditions are warm. The windows can fog up more quickly. Window fogging may impair visibility and endanger you and others.

Controls in detail

Climate control

Deactivating

It is possible to deactivate the air conditioning (cooling) function of the climate control system. The air in the vehicle will then no longer be cooled or dehumidified.

Climate control panel design A

- ▶ Press button **AC^{OFF}** (▷ page 179).

The indicator lamp on the button comes on.

The cooling function switches off after a short delay.

Climate control panel design B

- ▶ Press button **A/C** (▷ page 179).

The indicator lamp on the button goes out.

The cooling function switches off after a short delay.

Activating

Moist air can fog up the windows. You can dehumidify the air with the air conditioning.

Climate control panel design A

- ▶ Press button **AC^{OFF}** (▷ page 179).

The indicator lamp on the button goes out.

Climate control panel design B

- ▶ Press button **A/C** (▷ page 179).

The indicator lamp on the button comes on.

The air conditioning uses the refrigerant R134a. This refrigerant is free of CFCs which are harmful to the ozone layer.



If the air conditioning cannot be turned on again, this indicates that the air conditioning is losing refrigerant. The compressor has turned itself off.

Have the air conditioning checked at the nearest authorized Mercedes-Benz Center.

Rear passenger compartment adjustable air vents

The air conditioning for the rear passenger compartment is controlled via the climate control panel (▷ page 179).



The temperature at the center air vents for the rear passenger compartment ① and ③ is the same as at the dashboard center air vents.

The air vents for the rear passenger compartment are located in the rear center console.

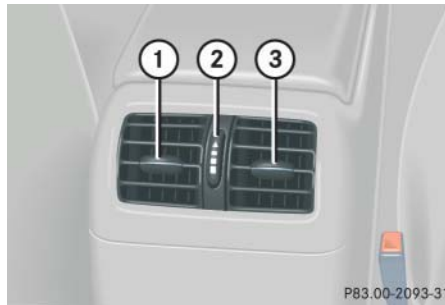

- ① Left center air vent
- ② Thumbwheel for air volume control for center air vents
- ③ Right center air vent

Controls in detail

Climate control

Adjusting air distribution

- ▶ Push the slide for the left center vent ① or right center vent ③ to the left, right, up, or down.

The air flow is directed in the corresponding direction.



For draft-free ventilation, push slides ① and ③ upward.

Adjusting air volume

- ▶ Turn thumbwheel ② up or down.

The air volume is increased or decreased.

Controls in detail

Automatic climate control*

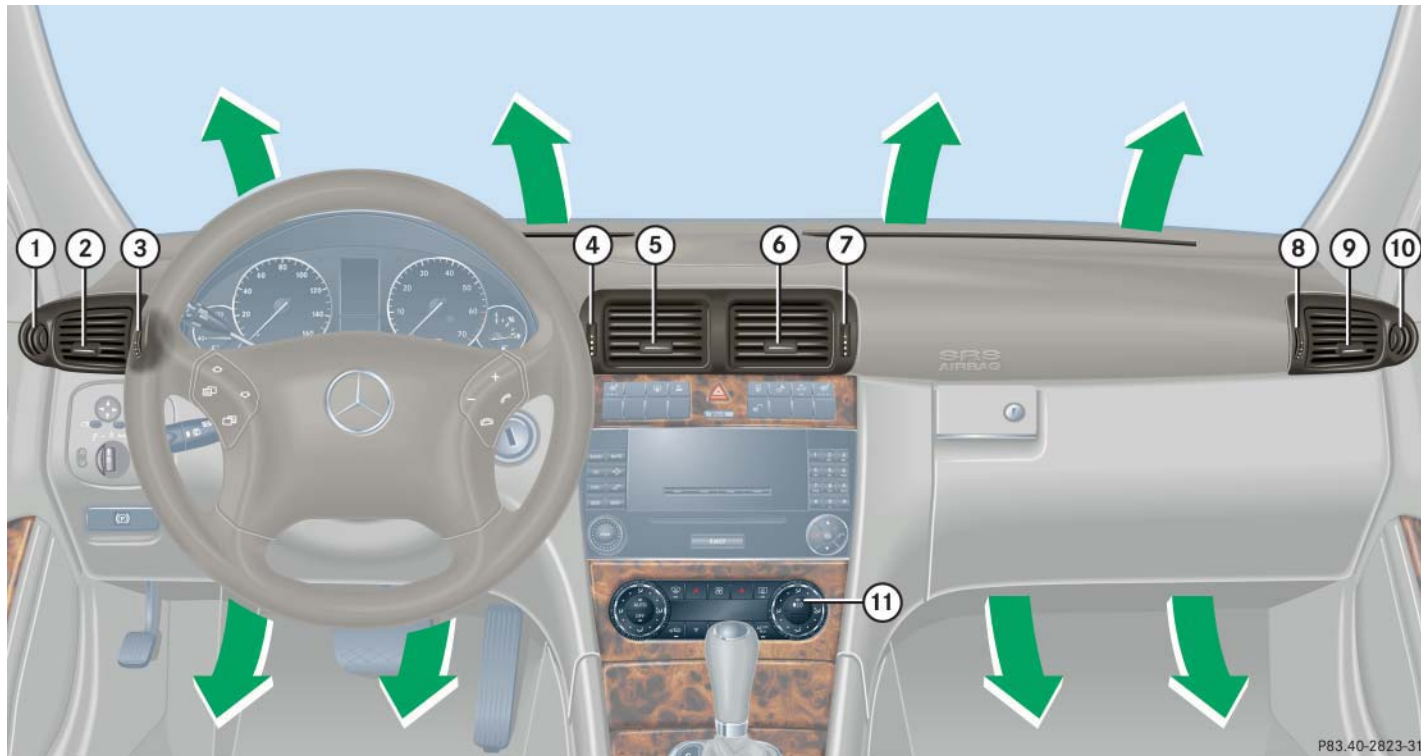

Item
① Left side defroster vent, fixed
② Left side air vent, adjustable
③ Thumbwheel for air volume control for left side air vent
④ Thumbwheel for air volume control for left center air vent
⑤ Left center air vent, adjustable
⑥ Right center air vent, adjustable
⑦ Thumbwheel for air volume control for right center air vent
⑧ Thumbwheel for air volume control for right side air vent
⑨ Right side air vent, adjustable
⑩ Right side defroster vent, fixed
⑪ Automatic climate control panel



For draft-free ventilation, move the sliders for the air vents ②, ⑤, ⑥, and ⑨ to the middle position.

Depending on production date, your vehicle is equipped with either automatic climate control panel design A or B.



Automatic climate control panel design A



Automatic climate control panel design B

Controls in detail

Automatic climate control*

Item
① Left side air distribution control
② Defrosting
③ Temperature control, left, raising
④ Display
⑤ Air volume control, raising
⑥ Temperature control, right, raising
⑦ Rear window defroster
⑧ Right side air distribution control
⑨ Charcoal filter
⑩ AC cooling on/off (AC ^{OFF} or A/C) Residual heat/ventilation
⑪ Temperature control, right, lowering
⑫ Air volume control, lowering
⑬ Temperature control, left, lowering
⑭ Air recirculation
⑮ Automatic climate control on/off (complete system)
⑯ Air distribution and air volume (automatic mode)

Controls in detail

Automatic climate control*



Feature availability is based on preliminary information at time of printing. The automatic climate control may not be available as optional equipment on all models.

The automatic climate control is operational whenever the engine is running. You can operate the climate control system in either the automatic or manual mode. The system cools or heats the interior depending on the selected interior temperature and the current outside temperature.

Warning



When operating the automatic climate control, the air that enters the passenger compartment through the air vents in the footwell can be very hot or very cold (depending on the set temperature). This may cause burns or frostbite on unprotected skin in the immediate area of the air vents. Always keep sufficient distance between unprotected parts of the body and the footwell air vents. If necessary change the air flow using the air distribution controls to direct the air away from the footwell air vents (▷ page 192).

Nearly all dust particles, pollutants and odors are filtered out before outside air enters the passenger compartment through the air distribution system.

The air conditioning will not engage (no cooling) if the mode **AC^{OFF}** is activated or mode **A/C** is deactivated (▷ page 198).

Warning!



Follow the recommended settings for heating and cooling given on the following pages. Otherwise the windows could fog up, impairing visibility and endangering you and others.



Severe conditions (e.g. strong air pollution) may require replacement of the filter before its scheduled interval. A clogged filter will reduce the air volume to the interior.

If the vehicle interior is hot, ventilate the interior before driving off, see “Opening (Summer opening feature)” (▷ page 247).

Keep the air intake grille in front of the windshield free of snow and debris.

Do not obstruct air flow by placing objects on the air flow-through exhaust slots below the rear window.

Deactivating the automatic climate control system

Deactivating

It is possible to deactivate the automatic climate control system.

- ▶ Press button **OFF** (▷ page 189).

The indicator lamp on the button **OFF** comes on.

The automatic climate control system is deactivated.



When the air conditioning is switched off, the outside air supply and circulation are also switched off. Only choose this setting for a short time. Otherwise the windows could fog up.

Reactivating

- ▶ Press button **OFF** (▷ page 189).

The indicator lamp on the button **OFF** goes out.

The automatic climate control system is reactivated.

Setting the temperature

Use temperature controls ③ and ⑬ for the left side or ⑥ and ⑪ for the right side (▷ page 189) to separately adjust the air temperature on each side of the passenger compartment. You should raise or lower the temperature setting in small increments, preferably starting at 72°F (22°C).



When operating the automatic climate control system in automatic mode, you will only rarely need to adjust the temperature, air volume and air distribution.

Controls in detail

Automatic climate control*

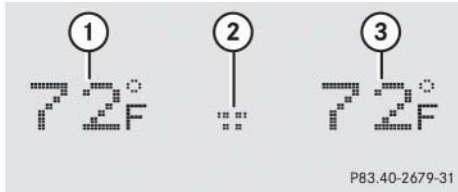

Display

- ① Temperature, left
- ② Blower speed
- ③ Temperature, right

Increasing

- ▶ Push temperature control ③ and/or ⑥ (▷ page 189).

The automatic climate control system will correspondingly adjust the interior air temperature.

Decreasing

- ▶ Push temperature control ⑪ and/or ⑬ (▷ page 189).

The automatic climate control system will correspondingly adjust the interior air temperature.

Adjusting air distribution

Use the button **AUTO** for automatic mode or air distribution controls ① and ⑧ (▷ page 189) to separately adjust the air distribution on each side of the passenger compartment. The following symbols are found on the controls:

Symbol	Function
	Directs air to the windshield and the side defroster vents
	Directs air into the entire vehicle interior
	Directs air to the footwells
	Directs air through the center, side and rear passenger compartment air vents

Adjusting manually

- ▶ Turn air distribution control ① or ⑧ (▷ page 189) to the desired symbol.

The indicator lamp on the button **AUTO** goes out.

The automatic air distribution is switched off. The air distribution is controlled according to the selected control setting.



Adjusting automatically

- ▶ Press button **AUTO** (▷ page 189).



The indicator lamp on the button comes on.

The air volume is controlled automatically for the entire vehicle, and the air distribution is controlled automatically for each separate half of the vehicle.

Windshield fogged on the outside



- ▶ Switch the windshield wipers on (▷ page 51).
- ▶ Switch to manual mode.
- ▶ Turn air distribution control ① or ⑧ to  or  (▷ page 189).

Adjusting air volume

Use button **AUTO** for automatic mode or air volume controls  or  (▷ page 189) to adjust air volume manually.

Adjusting manually

Seven blower speeds are available.

- ▶ Press air volume control  or  (▷ page 189) until the requested blower speed is attained.

The indicator lamp on the button **AUTO** goes out.

The automatic air distribution remains switched on.

Controls in detail

Automatic climate control*

Adjusting automatically

- ▶ Press button **AUTO** (▷ page 189).

The indicator lamp on the button comes on.

The air volume is controlled automatically for the entire vehicle, and the air distribution is controlled automatically for each separate half of the vehicle.

Controls in detail



Automatic climate control*

Defrosting



These settings should only be selected for a short time.

Activating



- ▶ Press button  or  (▷ page 189).

The indicator lamp on the button comes on.

The air conditioning switches automatically to the following functions:

- maximum blowing and heating power
- air flows onto the windshield and the front side windows
- the air recirculation mode is switched off

Deactivating

- ▶ Press button  or  (▷ page 189).

The indicator lamp on the button goes out. Defrosting is turned off.

The previous settings are once again in effect.

Maximum cooling MAXCOOL

If the left and right air distribution controls as well as the airflow volume control are set to **AUTO** (▷ page 189) and there is a high need for cooling, the display “MAXCOOL” appears.

This provides the fastest possible cooling of the vehicle interior (when side windows and tilt/sliding sunroof* are closed).

Air recirculation mode

Switch to air recirculation mode to prevent unpleasant odors from entering the vehicle from the outside. This setting cuts off the intake of outside air and recirculates the air in the passenger compartment.

Warning!



When the outside temperature is below 41°F (5°C), only switch to air recirculation mode for short periods to prevent window fogging.

Window fogging may impair visibility and endanger you and others.

Activating

- ▶ Press button  (▷ page 189).
The indicator lamp on the button comes on.



If you keep button  pressed the side windows and tilt/sliding sunroof* will close.

Warning!



Never operate the side windows and the tilt/sliding sunroof* if there is the possibility of anyone being harmed by the closing procedure.

In the event that the closing procedure causes potential danger, the closing of the side windows can be immediately halted by pressing or pulling the respective window switch. The closing of the tilt/sliding sunroof* can be immediately halted by moving the tilt/sliding sunroof* switch in the overhead control panel in any direction.

The closing of the side windows and tilt/sliding sunroof* can be reversed by again pressing and holding the button .

Controls in detail

Automatic climate control*



The air recirculation mode is activated automatically:

- at high outside temperatures
- if the concentration of carbon monoxide and nitrogen oxide in the outside air increases, for example in a tunnel (charcoal filter must be activated for the air recirculation mode to be activated automatically)

The indicator lamp on the button  is not lit when the air recirculation mode is automatically switched on.

After approx. 30 minutes, outside air is added to the air inside the vehicle.

If you have turned off the air conditioning (▷ page 198) or the outside temperature is below 41°F (5°C), the air recirculation mode will not switch on automatically.

Controls in detail

Automatic climate control*

Deactivating

- Press button  (▷ page 189).

The indicator lamp on the button goes out.



If you keep button  pressed the side windows and tilt/sliding sunroof* will return to their previous position.

The air recirculation mode is deactivated automatically:

- after five minutes if the outside temperature is below approximately 41°F (5°C)
- after five minutes if the air conditioning is turned off
- after 30 minutes if the outside temperature is above approximately 41°F (5°C)

At outside temperatures above 79°F (26°C) the system will not automatically switch back to outside air. A quantity of outside air is added after approximately 30 minutes.

Charcoal filter



An activated charcoal filter markedly reduces bad odors and removes pollutants from air entering the passenger compartment. The charcoal filter can be activated or deactivated.

The system switches automatically to the air recirculation mode, if the

- carbon monoxide (CO)
- or
- nitrogen oxide (NO_x)

concentration of the outside air increases beyond a predetermined level.



The automatic air recirculation mode does not function if the **AC^{OFF}** mode is activated (indicator lamp on button  illuminated) or **A/C** mode is deactivated (indicator lamp on button  not lit), or if the outside temperature has fallen below 41°F (5°C).

Activating

- ▶ Press button  (▷ page 189).

The indicator lamp on the button comes on.



If you keep button  pressed the side windows and tilt/sliding sunroof* will close.



The activated charcoal filter should be switched off when windows fog up on the inside, or if the passenger compartment needs to be quickly heated or cooled down.

Warning!



Never operate the side windows and the tilt/sliding sunroof* if there is the possibility of anyone being harmed by the closing procedure.

In the event that the closing procedure causes potential danger, the closing of the side windows can be immediately halted by pressing or pulling the respective window switch. The closing of the tilt/sliding sunroof* can be immediately halted by moving the tilt/sliding sunroof* switch in the overhead control panel in any direction.

The closing of the side windows and tilt/sliding sunroof* can be reversed by again pressing and holding the button .

Controls in detail

Automatic climate control*

Deactivating

- ▶ Press button  (▷ page 189).

The indicator lamp on the button goes out.



If you keep button  pressed the side windows and tilt/sliding sunroof* will return to their previous position.

Controls in detail

Automatic climate control*

Air conditioning

The air conditioning is operational while the engine is running and cools the interior air to the temperature set by the operator.



Condensation may drip out from underneath the vehicle. This is normal and not an indication of a malfunction.

Warning!



If you turn off the cooling function, the vehicle will not be cooled when weather conditions are warm. The windows can fog up more quickly. Window fogging may impair visibility and endanger you and others.

Deactivating

It is possible to deactivate the air conditioning (cooling) function of the automatic climate control system. The air in the vehicle will then no longer be cooled or dehumidified.

Automatic climate control panel design A

- ▶ Press button  (▷ page 189).

The indicator lamp on the button comes on.

The cooling function switches off after a short delay.

Automatic climate control panel design B

- ▶ Press button  (▷ page 189).

The indicator lamp on the button goes out.

The cooling function switches off after a short delay.

Activating

Moist air can fog up the windows. You can dehumidify the air with the air conditioning.

Automatic climate control panel design A

- ▶ Press button  (▷ page 189) again.

The indicator lamp on the button goes out.

The cooling function is switched on.

Automatic climate control panel design B

- ▶ Press button  (▷ page 189) again.

The indicator lamp on the button comes on.

The cooling function is switched on.

The air conditioning uses the refrigerant R134a. This refrigerant is free of CFCs which are harmful to the ozone layer.



If the air conditioning cannot be turned on again, this indicates that the air conditioning is losing refrigerant. The compressor has turned itself off.

Have the air conditioning checked at the nearest authorized Mercedes-Benz Center.

Residual heat and ventilation (available on automatic climate control panel design A only)

With the engine switched off, it is possible to continue to heat or ventilate the interior for up to 30 minutes. This feature makes use of the residual heat produced by the engine.

Activating

- ▶ Switch off ignition (▷ page 56).
- ▶ Press button  (▷ page 189).

The indicator lamp on the button comes on.

Controls in detail

Automatic climate control*

Deactivating

- ▶ Press button  (▷ page 189).

The indicator lamp on the button goes out.

The residual heat is automatically turned off:

- when the ignition is switched on
- after about 30 minutes
- if the battery voltage drops



How long the system will provide heating depends on

- the coolant temperature
- the temperature set by the operator

The blower will run at speed setting 1 regardless of the air distribution control setting.

Controls in detail

Automatic climate control*

Rear passenger compartment adjustable air vents

The air conditioning for the rear passenger compartment is controlled via the automatic climate control panel (▷ page 189).



The temperature at the center air vents for the rear passenger compartment ① and ③ is the same as at the dashboard center air vents.

The air vents for the rear passenger compartment are located in the rear center console.



- ① Left center air vent
- ② Thumbwheel for air volume control for center air vents
- ③ Right center air vent

Adjusting air distribution

- ▶ Push the slide for the left center vent ① or right center vent ③ to the left, right, up, or down.

The air flow is directed in the corresponding direction.



For draft-free ventilation, push slides ① and ③ upward.

Adjusting air volume

- ▶ Turn thumbwheel ② up or down.

The air volume is increased or decreased.

▼ Audio system

Audio and telephone, operation

These instructions are intended to help you become familiar with your Mercedes-Benz audio system. They contain useful tips and a detailed description of the user functions.

Warning!



In order to avoid distraction which could lead to an accident, the driver should enter system settings with the vehicle at a standstill and operate the system only when road and traffic conditions permit. Always pay full attention to traffic conditions first before operating system controls while driving.

Bear in mind that at a speed of just 30 mph (approximately 50 km/h), your car is covering a distance of 44 feet (approximately 14 m) every second.

Operating safety

Warning!



Any alterations made to electronic components can cause malfunctions.

The radio, amplifier, CD changer*, satellite radio*, and telephone* are interconnected. When one of the components is not operational or has not been removed/replaced properly, the function of other components may be impaired.

This condition might seriously impair the operating safety of your vehicle.

We recommend that you have any service work on electronic components carried out by an authorized Mercedes-Benz Center.

Controls in detail

Audio system

Operating and display elements

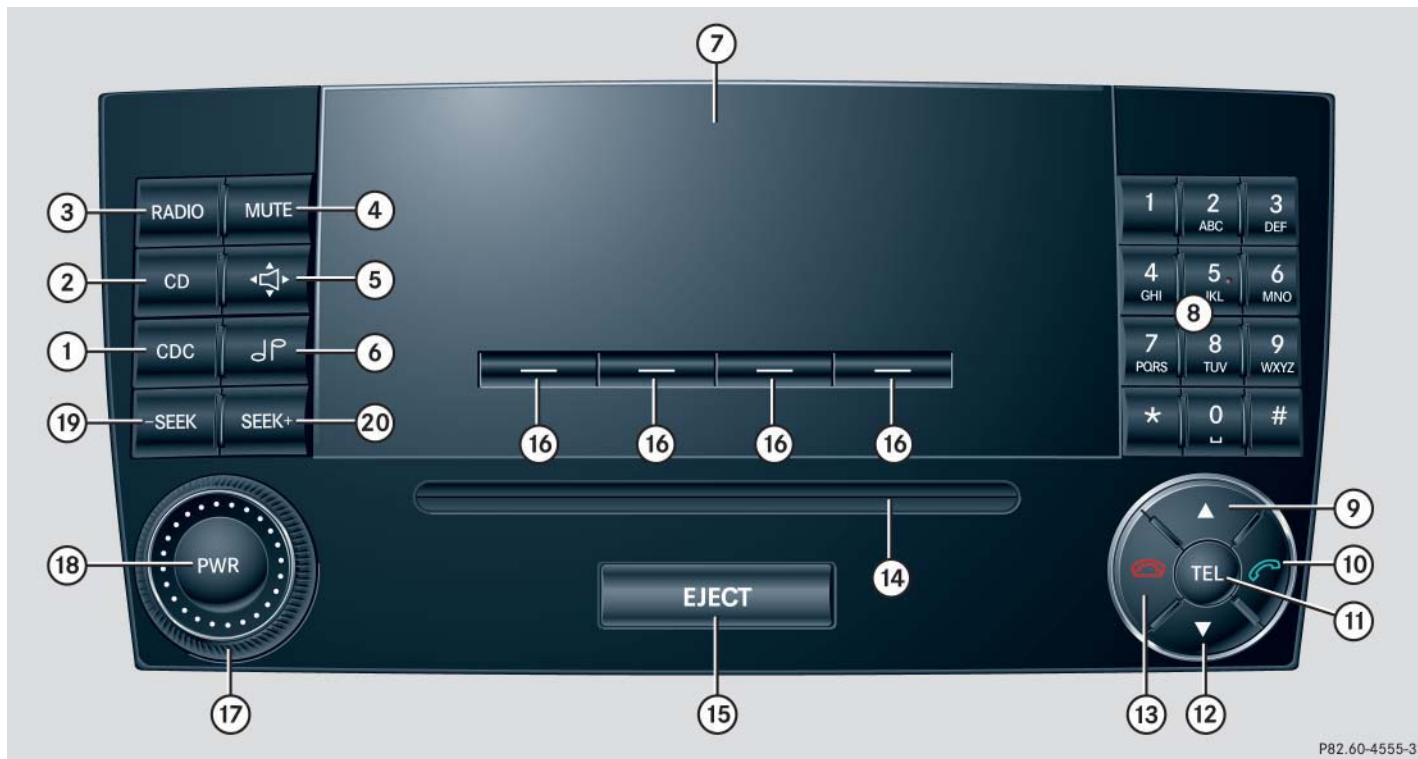

P82.60-4555-31

Controls in detail

Audio system

Item	Page
① CD changer mode selector	219
AUX mode selector	209
② Single CD mode selector	221
③ Radio mode selector	
④ Mute function (radio)	213
Pause (CD)	225
⑤ Volume distribution	207
⑥ Sound settings	205
⑦ Display	
⑧ Alphanumeric keypad	

Item	Page
⑨ Speed dialing memory (telephone) in descending order	
⑩ Accepting a call (telephone)	231
⑪ Telephone mode selector	226
⑫ Speed dialing memory (telephone) in ascending order	227
⑬ Terminating a call (telephone)	231
⑭ CD slot	
⑮ CD ejection	221

Item	Page
⑯ Soft keys	204
⑰ Volume	205
⑱ Switching on/off	204
⑲ Manual tuning / seek tuning (radio)	211
Track search, reverse (CD)	224
⑳ Manual tuning / seek tuning (radio)	211
Track search, fast forward (CD)	224

Controls in detail

Audio system

Button and soft key operation

In these instructions, the alphanumeric keypad (right side of radio panel) and the function buttons (left side of radio panel) are referred to as “buttons”. The four keys below the display panel are referred to as “soft keys”.



Do not press directly in the display face. Otherwise, the display will be damaged.

Operation

Switching the unit on/off

Switching on

- ▶ Turn the SmartKey in the starter switch to position **1** or **2**.
- ▶ If the audio system was on as you removed the SmartKey from the starter switch, the audio system will automatically come back on as you turn the SmartKey to position **1** or **2**.

or

- ▶ Press  button.



If the radio is switched on without the key in the starter switch, it will automatically switch off again after approx. 30 minutes.

If your vehicle is equipped with a telephone, the display may prompt you to enter your PIN (GSM network) or code (TDMA or CDMA network).

Switching off

- ▶ Remove SmartKey from starter switch.
or
- ▶ Press  button.



Should excessively high temperatures occur while the audio system is being operated, the display will dim. If temperatures continue to rise, HIGH TEMP will appear in the display, after which the audio system will be switched off for a cooling-down period.

Adjusting the volume

- ▶ Turn rotary control of  button.
The volume will increase or decrease depending on the direction turned.



If your vehicle equipment includes a Mercedes-Benz specified mobile telephone*, you can adjust its volume separately from the volume of the audio system while the telephone is being used.

Adjusting sound functions

The bass and treble functions are called up by pressing the  button.

Settings for bass and treble are stored separately for the AM and FM wavebands, weather band, CD mode and telephone mode.

Bass

- ▶ Press  button repeatedly until BASS appears in the display.

Controls in detail

Audio system



- ▶ Press + or - soft key to increase or decrease tone level accordingly.
or
- ▶ Press RES soft key briefly to reset bass tones to their center level.
The radio switches back to the standard radio menu eight seconds after the last soft key is pressed.

Controls in detail

Audio system

Adjusting treble

- ▶ Press **⏮** button repeatedly until TREBLE appears in the display.



- ▶ Press + or - soft key to increase or decrease tone level accordingly.

or

- ▶ Press RES soft key briefly to reset treble tones to their center level.

The radio switches back to the standard radio menu eight seconds after the last soft key is pressed.

Sound system*

You can either program the sound settings manually (▷ page 205) or choose settings via preset sound characteristics.

You can select from among the following settings:

- STANDARD: conventional stereo sound.
 - SURROUND: the sound is set for better three-dimensional acoustic characteristics.
 - SPEECH: the sound is optimized for the spoken word.
- ▶ Press **⏮** button repeatedly until STANDARD, SURROUND, or SPEECH appears in the display.

- ▶ Press <<< or >>> soft key repeatedly until the desired sound setting has been reached.

The sound is set accordingly.

or

- ▶ Press RES soft key briefly.

The sound setting is reset depending on the sound source activated.

- Radio mode: STANDARD
- CD/AUX mode: SURROUND
- Telephone: SPEECH

The radio switches back to the standard radio menu eight seconds after the last soft key is pressed.

Returning sound functions to factory settings

- ▶ Press  button to call up settings menu in the display.



P82.60-4452-31

- ▶ Press RES soft key briefly; the respective sound function is reset to its center level.

or

- ▶ Press and hold RES soft key until RESET appears in the display.

The sound settings for bass and treble are returned to their center level and the volume is set to a predefined level.

Vehicles with sound system*:

The sound setting is reset depending on the sound source activated.

- Radio mode: STANDARD
- CD/AUX mode: SURROUND
- Telephone: SPEECH

The radio switches back to the standard radio menu four seconds after the last soft key is pressed.

Adjusting volume distribution

Call up fader and balance functions by pressing the  button.

Fader



- ▶ Press  button repeatedly until FADER appears in the display.

Controls in detail

Audio system



P82.60-4470-31

- ▶ Press  or  soft key.

The volume is distributed accordingly between the front and rear of the vehicle.

or

- ▶ Press RES soft key briefly.

The fader is reset to its center level.

The radio switches back to the standard radio menu eight seconds after the last soft key is pressed.

Controls in detail

Audio system

Adjusting balance

- ▶ Press  button repeatedly until BALANCE appears in the display.



- ▶ Press <<< or >>> soft key.
The volume is distributed between the left and right sides of the vehicle.

or

- ▶ Press RES soft key briefly.
The balance is reset to its center level.
The radio switches back to the standard radio menu eight seconds after the last button is pressed.

Returning volume distribution to factory settings

- ▶ Press  button to call up settings menu in the display.



- ▶ Press RES soft key briefly; the respective volume distribution is reset to its center (flat) level.

or

- ▶ Press and hold RES soft key until RESET appears in the display.

The volume distribution settings for fader and balance are set to their center level.

The radio switches back to the standard radio menu four seconds after the last soft key is pressed.

Telephone* muting

If your vehicle equipment includes a Mercedes-Benz specified mobile telephone*, you can adjust its volume separately from the volume of the audio system while the telephone is being used.

Connecting an external audio source (AUX) to the radio*

An optional dealer-installed cinch-connector* for connecting an external audio source may become available for your vehicle model. Feature description is based on preliminary information at time of printing. Contact an authorized Mercedes-Benz Center for availability.

You can adjust the volume (▷ page 205), the sound settings (▷ page 205) and the volume distribution (▷ page 207) for the AUX input.

Calling up AUX mode

- ▶ Press and hold **CD** button until AUX appears in the display.

Canceling AUX mode

- ▶ Press any audio source button.

Radio operation

Selecting radio mode

- ▶ Press **RADIO** button.

Calling up wavebands

You can choose from among the FM, AM, and WB wavebands.

Weather band (▷ page 213).



FM waveband:	87.7.....107.9 MHz
AM waveband:	530.....1710 KHz

Calling up wavebands for radios without SAT

- ▶ Press FM or AM soft key to switch between FM and AM.

The FM and AM wavebands are called up one after another.

or

- ▶ Press WB soft key.

The weather band menu is called up.

The waveband currently selected appears in the upper left-hand corner of the display.

Controls in detail

Audio system

Calling up wavebands for radios with SAT

- ▶ Press FM, AM, or WB soft key repeatedly until desired waveband has been selected.

The FM, AM, and WB wavebands are called up one after another.

The waveband currently selected appears in the upper left-hand corner of the display.

Selecting a station

The following options are available for selecting a station:

- Direct frequency input (▷ page 210)
- Manual tuning (▷ page 211)
- Automatic seek tuning (▷ page 211)
- Scan search (▷ page 211)
- Station memory (▷ page 212)
- Automatic station memory (Autostore) (▷ page 212)

The station search proceeds in the following frequency increments:

- 200 kHz in FM range
- 10 kHz in AM range

Direct frequency input

- ▶ Select desired waveband.



- ▶ Press ***** button.
- ▶ Enter desired frequency with buttons **1** to **0**.



You can only enter frequencies within the respective waveband.

If a button is not pressed within four seconds, the radio will return to the last station tuned.

Manual tuning

- ▶ Select desired waveband.
- ▶ Press **SEEK+** or **SEEK-** button for approx. three seconds.
- ▶ Press button repeatedly until desired frequency has been reached.

Step-by-step station tuning takes place in ascending or descending order. Each time the button is pressed, the radio tunes further by 0.2 MHz. During manual tuning, the radio is muted.

Automatic seek tuning

- ▶ Select desired waveband.
- ▶ Press **SEEK+** or **SEEK-** button briefly.

The radio will tune to the next highest or next lowest receivable frequency.



If no station is received after two consecutive scans of the complete frequency range, then the scan stops at the frequency from which it began.

Controls in detail

Audio system

Scan search

- Starting scan search
 - ▶ Select desired waveband.



- ▶ Press **SC** soft key.

SC will appear in the display. The radio briefly tunes in all receivable stations on the waveband selected.

Controls in detail

Audio system

- Ending scan search
 - ▶ Press **SC** soft key or **SEEK+** or **-SEEK**.
The station last played will be selected and **SC** disappears from the display.

Station memory

You can store ten AM and ten FM stations in the memory.

- Storing stations
 - ▶ Tune in desired station.

- ▶ Press and hold desired station button **1** to **0** until a brief signal tone is heard.

The frequency is stored on the selected station button.

- Calling up stations

- ▶ Press desired station button **1** to **0** briefly.

Autostore – automatic station memory

The Autostore memory function provides an additional memory level. The station memory for manually stored stations is not overwritten.

- Calling up Autostore memory level and storing stations

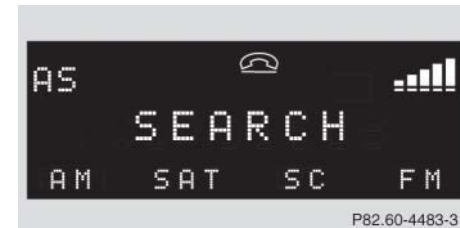

- ▶ Press **AS** soft key briefly.

The radio switches to the Autostore memory level. **AS** and **SEARCH** appear in the display and the radio finds the ten stations with the strongest signals. These stations are stored on the station buttons **1** to **0** in order of signal strength.

- Calling up stations
 - ▶ Press desired station button **1** to **0**.
- Leaving the Autostore memory level
 - ▶ Press FM or AM soft key briefly.

Interrupting radio mode

The radio mode is interrupted by an incoming call on the telephone* (▷ page 231).

- Mute on
 - ▶ Press **MUTE** button.

The radio mode is interrupted and MUTED appears in the display.
- Mute off
 - ▶ Press **MUTE** button.

The radio mode is again active.

Weather band



- ▶ Press WB soft key.
- The weather band station last received is tuned in.

Controls in detail

Audio system

Selecting a weather band station directly

- ▶ Select desired weather band station with buttons **1** to **7**.

If a station cannot be tuned in, a search is automatically started.

Search

- ▶ Press **SEEK+** or **-SEEK** button to tune in the next receivable weather band station.



If no weather band station is received after three consecutive scans of the complete frequency range, then the scan stops at the channel with which it began and NO WB FOUND appears in the display.

If this happens, switch back to standard radio mode.

Controls in detail

Audio system

Scan search

- Starting scan search
 - ▶ Press **SC** soft key.
SC will appear in the display. The radio briefly tunes in all receivable weather band stations.
- Ending scan search
 - ▶ Press **SC** soft key or **SEEK+** or **-SEEK**.
The weather band station last played will be selected and **SC** disappears from the display.

Introduction to satellite radio* (USA only)

SIRIUS satellite radio provides 100 channels of digital-quality radio, among others music, sports, news, and entertainment, free of commercials. SIRIUS satellite radio uses a fleet of high-power satellites to broadcast 24 hours per day, coast to coast, in the contiguous U.S.

This diverse, satellite-delivered programming is available for a monthly subscription fee.

For more information and service availability call the SIRIUS Service Center (▷ page 219), or contact www.siriusradio.com.



Additional satellite radio equipment and a subscription to a satellite radio service provider are required for the satellite radio operation described here.

Contact an authorized Mercedes-Benz Center for details and availability for your vehicle.

Note that categories and channels shown in illustrations are dependent on programming content delivered by the service provider. Programming content is subject to change. Therefore, channels and categories shown in illustrations and descriptions contained in this manual may differ from the channels and categories delivered by the service provider.



Satellite radio service may be unavailable or interrupted from time to time for a variety of reasons, such as environmental or topographic conditions and other things beyond the service provider's or our control. Service might also not be available in certain places (e.g., in tunnels, parking garages, or within or next to buildings) or near other technologies.

Program categories

The channels are categorized. Categories allow you to tune to stations broadcasting a certain type of program (category mode) (▷ page 217).

Calling up the SAT main menu

- ▶ Press SAT soft key.

SAT is displayed in the upper left-hand corner of the display.

Prior to activation of the satellite radio service (▷ page 215).

After activation of satellite radio service (▷ page 215).

Prior to activation of the satellite radio service



The telephone number of the SIRIUS Service Center (888-539-7474) is displayed.

Controls in detail

Audio system

- ▶ Press ESN soft key.

The twelve-digit electronic serial number (ESN) of the SAT tuner* installed in your vehicle is displayed.

This information is required to call the SIRIUS Service Center for an activation request.



Credit card information may also be required for your application.

The activation process takes approximately five to ten minutes after calling the SIRIUS Service Center.

After activation of the satellite radio service

The satellite radio main menu appears. The radio station selected last is audible, provided it can be received.

Controls in detail

Audio system



The system will tune to a default station if no station had been selected previously.



The first channel 001 is called up and the PTY system changes to All categories.

If no station can be received, **ACQUIRING** appears in the display.

If the Satellite radio service is not activated, **ACQUIRING** will also appear in the radio display and **NO SAT** will appear in the multifunction display.

Selecting a station

The following options are available:

- Selecting a station using the selected category (▷ page 217).
- Tuning via station presets (▷ page 216).
- Tuning via scan search (▷ page 218).
- Tuning via manual channel input (▷ page 216).
- Tuning via the program category list (▷ page 217).

Tuning via station presets

Ten satellite radio station presets are available.

You can access the presets via number keys.

Accessing via number keys

- ▶ Enter number of preset you wish to select, e.g. **1**.

The radio plays the station stored under this number and the PTY function changes to the category corresponding to the station.

Tuning via manual channel input



Example: tuning in channel 16

- ▶ Press ***** button.
Input line appears in the main radio menu.
- ▶ Use number keys to enter desired channel within eight seconds, e.g. **1** **6** MNO.
The system tunes to channel 16.
The station you have selected begins to play.



You can only enter available channel numbers.

Tuning via the program category list

The category list contains all currently receivable categories of programs. It is arranged alphabetically.

- Selecting a category
 - ▶ Press PTY soft key.



The current PTY category of the station is displayed.

- ▶ Press **<<<** or **>>>** soft key.
This switches between the individual categories.

When changing the category, the channel selected last in the new category becomes audible.

Controls in detail

Audio system

The system will automatically switch to a station of the selected category if the currently selected station is not of the selected category. Otherwise, the currently selected station remains tuned.

- Tuning a station within the selected category

The channels identified for the currently selected category are arranged numerically. Only one entry is visible at a time.

- ▶ Press **SEEK+** or **-SEEK** button briefly.
The next station within the category is started.

or

- ▶ Press and hold **SEEK+** or **-SEEK** button for approx. three seconds until desired station has been reached.

Controls in detail

Audio system

Tuning via scan search

Scan search is characterized as follows:

- Scan search plays a channel for approx. eight seconds and then skips to the next channel within the current category.
- Scan search can be terminated manually.
- ▶ Press **SC** soft key.
The search starts. **SC** appears in the display.
- ▶ Press **SC** soft key again.
The search stops.

Obtaining additional text information

Additional text information (artist, title) related to the current channel can be displayed.

- ▶ Press **INF** soft key.

The title being played is displayed.

- ▶ Press **INF** soft key again.

The name of the artist performing the title being played is displayed.



If a button is not pressed within four seconds, the radio will return to the standard display.

Storing stations

- ▶ Tune in desired station.
- ▶ Press and hold desired station button **1** to **0** until a brief signal tone is heard.

The frequency is stored on the selected station button.

The radio saves the current station at the memory preset selected. The memory preset selected appears in the status line, e.g. S3.



There are ten presets available.

An existing entry is overwritten in the memory list when a new entry is given.

Controls in detail

Audio system

Calling up the ESN information menu

- ▶ Press INF soft key.
- ▶ Press ESN soft key.

The twelve-digit electronic serial number (ESN) of the SAT tuner* installed in your vehicle is displayed.

- ▶ Press RET soft key to exit the menu.

CD mode

Safety precautions

Warning!



The single CD player and the CD changer* are Class 1 laser products. There is a danger of invisible laser radiation if the housing is opened or damaged.

Do not open the housing. The single CD player and the CD changer* do not contain any parts that can be serviced by the user. For safety reasons, have any service work which may be necessary performed only by qualified personnel.

Warning!



In order to avoid distraction which could lead to an accident, the driver should insert CDs with the vehicle at a standstill and operate the audio system only if permitted by road, weather and traffic conditions. Bear in mind that at a speed of just 30 mph (approximately 50 km/h), your car covers a distance of 44 feet (approximately 14 m) every second.

General notes

The system may not be able to play audio CDs with copy protection.

Playing copied CDs may cause malfunctions during playback.

Controls in detail

Audio system



If you affix stickers to the CDs, they can become warped due to the heat that develops in the CD drive or CD changer.

In certain situations, the CDs can then no longer be ejected and cause damage to the drive. Such damage is not covered by the Mercedes-Benz Limited Warranty.



Your CD drive or CD changer has been designed to play CDs which correspond to the EN 60908 standard. You can therefore only use CDs with a maximum thickness of 1.3 mm.

If you insert thicker data carriers, e.g. ones that have data on both sides (one side with DVD data, the other side with audio data), they cannot be ejected and will damage the drive.

Do not use CDs with an eight cm diameter, not even with a CD adapter. Attempting to play CDs with an eight cm diameter or playing such CDs with an adapter may cause damage to the CD drive. Such damage is not covered by the Mercedes-Benz Limited Warranty.

Should excessively high or low temperatures occur while in CD changer mode*, CD TEMP will appear in the display, and the CD will be muted until the temperature has reached an acceptable level for the system to continue operation.

The single CD player and the CD changer* play audio CDs.

Tips on handling CDs

- Handle CDs carefully to prevent interference during playback.
- Avoid scratches, fingerprints and dust on the CDs.
- Do not write on CDs or apply any labels or other material to them.
- Clean CDs from time to time with a commercially available cleaning cloth. Never wipe the CD in a circular motion; instead, wipe it in a straight line starting in the center and moving outward. Do not use solvents, anti-static sprays, etc. for cleaning.
- Replace the CD in its case after use.
- Protect CDs from heat and direct sunlight.

Operating the single CD player in the audio system unit

Loading a CD

The single CD player in the audio system unit has capacity for one CD. The CD slot for loading the drive is located underneath the soft keys.

- ▶ Make sure the system is switched on.
- ▶ Insert CD into CD slot. The label side of the CD must face upwards.

The system automatically pulls the CD into the CD slot. The audio CD begins to play.



If a CD is already loaded, it must be ejected before inserting a new CD. Inserting a second CD in the slot with another CD still loaded will cause damage to the CD drive not covered by the Mercedes-Benz Limited Warranty.



If a CD has been inserted incorrectly or cannot be read, **WRONG CDO** will appear in the display.

Ejecting a CD

- ▶ Make sure the system is switched on.
- ▶ Press **EJECT** button.
The system ejects the CD. **NO CD** will appear in the display.
- ▶ Remove CD from slot.



If you do not take the CD out of the CD slot within approx. 15 seconds, the system automatically pulls the CD back in and plays it.

If a CD is pulled back in, press **EJECT** button for five seconds; the CD will then be ejected.

Operational readiness of CD changer*

If a CD changer* has been installed in the vehicle, it can be operated from the front control panel of the audio system.

A loaded magazine must be installed to play CDs.

The CD changer is located in the glove box.

Loading/unloading the CD magazine



The CD changer* may not be able to play audio CDs with copy protection.

- ▶ Slide changer door to the right and press  button.
- ▶ Magazine will be ejected.

Controls in detail

Audio system

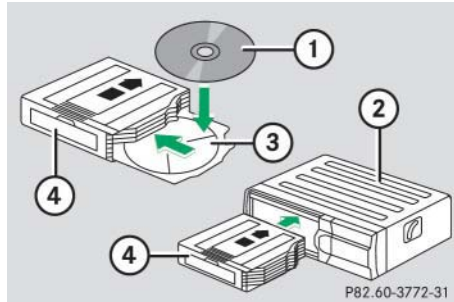

- ① CD
- ② CD changer
- ③ CD tray
- ④ CD magazine

- ▶ Remove magazine ④ and pull CD tray ③ fully out.
- ▶ Place CD ① in recess of tray, label side up.

- ▶ Push tray into magazine in direction of arrow.



CDs which have been inserted improperly or are unreadable will not be played.

- ▶ Push magazine into CD changer* ② in direction of arrow and close sliding door.

Playing CDs

Single CD player in the audio unit

- ▶ Press **CD** button.

CD 0 will appear in the upper left-hand corner of the display.

The CD will resume playback at the point where it was switched off.

*CD changer**

- ▶ Press **cdc** button.

CD and the selected magazine slot number appear in the upper left-hand corner of the display.

If you have not removed a CD since the last time the CD audio source was activated, the last CD listened to will begin to play at the point where it was switched off.

After the last track on a CD has finished, the next CD is automatically played.

Playing tracks

You have the following options:

- Audio system with CD changer*: selecting CDs
- Direct track entry
- Track skip forward/reverse
- Fast forward/reverse
- Scan
- Random tracks
- Repeat track

Selecting CDs in the audio unit with CD changer*

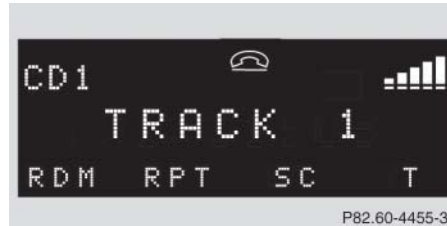

- ▶ You can select from among the inserted CDs with buttons

0 to **6**.

0 = CD player in the audio unit

1 to **6** = CDs in the

CD changer*

The magazine slot number of the selected CD appears next to **CD** in the display, and the number of the currently played track appears next to **TRACK**.

Controls in detail

Audio system



If there is no CD in the selected magazine slot, **NO CD** appears in the display with the corresponding slot number.

Direct track entry



You can make a direct selection from among the tracks on a CD.

- ▶ Press ***** button.
- ▶ Enter track number using buttons **1** to **0**.

Controls in detail

Audio system

- ▷▷ The number of the track being played appears next to **TRACK** in the display.

You can only enter available track numbers.

Skipping tracks forward/backward

- Skipping tracks forward
 - ▶ Press **SEEK+** button briefly.
The next track will be played.
- Skipping tracks backward
 - ▶ Press **-SEEK** button briefly.
If the track has been playing for more than ten seconds, the unit skips back to the beginning of the track currently playing. If less than ten seconds have been played, the unit skips back to the beginning of the previous track.

Pressing the **-SEEK** or **SEEK+** button repeatedly will result in multiple tracks being skipped.

Fast forward/reverse

- Fast forward
 - ▶ Press and hold **SEEK+** button until desired point has been reached.
- Reverse
 - ▶ Press and hold **-SEEK** button until desired point has been reached.



The track number and the relative time of the track is shown in the display during the search.

Scan

- Starting scan
 - ▶ Press **SC** soft key.
SC will appear in the display.
Each track on the current CD will be played for approx. eight seconds in ascending order.
- Ending scan
 - ▶ Press **SC** soft key or **-SEEK** or **SEEK+**.

Random play

The random function (RDM) plays the tracks of the current CD in random order.



When you start the RDM function, the RPT function is automatically switched off.

- Switching on random
 - ▶ Press RDM soft key.
RDM appears in the display.
A randomly selected track is played.
- Switching off random
 - ▶ Press RDM soft key again.

Repeat

The track being played is repeated until the repeat function is switched off.



When you start the RPT function, the RDM function is automatically switched off.

- Switching on repeat
 - ▶ Press RPT soft key.
RPT appears in the display.
- Switching off repeat
 - ▶ Press RPT soft key again.

Pause function

The CD changer mode is interrupted by an incoming call on the telephone* (▷ page 231).

Controls in detail

Audio system

- Switching on pause function



- ▶ Press **MUTE** button.
The CD changer mode is interrupted and PAUSE appears in the display.
- Switching off pause function
 - ▶ Press **MUTE** button.
The CD changer mode is active again.

Controls in detail

Audio system

Track and time display

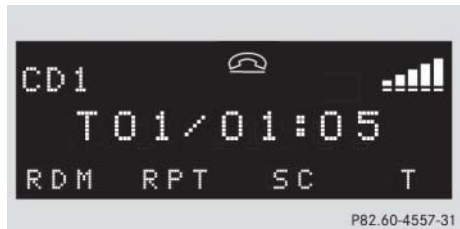

- ▶ Press T soft key.
The number of the track being played and the elapsed playing time appear in the display.
- ▶ Press T soft key again.
The total number of tracks and the total playing time of the CD appear in the display.
- ▶ Press T soft key.
The standard CD playback menu appears in the display.

GSM network phones

Using your Mercedes-Benz specified mobile telephone*, a number of functions and operating steps can be performed and displayed in the audio system display.

Further operating instructions not covered here can be found in the operating instructions for the multifunction steering wheel and the cellular telephone*.

If your audio system is set up for telephone operation, the  symbol will appear in the display.

When you insert your Mercedes-Benz specified mobile telephone* into the telephone cradle, you will be prompted to enter your PIN for 30 seconds (▷ page 227). This display disappears when you press any button.

When your mobile telephone is inserted into the telephone cradle, you will see the reception strength in the upper right-hand corner of the display.

Switching on the telephone

Switching on the telephone

- ▶ Press **TEL** button.

If the telephone was previously switched off, PROCESSING appears in the display and you will then be prompted to enter your PIN.

Switching off the telephone

- ▶ Press **TEL** button for approx. three seconds.

PROCESSING appears in the display until the telephone is off. Afterward, PHONE OFF appears in the display.

Controls in detail

Audio system

PIN entry

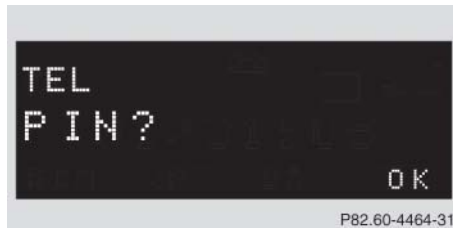

- ▶ Enter PIN number using buttons **1** to **0**.
- ▶ If necessary, correct number entered with the CLR soft key. Press soft key briefly to delete the last digit entered; press soft key and hold to delete the complete number.
- ▶ Press OK soft key after entering correct PIN.
- ▶ READY or ROAMING will appear in the display.



If the PIN is entered incorrectly three times, NEED PUK will appear in the display. Enter PUK via your telephone. Please refer to the separate telephone operating instructions for more information.

Adjusting the volume

- ▶ Turn rotary control of  button during a telephone call.

The volume will increase or decrease depending on the direction turned.



The volume can be adjusted separately for telephone mode and audio mode.

Adjusting sound

- ▶ Adjust sound during a telephone call. Sound adjustment (▷ page 205).

Placing a call

Entering a telephone number and starting the dialing process



- ▶ Enter desired telephone number using buttons **1** to **0**.

The number can have up to 32 digits, but only twelve of these are visible in the display. ▷▷

Controls in detail

Audio system

- ▶▶ If necessary, correct number entered with the CLR soft key. Press soft key briefly to delete the last digit entered; press soft key and hold to delete the complete number.
- ▶ After correct telephone number has been entered, press  button.



If the telephone number has been saved together with a name in the telephone book, the name will appear in the display.

Phone book

The numbers stored in the phone book of the telephone can be called up either by name or number.

In addition, incoming calls are stored in the phone book.







This is only possible, however, when the call information transmitted includes the number of the person calling. If the telephone number is not transmitted, NO NUMBER will be stored in the phone book.

- Searching and calling up telephone book entries by name



You can access your mobile telephone's phone book using the audio system. You can access both the main entries and the sub-entries of your phone book.





- ▶ Press MEM soft key or press button  or .
- ▶ Press desired numerical key  to .

The stored entries are selected according to the alphabetical order of the initial letters (e.g. for S-Schneider, press button  four times).



or

- ▶ Press and hold button  or .

The system jumps from one initial letter to the next in ascending or descending order.

- ▶ Press and hold button  or  until desired initial letter has been reached.

or

- ▶ Press button  or  repeatedly until desired entry has been reached.

The stored entries are selected in alphabetical order with the sub-entries.



Several sub-entries can be stored for each main entry (name). These entries are marked by a corresponding abbreviation that appears in the upper left-hand corner of the display. The following abbreviations for sub-entries are possible:

CEL = Mobile phone
 HOM = Home
 WOR = Work
 FAX = Fax
 PAG = Pager
 TEL = Main

- ▶ When you have selected a number, press  button.

The call will be made.

- Viewing the telephone number of a telephone book entry

- ▶ Search for desired entry.

- ▶ Press NUM soft key.

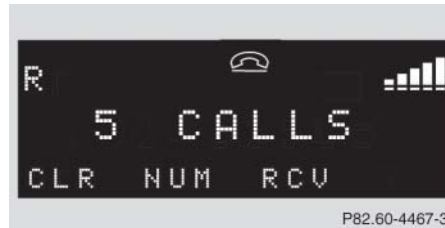

The telephone number of the phone book entry appears in the display.

- Returning calls received





Controls in detail

Audio system

- ▶ Press MEM soft key or press button  or .

- ▶ Press RCV soft key (received calls).

The number of received calls and then the call last received appear briefly in the display.

- ▶ Select desired telephone number with button  or .

The letter R and the number of the memory position appear in the upper left-hand corner of the display. The numbers are stored in the order of the calls received.

- ▶ When you have selected a number, press  button.

The call will be made.

Controls in detail

Audio system

- Speed dial

If you have stored telephone numbers as speed dial numbers in your telephone, you can also enter these with buttons **1** to **0** on the radio head unit.

- ▶ Press desired button **1** to **0** briefly.
- ▶ Press  button.
The call will be made.

- Turbo dial

If you have stored telephone numbers as turbo dial numbers in your telephone, you can also enter these with buttons **1** to **0** on the radio head unit.

- ▶ Press desired button **1** to **0** until the call is made.

Redial

If the number you have dialed is busy, you can again place calls to the last ten telephone numbers dialed using the redial function.





If you have activated the automatic redial function on your telephone, the number of the person being called is automatically redialed after a short waiting period if there is a busy signal. Refer to the separate operating instructions for the mobile telephone.

- Manual redial



- ▶ Press  button.

The telephone number last dialed will appear in the display.

- ▶ Select desired telephone number with button  or .

The letter L and the number of the memory position appears in the left-hand corner of the display. The numbers are stored in the order of the calls received.

- ▶ When you have selected a number, press  button.

The call will be made.

Accepting an incoming call

If the telephone is active in the background (reception symbol is visible in the display), the audio source is muted when an incoming call is received. A ringing tone can be heard and the caller's telephone number, or the name under which the telephone number has been saved in the phone book, appears in the display. If the caller's number is not transmitted with the call, CALL will appear in the display.

- ▶ Press  button.

The call is accepted.

Muting a call

It is possible to mute a call; the caller is then no longer able to hear you.

- Mute on
 - ▶ Press MUT soft key.
 - ▶ MIC MUTE will appear in the display.
- Mute off
 - ▶ Press MUT soft key again.

Terminating a call

- ▶ Press  button.

The current call is terminated and the muted audio source becomes active again.

Talking with two callers at the same time

If you wish to receive or place another call during an already active call, you can accept or place the second call and switch between the callers or combine them into one call. Note that the features described here are depending on availability from your mobile phone service provider.

- Placing/accepting a second call
 - ▶ Place new call by entering telephone number manually.
 - ▶ Press  button.

You are connected to the second caller; the first caller is kept on hold.

or

▷▷

Controls in detail



Audio system





- ▷▷ ▶ Press  button to accept a second call.



You will be notified of the second call acoustically, but you will not see this in the display.

You are connected with the second caller; the first caller is kept on hold.

- Switching between calls
 - ▶ Press  and  buttons.
This switches between the calls.
The non-active call is kept on hold.

- Terminating a call
 - ▶ Press  button.
The current call is terminated. You are again connected with the caller previously placed on hold.
- Combining two calls
 - ▶ Press  and  buttons.
The calls are combined into one call.
- Terminating a combined call
 - ▶ Press  button.
The connection to both callers is terminated.

TDMA or CDMA network phones

Using your Mercedes-Benz specified mobile telephone*, a number of functions and operating steps can be performed and displayed in the audio system display.

Further operating instructions not covered here can be found in the operating instructions for the multifunction steering wheel and the mobile telephone*.

If your audio system is set up for telephone operation, the  symbol will appear in the display.

When you insert your Mercedes-Benz specified mobile telephone* into the telephone cradle, you will be prompted to enter your PIN for 30 seconds (▷ page 233). This display disappears when you press any button.

When your mobile telephone is inserted into the telephone cradle, you will see the reception strength in the upper right-hand corner of the display.

Controls in detail

Audio system

Switching on the telephone

Switching on the telephone

- ▶ Press **TEL** button.

If you have programmed an unlock code for the telephone, you must now enter the code.



- ▶ Enter code using buttons **1** to **0**.
- ▶ If necessary, correct number entered with the **CLR** soft key. Press soft key briefly to delete the last digit entered; press soft key and hold to delete the complete number.

- ▶ Press **OK** soft key after entering correct code.

The telephone is unlocked. If you have entered an incorrect code, you must enter the correct code.

Switching off the telephone

- ▶ Press **TEL** button for approx. three seconds.

PROCESSING appears in the display until the telephone is off. Afterward, PHONE OFF appears in the display.

Adjusting the volume

- ▶ Turn rotary control of  button during a telephone call.

The volume will increase or decrease depending on the direction turned.



The volume can be adjusted separately for telephone mode and audio mode.

Adjusting sound

- ▶ Adjust sound during a telephone call. Sound adjustment (▷ page 205).

Placing a call

Entering a telephone number and starting the dialing process



- ▶ Enter desired telephone number using buttons **1** to **0**.

The number can have up to 32 digits, but only twelve of these are visible in the display. ▷▷

Controls in detail

Audio system

- ▶▶ If necessary, correct number entered with the CLR soft key. Press soft key briefly to delete the last digit entered; press soft key and hold to delete the complete number.
- ▶ After correct telephone number has been entered, press  button.



If the telephone number has been saved together with a name in the phone book, the name will appear in the display.

Phone book

The numbers stored in the phone book of the mobile telephone can be called up either by name or number.

In addition, incoming calls are stored in the phone book.







This is only possible, however, when the call information transmitted includes the number of the person calling. If the telephone number is not transmitted, NO NUMBER will be stored in the phone book.

- Searching and calling up phone book entries by name



You can access your mobile telephone's phone book with the audio system. You can access both the main entries and the sub-entries of your phone book.





- ▶ Press MEM soft key or press button  or .
- ▶ Press desired numerical key  to .

The stored entries are selected according to the alphabetical order of the initial letters (e.g. for S-Schneider, press button  four times).



or

- ▶ Press and hold button  or .

The system jumps from one initial letter to the next in ascending or descending order.

- ▶ Press and hold button  or  until desired initial letter has been reached.

or

- ▶ Press button  or  repeatedly until desired entry has been reached.

The stored entries are selected in alphabetical order with the sub-entries.



Several sub-entries can be stored for each main entry (name). These entries are marked by a corresponding abbreviation that appears in the upper left-hand corner of the display. The following abbreviations for sub-entries are possible:

CEL = Mobile phone
 HOM = Home
 WOR = Work
 FAX = Fax
 PAG = Pager
 TEL = Main

- ▶ When you have selected a number, press  button.

The call will be made.

- Viewing the telephone number of a phone book entry

- ▶ Search for desired entry.

- ▶ Press NUM soft key.



The telephone number of the phone book entry appears in the display.

- Returning calls received





Controls in detail

Audio system

- ▶ Press MEM soft key or press button  or .

- ▶ Press RCV soft key (received calls).

The number of received calls and then the call last received appear briefly in the display.

- ▶ Select desired telephone number with button  or .

The letter R and the number of the memory position appear in the upper left-hand corner of the display. The numbers are stored in the order of the calls received.

- ▶ When you have selected a number, press  button.

The call will be made.

Controls in detail

Audio system

- Speed dial

If you have stored telephone numbers as speed dial numbers in your telephone, you can also enter these with buttons **1** to **0** on the radio unit.

- ▶ Press desired button **1** to **0** briefly.
- ▶ Press  button.

The call will be made.

- Turbo dial

If you have stored telephone numbers as turbo dial numbers in your telephone, you can also enter these with buttons **1** to **0** on the radio unit.

- ▶ Press desired button **1** to **0** until the call is made.

Redial

If the number you have dialed is busy, you can again place calls to the last ten telephone numbers dialed using the redial function.





If you have activated the automatic redial function on your mobile telephone, the number of the person being called is automatically redialed after a short waiting period if there is a busy signal. Refer to the separate operating instructions for the mobile telephone.

- Manual redial



- ▶ Press  button.

The telephone number last dialed will appear in the display.

- ▶ Select desired telephone number with button  or .

The letter L and the number of the memory position appears in the left-hand corner of the display. The numbers are stored in the order of the calls received.

- ▶ When you have selected a number, press  button.

The call will be made.

Accepting an incoming call

If the telephone is active in the background (reception symbol is visible in the display), the audio source is muted when an incoming call is received. A ringing tone can be heard and the caller's telephone number, or the name under which the telephone number has been saved in the telephone book, appears in the display. If the caller's number is not relayed, CALL will appear in the display.

- ▶ Press  button.
The call is accepted.

Muting a call

It is possible to mute a call; the caller is then no longer able to hear you.

- Mute on
 - ▶ Press MUT soft key.
 - ▶ MIC MUTE will appear in the display.
- Mute off
 - ▶ Press MUT soft key again.

Terminating a call

- ▶ Press  button.

The current call is terminated and the muted audio source becomes active again.

Accepting a second incoming call

If you receive another call during an already active call, you can accept the second call and switch between the two.

- Accepting a second call
 - ▶ Place new call by entering telephone number manually.





You will be notified of the second call acoustically, but you will not see this in the display.

You are connected to the second caller; the first caller is kept on hold.

Controls in detail



Audio system

- Switching between calls
 - ▶ Press  button.
This switches between the calls.
The non-active call is kept on hold.
- Terminating a call
 - ▶ Press  button.
The current call is terminated. The connection to the caller previously kept on hold is also interrupted; however, reconnection is indicated by an acoustic signal.

Placing a second call

If you wish to place another call during an already active call, you can place the second call and switch between the callers or combine them into one call. Note that this feature is depending on availability from your mobile phone service provider.

- Placing a second call
 - ▶ Place a new call by entering telephone number manually.
 - ▶ Press  button.
You are connected to the second caller; the first caller is kept on hold.

- Terminating a call
 - ▶ Press  button.
The current call is terminated. The connection to the caller previously kept on hold is also interrupted; however, reconnection is indicated by an acoustic signal.
- Combining two calls
 - ▶ Press  button.
The calls are combined into one call.
- Terminating a combined call
 - ▶ Press  button.
The connection to both callers is terminated.

Emergency calls “911”

The following describes how to dial a “911” emergency call using the audio system head unit when a Mercedes-Benz specified mobile phone* is inserted in the phone cradle*. Unless otherwise specified, the descriptions refer to the audio system head unit.

Consult the separate telephone operating instructions that came with your mobile phone* for information on how to place a “911” emergency call on the mobile phone*.

Warning!



The “911” emergency call system is a public service. Using it without due cause is a criminal offense.

The following conditions must be met for a “911” emergency call:

- Telephone must be switched on.
- The corresponding mobile communications network must be available.



Emergency calls may not be possible with all telephone networks or if certain network services and/or telephone functions are active. Check with your local service providers.

If you cannot make an emergency call, you will have to initiate rescue measures yourself.

GSM network phones

Placing a “911” emergency call using audio head unit with the phone locked

- ▶ Press **TEL** button to switch to telephone operation.

PIN? appears in the audio display.

- ▶ Enter 911 using the number keypad on the audio head unit.
- ▶ Press OK soft key or  button for dialing to begin.

DIALING appears in the audio display while the telephone establishes the connection.

- ▶ Wait until the emergency call center answers, then describe the emergency.

Controls in detail

Audio system

Placing a “911” emergency call using audio head unit with the phone unlocked

- ▶ Press **TEL** button to switch to telephone operation.
- ▶ Enter 911 using the number keypad on the audio head unit.
- ▶ Press  button for dialing to begin. **DIALING** appears in the audio display while the telephone establishes the connection.
- ▶ Wait until the emergency call center answers, then describe the emergency.



If no SIM card is in the mobile phone, **NO SERVICE** appears in the audio display. In that case, you only can make an emergency call on the mobile phone itself, without the use of the head unit.

TDMA/CDMA network phones

Placing a “911” emergency call using audio head unit with the phone locked

- ▶ Press **TEL** button to switch to telephone operation. **CODE?** appears in the audio display.
- ▶ Enter 911 using the number keypad on the audio head unit.
- ▶ Press **OK** soft key or  button for dialing to begin. **DIALING** appears in the audio display while the telephone establishes the connection.
- ▶ Wait until the emergency call center answers, then describe the emergency.

Placing a “911” emergency call using audio head unit with the phone unlocked

- ▶ Press **TEL** button to switch to telephone operation.
- ▶ Enter 911 using the number keypad on the audio head unit.
- ▶ Press  button for dialing to begin. **DIALING** appears in the audio display while the telephone establishes the connection.
- ▶ Wait until the emergency call center answers, then describe the emergency.

▼ Power windows

Opening and closing the windows

The side windows are opened and closed electrically. The switches for all the side windows are on the driver's door. The switches for the respective windows are on the front passenger door and the rear doors.



- ① Left front window
- ② Right front window
- ③ Right rear window
- ④ Left rear window
- ⑤ Rear window override switch
(▷ page 80)

Warning!



When closing the windows, make sure there is no danger of anyone being harmed by the closing procedure.

The closing of the door windows can be immediately halted by releasing the switch or, if switch was pulled past the resistance point and released, by either pressing or pulling the respective switch.

If the window encounters an obstruction that blocks its path in a circumstance where you pulled the switch past the resistance point and released it to close the window, the automatic reversal function will stop the window and open it slightly.

Controls in detail

Power windows

If the window encounters an obstruction that blocks its path in a circumstance where you are closing the window by pulling and holding the switch, or by pressing and holding button  on the SmartKey, the automatic reversal function will not operate.

When leaving the vehicle, always remove the SmartKey from the starter switch, take it with you, and lock the vehicle. Do not leave children unattended in the vehicle, or with access to an unlocked vehicle. Unsupervised use of vehicle equipment can cause an accident and/or serious personal injury.

Controls in detail

Power windows



You can also open or close the windows using the SmartKey (summer opening/convenience closing feature) (▷ page 243).

You can close and reopen the windows using the air recirculation button  in the climate control panel (▷ page 179) or automatic climate control panel* (▷ page 189).

You can close and reopen the windows using the charcoal filter button  in the automatic climate control panel* (▷ page 189).

- ▶ Switch on ignition (▷ page 33).

Opening the windows

- ▶ Press switch ① to ④ to the resistance point.

The corresponding window will move downwards until you release the switch.

Closing the windows

- ▶ Pull switch ① to ④ to the resistance point.

The corresponding window will move upwards until you release the switch.

Warning!



If you pull and hold the switch up when closing the window, and upward movement of the window is blocked by some obstruction including but not limited to arms, hands, fingers, etc., the automatic reversal will not operate.

Fully opening the windows (Express-open)

- ▶ Press switch ① to ④ past the resistance point and release.

The corresponding window opens completely.

Fully closing the windows (Express-close)

- ▶ Pull switch ① to ④ past the resistance point and release.

The corresponding window closes completely.



If the upward movement of the window is blocked during the closing procedure, the window will stop and open slightly.

Remove the obstruction, pull the switch again past the resistance point and release.

If the window still does not close when there is no obstruction, then pull and hold the switch again. The side window will then close without the obstruction sensor function.

Warning!



Driver's door only:
If within five seconds you again pull the switch past the resistance point and release, the automatic reversal will not function.

Stopping windows

- ▶ Press or pull respective switch again.

Controls in detail

Power windows



Opening and closing the windows with the SmartKey

The tilt/sliding sunroof* (▷ page 247) will also be opened or closed when the power windows are operated with the SmartKey.

Warning!



Never operate the windows or tilt/sliding sunroof* if there is the possibility of anyone being harmed by the opening or closing procedure.

In the event that the procedure causes potential danger, the procedure can be immediately halted by releasing the transmit button on the SmartKey. To reverse direction of movement, press button  for opening or  for closing.



Controls in detail

Power windows





- ▶ Aim transmitter eye at the driver's door handle.

Opening (Summer opening feature)

- ▶ Press and hold button  after unlocking the vehicle.
The windows and tilt/sliding sunroof* begin to open after approximately one second.
- ▶ Release the  button to stop procedure.

Closing (Convenience feature)

- ▶ Press and hold button  after locking the vehicle.
The windows and tilt/sliding sunroof* begin to close after approximately one second.
- ▶ Release the  button to stop procedure.

Make sure all side windows and the tilt/sliding sunroof* are properly closed before leaving the vehicle.

Synchronizing power windows

The power windows must be resynchronized each time

- after the battery has been disconnected.
 - if the power windows cannot be fully opened (Express-open) or closed (Express-close).
- ▶ Switch on ignition (▷ page 33).
 - ▶ Pull the power window switches until the side windows are closed.
Hold the switches for approximately one second.
The power windows are synchronized.

▼ Power tilt/sliding sunroof*

Opening and closing the power tilt/sliding sunroof

The tilt/sliding sunroof can be opened and closed electrically. The switch for the tilt/sliding sunroof is on the overhead control panel.



Sunroof switch

- ① Push up to raise sunroof at rear
- ② Pull down to lower sunroof at rear
- ③ Push forward to slide sunroof closed
- ④ Push back to slide sunroof open

With the sunroof closed or tilted open, a screen can be slid into the roof opening to guard against sun rays. When sliding the sunroof open, the screen will also retract.



Screen

Controls in detail

Power tilt/sliding sunroof*

Warning!



When closing the tilt/sliding sunroof, make sure there is no danger of anyone being harmed by the closing procedure.

The opening/closing procedure of the tilt/sliding sunroof can be immediately halted by releasing the switch or, if the switch was moved past the resistance point and released, by moving the switch in any direction.

The tilt/sliding sunroof is made out of glass. In the event of an accident, the glass may shatter. This may result in an opening in the roof.

In a vehicle rollover, occupants not wearing their seat belts or not wearing them properly may be thrown out of the opening. Such an opening also presents a potential for injury for occupants wearing their seat belts properly as entire body parts or portions of them may protrude from the passenger compartment.



Controls in detail

Power tilt/sliding sunroof*

▷▷ When leaving the vehicle, always remove the SmartKey from the starter switch, take it with you, and lock the vehicle. Do not leave children unattended in the vehicle, or with access to an unlocked vehicle. Unsupervised use of vehicle equipment can cause an accident and/or serious personal injury.



To avoid damaging the seals, do not transport any objects with sharp edges which can stick out of the tilt/sliding sunroof.

Do not open the tilt/sliding sunroof if there is snow or ice on the roof, as this could result in malfunctions.

The tilt/sliding sunroof can be opened or closed manually should an electrical malfunction occur (▷ page 387).



You can also open or close the tilt/sliding sunroof using the SmartKey (summer opening/convenience closing feature) (▷ page 247).

You can close and reopen the tilt/sliding sunroof using the air recirculation button  in the climate control panel (▷ page 179) or automatic climate control panel* (▷ page 189).

You can close and reopen the tilt/sliding sunroof using the charcoal filter button  in the automatic climate control panel* (▷ page 189).

- ▶ Switch on ignition (▷ page 33).

Opening and closing the power tilt/sliding sunroof

- ▶ To open, close, raise, or lower the tilt/sliding sunroof, move the sunroof switch to resistance point in the required direction of arrows ① to ④. Release the sunroof switch when the tilt/sliding sunroof has reached the desired position.

Fully opening (Express-open) and closing (Express-close) the power tilt/sliding sunroof

- ▶ To open or close the tilt/sliding sunroof, move the sunroof switch past the resistance point in the required direction of arrow ④ or ③ and release. The tilt/sliding sunroof opens or closes completely.

Stopping the power tilt/sliding sunroof during Express-operation

- ▶ Move the sunroof switch in any direction.



If the movement of the tilt/sliding sunroof is blocked during the closing procedure, the tilt/sliding sunroof will stop and reopen slightly.



Opening and closing the power tilt/sliding sunroof with the SmartKey

The power windows (▷ page 243) will also be opened or closed when you operate the tilt/sliding sunroof with the SmartKey.

Warning!



Never operate the windows or tilt/sliding sunroof if there is the possibility of anyone being harmed by the opening or closing procedure.

In the event that the procedure causes potential danger, the procedure can be immediately halted by releasing the transmit button on the SmartKey. To reverse direction of movement, press button  for opening or  for closing.

Controls in detail

Power tilt/sliding sunroof*



- ▶ Aim transmitter eye at the driver's door handle.

Opening (Summer opening feature)

- ▶ Press and hold button  after unlocking the vehicle.

The windows and the tilt/sliding sunroof begin to open after approximately one second.

- ▶ Release the  button to stop procedure.

Controls in detail

Power tilt/sliding sunroof*

Closing (Convenience feature)

- ▶ Press and hold button  after locking the vehicle.

The windows and the tilt/sliding sunroof begin to close after approximately one second.

- ▶ Release the  button to stop procedure.

Make sure all side windows and the tilt/sliding sunroof are properly closed before leaving the vehicle.

Synchronizing the power tilt/sliding sunroof

The tilt/sliding sunroof must be synchronized

- after the battery has been disconnected or discharged
- after the tilt/sliding sunroof has been closed manually (▷ page 387)
- after a malfunction
- if the tilt/sliding sunroof does not open smoothly

- ▶ Switch on ignition (▷ page 33).
- ▶ Move and hold the sunroof switch in the direction of arrow ① (▷ page 245) until the tilt/sliding sunroof is fully raised at the rear.

Hold the sunroof switch for approximately one second.

- ▶ Check the Express-open feature (▷ page 246).

If the tilt/sliding sunroof opens completely, the tilt/sliding sunroof is synchronized. Otherwise repeat the above steps.

▼ Driving systems

The driving system of your vehicle is described on the following pages:

- Cruise control, with which the vehicle can maintain a preset speed

For information on the BAS, ABS, and ESP driving systems, see “Driving safety systems” (▷ page 83).

Cruise control

Cruise control automatically maintains the speed you set for your vehicle.

Use of cruise control is recommended for driving at a constant speed for extended periods of time. You can set or resume cruise control at any speed over 20 mph (30 km/h).

The cruise control function is operated by means of the cruise control lever.

The cruise control lever is the uppermost lever on the left-hand side of the steering column (▷ page 22).

Controls in detail

Driving systems

Warning!



Cruise control is a convenience system designed to assist the driver during vehicle operation. The driver is and must remain at all times responsible for the vehicle speed and for safe brake operation.

Only use cruise control if the road, traffic and weather conditions make it advisable to travel at a steady speed.

- The use of cruise control can be dangerous on winding roads or in heavy traffic because conditions do not allow safe driving at a steady speed.
- The use of cruise control can be dangerous on slippery roads. Rapid changes in tire traction can result in wheel spin and loss of control.
- Deactivate cruise control when driving in fog.

The “Resume” function should only be operated if the driver is fully aware of the previously set speed and wishes to resume this particular preset speed.

Controls in detail

Driving systems

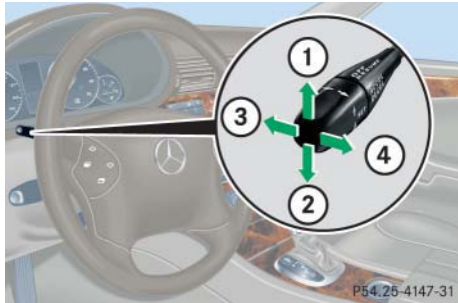

- ① Sets current or higher speed
- ② Sets current or lower speed
- ③ Cancels cruise control
- ④ Resumes at last set speed

Setting current speed

- ▶ Accelerate or decelerate to the desired speed.
- ▶ Briefly lift ① or depress ② the cruise control lever.

The current speed is set.

- ▶ Remove your foot from the accelerator pedal.

Cruise control is activated.



On uphill or downhill grades, cruise control may not be able to maintain the set speed. Once the grade eases, the set speed will be resumed.

Canceling cruise control

There are several ways to cancel cruise control:

- ▶ Step on the brake pedal.

Cruise control is canceled. The last speed set is stored for later use.

or

- ▶ Briefly push the cruise control lever to position ③.

Cruise control is canceled. The last speed set is stored for later use.



Vehicles with automatic transmission: Moving the gear selector lever to position **N** while driving also cancels cruise control. However, the gear selector lever should not be moved to position **N** while driving, except to coast when the vehicle is in danger of skidding (e.g. on icy roads).



Vehicles with manual transmission: The set cruise controlled speed is switched off when declutching exceeds four seconds during downshifting a gear.



The last stored speed is canceled when you turn off the engine.

Setting a higher speed

- ▶ Lift cruise control lever to position ① and hold it up until the desired speed is reached.
- ▶ Release cruise control lever.
The new speed is set.



Depressing the accelerator pedal does not deactivate cruise control. After brief acceleration (e.g. for passing), cruise control will resume the last speed set.

Setting a lower speed

- ▶ Depress cruise control lever to position ② and hold it down until the desired speed is reached.
- ▶ Release cruise control lever.
The new speed is set.



Vehicles with automatic transmission: When you use the cruise control lever to decelerate, the transmission will automatically downshift if the engine's braking power does not brake the vehicle sufficiently.

Fine adjustment in 1 mph (Canada: 1 km/h) increments

Faster

- ▶ Briefly tip cruise control lever in direction of arrow ①.

Slower

- ▶ Briefly tip cruise control lever in direction of arrow ②.

Setting to last stored speed ("Resume" function)

Warning!



The speed stored in memory should only be set again if prevailing road conditions permit. Possible acceleration or deceleration differences arising from returning to preset speed could cause an accident and/or serious injury to you and others.

- ▶ Briefly push cruise control lever to position ④.
The cruise control resumes the last set speed.
- ▶ Remove your foot from the accelerator pedal.

Controls in detail

Loading

Roof rack*

Warning!



Only use roof racks approved by Mercedes-Benz for your vehicle model to avoid damage to the vehicle. Follow manufacturer's installation instructions.

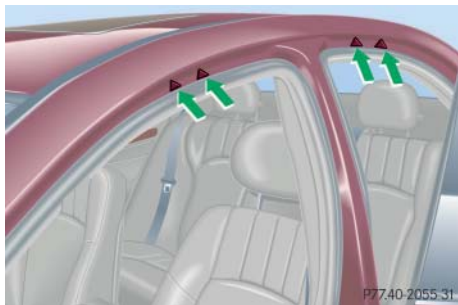

- ▶ Only mount the roof rack between the fastening points (see arrows).
- ▶ Secure the roof rack according to manufacturer's instructions for installation.



Load the roof rack in such a way that the vehicle cannot be damaged while driving.

Make sure

- you can fully raise the tilt/sliding sunroof*.
- you can fully open the trunk.

Ski sack* (Canada only)

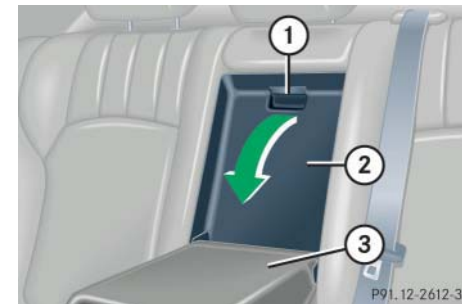

- ① Handle
- ② Cover
- ③ Armrest

Unfolding and loading

- ▶ Fold armrest ③ down (arrow).
- ▶ Pull handle ① and swing cover ② down.

Controls in detail

Loading



④ Hook and loop fastener

- ▶ Unfasten hook and loop fastener ④.
- ▶ Pull ski sack into passenger compartment and unfold.

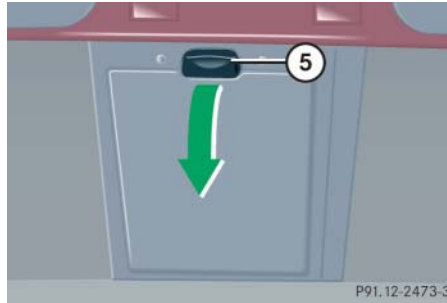

⑤ Button

- ▶ Open trunk lid.
- ▶ Press button ⑤.

The flap opens downward.

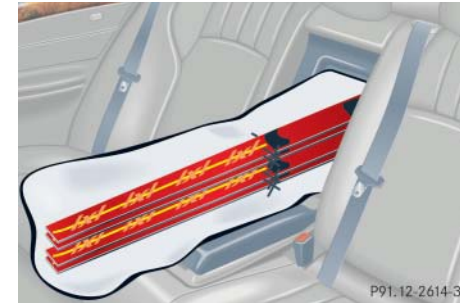

- ▶ From trunk, slide skis into ski sack.

Warning!



The ski sack is designed for up to four pairs of skis. Do not load the ski sack with other objects.

Always fasten the ski sack securely. In an accident, an unfastened ski sack can cause injury to vehicle occupants.



Controls in detail

Loading



⑥ Strap

- ▶ Tighten strap ⑥ by pulling at the loose end (arrow) until the skis in the ski sack are tightly secured.

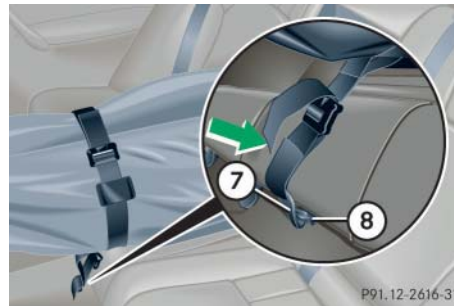

⑦ Hook

⑧ Eye

- ▶ Connect hook ⑦ to eye ⑧.
Tighten strap by pulling at the loose end (arrow).

Unloading and folding

- ▶ Loosen the straps.
- ▶ Disconnect hook ⑦ from eye ⑧.
- ▶ Unload skis.
- ▶ Close flap in trunk.
- ▶ Fold and flatten ski sack lengthwise.
- ▶ Place folded ski sack inside recess of backrest.
- ▶ Fasten hook and loop fastener.
- ▶ Close ski sack compartment cover.

Removing the ski sack

You can remove the ski sack for cleaning or drying.

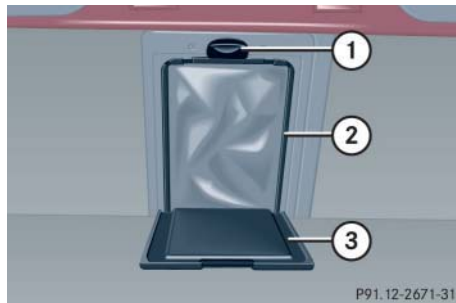

- ① Button
- ② Ski sack frame
- ③ Flap

- ▶ Open trunk lid.
- ▶ Press button ①.
- The flap ③ opens downward.
- ▶ Press button ① firmly until ski sack frame ② is released.
- ▶ Pull ski sack frame ② with ski sack out.

Warning!



Never drive vehicle with trunk open while the ski sack is removed. Deadly carbon monoxide (CO) gases may enter vehicle interior, resulting in unconsciousness and death.



To prevent unauthorized persons from accessing the trunk, always close the flap.

Installing the ski sack

Install the ski sack in the reverse order.

- ▶ Push ski sack frame ② with ski sack inward until the ski sack frame snaps into place.
- ▶ Close flap ③.
- ▶ Close trunk lid.

Split rear bench seat*

To expand the cargo area, you can fold down the left and right rear seat backrests.

The two sections can be folded down separately.

Warning!



When expanding the luggage area, always fold the seat cushions fully forward.

Unless you are transporting cargo, the backrests must remain properly locked in the upright position.

In an accident, during hard braking or sudden maneuvers, loose items will be thrown around inside the vehicle, and cause injury to vehicle occupants unless the items are securely fastened in the vehicle.

Always use the cargo tie down rings* (▷ page 258).

Controls in detail

Loading

Folding the backrest forward

The release handle ① is located in the trunk.

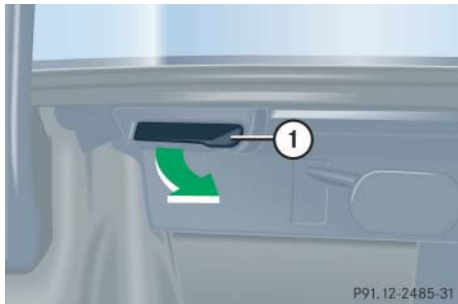

- ▶ Pull release handle ①.
- ▶ Fully retract and fold rearward head restraints (▷ page 110).

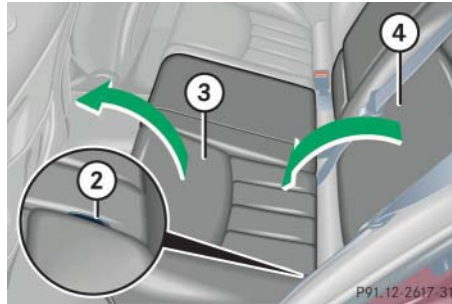

- ▶ Pull release handle ②.
- ▶ Fold seat cushion ③ forward.
- ▶ Fold backrest ④ forward.

Returning the backrest to original position

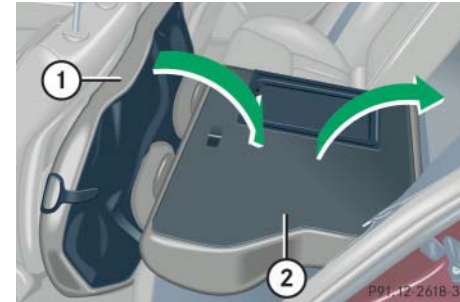

- ▶ Fold backrest ② rearward until it engages.
- ▶ Fold seat cushion ① rearward until it locks into position.

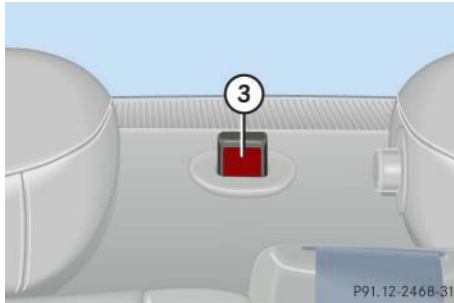

If the backrest is not locked into position, a red indicator ③ will be visible.

- ▶ Check for secure locking by pushing and pulling on the backrest.

Warning!



If a red indicator is visible with the backrest up, then the backrest is not properly locked into position.

Always lock backrest in its upright position when rear seat bench is occupied, cargo is being carried in the trunk, or the extended cargo compartment is not in use. Check for secure locking by pushing and pulling on the backrest.

In an accident, during hard braking or sudden maneuvers, loose items will be thrown around inside the vehicle, and cause injury to vehicle occupants unless the items are securely fastened in the vehicle.

To help avoid personal injury during a collision or sudden maneuver, exercise care when transporting cargo.



To prevent unauthorized persons from access to the trunk, always lock backrest in its upright position.

Controls in detail

Loading

Loading instructions

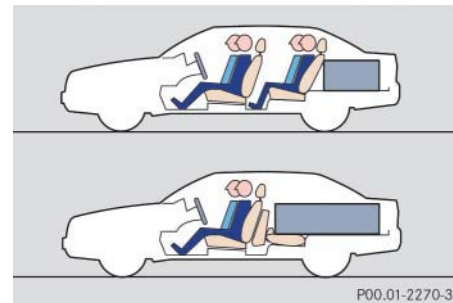

The total load weight including vehicle occupants and luggage/cargo should not exceed the load limit or vehicle capacity weight indicated on the corresponding placard located on the driver's door B-pillar.

The handling characteristics of a fully loaded vehicle depend greatly on the load distribution. It is therefore recommended to load the vehicle according to the illustrations shown, with the heaviest items being placed towards the front of the vehicle.

Controls in detail

Loading

Always place items being carried against front or rear seat backrests, and fasten them as securely as possible.

The heaviest portion of the cargo should always be kept as low as possible since it influences the handling characteristics of the vehicle.

Warning!



Always fasten items being carried as securely as possible.

In an accident, during hard braking or sudden maneuvers, loose items will be thrown around inside the vehicle and can cause injury to vehicle occupants unless the items are securely fastened in the vehicle.

To help avoid personal injury during a collision or sudden maneuver, exercise care when transporting cargo.

Never drive vehicle with trunk open. Deadly carbon monoxide (CO) gases may enter vehicle interior resulting in unconsciousness and death.



The trunk is the preferred place to carry objects.

The enlarged cargo area should only be used for items which do not fit in the trunk alone.

Cargo tie-down rings*

The four cargo tie-down rings are located in the trunk.

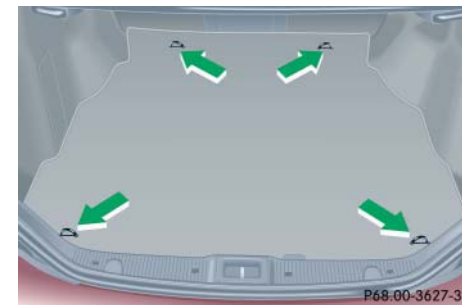

Cargo tie-down rings

- ▶ Carefully secure cargo by applying even load on all rings with rope sufficient strength to hold down the cargo.

Always follow loading instructions (▷ page 257).

▼ Useful features

Storage compartments

Warning!



To help avoid personal injury during a collision or sudden maneuver, exercise care when stowing objects in the vehicle. Put luggage or cargo in the trunk if possible. Do not pile luggage or cargo higher than the seat backs. Do not place anything on the shelf below the rear window.

Luggage nets cannot secure hard or heavy objects.

Keep compartment lids closed. This will help to prevent stored objects from being thrown about and injuring vehicle occupants during an accident.

Glove box

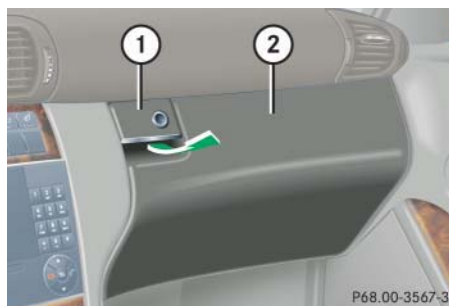

- ① Glove box lid release
- ② Glove box

Opening the glove box

- ▶ Pull lid release ①.
The glove box lid opens downward.

Closing the glove box

- ▶ Push lid up to close.

Controls in detail

Useful features

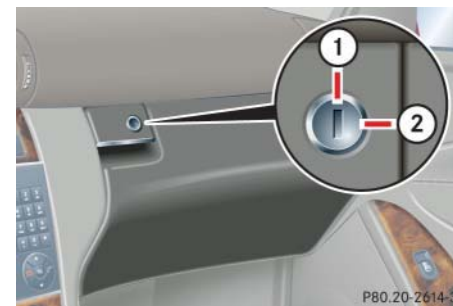

- ① Unlocking
- ② Locking

Locking the glove box

- ▶ Insert mechanical key (▷ page 383) into the glove box lock and turn it to position ②.

Unlocking the glove box

- ▶ Turn mechanical key in the glove box lock to position ①.

Controls in detail

Useful features

Armrest storage compartments

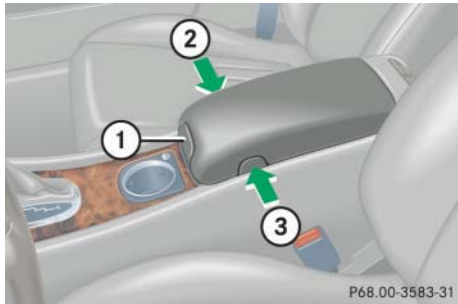

- ① Handle
- ② Button, passenger side
- ③ Button, driver's side

Opening storage compartment

- ▶ Pull handle ① and lift armrest.

Closing storage compartment

- ▶ Press armrest down until it engages into place.

Opening telephone compartment

- ▶ Press button ③ on driver's side or button ② on passenger side and lift armrest.

Closing telephone compartment

- ▶ Press armrest down until it engages into place.

Changing inclination of armrest



- ① Handle
- ▶ Pull up on armrest.

Lowering armrest

- ▶ Pull handle ① to lower armrest.

Armrest in the rear passenger compartment



- ▶ Pull the top of the armrest out and fold it down.

Cup holders in front of seat armrest

Warning!



In order to help prevent spilling liquids on vehicle occupants, only use containers that fit into the cup holder. Use lids on open containers and do not fill containers to a height where the contents, especially hot liquids, could spill during braking, vehicle maneuvers, or in an accident.

When not in use, keep the cup holder closed. An open cup holder may cause injury to you or others when contacted during braking, vehicle maneuvers, or in an accident.

Keep in mind that objects placed in the cup holder may come loose during braking, vehicle maneuvers, or in an accident and be thrown around in the vehicle interior. Objects thrown around in the vehicle interior may cause an accident and/or serious personal injury.

Controls in detail

Useful features

Underneath the swiveling cup holder is another stationary cup holder. You can only use this when the swiveling cup holder is pulled out and completely turned outward.

Sliding out the swiveling cup holder



- ▶ Push button ①.

The cup holder slides upward.



Controls in detail

Useful features



No objects should be in the swiveling cup holder when the swiveling cup holder is slid upward. Otherwise the swiveling cup holder or the objects could be damaged.

Turning the swiveling cup holder outward



- ▶ Turn the cup holder in the direction of arrow ② until it engages.
You can now use both cup holders.

Turning the swiveling cup holder inward and sliding it in



- ▶ Turn the cup holder in the direction of arrow ③ until it engages.
- ▶ Turn the cup holder in the direction of arrow ④ until it engages.



No objects should be in the stationary cup holder when the swiveling cup holder is turned inward and pushed in. Otherwise the swiveling cup holder or the objects could be damaged.

Cup holder in rear seat armrest

Warning!



In order to help prevent spilling liquids on vehicle occupants, only use containers that fit into the cup holder. Use lids on open containers and do not fill containers to a height where the contents, especially hot liquids, could spill during braking, vehicle maneuvers, or in an accident.

When not in use, keep the cup holder closed. An open cup holder may cause injury to you or others when contacted during braking, vehicle maneuvers, or in an accident.

Keep in mind that objects placed in the cup holder may come loose during braking, vehicle maneuvers, or in an accident and be thrown around in the vehicle interior. Objects thrown around in the vehicle interior may cause an accident and/or serious personal injury.

Controls in detail

Useful features

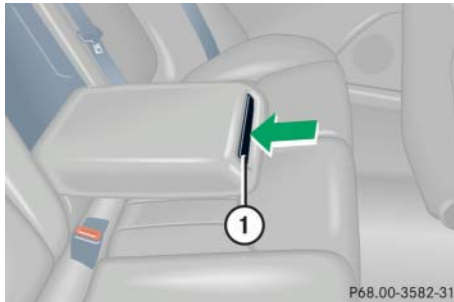

① Cup holder

Opening cup holder

- ▶ Briefly press the front of cup holder ①.
The cup holder slides out slightly.
- ▶ Pull out the cup holder until it stops.

Closing cup holder

- ▶ Slide cup holder ① in until it engages.

Parcel net in front passenger footwell

A small convenience parcel net is located in the front passenger footwell. It is for small and light items, such as road maps, mail, etc.

Warning!



Do not place heavy or fragile objects, or objects having sharp edges, in the parcel net.

In an accident, during hard braking or sudden maneuvers, they could be thrown around inside the vehicle, and cause injury to vehicle occupants.

Ashtrays

Center console ashtray

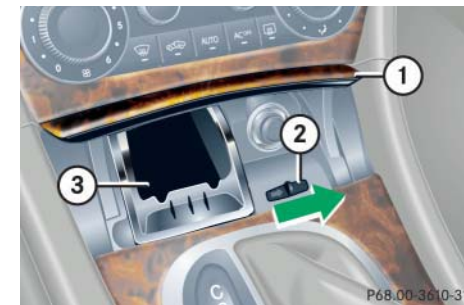

- ① Cover plate
- ② Sliding button
- ③ Ashtray insert

- ▶ Briefly press the bottom of cover plate ①.
The cover plate opens automatically.

Controls in detail

Useful features

Removing ashtray insert

Warning!



Remove front ashtray only with vehicle standing still. Set the parking brake to secure vehicle from movement. Move gear selector lever to position **N** (manual transmission: second gear). With gear selector lever in position **N** (manual transmission: second gear) turn off the engine.

- ▶ Secure vehicle from movement by setting the parking brake.
- ▶ Move the gear selector lever to position **N** (manual transmission: second gear).

Now you have more room to take out the ashtray insert.

- ▶ Push sliding button ② to the right.
The ashtray insert ③ slides out slightly.
- ▶ Remove the ashtray insert.

Reinstalling ashtray insert

- ▶ Push the ashtray insert ③ down into the retainer until it engages.
- ▶ Push down cover plate ① to close ashtray.

The cover plate engages.

Rear seat ashtray



- ① Button
- ② Ashtray insert
- ③ Cover

- ▶ Pull at top of cover ③.

Removing ashtray insert

- ▶ Push button ① to disengage ashtray insert ② and remove it.

Reinstalling ashtray insert

- ▶ Push the ashtray insert ② down into the retainer until it engages.
- ▶ Push at top of cover ③ to close ashtray.

Controls in detail

Useful features

Cigarette lighter



- ① Cover plate
- ② Cigarette lighter

- ▶ Switch on ignition (▷ page 33).
- ▶ Briefly press the bottom of cover plate ①.
The cover plate opens automatically.
- ▶ Push in cigarette lighter ②.
The cigarette lighter will pop out automatically when hot.

Warning!



Never touch the heating element or sides of the lighter; they are extremely hot. Hold the knob only.

When leaving the vehicle, always remove the SmartKey from the starter switch, take it with you, and lock the vehicle. Do not leave children unattended in the vehicle, or with access to an unlocked vehicle. Unsupervised use of vehicle equipment may cause an accident and/or serious personal injury.



The lighter socket can be used to accommodate electrical accessories up to a maximum 85 W.

- ▶ Push down cover plate ① to close ashtray.
The cover plate engages.

Electrical outlet in the rear passenger compartment



- ① Electrical outlet
- ② Cover

- ▶ Switch on ignition (▷ page 33).
- ▶ Pull at top of cover ②.
- ▶ Flip cover ① to the left and insert electrical plug (cigarette lighter type).



The electrical outlet can be used to accommodate electrical consumers (e.g. air pump, auxiliary lamps) up to a maximum of 180 W.

Controls in detail

Useful features

Telephone*

Warning!



Never operate radio transmitters equipped with a built-in or attached antenna (i.e. without being connected to an external antenna) from inside the vehicle while the engine is running. Doing so could lead to a malfunction of the vehicle's electronic system, possibly resulting in an accident and personal injury.

Radio transmitters, such as a portable telephone or a citizens band unit, should only be used inside the vehicle if they are connected to an antenna that is installed on the outside of the vehicle.

The external antenna must be approved by Mercedes-Benz. Please contact an authorized Mercedes-Benz Center for information on the installation of an approved external antenna. Refer to the radio transmitter operation instructions regarding use of an external antenna.

Warning!





Please do not forget that your primary responsibility is to drive the vehicle. A driver's attention to the road must always be his/her primary focus when driving. For your safety and the safety of others, we recommend that you pull over to a safe location and stop before placing or taking a telephone call.

If you choose to use the telephone¹ while driving, please use the hands-free device and only use the telephone when road, weather and traffic conditions permit. Some jurisdictions prohibit the driver from using a cellular telephone while driving a vehicle.

Only operate the COMAND* (Cockpit Management and Data System)¹ if road, weather and traffic conditions permit.

Bear in mind that at a speed of just 30 mph (approximately 50 km/h), your vehicle is covering a distance of 44 feet (approximately 14 m) every second.

¹ Observe all legal requirements.

You can take and place telephone calls using the  and  buttons on the steering wheel. To carry out other telephone functions, use the control system (▷ page 158).

See separate operating manual for instructions on how to use the telephone.

Tele Aid*



The initial activation of the Tele Aid system may only be performed by completing the subscriber agreement and placing an acquaintance call using the  button. Failure to complete either of these steps will result in a system that is not activated.

If you have any questions regarding activation, please call the Response Center at 1-800-756-9018 (in the USA) or 1-888-923-8367 (in Canada).



The Tele Aid system

(Telematic Alarm Identification on Demand)

The Tele Aid system consists of three types of response:



- automatic and manual emergency
- roadside assistance and
- information

The Tele Aid system is operational providing that the vehicle's battery is charged, properly connected, not damaged and cellular and GPS coverage is available.

The speaker volume of a Tele Aid call can be adjusted when using the volume control on the multifunction steering wheel. To raise, press button  and to lower, press button . The volume can also be adjusted using the volume knob on your audio system or COMAND* head unit.



Controls in detail

Useful features

- ▶ To activate, press the SOS button, the Roadside Assistance button  or the Information button , depending on the type of response required.



The SOS button is located above the interior rear view mirror.

The Roadside Assistance button  and the Information button  are located below the center armrest cover.

Shortly after the completion of your Tele Aid acquaintance call, you will receive a user ID and password. By visiting www.mbusa.com and selecting "Tele Aid" (USA only), you will have access to account information, remote door unlock and more.



Controls in detail

Useful features



The Tele Aid system utilizes the cellular network for communication and the GPS (Global Positioning System) satellites for vehicle location. If either of these signals are unavailable, the Tele Aid system may not function and if this occurs, assistance must be summoned by other means.

System self-check

Initially, after switching on ignition, malfunctions are detected and indicated (the indicator lamps in the SOS button, the Roadside Assistance button  and the Information button  stay on longer than ten seconds or do not come on). The message *Tele Aid malfunction. Drive to workshop* appears in the multifunction display.

Warning!



If the indicator lamps in the SOS button, in the Roadside Assistance button and/or in the Information button remain illuminated constantly in red and/or the message *Tele Aid malfunction. Drive to workshop* is displayed in the multifunction display after the system self-check, a malfunction in the system has been detected.

If a malfunction is indicated as outlined above, the system may not operate as expected. Have the system checked at the nearest Mercedes-Benz Center as soon as possible.

Emergency calls

An emergency call is initiated automatically following an accident in which the emergency tensioning devices (ETDs) or air bags deploy.

An emergency call can also be initiated manually by opening the cover next to the interior rear view mirror labeled SOS, then briefly pressing the button located under the cover. See (▷ page 269) for instructions on initiating an emergency call manually.

Once the emergency call is in progress, the indicator lamp in the SOS button will begin to flash. The message *Connecting call* appears in the multifunction display and the audio system is muted. When the connection is established, the message *Call connected* appears in the multifunction display. All information relevant to the emergency, such as the location of the vehicle (determined by the GPS satellite location system), vehicle model, identification number and color are generated.

A voice connection between the Response Center and the occupants of the vehicle will be established automatically soon after the emergency call has been initiated. The Response Center will attempt to determine more precisely the nature of the emergency provided they can speak to an occupant of the vehicle.

The Tele Aid system is available if

- it has been activated and is operational. Activation requires a subscription for monitoring services, connection and cellular air time
- the relevant cellular phone network and GPS signals are available and pass the information on to the Response Center



Location of the vehicle on a map is only possible if the vehicle is able to receive signals from the GPS satellite network and pass the information on to the Response Center.

Warning!



If the indicator lamp in the SOS button is flashing continuously and there was no voice connection to the Response Center established, then the Tele Aid system could not initiate an emergency call (e.g. the relevant cellular phone network is not available). The message `Call failed.` appears in the multifunction display for approximately ten seconds.

Should this occur, assistance must be summoned by other means.

Controls in detail

Useful features

Initiating an emergency call manually



① Cover

② SOS button

- ▶ Briefly press on cover ①.
The cover will open.
- ▶ Press SOS button ② briefly.
The indicator lamp in SOS button ② will flash until the emergency call is concluded.
- ▶ Wait for a voice connection to the Response Center.
- ▶ Close cover ① after the emergency call is concluded.

Controls in detail

Useful features

Warning!



If you feel at any way in jeopardy when in the vehicle (e.g. smoke or fire in the vehicle, vehicle in a dangerous road location), please do not wait for voice contact after you have pressed the emergency button. Carefully leave the vehicle and move to a safe location. The Response Center will automatically contact local emergency officials with the vehicle's approximate location if they receive an automatic SOS signal and cannot make voice contact with the vehicle occupants.

Roadside Assistance button

Located below the center armrest cover is the Roadside Assistance button .

- ▶ Press and hold button (for longer than two seconds).

A call to a Mercedes-Benz Roadside Assistance dispatcher will be initiated. The button will flash while the call is in progress. The message *Connecting call* will appear in the multifunction display and the audio system is muted.

When the connection is established, the message *Call connected* appears in the multifunction display. The Tele Aid system will transmit data generating the vehicle identification number, model, color and location (subject to availability of cellular and GPS signals).

A voice connection between the Roadside Assistance dispatcher and the occupants of the vehicle will be established.

- ▶ Describe the nature of the need for assistance.

The Mercedes-Benz Roadside Assistance dispatcher will either dispatch a qualified Mercedes-Benz technician or arrange to tow your vehicle to the nearest authorized Mercedes-Benz Center. For services such as labor and/or towing, charges may apply. Refer to the Roadside Assistance manual for more information.



The following is only available in the USA:

- Sign and Drive services: Services such as jump start, a few gallons of fuel or the replacement of a flat tire with the vehicle spare tire are obtainable.

Controls in detail

Useful features



The indicator lamp on the Roadside Assistance button  remains illuminated in red for approximately ten seconds during the system self-check after switching on ignition (together with the SOS button and the Information button ).

See system self-check (▷ page 268) when the indicator lamp does not come on in red or stays on longer than approximately ten seconds.

If the indicator lamp on the Roadside Assistance button  is flashing continuously and there was no voice connection to the Response Center established, then the Tele Aid system could not initiate a Roadside Assistance call (e.g. the relevant cellular phone network is not available). The message `Call failed.` appears in the multifunction display.

Roadside Assistance calls can be terminated using the  button on the multifunction steering wheel or the respective button for ending a telephone call on the audio system or COMAND* head unit.

Information button

Located below the center armrest cover is the Information button .

- ▶ Press and hold button (for longer than two seconds).

A call to the Customer Assistance Center will be initiated. The button will flash while the call is in progress. The message `Connecting call` will appear in the multifunction display and the audio system is muted.

When the connection is established, the message `Call connected` appears in the multifunction display. The Tele Aid system will transmit data generating the vehicle identification number, model, color and location (subject to availability of cellular and GPS signals).



A voice connection between the Customer Assistance Center representative and the occupants of the vehicle will be established. Information regarding the operation of your vehicle, the nearest Mercedes-Benz Center or Mercedes-Benz USA products and services is available to you.

For more details concerning the Tele Aid system, please visit www.mbusa.com and use your ID and password (sent to you separately) to learn more (USA only).

Controls in detail

Useful features



The indicator lamp on the Information button  remains illuminated in red for approximately ten seconds during the system self-check after switching on ignition (together with the SOS button and the Roadside Assistance button ).

See system self-check (▷ page 268) when the indicator lamp does not come on in red or stays on longer than approximately ten seconds.

If the indicator lamp on the Information button  is flashing continuously and there was no voice connection to the Response Center established, then the Tele Aid system could not initiate an Information call (e.g. the relevant cellular phone network is not available). The message *Call failed.* appears in the multifunction display.

Information calls can be terminated using the  button on the multifunction steering wheel or the respective button for ending a telephone call on the audio system or COMAND* head unit.



If the indicator lamps do not start flashing after pressing one of the buttons or remain illuminated (in red) at any time, the Tele Aid system has detected a malfunction or the service is not currently active, and may not initiate a call. Visit your Mercedes-Benz Center and have the system checked or contact the Response Center at 1-800-756-9018 (in the USA) or 1-888-923-8367 (in Canada) as soon as possible.

Upgrade scenario

An emergency call is possible even if other services are active.



If the indicator lamp continues to flash or the system does not reset, contact the Response Center at 1-800-756-9018 (in the USA) or 1-888-923-8367 (in Canada), or Mercedes-Benz Customer Assistance at 1-800-FOR-MERCEdes (1-800-367-6372) in the USA or Customer Service at 1-800-387-0100 in Canada.

Controls in detail

Useful features



The indicator lamp in the respective button flashes until the call is concluded. Calls can only be terminated by a Response Center or Customer Assistance Center representative except Roadside Assistance and Information calls, which can also be terminated by pressing button  on the multifunction steering wheel or the respective button for ending a telephone call on the audio system or COMAND* head unit.



When a Tele Aid call has been initiated, the audio system or the COMAND* system audio is muted and the selected mode (radio or CD) pauses. The optional cellular phone (if installed) switches off. If you must use this phone, the vehicle must be parked. Disconnect the coiled cord and place the call. The COMAND* navigation system (if engaged) will continue to run. The display in the instrument cluster is available for use, and spoken commands are only available by pressing the RPT button on the COMAND* unit. A pop-up window will appear in the COMAND* display to indicate that a Tele Aid call is in progress.

Remote door unlock

In case you have locked your vehicle unintentionally (e.g. SmartKey inside vehicle), and the reserve SmartKey is not handy:

- ▶ Contact the Mercedes-Benz Response Center at 1-800-756-9018 (in the USA) or 1-888-923-8367 (in Canada).

You will be asked to provide your password which you provided when you completed the subscriber agreement.

- ▶ Then return to your vehicle and pull the trunk recessed handle for a minimum of 20 seconds until the SOS button is flashing.

The message *Connecting call* appears in the multifunction display.

As an alternative, you may unlock the vehicle via Internet using the ID and password sent to you shortly after the completion of your acquaintance call.

The Response Center will then unlock your vehicle with the remote door unlocking feature.

Controls in detail

Useful features



The remote door unlock feature is available if the relevant cellular phone network is available.

The SOS button will flash and the message *Connecting call* will appear in the multifunction display to indicate receipt of the door unlock command.

Once the vehicle is unlocked, a Response Center specialist will attempt to establish voice contact with the vehicle occupants.

If the trunk recessed handle was pulled for more than 20 seconds before door unlock authorization was received by the Response Center, you must wait 15 minutes before pulling the trunk recessed handle again.

Stolen Vehicle Recovery services

In the event your vehicle was stolen:

- ▶ Report the incident to the police.
The police will issue a numbered incident report.
- ▶ Pass this number on to the Mercedes-Benz Response Center along with your password issued to you when you subscribed to the service.

The Response Center will then attempt to covertly contact the vehicle's Tele Aid system. Once the vehicle is located, the Response Center will contact the local law enforcement and you. The vehicle's location will only be provided to law enforcement.



When the anti-theft alarm or the tow-away alarm stays on for more than 30 seconds, a call is initiated automatically to the Response Center. See anti-theft alarm system* (▷ page 89) and tow-away alarm* (▷ page 91).

Garage door opener*

The built-in remote control is capable of operating up to three separately controlled devices, for example garage door openers, gate openers, or other devices compatible with HomeLink® or some other systems.

You can program the signal transmitter buttons.

Controls in detail

Useful features

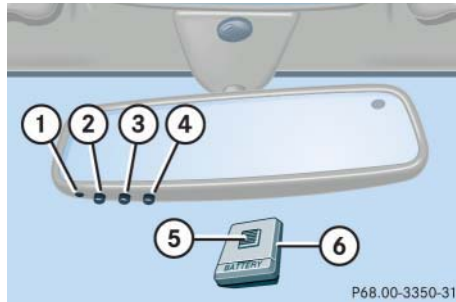

Remote control integrated into the interior rear view mirror

- ① Indicator lamp
- ② ③ ④ Signal transmitter button
- ⑤ Hand-held transmitter button
- ⑥ Hand-held remote control transmitter (not part of the vehicle equipment)

Warning!



Before programming the integrated remote control to a garage door opener or gate operator, make sure people and objects are out of the way of the device to prevent potential harm or damage. When programming a garage door opener, the door moves up or down. When programming a gate operator, the gate opens or closes.

Do not use the integrated remote control with any garage door opener that lacks safety stop and reverse features as required by U.S. federal safety standards (this includes any garage door opener model manufactured before April 1, 1982).

A garage door that cannot detect an object - signaling the door to stop and reverse - does not meet current U.S. federal safety standards.



Certain types of garage door openers are incompatible with the integrated opener. If you should experience difficulties with programming the transmitter, contact an authorized Mercedes-Benz Center, or call Mercedes-Benz Customer Assistance Center (in the USA only) at 1-800-FOR-MERCEdes, or Customer Service (in Canada) at 1-800-387-0100.

Controls in detail

Useful features



USA only:

This device complies with Part 15 of the FCC Rules. Operation is subject to the following two conditions:

- (1) This device may not cause harmful interference, and
- (2) this device must accept any interference received, including interference that may cause undesired operation.

Any unauthorized modification to this device could void the user's authority to operate the equipment.



Canada only:

This device complies with RSS-210 of Industry Canada. Operation is subject to the following two conditions:

- (1) This device may not cause interference, and
- (2) this device must accept any interference received, including interference that may cause undesired operation of the device.

Any unauthorized modification to this device could void the user's authority to operate the equipment.

Programming or reprogramming the integrated remote control

Step 1:

- ▶ Switch on ignition (▷ page 33).

Step 2:

- ▶ If you have previously programmed an integrated signal transmitter button and wish to retain its programming, proceed to step 3. Otherwise, press and hold the two outer signal transmitter buttons ② and ④ and release them only when the indicator lamp ① begins to flash after approximately 20 seconds (do not hold the button for longer than 30 seconds). This procedure erases any previous settings for all three channels and initializes the memory. If you later wish to program a second and/or third hand-held transmitter to the remaining two signal transmitter buttons, do not repeat this step and begin directly with step 3.

Controls in detail

Useful features

Step 3:

- ▶ Hold the end of the hand-held remote control transmitter ⑥ of the device you wish to train approximately 2 to 5 in (5 to 12 cm) away from the surface of the integrated remote control located on the interior rear view mirror, keeping the indicator lamp ① in view.

Step 4:

- ▶ Using both hands, simultaneously press the hand-held transmitter button ⑤ and the desired integrated signal transmitter button (②, ③ or ④). Do not release the buttons until completing step 5.

The indicator lamp ① on the integrated remote control will flash, first slowly and then rapidly.



The indicator lamp ① flashes the first time the signal transmitter button is programmed. If this button has already been programmed, the indicator lamp will only start flashing after 20 seconds.

Step 5:

- ▶ When the indicator lamp ① flashes rapidly, release both buttons.

Step 6:

- ▶ Press and hold the just-trained integrated signal transmitter button and observe the indicator lamp ①.

If the indicator lamp ① stays on constantly, programming is complete and your device should activate when the integrated signal transmitter button is pressed and released.



If the indicator lamp ① flashes rapidly for about two seconds and then turns to a constant light, continue with programming steps 8 through 12 as your garage door opener may be equipped with the “rolling code” feature.

Step 7:

- ▶ To program the remaining two buttons, repeat the steps above starting with step 3.

Controls in detail

Useful features

Rolling code programming

To train a garage door opener (or other rolling code devices) with the rolling code feature, follow these instructions after completing the “Programming” portion (steps 1 through 6) of this text. (A second person may make the following training procedures quicker and easier.)

Step 8:

- ▶ Locate “training” button on the garage door opener motor head unit.

Exact location and color of the button may vary by garage door opener brand. Depending on manufacturer, the “training” button may also be referred to as “learn” or “smart” button. If there is difficulty locating the transmitting button, refer to the garage door opener operator’s manual.

Step 9:

- ▶ Press “training” button on the garage door opener motor head unit.

The “training light” is activated.

You have 30 seconds to initiate the following step.

Step 10:

- ▶ Firmly press, hold for two seconds and release the programmed integrated signal transmitter button (②, ③ or ④).

Step 11:

- ▶ Press, hold for two seconds and release same button a second time to complete the training process.

Some garage door openers (or other rolling code equipped devices) may require you to perform this procedure a third time to complete the training.

Step 12:

- ▶ Confirm the garage door operation by pressing the programmed integrated signal transmitter button (②, ③ or ④).

Step 13:

- ▶ To program the remaining two buttons, repeat the steps above starting with step 3.

Gate operator/Canadian programming

Canadian radio-frequency laws require transmitter signals to “time-out” (or quit) after several seconds of transmission which may not be long enough for the integrated signal transmitter to pick up the signal during programming. Similar to this Canadian law, some U.S. gate operators are designed to “time-out” in the same manner.

If you live in Canada or if you are having difficulties programming a gate operator (regardless of where you live) by using the programming procedures, replace step 4 with the following:

Step 4:

- ▶ Continue to press and hold the integrated signal transmitter button (②, ③ or ④) while you press and re-press (“cycle”) your hand-held remote control transmitter ⑥ every two seconds until the frequency signal has been learned. Upon successful training, the indicator lamp ① will flash slowly and then rapidly after several seconds.
- ▶ Proceed with programming step 5 and step 6 to complete.

Operation of integrated remote control

- ▶ Switch on ignition (▷ page 33).
- ▶ Select and press the appropriate integrated signal transmitter button (②, ③ or ④) to activate the remote controlled device.

The integrated remote control transmitter continues to send the signal as long as the button is pressed – up to 20 seconds.

Erasing the integrated remote control memory

- ▶ Switch on ignition (▷ page 33).
- ▶ Simultaneously hold down the signal transmitter buttons ② and ④, for approximately 20 seconds, until the indicator lamp ① flashes rapidly. Do not hold for longer than 30 seconds.

The codes of all three channels are erased.



If you sell your vehicle, erase the codes of all three channels.

Controls in detail

Useful features

Reprogramming a single integrated signal transmitter button

To program a device using a signal transmitter button previously trained, follow these steps:

- ▶ Press and hold the desired signal transmitter button (②, ③ or ④). Do not release the button.
- ▶ The indicator lamp will begin to flash after 20 seconds. Without releasing the integrated signal transmitter button, proceed with programming starting with step 3.

Operation

The first 1000 miles (1500 km)

Driving instructions

At the gas station

Engine compartment

Tires and wheels

Winter driving

Maintenance

Vehicle care

Operation

The first 1 000 miles (1 500 km)

In the “Operation” section you will find detailed information on operating, maintaining and caring for your vehicle.

The more cautiously you treat your vehicle during the break-in period, the more satisfied you will be with its performance later on.

- Drive your vehicle during the first 1 000 miles (1 500 km) at varying but moderate vehicle and engine speeds.
- During this period, avoid heavy loads (full throttle driving) and excessive engine speeds (no more than $\frac{2}{3}$ of maximum rpm in each gear).
- Shift gears in a timely manner.
- Avoid accelerating by kick-down.
- Do not attempt to slow the vehicle down by shifting to a lower gear using the gear selector lever.
- Select positions **3**, **2** or **1** only when driving at moderate speeds (for hill driving).
- Select **C** as the preferred shift program (▷ page 169) for the first 1 000 miles (1 500 km).

After 1 000 miles (1 500 km) you may gradually increase vehicle and engine speeds to the permissible maximum.

All of the above instructions, as may apply to your vehicle type, also apply when driving the first 1 000 miles (1 500 km) after the engine or the rear differential has been replaced.



Always obey applicable speed limits.

▼ **Driving instructions**

Drive sensibly – save fuel

Fuel consumption, to a great extent, depends on driving habits and operating conditions.

To save fuel you should:

- Keep tires at the recommended tire inflation pressures.
- Remove unnecessary loads.
- Remove roof rack when not in use.
- Allow engine to warm up under low load use.
- Avoid frequent acceleration and deceleration.
- Have all maintenance work performed at the intervals specified in the Maintenance Booklet and as required by the maintenance service display. Contact an authorized Mercedes-Benz Center.

Fuel consumption is also increased by driving in cold weather, in stop-and-go traffic, on short trips and in hilly area.

Drinking and driving

Warning!



Drinking and driving and/or taking drugs and driving are very dangerous combinations. Even a small amount of alcohol or drugs can affect your reflexes, perceptions and judgement.

The possibility of a serious or even fatal accident are greatly increased when you drink or take drugs and drive.

Do not drink or take drugs and drive or allow anyone to drive who has been drinking or taking drugs.

Pedals

Warning!



Keep driver's foot area clear at all times. Objects stored in this area may impair pedal movement.

Power assistance

Warning!



With the engine not running, there is no power assistance for the brake and steering systems. In this case, it is important to keep in mind that a considerably higher degree of effort is necessary to brake and steer the vehicle.

Operation

Driving instructions

Brakes

Warning!



After driving in heavy rain for some time without applying the brakes or through water deep enough to wet brake components, the first braking action may be somewhat reduced and increased pedal pressure may be necessary to obtain expected braking effect. Maintain a safe distance from vehicles in front.

Resting your foot on the brake pedal will cause excessive and premature wear of the brake pads.

It can also result in the brakes overheating, thereby significantly reducing their effectiveness. It may not be possible to stop the vehicle in sufficient time to avoid an accident.

To help prevent brake disk corrosion after driving on wet road surfaces (particularly salted roads), it is advisable to brake the vehicle with considerable force prior to parking. The heat generated serves to dry the brakes.

If your brake system is normally only subject to moderate loads, you should occasionally test the effectiveness of the brakes by applying above-normal braking pressure at higher speeds. This will also enhance the grip of the brake pads.



Be very careful not to endanger other road users when you apply the brakes.

Refer to the description of the Brake Assist System (BAS) (> page 84).

If the parking brake is released and the brake warning lamp in the instrument cluster stays on, the brake fluid level in the reservoir is too low.

Brake pad wear or a leak in the system may be the reason for low brake fluid in the reservoir.

Have the brake system inspected immediately. Contact an authorized Mercedes-Benz Center.

All checks and service work on the brake system should be carried out by qualified technicians only. Contact an authorized Mercedes-Benz Center.

Only install brake pads and brake fluid recommended by Mercedes-Benz.

Warning!



If other than recommended brake pads are installed, or other than recommended brake fluid is used, the braking properties of the vehicle can be degraded to an extent that safe braking is substantially impaired. This could result in an accident.



When driving down long and steep grades, relieve the load on the brakes by shifting into a lower gear to use the engine's braking power. This helps prevent overheating of the brakes and reduces brake pad wear.

After hard braking, it is advisable to drive on for some time, rather than immediately parking, so that the air stream will cool down the brakes faster.

Driving off

Apply the brakes to test them briefly after driving off. Perform this procedure only when the road is clear of other traffic.

Warm up the engine smoothly. Do not place full load on the engine until the operating temperature has been reached.

When starting off on a slippery surface, do not allow a drive wheel to spin for an extended period with the ESP switched off. Doing so may cause serious damage to the drivetrain which is not covered by the Mercedes-Benz Limited Warranty.



Simultaneously depressing the accelerator pedal and applying the brake reduces engine performance and causes premature brake and drivetrain wear.

Parking



Set the parking brake whenever parking or leaving the vehicle. In addition, move gear selector lever to position **P** (manual transmission: first or reverse gear).

When parking on hills, always turn front wheels towards the road curb.

Operation

Driving instructions

Warning!



Do not park this vehicle in areas where combustible materials such as grass, hay or leaves can come into contact with the hot exhaust system, as these materials could be ignited and cause a vehicle fire.

To reduce the risk of personal injury as a result of vehicle movement, before turning off the engine and leaving the vehicle always:

- Keep right foot on brake pedal.
- Firmly depress parking brake pedal.
- Move the gear selector lever to position **P** (manual transmission: first or reverse gear).
- Slowly release brake pedal.
- When parked on an incline, turn front wheels towards the road curb.
- Turn the SmartKey in the starter switch to position **0** and remove the SmartKey from the starter switch.
- Take the SmartKey with you and lock the vehicle when leaving.

Operation

Driving instructions

Tires

Warning!



If you feel a sudden significant vibration or ride disturbance, or you suspect that possible damage to your vehicle has occurred, you should turn on the hazard warning flashers, carefully slow down, and drive with caution to an area which is a safe distance from the road.

Inspect the tires and the vehicle underbody for possible damage. If the vehicle or tires appear unsafe, have it towed to the nearest Mercedes-Benz Center or tire dealer for repairs.

Treadwear indicators (TWI) are required by law. These indicators are located in six places on the tread circumference and become visible at a tread depth of approximately $\frac{1}{16}$ in (1.6 mm), at which point the tire is considered worn and should be replaced.

The treadwear indicator appears as a solid band across the tread.

Warning!



Although the applicable federal motor vehicle safety laws consider a tire to be worn when the treadwear indicators (TWI) become visible at approximately $\frac{1}{16}$ in (1.6 mm), we recommend that you do not allow your tires to wear down to that level. As tread depth approaches $\frac{1}{8}$ in (3 mm), the adhesion properties on a wet road are sharply reduced.

Depending upon the weather and/or road surface (conditions), the tire traction varies widely.

Specified tire inflation pressures must be maintained. This applies particularly if the tires are subjected to high loads (e.g. high speeds, heavy loads, high ambient temperatures).

Warning!



Do not drive with a flat tire. A flat tire affects the ability to steer or brake the vehicle. You may lose control of the vehicle. Continued driving with a flat tire or driving at high speed with a flat tire will cause excessive heat build-up and possibly a fire.

Hydroplaning

Depending on the depth of the water layer on the road, hydroplaning may occur, even at low speeds and with new tires. Reduce vehicle speed, avoid track grooves in the road and apply brakes cautiously in the rain.

Tire traction

The safe speed on a wet, snow covered or icy road is always lower than on a dry road.

You should pay particular attention to the condition of the road whenever the outside temperatures are close to the freezing point.

Warning!



If ice has formed on the road, tire traction will be substantially reduced. Under such weather conditions, drive, steer and brake with extreme caution.

Mercedes-Benz recommends M+S rated radial-ply tires with a minimum tread depth of approximately $\frac{1}{6}$ in (4 mm) on all four wheels for the winter season to ensure normal balanced handling characteristics. On packed snow, they can reduce your stopping distance compared to summer tires. Stopping distance, however, is still considerably greater than when the road is not covered with snow or ice. Exercise appropriate caution.



Avoid spinning of a drive wheel. This may cause serious damage to the drivetrain which is not covered by the Mercedes-Benz Limited Warranty.

Tire speed rating

Regardless of the tire speed rating, local speed limits should be obeyed. Use prudent driving speeds appropriate to prevailing conditions.

Warning!



Even when permitted by law, never operate a vehicle at speeds greater than the maximum speed rating of the tires.

Exceeding the maximum speed for which tires are rated can lead to sudden tire failure, causing loss of vehicle control and possibly resulting in an accident and/or personal injury and possible death, for you and for others.

Operation

Driving instructions

C 230 Kompressor (Canada only), C 240, C 240 4MATIC, C 320 (USA only), C 320 4MATIC

Your vehicle is factory equipped with “H”-rated tires, which have a speed rating of 130 mph (210 km/h).

An electronic speed limiter prevents your vehicle from exceeding a speed of 130 mph (210 km/h).

C 230 Kompressor Sport, C 320 Sport

Your vehicle is factory equipped with “W”-rated tires, which have a speed rating of 168 mph (270 km/h).

An electronic speed limiter prevents your vehicle from exceeding a speed of 130 mph (210 km/h).



For information on speed rating for winter tires, see “Winter tires” (▷ page 332).

For additional general information on tire speed markings on tire sidewall, see “Tire speed rating” (▷ page 320).

Winter driving instructions

The most important rule for slippery or icy roads is to drive sensibly and to avoid abrupt acceleration, braking and steering maneuvers. Do not use the cruise control system under such conditions.

When the vehicle is in danger of skidding, move gear selector lever to position **N** or in case of manual transmission declutch.

Try to keep the vehicle under control by corrective steering action.



For information on driving with snow chains, see “Snow chains” (▷ page 333).

Warning!



On slippery road surfaces, never downshift in order to obtain braking action. This could result in drive wheel slip and reduced vehicle control. Your vehicle’s ABS will not prevent this type of control loss.

Road salts and chemicals can adversely affect braking efficiency. Increased pedal force may become necessary to produce the normal braking effect.

Depressing the brake pedal periodically when traveling at length on salt-strewn roads can bring road-salt-impaired braking efficiency back to normal.

If the vehicle is parked after being driven on salt-treated roads, the braking efficiency should be tested as soon as possible after driving is resumed.

Warning!



Make sure not to endanger any other road users when carrying out these braking maneuvers.

Warning!



If the vehicle becomes stuck in snow, make sure snow is kept clear of the exhaust pipe and from around the vehicle with the engine running. Otherwise, deadly carbon monoxide (CO) gases may enter vehicle interior resulting in unconsciousness and death.

To assure sufficient fresh air ventilation, open a window slightly on the side of the vehicle not facing the wind.

Warning!



The outside temperature indicator is not designed to serve as an ice-warning device and is therefore unsuitable for that purpose. Indicated temperatures just above the freezing point do not guarantee that the road surface is free of ice.

For more information, see “Winter driving” (▷ page 332).

Standing water



Do not drive through flooded areas or water of unknown depth. Before driving through water, determine its depth. Never accelerate before driving into water. The bow wave could force water into the engine and auxiliary equipment, thus damaging them.

If you must drive through standing water, drive slowly to prevent water from entering the passenger compartment or the engine compartment. Water in these areas could cause damage to electrical components or wiring of the engine or transmission, or could result in water being ingested by the engine through the air intake causing severe internal engine damage. Any such damage is not covered by the Mercedes-Benz Limited Warranty.

Operation

Driving instructions

Passenger compartment

Warning!



Always fasten items being carried as securely as possible.

In an accident, during hard braking or sudden maneuvers, loose items will be thrown around inside the vehicle, and cause injury to vehicle occupants unless the items are securely fastened in the vehicle.

The trunk is the preferred place to carry objects.

Driving abroad

Abroad, there is an extensive Mercedes-Benz service network at your disposal. If you plan to drive into areas which are not listed in the index of your Mercedes-Benz Center directory, you should request pertinent information from an authorized Mercedes-Benz Center.

Control and operation of radio transmitters

COMAND*, radio and telephone*

Warning!



Please do not forget that your primary responsibility is to drive the vehicle safely. Only operate the COMAND (Cockpit Management and Data System), radio or telephone¹ if road, weather and traffic conditions permit.

Bear in mind that at a speed of just 30 mph (approximately 50 km/h), your vehicle is covering a distance of 44 feet (approximately 14 m) every second.

¹ Observe all legal requirements

Telephones* and two-way radios

Warning!



Never operate radio transmitters equipped with a built-in or attached antenna (i.e. without being connected to an external antenna) from inside the vehicle while the engine is running. Doing so could lead to a malfunction of the vehicle's electronic system, possibly resulting in an accident and personal injury.

Radio transmitters, such as a portable telephone or a citizens band unit should only be used inside the vehicle if they are connected to an antenna that is installed on the outside of the vehicle.

Refer to the radio transmitter operation instructions regarding use of an external antenna.

Catalytic converter

Your Mercedes-Benz is equipped with monolithic-type catalytic converters, an important element in conjunction with the oxygen sensors to achieve substantial control of the pollutants in the exhaust emissions. Keep your vehicle in proper operating condition by following our recommended maintenance instructions as outlined in your Maintenance Booklet.



To prevent damage to the catalytic converters, only use premium unleaded gasoline in this vehicle.

Any noticeable irregularities in engine operation should be repaired promptly. Otherwise, excessive unburned fuel may reach the catalytic converter, causing it to overheat and potentially start a fire.

Warning!



As with any vehicle, do not idle, park or operate this vehicle in areas where combustible materials such as grass, hay or leaves can come into contact with the hot exhaust system, as these materials could be ignited and cause a vehicle fire.

Emission control

Certain systems of the engine serve to keep the toxic components of the exhaust gases within permissible limits required by law.

These systems, of course, will function properly only when maintained strictly according to factory specifications. Any adjustments on the engine should, therefore, be carried out only by qualified Mercedes-Benz Center authorized technicians. Engine adjustments should not be altered in any way. Moreover, the specified service jobs must be carried out regularly according to Mercedes-Benz servicing requirements. For details refer to the Maintenance Booklet.

Operation

Driving instructions

Warning!



Inhalation of exhaust gas is hazardous to your health. All exhaust gas contains carbon monoxide, and inhaling it can cause unconsciousness and lead to death.

Do not run the engine in confined areas (such as a garage) which are not properly ventilated. If you think that exhaust gas fumes are entering the vehicle while driving, have the cause determined and corrected immediately. If you must drive under these conditions, drive only with at least one window fully open at all times.

Coolant temperature

During severe operating conditions and stop-and-go city traffic, the coolant temperature may rise close to approximately 248°F (120°C).

The engine should not be operated with the coolant temperature over 248°F (120°C). Doing so may cause serious engine damage which is not covered by the Mercedes-Benz Limited Warranty.

Warning!



- Driving when your engine is badly overheated can cause some fluids, which may have leaked into the engine compartment, to catch fire. You could be seriously burned.
- Steam from an overheated engine can cause serious burns and can occur just by opening the hood. Stay away from the engine if you see or hear steam coming from it.

Turn off the engine, get out of the vehicle and do not stand near the vehicle until the engine has cooled down.

▼ At the gas station

Refueling

Warning!



Gasoline is highly flammable and poisonous. It burns violently and can cause serious injury. Whenever you are around gasoline, avoid inhaling fumes and skin contact, extinguish all smoking materials. Never allow sparks, flame or smoking materials near gasoline!

Warning!



Flexible Fuel Vehicles only (identified by a label reading **Premium gasoline or E85 only!** on fuel filler flap):

Ethanol fuel (E85) and its vapors are highly flammable, poisonous and burn easily. Ethanol fuel can cause serious injuries if ignited or if you come into contact with it or inhale fumes of it. Avoid inhalation of ethanol fumes and skin contact with ethanol. Extinguish all open flames before fueling. Never smoke or create sparks close to ethanol.

Operation

At the gas station

The fuel filler flap is located on the right-hand side of the vehicle towards the rear. Locking/unlocking the vehicle with the SmartKey automatically locks/unlocks the fuel filler flap.

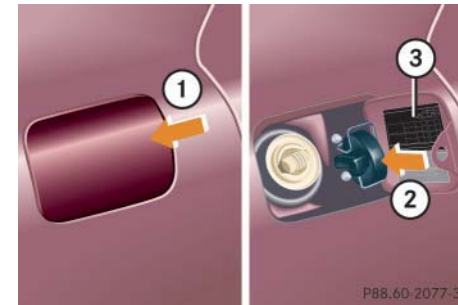

- ① To open the fuel filler flap
- ② To insert the fuel filler cap
- ③ Tire inflation pressure table

- ▶ Turn the engine off by turning the SmartKey to position **0**.
- ▶ Remove the SmartKey from the starter switch.



Operation

At the gas station

- ▷▷ Open the fuel filler flap by pushing at the point indicated by arrow ①.
The fuel filler flap springs open.
- ▶ Turn fuel cap counterclockwise and hold on to it until possible pressure is released.
- ▶ Take off cap and set it in direction of arrow ② in the recess on the fuel filler flap.
To prevent fuel vapors from escaping into open air, fully insert filler nozzle unit.
- ▶ Only fill your tank until the filler nozzle unit cuts out – **do not top up or overfill.**

Warning!



Overfilling of the fuel tank may create pressure in the system which could cause a gas discharge. This could cause the gas to spray back out when removing the fuel pump nozzle, which could cause personal injury.

- ▶ Replace fuel cap by turning it clockwise.
You will hear when fuel cap is tightened.
- ▶ Close fuel filler flap.





Only use premium unleaded gasoline with a minimum Posted Octane Rating of 91 (average of 96 RON/86 MON). Information on gasoline quality can normally be found on the fuel pump.

More information on gasoline can be found in the Factory Approved Service Products pamphlet.

Flexible Fuel Vehicles are identified by a label reading **Premium gasoline or E85 only!** on fuel filler flap.

For more information, see “Flexible Fuel Vehicles” (▷ page 435).



Leaving the engine running and the fuel cap open can cause the  malfunction indicator lamp (USA only) or the  malfunction indicator lamp (Canada only) to illuminate.

For more information, see “Practical hints” (▷ page 346) and (▷ page 347).

Check regularly and before a long trip

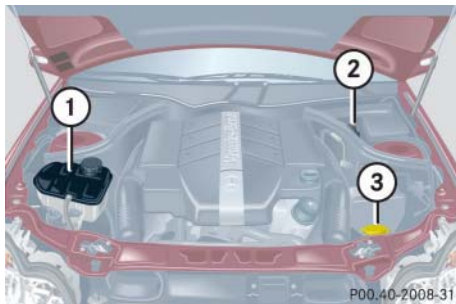

- ① Coolant
- ② Brake fluid (fuse box cover removed)
- ③ Windshield washer and headlamp cleaning system*



Opening the hood, see (▷ page 296).

Coolant

For normal replenishing, use water (potable water quality). For more information, see “Coolant level” (▷ page 301) and see “Fuels, coolants, lubricants, etc.” (▷ page 431).

Brake fluid



If you find that the brake fluid in the brake fluid reservoir has fallen to the minimum mark or below, have the brake system checked for brake pad thickness and leaks immediately. Notify an authorized Mercedes-Benz Center immediately. Do not add brake fluid as this will not solve the problem. For more information, see “Practical hints” (▷ page 345).

Removing fuse box cover (▷ page 414).

Windshield washer and headlamp cleaning system*

For more information on filling up the washer reservoir, see “Windshield washer system and headlamp cleaning system*” (▷ page 303).

Engine oil level

For more information on engine oil level, see “Engine oil” (▷ page 297).

Vehicle lighting

Check function and cleanliness. For more information on replacing light bulbs, see “Replacing bulbs” (▷ page 390).

Exterior lamp switch (▷ page 117).

Tire inflation pressure

More information on tire inflation pressure (▷ page 315).

Operation

Engine compartment

Hood

Warning!



Do not pull the release lever while the vehicle is in motion. Otherwise the hood could be forced open by passing air flow.

Opening

The hood lock release lever is located to the left of the steering wheel under the dashboard.



① Hood lock release lever

- ▶ Pull lever ① downwards.

The hood is unlocked and handle ② will extend out of the radiator grille.



To avoid damage to the windshield wipers or hood, never open the hood if the wiper arms are folded forward away from the windshield.

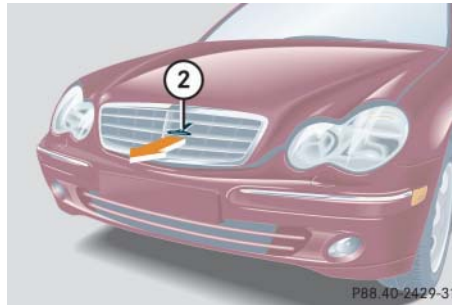

② Handle for opening the hood

- ▶ Pull handle ② to its stop out of radiator grille.
- ▶ Pull up on the hood (do not pull up on the handle) and then release it.

The hood will be automatically held open at shoulder height by gas-filled struts.

Warning!



To help prevent personal injury, stay clear of moving parts when the hood is open and the engine is running. Make sure the hood is properly closed before driving. When closing the hood, use extreme caution not to catch hands or fingers.

The radiator fan may continue to run for approximately 30 seconds or even restart after the engine has been turned off. Stay clear of fan blades.

Warning!



If you see flames or smoke coming from the engine compartment, or if the coolant temperature gauge indicates that the engine is overheated, do not open the hood. Move away from vehicle and do not open the hood until the engine has cooled. If necessary, call the fire department.

Warning!



The engine is equipped with a transistorized ignition system. Because of the high voltage it is dangerous to touch any components (ignition coils, spark plug sockets, diagnostic socket) of the ignition system

- with the engine running
- while starting the engine
- if ignition is “on” and the engine is turned manually

Closing

Warning!



Be careful that you do not close the hood on anyone.

- ▶ Let the hood drop from a height of approximately 1 ft (30 cm).
The hood will lock audibly.
- ▶ Check to make sure the hood is fully closed.

If you can raise the hood at a point above the headlamps, then it is not properly closed. Open it again and let it drop with somewhat greater force.

Engine oil

The amount of oil your engine needs will depend on a number of factors, including driving style. Higher oil consumption can occur when

- the vehicle is new
- the vehicle is driven frequently at higher engine speeds

Engine oil consumption checks should only be made after the vehicle break-in period.



Do not use any special lubricant additives, as these may damage the drive assemblies. Using special additives not approved by Mercedes-Benz may cause damage not covered by the Mercedes-Benz Limited Warranty. More information on this subject is available at any Mercedes-Benz Center.

Operation

Engine compartment

Checking engine oil level with the control system



When checking the oil level

- the vehicle must be parked on level ground
- with the engine at operating temperature, the vehicle must have been stationary for at least five minutes with the engine turned off
- with the engine not at operating temperature yet, the vehicle must have been stationary for at least 30 minutes with the engine turned off

To check the engine oil level via the multifunction display, do the following:

- ▶ Switch on ignition (▷ page 33).

The standard display (▷ page 129) should appear in the multifunction display.

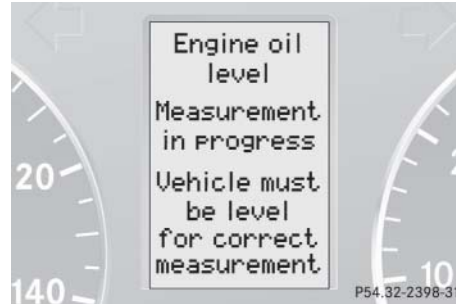

- ▶ Press button  or  on the steering wheel until the following message is seen in the multifunction display:



One of the following messages will subsequently appear in the indicator:

- Engine oil level OK
- Add 1.0 qt engine oil for max. oil level
(Canada: 1.0 l)
- Add 1.5 qts engine oil for max. oil level
(Canada: 1.5 l)
- Add 2.0 qts engine oil for max. oil level
(Canada: 2.0 l)



If you want to interrupt the checking procedure, press the  or  button on the multifunction steering wheel.

- ▶ If necessary, add engine oil.

For adding engine oil see (▷ page 299).

More information on engine oil can be found in the “Technical data” section (▷ page 431) and (▷ page 433).

Other display messages

If the SmartKey is not turned to position **2** in the starter switch, the following message will appear:

Switch ignition on to check engine oil level

- ▶ Switch on ignition (▷ page 33).

If you see the message:

Observe waiting time

- ▶ If engine is at operating temperature, wait five minutes before repeating check procedure.
- ▶ If engine is not at operating temperature yet, wait 30 minutes before repeating check procedure.

If you see the message:

Engine oil level

Not when engine on

- ▶ Turn off the engine.
- ▶ If the engine is at operating temperature, wait five minutes before checking oil.
- ▶ If the engine is not at operating temperature yet, you must wait 30 minutes before checking oil.

If there is excess engine oil with the engine at operating temperature, the following message will appear:

Engine oil level

Reduce oil level

- ▶ Have excess oil siphoned or drained off. Contact an authorized Mercedes-Benz Center.



Excess oil must be siphoned or drained off. It could cause damage to the engine and catalytic converter not covered by the Mercedes-Benz Limited Warranty.

More information on messages in the display concerning engine oil can be found in the “Practical hints” section (▷ page 368) and (▷ page 369).

Adding engine oil



Only use approved engine oils and oil filters required for vehicles with Maintenance System (U.S. vehicles) or FSS (Canada vehicles). For a listing of approved engine oils and oil filters, refer to the Factory Approved Service Products pamphlet in your vehicle literature portfolio, or contact an authorized Mercedes-Benz Center.

Using engine oils and oil filters of specification other than those expressly required for the Maintenance System (U.S. vehicles) or FSS (Canada vehicles), or changing of oil and oil filter at change intervals longer than those called for by the Maintenance System (U.S. vehicles) or FSS (Canada Vehicles) will result in engine damage not covered by the Mercedes-Benz Limited Warranty.

Operation

Engine compartment



C 230 Kompressor (all models)

- ① Filler cap
- ▶ Unscrew filler cap ① from filler neck.
- ▶ Add engine oil as required. Be careful not to overfill with oil.

Be careful not to spill any oil when adding. Avoid environmental damage caused by oil entering the ground or water.

! Excess oil must be siphoned or drained off. It could cause damage to the engine and catalytic converter not covered by the Mercedes-Benz Limited Warranty.

- ▶ Screw filler cap ① back on filler neck.



C 240 (all models) and C 320 (all models)

- ① Filler cap
- ▶ Unscrew filler cap ① from filler neck.
- ▶ Add engine oil as required. Be careful not to overfill with oil.

Be careful not to spill any oil when adding. Avoid environmental damage caused by oil entering the ground or water.

! Excess oil must be siphoned or drained off. It could cause damage to the engine and catalytic converter not covered by the Mercedes-Benz Limited Warranty.

- ▶ Screw filler cap ① back on filler neck.

More information on engine oil can be found in the “Technical data” section (▷ page 431) and (▷ page 433).

Transmission fluid level

The transmission fluid level does not need to be checked. If you notice transmission fluid loss or gear shifting malfunctions, have an authorized Mercedes-Benz Center check the transmission.

Coolant level

The engine coolant is a mixture of water and anticorrosion/antifreeze. To check the coolant level, the vehicle must be parked on level ground and the engine must be cool.

The coolant expansion tank is located on the passenger side of the engine compartment.

Warning!



In order to avoid any possibly serious burns:

- Use extreme caution when opening the hood if there are any signs of steam or coolant leaking from the cooling system, or if the coolant temperature gauge indicates that the coolant is overheated.
- Do not remove pressure cap on coolant reservoir if coolant temperature is above 158°F (70°C). Allow engine to cool down before removing cap. The coolant reservoir contains hot fluid and is under pressure.

- Using a rag, slowly open the cap approximately $\frac{1}{2}$ turn to relieve excess pressure. If opened immediately, scalding hot fluid and steam will be blown out under pressure.
- Do not spill antifreeze on hot engine parts. Antifreeze contains ethylene glycol which may burn if it comes into contact with hot engine parts.

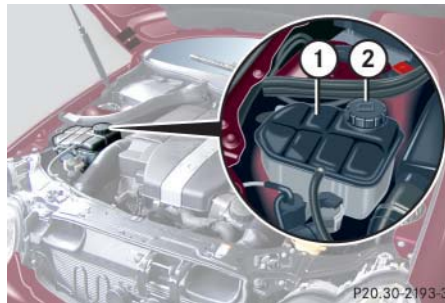

- ① Coolant expansion tank
- ② Cap

Operation

Engine compartment

- ▶ Using a rag, turn cap ② slowly approximately one half turn to the left to release any excess pressure.
- ▶ Continue turning the cap to the left and remove it.

The coolant level is correct if the level

- for cold coolant: reaches the black top part of the reservoir
- for warm coolant: is approx. 0.6 in (1.5 cm) higher

- ▶ Add coolant as required.
- ▶ Replace and tighten cap.

For more information on coolant, see “Coolants” (▷ page 437).

Operation

Engine compartment

Battery

Your vehicle's battery is located in the engine compartment on the right hand side (▷ page 404).

The battery should always be sufficiently charged in order to achieve its rated service life. Refer to Maintenance Booklet for battery maintenance intervals.

If you use your vehicle mostly for short-distance trips, you will need to have the battery charge checked more frequently.

When replacing the battery, always use batteries approved by Mercedes-Benz.

If you do not intend to operate your vehicle for an extended period of time, consult an authorized Mercedes-Benz Center about steps you need to observe.



Observe all safety instructions and precautions when handling automotive batteries.



Risk of explosion



Keep flames or sparks away from battery. Do not smoke.



Battery acid is caustic. Do not allow it to come into contact with skin, eyes or clothing.

In case it does, immediately flush affected area with clear water and seek medical help if necessary.



Wear eye protection.



Keep children away.



Follow the instructions in this Operator's Manual.

Batteries contain materials that can harm the environment if disposed of improperly. Recycling of batteries is the preferred method of disposal. Many states require sellers of batteries to accept old batteries for recycling.

Windshield washer system and headlamp cleaning system*

The windshield washer reservoir is located in the engine compartment.



① Washer fluid reservoir cap

Fluid for the windshield washer system and the headlamp cleaning system* is supplied from the windshield washer reservoir. It has a capacity of:

- 3.2 US qt (3.0 l) in vehicles without headlamp cleaning system*
- 6.4 US qt (6.0 l) in vehicles with headlamp cleaning system*

During all seasons, add MB Windshield Washer Concentrate “S” to water. Premix the windshield washer fluid in a suitable container.

- ▶ Refill the reservoir with MB Windshield Washer Concentrate and water (or commercially available premixed windshield washer solvent/antifreeze, depending on ambient temperatures).

Always use washer solvent/antifreeze where temperatures may fall below the freezing point. Failure to do so could result in damage to the washer system/reservoir.



Only use washer fluid which is suitable for plastic lenses. Improper washer fluid can damage the plastic lenses of the headlamps.

Operation

Engine compartment

Warning!



Washer solvent/antifreeze is highly flammable. Do not spill washer solvent/antifreeze on hot engine parts, because it may ignite and burn. You could be seriously burned.

For more information, see “Windshield washer and headlamp cleaning system*” (▷ page 439).

Operation

Tires and wheels

See an authorized Mercedes-Benz Center for information on tested and recommended rims and tires for summer and winter operation. They can also offer advice concerning tire service and purchase.

Warning!



Replace rims or tires with the same designation, manufacturer and type as shown on the original part. See an authorized Mercedes-Benz Center for further information. If incorrectly sized rims and tires are mounted:

- The wheel brakes or suspension components can be damaged.
- The operating clearance of the wheels and the tires may no longer be correct.

Warning!



Worn, old tires can cause accidents. If the tire tread is badly worn, or if the tires have sustained damage, replace them.

When replacing rims, only use genuine Mercedes-Benz wheel bolts specified for the particular rim type. Failure to do so can result in the bolts loosening and possibly an accident.

Retreaded tires are not tested or recommended by Mercedes-Benz, since previous damage cannot always be recognized on retreads. The operating safety of the vehicle cannot be assured when such tires are used.

Important guidelines

- Only use sets of tires and rims of the same type and make.
- Tires must be of the correct size for the rim.
- Break in new tires for approximately 60 miles (100 km) at moderate speeds.
- Regularly check the tires and rims for damage. Dented or bent rims can cause tire inflation pressure loss and damage to the tire beads.
- If vehicle is heavily loaded, check tire inflation pressure and correct as required.
- Do not allow your tires to wear down too far. Adhesion properties on wet roads are sharply reduced at tread depths under $\frac{1}{8}$ in (3 mm).
- When replacing individual tires, you should mount new tires on the front wheels first (on vehicles with same-sized wheels all around).

Tire care and maintenance

Warning!

Regularly check the tires for damage. Damaged tires can cause tire inflation pressure loss. As a result, you could lose control of your vehicle.

Worn, old tires can cause accidents. If the tire tread is badly worn, or if the tires have sustained damage, replace them.

Regularly check your tire inflation pressure at least once a month. For more information on checking tire inflation pressure see “Recommended tire inflation pressure” (> page 313).

Tire inspection

Every time you check your tire inflation pressure, you should also inspect your tires for wear and damage for the following:

- excessive treadwear (> page 306)
- cord or fabric showing through the tire’s rubber
- bumps, bulges, cuts, cracks, or splits in the tread or side of the tire

Replace the tire if you find any of the above conditions.

Make sure you also inspect the spare tire periodically for condition and tire inflation pressure. Spare tires will age and become worn over time even if never used, and thus should be inspected and replaced when necessary.

Life of tire

The service life of a tire is dependent upon varying factors including but not limited to:

- Driving style
- Tire inflation pressure
- Distance driven

Warning!

Tires and spare tire should be replaced after six years, regardless of the remaining tread.

Operation

Tires and wheels

Tread depth

Do not allow your tires to wear down too far. Adhesion properties on wet roads are sharply reduced at tread depths under $\frac{1}{8}$ in (3 mm).

Treadwear indicators (TWI) are required by law. These indicators are located in six places on the tread circumference and become visible at a tread depth of approximately $\frac{1}{16}$ in (1.6 mm), at which point the tire is considered worn and should be replaced.

Recommended minimum tire tread depth:

- Summer tires $\frac{1}{8}$ in (3 mm)
- Winter tires $\frac{1}{6}$ in (4 mm)

Warning!



Although the applicable federal motor safety laws consider a tire to be worn when the treadwear indicators (TWI) become visible at approximately $\frac{1}{16}$ in (1.6 mm), we recommend that you do not allow your tires

to wear down to that level. As tread depth approaches $\frac{1}{8}$ in (3 mm), the adhesion properties on a wet road are sharply reduced.

Depending upon the weather and/or road surface (conditions), the tire traction varies widely.

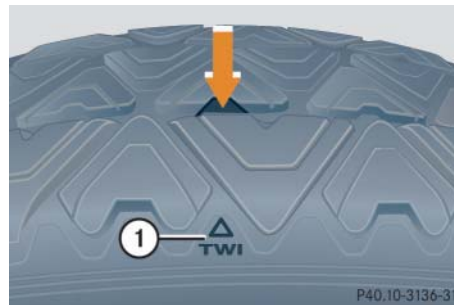

① TWI (Tread Wear Indicator)

The treadwear indicator appears as a solid band across the tread.

Storing tires



Keep unmounted tires in a cool, dry place with as little exposure to light as possible. Protect tires from contact with oil, grease and gasoline.

Cleaning tires



Never use a round nozzle to power wash tires. The intense jet of water can result in damage to the tire.

Always replace a damaged tire.

Direction of rotation

Unidirectional tires offer added advantages, such as better hydroplaning performance. To benefit, however, you must make sure the tires rotate in the direction specified.

An arrow on the sidewall indicates the intended direction of rotation (spinning) of the tire.



Spare wheels may be mounted against the direction of rotation (spinning) even with a unidirectional tire for temporary use only until the regular drive wheel has been repaired or replaced. Always observe and follow applicable temporary use restrictions and speed limitations indicated on the spare wheel.

Loading the vehicle

Two labels on your vehicle show how much weight it may properly carry.

- The Tire and Loading Information placard (Example A) or the Vehicle Tire Information placard (Example B) can be found on the driver's door B-pillar. This placard tells you important information about the number of people that can be in the vehicle and the total weight that can be carried in the vehicle. It also contains information on the proper size and recommended tire inflation pressures for the original equipment tires on your vehicle.

- The Certification label, also found on the driver's door B-pillar tells you about the gross weight capacity of your vehicle, called the Gross Vehicle Weight Rating (GVWR). The GVWR includes the weight of the vehicle, all occupants, fuel and cargo. The Certification label also tells you about the front and rear axle weight capacity, called the Gross Axle Weight Rating (GAWR). The GAWR is the total allowable weight that can be carried by a single axle (front or rear). Never exceed the GVWR or GAWR for either the front axle or rear axle.

Operation

Tires and wheels

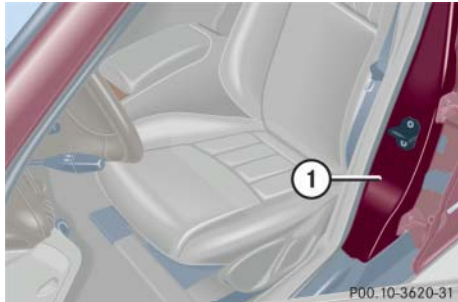

① Driver's door B-pillar

Following is a discussion on how to work with the information contained on the two placards with regards to loading your vehicle.

Tire and Loading Information

Warning!



Do not overload the tires by exceeding the specified load limit or vehicle capacity weight as indicated on the placard on the driver's door B-pillar. Overloading the tires can overheat them, possibly causing a blowout. Overloading the tires can also result in handling or steering problems, or brake failure.

Your vehicle is equipped with either the Tire and Loading Information placard (Example A) or the Vehicle Tire Information placard (Example B).



Data shown on placard examples is for illustration purposes only. Load limit data is specific to each vehicle and may vary from data shown in the illustrations below. Refer to placard on vehicle for actual data specific to your vehicle.

Placard (Example A)

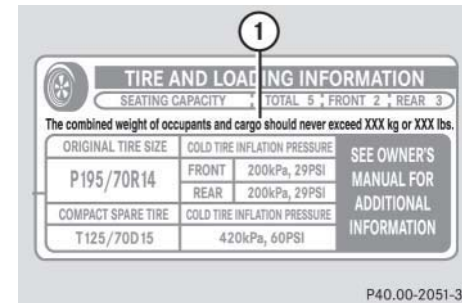

① Load limit information on the Tire and Loading Information placard

The placard showing the load limit information is located on the driver's door B-pillar. If your vehicle is equipped with the Tire and Loading Information placard (Example A), locate the statement "The combined weight of occupants and cargo should never exceed XXX kilograms or XXX lbs." on this placard. The combined weight of all occupants, cargo / luggage and trailer tongue load (if applicable) should never exceed the weight referenced in that statement.

Placard (Example B)

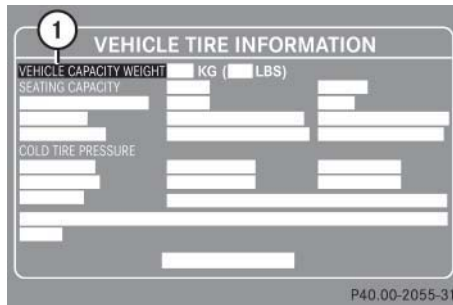

- ① Load limit information on the Vehicle Tire Information placard

The placard showing the load limit information is located on the driver's door B-pillar. If your vehicle is equipped with the Vehicle Tire Information placard (Example B), locate the heading "Vehicle Capacity Weight" on this placard. The combined weight of all occupants, cargo/luggage and trailer tongue (if applicable) should never exceed the weight listed next to vehicle capacity weight.

Seating capacity

The seating capacity gives you important information on the number of occupants that can be in the vehicle. Observe front and rear seating capacity. Your vehicle is equipped with either placard Example A or placard Example B located on the driver's door B-pillar (▷ page 308).



Data shown on placard examples is for illustration purposes only. Seating data is specific to each vehicle and may vary from data shown in the illustrations below. Refer to placard on vehicle for actual data specific to your vehicle.

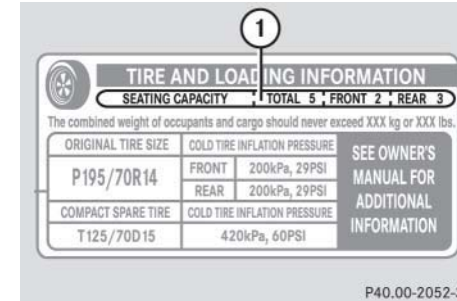

Placard (Example A)

- ① Seating capacity

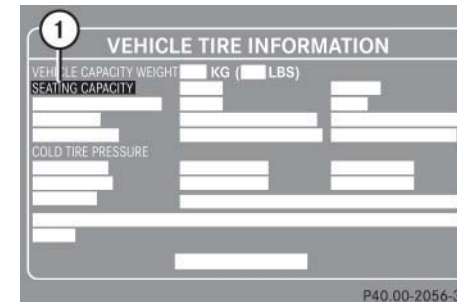

Placard (Example B)

- ① Seating capacity

Operation

Tires and wheels

Steps for determining correct load limit

The following steps have been developed as required of all manufacturers under Title 49, Code of U.S. Federal Regulations, Part 575 pursuant to the “National Traffic and Motor Vehicle Safety Act of 1966”.

Step 1 (Vehicles equipped with placard Example A)

- ▶ Locate the statement “The combined weight of occupants and cargo should never exceed XXX kg or XXX lbs.” on your vehicle’s placard.

Step 1 (Vehicles equipped with placard Example B)

- ▶ Locate the heading “Vehicle Capacity Weight” on your vehicle’s placard.

Step 2

- ▶ Determine the combined weight of the driver and passengers that will be riding in your vehicle.

Step 3

- ▶ Subtract the combined weight of the driver and passengers from XXX kilograms or XXX lbs.

Step 4

- ▶ The resulting figure equals the available amount of cargo and luggage load capacity. For example, if the “XXX” amount equals 1400 lbs and there will be five 150 lbs passengers in your vehicle, the amount of available cargo and luggage load capacity is 650 lbs ($1400 - 750 (5 \times 150) = 650$ lbs).

Step 5

- ▶ Determine the combined weight of luggage and cargo being loaded on the vehicle. That weight may not safely exceed the available cargo and luggage load capacity calculated in step 4.

Step 6 (if applicable)

- ▶ If your vehicle will be towing a trailer, load from your trailer will be transferred to your vehicle. Consult this manual to determine how this reduces the available cargo and luggage load capacity of your vehicle (▷ page 312).

The following table shows examples on how to calculate total and cargo load capacities with varying seating configurations and number and size of occupants. The following examples use a load limit of 1500 lbs. **This is for illustration purposes only.** Make sure you are using the actual load limit for your vehicle stated on the vehicle’s placard (▷ page 308).

Example	Combined weight limit of occupants and cargo from placard	Number of occupants (driver and passengers)	Seating configuration	Occupants weight	Combined weight of all occupants	Available cargo/luggage and trailer tongue weight (total load limit or vehicle capacity weight from placard minus combined weight of all occupants)
1	1500 lbs	5	front: 2 rear: 3	Occupant 1: 150 lbs Occupant 2: 180 lbs Occupant 3: 160 lbs Occupant 4: 140 lbs Occupant 5: 120 lbs	750 lbs	1500 lbs - 750 lbs = 750 lbs
2	1500 lbs	3	front: 1 rear: 2	Occupant 1: 200 lbs Occupant 2: 190 lbs Occupant 3: 150 lbs	540 lbs	1500 lbs - 540 lbs = 960 lbs
3	1500 lbs	1	front:1	Occupant 1: 150 lbs	150 lbs	1500 lbs - 150 lbs = 1350 lbs

The higher the weight of all occupants, the less cargo and luggage load capacity is available.

For more information, see “Trailer tongue load” (> page 312).

Operation

Tires and wheels

Certification label

Even after careful determination of the combined weight of all occupants, cargo and the trailer tongue load (if applicable) (▷ page 312) as to not exceed the permissible load limit, you must make sure that your vehicle never exceeds the Gross Vehicle Weight Rating (GVWR) and the Gross Axle Weight Rating (GAWR) for either the front or rear axle. You can obtain the GVWR and GAWR from the Certification label. The Certification Label can be found on the driver's door B-pillar, see "Technical data" (▷ page 420).

Gross Vehicle Weight Rating (GVWR): The total weight of the vehicle, all occupants, all cargo, and the trailer tongue load (▷ page 312) must never exceed the GVWR.

Gross Axle Weight Rating (GAWR): The total allowable weight that can be carried by a single axle (front or rear).

To assure that your vehicle does not exceed the maximum permissible weight limits (GVWR and GAWR for front and rear axle), have the loaded vehicle (including driver, passengers and all cargo and, if applicable, trailer fully loaded) weighed on a suitable commercial scale.

Trailer tongue load

The tongue load of any trailer is an important weight to measure because it affects the load you can carry in your vehicle. If a trailer is towed, the tongue load must be added to the weight of all occupants riding and any cargo you are carrying in the vehicle. The tongue load typically is ten percent of the trailer weight and everything loaded in it.

Your Mercedes-Benz has been designed primarily to carry passengers and their cargo. Mercedes-Benz does not recommend trailer towing with your vehicle.

Recommended tire inflation pressure

Warning!



Follow recommended tire inflation pressures.

Do not underinflate tires. Underinflated tires wear excessively and /or unevenly, adversely affect handling and fuel economy, and are more likely to fail from being overheated.

Do not overinflate tires. Overinflated tires can adversely affect handling and ride comfort, wear unevenly, increase stopping distance, and result in sudden deflation (blowout) because they are more likely to become punctured or damaged by road debris, potholes etc.

Your vehicle is equipped with either the Tire and Loading Information placard (Example A) or the Vehicle Tire Information placard (Example B) located on the driver’s door B-pillar (▷ page 308).

The tire inflation pressure should be checked regularly and should only be adjusted on cold tires. The tires can be considered cold if the vehicle has been parked for at least three hours or driven less than one mile (1.6 km).

Follow recommended cold tire inflation pressures listed on placard.

Keeping the tires properly inflated provides the best handling, tread life and riding comfort.

In addition to the tire placard on the driver’s door B-pillar, also consult the fuel filler flap for any additional information pertaining to special driving situations. For more information, see “Important notes on tire inflation pressure” (▷ page 314).



Data shown on placard examples is for illustration purposes only. Tire data is specific to each vehicle and may vary from data shown in the illustrations below. Refer to placard on vehicle for actual data specific to your vehicle.

Operation

Tires and wheels

Placard (Example A)

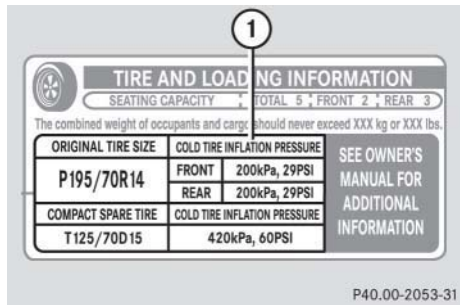

- ① Tire and Loading Information placard with recommended cold tire inflation pressures

Placard (Example A) lists the recommended cold tire inflation pressures for maximum loaded vehicle weight. The tire inflation pressures listed apply to the tires installed as original equipment.

Placard (Example B)

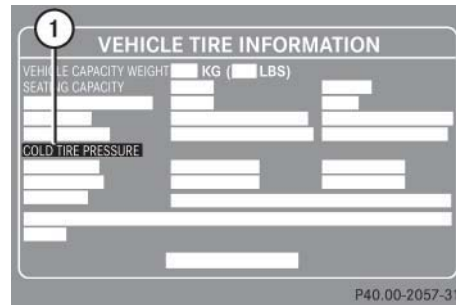

- ① Vehicle Tire Information placard with recommended cold tire inflation pressures

Placard (Example B) lists the recommended cold tire inflation pressures for maximum loaded vehicle weight. The tire inflation pressures listed apply to the tires installed as original equipment.



Placard (Example B) may list recommended cold tire inflation pressures for different vehicle loads.

Important notes on tire inflation pressure

Warning!



If the tire inflation pressure repeatedly drops:

- Check the tires for punctures from foreign objects.
- Check to see whether air is leaking from the valves or from around the rim.

Tire temperature and tire inflation pressure are also increased while driving, depending on the driving speed and the tire load.

If you will be driving your vehicle at high speeds of 100 mph (160 km/h) or higher, where it is legal and conditions allow, consult the placard on the inside of the fuel filler flap on how to adjust the cold tire inflation pressure. If you do not adjust the tire inflation pressure, excessive heat can build up and result in sudden tire failure.

Be sure to readjust the tire inflation pressure for normal driving speeds. You should wait until the tires are cold before adjusting the tire inflation pressure.

Some vehicles may have supplemental tire inflation pressure information for vehicle loads less than the maximum loaded vehicle condition. If such information is provided, it can be found on the placard located on the inside of the fuel filler flap.

Tire inflation pressure changes by approximately 1.5 psi (0.1 bar) per 18°F (10°C) of air temperature change. Keep this in mind when checking tire inflation pressure where the temperature is different from the outside temperature.

Checking tire inflation pressure

Regularly check your tire inflation pressure at least once a month.

Check and adjust the tire inflation pressure when the tires are cold. The tires can be considered cold if the vehicle has been parked for at least three hours or driven less than one mile (1.6 km).

If you check the tire inflation pressure when the tires are warm (the vehicle has been driven for several miles or sitting less than three hours), the reading will be approximately 4 psi (0.3 bar) higher than the cold reading. This is normal. Do not let air out to match the specified cold tire inflation pressure. Otherwise, the tire will be underinflated.

Follow the steps below to achieve correct tire inflation pressure:

- ▶ Remove the cap from the valve on one tire.
- ▶ Firmly press a tire gauge onto the valve.
- ▶ Read tire inflation pressure on tire gauge and check against the recommended tire inflation pressure on the placard on the driver's door B-pillar (▷ page 314). If necessary, add air to achieve the recommended tire inflation pressure. ▷▷

Operation

Tires and wheels



If you have overfilled the tire, release tire inflation pressure by pushing the metal stem of the valve with e.g. a tip of a pen. Then recheck the tire inflation pressure with the tire gauge.

- ▶ Install the valve cap.
- ▶ Repeat this procedure for each tire.



The recommended tire inflation pressures for your vehicle can be found on the tire placard located on the driver's door B-pillar. The tire inflation pressures are not listed in the owner's manual.

Warning!



Follow recommended tire inflation pressures.

Do not overinflate tires. Overinflating tires can result in sudden deflation (blowout) because they are more likely to become punctured or damaged by road debris, potholes, etc.

Do not underinflate tires. Underinflated tires wear unevenly, adversely affect handling and fuel economy, and are more likely to fail from being overheated.

Do not overload the tires by exceeding the specified load limit or vehicle capacity weight as indicated on the placard on the driver's door B-pillar. Overloading the tires can overheat them, possibly causing a blowout.

Potential problems associated with underinflated and overinflated tires

Underinflated tire inflation pressure

Underinflated tires can:

- cause excessive and uneven tire wear
- adversely affect fuel economy
- lead to tire failure from being overheated
- adversely affect handling characteristics

Warning!



Follow recommended tire inflation pressures.

Do not underinflate tires. Underinflated tires wear excessively and / or unevenly, adversely affect handling and fuel economy, and are more likely to fail from being overheated.

Overinflated tire inflation pressure

Overinflated tires can:

- adversely affect handling characteristics
- cause uneven tire wear
- be more prone to damage from road hazards
- adversely affect ride comfort
- increase stopping distance

Warning!



Follow recommended tire inflation pressures.

Do not overinflate tires. Overinflated tires can adversely affect handling and ride comfort, wear unevenly, increase stopping distance, and result in sudden deflation (blowout) because they are more likely to become punctured or damaged by road debris, potholes etc.

Tire labeling

Besides tire name (sales designation) and manufacturer name, a number of markings can be found on a tire.

Following are some explanations for the markings on your vehicle's tires:

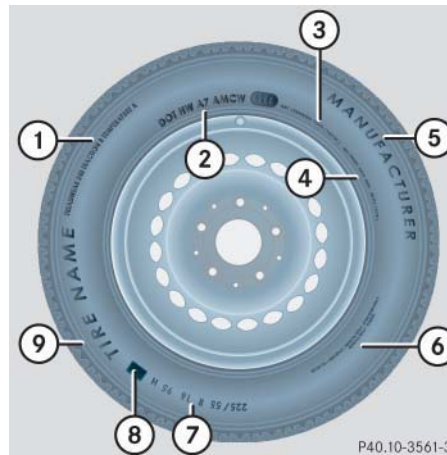

- ① Uniform Quality Grading Standards (▷ page 325)
- ② DOT, Tire Identification Number (TIN) (▷ page 322)
- ③ Maximum tire load (▷ page 323)
- ④ Maximum tire inflation pressure (▷ page 324)
- ⑤ Manufacturer
- ⑥ Tire ply material (▷ page 327)
- ⑦ Tire size designation, load and speed rating (▷ page 318)
- ⑧ Load identification (▷ page 321)
- ⑨ Tire name

i

For illustration purposes only. Actual data on tires is specific to each vehicle and may vary from data shown in above illustration.

For more information, see “Rims and Tires” (▷ page 424).

Operation

Tires and wheels

Tire size designation, load and speed rating

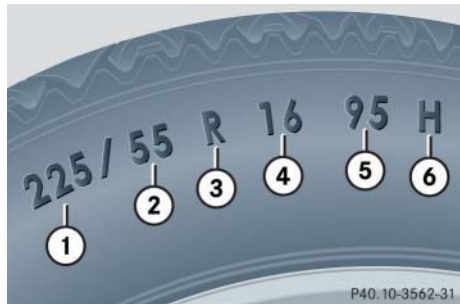

- ① Tire width
- ② Aspect ratio in %
- ③ Radial tire code
- ④ Rim diameter
- ⑤ Tire load rating
- ⑥ Tire speed rating



For illustration purposes only. Actual data on tires is specific to each vehicle and may vary from data shown in above illustration.

General:

Depending on the design standards used, the tire size molded into the sidewall may have no letter or a letter preceding the tire size designation.

No letter preceding the size designation (as illustrated above): Passenger car tire based on European design standards.

Letter “P” preceding the size designation: Passenger car tire based on U.S. design standards.

Letter “LT” preceding the size designation: Light Truck tire based on U.S. design standards.

Letter “T” preceding the size designation: Temporary spare tires which are high pressure compact spares designed for temporary emergency use only.

Tire width

The tire width ① (▷ page 318) indicates the nominal tire width in mm.

Aspect ratio

The aspect ratio ② (▷ page 318) is the dimensional relationship between tire section height and section width and is expressed in percentage. The aspect ratio is arrived at by dividing section height by section width.

Tire code

The tire code ③ (▷ page 318) indicates the tire construction type. The “R” stands for radial tire type. Letter “D” means diagonal or bias ply construction; letter “B” means belted-bias ply construction.

At the tire manufacturer’s option, any tire with a speed capability above 149 mph (240 km/h) can include a “ZR” in the size designation (for example: 245/40 ZR 18). For additional information, see “Tire speed rating” (▷ page 320).

Rim diameter

The rim diameter ④ (▷ page 318) is the diameter of the bead seat, not the diameter of the rim edge. Rim diameter is indicated in inches (in).

Tire load rating

The tire load rating ⑤ (▷ page 318) is a numerical code associated with the maximum load a tire can support.

For example, a load rating of 91 corresponds to a maximum load of 1356 lbs (615 kg) the tire is designed to support. See also “Maximum tire load” (▷ page 323) where the maximum load associated with the load index is indicated in kilograms and lbs.

Warning



The tire load rating must always be at least half of the GAWR (▷ page 328) of your vehicle. Otherwise, tire failure may be the result which may cause an accident and/or serious personal injury to you or others.

Always replace rims and tires with the same designation, manufacturer and type as shown on the original part.

Warning!



Do not overload the tires by exceeding the specified load limit or vehicle capacity weight as indicated on the placard located on the driver's door B-pillar. Overloading the tires can overheat them, possibly causing a blowout. Overloading the tires can also result in handling or steering problems, or brake failure.

Operation

Tires and wheels

For additional information on tire load rating, see “Load identification” (▷ page 321).



Tire load rating ⑤ (▷ page 318) and Tire speed rating ⑥ (▷ page 318) are also referred to as “service description”.

Operation

Tires and wheels

Tire speed rating

The tire speed rating ⑥ (▷ page 318) indicates the approved maximum speed for the tire.

Warning!



Even when permitted by law, never operate a vehicle at speeds greater than the maximum speed rating of the tires.

Exceeding the maximum speed for which tires are rated can lead to sudden tire failure, causing loss of vehicle control and possibly resulting in an accident and/or personal injury and possible death, for you and for others.



Tire load rating ⑤ (▷ page 318) and Tire speed rating ⑥ (▷ page 318) are also referred to as “service description”.

Summer tires

Index	Speed rating
Q	up to 100 mph (160 km/h)
R	up to 106 mph (170 km/h)
S	up to 112 mph (180 km/h)
T	up to 118 mph (190 km/h)
H	up to 130 mph (210 km/h)
V	up to 149 mph (240 km/h)
W	up to 168 mph (270 km/h)
Y	up to 186 mph (300 km/h)
(Y)	above 186 mph (300 km/h)
ZR	above 149 mph (240 km/h)

- At the tire manufacturer’s option, any tire with a speed capability above 149 mph (240 km/h) can include a “ZR” in the size designation (for example: 245/40 ZR18). To determine the maximum speed capability of the tire, the service description for the tire must be referred to. The service description is comprised of the tire load rating ⑤ (▷ page 318) and the tire speed rating ⑥ (▷ page 318).

If your tire includes “ZR” in the size designation and no service description ⑤ and ⑥ (▷ page 318) is given, the tire manufacturer must be consulted for the maximum speed capability.

If a service description ⑤ and ⑥ (▷ page 318) is given, the speed capability is limited by the speed symbol in the service description.
 Example: 245/40 ZR18 97Y.
 In this example, “97Y” is the service description. The letter “Y” designates the speed rating and the speed capability of the tire is limited to 186 mph (300 km/h).

- Any tire with a speed capability above 186 mph (300 km/h) must include a “ZR” in the size designation AND the service description must be placed in parenthesis. Example: 275/40 ZR 18 (99Y). The “(Y)” speed rating in parenthesis designates the maximum speed capability of the tire as being above 186 mph (300 km/h). Consult the tire manufacturer for the actual maximum permissible speed of the tire.

All-season and winter tires

Index	Speed rating
Q M+S	up to 100 mph (160 km/h)
T M+S	up to 118 mph (190 km/h)
H M+S	up to 130 mph (210 km/h)
V M+S	up to 149 mph (240 km/h)



The marking “M+S” next to the service description designates tires with mud and snow capabilities.

Operation

Tires and wheels

Load identification



① Load identification



For illustration purposes only. Actual data on tires is specific to each vehicle and may vary from data shown in above illustration.

Operation

Tires and wheels

In addition to tire load rating, special load information may be molded into the tire sidewall following the letter designating the tire speed rating ① (▷ page 321).

No specification given: absence of any text (like in above example) indicates a standard load (SL) tire.

XL or Extra Load: designates an extra load (or reinforced) tire.

Light Load: designates a light load tire.

C, D, E: designates load range associated with the maximum load a tire can carry at a specified pressure.

DOT, Tire Identification Number (TIN)

U.S. tire regulations require each new tire manufacturer or tire retreader to mold a TIN into or onto a sidewall of each tire produced.

The TIN is a unique identifier which facilitates efforts by tire manufacturers to notify purchasers in recall situations or other safety matters concerning tires and gives purchasers the means to easily identify such tires.

The TIN is comprised of “Manufacturer’s identification mark”, “Tire size”, “Tire type code”, and “Date of manufacture”.

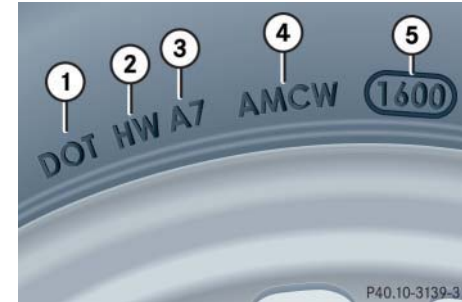

- ① DOT
- ② Manufacturer's identification mark
- ③ Tire size
- ④ Tire type code (at the option of the tire manufacturer)
- ⑤ Date of manufacture

i

For illustration purposes only. Actual data on tires is specific to each vehicle and may vary from data shown in above illustration.

DOT (Department of Transportation)

A tire branding symbol ① (▷ page 322) which denotes the tire meets requirements of the U.S. Department of Transportation.

Manufacturer's identification mark

The manufacturer's identification mark ② (▷ page 322) denotes the tire manufacturer.

New tires have a mark with two symbols. Retreaded tires have a mark with four symbols. For more information on retreaded tires, see (▷ page 304).

Tire size

The code ③ (▷ page 322) indicates the tire size.

Tire type code

The code ④ (▷ page 322) may, at the option of the manufacturer, be used as a descriptive code for identifying significant characteristics of the tire.

Date of manufacture

The date of manufacture ⑤ (▷ page 322) identifies the week and year of manufacture.

The first two figures identify the week, starting with "01" to represent the first full week of the calendar year. The second two figures represent the year.

For example, "3202" represents the 32nd week of 2002.

Maximum tire load



① Maximum tire load rating



For illustration purposes only. Actual data on tires is specific to each vehicle and may vary from data shown in above illustration.

The maximum tire load is the maximum weight the tires are designed to support.

Operation

Tires and wheels

Warning!



Do not overload the tires by exceeding the specified load limit or vehicle capacity weight as indicated on the placard located on the driver's door B-pillar. Overloading the tires can overheat them, possibly causing a blowout. Overloading the tires can also result in handling or steering problems, or brake failure.

For more information on tire load rating (▷ page 319).

For information on calculating total and cargo load capacities (▷ page 310).

Maximum tire inflation pressure

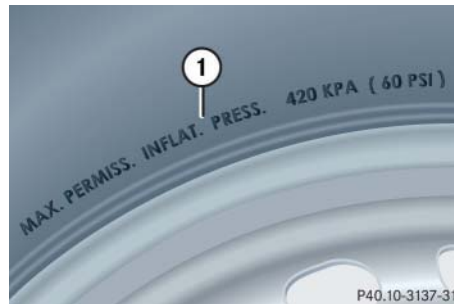

- ① Maximum permissible tire inflation pressure



For illustration purposes only. Actual data on tires is specific to each vehicle and may vary from data shown in above illustration.

This is the maximum permissible tire inflation pressure for the tire.

Always follow the recommended tire inflation pressure (▷ page 313) for proper tire inflation.

Warning!



Never exceed the max. tire inflation pressure. Follow recommended tire inflation pressures.

Do not underinflate tires. Underinflated tires wear excessively and / or unevenly, adversely affect handling and fuel economy, and are more likely to fail from being overheated.

Do not overinflate tires. Overinflated tires can adversely affect handling and ride comfort, wear unevenly, increase stopping distance, and result in sudden deflation (blowout) because they are more likely to become punctured or damaged by road debris, potholes etc.

Uniform Tire Quality Grading Standards (U.S. vehicles)

Tire manufacturers are required to grade tires based on three performance factors: treadwear, traction, and temperature resistance.

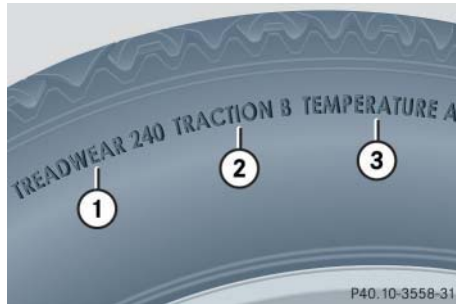

- ① Treadwear
- ② Traction
- ③ Temperature resistance



For illustration purposes only. Actual data on tires is specific to each vehicle and may vary from data shown in above illustration.

Quality grades can be found, where applicable, on the tire sidewall between tread shoulder and maximum section width. For example:

Treadwear	Traction	Temperature
200	AA	A

All passenger car tires must conform to federal safety requirements in addition to these grades.

Treadwear

The treadwear grade is a comparative rating based on the wear rate of the tire when tested under controlled conditions on a specified government test course. For example, a tire graded 150 would wear one and one-half ($1\frac{1}{2}$) times as well on the government course as a tire graded 100. The relative performance of tires depends upon the actual conditions of their use, however, and may depart significantly from the norm due to variations in driving habits, service practices and differences in road characteristics and climate.

Operation

Tires and wheels

Traction

The traction grades, from highest to lowest, are AA, A, B, and C. Those grades represent the tire's ability to stop on wet pavement as measured under controlled conditions on specified government test surfaces of asphalt and concrete. A tire marked C may have poor traction performance.

Warning!



The traction grade assigned to this tire is based on straight-ahead braking traction tests, and does not include acceleration, cornering, hydroplaning, or peak traction characteristics.

Temperature

The temperature grades are A (the highest), B, and C, representing the tire's resistance to the generation of heat and its ability to dissipate heat when tested under controlled conditions on a specified indoor laboratory test wheel. Sustained high temperature can cause the material of the tire to degenerate and reduce tire life, and excessive temperature can lead to sudden tire failure. The grade C corresponds to a level of performance which all passenger car tires must meet under the Federal Motor Vehicle Safety Standard No. 109. Grades B and A represent higher levels of performance on the laboratory test wheel than the minimum required by law.

Warning!



The temperature grade for this tire is established for a tire that is properly inflated and not overloaded. Excessive speed, underinflation, or excessive loading, either separately or in combination, can cause excessive heat build-up and possible tire failure.

Tire ply material

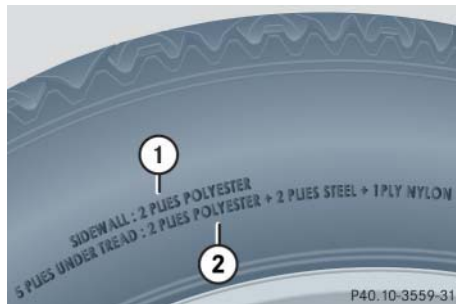

- ① Plies in sidewall
- ② Plies under tread



For illustration purposes only. Actual data on tires is specific to each vehicle and may vary from data shown in above illustration.

This marking tells you about the type of cord and number of plies in the sidewall and under the tread.

Tire and loading terminology

Accessory weight

The combined weight (in excess of those standard items which may be replaced) of automatic transmission, power steering, power brakes, power windows, power seats, radio, and heater, to the extent that these items are available as factory-installed equipment (whether installed or not).

Air pressure

The amount of air inside the tire pressing outward on each square inch of the tire. Air pressure is expressed in pounds per square inch (psi), or kilopascal (kPa) or bars.

Aspect ratio

Dimensional relationship between tire section height and section width expressed in percentage.

Bar

Another metric unit for air pressure. There are 14.5038 pounds per square inch (psi) to 1 bar; there are 100 kilopascals (kPa) to 1 bar.

Bead

The tire bead contains steel wires wrapped by steel cords that hold the tire onto the rim.

Cold tire inflation pressure

Tire inflation pressure when your vehicle has been sitting for at least three hours or driven no more than one mile (1.6 km).

Operation

Tires and wheels

Curb weight

The weight of a motor vehicle with standard equipment including the maximum capacity of fuel, oil, and coolant, and, if so equipped, air conditioning and additional optional equipment, but without passengers and cargo.

DOT (Department of Transportation)

A tire branding symbol which denotes the tire meets requirements of the U.S. Department of Transportation.

GAWR (Gross Axle Weight Rating)

The GAWR is the maximum permissible axle weight. The gross vehicle weight on each axle must never exceed the GAWR for the front and rear axle indicated on the certification label located on the driver's door B-pillar.

GVW (Gross Vehicle Weight)

The GVW comprises the weight of the vehicle including fuel, tools, spare wheel, installed accessories, passengers and cargo and, if applicable, trailer tongue load. The GVW must never exceed the GVWR indicated on the certification label located on the driver's door B-pillar.

GVWR (Gross Vehicle Weight Rating)

This is the maximum permissible vehicle weight of the fully loaded vehicle (weight of the vehicle including all options, passengers, fuel, and cargo and, if applicable, trailer tongue load). It is indicated on certification label located on the driver's door B-pillar.

Kilopascal (kPa)

The metric unit for air pressure. There are 6.9 kPa to one psi; another metric unit for air pressure is bars. There are 100 kilopascals (kPa) to one bar.

Maximum load rating

The maximum load in kilograms and pounds that can be carried by the tire.

Maximum loaded vehicle weight

The sum of curb weight, accessory weight, vehicle capacity weight and production options weight.

Maximum tire inflation pressure

This number is the greatest amount of air pressure that should ever be put in the tire under normal driving conditions.

Normal occupant weight

The number of occupants the vehicle is designed to seat, multiplied by 68 kilograms (150 lbs).

Occupant distribution

The distribution of occupants in a vehicle at their designated seating positions.

Production options weight

The combined weight of those installed regular production options weighing over 5 lbs (2.3 kilograms) in excess of those standard items which they replace, not previously considered in curb weight or accessory weight, including heavy duty brakes, ride levelers, roof rack, heavy duty battery, and special trim.

PSI (Pounds per square inch)

A standard unit of measure for air pressure -> bar, kilopascal (kPa).

Recommended tire inflation pressure

Recommended tire inflation pressure listed on placard located on driver's door B-pillar for normal driving conditions. Provides best handling, tread life and riding comfort.

Rim

A metal support for a tire or a tire and tube assembly upon which the tire beads are seated.

Sidewall

The portion of a tire between the tread and the bead.

TIN (Tire Identification Number)

Unique identifier which facilitates efforts by tire manufacturers to notify purchasers in recall situations or other safety matters concerning tires and gives purchasers the means to easily identify such tires. The TIN is comprised of "Manufacturer's identification mark", "Tire size", "Tire type code" and "Date of manufacture".

Tire load rating

Numerical code associated with the maximum load a tire can support.

Tire ply composition and material used

This indicates the number of plies or the number of layers of rubber-coated fabric in the tire tread and sidewall. Tire manufacturers also must indicate the ply materials in the tire and sidewall, which include steel, nylon, polyester, and others.

Operation

Tires and wheels

Tire speed rating

Part of tire designation; indicates the speed range for which a tire is approved.

Traction

Force exerted by the vehicle on the road via the tires. The amount of grip provided.

Tread

The portion of a tire that comes into contact with the road.

Treadwear indicators

Narrow bands, sometimes called “wear bars” that show across the tread of a tire when only $\frac{1}{6}$ in (1.6 mm) of tread remains.

Uniform Tire Quality Grading Standards

A tire information system that provides consumers with ratings for a tire’s traction, temperature and treadwear. Ratings are determined by tire manufacturers using government testing procedures. The ratings are molded into the sidewall of the tire.

Vehicle capacity weight

Rated cargo and luggage load plus 68 kilograms (150 lbs) times the vehicle’s designated seating capacity.

Vehicle maximum load on the tire

Load on an individual tire that is determined by distributing to each axle its share of the maximum loaded vehicle weight and dividing it by two.

Rotating tires

Warning!



Rotate front and rear wheels only if the tires are of the same dimension.

If your vehicle is equipped with mixed-size tires (different tire dimensions front vs. rear), tire rotation is not possible.

Tire rotation can be performed on vehicles with tires of the same dimension all around. If your vehicle is equipped with tires of the same dimension all around, tires can be rotated, observing a front-to-rear rotation pattern that will maintain the intended rotation (spinning) direction of the tire (▷ page 307).

In some cases, such as when your vehicle is equipped with mixed-size tires (different tire dimension front vs. rear), tire rotation is not possible.

If applicable to your vehicle's tire configuration, tires can be rotated according to the tire manufacturer's recommended intervals in the tire manufacturer's warranty pamphlet located in your vehicle literature portfolio. If none is available, tires should be rotated every 3000 to 6000 miles (5000 to 10000 km), or sooner if necessary, according to the degree of tire wear. The same rotation (spinning) direction must be maintained (▷ page 307).

Rotate tires before the characteristic tire wear pattern becomes visible (shoulder wear on front tires and tread center wear on rear tires).

Thoroughly clean the mounting face of wheels and brake disks, i.e. the inner side of the wheels/tires, during each rotation. Check for and ensure proper tire inflation pressure.

Operation

Tires and wheels

Warning!



Have the tightening torque checked after changing a wheel. Wheels could become loose if not tightened with a torque of 80 lb-ft (110 Nm).

Only use genuine Mercedes-Benz wheel bolts specified for your vehicle's rims.

For information on wheel change, see the "Practical hints" section (▷ page 377) and (▷ page 399).

Operation

Winter driving

Before the onset of winter, have your vehicle winterized at an authorized Mercedes-Benz Center. This service includes:

- Check of anticorrosion and antifreeze concentration.
- Addition of cleaning concentrate to the water of the windshield and headlamp cleaning system. Add MB Concentrate "S" to a premixed windshield washer solvent/antifreeze which is formulated for below freezing temperatures (▷ page 439).
- Battery test. Battery capacity drops with decreasing ambient temperature. A well charged battery helps to make sure that the engine can be started, even at low ambient temperatures.
- Tire change. Mercedes-Benz recommends M+S rated radial-ply tires with a minimum tread depth of approximately $\frac{1}{6}$ in (4 mm) on all four wheels for the winter season.

Winter tires

Always use winter tires at temperatures below 45°F (7°C) and whenever wintry road conditions prevail. Use of winter tires is the only way to achieve the maximum effectiveness of the ABS, ESP, and 4MATIC in winter operation.

For safe handling, make sure that all mounted winter tires are of the same make and have the same tread design.

Warning!



Winter tires with a tread depth under $\frac{1}{6}$ in (4 mm) must be replaced. They are no longer suitable for winter operation.

Always observe the speed rating of the winter tires installed on your vehicle. If the maximum speed for which your tires are rated is below the speed rating of your vehicle, you must place a notice to this effect where it will be seen by the driver. Such notices are available from your tire dealer or from any authorized Mercedes-Benz Center.

Warning!



If you use your spare tire when winter tires are fitted on the other wheels, be aware that the difference in tire characteristics may very well impair turning stability and that overall driving stability may be reduced. Adapt your driving style accordingly.

Have the spare tire replaced with a winter tire at the nearest authorized Mercedes-Benz Center.

Block heater (Canada only)

The engine is equipped with a block heater.

The electrical cable may be installed at an authorized Mercedes-Benz Center.

Snow chains

Snow chains should only be driven on snow-covered roads at speeds not to exceed 30 mph (50 km/h). Remove chains as soon as possible when driving on roads without snow.



When driving with snow chains, you may wish to deactivate the ESP (▷ page 85) before setting the vehicle in motion. This will improve the vehicle's traction.

Please observe the following guidelines when using snow chains:

- Use of snow chains is not permissible with all wheel/tire combinations.
- Snow chains should only be used on the rear wheels. Follow the manufacturer's mounting instructions.

- Only use snow chains that are approved by Mercedes-Benz. Your authorized Mercedes-Benz Center will be glad to advise you on this subject.
- Use of snow chains may be prohibited depending on location. Always check local and state laws before installing snow chains.



Even on vehicles with all-wheel-drive use snow chains on rear tires only.

Use of snow chains is not permissible with tire sizes:

- 245/40 R17 91W
- T 125/90 R16 98M
- T 125/80 R17 99M

Operation

Maintenance

We strongly recommend that you have your vehicle serviced by an authorized Mercedes-Benz Center, in accordance with the Maintenance Booklet at the times called for by the maintenance service indicator display.

Failure to have the vehicle maintained in accordance with the Maintenance Booklet and maintenance service indicator at the designated times/mileage will result in vehicle damage not covered by the Mercedes-Benz Limited Warranty.

The maintenance service indicator will notify you when your next maintenance service is due.

Starting approximately one month before your next maintenance service is due, one of the following messages will appear in the multifunction display while you are driving or when you switch on the ignition (example service A):

Service A in XX Days
Service A in XX Miles (Km)
A Service due now

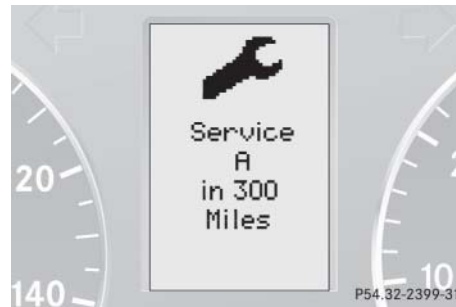

The type of maintenance service due is indicated in the multifunction display:



Basic service (A)



Extended service (B)



Vehicles equipped with FSS (Flexible Service System) only (Canada vehicles): The interval between maintenance services depends on your driving habits. A gentle driving style, moderate engine speeds and the avoidance of short-distance trips will lengthen the interval between services.

Clearing the maintenance service indicator

The maintenance service indicator is automatically cleared

- after ten seconds when you switch on the ignition or when reaching the maintenance service threshold while driving
- after 30 seconds, once the suggested maintenance service term has passed

You can also clear it yourself.



① Reset button

- ▶ Press reset button ① on the instrument cluster.

Maintenance service term exceeded

If you have exceeded the suggested maintenance service term, you will see the following message in the multifunction display:

Service A exceeded by XX Days
Service A exceeded by XX Miles (Km)





In addition, a signal sounds when the message appears.

Any authorized Mercedes-Benz Center will reset the maintenance service indicator following a completed maintenance service.

Calling up the maintenance service indicator

- ▶ Switch on ignition (▷ page 33).

The standard display of the control system appears (▷ page 129).

- ▶ Press button  or  on the multifunction steering wheel until the maintenance service indicator with the service symbol  or  and the service deadline appears in the multifunction display.



If the battery is disconnected, the days of disconnection will not be included in the count shown by the maintenance service indicator. To arrive at the true maintenance service deadline, you will need to subtract these days from the days shown in the maintenance service indicator.

Do not confuse the maintenance service indicator with the engine oil level indicator .

Resetting the maintenance service indicator

In the event that the maintenance service on your vehicle is not carried out by an authorized Mercedes-Benz Center, you can have the maintenance service indicator reset. The automotive maintenance facility carrying out the maintenance service will find the information for resetting the maintenance service indicator in the maintenance-relevant information for your vehicle. Such information is available from either your authorized Mercedes-Benz Center or directly from Mercedes-Benz.



If the maintenance service indicator was inadvertently reset, have an authorized Mercedes-Benz Center correct it.

Only reset if the proper maintenance service has been performed. Resetting the system without performing the proper service as called for by the maintenance service indicator will result in engine damage and/or other vehicle damage not covered by the Mercedes-Benz Limited Warranty.

▼ Vehicle care

Cleaning and care of the vehicle

Warning!



Many cleaning products can be hazardous. Some are poisonous, others are flammable. Always follow the instructions on the particular container. Always open your vehicle's doors or windows when cleaning the inside.

Never use fluids or solvents that are not designed for cleaning your vehicle.

While in operation, even while parked, your vehicle is subjected to varying external influences which, if gone unchecked, can attack the paintwork as well as the underbody and cause lasting damage.

Such damage is caused not only by extreme and varying climatic conditions, but also by:

- Air pollution
- Road salt
- Tar
- Gravel and stone chipping

To avoid paint damage, you should immediately remove:

- Grease and oil
- Fuel
- Coolant
- Brake fluid
- Bird droppings
- Insects
- Tree resins, etc.

Frequent washing reduces and/or eliminates the aggressiveness and potency of the above adverse influences.

More frequent washings are necessary to deal with unfavorable conditions:

- near the ocean
- in industrial areas (smoke, exhaust emissions)
- during winter operation

You should check your vehicle from time to time for stone chipping or other damage. Any damage should be repaired as soon as possible to prevent corrosion.

In doing so, do not neglect the underbody of the vehicle. A prerequisite for a thorough check is a washing of the underbody followed by a thorough inspection. Damaged areas need to be re-undercoated.

Your vehicle has been treated at the factory with a wax-base rustproofing in the body cavities which will last for the lifetime of the vehicle. Post-production treatment is neither necessary nor recommended by Mercedes-Benz because of the possibility of incompatibility between materials used in the production process and others applied later.

Operation

Vehicle care

We have selected car-care products and compiled recommendations which are specially matched to our vehicles and which always reflect the latest technology. You can obtain Mercedes-Benz approved car-care products at an authorized Mercedes-Benz Center.

Scratches, corrosive deposits, corrosion or damage due to negligent or incorrect care cannot always be removed or repaired with the car-care products recommended here. In such cases it is best to seek aid at an authorized Mercedes-Benz Center.

The following topics deal with the cleaning and care of your vehicle and give important “how-to” information as well as references to Mercedes-Benz approved car-care products.

Power washer

When using a power washer for cleaning the vehicle, always observe the manufacturer’s operating instructions.



Never use a round nozzle to power-wash tires. The intense jet of water can result in damage to the tire.

Always replace a damaged tire.

Always keep the jet of water moving across the surface. Do not aim directly at electrical parts, electrical connectors, seals, or other rubber parts.

Tar stains

Quickly remove tar stains before they dry and become more difficult to remove. A tar remover is recommended.

Paintwork, painted body components

Mercedes-Benz approved Paint Care should be applied when water drops on the paint surface do not “bead up”, normally every three to five months, depending on climate and washing detergent used.

Mercedes-Benz approved Paint Cleaner should be applied if the paint surface shows signs of embedded dirt (i.e. loss of gloss).

Do not apply any of these products or wax if your vehicle is parked in the sun or if the hood is still hot.

Use the appropriate MB-Touch-Up Stick for quick and provisional repairs of minor paint damage (i.e. chips from stones, vehicle doors, etc.).

Engine cleaning

Prior to cleaning the engine compartment, make sure to protect electrical components and connectors from the intrusion of water and cleaning agents.

Corrosion protection, such as MB Anticorrosion Wax, should be applied to the engine compartment after every engine cleaning. Before applying, all control linkage bushings and joints should be lubricated. The poly-V-belt and all pulleys should be protected from any wax.

Vehicle washing

Do not use hot water or wash your vehicle in direct sunlight. Only use a mild car wash detergent, such as Mercedes-Benz approved Car Shampoo.

Thoroughly spray the vehicle with a diffused jet of water. Direct only a very weak spray towards the ventilation intake. Use plenty of water and rinse the sponge and chamois frequently.

Rinse with clear water and thoroughly dry with a chamois. Do not allow cleaning agents to dry on the finish.

Due to the width of the vehicle, fold in exterior rear view mirrors prior to running the vehicle through an automatic car wash to prevent damage to the mirrors.

In the winter, thoroughly remove all traces of road salt as soon as possible.

When washing the underbody, do not forget to clean the inner sides of the wheels.

Ornamental moldings

For regular cleaning and care of very dirty chrome-plated parts, use a chrome cleaner.

Headlamps, tail lamps, side markers, turn signal lenses

Use a mild car wash detergent, such as Mercedes-Benz approved Car Shampoo, with plenty of water.

To prevent scratches, never apply strong force and only use a soft, non-scratchy cloth when cleaning the lenses. Do not attempt to wipe dirty lenses with a dry cloth or sponge.

Operation

Vehicle care

Wiper blades

- ▶ Fold wiper arms forward.

Warning!



For safety reasons, switch off wipers and remove SmartKey from starter switch before cleaning the wiper blades. Otherwise, the wiper motor could suddenly turn on and cause injury.

- ▶ Clean the wiper blade inserts with a clean cloth and detergent solution.



Fold the windshield wiper arms back onto the windshield before turning the SmartKey in the starter switch.

Hold on to the wiper when folding the wiper arm back. If released, the force of the impact from the tensioning spring could crack the windshield.

Window cleaning

- ▶ Fold wiper arms forward.

Warning!



For safety reasons, switch off wipers and remove SmartKey from starter switch before cleaning the windshield. Otherwise, the wiper motor could suddenly turn on and cause injury.

- ▶ Use a window cleaning solution on all glass surfaces.

An automotive glass cleaner is recommended.



Fold the windshield wiper arms back onto the windshield before turning the SmartKey in the starter switch.

Hold on to the wiper when folding the wiper arm back. If released, the force of the impact from the tensioning spring could crack the windshield.

Light alloy wheels

Mercedes-Benz approved Wheel Care should be used for regular cleaning of the light alloy wheels.

If possible, clean wheels once a week with Mercedes-Benz approved Wheel Care, using a soft bristle brush and a strong spray of water.

Follow the instructions on container.



Only use acid-free cleaning materials. Acid may cause corrosion or damage the clear coat.

Instrument cluster

Use a gentle dishwashing detergent or mild detergent for delicate fabrics as a washing solution. Wipe with a cloth moistened in lukewarm solution. Do not use scouring agents.

Steering wheel and gear selector lever

Wipe with a damp cloth and dry thoroughly or clean with Mercedes-Benz approved Leather Care.

Cup holders

Use a gentle dishwashing detergent or mild detergent for delicate fabrics as a washing solution. Wipe with a cloth moistened in lukewarm solution. Do not use scouring agents.

Hard plastic trim items

Pour Mercedes-Benz approved Interior Care onto soft lint-free cloth and apply with light pressure.

Headliner and rear window shelf

Clean with soft bristle brush, or use a dry-shampoo cleaner in case of excessive dirt.

Seat belts

The webbing must not be treated with chemical cleaning agents. Only use clear, lukewarm water and soap. Do not dry the webbing at temperatures above 176°F (80°C) or in direct sunlight.

Warning!

Do not bleach or dye seat belts as this may severely weaken them. In a crash they may not be able to provide adequate protection.

Upholstery

Using aftermarket seat covers or wearing clothing that have the tendency to give off coloring (e.g. when wet, etc.) may cause the upholstery to become permanently discolored. By lining the seats with a proper intermediate cover, contact-discoloration will be prevented.

Leather upholstery

Wipe leather upholstery with a damp cloth and dry thoroughly or clean with Mercedes-Benz approved Leather Care. Exercise particular care when cleaning perforated leather as its underside should not become wet.

Operation

Vehicle care

Cloth upholstery

Clean with soft bristle brush, or use a dry-shampoo cleaner in case of excessive dirt.

MB Tex upholstery

Pour Mercedes-Benz approved Interior Care onto soft lint-free cloth and apply with light pressure.

Plastic and rubber parts

Do not use oil or wax on these parts.

Wood trims

Dampen cloth using water and use damp cloth to clean wood trims in your vehicle. Do not use solvents like tar remover or wheel cleaner nor polishes or waxes as these may be abrasive.

Practical hints

What to do if ...

Where will I find ...?

Unlocking/locking in an emergency

Opening/closing in an emergency

Replacing SmartKey batteries

Replacing bulbs

Replacing wiper blades

Flat tire

Battery

Jump starting

Towing the vehicle

Fuses

Practical hints

What to do if ...

Lamps in instrument cluster

General information:

If any of the following lamps in the instrument cluster fails to come on during the

bulb self-check when switching on the ignition, have the respective bulb checked and replaced if necessary.

Problem	Possible cause	Suggested solution
 The yellow ABS malfunction indicator lamp comes on while driving.	<p>The ABS has detected a malfunction and has switched off. The BAS and the ESP are also switched off (see messages in display).</p> <p>The brake system is still functioning normally but without the ABS available.</p> <p>If the ABS control unit is malfunctioning, other systems such as the navigation system* or the automatic transmission* may also be malfunctioning.</p>	<ul style="list-style-type: none"> ▶ Continue driving with added caution. Wheels may lock during hard braking, reducing steering capability. ▶ Read and observe messages in the display (▷ page 352). ▶ Have the system checked at an authorized Mercedes-Benz Center as soon as possible. <p>Failure to follow these instructions increases the risk of an accident.</p>
	<p>The charging voltage has fallen below ten volts. The ABS has switched off.</p> <p>The battery might not be charged sufficiently.</p>	<ul style="list-style-type: none"> ▶ Switch off electrical consumers that are currently not needed, e.g. seat heating*. ▶ If necessary, have the generator (alternator) and battery checked. <p>When the voltage is above this value again, the ABS is operational again.</p>

Practical hints

What to do if ...

Problem		Possible cause	Suggested solution
BRAKE	(USA only)	The red brake warning lamp comes on while driving and you hear a warning sound.	▶ Release the parking brake (▷ page 48).
	(Canada only)	The red brake warning lamp comes on while driving.	▶ Risk of accident! Carefully stop the vehicle and notify an authorized Mercedes-Benz Center. Do not add brake fluid! This will not solve the problem.

Warning!





Driving with the brake warning lamp illuminated can result in an accident. Have your brake system checked immediately if the brake warning lamp stays on. Don't add brake fluid before checking the brake system. Overfilling the brake fluid reservoir can result in spilling brake fluid on hot engine parts and the brake fluid catching fire. You can be seriously burned.



If you find that the brake fluid in the brake fluid reservoir has fallen to the minimum mark or below, have the brake system checked for brake pad thickness and leaks.



Practical hints

What to do if ...

Problem	Possible cause	Suggested solution
 (USA only)  (Canada only) The yellow engine malfunction indicator lamp comes on while driving.	<p>There is a malfunction in:</p> <ul style="list-style-type: none">• The fuel management system• The ignition system• The emission control system• Systems which affect emissions <p>Such malfunctions may result in excessive emissions values and may switch the engine to its limp-home (emergency operation) mode.</p>	<p>► Have the vehicle checked as soon as possible by an authorized Mercedes-Benz Center.</p> <p>An on-board diagnostic connector is used by the service station to link the vehicle to the shop diagnostics system. It allows the accurate identification of system malfunctions through the readout of diagnostic trouble codes. It is located in the front left area of the footwell next to the parking brake pedal.</p>

Practical hints

What to do if ...

Problem		Possible cause	Suggested solution
 (USA only)	The yellow engine malfunction indicator lamp comes on while driving.	A loss of pressure has been detected in the fuel system. The fuel cap may not be closed properly or the fuel system may be leaky.	▶ Check the fuel cap (▷ page 293).
 (Canada only)			If it is not closed properly: ▶ Close the fuel cap. If it is closed properly: ▶ Have the fuel system checked by an authorized Mercedes-Benz Center.
		Your fuel tank is empty.	▶ After refuelling start, turn off and restart the engine three or four times in succession. The limp-home mode is canceled. You do not need to have your vehicle checked.

Practical hints

What to do if ...

Problem	Possible cause	Suggested solution
 The yellow ESP warning lamp comes on while driving.	The ESP is deactivated. Risk of accident! Adapt your speed and driving to the prevailing road, weather and traffic conditions.	▶ Switch the ESP back on (▷ page 85). If the ESP cannot be switched back on, have the system checked at an authorized Mercedes-Benz Center as soon as possible.
The yellow ESP warning lamp flashes while driving.	The ESP or traction control has come into operation because of detected traction loss in at least one tire.	▶ When driving off, apply as little throttle as possible. ▶ While driving, ease up on the accelerator. ▶ Adapt your speed and driving to the prevailing road and weather conditions. ▶ Do not deactivate the ESP. Exceptions: (▷ page 85). Failure to follow these instructions increases the risk of an accident.

Practical hints

What to do if ...

Problem	Possible cause	Suggested solution
The yellow fuel tank reserve warning lamp in the fuel gauge (▷ page 24) comes on while driving.	The fuel level has gone below the reserve mark.	▶ Refuel at the next gas station (▷ page 293).
 The red seat belt telltale illuminates for a brief period after starting the engine.	The telltale reminds you and your passengers to fasten seat belts.	▶ Fasten your seat belt. The telltale goes out.
The red seat belt telltale illuminates and a warning chime sounds for approximately six seconds after starting the engine.	The driver's seat belt is not fastened before the engine is started.	▶ Fasten the driver's seat belt. The telltale goes out.
SRS The red SRS indicator lamp comes on while driving.	There is a malfunction in the restraint systems. The air bags or emergency tensioning devices (ETDs) could deploy unexpectedly or fail to deploy in an accident.	▶ Drive with added caution to the nearest authorized Mercedes-Benz Center.

Warning!



In the event a malfunction of the SRS is indicated as outlined above, the SRS may not be operational.

For your safety, we strongly recommend that you visit an authorized Mercedes-Benz Center immediately to have the system checked; otherwise the SRS may not be deployed when needed in an accident,

which could result in serious or fatal injury, or it might deploy unexpectedly and unnecessarily which could also result in an accident and/or injury to you or to others.

Practical hints

What to do if ...

Lamp in center console

Problem	Possible cause	Suggested solution
 The front passenger front air bag off indicator lamp illuminates and remains illuminated with the weight of a typical adult or someone larger than a small individual on the front passenger seat.	The system is malfunctioning	<ul style="list-style-type: none">▶ Have the system checked as soon as possible by an authorized Mercedes-Benz Center.▶ Also note any messages in the multifunction display and follow corrective steps (▷ page 354).

Warning!



If the  indicator lamp illuminates and remains illuminated with the weight of a typical adult or someone larger than a small individual on the front passenger seat, do not have any passenger use the front passenger seat until the system has been repaired.

Practical hints

What to do if ...

Problem	Possible cause	Suggested solution
 The front passenger front air bag off indicator lamp does not illuminate and/or does not remain illuminated with the weight of a typical 12-month-old child in a standard child restraint or less on the front passenger seat.	The system is malfunctioning.	<ul style="list-style-type: none">▶ Make sure that there is nothing between seat cushion and child seat and check installation of the child seat.▶ Make sure that no objects applying supplemental weight onto the seat are present.▶ If the front passenger front air bag off indicator lamp remains out, have the system checked as soon as possible by an authorized Mercedes-Benz Center. Do not transport a child on the front passenger seat until the system has been repaired.▶ Also note any messages in the multifunction display and follow corrective steps (▷ page 354).

Warning!



If the  indicator lamp does not illuminate or remains out with the weight of a typical 12-month-old child in a standard

child restraint or less on the front passenger seat, do not transport a child on the front passenger seat until the system has been repaired.

Practical hints

What to do if ...

Vehicle status messages in the multifunction display





Warning and malfunction messages appear in the multifunction display located in the instrument cluster.





Certain warning and malfunction messages are accompanied by an audible signal.

Address these messages accordingly and follow the additional instructions given in this Operator's Manual.

Selecting the vehicle status message memory menu in the control system (▷ page 138) displays both cleared and uncleared messages.

High-priority messages appear in the multifunction display in red color.

Certain messages of high priority cannot be cleared from the multifunction display using the reset button (▷ page 126) or button , , , or  on the steering wheel.

Other messages of high priority and messages of less immediate priority can be cleared from the multifunction display using the reset button (▷ page 126) or button , , , or  on the steering wheel. They are then stored in the vehicle status message memory (▷ page 138). Remember that clearing a message will only make the message disappear. Clearing a message will not correct the condition that caused the message to appear.

Warning!



All categories of messages contain important information which should be taken note of and, where a malfunction is indicated, addressed as soon as possible at an authorized Mercedes-Benz Center.

Failure to repair condition noted may cause damage not covered by the Mercedes-Benz Limited Warranty, or result in property damage or personal injury.

Warning!



No messages will be displayed if either the instrument cluster or the multifunction display is inoperative.

Contact your nearest authorized Mercedes-Benz Center.



Switching on the ignition causes all instrument cluster lamps (except low beam headlamp indicator lamp, high beam headlamp indicator lamp, and turn signal indicator lamps unless activated) as well as the multifunction display to come on. Make sure the lamps and multifunction display are in working order before starting your journey.

On the pages that follow, you will find a compilation of the most important warning and malfunction messages that may appear in the multifunction display.

For your convenience the messages are divided into two sections:

- Text messages (▷ page 354)
- Symbol messages (▷ page 362)

Practical hints

What to do if ...

Text messages

Display message	Possible cause	Possible solution
Front-pass. airbag activated See Operator's Manual	Air bag is activated while driving even though a child, small individual, or object below the system's weight threshold is on the front passenger seat, or the front passenger seat is empty. Objects on the seat or forces acting on the seat may make the system sense supplemental weight.	Stop the vehicle in a safe location as soon as possible and check the following: <ul style="list-style-type: none">▶ Make sure that there is nothing between seat cushion and child seat and check installation of the child seat.▶ Make sure that no objects applying supplemental weight onto the seat are present. The system may recognize such supplemental weight and sense that an occupant on the front passenger seat is of a heavier weight than actually present. (Continued on next page)

Practical hints

What to do if ...

Display message	Possible cause	Possible solution
<p>Front-pass. airbag activated See Operator's Manual</p>		<p>If performing any of the above corrective steps is successful, the message Front-pass. airbag deactivated See Operator's Manual will appear in the multifunction display, confirming the situation has been remedied. Note that after performing the corrective steps, it may take up to 60 seconds for the message Front-pass. airbag deactivated See Operator's Manual to appear.</p> <p>If the message Front-pass. airbag activated See Operator's Manual remains on in the multifunction display and/or the  indicator lamp remains out even after performing the above corrective steps, have the system checked as soon as possible by an authorized Mercedes-Benz Center.</p>

Warning!



If the message Front-pass. airbag activated See Operator's Manual remains on in the multifunction display and/or the  indicator lamp

remains out even after performing the above corrective steps, do not have any children 12 years old and under and other small individuals use the front passenger seat until the system has been repaired.

Practical hints

What to do if ...

Display message	Possible cause	Possible solution
Front-pass. airbag deactivated See Operator's Manual	Air bag is deactivated while driving even though an adult or someone larger than a small individual is occupying the front passenger seat. Forces acting on the seat may make the system sense a decrease in weight.	<p>Stop the vehicle in a safe location as soon as possible and check the following:</p> <ul style="list-style-type: none">▶ Do not lean on armrests or lift yourself up using handle over the door. This may make the system sense that an occupant of a lesser weight than actually present is on the front passenger seat.▶ Re-position yourself.▶ Sit properly belted in a nearly upright position with your back against the seat backrest. <p>If performing any of the above corrective steps is successful, the message Front-pass. airbag activated See Operator's Manual will appear in the multifunction display, confirming the situation has been remedied.</p> <p>(Continued on next page)</p>

Practical hints

What to do if ...

Display message	Possible cause	Possible solution
Front-pass. airbag deactivated See Operator's Manual		<p>Note that after performing the corrective steps, it may take up to 60 seconds for the message Front-pass. airbag activated See Operator's Manual to appear.</p> <p>If the message Front-pass. airbag deactivated See Operator's Manual remains on in the multifunction display and/or the  indicator lamp remains on even after performing the above corrective steps, have the system checked as soon as possible by an authorized Mercedes-Benz Center.</p> <p>Do not have any passenger use the front passenger seat until the system has been repaired.</p>

Warning!



If the message Front-pass. airbag deactivated See Operator's Manual remains on in the multifunction display and/or the  indicator lamp remains illuminated even after performing the above corrective steps, do not have any passenger use the front passenger seat until the system has been repaired.

Practical hints

What to do if ...

Display message	Possible cause	Possible solution
ABS malfunction. Visit workshop.	<p>The ABS has detected a malfunction and has switched off. The ESP and the BAS are also deactivated.</p> <p>The brake system is still functioning normally but without the ABS available.</p>	<ul style="list-style-type: none"> ▶ Continue driving with added caution. Wheels may lock during hard braking, reducing steering capability. ▶ Have the system checked at an authorized Mercedes-Benz Center as soon as possible. <p>Failure to follow these instructions increases the risk of an accident.</p>
Display malfunction. Visit workshop.	The ABS or the ABS display is malfunctioning.	<ul style="list-style-type: none"> ▶ Continue driving with added caution. Wheels may lock during hard braking, reducing steering capability. ▶ Have the system checked at an authorized Mercedes-Benz Center as soon as possible. <p>Failure to follow these instructions increases the risk of an accident.</p>

Practical hints

What to do if ...

Display message	Possible cause	Possible solution
BAS unavailable See Operator's Manual	The charging voltage has fallen below ten volts. The BAS has switched off. The battery might not be charged sufficiently. The brake system is still functioning normally but without the BAS available.	<ul style="list-style-type: none"> ▶ Continue driving with added caution. ▶ If necessary, have the generator and battery checked. <p>When the voltage is above this value again, the BAS is operational again.</p>
malfunction. Visit workshop.	The BAS has detected a malfunction and switched off.	<ul style="list-style-type: none"> ▶ Continue driving with added caution. ▶ Have the system checked at an authorized Mercedes-Benz Center as soon as possible. <p>Failure to follow these instructions increases the risk of an accident.</p>
Display malfunction. Visit workshop.	The BAS or the BAS display is malfunctioning.	<ul style="list-style-type: none"> ▶ Continue driving with added caution. ▶ Have the system checked at an authorized Mercedes-Benz Center as soon as possible. <p>Failure to follow these instructions increases the risk of an accident.</p>

Practical hints

What to do if ...

Display message	Possible cause	Possible solution
ESP unavailable See Operator's Manual	The ESP was deactivated because of a malfunction or interrupted power supply. The ABS might not be operational. The brake system is still functioning normally but without the ESP available.	<ul style="list-style-type: none"> ▶ Continue driving with added caution. ▶ Visit an authorized Mercedes-Benz Center as soon as possible. Failure to follow these instructions increases the risk of an accident.
	If the yellow ESP warning lamp  flashes while driving and this message appears, the electronic traction system has switched off to prevent overheating of the drive wheel brakes.	As soon as the brakes have cooled off, the electronic traction system switches on again.
	The self-diagnosis has not been completed yet. The brake system is still functioning normally but without the ESP available.	The display will clear after driving a short distance at more than 12 mph (20 km/h).
	The charging voltage has fallen below ten volts. The ESP has switched off. The battery might not be charged sufficiently.	<ul style="list-style-type: none"> ▶ Continue driving with added caution. ▶ If necessary, have the generator and battery checked. When the voltage is above this value again, the ESP is operational again.

Practical hints

What to do if ...

Display message	Possible cause	Possible solution
ESP malfunction. Visit workshop.	The ESP is deactivated because of a malfunction. The brake system is still functioning normally but without the ESP available.	<ul style="list-style-type: none"> ▶ Continue driving with added caution. ▶ Visit an authorized Mercedes-Benz Center as soon as possible. <p>Failure to follow these instructions increases the risk of an accident.</p>
Display malfunction. Visit workshop.	The ESP or the ESP display is malfunctioning.	<ul style="list-style-type: none"> ▶ Continue driving with added caution. ▶ Visit an authorized Mercedes-Benz Center as soon as possible. <p>Failure to follow these instructions increases the risk of an accident.</p>
SRS Restraint system malfunction Drive to workshop	The system is malfunctioning.	<ul style="list-style-type: none"> ▶ Drive with added caution to the nearest authorized Mercedes-Benz Center.

Warning!



In the event a malfunction of the SRS is indicated as outlined above, the SRS may not be operational.

For your safety, we strongly recommend that you visit an authorized Mercedes-Benz Center immediately to have the system checked; otherwise the SRS may not be deployed when needed in an accident,

which could result in serious or fatal injury, or it might deploy unexpectedly and unnecessarily which could also result in injury.

Practical hints



What to do if ...

Symbol messages

Display symbol	Display message	Possible cause	Possible solution
	Battery Alternator Visit workshop.	The battery is no longer charging. Possible causes: <ul style="list-style-type: none"> • broken poly-V-belt • alternator malfunctioning 	<ul style="list-style-type: none"> ▶ Stop immediately and check the poly-V-belt. If it is broken: <ul style="list-style-type: none"> ▶ Do not continue to drive. Otherwise the engine will overheat due to an inoperative water pump which may result in damage to the engine. Notify an authorized Mercedes-Benz Center. If it is intact: <ul style="list-style-type: none"> ▶ Drive immediately to the nearest authorized Mercedes-Benz Center.
	Low voltage Charge battery	The battery has insufficient voltage.	▶ Start the engine (> page 46).
	Low voltage Switch off consumers	The battery has insufficient voltage.	▶ Turn off unnecessary electrical consumers.

Practical hints

What to do if ...

Display symbol	Display message	Possible cause	Possible solution
BRAKE (USA only)  (Canada only)	Parking brake Release brake.	You are driving with the parking brake set.	► Release the parking brake (> page 48).
	Brake wear Visit workshop.	The brake pads have reached their wear limit.	► Have the brake pads replaced as soon as possible.
BRAKE (USA only)  (Canada only)	Brake fluid Visit workshop.	There is insufficient brake fluid in the reservoir.	► Risk of accident! Stop the vehicle and notify an authorized Mercedes-Benz Center. Do not add brake fluid! This will not solve the problem.

Warning!



Driving with this message displayed can result in an accident. Have your brake system checked immediately. Do not add brake fluid before checking the brake system. Overfilling the brake fluid reservoir can result in spilling brake fluid on hot engine parts and the brake fluid catching fire. You can be seriously burned.



If you find that the brake fluid in the brake fluid reservoir has fallen to the minimum mark or below, have the brake system checked for brake pad thickness and leaks.



Brake pad thickness must be visually checked by a qualified technician at the intervals specified in the Maintenance booklet.

Practical hints

What to do if ...

Display symbol	Display message	Possible cause	Possible solution
	Coolant Check level	The coolant level is too low.	<ul style="list-style-type: none">▶ Add coolant (▷ page 301).▶ If you have to add coolant frequently, have the cooling system checked by an authorized Mercedes-Benz Center.

Warning!



Do not spill antifreeze on hot engine parts. Antifreeze contains ethylene glycol which may burn if it comes into contact with hot engine parts. You can be seriously burned.



Do not ignore the low engine coolant level warning. Extended driving with the message and symbol displayed may cause serious engine damage not covered by the Mercedes-Benz Limited Warranty.

Do not drive without sufficient amount of coolant in the cooling system. The engine will overheat causing major engine damage.

Practical hints

What to do if ...

Display symbol	Display message	Possible cause	Possible solution
	Coolant Stop, engine off!	The coolant is too hot.	<ul style="list-style-type: none">▶ Stop the vehicle and turn off the engine.▶ Only start the engine again after the message disappears. You could otherwise damage the engine.

Warning!



Driving when your engine is badly overheated can cause some fluids which may have leaked into the engine compartment to catch fire. You could be seriously burned.

Steam from an overheated engine can cause serious burns and can occur just by opening the hood. Stay away from the engine if you see or hear steam coming from it.

Turn off the engine, get out of the vehicle and do not stand near the vehicle until the engine has cooled down.

During severe operating conditions and stop-and-go city traffic, the coolant temperature may rise close to 248°F (120°C).



The engine should not be operated with the coolant temperature above 248°F (120°C). Doing so may cause serious engine damage which is not covered by the Mercedes-Benz Limited Warranty.





Practical hints

What to do if ...

Display symbol	Display message	Possible cause	Possible solution
	Coolant Stop, engine off!	The poly-V-belt could be broken.	<ul style="list-style-type: none"> ▶ Stop immediately and check the poly-V-belt. If it is broken: <ul style="list-style-type: none"> ▶ Do not continue to drive. Otherwise the engine will overheat due to an inoperative water pump which may result in damage to the engine. Notify an authorized Mercedes-Benz Center. If it is intact: <ul style="list-style-type: none"> ▶ Do not continue to drive the vehicle with this message displayed. Doing so could result in serious engine damage that is not covered by the Mercedes-Benz Limited Warranty. ▶ Observe the coolant temperature gauge in the instrument cluster (▷ page 24). ▶ Drive immediately to the nearest authorized Mercedes-Benz Center.
	Coolant Visit workshop.	The cooling fan for the coolant is malfunctioning.	<ul style="list-style-type: none"> ▶ Observe the coolant temperature gauge in the instrument cluster (▷ page 24). ▶ Have the fan replaced as soon as possible.

Practical hints

What to do if ...

Display symbol	Display message	Possible cause	Possible solution
	Cruise contr. Drive to workshop	Cruise control is malfunctioning.	▶ Visit an authorized Mercedes-Benz Center.
	Display malfunction. Visit workshop.	The instrument cluster display is malfunctioning.	▶ Continue driving with added caution. ▶ Visit an authorized Mercedes-Benz Center as soon as possible.
		The displays for several systems have malfunctioned. Some systems themselves may also have malfunctioned.	▶ Have the electronic systems checked by an authorized Mercedes-Benz Center.
	Display malfunction. Visit workshop.	Certain electronic systems are unable to relay information to the control system. The following systems may have failed: <ul style="list-style-type: none"> • Coolant temperature display • Tachometer • Cruise control display 	▶ Have the electronic systems checked by an authorized Mercedes-Benz Center.
	Doors open	You are attempting to drive with one or more doors open.	▶ Close the doors.

Practical hints

What to do if ...

Display symbol	Display message	Possible cause	Suggested solution
	<p>USA only: At next gas station add 1.0 qt engine oil</p> <p>Canada only: At next gas station add 1.0 l engine oil</p>	The engine oil level is too low.	<ul style="list-style-type: none"> ▶ Add engine oil (▷ page 299) and check the engine oil level (▷ page 298).
	<p>Engine oil level Stop, engine off!</p>	There is no oil in the engine. There is a danger of engine damage.	<ul style="list-style-type: none"> ▶ Carefully bring the vehicle to a halt as soon as possible. ▶ Turn off the engine. ▶ Add engine oil (▷ page 299) and check the engine oil level (▷ page 298).
	<p>Engine oil level Reduce oil level</p>	<p>You have added too much engine oil. There is a risk of damaging the engine or the catalytic converter.</p>	<ul style="list-style-type: none"> ▶ Have oil siphoned or drained off. Observe all legal requirements with respect to its disposal.
	<p>Change engine oil Visit workshop.</p>	It may be that there is water in the engine oil.	<ul style="list-style-type: none"> ▶ Have the engine oil checked.

Practical hints

What to do if ...

Display symbol	Display message	Possible cause	Suggested solution
	Engine oil level Visit workshop.	The engine oil has dropped to a critical level.	<ul style="list-style-type: none">▶ Check the engine oil level (> page 298) and add oil as required (> page 299).▶ If you must add engine oil frequently, have the engine checked for possible leaks.
	Oil sensor malfunction Visit workshop.	The measuring system is malfunctioning.	<ul style="list-style-type: none">▶ Have the measuring system checked by an authorized Mercedes-Benz Center.

When the message **At next gas station add 1.0 qt engine oil (Canada: 1.0 l)** appears while the engine is running and at operating temperature, the engine oil level has dropped to approximately the minimum level.

When this occurs, the warning will first come on intermittently and then stay on if the oil level drops further.



Visually check for oil leaks. If no obvious oil leaks are noted, drive to the nearest service station where the engine oil should be topped to the required level with an approved oil specified in the Factory Approved Service Products pamphlet.



The engine oil level warnings should not be ignored. Extended driving with the symbol displayed could result in serious engine damage that is not covered by the Mercedes-Benz Limited Warranty.

Practical hints

What to do if ...

Display symbol	Display message	Possible cause	Possible solution
	Check gas cap. See Operator's Manual	A loss of pressure has been detected in the fuel system. The fuel cap may not be closed properly or the fuel system may be leaky.	<ul style="list-style-type: none"> ▶ Check the fuel cap (▷ page 293). If it is not closed properly: <ul style="list-style-type: none"> ▶ Close the fuel cap. If it is closed properly: <ul style="list-style-type: none"> ▶ Have the fuel system checked by an authorized Mercedes-Benz Center.
	Hood open	You are driving with the hood open.	<ul style="list-style-type: none"> ▶ Close the hood (▷ page 296).
	Remove key.	You have forgotten to remove the SmartKey.	<ul style="list-style-type: none"> ▶ Remove the SmartKey from the starter switch.
	Replace key Drive to workshop	No additional code available for SmartKey.	<ul style="list-style-type: none"> ▶ Change the SmartKey.

Practical hints

What to do if ...

Display symbol	Display message	Possible cause	Possible solution
	3rd brake lamp	The high mounted brake lamp is malfunctioning. This message will only appear if all light emitting diodes have stopped working.	► Visit an authorized Mercedes-Benz Center as soon as possible.
	Backup lamp, left	The left backup lamp is malfunctioning.	► Replace the bulb as soon as possible.
	Backup lamp, right	The right backup lamp is malfunctioning.	► Replace the bulb as soon as possible.
	Brake lamp Drive to workshop	Brake lamp illumination is delayed or lamp is permanently on.	► Visit an authorized Mercedes-Benz Center as soon as possible.
	Brake lamp left	The left brake lamp is malfunctioning.	► Replace the bulb as soon as possible.
	Brake lamp right	The right brake lamp is malfunctioning.	► Replace the bulb as soon as possible.
	Display malfunction. Visit workshop.	The display for the lamps or the system is malfunctioning.	► Visit an authorized Mercedes-Benz Center as soon as possible.
	Front foglamp left	The left front fog lamp is malfunctioning.	► Visit an authorized Mercedes-Benz Center as soon as possible.
	Front foglamp right	The right front fog lamp is malfunctioning.	► Visit an authorized Mercedes-Benz Center as soon as possible.
	Front left side marker lamp	The left front side marker lamp is malfunctioning.	► Replace the bulb as soon as possible.
	Front right sider marker lamp	The right front side marker lamp is malfunctioning.	► Replace the bulb as soon as possible.

Practical hints

What to do if ...

Display symbol	Display message	Possible cause	Possible solution
	High beam left	The left high beam lamp is malfunctioning.	▶ Replace the bulb as soon as possible.
	High beam right	The right high beam lamp is malfunctioning.	▶ Replace the bulb as soon as possible.
	License plate lamp, left	The left license plate lamp is malfunctioning.	▶ Replace the bulb as soon as possible.
	License plate lamp, right	The right license plate lamp is malfunctioning.	▶ Replace the bulb as soon as possible.
	Light sensor Drive to workshop	The lamp sensor is malfunctioning. The headlamps switch on automatically.	<ul style="list-style-type: none"> ▶ In the control system, set lamp operation to manual (▷ page 150). ▶ Switch on the headlamps using the exterior lamp switch (▷ page 117). ▶ Visit an authorized Mercedes-Benz Center as soon as possible.
	Low beam left	The left low beam lamp is malfunctioning.	<p>Halogen headlamp:</p> <ul style="list-style-type: none"> ▶ Replace the bulb as soon as possible. <p>Bi-Xenon* headlamp:</p> <ul style="list-style-type: none"> ▶ Visit an authorized Mercedes-Benz Center as soon as possible.

Practical hints

What to do if ...

Display symbol	Display message	Possible cause	Possible solution
	Low beam right	The right low beam lamp is malfunctioning.	Halogen headlamp: ▶ Replace the bulb as soon as possible. Bi-Xenon* headlamp: ▶ Visit an authorized Mercedes-Benz Center as soon as possible.
	Parking lamp left front	The left front parking lamp is malfunctioning.	▶ Replace the bulb as soon as possible.
	Parking lamp right front	The right front parking lamp is malfunctioning.	▶ Replace the bulb as soon as possible.
	Rear fog lamp Substitute bulb on	The rear fog lamp is malfunctioning. A substitute bulb is being used.	▶ Replace the bulb as soon as possible.
	Switch off lights.	Headlamps have been turned on with the driver's door opened and the SmartKey removed from the starter switch.	▶ Switch off the headlamps.
	Taillamp left Substitute bulb on	The left tail lamp is malfunctioning. A substitute bulb is being used.	▶ Replace the bulb as soon as possible.
	Taillamp right Substitute bulb on	The right tail lamp is malfunctioning. A substitute bulb is being used.	▶ Replace the bulb as soon as possible.



Practical hints

What to do if ...

Display symbol	Display message	Possible cause	Possible solution
	Turn signal left front	The left front turn signal lamp is malfunctioning.	► Replace the bulb as soon as possible.
	Turn signal right front	The right front turn signal lamp is malfunctioning.	► Replace the bulb as soon as possible.
	Turn signal left mirror	The left turn signal in the side mirror is malfunctioning. This message will only appear if all light emitting diodes have stopped working.	► Visit an authorized Mercedes-Benz Center as soon as possible.
	Turn signal right mirror	The right turn signal in the side mirror is malfunctioning. This message will only appear if all light emitting diodes have stopped working.	► Visit an authorized Mercedes-Benz Center as soon as possible.
	Turn signal left rear Substitute bulb on	The left rear turn signal lamp is malfunctioning. A substitute bulb is being used.	► Replace the bulb as soon as possible.
	Turn signal right rear Substitute bulb on	The right rear turn signal lamp is malfunctioning. A substitute bulb is being used.	► Replace the bulb as soon as possible.

Practical hints

What to do if ...

Display symbol	Display message	Possible cause	Possible solution
	Belt system Drive to workshop	The seat belt system is malfunctioning.	► Visit an authorized Mercedes-Benz Center as soon as possible.
	Steering oil Visit workshop.	The steering gear oil level is too low. There is a danger of steering gear damage.	► Have the system checked by an authorized Mercedes-Benz Center.

Warning!











If the level of steering gear oil in reservoir is too low, the steering power assistance could fail. Much greater effort will then be needed to turn the steering wheel.

Do not add steering oil without checking the steering system.

Do not drive the vehicle. Have the system checked at an authorized Mercedes-Benz Center as soon as possible.

Practical hints

What to do if ...

Display symbol	Display message	Possible cause	Possible solution
	Close slid./pop-up sunroof	You have opened the driver's door with the SmartKey removed from the starter switch and the tilt/sliding sunroof open.	▶ Close the tilt/sliding sunroof (▷ page 245).
	Close slid./pop-up sunroof	You have opened the driver's door with the SmartKey removed from the starter switch and the tilt/sliding sunroof open.	▶ Close the tilt/sliding sunroof (▷ page 245).
	Tele Aid malfunction. Drive to workshop	One or more main functions of the Tele Aid system* are malfunctioning.	▶ Have the Tele Aid system* checked by an authorized Mercedes-Benz Center.
	Function unavailable.	This display appears if button  or  on the multifunction steering wheel is pressed and the vehicle is not equipped with a telephone*.	
	Trunk open	This message will appear whenever the trunk lid is open.	▶ Close the trunk lid.
	Washer fluid please refill	The fluid level has dropped to about $\frac{1}{3}$ of total reservoir capacity.	▶ Add washer fluid (▷ page 303).

▼ Where will I find ...?

First aid kit

The first aid kit is located in the trunk on the left side secured by a hook and loop fastener.

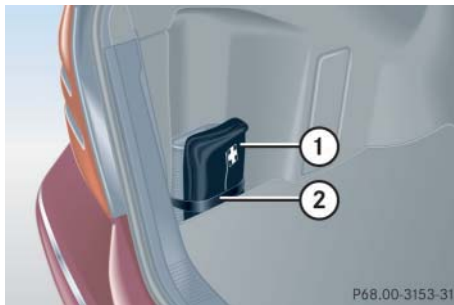

- ① First aid kit
- ② Hook and loop fastener

- ▶ Unfasten hook and loop fastener ②.
- ▶ Remove first aid kit ①.



Check expiration dates and contents for completeness at least once a year and replace missing/expired items.

Vehicle tool kit

The vehicle tool kit is located in the storage compartment underneath the trunk floor.

The following is included:

- Towing eye bolt
- Wheel wrench
- Alignment bolt
- Vehicle jack
- Spare wheel bolts
- Spare fuses
- Collapsible wheel chock
- A pair of gloves

Practical hints

Where will I find ...?

Removing the vehicle tool kit

- ▶ Lift up trunk floor cover and engage trunk floor handle in upper edge of trunk.



- ① Retaining screw
- ② Storage well casing

- ▶ Loosen retaining screw ① by turning it counterclockwise.

- ▶ Remove storage well casing ②.



Practical hints

Where will I find ...?

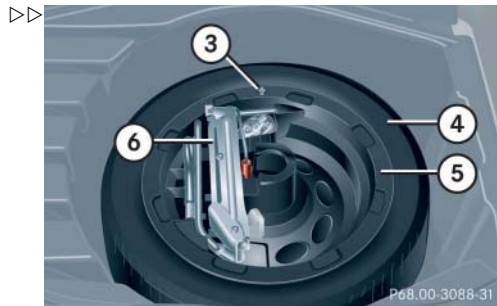

- ③ Arrow
- ④ Minispare wheel
- ⑤ Vehicle tool kit storage well casing
- ⑥ Vehicle tool kit

- ▶ Remove vehicle tool kit ⑥.

Storing the vehicle tool kit

- ▶ Place vehicle tool kit ⑥ in vehicle tool kit storage well casing ⑤.
- ▶ Place storage well casing ② over the vehicle tool kit storage well casing ⑤ and turn retaining screw ① clockwise as far it will go to secure the Minispare wheel.

❗

Arrow ③ on vehicle tool kit storage well casing ⑤ must point in the direction of travel. Otherwise you cannot place the storage well casing ② on top and secure the Minispare wheel with retaining screw ①.

❗

To prevent damage, always disengage trunk floor handle from upper edge of trunk and lower trunk floor before closing the trunk lid.

Vehicle jack

Warning!



The jack is designed exclusively for jacking up the vehicle at the jack take-up brackets built into both sides of the vehicle. To help avoid personal injury, use the jack only to lift the vehicle during a wheel change. Never get beneath the vehicle while it is supported by the jack. Keep hands and feet away from the area under the lifted vehicle. Always firmly set parking brake and block wheels before raising vehicle with jack.

Do not disengage parking brake while the vehicle is raised. Be certain that the jack is always vertical (plumb line) when in use, especially on hills. Always try to use the jack on level surface. Make sure the jack arm is fully seated in the jack take-up bracket. Always lower the vehicle onto sufficient capacity jackstands before working under the vehicle.

The vehicle jack is located in the storage compartment underneath the trunk floor.

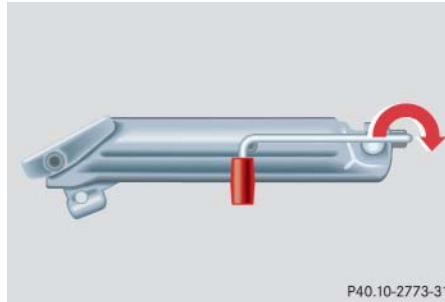

Storage position

- ▶ Remove vehicle jack from its compartment.
- ▶ Push crank handle up.

Practical hints

Where will I find ...?

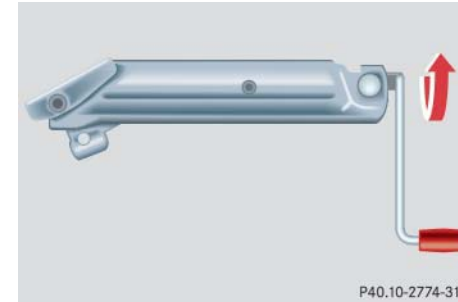

Operational position

- ▶ Turn crank handle clockwise until it engages (operational position).

Before storing the vehicle jack in its compartment:

- It should be fully collapsed.
- The handle must be folded in (storage position).

Practical hints

Where will I find ...?

Setting up the collapsible wheel chock

The collapsible wheel chock serves to additionally secure the vehicle, e.g. while changing the wheel.

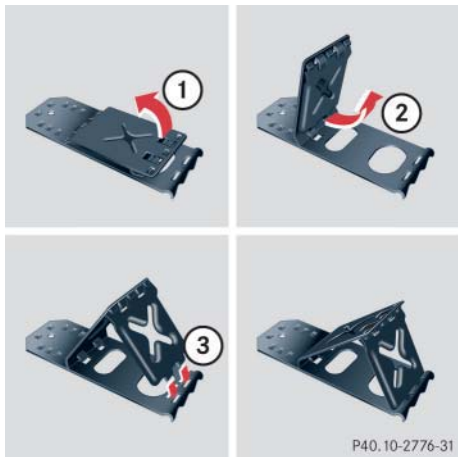

- ① Tilt the plate upward
- ② Fold the lower plate outward
- ③ Insert the plate

- ▶ Tilt both plates upward ①.
- ▶ Fold the lower plate outward ②.
- ▶ Guide the tabs of the lower plate all the way into the openings of the base plate ③.

Minispare wheel

The Minispare wheel is located in the storage compartment underneath the trunk floor.

Removing the Minispare wheel

- ▶ Lift up trunk floor cover and engage trunk floor handle in upper edge of trunk.
- ▶ Loosen the retaining screw (▷ page 377) in the middle of storage well casing.
- ▶ Remove the storage well casing (▷ page 377).

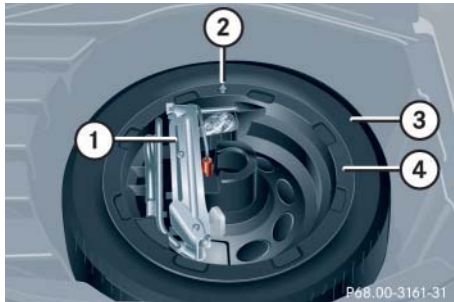

- ① Vehicle tool kit
 - ② Arrow
 - ③ Minispare wheel
 - ④ Vehicle tool kit storage well casing
- ▶ Remove vehicle tool kit storage well casing ④.
 - ▶ Remove Minispare wheel ③.

Storing the Minispare wheel

- ▶ Place Minispare wheel ③ in wheel well.
- ▶ Place vehicle tool kit storage well casing ④ over the Minispare wheel.
Make sure arrow ② on vehicle tool kit storage well casing ④ points in the direction of travel.
- ▶ Place storage well casing (▷ page 377) over vehicle tool kit storage well casing ④ and turn the retaining screw (▷ page 377) clockwise as far it will go to secure the Minispare wheel.



Arrow ② on vehicle tool kit storage well casing ④ must point in the direction of travel. Otherwise you cannot place the storage well casing (▷ page 377) on top and secure the Minispare wheel with the retaining screw (▷ page 377).

Practical hints

Where will I find ...?



To prevent damage, always disengage trunk floor handle from upper edge of trunk and lower trunk floor before closing the trunk lid.

Warning!



The dimensions of the Minispare wheel are different from those of the road wheels. As a result, the vehicle handling characteristics change when driving with a Minispare wheel mounted.

The Minispare wheel should only be used temporarily, and should be replaced with a regular road wheel as quickly as possible.

Practical hints

Where will I find ...?

In the case of a flat tire, you may temporarily use the Minispare wheel when observing the following restrictions:

- Do not exceed a vehicle speed of 50 mph (80 km/h).
- Drive to the nearest tire repair facility to have the flat tire repaired or replaced as appropriate.
- Do not operate vehicle with more than one Minispare wheel mounted.

For more information, see “Rims and Tires” (▷ page 424).

Spare wheel bolts

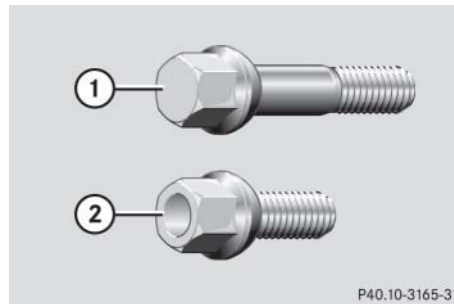

- ① Wheel bolt for light alloy rims
- ② Wheel bolt for Minispare wheel or other steel rims (located in trunk with spare wheel)



Wheel bolts ② must be used when mounting the Minispare wheel or other steel rims. The use of any wheel bolts other than wheel bolts ② for the Minispare wheel or other steel rims will physically damage the vehicle's brakes.

Warning!



Make sure to use the original length wheel bolts when remounting the original wheel after it has been repaired.

▼ **Unlocking/locking in an emergency**

Unlocking the vehicle

If you are unable to unlock the vehicle with the SmartKey, open the driver's door and the trunk using the mechanical key.



Unlocking the driver's door and/or the trunk with the mechanical key will trigger the anti-theft alarm system*.

To cancel the alarm, do one of the following:

- Press button or on the SmartKey.
- Insert the SmartKey in the starter switch.

Removing the mechanical key



- ① Mechanical key locking tab
- ② Mechanical key
- ▶ Move locking tab ① in direction of arrow.
- ▶ Slide mechanical key ② out of the housing.

Unlocking the driver's door

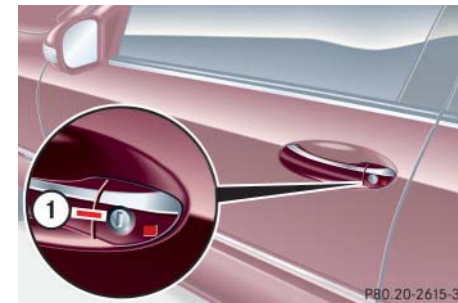

- ① Unlocking
 - ▶ Insert the mechanical key into the driver's door lock until it stops.
 - ▶ Turn the mechanical key counterclockwise to position ①.
- The driver's door is unlocked.

Practical hints

Unlocking/locking in an emergency

Unlocking and opening the trunk

A minimum height clearance of 5.71 ft (1.74 m) is required to open the trunk lid.

The trunk lid lock is located next to the handle above the rear license plate recess.

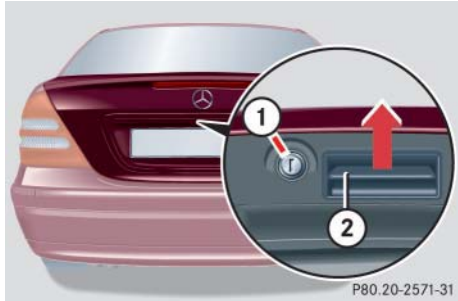

- ① Unlocking in an emergency
- ② Handle

- ▶ Insert the mechanical key into the trunk lid lock until it stops.
- ▶ Turn the mechanical key counterclockwise to position ①.
The trunk lid unlocks.
- ▶ Pull on handle ②.
The trunk lid opens.



The trunk lid swings open upwards automatically. Always make sure there is sufficient overhead clearance.

- ▶ Turn the mechanical key back and remove it from the trunk lid lock.

Locking the vehicle

If you are unable to lock the vehicle with the SmartKey, do the following:

- ▶ Close the passenger doors and the trunk lid.
- ▶ Press the central locking switch in the center console (▷ page 104).
- ▶ Check to see whether the locking knobs on the passenger doors have moved down.
- ▶ If necessary push them down manually.
Except for the driver's door, the vehicle should now be locked.

Practical hints

Unlocking/locking in an emergency

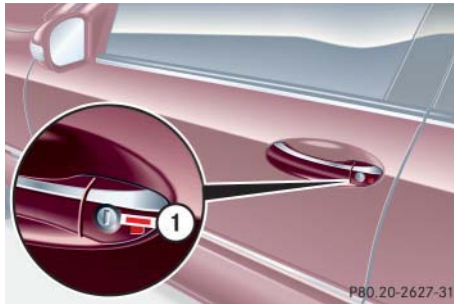

① Locking

- ▶ Insert the mechanical key into the driver's door lock until it stops.
- ▶ Turn the mechanical key clockwise to position ①.

The driver's door is locked.

Fuel filler flap

In case the central locking system does not release the fuel filler flap, you can open it manually.

Warning!



If you operate the emergency release button, be careful of the sharp edges so that you do not injure yourself.

The release button is on the right-hand side of the luggage compartment behind the side trim.

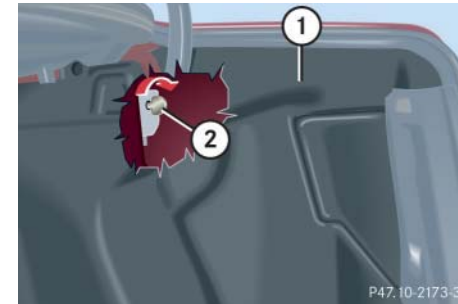

① Side trim

② Release button

- ▶ Open the trunk lid.
- ▶ Remove the side trim ① from the right-hand side of the luggage compartment.
- ▶ Turn release button ② clockwise as far as will go.

The fuel filler flap is released.

- ▶ Open the fuel filler flap from outside.

Practical hints

Unlocking/locking in an emergency

Manually unlocking the transmission gear selector lever

In the case of power failure the transmission gear selector lever can be manually unlocked, e.g. to tow the vehicle.

- ▶ Slide out the swiveling cup holder (▷ page 261).

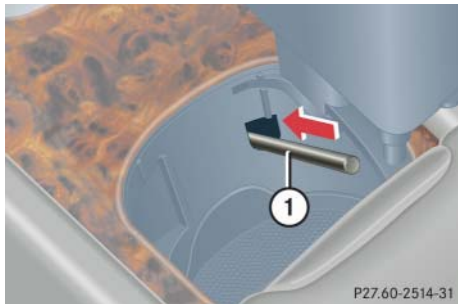

① Tool

- ▶ Insert a tool ① (e.g. flat blade screwdriver) into the opening.
- ▶ Perform the following two steps simultaneously:
 - ▶ Press tool ① forward in the direction of the arrow.
 - ▶ Move gear selector lever from position **P**.
- ▶ Remove tool ① from the opening.



The gear selector lever is locked again when moving it to position **P**.

▼ Opening/closing in an emergency

Power tilt/sliding sunroof*

You can open or close the tilt/sliding sunroof manually should an electrical malfunction occur.

The tilt/sliding sunroof drive is located behind the lens ① of the interior overhead light.



- ▶ Remove SmartKey from the starter switch.
- ▶ Pry of lens ① using a flat blade screwdriver.



- ▶ Slide both locking tabs ② in direction of the arrows.
- ▶ Lower the rear of the cover and remove.
- ▶ Remove the cover.
- ▶ Take the crank ③ out of the Operator's Manual pouch.



Do not disconnect electrical connectors.

- ▶ Insert crank ③ through hole on the left side.

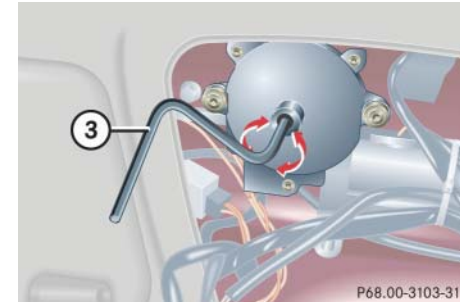

- ▶ Turn crank ③ clockwise to:
 - slide sunroof closed
 - raise sunroof at the rear
- ▶ Turn crank ③ counterclockwise to:
 - slide sunroof open
 - lower sunroof at the rear



Turn crank ③ slowly and smoothly.

The tilt/sliding sunroof must be synchronized after being operated manually (▷ page 248).

Practical hints

Replacing SmartKey batteries

If the batteries in the SmartKey are discharged, the vehicle can no longer be locked or unlocked. It is recommended to have the batteries replaced at an authorized Mercedes-Benz Center.

Warning!



Keep the batteries out of reach of children.

If a battery is swallowed, seek medical help immediately.

Batteries contain materials that can harm the environment if disposed of improperly. Recycling of batteries is the preferred method of disposal. Many states require sellers of batteries to accept old batteries for recycling.



When inserting the batteries, make sure they are clean and free of lint.



When replacing batteries, always replace both batteries.

The required replacement batteries are available at any Mercedes-Benz Center.

SmartKey

Replacement batteries: Lithium, type CR 2025 or equivalent.

- ▶ Remove the mechanical key (▷ page 383).

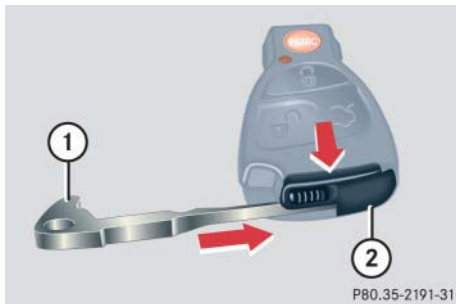

- ① Mechanical key
- ② Battery compartment

- ▶ Insert mechanical key ① in side opening and push grey slide. Battery compartment ② is unlatched.
- ▶ Pull battery compartment ② out of the housing in direction of arrow.
- ▶ Remove the batteries.

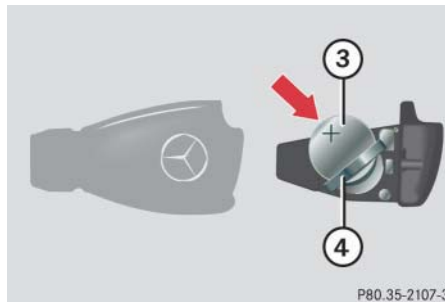

- ③ Battery
- ④ Contact spring

Practical hints

Replacing SmartKey batteries

- ▶ Using a lint-free cloth, insert new batteries ③ under contact spring ④ with the plus (+) side facing up.
- ▶ Return battery compartment ② into housing until it locks into place.
- ▶ Slide mechanical key ① back into the SmartKey.
- ▶ Check the operation of the SmartKey.

Practical hints

Replacing bulbs

Safe vehicle operation depends on proper exterior lighting and signaling. It is therefore essential that all bulbs and lamp assemblies are in good working order at all times.

Correct headlamp adjustment is extremely important. Have headlamps checked and readjusted at regular intervals and when a bulb has been replaced. See an authorized Mercedes-Benz Center for headlamp adjustment.



If the headlamps or front fog lamps are fogged up on the inside as a result of high humidity, driving the vehicle a distance with the lights on should clear up the fogging.



Substitute bulbs will be brought into use when lamps malfunction. Observe the messages in the multifunction display (▷ page 371).

Bulbs

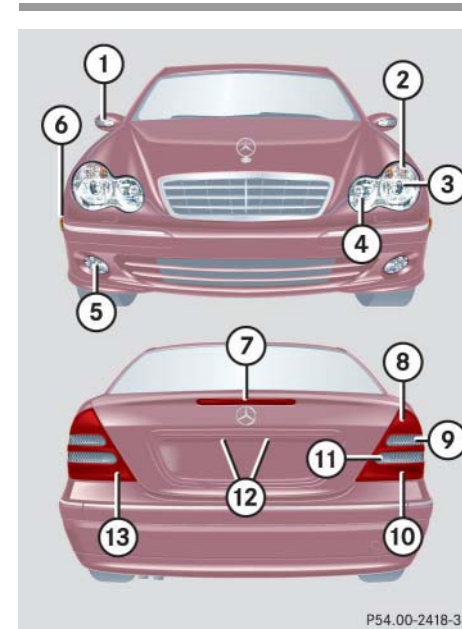

Practical hints

Replacing bulbs

Front lamps

	Lamp	Type
①	Additional turn signal lamp	LED
②	Halogen headlamp: Turn signal lamp	1156 A
	Bi-Xenon* headlamp: Turn signal lamp	2357 A
③	Halogen headlamp: Low beam	H7 (55 W)
	Bi-Xenon* headlamp: Low and high beam ¹	D2S-35 W

¹ Vehicles with Bi-Xenon* headlamps: Low beam and high beam use the same D2S-35W lamp. Do not replace the Xenon bulbs yourself. See an authorized Mercedes-Benz Center.

	Lamp	Type
④	Halogen headlamp: High beam/high beam flasher	H7 (55 W)
	Bi-Xenon* headlamp: High beam flasher	H7 (55 W)
	Parking and standing lamp	W 5 W
⑤	Front fog lamp	HB4 (51 W)
	Front fog lamp with cornering fog lamp*	H7 (55 W)
⑥	Side marker lamp	W 5 W

Rear lamps

	Lamp	Type
⑦	High mounted brake lamp	LED
⑧	Brake lamp	P 21 W
⑨	Turn signal lamp	PY 21 W
⑩	Parking and side marker lamp	P 21/5 W
⑪	Backup lamp	P 21 W
⑫	License plate lamps	C 5 W
⑬	Rear fog lamp (driver's side only), tail and standing lamp	P 21/4 W

Practical hints

Replacing bulbs

Warning!



Bulbs and bulb sockets can be very hot. Allow the lamp to cool down before changing a bulb.

Keep bulbs out of reach of children.

Halogen lamps contain pressurized gas. A bulb can explode if you

- touch or move it when hot
- drop the bulb
- scratch the bulb

Wear eye and hand protection.

Because of high voltage in Xenon lamps, it is dangerous to replace the bulb or repair the lamp and its components. We recommend that you have such work done by a qualified technician.

Notes on bulb replacement

- Only use 12 volt bulbs of the same type and with the specified watt rating.
- Switch lights off before changing a bulb to prevent short circuits.
- Always use a clean lint-free cloth when handling bulbs.
- Your hands should be dry and free of oil and grease.
- If the newly installed bulb does not come on, visit an authorized Mercedes-Benz Center.

Have the LEDs and bulbs for the following lamps replaced by an authorized Mercedes-Benz Center:

- Additional turn signals in the exterior rear view mirrors
- High mounted brake lamp
- Xenon* lamps
- Front fog lamps



Have the headlamp adjustment checked regularly.

Replacing bulbs for front lamps

Before you start to replace a bulb for a front lamp, do the following first:

- ▶ Turn the exterior lamp switch to position **0** (▷ page 117).
- ▶ Open the hood (▷ page 296) (except for side marker lamps).

Halogen headlamp

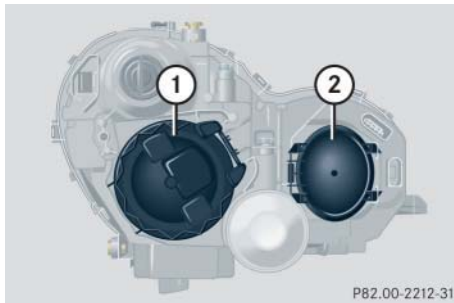

- ① Housing cover for low beam headlamp
- ② Housing cover for high beam headlamp, parking and standing lamp

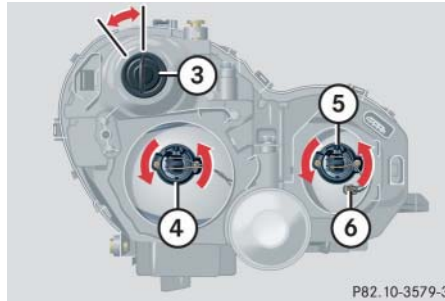

- ③ Bulb socket for turn signal lamp bulb
- ④ Bulb socket for low beam bulb
- ⑤ Bulb socket for high beam bulb
- ⑥ Bulb socket for parking and standing lamp bulb

Practical hints

Replacing bulbs

Low beam bulb

- ▶ Press the clamp on housing cover ① and remove it.
- ▶ Pull the electrical connector off.
- ▶ Turn bulb socket ④ counterclockwise and take out the bulb.
- ▶ Insert the new bulb so that its socket locates in the recess of the lamp housing.
- ▶ Turn bulb socket ④ clockwise until it engages.
- ▶ Plug the electrical connector onto the bulb.
- ▶ Align housing cover ① and press until it engages.

Practical hints

Replacing bulbs

High beam bulb

- ▶ Press the clamp on housing cover ② and remove it.
- ▶ Pull the electrical connector off.
- ▶ Turn bulb socket ⑤ counterclockwise and take out the bulb.
- ▶ Insert the new bulb so that its socket locates in the recess of the lamp housing.
- ▶ Turn bulb socket ⑤ clockwise until it engages.
- ▶ Plug the electrical connector onto the bulb.
- ▶ Align housing cover ② and press until it engages.

Front turn signal lamp bulb

- ▶ Turn bulb socket ③ with the bulb counterclockwise and remove it.
- ▶ Press gently onto the bulb and turn it counterclockwise out of bulb socket ③.
- ▶ Press new bulb gently into bulb socket ③ and turn clockwise until it engages.
- ▶ Place bulb socket ③ back into the lamp and turn it clockwise.

Parking and standing lamp bulb

- ▶ Press the clamp on housing cover ② and remove it.
- ▶ Pull out bulb socket ⑥ with the bulb.
- ▶ Pull the bulb out of bulb socket ⑥.
- ▶ Press the new bulb into bulb socket ⑥.
- ▶ Press bulb socket ⑥ back into the lamp.
- ▶ Align housing cover ② and press until it engages.

Bi-Xenon* headlamp

Warning!



Do not remove the cover ① for the Bi-Xenon headlamp. Because of high voltage in Bi-Xenon lamps, it is dangerous to replace the bulb or repair the lamp and its components. We recommend that you have such work done by a qualified technician.

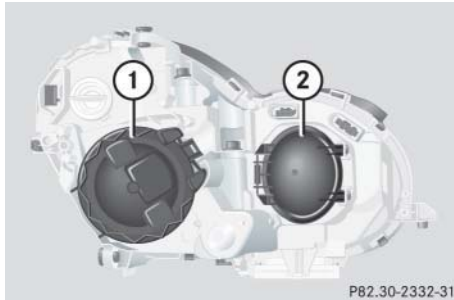

- ① Housing cover for Bi-Xenon headlamp
- ② Housing cover for high beam flasher, parking and standing lamp

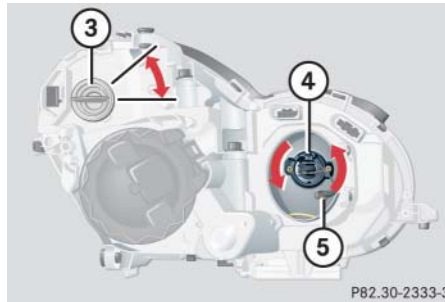

- ③ Bulb socket for turn signal lamp bulb
- ④ Bulb socket for high beam flasher bulb
- ⑤ Bulb socket for parking and standing lamp bulb

Practical hints

Replacing bulbs

High beam flasher bulb

- ▶ Press the clamp on housing cover ② and remove it.
- ▶ Pull the electrical connector off.
- ▶ Turn bulb socket ④ counterclockwise and take out the bulb.
- ▶ Insert the new bulb so that its socket locates in the recess of the lamp housing.
- ▶ Turn bulb socket ④ clockwise until it engages.
- ▶ Plug the electrical connector onto the bulb.
- ▶ Align housing cover ② and press until it engages.

Practical hints

Replacing bulbs

Front turn signal lamp bulb

- ▶ Turn bulb socket ③ with the bulb counterclockwise and remove it.
- ▶ Press gently onto the bulb and turn it counterclockwise out of bulb socket ③.
- ▶ Press new bulb gently into bulb socket ③ and turn clockwise until it engages.
- ▶ Place bulb socket ③ back into the lamp and turn it clockwise.

Parking and standing lamp bulb

- ▶ Press the clamp on housing cover ② and remove it.
- ▶ Pull out bulb socket ⑤ with the bulb.
- ▶ Pull the bulb out of bulb socket ⑤.
- ▶ Press the new bulb into bulb socket ⑤.
- ▶ Press bulb socket ⑤ back into the lamp.
- ▶ Align housing cover ② and press until it engages.

Side marker lamp

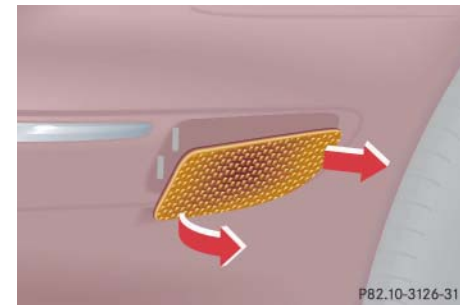

- ▶ Carefully slide the lamp towards the rear in direction of arrows.
- ▶ Remove the front end first.
- ▶ Turn the bulb socket with the bulb counterclockwise and remove it.
- ▶ Pull the bulb out of the bulb socket.
- ▶ Insert the new bulb into the bulb socket.
- ▶ Place the bulb socket back into the lamp and turn it clockwise.
- ▶ To reinstall the lamp, set the rear end in the bumper and let the front end engage.

Replacing bulbs for rear lamps

Before you start to replace a bulb for a rear lamp, do the following first:

- ▶ Turn the exterior lamp switch to position **0** (▷ page 117).
- ▶ Open the trunk lid (▷ page 99).

Tail lamp unit



① Latch

- ▶ Fold the corresponding trim panel to the side.
- ▶ Turn latch ① to vertical position and remove the bulb carrier.

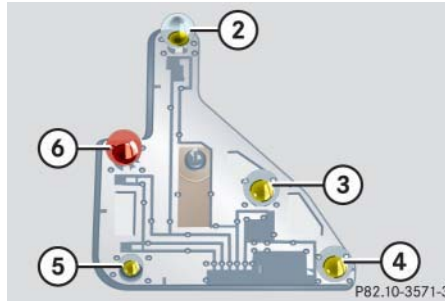

Bulb carrier

- ② Brake lamp bulb
 - ③ Backup lamp bulb
 - ④ Rear fog lamp (driver's side only), tail and standing lamp bulb
 - ⑤ Parking and side marker lamp bulb
 - ⑥ Turn signal lamp bulb
- ▶ Press gently onto the respective bulb and turn counterclockwise out of its bulb socket.
 - ▶ Press the new bulb gently into its bulb socket and turn clockwise until it engages.

Practical hints

Replacing bulbs

- ▶ Reinstall the bulb carrier and lock it again with latch ①.
- ▶ Reinstall the trim panel.

License plate lamp

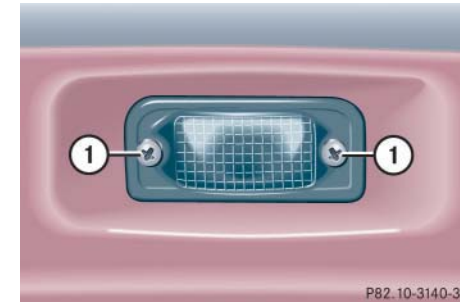

① Screw

- ▶ Loosen both screws ①.
- ▶ Remove the license plate lamp.
- ▶ Replace the bulb.
- ▶ Reinstall the license plate lamp.
- ▶ Retighten screws ①.

Practical hints

Replacing wiper blades

Removing wiper blades

Warning!



For safety reasons, switch off wipers and remove SmartKey from starter switch before replacing a wiper blade. Otherwise, the wiper motor could suddenly turn on and cause injury.

- ▶ Remove SmartKey from starter switch.
- ▶ Fold wiper arm forward.

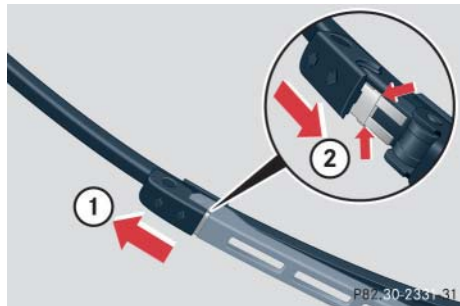

- ① Unlock
- ② Lock

- ▶ Pull the tab in direction of arrow ① and remove wiper blade.

Installing wiper blades

- ▶ Slide the wiper blade into the cutout on the wiper arm (see arrows).
- ▶ Slide the tab back in the direction of arrow ② until it audibly engages.
- ▶ Fold the wiper arm backward to rest on the windshield. Make sure you hold on to the wiper when folding the wiper arm back.



Never open the hood when the wiper arms are folded forward.

Hold on to the wiper when folding the wiper arm back. If released, the force of the impact from the tensioning spring could crack the windshield.

Do not allow the wiper arms to contact the windshield glass without a wiper blade inserted.

Make certain that the wiper blades are properly installed. Improperly installed wiper blades may cause windshield damage.

For your convenience, we recommend that you have this work carried out by an authorized Mercedes-Benz Center.

▼ Flat tire

Warning!



The dimensions of the Minispare wheel are different from those of the road wheels. As a result, the vehicle handling characteristics change when driving with a Minispare wheel mounted. Adapt your driving style accordingly.

The Minispare wheel is for temporary use only. When driving with Minispare wheel mounted, ensure proper tire inflation pressure and do not exceed a vehicle speed of 50 mph (80 km/h).

Drive to the nearest Mercedes-Benz Center as soon as possible to have the Minispare wheel replaced with a regular road wheel.

Never operate the vehicle with more than one Minispare wheel mounted.

Preparing the vehicle

- ▶ Park the vehicle as far as possible from moving traffic on a hard surface.
- ▶ Turn on the hazard warning flasher (▷ page 123).
- ▶ Turn the steering wheel so that the front wheels are in a straight ahead position.
- ▶ Set the parking brake (▷ page 54).
- ▶ Move the gear selector lever to **P** (manual transmission: to first or reverse gear).
- ▶ Turn off the engine (▷ page 56).
- ▶ Remove the SmartKey from the starter switch.
- ▶ Have any passenger exit the vehicle at a safe distance from the roadway.



Open doors only when conditions are safe to do so.

Mounting the Minispare wheel

Preparing the vehicle

Prepare the vehicle as described (▷ page 399).

- ▶ Take the wheel wrench, the wheel bolts, and the jack out of the trunk (▷ page 377).
- ▶ Take the Minispare wheel out of the trunk (▷ page 380).

Practical hints

Flat tire

Lifting the vehicle

- ▶ Prevent the vehicle from rolling away by blocking wheels with wheel chocks or other sizable objects.

One wheel chock is included with the vehicle tool kit (▷ page 377).

When changing wheel on a level surface:

- ▶ Place the wheel chock in front of and another sizable object behind the wheel that is diagonally opposite to the wheel being changed.

When changing wheel on a hill:

- ▶ Place the wheel chock and another sizable object on the downhill side blocking both wheels of the other axle.

Warning!



The jack is designed exclusively for jacking up the vehicle at the jack take-up brackets built into both sides of the vehicle. To help avoid personal injury, use the jack only to lift the vehicle during a wheel change. Never get beneath the vehicle while it is supported by the jack. Keep hands and feet away from the area under the lifted vehicle. Always firmly set parking brake and block wheels before raising vehicle with jack.

Do not disengage parking brake while the vehicle is raised. Be certain that the jack is always vertical (plumb line) when in use, especially on hills. Always try to use the jack on level surface. Make sure the jack arm is fully seated in the jack take-up bracket. Always lower the vehicle onto sufficient capacity jackstands before working under the vehicle.



- ▶ On wheel to be changed, loosen but do not yet remove the wheel bolts (approximately one full turn with wrench).

The jack take-up brackets are located directly behind the front wheel housings and in front of the rear wheel housings.

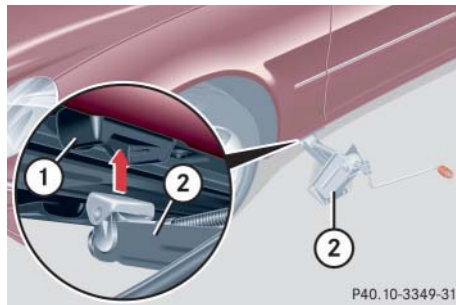

- ① Take-up bracket
- ② Jack

- ▶ Place jack ② on firm ground.
- ▶ Position jack ② under take-up bracket ① so that it is always vertical (plumb-line) as seen from the side, even if the vehicle is parked on an incline.

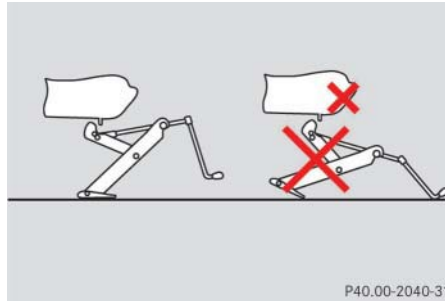

- ▶ Jack up the vehicle until the wheel is a maximum of 1.2 in (3 cm) from the ground. Never start engine while vehicle is raised.

Warning!



The jack is intended only for lifting the vehicle briefly for wheel changes. It is not suited for performing maintenance work under the vehicle.

- Never start the engine when the vehicle is raised.
- Never lie down under the raised vehicle.

Practical hints

Flat tire

Removing the wheel

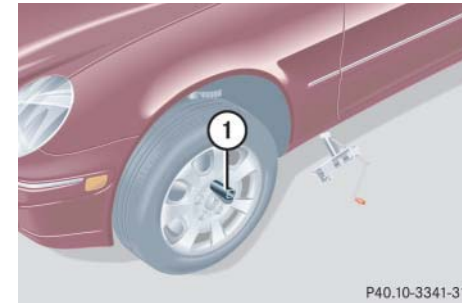

- ① Alignment bolt
- ▶ Unscrew upper-most wheel bolt and remove.
- ▶ Replace this wheel bolt with alignment bolt ① supplied in the tool kit.
- ▶ Remove the remaining bolts.



Do not place wheel bolts in sand or dirt. This could result in damage to the bolts and wheel hub threads.

- ▶ Remove the wheel.

Practical hints

Flat tire

Mounting the spare wheel

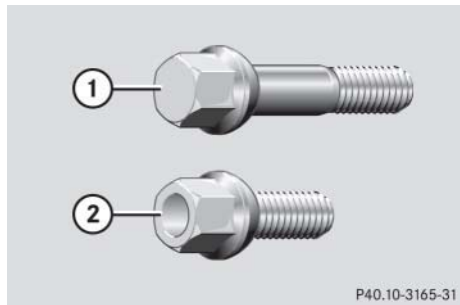

- ① Wheel bolt for light alloy rims
- ② Wheel bolt for Minispare wheel or other steel rims (located in trunk with spare wheel)



Wheel bolts ② must be used when mounting the Minispare wheel or other steel rims. The use of any wheel bolts other than wheel bolts ② for the Minispare wheel or other steel rims will physically damage the vehicle's brakes.

- ▶ Clean contact surfaces of wheel and wheel hub.



To avoid paint damage, place wheel flat against hub and hold it there while installing first wheel bolt.

Warning!



Always replace wheel bolts that are damaged or rusted.

Never apply oil or grease to wheel bolts.

Damaged wheel hub threads should be repaired immediately. Do not continue to drive under these circumstances! Contact an authorized Mercedes-Benz Center or call Roadside Assistance.

Incorrect wheel bolts or improperly tightened wheel bolts can cause the wheel to come off. This could cause an accident. Make sure to use the correct wheel bolts.

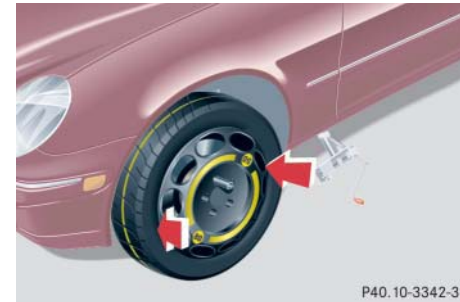

- ▶ Guide spare wheel onto the alignment bolt and push it on.
- ▶ Insert wheel bolts and tighten them slightly.

Practical hints

Flat tire

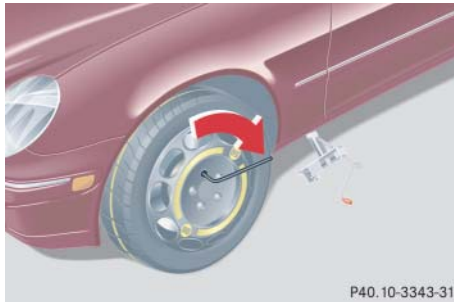

- ▶ Unscrew the alignment bolt, install last wheel bolt and tighten slightly.

Warning!



Only use genuine equipment Mercedes-Benz wheel bolts. Other wheel bolts may come loose.

Do not tighten the wheel bolts when the vehicle is raised. Otherwise the vehicle could fall off the jack.

Lowering the vehicle

- ▶ Lower vehicle by turning crank counterclockwise until vehicle is resting fully on its own weight.
- ▶ Remove the jack.

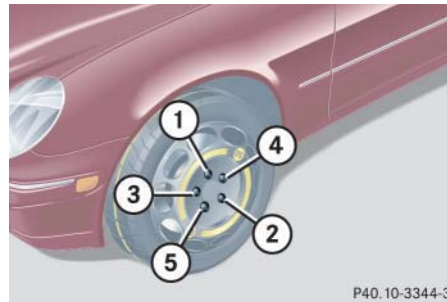

① - ⑤ Wheel bolts

- ▶ Tighten the five wheel bolts evenly, following the diagonal sequence illustrated (① to ⑤), until all bolts are tight. Observe a tightening torque of 80 lb-ft (110 Nm).

Warning!



Have the tightening torque checked after changing a wheel. The wheels could come loose if they are not tightened to a torque of 80 lb-ft (110 Nm).

Before storing the jack, it should be fully collapsed, with handle folded in (storage position) (▷ page 379).

- ▶ Store the jack and the other vehicle tools in the trunk.

Practical hints

Battery

The battery is located in the engine compartment on the right hand side.

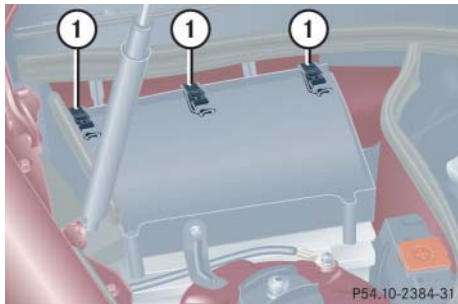

① Clamps

Removing filter box:

- ▶ Release clamps ①.
- ▶ Remove filter box.

Installing filter box:

- ▶ Insert filter box properly.
- ▶ Secure it with clamps ①.

Warning!



Failure to follow these instructions can result in severe injury or death.

Observe all safety instructions and precautions when handling automotive batteries (> page 302).

Never lean over batteries while connecting, you might get injured.

Battery fluid contains sulfuric acid. Do not allow this fluid to come in contact with eyes, skin or clothing. In case it does, immediately flush affected area with water and seek medical help if necessary.

A battery will also produce hydrogen gas, which is flammable and explosive. Keep flames or sparks away from battery, avoid improper connection of jumper cables, smoking, etc.



Never loosen or detach battery terminal clamps while the engine is running or the SmartKey is in the starter switch. Otherwise the alternator and other electronic components could be severely damaged.

Have the battery checked regularly by an authorized Mercedes-Benz Center.

Refer to Maintenance Booklet for maintenance intervals or contact an authorized Mercedes-Benz Center for further information.

Warning!



Do not place metal objects on the battery as this could result in a short circuit.

Use leak-proof battery only to avoid the risk of acid burns in the event of an accident.

Warning!



With a disconnected battery

- you will no longer be able to turn the SmartKey in the starter switch
- the gear selector lever will remain locked in position **P**

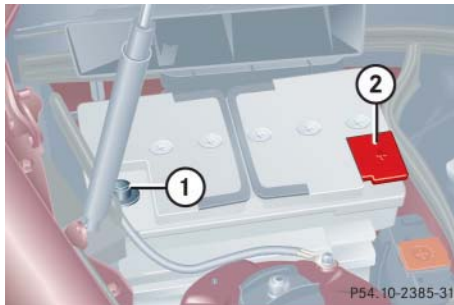

① Negative terminal

② Positive terminal cover

Disconnecting the battery

- ▶ Turn off the engine (▷ page 56).
- ▶ Turn off all electrical consumers.
- ▶ Remove SmartKey from starter switch.
- ▶ Open the hood (▷ page 296).
- ▶ Remove the filter box (▷ page 404).
- ▶ Disconnect the battery negative lead from negative terminal ①.
- ▶ Remove cover ② from the positive terminal.
- ▶ Disconnect the battery positive lead.

Removing the battery

- ▶ Remove the screw-nuts securing the battery.
- ▶ Remove the battery bracket.
- ▶ Take out the battery.

Practical hints

Battery

Charging and reinstalling the battery

- ▶ Charge battery in accordance with the instructions of the battery charger manufacturer.
- ▶ Reinstall the charged battery. Follow the previously described steps in reverse order.

Warning!



Never charge a battery while still installed in the vehicle. Gases may escape during charging and cause explosions that may result in paint damage, corrosion or personal injury.

Practical hints

Battery

Reconnecting the battery

- ▶ Turn off all electrical consumers.
- ▶ Remove SmartKey from starter switch.
- ▶ Connect the battery positive lead and fasten its cover ②.
- ▶ Connect the battery negative lead.



NEVER invert the terminal connections!

- ▶ Reinstall the filter box (▷ page 404).



The battery, its filler caps and the vent tube must always be securely installed when the vehicle is in operation.



The following procedures must be carried out following any interruption of battery power (e.g. due to reconnection):

- Set the clock (▷ page 145).
Vehicles with COMAND*:
See COMAND operator's manual.
- Synchronize side windows (▷ page 244).
- Synchronize tilt/sliding sunroof* (▷ page 248).

Batteries contain materials that can harm the environment if disposed of improperly. Large 12 volt storage batteries contain lead. Recycling of batteries is the preferred method of disposal. Many states require sellers of batteries to accept old batteries for recycling.

▼ Jump starting

Warning!



Failure to follow these directions will cause damage to the electronic components, and can lead to a battery explosion and severe injury or death.

Never lean over batteries while connecting or jump starting, you might get injured.

Battery fluid contains sulfuric acid. Do not allow this fluid to come in contact with eyes, skin or clothing. In case it does, immediately flush affected area with water, and seek medical help if necessary.

A battery will also produce hydrogen gas, which is flammable and very explosive. Keep flames or sparks away from battery, avoid improper connection of jumper cables, smoking, etc.

Attempting to jump start a frozen battery can result in it exploding, causing personal injury.

Read all instructions before proceeding.

If the battery is discharged, the engine can be started with jumper cables and the battery of another vehicle. Observe the following:

- Jump starting should only be performed when the engine and catalytic converter are cold.
- Do not start the engine if the battery is frozen. Let the battery thaw out first.
- Only jump start from batteries with the same voltage rating (12 V). Jump starting with a more powerful battery could damage the vehicle's electrical system, which will not be covered by the Mercedes-Benz Limited Warranty.
- Only use jumper cables with sufficient cross-section and insulated terminal clamps.
- Always make sure the jumper cables are not on or near pulleys, fans, or other parts that move when an engine is started or running.

Practical hints

Jump starting



Avoid repeated and lengthy starting attempts.

Do not attempt to start the engine using a battery quick charge unit.

If engine does not run after several unsuccessful starting attempts, have it checked at the nearest authorized Mercedes-Benz Center.

Excessive unburned fuel generated by repeated failed starting attempts may damage the catalytic converter and may present a fire risk.

Make sure the jumper cables do not have loose or missing insulation.

Make sure the cable clamps do not touch any other metal part while the other end is still attached to a battery.

Practical hints

Jump starting

Warning!



Keep flames or sparks away from battery. Do not smoke.

Observe all safety instructions and precautions when handling automotive batteries (▷ page 302).

The battery is located in the engine compartment on the right hand side. The terminals for jump starting are located in front of the battery.

- ▶ Make sure the two vehicles do not touch.
- ▶ Turn off all electrical consumers.
- ▶ Apply parking brake.
- ▶ Shift gear selector lever to position **P** (manual transmission: to Neutral).

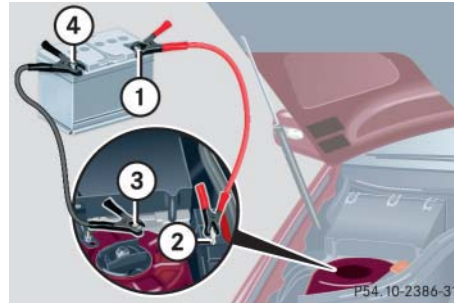

- ① Positive terminal of charged battery
 - ② Positive under hood terminal in front of discharged battery
 - ③ Negative under hood terminal in front of discharged battery
 - ④ Negative terminal of charged battery
- ▶ Connect positive terminal ① of the charged battery with positive under hood terminal ② in front of the discharged battery with the jumper cables. Clamp cable to charged battery ① first.
 - ▶ Start engine of the vehicle with the charged battery and run at idle speed.

- ▶ Connect negative terminal ④ of the charged battery with negative under hood terminal ③ in front of the discharged battery with the jumper cables. Clamp cable to charged battery ④ first.
- ▶ Start the engine of the disabled vehicle.

You can now again turn on the electrical consumers. Do not turn on the lights under any circumstances.

- ▶ Remove the jumper cables first from negative terminals ③ and ④ and then from positive terminals ② and ①.

You can now turn on the lights.

- ▶ Have the battery checked at the nearest authorized Mercedes-Benz Center.



Vehicles with automatic transmission and/or 4MATIC:
Do not tow-start the vehicle.

▼ Towing the vehicle

Mercedes-Benz recommends that the vehicle be transported with all wheels off the ground using flatbed or appropriate wheel lift/dolly equipment. This method is preferable to other types of towing.



Use flatbed or wheel lift/dolly equipment with the SmartKey in the starter switch turned to position **0**.

Do not tow with sling-type equipment. Towing with sling-type equipment over bumpy roads will damage radiator and supports.

To prevent damage during transport, do not tie down vehicle by its chassis or suspension parts.

Switch off the tow-away alarm* (▷ page 91) and deactivate the automatic central locking (▷ page 153).

When circumstances do not permit the recommended towing methods, the vehicle may be towed with all wheels on the ground or front wheels raised (except vehicles with 4MATIC) only so far as necessary to have the vehicle moved to a safe location where the recommended towing methods can be employed.



Vehicles with automatic transmission and/or 4MATIC:
Do not tow-start the vehicle.



Vehicles with 4MATIC:
Do not tow with one axle raised. Doing so could damage the transfer case, which is not covered by the Mercedes-Benz Limited Warranty.

All wheels must be on or off the ground. Observe instructions for towing the vehicle with all wheels on the ground.

Practical hints

Towing the vehicle



If the vehicle is towed with the front axle raised (not permissible for vehicles with 4MATIC), the engine must be shut off (SmartKey in starter switch position **0** or **1**). Otherwise the ESP will immediately be engaged and will apply the rear wheel brakes.

When towing the vehicle with all wheels on the ground, the gear selector lever must be in position **N** (manual transmission: gears disengaged) and the SmartKey must be in starter switch position **2**.

When towing the vehicle with all wheels on the ground or the front axle raised, the vehicle may be towed only for distances up to 30 miles (50 km) and at a speed not to exceed 30 mph (50 km/h).

Practical hints

Towing the vehicle



To be certain to avoid a possibility of damage to the drivetrain, however, we recommend the drive shaft be disconnected at the rear axle drive flange (vehicles with 4MATIC: disconnected at the front and rear axle drive flanges) for any towing beyond a short tow to a nearby garage.

Warning!



If circumstances require towing the vehicle with all wheels on the ground, always tow with a tow bar if:

- the engine will not run
- there is a malfunction in the power supply or in the vehicle's electrical system

as that will be necessary to adequately control the towed vehicle.

Prior to towing the vehicle with all wheels on the ground, make sure the SmartKey is in starter switch position **2**.

If the SmartKey is left in starter switch position **0** for an extended period of time, it can no longer be turned in the switch. In this case, the steering is locked. To unlock, remove SmartKey from starter switch and reinsert.



To signal turns while being towed with the hazard warning flasher in use, switch on ignition and activate the combination switch for the left or right turn signal in the usual manner – only the selected turn signal will operate.

Upon canceling the turn signal, the hazard warning flasher will operate again.

Warning!



With the engine not running, there is no power assistance for the brake and steering systems. In this case, it is important to keep in mind that a considerably higher degree of effort is necessary to brake and steer the vehicle. Adapt your driving accordingly.



When towing the vehicle with all wheels on the ground, please note the following:

With the automatic central locking activated and the SmartKey in starter switch position **2**, the vehicle doors lock if the left front wheel as well as the right rear wheel are turning at vehicle speeds of approx. 9 mph (15 km/h) or more.

Switch off the tow-away alarm* (▷ page 91).

To prevent the vehicle doors from locking, deactivate the automatic central locking (▷ page 153).

Towing of the vehicle should only be done using the properly installed towing eye bolt. Never attach tow cable, tow rope or tow rod to vehicle chassis, frame or suspension parts.

Practical hints

Towing the vehicle



If the battery is disconnected or discharged

- the SmartKey will not turn in the starter switch. For more information, see “Battery” (▷ page 404) and “Jump starting” (▷ page 407).
- the gear selector lever will remain locked in position **P**. For information on manually unlocking the transmission gear selector lever see (▷ page 386).

Practical hints

Towing the vehicle

Installing towing eye bolt

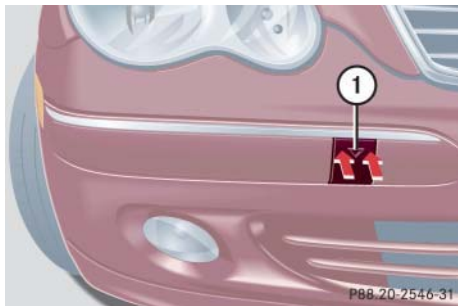

① Cover on right side of front bumper.

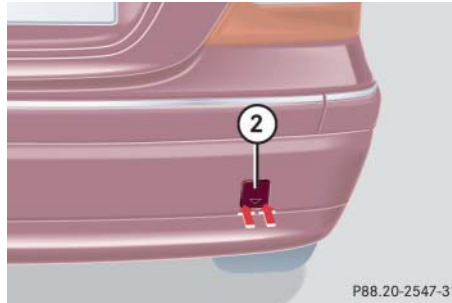

② Cover on right side of rear bumper.

Removing cover

- ▶ Press mark on cover ① or ② in direction of arrows.
- ▶ Lift cover off to reveal threaded hole for towing eye bolt.

The towing eye bolt is supplied with the tool kit (located in the compartment underneath the trunk floor).

- ▶ Screw towing eye bolt in to its stop and tighten with lug wrench.

Reinstalling cover

- ▶ Fit cover ① or ② and snap into place.

▼ Fuses

The electrical fuses in your vehicle serve to stop the supply of electricity to a device that is malfunctioning. This helps to prevent damage to the other vehicle electronics.

The following aids are available to help you change fuses (▷ page 413):

- Fuse chart
- Spare fuses
- Fuse extractor

Warning!



Only use fuses approved for Mercedes-Benz with the specified amperage for the system in question. Otherwise, a short circuit could result and cause a fire.



Only install fuses that have been tested and approved by Mercedes-Benz and that have the specified amperage rating.

Otherwise, electrical parts or systems could be damaged.

Never attempt to repair or bridge a blown fuse. Have the cause determined and remedied by an authorized Mercedes-Benz Center.

The electrical fuses are located in different fuse boxes:

- Main fuse box in passenger compartment (▷ page 414)
- Fuse box in engine compartment (▷ page 414)
- Fuse box in trunk (▷ page 416)

Aids for changing fuses

Fuse chart

The fuse chart is found in the main fuse box in the passenger compartment (▷ page 414). The amperages of the fuses are also given there.

Spare fuses

Spare fuses are found in the vehicle tool kit in the spare wheel well (▷ page 377).

Fuse extractor

The fuse extractor is found in the fuse box cover in the trunk (▷ page 416).

Practical hints

Fuses

Main fuse box in passenger compartment

The main fuse box is located in the passenger compartment on the driver's side of the cockpit.



① Main fuse box cover

Opening fuse box

- ▶ Open the driver's door.
- ▶ Pull fuse box cover ① open with a screw driver or similar tool (see arrow).
- ▶ Remove fuse box cover ① rearward.

Closing fuse box

- ▶ Attach fuse box cover ① in the front.
- ▶ Fold fuse box cover ① in until it engages.

Fuse box in engine compartment

The fuse box is located in the engine compartment on the driver's side.

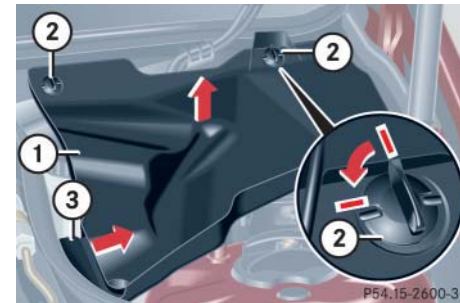

- ① Cover
- ② Screws
- ③ Retainer

Removing cover

- ▶ Twist screws ② 90° counterclockwise.
- ▶ Lift the rear of cover ①.
- ▶ Slide out retainer ③ and remove cover ① by pulling towards front.

Opening fuse box

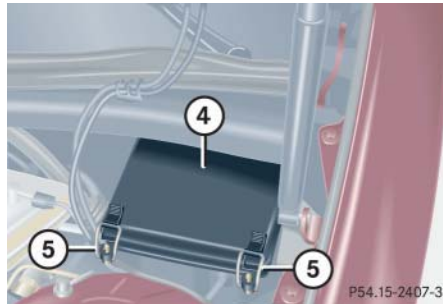

- ④ Fuse box cover
- ⑤ Clamps

- ▶ With a dry cloth, remove any moisture from the fuse box.
- ▶ Release clamps ⑤.
- ▶ Remove fuse box cover ④.

Closing fuse box

- ▶ Make sure that the sealing rubber is properly positioned.
- ▶ Press fuse box cover ④ down and secure with clamps ⑤.

Installing cover

- ▶ Insert cover ① sideways into retainer ③.
- ▶ Twist screws ② 90° clockwise.

Practical hints

Fuses

Fuse box in trunk

The fuse box is located in the trunk behind the left-hand trim panel.

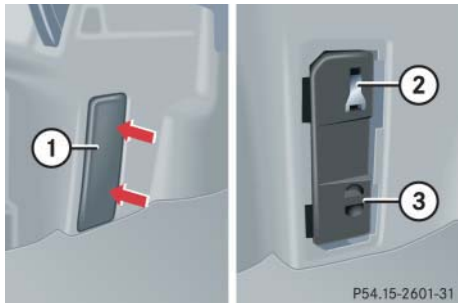

- ① Trim panel
- ② Fuse extractor
- ③ Fuse box cover

Opening fuse box

- ▶ Pull away trim panel ①.
- ▶ Remove fuse box cover ③.

Closing fuse box

- ▶ Insert fuse box cover ③ until it engages.
- ▶ Insert trim panel ①.

Technical data

Parts service

Warranty coverage

Identification labels

Layout of poly-V-belt drive

Engine

Rims and Tires

Electrical system

Main dimensions

Weights

Fuels, coolants, lubricants, etc.

Technical data

Parts service

The “Technical data” section provides the necessary technical data for your vehicle.

All authorized Mercedes-Benz Centers maintain a stock of genuine Mercedes-Benz parts required for maintenance and repair work. In addition, strategically located parts distribution centers provide quick and reliable parts service.

More than 300 000 different parts for Mercedes-Benz models are available.

Genuine Mercedes-Benz parts are subject to stringent quality inspections. Each part has been specifically developed, manufactured or selected for and adapted to Mercedes-Benz vehicles.

Therefore, genuine Mercedes-Benz parts should be installed.



The use of non-genuine Mercedes-Benz parts and accessories not authorized by Mercedes-Benz could damage the vehicle, which is not covered by the Mercedes-Benz Limited Warranty, or could compromise the vehicle's durability or safety.

▼ **Warranty coverage**

Your vehicle is covered under the terms of the warranties printed in the Service and Warranty Information booklet. Your authorized Mercedes-Benz Center will exchange or repair any defective parts originally installed in the vehicle in accordance with the terms of the following warranties:

- New Vehicle Limited Warranty
- Emission System Warranty
- Emission Performance Warranty
- California, Maine, Massachusetts, and Vermont Emission Control Systems Warranty

Replacement parts and accessories are covered by the Mercedes-Benz Parts and Accessories warranties, copies of which are available at any Mercedes-Benz Center.

Loss of Service and Warranty Information Booklet

Should you lose your Service and Warranty Information booklet, have an authorized Mercedes-Benz Center arrange for a replacement. It will be mailed to you.

Technical data

Identification labels

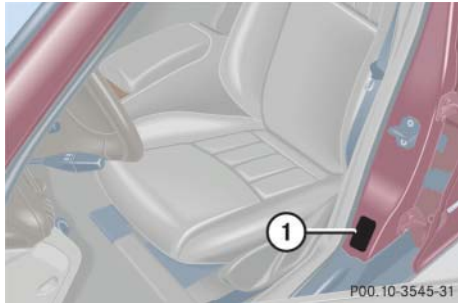

- ① Certification label
(includes Paintwork code)



- ② Vehicle Identification Number (VIN)

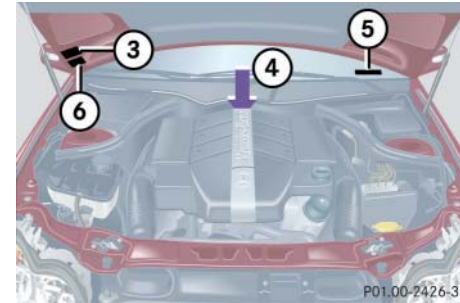

- ③ Emission control information label, includes both federal and California certification exhaust emission standards
④ Engine number (engraved on engine)
⑤ VIN, visible (lower edge of windshield)
⑥ Vacuum line routing diagram label

i

When ordering parts, please specify vehicle identification and engine numbers.

▼ Layout of poly-V-belt drive

C 230 Kompressor (all models)

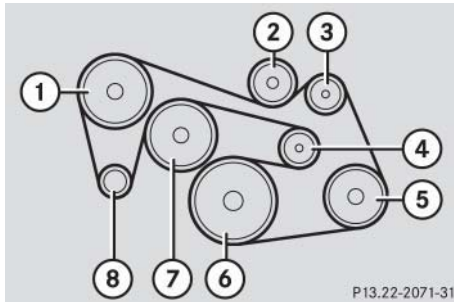

- ① Power steering pump
- ② Idler pulley
- ③ Supercharger
- ④ Automatic belt tensioner
- ⑤ Air conditioning compressor
- ⑥ Crankshaft
- ⑦ Coolant pump
- ⑧ Generator (alternator)

C 240 (all models)/C 320 (all models)

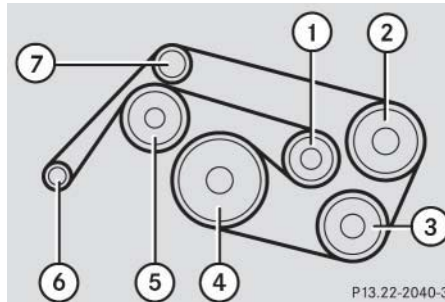

- ① Automatic belt tensioner
- ② Power steering pump
- ③ Air conditioning compressor
- ④ Crankshaft
- ⑤ Coolant pump
- ⑥ Generator (alternator)
- ⑦ Idler pulley

Technical data

Engine

Model	C 230 Kompressor (203.040) ¹ (Canada only) C 230 Kompressor Sport (203.040) ¹	C 240 (203.061) ¹ C 240 4MATIC (203.081) ¹
Engine	271	112
Mode of operation	4-stroke engine, gasoline injection	4-stroke engine, gasoline injection
No. of cylinders	4	6
Bore	3.23 in (82.00 mm)	3.54 in (89.90 mm)
Stroke	3.35 in (85.00 mm)	2.68 in (68.20 mm)
Total piston displacement	109.6 cu in (1796 cm ³)	158.5 cu in (2597 cm ³)
Compression ratio	8.5:1	10.5:1
Output acc. to SAE J 1349	189 hp/5800 rpm ² (141 kW/5800 rpm)	168 hp/5500 rpm ² (125 kW/5500 rpm)
Maximum torque acc. to SAE J 1349	192 lb-ft/3500 - 4000 rpm (260 Nm/3500 - 4000 rpm)	177 lb-ft/4500 rpm (240 Nm/4500 rpm)
Maximum engine speed	6000 rpm	6200 rpm
Firing order	1-3-4-2	1-4-3-6-2-5
Poly-V-belt	2420 mm	2380 mm

¹ The quoted data apply only to the standard vehicle. See an authorized Mercedes-Benz Center for the corresponding data of all special bodies and special equipment.

² Premium fuel required. Performance may vary with fuel octane rating.

Technical data

Engine

Model	C 320 (203.064)¹ (USA only) C 320 Sport (203.064)¹ C 320 4MATIC (203.084)¹
Engine	112
Mode of operation	4-stroke engine, gasoline injection
No. of cylinders	6
Bore	3.54 in (89.90 mm)
Stroke	3.31 in (84.00 mm)
Total piston displacement	195.2 cu in (3 199 cm ³)
Compression ratio	10:1
Output acc. to SAE J 1349	215 hp/5700 rpm ² (160 kW/5700 rpm)
Maximum torque acc. to SAE J 1349	229 lb-ft/3000 - 4600 rpm (310 Nm/3000 - 4600 rpm)
Maximum engine speed	6000 rpm
Firing order	1-4-3-6-2-5
Poly-V-belt	2380 mm

¹ The quoted data apply only to the standard vehicle. See an authorized Mercedes-Benz Center for the corresponding data of all special bodies and special equipment.

² Premium fuel required. Performance may vary with fuel octane rating.

Technical data

Rims and Tires

Only use tires and rims which have been specifically developed for your vehicle and tested and approved by Mercedes-Benz. Other tires and rims can have detrimental effects, such as

- poor handling characteristics
- increased noise
- increased fuel consumption



Moreover, tires and rims not approved by Mercedes-Benz may, under load, exhibit dimensional variations and different tire deformation characteristics that could cause them to come into contact with the vehicle body or axle parts. Damage to the tires or the vehicle may be the result.



Further information on tires and rims is available at any authorized Mercedes-Benz Center. A placard with the recommended tire inflation pressures is located on the driver's door B-pillar. Some vehicles may have supplemental tire inflation pressure information for driving at high speeds (▷ page 314) or for vehicle loads less than the maximum loaded vehicle condition. If such information is provided, it can be found on the placard located on the inside of the fuel filler flap. The tire inflation pressure should be checked regularly and should only be adjusted on cold tires. Follow tire manufacturer's maintenance recommendation included with vehicle.

Technical data

Rims and Tires

Same size tires

Model	C 230 Kompressor (Canada only) C 230 Kompressor Sport C 240 C 240 4MATIC C 320 (USA only) C 320 Sport C 320 4MATIC
Rims (light alloy)	7 J x 16 H2
Wheel offset	1.22 in (31 mm)
All-season tires (radial-ply tires)	205/55 R16 91H M+S
Summer tires (radial-ply tires)	-
Winter tires (radial-ply tires)	205/55 R16 91H M+S

Technical data

Rims and Tires

Mixed size tires

Model	C 230 Kompressor Sport C 320 Sport
Front axle:	
Rims (light alloy)	7 ¹ / ₂ J x 17 H2
Wheel offset	1.42 in (36 mm)
Summer tires (radial-ply tires)	225/45 R17 91W
Rear axle:	
Rims (light alloy)	8 ¹ / ₂ J x 17 H2
Wheel offset	1.34 in (34 mm)
Summer tires (radial-ply tires)	245/40 R17 91W ¹

¹ Must not be used with snow chains.

Technical data

Rims and Tires

Minispare wheel

Model	C 230 Kompressor (Canada only) C 240 C 240 4MATIC C 320 (USA only) C 320 4MATIC	C 230 Kompressor Sport C 320 Sport
Rim (steel)	3.5 B x 16 H2	3.5 B x 17 H2
Wheel offset	0.67 in (17 mm)	0.67 in (17 mm)
Tire	T 125/90 R16 98M ¹	T 125/80 R17 99M ¹

¹ Must not be used with snow chains.

Technical data

Electrical system

Model	C 230 Kompressor (all models)	C 240 (all models) C 320 (all models)
Generator (alternator)	14 V/120 A	14 V/120 A
Starter motor	12 V/1.1 kW	12 V/1.7 kW
Battery	12 V/100 Ah	12 V/100 Ah
Spark plugs	Bosch F 6 MPP 332	Bosch F 8 DPP 332 NGK PFR 5 R-11
Electrode gap	0.031 in (0.8 mm)	0.039 in (1.0 mm)
Tightening torque	18 – 22 lb-ft (25 – 30 Nm)	15 – 22 lb-ft (20 – 30 Nm)

▼ Main dimensions

Model	C 230 Kompressor C 240 C 240 4MATIC C 320 C 320 4MATIC	C 230 Kompressor Sport C 320 Sport
Overall vehicle length	178.4 in (4531 mm)	178.4 in (4531 mm)
Overall vehicle width	68.0 in (1728 mm)	68.0 in (1728 mm)
Overall vehicle height	56.3 in (1429 mm)	55.6 in (1413 mm)
Wheelbase	106.9 in (2715 mm)	106.9 in (2715 mm)
Track, front	59.3 in (1505 mm)	59.3 in (1505 mm)
Track, rear	58.1 in (1476 mm)	58.1 in (1476 mm)

Technical data

Weights

Roof load max.	220 lb (100 kg)
Trunk load max.	220 lb (100 kg)

▼ Fuels, coolants, lubricants, etc.

Capacities

Vehicle components and their respective lubricants must match. Therefore only use products tested and approved by Mercedes-Benz.

Please refer to the Factory Approved Service Products pamphlet, or inquire at your Mercedes-Benz Center.

	Model	Capacity	Fuels, coolants, lubricants, etc.
Engine with oil filter	C 230 Kompressor (all models) C 240 C 240 4MATIC C 320 C 320 4MATIC C 320 Sport	5.8 US qt (5.5 l) 7.9 US qt (7.5 l) 7.4 US qt (7.0 l) 7.9 US qt (7.5 l) 7.4 US qt (7.0 l) 7.9 US qt (7.5 l)	Approved engine oils
Automatic transmission	C 230 Kompressor (all models) C 240 (all models) C 320 (all models)	8.5 US qt (8.0 l) 8.5 US qt (8.0 l) 8.5 US qt (8.0 l)	MB Automatic Transmission Fluid
Manual transmission		1.3 US qt (1.2 l)	MB Manual Transmission Oil
Rear axle	C 230 Kompressor (all models) C 240 (all models) C 320 (all models)	1.2 US qt (1.1 l) 1.2 US qt (1.1 l) 1.2 US qt (1.1 l)	Hypoid gear oil SAE 85 W 90
Front axle	C 240 4MATIC C 320 4MATIC	0.5 US qt (0.46 l)	Hypoid gear oil SAE 85 W 90
Transfer case	C 240 4MATIC C 320 4MATIC	approx. 0.62 US qt (0.59 l)	MB Transfer case fluid

Technical data

Fuels, coolants, lubricants, etc.

	Model	Capacity	Fuels, coolants, lubricants, etc.
Power steering		approx. 1.1 US qt (1.0 l)	MB Power Steering Fluid (Pentosin CHF 11S)
Front wheel hubs		approx. 2.1 oz (60 g) each	High temperature roller bearing grease
Brake system		0.5 US qt (0.5 l)	MB Brake Fluid (DOT 4+)
Cooling system	C 230 Kompressor (all models) C 240 (all models) C 320 (all models)	approx. 5.9 US qt (5.6 l) approx. 6.8 US qt (6.4 l) approx. 6.8 US qt (6.4 l)	MB 325.0 Anticorrosion/antifreeze agent
Fuel tank including a reserve of		16.4 US gal (62.0 l) 2.1 US gal (8.0 l)	Premium unleaded gasoline: Minimum Posted Octane 91 (Avg. of 96 RON/86 MON) Flexible Fuel Vehicle (identified by a label reading Premium gasoline or E85 only! on fuel filler flap): Alternative fuel: Ethanol fuel (E85)
Air conditioning system			R-134a refrigerant and special PAG lubricant oil (never R-12)
Windshield washer		3.2 US qt (3.0 l)	MB Windshield Washer Concentrate ¹
Windshield washer and headlamp cleaning system*		6.4 US qt (6.0 l)	

¹ Use MB Windshield Washer Concentrate "S" and water for temperatures above freezing point or MB Windshield Washer Concentrate "S" and commercially available premixed windshield washer solvent/antifreeze for temperatures below freezing point. Follow suggested mixing ratios (▷ page 439).

Engine oils

Engine oils are specifically tested for their suitability in our engines and durability for our service intervals. Therefore, only use approved engine oils and oil filters required for vehicles with Maintenance System (U.S. vehicles) or FSS (Canada vehicles). For a listing of approved engine oils and oil filters, refer to the Factory Approved Service Products pamphlet, or contact an authorized Mercedes-Benz Center.

Using engine oils and oil filters of specification other than those expressly required for the Maintenance System (U.S. vehicles) or FSS (Canada vehicles), or changing of oil and oil filter at change intervals longer than those called for by the Maintenance System (U.S. vehicles) or FSS (Canada Vehicles) will result in engine damage not covered by the Mercedes-Benz Limited Warranty.

Please follow Maintenance System (U.S. vehicles) or FSS (Canada vehicles) recommendations for scheduled oil changes. Failure to do so will result in engine damage not covered by the Mercedes-Benz Limited Warranty.

Engine oil additives

Do not blend oil additives with engine oil. They may damage the engine.

Damage or malfunctions resulting from blending oil additives are not covered by the Mercedes-Benz Limited Warranty.

Air conditioning refrigerant

R-134a (HFC) refrigerant and special PAG lubricating oil are used in the air conditioning system.

Never use R-12 (CFC) or mineral-based lubricating oil. Otherwise damage to the system will occur.

Brake fluid

During vehicle operation, the boiling point of the brake fluid is continuously reduced through the absorption of moisture from the atmosphere. Under extremely strenuous operating conditions, this moisture content can lead to the formation of bubbles in the system, thus reducing the system's efficiency.

Therefore, the brake fluid must be replaced every two years, preferably in the spring.

Only brake fluid approved by Mercedes-Benz is recommended. Your authorized Mercedes-Benz Center will provide you with additional information.

Technical data

Fuels, coolants, lubricants, etc.

Premium unleaded gasoline



To maintain the engine's durability and performance, premium unleaded gasoline must be used. If premium unleaded is not available and low octane fuel is used, follow these precautions:

- Have the fuel tank only partially filled with unleaded regular and fill up with premium unleaded as soon as possible.
- Avoid full throttle driving and abrupt acceleration.
- Do not exceed an engine speed of 3000 rpm if the vehicle is loaded with a light load such as two persons and no luggage.
- Do not exceed $\frac{2}{3}$ of maximum accelerator pedal position if the vehicle is fully loaded or operating in mountainous terrain.

Fuel requirements



Flexible Fuel Vehicles (identified by a label reading **Premium gasoline or E85 only!** on fuel filler flap) are designed to operate on premium unleaded gasoline or ethanol fuel (E85) or any mixture of these two.

For more information, see "Flexible Fuel Vehicles" (▷ page 435).

Only use premium unleaded fuel:

- The octane number (posted at the pump) must be 91 min. It is an average of both the Research (R) octane number and the Motor (M) octane number: $(R+M)/2$. This is also known as the ANTI-KNOCK INDEX.

Unleaded gasoline containing oxygenates such as ethanol, IPA, IBA and TBA can be used provided the ratio of any one of these oxygenates to gasoline does not exceed 10%; MTBE must not exceed 15%.

The ratio of methanol to gasoline must not exceed 3% plus additional cosolvents.

Using mixtures of ethanol and methanol is not allowed. Gasohol, which contains 10% ethanol and 90% unleaded gasoline, can be used.

These blends must also meet all other fuel requirements, such as resistance to spark knock, boiling range, vapor pressure, etc.

Technical data

Fuels, coolants, lubricants, etc.

Gasoline additives

A major concern among engine manufacturers is carbon build-up caused by gasoline. Mercedes-Benz recommends only the use of quality gasoline containing additives that prevent the build-up of carbon deposits.

After an extended period of using fuels without such additives, carbon deposits can build up especially on the intake valves and in the combustion area, leading to engine performance problems such as:

- Warm-up hesitation
- Unstable idle
- Knocking/pinging
- Misfire
- Power loss

In areas where carbon deposits may be encountered due to lack of availability of gasolines which contain these additives, Mercedes-Benz recommends the use of additives approved by us for use on Mercedes-Benz vehicles. Refer to Factory Approved Service Products pamphlet for a listing of approved product(s). Follow directions on product label.

Do not blend any specific fuel additives with fuel. This only results in unnecessary cost and may be harmful to engine operation.

Damage or malfunction resulting from poor fuel quality or from blending additional fuel additives other than those tested and approved by us for use on Mercedes-Benz vehicles listed in the Factory Approved Service Products pamphlet are not covered by the Mercedes-Benz Limited Warranty.

Flexible Fuel Vehicles

Flexible Fuel Vehicles are identified by a label reading **Premium gasoline or E85 only!** on fuel filler flap.

These vehicles are designed to operate on premium unleaded gasoline or ethanol fuel (E85), or on any mixture of these two.

Ethanol fuel (E85) is a mixture of approximately 85% ethanol and 15% unleaded gasoline.

Warning!



Ethanol fuel (E85) and its fumes are highly flammable, poisonous and burn easily. Ethanol fuel can cause serious injuries if ignited or if you come into contact with it or inhale fumes of it. Avoid inhalation of ethanol fumes and skin contact with ethanol. Extinguish all open flames before fueling. Never smoke or create sparks close to ethanol.

Technical data

Fuels, coolants, lubricants, etc.

Switching fuels

For best performance and driveability it is recommended to use either one or the other fuel. A refueling pattern that alternates between the two different fuels should be avoided if possible.

When switching fuels, make sure:

- Fuel level is below half full.
- Fuel level is above reserve (fuel reserve warning lamp is not lit).
- Amount of added fuel is more than 5 gallons (20 liters).
- Ignition is off during refill.
- Immediately after refueling engine is started and operated for at least five minutes.

These precautions and recommendations are supposed to prevent any difficulties when starting and operating the engine which otherwise may be experienced before the engine has fully adapted to the different fuel.

If in spite of these recommendations the engine does not perform properly, adding more gasoline [at least 3 gallons (12 liters)] to the fuel may improve the engine behavior.

Cold weather performance

It is possible that starting times will significantly increase at temperatures below 32°F (0°C). At low temperatures the use of a block heater (Canada only) is recommended (see an authorized Mercedes-Benz Center for further information). Rough idling may also be experienced at such temperatures before the engine is fully warmed up.



E85 fuel is unsuitable for use when ambient temperatures fall below 14°F (-10°C).

Hot weather performance

At ambient temperatures above 95°F (35°C) start times may increase and be accompanied by a rough idle following the start.

Cruising range

E85 fuel contains less energy per gallon than gasoline. To make sure that engine performance with ethanol fuel is similar to that when using gasoline, the engine must burn more ethanol fuel. As a result, it is to be expected that the fuel consumption will increase when using E85 compared to gasoline operation.



Use of E85 may reduce your driving range.

Maintenance

Please inform your Mercedes-Benz Center if you use or have used E85 fuel when your vehicle is delivered for maintenance or repairs.

Coolants

The engine coolant is a mixture of water and anticorrosion/antifreeze, which provides:

- Corrosion protection
- Freeze protection
- Boiling protection (by increasing the boiling point)

The cooling system was filled at the factory with a coolant providing freeze protection to approximately -22°F (-30°C) and corrosion protection.

If the antifreeze mixture is effective to -22°F (-30°C), the boiling point of the coolant in the pressurized cooling system is reached at approx. 266°F (130°C).

The coolant solution must be used year-round to provide the necessary corrosion protection and increase boil-over protection. Refer to Maintenance Booklet for replacement interval.

Coolant system design and coolant used determine the replacement interval. The replacement interval published in the Maintenance Booklet is only applicable if MB 325.0 anticorrosion/antifreeze solution or other Mercedes-Benz approved products of equal specification (see Factory Approved Service Products pamphlet) are used to renew the coolant concentration or bring it back up to the proper level.

To provide important corrosion protection, the solution must be at least 45% anticorrosion/antifreeze [equivalent to freeze protection to approx. -22°F (-30°C)].

If you use a solution that is more than 55% anticorrosion/antifreeze [freeze protection to approx. -49°F (-45°C)], the engine temperature will increase due to the lower heat transfer capability of the solution. Therefore, do not use more than this amount of anticorrosion/antifreeze.

If the coolant level is low, water and MB 325.0 anticorrosion/antifreeze should be used to bring it up to the proper level (have cooling system checked for signs of leakage). Please make sure the mixture is in accordance with label instructions.

The water in the cooling system must meet minimum requirements, which are usually satisfied by normal drinking water. If you are not sure about the water quality, consult an authorized Mercedes-Benz Center.

Technical data

Fuels, coolants, lubricants, etc.

Anticorrosion/antifreeze

Your vehicle contains a number of aluminum parts. The use of aluminum components in motor vehicle engines necessitates that anticorrosion/antifreeze coolant used in such engines be specifically formulated to protect the aluminum parts.

Failure to use such anticorrosion/antifreeze coolant will result in a significantly shortened service life.

Therefore, the following product is strongly recommended for use in your vehicle:

Mercedes-Benz 325.0

Anticorrosion/Antifreeze Agent.

Before the start of the winter season (or once a year in hot southern regions), you should have the anticorrosion/antifreeze concentration checked. The coolant is also regularly checked each time you bring your vehicle to an authorized Mercedes-Benz Center for service.

Anticorrosion/antifreeze quantity

Model	Approx. freeze protection	
	-35°F (-37°C)	-49°F (-45°C)
C 230 Kompressor (all models)	3.0 US qt (2.8 l)	3.3 US qt (3.1 l)
C 240 (all models)	3.4 US qt (3.2 l)	3.8 US qt (3.6 l)
C 320 (all models)	3.4 US qt (3.2 l)	3.8 US qt (3.6 l)

Windshield washer and headlamp cleaning system*

Both the windshield washer and headlamp cleaning system* are supplied from the windshield washer fluid reservoir.

The washer fluid reservoir has a capacity of approx.:

- 3.2 US qt (3.0 l) in vehicles without headlamp cleaning system*
- 6.4 US qt (6.0 l) in vehicles with headlamp cleaning system*

- ▶ Refill the reservoir with MB Windshield Washer Concentrate “S” and water (or concentrate and commercially available premixed windshield washer solvent/antifreeze, depending on ambient temperatures).

Warning!



Washer solvent/antifreeze is highly flammable. Do not spill washer solvent/antifreeze on hot engine parts, because it may ignite and burn. You could be seriously burned.

Technical data

Fuels, coolants, lubricants, etc.

Windshield and headlamp washer fluid mixing ratio

For temperatures above freezing point, use MB Windshield Washer Concentrate “S” and water:

- 1 part “S” to 100 parts water
(1.34 fl oz [40 ml] “S” to 1 gallon [4.0 l] water)

For temperatures below freezing point, use MB Windshield Washer Concentrate “S” and commercially available premixed windshield washer solvent/antifreeze:

- 1 part “S” to 100 parts solvent
(1.34 fl oz [40 ml] “S” to 1 gallon [4.0 l] solvent)



ABS

(Antilock Brake System)

Prevents the wheels from locking up during braking so that the vehicle can continue to be steered.

Accessory weight

(▷ page 327)

Air pressure

(▷ page 327)

Alignment bolt

Metal pin with thread. The centering pin is an aid used when changing a tire to align the wheel with the wheel hub.

Aspect ratio

(▷ page 327)

Bar

(▷ page 327)

BAS

(Brake Assist System)

System for potentially reducing braking distances in emergency braking situations. The system is activated when it senses an emergency based on how fast the brake is applied.

Bead

(▷ page 327)

Bi-Xenon headlamps*

Headlamps which use an electric arc as the light source and produce a more intense light than filament headlamps. Bi-Xenon headlamps produce low beam and high beam.

CAC

(Customer Assistance Center)

Mercedes-Benz customer service center, which can help you with any questions about your vehicle and provide assistance in the event of a breakdown.

CAN system

(Controller Area Network)

Data bus network serving to control vehicle functions such as door locking or windshield wiping depending on vehicle settings and/or ambient conditions.

Cockpit

All instruments, switches, buttons and indicator/warning lamps in the passenger compartment needed for vehicle operation and monitoring.

Cold tire inflation pressure

(▷ page 327)

COMAND*

(Cockpit Management and Data System)

Information and operating center for vehicle sound and communications systems, including the radio and the navigation system, as well as other optional equipment (CD changer*, telephone*, etc.).

Technical terms

Control system

The control system is used to call up vehicle information and to change component settings. Information and messages appear in the multifunction display. The driver uses the buttons on the multifunction steering wheel to navigate through the system and to adjust settings.

Cruise control

Driving convenience system that automatically maintains the vehicle speed set by the driver.

Curb weight

(▷ page 328)

DOT

(Department of Transportation)
(▷ page 328)

Engine number

The number set by the manufacturer and placed on the cylinder block to uniquely identify each engine produced.

Engine oil viscosity

Measurement for the inner friction (viscosity) of the oil at different temperatures. The higher the temperature an oil can tolerate without becoming thin, or the lower the temperature it can tolerate without becoming viscous, the better the viscosity.

ESP

(Electronic Stability Program)
Improves vehicle handling and directional stability.

ETD

(Emergency Tensioning Device)
Device which deploys in certain frontal and rear collisions exceeding the system's threshold to tighten the seat belts.
->SRS

FSS (Canada vehicles)

(Flexible Service System)

Maintenance service indicator in the multifunction display that informs the driver when the next vehicle maintenance service is due. FSS evaluates engine temperature, oil level, vehicle speed, engine speed, distance driven and the time elapsed since your last maintenance service, and calls for the next maintenance service accordingly.

GAWR

(Gross Axle Weight Rating)
(▷ page 328)

Gear range

Number of gears which are available to the automatic transmission for shifting. The automatic gear shifting process can be adapted to specific operating conditions using the gear selector lever.

GPS

(Global Positioning System)
Satellite-based system for relaying geographic location information to and from vehicles equipped with special receivers. Employs CD digital maps for navigation.

GVW

(Gross Vehicle Weight) (▷ page 328)

GVWR

(Gross Vehicle Weight Rating)
(▷ page 328)

Instrument cluster

The displays and indicator/warning lamps in the driver's field of vision, including the tachometer, speedometer, engine temperature display and fuel gauge.

Kickdown

Depressing the accelerator past the point of resistance shifts the transmission down to the lowest possible gear. This very quickly accelerates the vehicle and should not be used for normal acceleration needs.

Kilopascal (kPa)

(▷ page 328)

Lock button

Button on the door which indicates whether the door is locked or unlocked. Pushing the lock button down on an individual door from inside will lock that door.

Maintenance System (U.S. vehicles)

Maintenance service indicator in the multifunction display that informs the driver when the next vehicle maintenance service is due. The Maintenance System in your vehicle tracks distance driven and the time elapsed since your last maintenance service, and calls for the next maintenance service accordingly.

Maximum tire inflation pressure

(▷ page 328)

Maximum load rating

(▷ page 328)

Maximum loaded vehicle weight

(▷ page 328)

Memory function*

Used to store three individual seat, steering wheel and mirror positions for each SmartKey.

Technical terms

MON

(Motor Octane Number)
The Motor Octane Number for gasoline as determined by a standardized method. It is an indication of a gasoline's ability to resist undesired detonation (knocking). The average of both the MON (Motor Octane Number) and →RON (Research Octane Number) is posted at the pump, also known as ANTI-KNOCK INDEX.

Multifunction display

Display field in the instrument cluster used to present information provided by the control system.

Multifunction steering wheel

Steering wheel with buttons for operating the control system.

Normal occupant weight

(▷ page 329)

OCS

(Occupant Classification System)
The system automatically turns the front passenger front air bag on or off based on the classified occupant size category determined by weight sensor readings from the seat.

Occupant distribution

(▷ page 329)

Overspeed range

Engine speeds within the red marking of the tachometer dial. Avoid this engine speed range, as it may result in serious engine damage that is not covered by the Mercedes-Benz Limited Warranty.

Poly-V-belt drive

Drives engine-components (alternator, AC compressor, etc.) from the engine.

Power train

Collective term designating all components used to generate and transmit motive power to the drive axles, including

- engine
- clutch/torque converter
- transmission
- transfer case
- drive shaft
- differential
- axle shafts/axles

Production options weight

(▷ page 329)

Program mode selector switch

Used to switch the automatic transmission* between standard operation **S** and comfort operation **C**.

PSI

(Pounds per square inch) (▷ page 329)

Recommended tire inflation pressure

(▷ page 329)

Restraint systems

Seat belts, child restraints, lower anchors and tethers for children (LATCH). As independent systems, their protective functions complement one another.

Rim

(▷ page 329)

RON

(Research Octane Number)
The Research Octane Number for gasoline as determined by a standardized method. It is an indication of a gasoline's ability to resist undesired detonation (knocking). The average of both the →MON (Motor Octane Number) and RON (Research Octane Number) is posted at the pump, also known as ANTI-KNOCK INDEX.

Shift lock

When the vehicle is parked, this lock prevents the transmission gear selector lever from being moved out of position **P** without SmartKey turned and brake pedal depressed.

Sidewall

(▷ page 329)

SRS

(Supplemental Restraint System)
Air bags, air bag control unit (with crash sensor), emergency tensioning device. Though independent systems, they are closely interfaced to provide effective occupant protection.

Tele Aid* System

(Telematic Alarm Identification on Demand)

The Tele Aid system consists of three types of response: automatic and manual emergency, roadside assistance and information. Tele Aid is initially activated by completing a subscriber agreement and placing an acquaintance call.

The Tele Aid system is operational provided that the vehicle's battery is charged, properly connected, not damaged and cellular and GPS coverage is available.

Technical terms

Telematics*

A combination of the terms “tele-communications” and “informatics”.

Tightening torque

Force times lever arm (e.g. a lug wrench) with which threaded fasteners such as wheel bolts are tightened.

TIN

(Tire Identification Number)
(▷ page 329)

Tire load rating

(▷ page 329)

Tire ply composition and material used

(▷ page 329)

Tire speed rating

(▷ page 330)

Traction

(▷ page 330)

Tread

(▷ page 330)

Treadwear indicators

(▷ page 330)

Uniform Tire Quality Grading Standards

(▷ page 330)

Vehicle capacity weight

(▷ page 330)

Vehicle maximum load on the tire

(▷ page 330)

VIN

(Vehicle Identification Number)
The number set by the manufacturer and placed on the body to uniquely identify each vehicle produced.

A

- ABS 83, 441
 - ABS control 83
 - Indicator lamp 25
 - Malfunction indicator lamp 344
 - Messages in display 358
- Accelerator position,
 - automatic transmission* 170
- Accessory weight 327
- Accident
 - In case of 53
- Activating
 - Air conditioning (cooling) 186, 198
 - Air recirculation mode 184, 195
 - Anti-theft alarm system* 90
 - Automatic climate control* 189
 - Central locking (control system) 153
 - Charcoal filter 197
 - Climate control 179
 - Climate control system 181
 - Defrosting 183, 194
 - Easy-entry/exit feature* 154
 - ESP 87
 - Exterior headlamps 49
 - Exterior lamps 118
 - Exterior rear view
 - mirror parking position* 174
 - Hazard warning flasher 123
 - Headlamps 49
 - High beam headlamps 50
 - High beams 121
 - Ignition 33
 - Immobilizer 56, 89
 - Low beam headlamps 49
 - Rear window defroster 177
 - Residual heat 199
 - Seat heating* 113
 - Tow-away alarm* 91
 - Windshield wipers 51
- Adding
 - Coolant 301
 - Engine oil 299
- Additional turn signals 391
- Adjustable air vents, rear
 - passenger compartment 187, 200
- Adjusting 35
 - Air distribution 182, 192
 - Air volume 182, 193
 - Backrest contour 112
 - Backrest side bolsters 112
 - Backrest tilt, manual seat 36
 - Backrest tilt, power seat* 38
 - Exterior rear view mirrors 41
 - Folding back rear seat
 - head restraints, electrical 110
 - Folding back rear seat
 - head restraints, manual 110
 - Head restraint height,
 - manual seat 37
 - Head restraint height,
 - power seat* 38
 - Head restraint height, rear seats 109
 - Head restraint tilt, manual seat 37
 - Head restraint tilt, power seat* 39
 - Head restraint tilt, rear seats 111
 - Instrument cluster illumination 126
 - Interior rear view mirror 41
 - Manual seat 36
 - Mirrors 41

Index

- Multicontour seat* 112
- Placing upright rear seat head restraints 110
- Power seat* 38
- Rear seat head restraints 109
- Seat belt height 45
- Seat cushion depth 112
- Seat cushion tilt, manual seat 36
- Seat cushion tilt, power seat* 38
- Seat fore and aft adjustment, manual seat 36
- Seat fore and aft adjustment, power seat* 38
- Seat height, manual seat 36
- Seat height, power seat* 38
- Seats 35
- Steering column height, electrical* 41
- Steering column height, manual 40
- Steering column length, electrical* 41
- Steering column length, manual 40
- Steering wheel 39
- Adjusting air distribution and volume 182
- Adjusting sound functions 205
- Adjusting the volume 205
- Aids for changing fuses 413
- Air bags 59
 - Children 60
 - Front 63
 - Passenger 63
 - Safety guidelines 62
 - Side impact 64
 - Window curtain 64
- Air conditioning (cooling) 185
 - Turning off 186, 198
 - Turning on 186, 198
- Air conditioning refrigerant 433
- Air distribution
 - Adjusting 182, 192
- Air pressure see Tire inflation pressure
- Air recirculation mode 184, 195
 - Activating 184, 195
 - Deactivating 185, 196
- Air vents, rear passenger compartment
 - Adjustable 187, 200
- Air volume
 - Adjusting 182, 193
- Alarm
 - Audible 81, 89
 - Canceling 90, 92
 - Visual 89
- Alarm system
 - Anti-theft* 89
 - Tow-away* 91
- Alignment bolt (vehicle tool kit) 401, 441
- Anticorrosion/antifreeze 438
- Antiglare
 - Manual 172
- Antilock Brake System see ABS
- Anti-theft alarm system*
 - Arming 90
 - Canceling alarm 90
 - Disarming 90

- Anti-theft systems 89
 - Anti-theft alarm system* 89
 - Immobilizer 89
 - Tow-away alarm* 91
- Aquaplaning see Hydroplaning
- Armrest
 - Changing inclination of 260
 - Storage spaces 260
- Armrest in rear passenger compartment 261
- Ashtrays 263
- Aspect ratio 327
- ATF 300
- AUDIO menu 135
 - Selecting radio station 136
 - Selecting satellite radio* station 136
- Audio system 201
 - Audio and telephone, operation 201
 - Button and soft key operation 204
 - CD* operation 219
 - Operating and display elements 202
 - Operating safety 201
 - Operation 204
 - Radio operation 209
 - Switching off 205
 - Switching on 204
 - Telephone* operation 226
- Auto-dimming* for rear view mirror 173
- Automatic central locking
 - Activating/deactivating (control system) 153
- Automatic climate control* 188
 - Activating 189
 - Adjusting air distribution 192
 - Air recirculation mode 195
 - Deactivating 189
 - Defrosting 194
 - Setting the temperature 191
- Automatic headlamp mode 118
- Automatic lighting control
 - Activating 124
 - Deactivating 124
- Automatic locking when driving 103
- Automatic shift program
 - Automatic transmission* 169
- Automatic time change (summer/winter) 147
- Automatic Transmission Fluid see ATF
- Automatic transmission* 164
 - Accelerator position 170
 - Automatic shift program 169
 - Emergency operation (Limp Home Mode) 171
 - Fluid level 300
 - Gear ranges 167
 - Gear selector lever 47, 164
 - Gear selector lever position 164, 168
 - Gear shifting malfunctions 171
 - Kickdown 170
 - Manual shifting 166
 - One-touch gearshifting 166
 - Program mode selector switch, automatic shift program 169
 - Starting with 47
 - Transmission fluid 300

Index

B

- Backrest
 - Folding forward 256
 - Folding rearward 256
- Backrest contour
 - Adjusting 112
- Backrest side bolsters
 - Adjusting 112
- Backrest tilt
 - Manual seat 36
 - Power seat* 38
- Backup lamps
 - Messages in display 371
 - Replacing bulbs 391
- Bar 327
- BAS 84, 441
 - Messages in display 359
- Batteries, SmartKey
 - Changing 389
 - Check lamp 97
 - Checking 97
- Battery discharged
 - Jump starting 407
- Battery, vehicle 302, 404
 - Charging 405
 - Disconnecting 405
 - Reconnecting 406
 - Reinstalling 405
 - Removing 405
- Bead 327
- Bi-Xenon headlamps* 441
- Bi-Xenon type*
 - Front lamp bulbs 395
- Block heater (Canada only) 333
- Blocking
 - Rear door window operation 80
- Bolts
 - For spare wheel 382
- Brake Assist System see BAS
- Brake fluid 433
 - Checking 295
 - Message in display 363
- Battery discharged
 - Jump starting 407
- Battery, vehicle 302, 404
 - Charging 405
 - Disconnecting 405
 - Reconnecting 406
 - Reinstalling 405
 - Removing 405
- Brake lamp bulbs 391
- Brake lamp, high mounted 391
- Brake lamps
 - Messages in display 371
- Brake pads
 - Message in display 363
- Brakes 284
 - Warning lamp 25, 345
- Break-in period 282
- Bulbs, replacing 390
 - Additional turn signals 391
 - Backup lamps 391, 397
 - Brake lamps 391, 397
 - Cornering fog lamps* 391
 - Fog lamp, rear 391, 397
 - Fog lamps, front 391
 - Front lamps 391
 - High beam flasher 391
 - High beam headlamps 391
 - High mounted brake lamp 391
 - License plate lamps 391, 397

- Low beam headlamps 391
 - Parking lamps, front 391, 394, 396
 - Parking lamps, rear 391, 397
 - Rear lamps 391
 - Side marker lamps, front 391, 396
 - Side marker lamps, rear 391, 397
 - Standing lamps, front 391, 394, 396
 - Standing lamps, rear 391, 397
 - Tail lamp unit 397
 - Tail lamps 391, 397
 - Turn signal lamps,
 - front 391, 394, 396
 - rear 391, 397
 - Button
 - Audio system 204
- C**
- CAC 441
 - California
 - Important notice 11
 - Calling up
 - Maintenance service indicator 335
 - Range (distance to empty) 158
 - CAN system 441
 - Cargo area see Trunk
 - Cargo tie-down rings* 258
 - Catalytic converter 291
 - CD changer* 219
 - CD changer* operation 221
 - CD player*
 - Operating 137
 - CD* operation 219
 - Center console 27
 - Front passenger front air bag off indicator lamp 27, 64
 - Lamp in 350–351
 - Lower part 28
 - Upper part 27
 - Center console ashtray 263
- Centigrade
 - Setting temperature units 143
- Central locking
 - Automatic 103
 - From inside 104
 - Locking from inside 104
 - Switch 104
 - Switching on/off (control system) 153
 - Unlocking from inside 104
- Central locking switch 104
- Central unlocking
 - Switch 104
 - Unlocking from inside 104
- Central unlocking switch 104
- Certification label 420
- Changing
 - Batteries (SmartKey) 389
 - CDs 219
- Changing key setting 155
- Charcoal filter 196
 - Activating 197
 - Deactivating 197

Index

- Charging
 - Vehicle battery 405
- Checking
 - Brake fluid 295
 - Coolant level 295, 301
 - Engine oil level 295, 298
 - Tire inflation pressure 295
 - Vehicle lighting 295
 - Washer reservoir level 295
- Child safety 68
 - Air bags 60
 - Front passenger front air bag off indicator lamp 75
 - Infant and child restraint systems 64, 68
 - LATCH-type child seat anchors 78
 - OCS 71
- Child safety switch see
 - Blocking of rear door window operation
- Child seat anchors see
 - LATCH-type child seat anchors
- Cigarette lighter 265
- Cleaning
 - Cloth upholstery 342
 - Cup holders 341
 - Gear selector lever 341
 - Hard plastic trim items 341
 - Headlamps 172
 - Headliner and shelf below rear window 341
 - Instrument cluster 340
 - Leather upholstery 341
 - Light alloy wheels 340
 - MB Tex upholstery 342
 - Plastic and rubber parts 342
 - Seat belts 341
 - Steering wheel 341
 - Upholstery 341
 - Windows 340
 - Windshield 52
 - Wiper blades 340
 - Wood trims 342
- Cleaning tires 306
- Climate control 178
- Clock 25, 129, 145, 146
- Closing
 - Cup holder, in rear seat armrest 263
 - Glove box 259
 - Hood 297
 - Tilt/sliding sunroof* 245
 - Tilt/sliding sunroof* in an emergency 387
 - Tilt/sliding sunroof* with SmartKey 247
 - Trunk lid 101
 - Windows 241, 242
 - Windows with SmartKey 243
- Cloth upholstery
 - Cleaning 342
- Cockpit 22, 441
- Cockpit Management and Data System see COMAND*
- Cold tire inflation pressure 327
- Collapsible wheel chock 380
- COMAND* 441
- COMAND* see separate operating instructions

- Combination switch 121
 - High beam flasher 50
 - Turn signals 50
 - Windshield wipers 51
- Control and operation of radio transmitters 290
- Control system 129, 442
 - AUDIO menu 135
 - Convenience submenu 154
 - Display digital speedometer 135
 - Display outside temperature 135
 - Functions 130, 133
 - Instrument cluster
 - submenu 143, 145
 - Lighting submenu 149
 - Menus 132, 133
 - Multifunction display 129
 - Multifunction steering wheel 130
 - NAV* menu 138
 - Selecting radio system 136
 - Selecting satellite radio* system 136
 - Settings menu 140
 - Standard display menu 134
 - Submenu Time/Date 145
- Submenus 131, 133
- TEL* menu 158
- Trip computer menu 156
- Vehicle status message
 - memory menu 138
 - Vehicle submenu 153
- Controller Area Network see CAN system
- Convenience submenu 154
 - Activating
 - easy-entry/exit feature* 154
 - Setting key dependency 155
 - Setting parking position* for
 - exterior rear view mirror 156
- Coolant 301
 - Adding 301
 - Anticorrosion/antifreeze
 - quantity 437
 - Capacities 431, 432
 - Checking level 301
 - Messages in display 364–366
 - Temperature 292
 - Temperature gauge 127
- Coolant level
 - Checking 295, 301
- Coolant temperature gauge 25
- Coolants 437
- Cornering fog lamps* 122
 - Replacing bulbs 391
 - Switching off 122, 123
 - Switching on 122, 123
- Cruise control 249, 442
 - Canceling 250
 - Driving downhill 250
 - Driving uphill 250
 - Fine adjustment 251
 - Message in display 367
 - Setting current speed 250
 - Setting speeds 251
- Cruise control lever 249
- Cruising range, fuel 436
- Cup holder
 - In rear seat armrest 262
- Cup holders
 - Cleaning 341
 - In front of seat armrest 261
- Curb weight 328
- Customer Assistance Center see CAC

Index

D

- Date (day)
 - Setting 148
- Date (month)
 - Setting 147
- Date (year)
 - Setting 149
- Daytime running lamp mode 119
 - Setting 150
- Deactivating
 - Air conditioning (cooling) 186, 198
 - Air recirculation mode 185, 196
 - Alarm 90
 - Anti-theft alarm system* 90
 - Automatic climate control* 189
 - Central locking (control system) 153
 - Charcoal filter 197
 - Climate control 179
 - Climate control system 181
 - Cruise control 250
 - Defrost 194
 - Defrosting 183
 - Engine with the SmartKey 56
 - ESP 86
 - Exterior lamps 118
 - Exterior lamps delayed shut-off 151
 - Hazard warning flasher 123
 - Headlamps 55
 - Immobilizer 89
 - Interior lighting delayed shut-off 153
 - Rear window defroster 177
 - Residual heat 199
 - Seat heating* 113
 - Tow-away alarm* 91
- Deep water see Standing water
- Defogging
 - Windshield 182, 193
- Defrosting 183, 194
- Delayed shut-off
 - Exterior lamps 151
 - Interior lighting 153
- Department of Transportation see DOT
- Dialing
 - A number (telephone*) 160
- Difficulties
 - While driving see Problems while driving
 - With starting 47
- Digital clock 129
- Digital speedometer 135
- Direction of rotation (tires) 307
- Discharged battery
 - Jump starting 407
- Disconnecting
 - Vehicle battery 405
- Display
 - Messages in display 367
- Display elements
 - Audio system 202
- Displays
 - Digital speedometer 135
 - Maintenance service indicator 334
 - Outside temperature 135
 - Selecting display for status indicator 144
 - Showing vehicle status messages 139
 - Symbol messages 362
 - Text messages 354
 - Vehicle status messages 352

- Distance to empty (range)
 - Calling up 158
 - Door control panel 30
 - Door entry lamps 125
 - Door handle 98
 - Door unlock
 - With Tele Aid* 273
 - Doors
 - Message in display 367
 - Opening from inside vehicle 98
 - Opening from the outside 96
 - DOT 328
 - Downhill driving
 - Cruise control 250
 - Downshifting 166
 - Manual transmission 163
 - Drink holder see Cup holders
 - Drinking and driving 283
 - Driving
 - Driving abroad 290
 - General instructions 43, 283
 - Hydroplaning 286
 - In winter 288
 - Problems 53
 - Safety systems 83
 - Through standing water 289
 - Driving abroad 290
 - Driving instructions 283
 - Driving off 285
 - Driving safety systems
 - 4MATIC 88
 - ABS 83
 - BAS 84
 - ESP 85
 - Driving systems 249
 - Cruise control 249
 - Driving safety systems 83
- E**
- Easy-entry/exit feature* 106
 - Activating 154
 - Electrical fuses 413
 - Electrical outlet in
 - rear passenger compartment 265
 - Electrical system
 - Technical data 428
 - Electronic Stability Program see ESP
 - Emergency call 911 239
 - Emergency call system* 267
 - Emergency calls
 - Initiating an emergency call 269
 - With Tele Aid* 268
 - Emergency operation
 - (Limp Home Mode) 171

Index

- Emergency operations
 - Closing power
 - tilt/sliding sunroof* 387
 - Locking the vehicle 384
 - Opening power
 - tilt/sliding sunroof* 387
 - Releasing trunk lid from inside 102
 - Remote door unlock 273
 - Unlocking the vehicle 383
- Emergency Tensioning Device see ETD
- Emission control 291
- Emission control information label 420
- Ending
 - A call (telephone*) 160
- Engine
 - Compartment 296
 - Starting with
 - automatic transmission* 47
 - Starting with
 - manual transmission 46
 - Starting with the SmartKey,
 - automatic transmission* 47
 - Starting with the SmartKey,
 - manual transmission 46
 - Technical data 422
 - Turning off with the SmartKey 56
- Engine cleaning 339
- Engine compartment 296
 - Fuse box in 414
 - Hood 296
- Engine malfunction
 - indicator lamp 25, 346
- Engine number 420, 442
- Engine oil 297
 - Adding 299
 - Additives 433
 - Checking level 295, 298
 - Consumption 297
 - Display messages 298, 368–369
 - Filler neck,
 - C 230 Kompressor (all models) 300
 - Filler neck,
 - C 240 (all models) and C 320 (all models) 300
 - Messages in display 298, 368–369
 - Viscosity 442
- Engine oil level
 - Checking 295, 298
- Engine oils 433
- ESP 85, 442
 - Four wheel electronic traction system with ESP 88
 - Messages in display 360–361
 - Switching off 86
 - Switching on 87
 - Warning lamp 25, 348
- ETD 67, 442
 - Safety guidelines 62
- Ethanol fuel
 - At the gas station 293
 - Requirements 435
 - Switching fuels 436
- Exterior lamp switch 49, 117
- Exterior lamps
 - Delayed shut-off 151
- Exterior rear view mirrors
 - Adjusting 41
 - Parking position* for 156

F

- Fahrenheit
 - Setting temperature units 143
- Fastening the seat belts 43
- Filler neck
 - C 230 Kompressor (all models) 300
 - C 240 (all models) and C 320 (all models) 300
- Fine adjustment
 - Cruise control 251
- First aid kit 377
- Flat tire 399
 - Lowering the vehicle 403
 - Minispare wheel 380
 - Mounting the spare wheel 399
 - Preparing the vehicle 399
- Flexible fuel vehicles 435
 - At the gas station 293
 - Switching fuels 436
- Flexible Service System see FSS
- Fog lamp, rear
 - Message in display 373
 - Replacing bulb 391
 - Switching on 121
- Fog lamps, front
 - Messages in display 371
 - Replacing bulbs 391
 - Switching on 120
- Four wheel electronic traction system (4MATIC) with ESP 88
- 4MATIC 88
- Front air bags 63
- Front fog lamps
 - Indicator lamp 117
 - Switching on 120
- Front lamps
 - Bi-Xenon* type 395
 - Halogen-type 393
 - Messages in display 371–374
 - Replacing bulbs 391, 393
 - Switching on 117
- Front passenger front air bag
 - Messages in display 354–357
- Front passenger front air bag off indicator lamp 27, 64, 350–351
- Front seat head restraints
 - Installing, manual seat 108
 - Installing, power seat* 109
 - Manual seat 108
 - Power seat* 108
 - Removing, manual seat 108
 - Removing, power seat* 108
- Front seats
 - Heating* 113
- FSS (Canada vehicles) 334, 442
- Fuel 294
 - Additives 435
 - Cruising range 436
 - E85 (ethanol fuel) 436
 - Fuel reserve warning lamp 349
 - Gasoline additives 435
 - Premium unleaded gasoline 294, 432, 434
 - Requirements 434, 435
 - Switching (Flexible Fuel Vehicle) 436
 - Technical data 431, 432

Index

- Fuel additives 435
- Fuel cap
 - Message in display 347, 370
- Fuel consumption statistics
 - After start 157
 - Since last reset 157
- Fuel filler flap 293
 - Locking 293
 - Opening in an emergency 385
 - Unlocking 293
- Fuel gauge 25
- Fuel requirements 434
 - For ethanol fuel 435
- Fuel reserve
 - Warning lamp 25
- Fuel tank
 - Capacity 432
 - Filler flap 293
- Fuels, coolants, lubricants etc.
 - Capacities 431
- Functions (control system) 130, 133
 - Resetting 141
- Fuse box
 - In engine compartment 414
 - In trunk 416
- Fuse chart 413
- Fuse extractor 413, 416
- Fuses 413
 - Aids for changing fuses 413
 - Fuse box in engine compartment 414
 - Fuse box in trunk 416
 - Fuse chart 413
 - Fuse extractor 413, 416
 - Main fuse box in passenger compartment 414
 - Spare fuses 413
- G**
- Garage door opener* 274
- Gasoline additives 435
- Gasoline see Fuel
- GAWR 328
- Gear range 442
 - Automatic transmission* 167
 - Limiting 167
 - Shifting into optimal 166
- Gear range limit
 - Canceling 166
- Gear selector lever 47, 164
 - Cleaning 341
 - Lock 47
 - Position (automatic transmission*) 129, 164, 168
- Gearshift lever 46, 163

Global
 Locking 96
 Unlocking 96
Global Positioning System see GPS
Glove box 259
 Closing 259
 Locking 259
 Opening 259
 Unlocking 259
Good visibility 172
GPS 443
Gross Axle Weight Rating see GAWR
Gross Vehicle Weight Rating see GVWR
Gross Vehicle Weight see GVW
GVW 328
GVWR 328

H

Halogen-type
 Front lamp bulbs 393
Hands-free microphone 29
Hard plastic trim items
 Cleaning 341
Hazard warning flasher 123
 Switching off 123
 Switching on 123
Head restraints 107
 Front seats, manual seat 108
 Front seats, power seat* 108
 Manual seat 37
 Power seat* 38
 Rear seats 109
Head unit
 Time synchronization* with 145
Headlamp cleaning system* 303

Headlamp shut-off delay see
 Delayed shut-off, exterior lamps
Headlamps
 Automatic control 118
 Bi-Xenon* 441
 Bi-Xenon* type
 Replacing bulbs 395
 Cleaning 339
 Cleaning system* 172, 303, 439
 Halogen-type, replacing bulbs 393
 Refilling washer fluid 303
 Switching off 55
 Switching on 49
 Washer fluid 439
Headliner and shelf below rear window
 Cleaning 341
Heated seats* 113

Index

Height adjustment
 Head restraints, manual seat 37
 Head restraints, power seat* 38
 Rear seat head restraints 109
 Seat belts 45
 Steering wheel,
 electrical* adjustment 40
 Steering wheel,
 manual adjustment 40
High beam flasher 50, 121
High beam headlamps
 Indicator lamp 25
 Messages in display 372
 Replacing bulbs 391, 394
 Switching on 50, 121
High beam headlamps xenon type*
 Replacing bulbs 395
High mounted brake lamp 391
Hood 296
 Closing 297
 Message in display 370
 Opening 296
Horn 23
Hydroplaning 286

I
Identification labels 420
 Certification label 420
 Emission control information
 label 420
 Vacuum line routing diagram
 label 420
 Vehicle Identification Number 420
Ignition 33
 Switching on,
 automatic transmission* 47
 Switching on,
 manual transmission 46
Immobilizer 89
 Activating 89
 Deactivating 89
Indicator lamps see
 Lamps, indicator and warning
Infant and child restraint systems 68
 Installing 77
 LATCH-type child seat anchors 78

Information
 About service and warranty 10
Inside door handle 98
Installing
 Infant and child restraint systems 77
 Ski sack* (Canada only) 255
 Towing eye bolt 412
 Wiper blades 398
Instrument cluster 24, 126, 443
 Cleaning 340
 Coolant temperature gauge 127
 Illumination 126
 Lamps in 344–349
 Multifunction display 129
 Outside temperature indicator 128
 Selecting language 144
Instrument lighting 126
Instruments and controls see Cockpit

- Interior lighting 124
 - Activating automatic control 124
 - Deactivating automatic control 124
 - Delayed shut-off 153
 - Manual operation 124
 - Interior rear view mirror
 - Adjusting 41
 - Antiglare 172
 - Interior storage spaces 259
 - Armrest 260
 - Cup holder in rear seat armrest 262
 - Cup holders in front of seat
 - armrest 261
 - Glove box 259
 - Parcel net in front
 - passenger footwell 263
 - Intermittent wiping 52
- J**
- Jack 377
 - Jump starting 407
- K**
- Key dependency memory
 - Settings 155
 - Key positions in starter switch 33
 - Key, mechanical 383
 - Key, SmartKey
 - Battery check lamp 96
 - Checking the batteries 97
 - Factory setting 96
 - Global locking 96
 - Global unlocking 96
 - Loss of 98
 - Messages in display 370
 - Positions in starter switch 33
 - Remote control 94
 - Restoring to factory setting 97
 - Selective setting 96
 - Starting the engine,
 - automatic transmission* 47
 - Starting the engine,
 - manual transmission 46
 - Turning off the engine 56
 - Unlocking the trunk lid 98
 - Unlocking with 32
- Kickdown 170, 443
 - Kilometers/miles in speedometer 143
 - Kilopascal 328
 - Km/h or mph in speedometer 143

Index

L

- Labels, identification 420
- Lamp bulbs, exterior 390
- Lamp sensor
 - Message in display 372
- Lamps, exterior
 - Front 391
 - Light sensor 372
 - Messages in display 371–374
 - Rear 391
- Lamps, indicator and warning
 - ABS 25, 344
 - Battery (SmartKey) 96
 - Brakes 25, 345
 - Engine diagnostics 346, 349
 - Engine malfunction 25, 346–347
 - ESP 25, 348
 - Front fog lamps 117
 - Front passenger front
 - air bag off 27, 64, 350–351
 - Fuel reserve 25, 349
 - High beam headlamps 25
 - Instrument cluster 344–349
 - Low beam headlamps 25
 - Maintenance service indicator 334
 - Rear fog lamp 117
 - Seat belt telltale 25, 349
 - SRS 25, 59, 349
 - Turn signals 25
- Language
 - Multifunction display 144
 - Setting 144
- LATCH-type child seat anchors 78
 - Folding back 79
 - Folding out 78
- Layout of poly-V-belt drive 421
- Leather upholstery
 - Cleaning 341
- License plate lamps
 - Messages in display 372
 - Replacing bulbs 391
- Light alloy wheels
 - Cleaning 340
 - Technical data 425, 426
- Light sensor 372
- Lighter see Cigarette lighter
- Lighting 117
 - Automatic headlamp mode 118
 - Combination switch 121
 - Daytime running lamp mode 119
 - Door entry lamps 125
 - Exterior lamp switch 117
 - Front fog lamps 120
 - High beams 121
 - Instrument cluster illumination 126
 - Instruments 126
 - Interior 124
 - Locator lighting 120
 - Low beam 117
 - Manual headlamp mode 118
 - Night security illumination 120
 - Parking lamps 117
 - Rear fog lamp 121
 - Settings (control system) 149
 - Standing lamps 117
 - Trunk lamp 125
- Limiting the gear range 167
- Limp Home Mode 171
- Loading 252
 - Cargo tie-down rings* 258
 - Instructions 257
 - Roof rack* 252
 - Split rear bench seat* 255
- Loading terminology 327
- Loading the vehicle 307

Locator lighting 120
 Setting 151
 Lock button 443
 Locking 54, 94
 Automatic while driving 103
 Centrally from inside 104
 Fuel filler flap 293
 Global, SmartKey 96
 Glove box 259
 Vehicle in an emergency 384
 Loss of keys 98
 Loss of Service and Warranty
 Information Booklet 419
 Low beam headlamps
 Indicator lamp 25
 Messages in display 372-373
 Replacing bulbs 391, 393
 Switching on 49
 Lowering
 Vehicle 403
 Lubricants
 Technical data 431

M
 Main dimensions 429
 Main fuse box
 In passenger compartment 414
 Main odometer 129
 Maintenance 12, 334
 Vehicles with E85 fuel 436
 Maintenance service
 Calling up the maintenance
 service indicator 335
 Major service (Service B) 334
 Minor service (Service A) 334
 Overdue 335
 Types 335
 When due 334
 Maintenance service indicator 334
 Calling up 335, 336
 Clearing 335, 336
 Maintenance System
 (U.S. vehicles) 334, 443
 Manual headlamp mode 118

Manual operations
 Fuel filler flap 385
 Interior lighting control 124
 Locking the vehicle 384
 Tilt/sliding sunroof* 387
 Unlocking the driver's door 383
 Unlocking the trunk 384
 Unlocking transmission
 gear selector lever 386
 Manual seat
 Adjusting 36
 Adjusting backrest tilt 36
 Adjusting head restraint height 37
 Adjusting head restraint tilt 37
 Adjusting seat cushion tilt 36
 Adjusting seat height 36
 Front seat head restraints 108
 Seat fore and aft adjustment 36
 Manual transmission 162
 Gearshift lever 46, 163
 Shifting into reverse 163
 Starting with 46

Index

- MAXCOOL maximum cooling 194
- Maximum load rating 328
- Maximum loaded vehicle weight 328
- Maximum tire inflation pressure 328
- MB Tex upholstery
 - Cleaning 342
- Mechanical key 383
- Memory function* 114, 443
 - Recalling positions from memory 115
 - Storing exterior rear view mirror parking position 116
 - Storing key dependent settings 115
- Menus 130
 - AUDIO 135
 - In control system 132, 133
 - NAV* 138
 - Settings menu 140
 - Standard display 134
 - Submenus 131
 - TEL* 158
 - Trip computer 156
 - Vehicle status message memory 138
- Microphone
 - Hands-free microphone 29
- Miles/kilometers in speedometer
 - Setting 143
- Minispare wheel 380, 427
- Mirrors
 - Activating exterior rear view mirror parking position* 174
 - Adjusting 41
 - Auto-dimming* for
 - interior mirror 173
 - Auto-dimming* for
 - rear view mirror 173
 - Exterior rear view mirror 41
 - Exterior rear view mirror parking position* 156
 - Interior rear view mirror 41
 - Storing exterior rear view mirror parking position* 116
- MON 294, 444
- Motor Octane Number see MON
- Mph or km/h in speedometer 143
- Multicontour seats* 112
- Multifunction display 129, 444
 - Displaying gear range 167
 - Selecting language 144
 - Setting date (day) 148
 - Setting date (month) 147
 - Setting date (year) 149
- Multifunction display messages
 - ABS 358
 - BAS 359
 - Brake fluid 363
 - Brake pads 363
 - Coolant 364–366
 - Cruise control 367
 - Display 367
 - Doors 367
 - Engine oil 368–369
 - ESP 360–361
 - Front passenger front air bag 354–357

Fuel cap 347, 370
 Hood 370
 Key, SmartKey 370
 Lamps, exterior 371–374
 Oil 368–369
 Parking brake 363
 Restraint system 361
 Seat belt system 375
 SRS 361
 Steering gear oil level 375
 Tele Aid* 376
 Telephone* 376
 Tilt/sliding sunroof* 376
 Trunk lid 376
 Windshield washer fluid 376
 Multifunction steering
 wheel 26, 130, 444
 Buttons 130

N

Navigation system*
 Operating 138
 See separate COMAND*
 operating instructions
 Night security illumination 120
 Setting 151
 Normal occupant weight 329

O

Occupant Classification System see OCS
 Occupant distribution 329
 Occupant safety 58
 Air bags 59
 Children and air bags 60
 Children in the vehicle 68
 Fastening the seat belt 43
 Front passenger front air bag off
 indicator lamp 75
 Infant and child restraint systems 68
 LATCH-type child seat anchors 78
 OCS 71
 Seat belts 43, 62
 OCS 71, 444
 Self-test 76
 Odometer, main 129

Oil level see Engine oil level
 Oil see Engine oil
 One-touch gearshifting 166
 Canceling gear range limit 166
 Downshifting 166
 Upshifting 166
 Opening
 Cup holder, in rear seat armrest 263
 Doors from the inside 98
 Fuel filler flap 294
 Fuel filler flap manually 385
 Glove box 259
 Hood 296
 Power tilt/sliding sunroof*
 in an emergency 387
 Side windows 241
 Tilt/sliding sunroof* 245, 387
 Tilt/sliding sunroof*
 with SmartKey 247
 Trunk 98
 Trunk from the inside 100
 Trunk from the outside 99
 Windows 241
 Windows with SmartKey 243

Index

- Operating
 - Audio system 201
 - CD player* 137
 - COMAND* see separate operating instructions
 - Navigation system* 138
 - Radio 136
 - Radio transmitters 290
 - Satellite radio* 136
 - Telephone* 158, 201, 226
 - Vehicle outside the
 - USA and Canada 13
 - Operating safety
 - Audio system 201
 - Operator's Manual 10
 - Ornamental moldings 339
 - Outer seats
 - Rear seat head restraints 109, 111
 - Outside temperature 135
 - Outside temperature indicator 128
 - Overdue maintenance service 335
 - Overhead control panel 29
 - Overspeed range 444
- P**
- Paintwork 338
 - Panic alarm* 81
 - Panic button on SmartKey 81
 - Parcel net
 - In front passenger footwell 263
 - Parking 54, 285
 - Parking brake 48, 54
 - Engaging 54
 - Message in display 363
 - Releasing 48
 - Parking lamps
 - Messages in display 373
 - Parking lamps, front
 - Replacing bulbs 391
 - Parking lamps, rear
 - Replacing bulbs 391
 - Parking position*
 - Exterior rear view mirrors 116, 156, 174
 - Parts service 418
 - PASS AIR BAG OFF indicator lamp see Front passenger front air bag off indicator lamp
 - Passenger compartment 290
 - Interior lighting 124
 - Interior rear view mirror 41
 - Main fuse box in 414
 - Parcel net in front
 - passenger footwell 263
 - Passenger safety see Occupant safety
 - Pedals 283
 - Performance
 - In cold weather 436
 - In hot weather 436
 - Phone book*
 - Loading 160
 - Quick search 161
 - Phone number*
 - Dialing 160
 - Redialing 161
 - Plastic and rubber parts
 - Cleaning 342
 - Playing
 - CDs 222
 - Poly-V-belt drive 444
 - Layout 421

- Positions (memory function*)
 - Recalling from memory 115
 - Storing into memory 115
- Potential problems associated with underinflated and overinflated tires 316
- Power assistance 283
- Power seat*
 - Adjusting backrest tilt 38
 - Adjusting head restraint height 38
 - Adjusting head restraint tilt 39
 - Adjusting seat cushion tilt 38
 - Adjusting seat height 38
 - Memory function* 114
 - Removing/installing front head restraints 108
 - Seat fore and aft adjustment 38
- Power tilt/sliding sunroof* 245
- Power train 444
- Power washer 338
- Power windows 241
 - Blocking of rear door window operation 80
 - Side windows 241
 - Synchronizing 244
- Practical hints
 - Collapsible wheel chock 380
 - First aid kit 377
 - Fuses 413
 - Lamp in center console 350
 - Lamps in instrument cluster 344
 - Minispare wheel 380
 - Spare wheel bolts 382
 - Symbol messages 362
 - Text messages 354
 - Towing the vehicle 409
 - Vehicle jack 377, 379
 - Vehicle status messages in the display 352
 - Vehicle tool kit 377
- Premium unleaded gasoline 434
- Problems
 - While driving 53
 - With vehicle 17
- Product information 9
- Production options weight 329
- Program mode 129
- Program mode selector switch 444
 - Automatic shift program, automatic transmission* 169
- PSI 329
- Q**
 - Quick search
 - Phone book* 161
- R**
 - Radio
 - Selecting stations 136
 - Radio operation 209
 - Radio see Radio operation
 - Radio transmitters, control and operation 290
 - Range (distance to empty)
 - Calling up 158
 - Reading lamp 124
 - Rear bench seat
 - Foldable* 255
 - Rear door window
 - Blocking operation 80
 - Rear fog lamp 391
 - Bulb 391
 - Indicator lamp 117
 - Switching on 121
 - Rear lamp bulbs
 - Replacing 397
 - Rear lamps
 - Messages in display 371–374

Index

- Rear lamps see Tail lamps
- Rear outer seats
 - Adjusting head restraint height 109
- Rear passenger compartment
 - Adjustable air vents 187, 200
- Rear seat ashtray 264
- Rear seat head restraints 109
 - Adjusting 109
 - Adjusting tilt 111
 - Folding back, electrical 110
 - Folding back, manual 110
 - Installing 111
 - Outer seats 111
 - Placing upright 110
 - Removing 111
- Rear view mirrors see Mirrors
- Rear window defroster 177
- Rear window sunshade* 176
- Recommended tire
 - inflation pressure 329
- Reconnecting
 - Vehicle battery 406
- Recovery services
 - For stolen vehicle 274
- Refrigerant
 - Air conditioning 433
- Refueling 293
- Regular checks 295
- Reinstalling vehicle battery 405
- Remote control
 - SmartKey 94
- Remote door unlock
 - With Tele Aid* 273
- Removing
 - Ski sack* (Canada only) 255
 - Vehicle battery 405
 - Vehicle tool kit 377
 - Wheel 401
 - Wiper blades 398
- Replacing
 - Backup lamp bulbs 397
 - Brake lamp bulbs 397
 - Bulbs 390
 - Fog lamp bulb, rear 397
 - Front lamp bulbs 391, 393
 - Fuses 413
 - High beam bulbs 394
 - High beam bulbs
 - (xenon-type* headlamps) 395
 - License plate lamp bulbs 397
 - Low beam bulbs 393
 - Parking lamp bulbs, front 394, 396
 - Parking lamp bulbs, rear 397
 - Rear lamp bulbs 391, 397
 - Side marker lamp bulbs, front 396
 - Side marker lamp bulbs, rear 397
 - Standing lamp bulbs, front 394, 396
 - Standing lamp bulbs, rear 397
 - Tail lamp bulbs 397
 - Turn signal lamp bulbs,
 - front 394, 396
 - Turn signal lamp bulbs,
 - rear 397
 - Wiper blades 398

Reporting
 Safety defects 18
 Research Octane Number see RON
 Reset button in the
 instrument cluster 126, 140, 141
 Resetting
 All functions (control system) 140
 All functions of a submenu 141
 Fuel consumption 158
 Maintenance service indicator 336
 Trip odometer 127
 Residual heat utilization 199
 Residual ventilation 199
 Restraint system
 Message in display 361
 Restraint system see Infant and
 child restraint systems
 Reverse (manual transmission)
 Shifting into 163
 Rim 329
 Rims 424
 Roadside Assistance 12
 RON 294, 445
 Roof rack* 252
 Rubber parts
 Cleaning 342

S

Safety
 Occupant 58
 Safety belts see Seat belts
 Safety defects
 Reporting 18
 Safety systems
 Driving 83
 Satellite radio
 Additional text information 218
 general information 214
 Manual channel input 216
 Storing station 218
 Seat belt force limiter 67
 Seat belt height adjustment 45
 Seat belt height adjustment,
 front seats 45
 Seat belt system
 Message in display 375
 Seat belt telltale 25
 Seat belts 64
 Cleaning 341
 Fastening 43
 Height adjustment 45
 Proper use of 45, 66
 Safety guidelines 62
 Telltale 349
 Seat cushion depth
 Adjusting 112
 Seat heating*
 Switching off 113
 Switching on 113
 Seating capacity 309
 Seats 106
 Adjusting 35
 Easy entry/exit feature* 106
 Heating* 113
 Manual seat 36
 Multicontour seat* 112
 Power seat* 38
 Split rear bench seat* 255
 Securing cargo
 Cargo tie-down rings* 258

Index

- Selecting
 - Automatic time change
 - (summer/winter) 147
 - Display for status indicator 144
 - Station (satellite radio) 216
- Selecting radio mode 209
- Selector lever see gear selector lever
- Self-test
 - OCS 76
 - Tele Aid* 268
- Service
 - Parts 418
- Service and Warranty Booklet
 - Loss of 419
- Service and warranty information 10
- Service life (tires) 305
- Service see Maintenance
- Service System see FSS
- Setting
 - Convenience functions 154
 - Cruise control 250
 - Date (day) 148
 - Date (month) 147
 - Date (year) 149
 - Daytime running lamp mode 150
 - Exterior rear view mirror
 - parking position* 116
 - Higher speed in cruise control 251
 - Hours (clock) 145
 - Individual vehicle settings 140
 - Instrument lighting 126
 - Interior lighting delayed shut-off 153
 - Key dependent memory 155
 - Lamps and lighting
 - (control system) 149
 - Language, multifunction display 144
 - Locator lighting 151
 - Lower speed in cruise control 251
 - Miles/kilometers in
 - speedometer 143
 - Minutes (clock) 146
 - Night security illumination 151
 - Parking position* for exterior
 - rear view mirrors 156
 - Speed in cruise control 251
 - Speedometer display mode 143
 - Temperature (interior) 181, 191
 - Temperature indicator 143
 - Time display mode (clock) 147
 - Units
 - Speedometer 143
 - Temperature 143
 - Setting current speed 250
 - Setting the temperature 181
- Settings
 - Convenience functions 154
 - Factory, SmartKey 96
 - Individual, SmartKey 155
 - Lighting (control system) 149
 - Menus and submenus 131
 - Resetting all (control system) 140
 - Resetting in the submenu 141
 - Selective, SmartKey 96
- Settings menu
 - Functions in 140
 - Individual vehicle settings 140
 - Submenus 141
- Shift lock 445
- Shift program mode 129

- Shifting
 - Gear selector lever 47, 164
 - Gear selector lever positions 168
 - Gearshift lever 46, 163
 - Into optimal gear range
 - (automatic transmission*) 166
 - Into reverse
 - (manual transmission) 163
- Side impact air bags 64
- Side marker lamps, front
 - Messages in display 371
 - Replacing bulbs 391
- Side marker lamps, rear
 - Replacing bulbs 391
- Side markers
 - Cleaning 339
- Side windows
 - Automatic opening 242
 - Cleaning 340
 - Closing 241, 242, 243
 - Closing fully 242
 - Closing with SmartKey 243
 - Opening 241, 242, 243
 - Opening fully 242
 - Opening with SmartKey 243
 - Stopping 243
 - Synchronizing power windows 244
- Sidewall 329
- Simultaneous wiping and washing
 - Windshield wipers 52
- Single CD mode selector 203
- Single wipe 52
- Ski sack* (Canada only) 252
 - Installing 255
 - Removing 255
 - Unfolding and loading 252
 - Unloading and folding 254
- Sliding in
 - Swiveling cup holder,
 - in front of seat armrest 262
- Sliding out
 - Swiveling cup holder,
 - in front of seat armrest 261
- SmartKey 94
 - Changing batteries 389
 - Locking and unlocking 94
 - Opening and closing the
 - tilt/sliding sunroof* with 247
 - Opening and closing the
 - windows with 243
 - Unlocking with 32
- Snow chains 333
- Soft keys
 - Audio system 204
- Sound system* 206
- Spare fuses 413
- Spare wheel 427
 - Bolts 382
 - Mounting 399
- Speed
 - Setting current 250
- Speed settings
 - Cruise control 251
- Speedometer 25
 - Settings units 143

Index

- Speedometer display mode
 - Selecting 143
- Split rear bench seat* 255
- SRS 66, 445
 - Indicator lamp 25, 349
 - Message in display 361
- Standing lamps, front
 - Replacing bulbs 391
- Standing lamps, rear
 - Replacing bulbs 391
- Standing water
 - Driving instructions 289
- Starter switch 23, 33
 - Positions 33
- Starting difficulties 47
- Starting position 33
- Starting the engine 46
- Station (satellite radio)
 - Selecting 216
- Steering column
 - Height adjustment, electrical* 41
 - Height adjustment, manual 40
 - Length adjustment, electrical* 41
 - Length adjustment, manual 40
- Steering gear oil
 - Message in display 375
- Steering wheel
 - Adjusting 39
 - Buttons 26
 - Cleaning 341
 - Electrical adjustment* 40
 - Manual adjustment 40
- Stolen vehicle
 - Recovery services 274
- Stopping
 - Tilt/sliding sunroof* 247
 - Windows 243
- Storage compartments
 - Glove box 259
- Storage spaces
 - Cup holder in rear seat armrest 262
 - Cup holders in front
 - of seat armrest 261
- Storing
 - Station (satellite radio) 218
 - Storing (memory function*)
 - Positions into memory 115
 - Storing tires 306
- Submenus
 - Convenience 154
 - For settings 131
 - In control system 133
 - Instrument cluster 143, 145
 - Lighting 149
 - Resetting functions
 - in control system 141
 - Selecting 141
 - Settings menu 141
 - Time/Date 145
 - Vehicle 153
- Substitute lamps
 - Bulbs 390
- Sun visors 175
- Sunshade* 176
- Supplemental Restraint System see SRS
- Switching
 - Fuel (Flexible fuel vehicle) 436
- Switching off
 - Audio system 205
 - Automatic central locking
 - (control system) 153
 - Cornering fog lamps* 122, 123

- Delayed (exterior lamps) 151
 - Engine 56
 - ESP 86
 - Hazard warning flasher 123
 - Headlamps 55
 - Seat heating* 113
 - Switching on
 - Audio system 204
 - Automatic central locking (control system) 153
 - Cornering fog lamps* 122, 123
 - ESP 87
 - Front fog lamps 120
 - Hazard warning flasher 123
 - Headlamps 49
 - High beam headlamps 50
 - High beams 121
 - Low beam headlamps 49
 - Rear fog lamp 121
 - Seat heating* 113
 - Windshield wipers 51
 - Symbols 15
 - Synchronizing
 - Power windows 244
 - Tilt/sliding sunroof* 248
- T**
- Tachometer 25, 128
 - Overspeed range 128
 - Tail lamps
 - Cleaning 339
 - Messages in display 373
 - Replacing bulbs 391, 397
 - Tar stains 338
 - Technical data
 - Air conditioning refrigerant 433
 - Brake fluid 433
 - Coolant 431, 432
 - Coolants 437
 - Electrical system 428
 - Engine 422
 - Engine oil additives 433
 - Engine oils 433
 - Flexible fuel vehicles 435
 - Fuel requirements 434
 - Fuels 431, 432
 - Gasoline additives 435
 - Lubricants 431
 - Main dimensions 429
 - Premium unleaded gasoline 434
 - Rims and tires 424
 - Weights 430
 - Windshield washer 432
 - Windshield washer and headlamp cleaning* system 432, 439
 - Tele Aid* 267
 - Emergency calls 268
 - Hands-free microphone 29
 - Information 271
 - Initiating an emergency call manually 269
 - Message in display 376
 - Remote door unlock 273
 - Roadside Assistance 270
 - SOS button 269
 - Stolen Vehicle
 - Recovery services 274
 - System self-check 268
 - Tele Aid System 267, 445
 - Upgrade scenario 272
 - Telematics* 446

Index

- Telephone* 26, 266
 - Answering a call 159
 - Dialing a number
 - from the phone book 160
 - Ending a call 160
 - Hands-free microphone 29
 - Loading phone book 160
 - Message in display 376
 - Operation 158, 226
 - Redialing 161
- Temperature
 - Display mode 143
 - Setting interior temperature 181
 - Setting units in display 143
 - Tires 314
- Tie-down rings* (trunk) 258
- Tightening torque (wheel bolts) 403, 446
- Tilt
 - Head restraint, manual seat 37
 - Head restraint, power seat* 39
- Tilt/sliding sunroof*
 - Closing 245, 387
 - Closing with SmartKey 247
 - Messages in display 376
 - Opening 245, 387
 - Opening with SmartKey 247
 - Stopping 247
 - Synchronizing 248
- Time
 - Setting hours 145
 - Setting minutes 146
- Time display
 - Setting 147
- Time synchronization*
 - With head unit 145
- TIN 329
- Tire
 - Vehicle maximum load on 330
 - Tire and Loading Information 308
 - Tire and loading terminology 327
 - Tire care and maintenance 305
- Tire Identification Number see TIN
- Tire inflation pressure
 - Air pressure 327
 - Checking 295, 313, 315
- Tire inspection 305
- Tire load rating 329
- Tire ply composition and material used 329
- Tire speed rating 287, 320, 330
- Tire terminology 327
- Tire traction 287
- Tires 304, 424
 - Direction of rotation 307
 - Driving instructions 286
 - Retreads 304
 - Rims and tires 424
 - Rotating 331
 - Service life 305
 - Temperature 314, 326
 - Tread depth 306, 332
 - Wear pattern 331
 - Winter 332

- Tools 377
- Tow away alarm*
 - Canceling alarm 92
- Tow-away alarm* 91
 - Arming 91
 - Disarming 91
 - Disarming for transport 91
- Towing eye bolt (vehicle tool kit)
 - Installing 412
- Towing the vehicle 409
- Traction 170, 330
- Transmission gear selector lever
 - Unlocking manually 386
- Transmission see
 - Automatic* or Manual transmission
- Traveling abroad 290
- Tread 330
- Tread depth 306
- Tread depth (tires) 332
- Treadwear indicators 330
- Trip computer 156
- Trip odometer
 - Resetting 127
- Trunk
 - Closing the lid 101
 - Fuse box in 416
 - Lamp 125
 - Opening 98
 - Opening from inside vehicle 100
 - Opening from outside vehicle 99
 - Tie-down rings 258
 - Trunk lid emergency release 102
- Trunk lid
 - Closing 101
 - Emergency release 102
 - Message in display 376
- Turn signal lamps, front
 - Messages in display 374
 - Replacing bulbs 391
- Turn signal lamps, in mirrors
 - Messages in display 374
- Turn signal lamps, rear
 - Messages in display 374
 - Replacing bulbs 391
- Turn signals 50
 - Additional in mirrors 391
 - Cleaning lenses 339
 - Front bulbs 391
 - Indicator lamps 25
 - Rear bulbs 391
- Turning inward
 - Swiveling cup holder,
 - in front of seat armrest 262
- Turning off
 - Engine 56
- Turning outward
 - Swiveling cup holder,
 - in front of seat armrest 262

Index

U

- Uniform Tire Quality Grading Standards 330
- Units
 - Setting speedometer units 143
 - Setting temperature units 143
- Unlocking 32, 94
 - Centrally from inside 104
 - Driver's door in an emergency 383
 - Fuel filler flap 293
 - Global 96
 - Glove box 259
 - In an emergency 383
 - Selective settings 96
 - Transmission gear selector
 - lever manually 386
 - Trunk in an emergency 384
 - Vehicle in an emergency 273
 - With the SmartKey 32

- Upgrade scenario
 - Tele Aid* 272
- Uphill driving
 - Cruise control 250
- Upholstery
 - Cleaning 341
- Upshifting 166
- Useful features 259
 - Ashtrays 263
 - Cigarette lighter 265
 - Electrical outlet 265
 - Interior storage spaces 259
 - Tele Aid* 267
 - Telephone* 266

V

- Vacuum line routing diagram label 420
- Vehicle
 - Individual settings 140, 142
 - Locking 104
 - Locking in an emergency 384
 - Lowering 403
 - Performance in cold weather 436
 - Performance in hot weather 436
 - Service battery 404
 - Towing 409
 - Unlocking 104
 - Unlocking in an emergency 383
 - With flexible fuel 435
- Vehicle battery 404
- Vehicle capacity weight 330
- Vehicle care 337
 - Cloth upholstery 342
 - Cup holders 341
 - Engine cleaning 339
 - Gear selector lever 341
 - Hard plastic trim items 341
 - Headlamps 339
 - Instrument cluster 340

- Leather upholstery 341
 - Light alloy wheels 340
 - MB Tex upholstery 342
 - Ornamental moldings 339
 - Paintwork 338
 - Plastic and rubber parts 342
 - Power washer 338
 - Seat belts 341
 - Side markers 339
 - Steering wheel 341
 - Tail lamps 339
 - Tar stains 338
 - Turn signals 339
 - Upholstery 341
 - Vehicle washing 339
 - Window cleaning 340
 - Wiper blades 340
 - Wood trims 342
 - Vehicle Identification Number see VIN
 - Vehicle jack 379
 - Vehicle lighting
 - Checking 295
 - Vehicle loading terminology 327
 - Vehicle maximum load on the tire 330
 - Vehicle status message memory 138
 - Calling up 138
 - Clearing 139
 - Vehicle status messages
 - Displaying 139
 - Vehicle tool kit 377
 - Alignment bolt 377
 - Collapsible wheel chock 377
 - Gloves 377
 - Jack 377
 - Removing 377
 - Spare fuses 377
 - Spare wheel bolts 377
 - Towing eye bolt 377
 - Vehicle jack 377
 - Wheel wrench 377
 - Vehicle washing 339
 - VIN 420, 446
- W**
- Warning lamps see
 - Lamps, indicator and warning
 - Warning sounds
 - Drivers seat belts 64
 - Parking brake 48
 - Warranty coverage 419
 - Washer fluid see Windshield washer fluid
 - Washer reservoir level
 - Checking 295
 - Washing the vehicle 337
 - Wear pattern (tires) 331
 - Weights 430
 - Wheel bolts 382
 - Wheel change
 - Tightening torque 403
 - Wheels
 - Tires and wheels 304
 - Window curtain air bags 64
 - Windows see Side windows

Index

- Windshield
 - Defogging 182, 193
 - Refilling washer fluid 303
 - Replacing wiper blades 398
 - Washer fluid 303, 439
 - Washer system 439
 - Windshield washer fluid 439
 - Message in display 376
 - Mixing ratio 439
 - Refilling 303
 - Wiping with 52
 - Windshield washer system 439
 - Windshield wipers 51
 - Fast wiper speed 51
 - Intermittent wiping 52
 - Replacing wiper blades 398
 - Single wipe 52
 - Switching on 51
 - Wiping with
 - windshield washer fluid 52
 - Winter driving 332
 - Block heater (Canada only) 333
 - Snow chains 333
 - Tires 332
 - Winter driving instructions 288
 - Winter tires 332
 - Wiper blades
 - Cleaning 340
 - Installing 398
 - Removing 398
 - Replacing 398
 - Wiping
 - With windshield washer fluid 52
 - Wood trims
 - Cleaning 342
- X**
- Xenon headlamps
 - Bi-Xenon* 441

Service and Literature

Your authorized Mercedes-Benz Center has trained technicians and original Mercedes-Benz parts to service your vehicle properly.
For expert advice and quality service, see an authorized Mercedes-Benz Center.

If you are interested in obtaining service literature for your vehicle, please contact an authorized Mercedes-Benz Center.
We consider this the best way for you to obtain accurate information for your vehicle.

For further information you can find us on the Mercedes-Benz web-site www.mbusa.com or www.mercedes-benz.ca.

Warning!



To help avoid personal injury, be extremely careful when performing any service work or repairs. Improper or incomplete service or the use of incorrect or inappropriate parts or materials may damage the vehicle or its equipment, which may in turn result in personal injury.

If you have questions about carrying out any type of service, turn to the advice of an authorized Mercedes-Benz Center.

We reserve the right to modify the technical details of the vehicle as given in the data and illustrations of this Operator's Manual.
Reprinting, translation and copying, even of excerpts, is not permitted without our prior authorization in writing.

Title illustration no. P00.01-2840-31

Press time May 18, 2004

GSP/TIP

Printed in Germany

