



Operator's Manual
E-Class Wagon



Mercedes-Benz



Order No. 6515 1187 13 Part No. 211 584 09 97 USA Edition B 2007

E-Class Wagon

E 350 4MATIC

E 63 AMG

Our company and staff congratulate you on the purchase of your new Mercedes-Benz.

Your selection of our product is a demonstration of your trust in our company name. Furthermore, it exemplifies your desire to own an automobile that will be as easy as possible to operate and provide years of service.

Your Mercedes-Benz represents the efforts of many skilled engineers and craftsmen. To help assure your driving pleasure, and also the safety of you and your passengers, we ask you to make a small investment of time:

- Please read this manual carefully, then return it to your vehicle where it will be handy for your reference.
- Please follow the recommendations contained in this manual. They are designed to acquaint you with the operation of your Mercedes-Benz.
- Please pay attention to the warnings and cautions contained in this manual. They are designed to help improve the safety of the vehicle operator and occupants.

We extend our best wishes for many miles of safe, pleasurable driving.

Mercedes-Benz USA, LLC
A DaimlerChrysler Company

Introduction	9	At a glance	21	Getting started	35
Product information	9	Exterior view	22	Unlocking	36
Operator's Manual	10	Cockpit	24	Unlocking with the SmartKey	36
Service and warranty information ..	10	Instrument cluster	26	Unlocking with KEYLESS-GO*	37
Important notice for California		Multifunction steering wheel	28	Starter switch positions	37
retail buyers and lessees of		Center console	29	Adjusting	41
Mercedes-Benz automobiles	11	Upper part	29	Seats	41
Maintenance	12	Lower part	30	Steering wheel	45
Roadside Assistance	12	Overhead control panel	31	Mirrors	47
Change of address or ownership....	12	Storage compartments	32	Driving	49
Operating your vehicle outside		Door control panel	34	Fastening the seat belts	49
the USA or Canada	13			Starting the engine	52
Where to find it	14			Parking brake	54
Symbols	15			Driving	55
Operating safety	16			Switching on headlamps	56
Proper use of the vehicle	16			Turn signals	56
Problems with your vehicle	17			Windshield wipers	57
Reporting safety defects	18			Rear window wiper/washer	59
Reporting safety defects	18			Problems while driving	60
Vehicle data recording	19			Parking and locking	61
Information regarding electronic				Parking brake	62
recording devices	19			Switching off headlamps	63
				Turning off engine	63
				Releasing seat belts	64
				Locking	64

Contents

Safety and Security	67	Anti-theft systems	106	Seats	128
Occupant safety	68	Immobilizer	106	Front seat active head restraints .	128
Air bags	70	Anti-theft alarm system.....	106	Rear seat head restraints.....	128
Occupant Classification System				Lumbar support	131
(USA only)	75	Controls in detail	109	Multicontour seat*	131
BabySmart™ air bag deactivation		Locking and unlocking.....	110	Seat heating*	132
system (Canada only).....	81	SmartKey	110	Seat ventilation*	133
Seat belts	82	SmartKey with KEYLESS-GO*	113	Folding bench seat in cargo	
Preventive occupant safety		Checking batteries in the		compartment	
(PRE-SAFE®)	86	SmartKey or SmartKey with		(optional on E 63 AMG).....	134
Active head restraints	87	KEYLESS-GO*	119	Memory function	138
Children in the vehicle.....	88	Loss of the SmartKey or		Storing positions into memory.....	139
Blocking of rear door window		SmartKey with KEYLESS-GO*	119	Recalling positions from memory.	139
operation.....	95	Opening the doors from the		Storing exterior rear view mirror	
Panic alarm	96	inside	120	parking position	140
Activating	96	Opening the tailgate.....	121	Lighting	141
Deactivating	96	Closing the tailgate	123	Exterior lamp switch	141
Driving safety systems.....	97	Automatic central locking	126	Combination switch	145
ABS	97	Locking and unlocking from the		Corner-illuminating front fog	
BAS	99	inside	127	lamps*	146
Adaptive Brake	99			Hazard warning flasher	148
EBP	100			Interior lighting in the front	149
ESP®	100			Interior lighting in the rear	150
Four wheel electronic traction				Door entry lamps	151
system (4MATIC) with the ESP® ...	104			Cargo compartment lamps	151

Instrument cluster	152	Gear ranges	192	Air recirculation mode	216
Adjusting instrument cluster illumination	152	Automatic shift program	193	Air conditioning	218
Coolant temperature indicator	153	Gear selector lever one-touch gearshifting	194	Residual heat and ventilation (Canada only)	219
Trip odometer	153	Steering wheel gearshift control one-touch gearshifting E 63 AMG ..	195	Rear passenger compartment adjustable air vents	220
Tachometer	153	Manual shift program E 63 AMG ...	197	4-zone automatic climate control	222
Outside temperature indicator	154	Emergency operation (Limp-Home Mode)	199	Deactivating the climate control system	227
Control system	155	Good visibility	200	Operating the climate control system in automatic mode	228
Multifunction display	155	Headlamp cleaning system*	200	Setting the temperature	229
Multifunction steering wheel	156	Rear view mirrors	200	Adjusting air distribution	230
Menus	158	Sun visors	203	Adjusting air volume	231
Standard display menu	161	Roller sunblind in the rear doors* ..	204	Front defroster	231
AMG menu	161	Rear window defroster	204	Maximum cooling MAX COOL (USA only)	232
AUDIO menu	165	Dual-zone automatic climate control ..	206	Air recirculation mode	233
NAV* menu	167	Deactivating the climate control system	211	Air conditioning	235
Distronic* menu	167	Operating the climate control system in automatic mode	211	Residual heat and ventilation (Canada only)	236
Vehicle status message memory menu	168	Setting the temperature	212	Rear climate control	237
Settings menu	169	Adjusting air distribution	213		
Trip computer menu	183	Adjusting air volume	214		
TEL* menu	184	Front defroster	214		
Automatic transmission	187	Maximum cooling MAX COOL (USA only)	216		
Gear selector lever	187				
Shifting procedure	188				
Gear selector lever positions	189				
Driving tips	191				

Contents

Power windows.....	239	Vehicles without a third seat bench (E 63 AMG only) - storage space under the cargo compartment floor	277	Operation	307
Opening and closing the windows	239	Useful features	280	The first 1000 miles (1 500 km)	308
Synchronizing power windows	241	Storage compartments	280	Driving instructions	309
Summer opening feature.....	241	Cup holders.....	282	Drive sensibly – save fuel.....	309
Convenience closing feature	242	Ashtrays.....	285	Drinking and driving.....	309
Power tilt/sliding sunroof.....	243	Cigarette lighter	286	Pedals	309
Opening and closing the power tilt/sliding sunroof	243	Power outlet.....	287	Power assistance	310
Synchronizing the power tilt/sliding sunroof	245	Heated steering wheel (Canada only)	288	Brakes.....	310
Driving systems	246	Floor mats.....	289	Driving off	312
Cruise control.....	246	Telephone*	289	Parking.....	313
Distronic*	249	Tele Aid	292	Tires.....	313
Airmatic DC (Dual Control) (only available on E 63 AMG).....	261	Garage door opener	300	Hydroplaning.....	314
Loading.....	266			Tire traction	314
Split rear bench seat	266			Tire speed rating.....	315
Expanding the cargo compartment.....	268			Winter driving instructions	316
Loading instructions.....	269			Standing water.....	317
Cargo tie-down rings	270			Passenger compartment.....	317
Cargo management system* (Canada only)	271			Driving abroad	317
Storage box in cargo compartment (Canada only).....	274			Control and operation of radio transmitter	318
Twin roller blind.....	275			Catalytic converter.....	318
				Emission control	319
				Coolant temperature.....	320

At the gas station	321	Maximum tire inflation pressure ...	355	Practical hints	377
Refueling.....	321	Uniform Tire Quality Grading		What to do if	378
Check regularly and before a		Standards (U.S. vehicles).....	356	Lamps in instrument cluster	378
long trip.....	322	Tire ply material	358	Lamp in center console	391
Engine compartment	324	Tire and loading terminology.....	358	Vehicle status messages in the	
Hood	324	Rotating tires	361	multifunction display	394
Engine oil	326	Winter driving	363	Where will I find ...?	430
Transmission fluid level.....	328	Winter tires	363	First aid kit.....	430
Coolant level	329	Block heater* (Canada only).....	364	Vehicle tool kit, jack and spare	
Battery	330	Snow chains.....	364	wheel	430
Windshield/rear window washer		Maintenance.....	365	Unlocking/locking in an emergency ..	435
system and headlamp cleaning		Maintenance service indicator		Unlocking the vehicle	435
system*	331	message	365	Locking the vehicle	436
Tires and wheels.....	332	Calling up the maintenance		Manually unlocking the gear	
Important guidelines	332	service indicator display	367	selector lever	437
Tire care and maintenance.....	333	Resetting the maintenance		Opening/closing in an emergency	438
Direction of rotation.....	335	service indicator	367	Power tilt/sliding sunroof.....	438
Loading the vehicle	335	Vehicle care.....	368	Resetting activated head restraints....	439
Recommended tire inflation		Cleaning and care of vehicle	368	Replacing SmartKey batteries	440
pressure	340			SmartKey/SmartKey with	
Checking tire inflation pressure ...	341			KEYLESS-GO*	440
Tire labeling.....	349			Replacing bulbs.....	442
Load identification	353			Bulbs.....	442
DOT, Tire Identification Number				Replacing bulbs for front lamps	444
(TIN)	353			Replacing bulbs for rear lamps	447
Maximum tire load	355				

Contents

Replacing wiper blades	448			Fuels, coolants, lubricants etc.....	486
Placing front wiper arms in vertical position.....	448	Technical data	473	Capacities	486
Removing front wiper blades.....	449	Parts service.....	474	Engine oils	489
Installing front wiper blades	449	Warranty coverage.....	475	Engine oil additives	489
Removing rear wiper blade.....	449	Loss of Service and Warranty Information Booklet	475	Air conditioning refrigerant	489
Installing rear wiper blade	450	Identification labels	476	Brake fluid.....	489
Flat tire	451	Layout of poly-V-belt drive	478	Premium unleaded gasoline.....	490
Preparing the vehicle.....	451	E 350 4MATIC	478	Fuel requirements.....	490
Sealing tires with TIREFIT	451	E 63 AMG.....	478	Gasoline additives.....	491
Mounting the spare wheel	456	Engine.....	479	Coolants	491
Battery	462	Rims and tires.....	480	Windshield washer system and headlamp cleaning system*	494
Disconnecting the battery	464	Same size tires.....	481		
Removing the battery	464	Mixed size tires	482		
Charging and reinstalling the battery.....	465	Spare wheel	483	Index	495
Reconnecting the battery	465	Electrical system	484		
Jump starting	466	Main dimensions and weight	485		
Towing the vehicle	468	Main dimensions	485		
Installing towing eye bolt.....	470	Weight.....	485		
Fuses	471				
Fuse box in passenger compartment.....	472				
Fuse box in cargo compartment...	472				

▼ Product information

Please observe the following in your own best interest:

We recommend using Genuine Mercedes-Benz Parts as well as conversion parts and accessories explicitly approved by us for your vehicle model.

We have tested these parts to determine their reliability, safety and special suitability for Mercedes-Benz vehicles.

We are unable to make an assessment for other products and therefore cannot be held responsible for them, even if in individual cases an official approval or authorization by governmental or other agencies should exist. Use of such parts and accessories could adversely affect the safety, performance or reliability of your vehicle. Please do not use them.

Genuine Mercedes-Benz Parts as well as conversion parts and accessories approved by us are available at your authorized Mercedes-Benz Center where you will receive comprehensive information, also on permissible technical modifications, and where proper installation will be performed.

This Operator's Manual contains a great deal of useful information. We urge you to read it carefully and familiarize yourself with the vehicle before driving.

For your own safety and longer service life of the vehicle, we urge you to follow the instructions and warnings contained in this manual. Ignoring them could result in damage to the vehicle or personal injury to you or others. Vehicle damage caused by failure to follow instructions is not covered by the Mercedes-Benz Limited Warranty.

Your vehicle may have some or all of the equipment described in this manual. Therefore, you may find explanations for optional equipment not installed in your vehicle. If you have any questions about the operation of any equipment, your authorized Mercedes-Benz Center will be glad to demonstrate the proper procedures.

We continuously strive to improve our product, and ask for your understanding that we reserve the right to make changes in design and equipment. Therefore, information, illustrations and descriptions in this Operator's Manual might differ from your vehicle.

Optional equipment is also described in this manual, including operating instructions wherever necessary. Since they are special-order items, the descriptions and illustrations herein may vary slightly from the actual equipment of your vehicle.

If there are any equipment details that are not shown or described in this Operator's Manual, your authorized Mercedes-Benz Center will be glad to inform you of correct care and operating procedures. The Operator's Manual and Maintenance Booklet are important documents and should be kept with the vehicle.

Service and warranty information

The Service and Warranty Information Booklet contains detailed information about the warranties covering your Mercedes-Benz, including:

- New Vehicle Limited Warranty
- Emission System Warranty
- Emission Performance Warranty
- California, Maine, Massachusetts, New York, and Vermont Emission Control System Warranty (California, Maine, Massachusetts, New York, and Vermont only)
- State Warranty Enforcement Laws (Lemon Laws)

Important notice for California retail buyers and lessees of Mercedes-Benz automobiles

Under California law you may be entitled to a replacement of your vehicle or a refund of the purchase price or lease price, if Mercedes-Benz USA, LLC and / or its authorized repair or service facilities fail to fix one or more substantial defects or malfunctions in the vehicle that are covered by its express warranty after a reasonable number of repair attempts. During the period of 18 months from original delivery of the vehicle or the accumulation of 18000 miles (approximately 29000 km) on the odometer of the vehicle, whichever occurs first, a reasonable number of repair attempts is presumed for a retail buyer or lessee if one or more of the following occurs:

- (1) the same substantial defect or malfunction results in a condition that is likely to cause death or serious bodily injury if the vehicle is driven, that defect or malfunction has been subject to repair two or more times, and you have directly notified Mercedes-Benz USA, LLC in writing of the need for its repair,
- (2) the same substantial defect or malfunction of a less serious nature than category (1) has been subject to repair four or more times and you have directly notified us in writing of the need for its repair, or
- (3) the vehicle is out of service by reason of repair of the same or different substantial defects or malfunctions for a cumulative total of more than 30 calendar days.

Written notification should not be sent to a dealer, it should be addressed to Mercedes-Benz USA, LLC
Customer Assistance Center
One Mercedes Drive
Montvale, NJ 07645-0350

Maintenance

The Maintenance Booklet describes all the necessary maintenance work which should be performed at regular intervals.

Always have the Maintenance Booklet with you when you take the vehicle to your authorized Mercedes-Benz Center for service. The service advisor will record each service in the booklet for you.

Roadside Assistance

The Mercedes-Benz Roadside Assistance Program provides factory trained technical help in the event of a breakdown. Calls to the toll-free Roadside Assistance number

1-800-FOR-MERCEdes (in the USA)
1-800-387-0100 (in Canada)

will be answered by Mercedes-Benz Customer Assistance Representatives 24 hours a day, 365 days a year.

For additional information refer to the Mercedes-Benz Roadside Assistance Program brochure in your vehicle literature portfolio.

Change of address or ownership

If you change your address, be sure to send in the "Change of Address Notice" found in the Service and Warranty Information Booklet, or simply call the Mercedes-Benz Customer Assistance Center (in the USA) at 1-800-FOR-MERCEdes, or Customer Service (in Canada) at 1-800-387-0100. It is in your own interest that we can contact you should the need arise.

If you sell your Mercedes, please leave all literature with the vehicle to make it available to the next operator.

If you bought this vehicle used, be sure to send in the "Notice of Purchase of Used Car" found in the Service and Warranty Information Booklet, or call the Mercedes-Benz Customer Assistance Center (in the USA) at 1-800-FOR-MERCEdes, or Customer Service (in Canada) at 1-800-387-0100.

Operating your vehicle outside the USA or Canada

If you plan to operate your vehicle in foreign countries, please be aware that:

- service facilities or replacement parts may not be readily available,
- unleaded gasoline for vehicles with catalytic converters may not be available; the use of leaded fuels will damage the catalyts,
- gasoline may have a considerably lower octane rating, and improper fuel can cause engine damage.

Certain Mercedes-Benz models are available for delivery in Europe under our European Delivery Program. For details, consult your authorized Mercedes-Benz Center or write to:

In the USA:

Mercedes-Benz USA, LLC
European Delivery Department
One Mercedes Drive
Montvale, NJ 07645-0350

In Canada:

Mercedes-Benz Canada, Inc.
European Delivery Department
98 Vanderhoof Avenue
Toronto, Ontario M4G 4C9

Where to find it

This Operator's Manual is designed to provide comprehensive support information for you, the vehicle operator. Each section has its own reference color.

At a glance

Here you will find an overview of all the controls that can be operated from the driver's seat.

Getting started

Here you will find all the information you need for your first drive. You should read this section first if this is your first Mercedes-Benz vehicle or if you are renting or borrowing this vehicle.

Safety and Security

Here you will find descriptions of the safety and security features of your vehicle.

Controls in detail

Here you will find detailed information about the equipment installed in your vehicle. This section expands on the "Getting started" section and also describes technical innovations. If you are already familiar with the basic functions of your vehicle, this section will be of particular interest to you.

Operation

Here you will find all the information you need for the proper operation of your vehicle.

Practical hints

This section provides fast assistance for dealing with problems you may encounter.

Technical data

All important technical data for your vehicle can be found in this section.

Indexes

The table of contents and the index are designed to help you find information quickly and easily.

The following publications are part of your vehicle documentation:

- this Operator's Manual
- the Maintenance Booklet

Separate operating instructions will be provided as required depending on the equipment options installed in your vehicle.

▼ Symbols

Registered trademarks®:

- ESP® is a registered trademark of DaimlerChrysler.
- BabySmart™ is a trademark of Siemens Automotive Corp.
- HomeLink® is a registered trademark of Prince, a Johnson Controls Company.

The following symbols are found in this Operator's Manual:

- * Optional equipment is identified with an asterisk. Since standard equipment varies between models, the descriptions and illustrations in this manual may differ slightly from the actual equipment of your vehicle.

Warning!



Warning notices draw your attention to hazards that may endanger your health or life, or the health or life of others.

 *Highlights hazards that may result in damage to your vehicle.*

 *Helpful hints or further information you may find useful.*

- ▶ This symbol points to instructions for you to follow.
- ▶ A number of these symbols appearing in succession indicates a multiple-step procedure.

- ▷ page This symbol tells you where to look for further information on a topic.
- ▷▷ This continuation symbol marks a warning which is continued on the next page.
- ▷▷ This continuation symbol marks a procedure which is continued on the next page.
- > This symbol is used to indicate cross-references to term definitions.
- Display Words appearing in the multi-function display are printed in the type shown here.

Warning!



Work improperly carried out on electronic components and associated software could cause them to cease functioning. Because the vehicle's electronic components are interconnected, any modifications made may produce an undesired effect on other systems. Electronic malfunctions could seriously impair the operating safety of your vehicle.

Contact your authorized Mercedes-Benz Center for repairs or modifications to electronic components.

Other improper work or modifications on the vehicle could also have a negative impact on the operating safety of the vehicle.

Some safety systems only function while the engine is running. You should therefore never turn off the engine while driving.

Warning!



Heavy blows against the vehicle underbody or tires / wheels, for example when running over an obstacle, road debris or a pothole, may cause serious damage to and impair the operating safety of your vehicle. If you feel a sudden strong vibration or ride disturbance, or you suspect that damage to your vehicle has occurred, you should turn on your hazard warning flashers, carefully slow down, and drive with caution to an area which is a safe distance from the road.

Inspect the vehicle underbody and tires / wheels for possible damage. If the vehicle appears unsafe, have it towed to the nearest authorized Mercedes-Benz Center or other qualified maintenance or repair facility for further inspection or repairs.

Proper use of the vehicle

Proper use of the vehicle requires that you are familiar with the following information and rules:

- the safety precautions in this manual
- the “Technical data” section in this manual
- traffic rules and regulations
- motor vehicle laws and safety standards

Warning!



Various warning labels are attached to your vehicle. These warning labels are intended to make you and others aware of various risks. You should not remove any of these warning labels unless explicitly instructed to do so by information on the label itself. Removal of any of these labels may cause you and others to be unaware of certain risks which may result in an accident and/or personal injury.

▼ Problems with your vehicle

If you should experience a problem with your vehicle, particularly one that you believe may affect its safe operation, we urge you to immediately contact an authorized Mercedes-Benz Center to have the problem diagnosed and corrected if required. If the matter is not handled to your satisfaction, please discuss the problem with the Mercedes-Benz Center management, or if necessary contact us at one of the following addresses:

In the USA:

Customer Assistance Center
Mercedes-Benz USA, LLC
One Mercedes Drive
Montvale, NJ 07645-0350

In Canada:

Customer Relations Department
Mercedes-Benz Canada, Inc.
98 Vanderhoof Avenue
Toronto, Ontario M4G 4C9

Reporting safety defects

For the USA only:

The following text is published as required of manufacturers under Title 49, Code of U.S. Federal Regulations, Part 575 pursuant to the “National Traffic and Motor Vehicle Safety Act of 1966”.

Reporting safety defects

If you believe that your vehicle has a defect which could cause a crash or could cause injury or death, you should immediately inform the National Highway Traffic Safety Administration (NHTSA) in addition to notifying Mercedes-Benz USA, LLC.

If NHTSA receives similar complaints, it may open an investigation, and if it finds that a safety defect exists in a group of vehicles, it may order a recall and remedy campaign. However, NHTSA cannot become involved in individual problems between you, your dealer, or Mercedes-Benz USA, LLC.

To contact NHTSA, you may call the Vehicle Safety Hotline toll-free at 1-888-327-4236 (TTY: 1-800-424-9153); go to <http://www.safercar.gov>; or write to: Administrator, NHTSA, 400 Seventh Street, SW., Washington, DC 20590. You can also obtain other information about motor vehicle safety from <http://www.safercar.gov>.

▼ Vehicle data recording

Information regarding electronic recording devices

(Including notice pursuant to California Code § 9951)

Please note that your vehicle is equipped with devices that can record vehicle systems data and, if equipped with the Tele Aid system, may transmit some data in certain accidents.

This information helps, for example, to diagnose vehicle systems after a collision and to continuously improve vehicle safety. DaimlerChrysler may access the information and share it with others

- for safety research or vehicle diagnosis purposes
- with the consent of the vehicle owner or lessee
- in response to an official request by law enforcement or other government agency
- for use in dispute resolution involving DaimlerChrysler, its affiliates or sales/service organization and/or
- as otherwise required or permitted by law.

Please check the Tele Aid subscription service agreement for details regarding the information that may be recorded or transmitted via that system.

Exterior view

Cockpit

Instrument cluster

Multifunction steering wheel

Center console

Overhead control panel

Storage compartments

Door control panel



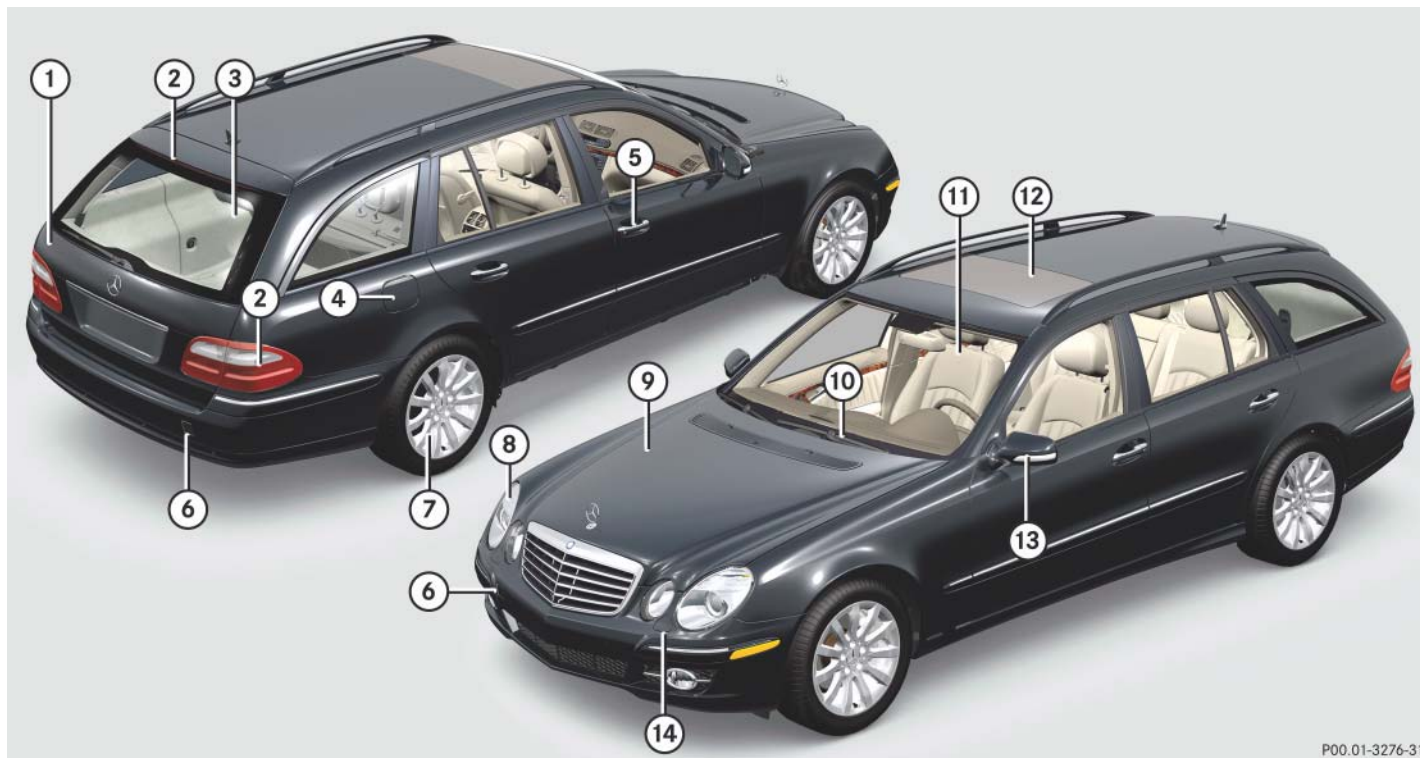

P00.01-3276-31

Item	Page
① Tailgate	
• Unlocking	121
• Opening and closing	121, 123
• Spare wheel	433
• Vehicle tool kit	431
② Rear lamps	443
③ Rear window, defrosting	204
④ Fuel filler flap	321
Gasoline	490
⑤ Doors	
• Locking and unlocking	110
• Opening and closing	120

Item	Page
⑥ Towing eye bolt	470
General information	468
⑦ Rims and tires	480
• Checking tire inflation pressure	341
• Spare wheel	433
• Flat tire	451
⑧ Front lamps	442
⑨ Hood, opening	324
Engine oil	326
Coolant	329

Item	Page
⑩ Windshield wipers	57
Wiper blades, replacing	448
Wiper blades, cleaning	372
⑪ Window, cleaning	372
⑫ Roof	
• Power tilt/sliding sun-roof	243
⑬ Exterior rear view mirror	47
Parking position	140
⑭ Headlamp cleaning system*	200

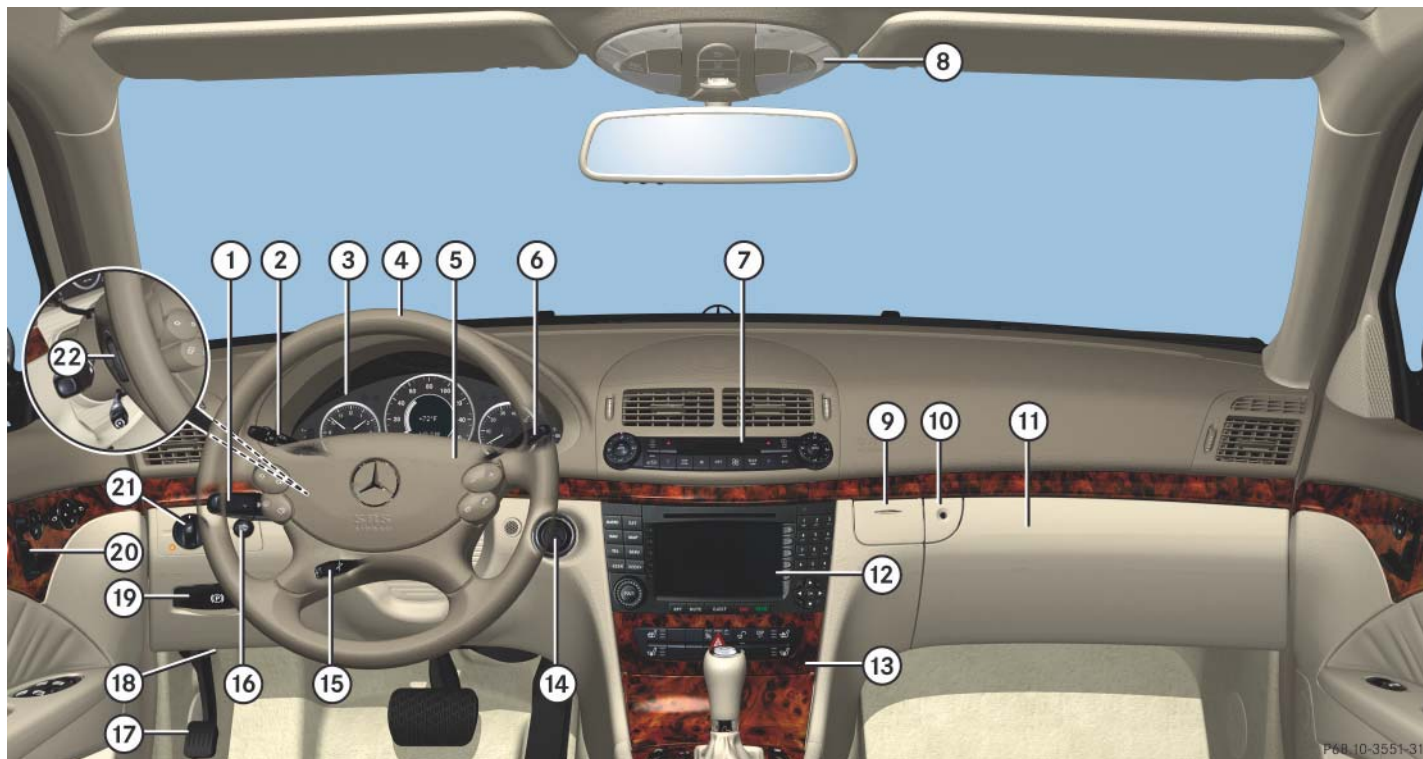

Item	Page
① Combination switch	
• Turn signals	56
• Windshield wipers	57
• Rear window wiper	59
• High beam	56
② Cruise control lever	
• Cruise control	246
• Distronic*	249
③ Instrument cluster	26, 152
④ Multifunction steering wheel	28, 156
⑤ Horn	
⑥ Lever for Voice Control System*, see separate operating instructions	





Item	Page
⑦ Dual-zone automatic climate control, USA only	206
4-zone automatic climate control*	222
⑧ Overhead control panel	31
⑨ Mobile phone/Glasses box	280
⑩ Glove box lid release, glove box lock	280
⑪ Glove box	280
⑫ COMAND system, see separate operating instructions	
⑬ Center console	29
⑭ Starter switch	38







Item	Page
⑮ Steering wheel adjustment stalk	45
Heated steering wheel (Canada only)	288
⑯ Headlamp cleaning button*	200
⑰ Parking brake pedal	54, 62
⑱ Hood lock release	324
⑲ Parking brake release	54
⑳ Door control panel	34
㉑ Exterior lamp switch	141
㉒ Steering wheel gearshift control (E 63 AMG only)	195





Instrument cluster



P54.30-9419-31

	Item	Page
①	 Left turn signal indicator lamp	
②	 ESP® warning lamp	379
③	Speedometer	
④	Multifunction display	155
⑤	 Distance warning lamp	385
	Vehicles without DISTRONIC*: Warning lamp without function. It illuminates when the ignition is on. It should go out when the engine is running.	
⑥	 Right turn signal indicator lamp	
⑦	Coolant temperature indicator with:	153
	 Coolant temperature warning lamp	384





	Item	Page
⑧	Tachometer with:	
	 Supplemental Restraint System (SRS) indicator lamp	388
	 Antilock Brake System (ABS) indicator lamp	378
	 Seat belt telltale	386
	 Low beam headlamp indicator lamp	56
	 High beam headlamp indicator lamp	56
⑨	Main odometer with:	
	• Gear selector lever position	189
	• Program mode	193
⑩	Clock with:	174
	 Brake warning lamp, USA only	381
	 Brake warning lamp, Canada only	381





	Item	Page
	 Engine malfunction indicator lamp, USA only	382
	 Engine malfunction indicator lamp, Canada only	382
	 Low tire pressure telltale*, Canada only	389
⑪	Fuel display with:	
	 Fuel tank reserve warning lamp	385
⑫	Reset button for:	
	• Resetting trip odometer	153
	• Adjusting instrument cluster illumination	152
	• Confirming new time settings	174

Multifunction steering wheel



P46.10-2759-31

Item	Page
① Multifunction display in speedometer	155
Operating control system	156
② Selecting the submenu or setting the volume: Press button	
 up/to increase	
 down/to decrease	
③ Telephone*: Press button	
 to take a call	
to dial	
to redial	
 to end a call	
to reject an incoming call	

Item	Page
④ Menu systems: Press button	
 for next menu	
 for previous menu	
⑤ Moving within a menu: Press button	
 for next display	
 for previous display	

▼ Center console

Upper part

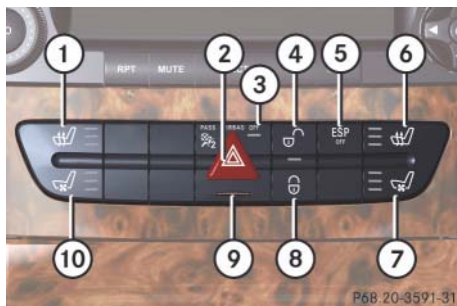

Item	Page
① Seat heating*, driver's side	132
② Hazard warning flasher switch	148
③ Front passenger front air bag off indicator lamp	79, 81
④ Central unlocking switch	127
⑤ Electronic Stability Program (ESP®) control switch	102
⑥ Seat heating*, front passenger side	132
⑦ Seat ventilation*, front passenger side	133

Item	Page
⑧ Central locking switch	127
⑨ Opening/closing button for CD changer, see separate COMAND operating instructions	
⑩ Seat ventilation*, driver's side	133

Center console

Lower part

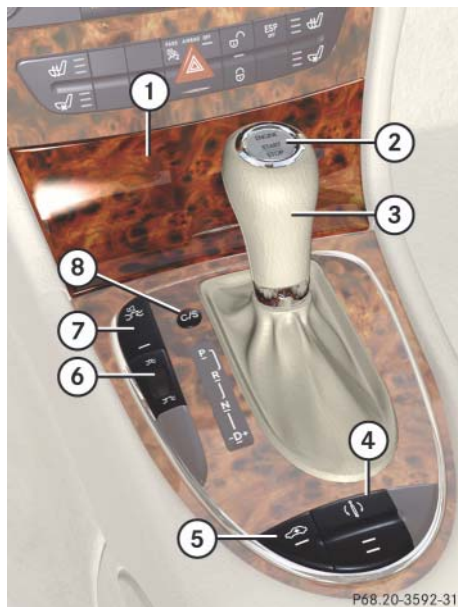

	Item	Page
①	Ashtray	285
②	KEYLESS-GO* start/stop button	39
③	Gear selector lever for automatic transmission	52, 187
④	Adaptive Damping System (ADS) switch ¹	262
⑤	Vehicle level control switch ¹	265

¹ Only available on E 63 AMG.

	Item	Page
⑥	Thumbwheel for setting distance for Distronic*	257
⑦	Distance warning function* on/off switch	258
⑧	Program mode selector switch for automatic transmission	193

▼ Overhead control panel



Item	Page
① Rear interior lighting on/off	150
② Automatic interior lighting	149
③ Front interior lighting on/off	149
④ Right reading lamp on/off	149
⑤ Tilt/sliding sunroof	243
⑥ Tele Aid (emergency call system) button	295
⑦ Rear view mirror	200

Item	Page
⑧ Front reading lamps	150
⑨ Garage door opener	300
⑩ Hands-free microphone for Tele Aid (emergency call system), telephone*, and Voice Control System*, see separate operating instructions	292 184
⑪ Ambient lighting	151
⑫ Interior lighting	
⑬ Left front reading lamp on/off	150

Storage compartments

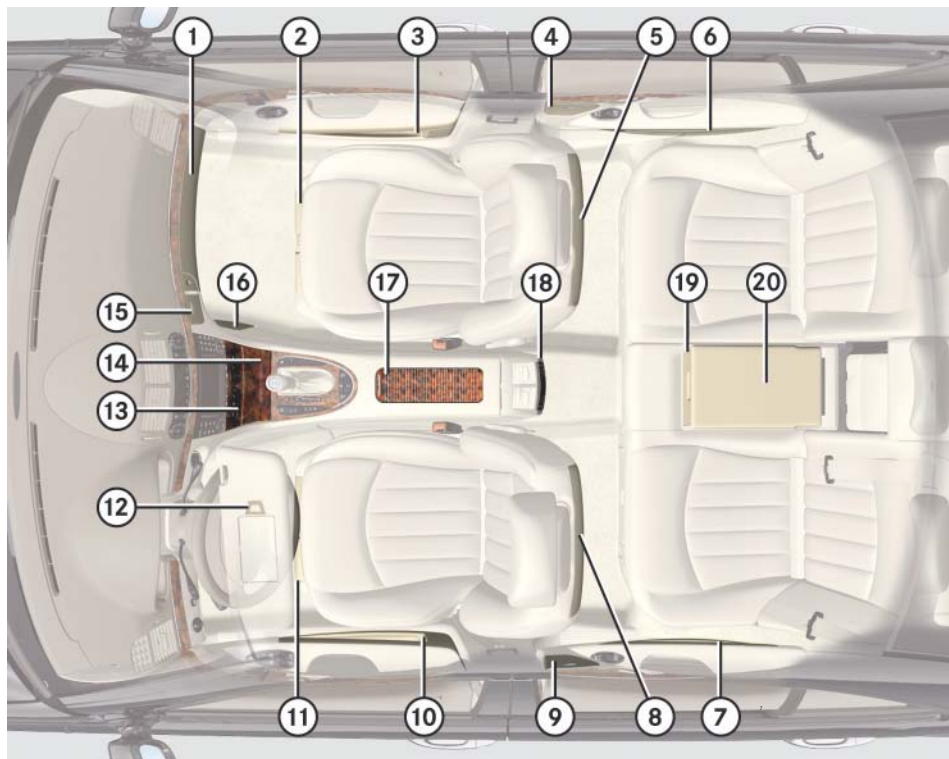

P68.00-4424-31

Item	Page	Item	Page
① Glove box	280	⑭ Ashtray with cigarette lighter	286
② Front passenger seat storage compartment with first aid kit	430	⑮ Mobile phone/Glasses box	280
③ Door pocket		⑯ Parcel net in front passenger footwell	282
④ Ashtray	285	⑰ Storage compartment with cup holders/telephone* compartment	283
⑤ Ruffled storage bag	281	⑱ Rear storage compartment in the rear center console	280
⑥ Door pocket		⑲ Cup holder in the rear armrest	283
⑦ Door pocket		⑳ Storage compartment in the rear armrest	281
⑧ Ruffled storage bag	281	㉑ Storage box, Canada only	274
⑨ Ashtray	285	㉒ Storage compartment*	
⑩ Door pocket		㉓ Luggage box (Vehicles without foldable third row, E 63 AMG only)	
⑪ Driver's seat storage compartment	430	㉔ Storage compartment*	
⑫ Sun visor card clip			
⑬ CD changer			

Door control panel



	Item	Page
①	Inside door handle	120
②	Seat adjustment	43
③	Memory function (for storing seat, exterior mirror and steering wheel settings)	138
④	Exterior rear view mirror adjustment	47
⑤	Switches for opening/closing front and rear side windows, rear window override switch	239
⑥	Remote tailgate release switch, tailgate opening system*	121

Unlocking

Adjusting

Driving

Parking and locking



Unlocking





The “Getting started” section provides an overview of the vehicle’s most basic functions.

If you are already familiar with the basic functions described here, the “Controls in detail” section will provide you with further information. The corresponding page references are located at the end of each segment.

Unlocking with the SmartKey



SmartKey with remote control

- ①  Lock button
- ②  Opening button for tailgate*
- ③  Unlock button
- ④  Panic button (▷ page 96)

Warning!



When leaving the vehicle, always remove the SmartKey from the starter switch, take it with you, and lock the vehicle. Do not leave children unattended in the vehicle, or with access to an unlocked vehicle. A child’s unsupervised access to a vehicle could result in an accident and/or serious personal injury.

- ▶ Press unlock button  on the SmartKey.
 - All turn signal lamps flash once.
 - An acoustic signal sounds once.
 - The locking knobs in the doors move up.
 - The anti-theft alarm system is disarmed.
- ▶ Get in the vehicle and insert the SmartKey in the starter switch.

For more information, see “Locking and unlocking” (▷ page 110).

Unlocking with KEYLESS-GO*

With the KEYLESS-GO function, you can lock and unlock the vehicle without using the remote control buttons on the SmartKey and start the engine without inserting the SmartKey in the starter switch.

Warning!



When leaving the vehicle, always take the SmartKey with KEYLESS-GO with you, and lock the vehicle. Do not leave children unattended in the vehicle, or with access to an unlocked vehicle. A child's unsupervised access to a vehicle could result in an accident and/or serious personal injury.

i To unlock the vehicle, the SmartKey with KEYLESS-GO must be outside the vehicle, no further than approximately 3 feet (1 meter) away from the door.

- ▶ Pull an outside door handle.
 - All turn signal lamps flash once.
 - An acoustic signal sounds once.
 - The locking knobs in the doors move up.
 - The anti-theft alarm system is disarmed.
- ▶ Get in the vehicle.

For more information, see “SmartKey with KEYLESS-GO*” (▷ page 113).

Starter switch positions

Warning!



When leaving the vehicle, always remove the SmartKey or SmartKey with KEYLESS-GO* from the starter switch, take it with you, and lock the vehicle. Do not leave children unattended in the vehicle, or with access to an unlocked vehicle. A child's unsupervised access to a vehicle could result in an accident and/or serious personal injury.

Unlocking

SmartKey



Starter switch

0 For removing SmartKey

1 Power supply for some electrical consumers, such as seat adjustment

2 Ignition (power supply for all electrical consumers) and driving position.

All lamps (except low beam headlamp indicator lamp, high beam headlamp indicator lamp, and turn signal indicator lamps unless activated) in the instrument cluster come on. If a lamp in the instrument cluster fails to come on when the ignition is switched on, have it checked and replaced if necessary. If a lamp in the instrument cluster remains on after starting the engine or comes on while driving, refer to “Lamps in instrument cluster” (▷ page 378).

3 Starting position

i When you switch on the ignition, the indicator and warning lamps (except low beam headlamp indicator lamp, high beam headlamp indicator lamp, and turn signal indicator lamps unless activated) in the instrument cluster come on. The indicator and warning lamps (except low beam headlamp indicator lamp, high beam headlamp indicator lamp, and turn signal indicator lamps if activated) should go out when the engine is running. This indicates that the respective systems are operational.

i The SmartKey can only be removed from the starter switch with the gear selector lever in position **P**.

i If the SmartKey is left in starter switch position **0** for an extended period of time, it can no longer be turned in the switch. In this case, the steering is locked. To unlock, remove SmartKey from the starter switch and reinsert.

! If the SmartKey cannot be turned in the starter switch, the battery may not be sufficiently charged.

- Check the battery and charge it if necessary (▷ page 440).
- Get a jump start (▷ page 466).

To prevent accelerated battery discharge or a completely discharged battery, always remove the SmartKey from the starter switch when the engine is not in operation.

For information on starting the engine using the SmartKey, see “Starting with the SmartKey” (▷ page 52).

SmartKey with KEYLESS-GO*

If the SmartKey with KEYLESS-GO is inside the vehicle, pressing the KEYLESS-GO start/stop button on the gear selector lever corresponds to turning the SmartKey to the various starter switch positions.

If you firmly depress the brake pedal during pressing the KEYLESS-GO start/stop button, the engine starts automatically.

i The function of the SmartKey overrides the KEYLESS-GO function.



KEYLESS-GO start/stop button

- ① USA only
- ② Canada only

The SmartKey with KEYLESS-GO must be located in the vehicle.

- ▶ Make sure the gear selector lever is set to **P**.
- ▶ Do not depress the brake pedal.

Position 0

Before you press the KEYLESS-GO start/stop button, the vehicle's on-board electronics have status **0** (as with SmartKey removed).

Position 1

- ▶ Press KEYLESS-GO start/stop button once.

This supplies power for some electrical consumers, such as seat adjustment.

i If you now press the KEYLESS-GO start/stop button

- once again, the ignition (position **2**) is switched on
- twice, the power supply is again switched off

Unlocking

Ignition (or position 2)

- ▶ Press KEYLESS-GO start/stop button twice.

This supplies power for all electrical consumers. All lamps in the instrument cluster (except low beam headlamp indicator lamp, high beam headlamp indicator lamp, and turn signal indicator lamps unless activated) come on. If a lamp in the instrument cluster fails to come on when the ignition is switched on, have it checked and replaced if necessary. If a lamp in the instrument cluster remains on after starting the engine or comes on while driving, see “Lamps in instrument cluster” (▷ page 378).

i *If you now press the KEYLESS-GO start/stop button once, the power supply is again switched off.*

i *When you switch on the ignition, the indicator and warning lamps (except low beam headlamp indicator lamp, high beam headlamp indicator lamp, and turn signal indicator lamps unless activated) in the instrument cluster come on. The indicator and warning lamps (except low beam headlamp indicator lamp, high beam headlamp indicator lamp, and turn signal indicator lamps if activated) should go out when the engine is running. This indicates that the respective systems are operational.*

For information on starting the engine using the KEYLESS-GO start/stop button, see “Starting with KEYLESS-GO*” (▷ page 53).

▼ Adjusting

Warning!



All seat, head restraint, steering wheel, and rear view mirror adjustments, as well as fastening of seat belts, must be done before the vehicle is put into motion.

Seats

Warning!



Do not adjust the driver's seat while driving. Adjusting the seat while driving could cause the driver to lose control of the vehicle.

Never ride in a moving vehicle with the seat backrest in an excessively reclined position as this can be dangerous. You could slide under the seat belt in a collision. If you slide under it, the seat belt would apply force at the abdomen or neck. That could cause serious or fatal injuries. The seat back and seat belts provide the best restraint when the wearer is in a nearly upright position and seat belts are properly positioned on the body.

Warning!



Your seat must be adjusted so that you can correctly fasten your seat belt (▷ page 49).

Observe the following points:

- Adjust the backrest until your arms are slightly angled when holding the steering wheel.
- Adjust the seat to a comfortable seating position that still allows you to reach the accelerator/brake pedal safely. The position should be as far to the rear as possible, consistent with ability to properly operate controls.
- Adjust the head restraint so that it is as close to the head as possible and the center of the head restraint supports the back of the head at eye level.
- Never place hands under the seat or near any moving parts while a seat is being adjusted.

Failure to do so could result in an accident and/or serious personal injury.

Adjusting

Warning!



When leaving the vehicle, always remove the SmartKey or the SmartKey with KEYLESS-GO* from the starter switch, take it with you, and lock the vehicle.

Even with the SmartKey or the SmartKey with KEYLESS-GO* removed from the starter switch or the SmartKey with KEYLESS-GO* removed from the vehicle, the power seats can be operated when the respective door is open. Therefore, do not leave children unattended in the vehicle, or with access to an unlocked vehicle. A child's unsupervised access to a vehicle could result in an accident and/or serious personal injury.

Warning!



Canada only: Children 12 years old and under must never ride in the front seat, except in a Mercedes-Benz authorized BabySmart™ compatible child seat, which operates with the BabySmart™ system installed in the vehicle to deactivate the front passenger front air bag when it is properly installed. Otherwise they will be struck by the air bag when it inflates in a crash. If this happens, serious or fatal injury will result.

According to accident statistics, children are safer when properly restrained in the rear seating positions than in the front seating position. Thus, we strongly recommend that children be placed in the rear seats. Regardless of seating position, children 12 years old and under must be seated and properly secured in an appropriately sized infant restraint, toddler restraint, or booster seat recommended for the size and weight of the child. For additional information, see "Children in the vehicle" (▷ page 88).

A child's risk of serious or fatal injuries is significantly increased if the child restraints are not properly secured in the vehicle and the child is not properly secured in the child restraint.

Seat adjustment

The seat adjustment switches are located on the front doors.



- ① Seat fore and aft adjustment
- ② Backrest tilt
- ③ Seat height
- ④ Seat cushion tilt
- ⑤ Head restraint height

- ▶ Switch on the ignition (▷ page 37).
- or
- ▶ Open the respective door.

i The memory function (▷ page 138) lets you store the settings for the seat position together with the settings for the steering wheel and the exterior rear view mirrors.

Seat fore and aft adjustment

- ▶ Press the switch forward or backward in direction of arrow ①.

! When moving the seat, make sure there are no items in the footwell or behind the seats. Otherwise you could damage the seats.

Seat cushion tilt

- ▶ Press the switch up or down in direction of arrow ④ until your upper legs are lightly supported.

Backrest tilt

- ▶ Press the switch forward or backward in direction of arrow ②.

Seat height

- ▶ Press the switch up or down in direction of arrow ③.

Head restraint height

- ▶ Press the switch up or down in direction of arrow ⑤.

i Adjust the head restraint in such a way that it is as close to the head as possible.

Warning!



For your protection, drive only with properly positioned head restraints.

Adjust head restraint so that the center of the head restraint supports the back of the head at eye level. This will reduce the potential for injury to the head and neck in the event of an accident or similar situation.

Do not drive the vehicle without the seat head restraints. Head restraints are intended to help reduce injuries during an accident.

Adjusting

Head restraint adjusting



Manually adjust the head restraint.

- ▶ Push or pull on the upper edge of the head restraint cushion to the desired position.

Comfort head restraint* adjusting



- ① Head restraint side adjustment
- ② Head restraint fore and aft adjustment

Warning!



When folding back the side cushions, never reach between the side cushion and the mounting post. You could otherwise be trapped.

To adjust the head restraint sides:

- ▶ Pull or push sides ① into desired position.

To move the head restraint forward or backward:

- ▶ Pull or push head restraint in direction of arrow ②.

i Adjust the head restraint in such a way that it is as close to the head as possible.

For more information on seats, see “Seats” (▷ page 128).

Steering wheel

Warning!



Do not adjust the steering wheel while driving. Adjusting the steering wheel while driving could cause the driver to lose control of the vehicle.

When leaving the vehicle, always remove the SmartKey or the SmartKey with KEYLESS-GO* from the starter switch, take it with you, and lock the vehicle.

Even with the SmartKey or the SmartKey with KEYLESS-GO* removed from the starter switch or the SmartKey with KEYLESS-GO* removed from the vehicle, the steering wheel adjustment feature can be operated when the driver's door is open. Therefore, do not leave children unattended in the vehicle, or with access to an unlocked vehicle. A child's unsupervised access to a vehicle could result in an accident and/or serious personal injury.

Steering wheel adjustment

The steering wheel adjustment stalk is located on the lower left of the steering column.

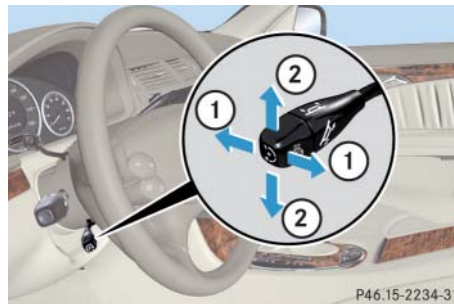

- ① Adjusting steering column, in or out
- ② Adjusting steering column, up or down

► Switch on the ignition (▷ page 37).

or

► Open the driver's door.

i *The memory function (▷ page 138) lets you store the settings for the steering wheel together with the settings for the exterior rear view mirrors and the driver's seat position.*

Adjusting steering column in or out

► Move stalk in direction of arrows ① until a comfortable steering wheel position is reached with your arms slightly bent at the elbow.

Adjusting steering column up or down

► Move stalk in direction of arrows ②.

Make sure your legs can move freely and all the displays (incl. malfunction and indicator lamps) on the instrument cluster are clearly visible.

Adjusting

Easy-entry/exit feature

This feature allows for easier entry into and exit from the vehicle. When entering and exiting the vehicle, the steering wheel is in its uppermost position.

The easy-entry/exit feature can be activated or deactivated in the Convenience sub-menu of the control system (▷ page 181).

Warning!



You must make sure no one can become trapped or injured by the moving steering wheel when the easy-entry/exit feature is activated.

To stop steering wheel movement, do one of the following:

- Move steering wheel adjustment stalk.
- Press one of the memory position buttons (▷ page 139).

Do not leave children unattended in the vehicle, or with access to an unlocked vehicle. Children could open the driver's door and unintentionally activate the easy-entry/exit feature, which could result in an accident and/or serious personal injury.

With the easy-entry/exit feature activated, the steering wheel will return to its last set position when you:

- close the driver's door with the ignition switched on
- or
- insert the SmartKey into the starter switch or press the KEYLESS-GO* start/stop button (▷ page 39) once with the driver's door closed

i *The last set steering wheel position is stored when*

- *the ignition is switched off (▷ page 63)*
- *the position is stored in memory (▷ page 139)*

With the easy-entry/exit feature activated, the steering wheel tilts upwards when you:

- remove the SmartKey from the starter switch
- or
- open the driver's door with the SmartKey in starter switch position **0** or **1** or the KEYLESS-GO* start/stop button (▷ page 39) in position **1**

i *If the current position for the steering wheel is in the uppermost tilt position, the steering wheel will no longer be able to move upward when the easy-entry/exit feature is activated.*

The adjustment procedure is briefly interrupted when the engine is started.

Warning!

Let the system complete the adjustment procedure before setting the vehicle in motion. All steering wheel adjustment must be completed before setting the vehicle in motion. Driving off with the steering wheel still adjusting could cause the driver to lose control of the vehicle.

Mirrors

Adjust the interior and exterior rear view mirrors before driving so that you have a good view of the road and traffic conditions.

Warning!

In case of an accident, liquid electrolyte may escape the mirror housing if the mirror glass breaks.

Electrolyte has an irritating effect. Do not allow the liquid to come into contact with eyes, skin, clothing, or respiratory system. In case it does, immediately flush affected area with water, and seek medical help if necessary.

! *Electrolyte drops coming into contact with the vehicle paint finish can only be completely removed while in their liquid state and by applying plenty of water.*

Interior rear view mirror

- ▶ Manually adjust the interior rear view mirror.

For more information, see “Rear view mirrors” (▷ page 200).

Exterior rear view mirrors**Warning!**

Exercise care when using the passenger-side exterior rear view mirror. The mirror surface is convex (outwardly curved surface for a wider field of view). Objects in mirror are closer than they appear. Check your interior rear view mirror or glance over your shoulder before changing lanes.

Adjusting

The buttons are located on the driver's door.



- ① Driver's side exterior rear view mirror button
 - ② Adjustment button
 - ③ Passenger-side exterior rear view mirror button
- ▶ Switch on the ignition (▷ page 37).
 - ▶ Press button ① for the driver's side exterior rear view mirror or button ③ for the passenger-side exterior rear view mirror.
 - ▶ Push adjustment button ② up, down, left or right according to the desired setting.

! *If an exterior rear view mirror was forcibly pushed forward (hit from the rear) or forcibly pushed rearward (hit from the front), reposition it by applying firm pressure until it snaps into place. The mirror housing is now properly positioned and you can adjust the mirror the usual manner.*

i *At low ambient temperatures, the exterior rear view mirrors will be heated automatically.*

i *The memory function (▷ page 138) lets you store the settings for the exterior rear view mirrors together with the settings for the steering wheel and the driver's seat position.*

For more information, see “Activating exterior rear view mirror parking position” (▷ page 202).

For more information, see “Rear view mirrors” (▷ page 200).

▼ Driving

Warning!



Make sure that absolutely no objects are obstructing the pedals' range of movement. Keep the driver's footwell clear of all obstacles. If there are any floor mats or carpets in the footwell, make sure that the pedals still have sufficient clearance.

During sudden driving or braking maneuvers the objects could get caught between the pedals. You could then no longer brake or accelerate. This could lead to accidents and injury.

Fastening the seat belts

Warning!



Always fasten your seat belt before driving off. Always make sure all of your passengers are properly restrained, even those sitting in the rear.

Failure to wear and properly fasten and position your seat belt greatly increases your risk of injuries and their likely severity in an accident. You and your passengers should always wear seat belts.

If you are ever in an accident, your injuries can be considerably more severe without your seat belt properly buckled. Without your seat belt buckled, you are much more likely to hit the interior of the vehicle or be ejected from it. You can be seriously injured or killed.

In the same crash, the possibility of injury or death is lessened if you are wearing your seat belt. The air bags can only provide the protection they were designed to afford if the occupants are using their seat belts (> page 82).

Warning!



Canada only: Children 12 years old and under must never ride in the front seat, except in a Mercedes-Benz authorized BabySmart™ compatible child seat, which operates with the BabySmart™ system installed in the vehicle to deactivate the front passenger front air bag when it is properly installed. Otherwise they will be struck by the air bag when it inflates in a crash. If this happens, serious or fatal injury will result.

According to accident statistics, children are safer when properly restrained in the rear seating positions than in the front seating position. Thus, we strongly recommend that children be placed in the rear seats. Regardless of seating position, children 12 years old and under must be seated and properly secured in an appropriately sized infant restraint, toddler restraint, or booster seat recommended for the size and weight of the child. For additional information, see "Children in the vehicle" (> page 88).



Driving

▷▷ A child's risk of serious or fatal injuries is significantly increased if the child restraints are not properly secured in the vehicle and the child is not properly secured in the child restraint.

Warning!



Never let more people ride in the vehicle than there are seat belts available. Be sure everyone riding in the vehicle is correctly restrained with a separate seat belt. Never use a seat belt for more than one person at a time.

Warning!



Never ride in a moving vehicle with the seat backrest in an excessively reclined position as this can be dangerous. You could slide under the seat belt in a collision. If you slide under it, the seat belt would apply force at the abdomen or neck. That could cause serious or even fatal injuries. The seat backrest and seat belt provide the best restraint when the wearer is in a nearly upright position and the seat belt is properly positioned on the body.

Warning!



Read and observe the additional warning notices printed in the "Safety and Security" section (▷ page 72) and (▷ page 83).

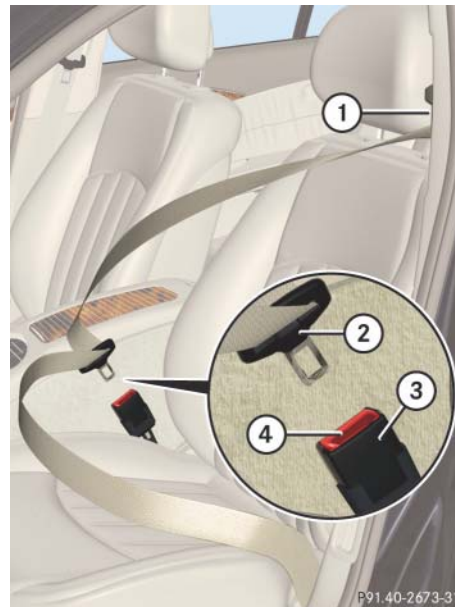

- ① Belt outlet
- ② Latch plate
- ③ Buckle
- ④ Release button

► With a smooth motion, pull the seat belt from belt outlet ①.

- ▶ Place the shoulder portion of the seat belt across the top of your shoulder and the lap portion across your hips.
- ▶ Push latch plate ② into buckle ③ until it clicks.
- ▶ If necessary, tighten the lap portion to a snug fit by pulling shoulder portion up.

Belt outlet height adjustment



① Release button

- ▶ Press release button ① and move the seat belt height adjuster upward or downward.

Proper use of seat belts

- Do not twist the seat belt when fastening.
- Adjust seat belt so that the shoulder portion is located as close as possible to the middle of the shoulder (it should not touch the neck). Never pass the shoulder portion of the seat belt under your arm.
- Position the lap belt as low as possible on your hips (over hip joint) and not across the abdomen.
- Place the seat backrest in a nearly upright position.
- Never use a seat belt for more than one person at a time.
- Do not fasten a seat belt around a person and another object at the same time. When using a seat belt to secure infant restraint or toddler restraint or children in booster seats, always follow the child seat manufacturer's instructions.

- Check your seat belt periodically during travel to make sure that it is properly positioned.
- Make sure that the seat belt is always fitted snugly. Take special care of this when wearing loose clothing.

Warning!



Do not pass seat belts over sharp edges. They could tear.

Do not allow the seat belt to get caught in the door or in the seat adjustment mechanism. This could damage the seat belt.

Never attempt to make modifications to seat belts. This could impair the effectiveness of the seat belts.

Do not bleach or dye seat belts as this may severely weaken them. In a crash they may not be able to provide adequate protection.

Damaged seat belts or seat belts that were highly stressed in an accident must be replaced. Contact an authorized Mercedes-Benz Center.

Starting the engine

Warning!



Inhalation of exhaust gas is hazardous to your health. All exhaust gas contains carbon monoxide (CO), and inhaling it can cause unconsciousness and possible death.

Do not run the engine in confined areas (such as a garage) which are not properly ventilated. If you think that exhaust gas fumes are entering the vehicle while driving, have the cause determined and corrected immediately. If you must drive under these conditions, drive only with at least one window fully open.

Automatic transmission



Gearshift pattern for automatic transmission

- P** Park position with gear selector lever lock
- R** Reverse gear
- N** Neutral
- D** Drive position

For more information, see the “Controls in detail” section (▷ page 187).

Starting with the SmartKey

For information on turning off the engine with the SmartKey, see “Turning off engine” (▷ page 63).

- ▶ Make sure the gear selector lever is set to **P**.
- ▶ Do not depress the accelerator.
- ▶ Turn the SmartKey in the starter switch to position **3** and hold until the engine starts (▷ page 38).

i You can also use the “touch-start” function. Turn the SmartKey to position **3** (▷ page 38) and release it again immediately. The engine then starts automatically.

Starting with KEYLESS-GO*

Warning!

As long as the SmartKey with KEYLESS-GO is in your vehicle, the vehicle can be started. Therefore, never leave children unattended in the vehicle, as they could otherwise accidentally start the engine.

When leaving the vehicle, always take the SmartKey with KEYLESS-GO with you and lock the vehicle. Do not leave children unattended in the vehicle, or with access to an unlocked vehicle.

You can start your vehicle without the SmartKey in the starter switch using the KEYLESS-GO start/stop button on the gear selector lever.

For information on turning off the engine with KEYLESS-GO, see “Turning off with KEYLESS-GO*” (▷ page 64).

The SmartKey with KEYLESS-GO must be located in the vehicle.

**KEYLESS-GO start/stop button**

- ① USA only
- ② Canada only

- ▶ Make sure the gear selector lever is set to **P**.
 - ▶ Depress the brake pedal during the starting procedure. Do not depress accelerator.
- The gear selector lever lock is released.
- ▶ Press KEYLESS-GO start/stop button once.

The engine starts if the SmartKey with KEYLESS-GO is in the vehicle.

Starting difficulties

If the SmartKey is left in starter switch position **0** for an extended period of time, it can no longer be turned in the switch. In this case, the steering is locked.

- ▶ To unlock remove SmartKey from the starter switch and reinsert.

If the engine does not start as described, carry out the following steps:

- ▶ If you are starting the engine with the SmartKey, turn SmartKey in starter switch to position **0** and repeat starting procedure.
- ▶ If you are starting the engine with KEYLESS-GO: Close any doors that may be open to allow for better detection of the SmartKey with KEYLESS-GO.

Or:

Start the engine with the SmartKey as radio signals from another source may be interfering with the SmartKey with KEYLESS-GO.



Driving

- ▷▷ Repeat the starting procedure (▷ page 52). Remember that extended starting attempts can drain the battery.
- ▶ Get a jump start (▷ page 466).

If the engine does not start after several starting attempts, there could be a malfunction in the engine electronics or in the fuel supply system.

- ▶ Notify an authorized Mercedes-Benz Center.

Parking brake

Warning!



Engaging the parking brake while the vehicle is in motion can cause the rear wheels to lock up. You could lose control of the vehicle and cause an accident. In addition, the vehicle's brake lights do not light up when the parking brake is engaged.

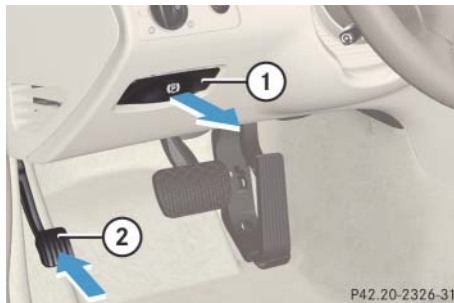

- ① Release handle
- ② Parking brake pedal

Warning!



When leaving the vehicle, always remove the SmartKey or the SmartKey with KEYLESS-GO* from the starter switch, take it with you, and lock the vehicle. Do not leave children unattended in the vehicle, or with access to an unlocked vehicle. Children could release the parking brake, which could result in an accident and/or serious personal injury.

- ▶ Release the parking brake by pulling on release handle ①.

The warning lamp **BRAKE** (USA only) or **(P)** (Canada only) in the instrument cluster goes out.

Driving

- ▶ Depress the brake pedal.
 - ▶ Move the gear selector lever to position **D** or **R**.
- i** Wait for the gear selection process to complete before setting the vehicle in motion.
- ▶ Release the brake pedal.
 - ▶ Carefully depress the accelerator pedal.
- i** Once the vehicle is in motion, the automatic central locking system engages and the locking knobs drop down.
- The automatic door lock feature can be deactivated (▷ page 180).
- You can open a locked door from the inside. Open door only when conditions are safe to do so.

! If you hear a warning signal and the message **Release parking brake** appears in the multifunction display when driving off, you have forgotten to release the parking brake.

Release the parking brake (▷ page 62).

After a cold start, the automatic transmission shifts at a higher engine revolution. This allows the catalytic converter to reach its operating temperature earlier.

Warning!



On slippery road surfaces, never downshift in order to obtain braking action. This could result in drive wheel slip and reduced vehicle control. Your vehicle's ABS will not prevent this type of loss of control.

Warning!



It is dangerous to shift the gear selector lever out of **P** or **N** if the engine speed is higher than idle speed. If your foot is not firmly on the brake pedal, the vehicle could accelerate quickly forward or in reverse. You could lose control of the vehicle and hit someone or something. Only shift into gear when the engine is idling normally and when your right foot is firmly on the brake pedal.

For more information on driving, see “Driving instructions” (▷ page 309).

! Simultaneously depressing the accelerator pedal and applying the brakes reduces engine performance and causes premature brake and drivetrain wear.

Driving

Switching on headlamps

Low beam headlamps

The exterior lamp switch is located on the dashboard to the left of the steering wheel.



Exterior lamp switch

- ① Off
- ② Low beam headlamps on

- ▶ Turn the exterior lamp switch to position .

The low beam headlamps and the low beam headlamp indicator lamp  in the instrument cluster come on (▷ page 141).

High beam

The combination switch is located on the left of the steering column.

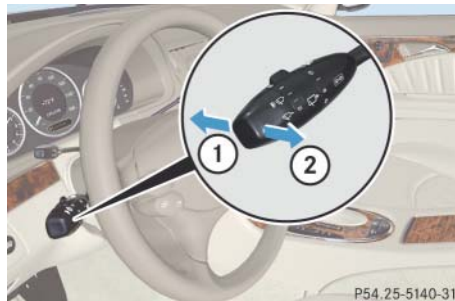

Combination switch

- ① High beam
- ② High beam flasher

- ▶ Push the combination switch in direction of arrow ①.

The high beam headlamps and the high beam headlamp indicator lamp  in the instrument cluster come on (▷ page 26).

For more information on headlamps, see “Lighting” (▷ page 141).

Turn signals

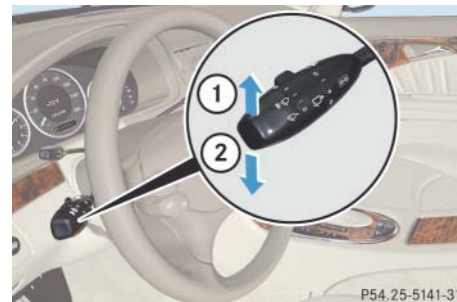

The combination switch is located on the left of the steering column.



Combination switch

- ① Turn signals, right
- ② Turn signals, left

- ▶ Press the combination switch in direction of arrow ① or ②.

The corresponding turn signal indicator lamp  or  in the instrument cluster flashes.

The combination switch resets automatically after major steering wheel movements.

i To signal minor directional changes such as changing lanes, press combination switch only to point of resistance and release. The corresponding turn signals will flash three times.

Windshield wipers

The combination switch is located on the left of the steering column.

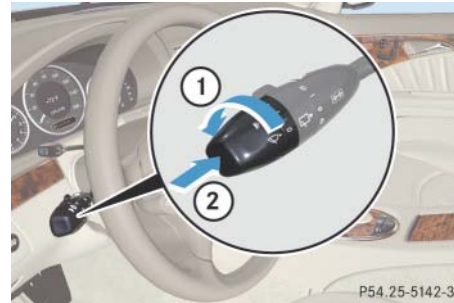

Combination switch

- ① Switching on windshield wipers
- ② Single wipe
Wiping with windshield washer fluid
- ▶ Switch on the ignition (> page 37).

! Do not operate the windshield wipers when the windshield is dry. Dust that accumulates on a windshield might scratch the glass and/or damage the wiper blades when wiping occurs on a dry windshield. If it is necessary to operate the windshield wipers in dry weather conditions, always operate the windshield wipers with windshield washer fluid (> page 59).



! If anything blocks the windshield wipers (leaves, snow, etc.), switch them off immediately.

- For safety reasons, stop the vehicle in a safe location and
 - remove SmartKey from starter switch
 - or
 - turn off the engine by pressing the KEYLESS-GO* start/stop button and open the driver's door (with the driver's door open, starter switch is in position 0, same as with SmartKey removed from starter switch)

before attempting to remove any blockage.

- Remove blockage.
- Turn the windshield wipers on again. ▷▷

Driving

▷▷ If windshield wipers fail to function at all in combination switch position  or ,

- set the combination switch to the next higher wiper speed
- have the windshield wipers checked at the nearest authorized Mercedes-Benz Center.

Switching on/off windshield wipers

▶ Turn the combination switch to the desired position depending on the intensity of the rain.

 Windshield wipers off

 Slow intermittent wiping
Rain sensor operation with low sensitivity.

 Fast intermittent wiping
Rain sensor operation with high sensitivity.

 Slow continuous wiping

 Fast continuous wiping



 When the windshield wipers are switched on and you brake the vehicle to a stop, the time interval between wiper operations is increased.

Intermittent wiping

Only switch on intermittent wiping under wet weather conditions or in the presence of precipitation.

 Do not leave windshield wipers in intermittent setting when the vehicle is taken to an automatic car wash or during windshield cleaning. Windshield wipers will operate in the presence of water sprayed on the windshield, and windshield wipers may be damaged as a result.

 If you have set intermittent wiping, dirt on the surface of the rain sensor or optical effects may cause the windshield wipers to wipe in an undesired fashion. This could then damage the windshield wiper blades or scratch the windows. You should therefore switch off the windshield wipers when weather conditions are dry.

▶ Turn the combination switch to position  or .

The wipers move across the windshield. Afterward, the wiping intervals are determined by the wetness of the windshield.

After the initial wipe, pauses between wipes are automatically controlled by the rain sensor.

 Intermittent wiping is interrupted when the vehicle is at a standstill and a door is opened. This protects persons getting into or out of the vehicle from being sprayed.

Intermittent wiping will be continued when

- all doors are closed
- and
- the gear selector lever is in position **D** or **R**
- or
- the wiper setting is changed using the combination switch

Single wipe

▶ Press the combination switch briefly in direction of arrow ② (▷ page 57) to the resistance point.

The windshield wipers wipe one time without washer fluid.

Wiping with windshield washer fluid

- ▶ Push the combination switch in direction of arrow ② (▷ page 57) past the resistance point.

The windshield wipers operate with washer fluid.

i To prevent smears on the windshield or noisy/chattering wiper blades, wipe with windshield washer fluid every now and then even when it is raining.

For information on filling up the windshield washer reservoir, see “Windshield/rear window washer system and headlamp cleaning system*” (▷ page 331).

Rear window wiper/washer

The combination switch is located on the left of the steering column.

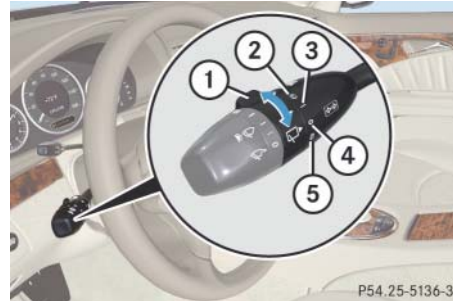

Combination switch

- ① Rear window wiper switch
- ② Wiping rear window with washer fluid
- ③ Intermittent wiping
- ④ Rear window wiper off
- ⑤ Wiping rear window with washer fluid

i The rear window wiper engages automatically if the gear selector lever is moved to position **R** with the windshield wipers switched on.

- ▶ Switch on the ignition (▷ page 37).

Activating intermittent wipe

- ▶ Turn rear window wiper switch ① to position ③.

Deactivating intermittent wipe

- ▶ Turn rear window wiper switch ① to position ④.

Wiping with windshield washer fluid

- ▶ Turn and hold rear window wiper switch ① to position ② or ⑤ until the rear window is clean.

The rear window wiper operates with washer fluid.

For information on filling up the windshield washer reservoir, see “Windshield/rear window washer system and headlamp cleaning system*” (▷ page 331).

Problems while driving

The engine runs erratically and misfires

- An ignition cable may be damaged.
- The engine electronics may not be operating properly.
- Unburned gasoline may have entered the catalytic converter and damaged it.
- ▶ Give very little gas.
- ▶ Have the problem repaired by an authorized Mercedes-Benz Center as soon as possible.

The coolant temperature is above 248°F (120°C)

The coolant is too hot and is no longer cooling the engine.

- ▶ Stop the vehicle as soon as possible in a safe location and turn off the engine. Allow engine and coolant to cool off.
- ▶ Check the coolant level and add coolant if necessary (▷ page 329).

In case of accident

If the vehicle is leaking fuel:

- ▶ Do not start the engine under any circumstances.
- ▶ Notify local fire and/or police authorities.

If the extent of the damage cannot be determined:

- ▶ Notify an authorized Mercedes-Benz Center.

If no damage can be determined on the

- major assemblies
- fuel system
- engine mount:
- ▶ Start the engine in the usual manner.

▼ Parking and locking

You have now completed your first drive. You have properly stopped and parked your vehicle. End your drive as follows.

Warning!



With the engine not running, there is no power assistance for the brake and steering systems. In this case, it is important to keep in mind that a considerably higher degree of effort is necessary to brake and steer the vehicle.

Warning!



Vehicles with Airmatic: If you have selected the Comfort suspension tuning (▷ page 262), the vehicle lowers slightly when it is locked. You should therefore make sure that no one is standing near the wheel arches or lying underneath the vehicle when it is being locked. Otherwise, personal injury could result.

Warning!



Do not park this vehicle in areas where combustible materials such as grass, hay or leaves can come into contact with the hot exhaust system, as these materials could be ignited and cause a vehicle fire.

To reduce the risk of personal injury, or damage to the vehicle drivetrain, as a result of vehicle movement, before turning off the engine and leaving the vehicle always:

- Keep right foot on brake pedal.
- Firmly depress parking brake pedal.
- Move the gear selector lever to position **P**.
- Slowly release brake pedal.
- When parked on an incline, turn front wheel towards the road curb.

- Turn the SmartKey to starter switch position **0** and remove, or press start / stop button (vehicles with KEYLESS-GO*).
- Take the SmartKey or the SmartKey with KEYLESS-GO* and lock vehicle when leaving.

! *Vehicles with Airmatic: If you have selected the Comfort suspension tuning (▷ page 262), the vehicle lowers slightly when you lock it within approximately 60 seconds after switching off the engine. When parking, make sure that your vehicle cannot come into contact with other objects, such as a curb, while lowering. Your vehicle could otherwise be damaged.*

Parking and locking

Parking brake

Warning!



Engaging the parking brake while the vehicle is in motion can cause the rear wheels to lock up. You could lose control of the vehicle and cause an accident. In addition, the vehicle's brake lights do not light up when the parking brake is engaged. Make sure not to endanger any other road users when you engage the parking brake.

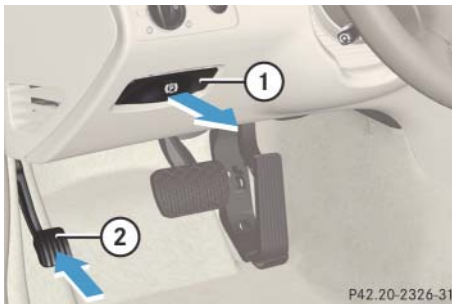

- ① Release handle
- ② Parking brake pedal

► Step firmly on parking brake pedal ②.

When the engine is running, the warning lamp **BRAKE** (USA only) or **(P)** (Canada only) in the instrument cluster will be illuminated.

Warning!



When leaving the vehicle, always remove the SmartKey or the SmartKey with KEYLESS-GO* from the starter switch, take it with you and lock the vehicle. Do not leave children unattended in the vehicle, or with access to an unlocked vehicle. Children could release the parking brake and/or move the gear selector lever from position **P**, either of which could result in an accident and/or serious personal injury.

Warning!

Getting out of your vehicle with the gear selector lever not fully engaged in position **P** is dangerous. Also, when parked on an incline, position **P** alone may not prevent your vehicle from moving, possibly hitting people or objects.

Always set the parking brake in addition to shifting to position **P**.

When parked on an incline, turn front wheels towards the road curb.

Switching off headlamps

- ▶ Turn the exterior lamp switch to **0** (▷ page 56).

For more information, see the “Controls in detail” section (▷ page 141).

Turning off engine

- ▶ Move the gear selector lever to position **P**.
- ▶ Apply the parking brake (▷ page 62).

i Always set the parking brake in addition to shifting to position **P**.

On slopes, turn the front wheels towards the road curb.

Turning off with the SmartKey

- ▶ Turn the SmartKey in the starter switch (▷ page 38) to position **0** and remove it.

The immobilizer is activated.

i *The SmartKey can only be removed from the starter switch with the gear selector lever in position **P**.*

Parking and locking

Turning off with KEYLESS-GO*

- ▶ Place the gear selector lever in **P**.
- ▶ Press the KEYLESS-GO start/stop button to shut off the engine.

With the driver's door closed, the starter switch is now in position **1**. With the driver's door opened, the starter switch is set to position **0**, same as SmartKey removed from starter switch (▷ page 38).

i If you hear a warning signal, you have tried to turn off the engine while the gear selector lever was not in position **P**.

In addition, the message **Gear selector lever in Park position** appears in the multi-function display.

Place the gear selector lever in position **P**.

Releasing seat belts

- ▶ Press the seat belt release button (▷ page 50).

Allow the retractor to completely rewind the seat belt by guiding the latch plate.

! *Make sure the seat belt retracts fully so that the seat belt and/or latch plate cannot get caught or pinched in the door or in the seat mechanism. This can damage the seat belt and impair the effectiveness of the seat belt, and/or cause damage to the door and/or door trim panel. Such damage is not covered by the Mercedes-Benz Limited Warranty.*

Damaged seat belts must be replaced. Contact an authorized Mercedes-Benz Center.

Locking

Warning!



To prevent possible personal injury, always keep hands and fingers away from the door openings when closing the doors. Be especially careful when small children are around.

Before closing doors, make sure that there is no possibility of someone getting caught in a door during closing.

Warning!



When leaving the vehicle, always take the SmartKey or the SmartKey with KEYLESS-GO* with you, and lock the vehicle. Do not leave children unattended in the vehicle, or with access to an unlocked vehicle. A child's unsupervised access to a vehicle could result in an accident and/or serious personal injury.

- ▶ Exit the vehicle and close all doors and the tailgate.

i If you hear a warning signal you have forgotten to switch off the headlamps before opening the driver's door.

In addition the message **Switch off lights** appears in the multifunction display.

Switch off the headlamps.

Locking with the SmartKey

- ▶ After exiting the vehicle, press lock button **🔒** on the SmartKey (▷ page 36).
 - All turn signal lamps flash three times.
 - An acoustic signal sounds three times.
 - The locking knobs in the doors move down.
 - The anti-theft alarm system is armed.

For more information, see the “Controls in detail” section (▷ page 110).

Locking with KEYLESS-GO*

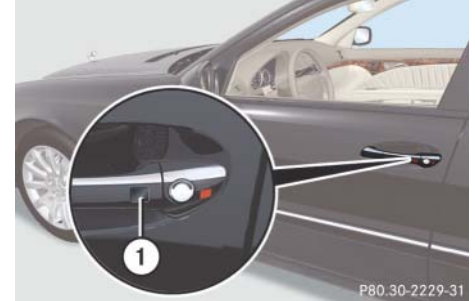

① Lock button

- ▶ After exiting the vehicle, press lock button **①** on an outside door handle.
 - All turn signal lamps flash three times.
 - An acoustic signal sounds three times.
 - The locking knobs in the doors move down.
 - The anti-theft alarm system is armed.

For more information, see “SmartKey with KEYLESS-GO*” (▷ page 113).

Occupant safety

Panic alarm

Driving safety systems

Anti-theft systems



Occupant safety

In this section you will learn the most important facts about the restraint systems of the vehicle.

The restraint systems are

- Seat belts (▷ page 82)
- Child restraints (▷ page 89)
- Lower Anchors and Tethers for CHildren (LATCH) (▷ page 94)

Additional protection is provided by

- Supplemental Restraint System (SRS) with
 - Air bags (▷ page 70)
 - Air bag control unit (with crash sensors)
 - Emergency Tensioning Device (ETD) for seat belts (▷ page 85)
- Active head restraints (▷ page 87)
- Preventive occupant safety (PRE-SAFE®) (▷ page 86)

Air bag system components with

- Front passenger front air bag off indicator lamp (▷ page 79)
- USA only:
Front passenger seat with Occupant Classification System (OCS) (▷ page 75)
- Canada only:
Front passenger seat with BabySmart™ air bag deactivation system (▷ page 81)

As independent systems, their protective functions work in conjunction with each other.

i For information on infants and children traveling with you in the vehicle and restraint systems for infants and children, see “Children in the vehicle” (▷ page 88).

The SRS system conducts a self-test when the ignition is switched on and in regular intervals while the engine is running. This facilitates early detection of malfunctions. The **SRS** indicator lamp in the instrument cluster lights up when the ignition is switched on and goes out no later than a few seconds after the engine has been started.

The SRS components are in operational readiness if the **SRS** indicator lamp is not lit when the engine is running.

A malfunction in the system has been detected if the **SRS** indicator lamp:

- fails to go out after approximately 4 seconds after the engine was started
- does not come on at all
- comes on after the engine was started or while driving

Warning!

Modifications to or work improperly conducted on restraint systems (such as seat belts and anchors, emergency tensioning devices, seat belt force limiters or air bags) or their wiring, as well as tampering with interconnected electronic systems, can lead to the restraint systems no longer functioning as intended.

Air bags or emergency tensioning devices, for example, could deploy inadvertently or fail to deploy in accidents although the deceleration threshold for air bag deployment is exceeded. Therefore, never modify the restraint systems. Do not tamper with electronic components or their software.

Warning!

In the event that the **SRS** indicator lamp comes on during driving or does not come on at all, the SRS self-check has detected a malfunction. For your safety, we strongly recommend that you visit an authorized Mercedes-Benz Center immediately to have the system checked; otherwise the SRS may not be activated when needed in an accident, which could result in serious or fatal injury, or it might deploy unexpectedly and unnecessarily which could also result in injury.

In addition, improper repair work on the SRS creates a risk of rendering the SRS inoperative or causing unintended air bag deployment. Work on the SRS must therefore only be performed by qualified technicians. Contact an authorized Mercedes-Benz Center.

If it is necessary to modify an air bag system to accommodate a person with disabilities, contact your local authorized Mercedes-Benz Center or call our Customer Assistance Center at 1-800-FOR-MERCEdes (1-800-367-6372) for details.

Occupant safety

Air bags

Warning!



Air bags are designed to reduce the potential of injury and fatality in certain frontal impacts (front air bags), side impacts (side impact air bags and window curtain air bags) or rollovers (window curtain air bags). However, no system available today can totally eliminate injuries and fatalities.

The activation of the air bags temporarily releases a small amount of dust from the air bags. This dust, however, is neither injurious to your health, nor does it indicate a fire in the vehicle. The dust might cause some temporary breathing difficulty for people with asthma or other breathing trouble. To avoid this, you may wish to get out of the vehicle as soon as it is safe to do so. If you have any breathing difficulty but cannot get out of the vehicle after the air bag inflates, then get fresh air by opening a window or door.

Warning!



To reduce the risk of injury when the front air bags inflate, it is very important for the driver and front passenger to always be in a properly seated position and to wear their respective seat belts.

For maximum protection in the event of a collision always be in normal seated position with your back against the backrest. Fasten your seat belt and make sure that it is properly positioned on your body.

Since the air bag inflates with considerable speed and force, a proper seating and hands on steering wheel position will help to keep you at a safe distance from the air bag. Occupants who are unbelted, out of position or too close to the air bag can be seriously injured or killed by an air bag as it inflates with great force in the blink of an eye:

- Sit properly belted in a nearly upright position with your back against the seat backrest.

- Adjust the driver seat as far as possible rearward, still permitting proper operation of vehicle controls. The distance from the center of the driver's breastbone to the center of the air bag cover on the steering wheel must be at least 10 in (25 cm) or more. You should be able to accomplish this by a combination of adjustments to the seat and steering wheel. If you have any problems, please contact your authorized Mercedes-Benz Center.
- Do not lean your head or chest close to the steering wheel or dashboard.
- Keep hands on the outside of steering wheel rim. Placing hands and arms inside the rim can increase the risk and potential severity of hand/arm injury when driver front air bag inflates.
- Adjust the front passenger seat as far as possible rearward from the dashboard when the seat is occupied.

- Occupants, especially children, should never place their bodies or lean their heads in the area of the door where the side impact air bag inflates. This could result in serious injuries or death should the air bag be triggered. Always sit nearly upright, properly use the seat belts and use an appropriately sized infant restraint, toddler restraint, or booster seat recommended for the size and weight of the child.
- Canada only: Children 12 years old and under must never ride in the front seat, except in a Mercedes-Benz authorized BabySmart™ compatible child seat, which operates with the BabySmart™ system installed in the vehicle to deactivate the front passenger front air bag when it is properly installed. Otherwise they will be struck by the air bag when it inflates in a crash. If this happens, serious or fatal injury will result.

Failure to follow these instructions can result in severe injuries to you or other occupants.

If you sell your vehicle, it is important that you make the buyer aware of this safety information. Be sure to give the buyer this Operator's Manual.

Warning!



Accident research shows that the safest place for children in an automobile is in the rear seat.

It should be noted that with respect to both front and rear side impact air bags there is a possibility for a side impact air bag related injury if occupants, especially children, are not properly seated or restrained when next to a side impact air bag which needs to deploy rapidly in a side impact in order to do its job.

To help avoid the possibility of injury, please follow these guidelines:

- (1) Occupants, especially children, should never place their bodies or lean their heads in the area of the door where the side impact air bag inflates. This could result in serious injuries or death should the side impact air bag be deployed.



Occupant safety



(2) Always sit nearly upright, properly use the seat belts and for children 12 years old and under, use an appropriately sized infant restraint, toddler restraint, or booster seat recommended for the size and weight of the child.

(3) Always wear seat belts properly.

If you believe that, even with the use of these guidelines, it would be safer for your rear seat occupants to have the rear mounted side impact air bags deactivated, then deactivation can be accomplished upon your written request to do so at your authorized Mercedes-Benz Center at an additional cost.

Please contact your local authorized Mercedes-Benz Center or call our Customer Assistance Center at 1-800-FOR-MERCEdes (1-800-367-6372) for details.

i *Air bags are designed to deploy only in certain frontal impacts (front air bags), side impacts (side impact and window curtain air bags) which exceed preset thresholds and in certain rollovers (window curtain air bags). Only during these events will they provide their supplemental protection.*

The driver and passengers should always wear their seat belts. Otherwise it is not possible for air bags to provide their supplemental protection.

In case of other types of impacts and impacts below air bag deployment thresholds, air bags will not be deployed. The driver and passenger will then be protected to the extent possible by a properly fastened seat belt. A properly fastened seat belt is also needed to provide the best protection in a rollover.

We caution you not to rely on the presence of the air bags in order to avoid wearing your seat belt.

It is important to your safety and that of your passengers that you replace deployed air bags and repair any malfunctioning air bags to make sure that the vehicle will continue to provide supplemental crash protection for occupants.

Safety guidelines for the seat belt, emergency tensioning device and air bag

Warning!



- Damaged seat belts or seat belts that were highly stressed in an accident must be replaced and their anchoring points must also be checked. Use only seat belts installed or supplied by an authorized Mercedes-Benz Center.
- Air bags and emergency tensioning devices (ETDs) are designed to function on a one-time-only basis. An air bag or ETD that was activated must be replaced.
- No modifications of any kind may be made to any components or wiring of the SRS. This includes changing or removing any component or part of the SRS, the installation of additional trim material, badges etc. over the steering wheel hub, front passenger front air bag cover, outboard sides of the front seat backrests, door trim panels,

or door frame trims, and installation of additional electrical/electronic equipment on or near SRS components and wiring. Keep area between air bags and occupants free from objects (e.g. packages, purses, umbrellas, etc.).

- Do not pass seat belts over sharp edges. They could tear.
- Do not make any modification that could change the effectiveness of the seat belts.
- Do not bleach or dye seat belts as this may severely weaken them. In a crash they may not be able to provide adequate protection.
- Do not hang items such as coat hangers from the coat hooks or handles over the door. These items may turn into projectiles and cause head and other injuries when the window curtain air bag is deployed.
- Never place your feet on the instrument panel, dashboard, or on the seat. Always keep both feet on the floor in front of the seat.

- Air bag system components will be hot after an air bag has inflated. Do not touch.
- In addition, improper repair work on the SRS creates a risk of rendering the SRS inoperative or causing unintended air bag deployment. Work on the SRS must therefore only be performed by qualified technicians. Contact an authorized Mercedes-Benz Center.
- For your protection and the protection of others, when scrapping the air bag unit or emergency tensioning device, our safety instructions must be followed. These instructions are available from your authorized Mercedes-Benz Center.
- Given the considerable deployment speed, required inflation volume, and the textile structure of the air bags, there is the possibility of abrasions or other, potentially more serious injuries from air bag deployment.

Warning!



Only use seat covers which have been tested and approved by Mercedes-Benz for your vehicle model. Using other seat covers may interfere with or prevent the deployment of the side impact air bags. Contact your authorized Mercedes-Benz Center for availability.

When you sell your vehicle we strongly urge you to give notice to the subsequent owner that it is equipped with an SRS by alerting them to the applicable section in the Operator's Manual.

Occupant safety

Front air bags

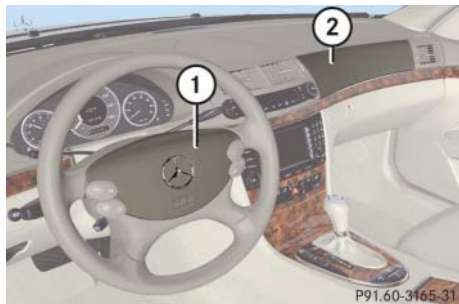

- ① Driver front air bag
- ② Front passenger front air bag

Driver and front passenger front air bags are deployed:

- in the event of certain frontal impacts
- if impact exceeds a preset deployment threshold
- independently of the side impact air bags

i The front air bags in this vehicle have been designed to inflate in two stages. This allows the air bag to have different rates of inflation that are based on the rate of vehicle deceleration as assessed by the air bag control unit.

USA only:

On the front passenger side, the front air bag deployment is additionally influenced by the passenger's weight category as identified by the Occupant Classification System (OCS) (> page 75).

USA only:

The lighter the front passenger side occupant, the higher the vehicle deceleration rate required for the second stage inflation of the air bag.

The air bags will not deploy in impacts which do not exceed the system's deployment thresholds. You will then be protected by the fastened seat belts.

The front passenger front air bag will only be deployed if:

- the system senses that the front passenger seat is occupied
- the **PASS AIR BAG OFF**  indicator lamp in the center console is not lit (> page 79)
- the impact exceeds a preset deployment threshold

! *Canada only:*

Do not place objects heavier than 20 lb (9 kg) on the front passenger seat. This could cause the front or side impact air bag on the front passenger side to deploy in a crash which exceeds the system's deployment threshold.

Side impact air bags, window curtain air bags

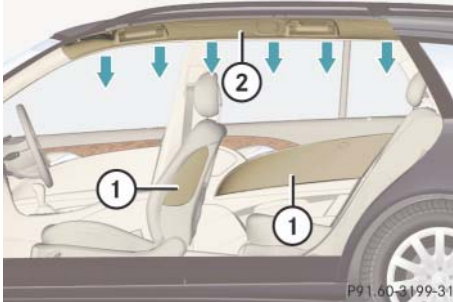

- ① Side impact air bags
- ② Window curtain air bag

The side impact air bags ① and window curtain air bags ② are deployed:

- on the impacted side of the vehicle
- in impacts exceeding a preset deployment threshold
- independently of the front air bags

In addition, the window curtain air bags ② are deployed:

- in certain vehicle rollovers

The side impact air bags ① and window curtain air bags ② are not deployed in impacts which do not exceed the system's deployment threshold.

Occupant Classification System (USA only)

The Occupant Classification System (OCS) automatically turns the front passenger front air bag on or off based on the classified occupant weight category determined by weight sensor readings from the front passenger seat.

i *The system does not deactivate the front passenger side impact air bag, the window curtain air bag and the emergency tensioning device.*

Occupants must sit properly belted in a position that is as upright as possible with their back against the seat backrest and feet on the floor to be correctly classified. If the occupant's weight is transferred to another object in the vehicle (e.g. by leaning on armrests), the OCS may not be able to properly approximate the occupant's weight category.

Occupant safety

Furthermore, the occupant weight may appear to increase or decrease due to objects hanging on the seat, other passengers pushing on the seat, objects lodged underneath the seat or stuffed between seat and middle console or between seat and door or due to objects applying pressure on the back of the seat. Always make sure that the seat has clearance in all directions at all times.



i *If your seat, including your trim cover and cushion needs to be serviced in any way, take the vehicle to your authorized Mercedes-Benz Center.*

Only seat accessories approved by Mercedes-Benz may be used.

Both driver and the front passenger should always use the **PASS AIR BAG OFF**  indicator lamp as an indication of whether or not the front passenger is properly positioned.

Warning!





If the **PASS AIR BAG OFF**  indicator lamp illuminates when an adult or someone larger than a small individual is in the front passenger seat, have the front passenger re-position himself or herself in the seat until the **PASS AIR BAG OFF**  indicator lamp goes out, or check whether objects are caught under or around the seat.

More information about air bag display messages (> page 401).

In the event of a collision, the air bag control unit will not allow front passenger front air bag deployment when the OCS classified the front passenger seat occupant as being up to or less than the weight of a typical 12-month-old child in a standard child restraint or if the front passenger seat is sensed as being empty.

When the OCS senses that the front passenger seat occupant is classified as being up to or less than the weight of a typical 12-month-old child in a standard child restraint, the **PASS AIR BAG OFF**  indicator lamp will illuminate when the engine is started and remain illuminated, indicating that the front passenger front air bag is deactivated.

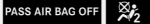
When the OCS senses that the front passenger seat is classified as being empty, the **PASS AIR BAG OFF**  indicator lamp will illuminate when the engine is started and remain illuminated, indicating that the front passenger front air bag is deactivated.

When the OCS senses that the front passenger seat occupant is classified as being heavier than the weight of a typical 12-month-old child seated in a standard child restraint or as being a small individual (such as a young teenager or a small adult), the  indicator lamp will illuminate for approximately 6 seconds when the engine is started and then, depending on occupant weight sensor readings from the seat, remain illuminated or go out. With the  indicator lamp illuminated, the front passenger front air bag is deactivated. With the  indicator lamp out, the front passenger front air bag is activated.

When the OCS senses that the front passenger seat occupant is classified as an adult or someone larger than a small individual, the  indicator lamp will illuminate for approximately 6 seconds when the engine is started and then go out, indicating that the front passenger front air bag is activated.

If the  indicator lamp is illuminated, the front passenger front air bag is deactivated and will not be deployed.

If the  indicator lamp is not illuminated, the front passenger front air bag is activated and will be deployed:

- in the event of certain frontal impacts
- if impact exceeds a preset deployment threshold
- independently of the side impact air bags

If the front passenger front air bag is deployed, the rate of inflation will be influenced by:

- the rate of relevant vehicle deceleration as assessed by the air bag control unit
- front passenger's weight category as identified by the Occupant Classification System (OCS).

Warning!



According to accident statistics, children are safer when properly restrained in the rear seating positions than in the front seating position. Thus, we strongly recommend that children be placed in the rear seats whenever possible. Regardless of seating position, children 12 years old and under must be seated and properly secured in an appropriate infant or child restraint recommended for the size and weight of the child.

The infant or child restraint must be properly secured with the vehicle's seat belt, the seat belt and top tether strap, or lower anchors and top tether strap, fully in accordance with the child seat manufacturer's instructions.

Always sit nearly upright, properly use the seat belts and for children 12 years old and under, use an appropriately sized infant restraint, toddler restraint, or booster seat recommended for the size and weight of the child.



Occupant safety



Children can be killed or seriously injured by an inflating air bag. Note the following important information when circumstances require you to place a child in the front passenger seat:

- Your vehicle is equipped with air bag technology designed to turn off the front passenger front air bag in your vehicle when the system senses the weight of a typical 12-month-old child or less along with the weight of a standard appropriate child restraint on the front passenger seat.
- A child in a rear-facing child restraint on the front passenger seat will be seriously injured or even killed if the front passenger front air bag inflates in a collision which could occur under some circumstances, even with the air bag technology installed in your vehicle. The only means to completely eliminate this risk is to never place a child in a rear-facing child restraint in the front seat. We therefore strongly recommend that you always place a child in a rear-facing child restraint in the back seat.

- If you must install a rear-facing child restraint on the front passenger seat because circumstances require you to do so, make sure that the

 indicator lamp is illuminated, indicating that the front passenger front air bag is deactivated. Should the indicator lamp not illuminate or go out while the restraint is installed, please check installation. Periodically check the indicator lamp while driving to make sure the lamp is illuminated. If the



 indicator lamp goes out or remains out, do not transport a child on the front passenger seat until the system has been repaired. A child in a rear-facing child restraint on the front passenger seat will be seriously injured or even killed if the front passenger front air bag inflates.

- If you have to place a child in a forward-facing child restraint on the front passenger seat, move the seat as far back as possible, use the proper child restraint recommended for the age, size and weight of the child, and secure child restraint with the vehicle's seat belt according to the child seat manufacturer's instructions. For children larger than the typical 12-month-old child, the front passenger front air bag may or may not be activated (▷ page 79).

i Deployment of the driver front air bag does not mean that the front passenger front air bag also should have deployed.

The Occupant Classification System (▷ page 75) may have determined:

- that the seat was empty or occupied by the weight up to or less than that of a typical 12-month-old child seated in a standard child restraint - both instances where the system suppresses deployment of the front passenger front air bag even though the impact met the criteria and was of sufficient severity to deploy the driver front air bag
- that the seat was occupied by a small individual (such as a young teenager or a small adult) or a child weighing more than the weight of a typical 12-month-old child in a standard child restraint - instances where the system may suppress deployment of the front passenger front air bag even though the impact met the criteria and was of sufficient severity to deploy the driver front air bag

The **PASS AIR BAG OFF**  indicator lamp is located in the center console.



① Indicator lamp

The **PASS AIR BAG OFF**  indicator lamp ① will be illuminated, except with the SmartKey removed or in starter switch position **0** (▷ page 37).

Warning!



If the **SRS** indicator lamp and the **PASS AIR BAG OFF**  indicator lamp are lit at the same time, there is a malfunction in the Occupant Classification System. The front passenger front air bag will be deactivated in this case.

In order to ensure proper operation of the air bag system and OCS:

- Have the system checked as soon as possible by qualified technicians. Contact an authorized Mercedes-Benz Center.
- Do not place more than 4.4 lb (2 kg) into the ruffled storage bag on the back of the front passenger seat. Otherwise, the OCS may not be able to properly approximate the occupant weight category.







Occupant safety



- Do not place objects under and/or around the front passenger seat.
- Do not hang anything from or attach any items to the seats.
- Do not stuff objects such as books between the middle console and the front passenger seat.
- Do not move the front passenger seat backwards against stiff objects.
- Sit properly belted in a nearly upright position with your back against the seat backrest.
- Do not lean on the armrests or lift yourself from the seat by using the handle over the door as this may cause the OCS to be unable to correctly approximate the occupant weight category.
- Only have the seat repaired or replaced by an authorized Mercedes-Benz Center.
- Read and observe all warnings in this chapter.

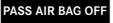

Self-test Occupant Classification System (USA only)

After turning the SmartKey in the starter switch to position **1** or **2** or pressing the KEYLESS-GO* start/stop button once or twice, the   indicator lamp located in the center console illuminates. If an adult occupant is properly sitting on the front passenger seat and the system senses the occupant as being an adult, the   indicator lamp will illuminate and go out after approximately 6 seconds.

If the seat is not occupied and the system senses the front passenger seat as being empty, the   indicator lamp will illuminate and not go out.

Warning!



If the   indicator lamp should not illuminate, the system is not functioning. You must see an authorized Mercedes-Benz Center before seating any child on the front passenger seat.

For more information, see the “Practical hints” section (▷ page 391).

Warning!



Never place anything between seat cushion and child seat (e.g. pillow), since it reduces the effectiveness of the Occupant Classification System. The bottom of the child seat must make full contact with the passenger seat cushion. An incorrectly mounted child seat could cause injuries to the child in case of an accident, instead of increasing protection for the child.

Follow the manufacturer’s instructions for installation of child seats.

BabySmart™ air bag deactivation system (Canada only)



① **PASS AIR BAG OFF**  indicator lamp

Special BabySmart™ compatible child seats, designed for use with the Mercedes-Benz system, are required for use with the BabySmart™ air bag deactivation system. Please contact your authorized Mercedes-Benz Center for information on availability. With the special child seat properly installed, the front passenger front air bag will not deploy.

The **PASS AIR BAG OFF**  indicator lamp located in the center console will be illuminated, except with the SmartKey removed or in starter switch position **0**.

i *The system does not deactivate the side impact air bag, the window curtain air bag and the emergency tensioning device.*

Self-test BabySmart™ without special child seat installed (Canada only)

After turning the SmartKey in the starter switch to position **1** or **2** or pressing the KEYLESS-GO* start/stop button once or twice, the **PASS AIR BAG OFF**  indicator lamp located in the center console comes on for approximately 6 seconds and then goes out.

If the **PASS AIR BAG OFF**  indicator lamp should not come on or is continuously lit, the system is not functioning. You must see an authorized Mercedes-Benz Center before seating any child on the passenger seat.

More information can be found in the “Practical hints” section (▷ page 393).

Warning!



The BabySmart™ air bag deactivation system will ONLY work with a special child seat designed to operate with it. It will not work with child seats which are not BabySmart™ compatible.

Never place anything between seat cushion and child seat (e.g. pillow), since it reduces the effectiveness of the deactivation system. The bottom of the child seat must make full contact with the passenger seat cushion. An incorrectly mounted child seat could cause injuries to the child in case of an accident, instead of protecting the child.

Follow the manufacturer's instructions for installation of special child seats.

Occupant safety

Warning!



When using a BabySmart™ compatible child seat on the front passenger seat, the front passenger front air bag will not deploy only if the **PASS AIR BAG OFF**  indicator lamp remains illuminated.

Please be sure to check the indicator every time you use the special system child seat. Should the indicator lamp go out while the restraint is installed, please check installation. If the indicator lamp remains out, do not use the BabySmart™ restraint to transport children on the front passenger seat until the system has been repaired.

Warning!



Do not place powered-on laptops, cell phones, electronic tags such as those used in ski passes and like electronic devices on the front passenger seat. Signals from such devices may interfere with the BabySmart™ system. Such signal interference may cause the **PASS AIR BAG OFF**  indicator lamp not to come on during self-test or be continuously lit, indicating that the system is not functioning.

Seat belts

The use of seat belts and infant and child restraint systems is required by law in all 50 states, the District of Columbia, the U.S. territories and all Canadian provinces.

Even where this is not the case, all vehicle occupants should have their seat belts fastened whenever the vehicle is in motion.

For more information, see “Fastening the seat belts” (▷ page 49).

 For information on infants and children traveling with you in the vehicle and restraint systems for infants and children, see “Children in the vehicle” (▷ page 88).

Warning!

Always fasten your seat belt before driving off. Always make sure your passenger is properly restrained.

Failure to wear and properly fasten and position your seat belt greatly increases your risk of injuries and their likely severity in an accident. You and your passengers should always wear seat belts.

If you are ever in an accident, your injuries can be considerably more severe without your seat belt properly buckled. Without your seat belt buckled, you are much more likely to hit the interior of the vehicle or be ejected from it. You can be seriously injured or killed.

In the same crash, the possibility of injury or death is lessened if you are properly wearing your seat belt. Air bags can only protect as they are designed if the occupants are properly wearing their seat belts.

Warning!

Never ride in a moving vehicle with the seat backrest in an excessively reclined position as this can be dangerous. You could slide under the seat belt in a collision. If you slide under it, the seat belt would apply force at the abdomen or neck. That could cause serious or even fatal injuries. The seat backrest and seat belt provide the best restraint when the wearer is in a nearly upright position and the seat belt is properly positioned on the body.

Warning!

Never let more people ride in the vehicle than there are seat belts available. Be sure everyone riding in the vehicle is correctly restrained with a separate seat belt. Never use a seat belt for more than one person at a time.

Warning!

Damaged seat belts or seat belts that were highly stressed in an accident must be replaced and their anchoring points must also be checked.

Only use seat belts which have been approved by Mercedes-Benz.

Do not make any modifications to the seat belts. This can lead to unintended activation or to failure.

Do not bleach or dye seat belts as this may severely weaken them. In a crash they may not be able to provide adequate protection.

Have all work carried out only by qualified technicians. Contact an authorized Mercedes-Benz Center.

Occupant safety

Warning!



USE SEAT BELTS PROPERLY

- Seat belts can only work when used properly. Never wear seat belts in any other way than as described in this section, as that could result in serious injuries in case of an accident.
- Each occupant should wear their seat belt at all times, because seat belts help reduce the likelihood of and potential severity of injuries in accidents, including rollovers. The integrated restraint system includes SRS (driver front air bag, front passenger front air bag, side impact air bags, window curtain air bags for side windows), ETD (seat belt emergency tensioning device), and front seat knee bolsters.

The system is designed to enhance the protection offered to properly belted occupants in certain frontal (front air bags and ETD) and side (side impact and window curtain air bags and ETD) impacts which exceed preset deployment thresholds and in certain rollovers (window curtain air bags and ETD).

- Never wear the shoulder belt under your arm, against your neck or off your shoulder. In a frontal crash, your body would move too far forward. That would increase the chance of head and neck injuries. The shoulder belt would also apply too much force to the ribs or abdomen, which could severely injure internal organs such as your liver or spleen.



- Never wear seat belts over rigid or breakable objects in or on your clothing, such as eyeglasses, pens, SmartKeys etc., as these might cause injuries.
- Position the lap belt as low as possible on your hips and not across the abdomen. If the lap belt is positioned across your abdomen, it could cause serious injuries in a crash.
- Never use a seat belt for more than one person at a time. Do not fasten a seat belt around a person and another person or other objects.
- Seat belts should not be worn twisted. In a crash, you wouldn't have the full width of the seat belt to distribute impact forces. The twisted seat belt against your body could cause injuries.

- Pregnant women should also always use a lap-shoulder belt. The lap belt portion should be positioned as low as possible on the hips to avoid any possible pressure on the abdomen.
- Never place your feet on the instrument panel, dashboard, or on the seat. Always keep both feet on the floor in front of the seat.
- When using a seat belt to secure infant restraint or toddler restraint or children in booster seats, always follow the child seat manufacturer's instructions.

When the engine is started, the seat belt telltale  will always illuminate for 6 seconds to remind you and your passengers to fasten your seat belts.

If the driver's seat belt is not fastened when the engine is started, an additional warning chime will also sound for a maximum of 6 seconds or until the driver's seat belt is fastened.

If after these 6 seconds the driver's or the front passenger's seat belt (with the front passenger seat occupied) is not fastened with front doors closed,

- the seat belt telltale  remains illuminated for as long as either the driver's or front passenger's seat belt is not fastened.
If you and/or your passenger release the seat belt during driving, the seat belt telltale  starts flashing and the warning chime sounds.
- and if the vehicle speed once exceeds 15 mph (25 km/h), the seat belt telltale  starts flashing and a warning chime sounds with increasing intensity for a maximum of 60 seconds or until the driver's and the front passenger's seat belt are fastened.

If the driver's or the front passenger's seat belt remains unfastened after 60 seconds, the warning chime stops sounding, the seat belt telltale  stops flashing but continues to be illuminated.

After a vehicle standstill the warning chime is reactivated and the seat belt telltale  is flashing again if the vehicle speed once exceeds 15 mph (25 km/h).

The seat belt telltale  will only go out if both the driver's and front passenger's seat belt (with the front passenger seat occupied) are fastened, or the vehicle is standing still and a front door is opened.

For more information, see "Practical hints" (▷ page 386).

Emergency Tensioning Device (ETD), seat belt force limiter

The seat belts for the front and second row outer seats are equipped with emergency tensioning devices and seat belt force limiters.

The ETD is designed to activate in the following cases:

- in frontal or rear-end impacts exceeding the system deployment threshold
- in certain vehicle rollovers

Occupant safety

- if the restraint systems are operational and functioning correctly, see **SRS** indicator lamp (▷ page 68)

i *The ETDs for the front seats will only activate if the front seat belts are fastened (latch plate properly inserted into buckle).*

The ETDs for the second row outer seats will activate with or without the respective seat belts fastened.

In an impact, emergency tensioning devices remove slack from the seat belts. Seat belt force limiters reduce the peak force exerted by the seat belts on occupants during a crash.

Warning!



An emergency tensioning device (ETD) that was activated must be replaced.

When disposing of the emergency tensioning device, our safety instructions must be followed. These are available at your authorized Mercedes-Benz Center.

Automatic comfort-fit feature seat belt

An automatic comfort-fit feature for front seats reduces the retracting force of the seat belts when they are in normal use.

Preventive occupant safety (PRE-SAFE®)

Warning!



The PRE-SAFE® system is intended to reduce the effects of a crash on properly seat-belted vehicle occupants. Despite having the PRE-SAFE® system in your vehicle, the possibility of injuries occurring as a result of an accident cannot be eliminated. Therefore, you should always drive carefully and adjust your driving to the prevailing road, weather, and traffic conditions.

Your vehicle automatically takes preventive measures to better protect the occupants in the following hazardous situations:

- You execute an emergency braking maneuver and the Brake Assist System (▷ page 99) is activated.
- The PRE-SAFE® system detects a critical driving dynamics situation.

In such cases, the following systems are automatically activated:

- The front seat belts are pre-tensioned electrically.
- If the vehicle is in a severe skid or is spinning, the door windows and the tilt/sliding sunroof close until a small gap remains.

i *If the closing procedure of the tilt/sliding sunroof or door window is blocked, the tilt/sliding sunroof or door window will stop and open slightly.*

Vehicles with front passenger seat memory function*:

- If seat is in an unfavorable position, it will be adjusted to a better position.

i *The PRE-SAFE® system is activated in the previously described circumstances only at speeds exceeding 20 mph (30 km/h).*

When the critical driving dynamic situation has passed without an accident occurring, the pre-tensioning on the seat belts is deactivated.

You can then adjust the seat, the door windows and the tilt/sliding sunroof to their previous position.

If the seat belts do not release:

- ▶ Adjust the backrest or seat slightly to the rear until the seat belt tension is diminished.

The locking mechanism releases.

Active head restraints

The active head restraints offer the driver and front passenger increased protection from whiplash type injuries. In the event of a rear-end collision, the head restraints on the driver's and front passenger's seats are designed to move forward in the direction of travel, providing the head with increased support earlier on in the collision

sequence. The active head restraints move forward whether the seat is occupied or not.

Warning!



Do not attach any objects (e.g. hangers) to the head restraint posts. Otherwise, the active head restraints may not function properly or offer the degree of protection they were designed for in the event of a collision.

Warning!



Only use seat or head restraint covers which have been tested and approved by Mercedes-Benz for your vehicle model. Using other seat or head restraint covers may interfere with or prevent the activation of the active head restraints. Contact your authorized Mercedes-Benz Center for availability.

Occupant safety

For information on resetting the activated active head restraints, see “Resetting activated head restraints” (▷ page 439).

You cannot remove the active head restraint on the driver’s and front passenger’s seats.

For removal of the active head restraints we recommend that you contact an authorized Mercedes-Benz Center.

Warning!



For your protection, drive only with properly positioned head restraints.

Adjust the head restraint so that the center of the head restraint supports the back of the head at eye level. This will reduce the potential for injury to the head and neck in the event of an accident or similar situation.

Do not drive the vehicle without the seat head restraints. Head restraints are intended to help reduce injuries during an accident.

For information on head restraint adjustment, see “Seats” (▷ page 41).

Children in the vehicle

If an infant or child is traveling with you in the vehicle:

- ▶ Secure the child using an infant or child restraint appropriate to the age and size of the child.
- ▶ Make sure that the infant or child is properly secured at all times while the vehicle is in motion.

Infant and child restraint seats and information on choosing an appropriate restraint system can be obtained from any Mercedes-Benz Center.

Warning!



Do not leave children unattended in the vehicle, even if they are secured in a child restraint system. The children could

- injure themselves on parts of the vehicle
- be seriously or fatally injured through excessive exposure to extreme heat or cold

Do not expose the child restraint system to direct sunlight. The child restraint system's metal parts, for example, could become very hot, and the child could be burned on these parts.

If children open a door, they could

- injure other persons
- get out of the car and injure themselves or be injured by following traffic

Do not carry heavy or hard objects in the passenger or cargo compartment unless they are firmly secured in place. For more information, see “Loading” (▷ page 266) and “Useful features” (▷ page 280).

Unsecured or improperly positioned cargo increases a child's risk of injury in the event of

- strong braking maneuvers
- sudden changes of direction
- an accident

Infant and child restraint systems

We recommend all infants and children be properly restrained at all times while the vehicle is in motion.

Canada only:

Use only a BabySmart™ compatible child restraint for the front passenger seat in this vehicle.

All lap-shoulder belts except the driver's seat belt have special seat belt retractors for secure fastening of child restraints.

To fasten a child restraint, follow child restraint instructions for mounting. Then pull the shoulder belt out completely and let it retract. During seat belt retraction, a ratcheting sound can be heard to indicate that the special seat belt retractor is activated. The seat belt is now locked. Push down on child restraint to take up any slack.

To deactivate, release seat belt buckle and let seat belt retract completely. The seat belt can again be used in the usual manner.

Warning!



Never release the seat belt buckle while the vehicle is in motion, since the special seat belt retractor will be deactivated.

i *Information on child seats with mounting fittings for tether anchorages (▷ page 92).*

For information on LATCH-type child seat anchors (▷ page 94).

The use of infant or child restraints is required by law in all 50 states, the District of Columbia, the U.S. territories and all Canadian provinces.

Infants and small children should be seated in an appropriate infant or child restraint system properly secured in accordance with the manufacturer's instructions for the child restraint, that complies with U.S. Federal Motor Vehicle

Occupant safety

Safety Standards 213 and 225 and Canadian Motor Vehicle Safety Standards 213 and 210.2.

A statement by the child restraint manufacturer of compliance with these standards can be found on the instruction label on the restraint and in the instruction manual provided with the restraint.

When using any infant or child restraint system, be sure to carefully read and follow all manufacturer's instructions for installation and use.

Please read and observe warning labels affixed to the inside of the vehicle and to infant or child restraints.

Warning!



Canada only: Children 12 years old and under must never ride in the front seat, except in a Mercedes-Benz authorized BabySmart™ compatible child seat, which operates with the BabySmart™ system installed in the vehicle to deactivate the front passenger front air bag when it is properly installed. Otherwise they will be struck by the air bag when it inflates in a crash. If this happens, serious or fatal injury will result.

According to accident statistics, children are safer when properly restrained in the rear seating positions than in the front seating position. Thus, we strongly recommend that children be placed in the rear seats whenever possible. Regardless of seating position, children 12 years old and under must be seated and properly secured in an appropriate infant or child restraint recommended for the size and weight of the child.

Always sit nearly upright, properly use the seat belts and for children 12 years old and under, use an appropriately sized infant restraint, toddler restraint, or booster seat recommended for the size and weight of the child.

The infant or child restraint must be properly secured with the vehicle's seat belt, the seat belt and top tether strap, or lower anchors and top tether strap, fully in accordance with the child seat manufacturer's instructions.

Children can be killed or seriously injured by an inflating air bag. Note the following important information when circumstances require you to place a child in the front passenger seat:

- USA only: Your vehicle is equipped with air bag technology designed to turn off the front passenger front air bag in your vehicle when the OCS senses the weight of a typical 12-month-old child or less along with the weight of a standard appropriate child restraint on the front passenger seat.

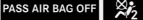
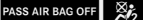
- A child in a rear-facing child restraint on the front passenger seat will be seriously injured or even killed if the front passenger front air bag inflates in a collision which could occur under some circumstances, even with the air bag technology installed in your vehicle. The only means to completely eliminate this risk is to never place a child in a rear-facing child restraint in the front seat. We therefore strongly recommend that you always place a child in a rear-facing child restraint in the back seat.
- If you must install a rear-facing child restraint on the front passenger seat because circumstances require you to do so, make sure that the  indicator lamp is illuminated, indicating that the front passenger front air bag is deactivated. Should the light not illuminate or go out while the restraint is installed, please check installation. Periodically check the indicator lamp while driving to make sure the lamp is illuminated. If the  indicator lamp goes out or remains out, do not transport a child on the front passenger seat until the system has been repaired. A child in a rear-facing child restraint on the front passenger seat will be seriously injured or even killed if the front passenger front air bag inflates.
- If you have to place a child in a forward-facing child restraint on the front passenger seat, move the seat as far back as possible, use the proper child restraint recommended for the age, size and weight of the child, and secure child restraint with the vehicle's seat belt according to the child seat manufacturer's instructions. For children larger than the typical 12-month-old child, the front passenger front air bag may or may not be activated (▷ page 79).

Occupant safety

Warning!



Infants and small children should never share a seat belt with another occupant. During an accident, they could be crushed between the occupant and seat belt.

A child's risk of serious or fatal injuries is significantly increased if the child restraints are not properly secured in the vehicle and the child is not properly secured in the child restraint.

Children too big for a toddler restraint must ride in seats using regular seat belts. Position shoulder belt across chest and shoulder, not face or neck. A booster seat may be necessary to achieve proper seat belt positioning for children over 41 lb until they reach a height where a lap/shoulder belt fits properly without a booster.

When the child restraint is not in use, remove it from the vehicle or secure it with the seat belt to prevent the child restraint from becoming a projectile in the event of an accident.

Do not leave children unattended in the vehicle, even if the children are secured in a child restraint system. Unsupervised children in a child restraint system may use vehicle equipment and may cause an accident and/or serious personal injury.

Installation of infant and child restraint systems

Prior to installing a tether strap, note the following steps:

- ▶ Roll up retractable luggage cover and partition net.
- ▶ Remove storage box (if so equipped) (▷ page 275).

If the storage box is not removed:

- the top tether anchorage ring located on the floor (▷ page 93) for use with a child restraint in the rear center seat position cannot be accessed.
- the hook of the top tether strap when attached to the anchorage ring on an outer rear seat backrest may push against the storage box and prevent the backrest from properly locking into position.
- ▶ If you place a child seat in the left or center rear seat position, remove twin roller blind (▷ page 276) and return seat to its original position.

! Do not reinstall twin roller blind with a child seat and top tether installed in the left and center rear seat position.

- ▶ If you place a child seat in the right rear seat position, the twin roller blind can remain installed if so desired.
- ▶ Fold the rear backrest slightly forward (▷ page 266).
- ▶ Guide top tether strap between head restraint and top of seat back.

Head restraints must be installed (if removable) and positioned such that the top tether strap can pass freely between the head restraint and top of the seat back.

Make sure the tether strap is not twisted.

- ▶ Fold the rear backrest back until it locks in place (▷ page 267).

i With a child seat and top tether installed in the right rear seat position and twin roller blind installed, make sure the top tether strap is positioned between seat backrest and twin roller blind.

Warning!



Always lock backrest in its upright position when rear seat bench is occupied by passengers, or the extended cargo compartment is not in use. Check for secure locking by pushing and pulling on the backrest.

Anchorage rings ① are located on the back side of the outer rear backrests and on the floor behind the rear center seat.

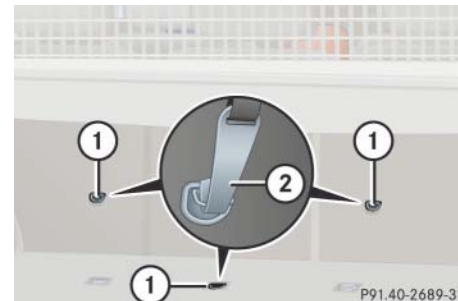

① Anchorage ring

② Hook

- ▶ Fold up anchorage ring ①.
- ▶ Securely fasten hook ②, which is part of the tether strap, to anchorage ring ①.

Occupant safety

i For safety, make sure the hook has attached to the ring beyond the safety catch, as illustrated below.

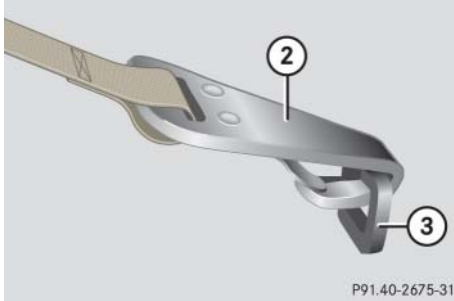

- ① Anchorage ring
- ② Hook

Once the top tether anchorage hook is attached, the child restraint itself can be secured.

- ▶ Install the child restraint system and tighten the top tether strap according to the child restraint manufacturer's instructions.

Child seat anchors - LATCH type

This vehicle is equipped with two LATCH (Lower Anchors and Tethers for Children) type anchors (at each of the outer second row seats) for the installation of a "LATCH" child seat with the matching mounting fittings.

The anchors are located behind an upholstery blend.

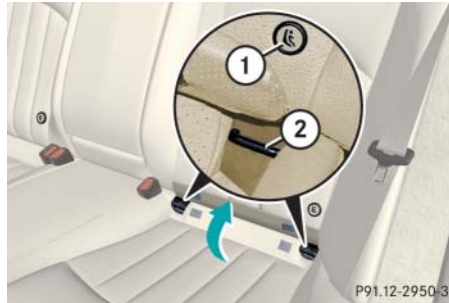

- ① Indicates the position of the anchors
- ② Anchors

- ▶ Lift up upholstery blend to access the anchors ②.

- ▶ Install child seat according to the manufacturer's instructions.

i Make sure the seat belt for the center seat can operate freely with a child seat installed.

i Non-LATCH type child seats may also be used and can be installed using the vehicle's seat belt system (▷ page 89). Install child seat according to the manufacturer's instructions.

Warning!

Children too big for a toddler restraint must ride in seats using regular seat belts. Position shoulder belt across chest and shoulder, not face or neck. A booster seat may be necessary to achieve proper seat belt positioning for children over 41 lb until they reach a height where a lap/shoulder belt fits properly without a booster.

Install child seat according to manufacturer's instructions.

The child seat must be firmly attached to the right and left side anchors ②.

An incorrectly mounted child seat may come loose during an accident which could result in serious injury or death to the child.

Damaged or impact damaged child seats or child seat mounting fittings must be replaced.

Do not leave children unattended in the vehicle, even if the children are secured in a child restraint system.

Blocking of rear door window operation

- ① Override switch
- ② Indicator lamp

▶ Press override switch ①.

Indicator lamp ② comes on. The rear door windows can no longer be operated using the switches located in the rear doors.

! *Operation of the rear door windows with the switches located on the door control panel of the driver's door is still possible.*

Warning!

Activate the override switch when children are riding in the back seats of the vehicle. The children may otherwise injure themselves, e.g. by becoming trapped in the window opening.

When leaving the vehicle, always remove the SmartKey or SmartKey with KEYLESS-GO* from the starter switch, take it with you, and lock the vehicle. Do not leave children unattended in the vehicle, or with access to an unlocked vehicle. A child's unsupervised access to a vehicle could result in an accident and/or serious personal injury.

For more information on power windows, see the "Controls in detail" section (▷ page 239).

Panic alarm



① PANIC button

i USA only:

This device complies with Part 15 of the FCC Rules. Operation is subject to the following two conditions:

- (1) This device may not cause harmful interference, and
- (2) this device must accept any interference received, including interference that may cause undesired operation.

Any unauthorized modification to this device could void the user's authority to operate the equipment.

i Canada only:

This device complies with RSS-210 of Industry Canada. Operation is subject to the following two conditions:

- (1) This device may not cause interference, and
- (2) this device must accept any interference received, including interference that may cause undesired operation of the device.

Any unauthorized modification to this device could void the user's authority to operate the equipment.

Activating

- ▶ Press and hold button ① for at least 1 second.

An audible alarm and flashing exterior lamps will operate briefly.

Deactivating

- ▶ Press button ① again.

or

- ▶ Insert the SmartKey or the SmartKey with KEYLESS-GO* in the starter switch.

or

- ▶ Press the KEYLESS-GO* start/stop button.

The SmartKey with KEYLESS-GO* must be inside the vehicle.

▼ Driving safety systems

In this section you will find information on the following driving safety systems:

- ABS (Antilock Brake System)
- Adaptive Brake
- BAS (Brake Assist System)
- EBP (Electronic Brake Proportioning)
- ESP® (Electronic Stability Program)
- 4MATIC (Four Wheel Electronic Traction System)

Warning!



The following factors increase the risk of accidents:

- Excessive speed, especially in turns
- Wet and slippery road surfaces
- Following another vehicle too closely

The ABS, BAS, ESP®, Adaptive Brake, and 4MATIC cannot reduce this risk.

Always adjust your driving style to the prevailing road and weather conditions.

i In winter operation, the maximum effectiveness of the ABS, the BAS, the EBP, the ESP®, and 4MATIC is only achieved with winter tires (> page 363), or snow chains as required.

ABS

Warning!



Do not pump the brake pedal. Use firm, steady brake pedal pressure instead. Pumping the brake pedal defeats the purpose of the ABS and significantly reduces braking effectiveness.

The Antilock Brake System (ABS) regulates the brake pressure so that the wheels do not lock during braking. This allows you to maintain the ability to steer your vehicle.

The ABS is functional above a speed of approximately 5 mph (8 km/h) independent of road surface conditions.

On slippery road surfaces, the ABS will respond even to light brake pressure.

The  indicator lamp in the instrument cluster comes on when you switch on the ignition. It goes out when the engine is running.

Driving safety systems

Braking

At the instant one of the wheels is about to lock up, a slight pulsation can be felt in the brake pedal, indicating that the ABS is in the regulating mode.

- ▶ Keep firm and steady pressure on the brake pedal while experiencing the pulsation.

Continuous, steady brake pedal pressure yields the advantages provided by the ABS, namely braking power and the ability to steer the vehicle.

The pulsating brake pedal can be an indication of hazardous road conditions and functions as a reminder to take extra care while driving.

Emergency brake maneuver

- ▶ Keep continuous full pressure on the brake pedal.

Warning!



When the ABS is malfunctioning, the BAS and the ESP® are also switched off.

When the ABS is malfunctioning, the wheels may lock during hard braking, reducing steering capability and extending the braking distance.

Warning!



The ABS cannot prevent the natural laws of physics from acting on the vehicle, nor can it increase braking or steering efficiency beyond that afforded by the condition of the vehicle brakes and tires or the traction afforded. The ABS cannot prevent accidents, including those resulting from excessive speed in turns, following another vehicle too closely, or hydroplaning. Only a safe, attentive, and skillful driver can prevent accidents. The capabilities of an ABS equipped vehicle must never be exploited in a reckless or dangerous manner which could jeopardize the user's safety or the safety of others.

For more information, see the “Practical hints” section (▷ page 378).

BAS

The Brake Assist System (BAS) operates in emergency situations. If you apply the brakes very quickly, the BAS automatically provides full brake boost, thereby potentially reducing the braking distance.

- ▶ Apply continuous full braking pressure until the emergency braking situation is over.

The ABS will prevent the wheels from locking.

When you release the brake pedal, the brakes function again as normal. The BAS is then deactivated.

Warning!



If the BAS is malfunctioning, the brake system is still functioning normally, but without the additional brake boost available that BAS would normally provide in an emergency braking maneuver. Therefore, the braking distance may increase.

Warning!



The BAS cannot prevent the natural laws of physics from acting on the vehicle, nor can it increase braking efficiency beyond that afforded by the condition of the vehicle brakes and tires or the traction afforded. The BAS cannot prevent accidents, including those resulting from excessive speed in turns, following another vehicle too closely, or hydroplaning. Only a safe, attentive, and skillful driver can prevent accidents. The capabilities of a BAS equipped vehicle must never be exploited in a reckless or dangerous manner which could jeopardize the user's safety or the safety of others.

Adaptive Brake

Adaptive Brake provides a high level of braking safety as well as increased braking comfort.

Important notes on using the brake system

- Following extended periods of only minor loads to your brake system, you should occasionally apply the brakes when traveling at high speeds. This improves the grip of the brake pads.

Warning!



Make sure not to endanger any other road users when carrying out these braking maneuvers.

Driving safety systems

- After driving on wet or snow-covered roads, you should apply your brakes firmly before parking your vehicle. This produces heat which serves to dry the brake disks and help prevent corrosion.
- On long and steep grades, shift to a lower gear (gear range **1**, **2**, or **3**) to prevent the brakes from overheating and to reduce brake wear.
- After hard braking, it is advisable to drive on for some time so that the air stream will cool down the brakes faster.
- Only Mercedes-Benz approved components (e.g. brake pads) should be installed on your vehicle. Brake pads not approved by Mercedes-Benz may impair the safety of your vehicle.

EBP

The Electronic Brake Proportioning (EBP) enhances braking effectiveness by allowing the rear brakes to supply a greater proportion of the braking effort in straight line breaking without a loss of vehicle stability.

Warning!



When the EBP is malfunctioning, the ABS, BAS, and ESP® are also switched off.

If the EBP is malfunctioning, the brake system will still function with full brake boost. However, the rear wheels could lock up during emergency braking situations, for example. You could lose control of the vehicle and cause an accident. Adapt your driving style to the changed driving characteristics.

ESP®

The Electronic Stability Program (ESP®) is operational as soon as the engine is running and monitors the vehicle's traction (force of adhesive friction between the tires and the road surface) and handling.

The ESP® recognizes when a wheel is spinning or if the vehicle starts to skid. By applying the brakes to the appropriate wheel and by limiting engine output, the ESP® works to stabilize the vehicle. The ESP® is especially useful while driving off and on wet or slippery road surfaces. The ESP® also stabilizes the vehicle during braking maneuvers.

The ESP® warning lamp  in the instrument cluster flashes when the ESP® is engaged.

The ESP® warning lamp  in the instrument cluster comes on when you switch on the ignition. It goes out when the engine is running.

Warning!

Never switch off the ESP[®] when you see the ESP[®] warning lamp  flashing in the instrument cluster. In this case proceed as follows:

- While driving off, apply as little throttle as possible.
- While driving, ease up on the accelerator.
- Adapt your speed and driving style to the prevailing road conditions.

Failure to observe these guidelines could cause the vehicle to skid.

The ESP[®] cannot prevent accidents resulting from excessive speed.

Warning!

The ESP[®] cannot prevent the natural laws of physics from acting on the vehicle, nor can it increase the traction afforded. The ESP[®] cannot prevent accidents, including those resulting from excessive speed in turns, or hydroplaning. Only a safe, attentive, and skillful driver can prevent accidents. The capabilities of an ESP[®] equipped vehicle must never be exploited in a reckless or dangerous manner which could jeopardize the user's safety or the safety of others.

! *The ESP[®] will only function properly if you use wheels of the recommended tire size (▷ page 480).*

! *Vehicles without 4MATIC:*

Because the ESP[®] operates automatically, the engine and the ignition must be shut off (SmartKey in starter switch position 0 or 1 or KEYLESS-GO start/stop button in position 0 or 1) when:*

- *the parking brake is being tested on a brake test dynamometer*
- *the vehicle is being towed with the front axle raised*

Active braking action through the ESP[®] may otherwise seriously damage the brake system.

For information on vehicles with 4MATIC, see "Four wheel electronic traction system (4MATIC) with the ESP[®]" (▷ page 104).

For more information, see the "Practical hints" section (▷ page 379) and (▷ page 400).

Driving safety systems

Switching off the ESP®

Switching off the ESP® (except E 63 AMG)

Warning!



The ESP® should not be switched off during normal driving other than in the circumstances described below. Disabling of the system will reduce vehicle stability in driving maneuvers.

Do not switch off the ESP® when a spare wheel is mounted.

To improve the vehicle's traction, switch off the ESP® in driving situations where it would be advantageous to have drive wheels spin and thus cut into surfaces for better grip such as:

- when driving with snow chains
- in deep snow
- in sand or gravel

Warning!



Switch on the ESP® immediately if the aforementioned circumstances do not apply anymore. Otherwise the ESP® will not stabilize the vehicle when it is starting to skid or a wheel is spinning.

When you switch off the ESP®

- the ESP® does not stabilize the vehicle
- the engine output is not limited, which allows the drive wheels to spin and thus cut into surfaces for better grip
- the traction control will still apply the brakes to a spinning wheel
- the ESP® continues to operate when you are braking
- you cannot activate the cruise control or the DISTRONIC*
- the cruise control or DISTRONIC* switch off if currently activated

i When the ESP® is switched off and one or more drive wheels are spinning, the ESP® warning lamp  in the instrument cluster flashes. However, the ESP® will then not stabilize the vehicle.

The switch is located on the center console.



① ESP® switch

- ▶ With the engine running, press ESP® switch ① until the ESP® warning lamp  in the instrument cluster comes on.

The ESP® is switched off.

Warning!

When the ESP® warning lamp  is illuminated continuously, the ESP® is switched off or is not operational due to a malfunction. Vehicle stability in standard driving maneuvers is reduced.

Adapt your speed and driving to the prevailing road conditions and to the non-operating status of the ESP®.

! *Avoid spinning of a drive wheel for an extended period with the ESP® switched off. This may cause serious damage to the drivetrain which is not covered by the Mercedes-Benz Limited Warranty.*

Switching off the ESP® (E 63 AMG only)**Warning!**

The ESP® should not be switched off during normal driving. Disabling of the system will result in the following:

- no restriction to engine torque
- loss of system supported traction control

“ESP® OFF” is designed for driving on closed tracks when the vehicle’s natural oversteer and understeer characteristics are desired and requires a highly skilled and experienced driver able to handle these critical driving situations.

You could lose control of your vehicle and cause an accident.

Please be aware of these limits when you switch off the ESP®.

Do not switch off the ESP® when a spare wheel is mounted.

When you switch off the ESP®

- the ESP® does not stabilize the vehicle
- the engine output is not limited, which allows the drive wheels to spin
- the traction control will still apply the brakes to a spinning wheel
- the ESP® operates while you are braking
- you cannot activate the cruise control or the DISTRONIC*
- the cruise control or DISTRONIC* switch off if currently activated

i *When the ESP® is switched off and one or more drive wheels are spinning, the ESP® warning lamp  in the instrument cluster flashes. However, the ESP® will then not stabilize the vehicle.*

Driving safety systems

The switch is located on the center console.



① ESP® switch

- ▶ With the engine running, press ESP® switch ① until the ESP® warning lamp  in the instrument cluster comes on.

The ESP® is switched off.

Warning!



When the ESP® warning lamp  is illuminated continuously, the ESP® is switched off or is not operational due to a malfunction. Vehicle stability in standard driving maneuvers is reduced.

Adapt your speed and driving to the prevailing road conditions and to the non-operating status of the ESP®.

! *Avoid spinning of a drive wheel for an extended period with the ESP® switched off. This may cause serious damage to the drivetrain which is not covered by the Mercedes-Benz Limited Warranty.*

Switching on the ESP®

- ▶ Press ESP® switch ① until the ESP® warning lamp  in the instrument cluster goes out.

You are now again in normal driving mode with the ESP® switched on.

Four wheel electronic traction system (4MATIC) with the ESP®

Models with all-wheel-drive only.

The 4MATIC improves the vehicle's ability to use available traction, e.g. during winter operation in mountains under slippery road conditions, by applying power to all four wheels.

Warning!



If you see the ESP® warning lamp  flashing in the instrument cluster, proceed as follows:

- While driving off, apply as little throttle as possible.
- While driving, ease up on the accelerator.
- Adapt your speed and driving style to the prevailing road conditions.

Failure to observe these guidelines could cause the vehicle to skid.

The ESP® cannot prevent accidents resulting from excessive speed.

! Do not tow with one axle raised.

Otherwise the transfer case can be damaged, which is not covered by the Mercedes-Benz Limited Warranty.

! Performance testing must only be conducted on a two-axle dynamometer.

Otherwise the transfer case can be damaged, which is not covered by the Mercedes-Benz Limited Warranty.

! Because the ESP® operates automatically, the engine and the ignition must be shut off (SmartKey in starter switch position **0** or **1** or KEYLESS-GO start/stop button* in position **0** or **1**) when the parking brake is being tested on a brake test dynamometer.

Active braking action through the ESP® may otherwise seriously damage the brake system.

Operational tests with the engine running can only be conducted on a two-axle dynamometer.

Anti-theft systems

Immobilizer

The immobilizer prevents unauthorized persons from starting your vehicle.

Activating

With the SmartKey

- ▶ Remove the SmartKey from the starter switch.

*With KEYLESS-GO**

- ▶ Turn off the engine by means of the start/stop button on the gear selector lever.
- ▶ Open the driver's door.

Deactivating

With the SmartKey

- ▶ Switch on the ignition.

*With KEYLESS-GO**

- ▶ Start the engine by means of the start/stop button on the gear selector lever.

i *In case the engine cannot be started (yet the vehicle's battery is charged), the system is not operational. Contact an authorized Mercedes-Benz Center or call 1-800-FOR-MERCEdes (in the USA), or 1-800-387-0100 (in Canada).*

Anti-theft alarm system

Once the alarm system has been armed, a visual and audible alarm is triggered when someone opens:

- a door
- the tailgate
- the hood

The alarm will stay on, even if the activating element (a door, for example) is immediately closed.

The alarm system will also be triggered when

- the vehicle is opened using the mechanical key
- someone opens a door from the inside

i If the alarm stays on for more than 30 seconds, a call to the Response Center is initiated automatically by the Tele Aid system (▷ page 292) provided Tele Aid service was subscribed to and properly activated, and that necessary cellular service and GPS coverage are available.

Arming the alarm system

The indicator lamp located in the central locking switch in the center console.



① Indicator lamp

- ▶ Lock the vehicle with the SmartKey or KEYLESS-GO*.

The turn signal lamps flash three times to indicate that the alarm system is armed. The indicator lamp ① begins to flash after approximately 30 seconds after arming the alarm system.

i If the turn signal lamps do not flash three times, one of the following elements may not be properly closed:

- a door
- the tailgate

Close the respective element and lock the vehicle again.

Disarming the alarm system

- ▶ Unlock the vehicle with the SmartKey or KEYLESS-GO*.

The turn signal lamps flash once to indicate that the alarm system is disarmed.

i The alarm system will rearm automatically after approximately 40 seconds if neither a door nor the tailgate was opened.

Canceling the alarm

With the SmartKey

- ▶ Insert the SmartKey in the starter switch.

or

- ▶ Press button  or  on the SmartKey.

With KEYLESS-GO*

- ▶ Pull an outside door handle.

The SmartKey with KEYLESS-GO must be within 3 ft (1 m) of the vehicle.

or

- ▶ Press the KEYLESS-GO* start/stop button (▷ page 39).

The SmartKey with KEYLESS-GO must be inside the vehicle.

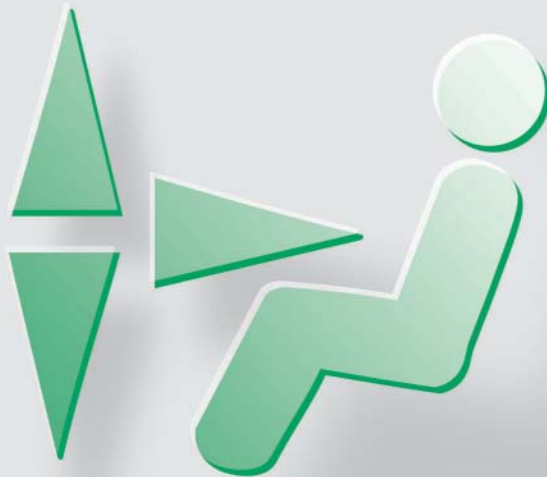

Locking and unlocking

Seats

Memory function

Lighting

Instrument cluster

Control system

Automatic transmission

Good visibility

Dual-zone automatic climate control

4-zone automatic climate control

Power windows

Power tilt/sliding sunroof

Driving systems

Loading

Useful features

Locking and unlocking

In the “Controls in detail” section you will find detailed information on how to operate the equipment installed on your vehicle. If you are already familiar with the basic functions of your vehicle, this section will be of particular interest to you.

To quickly familiarize yourself with the basic functions of the vehicle, refer to the “Getting started” section of this manual. The corresponding page numbers are given at the beginning of each segment.

For more information on locking and unlocking, see “Getting started” (▷ page 36) and (▷ page 61).

SmartKey

Your vehicle comes supplied with two SmartKeys, each with remote control and a removable mechanical key.

The locking tabs for the mechanical key portion of the two SmartKeys are a different color to help distinguish each SmartKey unit.

The SmartKey provides an extended operating range. To prevent theft, however, it is advisable to only unlock the vehicle when you are in close proximity to it.

The SmartKey centrally locks and unlocks

- the doors
- the tailgate
- the fuel filler flap



P80.35-2276-31

SmartKey with remote control

- ① Lock button
- ② Opening button for the tailgate
- ③ Mechanical key locking tab
- ④ Unlock button
- ⑤ Battery check lamp
- ⑥ PANIC button (▷ page 96)

! To prevent possible malfunction, avoid exposing the SmartKey to high levels of electromagnetic radiation.

Warning!

When leaving the vehicle, always remove the SmartKey from the starter switch, take it with you and lock the vehicle. Do not leave children unattended in the vehicle, or with access to an unlocked vehicle. It is possible for children to open a locked door from the inside, which could result in an accident and/or serious personal injury.

i USA only:

This device complies with Part 15 of the FCC Rules. Operation is subject to the following two conditions:

- (1) This device may not cause harmful interference, and*
- (2) this device must accept any interference received, including interference that may cause undesired operation.*

Any unauthorized modification to this device could void the user's authority to operate the equipment.

i Canada only:

This device complies with RSS-210 of Industry Canada. Operation is subject to the following two conditions:

- (1) This device may not cause interference, and*
- (2) this device must accept any interference received, including interference that may cause undesired operation of the device.*

Any unauthorized modification to this device could void the user's authority to operate the equipment.

i *You can also open and close the windows and tilt/sliding sunroof using the SmartKey (▷ page 241).*

! *If you can no longer lock or unlock the vehicle with the SmartKey, then the batteries in the SmartKey are discharged, the SmartKey is malfunctioning or the vehicle battery is drained.*

- *Check the batteries in the SmartKey (▷ page 119) and replace them if necessary (▷ page 440).*
- *Use the mechanical key to unlock the driver's door (▷ page 435).*
- *Use the mechanical key to lock the driver's door.*
- *Have the vehicle battery checked by an authorized Mercedes-Benz Center.*

If the SmartKey is malfunctioning, contact an authorized Mercedes-Benz Center.

Locking and unlocking

Factory setting

i When unlocking or locking the vehicle with the SmartKey an acoustic signal sounds. The acoustic signal is activated at the factory. If you wish to deactivate the feature, or adjust its signal volume, contact an authorized Mercedes-Benz Center.

Global unlocking

- ▶ Press button .
- All turn signal lamps flash once.
- An acoustic signal sounds once.
- The locking knobs in the doors move up.
- The anti-theft alarm system is disarmed.

The vehicle will lock again automatically and rearm the anti-theft alarm system within approximately 40 seconds of unlocking if:

- neither a door nor the tailgate is opened
- the SmartKey is not inserted in the starter switch
- the central locking switch is not activated

Global locking



- ▶ Press button .

With the tailgate and all doors closed:

- All turn signal lamps flash three times.
- An acoustic signal sounds three times.
- The locking knobs in the doors move down.
- The anti-theft alarm system is armed.

Selective setting

If you frequently travel alone, you may wish to reprogram the SmartKey so that pressing  only unlocks the driver's door and the fuel filler flap.

- ▶ Press and hold buttons  and  simultaneously for about 5 seconds until battery check lamp  (▷ page 110) flashes twice.

The SmartKey will then function as follows:

Unlocking driver's door and fuel filler flap

- ▶ Press button  once.
 - All turn signal lamps flash once.
 - An acoustic signal sounds once.
 - The locking knob in the driver's door moves up.
 - The anti-theft alarm system is disarmed.

Global unlocking



- ▶ Press button  twice.
 - All turn signal lamps flash once.
 - An acoustic signal sounds once.

- The locking knobs in the doors move up.
- The anti-theft alarm system is disarmed.

Global locking

- ▶ Press button .
 - All turn signal lamps flash three times.
 - An acoustic signal sounds three times.
 - The locking knobs in the doors move down.
 - The anti-theft alarm system is armed.

Restoring to factory setting

- ▶ Press and hold buttons  and  simultaneously for about 5 seconds until battery check lamp  (▷ page 110) flashes twice.

SmartKey with KEYLESS-GO*

Vehicles equipped with KEYLESS-GO come with two SmartKeys with KEYLESS-GO, each with remote control and a removable mechanical key.

The locking tabs for the mechanical key portion of the two SmartKeys with KEYLESS-GO are a different color to help distinguish each SmartKey with KEYLESS-GO unit.

The KEYLESS-GO function is integrated into the SmartKey. On these vehicles, the validity of the SmartKey with KEYLESS-GO is checked every time you pull an outside door handle.





If the SmartKey with KEYLESS-GO is valid, your vehicle unlocks

- the doors
- the tailgate
- the fuel filler flap

Locking and unlocking



SmartKey with KEYLESS-GO

- ①  Lock button
- ②  Opening button for the tailgate
- ③ Mechanical key locking tab
- ④  Unlock button
- ⑤ Battery check lamp
- ⑥  PANIC button (▷ page 96)

! To prevent possible malfunction, avoid exposing the SmartKey with KEYLESS-GO to high levels of electromagnetic radiation.

Warning!



When leaving the vehicle, always take the SmartKey with KEYLESS-GO with you and lock the vehicle. Do not leave children unattended in the vehicle, or with access to an unlocked vehicle. It is possible for children to open a locked door from the inside, which could result in an accident and/or serious personal injury.

i USA only:

This device complies with Part 15 of the FCC Rules. Operation is subject to the following two conditions:

- (1) *This device may not cause harmful interference, and*
- (2) *this device must accept any interference received, including interference that may cause undesired operation.*

Any unauthorized modification to this device could void the user's authority to operate the equipment.

i Canada only:

This device complies with RSS-210 of Industry Canada. Operation is subject to the following two conditions:

- (1) *This device may not cause interference, and*
- (2) *this device must accept any interference received, including interference that may cause undesired operation of the device.*

Any unauthorized modification to this device could void the user's authority to operate the equipment.

i You can also open and close the windows and tilt/sliding sunroof using the SmartKey with KEYLESS-GO* (▷ page 241).

! If you can no longer lock or unlock the vehicle with the SmartKey with KEYLESS-GO, then the batteries in the SmartKey with KEYLESS-GO are discharged, the SmartKey with KEYLESS-GO is malfunctioning or the vehicle battery is drained.

- Check the batteries in the SmartKey with KEYLESS-GO (▷ page 119) and replace them if necessary (▷ page 440).
- Use the mechanical key to unlock the driver's door (▷ page 435).
- Use the mechanical key to lock the driver's door.
- Have the vehicle battery checked by an authorized Mercedes-Benz Center.

If the SmartKey with KEYLESS-GO is malfunctioning, contact an authorized Mercedes-Benz Center.

Important notes on using KEYLESS-GO

- You can also use the SmartKey with KEYLESS-GO like a normal SmartKey (▷ page 110).
- You can combine KEYLESS-GO functions with normal SmartKey functions (e.g. unlocking with KEYLESS-GO and locking with button ).
- Always carry the SmartKey with KEYLESS-GO with you.
- Never store the SmartKey with KEYLESS-GO together with:
 - Electronic items such as a cellular phone or another SmartKey with KEYLESS-GO
 - Metallic objects such as coins or metal foil
 Doing so could impair the function of the KEYLESS-GO system.
- To lock or unlock the vehicle, the SmartKey with KEYLESS-GO must be located outside the vehicle within approximately 3 ft (1 m) of a door or the tailgate.
- In order to start the engine with the SmartKey with KEYLESS-GO:
 - The SmartKey with KEYLESS-GO must be located in the vehicle.
 - The brake pedal must be firmly depressed. Do not depress the accelerator.
- If the SmartKey with KEYLESS-GO is positioned farther away from the vehicle, the system may no longer recognize the SmartKey with KEYLESS-GO. The vehicle cannot be locked or the engine started via the KEYLESS-GO system.
- If the SmartKey with KEYLESS-GO is removed from the vehicle (e.g. if passenger exits the vehicle with the SmartKey with KEYLESS-GO)
 - when pressing the KEYLESS-GO start/stop button or trying to lock the vehicle with the outside door handle the message *Key not recognized* appears in the multifunction display

Locking and unlocking

- with the engine running, the message **Key not recognized** appears in the multifunction display while driving off.

Find the SmartKey with KEYLESS-GO or change its present location immediately (e.g. place it on the front passenger seat or insert it in shirt pocket).

- If you have started the engine with the KEYLESS-GO start/stop button, you can turn it off again with:
 - the KEYLESS-GO start/stop button
 - the SmartKey with KEYLESS-GO inserted in the starter switch, when the automatic transmission is in position **P**

- Remember that the engine can be started by anyone with a SmartKey with KEYLESS-GO that is left inside the vehicle.

Possibility 1: (One SmartKey with KEYLESS-GO in the vehicle, one SmartKey with KEYLESS-GO outside the vehicle):

If you leave the SmartKey with KEYLESS-GO behind when exiting and locking the vehicle, no message appears in the multifunction display.

Possibility 2: (One SmartKey with KEYLESS-GO in the vehicle, no SmartKey with KEYLESS-GO outside the vehicle):

When exiting and trying to lock the vehicle, the message **Key still in vehicle** appears in the multifunction display. The vehicle will not be locked.

Factory setting

i When unlocking or locking the vehicle with the SmartKey or with the KEYLESS-GO function an acoustic signal sounds. The acoustic signal is activated at the factory. If you wish to deactivate the feature, or adjust its signal volume, contact an authorized Mercedes-Benz Center.

Global unlocking

- ▶ Pull an outside door handle.
 - All turn signal lamps flash once.
 - An acoustic signal sounds once.
 - The locking knobs in the doors move up.
 - The anti-theft alarm system is disarmed.

The vehicle will lock again automatically and rearm the anti-theft alarm system within approximately 40 seconds if:



- neither a door nor the tailgate is opened
- the central locking switch is not activated

Global locking

- ▶ Press lock button on an outside door handle (▷ page 65).
 - All turn signal lamps flash three times.
 - An acoustic signal sounds three times.
 - The locking knobs in the doors move down.
 - The anti-theft alarm system is armed.

Selective setting

If you frequently travel alone, you may wish to reprogram the SmartKey with KEYLESS-GO so when you pull the driver's outside door handle, only the driver's door and the fuel filler flap unlocks.

- ▶ Press and hold buttons  and  simultaneously for about 5 seconds until battery check lamp ⑤ (▷ page 114) flashes twice.

The SmartKey with KEYLESS-GO will then function as follows:

Unlocking driver's door and fuel filler flap

- ▶ Pull the driver's outside door handle.
 - All turn signal lamps flash once.
 - An acoustic signal sounds once.
 - The locking knob in the driver's door moves up.
 - The anti-theft alarm system is disarmed.

Locking and unlocking

Global unlocking



- ▶ Pull any outside door handle other than the driver's outside door handle.
 - All turn signal lamps flash once.
 - An acoustic signal sounds once.
 - The locking knobs in the doors move up.
 - The anti-theft alarm system is disarmed.

Global locking

- ▶ Press lock button on an outside door handle (▷ page 65).
 - All turn signal lamps flash three times.
 - An acoustic signal sounds three times.
 - The locking knobs in the doors move down.
 - The anti-theft alarm system is armed.

i You can also lock the vehicle using the **KEYLESS-GO** lock button on the tailgate (depending on vehicle production date) or, vehicles with tailgate opening/closing system*, **KEYLESS-GO** locking/ closing switch* (▷ page 126).

Restoring to factory setting

- ▶ Press and hold buttons  and  simultaneously for about 5 seconds until battery check lamp ⑤ (▷ page 114) flashes twice.

Global locking using the **KEYLESS-GO** lock button on the tailgate

Depending on production date your vehicle may be equipped with the **KEYLESS-GO** lock button on the tailgate.



① **KEYLESS-GO** lock button on the tailgate

With the tailgate and all doors closed:

- ▶ Press lock button  on the tailgate.
 - All turn signal lamps flash three times.
 - An acoustic signal sounds three times.
 - The locking knobs in the doors move down.
 - The anti-theft alarm system is armed.

 To prevent a possible inadvertent lockout, the tailgate will open automatically if a SmartKey with KEYLESS-GO is recognized inside the vehicle or in the cargo compartment.

 You can also lock the vehicle using the lock button on an outside door handle (▷ page 65) or, vehicles with tailgate opening/closing system*, KEYLESS-GO locking/ closing switch* (▷ page 126).

Checking batteries in the SmartKey or SmartKey with KEYLESS-GO*



- ▶ Press button  or .

The battery check lamp (▷ page 110) or (▷ page 114) comes on briefly to indicate that the SmartKey or SmartKey with KEYLESS-GO batteries are in order.

 If the battery check lamp does not come on briefly during check, the SmartKey or SmartKey with KEYLESS-GO batteries are discharged.

Replace the batteries (▷ page 440).

You can obtain the required batteries at any authorized Mercedes-Benz Center.

 If the batteries are checked within signal range of the vehicle, pressing button  or  will lock or unlock the vehicle accordingly.

Loss of the SmartKey or SmartKey with KEYLESS-GO*

If you lose your SmartKey, SmartKey with KEYLESS-GO or mechanical key, you should do the following:

- ▶ Have the SmartKey or SmartKey with KEYLESS-GO deactivated by an authorized Mercedes-Benz Center.
- ▶ Report the loss of the SmartKey, SmartKey with KEYLESS-GO or the mechanical key immediately to your car insurance company.
- ▶ Have the mechanical lock replaced if necessary.

Your authorized Mercedes-Benz Center will be glad to supply you with a replacement.

Locking and unlocking

Opening the doors from the inside



You can open a locked door from the inside. Open door only when conditions are safe to do so.



- ① Locking knob
- ② Inside door handle

i If the vehicle has previously been locked with the SmartKey or KEYLESS-GO*, opening a door from the inside will trigger the anti-theft alarm system.

To cancel the alarm, do one of the following:

- Press button  or  on the SmartKey.
- Insert the SmartKey in the starter switch.

In vehicles with KEYLESS-GO:*

- Press the KEYLESS-GO* start/stop button (▷ page 39).
The SmartKey with KEYLESS-GO must be inside the vehicle.*
- Pull an outside door handle.
The SmartKey with KEYLESS-GO must be within 3 ft (1 m) of the vehicle.*

Front doors

- ▶ Pull on door handle ② on the respective front door to open door.

If door was locked, locking knob ① will move up.

i If you hear a warning signal you have forgotten to switch off the headlamps before opening the driver's door.

In addition the message Switch off lights appears in the multifunction display.

Switch off the headlamps.

Rear doors

- ▶ Pull up locking knob ① on the respective rear door to unlock door.
- ▶ Pull on door handle ② on the respective rear door to open door.

Opening the tailgate

Warning!



Make sure the cargo compartment is closed when the engine is running and while driving. Among other dangers, such as blocked visibility, exhaust fumes may enter the vehicle interior. These fumes are damaging to your health.

You can open the tailgate if the vehicle is stationary.

A minimum height clearance of 6.81 ft (2.07 m) is required to open the tailgate.

! *The tailgate swings open upwards automatically. Always make sure there is sufficient overhead clearance.*

Opening the tailgate from the outside

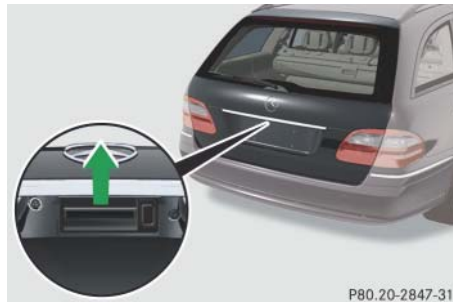

- ▶ Press and hold button  on the SmartKey or SmartKey with KEYLESS-GO* until tailgate unlocks and begins to open.

or

- ▶ Pull on handle.

In vehicles without KEYLESS-GO*: The vehicle must be unlocked.

! *Vehicles with tailgate opening/closing system*: To stop the opening procedure, press button  on the SmartKey or SmartKey with KEYLESS-GO* or pull on handle.*

Opening the tailgate from the inside automatically*



- ① Remote tailgate opening switch

- ▶ Pull and hold remote tailgate release switch ① until
 - the tailgate is completely open (opened to its full extent),
 or
 - the tailgate has reached the desired opening angle.



Locking and unlocking

- ▷▷ The tailgate stops moving as soon as you release the switch. The indicator lamp in the switch comes on. It remains lit until the tailgate is closed again.

! *The tailgate swings open upwards as long as you pull and hold the remote tailgate release switch. Always make sure there is sufficient overhead clearance. To stop the opening procedure, release the remote tailgate release switch.*

Opening the tailgate from the inside with handle

A minimum height clearance of 6.81 ft (2.07 m) is required to open the tailgate. The handle is located on the inside of the tailgate.

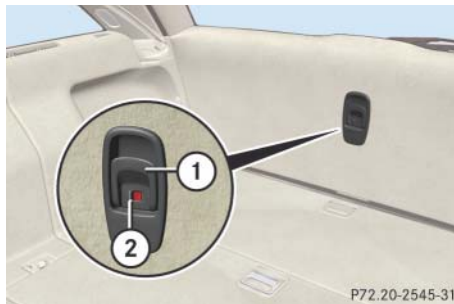

- ① Handle
- ② Catch

- ▶ To unlock the tailgate, move the catch ② to the right.
- ▶ Pull handle ① down and swing tailgate upward.

! *Always make sure there is sufficient overhead clearance.*

i *To lock the tailgate, move the catch ② to the left.*

Warning!



When leaving the vehicle, always remove the SmartKey or the SmartKey with KEYLESS-GO* from the starter switch, take it with you, and lock the vehicle. Do not leave children unattended in the vehicle. Children could open the tailgate from the inside, which could result in an accident and/or serious personal injury.

Limiting opening height of tailgate*

Vehicles with tailgate opening/closing system*:

The tailgate opening height can be limited when transporting goods on a roof rack (e.g. presence of an optional MB sport luggage container). When activated, the tailgate opens to approximately the height of the roof edge.

Activating

- ▶ Pull on the tailgate handle (▷ page 121).
- ▶ Press the tailgate closing switch (▷ page 125) for approximately 2 seconds.

An acoustic signal sounds once. The opening height of the tailgate is limited. When you now open the tailgate it will stop at the limited height position.

Deactivating

- ▶ Press the tailgate closing switch (▷ page 125) for approximately 2 seconds again.

An acoustic signal sounds two times. The opening height of the tailgate is not limited anymore.

Closing the tailgate

Warning!



Make sure the cargo compartment is closed when the engine is running and while driving. Among other dangers, such as blocked visibility, exhaust fumes may enter the vehicle interior. These fumes are damaging to your health.

 *Do not place the SmartKey in the cargo compartment. You may lock yourself out.*

Locking and unlocking

i If the vehicle was previously centrally locked, the tailgate will lock automatically after closing it. All turn signal lamps flash three times to confirm locking.

Vehicles with KEYLESS-GO*: To prevent a possible inadvertent lockout, the tailgate will open automatically if a SmartKey with KEYLESS-GO is recognized inside the vehicle or in the cargo compartment.

The vehicle is only locked when the turn signals flash three times. If you are carrying a second SmartKey with KEYLESS-GO with you, you can still lock the vehicle.

Closing tailgate from the outside manually



① Handle

- ▶ Lower tailgate using handle ①.
- ▶ Close tailgate with hands placed flat on the tailgate.



- ① Strap in vehicles with folding bench seat
- ▶ Pull the tailgate down from the inside of the vehicle using strap ①.

Warning!



To prevent possible personal injury, always keep hands and fingers away from the cargo compartment opening when closing the tailgate. Be especially careful when small children are around.

When leaving the vehicle, always remove the SmartKey or SmartKey with KEYLESS-GO* from the starter switch, take it with you, and lock the vehicle. Do not leave children unattended in the vehicle, or with access to an unlocked vehicle. A child's unsupervised access to a vehicle could result in an accident and/or serious personal injury.

Closing the tailgate from the outside automatically*

Warning!



Monitor the closing procedure carefully to make sure no one is in danger of being injured. To prevent possible personal injury, always keep hands and fingers away from the cargo compartment opening when closing the tailgate. Be especially careful when small children are around. To stop the closing procedure, do one of the following:

- press button  on the SmartKey or SmartKey with KEYLESS-GO
- press or pull the tailgate opening switch (on the driver's door)
- press the tailgate closing switch
- press the KEYLESS-GO locking/closing* switch
- pull the tailgate handle

When leaving the vehicle, always remove the SmartKey or the SmartKey with KEYLESS-GO* from the starter switch, take it with you, and lock the vehicle. Do not leave children unattended in the vehicle. Children could open the tailgate from the inside, which could result in an accident and/or serious personal injury.

In vehicles with tailgate opening/closing system* you can close the tailgate separately from the outside using the tailgate closing switch.



Vehicles without KEYLESS-GO*

- ① Tailgate closing switch



Vehicles with KEYLESS-GO*

- ① Tailgate closing switch
- ▶ Press tailgate closing switch ① briefly.

The tailgate closes.

i If the tailgate lid comes into contact with an object while closing (e.g. luggage that has been piled too high) in the upper motion sequence, the closing procedure is stopped and the tailgate re-opens slightly.

Locking and unlocking

Closing tailgate and locking vehicle from outside (vehicles with KEYLESS-GO*)

In vehicles with tailgate opening/closing system* and KEYLESS-GO, you can close the tailgate and lock the vehicle simultaneously from the outside using the KEYLESS-GO locking/closing switch.



① KEYLESS-GO locking/closing switch

- ▶ Make sure you have the SmartKey with KEYLESS-GO with you.

- ▶ Press switch ① briefly.

With all doors closed:

- The locking knobs in the doors move down.
- The tailgate starts to close automatically.
- All turn signal lamps flash three times to confirm locking once the tailgate has closed completely.
- An acoustic signal sounds three times.
- The anti-theft alarm system is armed.

i If the tailgate lid comes into contact with an object while closing (e.g. luggage that has been piled too high) in the upper motion sequence, the closing procedure is stopped and the tailgate reopens slightly.

Automatic central locking

The doors and the tailgate automatically lock when the ignition is switched on and the wheels are turning at vehicle speeds of approximately 9 mph (15 km/h) or more. The locking knobs in the doors move down.

You can open a locked door from the inside. Open door only when conditions are safe to do so.

i The doors are designed to unlock automatically after an accident if the force of the impact exceeds a preset threshold. The vehicle locks automatically when the ignition is switched on and the wheels are turning at vehicle speeds of approximately 9 mph (15 km/h) or more. You could therefore lock yourself out when the vehicle

- is pushed or towed
- is on a test stand

You can deactivate the automatic locking mode using the control system (▶ page 180).

Locking and unlocking from the inside

Warning!



When leaving the vehicle, always remove the SmartKey or SmartKey with KEYLESS-GO* from the starter switch, take it with you, and lock the vehicle. Do not leave children unattended in the vehicle, or with access to an unlocked vehicle. A child's unsupervised access to a vehicle could result in an accident and/or serious personal injury.

You can lock or unlock the doors and the tailgate from inside using the central locking switch. This can be useful, for example, if you want to lock the vehicle before starting to drive.

The fuel filler flap cannot be locked or unlocked with the central locking switch.

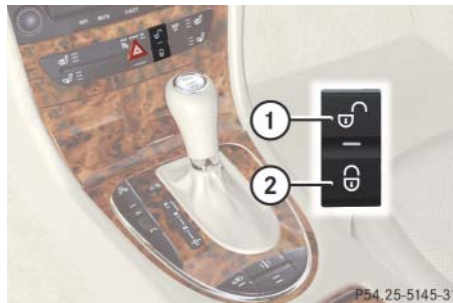

Central locking switch

- ① Unlocking
- ② Locking

i You can open a locked door from inside at any time. Open door only when conditions are safe to do so.

If the vehicle was previously centrally locked with the SmartKey or with KEYLESS-GO, it will not unlock using the central locking switch.*

If the vehicle was previously locked with the central locking switch:

- and the SmartKey or SmartKey with KEYLESS-GO* is set to factory settings, the complete vehicle is unlocked when a door is opened from the inside
- and the SmartKey or SmartKey with KEYLESS-GO* is set to selective settings, only the door opened from the inside is unlocked

Locking

- ▶ Press lower half ② of the central locking switch.

If all doors are closed, the vehicle locks.

Unlocking

- ▶ Press upper half ① of the central locking switch.

The vehicle unlocks.

Seats

For more information on seat adjustment, see “Adjusting” (▷ page 41).

For more information on folding the seats, see “Loading” (▷ page 266).

Front seat active head restraints

Warning!



For your protection, drive only with properly positioned head restraints.

Adjust the head restraint so that the center of the head restraint supports the back of the head at eye level. This will reduce the potential for injury to the head and neck in the event of an accident or similar situation.

Do not drive the vehicle without the seat head restraints. Head restraints are intended to help reduce injuries during an accident.

You cannot remove the active head restraint on the driver’s and front passenger’s seats.

For removal of the active head restraints we recommend that you contact an authorized Mercedes-Benz Center.

 *Adjust the head restraint in such a way that it is as close to the head as possible.*

For information on head restraint adjustment, see “Seat adjustment” (▷ page 43).

For information on active head restraints, see “Active head restraints” (▷ page 87).

Rear seat head restraints

Warning!



For safety reasons, always drive with the rear head restraints in the upright position when the rear seats are occupied.

Keep the area around head restraints clear of articles (e.g. clothing) to not obstruct the folding operation of the head restraints.

Warning!



For your protection, drive only with properly positioned head restraints.

Adjust head restraint so that the head restraint supports the back of the head at eye level. This will reduce the potential for injury to the head and neck in the event of an accident or similar situation.

Do not drive the vehicle without the seat head restraints. Head restraints are intended to help reduce injuries during an accident.

Do not interchange head restraints from front and rear seat.

Folding head restraints backward manually (rear outer seats only)

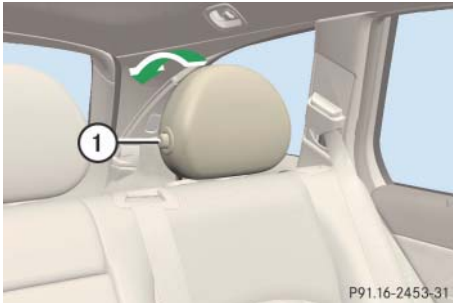

① Release button

- ▶ Press the release button ① and fold the head restraints backward.

Placing head restraints upright



- ▶ Pull the head restraint forward until it locks into position.

! Make sure the head restraints engage when placing them upright. Otherwise their protective function cannot be assured.

Head restraint height (rear outer seats only)

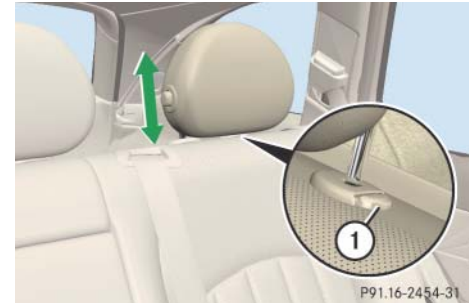

① Release button

Raising:

- ▶ Manually adjust the height of the head restraint by pulling it upward.

If the head restraint is fully retracted, push release button ① and pull the head restraint out.

Lowering:

- ▶ To lower the head restraint, push release button ① and push down on the head restraint.

Seats

Head restraint tilt (rear outer seats only)

Two different head restraint angle positions are available.

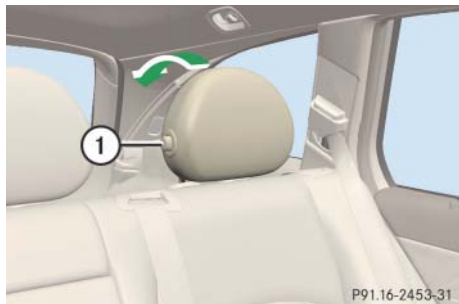

① Release button

- ▶ Press the release button ① and tilt the head restraint to the desired position.

Removing and installing rear seat head restraints

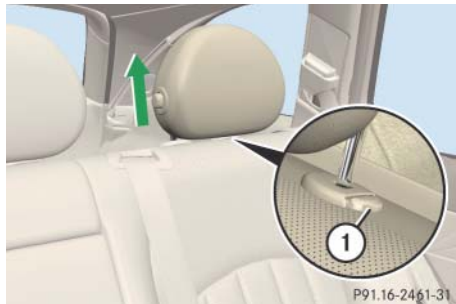

① Release button

Removing rear seat head restraints

- ▶ Placing head restraints upright (▷ page 129).
- ▶ Pull head restraint to its highest position.
- ▶ Push release button ① and pull out head restraint.

Installing rear seat head restraints

- ▶ Insert head restraint and push it down until it engages.
- ▶ Push button ① and adjust head restraint to desired position.

i When installing the head restraints, make sure that:

- The proper head restraint for each seat is installed. The bars of the head restraint designed for the middle rear seat are of even length and shorter than those designed for use on the outer rear seats.
- The head restraints engage fully.

Lumbar support

The curvature of the front seats can be adjusted to help enhance lower back support and seating comfort.



① Adjustment lever

- ▶ Move adjustment lever ① in direction of the arrows until you have reached a comfortable seating position.

Multicontour seat*

The multicontour seat has a movable seat cushion and inflatable air cushions built into the backrest to provide additional lumbar and side support.

The seat cushion movement, backrest cushion height and curvature can be continuously varied with switches on the right side of the seat on the driver side, or the left side of the seat on the passenger side.



- ① Backrest side bolster
- ② Backrest center
- ③ Backrest bottom
- ④ Seat cushion depth

- ▶ Switch on the ignition (▷ page 37).

Seat cushion depth

- ▶ Adjust the seat cushion depth to the length of your upper leg using switch ④.

Backrest contour

- ▶ Adjust the contour of the backrest to the desired position using **+** or **-**.
- ▶ Move the backrest support cushion to the bottom by using button ③ or to the center by using button ②.

Backrest side bolsters

- ▶ Adjust the side bolsters so that they provide good lateral support using switch ①.

i If, after a period of time, the seat no longer provides the desired contour, then repeat the adjustment procedure.

Seats

Seat heating*

The red indicator lamps in the switch show the heating level selected.

Level	
3	Three indicator lamps on (highest level). The seat heating automatically switches to level 2 after approximately 5 minutes.
2	Two indicator lamps on. The seat heating automatically switches to level 1 after approximately 10 minutes.
1	One indicator lamp on (lowest level). The seat heating automatically switches off after approximately 20 minutes.
off	No indicator lamp on.



① Front seat heating switch



① Rear seat heating switch (Canada only)

Depending on production date, your vehicle may not be equipped with the rear seat heating.

Switching seat heating on

- ▶ Switch on the ignition (▷ page 37).
 - ▶ Press switch ①.
- Three red indicator lamps on the switch come on.
- ▶ Continue pressing switch ① until desired seat heating level is reached.

Switching seat heating off

- ▶ Press switch ① repeatedly until all indicator lamps go out.

i If one or more of the lamps on the seat heating switch are flashing, there is insufficient voltage available since too many electrical consumers are turned on. The seat heating switches off automatically.

The seat heating will switch back on again automatically as soon as sufficient voltage is available.

Seat ventilation*

Level	
3	Three indicator lamps on (highest level).
2	Two indicator lamps on.
1	One indicator lamp on (lowest level).
off	No indicator lamp on.

i The seat ventilation for the driver's seat can be activated using summer opening feature (▷ page 241).

The blue indicator lamps on the switch show the ventilation level selected.



① Seat ventilation switch

▶ Switch on the ignition (▷ page 37).

Switching seat ventilation on

▶ Press button ① repeatedly until the desired ventilation level is set.

One or more blue indicator lamps on the switch show the selected ventilation level.

Switching seat ventilation off

▶ Press button ① repeatedly until all indicator lamps go out.

i If one or more of the lamps on the seat ventilation switch are flashing, there is insufficient voltage available since too many electrical consumers are turned on. The seat ventilation switches off automatically.

The seat ventilation will switch back on again automatically as soon as sufficient voltage is available.

Seats

Folding bench seat in cargo compartment (optional on E 63 AMG)

i *The folding bench seat in the cargo compartment is approved only for persons up to a height of 4.6 ft (1.40 m) and a maximum weight of 110 lb (50 kg).*

The twin roller blind must be installed when the folding bench seat is in use.

Warning!



When using the folding bench seat in the cargo compartment, the seats in front of it must be in the driving position.

Only drive when the head restraints for the folding bench seat have been properly adjusted. The head restraints should be adjusted so that the back of the head is supported at approximately eye level. This can reduce a child's risk of injury in the event of an accident.

Warning!



Make sure that the seat belt is positioned correctly on the body and is engaged in the seat belt buckle.

Damaged covers should be replaced with original covers only.

Do not leave children unattended in the vehicle, even when they are secured in a child restraint system.

Make sure that luggage and other objects are adequately secured. The load could otherwise injure someone in the event of an accident, during hard braking or steering maneuvers.

Folding out the folding bench seat

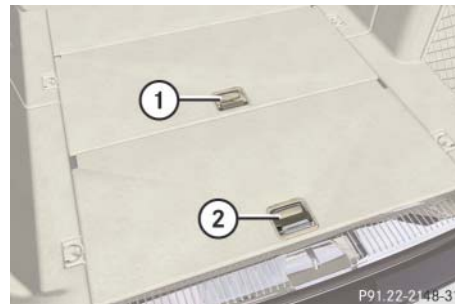

- ① Release handle for seat backrest
- ② Release handle for seat cushion

Before folding out the seat backrest, you must:

- fold the rear seat backrests into an upright position and lock them into place
- move the handle for the twin roller blind into the upper position

i *The rear seat backrests can be adjusted to a more reclined position to make the folding bench seat more comfortable (▷ page 268).*

- ▶ Pull release handle ① and fold seat backrest for the folding bench seat upward.

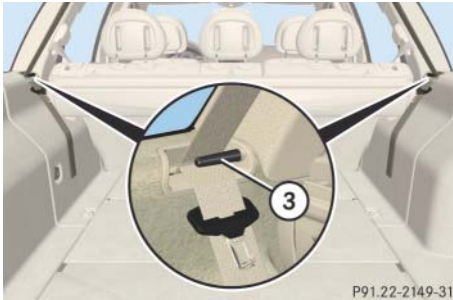

③ Mountings for seat belts

- ▶ Hook seat belts into mountings ③.
- ▶ Pull release handle ② (▷ page 134) and fold seat cushion for the folding bench seat into sitting position.
- ▶ Press seat cushion as far down as it will go.
The backrest will then also engage properly.
- ▶ Fold head restraints into upright position.

Removing and installing seat cushions

i *You must remove the seat cushion when you want to raise the loading floor, e.g. in the event of a flat tire.*

Removing

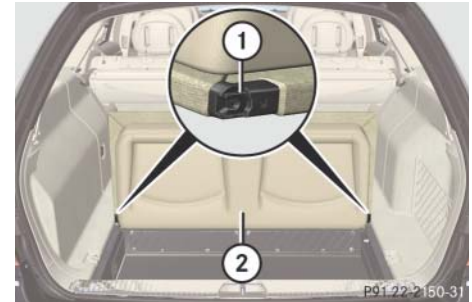

- ① Seat guides
- ② Seat cushion

- ▶ Fold seat cushion ② upward and remove it from seat guides ①.

Seats

Installing

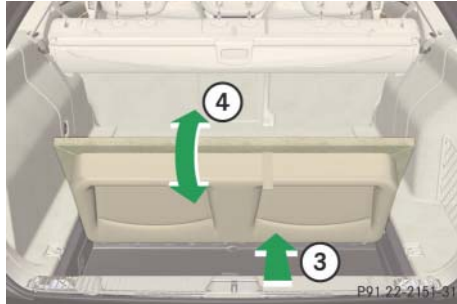

- ▶ Insert seat cushion ② (▷ page 135) into seat guides ① (▷ page 135) from behind ③ at a slight angle.
- ▶ Fold seat cushion ② (▷ page 135) back into original position ④ until it engages.

Folding back folding bench seat



- ① Tab
- ② Backrest
- ▶ Pull seat cushion upward using tab ① and fold it back into original position until it engages.

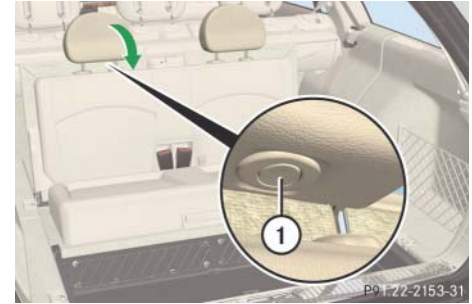

- ① Release knob
- ▶ Press release knob ① and fold head restraints down.

! To avoid damage, insert the head restraints completely into their guides and engage the seat belt buckles in their guides.

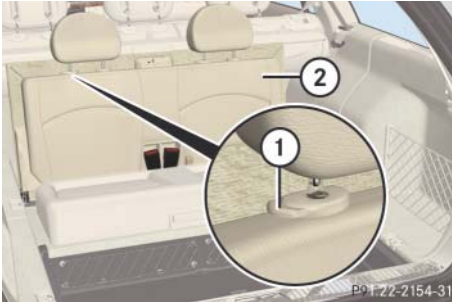

① Release catch

② Backrest

- ▶ Press release catch ① and push head restraints as far in as they will go.
- ▶ Fold seat backrest ② of folding bench seat back into original position until it engages.

Memory function

Prior to operating the vehicle, the driver should check and adjust the seat height, seat position fore and aft, and seat backrest angle if necessary, to ensure adequate control, reach and comfort. The head restraint should also be adjusted for proper height. See also the section on air bags (▷ page 70) for more information on proper seat positioning.

In addition, adjust the steering wheel to ensure adequate control, reach, operation and comfort. Both the interior and outside rear view mirrors should be adjusted for adequate rear vision.

Fasten seat belts. Infants and small children should be seated in a properly secured restraint system that complies with U.S. Federal Motor Vehicle Safety Standards 213 and 225 and Canadian Motor Vehicle Safety Standards 213 and 210.2.

With the memory function you can store up to three different settings.

Each stored position on the driver's side includes the following settings:

- Driver's seat, backrest, head restraint position
- Multicontour seat*: previously saved setting
- Steering wheel position
- Exterior rear view mirror positions

Each stored position on the front passenger side includes the following settings:

- Front passenger seat, backrest, head restraint position
- Multicontour seat*: previously saved setting

Warning!



Do not activate the memory function while driving. Activating the memory function while driving could cause the driver to lose control of the vehicle.



M Memory button

1, 2, 3 Memory position button

- ▶ Switch on the ignition (▷ page 37).

or

- ▶ Open the respective door.

Storing positions into memory

- ▶ Adjust the seats, steering wheel and exterior rear view mirrors to the desired position (▷ page 41).
- ▶ Press memory button **M**.
- ▶ Release memory button **M** (▷ page 139) and press memory position button **1, 2 or 3** (▷ page 139) within 3 seconds.

All the settings are stored at the selected position.

Recalling positions from memory

! Do not operate the power seats using the memory button if the seat backrest is in an excessively reclined position. Doing so could cause damage to front or rear seats.

First move seat backrest to an upright position.

- ▶ Press and hold memory position button **1, 2 or 3** (▷ page 139) until the seat, steering wheel and exterior rear view mirrors have completely moved to the stored positions.

i Releasing the memory position button stops movement to the stored positions immediately.

The multicontour seat will continue to be adjusted.*

Memory function

Storing exterior rear view mirror parking position

For easier parking, you can adjust the passenger-side exterior rear view mirror so that you can see the right rear wheel as soon as you engage reverse gear **R**.

For information on activating the parking position, see “Activating exterior rear view mirror parking position” (▷ page 202).



- ① Driver's side exterior rear view mirror button
- ② Passenger side exterior rear view mirror button
- ③ Adjustment button
- ④ Memory button **M**

- ▶ Stop the vehicle.
- ▶ Switch on the ignition (▷ page 37).

- ▶ Press button ②.

The passenger-side exterior rear view mirror is selected.

- ▶ Adjust the exterior rear view mirror with button ③ so that you see the rear wheel and the road curb.

- ▶ Press memory button **M** ④.

- ▶ Within 3 seconds, press bottom of adjustment button ③.

The parking position is stored if the mirror does not move.

i If the mirror does move, repeat the above steps. After the setting is stored, you can move the mirror again.

▼ Lighting

For information on how to switch on the headlamps and use the turn signals, see “Switching on headlamps” (▷ page 56) and see “Turn signals” (▷ page 56).

i If you drive in countries where vehicles drive on the other side of the road than the country where the vehicle is registered, you must have the headlamps modified for symmetrical low beams. Relevant information can be obtained at your authorized Mercedes-Benz Center.

i Vehicles equipped with active Bi-Xenon* headlamps:

The active Bi-Xenon headlamps monitor your steering angle and driving speed, then automatically shift their beams to either side to better follow the curvature of the road ahead, increasing usable illumination over conventional headlamps.

Exterior lamp switch



Exterior lamp switch

1		Standing lamps, left (turn left two stops)
2		Standing lamps, right (turn left one stop)
3		Off Daytime running lamp mode (▷ page 143)
4		Automatic headlamp mode Daytime running lamp mode (▷ page 143)
5		Parking lamps (also side marker lamps, tail lamps, license plate lamps, instrument panel lamps)
6		Low beam headlamps or high beam headlamps when the combination switch is pushed forward. The tail lamps, license plate lamps, side marker lamps, parking lamps and instrument panel lamps also come on.
7		Front fog lamps
8		Rear fog lamp

Lighting

i If you hear a warning signal you have forgotten to switch off the headlamps before opening the driver's door.

In addition the message *Switch off lights appears in the multifunction display.*

Switch off the headlamps.

Manual headlamp mode

The low beam headlamps and the parking lamps can be switched on and off with the exterior lamp switch.

- ▶ Turn the exterior lamp switch to position .

Automatic headlamp mode

The following lamps switch on and off automatically depending on the brightness of the ambient light:

- Low beam headlamps
- Tail and parking lamps
- License plate lamps
- Side marker lamps



Warning!



If the exterior lamp switch is set to **AUTO**,

- the headlamps may switch off unexpectedly when the system senses bright ambient light, for example light from oncoming traffic.
- the headlamps will not be automatically switched on under foggy conditions.

To minimize risk to you and to others, activate headlamps by turning exterior lamp switch to  when driving or when traffic and/or ambient lighting conditions require you to do so.

In low ambient lighting conditions, only switch from position **AUTO** to  with the vehicle at a standstill in a safe location. Switching from **AUTO** to  will briefly switch off the headlamps. Doing so while driving in low ambient lighting conditions may result in an accident.

The automatic headlamp feature is only an aid to the driver. The driver is responsible for the operation of the vehicle's lights at all times.

- ▶ Turn exterior lamp switch to position **AUTO**.

With the SmartKey in starter switch position **1** or the KEYLESS-GO* start/stop button pressed once, only the parking lamps and the side marker lamps will switch on and off automatically.

When the engine is running, the low beam headlamps, the tail and parking lamps, the licence plate lamps and the side marker lamps will switch on and off automatically.

i *USA only:*
With the automatic headlamp mode activated you can switch on the high beam headlamps in low ambient lighting conditions.

Daytime running lamp mode

- ▶ Turn the exterior lamp switch to position **0** or **AUTO**.

When the engine is running, the low beam headlamps are automatically switched on.

In low ambient light conditions, the following lamps will switch on additionally:

- Tail and parking lamps
- License plate lamps
- Side marker lamps

i *With the daytime running lamp mode activated and the engine running, you cannot switch off the low beam headlamps manually.*

Canada only

The daytime running lamp mode is mandatory and therefore in a constant mode.



i *With the exterior lamp switch in position **0** or **AUTO**, you cannot switch on the high beam headlamps.*

The high beam flasher is available at all times.

For nighttime driving turn the exterior lamp switch in position  to permit activation of the high beam headlamps.

When the engine is running, and you shift from a driving position to position **N** or **P**, the low beam headlamps will switch off with a 3 minute delay.

When the engine is running, and you

- turn the exterior lamp switch to position , the parking lamps and the side marker lamps switch on additionally.
- turn the exterior lamp switch to position , the manual headlamp mode has priority over the daytime running lamp mode.

The corresponding exterior lamps switch on (> page 141).

Lighting



USA only

By default, the daytime running lamp mode is deactivated. Activate the daytime running lamp mode using the control system, see “Setting daytime running lamp mode (USA only)” (▷ page 176).

i With the daytime running lamp mode activated and the exterior lamp switch in position **0**, you cannot switch on the high beam headlamps.

The high beam flasher is available at all times.

*For nighttime driving turn the exterior lamp switch in position  or **AUTO** to permit activation of the high beam headlamps.*

When the engine is running, and you turn the exterior lamp switch to position  or , the manual headlamp mode has priority over the daytime running lamp mode.

The corresponding exterior lamps switch on (▷ page 141).



Locator lighting and night security illumination

Locator lighting and night security illumination are described in the “Control system” section, see (▷ page 177) and (▷ page 178).

Fog lamps

Warning!



In low ambient lighting or foggy conditions, only switch from position **AUTO** to  with the vehicle at a standstill in a safe location. Switching from **AUTO** to  will briefly switch off the headlamps. Doing so while driving in low ambient lighting conditions may result in an accident.

i Fog lamps will operate with the parking lamps and/or the low beam headlamps on. Fog lamps should only be used in conjunction with low beam headlamps. Consult your State or Province Motor Vehicle Regulations regarding permissible lamp operation.

i Fog lamps cannot be switched on with the exterior lamp switch in position **AUTO**. To switch on the fog lamps, turn the exterior lamp switch to position  first.

Front fog lamps

- ▶ Switch on the low beam headlamps  (▷ page 141).
- ▶ Pull out the exterior lamp switch to first stop.

The front fog lamps switch on.

The green indicator lamp  in the exterior lamp switch comes on (▷ page 141).

- ▶ Push in the exterior lamp switch.

The front fog lamps switch off.

The green indicator lamp  in the exterior lamp switch goes out.

Rear fog lamp (driver's side only)

- ▶ Switch on the low beam headlamps  (▷ page 141).
- ▶ Pull out the exterior lamp switch to second stop.

The front fog lamps and the rear fog lamp switch on.

The yellow indicator lamp  in the exterior lamp switch comes on (▷ page 141).

- ▶ Push in the exterior lamp switch to first stop.

The rear fog lamp switches off.

The yellow indicator lamp  in the exterior lamp switch goes out.

The front fog lamps remain lit.

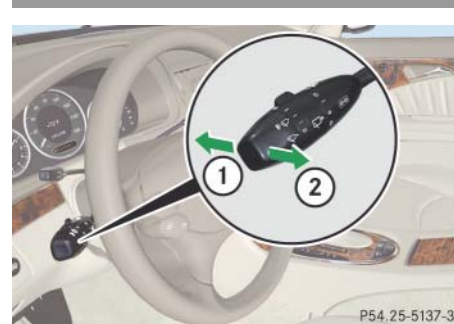
Combination switch**Combination switch**

- ① High beam
- ② High beam flasher

Lighting

High beam

- ▶ Turn the exterior lamp switch to position  (▷ page 141).
- ▶ Push the combination switch in direction of arrow ① to switch on the high beam.

The high beam headlamp indicator lamp  in the instrument cluster comes on (▷ page 26).

- ▶ Pull the combination switch in direction of arrow ② to its original position to switch off the high beam.

The high beam headlamp indicator lamp  in the instrument cluster goes out.

High beam flasher

- ▶ Pull the combination switch briefly in direction of arrow ②.

Corner-illuminating front fog lamps*

The corner-illuminating front fog lamps improve illumination of the area in the direction into which you are turning.

The corner-illuminating front fog lamps will operate with the engine running and with

- the exterior lamp switch in position  (▷ page 141)
or
- the exterior lamp switch in position **AUTO** (▷ page 141)
or
- the daytime running lamp mode activated (▷ page 143).

i With the automatic headlamp mode activated: The corner-illuminating front fog lamps will only come on in low ambient lighting conditions.

i If you are driving faster than 25 mph (40 km/h), the corner-illuminating function is not available.

Driving forward

Switching on corner-illuminating front fog lamps

- ▶ Switch on the left or right turn signal (▷ page 56), depending on whether you are turning left or right.

The respective front fog lamp comes on and illuminates the area in the direction into which you are turning.

or

- ▶ Turn steering wheel in desired direction.

The front fog lamp on the side of your steering direction comes on.

i If you have switched on the turn signal for one side but turn the steering wheel in the opposite direction, the corner-illuminating front fog lamp comes on for the side indicated by the turn signal.

The corner-illuminating front fog lamp remains lit for a maximum of 3 minutes. Afterward, it goes out even if the turn signal is still switched on.

i The corner-illuminating front fog lamps temporarily come on on both sides of the vehicle if you turn the steering wheel in one direction and then again in the other direction shortly thereafter.

i The corner-illuminating front fog lamps will come on automatically depending on the steering angle, even if you did not switch on either turn signal.

If the corner-illuminating front fog lamps came on automatically, they will also go out automatically depending on the steering angle.

Switching off corner-illuminating front fog lamps

The combination switch for the turn signal resets automatically after major steering wheel movements. This will switch off the corner-illuminating front fog lamps if they were activated by switching on the left or right turn signal.

If the turn signal should stay on after making the turn, the turn signal and the corner-illuminating front fog lamps can be switched off by returning the combination switch to its original position.

i There may be a brief delay before the corner-illuminating front fog lamps switch off.

Driving in reverse

Switching on corner-illuminating front fog lamps

- ▶ Place the gear selector lever in position **R**.

The front fog lamp opposite to your steering direction comes on.

Switching off corner-illuminating front fog lamps

- ▶ Place the gear selector lever out of position **R**.

The respective front fog lamp goes out.

Lighting

Hazard warning flasher

The hazard warning flasher can be switched on at all times, even with the SmartKey removed from the starter switch or with the SmartKey with KEYLESS-GO* removed from the vehicle.

The hazard warning flasher switches on automatically when an air bag deploys.

The hazard warning flasher switch is located on the upper part of the center console.



① Hazard warning flasher switch

Switching on hazard warning flasher

- ▶ Press the hazard warning flasher switch ①.

All turn signals are flashing.

i With the hazard warning flasher activated and the combination switch set for either left or right turn, only the respective left or right turn signals will operate when the ignition is switched on.

Switching off hazard warning flasher

- ▶ Press hazard warning flasher switch ① again.

i If the hazard warning flasher has been activated automatically, press hazard warning flasher switch ① once to switch it off.

Interior lighting in the front

The controls are located in the overhead control panel.

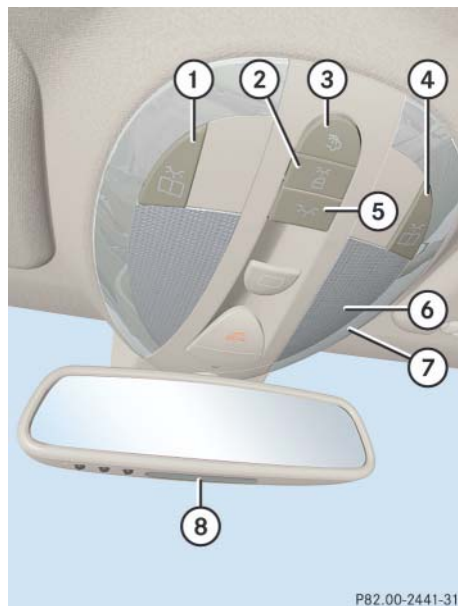

- ① Left front reading lamp on/off
- ② Automatic control on/off
- ③ Rear interior lighting on/off
- ④ Right front reading lamp on/off
- ⑤ Front interior lighting on/off
- ⑥ Interior lighting
- ⑦ Ambient lighting
- ⑧ Front reading lamps

! *An interior lamp switched on manually does not go out automatically.*

Leaving an interior lamp switch in the ON position for extended periods of time with the engine turned off could result in a discharged battery.

Deactivating automatic control

i *The interior lighting is factory-set to automatic mode.*

- ▶ Press switch ②.

The interior lighting remains switched off in darkness, even when you:

- unlock the vehicle
- remove the SmartKey from the starter switch

- open a door
- open the tailgate

Activating automatic control

- ▶ Press switch ②.

The interior lighting switches on in darkness, when you:

- unlock the vehicle
- remove the SmartKey from the starter switch
- open a door
- open the tailgate

The interior lighting switches off after a preset time (> page 179).

i *If a door remains open, the interior lighting switches off automatically after approximately 5 minutes.*

An interior lamp switched on manually does not go out automatically.

Lighting

Manual control

Switching front/rear interior lighting on and off

- ▶ Press front/rear interior lighting switch ⑤ or ③ (▷ page 149) to switch on the desired interior light.
- ▶ Press front/rear interior lighting switch ⑤ or ③ again to switch off the respective interior light.

Switching front reading lamps on and off

The front reading lamps are located in the lower edge of the interior rear view mirror.

- ▶ Press front reading lamp switch ① or ④ (▷ page 149) to switch on the desired front reading lamp.
- ▶ Press front reading lamp switch ① or ④ again to switch off the respective front reading lamp.

Ambient lighting

You can switch the ambient lighting ⑦ (▷ page 149) on and off, using the “Control system” (▷ page 178).

Interior lighting in the rear

The overhead control panel is located above the rear seat bench.

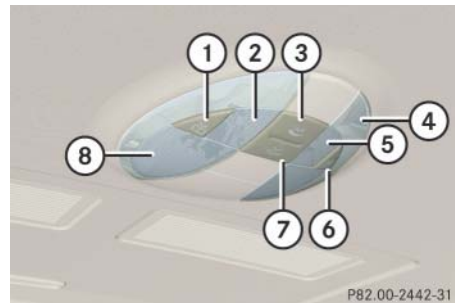

- ① Left rear reading lamp on/off
- ② Left rear reading lamp
- ③ Ambient lighting switch, to brighten
- ④ Ambient lighting
- ⑤ Right rear reading lamp
- ⑥ Right rear reading lamp on/off
- ⑦ Ambient lighting switch, to dim
- ⑧ Rear interior lamp

Rear reading lamps

- ▶ Press rear reading lamp switch ① or ⑥ to switch on the respective rear reading lamp.
- ▶ Press rear reading lamp switch ① or ⑥ again to switch off the respective rear reading lamp.

Ambient lighting

- ▶ Press ambient lighting switch ③ or ⑦ repeatedly until ambient lighting ④ has reached the desired intensity.

You can switch the ambient lighting on and off, using the “Control system” (> page 178).

Door entry lamps

For better orientation in the dark, the corresponding door entry lamps will switch on in the darkness when you open a door and the automatic control is activated.

The door entry lamps will switch off when the corresponding door is closed.

i *If you turn the SmartKey in the starter switch to position 0 and switch off the headlights, the door entry lamps will remain lit for approximately 5 minutes.*

Cargo compartment lamps

The cargo compartment lamps switch on if the cargo compartment is opened.

If you leave the tailgate open for an extended period of time, the cargo compartment lamps will switch off automatically after approximately 10 minutes.

Instrument cluster

A full view illustration of the instrument cluster can be found in the “At a glance” section of this manual (▷ page 26).



① Reset button

The instrument cluster is activated when you

- open a door
- switch on the ignition (▷ page 37)
- press the reset button ①
- switch on the exterior lamps

You can modify the instrument cluster settings in the instrument cluster submenu of the control system (▷ page 172).

Warning!



No messages will be displayed if either the instrument cluster or the multifunction display is inoperative.

As a result, you will not be able to see information about your driving conditions, such as speed or outside temperature, warning/indicator lamps, malfunction/warning messages or the failure of any systems. Driving characteristics may be impaired.

If you must continue to drive, please do so with added caution. Visit an authorized Mercedes-Benz Center as soon as possible.

Adjusting instrument cluster illumination

Use the reset button ① to adjust the illumination brightness for the instrument cluster.

i *The instrument cluster illumination is dimmed or brightened automatically to suit ambient light conditions.*

The instrument cluster illumination will also be adjusted automatically when you switch on the vehicle's exterior lamps.

To brighten illumination

- ▶ Turn the reset button ① in the instrument cluster clockwise.

The instrument cluster illumination will brighten.

To dim illumination

- ▶ Turn the reset button ① in the instrument cluster counterclockwise.

The instrument cluster illumination will dim.

Coolant temperature indicator

Warning!



- Driving when your engine is overheated can cause some fluids which may have leaked into the engine compartment to catch fire. You could be seriously burned.
- Steam from an overheated engine can cause serious burns which can occur just by opening the engine hood. Stay away from the engine if you see or hear steam coming from it.

Turn off the engine, get out of the vehicle and do not stand near the vehicle until the engine has cooled down.

! Excessive coolant temperature triggers the coolant temperature warning lamp (▷ page 384) and (▷ page 413) and a warning in the multifunction display (▷ page 384) and (▷ page 413).

The engine should not be operated with the coolant temperature above 248 °F (120 °C). Doing so may cause serious engine damage which is not covered by the Mercedes-Benz Limited Warranty.

i During severe operating conditions, e.g. stop-and-go traffic, the coolant temperature may rise close to 248 °F (120 °C).

Trip odometer

Make sure you are viewing the trip odometer display (▷ page 155).

- ▶ If it is not displayed, press button or repeatedly until the trip odometer appears.
- ▶ Press and hold the reset button (▷ page 152) until the trip odometer is reset.

Tachometer

The red marking on the tachometer denotes excessive engine speed.

! Avoid driving at excessive engine speeds, as it may result in serious engine damage that is not covered by the Mercedes-Benz Limited Warranty.

To help protect the engine, the fuel supply is interrupted if the engine is operated within the red marking.

Outside temperature indicator

Warning!



The outside temperature indicator is not designed to serve as an ice-warning device and is therefore unsuitable for that purpose.

Indicated temperatures just above the freezing point do not guarantee that the road surface is free of ice. The road may still be icy, especially in wooded areas or on bridges.

The outside temperature is displayed in the instrument cluster (▷ page 26).

The temperature sensor is located in the front bumper area. Due to its location, the sensor can be affected by road or engine heat during idling or slow driving. This means that the accuracy of the displayed temperature can only be verified by comparison to a thermometer placed next to the sensor, not by comparison to external displays (e.g. bank signs etc.).

When moving the vehicle into colder ambient temperatures (e.g. when leaving your garage), you will notice a delay before the lower temperature is displayed.

A delay also occurs when ambient temperatures rise. This prevents inaccurate temperature indications caused by heat radiated from the engine during idling or slow driving.

▼ Control system

The control system is activated as soon as the SmartKey in the starter switch is turned to position **1** or as soon as the KEYLESS-GO start/stop button* is in position **1**. The control system enables you to:

- call up information about your vehicle
- change vehicle settings

For example, you can use the control system to find out when your vehicle is next due for service, to set the language for messages in the instrument cluster display, and much more.

i *The displays for the audio systems (radio, CD player) will appear in English, regardless of the language selected.*

Warning!



A driver's attention to the road and traffic conditions must always be his / her primary focus when driving.

For your safety and the safety of others, selecting features through the multifunction steering wheel should only be done by the driver when traffic and road conditions permit it to be done safely.

Bear in mind that at a speed of just 30 mph (approximately 50 km / h), your vehicle is covering a distance of 44 feet (approximately 14 m) every second.

The control system relays information to the multifunction display.

Multifunction display



- ① Outside temperature
- ② Trip odometer
- ③ Automatic transmission program mode
- ④ Main odometer
- ⑤ Current gear selector lever position

Above illustration shows the standard display.

For more information on menus displayed in the multifunction display, see “Menus” (▷ page 158).

Control system

Multifunction steering wheel

The displays in the multifunction display and the settings in the control system (▷ page 155) are controlled by the buttons on the multifunction steering wheel.



- ① Multifunction display

Operating the control system

- ② Selecting the submenu or setting the volume:

Press button

 up/to increase

 down/to decrease

- ③ Telephone*:

Press button

 to take a call
to dial
to redial

 to end a call
to reject an incoming call

- ④ Menu systems:

Press button

 for next menu

 for previous menu

- ⑤ Moving within a menu:

Press button

 for next display





 for previous display

Depending on the selected menu (▷ page 158), pressing the buttons on the multifunction steering wheel will alter what is shown in the multifunction display.

The information available in the multifunction display is arranged in menus, each containing a number of functions or sub-menus.

The individual functions are then found within the relevant menu (radio or CD operations under AUDIO, for example). These functions serve to call up relevant information or to customize the settings for your vehicle.

It is helpful to think of the menus, and the functions within each menu, as being arranged in a circular pattern.

- If you press button  or  repeatedly, you will pass through each menu one after the other.
- If you press button  or  repeatedly, you will pass through each function display, one after the other, in the current menu.

In the *Settings* menu, instead of functions you will find a number of submenus for calling up and changing settings. For instructions on using these submenus, see the “Settings menu” section (▷ page 169).

The number of menus available in the system depends on which optional equipment is installed in your vehicle.

The menus are described on the following pages.

Control system

Menus

This is what you will see when you scroll through the menus.

The table on the next page provides an overview of the individual menus.

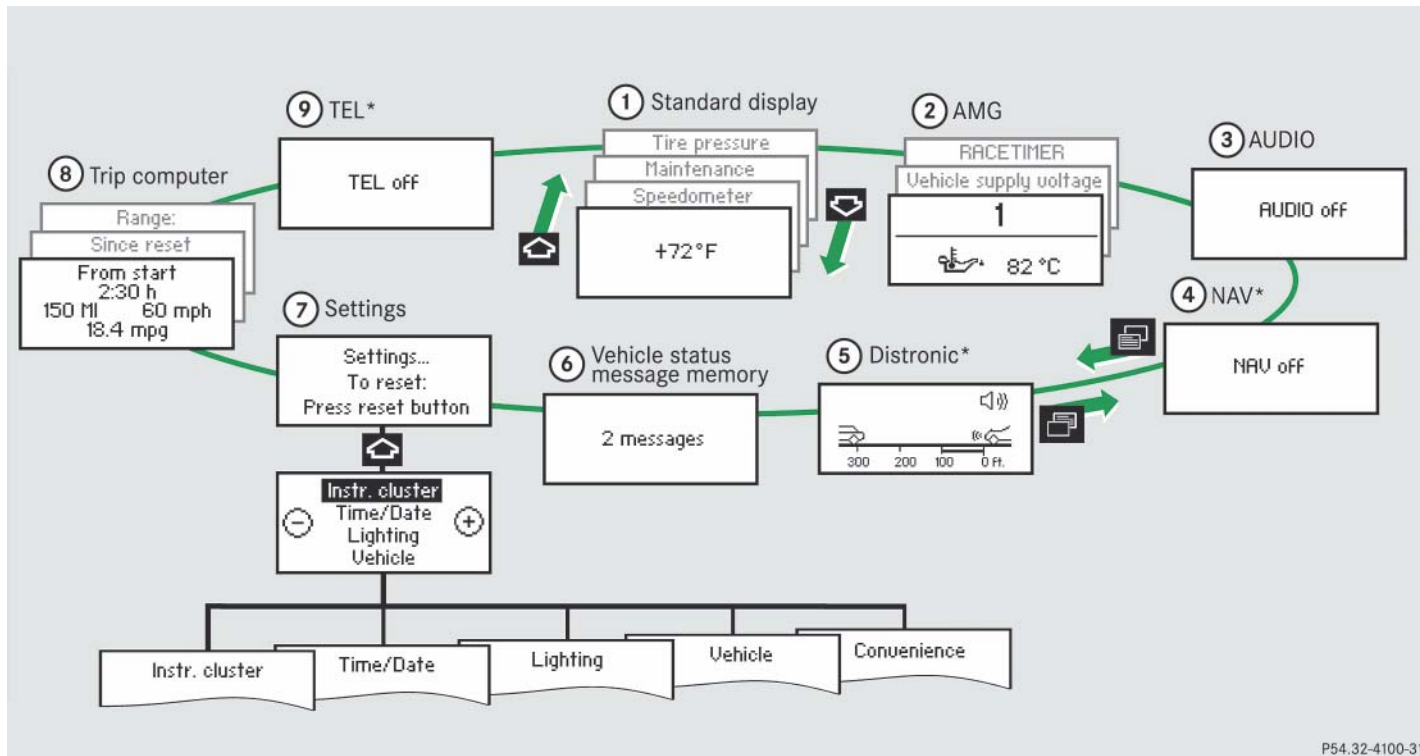

P54.32-4100-31

Menus, submenus and functions

	Menu ①	Menu ②	Menu ③	Menu ④	Menu ⑤
	Standard display (▷ page 161)	AMG¹ (▷ page 161)	AUDIO (▷ page 165)	NAV* (▷ page 167)	Distronic* (▷ page 167)
Commands/submenus	Digital speedometer Calling up maintenance system display	Engine oil temperature Vehicle supply voltage RACETIMER Overall analysis Lap analysis	Selecting radio station Selecting satellite radio station* Operating CD player	Show route guidance instructions, current direction traveled	Calling up settings

¹ AMG vehicles only.

Control system



	Menu ⑥ Vehicle status message memory ¹ (▷ page 168)	Menu ⑦ Settings (▷ page 169)	Menu ⑧ Trip computer (▷ page 183)	Menu ⑨ TEL* (▷ page 184)
Commands/submenus	Calling up vehicle malfunction, warning and system status messages stored in memory	Resetting to factory settings Instrument cluster submenu Time/Date submenu Lighting submenu Vehicle submenu Convenience submenu	Fuel consumption statistics since start Fuel consumption statistics since the last reset Resetting fuel consumption statistics Distance to empty	Loading phone book Searching for name in phone book

¹ The vehicle status message memory menu is only displayed if there is a message stored.

i The headings used in the menus table are designed to facilitate navigation within the system and are not necessarily identical to those shown in the control system displays.

The first function displayed in each menu will automatically show you which part of the system you are in.



Standard display menu

- ▶ Press button  or  repeatedly to select the functions in the standard display menu.

The following functions are available:

Function	Page
Calling up digital speedometer	161
Calling up maintenance service indicator	365

Display digital speedometer

- ▶ Press button  or  repeatedly until the digital speedometer appears in the multifunction display.

AMG menu

- i** *This function is only available in AMG vehicles.*



The main screen of the AMG menu shows you the gear currently engaged as well as the engine oil temperature.

- ▶ Press button  or  repeatedly until you see the AMG menu.



- ① Gear indicator
- ② Engine oil temperature

- i** *The engine oil temperature symbol flashes if the engine oil temperature has not yet reached 80°C. During this time, avoid driving at full engine speed.*



Use buttons  or  to select the following functions in the AMG menu:

Function	Page
Vehicle supply voltage	162
RACETIMER	162
Overall analysis	164
Lap analysis	164

- i** *If the engine reaches the overspeed range in the manual shift program, the menu will be shown in red. In addition, you will see **UP** next to gear indicator ① as a reminder to upshift.*

Control system

Vehicle supply voltage

- ▶ Press button  or  repeatedly until you see the AMG menu.
- ▶ Press button  repeatedly until you see the vehicle supply voltage.



- ① Gear indicator
- ② Vehicle supply voltage



RACETIMER

Warning!



The RACETIMER feature is only for use on roads and in conditions where high speed driving is permitted. Racing on public roads is prohibited under all circumstances and the driver is and must always remain responsible for following posted speed limits.

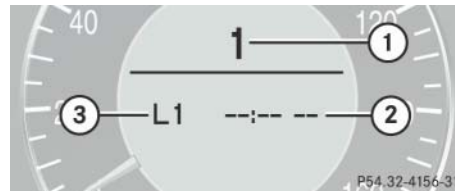

The RACETIMER allows you to time and save driving stretches in hours, minutes and seconds.

- ▶ Press button  or  repeatedly until you see the AMG menu.
- ▶ Press button  repeatedly until you see the RACETIMER.



- ① Gear indicator
- ② RACETIMER
- ③ Lap

i You can start the RACETIMER when the engine is running or the starter switch is in position 2 (> page 37).

i While the RACETIMER is being displayed, you cannot adjust the volume using buttons  or .

Starting the RACETIMER

- ▶ Press button .

The timer starts.

Displaying intermediate time

- ▶ Press button **—** while the timer is running.

The intermediate time is shown for 5 seconds.

Stopping the RACETIMER

- ▶ Press button **+**.

The timer stops.

i When you stop the vehicle and turn the Smartkey to position 1 (▷ page 38) or, in vehicles with KEYLESS-GO*, turn off the engine and do not open the driver's door, the RACETIMER stops timing. Timing is resumed when you switch the ignition back on (▷ page 38) or restart the engine (▷ page 52) and then press the **+** button.

Saving lap time and starting a new lap

i You can save up to nine laps.

- ▶ Press button **—** while the timer is running.

The intermediate time will be shown for 5 seconds.

- ▶ Press button **—** within the next 5 seconds.

The intermediate time shown will be saved as a lap time.

The RACETIMER begins timing the new lap. The new lap begins to be timed as soon as the intermediate time is called up.

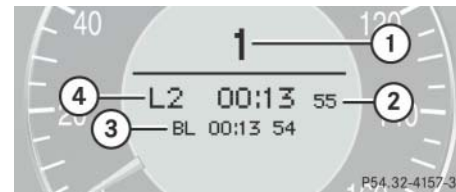

- ① Gear indicator
- ② RACETIMER
- ③ Best lap time
- ④ Lap number

Control system

Resetting current lap

- ▶ Press button **+** while the timer is running.

The timer stops.

- ▶ Press button **-**.

The lap time is reset to “0”.

Deleting all laps

i It is not possible to delete a single saved lap.

- ▶ Press button **+** while the timer is running.

The timer stops.

- ▶ Press the reset button twice (▷ page 27).

- ▶ Press button **+**.

The timer starts. The saved laps are deleted.

i When you switch off the engine, the RACETIMER will be reset to “0” after 30 seconds. All laps are deleted.

Overall analysis

i These functions are only available if you have saved at least one lap and have stopped the RACETIMER.

- ▶ Press button **☰** or **☷** repeatedly until you see the AMG menu.

- ▶ Press button **⬆** repeatedly until you see the overall analysis.

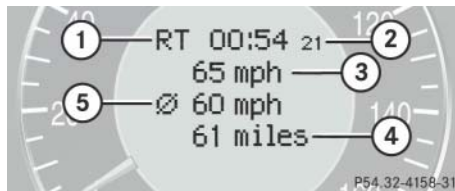

- ① Overall analysis of RACETIMER
- ② Overall driving time
- ③ Maximum speed
- ④ Overall distance driven
- ⑤ Average speed

Lap analysis

i These functions are only available if you have saved at least two laps and have stopped the RACETIMER.

- ▶ Press button **☰** or **☷** repeatedly until you see the AMG menu.

- ▶ Press button **⬆** repeatedly until you see the lap analysis.

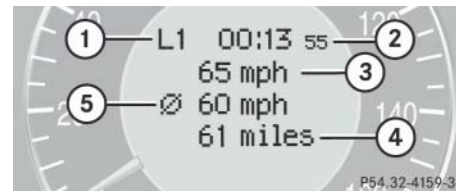

- ① Lap number
- ② Lap time
- ③ Maximum speed
- ④ Lap length
- ⑤ Average speed during lap

- ▶ Press button **⬆** or **⬇** to see other lap analyses.

i Each lap is shown in its own submenu. The fastest lap is indicated by flashing symbol ①.

AUDIO menu



The functions in the **AUDIO** menu operate the audio equipment which you currently have turned on.

If no audio equipment is currently turned on, the message **AUDIO off** appears in the multifunction display.

The following functions are available:

Function	Page
Selecting radio station	165
Selecting satellite radio station*	165
Operating CD player	166

Selecting radio station

- ▶ Turn on **COMAND** and select radio. Refer to separate **COMAND** operating instructions.
- ▶ Press button  or  repeatedly until you see the currently tuned station in the multifunction display.

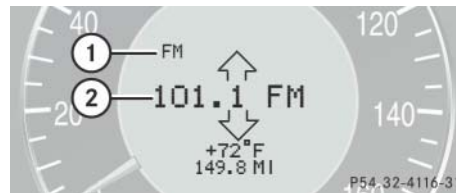

- ① Waveband setting
- ② Station frequency

- ▶ Press button  or  repeatedly until the desired station is found.

i You can only store new stations using the corresponding feature on the radio, see separate operating instructions.

You can also operate the radio in the usual manner.

Selecting satellite radio station* (USA only)

The satellite radio is treated as a radio application.

- ▶ Select **SAT** radio with the corresponding softkey in the radio menu.



- ① SAT mode and preset number
- ② Setting for station selection using memory
- ③ Channel name or number

- ▶ Press button  or  repeatedly until the desired channel is found.

Control system

i Additional optional satellite radio equipment and a subscription to satellite radio service provider are required for satellite radio operation. Contact an authorized Mercedes-Benz Center for details and availability for your vehicle.



For more information, refer to separate COMAND operating instructions.

Operating CD player

i The COMAND system and the CD changer can play audio CDs as well as MP3-CDs.

For more information on operating the CD changer refer to separate COMAND operating instructions.

Selecting CD track

- ▶ Turn on COMAND and select CD or CD changer. Refer to separate COMAND operating instructions.
- ▶ Press button  or  repeatedly until the settings for the CD currently being played appear in the multifunction display.

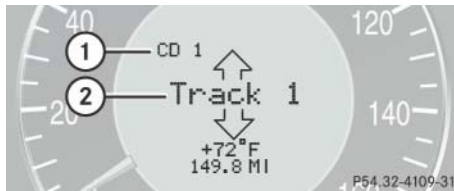



- ① Current CD (for CD changer)
- ② Current track

▶ Press button  or  repeatedly until the desired track is selected.

i To select a CD from the CD changer magazine, press a number on the COMAND system key pad located in the center console.

Selecting MP3-CD track

- ▶ Turn on COMAND and select MP3-CD. Refer to separate COMAND operating instructions.
- ▶ Press button  or  repeatedly until the settings for the MP3-CD currently being played appear in the multifunction display.

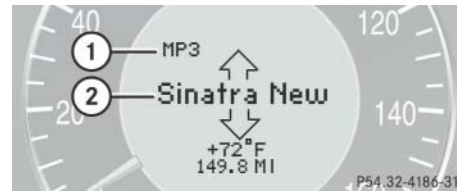

- ① MP3 mode
- ② Current track



▶ Press button  or  repeatedly until the desired track is selected.

i Level of information displayed will vary depending on the information contained on the MP3-CD insert in the single CD player of the COMAND system.

To select a MP3-CD from the CD changer magazine, press a number on the COMAND system key pad located in the center console.

NAV* menu

The NAV menu contains the functions needed to operate your navigation system.



- ▶ Press button  or  repeatedly until you see the message NAV in the multifunction display.
- If COMAND is switched off, the message NAV off appears in the multifunction display.
- With COMAND switched on but route guidance not activated, the direction of travel and, if available, the name of the street currently traveled on appear in the multifunction display.
- With COMAND switched on and route guidance activated, the direction of travel and maneuver instructions appear in the multifunction display.

Please refer to the COMAND manual for instructions on how to activate the route guidance system.

Distronic* menu

Use the Distronic menu to display the current settings for your Distronic system. What information is shown in the multifunction display depends on whether the Distronic system is active or inactive.

Please refer to the “Driving systems” section of this manual (▶ page 249) for instructions on how to activate Distronic.

- ▶ Press button  or  repeatedly until you see one of the following two pictures in the multifunction display.

Distronic deactivated

When Distronic is deactivated, you will see the standard display in the multifunction display.

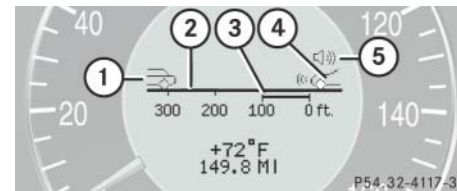

- ① Vehicle ahead, if detected
- ② Actual distance to vehicle ahead
- ③ Preset distance threshold to vehicle ahead
- ④ Your vehicle
- ⑤ Symbol for activated distance warning function

Control system

Distronic activated

With DISTRONIC activated, the DISTRONIC display is shown in the multifunction display and one or two segments around the set speed are illuminated in the speedometer.

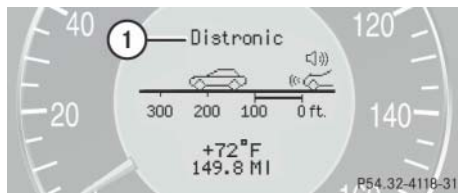

① DISTRONIC activated

Vehicle status message memory menu



Use the vehicle status message memory menu to scan malfunction and warning messages that may be stored in the system. Such messages appear in the multifunction display and are based on conditions or system status the vehicle's system has recorded.

The vehicle status message memory menu only appears if there are any messages stored.

Warning!



Malfunction and warning messages are only indicated for certain systems and are intentionally not very detailed. The malfunction and warning messages are simply a reminder with respect to the operation of certain systems and do not replace the owner's and / or driver's responsibility to maintain the vehicle's operating safety by having all required maintenance and safety checks performed on the vehicle and by bringing the vehicle to an authorized Mercedes-Benz Center to address the malfunction and warning messages (▷ page 394).



- ▶ Press button  or  repeatedly until the vehicle status message memory appears in the multifunction display.

If the vehicle status message memory menu does not appear, then there are no messages stored.

Vehicle status messages have been recorded

If conditions have occurred causing status messages to be recorded, the number of messages appears in the multifunction display:



- Press button  or .



The stored messages will now be displayed in the order in which they have occurred. For malfunction and warning messages, see “Vehicle status messages in the multifunction display” (▷ page 394).

Should the vehicle’s system record any conditions while driving, the number of messages will reappear in the multifunction display when the SmartKey in the starter switch is turned to position **0** or removed from the starter switch.

i *The vehicle status message memory will be cleared when you turn the SmartKey in the starter switch to position 1 or 2. You will then only see high-priority messages in the multifunction display (▷ page 394).*

Settings menu

In the Settings menu there are two functions:

- The function To reset: Press reset button for 3 seconds, with which you can reset all the settings to the original factory settings.
 - A collection of submenus with which you can make individual settings for your vehicle.
- Press button  or  repeatedly until the Settings menu is seen in the multifunction display.



Control system

The following settings and submenus are available in the Settings menu:

Function	Page
Resetting all settings	170
Submenus in the Settings menu	170
Instrument cluster submenu	172
Time/date submenu	174
Lighting submenu	176
Vehicle submenu	180
Convenience submenu	181

Resetting all settings

You can reset all the functions of all submenus to the factory settings.

- ▶ Press the reset button in the instrument cluster (▷ page 152) for approximately 3 seconds.

In the multifunction display you will see the request to press the reset button again to confirm.

- ▶ Press the reset button again.

The functions of all the submenus will reset to factory settings.

i *The settings you have changed will not be reset unless you confirm the action by pressing the reset button a second time. After approximately 5 seconds, the Settings menu reappears in the multifunction display.*

For safety reasons, the Headlamp mode function in the Lighting submenu is not reset while driving.

Submenus in the Settings menu

- ▶ Press button **▲**.

In the multifunction display you see the collection of the submenus.



- ▶ Press button **■**.

The selection marker moves to the next submenu.

The submenus are arranged by hierarchy. Scroll down with button **■**, scroll up with button **+**.

With the selection marker on the desired submenu, use the button **▲** to access the individual functions within that submenu. Once within the submenu, you can use the button **▲** to move to the next function or the button **▼** to move to the previous function within that submenu.

The settings themselves are made with button **+** or **■**.

The table below shows what settings can be changed within the various menus. Detailed instructions on making individual settings can be found on the following pages.

Instrument cluster (▷ page 172)	Time/Date (▷ page 174)	Lighting (▷ page 176)	Vehicle (▷ page 180)	Convenience (▷ page 181)
Selecting speedometer display mode	Synchronizing the time	Setting daytime running lamp mode (USA only)	Setting automatic locking	Activating easy-entry / exit feature
Selecting language	Setting the time (hours)	Setting locator lighting	Limiting opening height of tailgate*	Setting parking position for exterior rear view mirror ¹
Selecting display (speed display or outside temperature) for status line	Setting the time (minutes)	Setting ambient lighting	Audio search function	
Selecting display (speed display or outside temperature) for basic display	Setting the date (month) Setting the date (day) Setting the date (year)	Setting headlamps delayed shut-off Setting interior lighting delayed shut-off		

¹ If equipped.

Control system

Instrument cluster submenu

Access the Instr. cluster submenu via the Settings menu. Use the Instr. cluster submenu to change the instrument cluster display settings. The following functions are available:

Function	Page
Selecting speedometer display mode	172
Selecting language	172
Selecting display (speed display or outside temperature) for status line display	173
Selecting display (speed display or outside temperature) for basic display	173

Selecting speedometer display mode

- ▶ Move the selection marker with button **+** or **-** to the Instr. cluster submenu.
- ▶ Press button **▲** or **▼** repeatedly until the message Display unit Speed-/odometer appears in the multifunction display.

The selection marker is on the current setting.



- ▶ Press button **+** or **-** to set speedometer unit to km or miles.

Selecting language

- ▶ Move the selection marker with button **+** or **-** to the Instr. cluster submenu.
- ▶ Press button **▲** or **▼** repeatedly until the message Language appears in the multifunction display.

The selection marker is on the current setting.



- ▶ Press button **+** or **-** to select the language to be used for the multifunction display messages.

Available languages:

- German
- English
- French
- Italian
- Spanish
- Dutch
- Danish
- Swedish
- Portuguese
- Turkish
- Russian

i Russian is available for Canada vehicles only.

Selecting display (speed display or outside temperature) for status line display

- ▶ Move the selection marker with button **+** or **-** to the Instr. cluster submenu.
- ▶ Press button **↶** or **↷** repeatedly until the message Status line display appears in the multifunction display.

The selection marker is on the current setting.

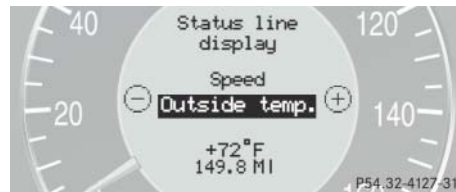

- ▶ Press button **+** or **-** to select the status line to Speed or Outside temp..

i You will see the status indicator when you have called up a different display from the standard display.

Selecting display (speed display or outside temperature) for basic display

- ▶ Move the selection marker with button **+** or **-** to the Instr. cluster submenu.
- ▶ Press button **↶** or **↷** repeatedly until the message Basic display appears in the multifunction display.

The selection marker is on the current setting.



- ▶ Press button **+** or **-** to select the display permanently shown in the multifunction display.

Control system

Time /Date submenu

Access the Time/Date submenu via the Settings menu. Use the Time/Date submenu to change the time and date display settings. The following functions are available:

Function	Page
Synchronizing the time	174
Setting the time (hours)	174
Setting the time (minutes)	175
Setting the date (month)	175
Setting the date (day)	175
Setting the date (year)	176

i Information on setting the time, refer to separate COMAND instructions.

Synchronizing the time

This function can only be seen on vehicles with COMAND and navigation module*.

- ▶ Move the selection marker with button **+** or **-** to the Time/Date submenu.
- ▶ Press button **▲** or **▼** repeatedly until the message **Time, synchroniz. with Head Unit** appears in the multi-function display.

The selection marker is on the current setting.



- ▶ Press button **+** or **-** to select the desired setting.

Setting the time (hours)

This function can only be seen when time synchronization is switched off.

- ▶ Move the selection marker with button **+** or **-** to the Time/Date submenu.
- ▶ Press button **▲** or **▼** repeatedly until the message **Time, hours** appears in the multifunction display.

The selection marker is on the hour setting.



- ▶ Press button **+** or **-** to set the hours.
- ▶ Confirm by pressing reset button (▷ page 152).

Setting the time (minutes)

This function can only be seen when time synchronization is switched off.

- ▶ Move the selection marker with button **+** or **-** to the Time/Date submenu.
- ▶ Press button **↕** or **↓** repeatedly until the message **Time, minute(s)** Press R to confirm appears in the multifunction display.

The selection marker is on the minute setting.



- ▶ Press button **+** or **-** to set the minutes.
- ▶ Confirm by pressing reset button (▷ page 152).

Setting the date (month)

- ▶ Move the selection marker with button **+** or **-** to the Time/Date submenu.
- ▶ Press button **↕** or **↓** repeatedly until the message **Set date Month** appears in the multifunction display.

The selection marker is on the month setting.

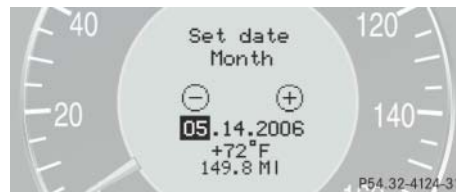

- ▶ Press button **+** or **-** to set the month.

Setting the date (day)

- ▶ Move the selection marker with button **+** or **-** to the Time/Date submenu.
- ▶ Press button **↕** or **↓** repeatedly until the message **Set date Day** appears in the multifunction display.

The selection marker is on the day setting.



- ▶ Press button **+** or **-** to set the day.

Control system

Setting the date (year)

- ▶ Move the selection marker with button **+** or **-** to the Time/Date submenu.
- ▶ Press button **↶** or **↷** repeatedly until the message **Set date Year** appears in the multifunction display.

The selection marker is on the year setting.



- ▶ Press button **+** or **-** to set the year.

Lighting submenu

Access the Lighting submenu via the Settings menu. Use the Lighting submenu to change the lamp and lighting settings on your vehicle. The following functions are available:

Function	Page
Setting daytime running lamp mode (USA only)	176
Setting locator lighting	177
Setting ambient lighting	178
Setting headlamps delayed shut-off	178
Setting interior lighting delayed shut-off	179

Setting daytime running lamp mode (USA only)

i This function is not available in countries where the daytime running lamp mode is mandatory and therefore in a constant mode.

- ▶ Move the selection marker with button **+** or **-** to the Lighting submenu.
- ▶ Press button **↶** or **↷** repeatedly until the message **Headlamp mode** appears in the multifunction display.

The selection marker is on the current setting.



- ▶ Press button **+** or **-** to select manual operation (manual) or daytime running lamp mode (constant) activated.

With daytime running lamp mode activated and the exterior lamp switch in position **0** or **AUTO**, the low beam headlamps are switched on when the engine is running.

In low ambient light conditions the following lamps will switch on additionally:

- Parking lamps
- Tail lamps
- License plate lamps
- Side marker lamps

For more information on the daytime running lamp mode, see “Lighting” (▷ page 141).

i For safety reasons, resetting the Lighting submenu to factory settings while driving (▷ page 170) will not deactivate the daytime running lamp mode.

The following message appears in the multifunction display: Lighting - Cannot be completely reset to factory settings while driving.

Setting locator lighting

With the locator lighting feature activated and the exterior lamp switch in position **AUTO**, the following lamps will switch on during darkness when the vehicle is unlocked using button **U** on the SmartKey or SmartKey with KEYLESS-GO*:

- Parking lamps
- Tail lamps
- License plate lamps
- Side marker lamps
- Front fog lamps



The locator lighting switches off when the driver’s door is opened.

If you do not open a door after unlocking the vehicle with the SmartKey, the lamps will switch off automatically after approximately 40 seconds.

- ▶ Move the selection marker with button **+** or **-** to the Lighting submenu.





Control system

- ▷▷ Press button  or  repeatedly until the message **Function Surround lighting** appears in the multifunction display.





The selection marker is on the current setting.



- ▶ Press button  or  to switch the locator lighting function On or Off.
- ▶ Turn the exterior lamp switch to position **AUTO** when exiting the vehicle. The locator lighting feature is activated.



Setting ambient lighting

Use this function to adjust the brightness of the ambient lighting.

- ▶ Move the selection marker with button  or  to the **Lighting** submenu.
- ▶ Press button  or  repeatedly until the message **Ambient light level** appears in the multifunction display.

The selection marker is on the current setting.



- ▶ Press button  or  to select the desired brightness of the ambient lighting.

The setting 1 represents the darkest level and setting 5 the brightest level. The ambient light is switched off at setting 0.

Setting night security illumination (Headlamps delayed shut-off)

Use this function to set whether you would like the exterior lamps to remain on for 15 seconds during darkness after exiting the vehicle and closing all doors.

With the delayed shut-off feature activated and the exterior lamp switch in position **AUTO** before the engine is turned off, the following lamps will switch on when the engine is turned off:

- Parking lamps
- Tail lamps
- License plate lamps
- Side marker lamps
- Front fog lamps

If after turning off the engine you do not open a door or do not close an opened door, the lamps will automatically switch off after 60 seconds.

- ▶ Move the selection marker with button **+** or **-** to the Lighting submenu.
- ▶ Press button **↶** or **↷** repeatedly until the message **Headlamps delayed shut-off** appears in the multifunction display.

The selection marker is on the current setting.

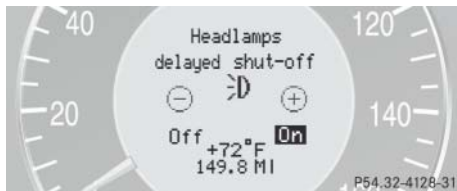

- ▶ Press button **+** or **-** to switch **Headlamps delayed shut-off** On or Off.
- ▶ Turn the exterior lamp switch to position **AUTO** before turning off the engine.

You can temporarily deactivate the delayed shut-off feature:

- ▶ Before exiting the vehicle, turn the SmartKey in the starter switch to position **0**.
- ▶ Then turn it to position **2** and back to position **0**.

The delayed shut-off feature is deactivated. It will reactivate as soon as you reinsert the SmartKey in the starter switch.

Vehicles with KEYLESS-GO*:

- ▶ Press the KEYLESS-GO start / stop button on the gear selector lever (▷ page 39).

Setting interior lighting delayed shut-off

Use this function to set whether you would like the interior lighting to remain on for 10 seconds during darkness after you have removed the SmartKey from the starter switch.

- ▶ Move the selection marker with button **+** or **-** to the Lighting submenu.
- ▶ Press button **↶** or **↷** repeatedly until the message **Interior lighting delayed shut-off** appears in the multifunction display.

The selection marker is on the current setting.

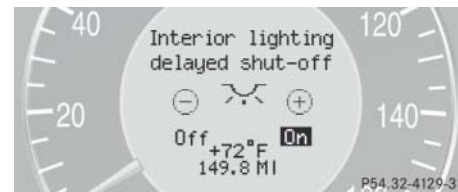

- ▶ Press button **+** or **-** to switch **Interior lighting delayed shut-off** On or Off.

Control system

Vehicle submenu

Access the Vehicle submenu via the Settings menu. Use the Vehicle submenu to make general vehicle settings. The following functions are available:

Function	Page
Setting automatic locking	180
Limiting opening height of tailgate*	180
Audio search function	180

Setting automatic locking

Use this function to activate or deactivate the automatic central locking. With the automatic central locking system activated, the vehicle is centrally locked at vehicle speeds of approximately 9 mph (15 km/h).

- ▶ Move the selection marker with button **+** or **-** to the Vehicle submenu.

- ▶ Press button **▲** or **▼** repeatedly until the message Automatic door locking appears in the multifunction display.

The selection marker is on the current setting.



- ▶ Press button **+** or **-** to switch Automatic door locking On or Off.

Limiting opening height of tailgate*

Use this function to activate or deactivate the limiting opening height of tailgate.

- ▶ Move the selection marker with button **+** or **-** to the Vehicle submenu.

- ▶ Press button **▲** or **▼** repeatedly until the message Tailgate opening limiter appears in the multifunction display.

The selection marker is on the current setting.





- ▶ Press button **+** or **-** to switch Tailgate opening limiter On or Off.

Setting station selection mode



Use the Audio search function to select the manual or memory station selection mode for the radio (▷ page 165).

- ▶ Move the selection marker with button **+** or **-** to the Vehicle submenu.

- ▶ Press button  or  repeatedly until the message Audio search function appears in the multifunction display.

The selection marker is on the current setting.



- ▶ Press button  or  to select the desired station selection mode. You can select:
 - frequenc.
 - memory selects next stored station

Convenience submenu

Access the Convenience submenu via the Settings menu. Use the Convenience submenu to change the settings for a number of convenience features. The following functions are available:

Function	Page
Activating easy-entry / exit feature	181
Setting parking position for exterior rear view mirror ¹	182

¹ If equipped.

Activating easy-entry / exit feature

Use this function to activate and deactivate the easy-entry / exit feature (▷ page 46).

Warning!



You must make sure no one can become trapped or injured by the moving steering wheel when the easy-entry / exit feature is activated.

To stop steering wheel movement, do one of the following:

- Move steering column stalk (▷ page 45).
- Press one of the memory position buttons (▷ page 139).

Do not leave children unattended in the vehicle, or with access to an unlocked vehicle. Children could open the driver's door and unintentionally activate the easy-entry / exit feature, which could result in an accident and/or serious personal injury.

Control system

- ▶ Move the selection marker with button **+** or **-** to the Convenience submenu.
- ▶ Press button **↶** or **↷** repeatedly until the message Easy-entry function appears in the multifunction display.

The selection marker is on the current setting.



- ▶ Press button **+** or **-** to switch Easy-entry function On or Off.

Setting parking position for exterior rear view mirror

Depending on production date, your vehicle may not be equipped with this function.

Use the Mirror adjust. parking aid function to select whether the passenger-side exterior rear view mirror should be turned downward during parking maneuvers when reverse gear **R** is engaged. For additional information, see “Activating exterior rear view mirror parking position” (▶ page 202).

- ▶ Move the selection marker with button **+** or **-** to the Convenience submenu.

- ▶ Press button **↶** or **↷** repeatedly until the message Mirror adjust. parking aid appears in the multifunction display.

The selection marker is on the current setting.







- ▶ Press button **+** or **-** to switch Mirror adjust. parking aid On or Off.

Trip computer menu

Use the trip computer menu to call up statistical data on your vehicle. The following information is available:

Function	Page
Fuel consumption statistics since start	183
Fuel consumption statistics since last reset	183
Resetting fuel consumption statistics	184
Distance to empty	184



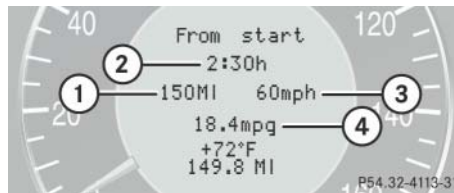

Fuel consumption statistics since start

- ▶ Press button  or  repeatedly until you see the first function of the trip computer menu.
- ▶ Press button  or  repeatedly until the message *From start* appears in the multifunction display.



- ① Distance driven since start
- ② Time elapsed since start
- ③ Average speed since start
- ④ Average fuel consumption since start

Fuel consumption since last reset

- ▶ Press button  or  repeatedly until you see the first function of the trip computer menu.
- ▶ Press button  or  repeatedly until the message *Since reset* appears in the multifunction display.

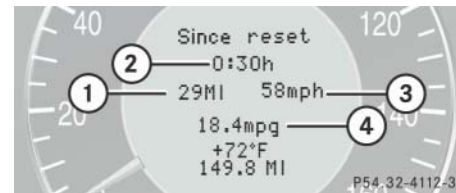





- ① Distance driven since last reset
- ② Time elapsed since last reset
- ③ Average speed since last reset
- ④ Average fuel consumption since last reset

i All statistics stored since the last engine start will be reset approximately 4 hours after the SmartKey in the starter switch is turned to position 0 or removed from the starter switch.





Resetting will not occur if you turn the SmartKey back to position 1 or 2 within this time period.

Control system

Resetting fuel consumption statistics

- ▶ Press button  or  repeatedly until you see the first function of the trip computer menu.
- ▶ Press button  or  repeatedly until you see the reading that you want to reset in the multifunction display.
- ▶ Press and hold the reset button in the instrument cluster (> page 152) until the value is reset to 0.

Distance to empty

- ▶ Press button  or  repeatedly until you see the first function of the trip computer menu.
- ▶ Press button  or  repeatedly until the message Range: appears in the multifunction display.

The calculated remaining driving range based on the current fuel tank level appears in the multifunction display.



i *If only very little fuel is left in the tank, a vehicle at the fuel pump is shown instead of the range.*

TEL* menu

Warning!



A driver's attention to the road must always be his / her primary focus when driving. For your safety and the safety of others, we recommend that you pull over to a safe location and stop before placing or taking a telephone call. If you choose to use the telephone while driving, please use the hands-free device and only use the telephone when weather, road and traffic conditions permit.



Some jurisdictions prohibit the driver from using a cellular telephone while driving a vehicle.

Bear in mind that at a speed of just 30 mph (approximately 50 km / h), your vehicle is covering a distance of 44 feet (approximately 14 m) every second.

Never operate radio transmitters equipped with a built-in or attached antenna (i.e. without being connected to an external antenna)

from inside the vehicle while the engine is running. Doing so could lead to a malfunction of the vehicle's electronic system, possibly resulting in an accident and /or serious personal injury.

You can use the functions in the **Te1** menu to operate your telephone, provided it is connected to a hands-free system and switched on.

- ▶ Switch on the telephone and COMAND.
- ▶ Press button  or  on the steering wheel repeatedly until the **Te1** menu appears in the multifunction display.

Which messages will appear in the multifunction display depends on whether your telephone is switched on or off:

- If the telephone is off, the message in the multifunction display is: **TEL off**.

- If the telephone is on:

The telephone will then search for a network. During this time the multifunction display is empty.

As soon as the telephone has found a network, **READY** appears in the multifunction display.



This standby message indicates that your telephone is ready for use and you can operate it using the control system.

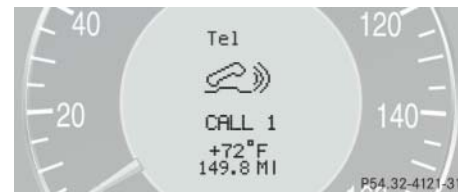

Answering a call

When your telephone is ready to receive calls, you can answer a call at any time. In the multifunction display you will then see the message, or if available, the caller ID (number and name):



- ▶ Press button .

You have answered the call. In the multifunction display you see the length of the call.

 *If you do not wish to accept a call, press button .*

Ending a call





- ▶ Press button .

You have ended the call. In the multifunction display you will again see the standby message.

Control system



Dialing a number from the phone book

If your telephone is ready to receive calls, you may select and dial a number from the phone book at any time.



- ▶ Press button  or  repeatedly until you see the Tel menu in the multifunction display.
- ▶ Press button  or .

The control system reads the phone book which is stored in the telephone. This may take several minutes. In the multifunction display you will see the message *Please wait*.

When the message *Please wait* disappears, the phone book has been loaded.

- ▶ Press button  or  repeatedly until the desired name appears in the multifunction display.

The stored names are displayed in ascending or descending alphabetical order.

i If you press and hold button  or  for longer than 1 second, the system scrolls rapidly through the list of names until you release the button again.

Cancel the quick search mode by pressing button .

- ▶ Press button .

The system dials the selected phone number.



- If the connection is successful, the name of the party you are calling and the duration of the call will appear in the multifunction display.





- If no connection is made, the control system stores the dialed number in the redial memory.

Redialing

The control system stores the most recently dialed phone numbers. This eliminates the need to search through your entire phone book.

- ▶ Press button  or  repeatedly until you see the Tel menu in the multifunction display.
- ▶ Press button .

In the multifunction display you see the first number in the redial memory.

- ▶ Press button  or  repeatedly until the desired name appears in the multifunction display.
- ▶ Press button .

The control system dials the selected phone number.

▼ Automatic transmission

For more information on driving with an automatic transmission, see “Automatic transmission” (▷ page 52).

Your vehicle’s transmission adapts its gear shifting process to your individual driving style by continually adjusting the shift points up or down. These shift point adjustments are performed based on current operating and driving conditions.

If the operating conditions change, the automatic transmission reacts by adjusting its shift program.

i During the brief warm-up, transmission upshifting is delayed. This allows the catalytic converter to heat up more quickly to operating temperature.

Warning!



Make sure that absolutely no objects are obstructing the pedals’ range of movement. Keep the driver’s footwell clear of all obstacles. If there are any floor mats or carpets in the footwell, make sure that the pedals still have sufficient clearance.

During sudden driving or braking maneuvers the objects could get caught between the pedals. You could then no longer brake or accelerate. This could lead to accidents and injury.

Gear selector lever

The gear selector lever is located on the lower part of the center console.



Gearshift pattern for automatic transmission

- P Park position
- R Reverse gear
- N Neutral
- D Drive position

i The current gear selector lever position **P**, **R**, **N** or **D** appears in the multifunction display (▷ page 189).

Automatic transmission

Warning!



It is dangerous to shift the gear selector lever out of park position **P** or neutral position **N** if the engine speed is higher than idle speed. If your foot is not firmly on the brake pedal, the vehicle could accelerate quickly forward or reverse. You could lose control of the vehicle and hit someone or something. Only shift into gear when the engine is idling normally and when your right foot is firmly on the brake pedal.

An additional indication of the current gear selector lever position can be found on the cover of the shifting-gate.

The indicators come on when you activate a switch (e.g. unlocking the vehicle or opening a door) and go out after approximately 15 minutes.

Shifting procedure

The automatic transmission selects individual gears automatically, depending on:

- gear selector lever position **D** (▷ page 189) with gear ranges (▷ page 192)
- the selected program mode:
(**C/S**) (▷ page 193)
or
(**M/C/S**) (E 63 AMG only)
(▷ page 197)
- the position of the accelerator pedal (▷ page 191)
- the vehicle speed

! Allow engine to warm up under low load use. Do not place full load on the engine until the operating temperature has been reached.

*Shift into reverse gear **R** or park position **P** only when the vehicle is stopped.*

Avoid spinning of a drive wheel for an extended period when driving off on slippery road surfaces. This may cause serious damage to the drivetrain which is not covered by the Mercedes-Benz Limited Warranty.

When the gear selector lever is in drive position **D**, you can influence transmission shifting by:

- limiting the gear range
- changing gears manually

Gear selector lever positions

The current gear selector lever position appears in the multifunction display.



① Current gear selector lever position

	Effect
P	<p>Park position</p> <p>Gear selector lever position when the vehicle is parked. Place gear selector lever in park position P only when vehicle is stopped. The park position is not intended to serve as a brake when the vehicle is parked. Rather, the driver should always set the parking brake in addition to placing the gear selector lever in park position P to secure the vehicle.</p>

	Effect
	<p>The SmartKey can only be removed from the starter switch with the gear selector lever in park position P. With the SmartKey removed, the gear selector lever is locked in park position P.</p> <p>If the vehicle's electrical system is malfunctioning, the gear selector lever could remain locked in park position P (▷ page 437).</p>
R	<p>Reverse gear</p> <p>Place gear selector lever in position R only when vehicle is stopped. (Continued on next page)</p>

Automatic transmission

	Effect
N	<p>Neutral</p> <p>No power is transmitted from the engine to the drive axle. When the brakes are released, the vehicle can be moved freely (pushed or towed).</p> <p>To avoid damage to the transmission, never engage neutral position N while driving.</p> <p>If the ESP® is deactivated or malfunctioning: Move gear selector lever to neutral position N only if the vehicle is in danger of skidding, e.g. on icy roads.</p>
D	<p>Drive</p> <p>The transmission shifts automatically. All forward gears are available.</p>

! *Coasting the vehicle, or driving for any other reason with gear selector lever in neutral position **N** can result in transmission damage that is not covered by the Mercedes-Benz Limited Warranty.*

Warning!



Getting out of your vehicle with the gear selector lever not fully engaged in park position **P** is dangerous. Also, park position **P** alone is not intended to or capable of preventing your vehicle from moving, possibly hitting people or objects.

Always set the parking brake in addition to shifting to park position **P** (▷ page 62).

When parked on an incline, turn the front wheels towards the road curb.

Do not park this vehicle in areas where combustible materials such as grass, hay or leaves can come into contact with the hot exhaust system, as these materials could be ignited and cause a vehicle fire.

Warning!



When leaving the vehicle, always remove the SmartKey or SmartKey with KEYLESS-GO* from the starter switch, take it with you, and lock the vehicle. Do not leave children unattended in the vehicle, or with access to an unlocked vehicle. Children could move the gear selector lever from park position **P**, which could result in an accident and/or serious personal injury.

Driving tips

Accelerator position

Your driving style influences the transmission's shifting behavior:

Less throttle	Earlier upshifting
More throttle	Later upshifting

Kickdown

Use kickdown when you want maximum acceleration.

- ▶ Press the accelerator past the point of resistance.

Depending on the engine speed the transmission shifts into a lower gear.

- ▶ Ease on the accelerator when you have reached the desired speed.

The transmission shifts up again.

Stopping

When you stop briefly, e.g. at traffic lights:

- ▶ Leave the transmission in gear.
- ▶ Hold the vehicle with the brake.

When you stop for a longer period of time with the engine idling and/or on a hill:

- ▶ Set the parking brake.
- ▶ Move the gear selector lever to park position **P**.

Maneuvering

When you maneuver in tight areas, e.g. when pulling into a parking space:

- ▶ Control the vehicle speed by gradually releasing the brakes.
- ▶ Accelerate gently.
- ▶ Never abruptly step on the accelerator.

Working on the vehicle

Warning!



When working on the vehicle, set the parking brake and move gear selector lever to park position **P**. Otherwise the vehicle could roll away.

Automatic transmission

Gear ranges

With the gear selector lever in drive position **D** and driving in program mode **C** or **S** (▷ page 193), you can select a gear range for the automatic transmission to operate within.

Gear selector lever (▷ page 194):

You can limit the gear range by pressing the gear selector lever to the left (**D-**), and reverse the gear range limit by pressing the gear selector lever to the right (**D+**).

Steering wheel gearshift control (E 63 AMG only) (▷ page 195):

You can limit the gear range by pulling the left gearshift paddle on the steering wheel gearshift control, and reverse the gear range limit by pulling the right gearshift paddle on the steering wheel gearshift control.

The selected gear range appears in the multifunction display.



① Current gear range

Effect	
6	The transmission shifts through sixth gear only (applies to vehicles with 7-speed automatic transmission only).
5	The transmission shifts through fifth gear only (applies to vehicles with 7-speed automatic transmission only).

Effect	
4	The transmission shifts through fourth gear only.
3	The transmission shifts through third gear only. With this selection you can use the braking effect of the engine.
2	The transmission shifts through second gear only. Allows the use of engine's braking power when driving <ul style="list-style-type: none"> • on steep downgrades • in mountainous regions • under extreme operating conditions
1	The transmission operates in first gear only. For maximum use of engine's braking effect on very steep or lengthy downgrades.

Automatic shift program

The program mode selector switch is located on the lower part of the center console.



Program mode selector switch

- C** Comfort For comfort driving
- S** Sport For standard driving



Program mode selector switch (E 63 AMG only)

- M** Manual For manual gear shifting (▷ page 197)
- C** Comfort For standard driving
- S** Sport For sporty driving

The selected program mode appears in the multifunction display.



① Current program mode

! Never change the program mode when the gear selector lever is out of park position **P**. This could result in a change of driving characteristics for which you may not be prepared.

i The last selected program mode (**C** or **S**) is switched on when the engine is restarted.

Automatic transmission

- ▶ Press program mode selector switch repeatedly until the letter of the desired program mode appears in the multifunction display.

Select **C** for comfort driving (E 63 AMG: for standard driving):

- The vehicle starts out in second gear (both forward and reverse) for gentler starts. This does not apply if full throttle is applied or gear range **1** is selected.
- Traction and driving stability are improved on icy roads.
- Upshifts occur earlier even when you give more gas. The engine then operates at lower rpms and the wheels are less likely to spin.

Select **S** for standard driving (E 63 AMG: for sporty driving):

- The vehicle starts out in first gear.
- Upshifts occur later.

Gear selector lever one-touch gearshifting

With the gear selector lever in drive position **D** and driving in program mode **C** or **S**, you can limit or extend the gear range.

If your vehicle is equipped with manual shift program **M**, you can use the gear selector lever to manually shift the gears.

 For information on using the gear selector lever in program mode **M**, see “Manual shift program E 63 AMG” (▷ page 197).

 Allow engine to warm up under low load use. Do not place full load on the engine until the operating temperature has been reached.

Shift into reverse gear **R** or park position **P** only when the vehicle is stopped.

Avoid spinning of a drive wheel for an extended period when driving off on slippery road surfaces. This may cause serious damage to the drivetrain which is not covered by the Mercedes-Benz Limited Warranty.

The following instructions describe operation of the gear selector lever when driving in the automatic program mode **C** or **S**.

Limiting gear range

Warning!



On slippery road surfaces, never downshift in order to obtain braking action. This could result in drive wheel slip and reduced vehicle control. Your vehicle's ABS will not prevent this type of loss of control.

- ▶ Briefly press the gear selector lever to the left in the **D-** direction.

The transmission will shift to the next lower gear as permitted by the shift program. This action simultaneously limits the gear range of the transmission (▷ page 192).

 To avoid overrevving the engine when downshifting, the transmission will not shift to a lower gear if the engine's max. speed would be exceeded.

Extending gear range

- ▶ Briefly press the gear selector lever to the right in the **D+** direction.

The transmission will shift to the next higher gear as permitted by the shift program. This action simultaneously extends the gear range of the transmission.

i If you press on the accelerator when the engine has reached its rpm limit, the transmission will upshift beyond any gear range limit selected.

Canceling gear range limit

- ▶ Press and hold the gear selector lever in the **D+** direction until **D** reappears in the multifunction display (▷ page 189).

The transmission will shift from the current gear range directly to gear range **D**.

Shifting into optimal gear range

- ▶ Press and hold the gear selector lever in the **D-** direction.

The transmission will automatically select the gear range suited for optimal acceleration and deceleration. This will involve shifting down one or more gears.

Steering wheel gearshift control one-touch gearshifting E 63 AMG

With the gear selector lever in drive position **D** and driving in program mode **C** or **S**, you can limit or extend the gear range.

If your vehicle is equipped with manual shift program **M**, you can use the steering wheel gearshift control to manually shift the gears.

i For information on using the steering wheel gearshift control in program mode **M**, see “Manual shift program E 63 AMG” (▷ page 197).

! Allow engine to warm up under low load use. Do not place full load on the engine until the operating temperature has been reached.

Shift into reverse gear **R** or park position **P** only when the vehicle is stopped.

Avoid spinning of a drive wheel for an extended period when driving off on slippery road surfaces. This may cause serious damage to the drivetrain which is not covered by the Mercedes-Benz Limited Warranty.



- ① Left shift paddle: limiting gear range or downshift (in program mode **M**)
- ② Right shift paddle: extending gear range or upshift (in program mode **M**)

Automatic transmission

i You cannot shift with the steering wheel gearshift paddles when the gear selector lever is in position **P**, **N** or **R**.

The following instructions describe operation of the steering wheel gearshift control when driving in the automatic program mode **C** or **S**.

Limiting gear range

Warning!



On slippery road surfaces, never downshift in order to obtain braking action. This could result in drive wheel slip and reduced vehicle control. Your vehicle's ABS will not prevent this type of loss of control.

- ▶ Briefly pull left shift paddle ①.

The transmission will shift to the next lower gear as permitted by the shift program. This action simultaneously limits the gear range of the transmission (▷ page 192).

i To avoid overrevving the engine when downshifting, the transmission will not shift to a lower gear if the engine's max. speed would be exceeded.

Extending gear range

- ▶ Briefly pull right shift paddle ②.

The transmission will shift to the next higher gear as permitted by the shift program. This action simultaneously extends the gear range of the transmission.

i If you press on the accelerator when the engine has reached its rpm limit, the transmission will upshift beyond any gear range limit selected.

Canceling gear range limit

- ▶ Pull and hold right shift paddle ② until **D** reappears in the multifunction display (▷ page 189).

The transmission will shift from the current gear range directly to gear range **D**.

Shifting into optimal gear range

- ▶ Pull and hold left shift paddle ①.

The transmission will automatically select the gear range suited for optimal acceleration and deceleration. This will involve shifting down one or more gears.

Manual shift program E 63 AMG

In addition to the automatic shift program **C** or **S**, your vehicle is equipped with the manual shift program **M**.

In the manual program mode **M**, system-controlled automatic gearshifting is switched off and you need to change the gears by manually upshifting or downshifting using the steering wheel gearshift paddles (▷ page 195) or the gear selector lever.

! Allow engine to warm up under low load use. Do not place full load on the engine until the operating temperature has been reached.

Shift into reverse gear **R** or park position **P** only when the vehicle is stopped.

Avoid spinning of a drive wheel for an extended period when driving off on slippery road surfaces. This may cause serious damage to the drivetrain which is not covered by the Mercedes-Benz Limited Warranty.

The program mode selector switch is located on the lower part of the center console.



Program mode selector switch

M Manual	For manual gear shifting
C Comfort	For standard driving
S Sport	For sporty driving

The selected program mode appears in the multifunction display (▷ page 193).

i For information on automatic program modes **C** or **S**, see “Automatic shift program” (▷ page 193), “Gear selector lever one-touch gearshifting” (▷ page 194), and “Steering wheel gearshift control one-touch gearshifting E 63 AMG” (▷ page 195).

Activating manual shift program

- ▶ Press program mode selector switch repeatedly until the **M** for manual program mode **M** appears in the multifunction display.

The transmission switches to the manual program mode **M**. Automatic shifting is switched off. The gear range is not limited.

You can change the gears manually when the gear selector lever is in drive position **D**. You can upshift or downshift through the gears in succession.

i The manual program mode **M** will not be stored. When the engine is turned off with the manual program mode **M** selected, the transmission will go to the automatic program mode (**C** or **S**) when the engine is restarted.

Automatic transmission

Upshifting

! In the manual program mode **M**, the transmission will not upshift, even if the engine has reached its overrevving range. Shift up to the next gear before the engine has reached its overrevving range. Make absolutely certain that the engine speed does not reach the red marking on the tachometer (▷ page 26). Otherwise the engine could be damaged which is not covered by the Mercedes-Benz Limited Warranty.

- ▶ Briefly press the gear selector lever to the right in the **D+** direction.

or

- ▶ Briefly pull right shift paddle ② (▷ page 195).

The transmission shifts to the next higher gear.

If, instead of the manual program mode symbol **M**, the **⏏** symbol appears in the multifunction display (▷ page 193), shift to the next higher gear. The fuel supply will otherwise be interrupted to prevent the engine from overrevving.

If you have selected the AMG menu in the control system and you are driving in the manual program mode **M**, upshift indicator ② in the multifunction display advises you to upshift before the engine reaches the overspeed range. Thus you can drive at the maximum engine speed for each gear without overrevving the engine.

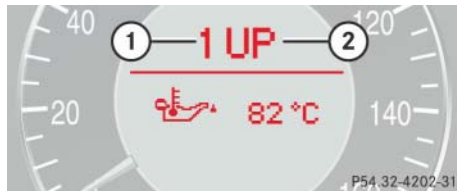

- ① Gear indicator
- ② Upshift indicator

- ▶ Shift to the next higher gear.

The fuel supply will otherwise be interrupted to prevent the engine from overrevving.

Downshifting

Warning!



On slippery road surfaces, never downshift in order to obtain braking action. This could result in drive wheel slip and reduced vehicle control. Your vehicle's ABS will not prevent this type of loss of control.

- ▶ Briefly press the gear selector lever to the left in the **D-** direction.

or

- ▶ Briefly pull left shift paddle ① (▷ page 195).

The transmission shifts to the next lower gear.

i When you brake or stop, the transmission shifts down to a gear from which you can easily accelerate or take off.

Kickdown

Using the kickdown when driving in the manual program mode **M** is not possible.

Deactivating manual shift program

- ▶ Press the program mode selector switch (▷ page 197) repeatedly until **C** or **S** appears in the multifunction display.

or

- ▶ Restart the engine.

The transmission will go to the automatic program mode (**C** or **S**).

The manual program mode **M** is not stored.

Emergency operation (Limp-Home Mode)

If vehicle acceleration becomes less responsive or sluggish or the transmission no longer shifts, the transmission is most likely operating in limp-home (emergency operation) mode. In this mode only second gear and reverse gear can be selected.

- ▶ Stop the vehicle in a safe location.
- ▶ Move the gear selector lever to park position **P**.
- ▶ Turn off the engine.
- ▶ Wait at least 10 seconds before restarting.
- ▶ Restart the engine.
- ▶ Move the gear selector lever to position **D** (for second gear) or position **R**.
- ▶ Have the transmission checked at an authorized Mercedes-Benz Center as soon as possible.

Good visibility

For information on windshield wipers, see “Windshield wipers” (▷ page 57).

Headlamp cleaning system*

The button is located on the left side of the dashboard.



① Headlamp cleaning button

- ▶ Switch on the ignition (▷ page 37).
- ▶ Press button ①.

The headlamps are cleaned with a high-pressure water jet.

i The headlamps will automatically be cleaned when you have

- switched on the headlamps and
- operated the windshield wipers with windshield washer fluid fifteen times

When you switch off the ignition, the counter resets.

For information on filling up the washer reservoir, see “Windshield/rear window washer system and headlamp cleaning system*” (▷ page 331).

Rear view mirrors

For more information on setting the rear view mirrors, see “Mirrors” (▷ page 47).

Auto-dimming mirrors

The reflection brightness of the exterior rear view mirror on the driver’s side and the interior rear view mirror will respond automatically to glare when

- the ignition is switched on and
- incoming light from headlamps falls on the sensor in the interior rear view mirror

The rear view mirrors will not react if

- reverse gear **R** is engaged
- the interior lighting is turned on

Warning!

The auto-dimming function does not react if incoming light is not aimed directly at the sensors in the interior rear view mirror.

The interior rear view mirror and the exterior rear view mirror on the driver's side do not react, for example, when transporting cargo which covers the rear window.

Light hitting the mirror(s) at certain angles (incident light) could blind you. As a result, you may not be able to observe traffic conditions and could cause an accident.

Warning!

In case of an accident, liquid electrolyte may escape from the mirror housing if the mirror glass breaks.

Electrolyte has an irritating effect. Do not allow the liquid to come into contact with eyes, skin, clothing, or respiratory system. In case it does, immediately flush affected area with water, and seek medical help if necessary.

! *Electrolyte drops coming into contact with the vehicle paint finish can be completely removed only while in the liquid state by applying plenty of water.*

Warning!

Exercise care when using the passenger-side exterior rear view mirror. The mirror surface is convex (outwardly curved surface for a wider field of view). Objects in mirror are closer than they appear. Check your interior rear view mirror or glance over your shoulder before changing lanes.

Good visibility

Activating exterior rear view mirror parking position

Follow these steps to activate the mirror parking position so that the passenger-side exterior rear view mirror will be turned downward to the stored position.

The buttons are located on the driver's door.



- ① Driver's side exterior rear view mirror button
- ② Adjustment button
- ③ Passenger-side exterior rear view mirror button

- ▶ Switch on the ignition (▷ page 37).
- ▶ Vehicles equipped with Mirror adjust. parking aid function in the Convenience submenu (▷ page 182): Make sure the Mirror adjust. parking aid function in the Convenience submenu of the control system is switched to On.
- ▶ Make sure you have stored a parking position for the passenger-side exterior rear view mirror (▷ page 140).
- ▶ Press button ③ for the passenger-side exterior rear view mirror.
- ▶ Place the gear selector lever in reverse gear **R**.

The passenger-side exterior rear view mirror will be turned downward to the stored position.

The exterior rear view mirror returns to its previously stored driving position:

- 10 seconds after you put the gear selector lever out of position **R**
- immediately once your vehicle exceeds a speed of approximately 6 mph (10 km/h)
- immediately when you press button ① for driver's side mirror.

Sun visors

The sun visors protect you from sun glare while driving.

Warning!



Do not use the vanity mirror while driving. Keep the mirrors in the sun visors closed while vehicle is in motion. Reflected glare can endanger you and others.

- ▶ Swing sun visor ① down when you experience glare.

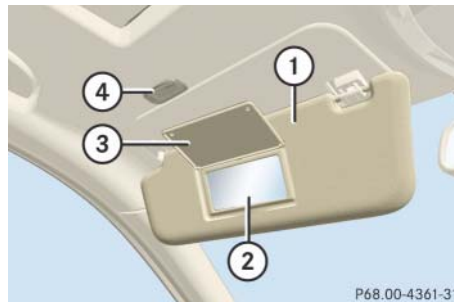

- ① Sun visor
- ② Vanity mirror
- ③ Mirror cover
- ④ Mirror lamp

- ▶ To use the vanity mirror ②, lift up the mirror cover ③.

i If sun visor ① is disengaged from mounting ⑦ with mirror cover ③ open, mirror lamp ④ will switch off.

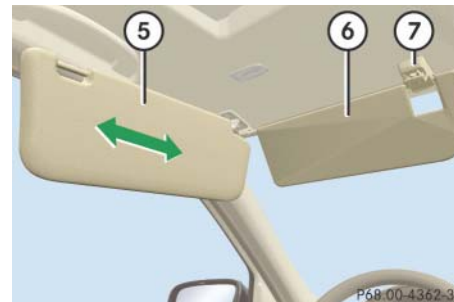

- ⑤ Sun visor
- ⑥ Additional visor*
- ⑦ Mounting

If sunlight enters through a side window:

- ▶ Disengage sun visor ⑤ from mounting ⑦.
- ▶ Pivot sun visor ⑤ to the side.
- ▶ Adjust the sun visor ⑤ by pushing or pulling in direction of the arrows.

i Close mirror cover ③ (if open) before you disengage the sun visor ⑤ from mounting ⑦ and pivot it to the side.

Good visibility

Roller sunblind in the rear doors*

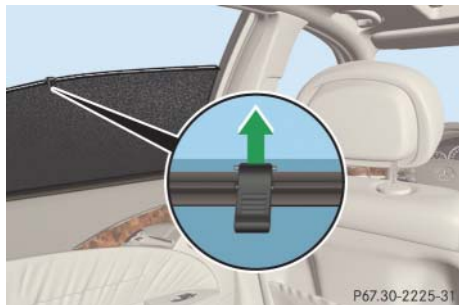

- ▶ Pull the roller sunblind out using the hooks.
- ▶ Attach the hooks at the top.

! Always guide the sunblind by hand. Do not let it snap back, as the retractor could be damaged.

Rear window defroster

The rear window defroster uses a large amount of power. To keep the battery drain to a minimum, switch off the defroster as soon as the rear window is clear. The defroster is automatically deactivated after approximately 6 to 17 minutes of operation depending on the outside temperature.



Warning!



Any accumulation of snow and ice should be removed from the rear window before driving. Visibility could otherwise be impaired, endangering you and others.

- ▶ Switch on the ignition (▷ page 37).

Activating

- ▶ Press button  (▷ page 208) or button  (▷ page 224) or button  (▷ page 209) or (▷ page 225) on the respective climate control panel.

The indicator lamp on the button comes on.

Deactivating

- ▶ Press button  or  again.

The indicator lamp on the button goes out.

! *If the rear window defroster switches off too soon and the indicator lamp starts flashing, this means that too many electrical consumers are operating simultaneously and there is insufficient voltage in the battery. The system responds automatically by deactivating the rear window defroster.*

As soon as the battery has sufficient voltage, the rear window defroster automatically turns itself back on.

Dual-zone automatic climate control

(only available on E 350 4MATIC)

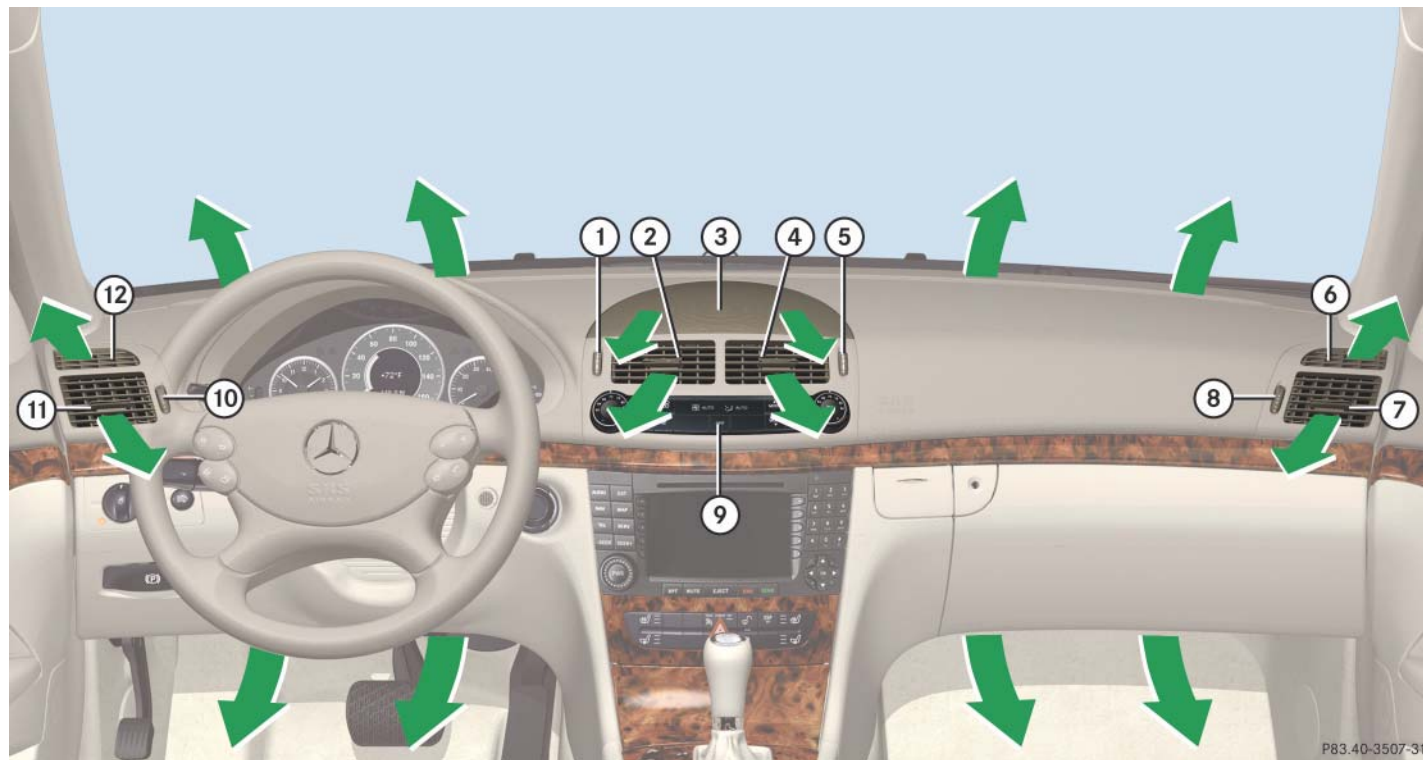

Dual-zone automatic climate control

- ① Thumbwheel for air volume control for left center air vent
- ② Left center air vent, adjustable
- ③ Cockpit air vent, fixed (Canada only)
- ④ Right center air vent, adjustable
- ⑤ Thumbwheel for air volume control for right center air vent
- ⑥ Right side defroster air vent, fixed
- ⑦ Right side air vent, adjustable
- ⑧ Thumbwheel for air volume control for right side air vent
- ⑨ Climate control panel
- ⑩ Thumbwheel for air volume control for left side air vent
- ⑪ Left side air vent, adjustable
- ⑫ Left side defroster air vent, fixed

i For draft-free ventilation, move the sliders for the center air vents and side air vents to the middle position.

Dual-zone automatic climate control

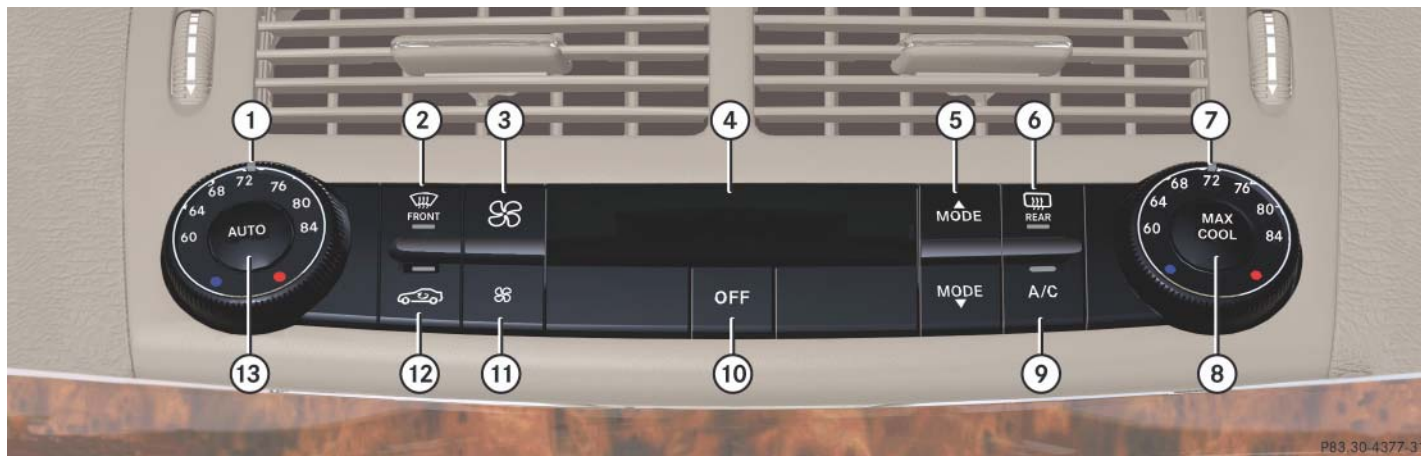

P83_30-4377-31

USA only

① Temperature control, driver's side

② Front defroster

③ Increasing air volume

④ Display

⑤ Air distribution

⑥ Rear window defroster

⑦ Temperature control, passenger side

⑧ MAX COOL on/off

⑨ AC cooling on/off

⑩ Climate control on/off

⑪ Decreasing air volume

⑫ Air recirculation

⑬ Air distribution and air volume
(automatic, manual)

Dual-zone automatic climate control

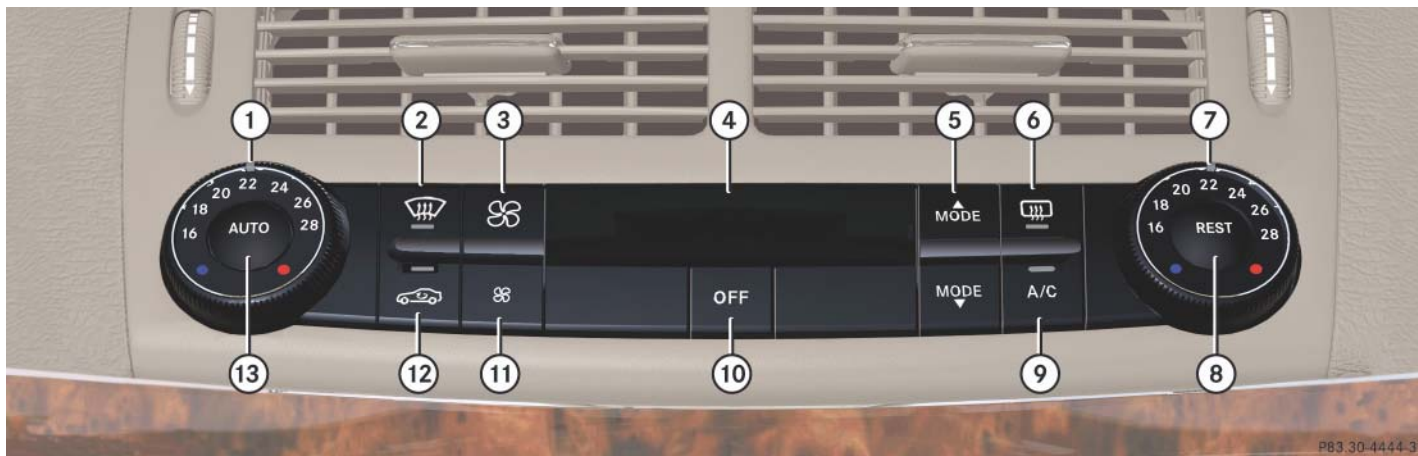

P83_30-4444_31

Canada only

① Temperature control, driver's side	⑥ Rear window defroster	⑪ Decreasing air volume
② Front defroster	⑦ Temperature control, passenger side	⑫ Air recirculation
③ Increasing air volume	⑧ Residual heat/ventilation	⑬ Air distribution and air volume (automatic, manual)
④ Display	⑨ AC cooling on/off	
⑤ Air distribution	⑩ Climate control on/off	

Dual-zone automatic climate control

The climate control is operational whenever the engine is running. You can operate the climate control system in either the automatic or manual mode. The system cools or heats the interior depending on the selected interior temperature and the current outside temperature.

Warning!



When operating the climate control, the air that enters the passenger compartment through the air vents can be very hot or very cold (depending on the set temperature). This may cause burns or frostbite to unprotected skin in the immediate area of the air vents. Always keep sufficient distance between unprotected parts of the body and the air vents. If necessary, use the air distribution control (▷ page 208) to direct the air to air vents in the vehicle interior that are not in the immediate area of unprotected skin.

Nearly all dust particles, pollutants and odors are filtered out before outside air enters the passenger compartment through the air distribution system.

The air conditioning will not engage (no cooling) if the **A/C** mode is deactivated (▷ page 218).

Warning!



Follow the recommended settings for heating and cooling given on the following pages. Otherwise the windows could fog up, impairing visibility and endangering you and others.

i Severe conditions (e.g. strong air pollution) may require replacement of the filter before its scheduled interval. A clogged filter will reduce the air volume to the interior.

If the vehicle interior is hot, ventilate the interior before driving off, see “Summer opening feature” (▷ page 241). The climate control will then adjust the interior temperature to the set value much faster.

Keep the air intake grille in front of the windshield free of snow and debris.

Do not obstruct air flow by placing objects on the air flow-through exhaust slots below the rear window.

Deactivating the climate control system

Warning!



When the climate control is switched off, the outside air supply and circulation are also switched off. Only choose this setting for a short time. Otherwise the windows could fog up, impairing visibility and endangering you and others.



Deactivating

- ▶ Press button **OFF** (▷ page 208) or (▷ page 209).

Reactivating

- ▶ Make sure the ignition is switched on.
- ▶ Press button **OFF** (▷ page 208) or (▷ page 209) again.

The previous settings are once again in effect.

i To switch the system on, you can also press another button, with the exception of  or .

Operating the climate control system in automatic mode

i When operating the climate control system in automatic mode, you will only rarely need to adjust the temperature, air volume and air distribution.

In automatic mode, cooling with dehumidify is switched on. This function can be switched off.

Warning!



If you switch off the cooling function the windows can fog up more quickly. Window fogging may impair visibility and endanger you and others.

Activating

- ▶ Press button **AUTO** (▷ page 208) or (▷ page 209) while the engine is running.



The indicators for automatic air volume and air distribution in display ④ (▷ page 208) or (▷ page 209) come on. Air volume and air distribution are automatically controlled

- ▶ Use temperature controls ① and ⑦ (▷ page 208) or (▷ page 209) to separately adjust the air temperature on each side of the passenger compartment.

The temperature of the vehicle interior is adjusted automatically.

Dual-zone automatic climate control

Deactivating

- ▶ Press button  or  (▷ page 208) or (▷ page 209).

The AUTO indicator for air volume in the display ④ (▷ page 208) or (▷ page 209) goes out. The automatic function for air volume is switched off, and air volume is controlled according to the desired setting. Automatic air distribution remains switched on.

or

- ▶ Press air distribution button ⑤ (▷ page 208) or (▷ page 209).

The AUTO indicator for air distribution in the display ④ (▷ page 208) or (▷ page 209) goes out. The automatic function for air distribution is switched off, and air distribution is controlled according to the desired position. Automatic air volume remains switched on.

Setting the temperature

Use temperature controls ① and ⑦ (▷ page 208) or (▷ page 209) to separately adjust the air temperature on each side of the passenger compartment. You should raise or lower the temperature setting in small increments, preferably starting at 72°F (22°C). The climate control will adjust to the set temperature as fast as possible.

Increasing

- ▶ Turn temperature control ① and/or ⑦ (▷ page 208) or (▷ page 209) slightly clockwise.

The climate control system will correspondingly adjust the interior air temperature.

Decreasing

- ▶ Turn temperature control ① and/or ⑦ (▷ page 208) or (▷ page 209) slightly counterclockwise.







The climate control system will correspondingly adjust the interior air temperature.

Dual-zone automatic climate control

Adjusting air distribution

Use air distribution control rocker switch ⑤ (▷ page 208) or (▷ page 209) to adjust the air distribution.

The following symbols are located in the display ④ (▷ page 208) or (▷ page 209):

Symbol	Function
	Directs air into the entire vehicle interior
	Directs air to the windshield, through the side air vents and cockpit air vent (Canada only)
	Directs air to the windshield and through the side air vents
	Directs air to the windshield, through the side air vents and to the footwells
	Directs air through the cockpit (Canada only), center, side and rear passenger compartment air vents
	Directs air to the footwells
	Directs air to the footwells and through the side air vents

- ▶ Use air distribution control rocker switch ⑤ (▷ page 208) or (▷ page 209) until the desired symbol appears in the display ④ (▷ page 208) or (▷ page 209).

The AUTO indicator for automatic air distribution in the display ④ goes out. The automatic function for air distribution is switched off, and air distribution is controlled according to the desired setting.

 *The air volume continues to be controlled according to the indicator in the display ④.*

Opening the cockpit air vent (Canada only) and center air vents

- ▶ Turn thumbwheels ① and ⑤ (▷ page 206) upward.

The cockpit air vent ③ and the center air vents ② and ④ are open.

Dual-zone automatic climate control

Closing the cockpit air vent (Canada only) and the center air vents

- ▶ Turn thumbwheels ① and ⑤ (▷ page 206) downward.

The cockpit air vent ③ and the center air vents ② and ④ are closed.

Opening the side air vents

- ▶ Turn thumbwheels ⑧ and ⑩ (▷ page 206) upward.

The side air vents ⑦ and ⑪ are open.



Closing the side air vents

- ▶ Turn thumbwheels ⑧ and ⑩ (▷ page 206) downward.

The side air vents ⑦ and ⑪ are closed.

Adjusting air volume

Nine blower speeds are available.

- ▶ Press button  to decrease or  to increase air volume (▷ page 208) or (▷ page 209) to the desired level.

The AUTO indicator for air volume in the display ④ (▷ page 208) or (▷ page 209) goes out. The automatic function for air volume is switched off, and air volume is controlled according to the desired setting.

 *The air distribution continues to be controlled according to the indicator in the display ④.*

Front defroster

You can use this setting to defrost the windshield, for example if it is iced up. You can also defog the windshield and the windows.

 *Keep this setting selected only until the windshield or the windows are clear again.*



Activating

- ▶ Press button  or  (▷ page 208) or (▷ page 209).



The indicator lamp on the button comes on.

The air conditioning switches automatically to the following functions:

- cooling on to dehumidify
- maximum blowing and heating power (depends on cooling temperature)
- air flows onto the windshield and the front windows
- the air recirculation mode is switched off

 *If you have switched on the defrost function using the  or  button, you cannot make any other settings.*

Deactivating

- ▶ Press button  or  (▷ page 208) or (▷ page 209) again.

The indicator lamp on the button goes out. Defrosting is turned off.

The previous settings are once again in effect.



 *The cooling remains switched on.*

Windshield fogged on the outside

 *Keep this setting selected only until the windshield is clear again.*

- ▶ Switch the windshield wipers on (▷ page 58).

If the automatic air distribution is switched off:



- ▶ Turn air distribution control  to  or  (▷ page 208) or (▷ page 209).

Dual-zone automatic climate control

Maximum cooling MAX COOL (USA only)

You can use this setting to provide the fastest possible cooling of the vehicle interior (when windows and tilt/sliding sunroof or tilt/sliding panel* are closed).



Activating

- ▶ Press button  (▷ page 208).
MAX COOL appears in the display  (▷ page 208).





The air conditioning switches automatically to the following functions:

- maximum cooling
- maximum blowing power
- the air recirculation mode is switched on

Deactivating

- ▶ Press button  (▷ page 208) again.
MAX COOL disappears in the display  (▷ page 208).

The previous settings are once again in effect.



 *To switch the maximum cooling function off, you can also press button , ,  or  (▷ page 208).*

Air recirculation mode

Switch to air recirculation mode to prevent unpleasant odors from entering the vehicle from the outside (e.g. before a driving through a tunnel). This setting cuts off the intake of outside air and recirculates the air in the passenger compartment.

Warning!





Fogged windows impair visibility, endangering you and others. If the windows begin to fog on the inside, switching off the air recirculation mode immediately should clear interior window fogging. If interior window fogging persists, make sure the air conditioning (▷ page 218) is activated, or press button  or .

Activating

- ▶ Briefly press button  (▷ page 208) or (▷ page 209).

The indicator lamp on the button comes on.

 *The air recirculation mode is activated automatically at high outside temperatures.*

The indicator lamp on button  is not lit when the air recirculation mode is automatically switched on.

A quantity of outside air is added after approximately 30 minutes.

If you have turned off the air conditioning (▷ page 218) or the outside temperature is below 41 °F (5 °C), the air recirculation mode will not switch on automatically.

Deactivating

- ▶ Press button  (▷ page 208) or (▷ page 209).

The indicator lamp on the button goes out.

 *The air recirculation mode is deactivated automatically:*

- *after 5 minutes if the outside temperature is below approximately 41 °F (5 °C)*
- *after 5 minutes if the air conditioning is turned off*
- *after 30 minutes if the outside temperature is above approximately 41 °F (5 °C)*

Air recirculation mode with convenience closing or opening feature

Warning!



Never operate the windows and tilt/sliding sunroof if there is the possibility of anyone being harmed by the opening or closing procedure.

In the event that the procedure causes potential danger, the closing of the windows can be immediately halted by pressing or pulling the respective window switch. The closing of the tilt/sliding sunroof can be immediately halted by moving the switch for the tilt/sliding sunroof in any direction.

The closing of the windows and the tilt/sliding sunroof can be reversed by again pressing and holding the  button.

Dual-zone automatic climate control

Convenience closing



- ▶ Press button  (▷ page 208) or (▷ page 209) for approximately 2 seconds.

The windows and tilt/sliding sunroof will close. You can release button  once the closing procedure has begun. The windows and tilt/sliding sunroof continue closing until they are fully closed. The indicator lamp on the button comes on. The air recirculation mode is activated.

Convenience opening

- ▶ Press button  for approximately 2 seconds.

The windows and tilt/sliding sunroof will return to their previous position. You can release button  once the opening procedure has begun. The windows and tilt/sliding sunroof continue opening until they have reached their previous position. The indicator lamp on the button goes out. The air recirculation mode is deactivated.

 *A window or tilt/sliding sunroof will only return to its previous position if it has not been moved to another position using the respective window switch or tilt/sliding sunroof switch after it was closed with button .*

A window or tilt/sliding sunroof that has been moved will remain in its current position if button  is used to reopen the remaining windows or tilt/sliding sunroof.

Air conditioning

The cooling function, only operational when the engine is running, cools the vehicle interior down to the selected temperature. The cooling function also dehumidifies the air in the vehicle interior, thus preventing the windows from fogging up.

 *Condensation may drip out from underneath the vehicle. This is normal and not an indication of a malfunction.*

Warning!



If you turn off the cooling function, the vehicle will not be cooled when weather conditions are warm. The windows can fog up more quickly. Window fogging may impair visibility and endanger you and others.

Deactivating

It is possible to deactivate the air conditioning (cooling) function of the climate control system. The air in the vehicle will then no longer be cooled or dehumidified.

- ▶ Press button  (▷ page 208) or (▷ page 209).

The indicator lamp on the button goes out.

Activating

Moist air can fog up the windows. You can dehumidify the air with the air conditioning.

- ▶ Press button  (▷ page 208) or (▷ page 209) again.

The indicator lamp on the button comes on.

The air conditioning uses the refrigerant R134a. This refrigerant is free of CFCs which are harmful to the ozone layer.

! *If the air conditioning cannot be turned on again, this indicates that the air conditioning is losing refrigerant. The compressor has turned itself off.*

Have the air conditioning checked at the nearest authorized Mercedes-Benz Center.

Residual heat and ventilation (Canada only)

With the engine switched off, it is possible to continue to heat or ventilate the interior for up to 30 minutes. This feature makes use of the residual heat produced by the engine.

i *If you switch on the residual heat function when temperatures are high, only the ventilation will be switched on.*

i *Regardless of the selected air volume, the blower operates at low speed.*

i *How long the system will provide heating depends on*

- *the coolant temperature*
- *the temperature set by the operator*

The blower will run at speed setting 1 regardless of the air distribution control setting.

Dual-zone automatic climate control

Activating

- ▶ Switch off the ignition.
- ▶ Press button **REST** (▷ page 209).
REST in the display ④ (▷ page 209) comes on.

Deactivating

- ▶ Press button **REST** (▷ page 209) again.
REST in the display ④ (▷ page 209) goes out.

i The residual heat is automatically turned off:

- when the ignition is switched on
- after about 30 minutes
- if the battery voltage drops
- if the coolant temperature is too low

Rear passenger compartment adjustable air vents

The air conditioning for the rear passenger compartment is controlled via the climate control panel (▷ page 208).

i The temperature at the center air vents ① and ② for the rear passenger compartment is nearly the same as at the dashboard center air vents.

The air vents for the rear passenger compartment are located in the rear center console.

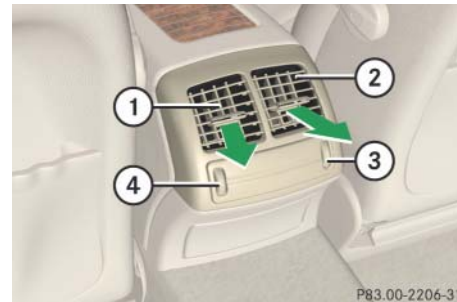

- ① Left center air vent, adjustable
- ② Right center air vent, adjustable
- ③ Thumbwheel for air volume control for right rear center air vent
- ④ Thumbwheel for air volume control for left rear center air vent

Adjusting air distribution

- ▶ Push the slider for the left center air vent ① or right center air vent ② to the left, right, up or down.

The air flow is directed in the corresponding direction.

 For draft-free ventilation, move the sliders for the center air vents ① and ② upward.

Adjusting air volume

- ▶ Turn thumbwheel ③ or ④ up or down.

The air volume is increased or decreased.

4-zone automatic climate control

(only available on E 63 AMG)

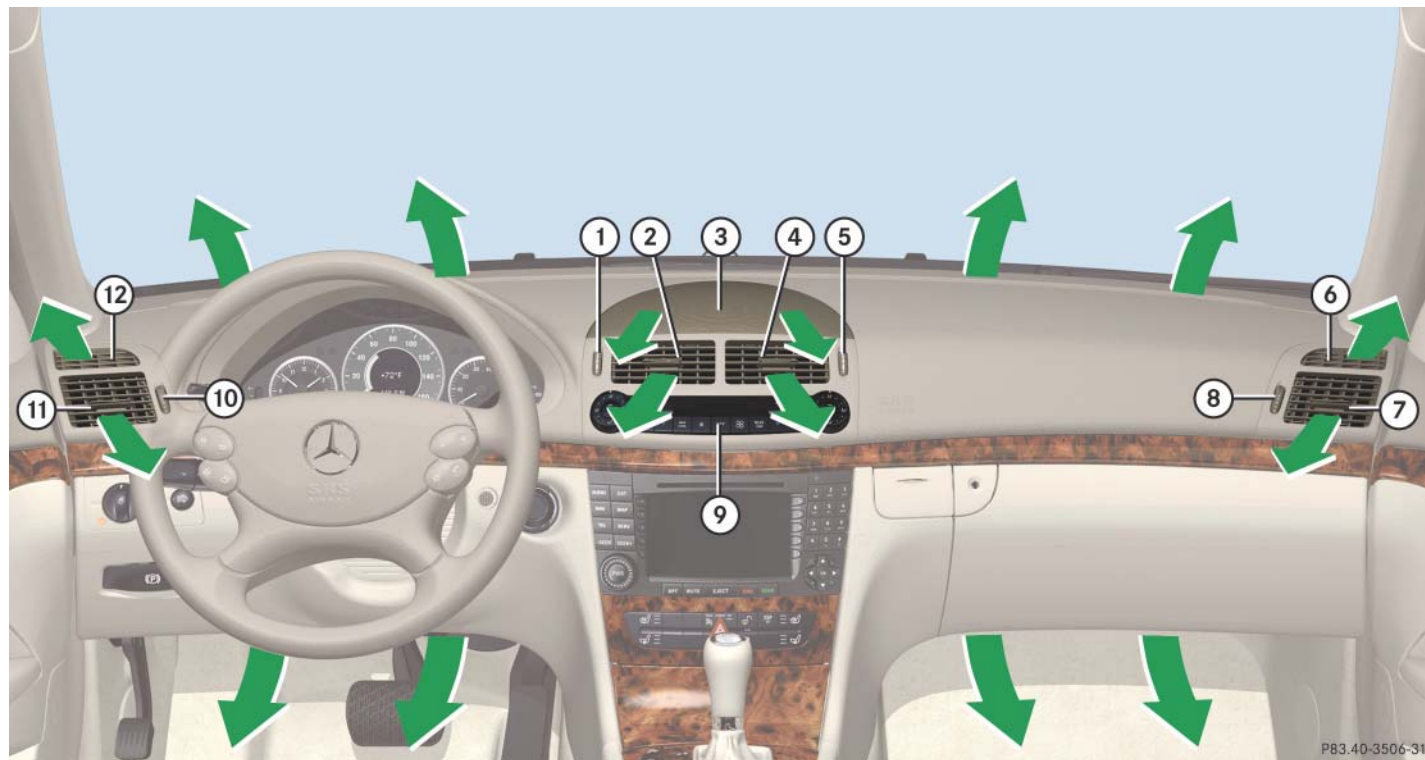

P83.40-3506-31

4-zone automatic climate control

- ① Thumbwheel for air volume control for left center air vent
- ② Left center air vent, adjustable
- ③ Cockpit air vent, fixed (Canada only)
- ④ Right center air vent, adjustable
- ⑤ Thumbwheel for air volume control for right center air vent
- ⑥ Right side defroster air vent, fixed
- ⑦ Right side air vent, adjustable
- ⑧ Thumbwheel for air volume control for right side air vent
- ⑨ Climate control panel
- ⑩ Thumbwheel for air volume control for left side air vent
- ⑪ Left side air vent, adjustable
- ⑫ Left side defroster air vent, fixed

i For draft-free ventilation, move the sliders for the center air vents and side air vents to the middle position.



- ① Thumbwheel for air volume control for side air vent
- ② Side air vent, adjustable

4-zone automatic climate control

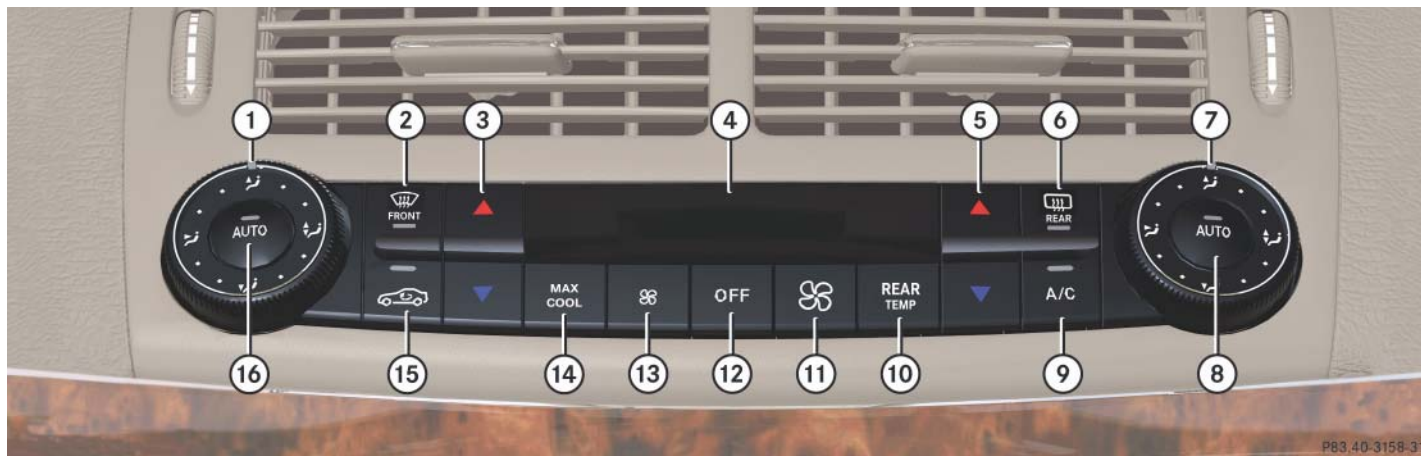

P83.40-3158-31

USA only

① Air distribution, driver's side	⑦ Air distribution, passenger side	⑫ Climate control on/off
② Front defroster	⑧ Air distribution and air volume, passenger side (automatic, manual)	⑬ Decreasing air volume
③ Temperature rocker switch, driver's side	⑨ AC cooling on/off	⑭ MAX COOL on/off
④ Display	⑩ Rear air-conditioning remote control	⑮ Air recirculation
⑤ Temperature rocker switch, passenger side	⑪ Increasing air volume	⑯ Air distribution and air volume, driver's side (automatic, manual)
⑥ Rear window defroster		

4-zone automatic climate control

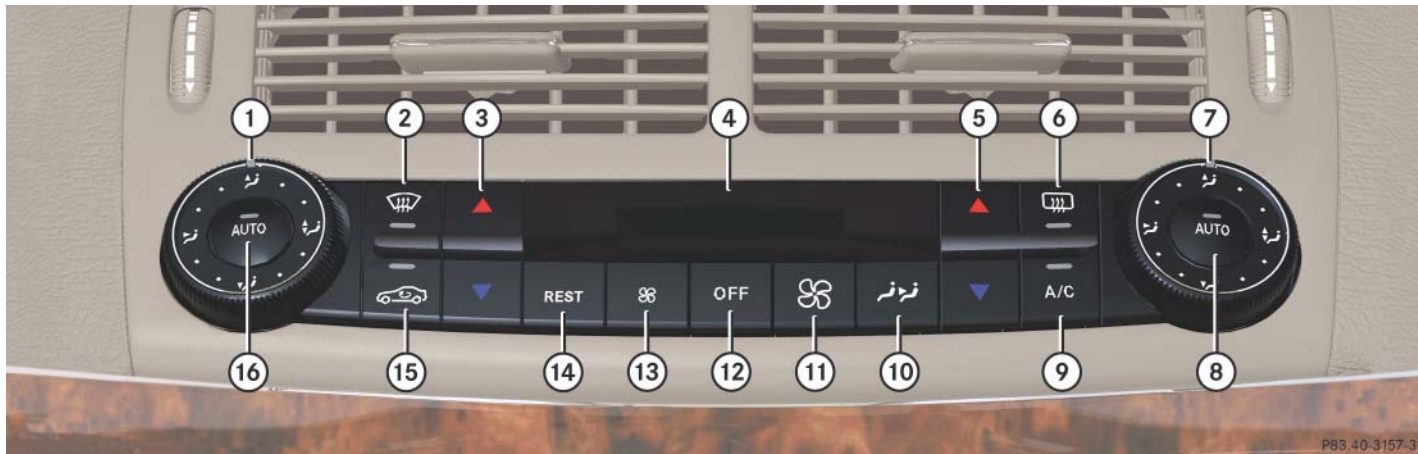

P83_40-3157-31

Canada only

① Air distribution, driver's side	⑦ Air distribution, passenger side	⑫ Climate control on/off
② Front defroster	⑧ Air distribution and air volume, passenger side (automatic, manual)	⑬ Decreasing air volume
③ Temperature rocker switch, driver's side	⑨ AC cooling on/off	⑭ Residual heat/ventilation
④ Display	⑩ Rear air-conditioning remote control	⑮ Air recirculation
⑤ Temperature rocker switch, passenger side	⑪ Increasing air volume	⑯ Air distribution and air volume, driver's side (automatic, manual)
⑥ Rear window defroster		

4-zone automatic climate control

Warning!



When operating the climate control, the air that enters the passenger compartment through the air vents can be very hot or very cold (depending on the set temperature). This may cause burn or frostbite to unprotected skin in the immediate area of the air vents. Always keep sufficient distance between unprotected parts of the body and the air vents. If necessary, use the air distribution controls (> page 224) or (> page 225) to direct the air to air vents in the vehicle interior that are not in the immediate area of unprotected skin.

The climate control is a 4-zone intelligent climate control system. Your vehicle interior is divided into 4 zones.



With the help of a sun sensor, the climate control determines the relation of the sun to the vehicle and automatically adjusts the inside temperature for every individual zone.

You can set the temperature for each of the 4 zones separately.

The climate control is operational whenever the engine is running. It cools the vehicle's interior according to the angle and intensity of the sun's rays, the outside temperature and the selected temperature. You can operate the climate control system in either the automatic or manual mode.

4-zone automatic climate control

Nearly all dust particles, pollutants and odors are filtered out before outside air enters the passenger compartment through the air distribution system.

The air conditioning will not engage (no cooling) if the **A/C** mode (▷ page 235) is deactivated.

Warning!

Follow the recommended settings for heating and cooling given on the following pages. Otherwise the windows could fog up, impairing visibility and endangering you and others.

i *Severe conditions (e.g. strong air pollution) may require replacement of the filter before its scheduled interval. A clogged filter will reduce the air volume to the interior.*

If the vehicle interior is hot, ventilate the interior before driving off, see “Summer opening feature” (▷ page 241). The climate control will then adjust the interior temperature to the set value much faster.

Keep the air intake grille in front of the windshield free of snow and debris.

Do not obstruct air flow by placing objects on the air flow-through exhaust slots below the rear window.

Deactivating the climate control system**Warning!**

When the climate control is switched off, the outside air supply and circulation are also switched off. Only choose this setting for a short time. Otherwise the windows could fog up, impairing visibility and endangering you and others.

Deactivating



- ▶ Press button **OFF** (▷ page 224) or (▷ page 225) until the display ④ (▷ page 224) or (▷ page 225) is cleared.

4-zone automatic climate control

Reactivating

- ▶ Make sure the ignition is switched on.
- ▶ Press button **OFF** (▷ page 224) or (▷ page 225) again.

The previous settings are once again in effect.

i To switch the system on, you can also press another button, with the exception of  (USA only) (▷ page 224) or  and **REST** (Canada only) (▷ page 225).

Operating the climate control system in automatic mode

i When operating the climate control system in automatic mode, you will only rarely need to adjust the temperature, air volume and air distribution.

In automatic mode, cooling with dehumidify is switched on. This function can be switched off.

Warning!



If you switch off the cooling function the windows can fog up more quickly. Window fogging may impair visibility and endanger you and others.

i You can switch the automatic climate control system on and off for each side of the passenger compartment as desired.

Activating

- ▶ Press button **AUTO** (▷ page 224) or (▷ page 225) while the engine is running.



The indicator lamp on the button comes on. AUTO appears in the display ④ (▷ page 224) or (▷ page 225). The air volume and air distribution are adjusted automatically.

- ▶ Use temperature rocker switches ③ and ⑤ (▷ page 224) or (▷ page 225) to separately adjust the air temperature on each side of the passenger compartment.

The temperature of the vehicle interior is adjusted automatically.



4-zone automatic climate control

Deactivating

- ▶ Press button  or  (▷ page 224) or (▷ page 225).

The AUTO indicator in the display  (▷ page 224) or (▷ page 225) goes out. The automatic function for air volume is switched off, and air volume is controlled according to the desired setting.



or

- ▶ Turn air distribution controls  and  (▷ page 224) or (▷ page 225) on each side of the passenger compartment to the desired symbol.

The indicator lamp on the corresponding button goes out. Automatic air distribution is switched off in the corresponding zone, and air distribution is controlled according to the desired position.

Automatic air volume remains switched on.



Setting the temperature

Use temperature control rocker switches  and  (▷ page 224) or (▷ page 225) to separately adjust the air temperature on each side of the passenger compartment. You should raise or lower the temperature setting in small increments, preferably starting at 72°F (22°C). The adjusted temperature appears in the display  (▷ page 224) or (▷ page 225). The climate control will adjust to the set temperature as fast as possible.

 *You can also adjust the temperature in the rear passenger compartment (▷ page 237).*



 *When operating the climate control system in automatic mode, you will only rarely need to adjust the temperature, air volume and air distribution.*

Increasing

- ▶ Push top of temperature control rocker switch  and/or  (▷ page 224) or (▷ page 225).

The climate control system will correspondingly adjust the interior air temperature.

Decreasing

- ▶ Push bottom of temperature control rocker switch  and/or  (▷ page 224) or (▷ page 225).





The climate control system will correspondingly adjust the interior air temperature.

4-zone automatic climate control

Adjusting air distribution

Use the air distribution controls ① and ⑦ (▷ page 224) or (▷ page 225) to separately adjust the air distribution on each side of the passenger compartment.

The following symbols are located on the controls:

Symbol	Function
	Directs air through the cockpit (Canada only), side and rear passenger compartment air vents
	Directs air to the windshield and through the side air vents
	Directs air into the entire vehicle interior
	Directs air to the footwells

- ▶ Turn air distribution controls ① and ⑦ (▷ page 224) or (▷ page 225) on each side of the passenger compartment to the desired symbol.

The indicator lamp on the corresponding button goes out and the automatic air distribution is switched off for the corresponding side. The air distribution is controlled according to the thumbwheel setting.

i You can also turn the air distribution control to a position between two symbols.

Opening the cockpit air vent (Canada only) and center air vents

- ▶ Turn thumbwheels ① and ⑤ (▷ page 222) upward.

The cockpit air vent ③ and the center air vents ② and ④ are open.

Closing the cockpit air vent (Canada only) and center air vents

- ▶ Turn thumbwheels ① and ⑤ (▷ page 222) downward.

The cockpit air vent ③ and the center air vents ② and ④ are closed.

Opening the side air vents

- ▶ Turn thumbwheels ⑧ and ⑩ (▷ page 222) upward.

The side air vents ⑦ and ⑪ are open.



Closing the side air vents

- ▶ Turn thumbwheels ⑧ and ⑩ (▷ page 222) downward.



The side air vents ⑦ and ⑪ are closed.

4-zone automatic climate control

Adjusting air volume

Use buttons **AUTO** (▷ page 224) or (▷ page 225) for automatic mode or air volume buttons  or  (▷ page 224) or (▷ page 225) to adjust air volume manually.

Nine blower speeds are available.

- ▶ Press button  to decrease or button  to increase air volume to the desired level.

The AUTO indicator for air volume in the display ④ (▷ page 224) or (▷ page 225) goes out. The selected blower speed is shown in the display ④. Automatic air distribution remains switched on.

The indicator lamps on the **AUTO** buttons remain lit.

Front defroster

You can use this setting to defrost the windshield, for example if it is iced up. You can also defog the windshield and the windows.

i *Keep this setting selected only until the windshield or the windows are clear again.*

Activating

- ▶ Press button  or  (▷ page 224) or (▷ page 225).

The indicator lamp on the button comes on. Display ④ (▷ page 224) or (▷ page 225) is cleared.

The air conditioning switches automatically to the following functions:

- cooling on to dehumidify
- maximum blowing and heating power (depends on cooling temperature)
- air flows onto the windshield and the front windows
- the air recirculation mode is switched off

i *If you have switched on the defrost function using the  or  button, you cannot make any other settings.*

Deactivating

- ▶ Press button  or  (▷ page 224) or (▷ page 225) again.

The indicator lamp on the button goes out. Defrosting is turned off.

The previous settings are once again in effect.

i *The cooling remains switched on.*





4-zone automatic climate control

Windshield fogged on the outside

 Keep this setting selected only until the windshield is clear again.

- ▶ Switch the windshield wipers on (▷ page 57).



If the automatic mode of the climate control is switched off:

- ▶ Turn air distribution controls  and  to  or  (▷ page 224) or  (▷ page 225).

Maximum cooling MAX COOL (USA only)

You can use this setting to provide the fastest possible cooling of the vehicle interior (when windows and tilt/sliding sunroof or tilt/sliding panel* are closed).



Activating

- ▶ Press button  (▷ page 224).
MAX COOL appears in the display  (▷ page 224).





The air conditioning switches automatically to the following functions:

- maximum cooling
- maximum blowing power
- the air recirculation mode is switched on

Deactivating

- ▶ Press button  (▷ page 224) again.
MAX COOL disappears in the display  (▷ page 224).

The previous settings are once again in effect.



 To switch the maximum cooling function off, you can also press button , ,  or  (▷ page 224).

4-zone automatic climate control

Air recirculation mode

Switch to air recirculation mode to prevent unpleasant odors from entering the vehicle from the outside (e.g. before driving through a tunnel). This setting cuts off the intake of outside air and recirculates the air in the passenger compartment.

Warning!

Fogged windows impair visibility, endangering you and others. If the windows begin to fog on the inside, switching off the air recirculation mode immediately should clear interior window fogging. If interior window fogging persists, make sure the air conditioning (▷ page 235) is activated, or press button  or .

Activating

- ▶ Press button  (▷ page 224) or (▷ page 225).

The indicator lamp on the button comes on.

 *The air recirculation mode is activated automatically at high outside temperatures and if the concentration of carbon monoxide (CO) and nitrogen oxide in the outside air increases, for example in a tunnel.*

The indicator lamp on button  is not lit when the air recirculation mode is automatically switched on.

A quantity of outside air is added after approximately 30 minutes.

Deactivating

- ▶ Press button  (▷ page 224) or (▷ page 225).

The indicator lamp on the button goes out.

 *The air recirculation mode is deactivated automatically:*

- *after 5 minutes if the outside temperature is below approximately 41 °F (5 °C)*
- *after 5 minutes if the air conditioning is turned off*
- *after 30 minutes if the outside temperature is above approximately 41 °F (5 °C)*

4-zone automatic climate control

Air recirculation mode with convenience closing or opening feature

Warning!





Never operate the windows and tilt/sliding sunroof if there is the possibility of anyone being harmed by the opening or closing procedure.

In the event that the procedure causes potential danger, the closing of the windows can be immediately halted by pressing or pulling the respective window switch. The closing of the tilt/sliding sunroof can be immediately halted by moving the switch for the tilt/sliding sunroof in any direction.

The closing of the windows and the tilt/sliding sunroof can be reversed by again pressing and holding the  button.

Convenience closing



- ▶ Press button  (▷ page 224) or (▷ page 225) for approximately 2 seconds.

The windows and tilt/sliding sunroof will close. You can release button  once the closing procedure has begun. The windows and tilt/sliding sunroof continue closing until they are fully closed. The indicator lamp on the button comes on. The air recirculation mode is activated.

Convenience opening

- ▶ Press button  for approximately 2 seconds.

The windows and tilt/sliding sunroof will return to their previous position. You can release button  once the opening procedure has begun. The windows and tilt/sliding sunroof continue opening until they have reached their previous position. The indicator lamp on the button goes out. The air recirculation mode is deactivated.

 *A window or tilt/sliding sunroof will only return to its previous position if it has not been moved to another position using the respective window switch or tilt/sliding sunroof switch after it was closed with button .*

A window or tilt/sliding sunroof that has been moved will remain in its current position if button  is used to reopen the remaining windows or tilt/sliding sunroof.

4-zone automatic climate control

Combination filter with pollutant-sensitive air-recirculation mode

The combination filter reduces pollutants and unpleasant odors in the outside air. The pollutant-sensitive air-recirculation mode automatically switches off the supply of outside air when pollutants are detected in the air.

i *The pollutant-sensitive air-recirculation mode is not possible if you have switched off the air conditioning or if the temperature falls below 41 °F (5 °C).*

Air conditioning

The cooling function, only operational when the engine is running, cools the vehicle interior down to the selected temperature. The cooling function also dehumidifies the air in the vehicle interior, thus preventing the windows from fogging up.

i *Condensation may drip out from underneath the vehicle. This is normal and not an indication of a malfunction.*

Warning!

If you turn off the cooling function, the vehicle will not be cooled when weather conditions are warm. The windows can fog up more quickly. Window fogging may impair visibility and endanger you and others.

Deactivating

It is possible to deactivate the air conditioning (cooling) function of the climate control system. The air in the vehicle will then no longer be cooled or dehumidified.

- ▶ Press button  (▷ page 224) or (▷ page 225).

The indicator lamp on the button goes out.

Activating

Moist air can fog up the windows. You can dehumidify the air with the air conditioning.

- ▶ Press button  (▷ page 224) or (▷ page 225) again.

The indicator lamp on the button comes on.

The air conditioning uses the refrigerant R134a. This refrigerant is free of CFCs which are harmful to the ozone layer.

4-zone automatic climate control

! *If the air conditioning cannot be turned on again, this indicates that the air conditioning is losing refrigerant. The compressor has turned itself off.*

Have the air conditioning checked at the nearest authorized Mercedes-Benz Center.

Residual heat and ventilation (Canada only)

With the engine switched off, it is possible to continue to heat or ventilate the interior for up to 30 minutes. This feature makes use of the residual heat produced by the engine.

i *If you switch on the residual heat function when temperatures are high, only the ventilation will be switched on.*

i *Regardless of the selected air volume, the blower operates at low speed.*

i *How long the system will provide heating depends on*

- *the coolant temperature*
- *the temperature set by the operator*

The blower will run at speed setting 1 regardless of the air distribution control setting.

Activating

- ▶ Switch off the ignition.
- ▶ Press button **REST** (▷ page 225).
REST in the display ④ (▷ page 225) comes on.

Deactivating

- ▶ Press button **REST** (▷ page 225) again.
REST in the display ④ (▷ page 225) goes out.
- i** *The residual heat is automatically turned off:*
 - *when the ignition is switched on*
 - *after about 30 minutes*
 - *if the battery voltage drops*
 - *if the coolant temperature is too low*

4-zone automatic climate control

Rear climate control

The rear climate control is adjusted via the front climate control panel (▷ page 224) or (▷ page 225) or the rear climate control panel.

The rear climate control panel is located in the rear center console.

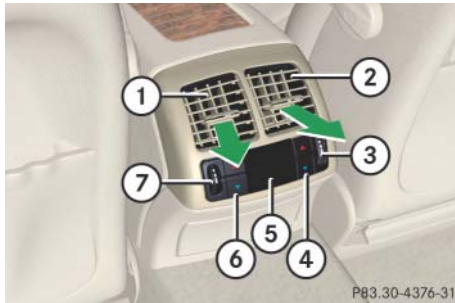

- ① Left rear center air vent, adjustable
- ② Right rear center air vent, adjustable
- ③ Thumbwheel for air volume control for right rear center air vent
- ④ Temperature rocker switch, right
- ⑤ Display
- ⑥ Temperature rocker switch, left
- ⑦ Thumbwheel for air volume control for left rear center air vent

Setting the temperature

Use temperature control rocker switches ④ and ⑥ to separately adjust the air temperature on each side of the rear passenger compartment.

i You can also adjust the rear temperature using the front climate control panel (▷ page 224) or (▷ page 225).

You should raise or lower the temperature setting in small increments, preferably starting at 72°F (22°C). The adjusted tem-

perature appears in the display ⑤. The rear climate control will adjust to the set temperature as fast as possible.

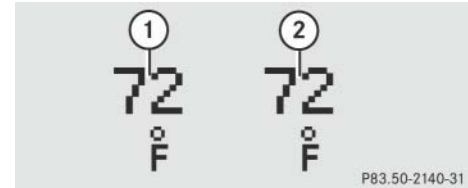

- ① Temperature, left
- ② Temperature, right

▶ Adjust the temperature to the desired setting for each side of the passenger compartment using the left and right temperature buttons.

The temperature in the rear passenger compartment is adjusted automatically.

i The rear climate control will not cool the air when the air conditioning is switched off (▷ page 235).

4-zone automatic climate control

Adjusting air distribution

- ▶ Push the slider for the left center air vent ① or right center air vent ② to the left, right, up, or down.

The air flow is directed in the corresponding direction.

i For draft-free ventilation, move sliders for the center air vents ① and ② upward.

Adjusting air volume

- ▶ Turn thumbwheel ③ or ⑦ up or down.

The air volume is increased or decreased.

Adjusting the rear settings with the front control panel

You can adjust the temperature for the rear climate control from the front climate control panel.

- ▶ Press button **REAR TEMP** or  (▷ page 224) or (▷ page 225).

The display switches over.



① Rear climate control display

- ▶ Set the desired temperature for the rear passenger compartment using temperature rocker switches ④ and ⑥.

After approximately 5 seconds after the last adjustment, the display switches back to its standard display.

i You can also press button **REAR TEMP** or  (▷ page 224) or (▷ page 225) once more to switch back to the standard display.

▼ Power windows

Opening and closing the windows

The windows are opened and closed electrically. The switches for all of the windows are on the driver's door. The switches for the respective windows are on the front passenger door and the rear doors.

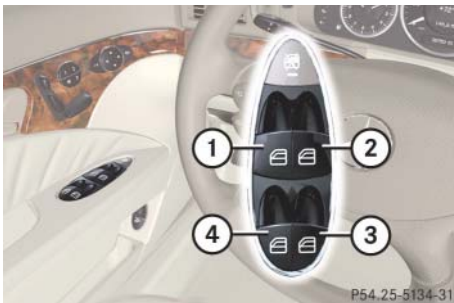

- ① Left front window
- ② Right front window
- ③ Right rear window
- ④ Left rear window

Warning!



When closing the windows, make sure that there is no danger of anyone being harmed by the closing procedure.

The closing of the windows can be immediately halted by releasing the switch or, if switch was pulled past the resistance point and released, by either pressing or pulling the respective switch.

The windows are equipped with the express-close and automatic reversal function. If the window encounters an obstruction that blocks its path in a circumstance where you pulled the switch past the resistance point and released it to close the window, the automatic reversal function will stop the window and open it slightly.

If the window encounters an obstruction that blocks its path in a circumstance where you are closing the window by pulling and holding the switch, by pressing and holding button  on the SmartKey, by pressing

and holding the lock button (vehicles with KEYLESS-GO*) on an outside door handle, or by pressing and holding the air recirculation button  on the climate control, the automatic reversal function will not operate.

When leaving the vehicle, always remove the SmartKey or SmartKey with KEYLESS-GO* from the starter switch, take it with you, and lock the vehicle. Do not leave children unattended in the vehicle, or with access to an unlocked vehicle. A child's unsupervised access to a vehicle could result in an accident and/or serious personal injury.

i You can also open or close the windows using the SmartKey, see “Summer opening feature” (▷ page 241) and “Convenience closing feature” (▷ page 242).

Depending on current position, the windows may also open or close when the air recirculation button  in the control panel of the climate control (▷ page 208), (▷ page 224) or (▷ page 225) is pressed and held.

Power windows

i *Operating the windows from the rear is not possible if you activate the override switch (▷ page 95).*

i *With the SmartKey in starter switch position 0 or removed from the starter switch, the windows can be operated:*

- *until you open the driver's or front passenger's door*
 - *for at least 5 minutes*
- ▶ Switch on the ignition (▷ page 37).

Opening the windows

- ▶ Press switch ① to ④ to the resistance point.

The corresponding window will move downwards until you release the switch.

Closing the windows

- ▶ Pull switch ① to ④ to the resistance point.

The corresponding window will move upwards until you release the switch.

Warning!



If you pull and hold the switch up when closing the window, and upward movement of the window is blocked by some obstruction including but not limited to arms, hands, fingers, etc., the automatic reversal will not operate.

Fully opening the windows (Express-open)

- ▶ Press switch ① to ④ past the resistance point and release.

The corresponding window opens completely.

Fully closing the windows (Express-close)

- ▶ Pull switch ① to ④ past the resistance point and release.

The corresponding window closes completely.

If the upward movement of the window is blocked during the closing procedure, the window will stop and open slightly.

Warning!



Driver's door only:

If within 5 seconds switch is again pulled past the resistance point and released, the automatic reversal will not operate.

! If the upward movement of the window is blocked during the closing procedure, the window will stop and open slightly.

Remove the obstruction, pull the respective power window switch again past the resistance point and release.

If the window still does not close when there is no obstruction, pull and hold the respective power window switch. The window will then close without the obstruction sensor function.

Stopping windows during Express-operation

- ▶ Press or pull the respective power window switch again.

Synchronizing power windows

The power windows must be synchronized

- after the battery has been disconnected
- if the power windows cannot be fully opened (Express-open) or closed (Express-close)

Synchronizing

- ▶ Close all doors.
- ▶ Switch on the ignition (▷ page 37).
- ▶ Pull switch ① to ④ until the windows are completely closed.
- ▶ Hold on to switches ① to ④ for approximately 1 second.

The power windows are synchronized.

Summer opening feature

If the weather is warm, you can ventilate the vehicle before driving off by simultaneously:

- opening the windows
- opening the tilt/sliding sunroof
- turning on the seat ventilation* for the driver's seat



i The seat ventilation* for the driver's seat is automatically set to the highest level if activated via summer opening feature.



P88 00-2326-31





Power windows

- ▷▷ Aim transmitter eye of the SmartKey or SmartKey with KEYLESS-GO* at the driver's outside door handle. The SmartKey or SmartKey with KEYLESS-GO* must be in close proximity to the driver's outside door handle.
- ▶ Press and hold button  until the windows and the tilt/sliding sunroof have reached the desired position.
- ▶ Release button  to interrupt procedure.

Convenience closing feature

When you lock the vehicle, you can close the windows and the tilt/sliding sunroof simultaneously.

- ▶ Aim transmitter eye of the SmartKey or SmartKey with KEYLESS-GO* at the driver's outside door handle (▷ page 241). The SmartKey or SmartKey with KEYLESS-GO* must be in close proximity to the driver's outside door handle.
- ▶ Press and hold button  until the windows and the tilt/sliding sunroof are completely closed.
- ▶ Release button  to interrupt procedure.

Vehicles with KEYLESS-GO*:



- ▶ Press and hold the lock button on an outside door handle (▷ page 65) until the windows and the tilt/sliding sunroof are completely closed.
- ▶ Release the lock button on the outside door handle to interrupt procedure.

Warning!



When closing the windows and the tilt/sliding sunroof, make sure that there is no danger of anyone being harmed by the closing procedure.

If potential danger exists, proceed as follows:

- Release button  to stop the closing procedure. To open, press and hold button . To continue the closing procedure after making sure that there is no danger of anyone being harmed by the closing procedure, press and hold button .

Vehicles with KEYLESS-GO*:

- Release the lock button (▷ page 65) on the outside door handle to stop the closing procedure.
- Immediately pull on the same outside door handle and hold firmly. The windows and the tilt/sliding sunroof will open for as long as the door handle is held but the door not opened.

▼ Power tilt/sliding sunroof

Opening and closing the power tilt/sliding sunroof

The tilt/sliding sunroof is opened and closed electrically. The switch for the tilt/sliding sunroof is on the overhead control panel.



Sunroof switch

- ① Push back to slide sunroof open
- ② Push forward to slide sunroof closed
- ③ Push up to raise sunroof at rear
- ④ Pull down to lower sunroof at rear

With the sunroof closed or tilted open, a screen can be slid into the sunroof opening to guard against sun rays. When sliding the sunroof open, the screen will also retract.



Warning!



When closing the tilt/sliding sunroof, make sure there is no danger of anyone being harmed by the closing procedure.

The opening/closing procedure of the tilt/sliding sunroof can be immediately halted by releasing the switch or, if the switch was moved past the resistance point and released, by moving the switch in any direction.

The tilt/sliding sunroof is made out of glass. In the event of an accident, the glass may shatter. This may result in an opening in the roof.

In a vehicle rollover, occupants not wearing their seat belts or not wearing them properly may be thrown out of the opening. Such an opening also presents a potential for injury for occupants wearing their seat belts properly as entire body parts or portions of them may protrude from the passenger compartment.



Power tilt/sliding sunroof



When leaving the vehicle, always remove the SmartKey or the SmartKey with KEYLESS-GO* from the starter switch, take it with you, and lock the vehicle. Do not leave children unattended in the vehicle, or with access to an unlocked vehicle. A child's unsupervised access to a vehicle could result in an accident and/or serious personal injury.

! To avoid damaging the seals, do not transport any objects with sharp edges which can stick out of the tilt/sliding sunroof.

Do not open the tilt/sliding sunroof if there is snow or ice on the roof, as this could result in malfunctions.

The tilt/sliding sunroof can be opened or closed manually should an electrical malfunction occur (▷ page 438).

! Please keep in mind that weather conditions can sometimes change rapidly. Make sure to close the tilt/sliding sunroof when leaving the vehicle. If water enters the vehicle interior, vehicle electronics could be damaged which is not covered by the Mercedes-Benz Limited Warranty.

i When the tilt/sliding sunroof is open, resonance noises may result in addition to the usual wind noises. They are caused by minimal pressure changes in the passenger compartment. To reduce or eliminate these noises, change the position of the tilt/sliding sunroof or open a side window slightly.

i You can also open or close the tilt/sliding sunroof using the SmartKey, see "Summer opening feature" (▷ page 241) and "Convenience closing feature" (▷ page 242).

Depending on current position, the tilt/sliding sunroof may also open or close when the air recirculation button  in the control panel of the climate control (▷ page 208), (▷ page 209), (▷ page 224) or (▷ page 225) is pressed and held.

▶ Switch on the ignition (▷ page 37).

Opening and closing the power tilt/sliding sunroof

▶ To open, close, raise or lower the tilt/sliding sunroof, move the sunroof switch to resistance point in the required direction of arrows ① to ④.

Release the sunroof switch when the tilt/sliding sunroof has reached the desired position.

Fully opening (Express-open) and closing (Express-close) the power tilt/sliding sunroof

▶ To open or close the tilt/sliding sunroof, move the sunroof switch past the resistance point in direction of arrow ① to ② and release.

The tilt/sliding sunroof opens or closes completely.

Stopping the power tilt/sliding sunroof during Express-operation

- ▶ Move the sunroof switch in any direction.

i *If the movement of the tilt/sliding sunroof is blocked during the Express-close procedure, the tilt/sliding sunroof will stop and reopen slightly.*

Synchronizing the power tilt/sliding sunroof

The tilt/sliding sunroof must be synchronized

- after the battery has been disconnected or discharged
- after the tilt/sliding sunroof has been closed manually (▷ page 438)
- after a malfunction
- if the tilt/sliding sunroof does not open smoothly

- ▶ Remove the respective fuse from the main fuse box (▷ page 472).
- ▶ Reinsert the fuse in the main fuse box.
- ▶ Switch on the ignition (▷ page 37).
- ▶ Move and hold the sunroof switch in direction of arrow ③ until the tilt/sliding sunroof is fully raised at the rear.
Keep holding the sunroof switch in direction of arrow ③ for approximately 1 second.
- ▶ Check the Express-open feature (▷ page 244).

If the tilt/sliding sunroof opens completely, the roof is synchronized. Otherwise repeat the above steps.

Driving systems

The driving systems of your vehicle are described on the following pages:

- Cruise control and DISTRONIC*, with which the vehicle can maintain a preset speed
- AIRMATIC DC adjusts the vehicle suspension characteristics automatically and controls the vehicle level

For information on the BAS, ABS, and ESP®, see “Driving safety systems” (▷ page 97).

Cruise control

The cruise control automatically maintains the speed you set for your vehicle.

Use of cruise control is recommended for driving at a constant speed for extended periods of time. You can set or resume cruise control at any speed above 20 mph (30 km/h).

The cruise control function is operated by means of the cruise control lever.

The cruise control lever is the uppermost lever on the left-hand side of the steering column (▷ page 24).

Warning!



The cruise control is a convenience system designed to assist the driver during vehicle operation. The driver is and must always remain responsible for the vehicle's speed and for safe brake operation.

Only use the cruise control if the road, traffic and weather conditions make it advisable to travel at a steady speed.

- The use of cruise control can be dangerous on winding roads or in heavy traffic because conditions do not allow safe driving at a steady speed.
- The use of cruise control can be dangerous on slippery roads. Rapid changes in tire traction can result in wheel spin and loss of control.
- Deactivate the cruise control when driving in fog.

The “Resume” function should only be operated if the driver is fully aware of the previously set speed and wishes to resume this particular preset speed.

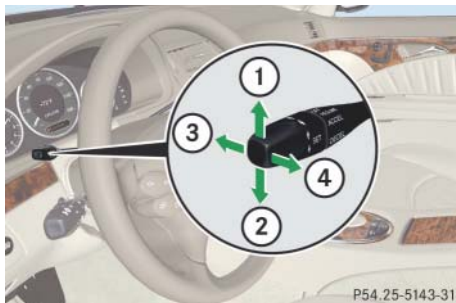

- ① Set current or higher speed
- ② Set current or lower speed
- ③ Cancel cruise control
- ④ Resume at last set speed

Warning!



The cruise control brakes automatically so that the set speed is not exceeded.

Keep in mind that the cruise control is a convenience system designed to assist the driver during vehicle operation. The driver is and must always remain responsible for the vehicle's speed and for safe brake operation.

Setting current speed

- ▶ Accelerate or decelerate to the desired speed.
- ▶ Briefly lift ① or depress ② the cruise control lever.
The current speed is set.
- ▶ Remove your foot from the accelerator pedal.
Cruise control is activated.

The selected speed appears in the multi-function display for approximately 5 seconds, and the corresponding speedometer segments from the selected speed to the vehicle maximum speed are illuminated.

i *On uphill or downhill grades, the cruise control may not be able to maintain the set speed. Once the grade eases, the set speed will be resumed.*

On downhill grades, the cruise control maintains the set speed with active braking action. In addition, on longer downhill grades the automatic transmission will automatically downshift.

Canceling cruise control

There are several ways to cancel the cruise control:

- ▶ Step on the brake pedal.
The cruise control is canceled. The last speed set is stored for later use.
- or
- ▶ Briefly push the cruise control lever in direction of arrow ③ (▷ page 247).

The cruise control is canceled. The last speed set is stored for later use.

i *The last stored speed is canceled when you turn off the engine.*

Driving systems

i The cruise control switches off automatically if

- you step on the brake pedal
- you depress the parking brake pedal

In this case the segments in the multifunction display (▷ page 252) go out and no warning sounds

- the vehicle speed is below 20 mph (30 km/h)
- the ESP® is in operation or switched off with the ESP® switch (▷ page 102)
- you move the gear selector lever to position **N** while driving

The segments in the multifunction display (▷ page 252) go out, and an acoustic warning sounds.

! Moving gear selector lever to position **N** while driving also cancels the cruise control. However, the gear selector lever should not be moved to position **N** while driving except to coast when the vehicle is in danger of skidding (e.g. on icy roads).

i Depressing the accelerator pedal does not deactivate the cruise control. After brief acceleration (e.g. for passing), the cruise control will resume the last speed set.

Setting a higher speed

- ▶ Lift cruise control lever in direction of arrow ① (▷ page 247) and hold it up until the desired speed is reached.
- ▶ Release the cruise control lever.
The new speed is set.

Setting a lower speed

- ▶ Depress the cruise control lever in direction of arrow ② (▷ page 247) and hold it down until the desired speed is reached.
- ▶ Release cruise control lever.
The new speed is set.

i When you use the cruise control lever to decelerate, the brake system will automatically brake the vehicle if the engine's braking power does not brake the vehicle sufficiently.

Fine adjustment in 1 mph (Canada: 1 km/h) increments

Faster

- ▶ Briefly tip the cruise control lever in direction of arrow ① (▷ page 247).

Slower

- ▶ Briefly tip the cruise control lever in direction of arrow ② (▷ page 247).

Setting to last stored speed ("Resume" function)

Warning!



The speed stored in memory should only be set again if prevailing road conditions permit. Possible acceleration or deceleration differences arising from returning to the preset speed could cause an accident and/or serious injury to you and others.

- ▶ Briefly pull the cruise control lever in direction of arrow ④ (▷ page 247).
The cruise control resumes the last set speed.
- ▶ Remove your foot from the accelerator pedal.

The selected speed appears in the multi-function display for approximately 5 seconds, and the corresponding speedometer segments from the selected speed to the vehicle maximum speed are illuminated.

Distronic*

When activated, the DISTRONIC adaptive cruise control system increases driving convenience afforded by the cruise control during travel on expressways and other major roads.

- If the DISTRONIC distance sensor detects a slower moving vehicle directly ahead, your vehicle speed will be reduced so that you follow that vehicle at a preset distance.
- If there is no vehicle directly ahead of you, DISTRONIC will function in the same way as cruise control (▷ page 246).

Warning!



DISTRONIC adaptive cruise control is no substitute for active driving involvement. It does not react to stationary objects, nor recognize or predict the curvature and lane layout or the movement of vehicles ahead. DISTRONIC can only apply a maximum of 20% of the vehicle's braking power.

It is the driver's responsibility at all times to be attentive to road, traffic and weather conditions and to provide the steering, braking and other driving inputs necessary to retain control of the vehicle.

Warning!



DISTRONIC is a convenience system, its speed adjustment reduction capability is intended to make cruise control more effective and usable when traffic speeds vary. It is not however, intended to, nor does it, replace the need for extreme care. The responsibility for the vehicle speed and the distance to the vehicle ahead, including most importantly brake operation to assure safe stopping distance, always rests with the driver.

DISTRONIC cannot take street and traffic conditions into account.

Driving systems

Warning!



Distronic requires familiarity with its operational characteristics. We strongly recommend that you review the following information carefully before operating the system.

i USA only:

This device has been approved by the FCC as a “Vehicular Radar System”. The radar sensor is intended for use in an automotive radar system only. Removal, tampering, or altering of the device will void any warranties, and is not permitted by the FCC. Do not tamper with, alter, or use in any non-approved way.

Any unauthorized modification to this device could void the user’s authority to operate the equipment.

i Canada only:

This device complies with RSS-210 of Industry Canada. Operation is subject to the following two conditions:

- (1) This device may not cause interference, and*
- (2) this device must accept any interference received, including interference that may cause undesired operation of the device.*

Removal, tampering, or altering of the device will void any warranties, and is not permitted. Do not tamper with, alter, or use in any non-approved way.

Any unauthorized modification to this device could void the user’s authority to operate the equipment.

Warning!



Distronic cannot take street and traffic conditions into account. Only use Distronic if the road, weather and traffic conditions make it advisable to travel at a steady speed.

Warning!



Use of Distronic can be dangerous on slippery roads. Rapid changes in tire traction can result in wheel spin and loss of control.

Distronic does not act upon adverse sight distance conditions. Do not use Distronic during conditions of fog and heavy rain, snow or sleet.

Warning!

Distronic cannot take weather conditions into account. Switch off DISTRONIC or do not turn it on if:

- roads are slippery or covered with snow or ice. The wheels could lose traction while braking or accelerating, and the vehicle could skid
- the sensor is dirty or visibility is diminished due to snow, rain or fog. The distance control could be impaired

Always pay attention to traffic conditions even while DISTRONIC is switched on. Otherwise, you may not be able to recognize dangerous situations until it is too late and could cause an accident resulting in personal or fatal injury to you or others.

Warning!

Close attention to road and traffic conditions is imperative at all times, regardless of whether or not DISTRONIC is activated.

Use of DISTRONIC can be dangerous on winding roads or in heavy traffic because conditions do not allow safe driving at a steady speed.

DISTRONIC will not react to stationary objects in the roadway (e.g. a stopped vehicle in a traffic jam or a disabled vehicle). DISTRONIC will also not respond to oncoming vehicles.

Switch off DISTRONIC:

- when changing from the left to the right lane if vehicles are moving more slowly in the left lane
- when entering a turn lane or highway off ramp
- in complex driving situations, such as in highway construction zones

In these situations, DISTRONIC will continue to maintain the set speed unless deactivated.

DISTRONIC is designed and intended only to maintain a set speed and keep a set distance from moving objects in front of it.

Warning!

The “Resume” function should only be operated if the driver is fully aware of the previously set speed and wishes to resume this particular preset speed.

Driving systems

Distronic displays in the speedometer dial



① Set speed

If Disticronic is activated, one or two segments come on around the set speed.

i *The vehicle speed displayed on the speedometer can briefly vary from the speed setting on the Disticronic system.*



① Segments

If Disticronic detects a vehicle directly ahead, the segments (representing the difference) from the speed of the vehicle ahead to the set speed come on.

If Disticronic calculates that there is a danger of collision:

- The distance warning lamp  in the instrument cluster comes on red.
- An intermittent warning sounds.

► Immediately brake the vehicle to avoid a collision.

Under no circumstances should the driver await the intermittent warning sound before braking. See the following warning note.

The intermittent warning sound ceases and the red distance warning lamp  goes out when the necessary distance to the vehicle ahead is again established.

Warning!

An intermittent warning sounds and the distance warning lamp  in the instrument cluster is illuminated if the Distronic system calculates that the distance to the vehicle ahead and your vehicle's current speed indicate that Distronic will not be capable of slowing the vehicle sufficiently to maintain the preset following distance, which creates a danger of a collision.

Immediately brake the vehicle to increase the distance to the vehicle in front of you. The warning sound is intended as a final caution that you have not interceded with your own braking inputs to avoid a potentially dangerous situation. Do not wait for the operation of the warning signal to intercede with your own braking, as that will result in potentially dangerous emergency braking which will not always result in an impact being avoided.

Tailgating increases the risk of an accident.



Warning!

Distronic brakes your vehicle with a maximum deceleration of 6.5 ft/s² (2 m/s²). This corresponds to about 20% of the maximum deceleration ability of your vehicle.

Distronic brakes the vehicle in an effort to restore the preset distance or to maintain the speed.

Distronic menu in the control system

In the Distronic menu you can read the current settings for Distronic. What appears in the multifunction display depends on whether Distronic and the distance warning function are turned on or off.

- ▶ Press button  or  repeatedly until you see one of the following displays.

Driving systems

Distronic deactivated

When Disticronic is deactivated you will see the standard display of Disticronic in the multifunction display.

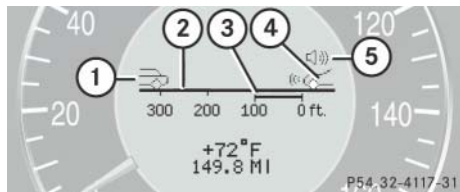

- ① Vehicle ahead, if detected
- ② Actual distance to vehicle ahead
- ③ Preset distance threshold to vehicle ahead
- ④ Your vehicle
- ⑤ Symbol for activated distance warning function

Distronic activated

If you turn Disticronic on, you will see the set speed in the multifunction display for about 5 seconds. When Disticronic is activated, you will see the following display in the multifunction display.

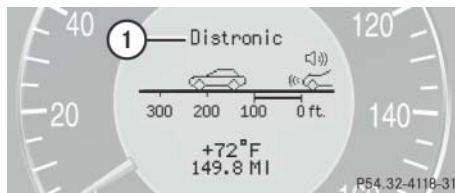

- ① Disticronic activated

Cruise control lever

The Disticronic system is operated by means of the cruise control lever.

The cruise control lever is the uppermost lever on the left-hand side of the steering column.

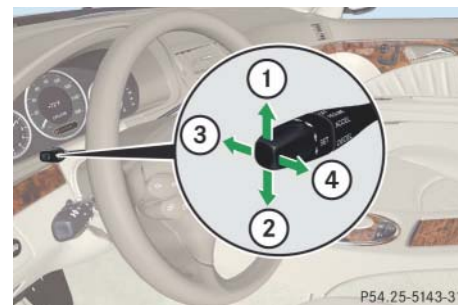

- ① Set current or higher speed
- ② Set current or lower speed
- ③ Deactivate Disticronic
- ④ Resume at last set speed

Activating Distronic

You can activate Distronic if

- you are driving between 20 mph (30 km/h) and 110 mph (180 km/h)
- the ESP® is activated (▷ page 100)

If Distronic has not been activated after pressing the cruise control lever you will see the message --- in the multifunction display.

In the following cases you cannot activate Distronic

- up to 2 minutes after starting the engine
- when you brake
- if you have set the parking brake
- if the gear selector lever is in position **P**, **R** or **N**
- if the ESP® is switched off

Setting the current speed

- ▶ Accelerate or decelerate to the desired speed.
- ▶ Briefly lift or depress the cruise control lever.
The current speed is set.
- ▶ Remove your foot from the accelerator pedal.

i *If you do not take your foot off the accelerator completely, the following message will appear in the multifunction display:*

DISTRONIC
override

The distance to a slower moving vehicles in front of you will not be set. Your vehicle speed will then be determined only by the accelerator pedal position.

Setting a higher speed

- ▶ Briefly tip the cruise control lever in direction of arrow ① (▷ page 254) to increase vehicle speed in increments of 5 mph (Canada: 10 km/h).

The new speed is set.

The stored speed is displayed in the multifunction display for approximately 5 seconds (▷ page 254), and one or two segments around the stored speed come on in the speedometer (▷ page 252).

i *Depressing the accelerator pedal does not deactivate Distronic. After brief acceleration (e.g. for passing), the cruise control will resume the last speed set.*

Driving systems

Setting a lower speed

- ▶ Briefly tip the cruise control lever in direction of arrow ② (▷ page 254) to decrease vehicle speed in increments of 5 mph (Canada: 10 km/h).

The new speed is set.

The stored speed is displayed in the multifunction display for approximately 5 seconds (▷ page 254), and one or two segments around the stored speed come on in the speedometer (▷ page 252).

i *When you use the cruise control lever to decelerate, the brakes will be applied to support deceleration.*

In addition, the transmission will automatically downshift on long downhill grades.

Fine adjustment in 1 mph (Canada: 1 km/h) increments

Faster

- ▶ Briefly tip the cruise control lever in direction of arrow ④ (▷ page 254).

Setting to last stored speed ("Resume" function)

Warning!



The speed stored in memory should only be set again if prevailing road conditions permit. Possible acceleration or deceleration differences arising from returning to the pre-set speed could cause an accident and/or serious injury to you and others.

- ▶ Briefly tip the cruise control lever in direction of arrow ④ (▷ page 254).
Distronic is activated and set to the last stored speed.
- ▶ Remove your foot from the accelerator pedal.

Deactivating Distronic

There are several ways to deactivate the Distronic system:

- ▶ Briefly tip the cruise control lever in direction of arrow ③ (▷ page 254).

or

- ▶ Step on the brake pedal.

Distronic will be deactivated. The last speed set will be stored into memory.

i *The following message will appear in the multifunction display for approximately 5 seconds:*

DISTRONIC off

The last stored speed is deleted when you turn off the engine.

Distronic deactivates automatically when

- you set the parking brake
- you drive slower than 20 mph (30 km/h)
- the ESP® is active (▷ page 100) or you deactivate the ESP®
- you move the gear selector lever into position **N**

A signal will sound. The DISTRONIC off message appears in the multifunction display for approximately 5 seconds.

Warning!



Distronic switches off and releases the brakes when the vehicle decelerates below the minimum speed of 20 mph (30 km/h) by operation of the system. At that time the driver must apply the brakes in order to reduce vehicle speed further or bring it to a stop.

Setting the following distance in Distronic

You can set the specified following distance for Distronic by varying the time setting between 1.0 and 2.0 seconds. Using this time setting and the current speed of your vehicle, Distronic calculates and sets the required following distance to the vehicle ahead. The set distance will be shown in the multifunction display.

The thumbwheel for making the time setting is located on the lower section of the center console.

Warning!



It is up to the driver to exercise discretion to select the appropriate setting given road conditions, traffic, driver's preferred driving style and applicable laws and driving recommendations for safe following distance.

Driving systems



- ① Distance warning function on/off switch
- ② Indicator lamp
- ③ Thumbwheel for setting distance

Increasing distance

Increasing the distance setting tells DISTRONIC to maintain a greater following distance to the vehicle ahead.

- Turn thumbwheel ③ towards .

Decreasing distance

Decreasing the distance setting tells DISTRONIC to maintain a smaller following distance to the vehicle ahead.

- Turn thumbwheel ③ towards .

Distance warning function

When DISTRONIC is deactivated, this function will continue to warn you when recognizing a stationary obstacle or a slower vehicle moving in the vehicle's path and the danger of a collision exists:

- The distance warning lamp  in the instrument cluster comes on.
- An intermittent warning will sound if necessary.

If these warnings are issued, you must brake manually to maintain a safe distance and avoid a collision with the vehicle ahead.

When pressing the brake pedal, the warning sound ceases. The warning sound will also cease when the distance to the vehi-

cle ahead is sufficient again without applying the brakes. In this case, the distance warning lamp will also go out.

Warning!



If the distance warning lamp  in the instrument cluster comes on while driving and/or an intermittent warning sounds, immediate attention on the part of the driver is required. As required by the traffic situation, apply the brakes and navigate around a possible obstacle. However, do not drive by relying on the distance warning function, as this will result in an emergency braking application. Especially depending on road surface conditions and driver reaction, this will not always enable you to avoid a collision.

i *Complex driving situations are not always fully recognized by DISTRONIC. This could result in wrong or missing distance warnings.*

Activating

- ▶ Press switch ①.

Indicator lamp ② on the switch comes on. A loudspeaker symbol appears in the multifunction display (▷ page 254).

Deactivating

- ▶ Press switch ①.

Indicator lamp ② on the switch goes out. No loudspeaker symbol appears in the multifunction display.

Driving with Distronic

This section describes a number of driving situations where special precaution is required on the part of the driver. Be prepared to brake in such situations. This will deactivate the Distronic system.

Warning!



Distronic works to maintain the speed selected by the driver unless a moving obstacle proceeding directly ahead of it in the same travel direction is detected (e.g. following another vehicle ahead of you at a distance set by Distronic). This means that:

- Your vehicle can pass another vehicle after you change lanes.
- While in a sharp turn or if the vehicle in front is in a sharp turn, Distronic could lose sight of a vehicle traveling in front of it, then your vehicle could accelerate to the previously selected speed.

Distronic regulates only the distance between your vehicle and those directly ahead of it, but does not register stationary objects in the road, e.g.:

- a stopped vehicle in a traffic jam
- a disabled vehicle
- an oncoming vehicle

The driver must always be on the alert, observe all traffic and intercede as required by steering or braking the vehicle.

Warning!



Distronic should not be used in snowy or icy road conditions.

Driving systems

The most likely cause for a malfunctioning system is a dirty sensor (located behind the hood grille), especially at times of snow and ice or heavy rain. In such a case, Distronic will switch off, and the message DISTRONIC currently unavailable See Operator's Manual appears in the multifunction display.

For cleaning and care of the Distronic sensor, see "Cleaning the Distronic* system sensor cover" (▷ page 372).

i *If the message DISTRONIC currently unavailable See Operator's Manual disappears during driving and the last speed stored flashes for approximately 5 seconds, the dirt (e.g. slush) has dissolved; Distronic works again.*

Turns and bends

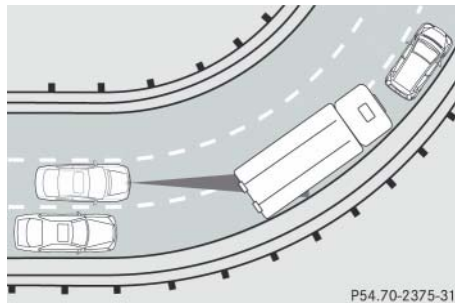

In turns or bends, Distronic may not detect a moving vehicle in front, or it may detect one too soon. This may cause your vehicle to brake late or unexpectedly.

Offset driving

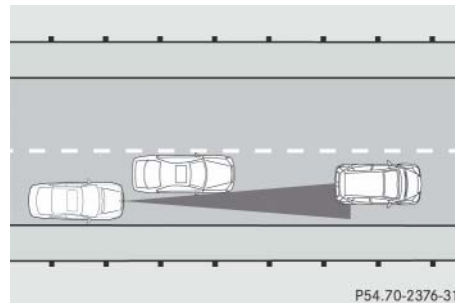

A vehicle traveling in your lane but offset from your direct line of travel may not be detected by Distronic. There will be insufficient distance to the vehicle ahead.

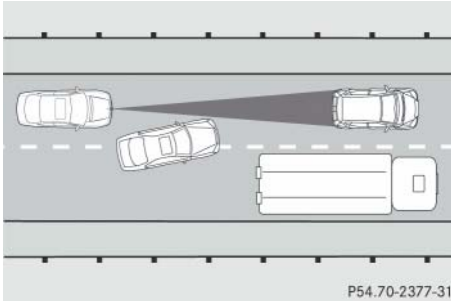
Lane changing

DISTRONIC has not yet detected the vehicle changing lanes. There will be insufficient distance to the lane-changing vehicle.

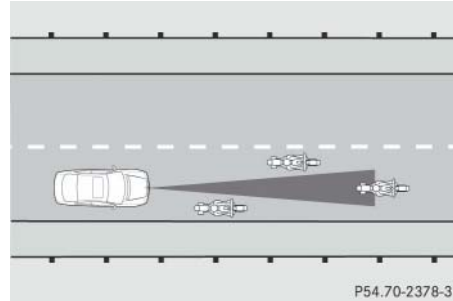
Narrow vehicles

Because of their narrow profile, the vehicles traveling near the outer edges of the lane have not yet been detected by DISTRONIC. There will be insufficient distance to the vehicles ahead.

**Airmatic DC (Dual Control)
(only available on E 63 AMG)**

Airmatic automatically selects the optimum suspension tuning and ride height for your vehicle. The Airmatic consists of two components:

- Adaptive Damping System (ADS)
- Vehicle level control

The ADS automatically selects the optimum damping for the respective driving conditions. At the same time the suspension is set to either Sport 1, Sport 2 or Comfort.

Driving systems

Suspension tuning

The suspension tuning is set according to:

- Your driving style
- Road surface conditions
- Your choice of suspension style, Sport 1, Sport 2 or Comfort, which you select using the damping button ①

The following suspension styles are available:

- Comfort
 - ▶ Both indicator lamps ② are off.
- Sport 1
 - ▶ One indicator lamp ② is on.
- Sport 2
 - ▶ Both indicator lamps ② are on.



① Damping button

② Indicator lamps

- ▶ Start the engine.
- ▶ Press the damping button ① until the desired suspension style is set.

! *If you have selected the Comfort suspension tuning, the vehicle lowers slightly when you lock it within approximately 60 seconds after switching off the engine. When parking, make sure that your vehicle cannot come into contact with other objects, such as a curb, while lowering. Your vehicle could otherwise be damaged.*

i *The selected suspension style is stored in memory, even after the SmartKey is removed from the starter switch.*

Vehicle level control

Your vehicle automatically adjusts its ride height to

- increase vehicle safety
- reduce fuel consumption

The following vehicle chassis ride heights can be selected:

- Normal
- Raised

The vehicle chassis ride height is raised or lowered according to the selected level setting and to the vehicle speed:

- At a speed exceeding approximately 68 mph (110 km/h) with normal level set or exceeding 75 mph (120 km/h) with raised level set, the ride height is reduced automatically. The table on the next page provides an overview of the vehicle levels.
- With decreasing speed, the ride height is again raised to the normal level.

i *These height adjustments are so small that you may not notice any change.*

Select the “Raised” level only when required by current driving conditions. Otherwise

- handling may be impaired
- fuel consumption may increase

Warning!

To help avoid personal injury, keep hands and feet away from wheel housing area, and stay away from under the vehicle when lowering the vehicle chassis.

Driving systems

The following vehicle level settings can be selected when the vehicle is stationary and the engine is running:

Vehicle level when stationary	Indicator lamp	Suspension tuning	Use for	Ride height increase over normal	Automatic lowering
Normal	Lamp off	Comfort	For driving on normal roads	None	Max. approx. 0.4 in (10 mm)
Normal	Lamp off	Sport 1 or 2	For driving on normal roads	None	Max. approx. 0.6 in (15 mm)
Raised	Lamp on	Comfort	For driving on rough roads or with snow chains	Approx. 0.8 in (20 mm)	Max. approx. 1.2 in (30 mm)
Raised	Lamp on	Sport 1 or 2	For driving on rough roads or with snow chains	Approx. 0.8 in (20 mm)	Max. approx. 1.4 in (35 mm)

The button is located in the lower section of the center console.



① Vehicle level control button

② Indicator lamp

- ▶ Start the engine (▷ page 52).
- ▶ Briefly press button ① to change from normal level to raised level. When vehicle is at raised level, pressing the button will return the vehicle to normal level.

When raised level is set, indicator lamp ② in the button comes on.

When normal level is set, indicator lamp ② in the button goes out.

i At a speed of approximately above 75 mph (120 km/h) or if the speed amounts to between 50 mph (80 km/h) and 75 mph (120 km/h) for approximately 5 minutes, the setting raised is canceled. The indicator lamp ② in the button goes out.

If you do not drive in this speed range, the raised level remains stored even if the SmartKey is removed from the starter switch.

Loading

Split rear bench seat

To expand the cargo compartment, you can fold down the left and right rear seat backrests.

The two sections can be folded down separately to enlarge the cargo compartment.

Warning!



When expanding the cargo compartment, always fold the seat cushions fully forward.

Unless you are transporting cargo, the backrests must remain properly locked in the up-right position.

In an accident, during hard braking or sudden maneuvers, loose items will be thrown around inside the vehicle, and cause injury to vehicle occupants unless the items are securely fastened in the vehicle.

Always use the cargo tie down rings (▷ page 270).

Folding the backrest forward

! To prevent damage, the following must be observed before folding the rear seat backrest forward:

- the head restraints must be folded back and fully inserted
- the front seat must be moved into its front-most position
- the seat cushions must be folded forward



- ① Release catch
- ② Seat cushion

- ▶ Pull release catch ① and use it to pull seat cushion ② up.

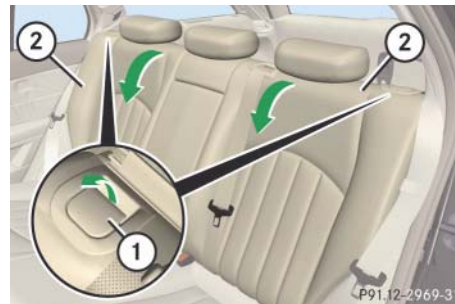

- ① Release catch
- ② Seat backrest

- ▶ Pull release catch ① up.

The seat backrest is released and the head restraints fold back.

- ▶ Fold the seat backrest ② forward.

i If the rear center seat is to be occupied while driving, it may be necessary to fold the seat belt buckle up again.

Returning seat backrest to original position



- ① Seat cushion
- ② Seat backrest

- ▶ Swing seat backrest ② to the rear until it engages.

- ▶ Swing seat cushion ① to the rear and press down from the rear of the cushion until it audibly engages.



- ▶ Swing the head restraint forward by hand until it engages.

Warning!



Always lock backrest in its upright position when rear seat bench is occupied, or the extended cargo compartment is not in use. Check for secure locking by pushing and pulling on the backrest.

In an accident, during hard braking or sudden maneuvers, loose items will be thrown around inside the vehicle, and cause injury to vehicle occupants unless the items are securely fastened in the vehicle.

To help avoid personal injury during a collision or sudden maneuver, exercise care when transporting cargo.

Loading

Adjusting seat backrest position

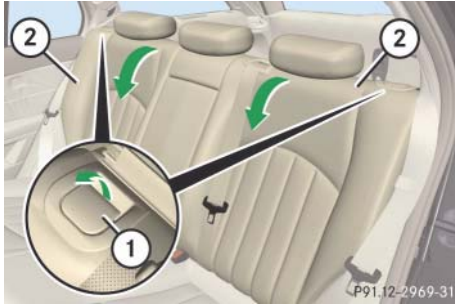

- ① Release catch
- ② Seat backrest

i The seat backrests can be placed in an alternative upright position. This creates a larger cargo compartment area or provides for improved seating comfort on the folding bench seat, if required.

- ▶ Pull right seat release catch ① up and fold seat backrest forward.
- ▶ With the seat backrest released, pull release catch ① up again.
- ▶ Pull left seat release catch ① up and fold seat backrest forward.
- ▶ With the seat backrest released, pull release catch ① up again.
- ▶ Fold left seat backrest to the rear until it engages.
- ▶ Fold right seat backrest to the rear until it engages.

The seat backrests are now in the alternative position.

Expanding the cargo compartment

Removing the rear seat cushions will provide you with a larger, flat cargo compartment.

- ▶ Fold the seat cushions forward (> page 266).

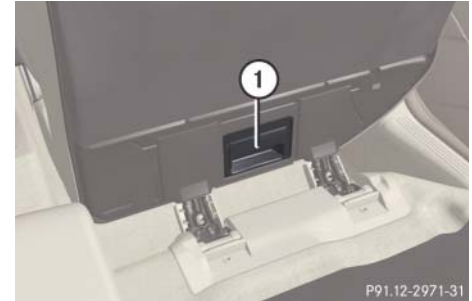

- ① Release lever
- ▶ Pull seat cushion release lever ① and remove the seat cushion by pulling it upward.
- ▶ Remove the head restraints (> page 130).

! Leave the seat cushion hinge in this position. The upholstery could be damaged if you fold the hinge back.

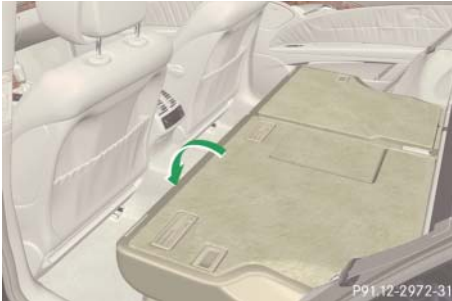

- ▶ Fold the seat backrest forward (▷ page 266).

Loading instructions

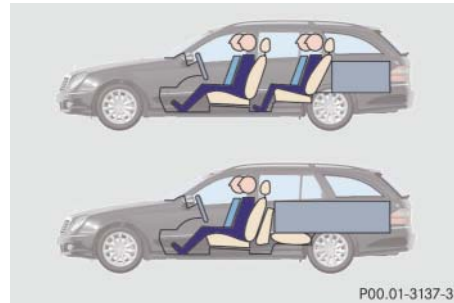

The total load weight including vehicle occupants and luggage/cargo should not exceed the load limit indicated on the corresponding placard located on the driver's door B-pillar.

The handling characteristics of a fully loaded vehicle depend greatly on the load distribution. It is therefore recommended to load the vehicle according to the illustrations shown, with the heaviest items being placed towards the front of the vehicle.

Always place items being carried against front or rear seat backrests, and fasten them as securely as possible.

The heaviest portion of the cargo should always be kept as low as possible since it influences the handling characteristics of the vehicle.

Warning!



Always fasten items being carried as securely as possible using cargo tie-down rings and fastening materials appropriate for the weight and size of the load.

In an accident, during hard braking or sudden maneuvers, loose items will be thrown around inside the vehicle and can cause injury to vehicle occupants unless the items are securely fastened in the vehicle.

To help avoid personal injury during a collision or sudden maneuver, exercise care when transporting cargo. Put luggage or cargo in the cargo compartment if possible. Do not pile luggage or cargo higher than the seat backs.

Never drive vehicle with tailgate open. Deadly carbon monoxide (CO) gases may enter vehicle interior resulting in unconsciousness and death.

Cargo tie-down rings

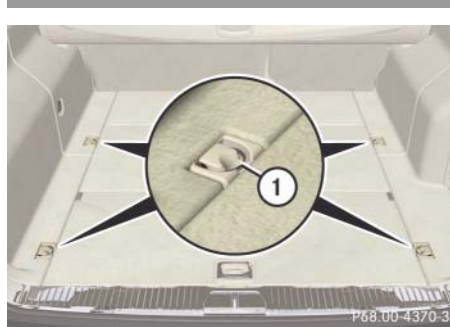

Four rings (1) are located in the cargo compartment.

- ▶ Carefully secure cargo by applying even load on all rings with rope of sufficient strength to hold down the cargo.

Always follow loading instructions (▷ page 269).

Rear seat

There is a cargo tie-down ring (1) located on each side of the footwell under the rear seat.

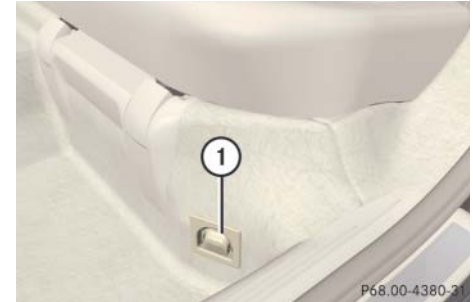

Cargo management system* (Canada only)

Your vehicle may be equipped with a cargo management system and accompanying accessories which enable you to utilize your cargo compartment in a variety of ways. You can store the cargo management system in the pouch that comes with the vehicle.

i The pouch and telescoping rod can be placed in the storage box in the cargo compartment.

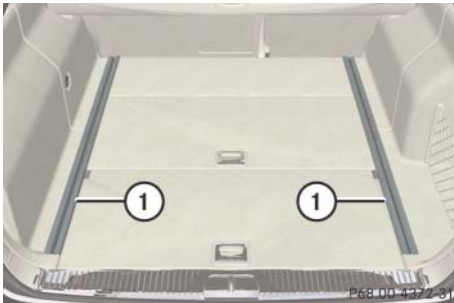

① Cargo rails

Inserting the mounting elements into the cargo rails

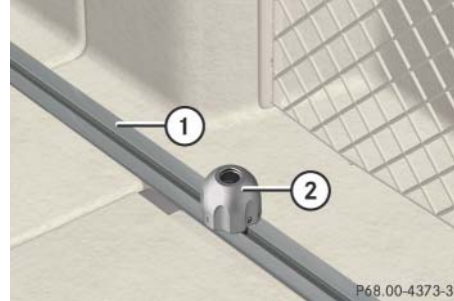







- ① Cargo rail
- ② Mounting element

You can move the mounting element to various engaging points on the cargo rail and fix it in place.

These engaging points are located 2 inches apart from one another on the cargo rail and are indicated by markings.

i You can turn the mounting element in the cargo rail to four positions:

-  To lock the mounting element.
-  To insert or remove the cargo tie-down ring, the belt reel or the telescoping rod.
-  To insert or remove the mounting element.
-  To move the mounting element to the next engaging point.

- ▶ Turn mounting element ② to .
- ▶ Insert mounting element ② in cargo rail ①.
- ▶ Turn mounting element ② until it engages in the  position.
You should be able to feel the mounting element engage in the cargo rail.

Loading

Inserting the cargo tie-down ring in the mounting element

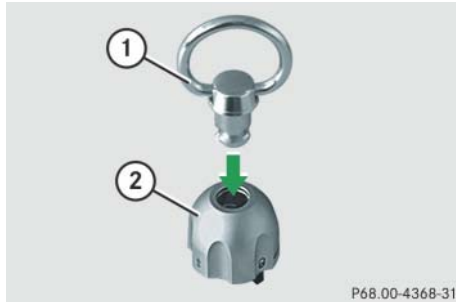



- ① Cargo tie-down ring
- ② Mounting element

Warning!



The cargo tie-down rings should be subject to equal loads. Make sure to comply with the information provided in the loading instructions (▷ page 269).

- ▶ Turn mounting element ② in the cargo rail to .
- ▶ Insert cargo tie-down ring ① into mounting element ②.
- ▶ Turn mounting element ② until it engages in the .

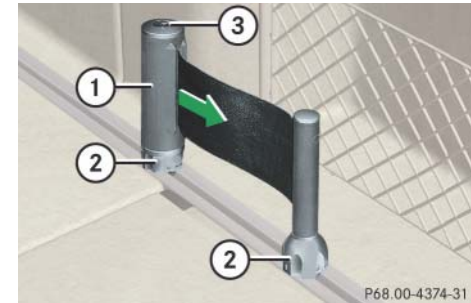

You should be able to feel the mounting element engage in the cargo rail.

Belt reel



- ① Belt reel
- ② Mounting element
- ③ Locking button

i The belt reel can be used to tighten light-weight loads against the side wall of the cargo compartment, thus securing them from slipping.

- ▶ Insert two mounting elements ② into a cargo rail.
- ▶ Turn mounting element ② in the cargo rail to .
- ▶ Insert belt reel ① into mounting element ②.
- ▶ Turn mounting element ② in the cargo rail until it engages in the  position.

You should be able to feel the mounting element engage in the cargo rail.

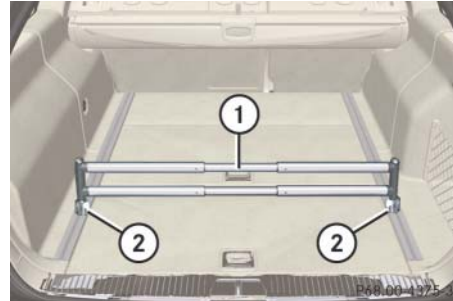

- ▶ Press locking button ③ on the belt reel and pull cargo net out in direction of arrow.
- ▶ Place load between the cargo net and the side wall of the cargo compartment.
- ▶ Press locking button ③ on belt reel. With the other hand, slowly pull net over load until it is taut.

Telescoping rod



- ① Telescoping rod
- ② Mounting element

i The telescoping rod can be used to tighten the load against the rear seats so as to secure it from slipping.

- ▶ Insert one mounting element ② into each cargo rail.
- ▶ Turn mounting element ② in cargo rail to .
- ▶ Insert telescoping rod ① into mounting element ②.
- ▶ Turn mounting element ② in cargo rail until it engages in the  position.

You should be able to feel the mounting element engage in the cargo rail.

Loading

Storage box in cargo compartment (Canada only)

Warning!



When you are using the storage box in the cargo compartment, the backrests of the seats in front of it must be completely engaged to the rear, and the twin roller blind must be installed.

Do not exceed the storage box's maximum load of 44 lb (20 kg), as it could otherwise become detached during an accident or sharp braking maneuvers, and could injure you or other passengers.

When leaving the vehicle, always remove the SmartKey or the SmartKey with KEYLESS-GO* from the starter switch, take it with you, and lock the vehicle. Do not leave children unattended in the vehicle, or with access to an unlocked vehicle. A child's unsupervised access to a vehicle could result in an accident and/or serious personal injury.

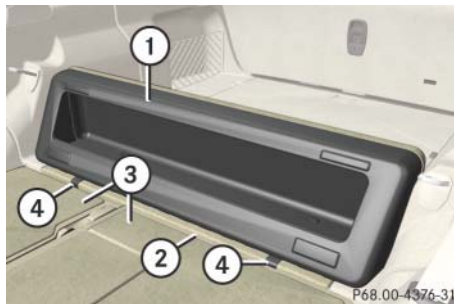

- ① Storage box
- ② Cargo compartment floor
- ③ Rear seat backrest
- ④ Locking hooks

Installing the storage box

- ▶ Fold rear seat backrest ③ forward (▷ page 266).
- ▶ Insert storage box ① from behind into cargo compartment with the opening pointing in direction of travel.
- ▶ Press locking hooks ④ of storage box ① into the space between the rear seat backrest ③ and the cargo compartment floor ②.

- ▶ Fold rear seat backrest ③ to the rear (▷ page 267).

i The storage box ① is additionally held in place from above by the twin roller blind.

Loading the storage box

- ▶ Fold rear seat backrest ③ forward (▷ page 266).
- ▶ Fill storage box ① with cargo through the opening on the front side.

i The storage box ① in the cargo compartment is covered by the rear bench seat and can hold a maximum of 44 lb (20 kg) cargo.

- ▶ Fold rear seat backrest ③ to the rear (▷ page 267).

Removing the storage box

- ▶ Fold rear seat backrest ③ forward (▷ page 266).
- ▶ Slide locking hooks ④ of storage box ① forward out of the retainers.
- ▶ Pull storage box ① to the rear and remove it from cargo compartment.
- ▶ Fold rear seat backrest ③ to the rear (▷ page 267).

Twin roller blind

The twin roller blind contains a cargo net and a cargo compartment cover.

It is located on the seat backrest of the rear bench seat.

Cargo net

Warning!



The cargo net cannot hold back heavy loads. The transported load should therefore always be tied down.

Objects which are insufficiently secured could otherwise injure you if they are thrown around in the event of an accident, during hard braking or steering maneuvers.

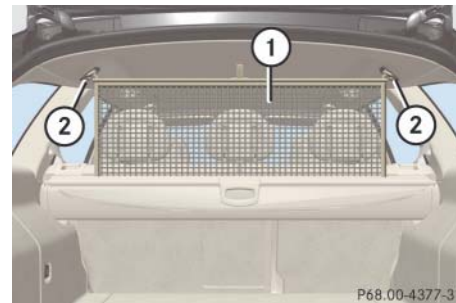

- ① Cargo net
- ② Mountings for cargo net

- ▶ Pull cargo net ① up and hook it onto mountings ②.

i You can use the cargo net even when the rear seat backrest is folded forward. The cargo net should then be hooked onto the front mountings.

Loading

Cargo compartment cover

The cargo compartment cover unlocks automatically while the tailgate is opening/closing and is automatically raised/lowered.

! When loading the vehicle, make sure not to load the cargo compartment over the lower edge of the side windows.

The twin roller blind could otherwise be damaged when the tailgate is being closed.

It is therefore unnecessary to roll up the cargo compartment cover before loading and unloading.

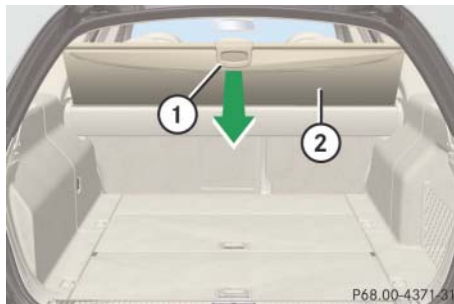

- ① Handle
- ② Cargo compartment cover

Rolling up the cargo compartment cover

- ▶ Use handle ① to pull cargo compartment cover ② down into the horizontal position.
- ▶ Unhook cargo compartment cover from its anchorages on the left and right sides.
To do so, pull cargo compartment cover ② slightly towards the rear and lower it.
- ▶ Slowly guide cargo compartment cover ② back until it stops.

Pulling out the cargo compartment cover

- ▶ Pull out cargo compartment cover ② towards the rear until it engages.

Removing the twin roller blind

- ▶ Roll up cargo net and cargo compartment cover.
- ▶ Fold both rear seat cushions forward (▷ page 266).
- ▶ First swing the right-hand and then the left-hand backrest of the rear seat forward (▷ page 266).
- ▶ Push twin roller blind to the left out of its anchorage on the rear seat backrest and remove it.

Vehicles without a third seat bench (E 63 AMG only) - storage space under the cargo compartment floor

The vehicle tool kit and jack are stored under the rear cargo compartment floor. A loading tray and a folding box are located under the front cargo compartment floor.

Opening the cargo compartment floor

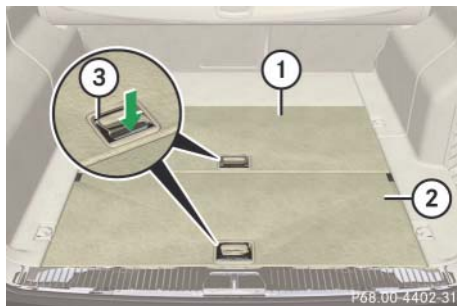

- ① Front cargo compartment floor
- ② Rear cargo compartment floor
- ③ Handle

- ▶ Use handle ③ to swing front cargo compartment floor ① or rear cargo compartment floor ② up until it is in a vertical position.

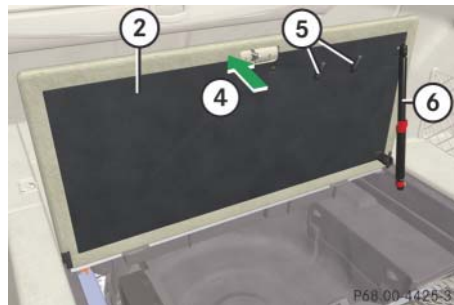

- ② Rear cargo compartment floor
 - ④ Locking in place
 - ⑤ Hooks
 - ⑥ Pneumatic spring
- ▶ Press rear cargo compartment floor ② slightly forward ④.
Pneumatic spring ⑥ engages, locking rear cargo compartment floor ② in place.

i You can transport objects when the cargo compartment floor is open and hang light luggage items from hooks ⑤.

Closing the front cargo compartment floor

- ▶ Swing front cargo compartment floor ① downward.
- ▶ Push front cargo compartment floor ① downward on the handle ③ until it locks into place.

Loading

Closing the rear cargo compartment floor

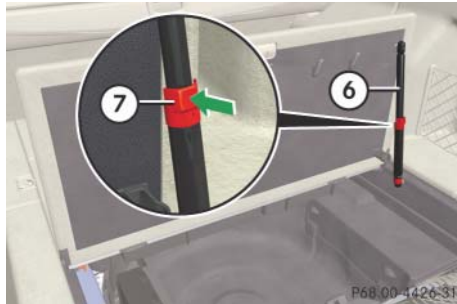

- ⑥ Pneumatic spring
- ⑦ Release button

- ▶ Press release button ⑦ and swing rear cargo compartment floor ② downward.
- ▶ Push front cargo compartment floor ① (▷ page 277) downward on the handle ③ (▷ page 277) until it locks into place.

Removing the rear cargo compartment floor

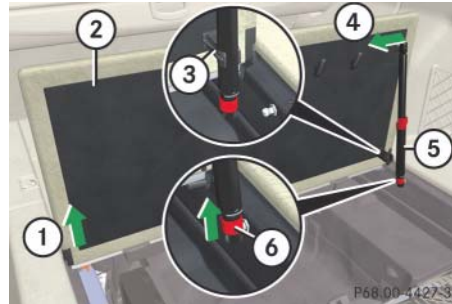

- ① Raising
- ② Rear cargo compartment floor
- ③ Retainer
- ④ Moving out
- ⑤ Pneumatic spring
- ⑥ Release catch

- ▶ Open rear cargo compartment floor ② (▷ page 277).
- ▶ Slide release catch ⑥ upward and remove pneumatic spring ⑤ from bolt by moving it to the left.
- ▶ Press pneumatic spring ⑤ into retainer ③.
- ▶ Move rear cargo compartment floor ② into an almost vertical position (to an angle of 85°).

i Rear cargo compartment floor ② can only be moved upwards out of the lug at an angle of 85°.

- ▶ Grip the top of rear cargo compartment floor ②, raise the left-hand side ① and move it to the left out of lug ④ on the right-hand side.

Expanding the cargo compartment floor

- ▶ Remove rear cargo compartment floor ② (▷ page 278).
- ▶ Open front cargo compartment floor ①.

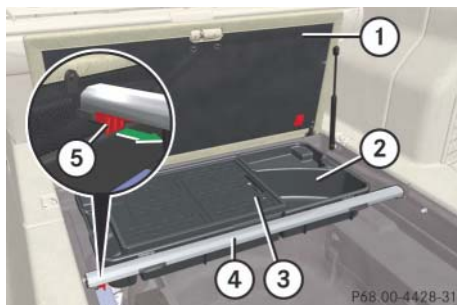

- ① Front cargo compartment floor
- ② Loading tray
- ③ Folding box
- ④ Crossbar
- ⑤ Release catch
- ▶ Remove loading tray ②.

- ▶ Slide release catch ⑤ all the way to the right and press left side of crossbar ④ upward.
- ▶ Pull crossbar ④ to the left away from the guide tab and remove it.

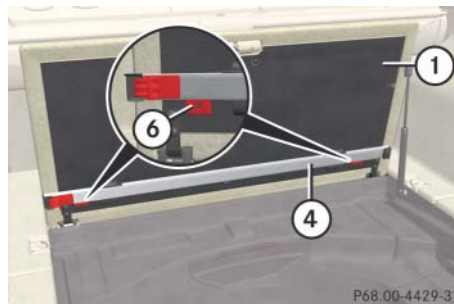

- ① Front cargo compartment floor
- ④ Crossbar
- ⑥ Retainer
- ▶ Store crossbar ④ in a suitable place. To do so, insert crossbar ④ into the two retainers ⑥ on front cargo compartment floor ①.

i The two retainers ⑥ must be unlocked in order to remove crossbar ④. To do so, push the tabs at the bottom of retainer ⑥ forward.

i You can store loading tray ② under the rear or the front cargo compartment floor.

Useful features

Storage compartments

Warning!



To help avoid personal injury during a collision or sudden maneuver, exercise care when storing objects in the vehicle. Put luggage or cargo in the cargo compartment if possible. Do not pile luggage or cargo higher than the seat backs.

Luggage nets cannot secure hard or heavy objects.

Keep compartment lids closed. This will help to prevent stored objects from being thrown around and injuring vehicle occupants during an accident.

Glove box

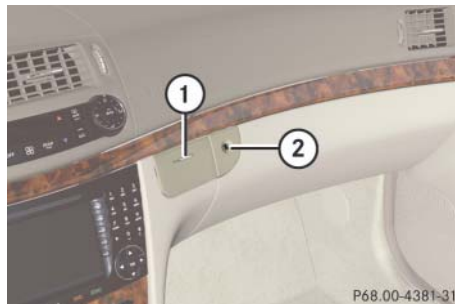

- ① Compartment for mobile phone/glasses
- ② Glove box lid release

Opening the glove box

- ▶ Push glove box lid release ②.
The glove box lid opens downward.

Closing the glove box

- ▶ Push glove box lid up to close.
- i** Close the compartment for glasses ① first before closing the glove box.

Storage compartment in the rear center console



- ▶ Briefly press the top of the compartment.
It extends automatically.

Storage compartment in the rear armrest

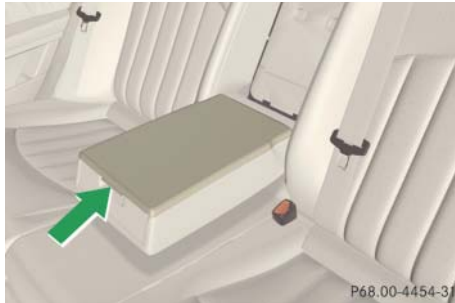

- ▶ Press the handle upwards and fold the rear armrest lid up.

Ruffled storage bags



Ruffled storage bags are located on the back of the front seats.

Warning!



Do not place objects with a combined weight of more than 4.4 lb (2 kg) into the ruffled storage bag. Otherwise, the Occupant Classification System OCS (> page 75) may not be able to properly approximate the occupant weight category.

The ruffled storage bag is intended for storing light-weight items only.

Heavy objects, objects with sharp edges or fragile objects may not be transported in the ruffled storage bag. In an accident, during hard braking, or sudden maneuvers, they could be thrown around inside the vehicle and cause injury to vehicle occupants.

The ruffled storage bag cannot protect transported goods in the event of an accident.

Useful features

Parcel net in front passenger footwell

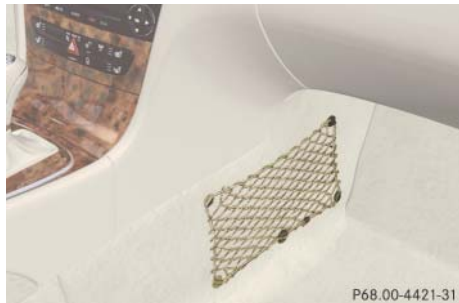

A small convenience parcel net is located in the front passenger footwell. It is for small and light items, such as road maps, mail, etc.

Warning!



The parcel net is intended for storing light-weight items only.

Heavy objects, objects with sharp edges or fragile objects may not be transported in the parcel net. In an accident, during hard braking, or sudden maneuvers, they could be thrown around inside the vehicle and cause injury to vehicle occupants.

The parcel net cannot protect transported goods in the event of an accident.

Cup holders

Warning!



In order to help prevent spilling liquids on vehicle occupants and/or vehicle equipment, only use containers that fit into the cup holder. Use lids on open containers and do not fill containers to a height where the contents, especially hot liquids, could spill during braking, vehicle maneuvers, or in an accident. Liquids spilled on vehicle occupants may cause serious personal injury. Liquids spilled on vehicle equipment may cause damage not covered by the Mercedes-Benz Limited Warranty.

When not in use, keep the cup holder closed. An open cup holder may cause injury to you or others when contacted during braking, vehicle maneuvers, or in an accident.

Keep in mind that objects placed in the cup holder may come loose during braking, vehicle maneuvers, or in an accident and be thrown around in the vehicle interior. Objects thrown around in the vehicle interior may cause an accident and/or serious personal injury.

Storage compartment with cup holder in the center armrest/telephone* compartment

The storage compartment in the center armrest contains a removable dual cup holder.

Opening storage compartment

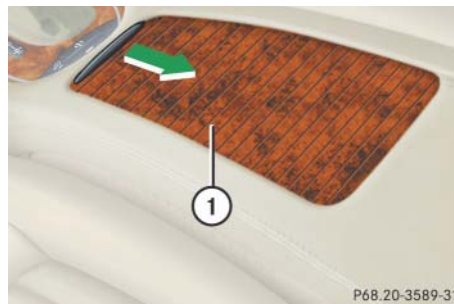

① Cover

▶ Slide cover ① in direction of arrow.

i The Roadside Assistance button  and the Information button  are located below the cover ①.



② Dual cup holder
③ Telephone* compartment

Closing storage compartment

▶ Slide cover ① back.

i The cup holder can be removed to increase storage space and for cleaning. Clean the cup holder only with clear, lukewarm water. Make sure to insert the cup holder in the guides when reinstalling it (▷ page 284).

Useful features

Removing cup holder

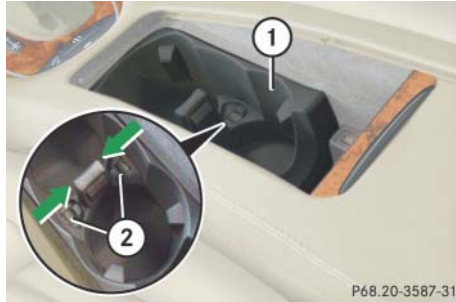

- ① Dual cup holder
- ② Locking pins
- ▶ Move both locking pins ② in direction of arrows.
- ▶ Take cup holder ① out upward.

Reinstalling cup holder



- ③ Locking pins
 - ▶ Insert cup holder.
 - ▶ Move both locking pins ③ in direction of arrows.
- !** Make sure that the cup holder is correctly positioned in the guides while you are reinstalling it. Otherwise the cup holder can be damaged.

Rear cup holder



- ▶ Briefly press the front of the rear armrest.

The cup holder extends automatically.

! Do not sit on or lean your body weight against the armrest when it is folded down, as you could otherwise damage it.

Cup holder in the folding third row bench seat



- ▶ Briefly press the front of the cup holder.
The cup holder unlocks.
- ▶ Pull the cup holder until it engages.

Ashtrays

Center console ashtray



- ① Cover
- ② Sliding button

Opening ashtray

- ▶ Briefly press the marking on the bottom of cover ①.
The ashtray opens automatically.

Removing ashtray insert

Warning!



Remove front ashtray only with vehicle standing still. Set the parking brake to secure vehicle from movement. Move gear selector lever to position **N**. With gear selector lever in position **N**, turn off the engine.

- ▶ Secure vehicle from movement by setting the parking brake. Move the gear selector lever to position **N**.
Now you have more room to take out the insert.
- ▶ Push sliding button ② to the right and hold.
- ▶ Grip and remove insert from ashtray frame.

Reinstalling ashtray insert

- ▶ Install insert by pushing it back into frame until it engages again.

Useful features

Rear door ashtray

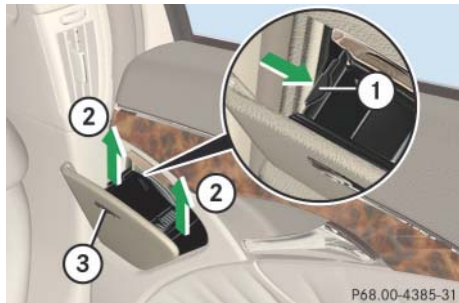

- ① Sliding button
- ② Insert slides out
- ③ Ashtray

Opening rear seat ashtray

- ▶ Briefly press the top of the ashtray ③.
The ashtray opens.

Removing ashtray insert

- ▶ Push sliding button ① and remove insert upwards ② from ashtray frame.

Reinstalling ashtray insert

- ▶ Install insert by pushing it back into ashtray frame until it engages again.

Cigarette lighter

Warning!



Never touch the heating element or sides of the lighter; they are extremely hot. Hold the knob only.

Make sure that any children traveling with you do not injure themselves or start a fire with the hot cigarette lighter.

When leaving the vehicle, always remove the SmartKey or the SmartKey with KEYLESS-GO* from the starter switch, take it with you, and lock the vehicle. Do not leave children unattended in the vehicle, or with access to an unlocked vehicle. A child's unsupervised access to a vehicle could result in an accident and/or serious personal injury.

The cigarette lighter is located in the center console compartment in front of the center armrest (▷ page 30).



① Cigarette lighter

- ▶ Switch on the ignition (▷ page 37).
- ▶ Push in cigarette lighter ①.

The lighter will pop out automatically when hot.

! *The lighter socket can be used to accommodate 12 V DC electrical accessories (up to a maximum of 85 W) designed for use with the standard “cigarette lighter” plug type. Keep in mind, however, that connecting accessories to the lighter socket (for example extensive connecting and disconnecting, or using plugs that do not fit properly) can damage the lighter socket. With the socket damaged, the lighter may no longer be able to be placed in the heating (pushed-in) position, or the lighter may pop out too early with the lighter not hot enough.*

To help avoid damaging the cigarette lighter socket, we recommend connecting 12 V DC electrical accessories designed for use with a standard “cigarette lighter” plug type to the 12 V power outlets in your vehicle whenever possible.

Power outlet

The power outlet is located in the rear passenger compartment.



- ▶ Switch on the ignition (▷ page 37).
- ▶ Flip up cover and insert electrical plug (cigarette lighter type).

i *The power outlet can be used to accommodate 12 V DC electrical accessories (e.g. air pump, auxiliary lamps) up to a maximum of 180 W.*

An additional power outlet is located on the left side in the cargo compartment.

Useful features

Heated steering wheel (Canada only)

The steering wheel heating warms up the leather area of the steering wheel.

The stalk is on the lower left-hand side of the steering wheel.



- ① Switching on
- ② Switching off
- ③ Indicator lamp

Switching on

- ▶ Switch on the ignition (▷ page 37).
- ▶ Turn switch at the tip of stalk in direction of arrow ①.

The steering wheel is heated. Indicator lamp ③ comes on.

i The steering wheel heating is temporarily suspended while indicator lamp ③ remains on when

- the temperature of the vehicle interior is above 86°F (30°C)
- the temperature of the steering wheel is above 95°F (35°C)

When these conditions do not apply anymore, steering wheel heating continues.

Switching off

- ▶ Turn switch at the tip of stalk in direction of arrow ②.

The heated steering wheel is switched off. Indicator lamp ③ goes out.

i Indicator lamp ③ flashes or goes out

- in case of power surge or undervoltage
- in case of a steering wheel heating malfunction

i The steering wheel heating switches off automatically when you remove the SmartKey from the starter switch or, on vehicles with KEYLESS-GO*, when you switch off the ignition (▷ page 64) and open the driver's door.

For information on steering wheel, see “Multifunction steering wheel” (▷ page 156).

Floormats

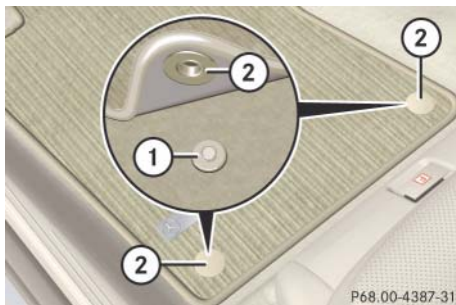

- ① Retainer pin
- ② Eyelet

i To install or remove the floormat more easily, move the driver's seat or front passenger seat as far to the rear as possible (▷ page 43).

Warning!



Whenever you are using floormats, make sure there is enough clearance and that the floormats are securely fastened.

Floormats should always be securely fastened using eyelets ② and retainer pins ①.

Before driving off, check that the floormats are securely in place and adjust them if necessary. A loose floormat could slip and hinder proper functioning of the pedals.

Do not place several floormats on top of each other as this may impair pedal movement.

Removing

- ▶ Pull floormat off of retainer pins ①.
- ▶ Remove the floormat.

Installing

- ▶ Lay down the floormat.
- ▶ Press the floormat eyelets ② onto retainer pins ①.

Telephone*

Warning!



Never operate radio transmitters equipped with a built-in or attached antenna (i.e. without being connected to an external antenna) from inside the vehicle while the engine is running. Doing so could lead to a malfunction of the vehicle's electronic system, possibly resulting in an accident and/or serious personal injury.

Radio transmitters, such as a portable telephone or a citizens band unit, should only be used inside the vehicle if they are connected to an antenna that is installed on the outside of the vehicle.

The external antenna must be approved by Mercedes-Benz. Please contact an authorized Mercedes-Benz Center for information on the installation of an approved external antenna. Refer to the radio transmitter operation instructions regarding use of an external antenna.

Warning!



Please do not forget that your primary responsibility is to drive the vehicle. A driver's attention to the road must always be his/her primary focus when driving. For your safety and the safety of others, we recommend that you pull over to a safe location and stop before placing or taking a telephone call.

If you choose to use the telephone¹ while driving, please use the hands-free device and only use the telephone when road, weather and traffic conditions permit. Some jurisdictions prohibit the driver from using a cellular telephone while driving a vehicle.

Only operate the COMAND¹ (Cockpit Management and Data System) if road, weather and traffic conditions permit.



¹ Observe all legal requirements.

Bear in mind that at a speed of just 30 mph (approximately 50 km/h), your vehicle is covering a distance of 44 feet (approximately 14 m) every second.

i Various mobile phone cradles can be installed in the front center armrest, see separate installation instructions for the mobile phone cradle. These mobile phone cradles can be obtained from an authorized Mercedes-Benz Center.

The functions and services available to you while using the mobile phone depend on your service provider and the type of mobile phone you are using. See also separate operating manual for instructions on how to use your mobile phone.

When the mobile phone is inserted in the cradle, you can operate the telephone using the following devices:

- mobile phone keypad
- buttons  and  on the multi-function steering wheel (▷ page 156)
- Voice Control System* (see separate operating instructions)

Please note that these functions are only available with Mercedes-Benz approved mobile phones. Please contact an authorized Mercedes-Benz Center for information on features available for your mobile phone of choice.

The cradle is located in the front center armrest.

- ▶ Open telephone compartment (▷ page 283).

Inserting mobile phone in mobile phone cradle

Once the mobile phone has been inserted in the mobile phone cradle, you have to use the hands-free device to respond during phone calls.

! Do not try to remove the mobile phone along with the cradle. You could otherwise damage the mobile phone cradle.

- ▶ If applicable, remove the cover for the external antenna connection from the back of the mobile phone and store it in a safe place. Be sure to comply with the mobile phone's operating instructions as well.



Example illustration

- ① Insert the mobile phone
 - ② Connector contact
 - ③ Mobile phone cradle
- ▶ Slide the lower end of the mobile phone into connector contact ② on cradle ③.

- ▶ Push the top of the mobile phone in direction of arrow ①, until the lug on the mobile phone release button engages.

The mobile phone is connected to the network via the external antenna.

The mobile phone is linked to the hands-free device and the multifunction steering wheel.

The battery is charged depending on its charge status and the position of the SmartKey in the starter switch. The charge procedure will be indicated in the mobile phone's display.

You can place or receive phone calls. You can control other functions of the mobile phone via the control system (▶ page 184), COMAND* or Voice Control System* (see separate operating instructions).

i When you take the SmartKey or SmartKey with KEYLESS-GO* out of the starter switch, the mobile phone remains switched on for approximately 10 minutes. If you place or receive a call during this time, the mobile phone switches off 10 minutes after the call has been completed.

Removing mobile phone from mobile phone cradle



Example illustration

- ① Release catch for mobile phone
- ② Mobile phone cradle

i When using a flip-style mobile phone, open flip top before removing from the cradle while a call is connected. Otherwise, the call will be disconnected.

- ▶ Press release catch in direction of arrow ① and take mobile phone out of mobile phone cradle ②.

Useful features

Changing mobile phone cradle

If you require a different cradle for your mobile phone, remove the present cradle before installing a new one.

Removing an existing mobile phone cradle

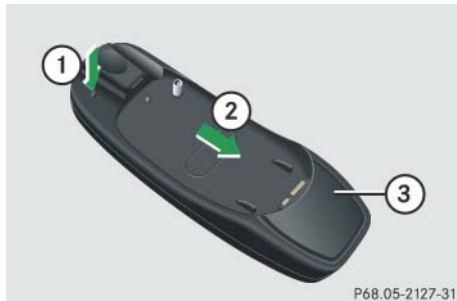

Example illustration

- ① To release the mobile phone cradle
 - ② To remove the mobile phone cradle
 - ③ Mobile phone cradle
- ▶ Press release button in direction of arrow ① and take mobile phone cradle ③ out in direction of arrow ②.

Installing a different mobile phone cradle

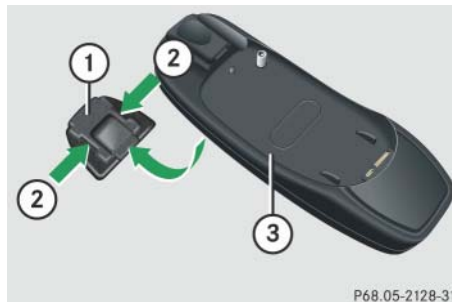

Example illustration

- ① Contact plate
 - ② Recesses
 - ③ Mobile phone cradle
- ▶ Insert mobile phone cradle ③ into recesses ② of contact plate ①.
 - ▶ Push mobile phone cradle ③ forward until it engages.

Tele Aid

! The initial activation of the Tele Aid system may only be performed by completing the subscriber agreement and placing an acquaintance call using button . Failure to complete either of these steps will result in a system that is not activated.

If you have any questions regarding activation, please call the Response Center at 1-800-756-9018 (in the USA) or 1-888-923-8367 (in Canada).

Shortly after the completion of your acquaintance call, you will receive a user ID and password. By visiting www.mbusa.com and selecting “Tele Aid” (USA only), you will have access to account information, remote door unlock and more.



The Tele Aid system



(Telematic Alarm Identification on Demand)

The Tele Aid system consists of three types of response:



- automatic and manual emergency
- Roadside Assistance and
- information

The Tele Aid system is operational providing that the vehicle's battery is charged, properly connected, not damaged and cellular and GPS coverage is available.

The speaker volume of a Tele Aid call can be adjusted when using the volume control on the multifunction steering wheel. To raise, press button  and to lower, press button  or use the volume knob on your COMAND headunit.



- ▶ To activate, press the SOS button, the Roadside Assistance button  or the Information button , depending on the type of response required.

 *The SOS button is located above the interior rear view mirror (▷ page 295).*

The Roadside Assistance button  and the Information button  are located below the center armrest cover (▷ page 283).

 *The Tele Aid system utilizes the cellular network for communication and the GPS (Global Positioning System) satellites for vehicle location. If either of these signals are unavailable, the Tele Aid system may not function and if this occurs, assistance must be summoned by other means.*

System self-check

Initially, after switching on the ignition, malfunctions are detected and indicated (the indicator lamps in the SOS button, the Roadside Assistance button  and the Information button  stay on longer than 10 seconds or do not come on). The message Tele Aid malfunction Drive to workshop appears in the multifunction display.

Warning!



If the indicator lamps in the SOS button, in the Roadside Assistance button and/or in the Information button remain illuminated constantly in red and/or the message *Tele Aid malfunction Drive to workshop* is displayed in the multifunction display after the system self-check, a malfunction in the system has been detected.

If a malfunction is indicated as outlined above, the system may not operate as expected. Have the system checked at the nearest Mercedes-Benz Center as soon as possible.

Emergency calls

An emergency call is initiated automatically following an accident in which the emergency tensioning devices (ETDs) or air bags deploy.

An emergency call can also be initiated manually by opening the cover next to the interior rear view mirror labeled SOS, then briefly pressing the button located under the cover. See (▷ page 295) for instructions on initiating an emergency call manually.

Once the emergency call is in progress, the indicator lamp in the SOS button will begin to flash. The message *Connecting call* appears in the multifunction display and the audio system is muted. When the connection is established, the message *Call connected* appears in the multifunction display. All information relevant to the emergency, such as the location of the vehicle (determined by the GPS satellite location system), vehicle model, identification number and color are generated.

A voice connection between the Response Center and the occupants of the vehicle will be established automatically soon after the emergency call has been initiated. The Response Center will attempt to determine more precisely the nature of the emergency provided they can speak to an occupant of the vehicle.

The Tele Aid system is available if:

- it has been activated and is operational. Activation requires a subscription for monitoring services, connection and cellular air time
- the relevant cellular phone network and GPS signals are available and pass the information on to the Response Center

i Location of the vehicle on a map is only possible if the vehicle is able to receive signals from the GPS satellite network and pass the information on to the Response Center.

Warning!



If the indicator lamp in the SOS button is flashing continuously and there was no voice connection to the Response Center established, then the Tele Aid system could not initiate an emergency call (e.g. the relevant cellular phone network is not available). The message `Call failed` appears in the multifunction display for approximately 10 seconds.

Should this occur, assistance must be summoned by other means.

Initiating an emergency call manually

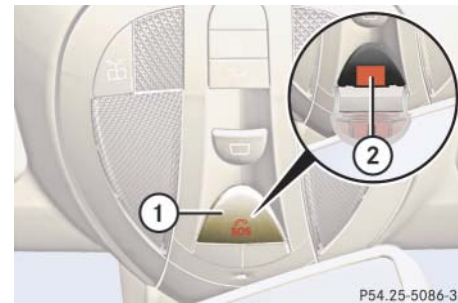

① Cover

② SOS button

- ▶ Briefly press on cover ①.

The cover will open.

- ▶ Press SOS button ② briefly.

The indicator lamp in SOS button ② will flash until the emergency call is concluded.

- ▶ Wait for a voice connection to the Response Center.
- ▶ Close cover after the emergency call is concluded.

Warning!



If you feel at any way in jeopardy when in the vehicle (e.g. smoke or fire in the vehicle, vehicle in a dangerous road location), please do not wait for voice contact after you have pressed the emergency button. Carefully leave the vehicle and move to a safe location. The Response Center will automatically contact local emergency officials with the vehicle's approximate location if they receive an automatic SOS signal and cannot make voice contact with the vehicle occupants.

Roadside Assistance button

Located below the center armrest cover is the Roadside Assistance button .

- ▶ Press and hold the button (for longer than 2 seconds).

A call to a Mercedes-Benz Roadside Assistance dispatcher will be initiated. The button will flash while the call is in progress. The message *Connecting call* will appear in the multifunction display and the audio system is muted.

When the connection is established, the message *Call connected* appears in the multifunction display. The Tele Aid system will transmit data generating the vehicle identification number, model, color and location (subject to availability of cellular and GPS signals).



A voice connection between the Roadside Assistance dispatcher and the occupants of the vehicle will be established.

- ▶ Describe the nature of the need for assistance.

The Mercedes-Benz Roadside Assistance dispatcher will either dispatch a qualified Mercedes-Benz technician or arrange to tow your vehicle to the nearest authorized Mercedes-Benz Center. For services such as labor and/or towing, charges may apply. Refer to the Roadside Assistance manual for more information.

The following is only available in the USA:

- Sign and Drive services: Services such as a jump start, a few gallons of fuel or the replacement of a flat tire with the vehicle spare tire are obtainable.

i The indicator lamp on the Roadside Assistance button  remains illuminated in red for approximately 10 seconds during the system self-check after switching on the ignition (together with the SOS button and the Information button ).

See system self-check (▷ page 293) when the indicator lamp does not come on in red or stays on longer than approximately 10 seconds.

If the indicator lamp on the Roadside Assistance button  is flashing continuously and there was no voice connection to the Response Center established, then the Tele Aid system could not initiate a Roadside Assistance call (e.g. the relevant cellular phone network is not available). The message *Call failed* appears in the multifunction display.

Roadside Assistance calls can be terminated using button  on the multifunction steering wheel or the respective button for ending a telephone call on the COMAND headunit.

Information button

The Information button  is located below the center armrest cover.



- ▶ Press and hold button (for longer than 2 seconds).

A call to the Customer Assistance Center will be initiated. The button will flash while the call is in progress. The message *Connecting call* will appear in the multifunction display and the audio system is muted.

When the connection is established, the message *Call connected* appears in the multifunction display. The Tele Aid system will transmit data generating the vehicle identification number, model, color and location (subject to availability of cellular and GPS signals).

A voice connection between the Customer Assistance Center representative and the occupants of the vehicle will be established. Information regarding the operation of your vehicle, the nearest authorized Mercedes-Benz Center or Mercedes-Benz USA products and services is available to you.

For more details concerning the Tele Aid system, please visit www.mbusa.com and use your ID and password (sent to you separately) to learn more (USA only).

i The indicator lamp on the Information button  remains illuminated in red for approximately 10 seconds during the system self-check after switching on the ignition (together with the SOS button and the Roadside Assistance button ).

Useful features

See system self-check (▷ page 293) when the indicator lamp does not come on in red or stays on longer than approximately 10 seconds.

If the indicator lamp on the Information button  is flashing continuously and there was no voice connection to the Response Center established, then the Tele Aid system could not initiate an Information call (e.g. the relevant cellular phone network is not available). The message **Call failed** appears in the multifunction display.

Information calls can be terminated using button  on the multifunction steering wheel or the respective button for ending a telephone call on the COMAND headunit.

! If the indicator lamps do not start flashing after pressing one of the buttons or remain illuminated (in red) at any time, the Tele Aid system has detected a malfunction or the service is not currently active, and may not initiate a call. Visit an authorized Mercedes-Benz Center and have the system checked or contact the Response Center at 1-800-756-9018 (in the USA) or 1-888-923-8367 (in Canada) as soon as possible.

Call priority

If other service calls such as a Roadside Assistance call or Information call are active, an Emergency call is still possible. In this case, the Emergency call will take priority and override all other active calls.

i The indicator lamp in the respective button flashes until the call is concluded. Calls can only be terminated by a Response Center or Customer Assistance Center representative except Roadside Assistance and Information calls, which can also be terminated by pressing button  on the multifunction steering wheel or the respective button for ending a telephone call on the COMAND headunit.

! If the indicator lamp continues to flash or the system does not reset, contact the Response Center at 1-800-756-9018 (in the USA) or 1-888-923-8367 (in Canada), or Mercedes-Benz Customer Assistance at 1-800-FOR-MERCEdes (1-800-367-6372) in the USA or Customer Service at 1-800-387-0100 in Canada.

i When a Tele Aid call has been initiated, the COMAND system audio is muted and the selected mode (radio or CD) pauses. The optional cellular phone (if installed) switches off. If you must use this phone, the vehicle must be parked. Disconnect the coiled cord and place the call. The COMAND navigation* system (if engaged) will continue to run. The multifunction display in the instrument cluster is available for use, and spoken commands are only available by pressing the RPT button on the COMAND unit. A pop-up window will appear in the COMAND display to indicate that a Tele Aid call is in progress.

Remote door unlock

In case you have locked your vehicle unintentionally (e.g. SmartKey inside vehicle), and the reserve SmartKey is not handy:

- ▶ Contact the Mercedes-Benz Response Center at 1-800-756-9018 (in the USA) or 1-888-923-8367 (in Canada).

You will be asked to provide your password which you provided when you completed the subscriber agreement.

- ▶ Then return to your vehicle and pull the tailgate recessed handle for a minimum of 20 seconds until the SOS button is flashing.

The message **Call connected** appears in the multifunction display.

As an alternative, you may unlock the vehicle via Internet using the ID and password sent to you shortly after the completion of your acquaintance call.

The Response Center will then unlock your vehicle with the remote door unlocking feature.

i *The remote door unlock feature is available if the relevant cellular phone network is available.*

*The SOS button will flash and the message **Call connected** will appear in the multifunction display to indicate receipt of the door unlock command.*

Once the vehicle is unlocked, a Response Center specialist will attempt to establish voice contact with the vehicle occupants.

If the tailgate recessed handle was pulled for more than 20 seconds before door unlock authorization was received by the Response Center, you must wait 15 minutes before pulling the tailgate recessed handle again.

Stolen Vehicle Recovery services

In the event your vehicle was stolen:

- ▶ Report the incident to the police.

The police will issue a numbered incident report.

- ▶ Pass this number on to the Mercedes-Benz Response Center along with your password issued to you when you subscribed to the service.

The Response Center will then attempt to covertly contact the vehicle's Tele Aid system. Once the vehicle is located, the Response Center will contact the local law enforcement and you. The vehicle's location will only be provided to law enforcement.

i *When the anti-theft alarm stays on for more than 30 seconds, a call is initiated automatically to the Response Center. See anti-theft alarm system (▷ page 106).*

Useful features

Garage door opener

The integrated remote control is capable of operating up to three separately controlled devices. It provides a convenient way to replace up to three hand-held remote controls used to operate devices such as garage door openers, gate openers, or other devices compatible with HomeLink® or some other systems.

Before the integrated remote control can be used, it must be programmed to the garage door opener, gate operator or other device you wish to operate. See the following instructions for programming information.

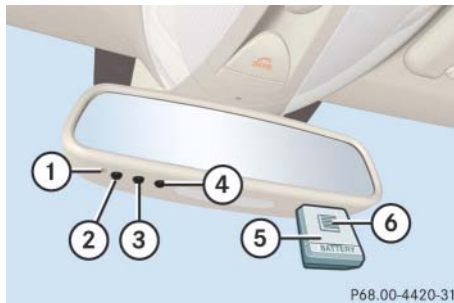

Interior rear view mirror with integrated remote control

- ① Indicator lamp
 - ② ③ ④ Signal transmitter button
- Needed for programming (not part of vehicle equipment):
- ⑤ Hand-held remote control of garage door opener, gate operator or other device
 - ⑥ Hand-held remote control button

Warning!



Before programming the integrated remote control to a garage door opener or gate operator, make sure people and objects are out of the way of the device to prevent potential harm or damage. When programming a garage door opener, the door moves up or down. When programming a gate operator, the gate opens or closes.

Do not use the integrated remote control with any garage door opener that lacks safety stop and reverse features as required by U.S. federal safety standards (this includes any garage door opener model manufactured before April 1, 1982). A garage door that cannot detect an object - signaling the door to stop and reverse - does not meet current U.S. federal safety standards.

When programming a garage door opener, park vehicle outside the garage.

Do not run the engine while programming the integrated remote control. Inhalation of exhaust gas is hazardous to your health. All exhaust gas contains carbon monoxide (CO), and inhaling it can cause unconsciousness and possible death.

Programming the integrated remote control

Step 1:

- ▶ Switch on the ignition (▷ page 37).

Step 2:

- ▶ If you have previously programmed a signal transmitter button and wish to retain its programming, proceed to step 3.

If you are programming the integrated remote control for the first time, press and hold the two outer signal transmitter buttons (②) and (④) and release them only when the indicator lamp (①) begins to flash after approximately 20 seconds (do not hold the button for longer than 30 seconds). This procedure erases any previous settings for all three channels and initializes the memory.

If you later wish to program a second and/or third hand-held transmitter to the remaining two signal transmitter buttons, do not repeat this step and begin directly with step 3.

Step 3:

- ▶ Hold the end of hand-held remote control (⑤) of the device you wish to train approximately 2 to 5 in (5 to 12 cm) away from the signal transmitter button (②, ③ or ④) to be programmed, while keeping the indicator lamp (①) in view.

Step 4:

- ▶ Using both hands, simultaneously press hand-held remote control button (⑥) and the desired signal transmitter button (②, ③ or ④). Do not release the buttons until step 5 is completed.

Indicator lamp (①) will flash, first slowly and then rapidly.

i *The indicator lamp (①) flashes immediately the first time the signal transmitter button is programmed. If this button has already been programmed, the indicator lamp will only start flashing after 20 seconds.*



Useful features

▷▷ Step 5:

- ▶ After indicator lamp ① changes from a slow to a rapidly flashing light, release the hand-held remote control button and the signal transmitter button.

Step 6:

- ▶ Press and hold the just-trained signal transmitter button (②, ③ or ④) and observe the indicator lamp ①.

If indicator lamp ① stays on constantly, programming is complete and your device should activate when the respective signal transmitter button (②, ③ or ④) is pressed and released.

i *If indicator lamp ① flashes rapidly for about 2 seconds and then turns to a constant light, continue with programming steps 8 through 12 as your garage door opener may be equipped with the “rolling code” feature.*

Step 7:

- ▶ To program the remaining two signal transmitter buttons, repeat the steps above starting with step 3.

Rolling code programming

To train a garage door opener (or other rolling code devices) with the rolling code feature, follow these instructions after completing the “Programming” portion (steps 1 through 6) of this text. (A second person may make the following training procedures quicker and easier.)

Step 8:

- ▶ Locate “training” button on the garage door opener motor head unit.
Exact location and color of the button may vary by garage door opener brand. Depending on manufacturer, the “training” button may also be referred to as “learn” or “smart” button. If there is difficulty locating the transmitting button, refer to the garage door opener Operator’s Manual.

Step 9:

- ▶ Press the “training” button on the garage door opener motor head unit.
The “training light” is activated.

You have 30 seconds to initiate the following two steps.

Step 10:

- ▶ Return to the vehicle and firmly press, hold for 2 seconds and release the programmed signal transmitter button (②, ③ or ④).

Step 11:

- ▶ Press, hold for 2 seconds and release same signal transmitter button a second time to complete the training process.

i *Some garage door openers (or other rolling code equipped devices) may require you to press, hold for 2 seconds and release the same signal transmitter button a third time to complete the training process.*

Step 12:

- ▶ Confirm the garage door operation by pressing the programmed signal transmitter button (②, ③ or ④).

Step 13:

- ▶ To program the remaining two signal transmitter buttons, repeat the steps above starting with step 3.

Gate operator/Canadian programming

Canadian radio-frequency laws require transmitter signals to “time-out” (or quit) after several seconds of transmission which may not be long enough for the integrated signal transmitter to pick up the signal during programming. Similar to this Canadian law, some U.S. gate operators are designed to “time-out” in the same manner.

If you live in Canada or if you are having difficulties programming a gate operator (regardless of where you live) by using the programming procedures, replace step 4 with the following:

Step 4:

- ▶ Press and hold the signal transmitter button (②, ③ or ④). Do not release this button until it has been successfully trained.
- ▶ While still holding down the signal transmitter button (②, ③ or ④), “cycle” your hand-held remote control button ⑥ as follows: Press and hold button ⑥ for 2 seconds, then release it for 2 seconds, and again press and hold it for 2 seconds. Repeat this sequence on the hand-held remote control until the frequency signal has been learned. Upon successful training, indicator lamp ① will flash slowly and then rapidly after several seconds.
- ▶ Proceed with programming step 5 and step 6 to complete.

i Upon completion of programming the integrated remote control, make sure you retain the hand-held remote control that came with the garage door opener, gate operator or other device. You may need it for use in other vehicles, for future programming of an integrated remote control, or simply for continued use as a hand-held remote control to operate the respective device in other situations.

Reprogramming a single signal transmitter button

To program a device using a signal transmitter button previously trained, follow these steps:

- ▶ Switch on the ignition (▷ page 37).
- ▶ Press and hold the desired signal transmitter button (②, ③ or ④). Do not release the button.
- ▶ Indicator lamp ① will begin to flash after 20 seconds. Without releasing the signal transmitter button, proceed with programming starting with step 3.

Useful features

Operation of integrated remote control

- ▶ Switch on the ignition (▷ page 37).
- ▶ Select and press the appropriate integrated signal transmitter button (②, ③ or ④) to activate the remote controlled device.

The integrated remote control transmitter continues to send the signal as long as the button is pressed – up to 20 seconds.

Erasing the integrated remote control memory

- ▶ Switch on the ignition (▷ page 37).
- ▶ Simultaneously press and hold outer signal transmitter buttons ② and ④, for approximately 20 seconds, until indicator lamp ① flashes rapidly. Do not hold for longer than 30 seconds.

The codes of all three channels are erased.

i *If you sell your vehicle, erase the codes of all three channels.*

Programming tips

If you are having difficulty programming the integrated remote control, here are some helpful tips:

- Check the frequency of hand-held remote control ⑤ (typically located on the reverse side of the remote). The integrated remote control is compatible with radio-frequency devices operating between 280-390 MHz.
- Put a new battery in hand-held remote control ⑤. This will increase the likelihood of the hand-held remote control sending a faster and more accurate signal to the integrated remote control.
- While performing step 3, hold hand-held remote control ⑤ at different lengths and angles from the signal transmitter button (②, ③ or ④) you are programming. Attempt varying angles at the distance of 2 to 5 inches (5 to 12 cm) away or the same angle at varying distances.

- If another hand-held remote control is available for the same device, try the programming steps again using that other hand-held remote control. Make sure new batteries are in the hand-held remote control before beginning the procedure.
- Straighten the antenna wire from the garage door opener assembly. This may help improve transmitting and/or receiving signals.

i *Certain types of garage door openers are incompatible with the integrated remote control. If you should experience further difficulties with programming the integrated remote control, contact an authorized Mercedes-Benz Center, or call Mercedes-Benz Customer Assistance Center (in the USA only) at 1-800-FOR-MERCEDES, or Customer Service (in Canada) at 1-800-387-0100.*

i USA only:

This device complies with Part 15 of the FCC Rules. Operation is subject to the following two conditions:

- (1) This device may not cause harmful interference, and*
- (2) this device must accept any interference received, including interference that may cause undesired operation.*

Any unauthorized modification to this device could void the user's authority to operate the equipment.

i Canada only:

This device complies with RSS-210 of Industry Canada. Operation is subject to the following two conditions:

- (1) This device may not cause interference, and*
- (2) this device must accept any interference received, including interference that may cause undesired operation of the device.*

Any unauthorized modification to this device could void the user's authority to operate the equipment.

The first 1000 miles (1500 km)

Driving instructions

At the gas station

Engine compartment

Tires and wheels

Winter driving

Maintenance

Vehicle care



The first 1 000 miles (1 500 km)

In the “Operation” section you will find detailed information on operating, maintaining and caring for your vehicle.

The more cautiously you treat your vehicle during the break-in period, the more satisfied you will be with its performance later on.

- Drive your vehicle during the first 1 000 miles (1 500 km) at varying but moderate vehicle and engine speeds.
- During this period, avoid heavy loads (full throttle driving) and excessive engine speeds (no more than $\frac{2}{3}$ of maximum rpm in each gear).
- Avoid accelerating by kickdown.
- Do not attempt to slow the vehicle down by shifting to a lower gear using the gear selector lever.
- Select positions **3**, **2** or **1** only when driving at moderate speeds (for hill driving).
- Select **C** as the preferred shift program (▷ page 193) for the first 1 000 miles (1 500 km).

After 1 000 miles (1 500 km) you may gradually increase vehicle and engine speeds to the permissible maximum.

Additional instructions for AMG vehicles:

- *During the first 1 000 miles (1 500 km), do not exceed a speed of 85 mph (140 km/h).*
- *During this period, avoid engine speeds above 4 500 rpm in each gear.*

All of the above instructions, as may apply to your vehicle type, also apply when driving the first 1 000 miles (1 500 km) after the engine or the rear differential has been replaced.

 Always obey applicable speed limits.

▼ Driving instructions

Drive sensibly – save fuel

Fuel consumption, to a great extent, depends on driving habits and operating conditions.

To save fuel you should:

- Keep tires at the recommended inflation pressures.
- Remove unnecessary loads.
- Remove roof rack when not in use.
- Allow engine to warm up under low load use.
- Avoid frequent acceleration and deceleration.
- Have all maintenance work performed at the intervals specified in the Maintenance Booklet and as required by the Maintenance System. Contact an authorized Mercedes-Benz Center.

Fuel consumption is also increased by driving in cold weather, in stop-and-go traffic, on short trips and in hilly area.

Drinking and driving

Warning!



Drinking and driving and/or taking drugs and driving are very dangerous combinations. Even a small amount of alcohol or drugs can affect your reflexes, perceptions and judgment.

The possibility of a serious or even fatal accident are greatly increased when you drink or take drugs and drive.

Do not drink or take drugs and drive or allow anyone to drive who has been drinking or taking drugs.

Pedals

Warning!



Make sure that absolutely no objects are obstructing the pedals' range of movement. Keep the driver's footwell clear of all obstacles. If there are any floor mats or carpets in the footwell, make sure that the pedals still have sufficient clearance.

Driving instructions

Power assistance

Warning!



With the engine not running, there is no power assistance for the brake and steering systems. In this case, it is important to keep in mind that a considerably higher degree of effort is necessary to brake and steer the vehicle.

Brakes

Warning!



After driving in heavy rain for some time without applying the brakes or through water deep enough to wet brake components, the first braking action may be somewhat reduced and increased pedal pressure may be necessary to obtain expected braking effect. Maintain a safe distance from vehicles in front.

Resting your foot on the brake pedal will cause excessive and premature wear of the brake pads.

It can also result in the brakes overheating, thereby significantly reducing their effectiveness. It may not be possible to stop the vehicle in sufficient time to avoid an accident.

! *Vehicles without 4MATIC:*
Because the ESP[®] operates automatically, the engine and the ignition must be shut off (SmartKey in starter switch position **0** or **1** or KEYLESS-GO start/stop button* in position **0** or **1**) when:

- the parking brake is being tested on a brake test dynamometer
- the vehicle is being towed with the front axle raised

Active braking action through the ESP[®] may otherwise seriously damage the brake system.

For information on vehicles with 4MATIC, see “Four wheel electronic traction system (4MATIC) with the ESP[®]” (> page 104).

To help prevent brake disk corrosion after driving on wet road surfaces (particularly salted roads), it is advisable to brake the vehicle with considerable force prior to parking. The heat generated serves to dry the brakes.

If your brake system is normally only subjected to moderate loads, you should occasionally test the effectiveness of the

brakes by applying above-normal braking pressure at higher speeds. This will also enhance the grip of the brake pads.

Warning!

Make sure not to endanger any other road users when carrying out these braking maneuvers.

Refer to the description of the Brake Assist System (BAS) (▷ page 99).

Brake pad wear or a leak in the system may be the reason for low brake fluid level in the reservoir.

The brake fluid level in the reservoir may be too low if the brake warning lamp in the instrument cluster comes on and an acoustic warning sounds although the parking brake is released (▷ page 381). Observe additional messages in the multi-function display that may appear (▷ page 411).

Have the brake system inspected immediately. Contact an authorized Mercedes-Benz Center.

All checks and service work on the brake system should be carried out by qualified technicians only. Contact an authorized Mercedes-Benz Center.

Only install brake pads and brake fluid recommended by Mercedes-Benz.

Warning!

If other than recommended brake pads are installed, or other than recommended brake fluid is used, the braking properties of the vehicle can be degraded to an extent that safe braking is substantially impaired. This could result in an accident.

! *When driving down long and steep grades, relieve the load on the brakes by shifting into a lower gear to use the engine's braking power. This helps prevent overheating of the brakes and reduces brake pad wear.*

After hard braking, it is advisable to drive on for some time, rather than immediately park, so that the air stream will cool down the brakes faster.

Driving instructions

High-performance brake system (E 63 AMG only)

The high-performance brake system is designed to operate under the extremely high operating demands required to accommodate the performance capabilities of the vehicle. The brakes may produce a squeaking-type noise depending on the

- vehicle speed
- brake force applied
- ambient conditions, e.g. temperature and humidity

As with any brake system, the wear of individual brake system components such as brake pads or disks strongly depends on your driving style and the conditions under which you operate the vehicle. Thus, a driving style calling for high demand braking will cause your vehicle's brakes to wear more quickly.

Warning!



New vehicle brake pads and discs, and replacement brake pads and discs may take several hundred miles of driving until they provide optimum braking efficiency. Until that time, you may need to use increased brake pedal pressure while braking. Please be aware of this and adjust your driving and braking accordingly during this break-in period.

Excessive high demand braking will cause correspondingly high brake wear. Please be attentive to the brake warning lamp in the instrument cluster and brake condition messages in the multifunction display. Especially for high performance driving, it is important to maintain and have the brake system checked regularly.

Driving off

Apply the brakes to test them briefly after driving off. Perform this procedure only when the road is clear of other traffic.

Warm up the engine smoothly. Do not place full load on the engine until the operating temperature has been reached.

! *When driving off on a slippery surface, do not allow a drive wheel to spin for an extended period with the ESP[®] switched off. Doing so may cause serious damage to the drivetrain which is not covered by the Mercedes-Benz Limited Warranty.*

! *Simultaneously depressing the accelerator pedal and applying the brake reduces engine performance and causes premature brake and drivetrain wear.*

Parking

Warning!



Do not park this vehicle in areas where combustible materials such as grass, hay or leaves can come into contact with the hot exhaust system, as these materials could be ignited and cause a vehicle fire.

To reduce the risk of personal injury, or damage to the vehicle drivetrain, as a result of vehicle movement, before turning off the engine and leaving the vehicle always:

- Keep right foot on brake pedal.
- Firmly depress parking brake pedal.

- Move the gear selector lever to position **P**.
- Slowly release brake pedal.
- When parked on an incline, turn front wheel towards the road curb.
- Turn the SmartKey in the starter switch to position **0** and remove the SmartKey from the starter switch, or press KEYLESS-GO* start/stop button (vehicles with KEYLESS-GO*).
- Take the SmartKey or the SmartKey with KEYLESS-GO* with you and lock vehicle when leaving.

Tires

Warning!



If you feel a sudden significant vibration or ride disturbance, or you suspect that possible damage to your vehicle has occurred, you should turn on the hazard warning flashers, carefully slow down, and drive with caution to an area which is a safe distance from the road.

Inspect the tires and the vehicle underbody for possible damage. If the vehicle or tires appear unsafe, have the vehicle towed to the nearest Mercedes-Benz Center or tire dealer for repairs.

Treadwear indicators (TWI) are required by law. These indicators are located in six places on the tread circumference and become visible at a tread depth of approximately $\frac{1}{16}$ in (1.6 mm), at which point the tire is considered worn and should be replaced.

Driving instructions

The treadwear indicator appears as a solid band across the tread.

Warning!



Although the applicable federal motor vehicle safety laws consider a tire to be worn when the treadwear indicators (TWI) become visible at approximately $\frac{1}{16}$ in (1.6 mm), we recommend that you do not allow your tires to wear down to that level. As tread depth approaches $\frac{1}{8}$ in (3 mm), the adhesion properties on a wet road are sharply reduced.

Depending upon the weather and/or road surface (conditions), the tire traction varies widely.

Specified tire inflation pressures must be maintained. This applies particularly if the tires are subjected to high loads (e.g. high speeds, heavy loads, high ambient temperatures).

Warning!



Do not drive with a flat tire. A flat tire affects the ability to steer or brake the vehicle. You could lose control of the vehicle. Continued driving with a flat tire or driving at high speed with a flat tire will cause excessive heat build-up and possibly a fire.

For more information, see “Tires and wheels” (▷ page 332).

Hydroplaning

Depending on the depth of the water layer on the road, hydroplaning may occur, even at low speeds and with new tires. Reduce vehicle speed, avoid track grooves in the road and apply brakes cautiously in the rain.

Tire traction

The safe speed on a wet, snow covered or icy road is always lower than on a dry road.

You should pay particular attention to the condition of the road whenever the outside temperatures are close to the freezing point.

Warning!



If ice has formed on the road, tire traction will be substantially reduced. Under such weather conditions, drive, steer and brake with extreme caution.

Mercedes-Benz recommends winter tires (▷ page 363) with a minimum tread depth of approximately $\frac{1}{6}$ in (4 mm) on all four wheels for the winter season to make sure normal balanced handling characteristics. On packed snow, they can reduce your stopping distance compared to summer tires. Stopping distance, however, is still considerably greater than when the road is not covered with snow or ice. Exercise appropriate caution.

! *Avoid spinning of a drive wheel. This may cause serious damage to the drivetrain which is not covered by the Mercedes-Benz Limited Warranty.*

Tire speed rating

Regardless of the tire speed rating, local speed limits should be obeyed. Use prudent driving speeds appropriate to prevailing conditions.

Warning!



Even when permitted by law, never operate a vehicle at speeds greater than the maximum speed rating of the tires.

Exceeding the maximum speed for which tires are rated can lead to sudden tire failure, causing loss of vehicle control and possibly resulting in an accident and/or personal injury and possible death, for you and for others.

An electronic speed limiter prevents your vehicle from exceeding a speed of:

- All models except E 63 AMG:
130 mph (210 km/h)
- E 63 AMG:
155 mph (250 km/h)
- E 63 AMG with increased top speed*:
186 mph (300 km/h)

The factory equipped tires on your vehicle may have a tire speed rating above the maximum speed permitted by the electronic speed limiter.

Make sure your tires have the required tire speed rating as specified for your vehicle in the “Technical data” section (▷ page 480), for example when purchasing new tires.

For information on how to identify the tire speed rating on a tire’s sidewall, see “Tire size designation, load and speed rating” (▷ page 349).

Driving instructions

If you are uncertain about the correct reading of the information given on a tire's sidewall, any authorized Mercedes-Benz Center will be glad to assist you.

i For information on speed ratings for winter tires, see "Winter driving" (▷ page 363).

For additional general information on tire speed markings on tire sidewall, see "Tire speed rating" (▷ page 360).

Winter driving instructions

The most important rule for slippery or icy roads is to drive sensibly and to avoid abrupt acceleration, braking and steering maneuvers. Do not use the cruise control system under such conditions.

When the vehicle is in danger of skidding, move gear selector lever to position **N**. Try to keep the vehicle under control by corrective steering action.

i For more information on driving with snow chains, see "Snow chains" (▷ page 364).

Warning!



On slippery road surfaces, never downshift in order to obtain braking action. This could result in drive wheel slip and reduced vehicle control. Your vehicle's ABS will not prevent this type of control loss.

Road salts and chemicals can adversely affect braking efficiency. Increased pedal force may become necessary to produce the normal braking effect.

Depressing the brake pedal periodically when traveling at length on salt-strewn roads can bring road-salt-impaired braking efficiency back to normal.

If the vehicle is parked after being driven on salt-treated roads, the braking efficiency should be tested as soon as possible after driving is resumed.

Warning!



Make sure not to endanger any other road users when carrying out these braking maneuvers.

Warning!

If the vehicle becomes stuck in snow, make sure that snow is kept clear of the exhaust pipe and from around the vehicle with the engine running. Otherwise, deadly carbon monoxide (CO) gases may enter vehicle interior resulting in unconsciousness and death.

To assure sufficient fresh air ventilation, open a window slightly on the side of the vehicle not facing the wind.

Warning!

The outside temperature indicator is not designed to serve as an ice-warning device and is therefore unsuitable for that purpose. Indicated temperatures just above the freezing point do not guarantee that the road surface is free of ice.

For more information, see “Winter driving” (▷ page 363).

Standing water

! *Do not drive through flooded areas or water of unknown depth. Before driving through water, determine its depth. Never accelerate before driving into water. The bow wave could force water into the engine and auxiliary equipment, thus damaging them.*

If you must drive through standing water, drive slowly to prevent water from entering the passenger compartment or the engine compartment. Water in these areas could cause damage to electrical components or wiring of the engine or transmission, or could result in water being ingested by the engine through the air intake causing severe internal engine damage. Any such damage is not covered by the Mercedes-Benz Limited Warranty.

Passenger compartment**Warning!**

Always fasten items being carried as securely as possible.

In an accident, during hard braking or sudden maneuvers, loose items will be thrown around inside the vehicle, and cause injury to vehicle occupants unless the items are securely fastened in the vehicle.

The cargo compartment is the preferred place to carry objects.

Driving abroad

Abroad, there is an extensive Mercedes-Benz service network at your disposal. If you plan to drive into areas which are not listed in the index of your Mercedes-Benz Center directory, you should request pertinent information from your authorized Mercedes-Benz Center.

Driving instructions

Control and operation of radio transmitter

COMAND, radio and telephone*

Warning!



Please do not forget that your primary responsibility is to drive the vehicle safely. Only operate the COMAND (Cockpit Management and Data System), radio or telephone¹ if road, weather and traffic conditions permit.

Bear in mind that at a speed of just 30 mph (approximately 50 km/h), your vehicle is covering a distance of 44 feet (approximately 14 m) every second.

¹ Observe all legal requirements.

Telephones and two-way radios

Warning!



Never operate radio transmitters equipped with a built-in or attached antenna (i.e. without being connected to an external antenna) from inside the vehicle while the engine is running. Doing so could lead to a malfunction of the vehicle's electronic system, possibly resulting in an accident and/or serious personal injury.

Radio transmitters, such as a portable telephone or a citizens band unit should only be used inside the vehicle if they are connected to an antenna that is installed on the outside of the vehicle.

Refer to the radio transmitter operation instructions regarding use of an external antenna.

Catalytic converter

Your vehicle is equipped with monolithic-type catalytic converters, an important element in conjunction with the oxygen sensors to achieve substantial control of the pollutants in the exhaust emissions. Keep your vehicle in proper operating condition by following our recommended maintenance instructions as outlined in your Maintenance Booklet.

! *To prevent damage to the catalytic converters, only use premium unleaded gasoline in this vehicle.*

Any noticeable irregularities in engine operation should be repaired promptly. Otherwise, excessive unburned fuel may reach the catalytic converter, causing it to overheat, which could potentially start a fire.

Warning!

As with any vehicle, do not idle, park or operate this vehicle in areas where combustible materials such as grass, hay or leaves can come into contact with the hot exhaust system, as these materials could be ignited and cause a vehicle fire.

Emission control

Certain parts of the engine and the emission control system serve to keep the toxic components of the exhaust gases within permissible limits required by law.

These systems will function properly only when maintained strictly according to factory specifications. Any adjustments on the engine should, therefore, be carried out only by qualified Mercedes-Benz Center authorized technicians. Engine adjustments should not be altered in any way. Moreover, the specified service procedures must be carried out regularly according to Mercedes-Benz servicing requirements. For details refer to the Maintenance Booklet.

Warning!

Inhalation of exhaust gas is hazardous to your health. All exhaust gas contains carbon monoxide (CO), and inhaling it can cause unconsciousness and lead to death.

Do not run the engine in confined areas (such as a garage) which are not properly ventilated. If you think that exhaust gas fumes are entering the vehicle while driving, have the cause determined and corrected immediately. If you must drive under these conditions, drive only with at least one window fully open at all times.

Driving instructions

Coolant temperature

During severe operating conditions and stop-and-go city traffic, the coolant temperature may rise close to approximately 248°F (120°C).

The engine should not be operated with the coolant temperature over 248°F (120°C). Doing so may cause serious engine damage which is not covered by the Mercedes-Benz Limited Warranty.

Warning!



- Driving when your engine is overheated can cause some fluids, which may have leaked into the engine compartment, to catch fire. You could be seriously burned.
- Steam from an overheated engine can cause serious burns which can occur just by opening the engine hood. Stay away from the engine if you see or hear steam coming from it.

Turn off the engine, get out of the vehicle and do not stand near the vehicle until the engine has cooled down.

▼ At the gas station

Refueling

Warning!



Gasoline is highly flammable and poisonous. It burns violently and can cause serious injury.

Never allow sparks, flame or smoking materials near gasoline!

Turn off the engine before refueling.

Whenever you are around gasoline, avoid inhaling fumes and skin or clothing contact, extinguish all smoking materials.

Direct skin contact with fuels and the inhalation of fuel vapors can damage your health.

The fuel filler flap is located on the right-hand side of the vehicle towards the rear. Locking/unlocking the vehicle with the remote control automatically locks/unlocks the fuel filler flap.

i In case that the central locking system does not release the fuel filler flap, or the opening mechanism is clamping, notify Roadside Assistance or an authorized Mercedes-Benz Center.



- ▶ Turn the engine off
 - by turning the SmartKey to position **0**.
 - by pressing the KEYLESS-GO* start/stop button. Open the driver's door (with the driver's door open, starter switch is now in position **0**, same as SmartKey removed from starter switch).
- ▶ Remove the SmartKey from the starter switch.

- ▶ Open the fuel filler flap by pushing at the point indicated by the arrow.

The fuel filler flap springs open.

- ▶ Turn the fuel cap to the left and hold on to it until possible pressure is released.
- ▶ Take off the cap and set it in the recess on the fuel filler flap.

To prevent fuel vapors from escaping into open air, fully insert filler nozzle unit.

- ▶ Only fill your tank until the filler nozzle unit cuts out – **do not top off or over-fill**.

Warning!



Overfilling of the fuel tank may create pressure in the system which could cause a gas discharge. This could cause the gas to spray back out when removing the fuel pump nozzle, which could cause personal injury.



At the gas station

▷▷ Replace fuel cap by turning it clockwise until it audibly engages.

▶ Close the fuel filler flap.

i Leaving the engine running and the fuel cap open can cause the yellow fuel tank reserve warning lamp to flash and the malfunction indicator lamp **CHECK ENGINE** (USA only) or the malfunction indicator lamp **IC** (Canada only) to illuminate. For more information, see also “Practical hints” (▷ page 382).

i Only use premium unleaded gasoline with a minimum Posted Octane Rating of 91 (average of 96 RON / 86 MON). Information on gasoline quality can normally be found on the fuel pump. For more information on gasoline, see the Factory Approved Service Products pamphlet (USA only) or contact an authorized Mercedes-Benz Center.

Check regularly and before a long trip

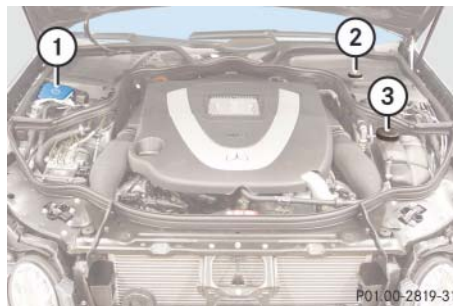

① Windshield washer system and headlamp cleaning system*

② Brake fluid

③ Coolant level

i Opening the hood, see (▷ page 324).

Windshield washer system and headlamp cleaning system*

For information on refilling the reservoir, see “Windshield washer system and headlamp cleaning system*” (▷ page 331).

Brake fluid

! If you find that the brake fluid in the brake fluid reservoir has fallen to the minimum mark or below, have the brake system checked for brake pad thickness and leaks immediately. Notify an authorized Mercedes-Benz Center immediately. Do not add brake fluid as this will not solve the problem. For more information, see “Practical hints” (▷ page 381).

For information on brake fluid, see “Fuels, coolants, lubricants, etc.” (▷ page 489).

Coolant

For normal replenishing, use water (potable water quality). For more information on coolant, see “Coolant level” (▷ page 329) and see “Fuels, coolants, lubricants etc.” (▷ page 486).

Engine oil level

For more information on engine oil level, see “Engine oil” (▷ page 326).

Vehicle lighting

Check function and cleanliness. For more information on replacing light bulbs, see “Replacing bulbs” (▷ page 442).

For more information, see “Exterior lamp switch” (▷ page 141).

Tire inflation pressure

For more information, see “Checking tire inflation pressure” (▷ page 341).

Engine compartment

Hood

Warning!



Do not pull the release lever while the vehicle is in motion. Otherwise the hood could be forced open by passing air flow.

This could cause the hood to come loose and injure you and/or others.

Opening

Warning!



If you see flames or smoke coming from the engine compartment, or if the coolant temperature indicator indicates that the engine is overheated, do not open the hood. Move away from vehicle and do not open the hood until the engine has cooled. If necessary, call the fire department.

Warning!



You could be injured when the hood is open – even when the engine is turned off.

Parts of the engine can become very hot. To prevent burns, let the engine cool off completely before touching any components on the vehicle. Comply with all relevant safety precautions.

Warning!



To help prevent personal injury, stay clear of moving parts when the hood is open and the engine is running.

The radiator fan may continue to run for approximately 30 seconds or even restart after the engine has been turned off. Stay clear of fan blades.

Warning!



The engine is equipped with a transistorized ignition system. Because of the high voltage it is dangerous to touch any components (ignition coils, spark plug sockets, diagnostic socket) of the ignition system

- with the engine running
- while starting the engine
- if ignition is “on” and the engine is turned manually

Engine compartment



① Release lever

- ▶ Pull release lever ①.

The hood is unlocked.



② Handle for opening the hood

- ▶ Lift the hood slightly.

Handle ② will extend out of the radiator grille.

! To avoid damage to the windshield wipers or hood, never open the hood if the wiper arms are folded forward away from the windshield.

! To avoid damage to handle ② never pull up the hood on handle ②.

- ▶ Pull handle ② to its stop out of radiator grille.
- ▶ Lift bottom of hood at edge of radiator grille.

The hood will be automatically held open at shoulder height by gas-filled struts.

Engine compartment

Closing

Warning!



When closing the hood, use extreme caution not to catch hands or fingers. Be careful that you do not close the hood on anyone.

Make sure that the hood is securely engaged before driving off. Do not continue driving if the hood can no longer engage after an accident, for example. The hood could otherwise come loose while the vehicle is in motion and endanger you and others.

- ▶ Let the hood drop from a height of approximately 1 ft (30 cm).

The hood will lock audibly.

- ▶ Check to make sure the hood is fully closed.

If you can raise the hood at a point above the headlamps, then it is not properly closed. Open it again and let it drop with somewhat greater force.

Engine oil

The amount of oil your engine needs will depend on a number of factors, including driving style. Higher oil consumption can occur when

- the vehicle is new
- the vehicle is driven frequently at higher engine speeds

Engine oil consumption checks should only be made after the vehicle break-in period.

i *Do not use any special lubricant additives, as these may damage the drive assemblies. Using special additives not approved by Mercedes-Benz may cause damage not covered by the Mercedes-Benz Limited Warranty.*

More information on this subject is available at any Mercedes-Benz Center.

Checking engine oil level

When checking the oil level

- the vehicle must be parked on level ground
- with the engine at operating temperature, the vehicle must have been stationary for at least 5 minutes with the engine turned off
- with the engine not at operating temperature yet, the vehicle must have been stationary for at least 5 minutes with the engine turned off

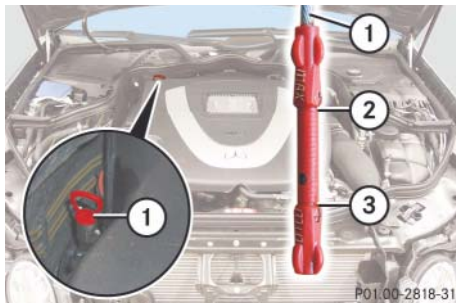

- ① Oil dipstick
- ② Upper (max) mark
- ③ Lower (min) mark

To check the engine oil level with the oil dipstick, do the following:

- ▶ Open the hood (▷ page 324).
- ▶ Pull out oil dipstick ①.
- ▶ Wipe oil dipstick ① clean.
- ▶ Fully insert oil dipstick ① into the dipstick guide tube.

- ▶ Pull out oil dipstick ① again after approximately 3 seconds to obtain accurate reading.

The oil level is correct when it is between the lower (min) mark ③ and upper (max) mark ② of oil dipstick ①.

- ❗ *All models (except E 63 AMG):
The filling quantity between the upper and lower marks on the oil dipstick is approximately 2.1 US qt. (2.0 l).*

*E 63 AMG:
The filling quantity between the upper and lower marks on the oil dipstick is approximately 1.6 US qt. (1.5 l).*

- ▶ If necessary, add engine oil.

For adding engine oil, see “Adding engine oil”.

For more information on engine oil, see “Fuels, coolants, lubricants etc.” (▷ page 486).

For more information on messages in the multifunction display concerning engine oil, see the “Practical hints” section (▷ page 416).

Adding engine oil

❗ *Only use approved engine oils and oil filters required for vehicles with Maintenance System (U.S. vehicles) or FSS PLUS (Canada vehicles). For a listing of approved engine oils and oil filters, refer to the Factory Approved Service Products pamphlet (USA only) in your vehicle literature portfolio, or contact an authorized Mercedes-Benz Center.*

Using engine oils and oil filters of specification other than those expressly required for the Maintenance System (U.S. vehicles) or FSS PLUS (Canada vehicles), or changing of oil and oil filter at change intervals longer than those called for by the Maintenance System (U.S. vehicles) or FSS PLUS (Canada vehicles) will result in engine or emission control system damage not covered by the Mercedes-Benz Limited Warranty.

Engine compartment

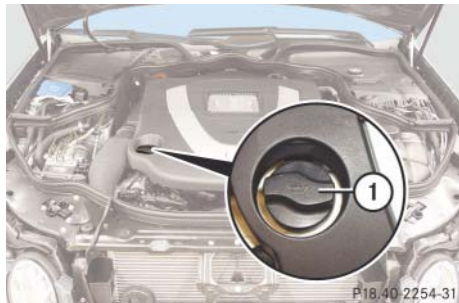

E 350

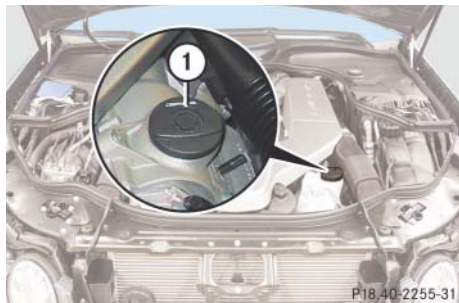

E 63 AMG

- ▶ Unscrew filler cap ① from filler neck.
- ▶ Add engine oil as required. Be careful not to overfill with oil.

Be careful not to spill any oil when adding. Avoid environmental damage caused by oil entering the ground or water.

! *Excess oil must be siphoned or drained off. It could cause damage to the engine and emission control system not covered by the Mercedes-Benz Limited Warranty.*

- ▶ Screw filler cap ① back on filler neck.

For more information on engine oil, see the “Technical data” section (▷ page 486) and (▷ page 489).

Transmission fluid level

The transmission fluid level does not need to be checked. If you notice transmission fluid loss or gear shifting malfunctions, have an authorized Mercedes-Benz Center check the transmission.

Coolant level

The engine coolant is a mixture of water and anticorrosion/antifreeze. To check the coolant level, the vehicle must be parked on level ground and the engine must be cool.

The coolant expansion tank is located on the driver's side of the engine compartment.

Warning!



In order to avoid any potentially serious burns:

- Use extreme caution when opening the hood if there are any signs of steam or coolant leaking from the cooling system, or if the coolant temperature gauge indicates that the coolant is overheated.
- Do not remove pressure cap on coolant reservoir if coolant temperature is above 158°F (70°C). Allow engine to cool down before removing cap. The coolant reservoir contains hot fluid and is under pressure.

- Do not spill antifreeze on hot engine parts. Antifreeze contains ethylene glycol which may burn if it comes into contact with hot engine parts.
- Using a rag, slowly open the cap approximately $1/2$ turn to relieve excess pressure. If opened immediately, scalding hot fluid and steam will be blown out under pressure.

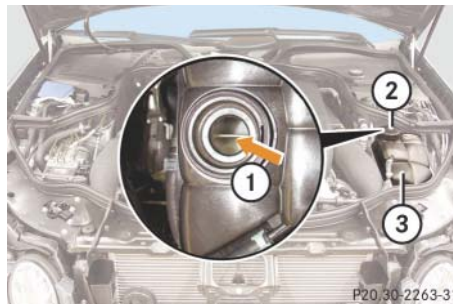

- ① Marking bar in the expansion tank
- ② Cap
- ③ Coolant expansion tank

- ▶ Using a rag, turn the cap ② slowly approximately one half turn counterclockwise to release any excess pressure.
- ▶ Continue turning the cap ② counterclockwise and remove it.

The coolant level is correct if the level:

- for cold coolant: reaches marking bar ① in the expansion tank ③
- for warm coolant: is approximately 0.6 in (1.5 cm) higher
- ▶ Add coolant as required.
- ▶ Replace and tighten cap ②.

For more information on coolant, see the “Technical data” section (▷ page 491).

Engine compartment

Battery

Your vehicle's battery is located in the cargo compartment on the right hand side (▷ page 462).

The battery should always be sufficiently charged in order to achieve its rated service life. Refer to Maintenance Booklet for battery maintenance intervals.

If you use your vehicle mostly for short-distance trips, you will need to have the battery charge checked more frequently.

When replacing the battery, always use batteries approved by Mercedes-Benz.

If you do not intend to operate your vehicle for an extended period of time, consult an authorized Mercedes-Benz Center about steps you need to observe.

Warning!



Observe all safety instructions and precautions when handling automotive batteries.



Risk of explosion.



Fire, open flames and smoking are prohibited when handling batteries. Avoid creating sparks.



Battery acid is caustic. Do not allow it to come into contact with skin, eyes or clothing.

Wear suitable protective clothing, especially gloves, apron and faceguard.



Wear eye protection.

Rinse any acid spills immediately with clear water. Contact a physician if necessary.



Keep children away.



Follow the instructions in this Operator's Manual.

Batteries contain materials that can harm the environment if disposed of improperly. Recycling of batteries is the preferred method of disposal. Many states require sellers of batteries to accept old batteries for recycling.

Windshield/rear window washer system and headlamp cleaning system*

The windshield washer reservoir is located in the engine compartment.



① Cap for windshield washer reservoir

Fluid for the windshield washer system and the headlamp cleaning system is supplied from the windshield washer reservoir. It has a capacity of:

- 4.8 US qt (4.5 l) in vehicles without headlamp cleaning system
- 7.4 US qt (7.0 l) in vehicles with headlamp cleaning system

During all seasons, add MB Windshield Washer Concentrate “MB SummerFit” to water. Premix the windshield washer fluid in a suitable container.

Warning!



Washer solvent/antifreeze is highly flammable. Do not spill washer solvent/ antifreeze on hot engine parts, because it may ignite and burn. You could be seriously burned.

- ▶ Use the tab to pull cap ① upwards.
- ▶ Refill the reservoir with MB Windshield Washer Concentrate and water (or commercially available premixed windshield washer solvent/antifreeze, depending on ambient temperatures).

❗ Always use washer solvent/antifreeze where temperatures may fall below freezing point. Failure to do so could result in damage to the washer system/reservoir.

❗ Only use washer fluid which is suitable for plastic lenses. Improper washer fluid can damage the plastic lenses of the headlamps.

For more information, see “Windshield and headlamp washer fluid mixing ratio” (▷ page 494).

Tires and wheels

See an authorized Mercedes-Benz Center for information on tested and recommended rims and tires for summer and winter operation. They can also offer advice concerning tire service and purchase.

Warning!



Replace rims or tires with the same designation, manufacturer and type as shown on the original part. See an authorized Mercedes-Benz Center for further information. If incorrectly sized rims and tires are mounted:

- The wheel brakes or suspension components can be damaged
- The correct operating clearance of the wheels and the tires are no longer guaranteed

Warning!



Worn, old tires can cause accidents. If the tire tread is badly worn, or if the tires have sustained damage, replace them.

When replacing rims, only use Genuine Mercedes-Benz wheel bolts specified for the particular rim type. Failure to do so can result in the bolts loosening and possibly an accident.

Retreaded tires are not tested or recommended by Mercedes-Benz, since previous damage cannot always be recognized on retreads. The operating safety of the vehicle cannot be assured when such tires are used.

Important guidelines

- Only use sets of tires and rims of the same type and make.
- Tires must be of the correct size for the rim.
- Break in new tires for approximately 60 miles (100 km) at moderate speeds.
- Regularly check the tires and rims for damage. Dented or bent rims can cause tire inflation pressure loss and damage to the tire beads.
- If vehicle is heavily loaded, check tire inflation pressure and correct as required.
- Do not allow your tires to wear down too far. Adhesion properties on wet roads are sharply reduced at tread depths of less than $\frac{1}{8}$ in (3 mm).
- When replacing individual tires, you should mount new tires on the front wheels first (on vehicles with same-sized wheels all around).

Tire care and maintenance

Warning!



Regularly check the tires for damage. Damaged tires can cause tire inflation pressure loss. As a result, you could lose control of your vehicle.

Worn, old tires can cause accidents. If the tire tread is badly worn, or if the tires have sustained damage, replace them.

Regularly check your tire inflation pressure at least once a month. For more information on checking tire inflation pressure, see “Recommended tire inflation pressure” (▷ page 340).

Tire inspection

Every time you check your tire inflation pressure, you should also inspect your tires for the following:

- excessive treadwear (▷ page 334)
- cord or fabric showing through the tire’s rubber
- bumps, bulges, cuts, cracks or splits in the tread or side of the tire

Replace the tire if you find any of the above conditions.

Make sure you also inspect the spare tire periodically for condition and inflation. Spare tires will age and become worn over time even if never used, and thus should be inspected and replaced when necessary.

Life of tire

The service life of a tire is dependent upon varying factors including but not limited to:

- Driving style
- Tire inflation pressure
- Distance driven

Warning!



Tires and spare tire should be replaced after 6 years, regardless of the remaining tread.

Tires and wheels

Tread depth

Do not allow your tires to wear down too far. Adhesion properties on wet roads are sharply reduced at tread depths of less than $\frac{1}{8}$ in (3 mm).

Treadwear indicators (TWI) are required by law. These indicators are located in six places on the tread circumference and become visible at a tread depth of approximately $\frac{1}{16}$ in (1.6 mm), at which point the tire is considered worn and should be replaced.

Recommended minimum tire tread depth:

- Summer tires $\frac{1}{8}$ in (3 mm)
- Winter tires $\frac{1}{6}$ in (4 mm)

Warning!



Although the applicable federal motor safety laws consider a tire to be worn when the treadwear indicators (TWI) become visible at approximately $\frac{1}{16}$ in (1.6 mm), we recommend that you do not allow your tires

to wear down to that level. As tread depth approaches $\frac{1}{8}$ in (3 mm), the adhesion properties on a wet road are sharply reduced.

Depending upon the weather and/or road surface (conditions), the tire traction varies widely.

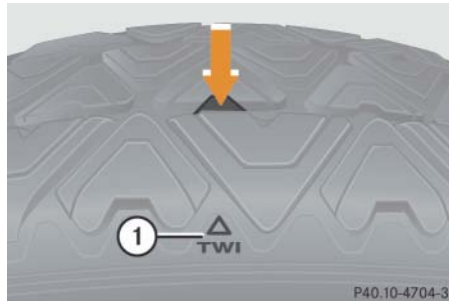

① TWI (Tred Wear Indicator)

The treadwear indicator appears as a solid band across the tread.

Storing tires

! *Keep unmounted tires in a cool, dry place with as little exposure to light as possible. Protect tires from contact with oil, grease and gasoline.*

Cleaning tires

! *Never use a round nozzle to power wash tires. The intense jet of water can result in damage to the tire.*

Always replace a damaged tire.

Direction of rotation

Unidirectional tires offer added advantages, such as better hydroplaning performance. To benefit, however, you must make sure the tires rotate in the direction specified.

An arrow on the sidewall indicates the intended direction of rotation (spinning) of the tire.

i *Spare wheels may be mounted against the direction of rotation (spinning) even with a unidirectional tire for temporary use only until the regular drive wheel has been repaired or replaced. Always observe and follow applicable temporary use restrictions and speed limitations indicated on the spare wheel.*

Loading the vehicle

Two labels on your vehicle show how much weight it may properly carry.

- 1) The Tire and Loading Information placard can be found on the driver's door B-pillar. This placard tells you important information about the number of people that can be in the vehicle and the total weight that can be carried in the vehicle. It also contains information on the proper size and recommended tire inflation pressures for the original equipment tires on your vehicle.
- 2) The certification label, also found on the driver's door B-pillar tells you about the gross weight capacity of your vehicle, called the Gross Vehicle Weight Rating (GVWR). The GVWR includes the weight of the vehicle, all occupants, fuel and cargo. The certification label also tells you about the front and rear axle weight capacity, called the Gross Axle Weight Rating (GAWR).

The GAWR is the total allowable weight that can be carried by a single axle (front or rear). Never exceed the GVWR or GAWR for either the front axle or rear axle.



① Driver's door B-pillar

Following is a discussion on how to work with the information contained on the two placards with regards to loading your vehicle.

Tires and wheels

Tire and Loading Information

Warning!



Do not overload the tires by exceeding the specified load limit as indicated on the placard on the driver's door B-pillar. Overloading the tires can overheat them, possibly causing a blowout. Overloading the tires can also result in handling or steering problems, or brake failure.

i Data shown on placard examples are for illustration purposes only. Load limit data are specific to each vehicle and may vary from data shown in the illustrations below. Refer to placard on vehicle for actual data specific to your vehicle.

Tire and Loading Information placard

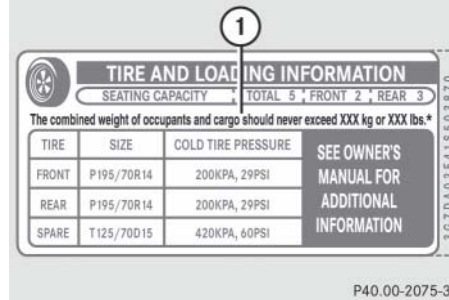

① Load limit information on the Tire and Loading Information placard

The placard showing the load limit information is located on the driver's door B-pillar.

- ▶ Locate the statement “The combined weight of occupants and cargo should never exceed XXX kilograms or XXX lbs.” on this placard.

The combined weight of all occupants, cargo/luggage and trailer tongue load (if applicable) should never exceed the weight referenced in that statement.

Seating capacity

The seating capacity gives you important information on the number of occupants that can be in the vehicle. Observe front and rear seating capacity. The Tire and Loading Information placard showing the seating capacity information is located on the driver's door B-pillar (▷ page 335).

i Data shown on placard examples are for illustration purposes only. Seating data are specific to each vehicle and may vary from data shown in the illustrations below. Refer to placard on vehicle for actual data specific to your vehicle.

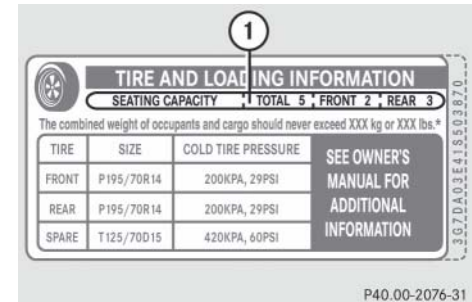

① Seating capacity information on the Tire and Loading Information placard

Steps for determining correct load limit

The following steps have been developed as required of all manufacturers under Title 49, Code of U.S. Federal Regulations, Part 575 pursuant to the “National Traffic and Motor Vehicle Safety Act of 1966”.

Step 1

- ▶ Locate the statement “The combined weight of occupants and cargo should never exceed XXX kg or XXX lbs.” on your vehicle’s placard.

Step 2

- ▶ Determine the combined weight of the driver and passengers that will be riding in your vehicle.

Step 3

- ▶ Subtract the combined weight of the driver and passengers from XXX kilograms or XXX lbs.

Step 4

- ▶ The resulting figure equals the available amount of cargo and luggage load capacity. For example, if the “XXX” amount equals 1400 lbs. and there will be five 150 lbs. passengers in your vehicle, the amount of available cargo and luggage load capacity is 650 lbs. (1400-750 (5 x 150) = 650 lbs.).

Step 5

- ▶ Determine the combined weight of luggage and cargo being loaded on the vehicle. That weight may not safely exceed the available cargo and luggage load capacity calculated in step 4.

Step 6 (if applicable)

- ▶ If your vehicle will be towing a trailer, load from your trailer will be transferred to your vehicle. Consult this manual to determine how this reduces the available cargo and luggage load capacity of your vehicle (▷ page 339).

The following table shows examples on how to calculate total and cargo load capacities with varying seating configurations and number and size of occupants. The following examples use a load limit of 1500 lbs. **This is for illustration purposes only.** Make sure you are using the actual load limit for your vehicle stated on the vehicle’s placard (▷ page 336).

Tires and wheels

Example	Combined weight limit of occupants and cargo from placard	Number of occupants (driver and passengers)	Seating configuration	Occupants weight	Combined weight of all occupants	Available cargo/luggage and trailer tongue weight (total load limit from placard minus combined weight of all occupants)
1	1500 lbs	5	front: 2 rear: 3	Occupant 1: 150 lbs Occupant 2: 180 lbs Occupant 3: 160 lbs Occupant 4: 140 lbs Occupant 5: 120 lbs	750 lbs	1500 lbs - 750 lbs = 750 lbs
2	1500 lbs	3	front: 1 rear: 2	Occupant 1: 200 lbs Occupant 2: 190 lbs Occupant 3: 150 lbs	540 lbs	1500 lbs - 540 lbs = 960 lbs
3	1500 lbs	1	front: 1	Occupant 1: 150 lbs	150 lbs	1500 lbs - 150 lbs = 1350 lbs

The higher the weight of all occupants, the less cargo and luggage load capacity is available.

For more information, see “Trailer tongue load” (> page 339).

Certification label

Even after careful determination of the combined weight of all occupants, cargo and the trailer tongue load (if applicable) (▷ page 339) as to not exceed the permissible load limit, you must make sure that your vehicle never exceeds the Gross Vehicle Weight Rating (GVWR) and the Gross Axle Weight Rating (GAWR) for either the front or rear axle. You can obtain the GVWR and GAWR from the certification label. The certification label can be found on the driver's door B-pillar, see "Technical data" (▷ page 476).

Gross Vehicle Weight Rating (GVWR): The total weight of the vehicle, all occupants, all cargo, and the trailer tongue load (▷ page 339) must never exceed the GVWR.

Gross Axle Weight Rating (GAWR): The total allowable weight that can be carried by a single axle (front or rear).

To assure that your vehicle does not exceed the maximum permissible weight limits (GVWR and GAWR for front and rear axle), have the loaded vehicle (including driver, passengers and all cargo and, if applicable, trailer fully loaded) weighed on a suitable commercial scale.

Trailer tongue load

The tongue load of any trailer is an important weight to measure because it affects the load you can carry in your vehicle. If a trailer is towed, the tongue load must be added to the weight of all occupants riding and any cargo you are carrying in the vehicle. The tongue load typically is 10 percent of the trailer weight and everything loaded in it.

Your Mercedes-Benz has been designed primarily to carry passengers and their cargo. Mercedes-Benz does not recommend trailer towing with your vehicle.

Tires and wheels

Recommended tire inflation pressure

Warning!



Follow recommended tire inflation pressures.

Do not underinflate tires. Underinflated tires wear excessively and/or unevenly, adversely affect handling and fuel economy, and are more likely to fail from being overheated.

Do not overinflate tires. Overinflated tires can adversely affect handling and ride comfort, wear unevenly, increase stopping distance, and result in sudden deflation (blowout) because they are more likely to become punctured or damaged by road debris, potholes etc.

Your vehicle is equipped with the Tire and Loading Information placard located on the driver's door B-pillar (▷ page 335).

The tire inflation pressure should be checked regularly and should only be adjusted on cold tires. The tires can be considered cold if the vehicle has been parked for at least 3 hours or driven less than 1 mile (1.6 km).

Follow recommended cold tire inflation pressures listed on placard.

Keeping the tires properly inflated provides the best handling, tread life and riding comfort.

In addition to the tire placard on the driver's door B-pillar, also consult the fuel filler flap for any additional information pertaining to special driving situations. For more information, see "Important notes on tire inflation pressure" (▷ page 341).

i Data shown on placard examples are for illustration purposes only. Tire data are specific to each vehicle and may vary from data shown in the illustrations below. Refer to placard on vehicle for actual data specific to your vehicle.

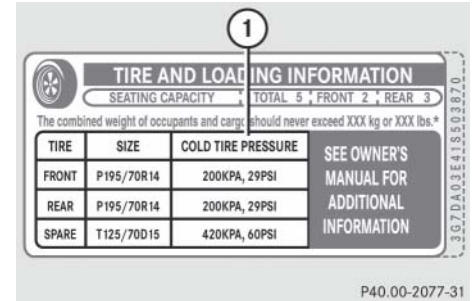

- ① Tire and Loading Information placard with recommended cold tire inflation pressures

The Tire and Loading Information placard lists the recommended cold tire inflation pressures for maximum loaded vehicle weight. The tire inflation pressures listed apply to the tires installed as original equipment.

Important notes on tire inflation pressure

Warning!



If the tire inflation pressure repeatedly drops:

- Check the tires for punctures from foreign objects.
- Check to see whether air is leaking from the valves or from around the rim.

Tire temperature and tire inflation pressure are also increased while driving, depending on the driving speed and the tire load.

If you will be driving your vehicle at high speeds of 100 mph (160 km/h) or higher, where it is legal and conditions allow, consult the placard on the inside of the fuel filler flap on how to adjust the cold tire inflation pressure. If you do not adjust the tire inflation pressure, excessive heat can build up and result in sudden tire failure.

i *Driving comfort may be reduced when the tire inflation pressure is adjusted to the value for speeds above 100 mph (160 km/h) as specified on the placard located on the inside of the fuel filler flap.*

Be sure to readjust the tire inflation pressure for normal driving speeds. You should wait until the tires are cold before adjusting the tire inflation pressure.

Some vehicles may have supplemental tire inflation pressure information for vehicle loads less than the maximum loaded vehicle condition. If such information is provided, it can be found on the placard located on the inside of the fuel filler flap (▷ page 321).

Tire inflation pressure changes by approximately 1.5 psi (0.1 bar) per 18°F (10°C) of air temperature change. Keep this in mind when checking tire inflation pressure where the temperature is different from the outside temperature.

Checking tire inflation pressure

Regularly check your tire inflation pressure at least once a month.

Check and adjust the tire inflation pressure when the tires are cold. The tires can be considered cold if the vehicle has been parked for at least 3 hours or driven less than 1 mile (1.6 km).

If you check the tire inflation pressure when the tires are warm (the vehicle has been driven for several miles or sitting less than 3 hours), the reading will be approximately 4 psi (0.3 bar) higher than the cold reading. This is normal. Do not let air out to match the specified cold tire inflation pressure. Otherwise, the tire will be underinflated.

Warning!



Follow recommend tire inflation pressures.

Do not underinflate tires. Underinflated tires wear excessively and/or unevenly, adversely affect handling and fuel economy, and are more likely to fail from being overheated.

Do not overinflate tires. Overinflated tires can adversely affect handling and ride comfort, wear unevenly, increase stopping distance, and result in sudden deflation (blowout) because they are more likely to become punctured or damaged by road debris, potholes etc.

Do not overload the tires by exceeding the specified load limit or vehicle capacity weight as indicated on the placard on the driver's door B-pillar. Overloading the tires can overheat them, possibly causing a blowout.

Checking tire inflation pressure manually

Follow the steps below to achieve correct tire inflation pressure:

- ▶ Remove the cap from the valve on one tire.
- ▶ Firmly press a tire gauge onto the valve.
- ▶ Read tire inflation pressure on tire gauge and check against the recommended tire inflation pressure on the placard on the driver's door B-pillar (▶ page 335). If necessary, add air to achieve the recommended tire inflation pressure.

i *If you have overfilled the tire, release tire inflation pressure by pushing the metal stem of the valve with e.g. a tip of a pen. Then recheck the tire inflation pressure with the tire gauge.*

- ▶ Install the valve cap.
- ▶ Repeat this procedure for each tire.

Run Flat Indicator (Canada only)

While the vehicle is being driven, the Run Flat Indicator monitors the set tire inflation pressures by evaluating each wheel's rotational speed. This allows the system to detect a significant loss of pressure in a tire. If a wheel's rotational speed changes due to falling tire inflation pressure, you will see a corresponding warning message in the multifunction display.

The Run Flat Indicator may function in a restricted manner or with a delay

- if snow chains are mounted to the vehicle
- in winter road conditions prevail in presence of ice and snow
- if you are driving on a loose surface (e.g. sand or gravel)
- if you are driving in a very sporty manner (involving rapid acceleration or high speeds in curves)

Warning!

When the multifunction display shows the message **Tire pressure Check tires**, one or more of your tires is significantly underinflated. You should stop and check your tires as soon as possible, and inflate them to the proper tire inflation pressure as indicated on the vehicle's tire information placard. Driving on a significantly underinflated tire causes the tire to overheat and can lead to tire failure. Underinflation also reduces fuel efficiency and tire tread life, and may affect the vehicle's handling and stopping ability. Each tire, including the spare, should be checked monthly when cold and set to the recommended tire inflation pressure as specified in the vehicle placard and owner's manual.

i *The recommended tire inflation pressures for your vehicle can be found on the tire placard located on the driver's door B-pillar (▷ page 335). The tire inflation pressures are not listed in the owner's manual.*

Warning!

The Run Flat Indicator does not provide a warning for wrongly selected tire inflation pressures. Always adjust tire inflation pressure according to the placard on the driver's door B-pillar or fuel filler flap.

The Run Flat Indicator does not replace regular checks of the tire inflation pressures since a gradual pressure loss in more than one tire cannot be detected by the Run Flat Indicator.

The Run Flat Indicator is not able to issue a warning due to a sudden dramatic loss of tire inflation pressure (e.g. tire blowout caused by a foreign object). In this case bring the vehicle to a halt by carefully applying the brakes and avoiding abrupt steering maneuvers.

Reactivating the Run Flat Indicator

The tire inflation pressure monitor must be reactivated in the following situations:

- If you have changed the tire inflation pressure
- If you have replaced the wheels or tires
- If you have installed new wheels or tires
- ▶ Using the tire placard on the driver's door B-pillar or, if available, the inside of the fuel filler flap, make sure the tire inflation pressure of all four tires is correct.

Warning!



The Run Flat Indicator can only warn you in a reliable manner if you have set the correct tire inflation pressures for each tire.

If an incorrect tire inflation pressure was set, the system will monitor the pressure according to the incorrect value.

Tires and wheels

- ▶ Switch on the ignition (▷ page 37).

Make sure the standard display menu appears in the multifunction display (▷ page 155).

- ▶ Press button  or  repeatedly until the following message appears in the multifunction display:

Run Flat Indicator
active
Menu: R-Button

- ▶ Press reset button (▷ page 27).

The following message will appear in the multifunction display:

Restart
Run Flat Indicator?
Cancel
Yes

If you wish to confirm activation:

- ▶ Press button .

The following message will appear in the multifunction display:

Run Flat Indicator
restarted

After a certain “learning phase”, the Run Flat Indicator checks the set pressure values for all four tires.

If you wish to cancel activation:

- ▶ Press button .

or

- ▶ Wait until the message

Restart
Run Flat Indicator?
Cancel
Yes
disappears.

Checking tire inflation pressure electronically with the Advanced Tire Pressure Monitoring System (Advanced TPMS)*, (Canada only)

The TPMS only functions on wheels that are equipped with the proper electronic sensors. It monitors the tire inflation pressure, as selected by the driver, in all four tires. A warning is issued to alert you to a decrease in pressure in one or more of the tires.

Tire pressure inquiries are made using the multifunction display. The present inflation pressures are displayed only after a few minutes' travel time.

i USA only:

This device complies with Part 15 of the FCC Rules. Operation is subject to the following two conditions:

- (1) This device may not cause harmful interference, and
- (2) this device must accept any interference received, including interference that may cause undesired operation.

Any unauthorized modification to this device could void the user's authority to operate the equipment.

i Canada only:



This device complies with RSS-210 of Industry Canada. Operation is subject to the following two conditions:

- (1) This device may not cause interference, and
- (2) this device must accept any interference received, including interference that may cause undesired operation of the device.

Any unauthorized modification to this device could void the user's authority to operate the equipment.

i

Possible differences between the readings of a tire pressure gauge of an air hose, e.g. gas station equipment, and the vehicle's control system can occur. Usually the readings issued by the control system are more precise.

- ▶ Switch on the ignition (▷ page 37).
- ▶ Press the  or  button until the current inflation pressures for each tire appear in the multifunction display.



i

When the message Tire pressure is only displayed after driving for a few minutes appears in the multifunction display, the individual inflation pressure values are matched with the tires. The individual values are displayed after a few minutes driving.

Warning!



It is the driver's responsibility to calibrate the TPMS on the recommended cold inflation pressure. Underinflated tires affect the ability to steer or brake the vehicle. You might lose control over the vehicle.

i

With a spare wheel mounted, the system may still indicate the tire inflation pressure of the removed road wheel for some minutes. If this happens, keep in mind that the indicated value where the spare wheel is mounted does not reflect the actual spare tire inflation pressure.

Tires and wheels

Warning!



The TPMS does not indicate a warning for wrongly selected inflation pressures. Always adjust tire inflation pressure according to the placard on the driver's door B-pillar or, if available, the supplemental tire pressure information on the inside of the fuel filler flap.

The TPMS is not able to issue a warning due to a sudden dramatic loss of pressure (e.g. tire blowout caused by a foreign object). In this case bring the vehicle to a halt by carefully applying the brakes and avoiding abrupt steering maneuvers.

Warning!



Each tire, including the spare (if provided), should be checked monthly when cold and inflated to the inflation pressure recommended by the vehicle manufacturer on the vehicle placard or the tire inflation pressure label. (If your vehicle has tires of a different size than the size indicated on the vehicle placard or the tire inflation pressure label, you should determine the proper tire inflation pressure for those tires).

As an added safety feature, your vehicle has been equipped with a tire pressure monitoring system (TPMS) that illuminates a low tire pressure telltale when one or more of your tires are significantly underinflated. Accordingly, when the low tire pressure telltale illuminates, you should stop and check your tires as soon as possible. Driving on a significantly underinflated tire causes the tire to overheat and can lead to tire failure.

Underinflation also reduces fuel efficiency and tire tread life, and may effect the vehicle's handling and stopping ability. Please note that the TPMS is not a substitute for proper tire maintenance, and it is the driver's responsibility to maintain correct tire pressure, even if underinflation has not reached the level to trigger illumination of the TPMS low tire pressure telltale.





i *Operating radio transmission equipment (e.g. wireless headsets, two-way radios) in or near the vehicle could cause the TPMS to malfunction.*

Reactivating Advanced TPMS*

The TPMS must be reactivated when you have adjusted the tire inflation pressure to a new level (e.g. because of different load or driving conditions). The TPMS is then recalibrated to the current tire inflation pressures.

Warning!

It is the driver's responsibility to calibrate the TPMS on the recommended cold inflation pressure. Underinflated tires affect the ability to steer or brake the vehicle. You might lose control over the vehicle.

- ▶ Using the tire placard on the driver's door B-pillar (▷ page 335) or, if available, the supplemental tire pressure information on the inside of the fuel filler flap (▷ page 321), make sure the tire inflation pressure of all four tires is correct.
- i** *Reactivate the TPMS after adjusting the tire inflation pressure to the inflation pressure recommended for the vehicle operating condition. Tire pressure should only be adjusted on cold tires. Observe the recommended tire inflation pressure on the placard on the driver's door B-pillar (▷ page 335). Some vehicles may have supplemental tire pressure information for driving at high speeds (▷ page 341) or for vehicle loads less than the maximum loaded vehicle condition (▷ page 341). If such information is provided, it can be found on the inside of the fuel filler flap (▷ page 321).*
- ▶ Press button  or  on the multifunction steering wheel repeatedly until the standard display menu appears in the multifunction display (▷ page 155).
 - ▶ Press the  or  button repeatedly until you see the current inflation pressures for each tire appear in the display or the following message appears in the display
Tire pressure
displayed after
driving for
a few minutes

- ▶ Press the reset button (▷ page 27).

The following message will appear in the multifunction display:

Restart tire
pressure monitor?

- ▶ Press the  button.

The following message will appear in the multifunction display:

Tire pressure monitor restarted

After a few minutes driving, the current tire inflation pressure values are accepted as reference values and then monitored.

If you wish to cancel activation:

- ▶ Press the  button.

Tires and wheels

Potential problems associated with underinflated and overinflated tires

Underinflated tires

Underinflated tires can:

- cause excessive and uneven tire wear
- adversely affect fuel economy
- lead to tire failure from being overheated
- adversely affect handling characteristics

Warning!



Follow recommended tire inflation pressures.

Do not underinflate tires. Underinflated tires wear excessively and/or unevenly, adversely affect handling and fuel economy, and are more likely to fail from being overheated.

Overinflated tires

Overinflated tires can:

- adversely affect handling characteristics
- cause uneven tire wear
- be more prone to damage from road hazards
- adversely affect ride comfort
- increase stopping distance

Warning!



Follow recommended tire inflation pressures.

Do not overinflate tires. Overinflated tires can adversely affect handling and ride comfort, wear unevenly, increase stopping distance, and result in sudden deflation (blowout) because they are more likely to become punctured or damaged by road debris, potholes etc.

Tire labeling

Besides tire name (sales designation) and manufacturer name, a number of markings can be found on a tire.

Following are some explanations for the markings on your vehicle's tires:

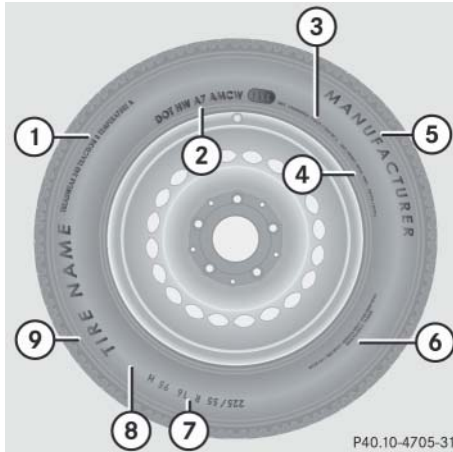

- ① Uniform Tire Quality Grading Standards (▷ page 356)
- ② DOT, Tire Identification Number (TIN) (▷ page 353)
- ③ Maximum tire load (▷ page 355)
- ④ Maximum tire inflation pressure (▷ page 355)
- ⑤ Manufacturer
- ⑥ Tire ply material (▷ page 358)
- ⑦ Tire size designation, load and speed rating (▷ page 349)
- ⑧ Load identification (▷ page 353)
- ⑨ Tire name

i For illustration purposes only. Actual data on tires are specific to each vehicle and may vary from data shown in above illustration.

For more information, see “Rims and tires” (▷ page 480).

Tire size designation, load and speed rating

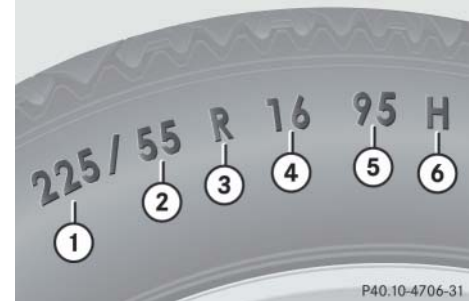

- ① Tire width
- ② Aspect ratio in %
- ③ Radial tire code
- ④ Rim diameter
- ⑤ Tire load rating
- ⑥ Tire speed rating

i For illustration purposes only. Actual data on tires are specific to each vehicle and may vary from data shown in above illustration.

Tires and wheels

General:

Depending on the design standards used, the tire size molded into the sidewall may have no letter or a letter preceding the tire size designation.

No letter preceding the size designation (as illustrated above): Passenger car tire based on European design standards.

Letter “P” preceding the size designation: Passenger car tire based on U.S. design standards.

Letter “LT” preceding the size designation: Light Truck tire based on U.S. design standards.

Letter “T” preceding the size designation: Temporary spare tires which are high pressure compact spares designed for temporary emergency use only.

Tire width

The tire width ① (▷ page 349) indicates the nominal tire width in mm.

Aspect ratio

The aspect ratio ② (▷ page 349) is the dimensional relationship between tire section height and section width and is expressed in percentage. The aspect ratio is arrived at by dividing section height by section width.

Tire code

The tire code ③ (▷ page 349) indicates the tire construction type. The “R” stands for radial tire type. Letter “D” means diagonal or bias ply construction; letter “B” means belted-bias ply construction.

At the tire manufacturer’s option, any tire with a speed capability above 149 mph (240 km/h) can include a “ZR” in the size designation (for example: 245/40 ZR 18). For additional information, see “Tire speed rating” (▷ page 351).

Rim diameter

The rim diameter ④ (▷ page 349) is the diameter of the bead seat, not the diameter of the rim edge. Rim diameter is indicated in inches (in).

Tire load rating

The tire load rating ⑤ (▷ page 349) is a numerical code associated with the maximum load a tire can support.

For example, a load rating of 91 corresponds to a maximum load of 1356 lb (615 kg) the tire is designed to support. See also “Maximum tire load” (▷ page 355) where the maximum load associated with the load index is indicated in kilograms and lb.

Summer tires

Index	Speed rating
Q	up to 100 mph (160 km/h)
R	up to 106 mph (170 km/h)
S	up to 112 mph (180 km/h)
T	up to 118 mph (190 km/h)
H	up to 130 mph (210 km/h)
V	up to 149 mph (240 km/h)
W	up to 168 mph (270 km/h)
Y	up to 186 mph (300 km/h)
(Y)	above 186 mph (300 km/h)
ZR	above 149 mph (240 km/h)

- At the tire manufacturer’s option, any tire with a speed capability above 149 mph (240 km/h) can include a “ZR” in the size designation (for example: 245/40 ZR18). To determine the maximum speed capability of the tire, the service description for the tire must be referred to. The service description

Warning!



The tire load rating must always be at least half of the GAWR (▷ page 359) of your vehicle. Otherwise, tire failure may be the result which may cause an accident and/or serious injury to you or others.

Always replace rims and tires with the same designation, manufacturer and type as shown on the original part.

Warning!



Do not overload the tires by exceeding the specified load limit as indicated on the placard located on the driver’s door B-pillar. Overloading the tires can overheat them, possibly causing a blowout. Overloading the tires can also result in handling or steering problems, or brake failure.

For additional information on tire load rating, see “Load identification” (▷ page 353).

i Tire load rating ⑤ (▷ page 349) and Tire speed rating ⑥ (▷ page 349) are also referred to as “service description”.

Tire speed rating

The tire speed rating ⑥ (▷ page 349) indicates the approved maximum speed for the tire.

Warning!



Even when permitted by law, never operate a vehicle at speeds greater than the maximum speed rating of the tires.

Exceeding the maximum speed for which tires are rated can lead to sudden tire failure, causing loss of vehicle control and possibly resulting in an accident and/or serious injury and possible death, for you and for others.

i Tire load rating ⑤ (▷ page 349) and Tire speed rating ⑥ (▷ page 349) are also referred to as “service description”.

Tires and wheels

is comprised of the tire load rating ⑤ (▷ page 349) and the tire speed rating ⑥ (▷ page 349).

If your tire includes “ZR” in the size designation and no service description ⑤ and ⑥ (▷ page 349) is given, the tire manufacturer must be consulted for the maximum speed capability.

If a service description ⑤ and ⑥ (▷ page 349) is given, the speed capability is limited by the speed symbol in the service description.

Example: 245/40 ZR18 97Y.

In this example, “97Y” is the service description. The letter “Y” designates the speed rating and the speed capability of the tire is limited to 186 mph (300 km/h).

- Any tire with a speed capability above 186 mph (300 km/h) must include a “ZR” in the size designation AND the service description must be placed in parenthesis. Example: 275/40 ZR 18 (99Y). The “(Y)” speed rating in parenthesis designates the maximum speed capability of the tire as being above 186 mph (300 km/h). Consult the tire manufacturer for the actual maximum permissible speed of the tire.

All-season and winter tires

Index	Speed rating
Q M+S ¹	up to 100 mph (160 km/h)
T M+S ¹	up to 118 mph (190 km/h)
H M+S ¹	up to 130 mph (210 km/h)
V M+S ¹	up to 149 mph (240 km/h)

¹ or M+S  for winter tires

i *Not all M+S rated tires provide special winter performance. Make sure the tires you use show M+S and the mountain/snowflake  marking on the tire sidewall. These tires meet specific snow traction performance requirements of the Rubber Manufacturers Association (RMA) and the Rubber Association of Canada (RAC) and have been designed specifically for use in snow conditions.*

Load identification



① Load identification

i For illustration purposes only. Actual data on tires are specific to each vehicle and may vary from data shown in above illustration.

In addition to tire load rating, special load identification ① may be molded into the tire sidewall following the letter designating the tire speed rating ⑥ (▷ page 349).

No specification given: absence of any text (like in above example) indicates a standard load (SL) tire.

XL or Extra Load: designates an extra load (or reinforced) tire.

Light Load: designates a light load tire.

C, D, E: designates load range associated with the maximum load a tire can carry at a specified pressure.

DOT, Tire Identification Number (TIN)

U.S. tire regulations require each new tire manufacturer or tire retreader to mold a TIN into or onto a sidewall of each tire produced.

The TIN is a unique identifier which facilitates efforts by tire manufacturers to notify purchasers in recall situations or other safety matters concerning tires and gives purchasers the means to easily identify such tires.

The TIN is comprised of “Manufacturer’s identification mark”, “Tire size”, “Tire type code” and “Date of manufacture”.

Tires and wheels

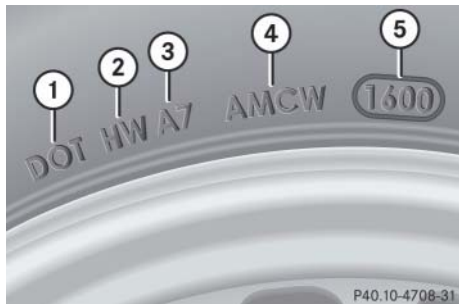

- ① DOT
- ② Manufacturer's identification mark
- ③ Tire size
- ④ Tire type code (at the option of the tire manufacturer)
- ⑤ Date of manufacture

i For illustration purposes only. Actual data on tires are specific to each vehicle and may vary from data shown in above illustration.

DOT (Department of Transportation)

A tire branding symbol ① (▷ page 354) which denotes the tire meets requirements of the U.S. Department of Transportation.

Manufacturer's identification mark

The manufacturer's identification mark ② (▷ page 354) denotes the tire manufacturer.

New tires have a mark with two symbols.

Retreaded tires have a mark with four symbols. For more information on retreaded tires, see (▷ page 332).

Tire size

The code ③ (▷ page 354) indicates the tire size.

Tire type code

The code ④ (▷ page 354) may, at the option of the manufacturer, be used as a descriptive code for identifying significant characteristics of the tire.

Date of manufacture

The date of manufacture ⑤ (▷ page 354) identifies the week and year of manufacture.

The first two figures identify the week, starting with "01" to represent the first full week of the calendar year. The second two figures represent the year.

For example, "3202" represents the 32nd week of 2002.

Maximum tire load

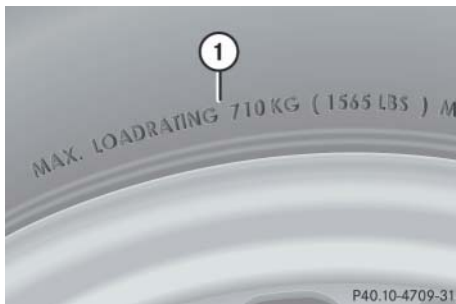

① Maximum tire load rating

i For illustration purposes only. Actual data on tires are specific to each vehicle and may vary from data shown in above illustration.

The maximum tire load is the maximum weight the tires are designed to support.

Warning!



Do not overload the tires by exceeding the specified load limit as indicated on the placard located on the driver's door B-pillar. Overloading the tires can overheat them, possibly causing a blowout. Overloading the tires can also result in handling or steering problems, or brake failure.

For more information on tire load rating (▷ page 350).

For information on calculating total and cargo load capacities (▷ page 337).

Maximum tire inflation pressure



① Maximum permissible tire inflation pressure

i For illustration purposes only. Actual data on tires are specific to each vehicle and may vary from data shown in above illustration.

This is the maximum permissible tire inflation pressure for the tire.

Tires and wheels

Always follow the recommended tire inflation pressure (▷ page 340) for proper tire inflation.

Warning!



Never exceed the max. tire inflation pressure. Follow recommended tire inflation pressures.

Do not underinflate tires. Underinflated tires wear excessively and/or unevenly, adversely affect handling and fuel economy, and are more likely to fail from being overheated.

Do not overinflate tires. Overinflated tires can adversely affect handling and ride comfort, wear unevenly, increase stopping distance, and result in sudden deflation (blowout) because they are more likely to become punctured or damaged by road debris, potholes etc.

Uniform Tire Quality Grading Standards (U.S. vehicles)

Tire manufacturers are required to grade tires based on three performance factors: treadwear, traction and temperature resistance.

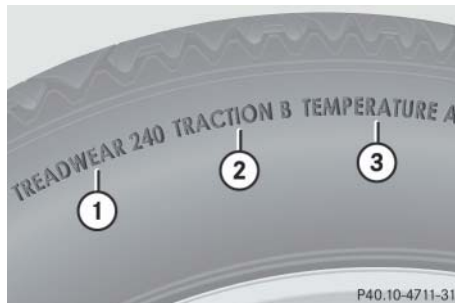

- ① Treadwear
- ② Traction
- ③ Temperature resistance

i For illustration purposes only. Actual data on tires are specific to each vehicle and may vary from data shown in above illustration.

Quality grades can be found, where applicable, on the tire sidewall between tread shoulder and maximum section width. For example:

Treadwear	Traction	Temperature
200	AA	A

All passenger car tires must conform to federal safety requirements in addition to these grades.

Treadwear

The treadwear grade is a comparative rating based on the wear rate of the tire when tested under controlled conditions on a specified government test course. For example, a tire graded 150 would wear one and one-half ($1\frac{1}{2}$) times as well on the government course as a tire graded 100. The relative performance of tires depends upon the actual conditions of their use, however, and may depart significantly

from the norm due to variations in driving habits, service practices and differences in road characteristics and climate.

Traction

The traction grades, from highest to lowest, are AA, A, B, and C. Those grades represent the tire's ability to stop on wet pavement as measured under controlled conditions on specified government test surfaces of asphalt and concrete. A tire marked C may have poor traction performance.

Warning!



The traction grade assigned to this tire is based on straight-ahead braking traction tests, and does not include acceleration, cornering, hydroplaning, or peak traction characteristics.

Temperature

The temperature grades are A (the highest), B, and C, representing the tire's resistance to the generation of heat and its ability to dissipate heat when tested under controlled conditions on a specified indoor laboratory test wheel. Sustained high temperature can cause the material of the tire to degenerate and reduce tire life, and excessive temperature can lead to sudden tire failure. The grade C corresponds to a level of performance which all passenger car tires must meet under the Federal Motor Vehicle Safety Standard No. 109. Grades B and A represent higher levels of performance on the laboratory test wheel than the minimum required by law.

Warning!



The temperature grade for this tire is established for a tire that is properly inflated and not overloaded. Excessive speed, underinflation, or excessive loading, either separately or in combination, can cause excessive heat build-up and possible tire failure.

Tires and wheels

Tire ply material

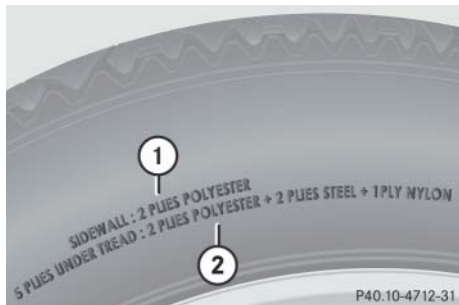

- ① Plies in sidewall
- ② Plies under tread

i For illustration purposes only. Actual data on tires are specific to each vehicle and may vary from data shown in above illustration.

This marking tells you about the type of cord and number of plies in the sidewall and under the tread.

Tire and loading terminology

Accessory weight

The combined weight (in excess of those standard items which may be replaced) of automatic transmission, power steering, power brakes, power windows, power seats, radio, and heater, to the extent that these items are available as factory-installed equipment (whether installed or not).

Air pressure

The amount of air inside the tire pressing outward on each square inch of the tire. Air pressure is expressed in pounds per square inch (psi), or kilopascal (kPa) or bar.

Aspect ratio

Dimensional relationship between tire section height and section width expressed in percentage.

Bar

Another metric unit for air pressure. There are 14.5038 pounds per square inch (psi) to 1 bar; there are 100 kilopascals (kPa) to 1 bar.

Bead

The tire bead contains steel wires wrapped by steel cords that hold the tire onto the rim.

Cold tire inflation pressure

Tire inflation pressure when your vehicle has been sitting for at least 3 hours or driven no more than 1 mile (1.6 km).

Curb weight

The weight of a motor vehicle with standard equipment including the maximum capacity of fuel, oil, and coolant, and, if so equipped, air conditioning and additional optional equipment, but without passengers and cargo.

DOT (Department of Transportation)

A tire branding symbol which denotes the tire meets requirements of the U.S. Department of Transportation.

GAWR (Gross Axle Weight Rating)

The GAWR is the maximum permissible axle weight. The gross vehicle weight on each axle must never exceed the GAWR for the front and rear axle indicated on the certification label located on the driver's door B-pillar.

GVW (Gross Vehicle Weight)

The GVW comprises the weight of the vehicle including fuel, tools, spare wheel, installed accessories, passengers and cargo and, if applicable, trailer tongue load. The GVW must never exceed the GVWR indicated on the certification label located on the driver's door B-pillar.

GVWR (Gross Vehicle Weight Rating)

This is the maximum permissible vehicle weight of the fully loaded vehicle (weight of the vehicle including all options, passengers, fuel, and cargo and, if applicable, trailer tongue load). It is indicated on certification label located on the driver's door B-pillar.

Kilopascal (kPa)

The metric unit for air pressure. There are 6.9 kPa to 1 psi; another metric unit for air pressure is bar. There are 100 kilopascals (kPa) to 1 bar.

Maximum load rating

The maximum load in kilograms and pounds that can be carried by the tire.

Maximum loaded vehicle weight

The sum of curb weight, accessory weight, total load limit, and production options weight.

Maximum tire inflation pressure

This number is the greatest amount of air pressure that should ever be put in the tire under normal driving conditions.

Normal occupant weight

The number of occupants the vehicle is designed to seat, multiplied by 68 kilograms (150 lb).

Occupant distribution

The distribution of occupants in a vehicle at their designated seating positions.

Production options weight

The combined weight of those installed regular production options weighing over 5 lb (2.3 kilograms) in excess of those standard items which they replace, not previously considered in curb weight or accessory weight, including heavy duty brakes, ride levelers, roof rack, heavy duty battery, and special trim.

Tires and wheels

PSI (Pounds per square inch)

A standard unit of measure for air pressure
-> bar, kilopascal (kPa).

Recommended tire inflation pressure

Recommended tire inflation pressure listed on Tire and Loading Information placard located on driver's door B-pillar for normal driving conditions. Provides best handling, tread life and riding comfort.

Rim

A metal support for a tire or a tire and tube assembly upon which the tire beads are seated.

Sidewall

The portion of a tire between the tread and the bead.

TIN (Tire Identification Number)

Unique identifier which facilitates efforts by tire manufacturers to notify purchasers in recall situations or other safety matters concerning tires and gives purchases the means to easily identify such tires. The TIN is comprised of "Manufacturer's identification mark", "Tire size", "Tire type code" and "Date of manufacture".

Tire load rating

Numerical code associated with the maximum load a tire can support.

Tire ply composition and material used

This indicates the number of plies or the number of layers of rubber-coated fabric in the tire tread and sidewall. Tire manufacturers also must indicate the ply materials in the tire and sidewall, which include steel, nylon, polyester, and others.

Tire speed rating

Part of tire designation; indicates the speed range for which a tire is approved.

Total load limit

Rated cargo and luggage load plus 68 kilograms (150 lb) times the vehicle's designated seating capacity.

Traction

Force exerted by the vehicle on the road via the tires. The amount of grip provided.

Tread

The portion of a tire that comes into contact with the road.

Treadwear indicators

Narrow bands, sometimes called "wear bars" that show across the tread of a tire when only $\frac{1}{16}$ in (1.6 mm) of tread remains.

Uniform Tire Quality Grading Standards

A tire information system that provides consumers with ratings for a tire's traction, temperature and treadwear. Ratings are determined by tire manufacturers using government testing procedures. The ratings are molded into the sidewall of the tire.

Vehicle maximum load on the tire

Load on an individual tire that is determined by distributing to each axle its share of the maximum loaded vehicle weight and dividing it by two.

Rotating tires

Warning!



Rotate front and rear wheels only if the tires are of the same dimension.

If your vehicle is equipped with mixed-size tires (different tire dimensions front vs. rear), tire rotation is not possible.

Tire rotation can be performed on vehicles with tires of the same dimension all around. If your vehicle is equipped with tires of the same dimension all around, tires can be rotated, observing a front-to-rear rotation pattern that will maintain the intended rotation (spinning) direction of the tire (▷ page 335).

In some cases, such as when your vehicle is equipped with mixed-size tires (different tire dimension front vs. rear), tire rotation is not possible.

If applicable to your vehicle's tire configuration, tires can be rotated according to the tire manufacturer's recommended intervals in the tire manufacturer's warranty pamphlet located in your vehicle literature portfolio. If none is available, tires should be rotated every 3000 to 6000 miles (5000 to 10000 km), or sooner if necessary, according to the degree of tire wear. The same rotation (spinning) direction must be maintained (▷ page 335).

Rotate tires before the characteristic tire wear pattern becomes visible (shoulder wear on front tires and tread center wear on rear tires).

Thoroughly clean the mounting face of wheels and brake disks, i.e. the inner side of the wheels/tires, during each rotation. Check for and ensure proper tire inflation pressure.

Tires and wheels

Warning!



Have the tightening torque checked after changing a wheel. Wheels could become loose if not tightened with a torque of 96 lb-ft (130 Nm).

Only use Genuine Mercedes-Benz wheel bolts specified for your vehicle's rims.

For information on wheel change, see the “Practical hints” section (▷ page 433) and (▷ page 456).

▼ Winter driving

Before the onset of winter, have your vehicle winterized at an authorized Mercedes-Benz Center. This service includes:

- Check of anticorrosion and antifreeze concentration.
- Addition of cleaning concentrate to the water of the windshield and headlamp cleaning system.

Add MB Concentrate “S” to a premixed windshield washer solvent/antifreeze which is formulated for temperatures below freezing point (▷ page 494).

- Battery test. Battery capacity drops with decreasing ambient temperature. A well charged battery helps to make sure that the engine can be started even at low ambient temperatures.
- Tire change.

Winter tires

Always use winter tires at temperatures below 45°F (7°C) and whenever wintry road conditions prevail. Not all M+S rated tires provide special winter performance. Make sure the tires you use show the mountain/snowflake  marking on the tire sidewall. These tires meet specific snow traction performance requirements of the Rubber Manufacturers Association (RMA) and the Rubber Association of Canada (RAC) and have been designed specifically for use in snow conditions. Use of winter tires is the only way to achieve the maximum effectiveness of the ABS, ESP® and 4MATIC in winter operation.

For safe handling, make sure that all mounted winter tires are of the same make and have the same tread design.

Warning!



Winter tires with a tread depth of less than $\frac{1}{6}$ in (4 mm) must be replaced. They are no longer suitable for winter operation.

Always observe the speed rating of the winter tires installed on your vehicle. If the maximum speed for which your tires are rated is below the speed rating of your vehicle, you must place a notice to this effect where it will be seen by the driver. Such notices are available at your tire dealer or any authorized Mercedes-Benz Center.

Warning!



If you use your spare tire when winter tires are fitted on the other wheels, be aware that the difference in tire characteristics may very well impair turning stability and that overall driving stability may be reduced. Adapt your driving style accordingly.



Winter driving

- ▷▷ Have the spare tire replaced with a winter tire at the nearest authorized Mercedes-Benz Center.

Block heater* (Canada only)

The engine is equipped with a block heater.

The electrical cable may be installed at an authorized Mercedes-Benz Center.

Snow chains

! *When driving with snow chains, always select the raised level of the level control system Airmatic (▷ page 262). Other settings may result in damage to your vehicle.*

! *Even on vehicles with all-wheel-drive, use snow chains on rear tires only.*

Some tire sizes do not leave adequate clearance for snow chains. To help avoid serious damage to your vehicle or tires, make sure that the use of snow chains is permissible as specified in the "Technical data" section of this Operator's Manual, see "Rims and tires" (▷ page 480).

Snow chains should only be driven on snow-covered roads at speeds not to exceed 30 mph (50 km/h). Remove chains as soon as possible when driving on roads without snow.

Please observe the following guidelines when using snow chains:

- Use of snow chains is not permissible with all wheel/tire combinations (▷ page 480).
- Use snow chains in pairs and on rear wheels only. Follow the manufacturer's mounting instructions.

! *If snow chains are mounted to the front wheels, they may scrape against the body or axle components. The tires or the vehicle could be damaged as a result.*

- Only use snow chains that are approved by Mercedes-Benz. Any authorized Mercedes-Benz Center will be glad to advise you on this subject.

- Use of snow chains may be prohibited depending on location. Always check local and state laws before installing snow chains.
- Do not use snow chains on the spare wheel (▷ page 483).

i *When driving with snow chains, you may wish to switch off the ESP® (▷ page 102) before setting the vehicle in motion. This will improve the vehicle's traction.*

i *E 63 AMG: Do not switch off the ESP® when driving in snow or with snow chains mounted.*

▼ Maintenance

We strongly recommend that you have your vehicle serviced by an authorized Mercedes-Benz Center, in accordance with the Maintenance Booklet at the times called for by the maintenance service indicator display.

Failure to have the vehicle maintained in accordance with the Maintenance Booklet and maintenance service indicator at the designated times/mileage will result in vehicle damage not covered by the Mercedes-Benz Limited Warranty.

Maintenance service indicator message

The maintenance service indicator will notify you when the next maintenance service is due.

Starting approximately 1 month before maintenance service is due, one of the following messages will appear in the multifunction display while you are driving or when you switch on the ignition (example service A):

Service A in XXXX miles (Km)

Service A in XXX days

Service A in X day

Service A due now

The maintenance services will be indicated by showing a service type A through type H in the multifunction display. Types A through H are classified based on estimated time needed to perform the maintenance service, ranging:

from Service A
(approximately 1 hour)

to Service H
(approximately 8 hours)

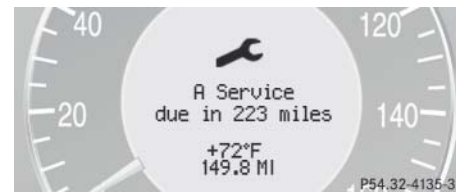

Refer to Maintenance Booklet for a listing of maintenance services and intervals they need to be performed at.

i *Vehicles equipped with Maintenance System only (U.S. vehicles. Canada vehicles, depending on vehicle production date):*

The Maintenance System in your vehicle tracks distance driven and the time elapsed since the last maintenance service and calculates other maintenance service work required.

i Vehicles equipped with FSS PLUS (Flexible Service System PLUS) only (Canada vehicles, depending on vehicle production date):

- FSS PLUS evaluates engine temperature, oil level, vehicle speed, engine speed, distance driven and the time elapsed since the last service and calculates other maintenance service work required.
- The interval between maintenance services depends on your driving habits. A gentle driving style, moderate engine speeds and the avoidance of short-distance trips will lengthen the interval between services.

Clearing the maintenance service indicator message

The maintenance service indicator message is automatically cleared

- after approximately 10 seconds, when you switch on the ignition or when reaching the service threshold while driving
- after approximately 30 seconds, once the suggested maintenance service term has passed

You can also clear it yourself:



- ▶ Press the reset button ① on the left side of the instrument cluster.

The maintenance service indicator message is cleared and the standard display appears in the multifunction display (▷ page 155).

Maintenance service term exceeded

If you have exceeded the suggested maintenance service term, you will see the following message in the multifunction display:





Service A exceeded by XXXXX miles (Km)
Service A exceeded by XXX days
Service A exceeded by X day

In addition, a signal sounds when the message appears.

Any authorized Mercedes-Benz Center will reset the maintenance service indicator following a completed maintenance service.

Calling up the maintenance service indicator display

You can call up the maintenance service indicator display at any time to check when the next maintenance service is due.

- ▶ Switch on the ignition (▷ page 38).
- ▶ Press button  or  on the multifunction steering repeatedly until the standard display appears in the multifunction display (▷ page 155).
- ▶ Press button  or  until the maintenance service indicator display with the service symbol  and the service deadline appears in the multifunction display.

i *If the battery is disconnected, the days of disconnection will not be included in the count shown by the maintenance service indicator. To arrive at the true maintenance service deadline, you will need to subtract these days from the days shown in the maintenance service indicator message or maintenance service indicator display.*

Do not confuse the maintenance service indicator with the engine oil level indicator .

Resetting the maintenance service indicator

In the event that the maintenance service on your vehicle is not carried out by an authorized Mercedes-Benz Center, you can have the maintenance service indicator reset. The automotive maintenance facility carrying out the maintenance service will find the information for resetting the maintenance service indicator in the maintenance-relevant information for your vehicle. Such information is available from either your authorized Mercedes-Benz Center or directly from Mercedes-Benz.

i *If the maintenance service indicator was inadvertently reset, have an authorized Mercedes-Benz Center correct it.*

Only reset if the proper maintenance service has been performed. Resetting the system without performing the proper service as called for by the maintenance service indicator will result in engine damage and/or other vehicle damage not covered by the Mercedes-Benz Limited Warranty.

Cleaning and care of vehicle

Warning!



Many cleaning products can be hazardous. Some are poisonous, others are flammable. Always follow the instructions on the particular container. Always open your vehicle's doors or windows when cleaning the inside.

Never use fluids or solvents that are not designed for cleaning your vehicle.

Always lock away cleaning products and keep them out of reach of children.

While in operation, even while parked, your vehicle is subjected to varying external influences which, if gone unchecked, can attack the paintwork as well as the vehicle underbody and cause lasting damage.

Such damage is caused not only by extreme and varying climatic conditions, but also by:

- Air pollution
- Road salt
- Tar
- Gravel and stone chipping

To avoid paint damage, you should immediately remove:

- Grease and oil
- Fuel
- Coolant
- Brake fluid
- Bird droppings
- Insects
- Tree resins etc.

Frequent washing reduces and/or eliminates the aggressiveness and potency of the above adverse influences.

More frequent washings are necessary to deal with unfavorable conditions:

- near the ocean
- in industrial areas (smoke, exhaust emissions)
- during winter operation

You should check your vehicle from time to time for stone chipping or other damage. Any damage should be repaired as soon as possible to prevent corrosion.

In doing so, do not neglect the underbody of the vehicle. A prerequisite for a thorough check is a washing of the underbody followed by a thorough inspection. Damaged areas need to be re-undercoated.

Your vehicle has been treated at the factory with a wax-base rustproofing in the body cavities which will last for the lifetime of the vehicle. Post-production treatment is neither necessary nor recommended by Mercedes-Benz because of the possibility of incompatibility between materials used in the production process and others applied later.

We have selected car-care products and compiled recommendations which are specially matched to our vehicles and which always reflect the latest technology. You can obtain Mercedes-Benz approved car-care products at an authorized Mercedes-Benz Center.

Scratches, corrosive deposits, corrosion or damage due to negligent or incorrect care cannot always be removed or repaired with the car-care products recommended here. In such cases it is best to seek aid at an authorized Mercedes-Benz Center.

The following topics deal with the cleaning and care of your vehicle and give important “how-to” information as well as references to Mercedes-Benz approved car-care products.

Power washer

! Follow the instructions provided by the power washer manufacturer on maintaining a distance between the vehicle and the nozzle of the power washer.

Never use a round nozzle to power-wash tires. The intense jet of water can result in damage to the tire.

Always replace a damaged tire.

Always keep the jet of water moving across the surface. Do not aim directly at electrical parts, electrical connectors, seals, or other rubber parts.

i *Vehicles with KEYLESS-GO*: If a door handle is hit by a strong jet of water, and a SmartKey with KEYLESS-GO* is in close proximity, i.e. within approximately 3 ft (approximately 1 m), the vehicle could be inadvertently locked or unlocked.*

Tar stains

Quickly remove tar stains before they dry and become more difficult to remove. A tar remover is recommended.

Paintwork, painted body components

! *Affixing stickers, magnets, adhesive tape or similar materials to painted body components may damage the paintwork.*

Mercedes-Benz approved Paint Care should be applied when water drops on the paint surface do not “bead up”. This should normally be done every 3 to 5 months, depending on the climate and washing detergent used.

Mercedes-Benz approved Paint Cleaner should be applied if the paint surface shows signs of embedded dirt (i.e. loss of gloss).

Do not apply any of these products or wax if your vehicle is parked in the sun or if the hood is still hot.

- ▶ Use the appropriate MB-Touch-Up Stick for quick and provisional repairs of minor paint damage (i.e. chips from stones, vehicle doors, etc.).

Vehicle care

Engine cleaning

Prior to cleaning the engine compartment, make sure to protect electrical components and connectors from contact with water and cleaning agents.

Corrosion protection, such as MB Anticorrosion Wax should be applied to the engine compartment after every engine cleaning. Before applying, all control linkage bushings and joints should be lubricated. The poly-V-belt and all pulleys should be protected from any wax.

Vehicle washing

In the winter, thoroughly remove all traces of road salt as soon as possible.

When washing the vehicle underbody, do not forget to clean the inner sides of the wheels.

i *Vehicles with KEYLESS-GO*:
If a door handle is hit by a strong jet of water, and a SmartKey with KEYLESS-GO* is in close proximity, i.e. within approximately 3 ft (approximately 1 m), the vehicle could be inadvertently locked or unlocked.*

Hand-wash

Do not use hot water or wash your vehicle in direct sunlight.

- ▶ Only use a mild car wash detergent, such as Mercedes-Benz approved Car Shampoo.
- ▶ Thoroughly spray the vehicle with a diffused jet of water.

Direct only a very weak spray towards the ventilation intake.

- ▶ Use plenty of water and rinse the sponge and chamois frequently.
- ▶ Rinse with clean water and thoroughly dry with a chamois.

Do not allow cleaning agents to dry on the finish.

! *Do not use scouring agents on these parts.*

Never apply strong force and only use a soft, non-scratching cloth when cleaning the vehicle. Do not attempt to wipe the surface with a dry cloth or sponge.

Otherwise you may scratch or damage the paint.

Automatic car wash

You can have your car washed in an automatic car wash from the start. Automatic car washes without brushes are preferable.

- ▶ To protect the filter system, switch the automatic climate control to air recirculation mode (▷ page 216) or (▷ page 233).

! *Do not clean your vehicle in an automatic touchless car wash which uses caustic spray. Otherwise the caustic spray will damage the paint or ornamental moldings.*

If the vehicle is very dirty, prewash it before running it through the automatic car wash.

! Make sure that the windshield wiper switch is set to **0** (▷ page 58). Otherwise, e.g. the rain sensor could activate and cause the wipers to move unintentionally. This may lead to vehicle damage.

Due to the width of the vehicle, fold in exterior rear view mirrors prior to running the vehicle through an automatic car wash to prevent damage to the mirrors.

i After running the vehicle through an automatic car wash, wipe any wax off of the windshield (▷ page 372) and the wiper blade inserts (▷ page 372). This will prevent smears and reduce wiping noise which can be caused by residual wax on the windshield.

When leaving the car wash, make sure that the mirrors are folded out. Otherwise they may vibrate.

Ornamental moldings

For regular cleaning and care of ornamental moldings, use a damp cloth.

! Do not use chrome cleaner on ornamental moldings. Although ornamental moldings may have chrome appearance, they could be made of anodized aluminum that will be damaged when cleaned with chrome cleaner. Instead, use a damp cloth to clean those ornamental moldings.

For very dirty ornamental moldings of which you are sure are chrome-plated, use a chrome cleaner. If in doubt whether an ornamental molding is chrome-plated, contact an authorized Mercedes-Benz Center.

Headlamps, tail lamps, side markers, turn signal lenses

► Use a mild car wash detergent, such as Mercedes-Benz approved Car Shampoo, with plenty of water.

! Only use window cleaning solutions that are suitable for plastic lamp lenses. Window cleaning solutions which are not suitable may damage the plastic lamp lenses of the headlamps. Therefore, do not use abrasives, solvents or cleaners that contain solvents.

Never apply strong force and only use a soft, non-scratching cloth when cleaning the lenses. Do not attempt to wipe dirty lenses with a dry cloth or sponge.

Otherwise you may scratch or damage the lens surface.

Vehicle care

Cleaning the DISTRONIC* system sensor cover



① DISTRONIC system sensor cover

- ▶ Switch off the ignition (▷ page 38).
- ▶ Use a mild car wash detergent, such as Mercedes-Benz approved Car Shampoo, with plenty of water and a non-scratching cloth to clean sensor cover ①.

! *To prevent scratches or damage, never apply strong force and only use a soft, non-scratching cloth when cleaning the sensor cover ①. Do not attempt to wipe dirty sensors with a dry cloth or sponge.*

- ▶ Restart the engine after cleaning sensor cover ①.

Cleaning the windows and the wiper blades

! *The windshield wipers must be in a vertical position before folding them away from the windshield. They could otherwise damage the hood.*

Never open the hood when the wiper arms are folded forward.

- ▶ Make sure the hood is fully closed.
- ▶ Switch on the ignition (▷ page 38).
- ▶ Turn combination switch to wiper setting  (▷ page 58).
- ▶ With wiper arms in vertical position, switch off the ignition (▷ page 63).

Warning!



For safety reasons, switch off wipers and remove SmartKey from starter switch (vehicles with KEYLESS-GO*): Make sure the vehicle's on-board electronics have status **0** before cleaning the windshield and/or the wiper blades. Otherwise, the wiper motor could suddenly turn on and cause injury.

! *Do not pull on the wiper blade inserts. They could tear.*

- ▶ Fold the wiper arms forward until they snap into place.
- ▶ Clean the wiper blade inserts with a clean cloth and detergent solution.
- ▶ Use a soft, clean cloth and a mild window cleaning solution on all outside and inside glass surfaces.

An automotive glass cleaner is recommended.

! Fold the windshield wiper arms back onto the windshield before turning the SmartKey in the starter switch or pressing the KEYLESS-GO start/stop button (vehicles with KEYLESS-GO*).

Hold on to the wiper when folding the wiper arm back. If released, the force of the impact from the tensioning spring could crack the windshield.

! To clean the window interior, do not use a dry cloth, abrasives, solvents or cleaners containing solvents. Do not touch the inside of the front, rear or side windows with hard objects such as an ice scraper or ring. Doing so may damage the windows.

Light alloy wheels

If possible, clean wheels once a week.

► Use Mercedes-Benz approved Wheel Care, a soft bristle brush and a strong spray of water for cleaning the light alloy wheels.

! Only use acid-free cleaning materials. Acid may cause corrosion or damage the clear coat.

! The vehicle should not be parked for an extended period of time immediately after it has been cleaned, especially not after the wheel rims have been cleaned with wheel rim cleaner. Wheel rim cleaners can lead to increased corrosion of the brake disks and brake pads. Non-approved wheel cleaners may also damage the wheel paint if the car is not driven after cleaning. Therefore, the vehicle's brake system should always be warmed-up before it is parked after cleaning. To do so, please drive your vehicle for several minutes to allow the brakes to dry. When applying Mercedes-Benz approved Tire Care and Mercedes-Benz approved Wheel Care products, take care not to spray them on the brake disks.

Plastic and rubber parts

- Use a gentle dishwashing detergent or mild detergent for delicate fabrics as a washing solution.
- Wipe with a cloth moistened in a luke-warm solution.

The surface may temporarily change color. If this is the case, wait for it to dry.

Warning!



Do not use cleaners or cockpit care sprays containing solvents to clean the cockpit or the steering wheel. Cleaners containing solvents will make the surface porous and vehicle occupants could suffer serious injuries from plastic parts coming loose in the event of air bag deployment.



Vehicle care

▷▷ **!** Do not use oil, wax or scouring agents on these parts.

Never apply strong force and only use a soft, non-scratching cloth when cleaning the surface. Do not attempt to wipe the surface with a dry cloth or sponge.

Otherwise you may scratch or damage the surface.

Hard plastic trim items

- ▶ Use Mercedes-Benz approved Interior Care, a soft, lint-free cloth and apply with light pressure.

! To prevent scratches, do not use scouring agents.

Steering wheel and gear selector lever

- ▶ Wipe with a damp cloth and dry thoroughly or clean with Mercedes-Benz approved Leather Care.

Carpets

- ▶ Use Mercedes-Benz approved Carpet and Fabric Care for cleaning the carpets.

Headliner and shelf below rear window

- ▶ Use a soft bristle brush or a dry-shampoo cleaner in case of excessive dirt.

Seat belts

- ▶ Only use clear, lukewarm water and soap.

! The seat belts must not be treated with chemical cleaning agents. Do not dry the seat belts at temperatures above 176 °F (80 °C) or in direct sunlight.

Warning!



Do not bleach or dye seat belts as this may severely weaken them. In a crash they may not be able to provide adequate protection.

Upholstery

Using aftermarket seat covers or wearing clothing that have the tendency to give off coloring (e.g. when wet, etc.) may cause the upholstery to become permanently discolored. By lining the seats with a proper intermediate cover, contact-discoloration will be prevented.

Warning!



Only use seat or head restraint covers which have been tested and approved by Mercedes-Benz for your vehicle model. Using other seat or head restraint covers may interfere with or prevent the activation of the active head restraints. Contact an authorized Mercedes-Benz Center for availability.

Leather upholstery

Please note that leather upholstery is a natural product and is therefore subject to a natural aging process. Leather upholstery may also react to certain ambient influences such as high humidity or high temperature by showing wrinkles for example.

- ▶ Wipe leather upholstery with a damp cloth and dry thoroughly or clean with Mercedes-Benz approved Leather Care.

! *Wipe with light pressure to avoid damage to the upholstery.*

Exercise particular care when cleaning perforated leather as its underside should not become wet.

Wood trims

- ▶ Dampen cloth using water and use damp cloth to clean wood trims in your vehicle.

! *Do not use solvents like tar remover or wheel cleaner nor polishes or waxes as these may be abrasive.*



What to do if ...

Where will I find ...?

Unlocking/locking in an emergency

Opening/closing in an emergency

Resetting activated head restraints

Replacing SmartKey batteries

Replacing bulbs

Replacing wiper blades

Flat tire

Battery

Jump starting

Towing the vehicle

Fuses

What to do if ...

Lamps in instrument cluster

General information:

If any of the following lamps in the instrument cluster fails to come on during the

bulb self-check when switching on the ignition, have the respective bulb checked and replaced if necessary.

Problem	Possible cause/consequence	Suggested solution
 <p>The yellow ABS indicator lamp comes on while the engine is running.</p>	<p>The ABS has detected a malfunction and has switched off. The BAS, ESP®, EBP and PRE-SAFE® are also switched off (see messages in the multifunction display).</p> <p>The brake system is still functioning normally but without the ABS available.</p> <p>If the ABS control unit is malfunctioning, other systems such as DISTRONIC*, or the automatic transmission may also be malfunctioning.</p> <p>The charging voltage has fallen below 10 volts. The ABS has switched off.</p> <p>The battery might not be charged sufficiently.</p>	<ul style="list-style-type: none"> ▶ Continue driving with added caution. Wheels may lock during hard braking, reducing steering capability. ▶ Read and observe messages in the multifunction display (▷ page 394). ▶ Have the system checked at an authorized Mercedes-Benz Center as soon as possible. <p>Failure to follow these instructions increases the risk of an accident.</p> <p>When the voltage is above this value again, the ABS is operational again and the ABS indicator lamp should go out.</p> <p>If the ABS indicator lamp does not go out:</p> <ul style="list-style-type: none"> ▶ Have the generator (alternator) and the battery checked.

Problem	Possible cause/consequence	Suggested solution
 The yellow ESP® warning lamp comes on while the engine is running.	<p>The ESP® has been switched off.</p> <p>Risk of accident!</p> <p>When the ESP® is switched off it will not stabilize the vehicle if the system recognizes that the vehicle starts to skid or that a wheel is spinning.</p>	<ul style="list-style-type: none"> ▶ Switch the ESP® back on (▷ page 104). Exceptions: (▷ page 102). ▶ If leaving the ESP® switched off, adapt your speed and driving to the prevailing road and weather conditions. <p>If the ESP® cannot be switched back on:</p> <ul style="list-style-type: none"> ▶ Have the system checked at an authorized Mercedes-Benz Center as soon as possible.
	<p>The ESP® is not operational due to a malfunction.</p> <p>Risk of accident!</p>	<ul style="list-style-type: none"> ▶ Observe additional messages in the multifunction display. ▶ Continue driving with added caution. ▶ Adapt your speed and driving to the prevailing road and weather conditions. ▶ Have the system checked at an authorized Mercedes-Benz Center as soon as possible.

What to do if ...

Problem	Possible cause/consequence	Suggested solution
 <p>The yellow ESP® warning lamp flashes while driving.</p>	<p>The ESP® or traction control has come into operation because of detected traction loss in at least one tire.</p> <p>The cruise control and the DISTRONIC* system are deactivated.</p>	<ul style="list-style-type: none">▶ When driving off, apply as little throttle as possible.▶ While driving, ease up on the accelerator.▶ Adapt your speed and driving to the prevailing road and weather conditions.▶ Do not deactivate the ESP®. Exceptions: (▷ page 102). <p>Failure to follow these instructions increases the risk of an accident.</p>

Problem		Possible cause/consequence	Suggested solution
BRAKE	(USA only)	The red brake warning lamp comes on while driving and you hear a warning sound.	<ul style="list-style-type: none"> ▶ Release the parking brake. ▶ Observe the additional message in the multifunction display.
	(Canada only)	The red brake warning lamp comes on while the engine is running and you hear a warning sound.	
		There is insufficient brake fluid in the reservoir.	<ul style="list-style-type: none"> ▶ Risk of accident! Do not drive any further. Consult a Mercedes-Benz Service Center. Under no circumstances should you top up the brake fluid. This will not solve the problem.

Warning!





Driving with the brake warning lamp illuminated can result in an accident. Have your brake system checked immediately if the brake warning lamp stays on. Do not add brake fluid before checking the brake system.



Overfilling the brake fluid reservoir can result in spilling brake fluid on hot engine parts and the brake fluid catching fire. You can be seriously burned.

! *If you find that the brake fluid in the brake fluid reservoir has fallen to the minimum mark or below, have the brake system checked for brake pad thickness and leaks.*

What to do if ...

Problem	Possible cause/consequence	Suggested solution
<div data-bbox="86 228 145 262"></div> <div data-bbox="193 232 309 258">(USA only)</div> <div data-bbox="86 273 145 306"></div> <div data-bbox="193 277 344 303">(Canada only)</div> <p data-bbox="193 322 448 412">The yellow engine malfunction indicator lamp comes on while driving.</p>	<p data-bbox="475 232 847 258">There may be a malfunction in the</p> <ul data-bbox="475 277 858 441" style="list-style-type: none"> <li data-bbox="475 277 788 303">• fuel management system <li data-bbox="475 322 679 348">• ignition system <li data-bbox="475 367 778 393">• emission control system <li data-bbox="475 412 858 437">• systems which affect emissions <p data-bbox="475 456 954 580">Such malfunctions may result in excessive emissions values and may switch the engine to its limp-home (emergency operation) mode.</p>	<p data-bbox="970 232 1489 512">▶ Have the vehicle checked as soon as possible by an authorized Mercedes-Benz Center. An on-board diagnostic connector is used by the service station to link the vehicle to the shop diagnostics system. It allows the accurate identification of system malfunctions through the readout of diagnostic trouble codes. It is located in the front left area of the footwell next to the parking brake.</p>

 *Some states may by law require you to visit a workshop immediately as soon as the engine malfunction indicator lamp comes on. Check local requirements.*

Problem	Possible cause/consequence	Suggested solution
<p> (USA only)</p> <p> (Canada only)</p> <p>The yellow engine malfunction indicator lamp comes on while driving.</p>	<p>A loss of pressure has been detected in the fuel system. The fuel cap may not be closed properly or the fuel system may be leaky.</p>	<ul style="list-style-type: none"> ▶ Check the fuel cap. <p>If it is not closed properly:</p> <ul style="list-style-type: none"> ▶ Close the fuel cap. <p>If it is closed properly:</p> <ul style="list-style-type: none"> ▶ Have the fuel system checked by an authorized Mercedes-Benz Center.
	<p>Your fuel tank is empty.</p>	<ul style="list-style-type: none"> ▶ After refuelling start, turn off and restart the engine three or four times in succession. <p>The limp-home mode is canceled. You do not need to have your vehicle checked.</p>

What to do if ...

Problem	Possible cause/consequence	Suggested solution
 <p>The red coolant temperature warning lamp comes on when the engine is running.</p>	<p>There is insufficient coolant in the reservoir.</p> <p>If this warning lamp comes on frequently, there is a leak in the cooling system.</p> <p>If the coolant level is correct, the electric radiator fan may be broken.</p>	<ul style="list-style-type: none"> ▶ Immediately add coolant to prevent engine from overheating (▷ page 329). ▶ Have the cooling system checked. ▶ If the coolant temperature is below 248°F (120°C), you can continue driving to the nearest authorized Mercedes-Benz Center. ▶ Avoid high engine loads (e.g. driving uphill) and stop-and-go driving.
<p>The red coolant temperature warning lamp comes on while driving and you hear a warning sound.</p>	<p>The coolant temperature has exceeded 248°F (120°C).</p>	<ul style="list-style-type: none"> ▶ Stop as soon as possible in a safe location and allow the engine and coolant to cool down.



Warning!



Driving when your engine is overheated can cause some fluids which may have leaked into the engine compartment to catch fire. You could be seriously burned.

Steam from an overheated engine can cause serious burns which can occur just by opening the engine hood. Stay away from the engine if you see or hear steam coming from it.

Turn off the engine, get out of the vehicle and do not stand near the vehicle until the engine has cooled down.

Problem	Possible cause/consequence	Suggested solution
 Only vehicles with Distronic*: The red distance warning lamp comes on while driving.	You are too close to the vehicle in front of you to maintain selected speed.	<ul style="list-style-type: none"> ▶ Apply the brakes immediately to increase the following distance.
Only vehicles with Distronic*: The red distance warning lamp comes on while driving and you hear a warning chime sound.	<ul style="list-style-type: none"> • You are gaining too rapidly on the vehicle ahead of you. • The distance warning system has recognized a stationary obstacle on your probable line of travel. 	<ul style="list-style-type: none"> ▶ Apply the brakes immediately. ▶ Carefully observe the traffic situation. You may need to brake or maneuver to avoid hitting an obstacle.
 The yellow fuel tank reserve warning lamp comes on while driving.	The fuel level has gone below the reserve mark.	<ul style="list-style-type: none"> ▶ Refuel at the next gas station (▷ page 321).

What to do if ...

Problem	Possible cause/consequence	Suggested solution
 The red seat belt telltale comes on for a maximum of 6 seconds after starting the engine.	The seat belt telltale reminds you and your passengers to fasten your seat belts before driving off.	<ul style="list-style-type: none"> ▶ Fasten your seat belts. <p>Regardless of whether the seat belts are fastened or not, the seat belt telltale always comes on and remains lit for 6 seconds after starting the engine.</p>
You hear a warning chime for a maximum of 6 seconds after starting the engine.	You have forgotten to fasten your seat belt.	<ul style="list-style-type: none"> ▶ Fasten your seat belts. <p>The warning chime stops sounding.</p>
The red seat belt telltale comes on while the vehicle is standing still and the engine is running or during driving.	You and/or your front passenger have forgotten to fasten your seat belts.	<ul style="list-style-type: none"> ▶ Fasten your seat belts. <p>The seat belt telltale goes out.</p>
	There are items placed on the front passenger seat and therefore the system senses the front passenger seat as being occupied.	<ul style="list-style-type: none"> ▶ Remove the items from the front passenger seat and put them in a safe place. <p>The seat belt telltale goes out.</p>

Problem	Possible cause/consequence	Suggested solution
 <p>During driving the red seat belt telltale flashes and you additionally hear an intermittent warning chime with increasing intensity.</p>	<p>The vehicle's speed once exceeded 15 mph (25 km/h) and you and/or your front passenger have forgotten to fasten your seat belts.</p>	<p>► Fasten your seat belts. The seat belt telltale goes out and the warning chime stops sounding.</p>
	<p>There are items placed on the front passenger seat and therefore the system senses the front passenger seat as being occupied.</p>	<p>► Remove the items from the front passenger seat and put them in a safe place. The seat belt telltale goes out and the warning chime stops sounding.</p>

i After 60 seconds with an unfastened seat belt the warning chime stops sounding and the seat belt telltale illuminates continuously. The seat belt telltale will only go out if both, the driver and front passenger's seat belt are fastened, or the vehicle is standing still and a front door is opened.

What to do if ...

Problem	Possible cause/consequence	Suggested solution
SRS The red SRS indicator lamp comes on while driving.	There is a malfunction in the restraint systems. The air bags or Emergency Tensioning Devices (ETDs) could deploy unexpectedly or fail to activate in an accident.	► Drive with added caution to the nearest authorized Mercedes-Benz Center.

Warning!



In the event a malfunction of the SRS is indicated as outlined above, the SRS may not be operational. For your safety, we strongly recommend that you visit an authorized Mercedes-Benz Center immediately to have the system checked; otherwise the SRS may not be activated when needed in an accident, which could result in serious or fatal injury, or it might deploy unexpectedly and unnecessarily which could also result in an accident and/or injury to you or to others.

Problem	Possible cause/consequence	Suggested solution
 Low tire pressure telltale for the Advanced TPMS* illuminates continuously.	The Advanced TPMS* detects a loss of pressure in at least one tire.	<ul style="list-style-type: none">▶ Carefully bring the vehicle to a halt, avoiding abrupt steering and braking maneuvers. Observe the traffic situation around you.▶ Read and observe messages in the multifunction display. <p>If the tire inflation pressure in the respective tire(s) has (have) been corrected, the low tire pressure telltale goes out after few minutes driving.</p>

What to do if ...

Warning!





Each tire, including the spare (if provided), should be checked monthly when cold and inflated to the inflation pressure recommended by the vehicle manufacturer on the vehicle placard or the tire inflation pressure label. (If your vehicle has tires of a different size than the size indicated on the vehicle placard or the tire inflation pressure label, you should determine the proper tire inflation pressure for those tires).

As an added safety feature, your vehicle has been equipped with a tire pressure monitoring system (TPMS) that illuminates a low tire pressure telltale when one or more of your tires is significantly under-inflated. Accordingly, when the low tire pressure telltale illuminates, you should stop and check your tires as soon as possible, and inflate them to the proper pressure. Driving on a significantly under-inflated tire causes the tire to overheat and can lead to tire failure.

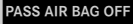

Under-inflation also reduces fuel efficiency and tire tread life, and may affect the vehicle's handling and stopping ability. Please note that the TPMS is not a substitute for proper tire maintenance, and it is the driver's responsibility to maintain correct tire pressure, even if under-inflation has not reached the level to trigger illumination of the TPMS low tire pressure telltale.

Lamp in center console



Problem	Possible cause/consequence	Suggested solution
(USA only)   The indicator lamp illuminates and remains illuminated with the weight of a typical adult or someone larger than a small individual on the front passenger seat.	The system is malfunctioning.	<ul style="list-style-type: none"> ▶ Have the system checked as soon as possible by an authorized Mercedes-Benz Center. ▶ Read and observe messages in the multifunction display and follow corrective steps (▷ page 401).

Warning!





If the   indicator lamp illuminates and remains illuminated with the weight of a typical adult or someone larger than a small individual on the front passenger seat, do not have any passenger use the front passenger seat until the system has been repaired.

What to do if ...

Problem	Possible cause/consequence	Suggested solution
<p>(USA only)</p> <p> </p> <p>The indicator lamp does not illuminate and/or does not remain illuminated with the weight of a typical 12-month-old child in a standard child restraint or less on the front passenger seat.</p>	<p>The system is malfunctioning.</p>	<ul style="list-style-type: none"> ▶ Make sure that there is nothing between seat cushion and child seat and check installation of the child seat. ▶ Make sure that no objects applying supplemental weight onto the seat are present. ▶ Make sure that no objects which apply forces to the seat are present (e.g. objects such as books, brief-cases etc. lodged behind or around the seat, head restraints pushing against roof etc.). The system may recognize such forces as supplemental weight. ▶ If the light remains out, have the system checked as soon as possible by an authorized Mercedes-Benz Center. Do not transport a child on the front passenger seat until the system has been repaired. ▶ Read and observe messages in the multifunction display and follow corrective steps (▷ page 401).



Warning!



If the   indicator lamp does not illuminate or remains out with the

weight of a typical 12-month-old child in a standard child restraint or less on the front passenger seat,

do not transport a child on the front passenger seat until the system has been repaired.

Problem	Possible cause/consequence	Suggested solution
<p>(Canada only)  </p> <p>The indicator lamp illuminates and remains illuminated (▷ page 81).</p>	<p>A BabySmart™ child seat is installed on the passenger seat. Therefore the front passenger front air bag is switched off.</p> <p>The system is malfunctioning when there is no BabySmart™ child seat installed on the passenger seat.</p>	<p>▶ Have the system checked at an authorized Mercedes-Benz Center as soon as possible.</p>
<p>The indicator lamp does not illuminate or does not remain illuminated with a BabySmart™ child seat properly installed on the passenger seat.</p>	<p>The system is malfunctioning.</p>	<p>▶ Make sure there is nothing between seat cushion and child seat.</p> <p>▶ Check installation of the child seat (▷ page 92).</p> <p>If the front passenger front air bag off indicator lamp remains out:</p> <p>▶ Have the system checked at an authorized Mercedes-Benz Center as soon as possible.</p> <p>Do not use the BabySmart™ restraint to transport children on the front passenger seat until the system has been repaired.</p>

What to do if ...

Vehicle status messages in the multifunction display





Warning and malfunction messages appear in the multifunction display located in the instrument cluster.





Certain warning and malfunction messages are accompanied by an audible signal.

Address these messages accordingly and follow the additional instructions given in this Operator's Manual.

Selecting the vehicle status message memory menu in the control system (▷ page 168) displays both cleared and uncleared messages.

High-priority messages appear in the multifunction display in red color.

Certain messages of high priority cannot be cleared from the multifunction display using the reset button (▷ page 152) or button , ,  or  on the multifunction steering wheel.

Other messages of high priority and messages of less immediate priority can be cleared from the multifunction display using the reset button (▷ page 152) or button , ,  or  on the multifunction steering wheel. They are then stored in the vehicle status message memory (▷ page 168). Remember that clearing a message will only make the message disappear. Clearing a message will not correct the condition that caused the message to appear.

Warning!



All categories of messages contain important information which should be taken note of and, where a malfunction is indicated, addressed as soon as possible at an authorized Mercedes-Benz Center.

Failure to repair condition noted may cause damage not covered by the Mercedes-Benz Limited Warranty, or result in property damage or personal injury.

Warning!

No messages will be displayed if either the instrument cluster or the multifunction display is inoperative.

As a result, you will not be able to see information about your driving conditions, such as speed or outside temperature, warning/indicator lamps, malfunction/warning messages or the failure of any systems. Driving characteristics may be impaired.

If you must continue to drive, please do so with added caution. Visit an authorized Mercedes-Benz Center as soon as possible.

i *Switching on the ignition causes all instrument cluster lamps (except low beam headlamp indicator lamp, high beam headlamp indicator lamp, and turn signal indicator lamps unless activated) as well as the multifunction display to come on. Make sure the lamps and multifunction display are in working order before starting your journey.*

On the pages that follow, you will find a compilation of the most important warning and malfunction messages that may appear in the multifunction display.

For your convenience the messages are divided into two sections:

- Text messages (▷ page 396)
- Symbol messages (▷ page 409)

What to do if ...

Text messages

Display message	Possible cause/consequence	Possible solution
<p>ABS</p> <p>ABS, ESP inoperative See Operator's Man.</p>	<p>ABS, ESP® as well as PRE-SAFE® have switched off due to a malfunction.</p> <p>BAS is also switched off.</p> <p>The brake system is still functioning normally but without the ABS, BAS, ESP® and PRE-SAFE® available.</p>	<ul style="list-style-type: none"> ▶ Continue driving with added caution. Wheels will lock during hard braking, reducing steering capability. ▶ Have the system checked at an authorized Mercedes-Benz Center as soon as possible. <p>Failure to follow these instructions increases the risk of an accident.</p>
<p>ABS, ESP unavailable See Operator's Man.</p>	<p>The ABS, ESP® as well as PRE-SAFE® were deactivated because of insufficient power supply. The charging voltage has fallen below 10 volts.</p> <p>BAS is also switched off.</p> <p>The brake system still functions normally but without the ABS, BAS, ESP® and PRE-SAFE® available.</p>	<p>When the voltage is above this value again, the ABS, ESP® and PRE-SAFE® are operational again and the message should disappear.</p> <p>If the message does not disappear:</p> <ul style="list-style-type: none"> ▶ Have the generator (alternator) and the battery checked.

Display message	Possible cause/consequence	Possible solution
Cruise control --- mph (USA only) --- km/h (Canada only)	You have tried to switch on cruise control below a speed of 20 mph (30 km/h).	► Drive faster than 20 mph (30 km/h) and save the speed.
DISTRONIC --- mph (USA only) --- km/h (Canada only)	You have tried to switch on Distronic below a speed of 20 mph (30 km/h).	► Drive faster than 20 mph (30 km/h) and save the speed.
inoperative	The Distronic* is malfunctioning or the display is malfunctioning.	► Visit an authorized Mercedes-Benz Center as soon as possible.

What to do if ...

Display message	Possible cause/consequence	Possible solution
DISTRONIC currently unavailable See Operator's Manual	DISTRONIC* is switched off and is temporarily unavailable. DISTRONIC* is deactivated if: <ul style="list-style-type: none"> • the DISTRONIC* cover in the radiator grille is dirty • its function is impaired by heavy precipitation or fog 	<ul style="list-style-type: none"> ▶ If necessary, clean the DISTRONIC* cover in the area of the radiator grille (▷ page 372). ▶ Restart the vehicle. or DISTRONIC* becomes operational again without the engine being restarted when: <ul style="list-style-type: none"> • dirt on the radiator grille has fallen off while driving (e.g. slush or snow) • the system recognizes full sensor availability (due to lessening rain or the road surface drying) • the message in the multifunction display disappears • the speed last stored flashes in the display for 5 seconds. You can operate DISTRONIC* as usual again.

Display message	Possible cause/consequence	Possible solution
DISTRONIC currently unavailable See Operator's Manual	DISTRONIC* is deactivated because the functionality is impaired by external interferences, e.g. high-frequency sources such as too stations, speed measuring systems etc.	<ul style="list-style-type: none"> ▶ Leave the area of the external interference. ▶ Activate DISTRONIC* again (▷ page 254) when the message DISTRONIC available again appears.
	DISTRONIC* is deactivated because the DISTRONIC* sensor has not sensed any other vehicles or objects, e.g. road sign or such, for a long time.	<ul style="list-style-type: none"> ▶ Activate DISTRONIC* again (▷ page 254) when the message DISTRONIC available again appears.

Warning!



DISTRONIC* cannot take weather conditions into account. Switch off DISTRONIC* or do not turn it on if the sensor is dirty or visibility is

diminished as a result of snow, rain or fog. The distance control may be impaired even before the system is able to detect a dirty sensor. The message



DISTRONIC currently unavailable
 See Operator's Manual
 will be displayed in the multifunction display and DISTRONIC* will be turned off.

What to do if ...

Display message	Possible cause/consequence	Possible solution
ESP inoperative See Operator's Man.	<p>The ESP® as well as BAS and PRE-SAFE® have detected a malfunction and switched off.</p> <p>The ABS may not be operational.</p> <p>The brake system is still functioning normally but without the ABS, BAS, ESP® and PRE-SAFE® available.</p>	<ul style="list-style-type: none">▶ Continue driving with added caution.▶ Have the system checked at an authorized Mercedes-Benz Center as soon as possible. <p>Failure to follow these instructions increases the risk of an accident.</p>

Display message	Possible cause/consequence	Possible solution
(USA only) Front passenger airbag enabled See Operator's Manual	Front passenger front air bag is activated while driving even though a child, small individual, or object below the system's weight threshold is on the front passenger seat, or the front passenger seat is empty. Objects on the seat or forces acting on the seat may make the system sense supplemental weight.	Stop the vehicle in a safe location as soon as possible and check the front passenger seat for the following: <ul style="list-style-type: none">▶ Switch off the ignition (▷ page 38).▶ Open the front passenger door.▶ Remove child and child restraint from front passenger seat and properly secure the child in rear seat employing the child restraint if necessary.▶ Remove any other items from on and around the front passenger seat and make sure the storage pocket on the back of the front passenger seat is empty.▶ Make sure that no objects which apply forces to the seat are present (e.g. objects such as books, briefcases etc. lodged behind or around the seat, head restraints pushing against roof etc.). The system may recognize such forces as supplemental weight and sense that an occupant on the front passenger seat is of a greater weight than actually present.▶ Keep the seat unoccupied, close the front passenger door and turn on the ignition (▷ page 38). (Continued on next page)

What to do if ...

Display message	Possible cause/consequence	Possible solution
		<p>Monitor the PASS AIR BAG OFF  indicator lamp on the center console (▷ page 29) and the multifunction display in the instrument cluster (▷ page 26) for the following:</p> <p>With the seat unoccupied and the ignition turned on,</p> <ul style="list-style-type: none"> the PASS AIR BAG OFF  indicator lamp on the center console should illuminate and remain illuminated, indicating that the OCS (▷ page 75) has deactivated the front passenger front air bag. the message Front passenger airbag enabled See Operator's Manual or the message Front passenger airbag disabled See Operator's Manual should not appear in the multifunction display at any time the seat is unoccupied. Wait at least 60 seconds for the system to complete the necessary check cycles and to make sure neither message appears in the multifunction display. <p>If above conditions are met, you can occupy the front passenger seat again. Depending on the front passenger classification sensed by the OCS (▷ page 75), the PASS AIR BAG OFF  indicator lamp will remain illuminated or go out.</p> <p>If above conditions are not met, the system is not working properly. Have the system checked as soon as possible by an authorized Mercedes-Benz Center.</p>

Warning!





If the **PASS AIR BAG OFF**  indicator lamp

remains out even after performing the above corrective steps, do not have any children 12 years old and under and

other small individuals use the front passenger seat until the system has been repaired.

Display message	Possible cause/consequence	Possible solution
<p>(USA only) Front passenger airbag disabled See Operator's Manual</p>	<p>Front passenger front air bag is deactivated while driving even though an adult or someone larger than a small individual is occupying the front passenger seat. Forces acting on the seat may make the system sense a decrease in weight.</p>	<p>Stop the vehicle in a safe location as soon as possible and check the front passenger seat for the following:</p> <ul style="list-style-type: none">▶ Switch off the ignition (▷ page 38).▶ Have the front passenger vacate the seat and exit the vehicle.▶ Adjust the seat in a height position (▷ page 43).▶ Make sure that no objects which apply forces to the seat are present (e.g. objects such as books, briefcases etc. lodged underneath, behind or around the seat). Such forces may cause the system to sense that an occupant of a lesser weight than actually present is on the front passenger seat.▶ Keep the seat unoccupied, close the front passenger door and turn on the ignition (▷ page 38). <p>(Continued on next page)</p>

What to do if ...

Display message	Possible cause/consequence	Possible solution
		<p>Monitor the PASS AIR BAG OFF  indicator lamp on the center console (▷ page 29) and the multifunction display in the instrument cluster (▷ page 26) for the following:</p> <p>With the seat unoccupied and the ignition turned on,</p> <ul style="list-style-type: none"> the PASS AIR BAG OFF  indicator lamp on the center console should illuminate and remain illuminated, indicating that the OCS (▷ page 75) has deactivated the front passenger front air bag. the message Front passenger airbag enabled See Operator's Manual or the message Front passenger airbag disabled See Operator's Manual should not appear in the multifunction display at any time the seat is unoccupied. Wait at least 60 seconds for the system to complete the necessary check cycles and to make sure neither message appears in the multifunction display. <p>If above conditions are met, you can occupy the front passenger seat again. Depending on the front passenger classification sensed by the OCS (▷ page 75), the PASS AIR BAG OFF  indicator lamp will remain illuminated or go out.</p> <p>If above conditions are not met, the system is not working properly. Have the system checked as soon as possible by an authorized Mercedes-Benz Center.</p>

Warning!



If the **PASS AIR BAG OFF**  indicator lamp

remains illuminated with an adult occupant on the front passenger seat even after performing the above corrective steps,

do not have any passenger use the front passenger seat until the system has been repaired.

Display message	Possible cause/consequence	Possible solution
<p>P Gear selector lever in Park position</p>	<p>You have tried to start the engine with the KEYLESS-GO* start/stop button with the gear selector lever not in position P.</p> <p>You have tried to turn off the engine with the KEYLESS-GO* start/stop button with the gear selector lever not in position P.</p>	<p>► Place the gear selector lever in position P.</p>
<p>P/N Shift gear select. lever to Neutral or Park</p>	<p>You have tried to start the engine with the KEYLESS-GO* start/stop button while the gear selector lever was in position R or D.</p>	<p>► Place the gear selector lever in position P or N. Make sure the brake pedal is depressed.</p>
<p>PRE-SAFE inoperative See Operator's Man.</p>	<p>PRE-SAFE® itself has failed. All other occupant safety systems, such as the air bags, are still available.</p> <p>If ESP® and PRE-SAFE® malfunction messages are displayed simultaneously, PRE-SAFE® has been deactivated as a result of these malfunctions. All other occupant safety systems, such as the air bags are still available.</p>	<p>► Visit an authorized Mercedes-Benz Center as soon as possible.</p>

What to do if ...

Display message	Possible cause/consequence	Possible solution
Check tires Then restart Run Flat Indicator	There was a warning message about a loss in the tire inflation pressure and the Run Flat Indicator has not been reactivated yet.	<ul style="list-style-type: none"> ▶ Make sure that the correct tire inflation pressure is set for each tire. ▶ Then reactivate the Run Flat Indicator.
Run Flat Indicator inoperative	The Run Flat Indicator is malfunctioning.	▶ Have the Run Flat Indicator checked by an authorized Mercedes-Benz Center.
	The Run Flat Indicator has been switched off due to an error.	
Tire pressure Check tires	The Run Flat Indicator indicates that the pressure is too low in one or more tires.	<ul style="list-style-type: none"> ▶ Carefully bring the vehicle to a halt, avoiding abrupt steering and braking maneuvers. Observe the traffic situation around you. ▶ Check and adjust tire inflation pressure as required (▷ page 341). ▶ If necessary, change the wheel (▷ page 451). ▶ Reactivate the Run Flat Indicator after adjusting the tire inflation pressure values (▷ page 343).

Display message	Possible cause/consequence	Possible solution
Tire pressure is only displayed after driving for a few minutes	Vehicles with Advanced TPMS*: The tire inflation pressure is being checked.	▶ Drive the vehicle for a few minutes.
Tire pressure monitor inoperative	The Advanced TPMS* is malfunctioning.	▶ Have the Advanced TPMS* checked by an authorized Mercedes-Benz Center.
Tire pressure monitor inoperative No wheel sensors	There are wheels without appropriate wheel sensors mounted (e.g. winter tires).	▶ Have the Advanced TPMS* checked by an authorized Mercedes-Benz Center. ▶ Have the appropriate wheel sensors installed by an authorized Mercedes-Benz Center.
Tire pres. monitor No wheel sensors	One or more sensors malfunction (e.g. battery in one or more wheel sensor is empty). One or more wheels without wheel sensors mounted (e.g. spare tire).	▶ Have the Advanced TPMS* checked by an authorized Mercedes-Benz Center. ▶ Have the wheel sensors installed by an authorized Mercedes-Benz Center. The tire pressure for the respective tire is shown in the multifunction display.

What to do if ...

Display message	Possible cause/consequence	Possible solution
Tire pressure monitor currently unavailable	The Advanced TPMS* is unable to monitor the tire pressure due to <ul style="list-style-type: none">• a nearby radio interference source.• excessive wheel sensor temperatures.	As soon as the causes for the malfunction are no longer present, the Advanced TPMS* automatically becomes active again after a few minutes driving.

Warning!





Do not drive with a flat tire. A flat tire affects the ability to steer or brake the vehicle.

You may lose control of the vehicle. Continued driving with a flat tire will cause excessive heat build-up and possibly a fire.

Symbol messages

Display symbol	Display message	Possible cause/consequence	Possible solution
		<p>The battery is no longer charging. Possible causes:</p> <ul style="list-style-type: none"> • alternator malfunctioning • broken poly-V-belt <p>Do not forget that the brake system requires electrical energy and may be operating with restricted capability. Considerably greater brake pedal force is required and the stopping distance is increased.</p>	<p>▶ Stop immediately in a safe location or as soon as it is safe to do so and check the poly-V-belt.</p> <p>If it is broken:</p> <p>▶ Do not continue to drive. Otherwise the engine will overheat due to an inoperative water pump which may result in damage to the engine. Notify an authorized Mercedes-Benz Center.</p> <p>If it is intact:</p> <p>▶ Drive immediately to the nearest authorized Mercedes-Benz Center. Adjust driving to be consistent with reduced braking responsiveness.</p>
		<p>There is a malfunction in the electronic system.</p>	<p>▶ Have the system checked at an authorized Mercedes-Benz Center as soon as possible.</p>

What to do if ...

Display symbol	Display message	Possible cause/consequence	Possible solution
	Battery/Alternator Stop vehicle	The battery is malfunctioning. The brake system requires electrical energy and therefore has only limited operation. Considerably greater brake pedal force is required and the stopping distance is increased.	<ul style="list-style-type: none"> ▶ Stop the vehicle in a safe location as soon as it is safe to do so. Adjust driving to be consistent with reduced braking responsiveness. ▶ Notify an authorized Mercedes-Benz Center.
	Low voltage Start engine	The battery has insufficient voltage.	▶ Start the engine (▷ page 52).
	Right rear backrest not locked	The rear seat backrest is not engaged.	▶ Adjust the rear seat backrest until it is fully engaged in position.
	Left rear backrest not locked	The rear seat backrest is not engaged.	▶ Adjust the rear seat backrest until it is fully engaged in position.
	Brakepad wear	The brake pads have reached their wear limit.	▶ Have the brake pads replaced as soon as possible.

! *Brake pad thickness must be visually inspected by a qualified technician at the intervals specified in the Maintenance Booklet.*

Display symbol	Display message	Possible cause/consequence	Possible solution
(USA only) BRAKE (Canada only) 	EBV, ABS, ESP inoperative See Operator's Man.	ABS, ESP®, EBP as well as PRE-SAFE® have switched off due to a malfunction. BAS is also switched off. The brake system is still functioning normally but without the ABS, BAS, ESP® and PRE-SAFE® available.	<ul style="list-style-type: none"> ▶ Continue driving with added caution. ▶ Adjust driving to be consistent with reduced braking responsiveness. ▶ Visit an authorized Mercedes-Benz Center as soon as possible.
	Release parking brake	You are driving with the parking brake set.	▶ Release the parking brake (▷ page 62).
	Check brake fluid level	There is insufficient brake fluid in the reservoir.	▶ Risk of accident! Stop the vehicle in a safe location as soon as it is safe to do so and notify an authorized Mercedes-Benz Center. Do not add brake fluid! This will not solve the problem.

Warning!





Driving with the message **Check brake fluid level** displayed can result in an accident. Have your brake system checked immediately.

Do not add brake fluid before checking the brake system. Overfilling the brake fluid reservoir can result in spilling brake fluid on hot engine parts and the brake fluid catching fire. You can be seriously burned.

! *If you find that the brake fluid in the brake fluid reservoir has fallen to the minimum mark or below, have the brake system checked for brake pad thickness and leaks.*

What to do if ...

Display symbol	Display message	Possible cause/consequence	Possible solution
 (USA only)  (Canada only)	Visit workshop	There may be a malfunction in the: <ul style="list-style-type: none"> • fuel injection system • ignition system • exhaust system • fuel system 	► Have the measuring system checked by an authorized Mercedes-Benz Center.
	Top up coolant See Operator's Manual	The coolant level is too low.	► Add coolant (▷ page 329). ► If you have to add coolant frequently, have the cooling system checked by an authorized Mercedes-Benz Center.

Warning!



Do not spill antifreeze on hot engine parts. Antifreeze contains ethylene glycol which may burn if it comes into contact with hot engine parts. You could be seriously burned.

! Do not ignore the low engine coolant level warning. Extended driving with the message and symbol displayed may cause serious engine damage not covered by the Mercedes-Benz Limited Warranty.

Do not drive without sufficient amount of coolant in the cooling system. The engine will overheat causing major engine damage.

Display symbol	Display message	Possible cause/consequence	Possible solution
	Coolant Stop, turn engine off	The coolant is too hot.	<ul style="list-style-type: none"> ▶ Stop the vehicle in a safe location or as soon as it is safe to do so and immediately turn off the engine. ▶ Only start the engine again after the message disappears. You could otherwise damage the engine. ▶ Apply the parking brake (▷ page 62). ▶ Observe the coolant temperature indicator in the instrument cluster (▷ page 27). <p>If the temperature rises again:</p> <ul style="list-style-type: none"> ▶ Contact an authorized Mercedes-Benz Center immediately.

Warning!



Driving when your engine is overheated can cause some fluids which may have leaked into the engine compartment to catch fire. You could be seriously burned.

Steam from an overheated engine can cause serious burns which can occur just by

opening the engine hood. Stay away from the engine if you see or hear steam coming from it.



Stop the vehicle in a safe location away from other traffic. Turn off the engine, get out of the vehicle and do not stand near the vehicle until the engine has cooled down.

During severe operation conditions and stop-and-go city traffic, the coolant temperature may rise close to 248°F (120°C).

! *The engine should not be operated with the coolant temperature above 248°F (120°C). Doing so may cause serious damage which is not covered by the Mercedes-Benz Limited Warranty.*

What to do if ...

Display symbol	Display message	Possible cause/consequence	Possible solution
	Coolant Stop, turn engine off	The poly-V-belt could be broken.	<ul style="list-style-type: none"> ▶ Stop the vehicle in a safe location and immediately turn off the engine. ▶ Check the poly-V-belt. <p>If it is broken:</p> <ul style="list-style-type: none"> ▶ Do not continue to drive. Otherwise the engine will overheat due to an inoperative water pump which may result in damage to the engine. Notify an authorized Mercedes-Benz Center. <p>If it is intact:</p> <ul style="list-style-type: none"> ▶ Do not continue to drive the vehicle with this message displayed. Doing so could result in serious engine damage that is not covered by the Mercedes-Benz Limited Warranty. ▶ Observe the coolant temperature indicator in the instrument cluster (▷ page 27). ▶ Drive immediately to the nearest authorized Mercedes-Benz Center.

Display symbol	Display message	Possible cause/consequence	Possible solution
		The cooling fan for the coolant is malfunctioning.	<ul style="list-style-type: none"> ▶ Observe the coolant temperature indicator in the instrument cluster (▷ page 27). If the coolant temperature is under 248°F (120°C), you may continue driving to an authorized Mercedes-Benz Center. ▶ Avoid placing heavy loads on the engine (e.g. by driving uphill) as well as stop-and-go traffic. ▶ Have the fan replaced as soon as possible.
	Display malfunction Visit workshop	Certain electronic systems are unable to relay information to the control system. The following systems may have failed: <ul style="list-style-type: none"> • Coolant temperature display • Tachometer • Cruise control display 	<ul style="list-style-type: none"> ▶ Have the electronic systems checked by an authorized Mercedes-Benz Center.
	Engine Service	There may be a malfunction in: <ul style="list-style-type: none"> • the fuel injection system • the ignition system • the exhaust system 	<ul style="list-style-type: none"> ▶ Have the engine checked as soon as possible by an authorized Mercedes-Benz Center.

What to do if ...

Display symbol	Display message	Possible cause/consequence	Possible solution
	Check oil level at next refueling	The engine oil has dropped to a critical level.	<ul style="list-style-type: none"> ▶ Check the engine oil level (▷ page 326) and add oil as required (▷ page 327). ▶ If you must add engine oil frequently, have the engine checked for possible leaks.



When the message `Check oil level at next refueling` appears while the engine is running and at operating temperature, the engine oil level has dropped to approximately the minimum level.

When this occurs, the warning will first come on intermittently and then stay on if the oil level drops further.

Visually check for oil leaks. If no obvious oil leaks are noted, drive to the nearest service station where the engine oil should be topped to the required level with an approved engine oil.

For information on approved engine oils, refer to the Factory Approved Service Products pamphlet (USA only) or contact an authorized Mercedes-Benz Center.

! *The engine oil level warnings should not be ignored. Extended driving with the symbol displayed could result in serious engine damage that is not covered by the Mercedes-Benz Limited Warranty.*

Display symbol	Display messages	Possible cause/consequence	Possible solution
	Reserve fuel	The fuel level has dropped below the reserve mark.	▶ Refuel at the next gas station (▷ page 321).
	Gas cap is open	A loss of pressure has been detected in the fuel system. The fuel cap may not be closed properly or the fuel system may be leaky.	▶ Check the fuel cap (▷ page 321). If it is not closed properly: ▶ Close the fuel cap. If it is closed properly: ▶ Have the fuel system checked by an authorized Mercedes-Benz Center.
	Replace air cleaner	The air cleaner is clogged.	▶ Have the air cleaner checked by an authorized Mercedes-Benz Center.

What to do if ...

Display symbol	Display messages	Possible cause/consequence	Possible solution
	Key still in vehicle	A SmartKey with KEYLESS-GO* left in the vehicle was recognized while locking the vehicle from the outside.	▶ Take the SmartKey with KEYLESS-GO* out of the vehicle.
	Please don't forget your key	This display appears (for a maximum of 60 seconds) if the driver's door is opened with the engine shut off and no SmartKey in the starter switch. This message is only a reminder.	▶ Take the SmartKey with KEYLESS-GO* with you when leaving the vehicle.
	Remove key	You have forgotten to remove the SmartKey.	▶ Remove the SmartKey from the starter switch.
	Get a new key	The SmartKey is malfunctioning.	▶ Contact an authorized Mercedes-Benz Center.

Display symbol	Display messages	Possible cause/consequence	Possible solution
	Change key batteries	The SmartKey with KEYLESS-GO* batteries are discharged.	▶ Replace the batteries (> page 440).
	Key not recognized	The SmartKey with KEYLESS-GO* is not recognized while the engine is running because <ul style="list-style-type: none"> • the SmartKey with KEYLESS-GO* is not in the vehicle • there is strong radio-frequency interference 	▶ Stop the vehicle as soon as it is safe to do so. ▶ Search for the SmartKey with KEYLESS-GO*. Otherwise the vehicle cannot be centrally locked nor can the engine be started again after the engine is stopped.
	Key not recognized	The SmartKey with KEYLESS-GO* is momentarily not recognized.	▶ Change the position of the SmartKey in the vehicle. ▶ Operate the vehicle with the SmartKey in the starter switch if necessary.

What to do if ...

Display symbol	Display messages	Possible cause/consequence	Possible solution
	Active headlamps inoperative	The active Bi-Xenon* headlamp system is malfunctioning.	► Contact an authorized Mercedes-Benz Center as soon as possible.
	Active headlamps Auxiliary bulb on	The active Bi-Xenon* headlamps are malfunctioning. Another light is being used.	► Contact an authorized Mercedes-Benz Center as soon as possible.
	Reverse lamp left side	The left reverse lamp is malfunctioning.	► Contact an authorized Mercedes-Benz Center as soon as possible.
	Reverse lamp right side	The right reverse lamp is malfunctioning.	► Contact an authorized Mercedes-Benz Center as soon as possible.
	Brake-/tail lamp, left Auxiliary bulb on	The left brake/tail lamp is malfunctioning. This message will only appear if a critical number of LEDs have stopped working.	► Contact an authorized Mercedes-Benz Center as soon as possible.
	Brake-/tail lamp, right Auxiliary bulb on	The right brake/tail lamp is malfunctioning. This message will only appear if a critical number of LEDs have stopped working.	► Contact an authorized Mercedes-Benz Center as soon as possible.
	3rd brake lamp	The high mounted brake lamp is malfunctioning. This message will only appear if a critical number of LEDs have stopped working.	► Visit an authorized Mercedes-Benz Center as soon as possible.

Display symbol	Display messages	Possible cause/consequence	Possible solution
	Front foglamp left side	The left front fog lamp is malfunctioning.	▶ Contact an authorized Mercedes-Benz Center as soon as possible.
	Front foglamp right side	The right front fog lamp is malfunctioning.	▶ Contact an authorized Mercedes-Benz Center as soon as possible.
	Front left marker lamp	The front left side marker lamp is malfunctioning.	▶ Contact an authorized Mercedes-Benz Center as soon as possible.
	Front right marker lamp	The front right side marker lamp is malfunctioning.	▶ Contact an authorized Mercedes-Benz Center as soon as possible.
	Front left park. lamp Auxiliary bulb on	The left front parking lamp is malfunctioning. A substitute bulb is being used.	▶ Contact an authorized Mercedes-Benz Center as soon as possible.
	Front right park. lamp Auxiliary bulb on	The right front parking lamp is malfunctioning. A substitute bulb is being used.	▶ Contact an authorized Mercedes-Benz Center as soon as possible.
	High beam left side	The left high beam lamp is malfunctioning.	▶ Replace the bulb as soon as possible.
	High beam right side	The right high beam lamp is malfunctioning.	▶ Replace the bulb as soon as possible.
	License plate lamp left side	The left license plate lamp is malfunctioning.	▶ Replace the bulb as soon as possible.
	License plate lamp right side	The right license plate lamp is malfunctioning.	▶ Replace the bulb as soon as possible.

What to do if ...

Display symbol	Display messages	Possible cause/consequence	Possible solution
	AUTO-Light inoperative	The light sensor is malfunctioning. The headlamps switch on automatically.	<ul style="list-style-type: none"> ▶ In the control system, set lamp operation to manual mode (▷ page 142). ▶ Switch on headlamps using the exterior lamp switch.
	Low beam left side	The left low beam lamp is malfunctioning.	Halogen headlamp: <ul style="list-style-type: none"> ▶ Replace the bulb as soon as possible. Bi-Xenon* headlamp: <ul style="list-style-type: none"> ▶ Contact an authorized Mercedes-Benz Center as soon as possible.
	Low beam right side	The right low beam lamp is malfunctioning.	Halogen headlamp: <ul style="list-style-type: none"> ▶ Replace the bulb as soon as possible. Bi-Xenon* headlamp: <ul style="list-style-type: none"> ▶ Contact an authorized Mercedes-Benz Center as soon as possible.

Display symbol	Display messages	Possible cause/consequence	Possible solution
	Rear left foglamp	The left rear fog lamp is malfunctioning.	▶ Contact an authorized Mercedes-Benz Center as soon as possible.
	Rear right foglamp	The right rear fog lamp is malfunctioning.	▶ Contact an authorized Mercedes-Benz Center as soon as possible.
	Switch off lights	Lamps have been turned on although the SmartKey in the starter switch is in position 0 .	▶ Switch off the headlamps.
	Tail lamp, left side Auxiliary bulb on	The left tail lamp is malfunctioning. A substitute bulb is being used.	▶ Contact an authorized Mercedes-Benz Center as soon as possible.
	Tail lamp, right side Auxiliary bulb on	The right tail lamp is malfunctioning. A substitute bulb is being used.	▶ Contact an authorized Mercedes-Benz Center as soon as possible.
	Cornering lamp left	The left corner-illuminating front fog lamp* is malfunctioning.	▶ Contact an authorized Mercedes-Benz Center as soon as possible.
	Cornering lamp right	The right corner-illuminating front fog lamp* is malfunctioning.	▶ Contact an authorized Mercedes-Benz Center as soon as possible.

What to do if ...

Display symbol	Display messages	Possible cause/consequence	Possible solution
	Rear left turn signal	The left rear turn signal lamp is malfunctioning.	▶ Contact an authorized Mercedes-Benz Center as soon as possible.
	Rear right turn signal	The right rear turn signal lamp is malfunctioning.	▶ Contact an authorized Mercedes-Benz Center as soon as possible.
	Front left turn signal	The left front turn signal lamp is malfunctioning.	▶ Replace the bulb as soon as possible.
	Front right turn signal	The right front turn signal lamp is malfunctioning.	▶ Replace the bulb as soon as possible.
	Left mirror turn signal	The turn signal in the left exterior rear view mirror is malfunctioning. This message will only appear if a critical number of LEDs have stopped working.	▶ Contact an authorized Mercedes-Benz Center as soon as possible.
	Right mirror turn signal	The turn signal in the right exterior rear view mirror is malfunctioning. This message will only appear if a critical number of LEDs have stopped working.	▶ Contact an authorized Mercedes-Benz Center as soon as possible.
	Switch off lights or remove key	The exterior lamp switch is set to AUTO and you have forgotten to take out the SmartKey. The parking lamps remain switched on.	▶ Switch off the headlamps. or ▶ Remove the SmartKey from the starter switch.

Display symbol	Display message	Possible cause/consequence	Possible solution
	Please correct tire pressure	The pressure is too low in one or more tires.	▶ Check and correct tire inflation pressure as required (▷ page 341).
	Tire pressure Caution, tire defect	One or more tires are deflating.	▶ Carefully bring the vehicle to a halt, avoiding abrupt steering and braking maneuvers. ▶ If necessary, change the wheel (▷ page 456).
	Tire pressure Check tires	One or more tires are deflating. The respective tire is indicated in the multifunction display.	▶ Carefully bring the vehicle to a halt, avoiding abrupt steering and braking maneuvers. ▶ If necessary, change the wheel (▷ page 456).

Warning!



Do not drive with a flat tire. A flat tire affects the ability to steer or brake the vehicle.

You may lose control of the vehicle. Continued driving with a flat tire will cause excessive heat build-up and possibly a fire.

What to do if ...



Display symbol	Display message	Possible cause/consequence	Possible solution
	Tire pressure Check tires	The tire pressure in one or more tires is already below the minimum value.	<ul style="list-style-type: none"> ▶ Carefully bring the vehicle to a halt, avoiding abrupt steering and braking maneuvers. ▶ Check and adjust tire pressure as required. ▶ If necessary, change the wheel (▷ page 456).
	Check tires	<p>The tire pressure in one or more tires is already below the minimum value.</p> <p>The respective tire is indicated in the multifunction display.</p>	<ul style="list-style-type: none"> ▶ Carefully bring the vehicle to a halt, avoiding abrupt steering and braking maneuvers. ▶ Check and adjust tire pressure as required. ▶ If necessary, change the wheel (▷ page 456).

Warning!



Do not drive with a flat tire. A flat tire affects the ability to steer or brake the vehicle.

You may lose control of the vehicle. Continued driving with a flat tire will cause excessive heat build-up and possibly a fire.

Display symbol	Display message	Possible cause/consequence	Possible solution
	Tele Aid inoperative	One or more main functions of the Tele Aid system are malfunctioning.	▶ Have the Tele Aid system checked by an authorized Mercedes-Benz Center.
	Tele Aid battery	The emergency power battery for the Tele Aid system is malfunctioning. If the vehicle battery is also dead, Tele Aid will not be operational.	▶ Have the Tele Aid system checked by an authorized Mercedes-Benz Center.
	Restraint system malfunction Visit workshop	The system is malfunctioning.	▶ Drive with added caution to the nearest authorized Mercedes-Benz Center.

Warning!











In the event a malfunction of the SRS is indicated as outlined above, the SRS may not be operational.

For your safety, we strongly recommend that you visit an authorized Mercedes-Benz Center immediately to have the system checked;

otherwise the SRS may not be activated when needed in an accident, which could result in serious or fatal injury, or it might deploy unexpectedly and unnecessarily which could also result in injury.

What to do if ...

Display symbol	Display message	Possible cause/consequence	Possible solution
	Function unavailable	This display appears if button  or  on the multifunction steering wheel is pressed and the vehicle is not equipped with a telephone.	
	Top up washer fluid	The fluid level has dropped to about $\frac{1}{3}$ of total reservoir capacity.	▶ Add washer fluid (▷ page 331).
		The cargo compartment is open.	▶ Close the cargo compartment.
		You are driving with the hood open.	▶ Stop the vehicle in a safe location as soon as it is safe to do so. ▶ Close the hood (▷ page 326). There is otherwise danger of an accident.
		You are driving with one or more doors open. The display symbol shows you which doors are open.	▶ Close the doors.
	Vehicle rising	Your vehicle is adjusting to your level selection.	

Display symbol	Display message	Possible cause/consequence	Possible solution
	Vehicle rising Please wait	The vehicle level is too low.	<ul style="list-style-type: none"> ▶ Do not drive off. <p>The Airmatic has not yet adjusted the vehicle level to the necessary height required for driving.</p> <ul style="list-style-type: none"> ▶ Wait until the message disappears from the multi-function display. <p>You may then drive off.</p>
	Stop, car too low	The Airmatic is malfunctioning.	<p>Avoid excessive steering input. The fender or tires could otherwise be damaged. Listen for scraping noises.</p> <ul style="list-style-type: none"> ▶ Do not drive faster than 50 mph (80 km/h). ▶ Drive to the side of the road and select a higher vehicle level (▷ page 262). <p>Depending on the type of malfunction, this may raise the vehicle's level.</p> <ul style="list-style-type: none"> ▶ Visit an authorized Mercedes-Benz Center as soon as possible. <p>There is otherwise danger of an accident.</p>
	Malfunction	<p>The system is functional only to a limited extent.</p> <p>The system display or the system is malfunctioning.</p>	<ul style="list-style-type: none"> ▶ Do not drive faster than 50 mph (80 km/h). ▶ Have the vehicle checked at an authorized Mercedes-Benz Center.

Where will I find ...?

First aid kit

The first aid kit is in the storage compartment at the front edge of the front passenger seat.

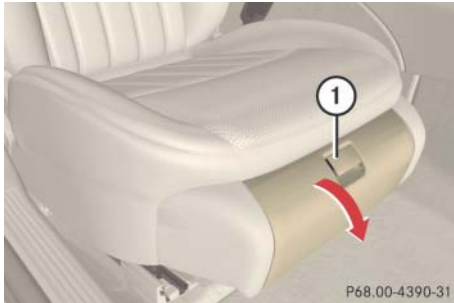

① Tab

- ▶ Pull tab ① upward.
- ▶ Fold the covering forward.
- ▶ Remove the first aid kit.

i Check expiration dates and contents for completeness at least once a year and replace missing/expired items.

Vehicle tool kit, jack and spare wheel

The vehicle tool kit, jack and spare wheel are stored in the compartment underneath the third row seat cushions and footwell (▶ page 431) or underneath the cargo compartment floor (E 63 AMG only).

The vehicle tool kit includes:

- One pair of universal pliers
- One towing eye bolt
- One wheel wrench
- One alignment bolt
- One fuse extractor
- Spare fuses
- Collapsible wheel chock
- A pair of gloves

Vehicles without foldable third row seat (E 63 AMG only) - Vehicle tool kit, jack and collapsible tire

The vehicle tool kit is located in the cargo compartment underneath the front cargo compartment floor.

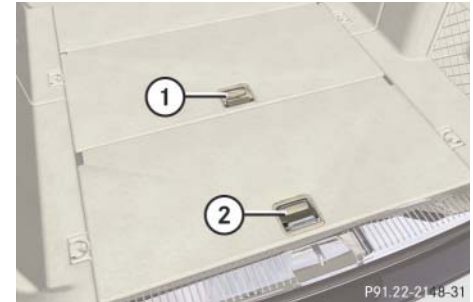

① Front cargo compartment floor

② Rear cargo compartment floor

- ▶ Pull release handle ① or ② and fold the respective cargo compartment floor upward.

**Vehicles with foldable third row seat -
Vehicle tool kit, jack and spare wheel
(except E 63 AMG) or
TIREFIT (E 63 AMG only)**

The vehicle tool kit is located in the cargo compartment underneath the third row seat cushions and footwell.

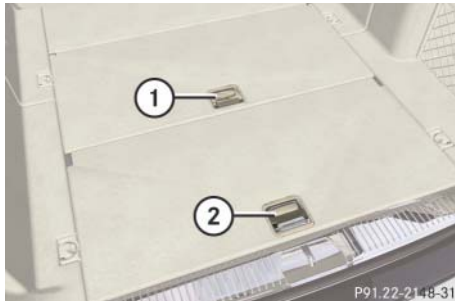

- ① Release handle for seat backrest
- ② Release handle for seat cushion

- ▶ Pull release handle ① and fold seat backrest for the folding bench seat upward.
- ▶ Pull release handle ②, fold seat cushion upward and remove it (▷ page 135).



- ① Release handle
- ② Footwell

- ▶ Pull release handle ① and fold footwell ② up.
- ▶ To lock, fold footwell ② back into its original position and press it down until it engages.

Vehicle tool kit (vehicles with spare wheel)

i In order to access the vehicle tool kit, you must first detach the side cover.

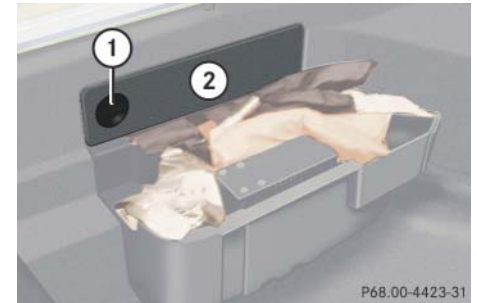

- ① Handle
- ② Cover

- ▶ Turn handle ① to the right as far as it will go and remove cover ②.

Where will I find ...?

Vehicle tool kit (vehicles with TIREFIT)

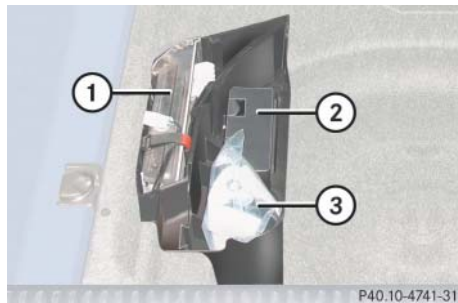

- ① Vehicle tool kit and jack
- ② Electric air pump
- ③ TIREFIT kit

Vehicle jack

Warning!



The jack is designed exclusively for jacking up the vehicle at the jack take-up brackets built into both sides of the vehicle. To help avoid personal injury, use the jack only to lift the vehicle during a wheel change. Never get beneath the vehicle while it is supported by the jack. Keep hands and feet away from the area under the lifted vehicle. Always firmly set parking brake and block wheels before raising vehicle with jack.

Do not disengage parking brake while the vehicle is raised. Be certain that the jack is always vertical (plumb line) when in use, especially on hills. Always try to use the jack on level surface. Make sure the jack arm is fully seated in the jack take-up bracket. Always lower the vehicle onto sufficient capacity jackstands before working under the vehicle.

The vehicle jack is located in the cargo compartment underneath the third row seat cushions and footwell (▷ page 431) or underneath the cargo compartment floor (▷ page 430).

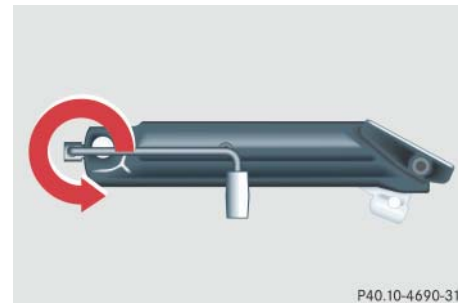

Storage position

- ▶ Remove vehicle jack from its compartment.
- ▶ Turn crank handle in direction of arrow as far as it will go.

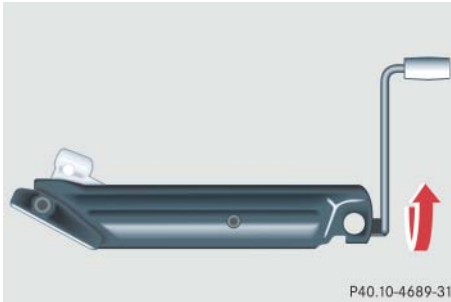

Operational position

- ▶ Turn crank handle clockwise.

Before storing the vehicle jack in its compartment:

- It should be fully collapsed.
- The handle must be folded in (storage position).

Spare wheel

If your vehicle is equipped with a spare wheel (Minispare or collapsible tire), it is located in the cargo compartment underneath the third row seat cushions and footwell (▷ page 431) or underneath the cargo compartment floor (▷ page 430). To access the spare wheel, fold seat cushions and footwell up (▷ page 431).

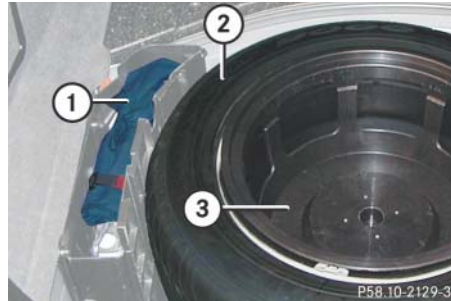

- ① Vehicle tool kit
Wheel bolt wrench and Jack
- ② Spare wheel
- ③ Luggage bowl

i Vehicles with collapsible tire (E 63 AMG only):
The electric air pump is underneath the luggage bowl ③.

Removing the spare wheel

- ▶ Turn luggage bowl ③ counterclockwise.
- ▶ Remove spare wheel ②.

Storing the spare wheel

- ▶ Place spare wheel ② in wheel well.
- ▶ Turn luggage bowl ③ clockwise to its stop to secure the spare wheel.



Where will I find ...?



Warning!



The dimensions of the spare wheel (Minispare or collapsible tire) are different from those of the road wheels. As a result, the vehicle handling characteristics change when driving with a spare wheel mounted. The Minispare wheel and collapsible tire should only be used temporarily, and replaced with a regular road wheel as quickly as possible.

In the case of a flat tire, you may temporarily use the spare wheel when observing the following restrictions:

- Do not exceed a vehicle speed of 50 mph (80 km/h).
- Drive to the nearest tire repair facility to have the flat tire repaired or replaced as appropriate.
- Do not operate vehicle with more than one spare wheel mounted.

For more information see the “Technical data” section (▷ page 483).

Setting up the collapsible wheel chock

The collapsible wheel chock serves to additionally secure the vehicle, e.g. while changing the wheel.



- ① Tilt the plates upward
- ② Fold the lower plate outward
- ③ Insert the plate

- ▶ Tilt both plates upward ①.
- ▶ Fold the lower plate outward ②.
- ▶ Guide the tabs of the lower plate all the way into the openings of the base plate ③.

Unlocking/locking in an emergency

▼ Unlocking/locking in an emergency

Unlocking the vehicle

If you cannot unlock the vehicle with the SmartKey or SmartKey with KEYLESS-GO*, open the driver's door using the mechanical key.

i *Unlocking your vehicle with the mechanical key and opening the driver's door or the cargo compartment will trigger the anti-theft alarm system.*

To cancel the alarm, insert the SmartKey or SmartKey with KEYLESS-GO in the starter switch.*

Removing the mechanical key

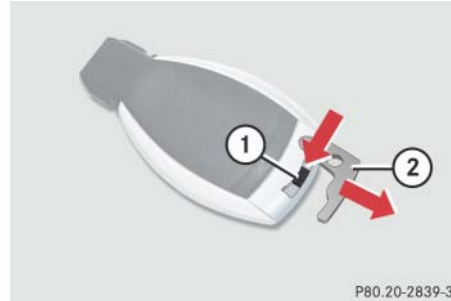

- ① Mechanical key locking tab
- ② Mechanical key

- ▶ Move locking tab ① in direction of arrow.
- ▶ Slide mechanical key ② out of the housing.

Unlocking the driver's door

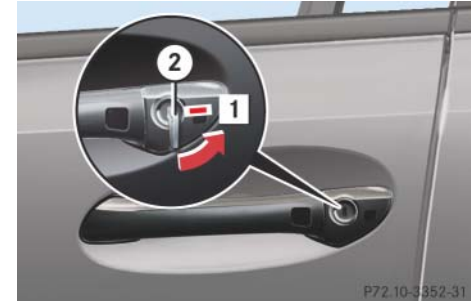

- 1 Unlocking
- ② Mechanical key

- ▶ Insert the mechanical key ② into the driver's door lock until it stops.
- ▶ Turn mechanical key ② counterclockwise to position 1 until the locking knobs move up.

The driver's door is unlocked.

- ▶ Pull door handle to open the driver's door.

Unlocking/locking in an emergency

Unlocking and opening the tailgate (Vehicles without foldable third row seat, E 63 AMG only)

A minimum height clearance of 6.81 ft (2.07 m) is required to open the tailgate.

The emergency release is located on the inside of the tailgate.

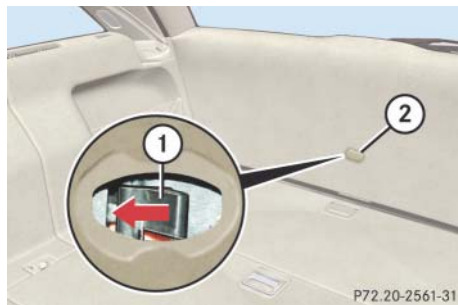

① Release lever



② Cover

- ▶ Remove cover ② from the trim on the tailgate.
- ▶ Push release lever ① in direction of arrow.
- ▶ Lift the tailgate.

! Always make sure there is sufficient overhead clearance.

i If the vehicle has previously been locked using the SmartKey, opening the tailgate from the inside will trigger the anti-theft alarm*.

To cancel the alarm, do one of the following:

- Press button  or  on the SmartKey.
- Insert the SmartKey in the starter switch.

Locking the vehicle

If you are unable to lock the vehicle with the SmartKey or SmartKey with KEYLESS-GO*, do the following:

- ▶ Close the passenger door, the rear doors and the tailgate.
- ▶ Press the central locking switch in the center console (▷ page 127).
- ▶ Check to see whether the locking knobs on the doors have moved down.
- ▶ If necessary, push them down manually.

Except for the driver's door, the vehicle should now be locked.

Unlocking/locking in an emergency

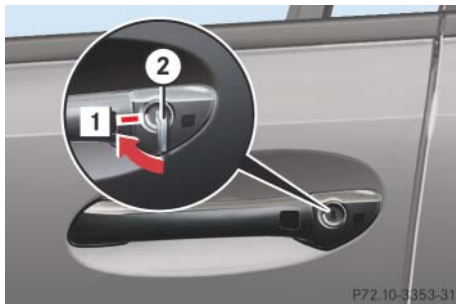

1 Locking

② Mechanical key

- ▶ Remove the mechanical key ② out of the SmartKey (▷ page 435).
- ▶ Insert the mechanical key ② into the driver's door lock until it stops.
- ▶ Turn the mechanical key ② clockwise to position 1.

The driver's door is locked.

i This procedure does not arm the anti-theft alarm system, nor does it lock the fuel filler flap.

Manually unlocking the gear selector lever

In case of power failure, the gear selector lever can be manually unlocked, e.g. to tow the vehicle.

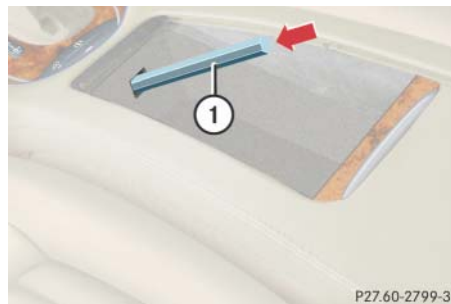

① Pin

- ▶ Open the storage compartment in the center armrest (▷ page 283).
- ▶ Take out the cup holder (▷ page 284).

- ▶ Insert a suitable object ① (e.g. a pin) through the hole and press the pin downward.

- ▶ Remove pin ①.

i The gear selector lever is locked again when moving it to position P.

Opening/closing in an emergency

Power tilt/sliding sunroof

You can open or close the tilt/sliding sunroof manually should an electrical malfunction occur.

The tilt/sliding sunroof drive is located behind cover ① of the interior overhead light.

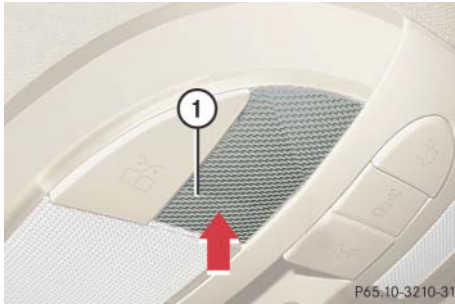

① Cover

- ▶ Remove the SmartKey from the starter switch.
- ▶ Press on cover ① in direction of the arrow to release it.

i Do not disconnect the electrical connectors.

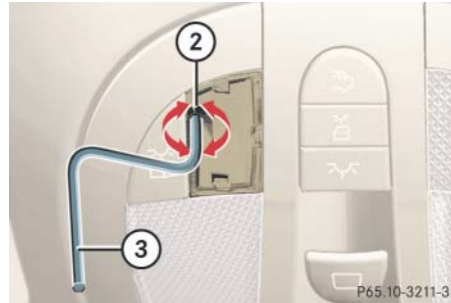

② Hole

③ Crank

- ▶ Take crank ③ out of the glove box.
- ▶ Insert crank ③ through hole ②.
- ▶ Turn crank ③ clockwise to:
 - slide sunroof closed
 - raise sunroof at the rear

- ▶ Turn crank ③ counterclockwise to:

- slide sunroof open
- lower sunroof at the rear

i Turn crank ③ slowly and smoothly.

The tilt/sliding sunroof must be synchronized after being operated manually (▷ page 245).

Resetting activated head restraints

▼ Resetting activated head restraints

If the active head restraints have been triggered in an accident, the active head restraints must be reset. Otherwise, the active head restraints cannot offer any additional protection in the event of another rear-end collision.

You can tell that the head restraints have been triggered when they have been moved forward and cannot be adjusted.

i For your convenience, we recommend that you have this work carried out by an authorized Mercedes-Benz Center.

You will find the reset tool for manually operating the head restraints in the Mercedes-Benz vehicle literature pouch.

Warning!

For safety reasons, have the active head restraints checked by an authorized Mercedes-Benz Center after a rear-end collision.

Warning!

When pushing back the head restraint cushion, take care that your fingers do not become caught between the head restraint cushion and the cover. Failing to do so may lead to injury.

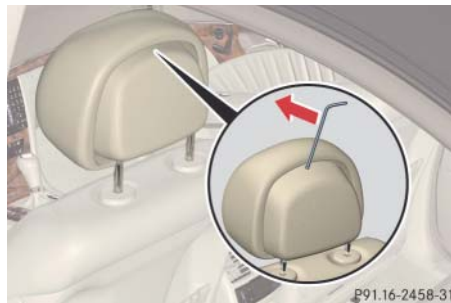

- ▶ Take the reset tool out of the Mercedes-Benz vehicle literature pouch.

- ▶ Guide reset tool into center of head restraint between head restraint cushion and rear head restraint cover.

! Be careful not to damage upholstery.

- ▶ Press reset tool forward in direction of arrow.
- ▶ Press reset tool downward until you hear the head restraint release mechanism audibly engage.
- ▶ Pull out reset tool.
- ▶ Firmly press head restraint cushion backward towards the rear of the vehicle until it engages.
- ▶ Repeat this procedure on the active head restraints for second head restraint.

For information on active head restraints, see “Active head restraints” (▷ page 87).

For information on head restraint adjustment, see “Seats” (▷ page 43).

Replacing SmartKey batteries

If the batteries in the SmartKey/SmartKey with KEYLESS-GO* are discharged, the vehicle can no longer be locked or unlocked. It is recommended to have the batteries replaced at an authorized Mercedes-Benz Center.

Warning!



Batteries contain poisonous and corrosive substances. Therefore keep the batteries out of reach of children.

If a battery is swallowed, seek medical help immediately.

Batteries contain materials that can harm the environment if disposed of improperly. Recycling of batteries is the preferred method of disposal. Many states require sellers of batteries to accept old batteries for recycling.

i When inserting the batteries, make sure they are clean and free of lint.

i When replacing batteries, always replace both batteries.

The required replacement batteries are available at any Mercedes-Benz Center.

SmartKey/SmartKey with KEYLESS-GO*

Replacement batteries: Lithium, type CR 2025 or equivalent.

- ▶ Remove the mechanical key ① out of the SmartKey/SmartKey with KEYLESS-GO* (> page 435).

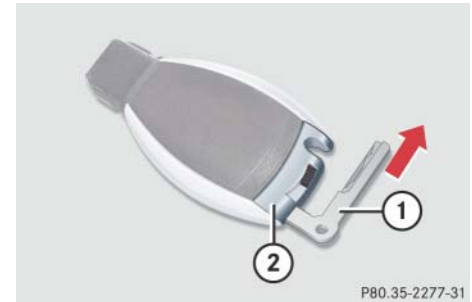

- ① Mechanical key
- ② Battery compartment

- ▶ Insert mechanical key ① into opening.
- ▶ Press mechanical key ① in direction of arrow.

The battery compartment is unlatched.

Replacing SmartKey batteries

- ▶ Pull battery compartment ② (▷ page 440) out of the housing.

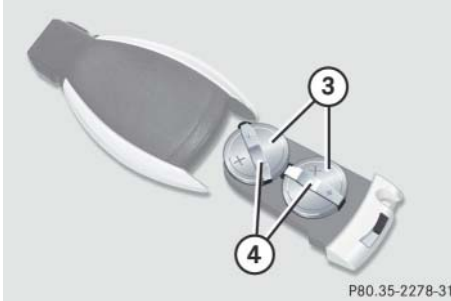

- ③ Battery
- ④ Contact spring

- ▶ Pull out batteries ③.

- ▶ Using a lint-free cloth, insert new batteries ③ under contact spring ④ with the positive terminal (+) side facing up.
- ▶ Return battery compartment ② (▷ page 440) into housing until it locks into place.
- ▶ Slide mechanical key ① (▷ page 440) back into the SmartKey/SmartKey with KEYLESS-GO*.
- ▶ Check the operation of the SmartKey/SmartKey with KEYLESS-GO*.

Replacing bulbs

Bulbs

Safe vehicle operation depends on proper exterior lighting and signaling. It is therefore essential that all bulbs and lamp assemblies are in good working order at all times.

Correct headlamp adjustment is extremely important. Have headlamps checked and readjusted at regular intervals and when a bulb has been replaced. Contact your authorized Mercedes-Benz Center for headlamp adjustment.

i If the headlamps or front fog lamps are fogged up on the inside as a result of high humidity, driving the vehicle a distance with the lights on should clear up the fogging.

i Substitute bulbs will be brought into use when lamps malfunction. Read and observe messages in the multifunction display (▷ page 420).

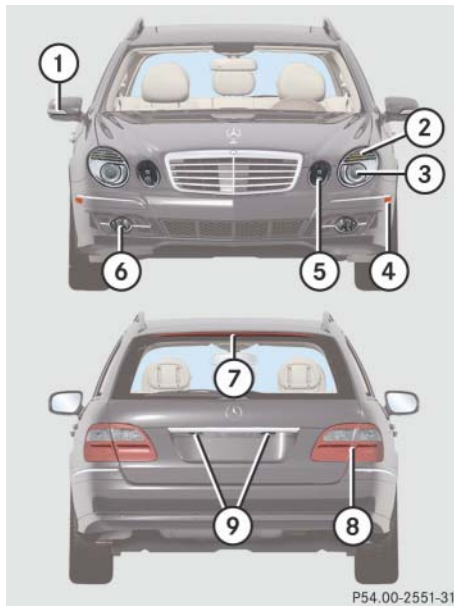

P54.00-2551-31

Front lamps

	Lamp	Type
①	Additional turn signal lamp	LED
②	Turn signal lamp	3547 A (28.5 W)
③	Halogen headlamp: Low beam	H7 (55 W)
	Bi-Xenon* headlamp: Low and high beam ¹	D1S-35 W
④	Side marker lamp	W 5 W

¹ Vehicles with Bi-Xenon* headlamps: Low beam and high beam use the same D1S-35W lamp. Do not replace the Bi-Xenon bulbs yourself. Contact your authorized Mercedes-Benz Center.

Lamp	Type
⑤ Halogen headlamp: High beam/high beam flasher	H7 (55 W)
Bi-Xenon* headlamp: High beam flasher	H7 (55 W)
Halogen headlamp: Parking and standing lamp	W 5 W Blue Vision
Bi-Xenon* headlamp: Parking an standing lamp	LED
⑥ Front fog lamp	H1 (55 W)
Corner-illuminating front fog lamp*	H1 (55 W)

Rear lamps

Lamp	Type
⑦ High mounted brake lamp	LED
⑧ Brake, tail, parking, standing, backup lamp and turn signal lamp. Rear fog lamp (driver's side only)	HiP LED*
⑨ License plate lamps	C 5 W

Warning!



Bulbs and bulb sockets can be very hot. Allow the lamp to cool down before changing a bulb.

Keep bulbs out of reach of children.

Halogen lamps contain pressurized gas. A bulb can explode if you:

- touch or move it when hot
- drop the bulb
- scratch the bulb

Wear eye and hand protection.

Because of high voltage in Bi-Xenon* lamps, it is dangerous to replace the bulb or repair the lamp and its components. We recommend that you have such work done by a qualified technician.

Replacing bulbs

Notes on bulb replacement

- Only use 12-volt bulbs of the same type and with the specified watt rating.
- Switch lights off before changing a bulb to prevent short circuits.
- Always use a clean lint-free cloth when handling bulbs.
- Your hands should be dry and free of oil and grease.
- If the newly installed bulb does not light up, visit an authorized Mercedes-Benz Center.

- Have the LEDs and bulbs for the following lamps replaced by an authorized Mercedes-Benz Center:
 - Additional turn signals in the exterior or rear view mirrors
 - High mounted brake lamp
 - Bi-Xenon* lamps
 - Front fog lamps
 - Rear lamps (except license plate lamps)
 - Front side marker lamps

! Do not replace the LEDs yourself. You could otherwise damage the LEDs or parts of the vehicle. Only have the LEDs replaced by an authorized Mercedes-Benz Center.

Replacing bulbs for front lamps

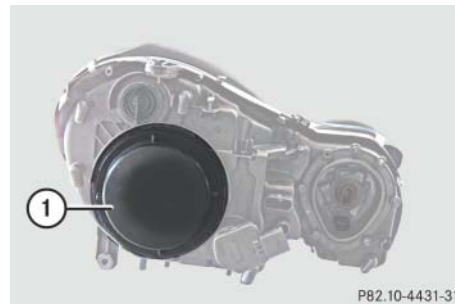

- ① Housing cover for low beam halogen or Bi-Xenon* headlamp

Warning!



Do not remove the cover ① for the Bi-Xenon* headlamp. Because of high voltage in Bi-Xenon* lamps, it is dangerous to replace the bulb or repair the lamp and its components. We recommend that you have such work done by a qualified technician.

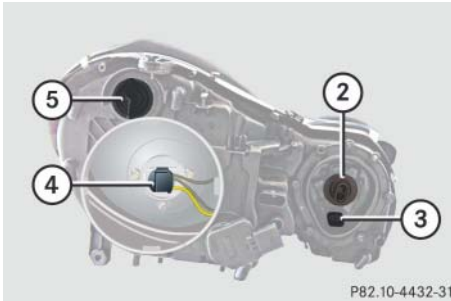

P82.10-4432-31

- ② Bulb socket for high beam headlamp/high beam flasher bulb
- ③ Bulb socket for parking and standing lamp bulb
- ④ Bulb socket for low beam headlamp bulb (halogen headlamps only)
- ⑤ Bulb socket for turn signal lamp bulb

Before you start to replace a bulb for a front lamp, do the following first:

- ▶ Turn the exterior lamp switch to position **0** (▷ page 141).
- ▶ Open the hood (▷ page 324).

Low beam bulb (halogen headlamps only)

- ▶ Turn housing cover ① counterclockwise and remove it.
- ▶ Turn bulb socket ④ with the bulb counterclockwise and remove it.
- ▶ Pull the bulb out of bulb socket ④.
- ▶ Press the new bulb gently into bulb socket ④.
- ▶ Place bulb socket ⑤ back into the lamp and turn it clockwise until it engages.
- ▶ Align housing cover ① and turn it clockwise until it engages.

High beam bulb/high beam flasher bulb (halogen headlamps)/high beam flasher bulb (Bi-Xenon* headlamps)

- ▶ Turn bulb socket ② with the bulb counterclockwise and remove it.
- ▶ Pull the bulb out of bulb socket ②.
- ▶ Press the new bulb gently into bulb socket ②.
- ▶ Place bulb socket ② back into the lamp and turn it clockwise until it engages.

Replacing bulbs

Front turn signal lamp bulb

- ▶ Turn bulb socket ⑤ with the bulb counterclockwise and remove it.
- ▶ Press gently onto the bulb and turn counterclockwise out of bulb socket ⑤.
- ▶ Press the new bulb gently into bulb socket ⑤ and turn clockwise until it engages.
- ▶ Place bulb socket ⑤ back into the lamp and turn it clockwise until it engages.

Parking and standing lamp bulb

Halogen headlamps

- ▶ Turn bulb socket ③ with the bulb counterclockwise and remove it.
- ▶ Pull the bulb out of bulb socket ③.
- ▶ Press the new bulb gently into bulb socket ③.
- ▶ Place bulb socket ③ back into the lamp and turn clockwise until it engages.

Bi-Xenon headlamps*

In vehicles with Bi-Xenon* headlamps, the bulbs of the parking and standing lamps are LEDs.

! *Do not replace the LEDs yourself. You could otherwise damage the LEDs or parts of the vehicle. Only have the LEDs replaced by an authorized Mercedes-Benz Center.*

Additional turn signal lamp bulbs

The additional turn signal lamps in the exterior rear view mirrors have LEDs.

If a malfunction occurs or LEDs fail to function, the entire turn signal unit must be replaced. Have the turn signal unit replaced by an authorized Mercedes-Benz Center.

Front side marker lamp bulbs

Since replacing the side marker lamp bulbs is a technically highly demanding process, we recommend you have the side marker lamp bulbs replaced by an authorized Mercedes-Benz Center.

Replacing bulbs for rear lamps

Tail lamp unit

The tail lamps are equipped with HiP bulbs.

Warning!



The bulbs in the tail lamps cannot be replaced individually. The tail lamp bulbs are under pressure and could explode during an attempt to replace them.

If the tail lamps are malfunctioning, have them exchanged at an authorized Mercedes-Benz Center.

License plate lamp

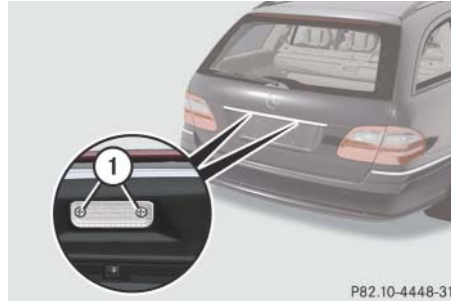

① Screw

- ▶ Turn the exterior lamp switch to position **0** (▷ page 141).
- ▶ Loosen both screws ①.
- ▶ Remove the license plate lamp.
- ▶ Replace the bulb.
- ▶ Reinstall the license plate lamp.
- ▶ Retighten screws ①.

Replacing wiper blades

Warning!



For safety reasons, switch off wipers and remove SmartKey from starter switch (vehicles with KEYLESS-GO*): Make sure the vehicle's on-board electronics have status **0** before replacing a wiper blade. Otherwise, the wiper motor could suddenly turn on and cause injury.

Warning!



Wiper blades are components that are subject to wear and tear. Change the wiper blades twice a year, preferably in the spring and fall. Otherwise the windows will not be properly wiped. As a result, you may not be able to observe surrounding traffic conditions and could cause an accident.

! To avoid damage to the hood:

- The wiper arms should only be folded forward when in the vertical position.
- Never open the hood when the wiper arm is folded forward.

! Hold on to the wiper when folding the wiper arm back. If released, the force of the impact from the tensioning spring could crack the windshield.

Do not allow the wiper arms to contact the windshield glass without a wiper blade inserted.

Make sure the wiper blades are properly installed. Improperly installed wiper blades may cause windshield damage.

For your convenience, we recommend that you have this work carried out by an authorized Mercedes-Benz Center.

Placing front wiper arms in vertical position



Wiper blades in vertical position

Vehicles with SmartKey

- ▶ Turn SmartKey to starter switch position **1** (▷ page 37).
- ▶ Turn combination switch to wiper setting  (▷ page 57).
- ▶ With wiper arms in the vertical position, turn SmartKey in starter switch to position **0**.
- ▶ Remove SmartKey from starter switch.

Vehicles with KEYLESS-GO*

- ▶ Turn off the engine (▷ page 64).
With the driver's door closed, the starter switch is now in position **1**.
- ▶ Turn combination switch to wiper setting **II** (▷ page 57).
- ▶ With wiper arms in the vertical position, open the driver's door.
The starter switch is set to position **0**, same as SmartKey removed from starter switch.
- ▶ Turn combination switch to wiper setting **0** (▷ page 57).

Removing front wiper blades

! Do not pull on the wiper blade inserts. They could tear.

- ▶ Fold the wiper arm forward until it snaps into place.

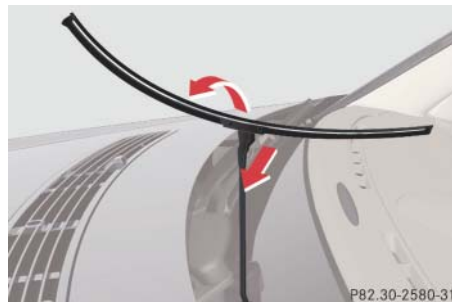

- ▶ Turn the wiper blade at a right angle to wiper arm.
- ▶ Slide the wiper blade sideways out of the retainer.

Installing front wiper blades

- ▶ Slide the wiper blade onto wiper arm until it locks in place.
- ▶ Rotate the wiper blade into position parallel to the wiper arm.
- ▶ Fold the wiper arm backward to rest on the windshield. Make sure you hold on to the wiper when folding the wiper arm back.

Removing rear wiper blade

! Hold on to the wiper when folding the wiper arm back. If released, the force of the impact from the tensioning spring could crack the rear window.

Do not allow the wiper arms to contact the rear window glass without a wiper blade inserted.

For your convenience, we recommend that you have this work carried out by an authorized Mercedes-Benz Center.

Make sure the wiper blades are properly installed. Improperly installed wiper blades may cause rear window damage.



Replacing wiper blades

- ▶▶ Remove the SmartKey from the starter switch.

Vehicles with KEYLESS-GO*:

- ▶ Make sure the vehicle's on-board electronics have status **0** (▶ page 39).

! Do not pull on the wiper blade inserts. They could tear.

- ▶ Fold the wiper arm away from the vehicle until it engages.

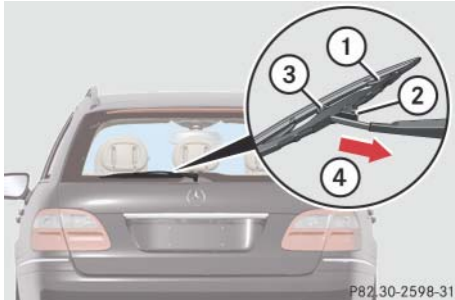

- ① Wiper blade
- ② Tab
- ③ Attachment
- ④ Removing

- ▶ Turn the wiper blade ① at a right angle to wiper arm.
- ▶ Press tab ② down and push wiper blade ① downward in direction of arrow ④.
- ▶ Remove wiper blade ①.

Installing rear wiper blade

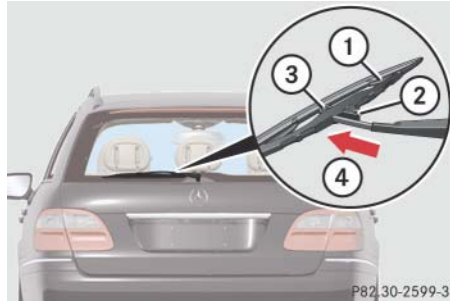

- ① Wiper blade
- ② Tab
- ③ Attachment
- ④ Installing

- ▶ Slide the wiper blade ① into attachment ③ in direction of arrow ④.
- ▶ Let tab ② latch into attachment ③ until it locks in place.
- ▶ Check if the wiper blade is securely fastened.
- ▶ Fold the wiper arm back towards the vehicle to rest on the rear windshield. Make sure you hold on to the wiper arm when folding it back.

▼ Flat tire

Preparing the vehicle

- ▶ Park the vehicle in a safe distance from moving traffic on a hard, flat surface when possible.
- ▶ Turn on the hazard warning flasher (▷ page 148).
- ▶ Turn the steering wheel so that the front wheels are in a straight ahead position.
- ▶ Set the parking brake (▷ page 62).
- ▶ Move the gear selector lever to **P**.

Vehicles with SmartKey:

- ▶ Turn off the engine (▷ page 63).
- ▶ Remove the SmartKey from the starter switch.

Vehicles with SmartKey with KEYLESS-GO*:

- ▶ Turn off the engine by pressing the KEYLESS-GO* start/stop button on the gear selector lever once (▷ page 64).
- ▶ Open the driver's door (this puts the ignition in position **0**, same as with the SmartKey removed from the starter switch). The driver's door then can be closed again.
- ▶ Have any passenger exit the vehicle at a safe distance from the roadway.

 *Open door only when conditions are safe to do so.*

Sealing tires with TIREFIT

E 63 AMG vehicles with foldable third row seat are equipped with TIREFIT.

Warning!



Keep TIREFIT away from sparks, open flame or heat source.

Do not smoke.

Small tire punctures, particularly those in the tread, can be sealed with TIREFIT. TIREFIT can be used in ambient temperatures down to -4°F (-20°C).

Flat tire

Warning!



TIREFIT is a limited repair device. TIREFIT cannot be used for cuts or punctures larger than approximately 0.16 in (4 mm) and tire damage caused by driving with extremely low tire inflation pressure, or on a flat tire, or a damaged wheel.

Do not drive the vehicle under such circumstances.

Contact your nearest Mercedes-Benz Center for assistance or call Roadside Assistance.

- ▶ Foreign objects (e.g. screws or nails) should not be removed from the tire.
- ▶ Take TIREFIT, the sticker, and the electric air pump out of the cargo compartment.
- ▶ Attach the sticker where it will be easily seen by the driver on the instrument cluster.

Warning!



Take care not to allow the contents of TIREFIT to come in contact with hair, eyes or clothing. TIREFIT is harmful if inhaled, swallowed or absorbed through the skin - causes skin, eye and respiratory irritation.

Any contact with eyes or skin should be flushed immediately with plenty of water.

If clothing comes in contact with TIREFIT, change clothing as soon as possible.

In case of allergic reaction or rash, consult a physician immediately.

Warning!



Keep TIREFIT out of reach of children. If swallowed, rinse mouth immediately with plenty of water and drink plenty of water.

Do not induce vomiting!

Consult a physician immediately.

Keep away from open flame or heat source.

i If sealant has leaked out, let it dry. You can then peel it off.

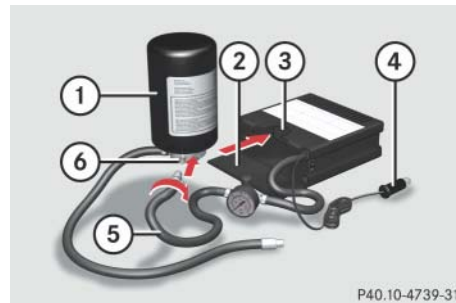

P40.10-4739-31

- ① TIREFIT container
- ② Flap
- ③ Notch
- ④ Electrical plug
- ⑤ Air hose
- ⑥ Flange

- ▶ Open flap ② on the electric air pump.
- ▶ Pull plug ④ and air hose ⑤ out of the pump housing.
- ▶ Screw the air pump's air hose ⑤ onto flange ⑥ of the TIREFIT container.

- ▶ Stick TIREFIT container ① upside down into notch ③ of the electric air pump.

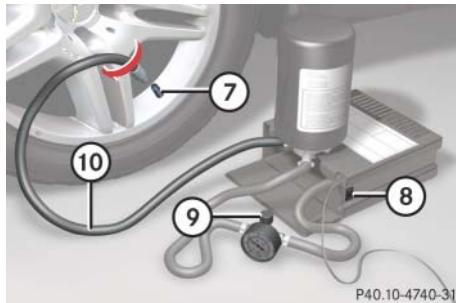

- ⑦ Tire valve
- ⑧ Electric air pump switch
- ⑨ Air hose with pressure gauge and vent screw
- ⑩ Filler hose

Warning!



Observe safety instructions on air pump label.

- ▶ Unscrew the valve cap from tire valve ⑦.
 - ▶ Screw filler hose ⑩ onto tire valve ⑦.
 - ▶ Insert electrical plug ④ into the vehicle cigarette lighter socket (▷ page 286).
 - ▶ Turn the SmartKey in the starter switch to position 1 (▷ page 37).
 - or
 - ▶ Press the KEYLESS-GO* start/stop button (▷ page 39) on the gear selector lever once. Do not depress brake pedal.
 - ▶ Press I on electric air pump switch ⑧.
- The electric air pump should now switch on and inflate the tire.

! Do not operate the electric air pump longer than 8 minutes without interruption. Otherwise it may overheat.

You may operate the air pump again after it has cooled off.

After 5 minutes, the pressure gauge must display at least 26 psi (1.8 bar). The air hose can become hot during inflation. Please exercise appropriate caution.

- ▶ If this tire inflation pressure is not attained, turn off the electric air pump, detach the filler hose from the tire valve, and drive vehicle back and forth very slowly approximately 30 ft (10 m).

This serves to better distribute the TIREFIT sealant material inside the tire.

- ▶ Unscrew the air pump's air hose ⑤ from flange ⑥ of the TIREFIT container.
- ▶ Screw air hose ⑤ onto tire valve ⑦.
- ▶ Inflate the tire again.



Flat tire



Warning!



If a tire inflation pressure of 26 psi (1.8 bar) is not attained, tire is too severely damaged for TIREFIT to provide a reliable tire repair.

In this case, TIREFIT cannot properly seal the tire.

Do not drive the vehicle.

Contact the nearest Mercedes-Benz Center or call Roadside Assistance.

- ▶ After attaining a tire inflation pressure of 26 psi (1.8 bar), press **0** on electric air pump switch **(8)**.

The electric air pump should now be switched off.

- ▶ Turn the SmartKey in the ignition to position **0** (▷ page 37).
or
- ▶ Press the KEYLESS-GO* start/stop button (▷ page 39) on the gear selector lever twice. Do not depress brake pedal.
- ▶ Detach the electric air pump.
The air hose may still be hot. Please exercise appropriate caution.
- ▶ Place the electric air pump back in the cargo compartment.
- ▶ Close the cargo compartment.
- ▶ Drive away immediately.
The TIREFIT sealant will distribute itself evenly inside the tire.

Warning!



Do not exceed vehicle speed of 50 mph (80 km/h). A TIREFIT repair is not designed to operate at higher speeds.

The sticker must be attached on the instrument cluster where it will be easily seen by the driver.

Vehicle handling characteristics may change. Adapt your driving accordingly.

- ▶ After driving vehicle for an initial 10 minutes, check tire inflation pressure using the pressure gauge on the air pump.

Warning!

If tire inflation pressure has fallen below 20 psi (1.3 bar) do not continue to drive the vehicle.

Park your vehicle safely away from the roadway and contact the nearest authorized Mercedes-Benz Center or Roadside Assistance.

- ▶ If tire inflation pressure is at least 20 psi (1.3 bar), inflate tire to correct pressure (see placard on the driver's door B-pillar), and drive to the nearest qualified workshop, e.g. an authorized Mercedes-Benz Center to have the damaged tire replaced.

Recommended duration of use: A maximum of 300 miles (500 km) at or below 50 mph (80 km/h) with the recommended tire inflation pressure.

Warning!

Follow recommend tire inflation pressures. Do not overinflate tires. Overinflating tires can result in sudden deflation (blowout) because they are more likely to become punctured or damaged by road debris, potholes, etc.

Do not underinflate tires. Underinflated tires wear unevenly, adversely affect handling and fuel economy, and are more likely to fail from being overheated.

- ▶ Visit an authorized Mercedes-Benz Center as soon as possible to obtain a new TIREFIT kit.
- ▶ Bring used TIREFIT materials to an authorized Mercedes-Benz Center for proper disposal.

Warning!

Do not exceed vehicle speed of 50 mph (80 km/h). A TIREFIT repair is not designed to operate at higher speeds.

The sticker must be attached on the instrument cluster where it will be easily seen by the driver.

Vehicle handling characteristics may change. Adapt your driving accordingly.

- ▶ Replace your TIREFIT container every four years. Replacement containers are available at your authorized Mercedes-Benz Center.

Flat tire

Mounting the spare wheel

Warning!



The dimensions of the spare wheel (Minispare or collapsible tire) are different from those of the road wheels. As a result, the vehicle handling characteristics change when driving with a spare wheel mounted. Adapt your driving style accordingly.

The spare wheel is for temporary use only. When driving with spare wheel mounted, ensure proper tire pressure and do not exceed a vehicle speed of 50 mph (80 km/h).

Drive to the nearest Mercedes-Benz Center as soon as possible to have the spare wheel replaced with a regular road wheel.

Never operate the vehicle with more than one spare wheel mounted.

Do not switch off the ESP® when a Minispare wheel or spare wheel with collapsible tire is mounted.

Preparing the vehicle

Prepare the vehicle as described (▷ page 451).

Vehicles with Minispare wheel (except E 63 AMG):

- ▶ Take the Minispare wheel, wheel wrench and the jack out of the cargo compartment (▷ page 433).

Vehicles with collapsible tire (E 63 AMG without folding third row seat only):

- ▶ Take the collapsible tire, wheel wrench, jack and electric air pump out of the cargo compartment (▷ page 433).

Lifting the vehicle

- ▶ Prevent the vehicle from rolling away by blocking wheels with wheel chocks or other sizeable objects.

One wheel chock is included with the vehicle tool kit (▷ page 430).

When changing wheel on a level surface:

- ▶ Place the wheel chock in front of and another sizeable object behind the wheel that is diagonally opposite to the wheel being changed.

Always try lifting the vehicle using the jack on a level surface. However, should circumstances require you to do so on a hill, place the wheel chock and the other sizeable object as follows:

- ▶ Place the wheel chock and another sizeable object on the downhill side blocking both wheels of the axle not being worked on.

Warning!

The jack is designed exclusively for jacking up the vehicle at the jack take-up brackets built into either side of the vehicle. To help avoid personal injury, use the jack only to lift the vehicle during a wheel change. Never get beneath the vehicle while it is supported by the jack. Keep hands and feet away from the area under the lifted vehicle. Always firmly set parking brake and block wheels before raising vehicle with jack.

Do not disengage parking brake while the vehicle is raised. Be certain that the jack is always vertical (plumb line) when in use, especially on hills. Always try to use the jack on level surface. Be sure that the jack arm is fully seated in the jack take-up bracket. Always lower the vehicle onto sufficient capacity jackstands before working under the vehicle.

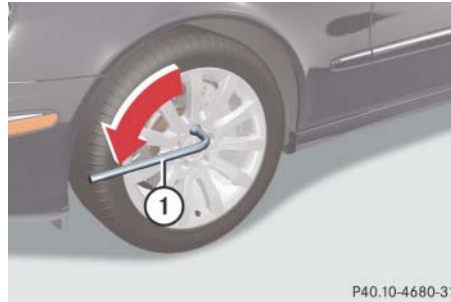

P40.10-4680-31

- ▶ On wheel to be changed, loosen but do not yet remove the wheel bolts (approximately one full turn with wrench).

The jack take-up brackets are located directly behind the front wheel housings and in front of the rear wheel housings.

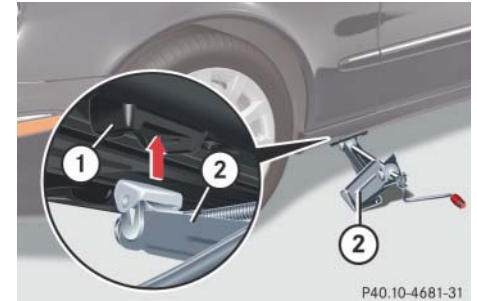

P40.10-4681-31

- ① Jack take-up bracket
- ② Jack

- ▶ Place jack ② on firm ground.
- ▶ Position jack ② under take-up bracket ① so that it is always vertical (plumb-line) as seen from the side, even if the vehicle is parked on an incline.



Flat tire

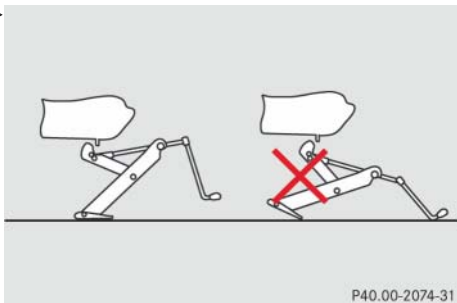

- ▶ Jack up the vehicle until the wheel is a maximum of 1.2 in (3 cm) from the ground. Never start engine while vehicle is raised.

Warning!



Position the jack only on the jack take-up brackets designed for this purpose. If the jack is not properly positioned, the vehicle may slip off of the jack.

Warning!



The jack is intended only for lifting the vehicle briefly for wheel changes. It is not suited for performing maintenance work under the vehicle.

- Never start the engine when the vehicle is raised.
- Never lie down under the raised vehicle.

Removing the wheel



① Alignment bolt

- ▶ Unscrew upper-most wheel bolt and remove.

- ▶ Replace this wheel bolt with alignment bolt ① supplied in the tool kit.

- ▶ Remove the remaining bolts.

! Do not place wheel bolts in sand or dirt. This could result in damage to the bolt and wheel hub threads.

- ▶ Remove the wheel.

Mounting the spare wheel

- ▶ Clean contact surfaces of wheel and wheel hub.

! To avoid paint damage, place wheel flat against hub and hold it there while installing first wheel bolt.

Warning!

Always replace wheel bolts that are damaged or rusted.

Never apply oil or grease to wheel bolts.

Damaged wheel hub threads should be repaired immediately. Do not continue to drive under these circumstances! Contact an authorized Mercedes-Benz Center or call Roadside Assistance.

Incorrect wheel bolts or improperly tightened wheel bolts can cause the wheel to come off. This could cause an accident. Be sure to use the correct wheel bolts.

- ▶ Guide the spare wheel onto the alignment bolt and push it on.
- ▶ Insert wheel bolts and tighten them slightly.

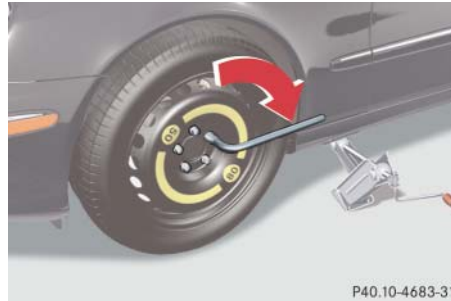

- ▶ Unscrew the alignment bolt, install last wheel bolt and tighten slightly.

Warning!

Only use Genuine equipment Mercedes-Benz wheel bolts. Other wheel bolts may come loose.

Do not tighten the wheel bolts when the vehicle is raised. Otherwise the vehicle could fall off the jack.

Vehicles with collapsible tire (E 63 AMG without folding third row seat only):

- ▶ Continue the procedure by following the instructions under “Inflating the collapsible tire” (▷ page 459) and then “Lowering the vehicle” (▷ page 461).

Vehicles with Minispare wheel (except E 63 AMG):

- ▶ Continue the procedure by following the instructions under “Lowering the vehicle” (▷ page 461).

Inflating the collapsible tire (E 63 AMG without foldable third row seat only)

Warning!

Inflate collapsible tire only after the wheel is properly mounted.

Inflate the collapsible tire using the electric air pump before lowering the vehicle.



Flat tire



Warning!



Observe instructions on air pump label.

! Do not lower the vehicle before inflating the collapsible tire. Otherwise the rim may be damaged.

- ▶ Take the electric air pump out of the cargo compartment (▷ page 431).

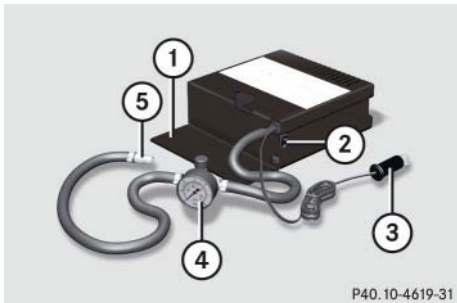

- ① Flap
- ② On/off switch
- ③ Electrical plug
- ④ Air hose with pressure gauge and vent screw
- ⑤ Union nut

- ▶ Open flap ① on electric air pump.
- ▶ Pull out electrical plug ③ and air hose with pressure gauge ④.
- ▶ Remove the valve cap from the collapsible tire valve.
- ▶ Screw union nut ⑤ onto the collapsible tire valve.
- ▶ Insert electrical plug ③ into vehicle cigarette lighter socket (▷ page 286).
- ▶ Turn the SmartKey in the starter switch to position 1.
- ▶ Press I on electric air pump switch ②.

The electric air pump should now switch on and inflate the collapsible tire.

- ▶ Inflate the tire to approximately 51 psi (3.5 bar).

This takes about 5 minutes for the collapsible tire. Air hose ④ and union nut ⑤ can become hot during inflation. Exercise proper caution to avoid burning yourself when using the equipment.

! Do not operate the electric air pump longer than 8 minutes without interruption. Otherwise it may overheat.

You may operate the electric air pump again after it has cooled off.

- ▶ Press 0 on electric air pump switch ②.
- ▶ Turn the SmartKey in the starter switch to position 0.
- ▶ If the tire pressure is above 51 psi (3.5 bar), release excess tire pressure using the vent screw.

Warning!

Follow recommend inflation pressures.

Do not overinflate tires. Overinflating tires can result in sudden deflation (blowout) because they are more likely to become punctured or damaged by road debris, potholes, etc.

Do not underinflate tires. Underinflated tires wear unevenly, adversely affect handling and fuel economy, and are more likely to fail from being overheated.

- ▶ Detach the electric air pump.
- ▶ Store the electrical plug ③ and the air hose ④ behind the flap ① and place the electric air pump back in the designated storage space underneath the cargo compartment floor (▷ page 430).

Lowering the vehicle

- ▶ Lower vehicle by turning crank counterclockwise until vehicle is resting fully on its own weight.
- ▶ Remove the jack.

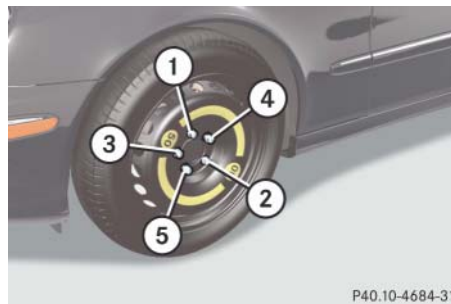

P40.10-4684-31

- ① - ⑤ Wheel bolts
- ▶ Tighten the five wheel bolts evenly, following the diagonal sequence illustrated (① to ⑤), until all bolts are tight. Observe a tightening torque of 96 lb-ft (130 Nm).

Warning!

Have the tightening torque checked after changing a wheel. The wheels could come loose if they are not tightened to a torque of 96 lb-ft (130 Nm).

Before storing the jack, it should be fully collapsed, with handle folded in (storage position).

- ▶ Store the jack and the other vehicle tools in the designated storage space underneath the cargo compartment floor (▷ page 430).

i Wrap the damaged wheel in the protective film that comes with the spare wheel and put the wheel in the cargo compartment.

Vehicles with TPMS or Advanced TPMS:*
Do not activate the tire inflation pressure monitor until a full size wheel/tire with functioning sensor has been placed back into service on the vehicle.

Battery

The battery is located in the cargo compartment on the right-hand side under a cover.



- ▶ Pull cover up and detach it.

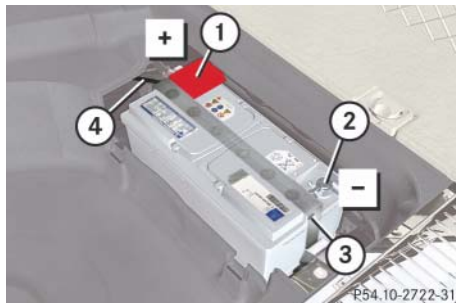

- ① Positive terminal
- ② Negative terminal
- ③ Lateral plug
- ④ Battery ventilation hose

Warning!



Jump starting must only be done using the designated terminal connections in the engine compartment (▷ page 467).

Warning!



Failure to follow these instructions can result in severe injury or death.

Observe all safety instructions and precautions when handling automotive batteries (▷ page 330).

Never lean over batteries while connecting, you might get injured.

Battery fluid contains sulfuric acid. Do not allow this fluid to come in contact with eyes, skin or clothing. In case it does, immediately flush affected area with water and seek medical help if necessary.

A battery will also produce hydrogen gas, which is flammable and explosive. Keep flames or sparks away from battery, avoid improper connection of jumper cables, smoking etc.

! The battery is a valve-regulated lead acid (VRLA) battery, also referred to as “fleece” battery. Such batteries do not require topping-up of the electrolyte level. VRLA batteries therefore do not have cell caps and the battery cover is non-removable. Do not attempt to open the battery as otherwise the battery will be damaged.

Even though VRLA batteries do not require topping-up of the electrolyte level and cannot be opened to check the electrolyte level, the battery condition must be checked periodically by performing a battery conductance test. Refer to Maintenance Booklet for battery condition testing intervals.

As with any other battery, disconnect the battery if you do not intend to operate your vehicle for an extended period of time to prevent battery discharge or connect an accessory battery charge unit expressly approved by Mercedes-Benz for your vehicle model to maintain the battery charge. Contact an authorized Mercedes-Benz Center for further information.

! The factory-equipped VRLA battery is leak-proofed. Only use a battery as replacement that has the same security features and is of identical size, voltage, and capacity as the factory-equipped battery.

The battery, the battery ventilation hose and the lateral plug must always be securely installed when the vehicle is in operation.

! Never loosen or detach battery terminal clamps while the engine is running or the Smart-Key is in the starter switch. Otherwise the alternator and other electronic components could be severely damaged.

Have the battery checked regularly by an authorized Mercedes-Benz Center.

Refer to Maintenance Booklet for maintenance intervals or contact an authorized Mercedes-Benz Center for further information.

Warning!



Do not place metal objects on the battery as this could result in a short circuit.

Use leak-proof battery only to avoid the risk of acid burns in the event of an accident.

Battery

Disconnecting the battery

Warning!



With a disconnected battery

- you will no longer be able to turn the SmartKey in the starter switch and pressing the KEYLESS-GO* start/stop button on the gear selector lever will have no effect
- the gear selector lever will remain locked in position **P**

! Always disconnect the battery in the order described below. Otherwise the vehicle's electronics can be damaged.

- ▶ Depress the parking brake pedal.
- ▶ Make sure the gear selector lever is set to position **P**.
- ▶ Turn off all electrical consumers.

- ▶ Remove SmartKey from starter switch.
Vehicles with KEYLESS-GO*:
 - ▶ Press the start/stop button until the engine shuts off.
 - ▶ Open the driver's door.
- ▶ Open the cargo compartment.
- ▶ Read and observe safety instructions and precautions (▷ page 330) and (▷ page 462).
- ▶ Access the cargo compartment underneath the third row seat cushions and footwell (▷ page 431).
- ▶ Remove cover to access battery (▷ page 462).
- ▶ Disconnect battery negative lead from negative terminal ② (▷ page 462).
- ▶ Remove cover ① (▷ page 462) from the positive terminal.
- ▶ Disconnect the battery positive lead.

Removing the battery

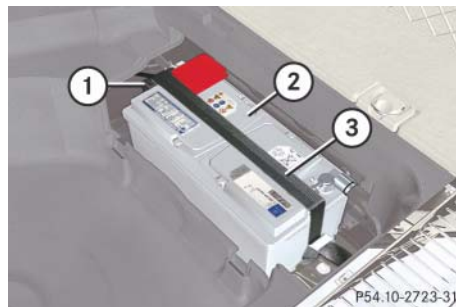

- ① Spacer
- ② Battery
- ③ Battery bracket
- ▶ Remove the screw-nuts securing the battery.
- ▶ Remove the battery bracket ③.
- ▶ Remove spacer ① from the battery's ventilation hose.

- ▶ Pull out the battery ventilation hose ④ (▷ page 462) from the battery (depending on battery arrangement in your vehicle model, the ventilation hose is located either on the left or right side of the battery).
- ▶ Take out the battery.

Charging and reinstalling the battery

Warning!



Never charge a battery while still installed in the vehicle unless the accessory battery charge unit* approved by Mercedes-Benz is being used. Gases may escape during charging and cause explosions that may result in paint damage, corrosion or personal injury.

An accessory battery charge unit* specially adapted for Mercedes-Benz vehicles and tested and approved by Mercedes-Benz is available, permitting the charging of the battery in its installed position. Contact an authorized Mercedes-Benz Center for information and availability. Charge battery in accordance with the separate instructions for the accessory battery charger*.

- ▶ Charge battery in accordance with the instructions of the battery charger manufacturer.
 - ▶ Reinstall the charged battery. Follow the previously described steps in reverse order.
- !** *The battery and the battery ventilation hose must always be securely installed when the vehicle is in operation.*

Reconnecting the battery

! *Always connect the battery in the order described below. Otherwise the vehicle's electronics can be damaged.*

- ▶ Turn off all electrical consumers.
- ▶ Connect the battery positive lead and fasten its cover.
- ▶ Connect the battery negative lead.

! *Never invert the terminal connections!*

i *The following procedures must be carried out following any interruption of battery power (e.g. due to reconnection):*

- *Set the clock (▷ page 174) (see COMAND operator's manual).*
- *Synchronize the side windows (▷ page 241).*
- *Synchronize the tilt/sliding sunroof (▷ page 245).*

Jump starting

Warning!



Failure to follow these directions will cause damage to the electronic components, and can lead to a battery explosion and severe injury or death.

Never lean over batteries while connecting or jump starting, you might get injured.

Battery fluid contains sulfuric acid. Do not allow this fluid to come in contact with eyes, skin or clothing. In case it does, immediately flush affected area with water, and seek medical help if necessary.

A battery will also produce hydrogen gas, which is flammable and very explosive. Keep flames or sparks away from battery, avoid improper connection of jumper cables, smoking, etc.

Attempting to jump start a frozen battery can result in it exploding, causing personal injury.

Read all instructions before proceeding.

! Do not tow-start the vehicle.

! Jump starting may only be performed on the designated jump start terminals located in the engine compartment (▷ page 467).

Avoid repeated and lengthy starting attempts.

Do not attempt to start the engine using a battery quick charge unit.

If the engine does not run after several unsuccessful starting attempts, have it checked at the nearest authorized Mercedes-Benz Center.

Excessive unburned fuel generated by repeated failed starting attempts may damage the catalytic converter.

Make sure the jumper cables do not have loose or missing insulation.

Make sure the cable clamps do not touch any other metal part while the other end is still attached to a battery.

If the battery is discharged, the engine can be started with jumper cables and the battery of another vehicle. Observe the following:

- Jump starting should only be performed when the engine and catalytic converter are cold.
- Do not start the engine if the battery is frozen. Let the battery thaw out first.
- Only jump start from batteries with the same voltage rating (12 V). Jump starting with a higher voltage battery could damage the vehicle's electrical system, which will not be covered by the Mercedes-Benz Limited Warranty.
- Only use jumper cables with sufficient cross-section and insulated terminal clamps.
- Always make sure the jumper cables are not on or near pulleys, fans or other parts that move when the engine is started or running.

Warning!



Keep flames or sparks away from battery. Do not smoke.

Observe all safety instructions and precautions when handling automotive batteries (▷ page 330).

The jump-start contacts are located in the engine compartment.

- ▶ Make sure the two vehicles do not touch.
- ▶ Turn off all electrical consumers.
- ▶ Apply the parking brake (▷ page 62).
- ▶ Make sure the gear selector lever is set to position **P**.
- ▶ Open the hood (▷ page 324).

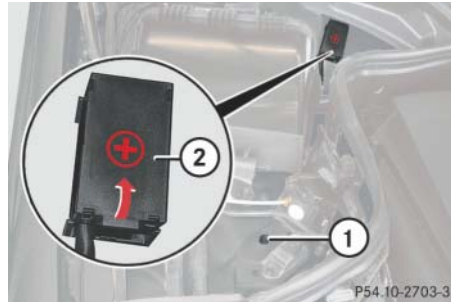

- ① Negative (-) terminal
- ② Cover of positive (+) terminal
- ▶ Open cover of the positive terminal.
- ▶ Connect positive terminal ② and the positive terminal of the charged battery with the jumper cable. Clamp cable to charged battery first.
- ❗ *Never invert the terminal connections!*
- ▶ Start engine of the vehicle with the charged battery and run at idle speed.
- ▶ Connect negative terminal ① and the negative terminal of the charged battery with the second jumper cable. Clamp cable to charged battery first.

- ▶ Start the engine of the disabled vehicle.

You can now turn on the electrical consumers. Do not switch on the headlamps under any circumstances.

- ▶ Remove the jumper cables first from negative terminals on each battery and then from the positive terminals on each battery.

You can now switch on the headlamps.

- ▶ Have the battery checked at the nearest authorized Mercedes-Benz Center.

Towing the vehicle

Mercedes-Benz recommends that the vehicle be transported with all wheels off the ground using flatbed or appropriate wheel lift/dolly equipment. This method is preferable to other types of towing.

! *Do not tow-start the vehicle.*

! *Use flatbed or wheel lift/dolly equipment with SmartKey in starter switch turned to position 0.*

Do not tow with sling-type equipment. Towing with sling-type equipment over bumpy roads will damage radiator and supports.

To prevent damage during transport, do not tie down vehicle by its chassis or suspension parts.

Switch off the tow-away alarm and the automatic central locking.

! *Vehicles with 4MATIC:*

Do not tow with one axle raised. Doing so could damage the transfer case, which is not covered by the Mercedes-Benz Limited Warranty.

All wheels must be on or off the ground. Observe instructions for towing the vehicle with all wheels on the ground.

When circumstances do not permit the recommended towing methods, the vehicle may be towed with all wheels on the ground or front wheels raised (except vehicles with 4MATIC) only so far as necessary to have the vehicle moved to a safe location where the recommended towing methods can be employed.

Warning!



If circumstances require towing the vehicle with all wheels on the ground, always tow with a tow bar if:

- the engine will not run
- there is a malfunction in the brake system
- there is a malfunction in the power supply or in the vehicle's electrical system

as that will be necessary to adequately control the towed vehicle.

Prior to towing the vehicle with all wheels on the ground, make certain the SmartKey is in starter switch position **2**.

If the SmartKey is left in the starter switch position **0** for an extended period of time, it can no longer be turned in the switch. In this case, the steering is locked. To unlock, remove SmartKey from starter switch and re-insert.

Warning!

With the engine not running, there is no power assistance for the brake and steering systems. In this case, it is important to keep in mind that a considerably higher degree of effort is necessary to brake and steer the vehicle. Adapt your driving accordingly.

! If the vehicle is towed with the front axle raised (not permissible for vehicles with 4MATIC), the gear selector lever must be in position **N** and the engine must be shut off (SmartKey in starter switch position **0** or **1**). Active braking action through the ESP® may otherwise seriously damage the brake system.

When towing the vehicle with all wheels on the ground, the gear selector lever must be in position **N** and the SmartKey must be in starter switch position **2**.

When towing the vehicle with all wheels on the ground or the front axle raised, the vehicle may be towed only for distances up to 30 miles (50 km) and at a speed not to exceed 30 mph (50 km/h).

! Towing of the vehicle should only be done using the properly installed towing eye bolt. Never attach tow cable, tow rope or tow rod to the vehicle chassis, frame or suspension parts.

i When towing the vehicle with all wheels on the ground, please note the following:

With the automatic central locking activated and the SmartKey in starter switch position **2**, or KEYLESS-GO* start/stop button in position **2**, the vehicle doors lock if the left front wheel as well as the right rear wheel are turning at vehicle speeds of approximately 9 mph (15 km/h) or more.

To prevent the vehicle door locks from locking, deactivate the automatic central locking (▷ page 126).

i To signal turns while being towed with the hazard warning flasher in use, turn SmartKey in starter switch to position **2** and activate the combination switch for the left or right turn signal in the usual manner – only the selected turn signal will operate.

Upon canceling the turn signal, the hazard warning flasher will operate again.

i The gear selector lever will remain locked in position **P** and the SmartKey will not turn in the starter switch if the battery is disconnected or discharged. For more information, see “Batteries” (▷ page 462) and “Jump starting” (▷ page 466).

For information on manual unlocking of the gear selector lever, see (▷ page 437).

Towing the vehicle

Installing towing eye bolt

Front of vehicle



① Cover on right side of front bumper

To remove cover:

- ▶ Press mark on cover ① in direction of arrow.
- ▶ Lift cover ① off to reveal the threaded hole for towing eye bolt.

The towing eye bolt is supplied with the tool kit (located in the storage compartment under the cargo compartment floor).

- ▶ Screw towing eye bolt in to its stop and tighten with lug wrench.

To reinstall cover:

- ▶ Fit cover ① and snap into place.

Rear of vehicle

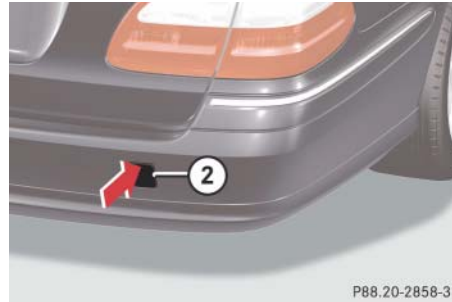

② Cover on right side of rear bumper

To remove cover:

- ▶ Pull cover ② in direction of arrow.
- ▶ Fold cover ② down to reveal the threaded hole for the towing eye bolt.

The towing eye bolt is supplied with the tool kit (located in the storage compartment under the cargo compartment floor).

- ▶ Screw towing eye bolt in to its stop and tighten with lug wrench.

To reinstall cover:

- ▶ Fit cover ② and snap into place.

▼ Fuses

The electrical fuses in your vehicle serve to switch off malfunctioning power circuits.

If a fuse is blown, the components and systems secured by that fuse will stop operating.

Warning!



Only use fuses approved by Mercedes-Benz with the specified amperage for the system in question and do not attempt to repair or bridge a blown fuse. Using other than approved fuses or using repaired or bridged fuses may cause an overload leading to a fire, and/or cause damage to electrical components and/or systems. Have the cause determined and remedied by an authorized Mercedes-Benz Center.

i *A blown fuse must be replaced by an appropriate spare fuse (recognizable by its color or the fuse rating given on the fuse) of the amperage recommended in the fuse chart. Any Mercedes-Benz Center will be glad to advise you on this subject.*

If a newly inserted fuse blows again, have the cause determined and rectified by an authorized Mercedes-Benz Center.

The following aids are available to help you replace fuses.

- Fuse chart

The fuse chart is located in the main fuse box in the passenger compartment (▷ page 472). The fuse chart explains the fuse allocation and fuse amperages.

- Spare fuses

Spare fuses are located in the vehicle tool kit in the cargo compartment (▷ page 430).

- Fuse extractor

The fuse extractor is located in the vehicle tool kit in the cargo compartment (▷ page 430).

The electrical fuses are located in different fuse boxes:

- in the passenger compartment on the driver's side (▷ page 472)
- in the cargo compartment (▷ page 472)

Before replacing fuses:

- ▶ Apply the parking brake (▷ page 62).
- ▶ Make sure the gear selector lever is set to position **P** (▷ page 187).
- ▶ Turn off all electrical consumers.
- ▶ Turn off the engine (▷ page 63).
- ▶ Remove the SmartKey from the starter switch.

Vehicles with KEYLESS-GO*:

- ▶ Open the driver's door.

Fuses

Fuse box in passenger compartment

The fuse box is located behind a cover in the dashboard on the driver's side.

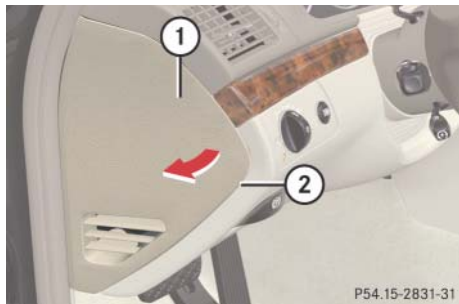

- ① Cover
- ② Recess in the cover

! Do not use sharp objects such as a screw driver to open the fuse box cover ① in the dashboard, as this could damage it.

Opening

- ▶ Open the driver's door.
- ▶ Insert flat, blunt object as a lever in recess ② on the edge of cover ①.
- ▶ Loosen cover ① from the dashboard using lever.
- ▶ Using your hands, pull cover ① in direction of arrow and remove.

Closing

- ▶ Hook cover ① into the opening at the front.
- ▶ Press cover ① back on until it engages.

! The cover ① must be properly positioned as described to prevent moisture or dirt from entering the fuse box and possibly impairing fuse operation.

Fuse box in cargo compartment

The fuse box is located behind the left-hand trim panel in the cargo compartment.

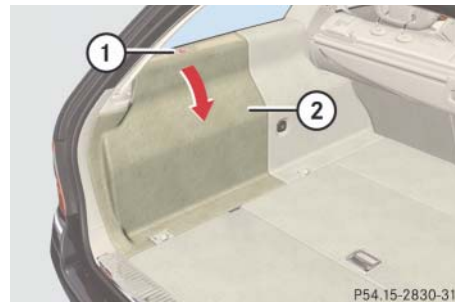

- ① Button for unlocking trim panel
- ② Trim panel

Opening trim panel

- ▶ Press button ①.
- ▶ Fold down trim panel ②.

Closing trim panel

- ▶ Fold up trim panel ②.



Parts service

Warranty coverage

Identification labels

Layout of poly-V-belt drive

Engine

Rims and tires

Electrical system

Main dimensions and weight

Fuels, coolants, lubricants etc.

The “Technical data” section provides the necessary technical data for your vehicle.

All authorized Mercedes-Benz Centers maintain a stock of Genuine Mercedes-Benz Parts required for maintenance and repair work. In addition, strategically located parts distribution centers provide quick and reliable parts service.

More than 300 000 different parts for Mercedes-Benz models are available.

Genuine Mercedes-Benz Parts are subjected to stringent quality inspections. Each part has been specifically developed, manufactured or selected for and adapted to Mercedes-Benz vehicles.

Therefore, Genuine Mercedes-Benz Parts should be installed.

! *The use of non-genuine Mercedes-Benz parts and accessories not authorized by Mercedes-Benz could damage the vehicle, which is not covered by the Mercedes-Benz Limited Warranty, or could compromise the vehicle's durability or safety.*

▼ Warranty coverage

Your vehicle is covered under the terms of the warranties printed in the Service and Warranty Information Booklet. Your authorized Mercedes-Benz Center will exchange or repair any defective parts originally installed in the vehicle in accordance with the terms of the following warranties:

- New Vehicle Limited Warranty
- Emission System Warranty
- Emission Performance Warranty
- California, Maine, Massachusetts, New York, and Vermont Emission Control System Warranty

Replacement parts and accessories are covered by the Mercedes-Benz Parts and Accessories Warranties, copies of which are available at any authorized Mercedes-Benz Center.

Loss of Service and Warranty Information Booklet

Should you lose your Service and Warranty Information Booklet, have your authorized Mercedes-Benz Center arrange for a replacement. It will be mailed to you.

Identification labels



① Certification label (on driver's B-pillar)

The Vehicle Identification Number (VIN) can be found in the following locations:

- on the certification label
- embossed under a cover in the front passenger footwell (▷ page 477)
- lower edge of windshield(▷ page 477)

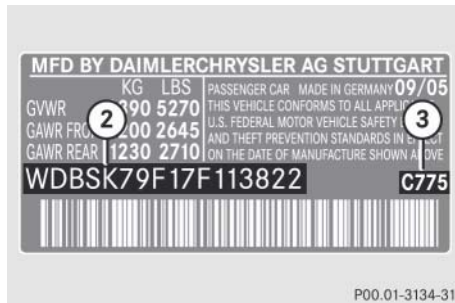

Example certification label (U.S. vehicles)

- ② VIN
- ③ Paintwork code

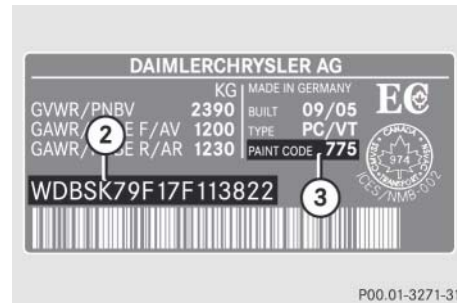

Example certification label (Canada vehicles)

- ② VIN
- ③ Paintwork code

i Data shown on certification label are for illustration purposes only. These data are specific to each vehicle and may vary from data shown in the illustration. Refer to certification label on vehicle for actual data specific to your vehicle.

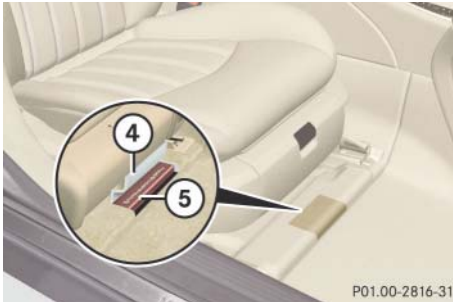

- ④ Cover
- ⑤ VIN

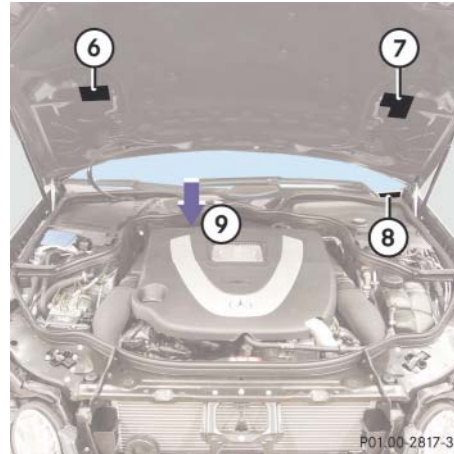

- ⑥ Emission control information label, includes both federal and California certification exhaust emission standards
- ⑦ Vacuum line routing diagram label
- ⑧ VIN (lower edge of windshield)
- ⑨ Engine number (engraved on engine)

i When ordering parts, please specify vehicle identification and engine number.

Layout of poly-V-belt drive

E 350 4MATIC

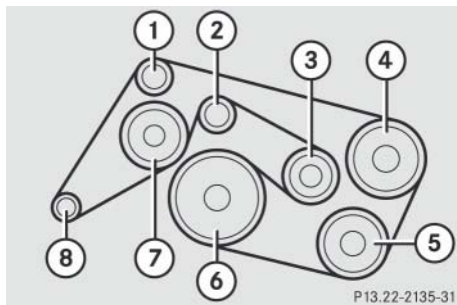

- ① Idler pulley
- ② Idler pulley
- ③ Automatic belt tensioner
- ④ Power steering pump
- ⑤ Air conditioning compressor
- ⑥ Crankshaft
- ⑦ Coolant pump
- ⑧ Generator (alternator)

E 63 AMG

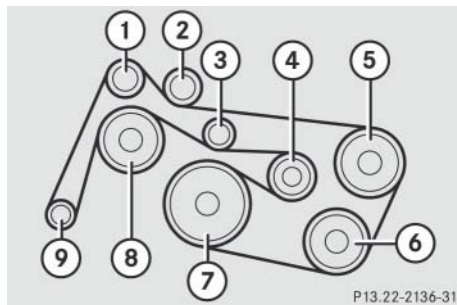

- ① Idler pulley
- ② Idler pulley
- ③ Idler pulley
- ④ Automatic belt tensioner
- ⑤ Power steering pump
- ⑥ Air conditioning compressor
- ⑦ Crankshaft
- ⑧ Coolant pump
- ⑨ Generator (alternator)

▼ Engine

Model	E 350 4MATIC (211.287 ¹)	E 63 AMG (211.277 ¹)
Engine	272	156
Mode of operation	4-stroke engine, gasoline injection	4-stroke engine, gasoline injection
No. of cylinders	6	8
Bore	3.66 in (92.90 mm)	4.02 in (102.20 mm)
Stroke	3.39 in (86.00 mm)	3.72 in (94.60 mm)
Total piston displacement	213.5 cu in (3498 cm ³)	378.8 cu in (6208 cm ³)
Compression ratio	10.7:1	11.3:1
Output acc. to SAE J 1349	268 hp / 6 000 rpm ² (200 kW / 6 000 rpm)	507 hp / 6 800 rpm ² (378 kW / 6 800 rpm)
Maximum torque acc. to SAE J 1349	258 lb-ft / 2 400 rpm - 5 000 rpm (350 Nm / 2 400 rpm - 5 000 rpm)	468 lb-ft / 5 200 rpm (635 Nm / 5 200 rpm)
Maximum engine speed	6 500 rpm	7 200 rpm
Firing order	1-4-3-6-2-5	1-5-4-2-6-3-7-8
Poly-V-belt	2404 mm	2369 mm

¹ The quoted data apply only to the standard vehicle. See an authorized Mercedes-Benz Center for the corresponding data of all special bodies and special equipment.

² Premium fuel required. Performance may vary with fuel octane rating.

Rims and tires

! Only use tires which have been tested and approved for your vehicle by Mercedes-Benz. Tires approved by Mercedes-Benz are developed to provide best possible performance in conjunction with the driving safety systems on your vehicle such as ABS or ESP®. Tires specially developed for your vehicle and tested and approved by Mercedes-Benz can be identified by finding the following on the tire's sidewall:

- MO = Mercedes-Benz Original equipment tires

AMG vehicles:

Does not apply to all approved tires on AMG vehicles. For information on tested and approved tires for AMG vehicles, contact an authorized Mercedes-Benz Center.

Using tires other than those approved by Mercedes-Benz may result in damage that is not covered by the Mercedes-Benz Limited Warranty.

! Using tires other than those approved by Mercedes-Benz can have detrimental effects, such as

- poor handling characteristics
- increased noise
- increased fuel consumption

Moreover, tires and rims not approved by Mercedes-Benz may, under load, exhibit dimensional variations and different tire deformation characteristics that could cause them to come into contact with the vehicle body or axle parts. Damage to the tires or the vehicle may be the result.

i Further information on tires and rims is available at any authorized Mercedes-Benz Center. A placard with the recommended tire inflation pressures is located on the driver's door B-pillar. Some vehicles may have supplemental tire inflation pressure information for driving at high speeds (▷ page 341) or for vehicle loads less than the maximum loaded vehicle condition.

If such information is provided, it can be found on the placard located on the inside of the fuel filler flap. The tire inflation pressure should be checked regularly and should only be adjusted on cold tires. Follow tire manufacturer's maintenance recommendation included with the vehicle.

i The following pages also list the approved wheel rim and tire sizes for equipping your vehicles with winter tires. Winter tires are not available as standard or optional factory-equipment, but can be purchased from an authorized Mercedes-Benz Center.

Depending on vehicle model and the standard or optional factory-equipped wheel rim/tire configuration on your vehicle (Appearance Package, Sport Package etc.), equipping your vehicle with winter tires approved for your vehicle model may also require the purchase of two or four wheel rims of the recommended size for use with these winter tires. See an authorized Mercedes-Benz Center for more information.

Same size tires

17" tires

Model	E 350 4MATIC
Rims (light alloy)	8 J x 17 H2
Wheel offset	1.5 in (38 mm)
All-season tires¹	245/45 R17 95H M+S
Winter tires^{1,2}	245/45 R17 99V XL (Extra Load) M+S 

¹ Radial-ply tires

² Not available as factory equipment.

18" tires

Model	E 63 AMG E 63 AMG (Performance Package*)
Rims (light alloy)	8.5 J x 18 H2
Wheel offset	1.5 in (38 mm)
Winter tires^{1,2}	245/40 R18 97V XL (Extra Load) M+S 

¹ Radial-ply tires

² Not available as factory equipment.

Rims and tires

Mixed size tires

Model	E 63 AMG	E 63 AMG (Performance Package*)
Front axle:		
Rims (light alloy)	8.5 J x 18 H2	8.5 J x 18 H2
Wheel offset	1.5 in (38 mm)	1.5 in (38 mm)
Summer tires¹	245/40 ZR18	245/40 ZR18
Rear axle:		
Rims (light alloy)	9 J x 18	9.5 J x 18 H2
Wheel offset	1.54 in (39 mm)	1.73 in (44 mm)
Summer tires^{1,2}	265/35 ZR18 XL (Extra Load)	265/35 ZR18 XL (Extra Load)

¹ Radial-ply tires

² Must not be used with snow chains.

Spare wheel

! Please compare the recommended tire inflation pressure for your vehicle with the tire inflation pressure on the yellow label located on the spare wheel rim.

If the tire inflation pressure on the yellow label on the spare wheel rim differs from the values given in this Operator's Manual, inflate the spare wheel tire to the recommended tire inflation pressure given on the yellow label on the spare wheel rim.

i Please note that the tire inflation pressure of the Minispare and the collapsible tire differs from the tire inflation pressure of the road tires.

Make sure the Minispare wheel is inflated to approximately 61 psi (4.2 bar).

Inflate the collapsible tire (> page 459) to approximately 51 psi (3.5 bar).

Minispare wheel (except E 63 AMG)

Rim	4 B x 17
Wheel offset	1.34 in (34 mm)
Tire¹	T 155/70 R17 110 M

¹ Must not be used with snow chains.

Collapsible tire (E 63 AMG without folding third row seat only)

Rim	6 B x 18
Wheel offset	0.98 in (25 mm)
Tire¹	175/55-18 95P

¹ Must not be used with snow chains.

i E 63 AMG with folding third row seat is equipped with TIREFIT (> page 451).

Electrical system

Model	E 350 4MATIC	E 63 AMG
Generator (alternator)	14 V/180 A	14 V/180 A
Starter motor	14 V/1.4 kW	14 V/2.1 kW
Battery	12 V/95 Ah ¹	12 V/95 Ah
Spark plugs	Bosch Platin Y 7 MPP33 NGK PLKR 6A	NGK ILZKAR7A 10
Electrode gap	0.031 in (0.8 mm)	0.039 in (1.00 mm)
Tightening torque	15 - 22 lb-ft (20 - 30 Nm)	15 - 18.5 lb-ft (20 -25 Nm)

¹ Depending on production date, your vehicle may be equipped with a 12 V/100 Ah battery.

▼ Main dimensions and weight

Main dimensions

Model	E 350 4MATIC	E 63 AMG
Overall vehicle length	193.1 in (4905 mm)	193.7 in (4919 mm)
Overall vehicle width (exterior view mirrors folded out)	81.2 in (2063 mm)	81.2 in (2063 mm)
Overall vehicle height	59.5 in (1511 mm)	-
Overall vehicle height (Airmatic DC) (E 63 AMG only)	-	59.1 in (1500 mm)
Wheelbase	112.4 in (2854 mm)	112.4 in (2854 mm)
Track, front	61.6 in (1565 mm)	61.1 in (1551 mm)
Track, rear	61.4 in (1560 mm)	61.4 in (1560 mm)

Weight

Roof load max.	220 lb (100 kg)
----------------	-----------------

Fuels, coolants, lubricants etc.

Capacities

Vehicle components and their respective lubricants must match. Therefore only use products tested and approved by Mercedes-Benz.

Please refer to the Factory Approved Service Products pamphlet (USA only), or inquire at an authorized Mercedes-Benz Center.

Warning!



Comply with all valid regulations with respect to handling, storing and disposing of service fluids. Otherwise you could endanger persons or the environment.

Keep service fluids out of the reach of children.

For health reasons, you should prevent service fluids from coming into direct contact with your skin or clothing.

If a service fluid is swallowed, contact a physician immediately.

	Model	Capacity	Fuels, coolants, lubricants etc.
Engine with oil filter	E 350 4MATIC	8.5 US qt (8.0 l)	Approved engine oils
Engine with oil filter including oil cooler	E 63 AMG	9.3 US qt (8.8 l)	Approved engine oils
Automatic transmission	E 350 4MATIC	8.6 US qt (8.1 l)	MB Automatic Transmission Fluid
	E 63 AMG	9.0 US qt (8.5 l)	
Front axle	E 350 4MATIC	1.69 US qt (1.6 l)	Hypoid gear oil SAE 85 W 90
Rear axle	E 350 4MATIC	1.69 US qt (1.6 l)	Hypoid gear oil SAE 85 W 90
	E 63 AMG	1.27 US qt (1.2 l)	

Fuels, coolants, lubricants etc.

	Model	Capacity	Fuels, coolants, lubricants etc.
Transfer case	E 350 4MATIC	0.62 US qt (0.585 l)	MB Transfer Case Fluid
Power steering	E 350 4MATIC	approx. 0.95 US qt (0.9 l)	MB Power Steering Fluid (Pentosin CHF 11S or, depending on vehicle production date, Chevron Texaco PSF 9 109) ¹
	E 63 AMG	1.3 US qt (1.2 l)	
Front wheel hubs	E 350 4MATIC	approx. 3.0 oz (85 g) each	High temperature roller bearing grease
	E 63 AMG	approx. 3.2 oz (90 g) each	
Brake system		0.63 US qt (0.6 l)	MB Brake Fluid (DOT 4+)
Cooling system	E 350 4MATIC	10.7 US qt (10.0 l)	MB 325.0 Anticorrosion/Antifreeze
	E 63 AMG	12.5 US qt (11.8 l)	

¹ For detailed information, please refer to the Factory Approved Service Products pamphlet (USA only) or contact an authorized Mercedes-Benz Center.

Fuels, coolants, lubricants etc.

	Model	Capacity	Fuels, coolants, lubricants etc.
Fuel tank		21.12 US gal (80.0 l)	Premium unleaded gasoline Minimum Posted Octane 91 (Avg. of 96 RON/86 MON)
	including a reserve of except E 63 AMG	2.38 US gal (9.0 l)	
	including a reserve of E 63 AMG	3.7 US gal (14.0 l)	
Air conditioning system			R-134a refrigerant and special PAG lubricant oil (never R-12)
Windshield washer system		4.8 US qt (4.5 l)	MB Windshield Washer Concentrate ¹
Windshield washer system and headlamp cleaning system*		6.9 US qt (6.5 l)	MB Windshield Washer Concentrate ¹

¹ Use MB Windshield Washer Concentrate “MB SummerFit” and water for temperatures above freezing point or MB Windshield Washer Concentrate “MB SummerFit” and commercially available premixed windshield washer solvent/antifreeze for temperatures below freezing point. Follow suggested mixing ratios (▷ page 494).

Engine oils

Engine oils are specifically tested for their suitability in our engines and durability for our service intervals. Therefore, only use approved engine oils and oil filters required for vehicles with Maintenance System (U.S. vehicles) or FSS PLUS (Canada vehicles). For a listing of approved engine oils and oil filters, refer to the Factory Approved Service Products pamphlet (USA only), or contact an authorized Mercedes-Benz Center.

! *Using engine oils and oil filters of specification other than those expressly required for the Maintenance System (U.S. vehicles) or FSS PLUS (Canada vehicles), or changing of oil and oil filter at change intervals longer than those called for by the Maintenance System (U.S. vehicles) or FSS PLUS (Canada vehicles) will result in engine or emission control system damage not covered by the Mercedes-Benz Limited Warranty.*

Please follow Maintenance System (U.S. vehicles) or FSS PLUS (Canada vehicles) recommendations for scheduled oil changes. Failure to do so will result in engine or emission control system damage not covered by the Mercedes-Benz Limited Warranty.

Engine oil additives

Do not blend oil additives with engine oil. They may damage the engine.

Damage or malfunctions resulting from blending oil additives are not covered by the Mercedes-Benz Limited Warranty.

Air conditioning refrigerant

R-134a (HFC) refrigerant and special PAG lubricating oil are used in the air conditioning system.

Never use R-12 (CFC) or mineral-based lubricating oil. Otherwise damage to the system will occur.

Brake fluid

Warning!



During vehicle operation, the boiling point of the brake fluid is continuously reduced through the absorption of moisture from the atmosphere. Under extremely strenuous operating conditions, this moisture content can lead to the formation of bubbles in the system, thus reducing the system's efficiency.

Therefore, the brake fluid must be replaced regularly. Refer to your vehicle's Maintenance Booklet for replacement interval.

Only brake fluid approved by Mercedes-Benz is recommended. Your authorized Mercedes-Benz Center will provide you with additional information.

Fuels, coolants, lubricants etc.

Premium unleaded gasoline

Warning!



Gasoline is highly flammable and poisonous. It burns violently and can cause serious personal injury.

Never allow sparks, flame or smoking materials near gasoline!

Turn off the engine before refueling.

Whenever you are around gasoline, avoid inhaling fumes and skin or clothing contact, extinguish all smoking materials.

Direct skin contact with fuels and the inhalation of fuel vapors can damage your health.

! *To maintain the engine's durability and performance, premium unleaded gasoline must be used. If premium unleaded gasoline is not available and low octane fuel is used, follow these precautions:*

- *Have the fuel tank only partially filled with unleaded regular gasoline and fill up with premium unleaded gasoline as soon as possible.*
- *Avoid full throttle driving and abrupt acceleration.*
- *Do not exceed an engine speed of 3000 rpm if the vehicle is loaded with a light load such as two persons and no luggage.*
- *Do not exceed $\frac{2}{3}$ of maximum accelerator pedal position if the vehicle is fully loaded or operating in mountainous terrain.*

Fuel requirements

Only use premium unleaded fuel:

- The octane number (posted at the pump) must be 91 min. It is an average of both the Research Octane Number (RON) and the Motor Octane Number (MON): $(RON+MON) / 2$. This is also known as the ANTI-KNOCK INDEX.

Unleaded gasoline containing oxygenates such as ethanol, IPA, IBA and TBA can be used provided the ratio of any one of these oxygenates to gasoline does not exceed 10%; MTBE must not exceed 15%.

The ratio of methanol to gasoline must not exceed 3% plus additional cosolvents.

Using mixtures of ethanol and methanol is not allowed. Gasohol, which contains 10% ethanol and 90% unleaded gasoline, can be used.

These blends must also meet all other fuel requirements, such as resistance to spark knock, boiling range, vapor pressure, etc.

Gasoline additives

A major concern among engine manufacturers is carbon build-up caused by gasoline. Mercedes-Benz recommends only the use of quality gasoline containing additives that prevent the build-up of carbon deposits.

After an extended period of using fuels without such additives, carbon deposits can build up, especially on the intake valves and in the combustion area, leading to engine performance problems such as:

- Warm-up hesitation
- Unstable idle
- Knocking/pinging
- Misfire
- Power loss

In areas where carbon deposits may be encountered due to lack of availability of gasolines which contain these additives, Mercedes-Benz recommends the use of additives approved by us for use on Mercedes-Benz vehicles. Refer to Factory Approved Service Products pamphlet (USA only) or contact an authorized Mercedes-Benz Center for a listing of approved product(s). Follow directions on product label.

Do not blend other fuel additives with fuel. This only results in unnecessary cost and may be harmful to the engine operation.

! *Damage or malfunction resulting from poor fuel quality or from blending additional fuel additives other than those tested and approved by us for use on Mercedes-Benz vehicles are not covered by the Mercedes-Benz Limited Warranty.*

For a listing of approved products, refer to the Factory Approved Service Products pamphlet (USA only) or contact an authorized Mercedes-Benz Center.

Coolants

The engine coolant is a mixture of water and anticorrosion/antifreeze, which provides:

- Corrosion protection
- Freeze protection
- Boiling protection (by increasing the boiling point)

The cooling system was filled at the factory with a coolant providing freeze protection to approximately -35°F (-37°C) and corrosion protection.

! *Add premixed coolant solution only. Adding water and MB 325.0 Anticorrosion/Antifreeze separately from each other, could cause engine damage not covered by the Mercedes-Benz Limited Warranty.*

If the antifreeze mixture is effective to -35°F (-37°C), the boiling point of the coolant in the pressurized cooling system is reached at approximately 266°F (130°C).

Fuels, coolants, lubricants etc.

The coolant solution must be used year round to provide the necessary corrosion protection and increase boil-over protection. Refer to Maintenance Booklet for replacement interval.

Coolant system design and coolant used determine the replacement interval. The replacement interval published in the Maintenance Booklet is only applicable if MB 325.0 Anticorrosion/Antifreeze solution or other Mercedes-Benz approved products of equal specification are used to renew the coolant concentration or bring it back up to the proper level.

For information on other Mercedes-Benz approved products of equal specification, refer to the Factory Approved Service Products pamphlet (USA only) or contact an authorized Mercedes-Benz Center.

To provide important corrosion protection, the solution must be at least 50% anticorrosion/antifreeze (equivalent to freeze protection to approximately -35°F [-37°C]). If you use a solution that is more than 55% anticorrosion/antifreeze (freeze protection to approximately -49°F [-45°C]), the engine temperature will increase due to the lower heat transfer capability of the solution. Therefore, do not use more than this amount of anticorrosion/antifreeze.

If the coolant level is low, water and MB 325.0 Anticorrosion/Antifreeze should be used to bring it up to the proper level (have cooling system checked for signs of leakage). Please make sure the mixture is in accordance with label instructions.

The water in the cooling system must meet minimum requirements, which are usually satisfied by normal drinking water. If you are not sure about the water quality, consult an authorized Mercedes-Benz Center.

Anticorrosion/antifreeze

Your vehicle contains a number of aluminum parts. The use of aluminum components in motor vehicle engines necessitates that anticorrosion/antifreeze coolant used in such engines be specifically formulated to protect the

aluminum parts. Failure to use such anticorrosion/antifreeze coolant will result in a significantly shortened service life.

Therefore, the following product is strongly recommended for use in your vehicle:
 MB 325.0 Anticorrosion/Antifreeze agent.

Before the start of the winter season (or once a year in hot southern regions), you should have the anticorrosion/antifreeze concentration checked. The coolant is also regularly checked each time you bring your vehicle to an authorized Mercedes-Benz Center for service.

Anticorrosion/antifreeze quantity

Model	Approx. freeze protection	
	-35°F (-37°C)	-49°F (-45°C)
E 350 4MATIC	5.3 US qt (5.0 l)	5.9 US qt (5.5 l)
E 63 AMG	6.2 US qt (5.9 l)	6.9 US qt (6.5 l)

Fuels, coolants, lubricants etc.

Windshield washer system and headlamp cleaning system*

Both the windshield washer system and headlamp cleaning system* are supplied from the windshield washer reservoir.

The windshield washer reservoir has a capacity of approximately:

- 6.9 US qt (6.5 l) in vehicles with a headlamp cleaning system*
- 4.8 US qt (4.5 l) in vehicles without a headlamp cleaning system*
- ▶ Refill the reservoir with MB Windshield Washer Concentrate and water (or concentrate and commercially available premixed windshield washer solvent/antifreeze, depending on ambient temperatures).

Warning!



Washer solvent/antifreeze is highly flammable. Do not spill washer solvent/antifreeze on hot engine parts, because it may ignite and burn. You could be seriously burned.

Windshield and headlamp washer fluid mixing ratio

For temperatures above freezing point, use MB Windshield Washer Concentrate “MB SummerFit” and water:

- 1 part “MB SummerFit” to 100 parts water
(1.34 fl oz [40 ml] “MB SummerFit” to 1 gal [4.0 l] water).

For temperatures below freezing point use MB Windshield Washer Concentrate “MB SummerFit” and commercially available premixed windshield washer solvent/antifreeze:

- 1 part “MB SummerFit” to 100 parts solvent
(1.34 fl oz [40 ml] “MB SummerFit” to 1 gal [4.0 l] solvent).

- A**
- ABS 97
 - Indicator lamp 378
 - Messages in display 396, 411
 - Accelerator position, automatic transmission 191
 - Accessory weight 358
 - Accident 60
 - Active Bi-Xenon headlamps* see Headlamps
 - Active head restraints 87
 - Adaptive Damping System see ADS
 - ADS 261
 - Air bags 70
 - Children 71
 - Front, Driver 74
 - Front, Passenger 74
 - Safety guidelines 72
 - Side impact 75
 - Window curtain 75
 - Air conditioning refrigerant 489
 - Air conditioning system see Climate control system
 - Air conditioning, Cooling 218, 235
 - Air distribution 213, 230
 - Air pressure 358
 - Air pressure see Tire inflation pressure 341
 - Air pump, electric
 - Turning on 460
 - Air recirculation mode 216, 233
 - Air vents 213, 230
 - Air volume 214, 231
 - Airmatic DC (Dual Control)
 - Messages in display 428
 - Suspension tuning 262
 - Airmatic DC (Dual Control) 261
 - Vehicle level control 262
 - Alarm system see Anti-theft systems
 - Alignment bolt (vehicle tool kit) 430, 458
 - AMG menu 161
 - Anticorrosion/antifreeze 493
 - Antilock Brake System see ABS
 - Anti-theft systems 106
 - Anti-theft alarm system 106
 - Immobilizer 106
 - Aquaplaning see Hydroplaning 314
 - Ashtrays 285
 - Aspect ratio 358
 - AUDIO menu 165
 - Operating CD player 166
 - Selecting radio station 165
 - Selecting satellite radio* station 165
 - Audio search function 180
 - Audio system
 - CD mode 166
 - Auto-dimming
 - Rear view mirrors 200
 - Automatic central locking, Control system 180
 - Automatic headlamp mode 142
 - Automatic lighting control, Interior lighting 149
 - Automatic locking when driving 180
 - Automatic shift program 193

- Automatic transmission
 - Accelerator position 191
 - Automatic shift program 193
 - Emergency operation (Limp-Home Mode) 199
 - Gear ranges 192
 - Gear selector lever 187
 - Gear selector lever control one-touch gearshifting 194
 - Gear selector lever positions 189
 - Gear shifting malfunctions 199
 - Kickdown 191
 - Kickdown, manual shift program 199
 - Manual shift program E 63 AMG 197
 - Program mode selector switch 193
 - Shifting procedure 188
 - Starting engine 52
 - Steering wheel gearshift control one-touch gearshifting E 63 AMG 195
- B**
- BabySmart™
 - Airbag deactivation system 81
 - Self-test 81
- Backrest 266
 - Folding rearward 267
 - Seat 43
 - Seat, multicontour* 131
- Backup lamps
 - Messages in display 420
 - Replacing bulbs 442
- Bar 358
- BAS 99
- Batteries, SmartKey
 - Checking battery condition 119
 - Replacing 440
- Batteries, SmartKey with KEYLESS-GO*
 - Checking battery condition 119
 - Replacing 440
- Batteries, Vehicle
 - Charging 465
 - Disconnecting 464
 - Installing 465
 - Jump starting 466
 - Messages in display 410
 - Reconnecting 465
 - Removing 464
- Bead 358
- Beverage holder see Cup holders
- Bi-Xenon headlamps* see Headlamps
- Block heater* (Canada only) 364
- Brake fluid
 - Checking 322
 - Messages in display 411
- Brake lamp
 - Cleaning lenses 371
 - Replacing bulbs 442
- Brake pads
 - Message in display 410
- Brake-in recommendations 308
- Brakes 310
 - High-performance brake system (E 63 AMG only) 312
 - Warning lamp 381
- Break-in period 308
- Bulbs see Replacing bulbs
- Button, In instrument cluster 27
- C**
- California retail buyers and lessees, important notice for 11
- Can holder see Cup holders
- Capacities and recommended fuel/lubricants 486

- Cargo compartment
 - Closing the tailgate 123
 - Fuse box 472
 - Lamp 151
 - Message in display 428
 - Opening 121
 - Tie-down rings 270
- Cargo compartment cover 276
- Cargo management system* 271
 - Belt reel 272
 - Cargo tie-down ring 272
 - Mounting elements 271
 - Telescoping rod 273
- Cargo net 275
- Cargo tie-down rings 270
- Carpets, cleaning 374
- Catalytic converter 318
- CD player 166
- Center console
 - Lower part 30
 - PASS AIR BAG OFF indicator lamp 391
 - Upper part 29
- Central locking
 - Automatic 126, 180
 - Locking/unlocking from inside 127
- Central locking switch 127
- Certification label 476
- Checking
 - Oil level 326
- Checking tire pressure electronically with the Advanced Tire Pressure Monitoring System (Advanced TPMS)*, (Canada only) 344
- Children in the vehicle 88
 - Air bags 71
 - Blocking of rear window operation 95
 - Indicator lamp, front passenger front air bag 81
 - Infant and child restraint systems 89
 - LATCH-type child seat anchors 94
- Cigarette lighter 286
- Climate control system
 - 4-zone automatic climate control 222
 - Air conditioning refrigerant 489
 - Air conditioning, Cooling 218, 235
 - Air distribution 213, 230
 - Air recirculation mode 216, 233
 - Air volume 214, 231
 - Automatic mode 211, 228
 - Control panel, Rear 220, 237
 - Deactivating system 211, 227
 - Dual-zone automatic climate control 206
 - Front defroster 214, 231
 - Maximum cooling MAX COOL 216, 232
 - Rear climate control 237
 - Residual engine heat (REST) 219, 236
- Clock 27, 174
 - Setting time 175
- Cockpit 24
- Cold tire inflation pressure 358
- Collapsible tire 483
- Collapsible wheel chock 434

- COMAND see separate COMAND operating instructions
 - Combination filter with pollutant-sensitive air-recirculation mode 235
 - Combination switch 56, 145
 - Control system 155
 - Multifunction display 155
 - Multifunction steering wheel 156
 - Resetting to factory settings 170
 - Control system menus 158, 159
 - AMG 161
 - AUDIO 165
 - Distronic* 167
 - NAV* 167
 - Settings 169
 - Standard display 161
 - TEL* 184
 - Trip computer 183
 - Vehicle status message memory 168
 - Control system submenus 157
 - Convenience 181
 - Instrument cluster 172
 - Lighting 176
 - Time/Date 174
 - Vehicle 180
 - Convenience submenu
 - Activating easy-entry/exit feature 181
 - Setting parking position for exterior rear view mirror 182
 - Coolant
 - Anticorrosion/antifreeze mixing ratio and quantity 493
 - Capacities 487
 - Checking coolant level 329
 - Messages in display 412, 413, 414
 - Temperature 320
 - Temperature indicator 153
 - Warning lamp 384
 - Corner-illuminating front fog lamps* 146
 - Cruise control 246
 - Cup holders 282
 - Curb weight 358
 - Customer Assistance Center (CAC) 17
- D**
- Date display, setting 175, 176
 - Daytime running lamp mode 143
 - Setting 176, 177
 - Deep water see Standing water
 - Defogging windshield 215, 232
 - Defrosting, Front 214, 231
 - Defrosting, Rear 204
 - Delayed shut-off
 - Exterior lamps 178
 - Interior lighting 179
 - Department of Transportation see DOT
 - Difficulties
 - While driving 60
 - With starting 53
 - Digital clock see Clock
 - Digital speedometer 161
 - Dimensions, vehicle 485
 - Direction of rotation (tires) 335
 - Displays
 - Digital speedometer 161
 - Distronic* 252
 - Maintenance service indicator 365
 - Messages in display 409
 - Multifunction display 155
 - Outside temperature 155, 173
 - Symbol messages 409
 - Text messages 396
 - Vehicle status message memory 169
 - Vehicle system settings, Control system 155
 - Distance to empty (Range), Trip computer 184

Distronic* 249
 Activating/deactivating 255
 Cleaning system sensor 372
 Control system 167
 Distance warning function 258
 Driving hints 259
 Menu 253
 Messages in display 397
 Sensor cover 372
 Warning and indicator lamps 252

Door
 Entry lamps 151
 Locking/unlocking, SmartKey 36,
 112
 Locking/unlocking, SmartKey with
 KEYLESS-GO* 37, 117
 Message in display 428
 Opening from inside/outside 120
 Remote door unlock (Tele Aid) 299
 Unlocking, Mechanical key 435

Door control panel 34
 Door handle 34
 DOT 359
 Drinking and driving 309

Driving
 Abroad 317
 Hydroplaning 314
 In winter 316
 Instructions 49, 309
 Problems 60
 Safety systems 97
 Through standing water 317
 With Distronic* 259

Driving safety systems
 4MATIC 104
 ABS 97
 BAS 99
 EBP 100
 ESP® 100

Driving systems
 Airmatic DC (Dual Control) 261
 Cruise control 246
 Distronic* 249

Driving tips 191
 Accelerator position 191
 Kickdown 191

E

Easy-entry/exit feature 46, 181
 EBP 100
 Electrical fuses see Fuses
 Electrical system, Technical data 484
 Electronic Stability Program see
 ESP® 100

Emergency calls
 Tele Aid calls 294

Emergency operation (Limp-Home
 Mode) 199

Emergency operations
 Gear selector lever, Unlocking 437
 Locking/unlocking the vehicle 435
 Remote door unlock 299
 Tilt/sliding sunroof, Manual
 operation 438

Emergency Tensioning Device see ETD

- Emergency, In case of
 - Battery, Jump starting 466
 - First aid kit 430
 - Flat tire, changing 451
 - Fuses 471
 - Hazard warning flasher 148
 - Instrument cluster, Indicator
 - lamps 378, 379, 380, 381, 382, 383, 384, 385, 388, 389
 - Roadside Assistance 12
 - Towing the vehicle 468
- Emission control 319
 - Information label 477
 - Vacuum line routing diagram label 477
- Emission control system warranties 10
- Engine
 - Belt layout 478
 - Block heater* (Canada only) 364
 - Cleaning 370
 - Compartment 324
 - Malfunction indicator lamp 382, 383, 412
 - Message in the display 382, 383, 412
 - Number 476
 - Starting 52
 - Starting with KEYLESS-GO* 53
 - Starting with the SmartKey 52
 - Tachometer 27
 - Technical data 479
 - Turning off with KEYLESS-GO* 64
 - Turning off with the SmartKey 63
- Engine compartment
 - Hood 324
- Engine coolant see Coolant
- Engine malfunction indicator lamp 382, 383, 412
- Engine oil
 - Adding 327
 - Additives 489
 - Changing 327
 - Checking level 326
 - Consumption 326
 - Filler neck 328
 - Messages in display 416
 - Oil dipstick 327
 - Recommended engine oils and oil filter 489
- Engine oil level 323
- ESP® 100
 - Four wheel electronic traction system with ESP® 104
 - Messages in display 396, 411
 - Warning lamp 379, 380
- ETD
 - Safety guidelines 72
- Exterior lamp switch 141
- Exterior rear view mirrors 47
- Exterior view 22
- F**
 - Filler neck, Engine oil 328
 - First aid kit 430
 - Flat tire 451
 - Lowering the vehicle 461
 - Mounting the spare wheel 456, 458
 - Preparing the vehicle 451
 - Sealing tires with TIREFIT 451
 - Spare wheel 456
 - TIREFIT kit 451
 - Flexible Service System see FSS
 - Floormats 289

- Fluids
 - Automatic transmission fluid 486
 - Brake fluid 487
 - Capacities 486
 - Engine coolant 487
 - Engine oil 486
 - Power steering fluid 487
 - Windshield washer and headlamp cleaning system 488
 - Fog lamps 144
 - Messages in display 420, 421, 422, 423
 - Replacing bulbs 444
 - Folding bench seat
 - Folding back 136
 - Folding bench seat in cargo compartment 134
 - Four wheel electronic traction system with ESP® see 4MATIC
 - 4MATIC 104
 - Front air bags 74
 - Front lamps see Headlamps
 - Front passenger front air bag
 - Messages in display 391
 - Front passenger front air bag off indicator lamp 74, 79
 - Front seat head restraints see Head restraints
 - FSS (Canada vehicles) 365
 - Fuel 309, 322
 - Additives 491
 - Capacities, Fuel tank 488
 - Filling the tank 321
 - Fuel filler flap and cap 321
 - Fuel reserve warning lamp 385
 - Premium unleaded gasoline 322
 - Requirements
 - Gasoline additives 491
 - Premium unleaded gasoline 490
 - Requirements, Octane rating (Gasoline engine) 490
 - Technical data 486
 - Fuel consumption statistics
 - Since last reset 183
 - Since start 183
 - Fuel filler flap 321
 - Locking/unlocking 321
 - Opening 321
 - Fuel reserve warning lamp 27
 - Fuel tank
 - Capacity 488
 - Filler flap 321
 - Fuel, Premium unleaded gasoline 322, 488, 490
 - Fuels, coolants, lubricants etc.
 - Capacities 486
 - Fuses 471
 - Aids for replacing fuses 471
 - Fuse box in cargo compartment 472
 - Fuse box in passenger compartment 472
 - Fuse chart 471
 - Fuse extractor 471
 - Replacing 471
 - Spare fuses 471
- G**
- Garage door opener 31, 300
 - Gasoline see Fuel
 - GAWR 359
 - Gear range
 - Automatic transmission 192
 - Limiting 192
 - Shifting into optimal 195, 196

- Gear selector lever 52, 187
 - Cleaning 374
 - Gearshift pattern 187
 - Lock 52
 - Position 188, 189
 - Position indicator 52
 - Shifting procedure 188
 - Unlocking in an emergency 437
- Gear selector lever one-touch gearshifting
 - Automatic transmission 194
- Glove box 280
- Good visibility 200
- Gross Axle Weight Rating see GAWR
- Gross Vehicle Weight Rating see GVWR
- Gross Vehicle Weight see GVW
- GVW 359
- GVWR 359

- H**
- Halogen headlamps see Headlamps
- Hard plastic trim items, cleaning 374
- Hazard warning flasher 148

- Head restraints 128
 - Comfort head restraint, Adjusting 44
 - Folding back 130
 - Front seat, Adjusting 43
 - Rear seat, Removing and installing 128
 - Removing and installing 130
- Headlamp cleaning system* 200
- Headlamp shut-off delay see Delayed shut-off, Exterior lamps
- Headlamps
 - Active Bi-Xenon headlamps* 141
 - Automatic headlamp mode 142
 - Bi-Xenon* 141
 - Cleaning lenses 371
 - Cleaning system* 200
 - Halogen 444
 - High beam see High beam flasher
 - High beam see High beam headlamps
 - Low beam see Low beam headlamps
 - Manual headlamp mode 142
 - Replacing bulbs 444
 - Switch 56
- Headliner and shelf below rear window,
 - Cleaning and care of 374
- Heated seats* 132

- Heated steering wheel (Canada only) 288
- Height adjustment
 - Vehicle level control 262
- High beam flasher 146
- High beam headlamps
 - Indicator lamp 27, 146
 - Replacing bulbs 443
 - Switching on 146
- High mounted brake lamp 443
- High-performance brake system (E 63 AMG only) 312
- Hood 324
 - Message in display 428
- Horn 25
- HVAC see Climate control system
- Hydroplaning 314

- I**
- Identification labels 476
- Identification Number, Vehicle (VIN) 477
- Ignition 38, 52
- Immobilizer 106
- Indicator lamps see Lamps, indicator and warning
- Infant and child restraint systems see Children in the vehicle

Inflation pressure see Tires, Inflation pressure

Inside door handle 120

Instrument cluster 26, 152

- Illumination brightness 152
- Lamps 378
- Multifunction display 155

Instrument lighting see Instrument cluster, Illumination brightness

Instrument panel see Instrument cluster

Instruments and controls see Cockpit

Interior lighting

- Delayed shut-off 179

Interior rear view mirror 47

- Auto-dimming mirrors 200

Interior storage spaces see Storage compartments

J

Jack 433

Jump starting 466

K

Key, Mechanical 435

- Loss of 119

Key, SmartKey

- Battery check lamp 110
- Checking batteries 119
- Factory setting 112
- Global locking 112, 113
- Global unlocking 112, 113
- Locking/unlocking 36, 65, 110
- Loss of 119
- Messages in the multifunction display 418, 419
- Opening and closing the power tilt/sliding sunroof 241
- Opening and closing the windows 241
- Opening, Tailgate 121
- Positions in starter switch 37
- Remote control 110
- Replacing batteries 440
- Restoring to factory setting 113
- Selective setting 112
- Starting the engine 52
- Turning off the engine 63

Key, SmartKey with KEYLESS-GO*

- Battery check lamp 114
- Checking batteries 119
- Factory setting 116
- Global locking 117, 118
- Global unlocking 117, 118
- Locking/unlocking 37, 65, 113
- Loss of 119
- Messages in the multifunction display 418, 419
- Opening and closing the power tilt/sliding sunroof 241
- Opening and closing the windows 241
- Opening, Tailgate 121
- Replacing batteries 440
- Restoring to factory setting 118
- Selective setting 117
- Starting the engine 53
- Turning off the engine 64

KEYLESS-GO* see Key, SmartKey with KEYLESS-GO*

Kickdown 191

Kilopascal 359

L

Labels

- Certification 476
- Emission control information 476
- Vacuum line routing diagram 477

Lamps, exterior

- Exterior lamp switch 56, 141
- Front 442
- Messages in display 420
- Rear 443
- Switching on/off 141

Lamps, indicator and warning

- ABS 27, 378
- Battery (SmartKey) 113, 117
- Brakes 381
- CHECK ENGINE 382, 383
- Coolant 384
- Distance warning lamp* 252
- Engine diagnostics 382, 383
- Engine malfunction 27, 382, 383
- ESP® 27, 379, 380
- Fog lamps 144
- Front passenger front air bag off 29, 74, 81, 391, 392
- Fuel reserve 27, 385
- High beam headlamps 27

- Instrument cluster 378, 379, 380, 381, 382, 383, 384, 385, 388, 389

- Low beam headlamps 27
- Seat belt telltale 27, 386
- Seat belts 386
- SRS 69
- Turn signals 27

Language, Setting 172

LATCH-type child seat anchors see Children in the vehicle

License plate lamps 443

- Messages in display 421
- Replacing bulbs 447

Light alloy wheels, cleaning 373

Lighter see Cigarette lighter 286

Lighting

- Daytime running lamp mode 143

Lighting, Exterior and interior 141

Limp-Home Mode 199

Loading 266

- Split rear bench seat* 266

Loading see Vehicle loading

Locator lighting 177

Lock button

- Door handle (KEYLESS-GO*) 65

Locking the vehicle 61

- In an emergency 436

Loss of

- Key, Mechanical 119
- Key, SmartKey 119
- Key, SmartKey with KEYLESS-GO* 119

Loss of Service and Warranty Information

- Booklet 475

Low beam headlamps 56

- Indicator lamp 27
- Replacing bulbs 442
- Switching on 56

Lubricants 486

Lumbar support 131

M

Maintenance 12

- Calling up service indicator 367
- Clearing service indicator message 366
- FSS (Canada vehicles) 365
- Maintenance System (U.S. vehicles) 365
- Resetting service indicator 367
- Service indicator 365
- Service indicator message 365

- Service term exceeded 366
 - Manual headlamp mode see Headlamps
 - Manual operations
 - Unlocking the tailgate 436
 - Manual shift program (E 63 AMG)
 - Deactivating 199
 - Manual shift program E 63 AMG 197
 - Maximum load rating, Tires 359
 - Maximum loaded vehicle weight, Tire inflation pressure 359
 - Maximum tire inflation pressure 359
 - Mechanical key 435
 - Memory function see Seats
 - Menus see Control system menus
 - Minispare wheel see Spare wheel
 - Mirrors
 - Adjusting 47
 - Auto-dimming 200
 - Exterior rear view mirror 47
 - Exterior rear view mirror parking positions 202
 - Interior rear view mirror 47
 - MON 322
 - Multicontour seat* 131
 - Multifunction display 155
 - Changing settings see Control system menus and Control system sub-menus
 - Selecting language 172
 - Multifunction display messages
 - ABS 396, 411
 - Batteries 410
 - Brake fluid 411
 - Brake pads 410
 - Cargo compartment 428
 - Check engine 382, 383
 - Coolant 412, 413, 414
 - Cruise control 397
 - DISTRONIC* 397
 - Door 428
 - Engine oil 416
 - ESP® 396, 400, 411
 - Fog lamps 420, 421, 422, 423
 - Hood 428
 - Light sensor 422
 - Parking brake 411
 - Parking lamps 421
 - PRE-SAFE® 405
 - Reserve fuel 417
 - SmartKey with KEYLESS-GO* 418, 419
 - SRS 427
 - Taillamps 423
 - Tele Aid 427
 - Telephone* 428
 - Tires 425
 - Turn signals 424
 - Windshield washer fluid 428
 - Multifunction steering wheel 28, 156
 - Button operation 156
- N**
- NAV* menu 167
 - Navigation system
 - See separate COMAND operating instructions 167
 - Net, parcel 282
 - Neutral gear position, Automatic transmission 187, 189
 - Night security illumination 144
 - Normal occupant weight 359
 - Number, vehicle identification (VIN) 476, 477

O

- Occupant Classification System see OCS
- Occupant distribution 359
- Occupant safety 68
 - Air bags 70
 - Children and air bags 71
 - Children in the vehicle 88
 - Fastening the seat belt 49
 - Front passenger front air bag off indicator lamp 79
 - Infant and child restraint systems 89
 - LATCH-type child seat anchors 94
 - OCS 75
 - Seat belts 49, 72
- OCS 75
 - Self-test 80
- Odometer 155
- Oil see Engine oil
- One-touch gearshifting
 - Gear selector lever 194
 - Steering wheel gearshift control
 - E 63 AMG 195
- Operating safety 16
- Ornamental moldings, Cleaning 371
- Outside temperature see Displays
- Overdue maintenance service 365, 366

Overhead control panel 31

P

- Paintwork, Cleaning 369
- Panic alarm 96
- Parcel net
 - Front passenger footwell 282
- Parking 313
 - On hills 61, 313
 - Over things that burn, Potential consequences 61, 313
- Parking brake 54, 62
 - Message in display 411
- Parking position
 - Exterior rear view mirrors 140, 202
 - Gear position 52
- Parts service 474
- PASS AIR BAG OFF indicator lamp see Front passenger front air bag off indicator lamp
- Passenger compartment
 - Fuse box 472
 - Interior lighting 149
 - Interior rear view mirror 47
 - Parcel net in front passenger footwell 282
- Passenger safety see Occupant safety
- Pedals 309
- Phone see Telephone*
- Plastic parts, cleaning 373
- Pliers, universal (vehicle tool kit) 430
- Poly-V-belt drive
 - Layout 478
- Positions (Memory function) see Seats
- Power assistance 310
- Power outlet 287
- Power seat see Seats
- Power tilt/sliding sunroof 243
 - Emergency operations 438
- Power tilt/sliding sunroof*
 - Opening/closing 243
 - Opening/closing in an emergency 438
 - Stopping 245
 - Synchronizing 245
- Power washer 369
- Power windows 239
 - Cleaning 372
 - Operating 239
 - Rear door window, Blocking operation 95
 - Synchronizing 241
- Practical hints 378

- PRE-SAFE®
 Messages in display 396, 405
- Problems
 While driving 60
 With vehicle 17
- Product information 9
- Production options weight 359
- Program mode see Automatic transmission, Automatic shift program
- Program mode selector switch
 Automatic shift program 193
- PSI 360
- Push-start see Tow-start
- R**
- Radio
 Selecting stations 165
 Selecting stations (satellite*) 165
- Radio transmitters 318
- Reading lamp, front 150
- Reading lamp, rear 151
- Rear bench seat, foldable 266
- Rear door ashtray see Ashtray
- Rear door window
 Blocking operation 95
- Rear fog lamp see Fog lamps 145
- Rear lamps see Tail lamps
- Rear seat head restraints see Head restraints
- Rear view mirrors see Mirrors
- Rear window defroster 204
- Rear window wiper/washer 59
- Recommended inflation pressure 360
- Recovery services, Stolen vehicle (Tele Aid) 299
- Refrigerant, Air conditioning 489
- Refueling 321
- Regular checks 322
- Reminder, Seat belt see Seat belts, Telltale 386
- Remote control see Key, SmartKey
- Remote door unlock (Tele Aid) 299
- Replacing bulbs
 Additional turn signals 446
 Brake lamps 444
 Headlamps 444
 High beam headlamps 443
 High mounted brake lamp 443
 License plate lamps 443, 447
 Low beam headlamps 442, 444
 Parking lamps 443, 446
 Side marker lamps 442
 Side marker lamps, front 446
- Tail lamps 443, 447
- Turn signal lamps 442, 446
- Reporting safety defects 18
- Research Octane Number see RON
- Reserve fuel
 Message in display 417
- Reset button, In instrument cluster 152, 170
- Reset tool
 Depository 439
- Restraint system see Children in the vehicle
- Reverse gear position, Automatic transmission 187, 189
- Rims 360, 480
- Roadside Assistance 12
- Roller sunblind* 204
- RON 322
- Rubber parts, cleaning 373
- Run Flat Indicator 342
- S**
- Safety
 Driving safety systems 97
 Occupant 68
 Reporting defects 18
- Safety belts see Seat belts 49

- Satellite radio* 165
- Seat belt force limiter 85
- Seat belts 82
 - Children in the vehicle 88
 - Cleaning 374
 - Fastening 49
 - Height adjustment 51
 - Proper use of 51, 84
 - Safety guidelines 72
 - Telltale 27, 386
 - Warning lamp 386
- Seat cushions
 - Removing and installing 135
- Seating capacity 336
- Seats 41, 128
 - Easy-entry/exit feature 46
 - Heater* 132
 - Memory function 138
 - Multicontour seat* 131
 - Split rear bench seat* 266
 - Ventilation* 133
- Securing cargo
 - Cargo tie-down rings 270
- Selector lever
 - Message in the display 405
- Selector lever see Gear selector lever
- Self-test
 - BabySmart™ airbag deactivation system 81
 - OCS 80
 - Tele Aid 293
- Service and warranty information 10
- Service intervals see Maintenance, Service indicator
- Service life, Tires 333
- Service see Maintenance
- Service system see FSS (Canada vehicles) or Maintenance System (US vehicles)
- Service, Parts 474
- Settings 116
 - Control system menus and submenus 157, 159
 - Date 175, 176
 - Individual, Vehicle 169
 - Memory function 139
 - Resetting all, Control system 170
 - Selective, SmartKey 112
 - Selective, SmartKey with KEYLESS-GO* 117
 - Time 175
- Shelf below rear window, cleaning 374
- Shift program mode, Automatic transmission 193
- Shifting, Automatic transmission 187
- Side impact air bags 75
- Side marker lamps
 - Cleaning lenses 371
- Side windows see Power windows
- Sidewall 360
- SmartKey see Key, SmartKey
- SmartKey with KEYLESS-GO* see Key, SmartKey with KEYLESS-GO*
- Snow chains 364
- Snow tires 363
- Spare fuses 471
- Spare wheel 433
 - Mounting 456
- Speed settings
 - Cruise control 248
 - Distronic* 255
- Speedometer 27, 252
- Split rear bench seat* 266
- SRS 68
 - Indicator lamp 27, 388
 - Message in display 427
- Standing water, Driving through 317

- Starter switch 37
 - Positions 37
- Starting difficulties, Engine 53
- Starting, Engine 52
- Steering column 45
- Steering wheel 45
 - Buttons 28
 - Cleaning 374
- Steering wheel gearshift control one-touch gearshifting E 63 AMG
 - Automatic transmission 195
- Stolen Vehicle Recovery services 299
- Storage box in cargo compartment 274
- Storage compartments 32
 - Cup holder 283
 - Glove box 280
 - Parcel net in front passenger footwell 280
 - Rear armrest 281
 - Rear center console 280
 - Ruffled storage bags 281
- Storing
 - Tires 334
- Submenus
 - In control system 159
- Submenus see Control system submenus
- Sun visors 203
- Sunroof see Power tilt/sliding sunroof
- Suspension tuning
 - For comfortable driving style 262
 - For sporty driving style 262
- Suspension tuning see Airmatic DC (Dual Control)
- Symbols used in this operator's manual 15
- T**
- Tachometer 27, 153
 - Overspeed range 153
- Tail lamps 447
 - Cleaning lenses 371
 - Messages in display 423
 - Replacing bulbs 447
- Tailgate
 - Closing 123
 - Lock button, KEYLESS-GO* 118
 - Opening 121, 122
- Taillamps
 - Messages in display 423
- Tar stains 369
- Technical data
 - Air conditioning refrigerant 489
 - Brake fluid 489
 - Capacities fuels, coolants, lubricants etc. 486
 - Coolant 491
 - Electrical system 484
 - Engine 479
 - Engine oil additives 489
 - Engine oils 489
 - Fuel requirements 490
 - Gasoline additives 491
 - Premium unleaded gasoline 490
 - Rims and tires 480
 - Weight 485
 - Windshield washer and headlamp cleaning system 488

- Tele Aid 292
 - Emergency calls 294
 - Information 297
 - Initiating an emergency call manually 295
 - Messages in display 427
 - Remote door unlock 299
 - Roadside Assistance 296
 - SOS button 295
 - Stolen Vehicle Recovery services 299
 - System self-check 293
- Telephone* 28, 184, 289
 - Answering/ending a call 185
 - Changing mobile phone cradle 292
 - Compartment 283
 - Hands-free microphone 31
 - Inserting mobile phone cradle 290
 - Installing a different mobile phone cradle 292
 - Message in display 428
 - Operation 184
 - Phone book 186
 - Redialing 186
- Temperature
 - Coolant 153
 - Interior temperature 212, 229
 - Outside 173
 - Setting display unit 173
- Tether attachment points, see Children in the vehicle
- Tie-down rings, Cargo compartment 270
- Tightening torque 461
- Time 175, 176
 - Setting minutes 175
- TIN 360
- Tire
 - Vehicle maximum load on 361
- Tire and Loading Information Placard 336
- Tire and loading terminology 358
- Tire Identification Number see TIN
- Tire inflation pressure 453
 - Checking 340
 - Checking tire pressure electronically with the Advanced Tire Pressure Monitoring System (Advanced TPMS)*, (Canada only) 344
- Tire inflation pressure see the placard on the fuel filler flap
- Tire load rating 360
- Tire ply composition and material used 360
- Tire speed rating 360
- TIREFIT
 - Instructions for use 451
- TIREFIT kit 451
- Tires 332, 480
 - Advanced Tire Pressure Monitoring System (Advanced TPMS)*, (Canada only) 344
 - Advanced TPMS malfunction telltale 389
 - Air pressure 340
 - Care and maintenance 333
 - Chains 364
 - Cleaning 334
 - Direction of rotation, Spinning 335
 - Driving instructions 313
 - Important notes, Tire inflation pressure 341
 - Inflation pressure 341, 348
 - Information Placard 336
 - Inspection 333
 - Messages in display 425
 - Problems under-/overinflation 348

- Retreads 332
- Rims and tires 480
- Rotation 361
- Service life 333
- Sizes 481
- Snow 363
- Speed rating 315, 351
- Storing 334
- Temperature 341, 357
- Terminology 358
- Traction 314
- Tread depth 334, 363
- Wear pattern 361
- Winter 363
- Tools 430
- Top tether
 - Children in the vehicle 92
- Total load limit 360
- Towing eye bolt 470
- Towing the vehicle 468
- Tow-start 466, 468
- Traction 360
- Transmission fluid level 328
- Transmission gear selector lever see Gear selector lever
- Transmission see Automatic transmission
- Traveling abroad 317
- Tread 360
- Tread depth 334, 363
- Treadwear indicators 360
- Trip computer 183
- Trip odometer 153
- Turn signals 56
 - Additional in mirrors 442
 - Bulbs 442
 - Cleaning lenses 371
 - Indicator lamps 27
 - Messages in display 424
 - Replacing bulbs 446
- Turning off engine 63
- Twin roller blind 275
- U**
- Uniform Tire Quality Grading
 - Standards 361
- Units, Settings
 - Speedometer 172
 - Temperature 172
- Unleaded gasoline, Premium 490
- Unlocking
 - Tailgate in an emergency 436
- Unlocking the vehicle 36
 - In an emergency 435
- Uphill driving
 - Cruise control 247
- Upholstery
 - Cleaning 374
- Useful features 280
- V**
- Vacuum line routing diagram label 477
- Vehicle
 - Battery 462
 - Care 368
 - Control system, settings menu 155
 - Dimensions 485
 - Individual settings 169, 171
 - Locking/unlocking 36, 61, 110
 - Locking/unlocking in an emergency 435, 436
 - Lowering 461
 - Modifications and alterations, Operating safety 16
 - Towing 468
 - Washing 368
 - Weight 485
- Vehicle jack 432
- Vehicle level control see Airmatic DC (Dual Control)
- Vehicle lighting 323

- Vehicle loading
 - Cargo tie-down rings 270
 - Instructions 269
 - Load limit 337
 - Terminology 358
- Vehicle maximum load on the tire 361
- Vehicle Recovery services, Stolen (Tele Aid) 299
- Vehicle status message memory 168
- Vehicle tool kit 430
 - Vehicle jack 432
- Vehicle washing 370
- W**
- Warning lamps see Lamps, Indicator and warning
- Warning sounds
 - Distance warning function* 258
 - Distronic* 252
 - Driver's or passenger's seat belt 85
 - Parking brake 55
 - Seat belt telltale 386, 387
- Warranty coverage 475
- Washer fluid see Windshield washer fluid
- Washer reservoir level 494
- Washing the vehicle 368
- Wear pattern, Tires 361
- Weight, Vehicle 485
- Wheel
 - Change 456
 - Removing 458
 - Spare 458
 - Tightening torque 461
- Wheels, Sizes 481
- Wheels, Tires and 332
- Window curtain air bags 75
- Windows see Power windows 239
- Windows, cleaning 372
- Windshield
 - Cleaning 59
 - Cleaning wiper blades 372
 - Defogging 215, 232
- Windshield washer fluid 494
 - Messages in display 428
 - Mixing ratio 494
 - Refilling 331
 - Wiping 59
- Windshield washer system 494
- Windshield wipers 57
 - Cleaning wiper blades 372
 - Replacing front wiper blades 449
 - Replacing rear wiper blade 450
- Winter driving
 - Block heater* (Canada only) 364
 - Snow chains 364
 - Tires 363
- Winter driving instructions 316
- Winter tires 363
- Wood trims, cleaning 375

Service and Literature

Your authorized Mercedes-Benz Center has trained technicians and Genuine Mercedes-Benz Parts to service your vehicle properly.
For expert advice and quality service, contact an authorized Mercedes-Benz Center.

If you are interested in obtaining service literature for your vehicle, please contact an authorized Mercedes-Benz Center.
We consider this the best way for you to obtain accurate information for your vehicle.

For further information you can find us on the Mercedes-Benz web-site www.mbusa.com or www.mercedes-benz.ca.

Warning!



To help avoid personal injury, be extremely careful when performing any service work or repairs. Improper or incomplete service or the use of incorrect or inappropriate parts or materials may damage the vehicle or its equipment, which may in turn result in personal injury.

If you have any questions about carrying out any type of service, turn to the advice of an authorized Mercedes-Benz Center.

We reserve the right to make changes in design and equipment.

Therefore, information, illustrations and descriptions in this Operator's Manual might differ from your vehicle.
Reprinting, translation and copying, even of excerpts, is not permitted without our prior authorization in writing.

Press time August 02, 2006

GSP/TIP

Printed in U. S. A.