



1645841581

Order No. 6515 4253 13 Part No. 164 584 15 81 USA Edition A , 2007

Operator's Manual M-Class



Operator's Manual
M-Class



Mercedes-Benz

ML 320 CDI

ML 350

ML 500

ML 63 AMG

Our company and staff congratulate you on the purchase of your new Mercedes-Benz.

Your selection of our product is a demonstration of your trust in our company name. Furthermore, it exemplifies your desire to own an automobile that will be as easy as possible to operate and provide years of service.

Your Mercedes-Benz represents the efforts of many skilled engineers and craftsmen. To help assure your driving pleasure, and also the safety of you and your passengers, we ask you to make a small investment of time:

- Please read this manual carefully, then return it to your vehicle where it will be handy for your reference.
- Please follow the recommendations contained in this manual. They are designed to acquaint you with the operation of your Mercedes-Benz.
- Please pay attention to the warnings and cautions contained in this manual. They are designed to help improve the safety of the vehicle operator and occupants.

We extend our best wishes for many miles of safe, pleasurable driving.

Mercedes-Benz USA, LLC
A DaimlerChrysler Company

Introduction	9	At a glance	21	Getting started	37
Product information	9	Exterior view	22	Unlocking	38
Operator's Manual	10	Cockpit	24	Unlocking with the SmartKey	38
Service and warranty information ..	10	Instrument cluster	26	Unlocking with KEYLESS-GO*	39
Important notice for California		Instrument cluster	28	Starter switch positions	39
retail buyers and lessees of		Multifunction steering wheel	30	Adjusting	43
Mercedes-Benz automobiles	11	Center console	31	Seats	43
Maintenance	12	Upper part	31	Steering wheel	46
Roadside Assistance	12	Lower part	32	Mirrors	49
Change of address or ownership....	13	Overhead control panel	33	Driving	51
Operating your vehicle		Storage compartments	34	Fastening the seat belts	51
outside the USA or Canada	13	Door control panel	36	Starting the engine	54
Where to find it	15			Parking brake	57
Symbols	16			Driving off	58
Operating safety	17			Switching on headlamps	59
Proper use of the vehicle	17			Turn signals	60
Problems with your vehicle	18			Windshield wipers	60
Reporting safety defects	19			Rear window wiper/washer	62
Reporting safety defects	19			Problems while driving	63
Vehicle data recording	20			Parking and locking	65
Information regarding electronic				Parking brake	65
recording devices	20			Switching off headlamps	66
				Turning off the engine	66
				Releasing seat belts	67
				Locking	68

Contents

Safety and Security	69	Controls in detail	107	Memory function*	134
Occupant safety	70	Locking and unlocking	108	Storing positions into memory	135
Air bags	71	SmartKey	108	Recalling positions from memory	135
Seat belts	77	SmartKey with KEYLESS-GO*	112	Lighting	136
Active head restraint	80	Opening the doors		Exterior lamp switch	136
Rear head restraints	81	from the inside	118	Combination switch	140
Children in the vehicle	82	Opening the tailgate	119	Corner-illuminating	
Blocking of rear door		Closing the tailgate	121	front fog lamps*	140
window operation	93	Automatic central locking	126	Hazard warning flasher	142
Panic alarm	95	Locking and unlocking		Interior lighting	142
Activating	95	from the inside	126	Door entry lamps	144
Deactivating	95	Seats	128	Cargo compartment lamp	144
Driving safety systems	96	Front seat active head restraints	128	Instrument cluster	145
ABS	96	Rear seat head restraints	128	Adjusting instrument	
BAS	97	Lumbar support	130	cluster illumination	145
ESP®	98	Multicontour seat*	130	Resetting trip odometer	146
EBP	101	Seat heating*	131	Tachometer	146
4-ETS	102	Seat ventilation*	132	Outside temperature indicator	146
Anti-theft systems	103				
Immobilizer	103				
Anti-theft alarm system	103				

Control system	147	Emergency operation		3-zone automatic climate control*	220
Multifunction display	147	(Limp-Home Mode)	198	Deactivating the	
Multifunction steering wheel	148	Transfer case	199	automatic climate	
Menus	150	Good visibility	200	control system	224
Standard display menu	154	Headlamp cleaning system*	200	Operating the automatic	
AMG menu	156	Rear view mirrors	200	climate control system in	
Off-road mode menu	159	Power folding exterior		automatic mode	225
Audio menu	159	rear view mirrors*	202	Setting the temperature	225
Navi* menu	161	Sun visors	203	Adjusting air distribution	226
AIRMATIC* /Compass menu	162	Rear window defroster	205	Adjusting air volume	227
DISTRONIC* menu	162	Climate control	206	Front defroster	227
Vehicle status message		Deactivating the		Maximum cooling MAX COOL	228
memory menu	163	climate control system	210	Air recirculation mode	228
Settings menu	164	Operating the climate control		Air conditioning	230
Vehicle configuration	178	system in automatic mode	210	Using driver-side settings	
Trip computer menu	180	Setting the temperature	211	for all temperature zones	231
Tel menu*	182	Adjusting air distribution	212	Residual heat and ventilation	232
Automatic transmission	185	Adjusting air volume	212	Rear automatic climate control	232
Gear selector lever	185	Front defroster	213	Power windows	236
Shifting procedure	188	Air recirculation mode	214	Opening and closing	236
Transmission positions	189	Air conditioning	216	Synchronizing the door windows ..	238
Driving tips	191	Residual heat and ventilation	216	Summer opening feature	239
Gear ranges	193	Rear climate control*	217	Convenience closing feature	239
Steering wheel gearshift control ..	194			Power tilt/sliding sunroof*	241
Shift program (ML 63 AMG only) ..	195			Opening and closing	241
				Synchronizing	244

Contents

Driving systems	245	Useful features	294	Operation	323
Cruise control.....	245	Storage compartments	294	The first 1000 miles (1500 km)	324
Distronic*	250	Parcel nets	297	Driving instructions	325
Distance warning function*	263	Cup holders.....	298	Drive sensibly – save fuel.....	325
Downhill Speed Regulation (DSR).....	264	Ashtrays*	300	Drinking and driving.....	325
Off-road driving program	268	Cigarette lighter*	301	Pedals	325
Air suspension package*	269	Power outlets	302	Power assistance	326
Adaptive Damping System (ADS)*	269	Floor mats*	303	Brakes.....	326
Vehicle level control*	270	Heated steering wheel*	304	Driving off	329
Parktronic system*	274	Telephone*	305	Parking.....	329
Rear view camera*	279	Tele Aid*	308	Tires.....	329
Loading.....	281	Garage door opener*	316	Hydroplaning.....	330
Carriers*	281	Compass	321	Tire traction	330
Loading instructions.....	281	Infrared reflecting windshield*	322	Tire speed rating.....	331
Cargo tie-down rings	283			Winter driving instructions	332
Hooks.....	284			Standing water.....	333
Expanding cargo compartment	284			Off-road driving	333
Cargo compartment cover blind...	286			Trailer towing.....	342
Partition net*	287			Passenger compartment.....	348
Cargo management system*	290			Driving abroad	348
				Control and operation of radio transmitters	348
				Catalytic converter (gasoline engine).....	349

Oxidation catalyst (diesel engine).....	349	DOT, Tire Identification Number (TIN).....	389	Practical hints	413
Emission control	350	Maximum tire load	391	What to do if	414
Coolant temperature.....	350	Maximum tire inflation pressure ...	391	Lamps in instrument cluster	414
At the gas station	352	Uniform Tire Quality Grading		Lamp in center console	426
Refueling.....	352	Standards (U.S. vehicles).....	392	Vehicle status messages in the multifunction display	428
Check regularly and before a long trip.....	354	Tire ply material	394	Where will I find ...?	469
Engine compartment	356	Tire and loading terminology.....	394	First aid kit.....	469
Hood	356	Rotating tires	397	Vehicle tool kit.....	469
Engine oil	358	Winter driving	399	Minispare wheel (except ML 63 AMG).....	473
Transmission fluid level.....	362	Winter tires	399	Collapsible tire (ML 63 AMG only).....	474
Coolant level	362	Block heater (Canada only)	400	Unlocking/locking in an emergency ..	475
Windshield/rear window washer system and headlamp cleaning system*	363	Snow chains.....	400	Unlocking the vehicle	475
Tires and wheels.....	365	Maintenance.....	401	Locking the vehicle	476
Important guidelines	365	Maintenance service indicator message	401	Unlocking and opening the tailgate	476
Tire care and maintenance.....	366	Calling up the maintenance service indicator display	403	Fuel filler flap.....	477
Direction of rotation.....	368	Resetting the maintenance service indicator	403	Opening/closing in an emergency	478
Loading the vehicle	368	Vehicle care.....	404	Power tilt/sliding sunroof*	478
Recommended tire inflation pressure	374	Cleaning and care of the vehicle ...	404	Resetting activated head restraints....	479
Checking tire inflation pressure ...	375			Replacing SmartKey batteries	480
Tire labeling.....	385				
Load identification	389				

Contents

Replacing bulbs	482	Fuses	522	Electrical system	540
Bulbs	482	Fuse box in		Main Dimensions.....	541
Replacing bulbs for front lamps....	485	engine compartment.....	523	Weights	542
Replacing bulbs for rear lamps.....	490	Fuse box in cargo compartment...	523	Fuels, coolants, lubricants.....	543
Adjusting headlamp aim.....	492	Fuse box in passenger		Capacities	543
Replacing wiper blades	494	compartment	524	Engine oils	546
Front wiper blades	494	Emergency engine shut-down	525	Engine oil additives	546
Rear wiper blade	495			Air conditioning refrigerant	546
Flat tire	497			Brake fluid.....	546
Preparing the vehicle.....	497	Technical data	527	Premium unleaded gasoline	
Mounting the spare wheel	498	Parts service.....	528	(gasoline engine).....	547
Bleeding the fuel system		Warranty coverage.....	529	Gasoline additives	
(diesel engine only).....	506	Loss of Service and Warranty		(gasoline engine).....	547
Battery	507	Information Booklet	529	Fuel requirements.....	548
Disconnecting, removing,		Identification labels	530	Coolants	549
reinstalling and		Layout of poly-V-belt drive	532	Windshield washer and	
reconnecting the battery.....	509	ML 350	532	headlamp cleaning* system.....	551
Charging the battery	514	ML 320 CDI.....	532		
Jump starting	515	ML 500	532		
Towing the vehicle	518	ML 63 AMG	533	Index.....	553
Installing towing eye bolt.....	520	Engine.....	534		
Stranded vehicle	521	Rims and tires.....	536		
		Same size tires.....	537		
		Spare wheel	538		

▼ Product information

Please observe the following in your own best interest:

We recommend using Genuine Mercedes-Benz Parts as well as conversion parts and accessories explicitly approved by us for your vehicle model.

We have tested these parts to determine their reliability, safety and special suitability for Mercedes-Benz vehicles.

We are unable to make an assessment for other products and therefore cannot be held responsible for them, even if in individual cases an official approval or authorization by governmental or other agencies should exist. Use of such parts and accessories could adversely affect the safety, performance or reliability of your vehicle. Please do not use them.

Genuine Mercedes-Benz parts as well as conversion parts and accessories approved by us are available at your authorized Mercedes-Benz Light Truck Center where you will receive comprehensive information, also on permissible technical modifications, and where proper installation will be performed.

Operator's Manual

This Operator's Manual contains a great deal of useful information. We urge you to read it carefully and familiarize yourself with the vehicle before driving.

For your own safety and longer service life of the vehicle, we urge you to follow the instructions and warnings contained in this manual. Ignoring them could result in damage to the vehicle or personal injury to you or others. Vehicle damage caused by failure to follow instructions is not covered by the Mercedes-Benz Limited Warranty.

Your vehicle may have some or all of the equipment described in this manual. Therefore, you may find explanations for optional equipment not installed in your vehicle. If you have any questions about the operation of any equipment, your authorized Mercedes-Benz Light Truck Center will be glad to demonstrate the proper procedures.

We continuously strive to improve our product, and ask for your understanding that we reserve the right to make changes in design and equipment. Therefore, information, illustrations and descriptions in this Operator's Manual might differ from your vehicle.

Optional equipment is also described in this manual, including operating instructions wherever necessary. Since they are special-order items, the descriptions and illustrations herein may vary slightly from the actual equipment of your vehicle.

If there are any equipment details that are not shown or described in this Operator's Manual, your authorized Mercedes-Benz Light Truck Center will be glad to inform you of correct care and operating procedures.

The Operator's Manual and Maintenance Booklet are important documents and should be kept with the vehicle.

Service and warranty information

The Service and Warranty Information Booklet contains detailed information about the warranties covering your Mercedes-Benz, including:

- New Light Truck Limited Warranty,
- Emission System Warranty,
- Emission Performance Warranty,
- California, Maine, Massachusetts, and Vermont Emission Control System Warranty (California, Maine, Massachusetts, and Vermont only),
- State Warranty Enforcement Laws (Lemon Laws).

Important notice for California retail buyers and lessees of Mercedes-Benz automobiles

Under California law you may be entitled to a replacement of your vehicle or a refund of the purchase price or lease price, if Mercedes-Benz USA, LLC and/or its authorized repair or service facilities fail to fix one or more substantial defects or malfunctions in the vehicle that are covered by its express warranty after a reasonable number of repair attempts. During the period of 18 months from original delivery of the vehicle or the accumulation of 18 000 miles (approx. 29 000 km) on the odometer of the vehicle, whichever occurs first, a reasonable number of repair attempts is presumed for a retail buyer or lessee if one or more of the following occurs:

- (1) the same substantial defect or malfunction results in a condition that is likely to cause death or serious bodily injury if the vehicle is driven, that defect or malfunction has been subject to repair two or more times, and you have directly notified Mercedes-Benz USA, LLC in writing of the need for its repair,
- (2) the same substantial defect or malfunction of a less serious nature than category (1) has been subject to repair four or more times and you have directly notified us in writing of the need for its repair, or
- (3) the vehicle is out of service by reason of repair of the same or different substantial defects or malfunctions for a cumulative total of more than 30 calendar days.

Written notification should not be sent to a dealer, it should be addressed to Mercedes-Benz USA, LLC, Customer Assistance Center, One Mercedes Drive, Montvale, NJ 07645-0350.

Maintenance

The Maintenance Booklet describes all the necessary maintenance work which should be performed at regular intervals.

Always have the Maintenance Booklet with you when you take the vehicle to your authorized Mercedes-Benz Light Truck Center for service. The service advisor will record each service in the booklet for you.

Roadside Assistance

The Mercedes-Benz Roadside Assistance Program provides factory-trained technical help in the event of a breakdown. Calls to the toll-free Roadside Assistance number

1-800-FOR-MERCEdes (in the USA)
1-800-387-0100 (in Canada)

will be answered by Mercedes-Benz Customer Assistance Representatives 24 hours a day, 365 days a year.

Roadside Assistance will be provided in accordance with standard program guidelines which include providing service to the vehicle up to a reasonable distance from a paved roadway. We will make every effort to assist in a breakdown situation, however, the accessibility of your vehicle will be determined by our authorized Mercedes-Benz Light Truck Center technician or the tow service provider on a case-by-case basis and may be a factor in our ability to respond.

Additional charges may be applicable for a breakdown location determined not to be a reasonably accessible roadside location as determined by our authorized technician and tow service provider.

For additional information refer to the Mercedes-Benz Roadside Assistance Program brochure in your vehicle literature portfolio.

Change of address or ownership

If you change your address, be sure to send in the “Change of Address Notice” found in the Service and Warranty Information Booklet, or simply call the Mercedes-Benz Customer Assistance Center (in the USA) at 1-800-FOR-MERcedes, or Customer Service (in Canada) at 1-800-387-0100. It is in your own interest that we can contact you should the need arise.

If you sell your Mercedes, please leave all literature with the vehicle to make it available to the next operator.

If you bought this vehicle used, be sure to send in the “Notice of Purchase of Used Truck” found in the Service and Warranty Information Booklet, or call the Mercedes-Benz Customer Assistance Center (in the USA) at 1-800-FOR-MERcedes, or Customer Service (in Canada) at 1-800-387-0100.

Operating your vehicle outside the USA or Canada

If you plan to operate your vehicle in foreign countries, please be aware that:

- service facilities or replacement parts may not be readily available,
- unleaded gasoline for vehicles with catalytic converters may not be available; the use of leaded fuels will damage the catalyts,
- gasoline may have a considerably lower octane rating, and improper fuel can cause engine damage.

Warning!



This Sport Utility Vehicle is designed for both on-road and off-road use. It can go places and perform tasks for which conventional 2-wheel drive passenger cars are not intended. This vehicle will handle and maneuver differently from conventional passenger cars in driving conditions which may occur on streets, highways and off-road use.

This vehicle has a higher ground clearance and a higher center of gravity than many passenger cars. As with other vehicles of this type, if you make sharp turns at excessive speeds or abrupt maneuvers, the vehicle may roll over or may go out of control and crash. Utility vehicles have a significantly higher rollover rate than other types of vehicles. Failure to operate this vehicle safely may result in an accident, rollover of the vehicle, and severe or fatal injury.

Before you start to drive this vehicle, read the Operator's Manual. Take time to become familiar with the driving characteristics of this vehicle. Be sure you are familiar with all vehicle controls. Learn how your vehicle handles on different road surfaces. Do not attempt sharp turns at excessive speeds or abrupt maneuvers or other unsafe driving actions that can cause loss of vehicle control. When driving off-road or working the vehicle hard, do not overload it. And, always wear your seat belts at all times. In a rollover crash, an unbelted person is significantly more likely to die than a person wearing a seat belt.

▼ Where to find it

This Operator's Manual is designed to provide comprehensive support information for you, the vehicle operator. Each section has its own reference color.

At a glance

Here you will find an overview of all the controls that can be operated from the driver's seat.

Getting started

Here you will find all the information you need for your first drive. You should read this section first if this is your first Mercedes-Benz vehicle or if you are renting or borrowing this vehicle.

Safety and Security

Here you will find descriptions of the safety and security features of your vehicle.

Controls in detail

Here you will find detailed information about the equipment installed on your vehicle. This section expands on the "Getting started" section and also describes technical innovations. If you are already familiar with the basic functions of your vehicle, this section will be of particular interest to you.

Operation

Here you will find all the information you need for the proper operation of your vehicle.

Practical hints

This section provides fast assistance for dealing with problems you may encounter.

Technical data

All important technical data for your vehicle can be found in this section.

Indexes

The table of contents and the index are designed to help you find information quickly and easily.

The following publications are part of your vehicle documentation:

- this Operator's Manual
- the Maintenance Booklet

Separate operating instructions will be provided as required depending on the equipment options installed in your vehicle.

Symbols

Trademarks:

- ESP® is a registered trademark of DaimlerChrysler.
- HomeLink® is a registered trademark of Prince, a Johnson Controls Company.

The following symbols are found in this Operator's Manual:

- * Optional equipment is identified with an asterisk. Since standard equipment varies between models, the descriptions and illustrations in this manual may differ slightly from the actual equipment of your vehicle.

Warning!



Warning notices draw your attention to hazards that may endanger your health or life, or the health or life of others.

 *Highlights hazards that may result in damage to your vehicle.*

 *Helpful hints or further information you may find useful.*

- ▶ This symbol points to instructions for you to follow.
- ▶ A number of these symbols appearing in succession indicates a multiple-step procedure.

▷ Page This symbol tells you where to look for further information on a topic.

▷▷ This continuation symbol marks a warning which is continued on the next page.

▷▷ This continuation symbol marks a procedure which is continued on the next page.

Display Words appearing in the multi-function display are printed in the type shown here.

▼ Operating safety

Warning!



Work improperly carried out on electronic components and associated software could cause them to cease functioning. Because the vehicle's electronic components are interconnected, any modifications made may produce an undesired effect on other systems. Electronic malfunctions could seriously impair the operating safety of your vehicle.

See an authorized Mercedes-Benz Light Truck Center for repairs or modifications to electronic components.

Other improper work or modifications on the vehicle could also have a negative impact on the operating safety of the vehicle.

Some safety systems only function while the engine is running. You should therefore never turn off the engine while driving.

Warning!



Heavy blows against the vehicle underbody or tires/wheels, for example when running over an obstacle, road debris or a pothole, may cause serious damage and impair the operating safety of your vehicle. If you feel a sudden significant vibration or ride disturbance, or you suspect that damage to your vehicle has occurred, you should turn on your hazard warning flashers, carefully slow down, and drive with caution to an area which is a safe distance from the road.

Inspect the vehicle underbody and tires/wheels for possible damage. If the vehicle appears unsafe, have it towed to the nearest authorized Mercedes-Benz Light Truck Center or other qualified maintenance or repair facility for further inspection or repairs.

Proper use of the vehicle

Proper use of the vehicle requires that you are familiar with the following information and rules:

- the safety precautions in this manual
- the “Technical data” section in this manual
- traffic rules and regulations
- motor vehicle laws and safety standards

Warning!



Various warning labels are attached to your vehicle. These warning labels are intended to make you and others aware of various risks. You should not remove any of these warning labels unless explicitly instructed to do so by information on the label itself. Removal of any of these labels may cause you and others to be unaware of certain risks which may result in an accident and/or personal injury.

Problems with your vehicle

If you should experience a problem with your vehicle, particularly one that you believe may affect its safe operation, we urge you to immediately contact an authorized Mercedes-Benz Light Truck Center to have the problem diagnosed and corrected if required. If the matter is not handled to your satisfaction, please discuss the problem with the Mercedes-Benz Light Truck Center management, or if necessary contact us at one of the following addresses:

In the USA:

Customer Assistance Center
Mercedes-Benz USA, LLC
One Mercedes Drive
Montvale, NJ 07645-0350

In Canada:

Customer Relations Department
Mercedes-Benz Canada, Inc.
98 Vanderhoof Avenue
Toronto, Ontario, M4G 4C9

▼ Reporting safety defects

For the USA only:

The following text is published as required of manufacturers under Title 49, Code of U.S. Federal Regulations, Part 575 pursuant to the “National Traffic and Motor Vehicle Safety Act of 1966”.

Reporting safety defects

If you believe that your vehicle has a defect which could cause a crash or could cause injury or death, you should immediately inform the National Highway Traffic Safety Administration (NHTSA) in addition to notifying Mercedes-Benz USA, LLC.

If NHTSA receives similar complaints, it may open an investigation, and if it finds that a safety defect exists in a group of vehicles, it may order a recall and remedy campaign. However, NHTSA cannot become involved in individual problems between you, your dealer, or Mercedes-Benz USA, LLC.

To contact NHTSA, you may call the Vehicle Safety Hotline toll-free at 1-888-327-4236 (TTY: 1-800-424-9153); go to <http://www.safercar.gov>; or write to: Administrator, NHTSA, 400 Seventh Street, SW., Washington, D.C. 20590. You can also obtain other information about motor vehicle safety from <http://www.safercar.gov>.

Vehicle data recording

Information regarding electronic recording devices

(Including notice pursuant to California Code § 9951)

Please note that your vehicle is equipped with devices that can record vehicle systems data and, if equipped with the Tele Aid* system, may transmit some data in certain accidents.

This information helps, for example, to diagnose vehicle systems after a collision and to continuously improve vehicle safety. DaimlerChrysler may access the information and share it with others

- for safety research or vehicle diagnosis purposes
- with the consent of the vehicle owner or lessee
- in response to an official request by law enforcement or other government agency
- for use in dispute resolution involving DaimlerChrysler, its affiliates or sales/service organization and/or
- as otherwise required or permitted by law.

Please check the Tele Aid* subscription service agreement for details regarding the information that may be recorded or transmitted via that system.



Exterior view

Cockpit

Instrument cluster

Multifunction steering wheel

Center console

Overhead control panel

Storage compartments

Door control panel

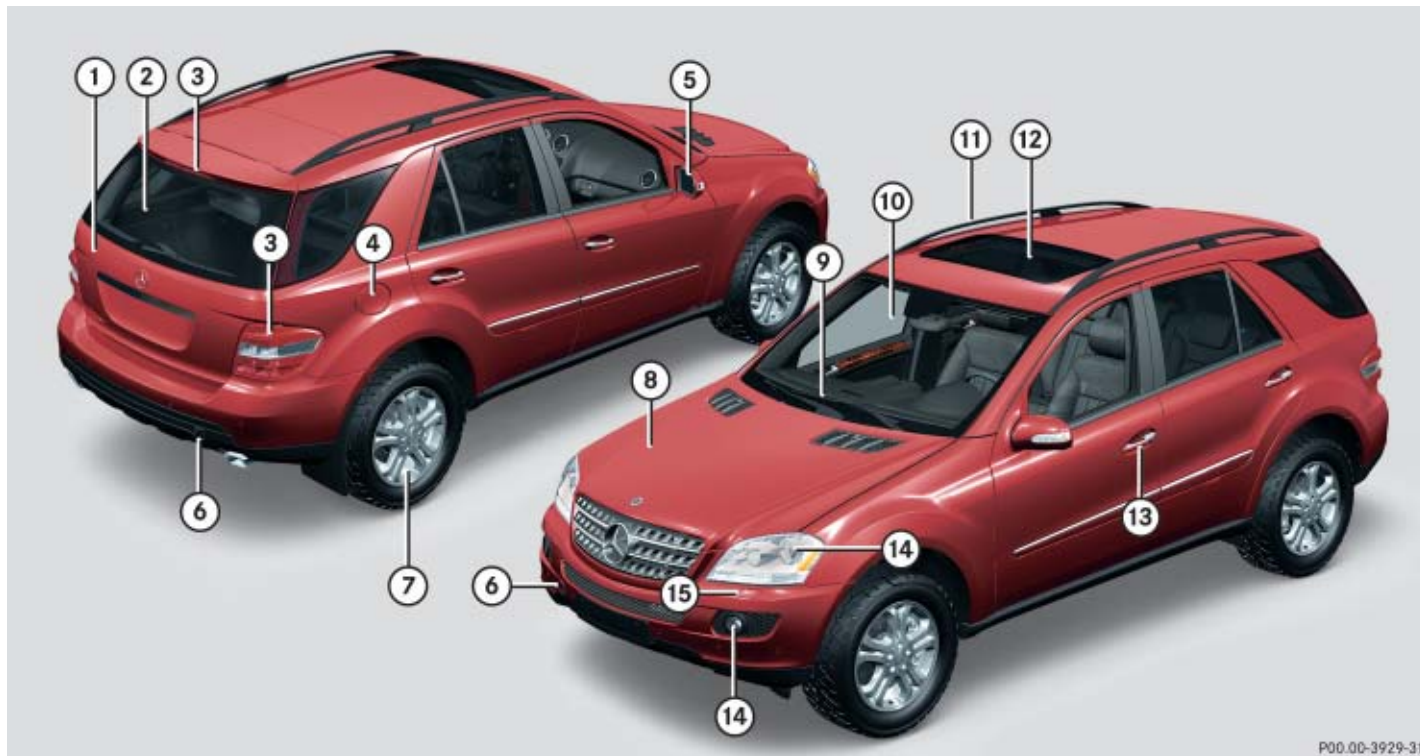

P00.00-3929-31

Item	Page
① Tailgate	
Opening	119
Closing	121
Power tailgate*	119, 124
Cargo compartment	
Vehicle tool kit	469
Spare wheel	473
② Rear window defroster	208
③ Rear lamps	483
④ Fuel filler flap	352
Refueling	352
Fuel	353, 547
⑤ Exterior rear view mirrors	
Adjusting	49
Auto-dimming rear view mirrors*	201
Power folding*	202

Item	Page
⑥ Towing eye bolt	
Installing	520
Vehicle tool kit	469
⑦ Tires and wheels	365, 536
Checking tire inflation pressure	375
Run Flat Indicator (Canada vehicles)	377
Tire Pressure Monitoring System (U.S. vehicles)	379
Advanced Tire Pressure Monitoring System* (Canada vehicles)	381
Flat tire	497
Spare wheel	473
⑧ Hood	356
Engine oil	358
Coolant	362

Item	Page
⑨ Windshield wipers	60
Wiper blades, replacing	494
Wiper blades, cleaning	410
⑩ Windshield	
Cleaning with wiper fluid	62
Cleaning	410
⑪ Roof rails	281
Carriers*	281
⑫ Power tilt/sliding sunroof*	241
⑬ Doors	
Locking and unlocking	108
Opening and closing	119
Locking/unlocking in an emergency	478
⑭ Front lamps	483
⑮ Headlamp cleaning system*	200

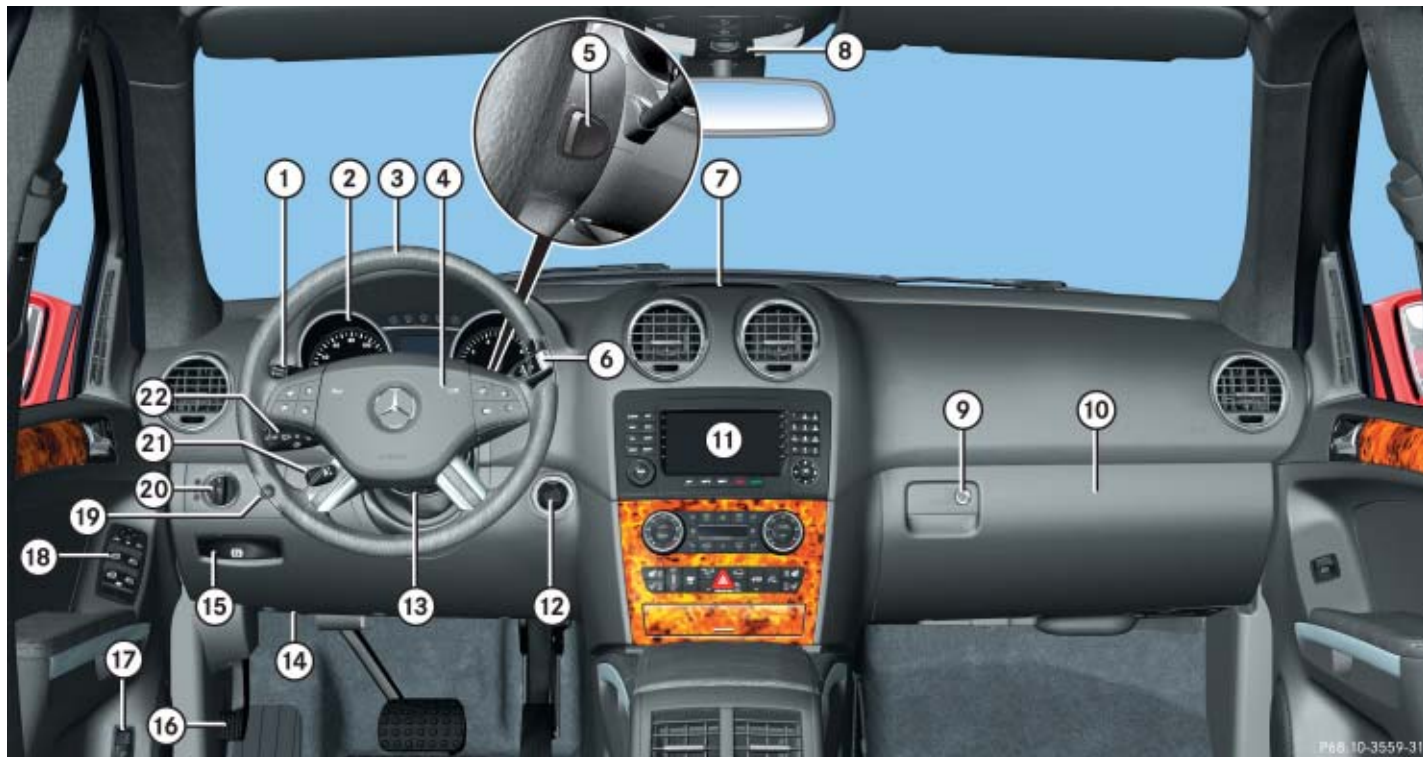



Item	Page
① Cruise control lever	246
② Instrument cluster	26
③ Multifunction steering wheel	30
④ Horn	
⑤ Steering wheel gearshift buttons	194
⑥ Gear selector lever for automatic transmission	54
⑦ Front Parktronic* warning indicators	276
⑧ Overhead control panel	33

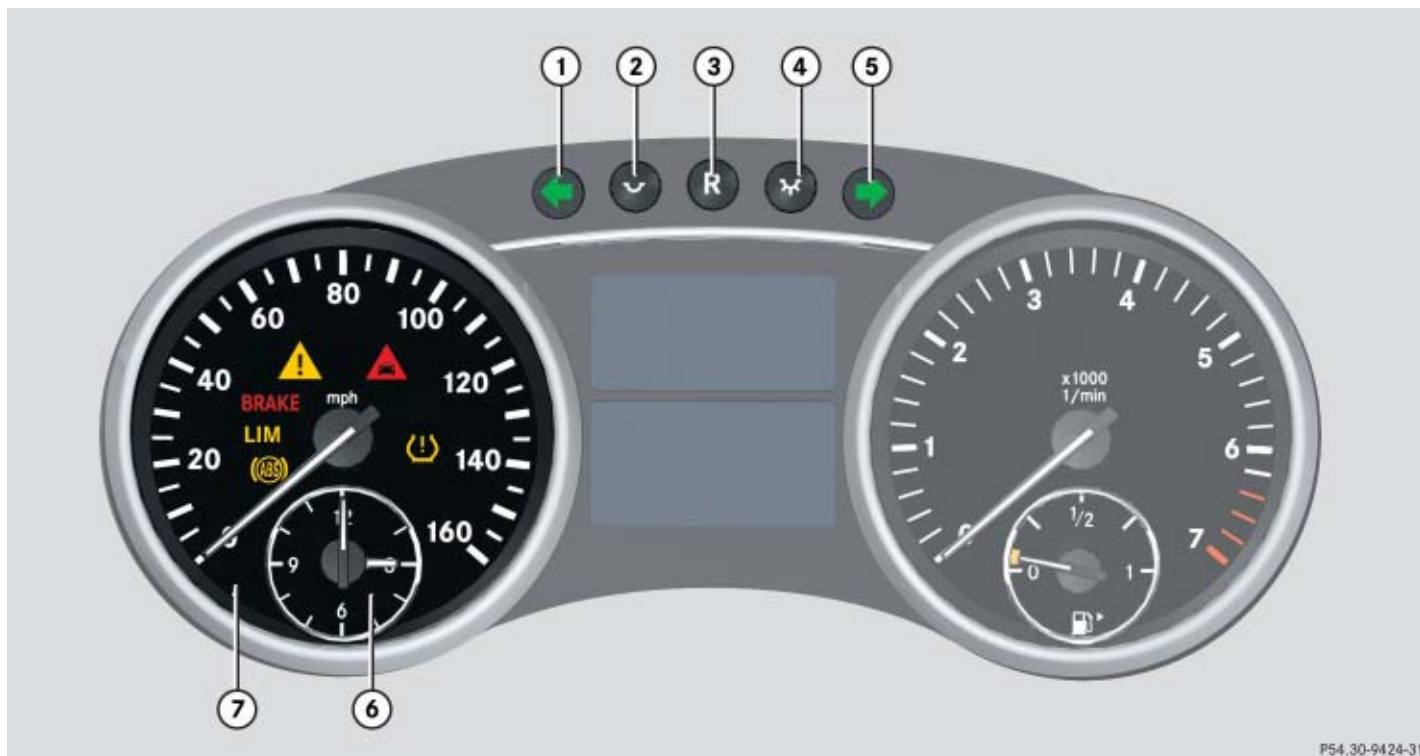

Item	Page
⑨ Glove box release	294
Glove box lock	295
⑩ Glove box	294
⑪ Center console	31
⑫ Starter switch	40
⑬ Steering wheel adjustment, manual	47
⑭ Hood lock release	356
⑮ Parking brake release	57
⑯ Parking brake pedal	65
⑰ Power tailgate switch*	119
⑱ Door control panel	36

Item	Page
⑲ Headlamp washer switch*	200
⑳ Exterior lamp switch	59, 136
㉑ Steering wheel adjustment, electrical* Heated steering wheel*	48 304
㉒ Combination switch	140
• High beam	59
• Turn signals	60
• Windshield wipers	60
• Rear window wiper	62







P54.30-9424-31

Item	Page
①  Left turn signal indicator lamp	
② To dim instrument cluster illumination	145
③ Reset button for:	
• Resetting trip odometer	146
• Resetting all settings	165
④ To brighten instrument cluster illumination	145
⑤  Right turn signal indicator lamp	
⑥ Clock	

Item	Page
⑦ Speedometer with:	
 Antilock Brake System (ABS) indicator lamp	414
 Variable speed limiter indicator lamp ¹	
 Distance warning lamp ²	423







¹ Lamp without function. It illuminates when the ignition is on. It should go out when the engine is running.

² Vehicles without DISTRONIC*: Warning lamp without function. It illuminates when the ignition is on. It should go out when the engine is running.

Item	Page
 Brake warning lamp, USA only	415
 Brake warning lamp, Canada only	415
 Electronic Stability Program (ESP [®]) warning lamp	419
 Combination low tire pressure/TPMS malfunction telltale, USA only	424
Low tire pressure telltale*, Canada only	424



P54.30-9421-31

Item	Page
⑧ Multifunction display with:	
• Trip odometer	146
• Main odometer	147
⑨ Tachometer with:	
 Seat belt telltale	79, 421
 Supplemental Restraint System (SRS) indicator lamp	70, 423
 Preglow indicator lamp ¹	55
 Engine malfunction indicator lamp, USA only	417
 Engine malfunction indicator lamp, Canada only	417
 High beam headlamp indicator	59, 140

¹ Vehicles with Diesel engine only.





Item	Page
⑩ Fuel gauge with:	
Fuel tank reserve warning lamp	420
 Fuel filler flap indicator: The fuel filler flap is located on the rear right-hand side	352
⑪ Multifunction display with:	
• Outside temperature display or digital speedometer (depending on selected setting in the control system)	147, 168
• Transmission position indicator	189
• Gear range indicator	193
• Selected program mode indicator ¹	196





¹ AMG vehicles only.

Item	Page
• Distance warning function* indicator	179
• Downhill Speed Regulation (DSR) indicator	265
• Off-road driving program indicator	268
• Rear window wiper indicator	62

Multifunction steering wheel



Item	Page
① Multifunction display	147
Operating the control system	148
② Telephone*: Press button	
 to take a call to dial to redial	
 to end a call to reject an incoming call	
③ Selecting the submenu or setting the volume: Press button	
 up/to increase	
 down/to decrease	

Item	Page
④ Voice Control* ¹	
⑤ Moving within a menu: Press button	
 for next display	
 for previous display	
⑥ Voice Control* ¹	
⑦ Menu systems: Press button	
 for next menu	
 for previous menu	

¹ Vehicles without Voice Control: Button without function.

▼ Center console

Upper part



Item	Page	Item	Page
① COMAND system, see separate operating instructions		⑧ Storage compartment*	296
② Climate control	206	⑨ Alarm system indicator lamp	104
3-zone automatic climate control*	220	⑩ Electronic Stability Program (ESP®) switch	100
Rear window defroster	205	⑪ Adaptive damping system (ADS)* switch	269
③ Seat heating*, front passenger side	131	⑫ Seat ventilation*, driver's side	132
④ Seat ventilation*, front passenger side	132	⑬ Seat heating*, driver's side	131
⑤ Parktronic system* deactivation switch	274	⑭ Switch for Downhill Speed Regulation (DSR)	265
⑥ Vehicle level control switch*	271	⑮ Hazard warning flasher	142
⑦ Front passenger front air bag off indicator lamp	89, 426	⑯ Switch for Off-road driving program	268
		ML 63 AMG: Program mode selector switch for automatic transmission	195

Center console

Lower part



	Item	Page
①	Storage compartment	296
	• Power outlet	302
	• Ashtray with cigarette lighter*	300
②	Cup holder	299
③	Armrest storage tray release	296
④	Armrest storage compartment release	296
⑤	Card, ticket holder (removable)	299

▼ Overhead control panel

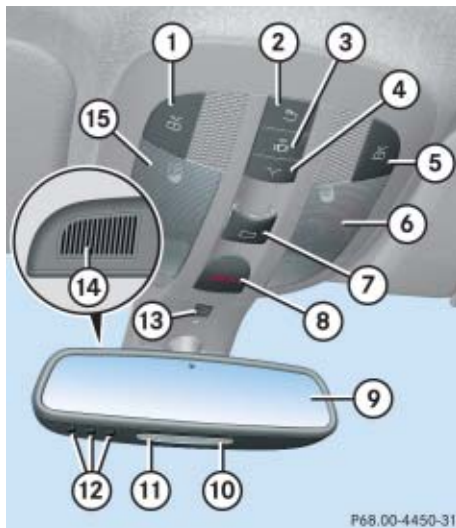

Item	Page
① Left reading lamp switch	142
② Rear interior lighting switch	142
③ Automatic interior lighting switch	142
④ Front interior lighting switch	142
⑤ Right reading lamp switch	142
⑥ Front right interior lamp	142
⑦ Tilt/sliding sunroof* switch	241
⑧ Tele Aid* (emergency call system) button	311
⑨ Interior rear view mirror	200
⑩ Front right reading lamp	142

Item	Page
⑪ Front left reading lamp	142
⑫ Garage door opener*	316
⑬ Vehicles without telephone* installed: Hands-free microphone for Tele Aid* (emergency call system)	308
⑭ Vehicles with telephone* installed: Hands-free microphone for Tele Aid* (emergency call system) and telephone*	308
⑮ Front left interior lamp	142

Storage compartments

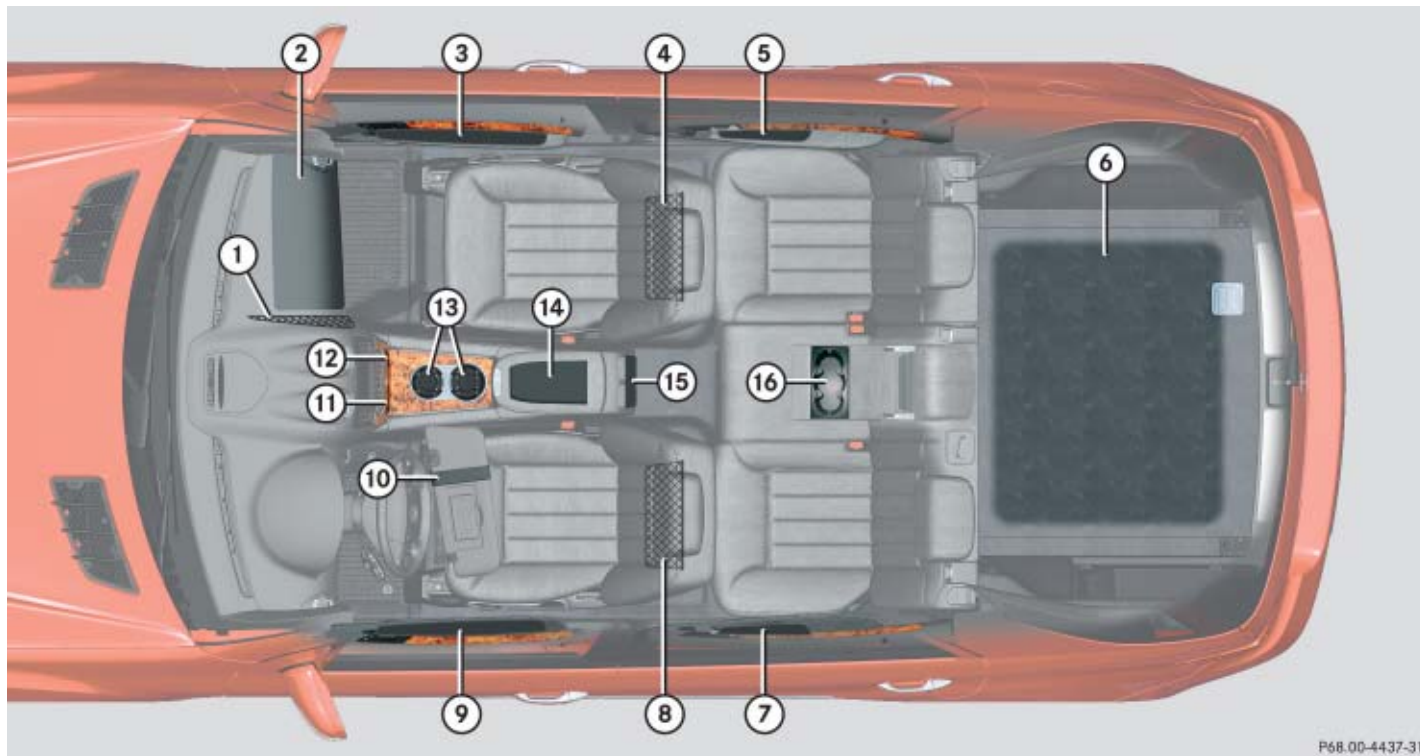

Item	Page
① Parcel net in front passenger footwell	298
② Glove box/CD changer*	294
③ Door pocket	
④ Parcel net on front passenger seat backrest	298
⑤ Door pocket	
⑥ Vehicle tool kit, spare wheel	469
⑦ Door pocket	
⑧ Parcel net on driver's seat backrest	298
⑨ Door pocket	
⑩ Holder for gas cards	203

Item	Page
⑪ Storage compartment* (depending on equipment configuration for your model)	296
⑫ Depending on vehicle configuration:	
Storage compartment	296
Ashtray*	300
⑬ Cup holders	298
⑭ Storage tray with telephone* compartment	296
Storage compartment with coin holder	296
⑮ Rear storage compartments	297
⑯ Cup holder in rear armrest	299

Door control panel



Item	Page
① Inside door handle	118
② Central unlocking switch Central locking switch	127 127
③ Exterior rear view mirror adjustment	49
④ Selection buttons for exterior rear view mirror adjustment	49
Power-folding exterior rear view mirrors*	202
⑤ Switches for opening/closing front and rear door windows	236
⑥ Rear door window override switch	93
⑦ Remote tailgate release switch, power tailgate*	119, 121

Unlocking

Adjusting

Driving

Parking and locking



Unlocking





The “Getting started” section provides an overview of the vehicle’s most basic functions. First-time Mercedes-Benz owners should pay special attention to the information given here.

If you are already familiar with the basic functions described here, the “Controls in detail” section will provide you with further information. The corresponding page references are located at the end of each segment.

Unlocking with the SmartKey



SmartKey

- ①  Lock button
- ②  Unlock button* for tailgate
- ③  Unlock button
- ④  PANIC Panic button (▷ page 95)

Warning!



When leaving the vehicle, always remove the SmartKey from the starter switch, take it with you, and lock the vehicle. Do not leave children unattended in the vehicle, or with access to an unlocked vehicle. Unsupervised use of vehicle equipment may cause an accident and/or serious personal injury.

- ▶ Press unlock button  on the SmartKey.

All turn signal lamps flash once. The vehicle unlocks. The locking knobs in the doors move up. The anti-theft alarm system is disarmed. The locator lighting comes on if the feature is enabled in the control system (▷ page 172).

- ▶ Enter the vehicle and insert the SmartKey in the starter switch.

For more information, see “Locking and unlocking” (▷ page 108).

Unlocking with KEYLESS-GO*

With the KEYLESS-GO function, you can lock or unlock the vehicle without using the remote control buttons on the SmartKey and start the engine without inserting the SmartKey into the starter switch.

 *To unlock the vehicle, the SmartKey with KEYLESS-GO must be outside the vehicle, no further than approximately 3 feet (1 meter) away from the respective door.*

Warning!



When leaving the vehicle, always take the SmartKey with KEYLESS-GO* with you, and lock the vehicle. Do not leave children unattended in the vehicle, or with access to an unlocked vehicle. Unsupervised use of vehicle equipment may cause an accident and/or serious personal injury.

- ▶ Grasp an outside door handle or the tailgate handle.

All turn signal lamps flash once. The vehicle unlocks. The locking knobs in the doors move up. The anti-theft alarm system is disarmed. The locator lighting comes on if the feature is enabled in the control system (▷ page 172).

-  *If the vehicle has been parked for more than 72 hours, you must pull an outside door handle in order to activate the KEYLESS-GO function.*

- ▶ Enter the vehicle.

For more information, see “SmartKey with KEYLESS-GO*” (▷ page 112).

Starter switch positions

Warning!



When leaving the vehicle, always remove the SmartKey or SmartKey with KEYLESS-GO* from the starter switch, take it with you and lock the vehicle. Do not leave children unattended in the vehicle, or with access to an unlocked vehicle. Unsupervised use of vehicle equipment may cause an accident and/or serious personal injury.

Unlocking

SmartKey



Starter switch

0 For removing SmartKey

1 Power supply for some electrical consumers, such as seat adjustment

2 Ignition (power supply for all electrical consumers) and driving position

All lamps (except high beam headlamp indicator lamp and turn signal indicator lamps unless activated) in the instrument cluster come on. If a lamp in the instrument cluster fails to come on when the ignition is switched on, have it checked and replaced if necessary. If a lamp in the instrument cluster re-

mains on after starting the engine or comes on while driving, refer to “Lamps in instrument cluster” (▷ page 414).

3 Starting position

i When you switch on the ignition, the indicator and warning lamps (except high beam headlamp indicator lamp and turn signal indicator lamps unless activated) in the instrument cluster come on. The indicator and warning lamps (except high beam headlamp indicator lamp and turn signal indicator lamps if activated) will go out when the engine is running. This indicates that the respective systems are operational.

i When the SmartKey is removed from the starter switch and the automatic transmission is in a position other than **P**, the automatic transmission automatically shifts to **P**.

! If the SmartKey cannot be turned in the starter switch, the battery may not be sufficiently charged.

- Check the battery and charge it if necessary (▷ page 507).
- Get a jump start (▷ page 515).

To prevent accelerated battery discharge or a completely discharged battery, always remove the SmartKey from the starter switch when the engine is not in operation.

SmartKey with KEYLESS-GO*

Vehicles equipped with the KEYLESS-GO feature are supplied with a SmartKey with integrated KEYLESS-GO function and a removable KEYLESS-GO start/stop button.

With the KEYLESS-GO start/stop button inserted and the SmartKey with KEYLESS-GO present in the vehicle, pressing the KEYLESS-GO start/stop button

- without the brake pedal depressed corresponds to the various starter switch positions (▷ page 42)
- with the brake pedal firmly depressed will start the engine (▷ page 54)

If you wish or should there be a need to insert the SmartKey with KEYLESS-GO in the starter switch, the KEYLESS-GO start/stop button can be easily removed by pulling it out of the starter switch.

i The KEYLESS-GO start/stop button does not need to be removed from the starter switch when you leave the vehicle. However, always take the SmartKey with KEYLESS-GO with you when you leave the vehicle. As long as the SmartKey with KEYLESS-GO is in the vehicle, the vehicle's electrical systems can be switched on or the engine can be started using the KEYLESS-GO start/stop button.

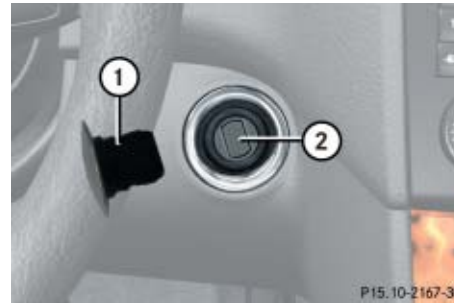

- ① KEYLESS-GO start/stop button
- ② Starter switch

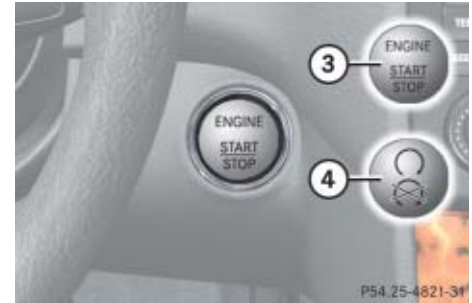

KEYLESS-GO start/stop button

- ③ USA only
- ④ Canada only

The SmartKey with KEYLESS-GO must be located in the vehicle.

- ▶ Insert KEYLESS-GO start/stop button ① into starter switch ② (if not inserted already).
- ▶ Make sure the automatic transmission is set to **P** (▷ page 187).
- ▶ Do not depress the brake pedal.

Unlocking

Position 0

Before you press the KEYLESS-GO start/stop button, the vehicle's on-board electronics have status **0** (as with SmartKey removed).

Position 1

- ▶ Press the KEYLESS-GO start/stop button once.

This supplies power for some electrical consumers, such as seat adjustment.

i If you now press the KEYLESS-GO start/stop button

- once more, the ignition (position **2**) is switched on
- twice more, the power supply is again switched off

Ignition (or Position 2)

- ▶ Press the KEYLESS-GO start/stop button twice.

This supplies power for all electrical consumers.

All lamps (except high beam headlamp indicator lamp and turn signal indicator lamps unless activated) in the instrument cluster come on. If a lamp in the instrument cluster fails to come on when the ignition is switched on, have it checked and replaced if necessary. If a lamp in the instrument cluster remains on after starting the engine or comes on while driving, refer to "Lamps in instrument cluster" (▷ page 414).

i If you now press the KEYLESS-GO start/stop button once more, the power supply is again switched off.

i When you switch on the ignition, the indicator and warning lamps (except high beam headlamp indicator lamp and turn signal indicator lamps unless activated) in the instrument cluster come on. The indicator and warning lamps (except high beam headlamp indicator lamp and turn signal indicator lamps if activated) should go out when the engine is running. This indicates that the respective systems are operational.

For information on starting the engine using the KEYLESS-GO start/stop button, see "Starting with KEYLESS-GO*" (▷ page 55).

For more information on KEYLESS-GO, see "SmartKey with KEYLESS-GO*" (▷ page 112).

▼ Adjusting

Warning!



All seat, head restraint, steering wheel, and rear view mirror adjustments, as well as fastening of seat belts, must be done before the vehicle is put into motion.

Seats

Warning!



Do not adjust the driver's seat while driving. Adjusting the seat while driving could cause the driver to lose control of the vehicle.

Never ride in a moving vehicle with the seat backrest in an excessively reclined position as this can be dangerous. You could slide under the seat belt in a collision. If you slide under it, the belt would apply force at the abdomen or neck. That could cause serious or fatal injuries. The seat backrest and seat belts provide the best restraint when the wearer is in a nearly upright position and belts are properly positioned on the body.

Your seat must be adjusted so that you can correctly fasten your seat belt (▷ page 51).

Never place hands under the seat or near any moving parts while a seat is being adjusted.

Warning!



When leaving the vehicle, always remove the SmartKey or SmartKey with KEYLESS-GO* from the starter switch, take it with you, and lock the vehicle.

Even with the SmartKey or the SmartKey with KEYLESS-GO* removed from the starter switch or the SmartKey with KEYLESS-GO* removed from the vehicle, the power seats can be operated when the respective door is open.

Therefore, do not leave children unattended in the vehicle, or with access to an unlocked vehicle. Unsupervised use of vehicle equipment may cause an accident and/or serious personal injury.

Warning!



According to accident statistics, children are safer when properly restrained in the rear seating positions than in the front seating position. Thus, we strongly recommend that children be placed in the rear seats whenever possible. Regardless of seating position, children 12 years old and under must be seated and properly secured in an appropriate infant, or toddler restraint, or booster seat recommended for the size and weight of the child. For additional information, see "Children in the vehicle" (▷ page 82).

A child's risk of serious or fatal injuries is significantly increased if the child restraints are not properly secured in the vehicle and/or the child is not properly secured in the child restraint.

Adjusting

Seat adjustment

The seat adjustment switch is located on the entry side of each front seat base.



- ① Head restraint height (vehicles with memory function)*
- ② Seat cushion tilt
- ③ Seat height
- ④ Backrest tilt
- ⑤ Seat fore and aft adjustment

! When moving the seat, make sure there are no items in the footwell or behind the seat. Otherwise you could damage the seat.

! When the rear seats are folded forward, e.g. for cargo compartment expansion (▷ page 284), the front seats may not be moved to the rearmost position. Otherwise you could damage the front and rear seats.

! When adjusting the seat backrest tilt and head restraint height, make sure the sun visor is folded up (▷ page 203). If the head restraint is in the uppermost position, it could hit and damage the sun visor.

i The memory function* (▷ page 134) lets you store the settings for the seat positions together with the settings for the steering wheel column and the exterior rear view mirrors.

- ▶ Switch on the ignition (▷ page 40).

or

Vehicles with memory function*:

- ▶ Open the respective door.

The seat can be adjusted with the respective door opened.

or

Vehicles without memory function*:

- ▶ The seat can be adjusted within 3 minutes after either front door has been opened.

Seat fore and aft adjustment

- ▶ Press the switch forward or backward in direction of arrow ⑤.

Adjust the seat to a comfortable seating position that still allows you to reach the accelerator/brake pedal safely. The position should be as far to the rear as possible, consistent with ability to properly operate controls.

Seat height

- ▶ Press the switch up or down in direction of arrow ③.

Seat cushion tilt

- ▶ Press the switch up or down in direction of arrow ② until your upper legs are lightly supported.

Seat backrest tilt

- ▶ Press the switch forward or backward in direction of arrow ④ until your arms are slightly angled when holding the steering wheel.

Head restraint height**Warning!**

Do not drive the vehicle without the seat head restraints. Head restraints are intended to help reduce injuries during an accident.

With a rear seat occupied, make sure to move the respective head restraint up from the lowest non-use position and have the occupant adjust the head restraint properly.

For your protection, drive only with properly positioned and engaged head restraints.

Adjust the head restraint so that it is as close to the head as possible and the center of the head restraint supports the back of the head at eye level. This will reduce the potential for injury to the head and neck in the event of an accident or similar situation.

! Do not attempt to remove front seat head restraints. They can only be removed by qualified technicians. We recommend that you have this work carried out by an authorized Mercedes-Benz Light Truck Center.

Vehicles with memory function*:

- ▶ Press switch ① (▷ page 44) up or down in direction of arrow.

Vehicles without memory function*:



- ① Head restraint
- ② Release button

Raising:

- ▶ Manually adjust the height of head restraint ① by pulling it upward.
If head restraint ① is fully retracted, push release button ② in direction of arrow and pull head restraint ① upward.

Lowering:

- ▶ To lower head restraint ①, push release button ② in direction of arrow and press down on head restraint ①.

Adjusting

Head restraint fore and aft adjustment



Manually adjust the angle of the head restraint.

- ▶ While seated, reach behind you with both hands and find lower edge of the head restraint.
- ▶ Adjust the head restraint to the desired position by pushing or pulling on the lower edge of the head restraint cushion.

For more information, see “Seats” (▷ page 128).

Steering wheel

Easy-entry/exit feature*

This feature allows for easier entry into and exit from the vehicle. When entering and exiting the vehicle, the steering wheel is in its uppermost position.

The easy-entry/exit feature can be activated or deactivated in the *Comfort* submenu of the control system (▷ page 177).

Warning!



You must make sure no one can become trapped or injured by the moving steering wheel when the easy-entry/exit feature is activated.

To stop steering wheel movement, do one of the following:

- Move steering wheel adjustment stalk* (▷ page 49).

- Press one of the memory position buttons or the memory button **M*** (▷ page 135).

Do not leave children unattended in the vehicle, or with access to an unlocked vehicle. Children could open the driver's door and unintentionally activate the easy-entry/exit feature, which could result in an accident and/or serious personal injury.

With the easy-entry/exit feature activated, the steering wheel will return to its last set position when you:

- close the driver's door with the ignition switched on
- or
- insert the SmartKey into the starter switch or press the KEYLESS-GO* start/stop button (▷ page 41) once with the driver's door closed

i The last set steering wheel position is stored when

- the ignition is switched off (▷ page 39)
- the position is stored in memory (▷ page 135)

With the easy-entry/exit feature activated, the steering wheel tilts upwards when you:

- remove the SmartKey from the starter switch,
or
- open the driver's door with the SmartKey in starter switch position **0** or **1** or the KEYLESS-GO* start/stop button in position **1** (▷ page 41)

i If the current position for the steering wheel is in the uppermost tilt position, the steering wheel will no longer be able to move upward when the easy-entry/exit feature is activated.

The adjustment procedure is briefly interrupted, when the engine is started.

Warning!



Let the system complete the adjustment procedure before setting the vehicle in motion. All steering wheel adjustment must be completed before setting the vehicle in motion. Driving off with the steering wheel still adjusting could cause the driver to lose control of the vehicle.

Steering wheel adjustment, manual

Warning!



Only adjust the steering wheel with the vehicle at a standstill and make sure the steering wheel is securely locked in place before driving off.

Driving without the steering wheel adjustment locked may cause an unexpected steering wheel movement which could cause the driver to lose control of the vehicle. Make sure the steering wheel is securely locked by trying to move it up and down, and in and out before driving off.

Make sure that

- you can reach the steering wheel with your arms slightly bent at the elbows
- you can move your legs freely
- all displays (including malfunction and indicator lamps) on the instrument cluster are clearly visible

The steering wheel adjustment release handle is located on the lower left of the steering column.

Adjusting



① Release handle

- ▶ To unlock the steering column, pull release handle ① out to its stop limit.
- ▶ Move steering wheel to the desired position.
- ▶ Push release handle ① back to its original position to relock the steering column.

The steering column is locked into position again.

- ▶ Make sure the steering column is securely locked by trying to move the steering wheel up and down as well as in and out before driving off.

Steering wheel adjustment, electrical*

Warning!



Do not adjust the steering wheel while driving. Adjusting the steering wheel while driving could cause the driver to lose control of the vehicle.

When leaving the vehicle, always remove the SmartKey or SmartKey with KEYLESS-GO* from the starter switch, take it with you, and lock the vehicle.

Even with the SmartKey or SmartKey with KEYLESS-GO* removed from the starter switch or the SmartKey with KEYLESS-GO* removed from the vehicle, the steering wheel adjustment feature can be operated when the driver's door is open. Therefore, do not leave children unattended in the vehicle, or with access to an unlocked vehicle. Unsupervised use of vehicle equipment may cause an accident and/or serious personal injury.

i The memory function* (▷ page 134) lets you store the settings for the steering wheel column together with the settings for seat positions and the exterior rear view mirrors.

Make sure that

- you can reach the steering wheel with your arms slightly bent at the elbows
- you can move your legs freely
- all displays (including malfunction and indicator lamps) on the instrument cluster are clearly visible

The steering wheel adjustment stalk is located on the lower left of the steering column.

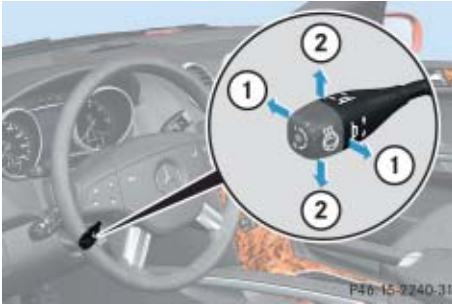

- ① Adjusting steering column, in or out
- ② Adjusting steering column, up or down

▶ Switch on the ignition (▷ page 40).
or

▶ Open the driver's door.

Adjusting steering column in or out

▶ Move stalk forward or back in direction of arrow ①.

Adjusting steering column up or down

▶ Move stalk up or down in direction of arrow ②.

Mirrors

Adjust the interior and exterior rear view mirrors before driving so that you have a good view of the road and traffic conditions.

Warning!



In case of an accident, liquid electrolyte may escape the mirror housing if the mirror glass breaks.

Electrolyte has an irritating effect. Do not allow the liquid to come into contact with eyes, skin, clothing, or respiratory system. In case it does, immediately flush affected area with water, and seek medical help if necessary.

! *Electrolyte drops coming into contact with the vehicle paint finish can only be completely removed while in their liquid state and by applying plenty of water.*

Interior rear view mirror

▶ Manually adjust the interior rear view mirror.

For more information, see “Rear view mirrors” (▷ page 200).

Exterior rear view mirrors

Warning!



Exercise care when using the passenger-side exterior rear view mirror. The mirror surface is convex (outwardly curved surface for a wider field of view). Objects in mirror are closer than they appear. Check your interior rear view mirror or glance over your shoulder before changing lanes.

Adjusting

The buttons are located on the driver's door.



- ① Driver's side exterior rear view mirror button
 - ② Adjustment button
 - ③ Passenger-side exterior rear view mirror button
- ▶ Switch on the ignition (▷ page 40).

- ▶ Press button ① for the driver's side exterior rear view mirror or button ③ for the passenger-side exterior rear view mirror.

The indicator lamp on the respective button comes on for approximately 15 seconds.

i If you do not make adjustments to the selected exterior rear view mirror within 15 seconds, the indicator lamp goes out. You will then have to select the desired exterior rear view mirror again before any adjustments can be made. Adjustments can only be made with the indicator lamp for the respective exterior rear view mirror button illuminated.

- ▶ Push adjustment button ② up, down, left, or right according to the desired setting.

! If an exterior rear view mirror was forcibly pushed forward (hit from the rear) or forcibly pushed rearward (hit from the front), reposition it by applying firm pressure until it snaps into place. The mirror housing is then properly positioned and you can adjust the mirror in the usual manner.

! Vehicle with power folding exterior rear view mirrors*:

If an exterior rear view mirror housing is forcibly pushed forward (hit from the rear) or forcibly pushed rearward (hit from the front), press fold button ① (▷ page 202) to fold mirrors in, then press fold button ① (▷ page 202) again to fold mirrors out. Do not force mirrors by hand as this may damage the adjustment mechanism.

The mirror housing is then properly positioned and you can adjust the mirror in the usual manner.

i The memory function* (▷ page 134) lets you store the settings for the exterior rear view mirrors together with the setting for the steering wheel column and the seat positions.

At low ambient temperatures, the exterior rear view mirrors will be heated automatically.

For more information, see "Rear view mirrors" (▷ page 200).

▼ Driving

Warning!



Make sure that absolutely no objects are obstructing the pedal's range of movement. Keep the driver's footwell clear of all obstacles. If there are any floor mats or carpets in the footwell, make sure that the pedals still have sufficient clearance.

During sudden driving or braking maneuvers, the objects could get caught between the pedals. You could then no longer brake or accelerate. This could lead to accidents and injury.

Fastening the seat belts

Warning!



Always fasten your seat belt before driving off. Always make sure your passengers are properly restrained, even those sitting in the rear and pregnant women.

Failure to wear and properly fasten and position your seat belt greatly increases your risk of injuries and their likely severity in an accident. You and your passengers should always wear seat belts.

If you are ever in an accident, your injuries can be considerably more severe without your seat belt properly buckled. Without your seat belt buckled, you are much more likely to hit the interior of the vehicle or be ejected from it. You can be seriously injured or killed.

In the same crash, the possibility of injury or death is lessened if you are wearing your seat belt. The air bags can only provide the protection they were designed to afford if the occupants are using their seat belts (▷ page 77).

Warning!



According to accident statistics, children are safer when properly restrained in the rear seating positions than in the front seating position. Thus, we strongly recommend that children be placed in the rear seats. Regardless of seating position, children 12 years old and under must be seated and properly secured in an appropriate infant or toddler restraint, or booster seat recommended for the size and weight of the child. For additional information, see "Children in the vehicle" (▷ page 82).

A child's risk of serious or fatal injuries is significantly increased if the child restraints are not properly secured in the vehicle and/or the child is not properly secured in the child restraint.

Warning!



Never ride in a moving vehicle with the seat backrest in an excessively reclined position as this can be dangerous. You could slide under the seat belt in a collision. If you slide under it, the belt would apply force at the abdomen or neck. That could cause serious or even fatal injuries. The seat backrest and seat belt provide the best restraint when the wearer is in a nearly upright position and the belt is properly positioned on the body.

Warning!



Never let more people ride in the vehicle than there are seat belts available. Make sure everyone riding in the vehicle is correctly restrained with a separate seat belt. Never use a seat belt for more than one person at a time.

Warning!



Read and observe the additional warning notices printed in the “Safety and Security” section (▷ page 73) and (▷ page 77).



- ① Seat belt outlet
- ② Latch plate
- ③ Buckle
- ④ Release button

- ▶ With a smooth motion, pull the belt out of seat belt outlet ①.
- ▶ Place the shoulder portion of the belt across the top of your shoulder and the lap portion across your hips.
- ▶ Push latch plate ② into buckle ③ (▷ page 52) until it clicks.
- ▶ If necessary, tighten the lap portion to a snug fit by pulling shoulder portion up.

- ▶ Press release button ① and move the seat belt height adjuster upward or downward.

Proper use of seat belts

- Do not twist the belt when fastening.
 - Adjust seat belt so that the shoulder portion is located as close as possible to the middle of the shoulder (it should not touch the neck). Never pass the shoulder portion of the belt under your arm. For this purpose, you can adjust the height of the belt outlet (▷ page 53).
 - Position the lap belt as low as possible on your hips (over hip joint) and not across the abdomen.
 - Place the seat backrest in a nearly upright position.
- Never use a seat belt for more than one person at a time.
 - Do not fasten a seat belt around a person and another object at the same time. When using a seat belt to secure infant or toddler restraints or children in booster seats, always follow the child seat manufacturer's instructions.
 - Check your seat belt periodically during travel to make sure that it is properly positioned.
 - Make sure the seat belt is always fitted snugly. Take special care of this when wearing loose clothing.

Seat belt height adjustment



① Release button

Warning!



Do not pass belts over sharp edges. They could tear.

Do not allow the belt to get caught in the door or in the seat adjustment mechanism. This could damage the belt.

Never attempt to make modifications to seat belts. This could impair the effectiveness of the belts.

Do not bleach or dye seat belts as this may severely weaken them. In a crash, they may not be able to provide adequate protection.

Damaged seat belts or belts that were highly stressed in an accident must be replaced. Contact an authorized Mercedes-Benz Light Truck Center.

Starting the engine

Warning!



Inhalation of exhaust gas is hazardous to your health. All exhaust gas contains carbon monoxide (CO), and inhaling it can cause unconsciousness and possible death.

Do not run the engine in confined areas (such as a garage) which are not properly ventilated. If you think that exhaust gas fumes are entering the vehicle while driving, have the cause determined and corrected immediately. If you must drive under these conditions, drive only with at least one window fully open.

Automatic transmission



Gearshift pattern for automatic transmission

- P** Park position
- R** Reverse gear
- N** Neutral
- D** Drive position

For more information on how to operate the gear selector lever, see “Automatic transmission” (▷ page 185).

Starting with the SmartKey

For information on turning off the engine with the SmartKey, see “Turning off the engine” (▷ page 66).

Gasoline engine

- ▶ Make sure the automatic transmission is set to **P**.

The transmission position indicator in the multifunction display should be on **P** (▷ page 147).

- ▶ Do not depress the accelerator.
- ▶ Turn the SmartKey in the starter switch to position **3** (▷ page 39) and hold until the engine starts.

i You can also use the “touch-start” function. Turn the SmartKey to position **3** and release it again immediately. The engine then starts automatically.

Diesel engine

- ▶ Make sure the automatic transmission is set to **P**.

The transmission position indicator in the multifunction display should be on **P** (▷ page 147).

- ▶ Do not depress the accelerator.
- ▶ Turn the SmartKey in the starter switch to position **2** (▷ page 40).

Preglow indicator lamp  in the instrument cluster comes on.

- ▶ As soon as preglow indicator lamp  goes out, turn the SmartKey in the starter switch to position **3** (▷ page 40) and release it.

The engine starts automatically.

i If the engine is at operating temperature, preglow indicator lamp  may not stay on and you can start the engine without preglowing.

Starting with KEYLESS-GO*

Warning!



As long as the SmartKey with KEYLESS-GO is in your vehicle, the vehicle can be started. Therefore, never leave children unattended in the vehicle, as they could otherwise accidentally start the engine.

When leaving the vehicle, always take the SmartKey with KEYLESS-GO with you and lock the vehicle. Do not leave children unattended in the vehicle, or with access to an unlocked vehicle.

You can start your vehicle without the SmartKey in the starter switch using the KEYLESS-GO start/stop button in the starter switch.

The SmartKey with KEYLESS-GO must be located in the vehicle.



KEYLESS-GO start/stop button

- ① USA only
- ② Canada only

- ▶ Make sure KEYLESS-GO start/stop button ① is inserted in the starter switch (▷ page 41).

i If you wish to start the engine using the SmartKey instead of the KEYLESS-GO feature, remove the KEYLESS-GO start/stop button from the starter switch (▷ page 41).

For information on turning off the engine with KEYLESS-GO, see “Turning off with KEYLESS-GO*” (▷ page 67).

Gasoline engine

- ▶ Make sure the automatic transmission is set to **P**.

The transmission position indicator in the multifunction display should be on **P** (▷ page 147).

- ▶ Depress the brake pedal during the starting procedure.
- ▶ Do not depress the accelerator.
- ▶ Press KEYLESS-GO start/stop button ① once.

The engine starts if the SmartKey with KEYLESS-GO is in the vehicle.

Diesel engine

- ▶ Make sure the automatic transmission is set to **P**.

The transmission position indicator in the multifunction display should be on **P**.

- ▶ Depress the brake pedal during the starting procedure.
- ▶ Do not depress the accelerator.
- ▶ Press KEYLESS-GO start / stop button ① once.

The engine preglows and starts if the SmartKey with KEYLESS-GO is in the vehicle.

i If the engine is at operating temperature, the time the engine needs to preglow is reduced.

Starting difficulties

If the engine does not start as described, carry out the following steps:

- ▶ If you are starting the engine with the SmartKey, turn SmartKey in starter switch to position **0** and repeat starting procedure.
 - ▶ If you are starting the engine with KEYLESS-GO*: Close any doors that may be open to allow for better detection of the SmartKey with KEYLESS-GO*.
- Or:
- ▶ Remove KEYLESS-GO* start/stop button from starter switch (▷ page 41).
 - ▶ Start the engine with the SmartKey as radio signals from another source may be interfering with the SmartKey with KEYLESS-GO*.
 - ▶ Repeat the starting procedure (▷ page 54). Remember that extended starting attempts can drain the battery.

- ▶ Get a jump start (▷ page 515).

If the engine does not start after several starting attempts, there could be a malfunction in the engine electronics or in the fuel supply system.

- ▶ Notify an authorized Mercedes-Benz Light Truck Center.

Parking brake

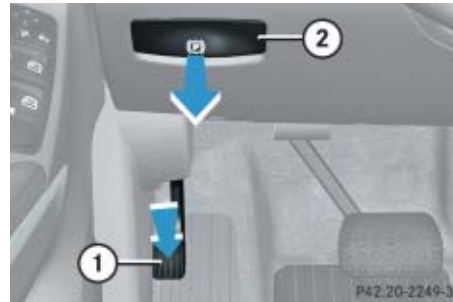

- ① Parking brake pedal
- ② Release handle

Warning!



When leaving the vehicle, always remove the SmartKey or SmartKey with KEYLESS-GO* from the starter switch, take it with you and lock the vehicle. Do not leave children unattended in the vehicle, or with access to an unlocked vehicle. Children could release the parking brake, which could result in an accident and/or serious injury.

- ▶ Release the parking brake by pulling on release handle ②.
- The warning lamp **BRAKE** (USA only) or **(P)** (Canada only) in the instrument cluster goes out.

Driving

Driving off

- ▶ Depress the brake pedal.

The gear selector lever can now be used.

- ▶ Shift automatic transmission to **D** or **R** (▷ page 187).

i Wait for the gear selection process to complete before setting the vehicle in motion.

i Shifting from gear position **P** to position **R**, **N**, or **D** is only possible with the brake pedal depressed. Without the brake pedal depressed, the gear selector lever can be moved, but the parking pawl remains engaged, not allowing shifting to occur.

- ▶ Release the brake pedal.
- ▶ Carefully depress the accelerator pedal.

! If you hear a warning signal and the message **Release parking brake** appears in the multifunction display when driving off, you have forgotten to release the parking brake.

Release the parking brake (▷ page 57).

i Once the vehicle is in motion, the automatic central locking system engages and the locking knobs drop down.

The automatic door lock feature can be deactivated (▷ page 176).

You can open a locked door from the inside. Open door only when conditions are safe to do so.

After a cold start, the automatic transmission shifts at a higher engine revolution. This allows the catalytic converter (gasoline engine) or the oxidation catalyst (diesel engine) to reach its operating temperature earlier.

Warning!



On slippery road surfaces, never downshift in order to obtain braking action. This could result in drive wheel slip and reduced vehicle control. Your vehicle's ABS will not prevent this type of loss of control.

Warning!



It is dangerous to shift the automatic transmission out of **P** or **N** if the engine speed is higher than idle speed. If your foot is not firmly on the brake pedal, the vehicle could accelerate quickly forward or in reverse. You could lose control of the vehicle and hit someone or something. Only shift into gear when the engine is idling normally and when your right foot is firmly on the brake pedal.

! Shift the automatic transmission to position **P** or **R** only when the vehicle is stopped in order to avoid damaging the transmission.

! Do not run cold engine at high engine speeds. Running a cold engine at high engine speeds may shorten the service life of the engine.

ML 63 AMG:

At engine temperatures below 68°F (20°C), the engine's maximum speed is restricted in order to protect it from damage. Avoid driving your vehicle at full speed when the engine is cold to prevent premature engine wear and/or diminished comfort.

! Simultaneously depressing the accelerator pedal and applying the brake reduces engine performance and causes premature brake and drivetrain wear.

For more information, see “Driving instructions” (▷ page 325).

For information on off-road driving, see “Off-road driving” (▷ page 333).

Switching on headlamps

Low beam headlamps

The exterior lamp switch is located on the dashboard to the left of the steering wheel.



Exterior lamp switch

- ① Off
- ② Low beam headlamps on
- ▶ Turn the exterior lamp switch to position .
 - The low beam headlamps come on.

High beam

The combination switch is located on the left of the steering column.



Combination switch

- ① High beam
- ② High beam flasher

- ▶ Push the combination switch in direction of arrow ①.

The high beam headlamp indicator lamp  in the instrument cluster comes on (▷ page 26).

For more information on headlamps, see “Lighting” (▷ page 136).

Driving

Turn signals

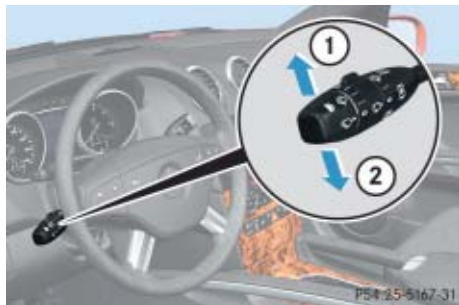

The combination switch is located on the left of the steering column.



Combination switch

- ① Turn signals, right
- ② Turn signals, left

- ▶ Press the combination switch in direction of arrow ① or ②.

The corresponding turn signal indicator lamp  or  in the instrument cluster flashes (▷ page 26).

The combination switch resets automatically after major steering wheel movement.

i If the combination switch is pressed to point of resistance and released, the corresponding turn signal will flash three times.

Windshield wipers

The combination switch is located on the left of the steering column.



Combination switch



- ① Single wipe
Wiping with windshield washer fluid
- ② Switching on windshield wipers

- ▶ Switch on the ignition (▷ page 40).





! Do not operate the windshield wipers when the windshield is dry. Dust that accumulates on a windshield might scratch the glass and/or damage the wiper blades when wiping occurs on a dry windshield. If it is necessary to operate the windshield wipers in dry weather conditions, always operate the windshield wipers with windshield washer fluid (▷ page 62).

! If anything blocks the windshield wipers (leaves, snow, etc.), switch them off immediately.

- For safety reasons, stop the vehicle in a safe location and
 - remove SmartKey from starter switchor
 - turn off the engine by pressing the KEYLESS-GO* start/stop button and open the driver's door (with the driver's door open, starter switch is in position 0, same as with SmartKey removed from starter switch) before attempting to remove any blockage.

- Remove blockage.
 - Turn the windshield wipers on again.
- If windshield wipers fail to function at all in combination switch position  or ,
- set the combination switch to the next higher wiper speed
 - have the windshield wipers checked at the nearest authorized Mercedes-Benz Light Truck Center

Switching on windshield wipers

- ▶ Turn the combination switch to the desired position depending on the intensity of the rain.
 -  Windshield wipers off
 -  Slow intermittent wiping
Rain sensor operation with low sensitivity.
 -  Fast intermittent wiping
Rain sensor operation with high sensitivity.
 -  Slow continuous wiping
 -  Fast continuous wiping



Intermittent wiping

Only switch on intermittent wiping under wet weather conditions or in the presence of precipitation.

When you select intermittent wiping, the rain sensor is activated. The rain sensor automatically sets a suitable wiping interval depending on the wetness of the sensor surface.

 Do not leave windshield wipers in intermittent setting when the vehicle is taken to an automatic car wash or during windshield cleaning. Wipers will operate in the presence of water sprayed on the windshield, and windshield wipers may be damaged as a result.

 If you have set intermittent wiping, dirt on the surface of the rain sensor or optical effects may cause the windshield wipers to wipe in an undesired fashion. This could then damage the windshield wiper blades or scratch the windows. You should therefore switch off the windshield wipers when weather conditions are dry.

- ▶ Turn the combination switch to position  or .

After the initial wipe, pauses between wipes are automatically controlled by the rain sensor.

 Intermittent wiping is interrupted when the vehicle is at a standstill and a front door is opened. This protects persons getting into or out of the vehicle from being sprayed.

Intermittent wiping will be continued when

- all doors are closed
and
- the automatic transmission is set to position **D** or **R**
or
- the wiper setting is changed using the combination switch

Single wipe

- ▶ Press the combination switch briefly in direction of arrow  to the resistance point.

The windshield wipers wipe one time without washer fluid.

Driving

Wiping with windshield washer fluid

- ▶ Press the combination switch in direction of arrow ① past the resistance point.

The windshield wipers operate with washer fluid.

i To prevent smears on the windshield, wipe with windshield washer fluid every now and then even when it is raining.

For information on filling up the washer reservoir, see “Windshield/rear window washer system and headlamp cleaning system*” (▷ page 363).

Rear window wiper/washer

The combination switch is located on the left of the steering column.

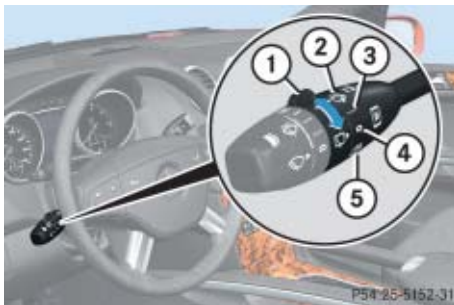

Combination switch

- ① Rear window wiper switch
- ② Wiping rear window with washer fluid
- ③ Intermittent wiping
- ④ Rear window wiper off
- ⑤ Wiping rear window with washer fluid



⑥ Rear window wiper indicator

- ▶ Switch on the ignition (▷ page 40).

i The rear window wiper engages automatically when the automatic transmission is shifted to position **R** with the windshield wipers switched on.

Activating intermittent wipe

- ▶ Turn rear window wiper switch ① to position ③ (▷ page 62).

In the lower multifunction display you will see indicator ⑥, indicating that the rear window wiper is activated.

Deactivating intermittent wipe

- ▶ Turn rear window wiper switch ① to position ④ (▷ page 62).

Indicator ⑥ for the rear window wiper is cleared from the lower multifunction display, indicating that the rear window wiper is deactivated.

Wiping with windshield washer fluid

- ▶ Turn and hold rear window wiper switch ① in position ② or ⑤ (▷ page 62) until the rear window is clean.

The rear window wiper operates with washer fluid.

For information on filling up the washer reservoir, see “Windshield/rear window washer system and headlamp cleaning system*” (▷ page 363).

Problems while driving

The engine runs erratically and misfires

- An ignition cable may be damaged (gasoline engine only).
 - The engine electronics may not be operating properly.
 - Unburned gasoline may have entered the catalytic converter and damaged it (gasoline engine only).
- ▶ Give very little gas.
 - ▶ Have the problem repaired by an authorized Mercedes-Benz Light Truck Center as soon as possible.

The coolant temperature is above 248°F (120°C)

The coolant is too hot and is no longer cooling the engine.

- ▶ Stop the vehicle in a safe location as soon as possible and turn off the engine. Allow engine and coolant to cool off.
- ▶ Check the coolant level and add coolant if necessary (▷ page 362).

Driving

In case of accident

If the vehicle is leaking fuel:

- ▶ Do not start the engine under any circumstances.
- ▶ Notify local fire and/or police authorities.

If the extent of the damage cannot be determined:

- ▶ Notify an authorized Mercedes-Benz Light Truck Center.

If no damage can be determined on the

- major assemblies
 - fuel system
 - engine mount:
- ▶ Start the engine in the usual manner.

▼ Parking and locking

You have now completed your first drive. You have properly stopped and parked your vehicle. End your drive as follows.

Warning!



With the engine not running, there is no power assistance for the brake and the steering system. In this case, it is important to keep in mind that a considerably higher degree of effort is necessary to brake and steer the vehicle.

Warning!



Do not park this vehicle in areas where combustible materials such as grass, hay or leaves can come into contact with the hot exhaust system, as these materials could be ignited and cause a vehicle fire.

To reduce the risk of personal injury, or damage to the vehicle drivetrain, as a result of vehicle movement, before turning off the engine and leaving the vehicle always:

- Keep right foot on brake pedal.
- Firmly depress parking brake pedal.
- Shift the automatic transmission to position **P**.
- Slowly release brake pedal.
- When parked on an incline, turn front wheel towards the road curb.
- Turn the SmartKey in the starter switch to position **0** and remove the SmartKey from the starter switch, or press the start/stop button (vehicles with KEYLESS-GO*).
- Take the SmartKey or the SmartKey with KEYLESS-GO* and lock vehicle when leaving.

Parking brake

Warning!



Engaging the parking brake while the vehicle is in motion can cause the rear wheels to lock up. You could lose control of the vehicle and cause an accident. In addition, the vehicle's brake lights do not light up when the parking brake is engaged. Make sure not to endanger any other road users when you engage the parking brake.

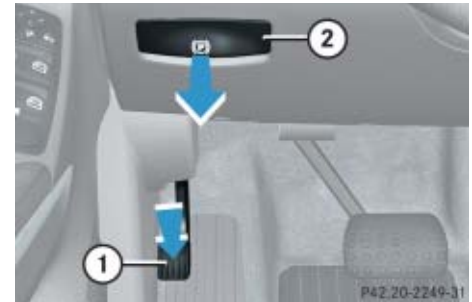

- ① Parking brake pedal
- ② Release handle

Parking and locking

- ▶ Step firmly on parking brake pedal ①.

When the engine is running, the warning lamp **BRAKE** (USA only) or  (Canada only) in the instrument cluster comes on.

Warning!



When leaving the vehicle, always remove the SmartKey or SmartKey with KEYLESS-GO* from the starter switch, take it with you and lock the vehicle. Do not leave children unattended in the vehicle, or with access to an unlocked vehicle. Children could release the parking brake and/or shift the automatic transmission out of position **P**, either of which could result in an accident and/or serious personal injury.

Warning!



Getting out of your vehicle with the automatic transmission not fully engaged in position **P** is dangerous. Also, when parked on an incline, position **P** alone may not prevent your vehicle from moving, possibly hitting people or objects.

Always set the parking brake in addition to shifting to position **P** (▷ page 187).

When parked on an incline, also turn front wheel towards the road curb.

Switching off headlamps

- ▶ Turn the exterior lamp switch to  (▷ page 59).

For more information, see “Lighting” (▷ page 136).

Turning off the engine

 If the engine cannot be turned off as described, see “Emergency engine shut-down” (▷ page 525).

- ▶ Shift the automatic transmission to position **P** (▷ page 187).

Warning!



Do not turn off the engine before the vehicle has come to a complete stop. With the engine not running, there is no power assistance for the brake and steering systems. In this case, it is important to keep in mind that a considerably higher degree of effort is necessary to brake and steer the vehicle.

- ▶ Apply the parking brake (▷ page 65).

 Always set the parking brake in addition to shifting the automatic transmission to position **P** (▷ page 187).

When parked on an incline, also turn front wheel towards the road curb.

Turning off with the SmartKey

- ▶ Turn the SmartKey in the starter switch to position **0** (▷ page 39).
- ▶ Remove the SmartKey from the starter switch.

The immobilizer is activated.

i If you turn off the engine using the SmartKey and remove the SmartKey from the starter switch with the transmission in a position other than **P**, the transmission will automatically shift to **P**.

Keep in mind that turning off the engine with the SmartKey alone will not automatically shift the transmission to **P**. Only when the SmartKey is removed from the starter switch will the transmission automatically shift to **P**.

Turning off with KEYLESS-GO*

- ▶ Press the KEYLESS-GO start/stop button (▷ page 41) to turn off the engine.

With the driver's door closed, the starter switch is now in position **1**. With the driver's door opened, the starter switch is set to position **0**, same as SmartKey removed from starter switch (▷ page 39).

i You can turn off the engine while driving by pressing and holding the KEYLESS-GO start/stop button for approximately 3 seconds.

i If you turn off the engine using the KEYLESS-GO start/stop button and open the driver's door with the transmission in a position other than **P**, the transmission will automatically shift to **P**.

Keep in mind that turning off the engine with the KEYLESS-GO start/stop button alone will not automatically shift the transmission to **P**. Only when the driver's door is opened will the transmission automatically shift to **P**.

Releasing seat belts

- ▶ Press the seat belt release button (▷ page 52).

Allow the retractor to completely rewind the seat belt by guiding the latch plate.

! Make sure the seat belt retracts fully so that the seat belt and/or latch plate cannot get caught or pinched in the door or in the seat mechanism. This can damage the seat belt and impair the effectiveness of the seat belt, and/or cause damage to the door and/or door trim panel. Such damage is not covered by the Mercedes-Benz Limited Warranty.

Damaged seat belts must be replaced. Contact an authorized Mercedes-Benz Light Truck Center.

Parking and locking

Locking

Warning!



To prevent possible personal injury, always keep hands and fingers away from the door openings when closing the doors. Be especially careful when small children are around.

Before closing doors, make sure there is no possibility of someone getting caught in a door during closing.

Warning!



When leaving the vehicle, always remove the SmartKey from the starter switch, take the SmartKey with KEYLESS-GO* with you, and lock your vehicle. Do not leave children unattended in the vehicle, or with access to an unlocked vehicle. Unsupervised use of vehicle equipment may cause an accident and/or serious personal injury.

- ▶ Exit the vehicle and close all doors and the tailgate.

i If you hear a warning signal you have forgotten to switch off the headlamps before opening the driver's door.

In addition the message Switch off lights appears in the multifunction display.

Switch off the headlamps.

Locking with the SmartKey

- ▶ Press lock button  on the SmartKey (▷ page 38).

With the tailgate and all doors closed, the turn signal lamps flash three times. The locking knobs on the doors move down. The anti-theft alarm system is armed.

For more information, see “Locking and unlocking” (▷ page 108).

Locking with KEYLESS-GO*



- ① Lock button on the outside door handle
- ▶ Press lock button ① on an outside door handle.

With the tailgate and all doors closed, the turn signal lamps flash three times. The locking knobs on the doors move down. The anti-theft alarm system is armed.

For more information, see “Locking and unlocking” (▷ page 108).

Occupant safety

Panic alarm

Driving safety systems

Anti-theft systems



Occupant safety

In this section you will learn the most important facts about the restraint systems of the vehicle.

The restraint systems are

- Seat belts (▷ page 77)
- Child restraints (▷ page 92)
- Lower Anchors and Tethers for Children (LATCH) (▷ page 91)

Additional protection potential provide

- Supplemental Restraint System (SRS) with
 - Air bags (▷ page 71)
 - Air bag control unit (with crash sensors)
 - Emergency Tensioning Device (ETD) for seat belts (▷ page 80)
- Active head restraints (▷ page 80)

Air bag system components with

- Front passenger front air bag off indicator lamp (▷ page 89)
- Front passenger seat with Occupant Classification System (OCS) (▷ page 85)

Although independent systems, their protective functions work in conjunction with each other.

 *For information on infants and children traveling with you in the vehicle and restraint systems for infants and children, see “Children in the vehicle” (▷ page 82).*

The SRS system conducts a self-test when the ignition is switched on and in regular intervals while the engine is running. This facilitates early detection of malfunctions. The **SRS** indicator lamp in the instrument cluster (▷ page 26) comes on when the ignition is switched on and goes out no later than a few seconds after the engine was started.

The SRS components are in operational readiness if the **SRS** indicator lamp is not lit when the engine is running.

A malfunction in the system has been detected if the **SRS** indicator lamp:

- fails to go out not later than approximately 4 seconds after the engine was started
- does not come on at all
- comes on after the engine was started or while driving

Warning!



Modifications to or work improperly conducted on restraint systems (such as seat belts and anchors, emergency tensioning devices, seat belt force limiters or air bags) or their wiring, as well as tampering with interconnected electronic systems, can lead to the restraint systems no longer functioning as intended.

Air bags or emergency tensioning devices, for example, could deploy inadvertently or fail to deploy in accidents although the deceleration threshold for air bag deployment is exceeded. Therefore, never modify the restraint systems. Do not tamper with electronic components or their software.

Warning!



In the event that the **SRS** indicator lamp comes on during driving or does not come on at all, the SRS self-check has detected a malfunction. For your safety, we strongly recommend that you visit an authorized Mercedes-Benz Light Truck Center immediately to have the system checked; otherwise the SRS may not deploy when needed in an accident, which could result in serious or fatal injury, or it might deploy unexpectedly and unnecessarily which could also result in injury.

In addition, improper work on the SRS creates a risk of rendering the SRS inoperative or causing unintended air bag deployment. Work on the SRS must therefore only be performed by qualified technicians. Contact an authorized Mercedes-Benz Light Truck Center.

If it is necessary to modify an air bag system to accommodate a person with disabilities, contact a local authorized Mercedes-Benz Light Truck Center or call our Customer Assistance Center at 1-800-FOR-MERCEdes (1-800-367-6372) for details.

Air bags

Warning!



Air bags are designed to reduce the potential of injury and fatality in certain frontal impacts (front air bags), side impacts (side impact air bags* and head protection window curtain air bags) or rollovers (head protection window curtain air bags). However, no system available today can totally eliminate injuries and fatalities.

The deployment of the air bags temporarily releases a small amount of dust from the air bags. This dust, however, is neither injurious to your health, nor does it indicate a fire in the vehicle. The dust might cause some temporary breathing difficulty for people with asthma or other breathing trouble. To avoid this, you may wish to get out of the vehicle as soon as it is safe to do so. If you have any breathing difficulty but cannot get out of the vehicle after the air bag inflates, then get fresh air by opening a window or door.

Occupant safety

Warning!



To reduce the risk of injury when the front air bags inflate, it is very important for the driver and front passenger to always be in a properly seated position and to wear their respective seat belt.

For maximum protection in the event of a collision always be in normal seated position with your back against the seat backrest. Fasten your seat belt and make sure it is properly positioned on your body (▷ page 51).

Since the air bag inflates with considerable speed and force, a proper seating and hands on steering wheel position will help to keep you at a safe distance from the air bag. Occupants who are unbelted, out of position or too close to the air bag can be seriously injured or killed by an air bag as it inflates with great force in the blink of an eye:

- Sit properly belted in a nearly upright position with your back against the seat backrest.

- Adjust the driver's seat as far as possible rearward, still permitting proper operation of vehicle controls. The distance from the center of the driver's breastbone to the center of the air bag cover on the steering wheel must be at least 10 inches (25 cm) or more. You should be able to accomplish this by a combination of adjustments to the seat and steering wheel. If you have any problems, please see an authorized Mercedes-Benz Light Truck Center.
- Do not lean your head or chest close to the steering wheel or dashboard.
- Keep hands on the outside of steering wheel rim. Placing hands and arms inside the rim can increase the risk and potential severity of hand/arm injury when driver's front air bag inflates.
- Adjust the front passenger seat as far as possible rearward from the dashboard when the seat is occupied.

- Always sit nearly upright, properly use the seat belts and use an appropriately sized infant or toddler restraint or booster seat recommended for the size and weight of the child.

Failure to follow these instructions can result in severe injuries to you or other occupants.

If you sell your vehicle, it is important that you make the buyer aware of this safety information. Be sure to give the buyer this Operator's Manual.

Warning!



Accident research shows that the safest place for children in an automobile is in the rear seat.

It should be noted that with respect to both, front side impact air bags or the rear side impact air bags*, there is a possibility for a side impact air bag related injury if occupants, especially children, are not properly seated or restrained when next to a side impact air bag which needs to deploy rapidly in a side impact in order to do its job.

To help avoid the possibility of injury, please follow these guidelines:

(1) Always sit nearly upright, properly use the seat belts and for children 12 years old and under, use an appropriately sized infant or toddler restraint or booster seat recommended for the size and weight of the child.

(2) Always wear seat belts properly.

Please contact your local authorized Mercedes-Benz Light Truck Center or call our Customer Assistance Center at 1-800-FOR-MERCEdes (1-800-367-6372) for details.

i *Air bags are designed to deploy only in certain frontal impacts (front air bags), and in side impacts (side impact and head protection window curtain air bags) which exceed preset thresholds, and in certain rollovers (head protection window curtain air bags). Only during these events will they provide their supplemental protection.*

The driver and passengers should always wear their seat belts. Otherwise it is not possible for air bags to provide their supplemental protection.

In case of other types of impacts and impacts below air bag deployment thresholds, air bags will not deploy. The driver and passenger will then be protected to the extent possible by a properly fastened seat belt. A properly fastened seat belt is also needed to provide the best possible protection in a rollover.

We caution you not to rely on the presence of the air bags in order to avoid wearing your seat belt.

It is important to your safety and that of your passengers that you replace deployed air bags and repair any malfunctioning air bags to make sure the vehicle will continue to provide supplemental crash protection for occupants.

Safety guidelines for the seat belt, emergency tensioning device and air bag

Warning!



- Damaged seat belts or belts that were highly stressed in an accident must be replaced and their anchoring points must also be checked. Only use belts installed or supplied by an authorized Mercedes-Benz Light Truck Center.
- Air bags and pyrotechnic emergency tensioning devices (ETDs) are designed to function on a one-time-only basis. An air bag or ETD that is deployed must be replaced.
- Do not pass belts over sharp edges. They could tear.
- Do not make any modification that could change the effectiveness of the belts. >>

Occupant safety



- Do not bleach or dye seat belts as this may severely weaken them. In a crash they may not be able to provide adequate protection.
- No modifications of any kind may be made to any components or wiring of the SRS. This includes changing or removing any component or part of the SRS, the installation of additional trim material, badges, etc. over the steering wheel hub, front passenger front air bag cover, outboard sides of the seat backrests, door trim panels, or door frame trims, and installation of additional electrical/electronic equipment on or near SRS components and wiring. Keep area between air bags and occupants free from objects (e.g. packages, purses, umbrellas, etc.).
- Do not hang items such as coat hangers from the coat hooks or handles over the door. These items may turn into projectiles and cause head and other injuries when window curtain air bag is deployed.

- Air bag system components will be hot after an air bag has inflated. Do not touch.
- Never place your feet on the instrument panel, dashboard, or on the seat. Always keep both feet on the floor in front of the seat.
- In addition, improper repair work on the SRS creates a risk of rendering the SRS inoperative or causing unintended air bag deployment. Work on the SRS must therefore only be performed by qualified technicians. Contact an authorized Mercedes-Benz Light Truck Center.
- For your protection and the protection of others, when scrapping the air bag unit or emergency tensioning device, our safety instructions must be followed. These instructions are available from your authorized Mercedes-Benz Light Truck Center.

- Given the considerable deployment speed, required inflation volume, and the textile structure of the air bags, there is the possibility of abrasions or other potentially more serious injuries resulting from air bag deployment.

Warning!



Only use seat covers which have been tested and approved by Mercedes-Benz for your vehicle model. Using other seat covers may interfere with or prevent the deployment of the front side impact air bags or the rear side impact air bags*. Contact an authorized Mercedes-Benz Light Truck Center for availability.

When you sell your vehicle we strongly urge you to give notice to the subsequent owner that it is equipped with an SRS by alerting them to the applicable section in the Operator's Manual.

Front air bags

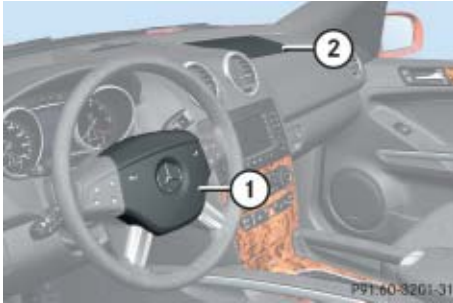

- ① Driver air bag
- ② Passenger air bag

Driver and front passenger front air bags are deployed:

- in the event of certain frontal impacts
- if impact exceeds a preset deployment threshold
- independently of the side impact air bags

i *The front air bags in this vehicle have been designed to inflate in two stages. This allows the air bag to have different rates of inflation that are based on the rate of relevant vehicle deceleration as assessed by the air bag control unit.*

On the front passenger-side, the front air bag deployment is additionally influenced by the passenger's weight category as identified by the Occupant Classification System (OCS) (▷ page 85).

The lighter the front passenger side occupant, the higher the vehicle deceleration rate required for the second stage inflation of the air bag.

The air bags will not deploy in impacts which do not exceed the system's deployment thresholds. You will then be protected by the fastened seat belts.

The passenger front air bag will only be deployed if:

- the system, based on OCS weight sensor readings, senses that the front passenger seat is occupied
- the  **PASS AIR BAG OFF** indicator lamp in the center console is not lit (▷ page 89)
- the impact exceeds a preset deployment threshold

Occupant safety

Side impact air bags, window curtain air bags

Warning!



The pressure sensors for side impact air bag control are located in the doors. Do not modify any components of the doors or door trim panels including, for example, the addition of door speakers.

Improper repair work on the doors or the modification or addition of components to the doors create a risk of rendering the side impact air bags inoperative or causing unintended air bag deployment. Work on the doors must therefore only be performed by qualified technicians. Contact an authorized Mercedes-Benz Light Truck Center.

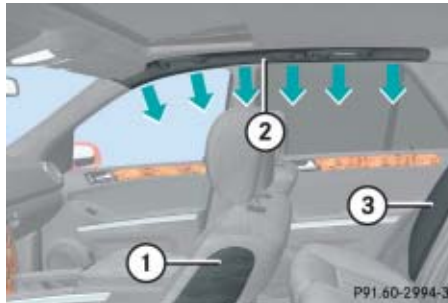

- ① Front side impact air bag
- ② Window curtain air bag
- ③ Rear side impact air bag*

The side impact air bags and window curtain air bags are deployed:

- on the impacted side of the vehicle
- in impacts exceeding a preset deployment threshold
- independently of the front air bags

In addition, the window curtain air bags ② are deployed in certain vehicle rollovers.

The front passenger side impact air bag will not deploy if the OCS senses that the front passenger seat is empty and the front passenger seat belt is not fastened (latch plate is not inserted into the buckle). With an empty front passenger seat and the seat belt fastened (latch plate properly inserted into buckle) the front passenger side impact air bag will deploy independently of the empty seat.

The side impact air bags and window curtain air bags are not deployed in impacts which do not exceed the system's deployment threshold.

Seat belts

Always wear your seat belt. All vehicle occupants always need to have their seat belts fastened and wear them properly.

In addition, applicable motor vehicle safety laws require you to wear seat belts. Even where this is not the case, we strongly recommend that all vehicle occupants have their seat belts fastened and wear them properly.

For more information, see “Fastening the seat belts” (▷ page 51).

i *For information on infants and children traveling with you in the vehicle and restraint systems for infants and children, see “Children in the vehicle” (▷ page 82).*

Warning!



Always fasten your seat belt before driving off. Always make sure all of your passengers are properly restrained, even those sitting in the rear and pregnant women.

Failure to wear and properly fasten and position your seat belt greatly increases your risk of injuries and their likely severity in an accident. You and your passengers should always wear seat belts.

If you are ever in an accident, your injuries can be considerably more severe without your seat belt properly buckled. Without your seat belt buckled, you are much more likely to hit the interior of the vehicle or be ejected from it. You can be seriously injured or killed.

In the same crash, the possibility of injury or death is lessened if you are properly wearing your seat belt. Air bags can only protect as they are designed if the occupants are properly wearing their seat belts.

Warning!



Never ride in a moving vehicle with the seat backrest in an excessively reclined position as this can be dangerous. You could slide under the seat belt in a collision. If you slide under it, the belt would apply force at the abdomen or neck. That could cause serious or even fatal injuries. The seat backrest and seat belt provide the best restraint when the wearer is in a nearly upright position and the belt is properly positioned on the body.

Warning!



Never let more people ride in the vehicle than there are seat belts available. Make sure everyone riding in the vehicle is correctly restrained with a separate seat belt. Never use a seat belt for more than one person at a time.

Occupant safety

Warning!



Damaged seat belts or belts that were highly stressed in an accident must be replaced and their anchoring points must also be checked.

Only use seat belts which have been approved by Mercedes-Benz.

Do not make any modifications to the seat belts. This can lead to unintended activation of the ETDs or to failure.

Do not bleach or dye seat belts as this may severely weaken them. In a crash they may not be able to provide adequate protection.

Have all work carried out only by qualified technicians. Contact an authorized Mercedes-Benz Light Truck Center.

Warning!



USE SEAT BELTS PROPERLY

- Seat belts can only work when used properly. Never wear seat belts in any other way than as described in this section, as that could result in serious injuries in case of an accident.
- Each occupant should wear their seat belt at all times, because seat belts help reduce the likelihood of and potential severity of injuries in accidents, including rollovers. The integrated restraint system includes SRS (driver air bag, passenger front air bag, side impact air bags, head protection window curtain air bags for side windows), ETD (seat belt emergency tensioning device), and front seat knee bolsters. The system is designed to enhance the protection offered to properly belted occupants in certain frontal (front air bags and ETD) and side (side impact, window curtain air bags and ETD) impacts which exceed preset deployment thresholds and in

certain rollovers (window curtain air bags and ETD).

- Never wear the shoulder belt under your arm, against your neck or off your shoulder. In a frontal crash, your body would move too far forward. That would increase the chance of head and neck injuries. The belt would also apply too much force to the ribs or abdomen, which could severely injure internal organs such as your liver or spleen.
- Never wear belts over rigid or breakable objects in or on your clothing, such as eyeglasses, pens, SmartKeys, etc., as these might cause injuries.
- Position the lap belt as low as possible on your hips and not across the abdomen. If the belt is positioned across your abdomen, it could cause serious injuries in a crash.



- Never use a seat belt for more than one person at a time. Do not fasten a seat belt around a person and another person or other objects.
- Belts should not be worn twisted. In a crash, you would not have the full width of the belt to distribute impact forces. The twisted belt against your body could cause injuries.
- Pregnant women should also use a lap-shoulder belt. The lap belt portion should be positioned as low as possible on the hips to avoid any possible pressure on the abdomen.
- Never place your feet on the instrument panel, dashboard or on the seat. Always keep both feet on the floor in front of the seat.
- When using a seat belt to secure infant or toddler restraints or children in booster seats, always follow the child seat manufacturer's instructions.

Enhanced seat belt reminder system

When the engine is started, the seat belt telltale  will always illuminate for 6 seconds to remind you and your passengers to fasten your seat belts.

If the driver's seat belt is not fastened when the engine is started, an additional warning chime will also sound for a maximum of 6 seconds or until the driver's seat belt is fastened.

If after these 6 seconds the driver's or the front passenger's seat belt (with the front passenger seat occupied) is not fastened with front doors closed,

- the seat belt telltale  remains illuminated for as long as either the driver's or front passenger's seat belt is not fastened
- and if the vehicle speed once exceeds 15 mph (25 km/h), the seat belt telltale  starts flashing and a warning chime sounds with increasing

intensity for a maximum of 60 seconds or until the driver's and the front passenger's seat belt are fastened.

If the driver's or the front passenger's seat belt remains unfastened after 60 seconds, the warning chime stops sounding, the seat belt telltale  stops flashing but continues to be illuminated.

The seat belt telltale  will only go out if both the driver's and the front passenger's seat belt (with the front passenger seat occupied) are fastened, or the vehicle is standing still and a front door is opened.

For more information, see "Practical hints" (> page 421).

Occupant safety

Emergency Tensioning Device (ETD), seat belt force limiter

Depending on vehicle production date, the seat belts for the front and rear or rear outer seats are equipped with emergency tensioning devices and belt force limiters.

The ETD is designed to activate in the following cases:

- in frontal or rear-end impacts exceeding the system deployment threshold
- in certain vehicle rollovers
- if the restraint systems are operational and functioning correctly, see **SRS** indicator lamp (▷ page 423)

i *The ETDs for the front seats will only activate if the respective front seat belt is fastened (latch plate properly inserted into buckle).*

The ETDs for the rear or rear outer seats (depending on vehicle production date) will activate with or without the respective seat belt fastened.

In an impact, emergency tensioning devices remove slack from the belts in such a way that the seat belts fit more snugly against the body. Belt force limiters, when activated, are employed to help reduce the peak force exerted by the seat belts on occupants during a crash.

Warning!



A pyrotechnic emergency tensioning device (ETD) that was activated must be replaced.

When disposing of the pyrotechnic emergency tensioning device, our safety instructions must be followed. These are available at your authorized Mercedes-Benz Light Truck Center.

Active head restraint

The active head restraints are intended to offer the driver and front passenger increased protection from whiplash type injuries. In the event of a rear-end collision, the active head restraints on the driver's and front passenger's seats are designed to move forward in the direction of travel, providing the head with increased support earlier on in the collision sequence. The active head restraints move forward whether the seat is occupied or not.

Warning!



Only use seat or head restraint covers which have been tested and approved by Mercedes-Benz for your vehicle model. Using other seat or head restraint covers may interfere with or prevent the activation of the active head restraint. Contact an authorized Mercedes-Benz Light Truck Center for availability.

Do not attach any objects (e.g. hangers) to the head restraints posts. Otherwise, the active head restraints may not be able to function properly or offer the intended degree of protection in the event of an accident.

Warning!

For your protection, drive only with properly positioned head restraints.

Adjust head restraint so that it is as close to the head as possible and the center of the head restraint supports the back of the head at eye level. This will reduce the potential for injury to the head and neck in the event of an accident or similar situation.

You cannot remove the active head restraint on the driver's and front passenger's seats.

For removal of the active head restraints we recommend that you contact an authorized Mercedes-Benz Light Truck Center.

For information on head restraint adjustment, see "Seats" (▷ page 43).

For information on resetting the activated active head restraints, see "Resetting activated head restraints" (▷ page 479).

Rear head restraints**Warning!**

Do not drive the vehicle without the seat head restraints installed when the rear seats are occupied. Head restraints are intended to help reduce injuries during an accident.

With a rear seat occupied, make sure to move the respective head restraint up from the lowest non-use position and have the occupant adjust the head restraint properly.

For your protection, drive only with properly positioned head restraints.

Adjust the head restraint in such a way that it is as close to the head as possible and the head restraint supports the back of the head at eye level. This will reduce the potential for injury to the head and neck in the event of an accident or similar situation.

Occupant safety

Children in the vehicle

If an infant or child is traveling with you in the vehicle:

- Secure the child using an infant or child restraint appropriate to the age and size of the child.
- Make sure the infant or child is properly secured at all times while the vehicle is in motion.

Warning!



Do not leave children unattended in the vehicle, even if they are secured in a child restraint system. The children could

- injure themselves on parts of the vehicle
- be seriously or fatally injured through excessive exposure to extreme heat or cold

Do not expose the child restraint system to direct sunlight. The child restraint system's metal parts, for example, could become very hot, and the child could be turned on these parts.

If children open a door, they could

- injure other persons
- get out of the car and injure themselves or be injured by following traffic

Do not carry heavy or hard objects in the passenger or cargo compartment unless they are firmly secured in place. For more information, see “Loading” (▷ page 281) and “Useful features” (▷ page 294).

Unsecured or improperly positioned cargo increases a child's risk of injury in the event of

- strong braking maneuvers
- sudden changes of direction
- an accident

Infant and child restraint systems

We recommend all infants and children be properly restrained at all times while the vehicle is in motion.

All lap-shoulder belts except the driver's seat belt have special seat belt retractors for secure fastening of child restraints.

To fasten a child restraint, follow child restraint instructions for mounting. Then pull the shoulder belt out completely and let it retract. During seat belt retraction, a ratcheting sound can be heard to indicate that the special seat belt retractor is activated. The belt is now locked. Push down on child restraint to take up any slack.

To deactivate, release seat belt buckle and let seat belt retract completely. To deactivate the special seat belt retractor for the front passenger seat, the front passenger seat must be in the most backward position. The seat belt can again be used in the usual manner.

Warning!

Never release the seat belt buckle while the vehicle is in motion, since the special seat belt retractor will be deactivated.

i For information on child seats with mounting fittings for tether anchorages, see “Installation of infant and child restraint system” (▷ page 92).

For information on LATCH-type child seat mounts, see “Child seat anchors – LATCH type” (▷ page 91).

The use of infant or child restraints is required by law in all 50 states, the District of Columbia, the U.S. territories and all Canadian provinces.

Infants and small children should be seated in an appropriate infant or child restraint system properly secured in accordance with the manufacturer’s instructions for the child restraint, that complies with U.S. Federal Motor Vehicle Safety Standards 213 and 225 and Canadian Motor Vehicle Safety Standard 213 and 210.2.

A statement by the child restraint manufacturer of compliance with these standards can be found on the instruction label on the restraint and in the instruction manual provided with the restraint.

When using any infant or child restraint system, make sure to carefully read and follow all manufacturer’s instructions for installation and use.

Please read and observe warning labels affixed to the inside of the vehicle and to infant or child restraints.

Warning!

According to accident statistics, children are safer when properly restrained in the rear seating positions than in the front seating position. Thus, we strongly recommend that children be placed in the rear seats whenever possible. Regardless of seating position, children 12 years old and under must be seated and properly secured in an appropriate infant or child restraint recommended for the size and weight of the child.

The infant or child restraint must be properly secured with the vehicle’s seat belt, the seat belt and top tether strap, or lower anchors and top tether strap, fully in accordance with the child seat manufacturer’s instructions.



Occupant safety



Always sit nearly upright, properly use the seat belts and use an appropriately sized infant or toddler restraint or booster seat recommended for the size and weight of the child.

Children can be killed or seriously injured by an inflating air bag. Note the following important information when circumstances require you to place a child in the front passenger seat:

- Your vehicle is equipped with air bag technology designed to turn off the front passenger front air bag in your vehicle when the OCS senses the weight of a typical 12-month-old child or less along with the weight of a standard appropriate child restraint on the front passenger seat.

- A child in a rear-facing child restraint on the front passenger seat will be seriously injured or even killed if the front passenger front air bag inflates in a collision which could occur under some circumstances, even with the air bag technology installed in your vehicle. The only means to completely eliminate this risk is to never place a child in a rear-facing child restraint in the front seat. We therefore strongly recommend that you always place a child in a rear-facing child restraint in the back seat.

- If you must install a rear-facing child restraint on the front passenger seat because circumstances require you to do so, make sure that the



PASS AIR BAG OFF

indicator lamp is illuminated, indicating that the front passenger front air bag is deactivated. Should the



PASS AIR BAG OFF

indicator lamp not illuminate or go out while the restraint is installed, please check installation.

Periodically check the



PASS AIR BAG OFF

indicator lamp while driving to make sure the lamp is illuminated. If the



PASS AIR BAG OFF

indicator lamp goes out or remains out, do not transport a child on the front passenger seat until the system has been repaired. A child in a rear-facing child restraint on the front passenger seat will be seriously injured or even killed if the front passenger front air bag inflates.

Occupant Classification System

The Occupant Classification System (OCS) automatically turns the front passenger front air bag on or off based on the classified occupant weight category determined by weight sensor readings from the front passenger seat.

 *The system does not deactivate the front passenger side impact air bag, the window curtain air bag, and the emergency tensioning device.*

Occupants must sit properly belted in a nearly upright position with their back against the seat backrest and feet on the floor to be correctly classified. If the occupant's weight is transferred to another object in the vehicle (e.g. by leaning on armrests), the OCS may not be able to properly approximate the occupant's weight category.

- If you have to place a child in a forward-facing child restraint on the front passenger seat, move the seat as far back as possible, use the proper child restraint recommended for the age, size and weight of the child, and secure child restraint with the vehicle's seat belt according to the child seat manufacturer's instructions. For children larger than the typical 12-month-old child, the front passenger front air bag may or may not be activated (▷ page 86).

Warning!



Infants and small children should never share a seat belt with another occupant. During an accident, they could be crushed between the occupant and seat belt.

A child's risk of serious or fatal injuries is significantly increased if the child restraints are not properly secured in the vehicle and/or the child is not properly secured in the child restraint.

Children too big for a toddler restraint must ride in seats using regular seat belts. Position shoulder belt across chest and shoulder, not face or neck. A booster seat may be necessary to achieve proper belt positioning for children from 41 lbs until they reach a height where a lap/shoulder belt fits properly without a booster.

When the child restraint is not in use, remove it from the vehicle or secure it with the seat belt to prevent the child restraint from becoming a projectile in the event of an accident.

Do not leave children unattended in the vehicle, even if the children are secured in a child restraint system. Unsupervised children in a child restraint system may use vehicle equipment and may cause an accident and/or serious personal injury.

Occupant safety

Furthermore, the occupant weight may appear to increase or decrease due to objects hanging on the seat, other passengers pushing on the seat, objects lodged underneath the seat or stuffed between seat and middle console or between seat and door or due to objects applying pressure on the back of the seat. Always make sure that the seat has clearance in all directions at all times.

i *If your seat, including your trim cover and cushion needs to be serviced in any way, take the vehicle to your authorized Mercedes-Benz Light Truck Center.*



Only seat accessories approved by Mercedes-Benz may be used.

Both, driver and the front passenger should always use the

 **PASS AIR BAG OFF** indicator lamp as an indication of whether or not the front passenger is properly positioned.

Warning!



If the  **PASS AIR BAG OFF** indicator lamp illuminates when an adult or someone larger than a small individual is in the front passenger seat, have the front passenger re-position himself or herself in the seat until the  **PASS AIR BAG OFF** indicator lamp goes out, or check whether objects are caught under or around the seat.

More information about air bag display messages (> page 440).

In the event of a collision, the air bag control unit will not allow front passenger front air bag deployment when the OCS classified the front passenger seat occupant as being up to or less than the weight of a typical 12-month-old child in a standard child restraint or if the front passenger seat is sensed as being empty.

When the OCS senses that the front passenger seat occupant is classified as being up to or less than the weight of a typical 12-month-old child in a standard child restraint, the  **PASS AIR BAG OFF** indicator lamp will illuminate when the engine is started and remain illuminated, indicating that the front passenger front air bag is deactivated.

When the OCS senses that the front passenger seat is classified as being empty, the  **PASS AIR BAG OFF** indicator lamp will illuminate when the engine is started and remain illuminated, indicating that the front passenger front air bag is deactivated.

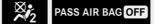
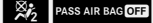
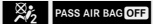
When the OCS senses that the front passenger seat occupant is classified as being heavier than the weight of a typical 12-month-old child seated in a standard child restraint or as being a small individual (such as a young teenager or a small adult), the  indicator lamp will illuminate for approximately 6 seconds when the engine is started and then, depending on occupant weight sensor readings from the seat, remain illuminated or go out. With the  indicator lamp illuminated, the front passenger front air bag is deactivated. With the  indicator lamp out, the front passenger front air bag is activated.

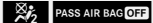
When the OCS senses that the front passenger seat occupant is classified as an adult or someone larger than a small individual, the  indicator lamp will illuminate for approximately 6 seconds when the engine is started and then go out, indicating that the front passenger front air bag is activated.

If the  indicator lamp is illuminated, the front passenger front air bag is deactivated and will not be deployed.

If the  indicator lamp is not illuminated, the front passenger front air bag is activated and will be deployed:

- in the event of certain frontal impacts
- if impact exceeds a preset deployment threshold
- independently of the side impact air bags.

If the front passenger front air bag is deployed, the rate of inflation will be influenced by:

- the rate of vehicle deceleration as assessed by the air bag control unit
- the front passenger's weight category as identified by the Occupant Classification System (OCS)

Warning!



According to accident statistics, children are safer when properly restrained in the rear seating positions than in the front seating position. Thus, we strongly recommend that children be placed in the rear seats whenever possible. Regardless of seating position, children 12 years old and under must be seated and properly secured in an appropriate infant or child restraint recommended for the size and weight of the child.

The infant or child restraint must be properly secured with the vehicle's seat belt, the seat belt and top tether strap, or lower anchors and top tether strap, fully in accordance with the child seat manufacturer's instructions.







Occupant safety



Children can be killed or seriously injured by an inflating air bag. Note the following important information when circumstances require you to place a child in the front passenger seat:

- Your vehicle is equipped with air bag technology designed to turn off the front passenger front air bag in your vehicle when the system senses the weight of a typical 12-month-old child or less along with the weight of a standard appropriate child restraint on the front passenger seat.
- A child in a rear-facing child restraint on the front passenger seat will be seriously injured or even killed if the front passenger front air bag inflates in a collision which could occur under some circumstances, even with the air bag technology installed in your vehicle. The only means to completely eliminate this risk is to never place a child in a rear-facing child restraint in the front seat. We therefore strongly recommend that you always place a child in a rear-facing child restraint in the back seat.

- If you must install a rear-facing child restraint on the front passenger seat because circumstances require you to do so, make sure that the  indicator lamp is illuminated, indicating that the front passenger front air bag is deactivated. Should the  indicator lamp not illuminate or go out while the restraint is installed, please check installation. Periodically check the  indicator lamp while driving to make sure the  indicator lamp is illuminated. If the  indicator lamp goes out or remains out, do not transport a child on the front passenger seat until the system has been repaired. A child in a rear-facing child restraint on the front passenger seat will be seriously injured or even killed if the front passenger front air bag inflates.

- If you have to place a child in a forward-facing child restraint on the front passenger seat, move the seat as far back as possible, use the proper child restraint recommended for the age, size and weight of the child, and secure child restraint with the vehicle's seat belt according to the child seat manufacturer's instructions. For children larger than the typical 12-month-old child, the front passenger front air bag may or may not be activated (▷ page 87).

i Deployment of the driver front air bag does not mean that the front passenger front air bag also should have deployed.

The Occupant Classification System (▷ page 85) may have determined:

- that the seat was empty or occupied by the weight up to or less than that of a typical 12-month-old child seated in a standard child restraint – both instances where the system suppresses deployment of the front passenger front air bag even though the impact met the criteria and was of sufficient severity to deploy the driver front air bag.
- that the seat was occupied by a small individual (such as a young teenager or a small adult) or a child weighing more than the weight of a typical 12-month-old child in a standard child restraint – instances where the system may suppress deployment of the front passenger front air bag even though the impact met the criteria and was of sufficient severity to deploy the driver front air bag.

The  **PASS AIR BAG OFF** indicator lamp is located in the center console.



1  **PASS AIR BAG OFF** indicator lamp

The  **PASS AIR BAG OFF** indicator lamp **1** will be illuminated, except with the SmartKey removed from the starter switch or with the starter switch in position **0** (▷ page 39).

Warning!



If the **SRS** indicator lamp and the  **PASS AIR BAG OFF** indicator lamp are lit at the same time, there is a malfunction in the Occupant Classification System. The front passenger front air bag will be deactivated in this case. Have the system checked as soon as possible by qualified technicians. Contact an authorized Mercedes-Benz Light Truck Center.

In order to ensure proper operation of the air bag system and OCS:

- Do not place more than 4.4 lbs (2 kg) into the parcel net on the back of the front passenger seat. Otherwise, the OCS may not be able to properly approximate the occupant weight category.
- Do not place objects under and/or around the front passenger seat.





Occupant safety



- Do not hang anything from or attach any items to the seats.
- Do not stuff objects such as books between the middle console and the front passenger seat.
- Do not move the front passenger seat backwards against stiff objects.
- Sit properly belted in a nearly upright position with your back against the seat backrest.
- Do not lean on the armrests or lift yourself from the seat by using the handle over the door as this may cause the OCS to be unable to correctly approximate the occupant weight category.
- Only have the seat repaired or replaced by an authorized Mercedes-Benz Light Truck Center.
- Read and observe all warnings in this chapter.

Self-test Occupant Classification System

After turning the SmartKey in the starter switch to position **1** or **2** or pressing the KEYLESS-GO* start/stop button once or twice, the  **PASS AIR BAG OFF** indicator lamp (▷ page 89) located in the center console illuminates. If an adult occupant is properly sitting on the front passenger seat and the system senses the occupant as being an adult, the  **PASS AIR BAG OFF** indicator lamp will illuminate and go out after approximately 6 seconds.

If the seat is not occupied and the system senses the front passenger seat as being empty, the  **PASS AIR BAG OFF** indicator lamp will illuminate and not go out.

Warning!



If the  **PASS AIR BAG OFF** indicator lamp should not illuminate, the system is not functioning. You must see an authorized Mercedes-Benz Light Truck Center before seating any child on the front passenger seat.

For more information, see the “Practical hints” section (▷ page 426).

Warning!



Never place anything between seat cushion and child seat (e.g. pillow), since it reduces the effectiveness of the Occupant Classification System. The bottom of the child seat must make full contact with the passenger seat cushion. An incorrectly mounted child seat could cause injuries to the child in case of an accident, instead of increasing protection for the child.

Follow the manufacturer’s instructions for installation of child seats.

Child seat anchors – LATCH type

This vehicle is equipped with two LATCH (Lower Anchors and Tethers for Children) type anchors (at each of the outer rear seats) for the installation of a LATCH child seat with matching mounting fittings.

Warning!



Children too big for a toddler restraint must ride in seats using regular seat belts. Position shoulder belt across chest and shoulder, not face or neck.

A booster seat may be necessary to achieve proper belt positioning for children over 41 lbs until they reach a height where a lap/shoulder belt fits properly without a booster.

Install child seat according to manufacturer's instructions.

The child seat must be firmly attached to the right and left side anchors ② (> page 92).

An incorrectly mounted child seat may come loose during an accident which could result in serious injury or death to the child.

Damaged or impact damaged child seats or child seat mounting fittings must be replaced.

Do not leave children unattended in the vehicle, even if the children are secured in a child restraint system.

The LATCH anchors are blended with covers.



① Anchorage ring covers

- ▶ Remove anchorage ring cover ① from the seat on which a child seat is to be installed.

Occupant safety



② Anchors

- ▶ Install a LATCH type child seat according to the manufacturer's instructions.

! Make sure the seat belt for the center seat can operate freely with a child seat installed.

i Non-LATCH type child seats may also be used and can be installed using the vehicle's seat belt system. Install child seat according to the manufacturer's instructions.

Installation of infant and child restraint system

This vehicle is equipped with tether anchorages for a top tether strap at each of the rear seating positions.

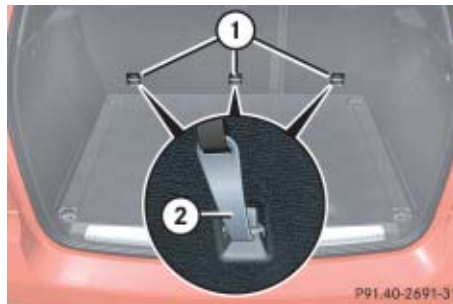

① Anchorage ring

② Hook

i For safety, make sure hook ② has attached to anchorage ring ① beyond the safety catch, as illustrated.

- ▶ Move the respective head restraint to its uppermost position (▷ page 129).
- ▶ Guide top tether strap between head restraint and top of seat backrest.

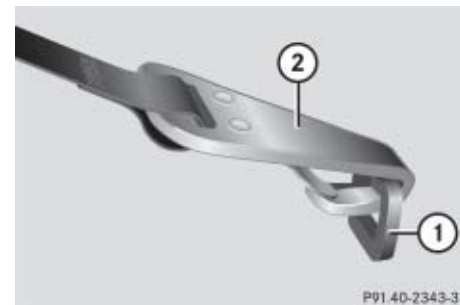

① Anchorage ring

② Hook

- ▶ Securely fasten hook ②, which is part of the tether strap, to anchorage ring ①.

Make sure

- the top tether strap is not twisted
- the head restraint is installed and positioned such that the top tether strap can pass freely between the head restraint and top of seat backrest
- top tether strap is positioned between the seat backrest and the cargo compartment cover blind (if installed)
- the top tether strap is positioned between the seat backrest and the partition net* (if installed)

Warning!



After installing top tether straps, make sure that the seat backrests are in an upright position and are properly locked. Check for secure locking by pushing and pulling on the seat backrests. If a seat backrest is not properly locked, the seat backrest could fold. The child seat would no longer be properly supported or positioned to provide its intended benefit.

- ▶ Lower the head restraint if necessary (▷ page 129).
Make sure the top tether strap can pass freely between the head restraint and top of seat backrest.
- ▶ Install the child restraint system and tighten the top tether strap according to the child restraint manufacturer's instructions.

Blocking of rear door window operation

With the override switch you can disable the rear side window switches in the rear door panels.

Warning!



Activate the override switch when children are riding in the back seats of the vehicle. The children could otherwise injure themselves, e.g. by becoming trapped in the window opening.

When leaving the vehicle, always remove the SmartKey or SmartKey with KEYLESS-GO* from the starter switch, take it with you, and lock the vehicle. Do not leave children unattended in the vehicle, or with access to an unlocked vehicle. Unsupervised use of vehicle equipment may cause an accident and/or serious personal injury.

Occupant safety

The override switch is located on the driver's door control panel.



① Override switch

For more information on power windows, see “Power windows” (▷ page 236).

Disabling

- ▶ Press override switch ① until it engages.

The switch engages in the recessed position.

The rear door windows can no longer be operated using the switches located in the rear doors.

i *Operating the rear door windows using the switches located on the door control panel of the driver's door is still possible.*

Enabling

- ▶ Press override switch ① once more.

The switch disengages from its recessed position back to its original position.

The rear door windows can again be operated using the switches located in the rear doors.

▼ Panic alarm



① PANIC button

i USA only:

This device complies with Part 15 of the FCC Rules. Operation is subject to the following two conditions:

- (1) This device may not cause harmful interference, and*
- (2) this device must accept any interference received, including interference that may cause undesired operation.*

Any unauthorized modification to this device could void the user's authority to operate the equipment.

i Canada only:

This device complies with RSS-210 of Industry Canada. Operation is subject to the following two conditions:

- (1) This device may not cause interference, and*
- (2) this device must accept any interference received, including interference that may cause undesired operation of the device.*

Any unauthorized modification to this device could void the user's authority to operate the equipment.

Activating

- ▶ Press and hold button ① for at least 1 second.

The SmartKey or SmartKey with KEYLESS-GO* must be within 30 ft (9 m) of the vehicle.

An audible alarm and flashing exterior lamps will operate briefly.

Deactivating

- ▶ Press button ① again.

The SmartKey or SmartKey with KEYLESS-GO* must be within 30 ft (9 m) of the vehicle.

or

- ▶ Insert SmartKey or the SmartKey with KEYLESS-GO* in the starter switch.

or

- ▶ Press the KEYLESS-GO* start/stop button (▷ page 41).

The SmartKey with KEYLESS-GO* must be in the vehicle.

Driving safety systems

In this section you will find information on the following driving safety systems:

- ABS (Antilock Brake System)
- BAS (Brake Assist System)
- ESP® (Electronic Stability Program)
- EBP (Electronic Brake Proportioning)
- 4-ETS (Electronic Traction System)

Warning!



The following factors increase the risk of accidents:

- Excessive speed, especially in turns
- Wet and slippery road surfaces
- Following another vehicle too closely

The ABS, BAS, ESP® and 4-ETS cannot reduce this risk.

Always adjust your driving style to the prevailing road and weather conditions.

i In winter operation, the maximum effectiveness of the ABS, the BAS, the ESP®, the EBP, and the 4-ETS is only achieved with winter tires (▷ page 399) or snow chains as required.

ABS

Warning!



Do not pump the brake pedal. Use firm, steady brake pedal pressure instead. Pumping the brake pedal defeats the purpose of the ABS and significantly reduces braking effectiveness.

The Antilock Brake System (ABS) regulates the brake pressure so that the wheels do not lock during braking. This allows you to maintain the ability to steer your vehicle.

The ABS is functional above a speed of approximately 5 mph (8 km/h) independent of road surface conditions.

On slippery road surfaces, the ABS will respond even to light brake pressure.

The  indicator lamp in the instrument cluster (▷ page 26) comes on when you switch on the ignition. It goes out when the engine is running.

Braking

At the instant one of the wheels is about to lock up, a slight pulsation can be felt in the brake pedal, indicating that the ABS is in the regulating mode.

- ▶ Keep firm and steady pressure on the brake pedal while experiencing the pulsation.

Continuous, steady brake pedal pressure yields the advantages provided by the ABS, namely braking power and ability to steer the vehicle.

The pulsating brake pedal can be an indication of hazardous road conditions and functions as a reminder to take extra care while driving.

Emergency brake maneuver

- ▶ Keep continuous full pressure on the brake pedal.

Warning!



When the ABS is malfunctioning, the BAS, the ESP[®], and the 4-ETS are also switched off. The basic driving and braking functions are still available.

When the ABS is malfunctioning, the wheels may lock during hard braking, reducing steering capability and extending the braking distance.

Warning!



The ABS cannot prevent the natural laws of physics from acting on the vehicle, nor can it increase braking or steering efficiency beyond that afforded by the condition of the vehicle brakes and tires or the traction afforded. The ABS cannot prevent accidents, including those resulting from

excessive speed in turns, following another vehicle too closely, or hydroplaning. Only a safe, attentive, and skillful driver can prevent accidents. The capabilities of an ABS equipped vehicle must never be exploited in a reckless or dangerous manner which could jeopardize the user's safety or the safety of others.

Off-road – ABS

With the off-road driving program switched on (▷ page 268), the ABS designed for off-road use is automatically activated.

When applying the brakes at speeds below approximately 18 mph (30 km/h), the front wheels are locked cyclically to shorten the braking distance (dig-in effect). This affects steering the vehicle.

For more information, see “Practical hints” (▷ page 413).

BAS

The Brake Assist System (BAS) operates in emergency situations. If you apply the brakes very quickly, the BAS automatically provides full brake boost, thereby potentially reducing braking distance.

- ▶ Apply continuous full braking pressure until the emergency braking situation is over.

The ABS will prevent the wheels from locking.

When you release the brake pedal, the brakes function again as normal. The BAS is then deactivated.

Warning!



If the BAS is malfunctioning, the brake system is still functioning, but without the additional brake boost available that BAS would normally provide in an emergency braking maneuver. Therefore, the braking distance may increase.

Warning!





The BAS cannot prevent the natural laws of physics from acting on the vehicle, nor can it increase braking efficiency beyond that afforded by the condition of the vehicle brakes and tires or the traction afforded. The BAS cannot prevent accidents, including those resulting from excessive speed in turns, following another vehicle too closely, or hydroplaning. Only a safe, attentive, and skillful driver can prevent accidents. The capabilities of a BAS equipped vehicle must never be exploited in a reckless or dangerous manner which could jeopardize the user's safety or the safety of others.

ESP®

The Electronic Stability Program (ESP®) is operational as soon as the engine is running. It monitors the vehicle's traction (force of adhesive friction between the tires and the road surface) and handling.

The ESP® recognizes when a wheel is spinning or if the vehicle starts to skid. By applying brakes to the appropriate wheel and by limiting engine output, the ESP® works to stabilize the vehicle. The ESP® is especially useful while driving off and on wet or slippery road surfaces. The ESP® also helps stabilize the vehicle during braking maneuvers.

The ESP® warning lamp  in the instrument cluster (> page 26) flashes when the ESP® is engaged.

The ESP® warning lamp  in the instrument cluster come on when you switch on the ignition. It goes out when the engine is running.

Warning!



Never switch off the ESP® when you see the ESP® warning lamp  flashing in the instrument cluster. In this case, proceed as follows:

- While driving off, apply as little throttle as possible.
- While driving, ease up on the accelerator.
- Adapt your speed and driving style to the prevailing road conditions.

Failure to observe these guidelines could cause the vehicle to skid.

The ESP® cannot prevent accidents resulting from excessive speed.

Warning!

The ESP® cannot prevent the natural laws of physics from acting on the vehicle, nor can it increase the traction afforded. The ESP® cannot prevent accidents, including those resulting from excessive speed in turns, following another vehicle too closely, or hydroplaning. Only a safe, attentive, and skillful driver can prevent accidents. The capabilities of an ESP® equipped vehicle must never be exploited in a reckless or dangerous manner which could jeopardize the user's safety or the safety of others.

! *Operational or performance test must only be conducted on a two-axle dynamometer. If such tests are necessary, contact an authorized Mercedes-Benz Light Truck Center. You could otherwise seriously damage the brake system or the transfer case which is not covered by the Mercedes-Benz Limited Warranty.*

! *Because the ESP® operates automatically, the engine and ignition must be shut off (SmartKey in starter switch position **0** or **1** or KEYLESS-GO* start/stop button in position **0** or **1**) when testing the brakes on a brake test dynamometer and such testing should be no longer than 10 seconds.*

Active braking action through the ESP® may otherwise seriously damage the brake system which is not covered by the Mercedes-Benz Limited Warranty.

i *The ESP® will only function properly if you use wheels of the recommended tire size (▷ page 536).*

For more information, see the “Practical hints” section (▷ page 419) and (▷ page 436).

Switching off the ESP®**Warning!**

The ESP® should not be switched off during normal driving other than in the circumstances described below. Disabling of the system will reduce vehicle stability in standard driving maneuvers.

Do not switch off the ESP® when a spare wheel is mounted.

To improve the vehicle's traction, switch off the ESP® in driving situations where it would be advantageous to have the drive wheels spin and thus cut into surfaces for better grip such as:

- when driving with snow chains
- in deep snow
- in sand or gravel

Driving safety systems

! Switch on the ESP® immediately if the aforementioned circumstances do not apply anymore.

When you switch off the ESP®

- the ESP® does not stabilize the vehicle
- the engine output is not limited, which allows the drive wheels to spin and thus cut into surfaces for better grip
- the 4-ETS will still apply the brake to a spinning wheel
- the ESP® continues to operate when you are braking
- you cannot activate the cruise control or the DISTRONIC* system
- the cruise control or the DISTRONIC* system switch off if currently activated

i When the ESP® is switched off and one or more drive wheels are spinning, the ESP® warning lamp  in the instrument cluster flashes. However, the ESP® will then not stabilize the vehicle.

The ESP® switch is located on the upper part of the center console.



① ESP® switch

- ▶ With the engine running, press ESP® switch ①.

The ESP® warning lamp  in the instrument cluster comes on.

The ESP® is deactivated.

Warning!



When the ESP® warning lamp  is illuminated continuously, the ESP® is switched off or is not operational due to a malfunction.

Adapt your speed and driving to the prevailing road conditions and to the non-operating status of the ESP®.

! Avoid spinning of a drive wheel for an extended period of time with the ESP® switched off. This may cause serious damage to the drivetrain which is not covered by the Mercedes-Benz Limited Warranty.

Switching on the ESP®

- ▶ Press ESP® switch ①.

The ESP® warning lamp  in the instrument cluster goes out.

You are now again in normal driving mode.

For more information, see “Practical hints” (▷ page 413).

Off-road – ESP®

With the off-road driving program switched on (▷ page 268), the ESP® designed for off-road use is automatically activated. At speeds below 27 mph (45 km/h), the ESP® assists in over-/understeering, thus improving vehicle traction.

ESP® Trailer Stabilization

If the trailer you are towing should begin to sway, the rig can only be stabilized by immediately applying the brakes hard. Steering during this maneuver will not help to stabilize the rig.

ESP® will assist you in such situations. ESP® recognizes when the trailer starts swaying and will apply the brakes to reduce the vehicle speed to a non-critical speed that allows the vehicle-trailer combination to stabilize.

The ESP® Trailer Stabilization is functional at vehicle speeds above approximately 40 mph (65 km/h) when the ESP® is switched on.

Warning



The system will not be able to assist when the trailer jackknifes

- on wet or icy roads
- on roads with slippery surface
- in sand or gravel

Trailers with a high center of gravity may tip over before the system recognizes swaying of the trailer.

i *If the ESP® has switched off due to a malfunction, ESP® cannot stabilize the rig.*

EBP

The EBP enhances braking effectiveness by allowing the rear brakes to supply a greater proportion of the braking effort without a loss of vehicle stability.

Warning!



If the EBP is malfunctioning, the brake system is still functioning. However, the rear wheels may lock during hard braking, causing you to lose control over the vehicle and possibly causing an accident. Adjust your driving style to the non-operating status of the EBP.

For more information, see the “Practical hints” section (▷ page 416) and (▷ page 448).

Driving safety systems

4-ETS

The 4-Electronic Traction System (4-ETS) improves the vehicle's ability to utilize available traction, especially under slippery road conditions. The brakes are applied to the spinning wheel and power is transferred to the wheel(s) with traction.

The ESP[®] warning lamp  in the instrument cluster, starts to flash at any vehicle speed, as soon as a tire loses traction and the wheel begins to spin.

 *If conditions require, switch on off-road driving program (▷ page 268).*

Warning!





When you see ESP[®] warning lamp  flashing in the instrument cluster, then proceed as follows:

- While driving off, apply as little throttle as possible.
- While driving, ease up on the accelerator.
- Adapt your speed and driving style to the prevailing road conditions.



Failure to observe these guidelines could cause the vehicle to skid.

The 4-ETS cannot prevent accidents resulting from excessive speed.

 *Operational or performance test must only be conducted on a two-axle dynamometer. If such tests are necessary, contact an authorized Mercedes-Benz Light Truck Center. You could otherwise seriously damage the brake system or the transfer case which is not covered by the Mercedes-Benz Limited Warranty.*

 *Because the ESP[®] operates automatically, the engine and ignition must be shut off (SmartKey in starter switch position **0** or **1** or KEYLESS-GO* start/stop button in position **0** or **1**) when testing the brakes on a brake test dynamometer and such testing should be no longer than 10 seconds.*

Active braking action through the ESP[®] may otherwise seriously damage the brake system which is not covered by the Mercedes-Benz Limited Warranty.

 *If the yellow ESP[®] warning lamp  comes on while driving, the 4-ETS is being switched off temporarily to prevent overheating of the drive wheel brakes. In addition, the message ESP inoperative See Operator's Manual appears in the multifunction display.*

For more information, see the “Practical hints” section (▷ page 414) and (▷ page 428).

Off-road - 4-ETS

With the off-road driving program switched on (▷ page 268), the 4-ETS designed for off-road use is automatically activated.

▼ Anti-theft systems

Immobilizer

The immobilizer prevents unauthorized persons from starting your vehicle.

Activating

With the SmartKey

- ▶ Remove the SmartKey from the starter switch.

With KEYLESS-GO*

- ▶ Press the KEYLESS-GO start/stop button (▷ page 41) on the starter switch once.
The engine is turned off.
- ▶ Open the driver's door.

Deactivating

With the SmartKey

- ▶ Turn the SmartKey in the starter switch to position **2** (▷ page 39).

With KEYLESS-GO*

- ▶ Switch on the ignition (▷ page 40).

i *Starting the engine will also deactivate the immobilizer.*

In case the engine cannot be started (yet the vehicle's battery is charged), the system is not operational. Contact an authorized Mercedes-Benz Light Truck Center or call 1-800-FOR-MERCEdes (in the USA), or 1-800-387-0100 (in Canada).

Anti-theft alarm system

Once the alarm system has been armed, a visual and audible alarm is triggered when someone opens

- a door
- the tailgate
- the hood

The alarm will stay on, even if the activating element (a door, for example) is immediately closed.

The alarm system will also be triggered when

- the vehicle is opened with the mechanical key, see "Unlocking the vehicle" (▷ page 475)
- a door is opened from the inside, see "Opening the doors from the inside" (▷ page 118)

Anti-theft systems

i If the alarm stays on for more than 30 seconds, a call to the Response Center is initiated automatically by the Tele Aid* system (▷ page 308) provided that the Tele Aid* service was subscribed to and properly activated, and that necessary cellular service and GPS coverage are available.

Arming the alarm system

The alarm system is armed after you have locked the vehicle with the SmartKey or SmartKey with KEYLESS-GO*.

The alarm system indicator lamp is located to the lower left of the hazard warning flasher.



① Alarm system indicator lamp

- ▶ Make sure all doors and the tailgate are closed.
- ▶ Lock the vehicle (▷ page 68).

The turn signal lamps flash three times to indicate that the vehicle is locked.

The alarm system is armed within approximately 10 seconds. Alarm system indicator lamp ① flashes.

i If the turn signal lamps do not flash three times, one of the following elements may not be properly closed:

- a door
- the tailgate

Close the respective element and lock the vehicle again.

Disarming the alarm system

- ▶ Unlock the vehicle (▷ page 38).

The turn signal lamps flash once to indicate that the alarm system is disarmed. Indicator lamp ① goes out.

i The alarm system will rearm automatically again after approximately 40 seconds if neither a door nor the tailgate is opened.



Canceling the alarm

To cancel the alarm:

With the SmartKey

- ▶ Insert the SmartKey in the starter switch.

or

- ▶ Press the  or  button on the SmartKey.

*With KEYLESS-GO**

- ▶ Grasp an outside door handle.

The SmartKey with KEYLESS-GO must be within 3 ft (1 m) of the vehicle.

or

- ▶ Press the KEYLESS-GO start/stop button (▷ page 41).

The SmartKey with KEYLESS-GO must be inside the vehicle.



Locking and unlocking

Seats

Memory function*

Lighting

Instrument cluster

Control system

Automatic transmission

Transfer case

Good visibility

Climate control

3-zone automatic climate control*

Power windows

Power tilt/sliding sunroof*

Driving systems

Loading

Useful features

Locking and unlocking

In the “Controls in detail” section you will find detailed information on how to operate the equipment installed in your vehicle. If you are already familiar with the basic functions of your vehicle, this section will be of particular interest to you.

To quickly familiarize yourself with the basic functions of the vehicle, refer to the “Getting started” section of this manual. The corresponding page numbers are given at the beginning of each segment.

For more information on locking and unlocking, see the “Getting started” section (▷ page 38) and (▷ page 68).

SmartKey

Your vehicle comes supplied with two SmartKeys, each with remote control and a removable mechanical key.

The locking tabs for the mechanical key portion of the two SmartKeys are a different color to help distinguish each SmartKey unit.

The SmartKey provides an extended operating range. To prevent theft, however, it is advisable to only unlock the vehicle when you are in close proximity to it.







The SmartKey centrally locks and unlocks:

- the doors
- the tailgate
- the fuel filler flap



P80.35-2285-31

SmartKey with remote control

- ①  Lock button
- ②  Unlock button* for tailgate
- ③  Locking tab for mechanical key
- ④  Unlock button
- ⑤  Battery check lamp
- ⑥  PANIC Panic button (▷ page 95)

Warning!

When leaving the vehicle, always remove the SmartKey from the starter switch, take it with you and lock the vehicle. Do not leave children unattended in the vehicle, or with access to an unlocked vehicle. It is possible for children to open a locked door from the inside, which could result in an accident and/or serious personal injury.

! To prevent possible malfunction, avoid exposing the SmartKey to high levels of electromagnetic radiation.

i USA only:

This device complies with Part 15 of the FCC Rules. Operation is subject to the following two conditions:

- (1) *This device may not cause harmful interference, and*
- (2) *this device must accept any interference received, including interference that may cause undesired operation.*

Any unauthorized modification to this device could void the user's authority to operate the equipment.

i Canada only:

This device complies with RSS-210 of Industry Canada. Operation is subject to the following two conditions:

- (1) *This device may not cause interference, and*
- (2) *this device must accept any interference received, including interference that may cause undesired operation of the device.*

Any unauthorized modification to this device could void the user's authority to operate the equipment.

i

You can also open and close the power windows and tilt/sliding sunroof using the SmartKey, see "Summer opening feature" (> page 239) and see "Convenience closing feature" (> page 239).*

Factory setting**Global unlocking**

- ▶ Press button .

All turn signal lamps flash once. The locking knobs in the doors move up. The anti-theft alarm system is disarmed.

The vehicle will lock again automatically and reactivate the anti-theft alarm system within approximately 40 seconds of unlocking if

- neither door nor tailgate is opened
- the SmartKey is not inserted in the starter switch
- the central locking switch is not activated

Locking and unlocking



Global locking

- ▶ Press button .

With the tailgate and all doors closed, the turn signal lamps flash three times. The locking knobs in the doors move down. The anti-theft alarm system is armed.

Selective setting

If you frequently travel alone, you may wish to reprogram the SmartKey so that pressing button  only unlocks the driver's door and the fuel filler flap.

- ▶ Press and hold buttons  and  simultaneously for about 5 seconds until battery check lamp  (▷ page 108) flashes twice.

The SmartKey will then function as follows:

Unlocking driver's door and fuel filler flap

- ▶ Press button  once.

All turn signal lamps flash once. The locking knob in the driver's door moves up. The anti-theft alarm system is disarmed.

Global unlocking

- ▶ Press button  twice.



All turn signal lamps flash once. The locking knobs in the doors move up. The anti-theft alarm system is disarmed.

Global locking

- ▶ Press button .

With the tailgate and all doors closed, the turn signal lamps flash three times. The locking knobs in the doors move down. The anti-theft alarm system is armed.

Restoring to factory setting



- ▶ Press and hold buttons  and  simultaneously for about 5 seconds until battery check lamp  (▷ page 108) flashes twice.

 *If you cannot lock or unlock the vehicle with the SmartKey, the batteries in the SmartKey are discharged, the SmartKey is malfunctioning, or the vehicle battery is drained.*



- *Check the batteries in the SmartKey and replace them if necessary (▷ page 480).*
- *Use the mechanical key to unlock the driver's door (▷ page 475).*
- *Lock the vehicle as described in the "Practical hints" section (▷ page 476).*
- *Have the vehicle battery and the vehicle battery connections checked (▷ page 507).*

If the SmartKey is malfunctioning, contact Roadside Assistance or an authorized Mercedes-Benz Light Truck Center.

Checking the batteries



- ▶ Press button  or .

Battery check lamp  (▷ page 108) comes on briefly to indicate that the SmartKey batteries are in order.

 *If battery check lamp  does not come on briefly during check, the SmartKey batteries are discharged.*

Replace the batteries (▷ page 480).

You can obtain the required batteries at any authorized Mercedes-Benz Light Truck Center.

 *If the batteries are checked within signal range of the vehicle, pressing the button  or  will lock or unlock the vehicle accordingly.*

Unlocking and opening the tailgate (Vehicles with power tailgate*)

You can unlock and open the tailgate separately.

A minimum height clearance of 7.2 ft (2.20 m) is required to open the tailgate.

- ▶ Press and hold button  on the SmartKey until the tailgate unlocks and begins to open.

 *The tailgate swings open upwards automatically. Always make sure there is sufficient overhead clearance.*

To stop the opening procedure, press button  on the SmartKey. The tailgate stops moving.

 *If the vehicle was previously centrally locked with the SmartKey, the tailgate will lock automatically when closed. The turn signals will flash three times to confirm locking.*

Loss of SmartKey or mechanical key

If you lose a SmartKey or mechanical key, you should do the following:

- ▶ Have the SmartKey deactivated by an authorized Mercedes-Benz Light Truck Center.
- ▶ Report the loss of the SmartKey or the mechanical key immediately to your car insurance company.
- ▶ If necessary, have the mechanical lock replaced.

Your authorized Mercedes-Benz Light Truck Center will be glad to supply you with a replacement.

Locking and unlocking

SmartKey with KEYLESS-GO*

Vehicles equipped with KEYLESS-GO come with two SmartKeys with KEYLESS-GO, each with remote control and a removable mechanical key.

The locking tabs for the mechanical key portion of the two SmartKeys with KEYLESS-GO are a different color to help distinguish each SmartKey with KEYLESS-GO unit.







The KEYLESS-GO function is integrated into the SmartKey. On these vehicles, the validity of the SmartKey with KEYLESS-GO is checked when you grasp an outside door handle.

If the SmartKey with KEYLESS-GO is valid, your vehicle unlocks

- the doors
- the tailgate
- the fuel filler flap



SmartKey with KEYLESS-GO*

- ①  Lock button
- ②  Unlock button* for tailgate
- ③  Locking tab for mechanical key
- ④  Unlock button
- ⑤  Battery check lamp
- ⑥  **PANIC** Panic button (▷ page 95)

Warning!



When leaving the vehicle, always take the SmartKey with KEYLESS-GO* with you and lock the vehicle. Do not leave children unattended in the vehicle, or with access to an unlocked vehicle. Unsupervised use of vehicle equipment may cause an accident and/or serious personal injury.

! To prevent possible malfunction, avoid exposing the SmartKey with KEYLESS-GO to high levels of electromagnetic radiation.

i USA only:
This device complies with Part 15 of the FCC Rules. Operation is subject to the following two conditions:

- (1) This device may not cause harmful interference, and
- (2) this device must accept any interference received, including interference that may cause undesired operation.

Any unauthorized modification to this device could void the user's authority to operate the equipment.

i Canada only:

This device complies with RSS-210 of Industry Canada. Operation is subject to the following two conditions:

- (1) This device may not cause interference, and
- (2) this device must accept any interference received, including interference that may cause undesired operation of the device.

Any unauthorized modification to this device could void the user's authority to operate the equipment.

i You can also open and close the power windows and tilt/sliding sunroof* using the SmartKey with KEYLESS-GO, see "Summer opening feature" (▷ page 239) and see "Convenience closing feature" (▷ page 239).

Important notes on using KEYLESS-GO*

- You can also use the SmartKey with KEYLESS-GO like a normal SmartKey (▷ page 108).
- You can combine KEYLESS-GO functions with normal SmartKey functions (e.g. unlocking with KEYLESS-GO and locking with the  button).
- Always carry the SmartKey with KEYLESS-GO with you.
- Never store the SmartKey with KEYLESS-GO together with:
 - electronic items such as a cellular phone or another SmartKey with KEYLESS-GO
 - metallic objects such as coins or metal foil

Doing so could impair the function of the KEYLESS-GO system.

- To lock or unlock the vehicle, the SmartKey with KEYLESS-GO must be located outside the vehicle within approximately 3 ft (1 m) of the respective door or the tailgate.
- In order to start the engine with the SmartKey with KEYLESS-GO:
 - The SmartKey with KEYLESS-GO must be located in the vehicle.
 - The KEYLESS-GO start/stop button must be inserted in the starter switch (▷ page 41).
 - The brake pedal must be firmly depressed. Do not depress the accelerator.
- If the SmartKey with KEYLESS-GO is positioned farther away from the vehicle, the system may no longer recognize the SmartKey with KEYLESS-GO. The vehicle then cannot be locked or the engine started via the KEYLESS-GO system.

Locking and unlocking

- If the SmartKey with KEYLESS-GO is removed from the vehicle (e.g. if a passenger exits the vehicle with the SmartKey with KEYLESS-GO)
 - when pressing the KEYLESS-GO start/stop button or trying to lock the vehicle with the lock button on an outside door handle the message **Key not detected** appears in the multifunction display
 - with the engine running, the message **Key not detected** appears in the multifunction display while driving off.
- If you have started the engine with the KEYLESS-GO start/stop button (▷ page 55), you can turn it off again with
 - the KEYLESS-GO start/stop button (▷ page 67)
 - the SmartKey inserted in the starter switch, when the automatic transmission is in position **P**
- Remember that the engine can be started by anyone with a SmartKey with KEYLESS-GO that is left inside the vehicle.

Possibility 1 (One SmartKey with KEYLESS-GO in the vehicle, one SmartKey with KEYLESS-GO outside the vehicle):

If you leave the SmartKey with KEYLESS-GO behind when exiting and locking the vehicle, no message appears in the multifunction display.

Possibility 2 (One SmartKey with KEYLESS-GO in the vehicle, no SmartKey with KEYLESS-GO outside the vehicle):

When exiting and trying to lock the vehicle, the message **Key detected in vehicle** will appear in the multifunction display. The vehicle will not be locked.

Factory setting

Global unlocking

- ▶ Grasp an outside door handle.

All turn signal lamps flash once. The locking knobs in the doors move up. The anti-theft alarm system is disarmed.

i *If the vehicle has been parked for more than 72 hours, you must pull an outside door handle in order to activate the KEYLESS-GO function.*

The vehicle will lock again automatically and reactivate the anti-theft alarm system within approximately 40 seconds of unlocking if

- neither a door nor the tailgate is opened
- the central locking switch is not activated

i *The vehicle could be inadvertently unlocked if the SmartKey with KEYLESS-GO is within 3 ft (1 m) of the vehicle and*

- *an outside door handle is splashed with water*
or
- *you attempt to clean an outside door handle*



Global locking

- ▶ Press the lock button on an outside door handle (▷ page 68).

With the tailgate and all doors closed, the turn signal lamps flash three times. The locking knobs in the doors move down. The anti-theft alarm system is armed.

Selective setting

If you frequently travel alone, you may wish to reprogram the SmartKey with KEYLESS-GO so when you grasp the driver's door handle only the driver's door and the fuel filler flap unlocks.

- ▶ Press and hold buttons  and  simultaneously for about 5 seconds until battery check lamp ⑤ (▷ page 112) flashes twice.

The SmartKey with KEYLESS-GO will then function as follows:

Unlocking driver's door and fuel filler flap

- ▶ Grasp the driver's outside door handle.
All turn signal lamps flash once. The locking knob in the driver's door moves up. The anti-theft alarm system is disarmed.

Locking and unlocking



Global unlocking

- ▶ Grasp any outside door handle other than the driver's outside door handle.
All turn signal lamps flash once. The locking knobs in the doors move up. The anti-theft alarm system is disarmed.

Global locking

- ▶ Press the lock button on an outside door handle (▷ page 68).
All turn signal lamps flash three times. The locking knobs in the doors move down. The anti-theft alarm system is armed.

Restoring to factory setting

- ▶ Press and hold buttons  and  simultaneously for about 5 seconds until battery check lamp ⑤ (▷ page 112) flashes twice.

! *If you can no longer lock or unlock the vehicle with the SmartKey with KEYLESS-GO, the batteries in the SmartKey are discharged, the SmartKey with KEYLESS-GO is malfunctioning or the vehicle battery is drained.*

- *Check the batteries in the SmartKey with KEYLESS-GO (▷ page 116) and replace them if necessary (▷ page 480).*
- *Use the mechanical key to unlock the driver's door (▷ page 475).*
- *Lock the vehicle as described in the "Practical hints" section (▷ page 476).*
- *Have the vehicle battery and the vehicle battery connections checked (▷ page 507).*

If the SmartKey with KEYLESS-GO is malfunctioning, contact an authorized Mercedes-Benz Light Truck Center.

Checking the batteries



- ▶ Press button  or .

Battery check lamp ⑤ (▷ page 112) comes on briefly to indicate that the SmartKey with KEYLESS-GO batteries are in order.

i *If battery check lamp ⑤ (▷ page 112) does not come on briefly during check, the SmartKey with KEYLESS-GO batteries are discharged.*

Replace the batteries (▷ page 480).

You can obtain the required batteries at any authorized Mercedes-Benz Light Truck Center.

i *If the batteries are checked within signal range of the vehicle, pressing the button  or  will lock or unlock the vehicle accordingly.*

Unlocking and opening the tailgate (Vehicles with power tailgate*)

You can unlock and open the tailgate separately.

A minimum height clearance of 7.2 ft (2.20 m) is required to open the tailgate.

The handle is located above the rear license plate recess.



- ▶ Pull on the handle
or
- ▶ Press and hold button  on the SmartKey with KEYLESS-GO until the tailgate unlocks and opens.

! *The tailgate swings open upwards automatically. Always make sure there is sufficient overhead clearance.*

To stop the opening procedure, press button  on the SmartKey. The tailgate stops moving.

i *If the vehicle was previously centrally locked with the SmartKey or SmartKey with KEYLESS-GO*, the tailgate will lock automatically when closed (▷ page 121). The turn signals will flash three times to confirm locking.*

Loss of the SmartKey with KEYLESS-GO

If you lose your SmartKey with KEYLESS-GO or mechanical key, you should do the following:

- ▶ Have the SmartKey with KEYLESS-GO deactivated by an authorized Mercedes-Benz Light Truck Center.
- ▶ Report the loss of the SmartKey with KEYLESS-GO or the mechanical key immediately to your car insurance company.
- ▶ Have the mechanical lock replaced if necessary.

Your authorized Mercedes-Benz Light Truck Center will be glad to supply you with a replacement.

Locking and unlocking

Opening the doors from the inside

You can open a locked door from the inside. Open door only when conditions are safe to do so.

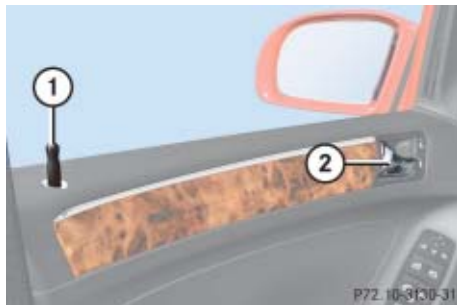



① Locking knob

② Inside door handle

i If the vehicle has previously been locked from the outside with the SmartKey or KEYLESS-GO*, opening a door from the inside will trigger the anti-theft alarm system.

To cancel the alarm, do one of the following:

With the SmartKey

- Insert the SmartKey in the starter switch.
- Press the  or  button on the SmartKey.

With KEYLESS-GO*

- Grasp an outside door handle.
- Press the KEYLESS-GO start/stop button ( page 41).

The SmartKey with KEYLESS-GO must be inside the vehicle.

Front doors

- ▶ Pull on inside door handle ② on the respective front door to open door.

If the door was locked, locking knob ① will move up.

Rear doors

- ▶ Pull up locking knob ① on the respective rear door to unlock door.
- ▶ Pull on inside door handle ② on the respective rear door to open door.

Opening the tailgate

Opening the tailgate from the outside

A minimum height clearance of 7.0 ft (2.13 m) is required to open the tailgate.

Vehicles with vehicle level control*: Depending on the set vehicle level a minimum height clearance of 7.2 ft (2.20 m) is required to open the tailgate.

The handle is located above the rear license plate recess.



i *Vehicles without KEYLESS-GO*:
The vehicle must be unlocked (▷ page 38).*

Vehicles with KEYLESS-GO:
When opening the tailgate, the vehicle is globally unlocked.*

- ▶ Pull on the handle.
The tailgate opens slightly.
- ▶ Pull tailgate upwards to open.

! *The tailgate swings open upwards automatically. Always make sure there is sufficient overhead clearance.*

Vehicles with power tailgate:
To stop the opening procedure, press button  on the SmartKey. The tailgate stops moving.*

i *If the vehicle was previously centrally locked, the tailgate will lock automatically after closing it (▷ page 121). The turn signals will flash three times to confirm locking.*

The tailgate can also be opened using the SmartKey (▷ page 108).

Opening the tailgate from the inside electrically*

In vehicles with power tailgate* you can open the tailgate from the inside if the vehicle is stationary.

A minimum height clearance of 7.0 ft (2.13 m) is required to open the tailgate.

Vehicles with vehicle level control*: Depending on the set vehicle level a minimum height clearance of 7.2 ft (2.20 m) is required to open the tailgate.

Locking and unlocking

The switch is located on the door control panel.



- ① Remote tailgate switch with indicator lamp
- ▶ Pull remote tailgate switch ① until tailgate begins to open.

The tailgate opens. The indicator lamp in the remote tailgate switch comes on and remains lit until the tailgate is closed. While the tailgate is opening, an acoustic signal sounds.

Warning!



Maintain sight of the area around the rear of the vehicle while operating the tailgate with the door-mounted remote tailgate switch or with the  button on the SmartKey or SmartKey with KEYLESS-GO*. Monitor the opening procedure carefully to make sure no one is in danger of being injured.

To interrupt the opening procedure, press or pull the door-mounted remote tailgate switch or press the  button on the SmartKey or SmartKey with KEYLESS-GO*.

! *The tailgate swings open upwards automatically. Always make sure there is sufficient overhead clearance. To stop the opening procedure, press or pull remote tailgate switch ① or press the  button on the SmartKey or SmartKey with KEYLESS-GO*. The tailgate stops moving.*

i *The tailgate can also be opened using the button  on the SmartKey (▷ page 108) or SmartKey with KEYLESS-GO* (▷ page 112).*

Limiting opening height of tailgate*

Vehicles with power tailgate*:

The tailgate opening height can be limited when transporting goods on a roof rack* (e.g. presence of an MB roof cargo container*). When activated, the tailgate opens to approximately 6.6 ft (2.00 m).

- ▶ Activate the limiting opening height of tailgate using the control system (▷ page 177).

Closing the tailgate

Closing the tailgate from the inside electrically*

In vehicles with power tailgate* you can close the tailgate from the inside using the remote tailgate switch.

- ▶ Press remote tailgate switch ① (▷ page 120) until tailgate begins to close.

The tailgate closes. While the tailgate is closing an acoustic signal sounds. The indicator lamp in the remote tailgate switch goes out.

To interrupt the closing procedure:

- ▶ Press or pull remote tailgate switch ① (▷ page 120).

 You can also close the tailgate manually (▷ page 122).

Warning!



Maintain sight of the area around the rear of the vehicle while operating the tailgate with the door mounted switch. Monitor the closing procedure carefully to make sure no one is in danger of being injured.

To interrupt the closing procedure, press or pull the door mounted remote tailgate switch.

Even with the SmartKey or the SmartKey with KEYLESS-GO* removed from the starter switch or the SmartKey with KEYLESS-GO* removed from the vehicle, the remote tailgate switch can be operated. Therefore, do not leave children unattended in the vehicle, or with access to an unlocked vehicle. Unsupervised use of vehicle equipment may cause an accident and/or serious personal injury.

Warning!



Only drive with the tailgate closed as, among other dangers such as blocked visibility, exhaust fumes may enter the vehicle interior.

If the tailgate comes into contact with an object while closing (e.g. luggage that has been piled too high) the closing procedure is stopped and the tailgate reopens.

Locking and unlocking

Closing the tailgate from the outside manually



① Handle

- ▶ Lower tailgate by pulling firmly on handle ①.
- ▶ Close tailgate with hands placed flat on it.

Once the tailgate touches the latch, the tailgate will pull itself shut automatically.

Warning!



To prevent possible personal injury, always keep hands and fingers away from the cargo compartment opening when closing the tailgate. Be especially careful when small children are around.

When leaving the vehicle, always remove the SmartKey or SmartKey with KEYLESS-GO* from the starter switch, take it with you, and lock the vehicle. Do not leave children unattended in the vehicle, or with access to an unlocked vehicle. Unsupervised use of vehicle equipment may cause an accident and/or serious personal injury.

Warning!



Only drive with the tailgate closed as, among other dangers such as blocked visibility, exhaust fumes may enter the vehicle interior.

i To prevent an inadvertent lockout, do not place the SmartKey in the cargo compartment.

Vehicles with KEYLESS-GO: To prevent a possible inadvertent lockout, the tailgate will open automatically if a SmartKey with KEYLESS-GO is recognized inside the vehicle.*

i If the vehicle was previously centrally locked with the SmartKey or KEYLESS-GO*, the tailgate will lock automatically after closing it. The turn signals flash three times to confirm locking.

Closing the tailgate from the outside (vehicles without KEYLESS-GO*)

In vehicles with power tailgate* you can close the tailgate from the outside using the tailgate closing switch or the  button on the SmartKey.



① Tailgate closing switch

► Press tailgate closing switch ① briefly.

The tailgate closes and an acoustic warning sounds.

i You can also close the tailgate manually (► page 122).

If the tailgate comes into contact with an object while closing (e.g. luggage that has been piled too high), the closing procedure is stopped and the tailgate reopens.

Warning!



Monitor the closing procedure carefully to make sure no one is in danger of being injured. To prevent possible personal injury, always keep hands and fingers away from the cargo compartment opening when closing the tailgate. Be especially careful when small children are around. To stop the closing procedure, do one of the following:

- Press tailgate closing switch ①.
- Press the  button on the SmartKey.
- Press or pull the remote tailgate switch (on the driver's door).

Even with the SmartKey removed from the starter switch, the tailgate closing switch can be operated. Therefore, do not leave children unattended in the vehicle, or with access to an unlocked vehicle. Unsupervised use of vehicle equipment may cause an accident and/or serious personal injury.

Warning!



Only drive with the tailgate closed as, among other dangers such as blocked visibility, exhaust fumes may enter the vehicle interior.

i Do not place the SmartKey in the open cargo compartment. You may lock yourself out.

i If the vehicle was previously centrally locked, the tailgate will lock automatically after closing it. The turn signals will flash three times to confirm locking.

Locking and unlocking

Closing the tailgate from the outside (vehicles with KEYLESS-GO*)

In vehicles with power tailgate* and KEYLESS-GO*, you can close the tailgate separately from the outside using the tailgate closing switch or the  button on the SmartKey with KEYLESS-GO*.



① Tailgate closing switch

Warning!



Monitor the closing procedure carefully to make sure no one is in danger of being injured. To prevent possible personal injury, always keep hands and fingers away from the cargo compartment opening when closing the tailgate. Be especially careful when small children are around. To stop the closing procedure, do one of the following:

- Press tailgate closing switch ①.
- Press the  button on the SmartKey with KEYLESS-GO.
- Press or pull the remote tailgate switch (on the driver's door).

Even with the SmartKey with KEYLESS-GO* removed from the vehicle, the tailgate closing switch can be operated. Therefore, do not leave children unattended in the vehicle, or with access to an unlocked vehicle. Unsupervised use of vehicle equipment may cause an accident and/or serious personal injury.

Warning!



Only drive with the tailgate closed as, among other dangers such as blocked visibility, exhaust fumes may enter the vehicle interior.

- ▶ Make sure you have the SmartKey with KEYLESS-GO* with you.
- ▶ Press tailgate closing switch ① briefly. The tailgate closes and an acoustic warning sounds.

If the tailgate comes into contact with an object while closing (e.g. luggage that has been piled too high), the closing procedure is stopped and the tailgate reopens.

i If the vehicle was previously centrally locked, the tailgate will lock automatically after closing it. The turn signals will flash three times to confirm locking.

i You can also close the tailgate manually (▷ page 122).

Closing the tailgate and locking the vehicle from the outside (vehicles with KEYLESS-GO*)

In vehicles with power tailgate and KEYLESS-GO*, you can close the tailgate and lock the vehicle simultaneously from the outside using the KEYLESS-GO* locking/closing switch or the  button on the SmartKey with KEYLESS-GO*.

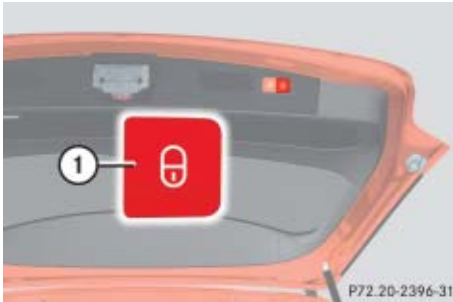

① KEYLESS-GO* locking/closing switch

Warning!



Monitor the closing procedure carefully to make sure no one is in danger of being injured. To prevent possible personal injury, always keep hands and fingers away from the cargo compartment opening when closing the tailgate. Be especially careful when small children are around. To stop the closing procedure, do one of the following:

- Press KEYLESS-GO* locking/closing switch ①.
- Press the  button on the SmartKey with KEYLESS-GO*.
- Press or pull the remote tailgate switch (on the driver's door).

Even with the SmartKey with KEYLESS-GO* removed from the vehicle, the tailgate closing switch can be operated. Therefore, do not leave children unattended in the vehicle, or with access to an unlocked vehicle. Unsupervised use of vehicle equipment may cause an accident and/or serious personal injury.

Warning!



Only drive with the tailgate closed as, among other dangers such as blocked visibility, exhaust fumes may enter the vehicle interior.

- ▶ Make sure you have the SmartKey with KEYLESS-GO* with you.
- ▶ Press KEYLESS-GO* locking/closing switch ① briefly.

The tailgate closes automatically. Once the tailgate is closed, the vehicle locks if doors are closed. The turn signals flash three times to confirm locking. The locking knobs in the doors move down. The anti-theft alarm system is armed.



Locking and unlocking

▷▷ If the tailgate comes into contact with an object while closing (e.g. luggage that has been piled too high), the closing procedure is stopped and the tailgate reopens.

i To prevent a possible inadvertent lockout, the tailgate will open automatically if a SmartKey with KEYLESS-GO* is recognized inside the vehicle.

Automatic central locking

The doors and the tailgate lock automatically when the ignition is switched on and the wheels are turning at vehicle speeds of approximately 9 mph (15 km/h) or more.

You can open a locked door from the inside. Open door only when conditions are safe to do so.

i The doors unlock automatically after an accident if the force of the impact exceeds a preset threshold.

The vehicle automatically locks when the ignition is switched on and the wheels are turning at vehicle speeds of approximately 9 mph (15 km/h) or more. You could therefore lock yourself out when the vehicle

- is pushed or towed
- is on a test stand

For information on towing the vehicle, see “Towing the vehicle” (▷ page 518).

You can deactivate the automatic locking mode using the control system (▷ page 176).

Locking and unlocking from the inside

You can lock or unlock the doors and the tailgate from inside using the central locking or unlocking switch. This can be useful, for example, if you want to lock the vehicle before starting to drive.

The fuel filler flap cannot be locked or unlocked with the central locking or unlocking switch.

Warning!



When leaving the vehicle, always remove the SmartKey or SmartKey with KEYLESS-GO* from the starter switch, take it with you, and lock the vehicle. Do not leave children unattended in the vehicle, or with access to an unlocked vehicle. Unsupervised use of vehicle equipment may cause an accident and/or serious personal injury.

The switches are located in the front-door control panels.

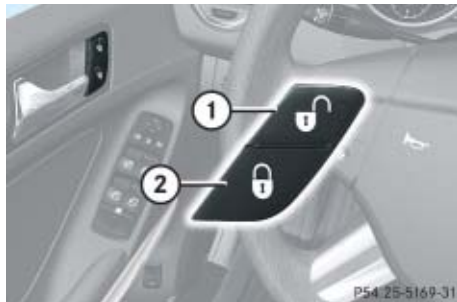

- ① Central unlocking switch
- ② Central locking switch

Locking

- ▶ Press central locking switch ②.

If all doors and the tailgate are closed, the vehicle locks.

Unlocking

- ▶ Press central unlocking switch ①.

The vehicle unlocks.

i You can open a locked door from the inside. Open door only when conditions are safe to do so.

If the vehicle was previously centrally locked with the SmartKey or the SmartKey with KEYLESS-GO, it will not unlock using the central unlocking switch ①.*

If the vehicle was previously locked with the central locking switch ②:

- *While in the selective remote control mode, only the front door opened from the inside is unlocked.*
- *While in the global remote control mode, the vehicle is unlocked completely when a front door is opened from the inside.*

i *With the passenger-side door opened, you cannot lock the vehicle with the central locking switch.*

Seats

For information on seat adjustment, see the “Getting started” section (▷ page 43).

For more information on seats, see “Loading” (▷ page 281).

Front seat active head restraints

Warning!



For your protection, drive only with properly positioned head restraints.

Adjust the head restraint so that it is close to the head as possible and the center of the head restraint supports the back of the head at eye level. This will reduce the potential for injury to the head and neck in the event of an accident or similar situation.

You cannot remove the active head restraints on the driver's and front passenger's seat.

For removal of the active head restraints we recommend that you contact an authorized Mercedes-Benz Light Truck Center.

For information on head restraint adjustment, see “Seats” (▷ page 43).

For information on active head restraints, see “Active head restraint” (▷ page 80).

Rear seat head restraints

Warning!



Do not drive the vehicle without the seat head restraints installed when the rear seats are occupied. Head restraints are intended to help reduce injuries during an accident.

With a rear seat occupied, make sure to move the respective head restraint up from the lowest non-use position and have the occupant adjust the head restraint properly.

For your protection, drive only with properly positioned head restraints.

Adjust the head restraint in such a way that it is as close to the head as possible and the center of the head restraint supports the back of the head at eye level. This will reduce the potential for injury to the head and neck in the event of an accident or similar situation.

Head restraint height

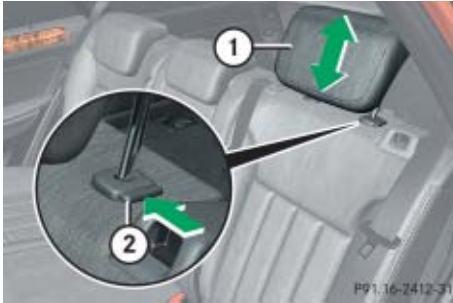

- ① Head restraint
- ② Release button

Raising:

- ▶ Manually adjust the height of head restraint ① by pulling it upward to the desired position.

Lowering:

- ▶ To lower head restraint ①, press release button ② and push down on head restraint ①.

Head restraint fore and aft adjustment



Manually adjust the angle of the head restraint.

- ▶ While seated, reach behind you with both hands and find lower edge of the head restraint.
- ▶ Adjust the head restraint to the desired position by pushing or pulling on the lower edge of the head restraint cushion.

Head restraints, removing and installing

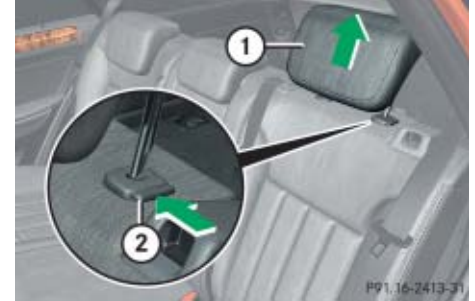

- ① Head restraint
- ② Release button

Removing

- ▶ Pull head restraint ① to its uppermost position.
- ▶ Press release button ② and pull out head restraint.

Seats

Installing

- ▶ Insert head restraint ① into openings on the seat backrest.
- ▶ Push head restraint ① down until it audibly engages.
- ▶ Press release button ② and adjust head restraint ① to the desired position (▷ page 129).

For more information on seats, see the “Getting started” section (▷ page 43).

Lumbar support

The curvature of the driver’s seat can be adjusted to help enhance lower back support and seating comfort.

The lever for lumbar support adjustment is located on the right hand side of the driver’s seat backrest.

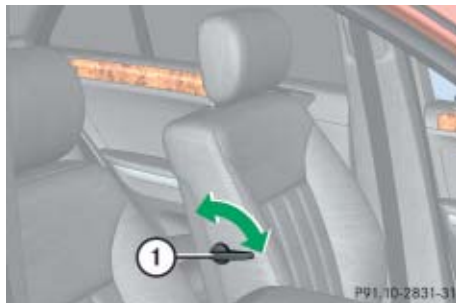

① Adjustment lever

- ▶ Move adjustment lever ① in direction of arrows until you have reached a comfortable seating position.

Multicontour seat*

The multicontour seat has an extendable seat cushion and inflatable air chambers built into the backrest to provide additional lumbar and side support.

The seat cushion depth, seat backrest cushion-height and curvature can be continuously varied with switches on the inside of each front seat base after the ignition is switched on (▷ page 39).



- ① Seat cushion depth
- ② Backrest side bolsters
- ③ Backrest center
- ④ Backrest bottom

- ▶ Switch on the ignition (▷ page 40).

Seat cushion depth

- ▶ Adjust the seat cushion depth to the length of your upper leg with switch ①.

Backrest contour

- ▶ Adjust the contour of the seat backrest to the desired position with switch **+** or **-**.
- ▶ Move the backrest support to the bottom with button ④ or to the center with button ③.

Backrest side bolsters

- ▶ Adjust the side bolsters so that they provide good lateral support using switch ②.

Seat heating*

The switches for front-seat heating are located in the center console.



- ① Seat heating switch, front seats
- ② Indicator lamps

The switches for rear seat heating* are located in the rear center console.

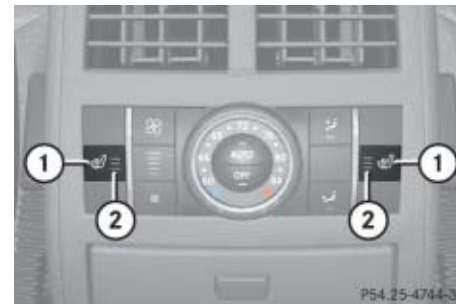

- ① Seat heating switch, rear seats
- ② Indicator lamps

Seats

The red indicator lamps in the switch come on to show which heating level you have selected.

Level	
3	Three indicator lamps on (highest level) The seat heating automatically switches to level 2 after approximately 5 minutes.
2	Two indicator lamps on The seat heating automatically switches to level 1 after approximately 10 minutes.
1	One indicator lamp on (lowest level) The seat heating automatically switches off after approximately 20 minutes.
off	No indicator lamp on

- ▶ Switch on the ignition (▷ page 40).

Switching on

- ▶ Press switch ①.

Three red indicator lamps ② in the switch come on.
- ▶ Continue pressing switch ① until desired seat heating level is reached.

Switching off

- ▶ Press switch ① repeatedly until all indicator lamps ② go out.

i If one or more of the indicator lamps ② on seat heating switch ① (▷ page 131) are flashing, there is insufficient voltage available since too many electrical consumers are switched on. The seat heating switches off automatically.

The seat heating will switch back on again automatically as soon as sufficient voltage is available.

Seat ventilation*

The switches for the seat ventilation are located in the center console.



- ① Seat ventilation switch, front seats
- ② Indicator lamps

The blue indicator lamps in the switch come on to show which ventilation level you have selected.

Level	
3	Three indicator lamps on (highest level)
2	Two indicator lamps on
1	One indicator lamp on (lowest level)
off	No indicator lamp on

- ▶ Switch on the ignition (▷ page 40).

Switching on

- ▶ Press button ① repeatedly until the desired ventilation level is set.

i *The seat ventilation for the driver's seat is automatically set to the highest level if activated via summer opening feature (▷ page 239).*

Switching off

- ▶ Press button ① repeatedly until all indicator lamps ② go out.

Memory function*

Prior to operating the vehicle, the driver should check and adjust the seat height, seat position fore and aft, and seat backrest angle if necessary, to ensure adequate control, reach and comfort. The head restraint should also be adjusted for proper height. See also the section on air bags (▷ page 71) for proper seat positioning.

In addition, adjust the steering wheel to ensure adequate control, reach, operation and comfort. Both the interior and exterior rear view mirrors should be adjusted for adequate rear vision.

Fasten seat belts. Infants and small children should be seated in a properly secured restraint system that complies with U.S. Federal Motor Vehicle Safety Standard 213 and 225 and Canadian Motor Vehicle Safety Standards 213 and 210.2.

With the memory function you can store up to three different settings for each front seat.

The following settings are saved for each stored position on the entry side of the driver's seat:

- Driver's seat, head restraint height and backrest position
- Steering wheel position
- Driver's side exterior rear view mirror position
- Passenger-side exterior rear view mirror position

The following settings are saved for each stored position on the entry side of the front passenger seat:

- Front passenger seat, head restraint height and backrest position

Warning!



Do not activate the memory function while driving. Activating the memory function while driving could cause the driver to lose control of the vehicle.

The memory button and stored position buttons are located on the entry side of each front seat base.



M Memory button

1, 2, 3 Stored position buttons

► Switch on the ignition (▷ page 40).

or

► Open the respective door.

Storing positions into memory

- Adjust the seats (▷ page 43).
- On the driver's side, additionally adjust the steering wheel (▷ page 48) and exterior rear view mirrors (▷ page 49) to the desired positions.
- Press memory button **M**.
- Release memory button **M** and press stored position **1**, **2** or **3** within 3 seconds.

All settings are stored to the selected position.

Recalling positions from memory

! Do not operate the power seats using memory button **M** if the seat backrest is in an excessively reclined position. Doing so could cause damage to front or rear seats.

Move seat backrest to an upright position first.

- Press and hold stored position button **1**, **2** or **3** until the seat, steering wheel and exterior rear view mirrors have fully moved to the stored positions.

i Releasing the stored position button stops movement to the stored positions immediately.

Lighting

For information on how to switch on the headlamps and use the turn signals, see “Switching on headlamps” (▷ page 59) and “Turn signals” (▷ page 60).

i If you drive in countries where vehicles drive on the other side of the road than the country in which the vehicle is registered, you must have the headlamps modified for symmetrical low beams. Relevant information can be obtained at any authorized Mercedes-Benz Light Truck Center.

i Vehicles equipped with active Bi-Xenon* headlamps:
The active Bi-Xenon* headlamps monitor the vehicles steering angle and vehicle speed, then automatically shift their beams to either side to better follow the curvature of the road ahead, increasing usable illumination over conventional headlamps.

Exterior lamp switch



Exterior lamp switch

- 0** Off
Daytime running lamp mode
(▷ page 138)
- AUTO** Automatic headlamp mode
Daytime running lamp mode
(▷ page 137)
- P<=>** Parking lamps (also tail lamps,
license plate lamps, side marker
lamps, instrument panel lamps)

☾ Low beam headlamps or high beam headlamps when the combination switch is pushed forward. The tail lamps, license plate lamps, side marker lamps, parking lamps and instrument panel lamps also come on.

P<=> Standing lamps, right
(turn left one stop)

<=>P Standing lamps, left
(turn left two stops)

☾ Indicator lamp for front fog lamps

☾ Indicator lamp for rear fog lamp

i If you hear a warning signal you have forgotten to switch off the headlamps before opening the driver's door.

In addition the message *Switch off lights* appears in the multifunction display.

Switch off the headlamps.

Manual headlamp mode

The low beam headlamps and the parking lamps can be switched on and off with the exterior lamp switch.

- ▶ Turn the exterior lamp switch to position .

Automatic headlamp mode

The following lamps switch on and off automatically depending on the brightness of the ambient light:

- Low beam headlamps
- Tail and parking lamps
- License plate lamps
- Side marker lamps



Warning!



If the exterior lamp switch is set to **AUTO**,

- the headlamps may switch off unexpectedly when the system senses bright ambient light, for example light from oncoming traffic
- the headlamps will not be automatically switched on under foggy conditions

To minimize risk to you and to others, activate headlamps by turning exterior lamp switch to  when driving or when traffic and/or ambient lighting conditions require you to do so.

In low ambient lighting conditions, only switch from position **AUTO** to  with the vehicle at a standstill in a safe location. Switching from **AUTO** to  will briefly switch off the headlamps. Doing so while driving in low ambient lighting conditions may result in an accident.

The automatic headlamp feature is only an aid to the driver. The driver is responsible for the operation of the vehicle's lights at all times.

- ▶ Turn the exterior lamp switch to position **AUTO**.

With the SmartKey in starter switch position **1** or the KEYLESS-GO* start/stop button pressed once, only the parking lamps and the side marker lamps will switch on and off automatically.

When the engine is running, the low beam headlamps, the tail and parking lamps, the license plate lamps, and the side marker lamps will switch on and off automatically.

Lighting

Daytime running lamp mode

- ▶ Turn the exterior lamp switch to position **0** or **AUTO**.

When the engine is running, the low beam headlamps are switched on.

In low ambient light conditions, the following lamps will switch on additionally:

- Tail and parking lamps
- License plate lamps
- Side marker lamps

i With the daytime running lamp mode activated and the engine running, you cannot switch off the low beam headlamps manually.

Canada only

The daytime running lamp mode is mandatory and therefore in a constant mode.



i With the exterior lamp switch in position **0** or **AUTO**, you cannot switch on the high beam headlamps.

The high beam flasher is available at all times.

For nighttime driving turn the exterior lamp switch to position  to permit activation of the high beam headlamps.

When the engine is running, and you shift from a driving position to position **N** or **P**, the low beam headlamps will switch off with a 3 minute delay.

When the engine is running, and you

- turn the exterior lamp switch to position , the parking lamps and the side marker lamps switch on additionally
- turn the exterior lamp switch to position , the manual headlamp mode has priority over the daytime running lamp mode

The corresponding exterior lamps switch on (▷ page 59).



USA only

By default, the daytime running lamp mode is deactivated. Activate the daytime running lamp mode using the control system, see “Setting daytime running lamp mode (USA only)” (▷ page 171).

i With the exterior lamp switch in position **0**, you cannot switch on the high beam headlamps.

The high beam flasher is available at all times.

*For nighttime driving turn the exterior lamp switch to position  or **AUTO** to permit activation of the high beam headlamps.*

When the engine is running, and you turn the exterior lamp switch to position  or , the manual headlamp mode has priority over the daytime running lamp mode.

The corresponding exterior lamps switch on (▷ page 136).



Locator lighting and night security illumination

The locator lighting and the night security illumination are described in the “Control system” section, see “Setting locator lighting” (▷ page 172) and “Setting night security illumination” (▷ page 172).



Fog lamps

Warning!



In low ambient lighting or foggy conditions, only switch from position **AUTO** to  with the vehicle at a standstill in a safe location. Switching from **AUTO** to  will briefly switch off the headlamps. Doing so while driving in low ambient lighting conditions may result in an accident.

 *Fog lamps will operate with the parking lamps and/or the low beam headlamps on. Fog lamps should only be used in conjunction with low beam headlamps. Consult your State or Province Motor Vehicle Regulations regarding permissible lamp operation.*

 *Fog lamps cannot be switched on with the exterior lamp switch in position **AUTO**. To switch on the fog lamps, turn the exterior lamp switch to position  first.*

Front fog lamps

- ▶ Switch on the low beam headlamps  (▷ page 136).



- ▶ Pull out the exterior lamp switch to first stop.

The front fog lamps switch on.

The green indicator lamp  in the exterior lamp switch comes on (▷ page 136).

- ▶ Push in the exterior lamp switch.

The front fog lamps switch off.

The green indicator lamp  in the exterior lamp switch goes out.

Rear fog lamp (driver's side only)

- ▶ Switch on the low beam headlamps  (▷ page 136).

- ▶ Pull out the exterior lamp switch to second stop.

The rear fog lamp switches on.

The yellow indicator lamp  in the exterior lamp switch comes on (▷ page 136).

- ▶ Push in the exterior lamp switch to first stop.

The rear fog lamp switches off.

The yellow indicator lamp  in the exterior lamp switch goes out.

The front fog lamps remain lit.

Lighting

Combination switch

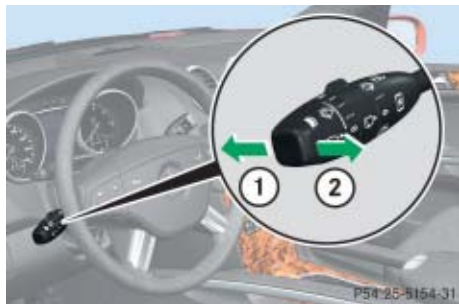

- ① High beam
- ② High beam flasher

High beam

- ▶ Canada only: Turn the exterior lamp switch to position  (▷ page 136).

or

- ▶ USA only: Turn the exterior lamp switch to position  or **AUTO** (▷ page 136).

- ▶ Push the combination switch in direction of arrow ① to switch on the high beam.

The high beam headlamp indicator lamp  in the instrument cluster comes on (▷ page 26).

- ▶ Pull the combination switch in direction of arrow ② to its original position to switch off the high beam.

The high beam headlamp indicator lamp  in the instrument cluster goes out.

High beam flasher

- ▶ Pull the combination switch briefly in direction of arrow ②.

Corner-illuminating front fog lamps*

The corner-illuminating front fog lamps improve illumination of the area in the direction into which you are turning.

The corner-illuminating front fog lamps will operate with the engine running and with

- the exterior lamp switch in position  (▷ page 136)
or
- the exterior lamp switch in position **AUTO** (▷ page 136)
or
- the daytime running lamp mode activated (▷ page 138)

i *The corner-illuminating front fog lamps will only come on in low ambient lighting conditions. If you are driving faster than 25 mph (40 km/h) or have the front fog lamps switched on, the corner-illuminating function is not available.*

Driving forward

Switching on corner-illuminating front fog lamps

- ▶ Switch on the left or right turn signal (▷ page 60), depending on whether you are turning left or right.

The respective front fog lamp comes on and illuminates the area in the direction into which you are turning.

or

- ▶ Turn steering wheel in desired direction.

The front fog lamp on the side of your steering direction comes on.

i *The corner-illuminating front fog lamps temporarily come on on both sides of the vehicle if you turn the steering wheel in one direction and then again in the other direction shortly thereafter.*

i *The corner-illuminating front fog lamps will come on automatically depending on the steering angle and vehicle speed, even if you did not switch on either turn signal. If the corner-illuminating front fog lamps came on automatically, they will also go out automatically depending on the steering angle and vehicle speed.*

Switching off corner-illuminating front fog lamps

The combination switch for the turn signal resets automatically after major steering wheel movements. This will switch off the corner-illuminating front fog lamps if they were activated by switching on the left or right turn signal.

If the turn signal should stay on after making the turn, the turn signal and the corner-illuminating front fog lamps can be switched off by returning the combination switch to its original position.

i *There may be a brief delay before the corner-illuminating front fog lamps switch off.*

Driving rearward

Switching on corner-illuminating front fog lamps

- ▶ Shift the automatic transmission to reverse gear **R** (▷ page 187).

The corner-illuminating front fog lamp opposite to your steering direction comes on.

Switching off corner-illuminating front fog lamps

- ▶ Shift the automatic transmission to a gear other than reverse gear **R** (▷ page 187).

The respective corner-illuminating front fog lamp goes out.

Lighting

Hazard warning flasher

The hazard warning flasher can be switched on at all times, even with the SmartKey removed from the starter switch or with the SmartKey with KEYLESS-GO* removed from the vehicle.

The hazard warning flasher switches on automatically when an air bag deploys.

The hazard warning flasher switch is located on the center console.



① Hazard warning flasher switch

Switching on hazard warning flasher

- ▶ Press hazard warning flasher switch ①.

All turn signals are flashing.

i With the hazard warning flasher activated and the combination switch set for either left or right turn, only the respective turn signals will operate when the ignition is switched on.

Switching off hazard warning flasher

- ▶ Press hazard warning flasher switch ① again.

i If the hazard warning flasher has been activated automatically, press hazard warning flasher switch ① once to switch it off.

Interior lighting

The controls for interior lighting are located in the overhead control panel.

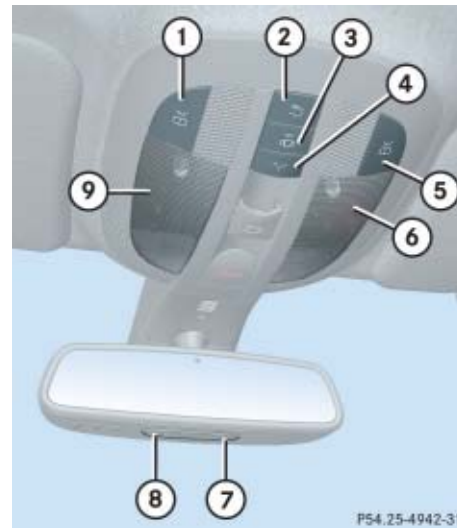

- ① Front left reading lamp switch
- ② Rear interior lighting switch
- ③ Automatic control switch
- ④ Front interior lighting switch
- ⑤ Front right reading lamp switch
- ⑥ Front right interior lamp
- ⑦ Front right reading lamp
- ⑧ Front left reading lamp
- ⑨ Front left interior lamp

! An interior lamp switched on manually does not go out automatically.

Leaving an interior lamp switch in the ON position for extended periods of time with the engine turned off could result in a discharged battery.

Automatic control

i The interior lighting is factory-set to automatic mode.

Deactivating

- ▶ Press switch ③.
The switch engages in the recessed position.

The interior lighting and the locator lighting (▷ page 172) remain switched off even when you

- unlock the vehicle
- open a door
- open the tailgate
- remove the SmartKey from the starter switch

Activating

- ▶ Press switch ③.
The switch disengages from its recessed position back to its original position.

The interior lighting and the locator lighting (▷ page 172) come on when you

- unlock the vehicle
- open a door
- open the tailgate
- remove the SmartKey from the starter switch

The interior lamps go out following an adjustable time delay (▷ page 173).

i If a door remains open, the interior lamps switch off automatically after approximately 5 minutes when the SmartKey is removed or in starter switch position 0.

Manual control

i An interior lamp switched on manually does not go out automatically.

Switching front interior lighting on and off

- ▶ Press front/rear interior lighting switch ④ or ② to switch on the respective interior light.
- ▶ Press front/rear interior lighting switch ④ or ② again to switch off the respective interior light.

Switching front reading lamps on and off

- ▶ Press front reading lamp switch ① or ⑤ to switch on the respective front reading lamp.
- ▶ Press front reading lamp switch ① or ⑤ again to switch off the respective front reading lamp.

Lighting

Switching rear interior reading lamps on and off

The rear interior reading lamps are located above the side windows.



① Rear interior reading lamp

- ▶ Press on reading lamp ① in direction of arrow.

The reading lamp comes on.

- ▶ Press on reading lamp ① in direction of arrow again.

The reading lamp goes out.

Door entry lamps

For better orientation in the dark, the corresponding door entry lamps come on when you open a door and the automatic control is activated.

The door entry lamps will switch off when the corresponding door is closed.

i If you turn the SmartKey in the starter switch to position **0** or remove the SmartKey from the starter switch, the door entry lamps will remain lit for approximately 5 minutes.

Cargo compartment lamp

The cargo compartment lamp comes on when the tailgate is opened.

If you leave the tailgate open for an extended period of time, the cargo compartment lamp will switch off automatically after approximately 5 minutes.

▼ Instrument cluster

For a full view illustration of the instrument cluster, see “Instrument cluster” (▷ page 26).



- ① To dim instrument cluster illumination
- ② Reset button
- ③ To brighten instrument cluster illumination

The instrument cluster is activated when you

- open a door
- switch on the ignition (▷ page 40)
- press reset button ②
- switch on the exterior lamps (▷ page 136)

You can change the instrument cluster settings in the instrument cluster submenu of the control system (▷ page 167).

Warning!



No messages will be displayed if either the instrument cluster or the multifunction display is inoperative.

As a result, you will not be able to see information about your driving conditions, such as speed or outside temperature, warning/indicator lamps, malfunction/warning messages or the failure of any systems. Driving characteristics may be impaired.

If you must continue to drive, do so with added caution. Contact an authorized Mercedes-Benz Light Truck Center as soon as possible.

Adjusting instrument cluster illumination

Use button ① or ③ to adjust the illumination brightness for the instrument cluster.

i *The instrument cluster illumination is dimmed or brightened automatically to suit ambient light conditions.*

The instrument cluster illumination will also be adjusted automatically when you switch on the vehicle's exterior lamps.

To brighten illumination

- ▶ Press and hold button ③ until the desired level of illumination is reached.



To dim illumination

- ▶ Press and hold button ① until the desired level of illumination is reached.

Instrument cluster

Resetting trip odometer

Make sure you are viewing the trip odometer display (▷ page 147).

- ▶ If it is not displayed, press button  or  on the multifunction steering wheel (▷ page 148) repeatedly until the trip odometer appears in the multifunction display.
- ▶ Press and hold reset button ② in the instrument cluster (▷ page 145) until the trip odometer is reset.

Tachometer

The red marking on the tachometer (▷ page 26) denotes excessive engine speed.

 **Avoid driving at excessive engine speeds, as it may result in serious engine damage that is not covered by the Mercedes-Benz Limited Warranty.**

To help protect the engine, the fuel supply is interrupted if the engine is operated within the red marking.

Outside temperature indicator

Warning!



The outside temperature indicator is not designed to serve as an ice-warning device and is therefore unsuitable for that purpose.

Indicated temperatures just above the freezing point do not guarantee that the road surface is free of ice. The road may still be icy, especially in wooded areas or on bridges.

The outside temperature is displayed in the multifunction display (▷ page 147).

The temperature sensor is located in the front bumper area. Due to its location, the sensor can be affected by road or engine heat during idling or slow driving. This means that the accuracy of the displayed temperature can only be verified by comparison to a thermometer placed next to the sensor, not by comparison to external displays (e.g. bank signs etc.).

When moving the vehicle into colder ambient temperatures (e.g. when leaving your garage), you will notice a delay before the lower temperature is displayed.

A delay also occurs when ambient temperatures rise. This prevents inaccurate temperature indications caused by heat radiated from the engine during idling or slow driving.

▼ Control system

The control system is activated as soon as the SmartKey in the starter switch is turned to position **1** (▷ page 40) or as soon as the KEYLESS-GO start/stop button* is in position **1** (▷ page 42). The control system enables you to

- call up information about your vehicle
- change vehicle settings

For example, you can use the control system to find out when your vehicle is next due for maintenance service, to set the language for messages in the instrument cluster display, and much more.

i *The displays for the audio systems (radio, CD player) will appear in English, regardless of the language selected.*

Warning!



A driver's attention to the road and traffic conditions must always be his/her primary focus when driving.

For your safety and the safety of others, selecting features through the multifunction steering wheel should only be done by the driver when traffic and road conditions permit it to be done safely.

Bear in mind that at a speed of just 30 mph (approximately 50 km/h), your vehicle is covering a distance of 44 feet (approximately 14 m) every second.

The control system relays information to the multifunction display.

Multifunction display

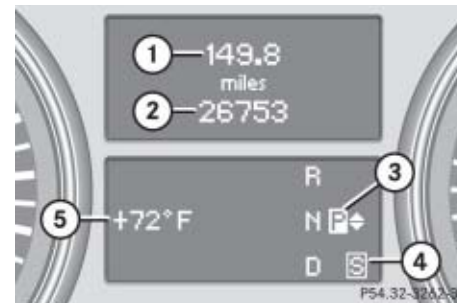

- ① Trip odometer
- ② Main odometer
- ③ Transmission position indicator
- ④ Current transmission program mode¹
- ⑤ Status indicator (outside temperature or digital speedometer)

For more information on menus displayed in the multifunction display, see “Menus” (▷ page 150).

¹ AMG vehicles only.

Control system

Multifunction steering wheel

The displays in the multifunction display and the settings in the control system are controlled by the buttons on the multifunction steering wheel.



① Multifunction display

Operating the control system

② Telephone*:
Press button

 to take a call
to dial
to redial

 to end a call
to reject an incoming call

③ Selecting the submenu or setting the volume:
Press button

 up/to increase

 down/to decrease

④ Voice Control*¹

⑤ Moving within a menu:
Press button

 for next display

 for previous display

⑥ Voice Control*¹

⑦ Menu systems:
Press button

 for next menu

 for previous menu





Depending on the selected menu (▷ page 150), pressing the buttons on the multifunction steering wheel will alter what is shown in the multifunction display.

The information available in the multifunction display is arranged in menus, each containing a number of functions or sub-menus.

The individual functions are then found within the relevant menu (radio or CD operations under *Audio*, for example). These functions serve to call up relevant information or to customize the settings for your vehicle.

¹ Vehicles without Voice Control: Button without function.

It is helpful to think of the menus, and the functions within each menu, as being arranged in a circular pattern.

- If you press button  or  repeatedly, you will pass through each menu one after the other.
- If you press button  or  repeatedly, you will pass through each function display, one after the other, in the current menu.

In the *Settings* menu, instead of functions, you will find a number of submenus for calling up and changing settings. For instructions on using these submenus, see “Settings menu” (▷ page 164).

The number of menus available in the system depends on which optional equipment is installed in your vehicle.

The menus are described on the following pages.

Control system

Menus

This is what you will see when you scroll through the menus ① to ⑥.

The table on the next page provides an overview of the individual menus.

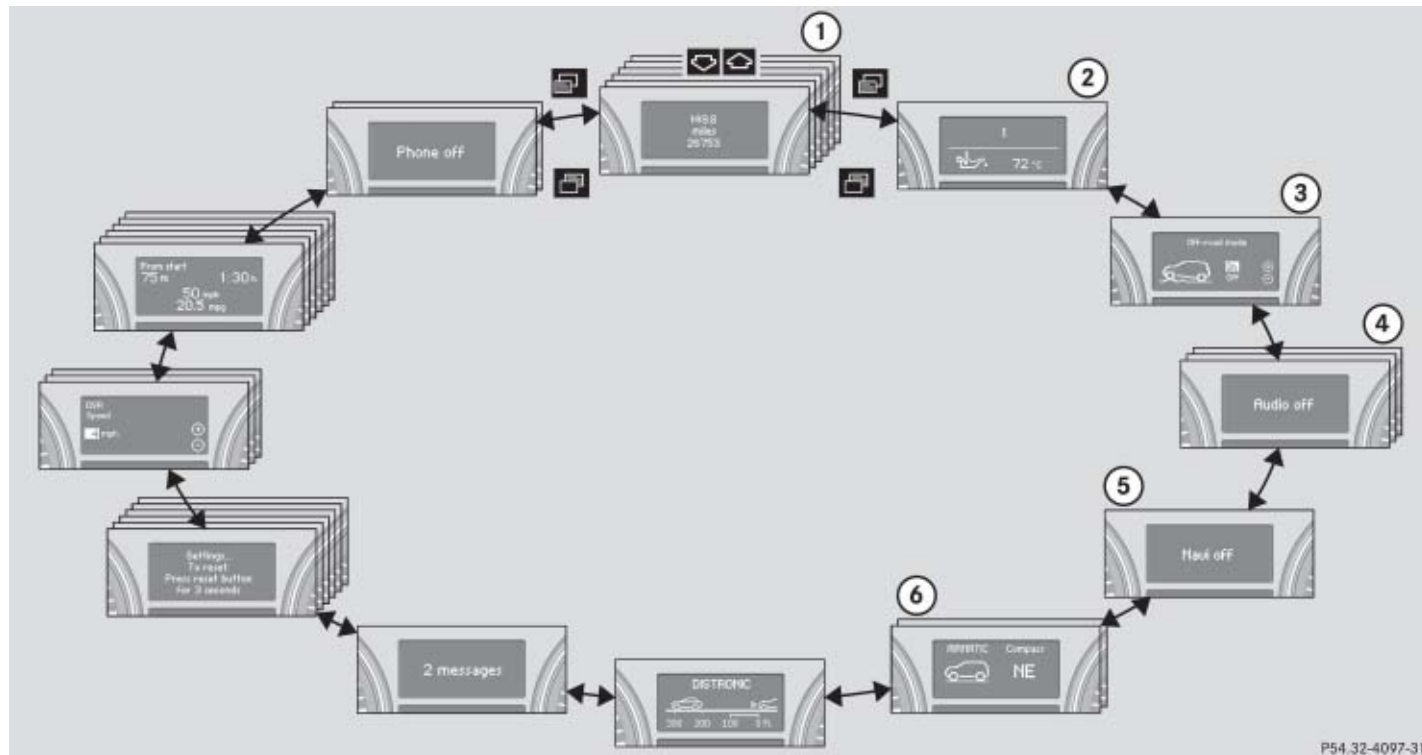

P54.32-4097-31

Menus, submenus and functions

	Menu ① Standard display (▷ page 154)	Menu ② AMG¹ (▷ page 156)	Menu ③ Off-road mode¹ (▷ page 159)	Menu ④ Audio (▷ page 159)	Menu ⑤ Navi* (▷ page 161)	Menu ⑥ Airmatic*/Compass (▷ page 162)
Commands/submenus	Trip- and main odometer	Engine oil temperature	Off-road driving program on/off	Selecting radio station	Route guidance instructions, current direction traveled	Compass
	Checking tire inflation pressure	Vehicle supply voltage		Selecting satellite radio station* (USA only)		Vehicle level*
	Checking coolant temperature	RACETIMER		Operating CD player		
	Calling up digital speedometer or outside temperature	Overall analysis				
	Calling up maintenance service indicator	Lap analysis				
	Checking engine oil level					

¹ AMG vehicles only.

i The headings used in the menus table are designed to facilitate navigation within the

system and are not necessarily identical to those shown in the control system displays. The first

function displayed in each menu will show you which part of the system you are in.

Control system

This is what you will see when you scroll through the menus ⑦ to ⑫.

The table on the next page provides an overview of the individual menus.

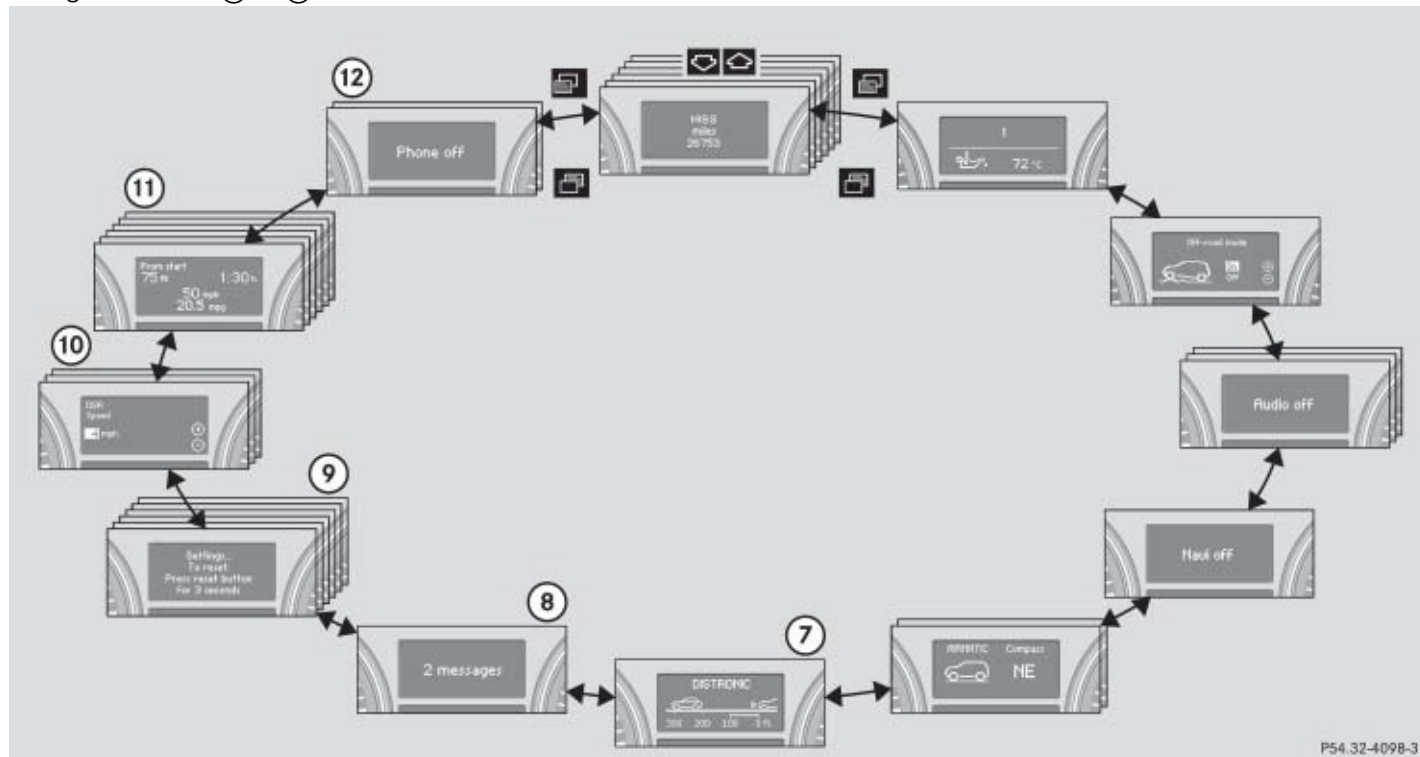

P54.32-4098-31

Menus, submenus and functions

	Menu ⑦ DISTRONIC*	Menu ⑧ Vehicle status message memory ¹	Menu ⑨ Settings	Menu ⑩ Vehicle configuration	Menu ⑪ Trip computer	Menu ⑫ Telephone*
	(▷ page 162)	(▷ page 163)	(▷ page 164)	(▷ page 178)	(▷ page 180)	(▷ page 182)
Commands/submenus	Calling up settings	Calling up vehicle mal-function, warning and system status messages stored in memory	Resetting to factory settings	Distance warning function* on/off	Fuel consumption statistics from start	Loading phone book
			Instrument cluster submenu	DSR (Downhill Speed Regulation) programmed default speed	Fuel consumption statistics since the last reset	Searching for name in phone book
			Time/Date submenu		Distance to empty	
			Lighting submenu			
			Vehicle submenu			
		Comfort submenu*				

¹ The vehicle status message memory menu is only displayed if there is a message stored.

i The headings used in the menus table are designed to facilitate navigation within the

system and are not necessarily identical to those shown in the control system displays. The first

function displayed in each menu will show you which part of the system you are in.

Control system

Standard display menu

In the standard display, the main odometer and the trip odometer appear in the multi-function display.



- ① Trip odometer
- ② Main odometer

- ▶ If you see another display, press button or repeatedly until the standard display appears.
- ▶ Press button or to select the functions in the standard display menu.

The following functions are available:

Function	Page
Checking tire inflation pressure	375
Checking coolant temperature	154
Calling up digital speedometer or outside temperature	155
Calling up maintenance service indicator	403
Checking engine oil level (ML 500)	358



Checking coolant temperature

Warning!



- Driving when your engine is overheated can cause some fluids which may have leaked into the engine compartment to catch fire. You could be seriously burned.
- Steam from an overheated engine can cause serious burns which can occur just by opening the hood. Stay away from the engine if you see or hear steam coming from it.

Stop the vehicle in a safe location away from other traffic. Turn off the engine, get out of the vehicle and do not stand near the vehicle until the engine has cooled down.

- ▶ Press button  or  repeatedly until the coolant temperature appears in the multifunction display.

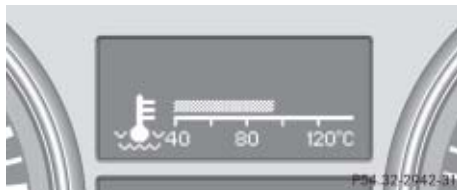



! Excessive coolant temperature triggers a warning message in the multifunction display (▷ page 450).

The engine should not be operated with the coolant temperature above 248 °F (120 °C). Doing so may cause serious engine damage which is not covered by the Mercedes-Benz Limited Warranty.

i During severe operating conditions, e.g. stop-and-go traffic, the coolant temperature may rise close to 248 °F (120 °C).

Calling up digital speedometer or outside temperature

- ▶ Press button  or  repeatedly until the digital speedometer or the outside temperature appears in the multifunction display.



Digital speedometer



Outside temperature

i You can select whether the digital speedometer or the outside temperature is shown in the multifunction display. You can change the setting in the submenu Instr. cluster via the function Status line display, see “Selecting display (digital speedometer or outside temperature) for status indicator” (▷ page 168).

Control system

AMG menu

i This function is only available in AMG vehicles.

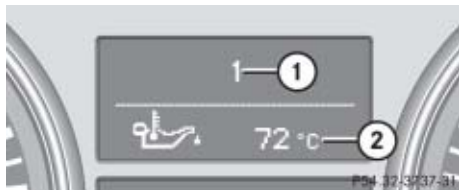

The main screen of the AMG menu shows you the gear currently engaged as well as the engine oil temperature.

- ▶ Press button  or  repeatedly until you see the AMG menu.



- ① Gear indicator
- ② Engine oil temperature



i The engine oil temperature symbol flashes if the engine oil temperature has not yet reached 80°C. During this time, avoid driving at full engine speed.

Use buttons  or  to select the following functions in the AMG menu:

Function	Page
Vehicle supply voltage	156
RACETIMER	157
Overall analysis	158
Lap analysis	159

i If the engine reaches the overspeed range in the manual shift program, the menu will be shown in red. In addition, you will see **UP** next to gear indicator ② as a reminder to upshift.

Vehicle supply voltage

- ▶ Press button  or  repeatedly until you see the AMG menu.
- ▶ Press button  repeatedly until you see the vehicle supply voltage.

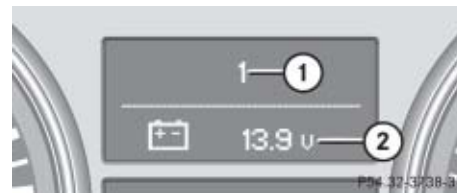

- ① Gear indicator
- ② Vehicle supply voltage

RACETIMER

Warning!

The RACETIMER feature is only for use on roads and in conditions where high speed driving is permitted. Racing on public roads is prohibited under any circumstances and the driver is and must always remain responsible for following posted speed limits.

The RACETIMER allows you to time and save driving stretches in hours, minutes and seconds.

- ▶ Press button or repeatedly until you see the AMG menu.

- ▶ Press button repeatedly until you see the RACETIMER.

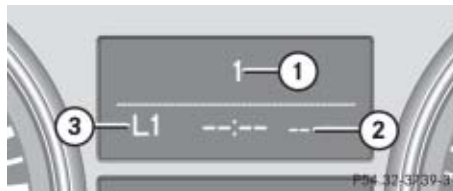

- ① Gear indicator
- ② RACETIMER
- ③ Lap

i You can start the RACETIMER when the engine is running or the starter switch is in position **2** (▷ page 40).

i While the RACETIMER is being displayed, you cannot adjust the volume using buttons or .

Starting the RACETIMER

- ▶ Press button .

The timer starts.

Displaying intermediate time

- ▶ Press button while the timer is running.

The intermediate time is shown for five seconds.

Stopping the RACETIMER

- ▶ Press button .

The timer stops.

i When you stop the vehicle and turn the SmartKey to position **1** (▷ page 40) or, in vehicles with KEYLESS-GO*, turn off the engine and do not open the driver's door, the RACETIMER stops timing. Timing is resumed when you switch the ignition back on (▷ page 40) or restart the engine (▷ page 54) and then press the button.

Control system

Saving lap time and starting a new lap

i You can save up to nine laps.

- ▶ Press button **[-]** while the timer is running.

The intermediate time will be shown for five seconds.

- ▶ Press button **[-]** within 5 seconds.

The intermediate time shown will be saved as a lap time.

The RACETIMER begins timing the new lap. The new lap begins to be timed as soon as the intermediate time is called up.



- ① Gear indicator
- ② RACETIMER
- ③ Best lap time
- ④ Lap number

Resetting current lap

- ▶ Press button **[+]** while the timer is running.

The timer stops.

- ▶ Press button **[-]**.

The lap time is reset to "0".

Deleting all laps

i It is not possible to delete a single saved lap.

- ▶ Press button **[+]** while the timer is running.

The timer stops.

- ▶ Press the reset button twice (▷ page 26).

- ▶ Press button **[+]**.

The timer starts. The saved laps are deleted.

i When you switch off the engine, the RACETIMER will be reset to "0" after 30 seconds. All laps are deleted.

Overall analysis

i These functions are only available if you have saved at least one lap and have stopped the RACETIMER.



- ▶ Press button **[⏏]** or **[⏏]** repeatedly until you see the AMG menu.
- ▶ Press button **[⏏]** repeatedly until you see the overall analysis.



- ① Overall analysis of RACETIMER
- ② Overall driving time
- ③ Maximum speed
- ④ Overall distance driven
- ⑤ Average speed

Lap analysis

i These functions are only available if you have saved at least two laps and have stopped the RACETIMER.

- ▶ Press button  or  repeatedly until you see the AMG menu.
- ▶ Press button  repeatedly until you see the lap analysis.



- ① Lap number
- ② Lap time
- ③ Maximum speed
- ④ Lap length
- ⑤ Average speed during lap

- ▶ Press button  or  to see other lap analyses.

i Each lap is shown in its own submenu. The fastest lap is indicated by flashing symbol ①.

Off-road mode menu

i This function is only available in AMG vehicles.

Use this function to switch the off-road driving program (▷ page 268) On or Off.

- ▶ Press button  or  repeatedly until you see the Off-road mode menu.

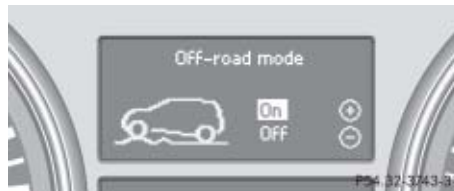

Off-road mode

- ▶ Press button  or  to switch the off-road driving program On or Off.

The symbol  appears in the lower multifunction display.



i The setting is stored when you turn off the engine.

Audio menu

The functions in the Audio menu operate the audio equipment which you currently have turned on.



If no audio equipment is currently turned on, the message Audio off appears in the multifunction display.

Control system

The following functions are available:

Function	Page
Selecting radio station	160
Selecting satellite radio station* (USA only)	160
Operating CD player	161



Selecting radio station

- ▶ Turn on the COMAND system and select radio. Refer to separate COMAND system operating instructions.
- ▶ Press button  or  repeatedly until the currently tuned station appears in the multifunction display.



- ① Waveband setting
- ② Station frequency

- ▶ Press button  or  repeatedly until the desired station is found.

The station search depends on the selected setting in the **Vehicle** submenu of the control system (▷ page 176). Pressing button  or  will either start a frequency scan or select the next stored radio station.

i You can only store new stations using the corresponding feature on the radio. Refer to separate COMAND system operating instructions.

You can also operate the radio in the usual manner.



Selecting satellite radio station* (USA only)

The satellite radio is treated as a radio application.

- ▶ Select satellite radio with the corresponding soft key on the COMAND system.



- ① SAT mode
- ② Channel name or number



- ▶ Press button  or  repeatedly until the desired channel is found.

i Additional optional satellite radio equipment and a subscription to satellite radio service provider are required for satellite radio operation. Contact an authorized Mercedes-Benz Light Truck Center for details and availability for your vehicle.

For more information, refer to separate COMAND system operating instructions.

Operating the CD player

Selecting CD track

- ▶ Turn on the COMAND system and select CD. Refer to separate COMAND system operating instructions.
- ▶ Press button  or  repeatedly until the settings for the CD currently being played appear in the multifunction display.





- ① Current CD (for CD changer*)
- ② Current track

- ▶ Press button  or  repeatedly until the desired track is selected.

i Vehicles with CD changer*: To select a CD from the magazine, press a number on the COMAND system key pad located in the center console.

Selecting MP3-CD track

- ▶ Turn on the COMAND system and select MP3. Refer to separate COMAND system operating instructions.
- ▶ Press button  or  repeatedly until the settings for the MP3-CD currently being played appear in the multifunction display.





- ① MP3 mode
- ② Current track

- ▶ Press button  or  repeatedly until the desired track is selected.

Navi* menu

The Navi menu contains the functions needed to operate your navigation system.

- ▶ Press button  or  repeatedly until the message Navi appears in the multifunction display.

Control system



The message shown in the multifunction display depends on the status of the navigation system:

- With the COMAND system switched off, the message *Navi off* appears in the multifunction display.
- With the COMAND system switched on but route guidance not activated, the direction of travel and, if applicable, the name of the street currently traveled on appear in the multifunction display.
- With the COMAND system switched on and route guidance activated, the direction of travel and maneuver instructions appear in the multifunction display.

Please refer to the COMAND system manual for instructions on how to activate the route guidance system.

AIRMATIC*/Compass menu

The AIRMATIC/Compass menu displays the messages for air suspension* and the direction into which you are currently driving.

- ▶ Press button  or  repeatedly until one of the following messages appears in the multifunction display.

Vehicles with steel suspension:



Vehicles with air suspension* or ML 63 AMG:



- ▶ Press button  or  repeatedly until the desired setting is found.



For information on air suspension, see “Air suspension package*” (▷ page 269).

For information on the compass, see “Vehicle submenu” (▷ page 174) and “Compass” (▷ page 321).

DISTRONIC* menu

Use the DISTRONIC menu (▷ page 255) to display the current settings for your Distronic system. The information shown in the multifunction display depends on whether the Distronic system is activated or deactivated.

Please refer to the “Driving systems” section of this manual (▷ page 250) for instructions on how to activate Distronic.

- ▶ Press button  or  repeatedly to select the Distronic menu in the multifunction display.

Vehicle status message memory menu



Use the vehicle status message memory menu to scan malfunction and warning messages that may be stored in the system. Such messages appear in the multifunction display and are based on conditions or system status the vehicle's system has recorded.

The vehicle status message memory menu only appears if messages have been stored.

Warning!



Malfunction and warning messages are only indicated for certain systems and are intentionally not very detailed. The malfunction and warning messages are simply a reminder with respect to the operation of certain systems and do not replace the owner's and/or driver's responsibility to maintain the vehicle's operating safety by having all required maintenance and safety checks performed on the vehicle and by bringing the vehicle to an authorized Mercedes-Benz Light Truck Center to address the malfunction and warning messages (> page 428).

- ▶ Press button  or  repeatedly until the vehicle status message memory appears in the multifunction display.

If the vehicle status message memory does not appear, no messages have been stored.

If conditions have occurred causing status messages to be recorded, the number of messages appears in the multifunction display:

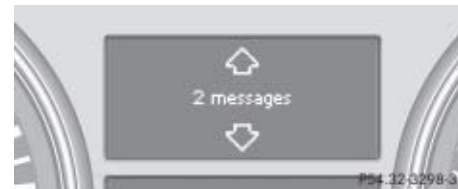

- ▶ Press button  or .

The stored messages will now be displayed in the order in which they have occurred. For malfunctions and warning messages, see “Vehicle status messages in the multifunction display” (> page 428).

i After you have scrolled through all recorded status messages, the first recorded message appears again.

Control system



Should the vehicle's system record any conditions while driving, the number of messages will reappear in the multifunction display

- when the SmartKey in the starter switch is turned to position **0** or removed from the starter switch.
or
- when you turn off the engine by pressing the KEYLESS-GO* start/stop button (▷ page 67) in the starter switch once and open the driver's door (this puts the starter switch in position **0**, same as with the SmartKey removed from the starter switch)

i The vehicle status message memory will be cleared when you turn the SmartKey in the starter switch to position **1** or **2**, or when you press the KEYLESS-GO* start/stop button once or twice without depressing the brake pedal. You will then only see high priority messages in the multifunction display (▷ page 428).

Settings menu

In the Settings menu there are two functions:

- The function Reset to factory settings?, with which you can reset all the settings to the original factory settings.
 - A collection of submenus with which you can make individual settings for your vehicle.
- ▶ Press button  or  repeatedly until the Settings menu appears in the multifunction display.



The following settings and submenus are available in the Settings menu:

Function	Page
Resetting all settings	165
Submenus in the settings menu	165
Instrument cluster submenu	167
Time/date submenu	169
Lighting submenu	171
Vehicle submenu	174
Comfort submenu*	177

Resetting all settings

You can reset the functions of all submenus to the factory settings.

- ▶ Press the reset button in the instrument cluster (▷ page 145) for approximately 3 seconds.

The request to press the reset button once more to confirm appears in the multifunction display.



- ▶ Press the reset button once more.

The functions of all the submenus will reset to factory settings.

i *The settings you have changed will not be reset unless you confirm the action by pressing the reset button a second time.*

After approximately 5 seconds, the Settings menu reappears in the multifunction display (▷ page 164).

i *For safety reasons, the function Lamp circuit headlamp in the Lighting submenu cannot be reset while driving.*

The following message appears in the multifunction display:

Settings
Cannot be completely reset to factory settings while driving

Submenus in the Settings menu



- ▶ Press button .

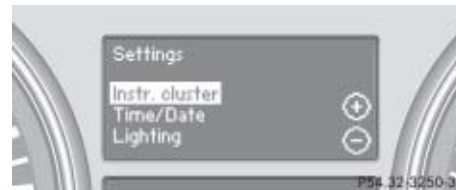

The collection of the submenus appears in the multifunction display.





- ▶ Press button .

The selection marker moves to the next submenu.

The submenus are arranged by hierarchy. Scroll down with button , scroll up with the button .

With the selection marker on the desired submenu, use the  button to access the individual functions within that submenu. Once within that submenu, you can use the  button to move to the next function or the  button to move to the previous function within that submenu.

The settings themselves are made with button  or .

Control system

The table below shows what settings can be changed within the various menus. Detailed instructions on making individual settings can be found on the following pages.

INSTRUMENT CLUSTER (▷ page 167)	TIME/DATE (▷ page 169)	LIGHTING (▷ page 171)	VEHICLE (▷ page 174)	COMFORT* (▷ page 177)
Selecting speedometer display mode	Setting the time (hours)	Setting daytime running lamp mode (USA only)	Compass adjustment	Activating easy-entry/exit feature*
Selecting language	Setting the time (minutes)	Setting locator lighting	Compass calibration	Setting fold-in function* for exterior rear view mirrors
Selecting display (digital speedometer or outside temperature) for status indicator	Setting the date (month)	Setting night security illumination	Audio search function	
	Setting the date (day)	Setting interior lighting delayed shut-off	Setting automatic locking	
	Setting the date (year)		Limiting opening height of tailgate*	

Instrument cluster submenu

Access the Instr. cluster submenu via the Settings menu. Use the Instr. cluster submenu to change the instrument cluster display settings.

The following functions are available:

Function	Page
Selecting speedometer display mode	167
Selecting language	167
Selecting display (digital speedometer or outside temperature) for status indicator	168

Selecting speedometer display mode

- ▶ Move the selection marker with button **+** or **-** to the Instr. cluster submenu.
- ▶ Press button **↶** or **↷** repeatedly until the message **Display unit** appears in the multifunction display.

The selection marker is on the current setting.

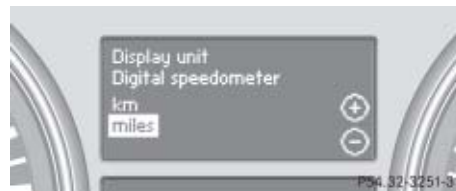

- ▶ Press button **+** or **-** to set speedometer unit to km or miles.

Selecting language

- ▶ Move the selection marker with button **+** or **-** to the Instr. cluster submenu.
- ▶ Press button **↶** or **↷** repeatedly until the message **Language** appears in the multifunction display.

The selection marker is on the current setting.



- ▶ Press button **+** or **-** to select the language to be used for the multifunction display messages.

▷▷

Control system

▷▷ Available languages:

- German
- English
- French
- Italian
- Spanish
- Dutch
- Swedish
- Danish
- Turkish
- Portuguese
- Russian (Canada only)

Selecting display (digital speedometer or outside temperature) for status indicator

- ▶ Move the selection marker with button **+** or **-** to the Instr. cluster submenu.
- ▶ Press button **↶** or **↷** repeatedly until the message *Status line display* appears in the multifunction display.

The selection marker is on the current setting.

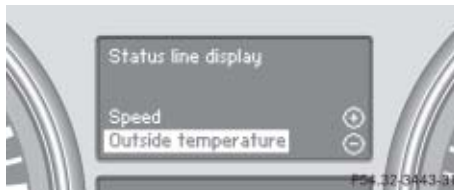

- ▶ Press button **+** or **-** to select the desired setting.

The selected display is then shown continuously in the status indicator (lower display).

The other display now appears in the menu of the standard display (▷ page 154):

- Digital speedometer
or
- Outside temperature

Time/Date submenu

Access the Time/Date submenu via the Settings menu. Use the Time/Date submenu to change the time and date settings.

The following functions are available:

Function	Page
Setting the time (hours)	169
Setting the time (minutes)	169
Setting the date (month)	170
Setting the date (day)	170
Setting the date (year)	170

i If your vehicle is equipped with the COMAND system and navigation module*, see separate COMAND system operating instructions for information on how to set the date and time.

Setting the time (hours)

This function is not available if your vehicle is equipped with the COMAND system and navigation module*.

- ▶ Move the selection marker with button **+** or **-** to the Time/Date submenu.
- ▶ Press button **↶** or **↷** repeatedly until the message **Clock Set hour** appears in the multifunction display.

The selection marker is on the hour setting.

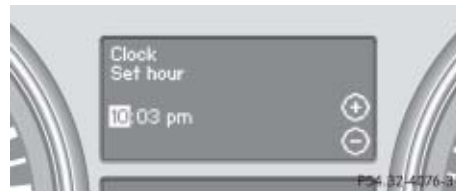

- ▶ Press button **+** or **-** to set the hour.

Setting the time (minutes)

This function is not available if your vehicle is equipped with the COMAND system and navigation module*.

- ▶ Move the selection marker with button **+** or **-** to the Time/Date submenu.
- ▶ Press button **↶** or **↷** repeatedly until the message **Clock Set minute(s)** appears in the multifunction display.

The selection marker is on the minute setting.

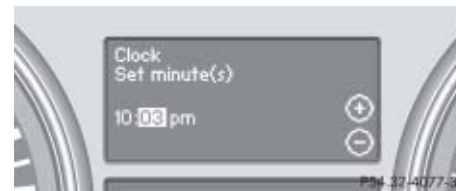

- ▶ Press button **+** or **-** to set the minutes.

Control system

Setting the date (month)

This function is not available if your vehicle is equipped with the COMAND system and navigation module*.

- ▶ Move the selection marker with button **+** or **-** to the Time/Date submenu.
- ▶ Press button **↶** or **↷** repeatedly until the message Date Set month appears in the multifunction display.

The selection marker is on the month setting.

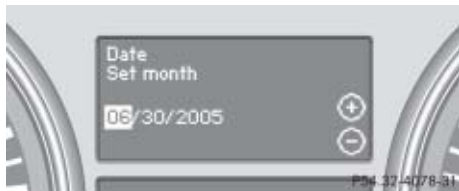

- ▶ Press button **+** or **-** to set the month.

Setting the date (day)

This function is not available if your vehicle is equipped with the COMAND system and navigation module*.

- ▶ Move the selection marker with button **+** or **-** to the Time/Date submenu.
- ▶ Press button **↶** or **↷** repeatedly until the message Date Set day appears in the multifunction display.

The selection marker is on the day setting.



- ▶ Press button **+** or **-** to set the day.

Setting the date (year)

This function is not available if your vehicle is equipped with the COMAND system and navigation module*.

- ▶ Move the selection marker with button **+** or **-** to the Time/Date submenu.
- ▶ Press button **↶** or **↷** repeatedly until the message Date Set year appears in the multifunction display.

The selection marker is on the year setting.

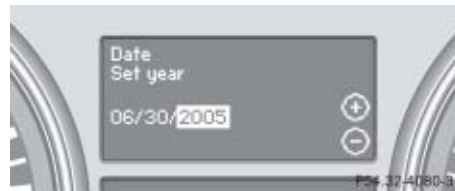

- ▶ Press button **+** or **-** to set the year.

Lighting submenu

Access the Lighting submenu via the Settings menu. Use the Lighting submenu to change the lamp and lighting settings on your vehicle.

The following functions are available:

Function	Page
Setting daytime running lamp mode (USA only)	171
Setting locator lighting	172
Setting night security illumination	172
Setting interior lighting delayed shut-off	173

Setting daytime running lamp mode (USA only)

i This function is not available in countries where the daytime running lamp mode is mandatory and therefore in a constant mode.

- ▶ Move the selection marker with button **+** or **-** to the Lighting submenu.
- ▶ Press button **↶** or **↷** repeatedly until the message Lamp circuit headlamp appears in the multifunction display.

The selection marker is on the current setting.



- ▶ Press button **+** or **-** to select manual operation (Manual) or daytime running lamp mode (Constant).

With daytime running lamp mode activated and the exterior lamp switch at position **0** or **AUTO**, the low beam headlamps are switched on when the engine is running.

In low ambient light conditions the following lamps will switch on additionally:

- Parking lamps
- Tail lamps
- License plate lamps
- Side marker lamps

For more information on the daytime running lamp mode, see “Lighting” (▷ page 136).

i For safety reasons, changing the setting for the daytime running lamp mode is not possible while the vehicle is in motion. The following message appears in the multifunction display:

Settings only possible at standstill

For safety reasons, resetting to factory settings (▷ page 165) while driving will not deactivate the daytime running lamp mode.

Control system





Setting locator lighting

With the locator lighting feature activated, the exterior lamp switch in position **AUTO** (▷ page 136) and the interior lighting in automatic mode (▷ page 143), the following lamps will switch on during darkness when the vehicle is unlocked using button  on the SmartKey or SmartKey with KEYLESS-GO:

- Parking lamps
- Tail lamps
- License plate lamps
- Side marker lamps
- Front fog lamps*



The locator lighting switches off when the driver's door is opened.

If you do not open a door after unlocking the vehicle with the SmartKey, the lamps will switch off automatically after approximately 40 seconds.

- ▶ Move the selection marker with button  or  to the Lighting submenu.
- ▶ Press button  or  repeatedly until the message **Function Surround lighting** appears in the multifunction display.

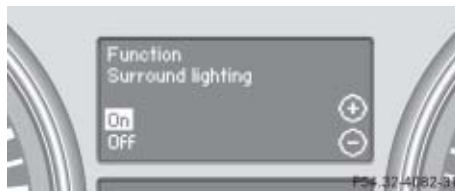
The selection marker is on the current setting.



- ▶ Press button  or  to switch the locator lighting function On or Off.
- ▶ Turn the exterior lamp switch to position **AUTO** when exiting the vehicle. The locator lighting feature is activated.

Setting night security illumination (Headlamps delayed shut-off)

Use this function to set whether you would like the exterior lamps to remain on for 15 seconds during darkness after exiting the vehicle and closing all doors.

With the headlamps delayed shut-off feature activated and the exterior lamp switch in position **AUTO** before the engine is turned off, the following lamps will switch on when the engine is turned off:

- Parking lamps
- Tail lamps
- License plate lamps
- Side marker lamps
- Front fog lamps*

If after turning off the engine you do not open a door or do not close an opened door, the lamps will automatically switch off after 60 seconds.

- ▶ Move the selection marker with button **+** or **-** to the Lighting submenu.
- ▶ Press button **↶** or **↷** repeatedly until the message Headlamp delayed shut-off appears in the multifunction display.

The selection marker is on the current setting.

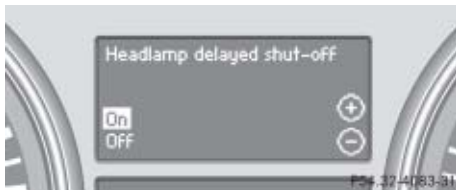

- ▶ Press button **+** or **-** to switch the headlamps delayed shut-off feature On or Off.

- ▶ Turn the exterior lamp switch to position **AUTO** before turning off the engine.

The headlamps delayed shut-off feature is activated.

You can temporarily deactivate the headlamps delayed shut-off feature:

- ▶ Before exiting the vehicle, turn the SmartKey in the starter switch to position **0**.
- ▶ Then turn it to position **2** and back to **0**.

The headlamps delayed shut-off feature is deactivated. It will reactivate as soon as you reinsert the SmartKey in the starter switch.

Vehicles with KEYLESS-GO*:

- ▶ Press KEYLESS-GO start/stop button in the starter switch (▷ page 41).

Setting interior lighting delayed shut-off

Use this function to set whether you would like the interior lighting to remain on for 10 seconds during darkness after you have removed the SmartKey from the starter switch.

- ▶ Move the selection marker with button **+** or **-** to the Lighting submenu.
- ▶ Press button **↶** or **↷** repeatedly until the message Int. light. delayed shut-off appears in the multifunction display.

The selection marker is on the current setting.

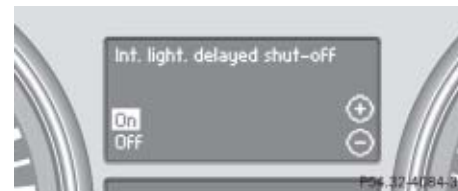

- ▶ Press button **+** or **-** to switch the interior lighting delayed shut-off feature On or Off.

Control system

Vehicle submenu

Access the **Vehicle** submenu via the **Settings** menu. Use the **Vehicle** submenu to make general vehicle settings.

The following functions are available:

Function	Page
Compass adjustment	174
Compass calibration	175
Audio search function	176
Setting automatic locking	176
Limiting opening height of tailgate*	177

Compass adjustment

This function is not available if your vehicle is equipped with the COMAND system and navigation module*.

Determine your location on the basis of the following zone maps.

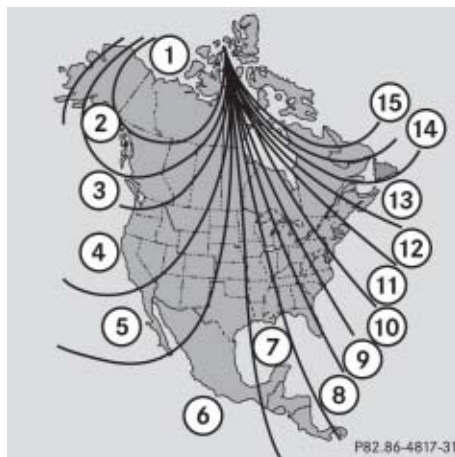

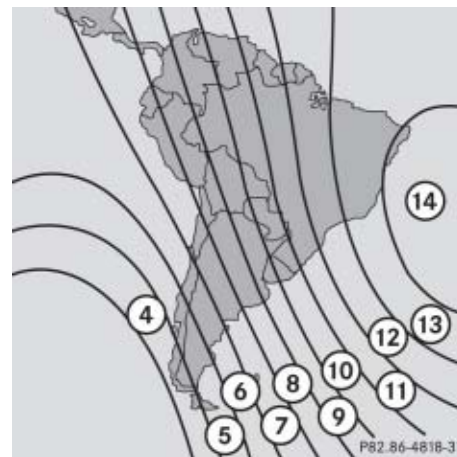

Zone map North America



Zone map South America

- ▶ Press button **+** or **-** to move the selection marker to the **Vehicle** submenu.

- ▶ Press button  or  repeatedly until the message **Compass setting Zone** appears in the multifunction display.

The selection marker is on the current setting.

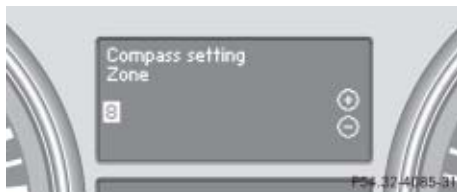

- ▶ Press button  or  to set the respective compass zone.



For information on how to call up the compass, see “Compass” (▷ page 321).



Compass calibration

i Make sure you are in area where you can drive a full circle with your vehicle without disturbing traffic in order to calibrate the compass.

This function is not available if your vehicle is equipped with the COMAND system and navigation module*.

In order to calibrate the compass properly, mind the following:

- Calibrate the compass in open terrain. Nearby buildings, bridges, power lines and large antenna masts, for example, could impair compass calibration.
- Switch off electrical consumers (e.g. climate control, windshield wipers, or rear window defroster).
- Close all doors and the tailgate.
- ▶ Start the engine (▷ page 54).
- ▶ Press button  or  to move the selection marker to the **Vehicle** submenu.

- ▶ Press button  or  repeatedly until the message **Compass Calibration** appears in the multifunction display.

The selection marker is on setting switched off.

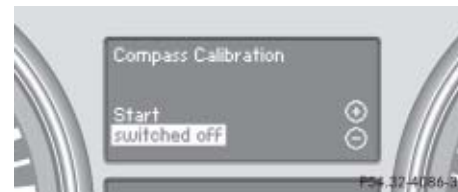

- ▶ Press button  to set the selection marker to **Start**.

The following message appears in the multifunction display:

Compass Calibration active
Please drive in a full circle ▷▷

Control system

- ▷▷ Drive a full circle at a vehicle speed of between 3 mph and 6 mph (5 km/h and 10 km/h).

When calibration was successful, the following message appears in the multifunction display:

Compass calibration
Completed successfully

i If the message *Compass calibration Completed successfully* does not appear in the multifunction display, drive another full circle.

If calibration does not succeed within 3 minutes, the message *Compass Calibration appears in the multifunction display again. Calibrating the compass has failed due to outside influences.*

Repeat compass calibration in a different location.

Audio search function

Use of the Audio search function to select a radio station will enable you to start a frequency scan (Freq.) (▷ page 160) or select a radio station stored in memory (Memory).

- ▶ Move the selection marker with button **+** or **-** to the Vehicle submenu.
- ▶ Press button **↶** or **↷** repeatedly until the message *Audio Search* function appears in the multifunction display.

The selection marker is on the current setting.



- ▶ Press button **+** or **-** to select *Freq.* or *Memory*.

Setting automatic locking

Use this function to activate or deactivate the automatic central locking. With the automatic central locking system activated, the vehicle is centrally locked at vehicle speeds of approximately 9 mph (15 km/h).

- ▶ Move the selection marker with button **+** or **-** to the Vehicle submenu.
- ▶ Press button **↶** or **↷** repeatedly until the message *Automatic door lock* appears in the multifunction display.

The selection marker is on the current setting.



- ▶ Press button **+** or **-** to switch the automatic central locking *On* or *Off*.

Limiting opening height of tailgate*

Use this function to activate or deactivate the limiting opening height of the tailgate.

- ▶ Move the selection marker with button **+** or **-** to the Vehicle submenu.
- ▶ Press button **↕** or **↙** repeatedly until the message **Opening limiter Tailgate** appears in the multifunction display.

The selection marker is on the current setting.

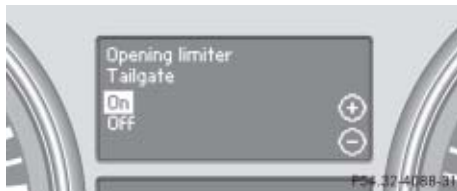

- ▶ Press button **+** or **-** to switch the limiting opening height of the tailgate **On** or **Off**.

Comfort submenu*

Access the **Comfort** submenu via the **Settings** menu. Use the **Comfort** submenu to change the settings for a number of convenience features.

The following functions are available:

Function	Page
Activating easy-entry/exit feature*	177
Setting fold-in function* for exterior rear view mirrors	178

Activating easy-entry/exit feature*

Use this function to activate and deactivate the easy-entry/exit feature (▷ page 46).

Warning!



You must make sure no one can become trapped or injured by the moving steering wheel when the easy-entry/exit feature is activated.

To stop steering wheel movement, do one of the following:

- Move steering wheel adjustment stalk* (▷ page 48).
- Press one of the memory position buttons or the memory button **M*** (▷ page 135).

Do not leave children unattended in the vehicle, or with access to an unlocked vehicle. Children could open the driver's door and unintentionally activate the easy-entry/exit feature, which could result in an accident and/or serious personal injury.

Control system

- ▶ Move the selection marker with button **+** or **-** to the Comfort submenu.
- ▶ Press button **↶** or **↷** repeatedly until the message **Easy-entry feature** appears in the multifunction display.

The selection marker is on the current setting.

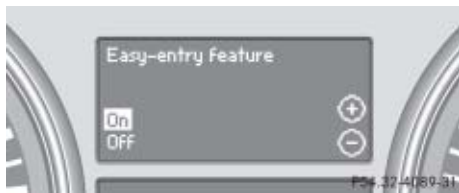

- ▶ Press button **+** or **-** to switch the easy-entry/exit feature On or Off.

Setting fold-in function* for exterior rear view mirrors

Using this function, you can set the exterior rear view mirrors to be automatically folded in when you lock your vehicle.

i With this function set to On and the exterior rear view mirrors folded in using the button on the door control panel (▷ page 202), the exterior rear view mirrors will not fold out when you switch on the ignition. You will then have to fold out the exterior rear view mirrors using the button on the door control panel (▷ page 202).

Make sure both exterior rear view mirrors are folded out completely before driving off.

- ▶ Move the selection marker with button **+** or **-** to the Comfort submenu.
- ▶ Press button **↶** or **↷** repeatedly until the message **Fold in mirrors when locking** appears in the multifunction display.

The selection marker is on the current setting.



- ▶ Press button **+** or **-** to switch function On or Off.





Vehicle configuration

The following functions are available:



Function	Page
Distance warning function* on/off	179
DSR set speed	179

Distance warning function*

In vehicles equipped with Distronic*, you can determine whether the distance warning function is to be enabled or disabled. With this function set to On, the system will alert you when recognizing a stationary obstacle or a slower vehicle moving in your vehicle's path and the danger of a collision exists, even when the Distronic* is switched off.

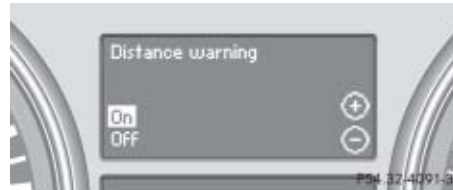

- ▶ Press button  or  repeatedly until the Vehicle configuration menu appears in the multifunction display.
- ▶ Press button  or  repeatedly until the message Distance warning appears in the multifunction display. The selection marker is on the current setting.



- ▶ Press button  or  to switch the distance warning function On or Off.







- ① Symbol for activated distance warning function

If the distance warning function is activated you will see the  symbol in the Standard display. When the distance warning function is deactivated the  symbol will not appear.

DSR (Downhill Speed Regulation) programmed default speed

In the Downhill Speed Regulation menu, you can program the default speed the DSR is set to when it is activated.

You can program the default speed between 4-10 mph (Canada: 6-18 km/h). The set value is increased in 1 mph (Canada: 2 km/h) increments.

- ▶ Press button  or  repeatedly until the Vehicle configuration menu appears in the multifunction display.
- ▶ Press button  or  repeatedly until the message DSR Speed appears in the multifunction display.

The selection marker is on the current setting.

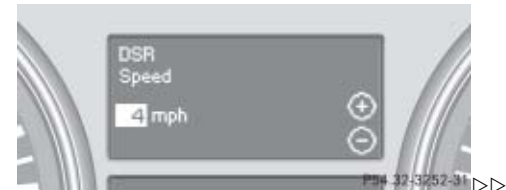

Control system

- ▷▷ Press button **+** or **-** repeatedly until the desired speed is shown in the multifunction display.

When DSR is switched on, DSR will use the programmed default speed to regulate the vehicle's speed.

i Once DSR is switched on, you can adjust the set speed using the cruise control lever (▷ page 266).

Trip computer menu

Use the trip computer menu to call up statistical data on your vehicle.

The following information is available:

Function	Page
Fuel consumption statistics from start	180
Fuel consumption statistics since the last reset	181
Distance to empty	181

i When you enter the trip computer menu, you will always see the fuel consumption statistics from start first.

Fuel consumption statistics from start

- ▶ Press button **☰** or **☷** repeatedly until the message **From start** appears in the multifunction display.

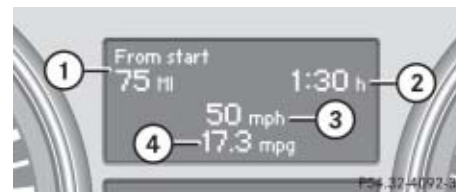



- ① Distance driven since start
- ② Time elapsed since start
- ③ Average speed since start
- ④ Average fuel consumption since start





i All statistics stored since the last engine start will be reset approximately 4 hours after the SmartKey in the starter switch is turned to position **0** or removed from the starter switch.

Resetting will not occur if you turn the SmartKey back to position **1** or **2** within this time period.

Resetting fuel consumption statistics

- ▶ Press button  or  repeatedly until the message *From start* appears in the multifunction display.
- ▶ Press and hold the reset button in the instrument cluster (▷ page 145) until the value is reset to 0.



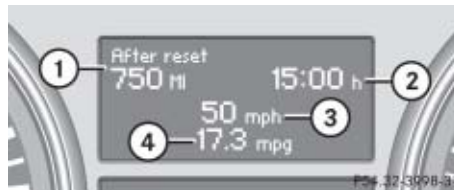

Fuel consumption statistics since the last reset

- ▶ Press button  or  repeatedly until the message *From start* appears in the multifunction display.
- ▶ Press button  or  repeatedly until the message *After reset* appears in the multifunction display.



- ① Distance driven since last reset
- ② Time elapsed since last reset
- ③ Average speed since last reset
- ④ Average fuel consumption since last reset





Resetting fuel consumption statistics manually

- ▶ Press button  or  repeatedly until the message *From start* appears in the multifunction display.
- ▶ Press button  or  repeatedly until the message *After reset* appears in the multifunction display.
- ▶ Press and hold the reset button in the instrument cluster (▷ page 145) until the value is reset to 0.

i The fuel consumption statistics reset automatically to 0 when either of the following values is exceeded:

- distance covered: 100 000 miles
- time elapsed: 10 000 hours

Distance to empty

- ▶ Press button  or  repeatedly until the message *From start* appears in the multifunction display.
- ▶ Press button  or  repeatedly until the message *Range:* appears in the multifunction display.

The calculated remaining driving range based on the current fuel tank level appears in the multifunction display.



Control system

Tel menu*

Warning!





A driver's attention to the road must always be his/her primary focus when driving. For your safety and the safety of others, we recommend that you pull over to a safe location and stop before placing or taking a telephone call. If you choose to use the telephone while driving, please use the hands-free device and only use the telephone when weather, road and traffic conditions permit.

Some jurisdictions prohibit the driver from using a cellular telephone while driving a vehicle.

Bear in mind that at a speed of just 30 mph (approximately 50 km/h), your vehicle is covering a distance of 44 feet (approximately 14 m) every second.

Never operate radio transmitters equipped with a built-in or attached antenna (i.e. without being connected to an external antenna) from inside the vehicle while the engine is running. Doing so could lead to a malfunction of the vehicle's electronic system, possibly resulting in an accident and/or personal injury.

You can use the functions in the **Tel** menu to operate your telephone, provided it is connected to a hands-free system and switched on.

- ▶ Switch on the telephone and COMAND system.
- ▶ Press button  or  on the multifunction steering wheel repeatedly until the message **Tel** appears in the multifunction display.

Which messages will appear in the multifunction display depends on whether your telephone is switched on or off:

- If the telephone is off, the message **Phone off** appears in the multifunction display.
- If the telephone is on:

The telephone will then search for a network. During this time the multifunction display is empty.

As soon as the telephone has found a network, the message **Ready** appears in the multifunction display.



This standby message indicates that your telephone is ready for use and you can operate it using the control system.

Answering a call

When your telephone is ready to receive calls, you can answer a call at any time. In the multifunction display you will then see the message:

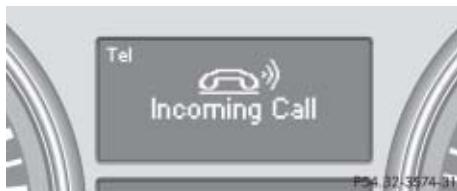

- ▶ Press button .

You have answered the call. The duration of the call appears in the multifunction display.

i If you do not wish to accept a call, press button .



Ending a call

- ▶ Press button .

You have ended the call. The standby message appears in the multifunction display.

Dialing a number from the phone book



If your telephone is ready to receive calls, you may select and dial a number from the phone book at any time.

- ▶ Press button  or  repeatedly until the message Tel appears in the multifunction display.

- ▶ Press button  or .

The control system reads the phone book which is stored in the telephone. This may take several minutes. The message Please wait appears in the multifunction display.



When the message Please wait disappears, the phone book has been loaded.

- ▶ Press button  or  repeatedly until the desired name appears in the multifunction display.

The stored names are displayed in ascending or descending alphabetical order.



① Name from the phone book

i If you press and hold  or  for longer than 1 second, the system scrolls rapidly through the list of names until you release the button again.

Cancel the quick search mode by pressing button .



Control system

▷▷ Press button .

The system dials the selected phone number.

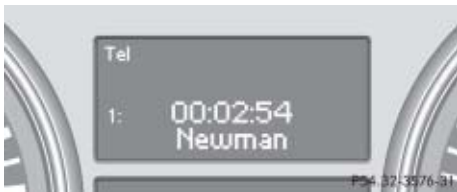

- If the connection is successful and this feature is supported by your network provider, the name of the party (if stored in your phone book) you are calling and the duration of the call will appear in the multifunction display.



- If no connection is made, the control system stores the dialed number in the redial memory.



Redialing

The control system stores the most recently dialed phone numbers. This eliminates the need to search through your entire phone book.

▶ Press button  or  repeatedly until the message Tel appears in the multifunction display.

▶ Press button .

The first number in the redial memory appears in the multifunction display.

▶ Press button  or  repeatedly until the desired name appears in the multifunction display.

▶ Press button .

The control system dials the selected phone number.

▼ Automatic transmission

For more information on driving with an automatic transmission, see “Automatic transmission” (▷ page 54).

Your vehicle’s transmission adapts its gear shifting process to your individual driving style by continually adjusting the shift points up or down. These shift point adjustments are performed based on current operating and driving conditions.

If the operating conditions change, the automatic transmission reacts by adjusting its shift program.

i *During the brief warm-up, transmission upshifting is delayed. This allows the catalytic converter (gasoline engine) or the oxidation catalyst (diesel engine) to heat up more quickly to operating temperature.*

Warning!



Make sure that absolutely no objects are obstructing the pedal’s range of movement. Keep the driver’s footwell clear of all obstacles. If there are any floor mats or carpets in the footwell, make sure that the pedals still have sufficient clearance.

During sudden driving or braking maneuvers the objects could get caught between the pedals. You could then no longer brake or accelerate. This could lead to accidents and injury.

Gear selector lever

The gear selector lever is located on the right of the steering column.



Gearshift pattern for automatic transmission

- P Park position
- R Reverse gear
- N Neutral
- D Drive position

Automatic transmission

i The current transmission position **P**, **R**, **N**, or **D** appears in the multifunction display (▷ page 189).

Warning!



It is dangerous to shift the automatic transmission out of park position **P** or neutral position **N** if the engine speed is higher than idle speed. If your foot is not firmly on the brake pedal, the vehicle could accelerate quickly forward or reverse. You could lose control of the vehicle and hit someone or something. Only shift into gear when the engine is idling normally and when your right foot is firmly on the brake pedal.

Shifting from P to N

Moving the gear selector lever up or down shifts the automatic transmission out of park position **P**:

- ▶ With the vehicle at a standstill, depress the brake pedal and keep it pressed.
- ▶ Move gear selector lever up or down to resistance point to select neutral position **N**.

i The gear selector lever returns to its original position.

Shifting from N to R or from N to D

- ▶ With the vehicle at a standstill, depress the brake pedal and keep it pressed.
 - ▶ Move gear selector lever up past the resistance point to select reverse gear **R**.
- or
- ▶ Move gear selector lever down past the resistance point to select drive position **D**.

i The gear selector lever returns to its original position.

- ▶ Release the parking brake (▷ page 57).
- ▶ Release the brake pedal.
- ▶ Carefully depress the accelerator pedal to drive off when it is safe to do so.

Shifting from P to R

- ▶ With the vehicle at a standstill, depress the brake pedal and keep it pressed.
- ▶ Move gear selector lever up past the resistance point to select reverse gear **R**.

 *The gear selector lever returns to its original position.*

- ▶ Release the parking brake (▷ page 57).
- ▶ Release the brake pedal.
- ▶ Carefully depress the accelerator pedal to drive off when it is safe to do so.

Shifting from P to D

- ▶ With the vehicle at a standstill, depress the brake pedal and keep it pressed.
- ▶ Move gear selector lever down past the resistance point to select drive position **D**.

 *The gear selector lever returns to its original position.*

- ▶ Release the parking brake (▷ page 57).
- ▶ Release the brake pedal.
- ▶ Carefully depress the accelerator pedal to drive off when it is safe to do so.

Shifting from D, R, or N to P

If you want to select park position **P** with the transmission being in drive position **D**, reverse gear **R** or neutral position **N**:

- ▶ With the vehicle at a standstill, depress the brake pedal and keep it pressed.
- ▶ Step firmly on parking brake pedal (▷ page 65).
- ▶ Press button on gear selector lever in direction of arrow (▷ page 185) to select park position **P**.
- ▶ Release the brake pedal.

 *Shift the automatic transmission directly from drive position **D** to reverse gear **R**, from reverse gear **R** to drive position **D** or directly to park position **P** only when the vehicle is stopped. Otherwise the automatic transmission could be damaged.*

When trying to free a vehicle stuck in mud or snow, see “Rocking the vehicle” (▷ page 192).

Automatic transmission

Shifting from D or R to N

If you want to select neutral position **N** with the transmission being in drive position **D** or reverse gear **R**:

- ▶ With the vehicle at a standstill, depress the brake pedal and keep it pressed.
- ▶ Step firmly on parking brake pedal (▷ page 65).

i *When the vehicle needs to be moved with the engine switched off and the transmission set to neutral position **N** (▷ page 186), e.g. in an automatic car wash, do not depress the parking brake pedal.*

- ▶ Move gear selector lever up to resistance point when in drive position **D** or down to resistance point when in reverse gear **R** to select neutral position **N**.
- ▶ Release the brake pedal.

Shifting procedure

The automatic transmission selects individual gears automatically, depending on:

- drive position **D** (▷ page 189) with gear ranges (▷ page 193)
- the selected program mode (**M/C/S**) (ML 63 AMG only) (▷ page 195)
- the position of the accelerator pedal (▷ page 191)
- the vehicle speed

! *Allow engine to warm up under low load use. Do not place full load on the engine until the operating temperature has been reached.*

*Shift into reverse gear **R** or park position **P** only when the vehicle is stopped.*

Avoid spinning of a drive wheel for an extended period when driving off on slippery road surfaces. This may cause serious damage to the drivetrain which is not covered by the Mercedes-Benz Limited Warranty.

With drive position **D** selected, you can use the steering wheel gearshift control buttons (▷ page 194) to influence transmission shifting by:

- limiting the gear range
- changing gears manually

Transmission positions

The current transmission position appears in the multifunction display.



① Current transmission position

! *If the current transmission position does not appear in the multifunction display due to a malfunction, for example, make sure that the automatic transmission is in the desired position by carefully driving off with the transmission in drive position **D**.*

ML 63 AMG:

*Select program mode **C** (▷ page 195).*

Do not limit the gear range.

	Effect
P	<p>Park position</p> <p>Shift into park position P only when vehicle is stopped. The park position is not intended to serve as a brake when the vehicle is parked. Rather, the driver should always set the parking brake in addition to shifting into park position P to secure the vehicle.</p> <p>If the vehicle's electrical system is malfunctioning, the automatic transmission could remain locked in park position P.</p> <ul style="list-style-type: none"> ▶ Have the vehicle checked as soon as possible by an authorized Mercedes-Benz Light Truck Center.

! *SmartKey:*

*If you turn off the engine using the SmartKey and remove the SmartKey from the starter switch, the transmission will shift to park position **P** automatically. Keep in mind that turning off the engine with the SmartKey alone will not automatically shift the transmission to park position **P**. Only when the SmartKey is removed from the starter switch, will the transmission automatically shift to park position **P**.*

KEYLESS-GO:*

*If you turn off the engine using the KEYLESS-GO start/stop button and open the driver's door, the transmission will shift to park position **P** automatically. Keep in mind that turning off the engine using the KEYLESS-GO start/stop button alone will not automatically shift the transmission to park position **P**. Only when the driver's door is opened, will the transmission automatically shift to park position **P**.*

*Even though this is possible, make it a practice to always shift into park position **P** before turning off the engine and removing the SmartKey from the starter switch, or when using KEYLESS-GO*, before turning off the engine with the start/stop button and opening the driver's door.*

Automatic transmission

! If you want the gear position to remain in neutral position **N** (for example when the vehicle is pulled through a car wash)

- do not remove the SmartKey from the starter switch

or, when using KEYLESS-GO*

- do not turn off the engine using the KEYLESS-GO start/stop button* and open the driver's door

Otherwise, the transmission will shift to park position **P** and lock the wheels, preventing the vehicle from being pulled through a car wash.

	Effect
R	Reverse gear Shift into reverse gear R only when the vehicle is stopped.

	Effect
N	Neutral No power is transmitted from the engine to the drive axle. When the brakes are released, the vehicle can be moved freely (pushed or towed). To avoid damage to the transmission, avoid shifting into neutral position N while driving, except: If the ESP® is deactivated or malfunctioning: Shift into neutral position N only when the vehicle is in danger of skidding, e.g. on icy roads.
D	Drive The transmission shifts automatically. All forward gears are available.

! Coasting the vehicle, or driving for any other reason in neutral position **N** can result in transmission damage that is not covered by the Mercedes-Benz Limited Warranty.

Warning!



Getting out of your vehicle without shifting into park position **P** is dangerous. Also, park position **P** alone is not intended to or capable of preventing your vehicle from moving, possibly hitting people or objects.

Always set the parking brake in addition to shifting to position **P** (▷ page 65).

When parked on an incline, turn the front wheels towards the road curb.

Do not park this vehicle in areas where combustible materials such as grass, hay or leaves can come into contact with the hot exhaust system, as these materials could be ignited and cause a vehicle fire.

Warning!

When leaving the vehicle, always remove the SmartKey or SmartKey with KEYLESS-GO* from the starter switch, take it with you, and lock the vehicle. Do not leave children unattended in the vehicle, or with access to an unlocked vehicle. Children could shift the automatic transmission out of park position **P**, which could result in an accident and/or serious personal injury.

Driving tips**Accelerator position**

Your driving style influences the transmission's shifting behavior:

Less throttle Earlier upshifting

More throttle Later upshifting

Kickdown

Use kickdown when you want maximum acceleration.

- ▶ Press the accelerator past the point of resistance.

Depending on the engine speed the transmission shifts into a lower gear.

- ▶ Ease on the accelerator when you have reached the desired speed.

The transmission shifts up again.

Stopping

When you stop briefly, e.g. at traffic lights:

- ▶ Leave the transmission in gear.
- ▶ Hold the vehicle with the brake.

When you stop for a longer period of time with the engine idling and/or on a hill:

- ▶ Set the parking brake.
- ▶ Shift into park position **P**.

Maneuvering

When you maneuver in tight areas, e.g. when pulling into a parking space:

- ▶ Control the vehicle speed by gradually releasing the brakes.
- ▶ Accelerate gently.
- ▶ Never abruptly step on the accelerator.

Automatic transmission

Rocking the vehicle

Rocking the vehicle by shifting between drive position **D** and reverse gear **R** can help free a vehicle stuck in mud or snow. The engine control system of this vehicle electronically limits shifting between drive position **D** and reverse gear **R** to very low speeds, i.e. approx. 5 mph (9 km/h). To shift between drive position **D** and reverse gear **R**, move the gear selector lever past the resistance point up or down.

Working on the vehicle

Warning!



When working on the vehicle, set the parking brake and shift to park position **P**. Otherwise the vehicle could roll away.

Hill start assist system

Warning!



The hill start assist system is not designed to function as a parking brake and does not prevent the vehicle from moving when parked on an incline.

Always set the parking brake in addition to shifting to park position **P**.

On uphill grades with a gradient angle of more than 5°, the hill start assist system maintains the pressure in the brake system for approximately 1 second after you have released the brake pedal. Therefore, you can start off smoothly without the vehicle moving immediately after releasing the brake pedal.

The hill start assist system is inactive

- when starting off on a level road or downhill grades
- with the transmission in neutral position **N**
- with the parking brake set
- if the ESP® has switched off due to a malfunction

Towing a trailer

If you tow a trailer, note the following points:

- Manually shift to a lower gear range (▷ page 193) if the transmission hunts between gears on inclines.

A lower gear range and reduction of speed reduces the chance to overload or overheat the engine.

For more information on trailer towing, see the “Operation” section (▷ page 342).

Gear ranges

With the automatic transmission in drive position **D**, you can select a gear range for the automatic transmission to operate within.

You can limit the gear range by pressing the left gearshift button on the steering wheel gearshift control, and reverse the gear range limit by pressing the right gearshift button on the steering wheel gearshift control (▷ page 194).

The selected gear range appears in the multifunction display.



① Current gear range

	Effect
6	The transmission shifts through sixth gear only.
5	The transmission shifts through fifth gear only.
4	The transmission shifts through fourth gear only.
3	The transmission shifts through third gear only. With this selection you can use the braking effect of the engine.

	Effect
2	The transmission shifts through second gear only. Allows the use of engine's braking power when driving: <ul style="list-style-type: none"> • on steep downgrades • in mountainous regions • under extreme operating conditions
1	The transmission operates in first gear only. For maximum use of engine's braking effect on very steep or lengthy downgrades.

Automatic transmission

Steering wheel gearshift control

With drive position **D** selected, you can limit or extend the gear range.

If your vehicle is equipped with manual shift program **M**, you can use the steering wheel gearshift control to manually shift the gears.

i *ML 63 AMG:*

For information on using the steering wheel gearshift control in program mode **M**, see “Shift program (ML 63 AMG only)” (▷ page 195).

! *Allow engine to warm up under low load use. Do not place full load on the engine until the operating temperature has been reached.*

*Shift into reverse gear **R** or park position **P** only when the vehicle is stopped.*

Avoid spinning of a drive wheel for an extended period when driving off on slippery road surfaces. This may cause serious damage to the drivetrain which is not covered by the Mercedes-Benz Limited Warranty.



- ① Left shift button: limiting gear range or downshift (in program mode **M**)
- ② Right shift button: extending gear range or upshift (in program mode **M**)

i *You cannot shift with the steering wheel gearshift control buttons when the transmission is in position **P**, **N** or **R**.*

Limiting gear range

Warning!



On slippery road surfaces, never downshift in order to obtain braking action. This could result in drive wheel slip and reduced vehicle control. Your vehicle's ABS will not prevent this type of loss of control.

- ▶ Briefly press left shift button ①.

The transmission will shift to the next lower gear as permitted by the shift program. This action simultaneously limits the gear range of the transmission (▷ page 193).

i *To avoid overrevving the engine when downshifting, the transmission will not shift to a lower gear if the engine's max. speed would be exceeded.*

Extending gear range

- ▶ Briefly press right shift button ②.

The transmission will shift to the next higher gear as permitted by the shift program. This action simultaneously extends the gear range of the transmission (▷ page 193).

i If you press on the accelerator when the engine has reached its rpm limit, the transmission will upshift beyond any gear range limit selected.

Canceling gear range limit

- ▶ Press and hold right shift button ② until the cipher for the current gear range disappears from the multifunction display (▷ page 193).

The transmission will shift from the current gear range directly to gear **D**.

Shifting into optimal gear range

- ▶ Press and hold left shift button ①.

The transmission will automatically select the gear range suited for optimal acceleration and deceleration. This will involve shifting down one or more gears.

Shift program (ML 63 AMG only)

! Allow engine to warm up under low load use. Do not place full load on the engine until the operating temperature has been reached.

*Shift into reverse gear **R** or park position **P** only when the vehicle is stopped.*

Avoid spinning of a drive wheel for an extended period when driving off on slippery road surfaces. This may cause serious damage to the drivetrain which is not covered by the Mercedes-Benz Limited Warranty.

You can choose between automatic shift program **C** or **S** and manual shift program **M**.



- ① Program mode selector switch

M Manual	For manual gear shifting
C Comfort	For standard driving
S Sport	For sporty driving

! Never change the program mode when the automatic transmission is out of park position **P**. This could result in a change of driving characteristics for which you may not be prepared.

Automatic transmission

The selected program mode appears in the multifunction display.



① Current program mode

Automatic shift program

You can choose between automatic shift program **C** or **S**.

- ▶ Press program mode selector switch repeatedly until the letter of the desired program mode appears in the multifunction display.

Select **C** for standard driving:

- The vehicle starts out in second gear (both forward and reverse) for gentler starts. This does not apply if full throttle is applied or gear range **1** is selected.
- Traction and driving stability are improved on icy roads.
- Upshifts occur earlier even when you give more gas. The engine then operates at lower rpms and the wheels are less likely to spin.

Select **S** for sporty driving:

- The vehicle starts out in first gear.
- Upshifts occur later.

i *The last selected program mode (**C** or **S**) is switched on when the engine is restarted.*

Manual shift program

In the manual program mode **M**, system-controlled automatic gearshifting is switched off and you need to change the gears by manually upshifting or downshifting using the steering wheel gearshift control buttons to the left and right of the steering wheel (▷ page 194).

Activating manual shift program

- ▶ Press program mode selector switch repeatedly until the **M** for the manual program mode **M** appears in the multifunction display.

The transmission switches to the manual program mode **M**. Automatic shifting is switched off. The gear range is not limited.

You can change the gears manually with drive position **D** selected. You can upshift or downshift through the gears in succession.

i The manual program mode **M** will not be stored. When the engine is turned off with the manual program mode **M** selected, the transmission will go to the automatic program mode (**C** or **S**) when the engine is restarted.

Upshifting

! In the manual program mode **M**, the transmission will not upshift, even if the engine has reached its overrevving range. Shift up to the next gear before the engine has reached its overrevving range. Make absolutely certain that the engine speed does not reach the red marking on the tachometer (▷ page 28). Otherwise the engine could be damaged which is not covered by the Mercedes-Benz Limited Warranty.

- ▶ Briefly press right shift button ② (▷ page 194).

The transmission shifts to the next higher gear.

If you have selected the AMG menu in the control system and you are driving in the manual program mode **M**, upshift indicator ② in the multifunction display advises you to upshift before the engine reaches the overspeed range. Thus you can drive at the maximum engine speed for each gear without overrevving the engine.

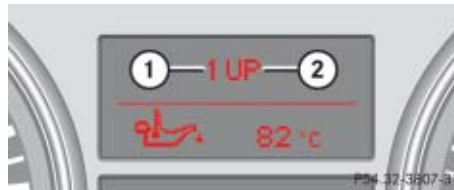

- ① Gear indicator
- ② Upshift indicator
- ▶ Shift to the next higher gear.

The fuel supply will otherwise be interrupted to prevent the engine from overrevving.

Downshifting

Warning!



On slippery road surfaces, never downshift in order to obtain braking action. This could result in drive wheel slip and reduced vehicle control. Your vehicle's ABS will not prevent this type of loss of control.

- ▶ Briefly press left shift button ① (▷ page 194).

The transmission shifts to the next lower gear.

i When you brake or stop, the transmission shifts down to a gear from which you can easily accelerate or drive off.

Automatic transmission

Kickdown

Using the kickdown when driving in the manual program mode **M** is not possible.

Deactivating manual shift program

- ▶ Press the program mode selector switch (> page 195) repeatedly until **C** or **S** appears in the multifunction display.

or

- ▶ Restart the engine.

The transmission will go to the automatic program mode (**C** or **S**).

The manual program mode **M** is not stored.

Emergency operation (Limp-Home Mode)

If vehicle acceleration becomes less responsive or sluggish or the transmission no longer shifts, the transmission is most likely operating in limp-home (emergency operation) mode. In this mode only second gear and reverse gear can be activated.

- ▶ Stop the vehicle in a safe location.
- ▶ Shift to park position **P**.
- ▶ Turn off the engine.
- ▶ Wait at least 10 seconds before restarting.
- ▶ Restart the engine.
- ▶ Shift to drive position **D** (for second gear) or reverse gear **R**.
- ▶ Have the transmission checked at an authorized Mercedes-Benz Light Truck Center as soon as possible.

▼ Transfer case

! *Operational or performance test must only be conducted on a two-axle dynamometer. If such tests are necessary, contact an authorized Mercedes-Benz Light Truck Center. You could otherwise seriously damage the brake system or the transfer case which is not covered by the Mercedes-Benz Limited Warranty.*

! *Because the ESP[®] operates automatically, the engine and ignition must be shut off (SmartKey in starter switch position **0** or **1** or KEYLESS-GO^{*} start/stop button in position **0** or **1**) when testing the brakes on a brake test dynamometer and such testing should be no longer than 10 seconds.*

Active braking action through the ESP[®] may otherwise seriously damage the brake system which is not covered by the Mercedes-Benz Limited Warranty.

i *The vehicle is equipped with full-time four-wheel drive. Both the front and rear axles are powered at all times when the vehicle is being operated.*

Good visibility

For information on the windshield wipers, see “Windshield wipers” (▷ page 60).

Headlamp cleaning system*

The button is located on the left side of the dashboard.



① Headlamp washer button

- ▶ Switch on the ignition (▷ page 40).
- ▶ Press button ①.

The headlamps are cleaned with a high-pressure water jet.

i *The headlamps will automatically be cleaned when you have*

- *switched on the headlamps and*
- *operated the windshield wipers with windshield washer fluid fifteen times*

When you switch off the ignition, the counter resets.

For information on filling up the washer reservoir, see “Windshield/rear window washer system and headlamp cleaning system*” (▷ page 363).

Rear view mirrors

For more information on setting the rear view mirrors, see “Mirrors” (▷ page 49).

Interior rear view mirror, antiglare position



① Lever

- ▶ Tilt the mirror to the antiglare position by moving lever ① towards the windshield.

The interior rear view mirror is dimmed.

Auto-dimming rear view mirrors*

The reflection brightness of the exterior rear view mirror on the driver's side and the interior rear view mirror will respond automatically to glare when

- the ignition is switched on and
- incoming light from headlamps falls on the sensor in the interior rear view mirror

The rear view mirror will not react if

- the automatic transmission is set to position **R**
- the interior lighting is turned on

Warning!

The auto-dimming function does not react if incoming light is not aimed directly at sensors in the interior rear view mirror.

The interior rear view mirror and the exterior rear view mirror on the driver's side do not react, for example, when transporting cargo which covers the rear window.

Light hitting the mirror(s) at certain angles (incident light) could blind you. As a result, you may not be able to observe traffic conditions and could cause an accident.

Warning!

In case of an accident, liquid electrolyte may escape from the mirror housing if the mirror glass breaks.

Electrolyte has an irritating effect. Do not allow the liquid to come into contact with eyes, skin, clothing, or respiratory system. In case it does, immediately flush affected area with water, and seek medical help if necessary.

! *Electrolyte liquid coming into contact with the vehicle paint finish can be completely removed only while in the liquid state and by applying plenty of water.*

Warning!

Exercise care when using the passenger-side exterior rear view mirror. The mirror surface is convex (outwardly curved surface for a wider field of view). Objects in mirror are closer than they appear. Check your interior rear view mirror or glance over your shoulder before changing lanes.

Good visibility

Power folding exterior rear view mirrors*

! Before you drive the vehicle through an automatic car wash, fold the exterior rear view mirrors in. Otherwise they may get damaged.

Folding the exterior rear view mirrors in and out automatically

When the corresponding function in the control system is activated (▷ page 178):

- The exterior rear view mirrors automatically fold in as soon as the vehicle is locked from the outside.
- The exterior rear view mirrors automatically fold out as soon as the vehicle is unlocked and the driver's or front passenger door are subsequently opened.

Synchronizing exterior rear view mirrors

The power folding rear view mirrors may have to be synchronized after the vehicle battery has been disconnected or discharged. If the exterior rear view mirrors do not fold properly upon locking or unlocking the vehicle although the corresponding function in the control system is activated (▷ page 178), do the following:

- ▶ Fold each exterior rear view mirror in completely (▷ page 203).
- ▶ Fold each exterior rear view mirror out completely (▷ page 203).

When the exterior rear view mirrors fold properly upon locking the vehicle, the exterior mirrors are synchronized. Otherwise repeat the above steps.

Folding the exterior rear view mirrors in and out manually

i The exterior rear view mirrors can vibrate if they are not folded out completely.

The button is located on the door control panel.



- ① Button for folding exterior rear view mirrors in and out
- ▶ Switch on the ignition (▷ page 40).

Folding in

- ▶ Briefly press button ①.

Both exterior rear view mirrors fold in.

i If you are driving at more than approximately 30 mph (47 km/h), you will not be able to fold the exterior mirrors in.

Folding out

- ▶ Briefly press button ① again.

Both exterior rear view mirrors fold out.

! If an exterior rear view mirror housing is forcibly pushed forward (hit from the rear) or forcibly pushed rearward (hit from the front) press button ① to fold mirrors in, then press button ① again to fold mirrors out. Do not force mirrors by hand as this may damage the adjustment mechanism.

The mirror housing is then properly positioned and you can adjust the mirror in the usual manner.

Please make sure both rear view mirrors are folded out before driving off.

Sun visors

The sun visors protect you from sun glare while driving.

Warning!

Do not use the vanity mirror while driving.

Keep the mirrors in the sun visors closed while vehicle is in motion. Reflected glare can endanger you and others.

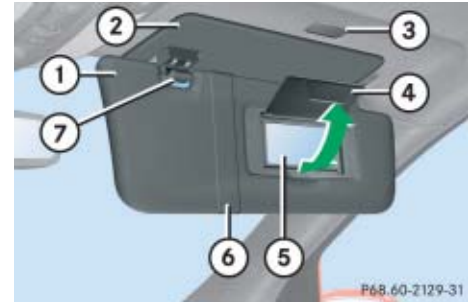

- ① Sun visor
- ② Additional sun visor*
- ③ Mirror lamp
- ④ Vanity mirror cover
- ⑤ Vanity mirror
- ⑥ Holder for gas cards
- ⑦ Mounting

Good visibility

Glare through the windshield

- ▶ Swing sun visor ① down.
- ▶ Make sure sun visor ① is properly engaged in mounting ⑦.
- ▶ When you do not experience glare anymore, swing sun visor ① up.

Vanity mirror

- ▶ Swing sun visor ① down.
- ▶ Flip up cover ④ to access vanity mirror ⑤.
Vanity mirror lamp ③ comes on.
- ▶ After using vanity mirror ⑤, flip down cover ④.
- ▶ Swing sun visor ① up.

Glare through a side window



- ① Sun visor
 - ② Additional sun visor*
- ▶ Swing sun visor ① down.
 - ▶ Disengage sun visor ① from mounting ⑦ (▷ page 203).
 - ▶ Pivot sun visor ① to the side.

! To avoid damage to vanity mirror cover ④ (▷ page 203), make sure it is closed before pivoting sun visor ① to the side.

- ▶ Adjust sun visor ① by pushing or pulling in the direction of arrows.
- ▶ Swing down additional sun visor* ② when you experience additional glare through the windshield.

Rear window defroster

The rear window defroster uses a large amount of power. To keep battery drain to a minimum, switch off the defroster as soon as the rear window is clear. The defroster is automatically deactivated after approximately 6 to 17 minutes of operation depending on the outside temperature.

Warning!



Any accumulation of snow and ice should be removed from the rear window before driving. Visibility could otherwise be impaired, endangering you and others.

- ▶ Switch on the ignition (▷ page 40).

Activating

- ▶ Press button  on the climate control panel (▷ page 208) or the automatic climate control* panel (▷ page 222).

The indicator lamp on the button comes on.

Deactivating

- ▶ Press button  once more.

The indicator lamp on the button goes out.

! *If the rear window defroster switches off too soon and the indicator lamp starts flashing, too many electrical consumers are operating simultaneously and there is insufficient voltage in the battery. The system responds automatically by switching the rear window defroster off.*

As soon as the battery has sufficient voltage, the rear window defroster switches back on automatically.

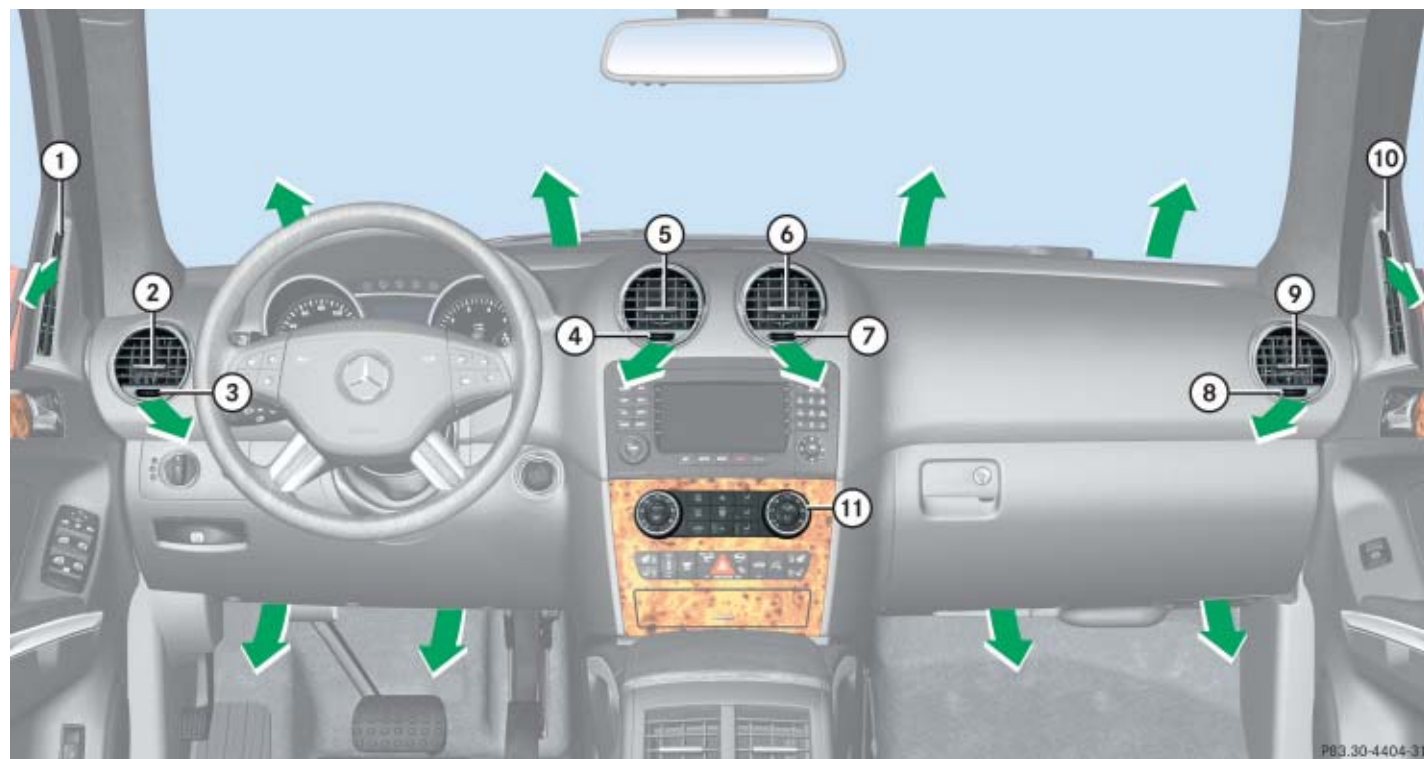







- ① Driver's door air vent, fixed
- ② Left side air vent, adjustable
- ③ Thumbwheel for air volume control for left side and door air vent
- ④ Thumbwheel for air volume control for left center air vent
- ⑤ Left center air vent, adjustable
- ⑥ Right center air vent, adjustable
- ⑦ Thumbwheel for air volume control for right center air vent
- ⑧ Thumbwheel for air volume control for right side and door air vent
- ⑨ Right side air vent, adjustable
- ⑩ Front passenger door air vent, fixed
- ⑪ Climate control panel

i For draft-free ventilation, move the sliders for center air vents and side air vents to the middle position.

Climate control



- | | | |
|---|---|--|
| ① | Temperature control, left | |
| ② | Air distribution and air volume (automatic, manual) | |
| ③ | Front defroster | |
| |  USA only | |
| |  Canada only | |
| ④ | Increasing air volume | |
| ⑤ | Air distribution (directs air through the windshield and side air vents) | |
| ⑥ | Rear climate control* on/off | |
| | Air supply for rear passenger compartment on/off | |
| |  USA only | |
| |  Canada only | |
| ⑦ | Temperature control, right | |
| ⑧ | AC cooling on/off | |
| | Residual heat/ventilation | |
| ⑨ | Air distribution (directs air through center and side air vents) | |
| ⑩ | Air distribution (directs air through the footwells and side air vents) | |
| ⑪ | Air volume display | |
| ⑫ | Decreasing air volume | |
| ⑬ | Rear window defroster | |
| |  USA only | |
| |  Canada only | |
| ⑭ | Air recirculation | |
| ⑮ | Interior temperature sensor | |
| ⑯ | Climate control on/off | |

The climate control is operational whenever the engine is running. You can operate the climate control system in either the automatic or manual mode. The system cools or heats the interior depending on the selected interior temperature and the current outside temperature.

Warning!

When operating the climate control, the air that enters the passenger compartment through the air vents can be very hot or very cold (depending on the set temperature). This may cause burns or frostbite to unprotected skin in the immediate area of the air vents.

Always keep sufficient distance between unprotected parts of the body and the air vents. If necessary, use the air distribution controls (> page 208) to direct the air to air vents in the vehicle interior that are not in the immediate area of unprotected skin.

Nearly all dust particles, pollutants and odors are filtered out before outside air enters the passenger compartment through the air distribution system.

The air conditioning will not engage (no cooling) if the **A/C** mode is deactivated (> page 216).

Warning!

Follow the recommended settings for heating and cooling given on the following pages. Otherwise the windows could fog up, impairing visibility and endangering you and others.

i Severe conditions (e.g. strong air pollution) may require replacement of the filter before its scheduled interval. A clogged filter will reduce the air volume to the interior.

If the vehicle interior is hot, ventilate the interior before driving off, see “Summer opening feature” (> page 239). The climate control will then adjust the interior temperature to the set value much faster.

Keep the air intake grille in front of the windshield free of snow and debris.

Climate control

Deactivating the climate control system

Warning!



When the climate control system is switched off, the outside air supply and circulation are also switched off. Only choose this settings for a short time. Otherwise the windows could fog up, impairing visibility and endangering you and others.

Deactivating

- ▶ Press button **OFF** (▷ page 208).

The indicator lamp on the button comes on.

Reactivating

- ▶ Press button **AUTO** (▷ page 208).

i You can also press button **OFF** (▷ page 208) on the climate control panel.

If you press button **FRONT** (▷ page 208) to reactivate the climate control system, the defrosting mode is activated.

Operating the climate control system in automatic mode

i When operating the climate control system in automatic mode, you will only rarely need to adjust the temperature, air volume and air distribution.

In automatic mode, cooling with dehumidify is switched on. This function can be switched off if necessary (▷ page 216).

Activating

- ▶ Press button **AUTO** (▷ page 208) while the engine is running.



The indicator lamp on the button comes on. The air volume and air distribution are adjusted automatically.

- ▶ Use temperature controls ① and ⑦ (▷ page 208) to separately adjust the air temperature on each side of the passenger compartment.

The interior air temperature is adjusted automatically.

i The settings for the passenger side are also used for the rear passenger compartment.

Deactivating

- ▶ Press button  or  (▷ page 208).

The indicator lamp on button **AUTO** goes out. The automatic operation of air volume switches off. The selected blower speed is shown in the air volume display ⑪ (▷ page 208).

or

- ▶ Press air distribution button ⑤, ⑨, or ⑩ (▷ page 208).

The indicator lamp on button **AUTO** goes out. The automatic operation of air distribution switches off.

Setting the temperature

Use temperature controls ① and ⑦ (▷ page 208) to separately adjust the air temperature on each side of the passenger compartment. You should raise or lower the temperature setting in small increments, preferably starting at 72°F (22°C). The climate control will adjust to the set temperature as fast as possible.

Increasing

- ▶ Turn temperature control ① and/or ⑦ (▷ page 208) slightly clockwise.

The climate control system will correspondingly adjust the interior air temperature.

Decreasing

- ▶ Turn temperature control ① and/or ⑦ (▷ page 208) slightly counterclockwise.



The climate control system will correspondingly adjust the interior air temperature.

Climate control

Adjusting air distribution

Press air distribution button (5), (9), or (10) (▷ page 208) to adjust the air distribution.

The following symbols are found on the controls:



Symbol	Function
	Directs air through the center and side air vents
	Directs air to the windshield and side air vents
	Directs air to the footwells and side air vents

- ▶ Press the desired air distribution button (5), (9), or (10) (▷ page 208).

The indicator lamp on button **AUTO** goes out.

Adjusting air volume

Five blower speeds are available.

- ▶ Press button  to decrease or button  to increase air volume (▷ page 208) to the desired level.

The indicator lamp on button **AUTO** (▷ page 208) goes out. The automatic operation of air volume switches off. The selected blower speed is shown in the air volume display (11) (▷ page 208).

Adjusting air volume for the center and side air vents

Opening the center air vents

- ▶ Turn thumbwheels (4) and (7) (▷ page 206) to the right.

The corresponding center air vents on the left and right are open.

Closing the center air vents

- ▶ Turn thumbwheels (4) and (7) (▷ page 206) to the left.

The corresponding center air vents on the left and right are closed.

Opening the side air vents

- ▶ Turn thumbwheels (3) and (8) (▷ page 206) to the right.

The corresponding side air vents on the left and right are open.

Closing the side air vents

- ▶ Turn thumbwheels (3) and (8) (▷ page 206) to the left.

The corresponding side air vents on the left and right are closed.

Front defroster

You can use this setting to defrost the windshield, for example if it is iced up. You can also use it to defog the windshield and side windows.

i *Keep this setting selected only until the windshield or the side windows are clear again.*

When the defrost setting has been selected, only the rear window defroster can be switched on. No other settings are possible.

Activating

- ▶ Press button  (▷ page 208).

The indicator lamp on the button comes on.

The climate control switches to the following functions automatically:

- maximum blower speed and heating power
- air flows onto the windshield and the front side windows (side air vents must be open)

- the air conditioning compressor switches on at outside temperatures above approximately 41 °F (5 °C) for air-drying

Deactivating

- ▶ Press button  (▷ page 208) once more.

The indicator lamp on the button goes out. Defrosting is turned off.

The previous settings are in effect again. The air conditioning compressor remains switched on.

i *To switch off, you can also press button **OFF** or **AUTO** (▷ page 208).*

Windshield fogged on the outside

i *Keep this setting selected only until the windshield is clear again.*



- ▶ Switch the windshield wipers on (▷ page 61).
- ▶ Press button  (▷ page 208).

The indicator lamp on the button comes on.

The climate control switches automatically to the following functions:

- maximum blower speed and heating power
- air flows onto the windshield and the front side windows (side air vents must be open)
- the air conditioning compressor switches on at outside temperatures above approximately 41 °F (5 °C) for air-drying

If the automatic air distribution is switched off:

- ▶ Press air distribution button  or  (▷ page 208).

Climate control

Air recirculation mode

Switch to air recirculation mode to prevent unpleasant odors from entering the vehicle from the outside (e.g. before driving through a tunnel). This setting cuts off the intake of outside air and recirculates the air in the passenger compartment.

Warning!



Fogged windows impair visibility, endangering you and others. If the windows begin to fog on the inside, switching off the air recirculation mode immediately should clear interior window fogging. If interior window fogging persists, make sure the air conditioning (▷ page 208) is activated, or press button .

Activating

▶ Press button  (▷ page 208).

The indicator lamp on the button comes on.

i *The air recirculation mode is activated automatically at high outside temperatures.*

The indicator lamp on button  is not lit when the air recirculation mode is switched on automatically.

A quantity outside air is added after approximately 30 minutes.

If you have turned off the air conditioning (▷ page 216) or the outside temperature is below 41 °F (5 °C), the air recirculation mode will not switch on automatically.

i *To cool the interior as fast as possible, the climate control automatically switches to air recirculation. The indicator lamp on button  is not lit when the air recirculation mode has been switched on automatically.*

Deactivating

▶ Press button .

The indicator lamp on the button goes out.

i *The air recirculation mode is deactivated automatically*

- *after 5 minutes if the outside temperature is below approximately 41 °F (5 °C)*
- *after 5 minutes if the air conditioning and air-drying is turned off*
- *after 30 minutes if the outside temperature is above approximately 41 °F (5 °C)*

Air recirculation mode with convenience closing and opening feature

Warning!



Never operate the windows and tilt/sliding sunroof* if there is the possibility of anyone being harmed by the opening or closing procedure.

In case the procedure causes potential danger:

Vehicles with or without tilt/sliding sunroof*: The closing of the windows can be immediately halted by pressing or pulling the respective window switch. The closing of the tilt/sliding sunroof* can be immediately halted by moving the switch for the tilt/sliding sunroof* in any direction.

The closing of the windows and the tilt/sliding sunroof* can be reversed by again pressing and holding the  button.

Convenience closing



- ▶ Press button  for approximately 2 seconds.

The windows and/or tilt/sliding sunroof* will close. You can release button  once the closing procedure has begun. The windows and tilt/sliding sunroof* continue closing until they are fully closed. The indicator lamp on the button comes on. The air recirculation mode is activated.

Convenience opening

- ▶ Press button  for approximately 2 seconds.

The windows and/or tilt/sliding sunroof* will return to their previous positions. You can release button  once the opening procedure has begun. The windows and tilt/sliding sunroof* continue opening until they have reached their previous positions. The indicator lamp on the button goes out. The air recirculation mode is deactivated.

 *A window or the tilt/sliding sunroof* will only return to its previous position if it has not been moved to another position using the respective window switch or tilt/sliding sunroof* switch after it was closed with button .*

Climate control

Air conditioning

The air conditioning is operational while the engine is running and cools the interior air to the temperature set by the operator. In addition, the air conditioning dehumidifies the interior air at outside temperatures above 41°F (5° C) and helps prevent window fogging.

 *Condensation may drip out from underneath the vehicle. This is normal and not an indication of a malfunction.*

Warning!



If you turn off the cooling function, the interior air is not dried. The windows can fog up more quickly. Window fogging may impair visibility and endanger you and others.

Deactivating

It is possible to deactivate the air conditioning (cooling) function of the climate control system. The air in the vehicle will then no longer be cooled or dehumidified.

- ▶ Press button  (▷ page 208).

The indicator lamp on the button goes out.

Activating

Moist air can fog up the windows. You can dehumidify the air with the air conditioning.

- ▶ Press button  (▷ page 208) again.

The indicator lamp on the button comes on.

The air conditioning uses the refrigerant R134a. This refrigerant is free of CFCs which are harmful to the ozone layer.

 *If the air conditioning cannot be turned on again, this indicates that the air conditioning is losing refrigerant. The compressor has turned off.*

Have the air conditioning checked at the nearest authorized Mercedes-Benz Light Truck Center.

Residual heat and ventilation

With the engine switched off, it is possible to continue to heat or ventilate the interior for up to 30 minutes. This feature makes use of the residual heat produced by the engine.

 *How long the system will provide heating depends on*

- *the coolant temperature*
- *the battery voltage*

Regardless of the temperature and air volume set on the climate control panel, the interior temperature is set to 72°F (22°C) and the blower runs on low speed to protect the vehicle battery.

Activating

- ▶ Switch off the ignition (▷ page 40).
- ▶ Press button  (▷ page 208).

The indicator lamp on the button comes on.

Deactivating

- ▶ Press button  (▷ page 208).

The indicator lamp on the button goes out.

i The residual heat is automatically turned off:

- when the ignition is switched on
- after about 30 minutes
- if the coolant temperature is too low
- if the battery voltage drops

Rear climate control*

The control panel for the rear climate control is only available if your vehicle is equipped with seat heating* for the rear seats.

The control panel is located on the rear of the front center console.

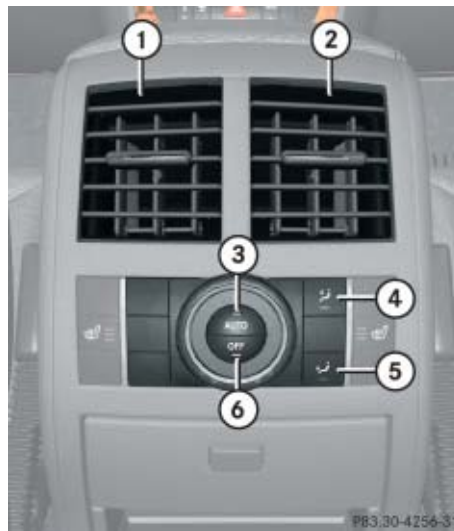

Rear climate control panel

①	Left rear center air vent, adjustable
②	Right rear center air vent, adjustable
③	Rear climate control on (automatic mode)
④	Air distribution (directs air through the center air vents)
⑤	Air distribution (directs air through the footwells and side air vents)
⑥	Rear air conditioning off

Climate control

Activating rear climate control

i *The climate control must be switched on (▷ page 218).*

- ▶ Press button **AUTO**.

The indicator lamp on the button comes on. The air volume and air distribution are adjusted automatically.

i *The temperature is adjusted according to the settings for the front passenger side made on the front climate control panel (▷ page 211).*

Deactivating rear climate control

- ▶ Press button **OFF**.

The indicator lamp on the button comes on.

The cooling function switches off after a short delay.

i *Switch off the rear climate control for improved cooling or heating output in the front passenger compartment.*

You can also switch off the rear climate control from the front passenger compartment (▷ page 218).

Operating from the front

Deactivating

- ▶ Press button **REAR OFF** on the front climate control panel (▷ page 208).

The indicator lamp on the button comes on.

Reactivating



- ▶ Press button **REAR OFF** on the front climate control panel (▷ page 208).

The indicator lamp on the button goes out. The rear climate control is adjusted automatically.

Adjusting air distribution

Use the air distribution controls ④ or ⑤ to adjust the air distribution for the rear passenger compartment.

The following symbols are found on the controls:

Symbol	Function
	Directs air to the center air vents
	Directs air to the footwells and the side air vents

Adjusting manually

- ▶ Press the desired air distribution control ④ or ⑤.

The indicator lamp in the **AUTO** button goes out.

Adjusting automatically

- ▶ Press button **AUTO** (▷ page 217).

The indicator lamp on the button comes on. The air distribution is adjusted automatically.

Adjusting air volume

The air volume for the rear zone corresponds to the air volume settings for the front passenger side. You can switch off the air supply for the rear zone.

You can switch off the supplied amount of air volume.

- ▶ Press button **OFF** (▷ page 217).

The indicator lamp on the button comes on.

3-zone automatic climate control*

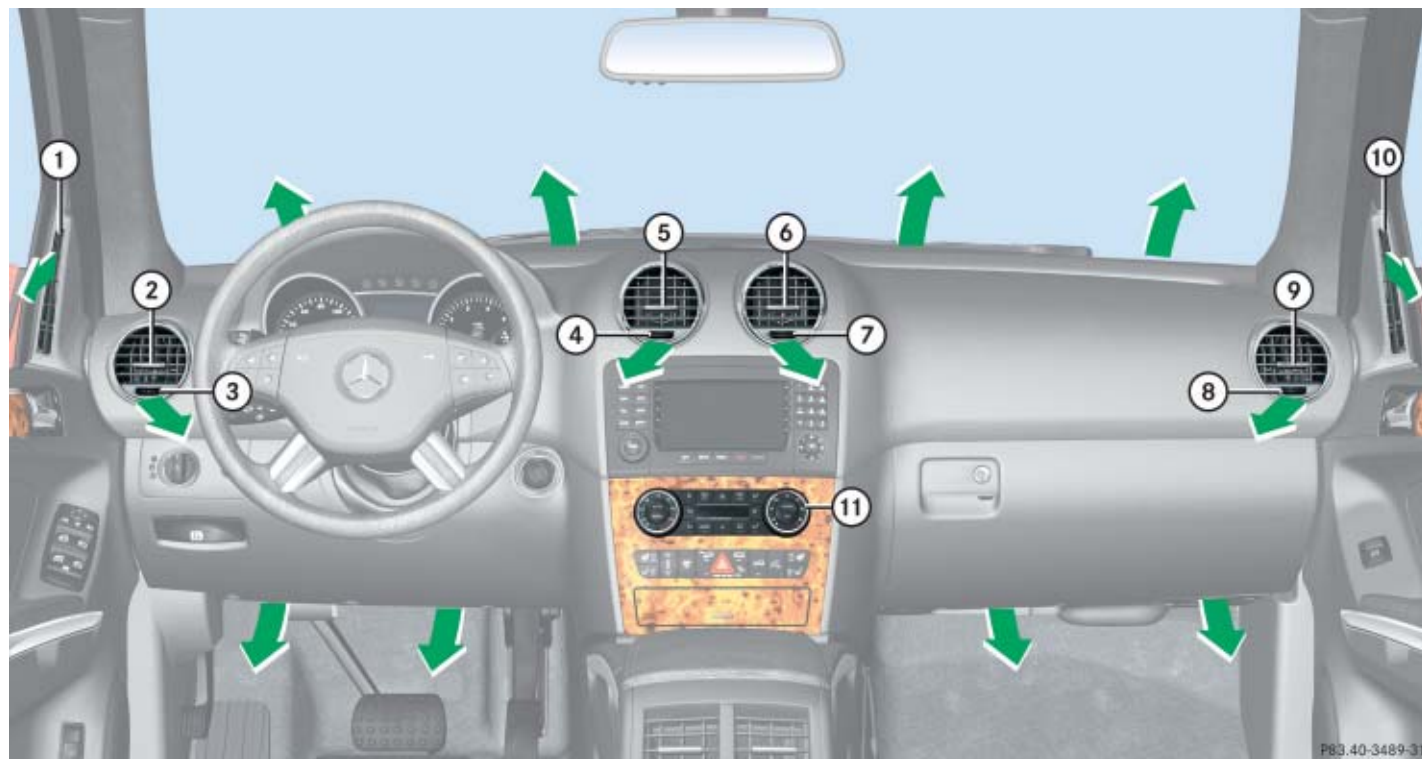







- ① Driver's door air vent, fixed
- ② Left side air vent, adjustable
- ③ Thumbwheel for air volume control for left side and door air vent
- ④ Thumbwheel for air volume control for left center air vent
- ⑤ Left center air vent, adjustable
- ⑥ Right center air vent, adjustable
- ⑦ Thumbwheel for air volume control for right center air vent
- ⑧ Thumbwheel for air volume control for right side and door air vent
- ⑨ Right side air vent, adjustable
- ⑩ Front passenger door air vent, fixed
- ⑪ Automatic climate control panel

i For draft-free ventilation, move the sliders for center air vents and side air vents to the middle position.

3-zone automatic climate control*



- | | | | |
|---|--|---|--|
| ① | Temperature control, left | ⑨ | Temperature control, right |
| ② | Air distribution and air volume (automatic, manual) | ⑩ | Automatic climate control on/off |
| ③ | Air distribution, driver's side | ⑪ | Air distribution, passenger side |
| ④ | Front defroster
 USA only
 Canada only | ⑫ | Air distribution, passenger side |
| ⑤ | Increasing air volume | ⑬ | AC cooling on/off
Residual heat/ventilation |
| ⑥ | Rear window defroster
 USA only
 Canada only | ⑭ | Display |
| ⑦ | Air distribution, passenger side | ⑮ | Decreasing air volume |
| ⑧ | Rear automatic climate control on/off
 USA only
 Canada only | ⑯ | Air recirculation |
| | | ⑰ | Air distribution, driver's side |
| | | ⑱ | Air distribution, driver's side |
| | | ⑲ | Interior temperature sensor |
| | | ⑳ | Adopting driver's side settings for all zones |

3-zone automatic climate control*

Warning!

When operating the automatic climate control, the air that enters the passenger compartment through the air vents can be very hot or very cold (depending on the set temperature). This may cause burns or frostbite to unprotected skin in the immediate area of the air vents.

Always keep sufficient distance between unprotected parts of the body and the air vents. If necessary, use the air distribution controls (> page 222) to direct the air to air vents in the vehicle interior that are not in the immediate area of unprotected skin.

The automatic climate control is a 3-zone intelligent automatic climate control system. Your vehicle interior is divided into 3 zones.



With the help of a sun sensor, the automatic climate control determines the relation of the sun to the vehicle and automatically adjusts the inside temperature for every individual zone.

The automatic climate control is operational whenever the engine is running. It cools the vehicle's interior according to the angle and intensity of the sun's rays, the outside temperature and the selected temperature. You can operate the automatic climate control in either the automatic or manual mode.

Nearly all dust particles, pollutants and odors are filtered out before outside air enters the passenger compartment through the air distribution system.

The air conditioning will not engage (no cooling) if the **A/C** mode is deactivated (> page 222).

3-zone automatic climate control*

Warning!



Follow the recommended settings for heating and cooling given on the following pages. Otherwise the windows could fog up, impairing visibility and endangering you and others.

i Severe conditions (e.g. strong air pollution) may require replacement of the filter before its scheduled interval. A clogged filter will reduce the air volume to the interior.

If the vehicle interior is hot, ventilate the interior before driving off, see “Summer opening feature” (▷ page 239). The automatic climate control will then adjust the interior temperature to the set value much faster.

Keep the air intake grille in front of the windshield free of snow and debris.

Deactivating the automatic climate control system

Warning!



When the automatic climate control system is switched off, the outside air supply and circulation are also switched off. Only choose this settings for a short time. Otherwise the windows could fog up, impairing visibility and endangering you and others.

Deactivating

- ▶ Press button **OFF** (▷ page 222) until the display ⑭ (▷ page 222) is cleared.

The indicator lamp on the button comes on.

Reactivating

- ▶ Press button **AUTO** (▷ page 222).

i You can also press button **OFF** (▷ page 222) on the automatic climate control panel.

If you press button **FRONT** (▷ page 222) to reactivate the automatic climate control system, the defrosting mode is activated.

3-zone automatic climate control*

Operating the automatic climate control system in automatic mode

You can switch the automatic climate control system on and off separately for each zone as needed.

i When operating the automatic climate control system in automatic mode, you will only rarely need to adjust the temperature, air volume and air distribution.

In automatic mode, cooling with dehumidify is switched on. This function can be switched off if necessary.

Activating



- ▶ Press button **AUTO** (▷ page 222) while the engine is running.

The indicator lamp on the button comes on. AUTO appears in the display (14) (▷ page 222). Air volume and air distribution are controlled separately for each zone.



- ▶ Use temperature controls (1) and (9) (▷ page 222) to separately adjust the air temperature on each side of the passenger compartment.

The temperature of the interior is adjusted automatically.

Deactivating

- ▶ Press one button of the air distribution (▷ page 222) or press button  or  (▷ page 222).

The indicator lamp on button **AUTO** goes out and AUTO disappears in the display (14) (▷ page 222).

Depending on which button you press – the air distribution button or the air volume button  or  – automatic control of either the air distribution or air volume is switched off.

Setting the temperature

Use temperature control (1) and (9) (▷ page 222) to separately adjust the air temperature on each side of the passenger compartment. You should raise or lower the temperature setting in small increments, preferably starting at 72°F (22°C). The automatic climate control will adjust to the set temperature as fast as possible.

Increasing

- ▶ Turn temperature control (1) and/or (9) slightly clockwise.

The automatic climate control system will correspondingly adjust the interior air temperature.

Decreasing

- ▶ Turn the temperature control (1) and/or (9) slightly counterclockwise.

The automatic climate control system will correspondingly adjust the interior air temperature.

3-zone automatic climate control*

Adjusting air distribution

Use the air distribution controls ③, ⑱, or ⑲ for the driver's side, or ⑦, ⑪, or ⑫ (▷ page 222) for the passenger side to separately adjust the air distribution on each side of the passenger compartment.

The following symbols are found on the buttons:

Symbol		Function
Driver's side	Passenger side	
		Directs air to the windshield and side air vents
		Directs air through the center, side and rear passenger compartment air vents
		Directs air to the footwells and side air vents

- ▶ Press the desired air distribution button (▷ page 222).

The indicator lamp on the desired button goes out.

Adjusting the air distribution for the center and side air vents

Opening the center air vents

- ▶ Turn thumbwheels ④ and ⑦ (▷ page 220) to the right.

The corresponding center air vents on the left and right are open.

Closing the center air vents

- ▶ Turn thumbwheels ④ and ⑦ (▷ page 220) to the left.

The corresponding center air vents on the left and right are closed.

Opening the side air vents

- ▶ Turn thumbwheels ③ and ⑧ (▷ page 220) to the right.

The corresponding side air vents on the left and right are open.

Closing the side air vents



- ▶ Turn thumbwheels ③ and ⑧ (▷ page 220) to the left.

The corresponding side air vents on the left and right are closed.

3-zone automatic climate control*

Adjusting air volume

Five blower speeds are available.

- ▶ Press button  to decrease or button  to increase air volume (▷ page 222) to the desired level.

The indicator lamp on button **AUTO** goes out.

The **AUTO** display disappears in the display ⑭ (▷ page 222) and the automatic mode is switched off. The selected blower speed appears in the display ⑭ (▷ page 222).

Front defroster

You can use this setting to defrost the windshield, such as when it is iced up. You can also use it to defog the windshield and side windows.

i *Keep this setting selected only until the windshield or the side windows are clear again.*

When the defrost setting has been selected, only the rear window defroster can be switched on. No other settings are possible.

Activating

- ▶ Press button  (▷ page 222).

The indicator lamp on the button comes on.

The automatic climate control switches to the following functions automatically:

- maximum blower speed and heating power
- air flows onto the windshield and the front side windows (side air vents must be open)
- the air conditioning compressor switches on at outside temperatures above approximately 41 °F (5 °C) for air-drying

Deactivating

- ▶ Press button  (▷ page 222).

The indicator lamp on the button goes out. Defrosting is turned off.

The previous settings are once again in effect.

i *To switch off, you can also press button **OFF** or **AUTO** (▷ page 222).*

3-zone automatic climate control*



Windshield fogged on the outside

 *Keep this setting selected only until the windshield is clear again.*

- ▶ Switch the windshield wipers on (▷ page 61).
- ▶ Press button  (▷ page 222).

AUTO appears in the display  (▷ page 222). Air volume and air distribution are controlled separately for each zone.

If the automatic air distribution and air volume are switched off:

- ▶ Press buttons  and  (▷ page 222).

Maximum cooling MAX COOL

If the air distribution control as well as the airflow volume control are set to  and there is a high need for cooling, the MAX COOL function is activated. “MAX COOL” appears in the front and rear display.

This provides the fastest possible cooling of the vehicle interior (when windows and tilt/sliding sunroof* are closed).

Air recirculation mode

Switch to air recirculation mode to prevent unpleasant odors from entering the vehicle from the outside (e.g. before driving through a tunnel). This setting cuts off the intake of outside air and recirculates the air in the passenger compartment.

Warning!



Fogged windows impair visibility, endangering you and others. If the windows begin to fog on the inside, switching off the air recirculation mode immediately should clear interior window fogging. If interior window fogging persists, make sure the air conditioning (▷ page 230) is activated, or press button .

3-zone automatic climate control*

Activating

▶ Press button  (▷ page 222).



The indicator lamp on the button comes on.

 *The air recirculation mode is activated automatically at high outside temperatures.*

The indicator lamp on button  is not lit when the air recirculation mode is automatically switched on.

A quantity of outside air is added after approximately 30 minutes.

If you have turned off the air conditioning (▷ page 230) or the outside temperature is below 41 °F (5 °C), the air recirculation mode will not switch on automatically.

 *To cool the interior as fast as possible, the automatic climate control automatically switches to air recirculation. The indicator lamp on button  is not lit when the system switches to air recirculation automatically.*

Deactivating

▶ Press button  (▷ page 222).

The indicator lamp on the button comes on.

 *The air recirculation mode is deactivated automatically*

- *after 5 minutes if the outside temperature is below approximately 41 °F (5 °C)*
- *after 5 minutes if the air conditioning and air-drying is turned off*
- *after 30 minutes if the outside temperature is above approximately 41 °F (5 °C)*

At outside temperatures above 79 °F (26 °C) the system will not automatically switch back to outside air. A quantity of outside air is added after approximately 30 minutes.

Air recirculation mode with convenience closing and opening feature

Warning!

Never operate the side windows and tilt/sliding sunroof* if there is the possibility of anyone being harmed by the opening or closing procedure.

In case the procedure causes potential danger:

Vehicles with or without tilt/sliding sunroof*: The closing of the windows can be immediately halted by pressing or pulling the respective window switch. The closing of the tilt/sliding sunroof* can be immediately halted by moving the switch for the tilt/sliding sunroof* in any direction.

The closing of the side windows and the tilt/sliding sunroof* can be reversed by again pressing and holding the  button.

3-zone automatic climate control*

Convenience closing



- ▶ Press button  for approximately 2 seconds.

The windows and/or tilt/sliding sunroof* will close. You can release button  once the closing procedure has begun. The windows and tilt/sliding sunroof* continue closing until they are fully closed. The indicator lamp on the button comes on. The air recirculation mode is activated.

Convenience opening

- ▶ Press button  for approximately 2 seconds.

The windows and/or tilt/sliding sunroof* will return to their previous positions. You can release button  once the opening procedure has begun. The windows and tilt/sliding sunroof* continue opening until they have reached their previous positions. The indicator lamp on the button goes out. The air recirculation mode is deactivated.

 *A window or the tilt/sliding sunroof* will only return to its previous position if it has not been moved to another position using the respective window switch or tilt/sliding sunroof* switch after it was closed with button .*

Air conditioning

The cooling function, only operational when the engine is running, cools the vehicle down to the selected interior temperature. The cooling function also dehumidifies the air in the vehicle interior, thereby preventing the windows from fogging up.

 *Condensation may drip out from underneath the vehicle. This is normal and not an indication of a malfunction.*

Warning!



If you turn off the cooling function, the interior air is not dried. The windows can fog up more quickly. Window fogging may impair visibility and endanger you and others.

3-zone automatic climate control*

Deactivating

It is possible to deactivate the air conditioning (cooling) function of the automatic climate control system. The air in the vehicle will then no longer be cooled or dehumidified.

- ▶ Press button  (▷ page 222).

The indicator lamp on the button goes out. The cooling function switches off after a short delay.

Activating

Moist air can fog up the windows. You can dehumidify the air with the air conditioning.

- ▶ Press button  again.

The indicator lamp on the button comes on.

The air conditioning uses the refrigerant R-134a. This refrigerant is free of CFCs which are harmful to the ozone layer.

! *If the air conditioning cannot be turned on again, this indicates that the air conditioning is losing refrigerant. The compressor has turned off.*

Have the air conditioning checked at the nearest authorized Mercedes-Benz Light Truck Center.

Using driver-side settings for all temperature zones

You can use the settings of the driver's side, such as temperature, air volume and air distribution, for all temperature zones. These settings only need to be made once and the automatic climate control system will automatically regulate the settings for all temperature zones quickly and comfortably.

Activating

- ▶ Adjust the temperature, air volume and air distribution (▷ page 222).
- ▶ Press button  (▷ page 222).

The indicator lamp on the button comes on.

The driver-side settings are used for all temperature zones.

Deactivating

- ▶ Press button  (▷ page 222) again.

The indicator lamp on the button goes out.

i *If you manually set the temperature, air volume or air distribution for the passenger side or the rear passenger compartment when the **MONO** setting is active, the **MONO** setting will be switched off.*

3-zone automatic climate control*

Residual heat and ventilation

With the engine switched off, it is possible to continue to heat or ventilate the interior for up to 30 minutes. This feature makes use of the residual heat produced by the engine.

i How long the system will provide heating depends on

- the coolant temperature
- the battery voltage

Regardless of the temperature and air volume set on the automatic climate control panel, an interior temperature is aimed at by 72°F (22°C) and the blower runs on low speed to protect the vehicle battery.

Activating

- ▶ Switch off the ignition (▷ page 39).
- ▶ Press button  (▷ page 222).

The indicator lamp on the button comes on.

Deactivating

- ▶ Press button .

The indicator lamp on the button goes out.

i The residual heat is automatically turned off:

- when the ignition is switched on
- after about 30 minutes
- if the coolant temperature is too low
- if the battery voltage drops

Rear automatic climate control

The control panel is located at the rear of the front center console.

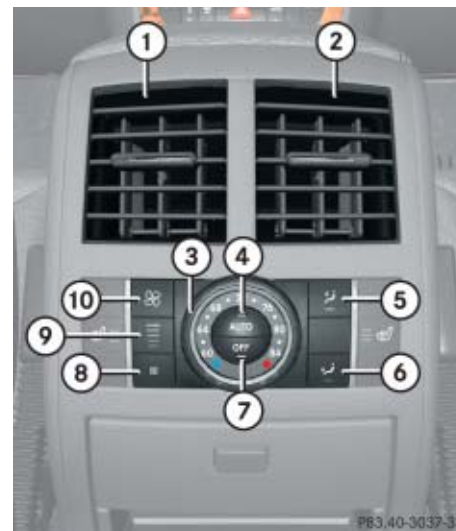

3-zone automatic climate control*

①	Left rear center air vent, adjustable
②	Right rear center air vent, adjustable
③	Temperature control
④	Air distribution and air volume (automatic, manual)
⑤	Air distribution (directs air through the center air vents)
⑥	Air distribution (directs air through the footwells and side air vents)
⑦	Rear automatic climate control on/off
⑧	Decreasing air volume
⑨	Indicator lamps for air volume settings
⑩	Increasing air volume

Activating rear automatic climate control

i *The automatic climate control must be switched on (▷ page 224).*

- ▶ Press button **AUTO**.

The indicator lamp on the button comes on. The temperature, air volume, and air distribution are adjusted automatically.

Deactivating rear automatic climate control

- ▶ Press button **OFF**.

The indicator lamp on the button goes out.

The cooling function switches off after a short delay.

i *Switch off the rear automatic climate control for improved cooling or heating output in the front passenger compartment.*

You can also switch off the rear automatic climate control from the front passenger compartment (▷ page 222).

Operating from the front

Deactivating

- ▶ Press button **REAR** (▷ page 222).

The indicator lamp on the button goes out.

In display ⑭ (▷ page 222), you will see the **REAR** symbol followed by MODE for approximately 3 seconds.

- ▶ Press button **OFF** (▷ page 222).

In display ⑭ (▷ page 222), you will see the **REAR** symbol followed by OFF.

The rear automatic climate control is switched off.

3-zone automatic climate control*

Reactivating

- ▶ Press button **REAR** (▷ page 222).

The indicator lamp on the button comes on.

In display ⑭ (▷ page 222), you will see the **REAR** symbol followed by ON and MODE. The MODE display is cleared and the indicator lamp on button **REAR** goes out after approximately 3 seconds.

The rear automatic climate control switches on.

Setting the temperature

- ▶ Press button **REAR** (▷ page 222).

The indicator lamp on the button comes on.

In display ⑭ (▷ page 222), you will see the **REAR** symbol followed by MODE.

- ▶ Set the desired temperature for the rear passenger compartment using temperature control ③ (▷ page 233).



After approximately 3 seconds after the last adjustment, the display switches back to its standard display and the indicator lamp on button **REAR** goes out.

i You can also press the **REAR** button once more to switch back to the standard display.

Adjusting air distribution

Use the air distribution controls ⑤ or ⑥ to adjust the air distribution for the rear passenger compartment.

The symbols on the controls represent the following functions:

Symbol	Function
	Directs air to the center air vents
	Directs air to the footwells and the side air vents

Adjusting manually

- ▶ Press the desired air distribution control.

The indicator lamp on button **AUTO** goes out.

3-zone automatic climate control*

Adjusting automatically

- ▶ Press button **AUTO** while the engine is running.

The indicator lamp on the button comes on. The air distribution is adjusted automatically.

Setting the temperature

Use temperature control ③ (▷ page 233) to separately adjust the air temperature of the rear passenger compartment.

You should raise or lower the temperature setting in small increments, preferably starting at 72°F (22°C). The automatic climate control will adjust to the set temperature as fast as possible.

i *The rear automatic climate control will not cool the air when the air conditioning is switched off (▷ page 231).*

Increasing the temperature

- ▶ Turn temperature control ③ (▷ page 233) slightly clockwise.

The rear automatic climate control will correspondingly adjust the interior air temperature for the rear passenger compartment.



Decreasing the temperature

- ▶ Turn temperature control ③ (▷ page 233) slightly counterclockwise.

The rear automatic climate control will correspondingly adjust the interior air temperature for the rear passenger compartment.

Adjusting air volume**Adjusting manually**

Five blower speeds are available.

- ▶ Press button  to decrease or button  to increase air volume to the desired level.

The indicator lamp on the button **AUTO** goes out. The selected blower speed is shown by the indicator lamps for air volume settings ⑨ (▷ page 233).

Adjusting automatically

- ▶ Press button **AUTO**.

The indicator lamp on the button comes on. The air volume is adjusted automatically.

Power windows

Opening and closing

The door windows are opened and closed electrically. The switches for all door windows are located on the driver's door control panel (▷ page 36). The switches for the respective door windows are located on the control panels of the front passenger door and the rear doors.

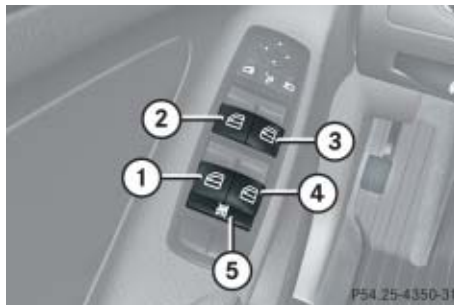

- ① Left rear door window
 - ② Left front door window
 - ③ Right front door window
 - ④ Right rear door window
 - ⑤ Override switch (▷ page 93)
- ▶ Switch on the ignition (▷ page 40).

Warning!



When closing the windows, make sure that there is no danger of anyone being harmed by the closing procedure.

Activate the override switch (▷ page 94) when children are riding in the back seats of the vehicle. The children could otherwise injure themselves, e.g. by becoming trapped in the window opening.

The closing of a door window can be immediately halted by releasing the switch or, if switch was pulled past the resistance point and released, by either pressing or pulling the respective switch.

If a door window encounters an obstruction that blocks its path in a circumstance where you pulled the switch past the resistance point and released it to close the door window, the automatic reversal function will stop the window and open it slightly.

If a door window encounters an obstruction that blocks its path in a circumstance where you are closing a door window by pulling and holding the switch, or by pressing and holding button  on the SmartKey, by pressing and holding the lock button (vehicles with KEYLESS-GO*) on a door handle, the automatic reversal function will not operate.

When leaving the vehicle, always remove the SmartKey or SmartKey with KEYLESS-GO* from the starter switch, take it with you, and lock the vehicle. Do not leave children unattended in the vehicle, or with access to an unlocked vehicle. Unsupervised use of vehicle equipment can cause an accident and/or serious personal injury.

 You can also open or close the windows using the SmartKey, see “Summer opening feature” (▷ page 239) and see “Convenience closing feature” (▷ page 239).

Depending on the current position, the power windows may also open or close when the air recirculation button  on the control panel of the climate control (▷ page 208) or automatic climate control (▷ page 222) is pressed and held.*

 With the SmartKey in starter switch position 0 or removed from the starter switch, the windows can be operated

- until you open the driver's or front passenger door
- for at least 5 minutes

Opening the door windows

- ▶ Press switch ①, ②, ③, or ④ (▷ page 236) to the resistance point.

The corresponding door window moves downwards until you release the switch.

Closing the door windows

- ▶ Pull switch ①, ②, ③, or ④ (▷ page 236) to the resistance point.

The corresponding door window moves upwards until you release the switch.

Warning!



If you pull and hold the switch up when closing the door window, and upward movement of the door window is blocked by some obstruction including but not limited to arms, hands, fingers, etc., the automatic reversal will not operate.

Power windows

Fully opening the door windows (Express-open)

- ▶ Press switch ①, ②, ③, or ④ (▷ page 236) past the resistance point and release.

The corresponding door window opens completely.

Fully closing the door windows (Express-close)

- ▶ Pull switch ①, ②, ③, or ④ (▷ page 236) past the resistance point and release.

The corresponding door window closes completely.

Warning!



Driver's door only:

If within 5 seconds switch is again pulled past the resistance point and released, the automatic reversal will not function.

If the upward movement of a door window is blocked during the closing procedure, the door window will stop and open slightly.

- ▶ Remove the obstruction.
- ▶ Pull the respective power window switch past the resistance point again and release.

i *If the door window still does not close when there is no obstruction, pull and hold the respective power window switch. The door window will then close without the obstruction sensor function.*

Stopping door windows during Express-operation

- ▶ Press or pull respective power window switch again.

Synchronizing the door windows

The door windows must be resynchronized

- after the battery was disconnected
- if the door windows cannot be fully opened (Express-open) or closed (Express-close)

i *Each door window must be resynchronized separately.*

- ▶ Close all doors.
- ▶ Switch on the ignition (▷ page 40).
- ▶ Pull and hold power window switch ①, ②, ③, or ④ (▷ page 236).

Once a door window is closed completely, hold the respective switch for approximately 3 seconds.

The door window is synchronized.

Summer opening feature



If the weather is warm, you can ventilate the vehicle before driving off by simultaneously:

- opening the door windows
- opening the tilt/sliding sunroof*
- switching on the seat ventilation* for the driver's seat



- ▶ Aim transmitter eye of the SmartKey or SmartKey with KEYLESS-GO* at the driver's outside door handle.

The SmartKey or SmartKey with KEYLESS-GO* must be in close proximity to the driver's outside door handle.

- ▶ Press and hold button  on the SmartKey or SmartKey with KEYLESS-GO* until the windows and the tilt/sliding sunroof* have reached the desired position.
- ▶ Release button  on the SmartKey or SmartKey with KEYLESS-GO* to interrupt the opening procedure.

Convenience closing feature



When locking the vehicle, you can close the windows and the tilt/sliding sunroof* simultaneously.

Warning!



When closing the windows and the tilt/sliding sunroof*, make sure that there is no danger of anyone being harmed by the closing procedure.

If potential danger exists, proceed as follows:

- Release button  to stop the closing procedure. To open, press and hold button . To continue the closing procedure after making sure that there is no danger of anyone being harmed by the closing procedure, press and hold button .





Power windows

▷▷ Vehicles with KEYLESS-GO*:

- Release the lock button (▷ page 68) on the driver's outside door handle to stop the closing procedure.
- Immediately pull on the same outside door handle and hold firmly. The windows and the tilt/sliding sunroof* will open for as long as the door handle is held but the door is not opened.

- ▶ Aim transmitter eye of the SmartKey or SmartKey with KEYLESS-GO* at the driver's outside door handle (▷ page 239).

The SmartKey or SmartKey with KEYLESS-GO* must be in close proximity to the driver's outside door handle.

- ▶ Press and hold button  on the SmartKey or SmartKey with KEYLESS-GO* until the windows and the tilt/sliding sunroof* are completely closed.
- ▶ Release button  on the SmartKey or SmartKey with KEYLESS-GO* to interrupt the closing procedure.

Vehicles with KEYLESS-GO*:

- ▶ Press and hold the lock button on an outside door handle (▷ page 68) until the windows and the tilt/sliding sunroof* are completely closed.
- ▶ Release the lock button on the outside door handle to interrupt the closing procedure.

Power tilt/sliding sunroof*

▼ Power tilt/sliding sunroof*

Opening and closing

The tilt/sliding sunroof is opened and closed electrically. The switch for the tilt/sliding sunroof is located on the overhead control panel.



Sunroof switch

- ① Push back to slide sunroof open
- ② Push forward to slide sunroof closed
- ③ Push up to raise sunroof at rear
- ④ Pull down to lower sunroof at rear

With the sunroof closed or tilted open, a screen can be slid into the roof opening to guard against sun rays. When sliding the sunroof open, the screen will also retract.



Power tilt/sliding sunroof*

Warning!



When closing the tilt/sliding sunroof, make sure that there is no danger of anyone being harmed by the closing procedure.

If the tilt/sliding sunroof encounters an obstruction that blocks its path in a circumstance where you are closing the tilt/sliding sunroof by moving the tilt/sliding sunroof switch past the resistance point, or by pressing and holding button  on the SmartKey, by pressing and holding the lock button (vehicles with KEYLESS-GO*) on the door handle, the automatic reversal function will not operate.

The opening/closing procedure of the tilt/sliding sunroof can be immediately halted by releasing the switch or, if the switch was moved past the resistance point and released, by moving the switch in any direction.

The tilt/sliding sunroof is made out of glass. In the event of an accident, the glass may shatter. This may result in an opening in the roof.

In a vehicle rollover, occupants not wearing their seat belts or not wearing them properly may be thrown out of the opening. Such an opening also presents a potential for injury for occupants wearing their seat belts properly as entire body parts or portions of them may protrude from the passenger compartment.

When leaving the vehicle, always remove the SmartKey or SmartKey with KEYLESS-GO* from the starter switch, take it with you, and lock your vehicle. Do not leave children unattended in the vehicle, or with access to an unlocked vehicle. Unsupervised use of vehicle equipment can cause an accident and/or serious personal injury.

! To avoid damaging the seals, do not transport any objects with sharp edges which can stick out of the tilt/sliding sunroof.

Do not open the tilt/sliding sunroof if there is snow or ice on the roof, as this could result in malfunctions.

The tilt/sliding sunroof can be opened or closed manually should an electrical malfunction occur (▷ page 478).

i When the tilt/sliding sunroof is open, resonance noises may result in addition to the usual wind noises. They are caused by minimal pressure changes in the passenger compartment. To reduce or eliminate these noises, change the position of the tilt/sliding sunroof or open a side window slightly.

i You can also open or close the tilt/sliding sunroof using the SmartKey or the KEYLESS-GO* function, see “Summer opening feature” (▷ page 239) and see “Convenience closing feature” (▷ page 239).

i Depending on the current position, the tilt/sliding sunroof may also open or close when the air recirculation button  on the control panel of the climate control (▷ page 208) or automatic climate control* (▷ page 222) is pressed and held.

- ▶ Switch on the ignition (▷ page 40).

Opening and closing

- ▶ To open, close, raise, or lower the tilt/sliding sunroof, move the sunroof switch to the resistance point in the required direction of arrows ① to ④ (▷ page 241).
- ▶ Release the sunroof switch when the tilt/sliding sunroof has reached the desired position.

Fully opening (Express-open) and closing (Express-close)

- ▶ To fully open or close the tilt/sliding sunroof, move the sunroof switch past the resistance point in the required direction of arrows ① to ② (▷ page 241) and release.
The tilt/sliding sunroof opens or closes completely.

Stopping the power tilt/sliding sunroof during Express-open

- ▶ Move the sunroof switch in any direction.
The movement of the tilt/sliding sunroof stops.

i *If the movement of the tilt/sliding sunroof is blocked during the closing procedure, the tilt/sliding sunroof will stop and reopen slightly.*

Warning!



If the tilt/sliding sunroof encounters an obstruction that blocks its path in a circumstance where you are closing the tilt/sliding sunroof by moving the tilt/sliding sunroof switch past the resistance point, or by pressing and holding button **6** on the SmartKey, by pressing and holding the lock button (vehicles with KEYLESS-GO*) on the door handle, the automatic reversal function will not operate.

The opening/closing procedure of the tilt/sliding sunroof can be immediately halted by releasing the switch or, if the switch was moved past the resistance point and released, by moving the switch in any direction.

Power tilt/sliding sunroof*

Synchronizing

The tilt/sliding sunroof must be synchronized

- after the battery has been disconnected or discharged
- after the tilt/sliding sunroof has been closed manually (▷ page 478)
- after a malfunction
- if the tilt/sliding sunroof does not open smoothly
- ▶ Remove the fuse for the tilt/sliding sunroof from the fuse box (▷ page 522).

i For information on which fuse box contains the fuse for the power tilt/sliding sunroof, see the fuse chart provided with the vehicle tool kit (▷ page 469).

- ▶ Reinsert the fuse in the main box.
- ▶ Switch on the ignition (▷ page 40).
- ▶ Press and hold the sunroof switch in the direction of arrow ③ (▷ page 241) until the tilt/sliding sunroof is fully raised at the rear.
- ▶ Hold the sunroof switch in the direction of arrow ③ for approximately 1 second.
- ▶ Open the tilt/sliding sunroof using the Express-open feature (▷ page 243).

If the tilt/sliding sunroof opens completely, it is synchronized.

If the tilt/sliding sunroof does not open completely:

- ▶ Repeat the above steps.

▼ Driving systems

The driving systems of your vehicle are described on the following pages:

- Cruise control (▷ page 245) and Distronic* (▷ page 250), with which the vehicle can maintain a preset speed.
- Distance warning function* (▷ page 263) is only available with Distronic*, which warns of stationary obstacle or slower moving vehicles that you are closing in on too quickly.
- Downhill Speed Regulation (DSR) (▷ page 264), which supports you when you are driving downhill.
- Off-road driving program (▷ page 268), which supports you when you are driving off-road.

- Air suspension package*
The system consists of two components.
 - Adaptive Damping System (ADS)* (▷ page 269), which adjusts the vehicle suspension characteristics.
 - Vehicle level control* (▷ page 270), which controls the vehicle level.
- Parktronic* (▷ page 274) and rear view camera* (▷ page 279), which serve as a parking aid.

For information on the ABS, BAS, EBP, ESP®, and 4-ETS, see “Driving safety systems” (▷ page 96).

Cruise control

The cruise control automatically maintains the speed you set for your vehicle.

The use of cruise control is recommended for driving at a constant speed for extended periods of time. You can set or resume cruise control at any speed above 20 mph (30 km/h).

The cruise control function is operated by means of the cruise control lever.

The cruise control lever is the uppermost lever on the left-hand side of the steering column (▷ page 24).

i *The cruise control should not be activated during off-road driving.*

Warning!



The cruise control is a convenience system designed to assist the driver during vehicle operation. The driver is and must always remain responsible for the vehicle's speed and for safe brake operation.

Only use the cruise control if the road, traffic and weather conditions make it advisable to travel at a constant speed.

- The use of the cruise control can be dangerous on winding roads or in heavy traffic because conditions do not allow safe driving at a constant speed.
- The use of the cruise control can be dangerous on slippery roads. Rapid changes in tire traction can result in wheel spin and loss of control.
- Deactivate the cruise control when driving in fog.

The "Resume" function should only be operated if the driver is fully aware of the previously set speed and wishes to resume this particular preset speed.

Warning!



The cruise control brakes automatically so that the set speed is not exceeded. The brake pedal depresses when the cruise control engages the brakes.

Keep driver's foot area clear at all times, including the area under the brake pedal. Objects stored in this area may impair pedal movement which could interfere with the braking ability of the cruise control system.

Do not place your foot under the brake pedal – your foot could become caught.

Keep in mind that the cruise control is a convenience system designed to assist the driver during vehicle operation. The driver is and must always remain responsible for the vehicle's speed and for safe brake operation.

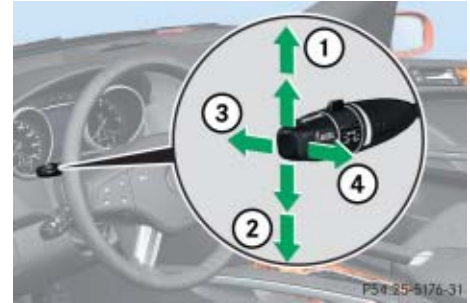

- ① Setting current or higher speed
Adjustment in 1 mph increments (to the resistance point) or 5 mph increments (past the resistance point) (Canada: 1 km/h or 10 km/h)
- ② Setting current or lower speed
Adjustment in 1 mph increments (to the resistance point) or 5 mph increments (past the resistance point) (Canada: 1 km/h or 10 km/h)
- ③ Canceling cruise control
- ④ Resume to last set speed

Activating cruise control

You can activate the cruise control when the vehicle speed is above 20 mph (30 km/h).

In the following cases you cannot activate the cruise control:

- when you brake
- when you have set the parking brake
- when the automatic transmission is set to position **P**, **R**, or **N**
- if the ESP® is switched off
- if the ESP® has switched off due to a malfunction

i *The vehicle speed displayed in the speedometer can briefly vary from the speed setting for the cruise control system.*

Setting current speed

- ▶ Accelerate or decelerate to the desired speed.
- ▶ Briefly lift the cruise control lever in direction of arrow ① or depress in direction of arrow ②.

The current speed is set.

- ▶ Remove your foot from the accelerator pedal.

The cruise control is activated.

The current set speed appears in the multifunction display for approximately 5 seconds.

i *On uphill grades, the cruise control may not be able to maintain the set speed. Once the grade eases, the set speed will be resumed.*

On downhill grades, the cruise control maintains the set speed by braking with the vehicle's braking system. In addition, on longer downhill grades the automatic transmission will downshift automatically.

Canceling cruise control

There are several ways to cancel the cruise control:

- ▶ Step on the brake pedal.

The cruise control is canceled. The last speed set is stored for later use.

or

- ▶ Briefly push the cruise control lever in direction of arrow ③ (▷ page 246).

The cruise control is canceled. The last speed set is stored for later use.

i *The last stored set speed is canceled when the engine is turned off.*

Driving systems

i The cruise control switches off automatically when

- you step on the brake pedal
- you depress the parking brake pedal

The cruise control switches off automatically and an acoustic warning will sound when

- the vehicle speed is below 20 mph (30 km/h)
- the ESP® is in operation
- the ESP® is switched off with the ESP® switch (▷ page 99)
- the ESP® has switched off due to a malfunction (▷ page 419)
- you set the automatic transmission to **N** while driving

Observe additional messages in the multifunction display that may appear.

! Setting the automatic transmission to **N** while driving cancels the cruise control. However, the automatic transmission should not be set to **N** while driving except to coast when the vehicle is in danger of skidding (e.g. on icy roads).

i Depressing the accelerator pedal does not deactivate the cruise control. After a brief acceleration (e.g. for passing), the cruise control will resume the last set speed.

Setting a higher speed

You can increase the speed in two ways.

Adjustment in 1 mph (Canada: 1 km/h) increments

i The set value is increased in 1 mph (Canada: 1 km/h) increments each time you lift the cruise control lever up to the resistance point.

- ▶ Briefly lift the cruise control lever up to the resistance point in direction of arrow ① (▷ page 246).
- ▶ Release the cruise control lever.

The vehicle speed increases in increments of 1 mph (Canada: 1km/h).

Adjustment in 5 mph (Canada: 10 km/h) increments

Warning!



You can increase the vehicle speed in 5 mph (Canada 10 km/h) increments. When using this feature, keep in mind that it may take a brief moment until the vehicle has reached the set speed.

Increase the vehicle speed to a value that the prevailing road conditions permit. Otherwise, sudden and unexpected acceleration of the vehicle could cause an accident and/or serious injury to you and others.

i The set value is increased in 5 mph (Canada: 10 km/h) increments each time you lift the cruise control lever past the resistance point.

- ▶ Briefly lift the cruise control lever up past the resistance point in direction of arrow ① (▷ page 246).

- ▶ Release the cruise control lever.

The vehicle speed increases in increments of 5 mph (Canada: 10 km/h).

i *The new speed is set and the vehicle will accelerate. Keep in mind that it may take a brief moment until the vehicle has reached the set speed.*

Setting a lower speed

You can reduce the speed in two ways.

i *When you use the cruise control lever to decelerate, the brake system will automatically brake the vehicle if the engine's braking power does not brake the vehicle sufficiently.*

Adjustment in 1 mph (Canada: 1 km/h) increments

i *The set value is decreased in 1 mph (Canada: 1 km/h) increments each time you press the cruise control lever down to the resistance point.*

- ▶ Briefly press the cruise control lever down to the resistance point in direction of arrow ② (▷ page 246).
- ▶ Release the cruise control lever.

The vehicle speed decreases in increments of 1 mph (Canada: 1 km/h).

Adjustment in 5 mph (Canada: 10 km/h) increments

Warning!



You can decrease the vehicle speed in 5 mph (Canada 10 km/h) increments. When using this feature, keep in mind that it may take a brief moment until the vehicle has reached the set speed.

Decelerate the vehicle speed to a value that the prevailing road conditions permit. Otherwise, sudden and unexpected deceleration of the vehicle could cause an accident and/or serious injury to you and others.

i *The set value is decreased in 5 mph (Canada: 10 km/h) increments each time you press the cruise control lever down past the resistance point.*

Driving systems

- ▶ Briefly press the cruise control lever down past the resistance point in direction of arrow ② (▷ page 246).

- ▶ Release the cruise control lever.

The vehicle speed decreases in increments of 5 mph (Canada: 10 km/h).

i *The new speed is set and the vehicle will decelerate. Keep in mind that it may take a brief moment until the vehicle has reached the set speed.*

Setting to last stored speed (“Resume” function)

Warning!



The set speed stored in memory should only be set again if prevailing road conditions permit. Possible acceleration or deceleration differences arising from returning to the preset speed could cause an accident and/or serious injury to you and others.

- ▶ Briefly pull the cruise control lever in direction of arrow ④ (▷ page 246).

The cruise control resumes to the last set speed, or if no speed is stored, it will set and store the current speed.

- ▶ Remove your foot from the accelerator pedal.

The last set speed appears in the multi-function display for approximately 5 seconds.

Distronic*

When activated, the Distronic adaptive cruise control system increases the driving convenience afforded by the cruise control while traveling on expressways and other major roadways.

- If the Distronic distance sensor detects a slower moving vehicle directly ahead, your vehicle speed will be reduced so that you follow that vehicle at your preset following distance.
- If there is no vehicle directly ahead of you, Distronic will function in the same way as standard cruise control (▷ page 245).

Warning!

Distronic is a convenience system. Its speed adjustment reduction capability is intended to make cruise control more effective and usable when traffic speeds vary. It is not however, intended to, nor does it, replace the need for extreme care. The responsibility for the vehicle's speed, distance to the preceding vehicle and, most importantly, brake operation to ensure a safe stopping distance, always rests with the driver.

Distronic cannot take road and traffic conditions into account.

Complex driving situations are not always fully recognized by Distronic. This could result in wrong or missing distance warnings.

Warning!

Distronic adaptive cruise control is no substitute for active driving involvement. It does not react to pedestrians or on stationary objects, nor does it recognize or predict the lane curvature or the movement of preceding vehicles.

Distronic can only apply a maximum of 20% of the vehicle's braking power.

It is the driver's responsibility at all times to be attentive to the road, weather and traffic conditions. Additionally, the driver must provide the steering, braking and other driving inputs necessary to remain in control of the vehicle.

High-frequency sources such as toll stations, speed measuring systems etc. can cause the Distronic system to malfunction.

Warning!

Distronic requires familiarity with its operational characteristics. We strongly recommend that you review the following information carefully before operating the system.

Warning!

Distronic cannot take road and traffic conditions into account. Only use Distronic if the road, weather and traffic conditions make it advisable to travel at a constant speed.

Warning!

Use of Distronic can be dangerous on slippery roads. Rapid changes in tire traction can result in wheel spin and loss of control. >>

Driving systems



DISTRONIC does not act upon adverse sight and distance conditions. Do not use DISTRONIC during conditions of fog, heavy rain, snow or sleet.

Warning!



DISTRONIC cannot take weather conditions into account. Switch off DISTRONIC or do not switch it on if:

- roads are slippery or covered with snow or ice. The wheels could lose traction while braking or accelerating, and the vehicle could skid.
- the sensor is dirty or visibility is diminished due to snow, rain or fog, for example. The distance control system functionality could be impaired.

Always pay attention to surrounding traffic conditions even while DISTRONIC is switched on. Otherwise, you may not be able to recognize dangerous situations until it is too late. This could cause an accident in which you and others could be injured.

Warning!



The “Resume” function should only be operated if the driver is fully aware of the previously set speed and wishes to resume this particular preset speed.

Warning!



Close attention to road and traffic conditions is imperative at all times, regardless of whether or not DISTRONIC is activated.

Use of DISTRONIC can be dangerous on winding roads or in heavy traffic because conditions do not allow safe driving at a continuous speed.

DISTRONIC will not react to stationary objects in the roadway (e.g. a stopped vehicle in a traffic jam or a disabled vehicle). DISTRONIC will also not respond to oncoming vehicles.

Switch off DISTRONIC:

- when changing from the left to the right lane if vehicles are moving more slowly in the left lane
- when entering a turn lane or highway off ramp
- in complex driving situations, such as in highway construction zones

In these situations, DISTRONIC will continue to maintain the set speed unless deactivated.

DISTRONIC is designed and intended only to maintain a set speed and keep a set distance from moving objects in front of it.

i *USA only: This device has been approved by the FCC as a “Vehicular Radar System”. The radar sensor is intended for use in an automotive radar system only. Removal, tampering, or altering of the device will void any warranties, and is not permitted by the FCC. Do not tamper with, alter, or use in any non-approved way.*

Any unauthorized modification to this device could void the user’s authority to operate the equipment.

i *Canada only:*

This device complies with RSS-210 of Industry Canada. Operation is subject to the following two conditions:

- (1) This device may not cause interference, and*
- (2) this device must accept any interference received, including interference that may cause undesired operation of the device.*

Removal, tampering, or altering of the device will void any warranties, and is not permitted. Do not tamper with, alter, or use in any non-approved way.

Any unauthorized modification to this device could void the user’s authority to operate the equipment.

Distronic displays in the speedometer dial



① Set speed

If Distronic is activated, one or two cruise control speed segments come on around the set speed.

i *The vehicle speed displayed on the speedometer can briefly vary from the speed setting on the Distronic system.*



① Set speed

② Cruise control speed segments

③ Speed of the vehicle ahead

If Distronic detects a vehicle directly ahead, the cruise control speed segments ②, which represents the difference from the speed of the preceding vehicle ③ to the driver’s selected set speed ①, appear in the speedometer.

Driving systems

If Distronic calculates that there is a danger of collision:

- The distance warning lamp  in the instrument cluster comes on (▷ page 27).
- An intermittent warning sounds.
- ▶ Immediately apply the brake to avoid a collision.

Under no circumstances should the driver await the intermittent warning sound before braking. See the following warning note.

The intermittent warning sound ceases and the distance warning lamp  goes out when the necessary distance to the vehicle ahead is again established.

Warning!



An intermittent warning sounds and the distance warning lamp  in the instrument cluster is illuminated if the Distronic system calculates that the distance to the vehicle ahead and your vehicle's current speed indicate that Distronic will not be capable of slowing the vehicle sufficiently to maintain the preset following distance, which creates a danger of a collision.

Immediately brake the vehicle to increase your distance to the preceding vehicle. The warning sound is intended as a final caution in which you should intercede with your own braking inputs to avoid a potentially dangerous situation. Do not wait for the operation of the warning signal to intercede with your own braking. This will result in potentially dangerous emergency braking which will not always result in an impact being avoided.

Tailgating increases the risk of an accident.

Warning!



Distronic brakes your vehicle with a maximum deceleration of 6.5 ft/s^2 (2 m/s^2). This corresponds to about 20% of the maximum deceleration of your vehicle.

Distronic brakes the vehicle in an effort to restore the preset distance or to maintain the set speed.

Keep driver's foot area clear at all times, including the area under the brake pedal. Objects stored in this area may impair pedal movement which could interfere with the braking ability of the Distronic system.



Do not place your foot under the brake pedal – your foot could become caught.

DISTRONIC menu in the control system

Use the DISTRONIC menu to display the current settings for your Distronic system. The information shown in the multifunction display depends on whether the Distronic system is activated or deactivated.

i For activating or deactivating the Distronic system, see “Activating Distronic” (▷ page 256) or, see “Deactivating Distronic” (▷ page 259).

For activating or deactivating the Distance warning function, see “Distance warning function*” (▷ page 179).

- ▶ Press button  or  repeatedly until you see one of the following two displays in the multifunction display.

Distronic activated

When you turn Distronic on, you will see the set speed in the multifunction display for about 5 seconds. When Distronic is activated, the following display appears in the multifunction display.

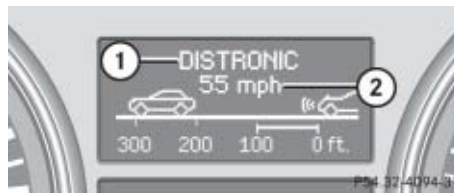

- ① Distronic activated
- ② Set vehicle speed

Distronic deactivated

When Distronic is deactivated, you will see the standard Distronic display in the multifunction display.

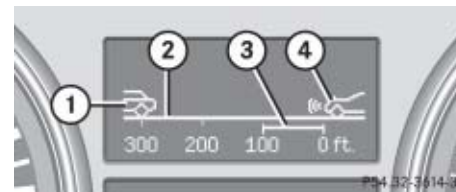

- ① Preceding vehicle, if detected
- ② Actual distance to the preceding vehicle
- ③ Preset distance threshold to the preceding vehicle
- ④ Your vehicle

Cruise control lever

The Distronic system is operated by means of the cruise control lever.

The cruise control lever is the uppermost lever on the left-hand side of the steering column.

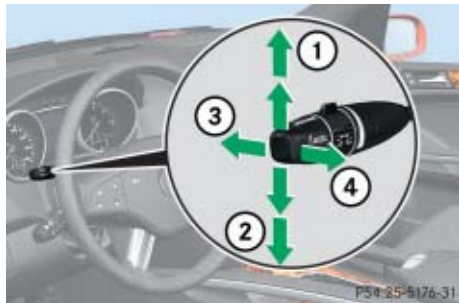

- ① Setting current or higher speed
Adjustment in 1 mph increments (to the resistance point) or 5 mph increments (past the resistance point) (Canada: 1 km/h or 10 km/h)
- ② Setting current or lower speed
Adjustment in 1 mph increments (to the resistance point) or 5 mph increments (past the resistance point) (Canada: 1 km/h or 10 km/h)
- ③ Deactivating Distronic
- ④ Activating Distronic or resuming to last set speed

Activating Distronic

You can activate Distronic when the vehicle speed is between 20 mph (30 km/h) and 110 mph (180 km/h).

When Distronic is activated the multifunction display will show a message such as **DISTRONIC 55 mph**.

If Distronic has not been activated after pressing the cruise control lever, you will see the message **DISTRONIC Off** in the multifunction display.

In the following cases you cannot activate Distronic:

- up to 2 minutes after starting the engine
- when you brake
- when you have set the parking brake
- when the automatic transmission is set to position **P**, **R**, or **N**
- if the ESP® is switched off
- if the ESP® has switched off due to a malfunction

Setting the current speed

- ▶ Accelerate or decelerate to the desired speed.
- ▶ Briefly lift the cruise control lever in direction of arrow ① or depress in direction of arrow ② (▷ page 255).
Distronic is activated and the current speed is set.
- ▶ Remove your foot from the accelerator pedal.

i *If you do not take your foot off of the accelerator pedal and continue to accelerate past the set speed, the following message will appear in the multifunction display:*

DISTRONIC Override

The distance to a slower moving vehicle in front of you will not be set. Your vehicle speed will then be determined only by the accelerator pedal position.

Setting a higher speed

You can increase the set speed in two ways.

Adjustment in 1 mph (Canada: 1 km/h) increments

i The set value is increased in 1 mph (Canada: 1 km/h) increments each time you lift the cruise control lever up to the resistance point.

- ▶ Briefly lift the cruise control lever up to the resistance point in direction of arrow ① (▷ page 255).
- ▶ Release the cruise control lever.

The vehicle speed increases in increments of 1 mph (Canada: 1 km/h).

Adjustment in 5 mph (Canada: 10 km/h) increments

Warning!



You can increase the vehicle speed in 5 mph (Canada: 10 km/h) increments. When using this feature, keep in mind that it may take a brief moment until the vehicle has reached the set speed.

Increase the vehicle speed to a value that the prevailing road conditions permit. Otherwise, sudden and unexpected acceleration of the vehicle could cause an accident and/or serious injury to you and others.

i The set value is increased in 5 mph (Canada: 10 km/h) increments each time you lift the cruise control lever up past the resistance point.

- ▶ Briefly lift the cruise control lever up past the resistance point in direction of arrow ① (▷ page 255).

- ▶ Release the cruise control lever.

The vehicle speed increases in increments of 5 mph (Canada: 10 km/h).

i The new speed is set and the vehicle will accelerate. Keep in mind that it may take a brief moment until the vehicle has reached the set speed.

Driving systems

Setting a lower speed

You can reduce the set speed in two ways.

i When you use the cruise control lever to decelerate, the brake system will automatically brake the vehicle if the engine's braking power does not brake the vehicle sufficiently.

Adjustment in 1 mph (Canada: 1 km/h) increments

i The set value is decreased in 1 mph (Canada: 1 km/h) increments each time you press the cruise control lever down to the resistance point.

▶ Briefly press the cruise control lever down to the resistance point in direction of arrow ② (▷ page 255).

▶ Release the cruise control lever.

The vehicle speed decreases in increments of 1 mph (Canada: 1 km/h).

Adjustment in 5 mph (Canada: 10 km/h) increments

Warning!



You can decrease the vehicle speed in 5 mph (Canada 10 km/h) increments. When using this feature, keep in mind that it may take a brief moment until the vehicle has reached the set speed.

Decelerate the vehicle speed to a value that the prevailing road conditions permit. Otherwise, sudden and unexpected deceleration of the vehicle could cause an accident and/or serious injury to you and others.

i The set speed value is decreased in 5 mph (Canada: 10 km/h) increments each time you press the cruise control lever down past the resistance point.

▶ Briefly press the cruise control lever down past the resistance point in direction of arrow ② (▷ page 255).

▶ Release the cruise control lever.

The vehicle set speed decreases in increments of 5 mph (Canada: 10 km/h).

i The new speed is set and the vehicle will decelerate. Keep in mind that it may take a brief moment until the vehicle has reached the set speed.

Setting to last stored speed ("Resume" function)

Warning!



The set speed stored in memory should only be set again if prevailing road conditions permit. Possible acceleration or deceleration differences arising from returning to the preset speed could cause an accident and/or serious injury to you and others.

- ▶ Briefly pull the cruise control lever in direction of arrow ④ (▷ page 255).
The Distronic resumes to the last set speed.
- ▶ Remove your foot from the accelerator pedal.

The last set speed or, if no speed is stored, the current set speed appears in the multifunction display for approximately 5 seconds.

Deactivating Distronic

There are several ways to deactivate the Distronic system:

- ▶ Step on the brake pedal.

or

- ▶ Briefly tip the cruise control lever in direction of arrow ③ (▷ page 256).

Distronic will be deactivated. The last set speed will be stored in memory.

i The following message appears in the multifunction display for approximately 5 seconds:
DISTRONIC Off.

The last stored set speed is deleted when the engine is turned off.

i The Distronic switches off automatically when

- you step on the brake pedal
- you depress the parking brake pedal

In this case, the Distronic speed segments in the speedometer (▷ page 253) will go out.

- the vehicle speed falls below 20 mph (30 km/h)
- the ESP[®] is in operation
- the ESP[®] is switched off with the ESP[®] switch (▷ page 99)
- the ESP[®] has switched off due to a malfunction (▷ page 419)
- you set the automatic transmission to **N** while driving

The Distronic speed segments in the speedometer (▷ page 253) will go out and an acoustic warning will sound.

Warning!



Distronic switches off and releases the brakes when the vehicle decelerates below the minimum speed of 20 mph (30 km/h) by operation of the system. At that time the driver must apply the brakes in order to reduce vehicle speed further or bring it to a stop.

! *Setting the automatic transmission to **N** while driving cancels the Distronic. However, the automatic transmission should not be set to **N** while driving except to coast when the vehicle is in danger of skidding (e.g. on icy roads).*

i *Depressing the accelerator pedal does not deactivate the Distronic. After a brief acceleration (e.g. for passing), the Distronic will resume the last set speed.*

Setting the following distance in Distronic

You can set the specified following distance for Distronic by varying the time setting between 1.0 and 2.0 seconds. Using this time setting and the current speed of your vehicle, Distronic calculates and sets the required following distance to the preceding vehicle. The set distance will be shown in the multifunction display (▷ page 255).

The distance setting switch for the time setting is located on the left-hand side of the steering column.

Warning!



It is up to the driver to exercise discretion to select the appropriate setting given road conditions, traffic, driver's preferred driving style and applicable laws and driving recommendations for safe following distance.



- ① Distance setting switch
- ② To decrease distance
- ③ To increase distance

Increasing distance

Increasing the distance setting tells Distronic to maintain a greater following distance to the preceding vehicle.

- ▶ Turn distance setting switch ① in direction of arrow ③.

Decreasing distance

Decreasing the distance setting tells Distronic to maintain a smaller following distance to the preceding vehicle.

- ▶ Turn distance setting switch ① in direction of arrow ②.

Driving with Distronic

This section describes a number of driving situations where special precaution is required on the part of the driver. Be prepared to brake in such situations. Braking will deactivate the Distronic system.

Warning!



Distronic works to maintain the speed selected by the driver unless a moving obstacle proceeding directly ahead of it in the same travel direction is detected (e.g. following another vehicle ahead of you at your set distance).

This means that:

- Your vehicle can pass another vehicle after you have changed lanes.
- While in a sharp turn or if the preceding vehicle is in a sharp turn, Distronic could lose sight of the preceding vehicle. Your vehicle could then accelerate to the previously selected speed.

Distronic regulates only the distance between your vehicle and those directly ahead of it, but does not register stationary objects in the road, e.g.:

- a stopped vehicle in a traffic jam
- a disabled vehicle
- an oncoming vehicle

The driver must always be alert, observe all traffic and intercede as required by means of steering or braking the vehicle.

Warning!



Distronic should not be used in snowy or icy road conditions.

The most likely cause for a malfunctioning system is a dirty sensor (located behind the hood grille), especially at times of snow and ice or heavy rain. In such a case, Distronic will switch off, and the message **DISTRONIC currently unavailable** – See Operator's Manual **appears** in the multi-function display.

For cleaning and care of the Distronic sensor, see “Cleaning the Distronic* system sensor cover” (▷ page 408).

i *If the message **DISTRONIC available** again **appears** during driving the dirt (e.g. slush) has dissolved; Distronic works again, if you reactivate it (▷ page 256).*

Driving systems

Turns and bends

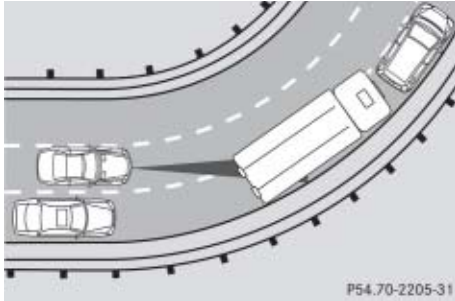

In turns or bends, Distronic may not detect a moving vehicle in front, or it may detect one too soon. This may cause your vehicle to brake late or unexpectedly.

Offset driving

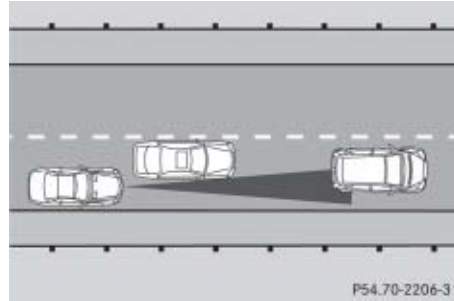

A vehicle traveling in your lane but offset from your direct line of travel may not be detected by Distronic. There will be insufficient distance to the vehicle ahead.

Lane changing

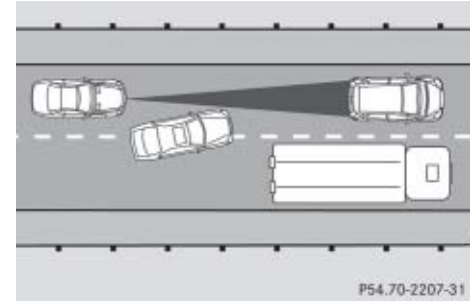

Distronic has not yet detected the vehicle changing lanes. There will be insufficient distance to the lane-changing vehicle.

Narrow vehicles

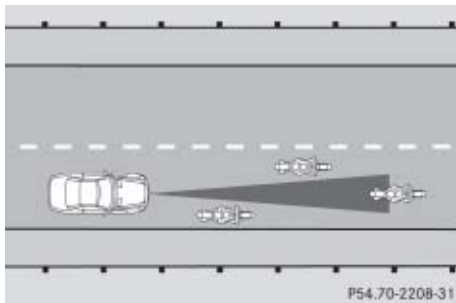

Because of their narrow profile, the vehicles traveling near the outer edges of the lane have not yet been detected by Distronic. There will be insufficient distance to the vehicles ahead.

Distance warning function*

When Distronic* is deactivated, this function will continue to warn you when recognizing a stationary obstacle or a slower vehicle moving in your vehicle's path and the danger of a collision exists:

- The distance warning lamp  in the instrument cluster comes on.
- An intermittent warning will sound if necessary.

If these warnings are issued, you must brake manually to maintain a safe distance and avoid a collision with the preceding vehicle.

When pressing the brake pedal, the warning sound ceases. The warning sound will also cease when the distance to the preceding vehicle is sufficient again without applying the brakes. In this case, the distance warning lamp will also go out.

Warning!



If the distance warning lamp  in the instrument cluster comes on while driving and/or an intermittent warning sounds, immediate attention on the part of the driver is required. As required by the traffic situation, apply the brakes and navigate around a possible obstacle. However, do not drive by relying on the distance warning function, as this will result in an emergency braking application. This will not always enable you to avoid a collision, especially when traveling on varying road surface conditions and with varying driver reaction.

Complex driving situations are not always fully recognized by the distance warning function. This could result in wrong or missing distance warnings.

- ▶ Switch on the distance warning function in the control system (▷ page 179).

Downhill Speed Regulation (DSR)

Warning!



Downhill Speed Regulation is a convenience system designed to assist the driver during vehicle operation. The system must be set to be appropriate for the topographical and weather conditions encountered which can change quickly. The driver is and must remain at all times responsible for the vehicle speed and for safe brake operation.

Depending on the programmed speed (▷ page 179), actual vehicle speed and gradient, switching on the DSR while driving can cause the vehicle to slow down rapidly and you may hear a sound which is caused by the activation of the vehicle's brake system through the DSR. Sudden and unexpected deceleration can result in loss of vehicle control, causing an accident and/or serious personal injury to you and others. Do not switch on the DSR in a circumstance where rapid deceleration could result in a loss of vehicle control.

For more information, see “Off-road driving” (▷ page 333).

The DSR is an aid for driving downhill. DSR regulates your vehicle's speed when driving downhill to the value set in the control system (▷ page 179). The steeper the downhill gradient is, the greater the brake application. On flat road surfaces, DSR brakes only slightly or not at all.

DSR regulates the vehicle's speed in automatic transmission positions **D**, or **R**.

i In addition, make use of the engine's braking effect by shifting the automatic transmission into a lower gear.

You can drive slower or faster than the set speed at any time by braking the vehicle or depressing the accelerator pedal.

i Whenever DSR is switched on, DSR will use the programmed default speed to regulate the vehicle's speed. The default speed programmed at the factory is 4 mph (Canada: 6 km/h). The default speed can be reprogrammed using the control system (▷ page 179). The next time DSR is switched on, DSR will use the newly programmed default speed to regulate the vehicle's speed.

Once DSR is switched on, you can adjust the set speed using the cruise control lever (▷ page 255). Keep in mind that adjusting the set speed using the cruise control lever with DSR switched on will not change the programmed default speed. If DSR is switched off and then switched on again, DSR will use the programmed default speed.

Depending on the road surface and level of downhill grade, the DSR may not be able to maintain the set speed. To maintain the set speed, apply the brakes if necessary.

Switching the Downhill Speed Regulation on/off

The switch is located in the lower part of the center console.



- ① DSR on/off
- ② Indicator lamp

Warning!



If the accelerator pedal is depressed while the Downhill Speed Regulation is activated, the vehicle can drive faster than the programmed set speed. You should therefore drive downhill with particular caution as it could otherwise lead to an accident and/or serious injury to you or others. Keep in mind that as soon as you remove the foot from the accelerator pedal with the DSR switched on, the DSR will start regulating the vehicle's speed including use of brakes if required. Depending on the programmed set speed, actual vehicle speed and gradient, the DSR can cause the vehicle to slow down rapidly. Sudden and unexpected deceleration can result in loss of vehicle control, causing an accident and/or serious personal injury to you and others.

Switching Downhill Speed Regulation on

i The DSR can only be switched on if the vehicle speed is below 18 mph (Canada: 30 km/h).

- ▶ Press DSR switch ① (▷ page 265).

The indicator lamp ② comes on.

The message DSR and the set speed appear in the multifunction display.



i If the DSR is switched on at a speed above 18 mph (Canada: 30 km/h), the message DSR Max. speed 18 mph (Canada: 30 km/h) appears in the multifunction display.

For information on how to program the set speed while driving, see “Adjusting Downhill Speed Regulation speed with DSR switched on” (▷ page 266).

Driving systems

Switching Downhill Speed Regulation off

- ▶ Press DSR switch ① (▷ page 265).

The indicator lamp ② goes out.

The message DSR Off appears in the multifunction display.

i At a speed above approximately 21 mph (Canada approx.: 35 km/h), the DSR is automatically switched off. The message DSR Off appears in the multifunction display and an acoustic signal sounds. For information on how to switch DSR on again, see “Switching Downhill Speed Regulation on” (▷ page 265).

Adjusting Downhill Speed Regulation speed with DSR switched on

With the DSR switched on (▷ page 265), the speed setting can be changed using the cruise control lever.

The cruise control lever is the uppermost lever on the left-hand side of the steering column.



Cruise control lever

- ① Increase set speed
- ② Reduce set speed

You can change the set speed between 3-10 mph (Canada: 4-18 km/h).

You can increase or reduce the set speed in two ways.

Adjustment in 1 mph (Canada: 1 km/h) increments

i The set value is increased or decreased in 1 mph (Canada: 1 km/h) increments each time you lift or depress the cruise control lever to the resistance point.

Increase set speed:

- ▶ Briefly lift the cruise control lever up to the resistance point in direction of arrow ① (▷ page 266).
- ▶ Release the cruise control lever.

The vehicle speed increases in increments of 1 mph (Canada: 1 km/h).

Reduce set speed:

- ▶ Briefly press the cruise control lever down to the resistance point in direction of arrow ② (▷ page 266).
- ▶ Release the cruise control lever.

The vehicle speed decreases in increments of 1 mph (Canada: 1 km/h).

Each time the set speed is changed, DSR will appear in the multifunction display and the changed set speed is shown.

i *The set speed is canceled when DSR is switched off. If DSR is switched on again, DSR will use the programmed default speed (▷ page 179).*

Adjustment in 5 mph (Canada: 10 km/h) increments

i *The set value is increased or decreased in 5 mph (Canada: 10 km/h) increments each time you lift or depress the cruise control lever past the resistance point.*

Increase set speed:

- ▶ Briefly lift the cruise control lever up past the resistance point in direction of arrow ① (▷ page 266).
- ▶ Release the cruise control lever.

The vehicle speed increases in increments of 5 mph (Canada: 10 km/h).

Reduce set speed:

- ▶ Briefly press the cruise control lever down past the resistance point in direction of arrow ② (▷ page 266).

- ▶ Release the cruise control lever.

The vehicle speed decreases in increments of 5 mph (Canada: 10 km/h).

Each time the set speed is changed, DSR will appear in the multifunction display and the newly set speed is shown.

i *The new speed is set and the vehicle will accelerate or decelerate. Keep in mind that it may take a brief moment until the vehicle has reached the new set speed.*

i *The set speed is canceled when DSR is switched off. If DSR is switched on again, DSR will use the programmed default speed (▷ page 179).*

Driving systems

Off-road driving program

The off-road driving program is designed to assist the driver when driving off-road in terrain and crossing water. The off-road driving program adjusts the engine power and shifting of the automatic transmission to be more suitable for the off-road use of the vehicle. In addition, the ABS, ESP®, and 4-ETS designed for off-road use are automatically activated.

In the following situations you should switch to the off-road driving program:

- during off-road driving
- when crossing water (▷ page 338)
- when towing up or down on steep gradients

The switch is located on the lower part of the center console.

i In the ML 63 AMG, the off-road driving program is switched on and off via the control system (▷ page 159).



- ① Switch for off-road driving program
- ② Indicator lamp

Switching Off-road driving program on

- ▶ Press switch ① (▷ page 268).

Indicator lamp ② comes on. The symbol  appears in the lower multifunction display.



Switching Off-road driving program off

- ▶ Press switch ① again.

Indicator lamp ② goes out. The symbol  disappears.

Air suspension package*

The system consists of two components. The vehicle level control* regulates the ride height of the vehicle. The Adaptive Damping System (ADS)* optimizes your vehicle's suspension tuning.

- Suspension tuning: Adaptive Damping System (ADS)* (▷ page 269)
- Vehicle level control* (▷ page 270)

ML 63 AMG

i The Air suspension package is part of the standard equipment range. Due to the vehicle's sportier suspension tuning, in comparison with standard vehicles, the level positions in the ADS settings as well as the speed thresholds for raising and lowering the vehicle have been modified.

i From the Highway/High-speed level, the vehicle is lowered to the ADS Sport level approx. 20 seconds after it is locked.

From the raised level, the vehicle is not lowered after it is locked.

When the engine is started, the previously selected setting, e.g. ADS COMF, is selected again.

! Be sure to observe this vehicle's differing values for ground clearance and vehicle height in comparison to standard vehicles. You could otherwise damage the vehicle. The values for

- opening the tailgate (▷ page 119)
- driving off-road (▷ page 333)
- the vehicle's main dimensions can be found in the "Technical data" section (▷ page 541)

Adaptive Damping System (ADS)*

The fine tuning of the damping and suspension is dependent on:

- your driving style
- road surface conditions
- your personal ADS settings
- your personal vehicle level settings

The ADS switch is located on the upper part of the center console.



- ① ADS switch
- ② Indicator lamp for SPORT setting
- ③ Indicator lamp for COMF setting

Driving systems

The following settings are available:

- **AUTO** (for normal driving situations)
Indicator lamps ② and ③ are off.
 - **SPORT** (for sporty driving)
Indicator lamp ② comes on.
With the ADS SPORT setting, the vehicle is lowered approximately 0.6 in (15 mm).
ML 63 AMG:
The vehicle is lowered approximately 0.3 in (8 mm).
 - **COMF** (for comfort driving)
Indicator lamp ③ comes on.
ML 63 AMG:
The vehicle is raised approximately 0.28 in (7 mm).
- ▶ Start the engine (▷ page 39).
- ▶ Press ADS switch ① repeatedly until the desired suspension tuning is reached.

i *The setting is stored when you turn off the engine.*

Vehicle level control*

The vehicle level control automatically regulates the ride height to

- reduce fuel consumption
- improve driving stability by lowering the center of gravity

The vehicle automatically regulates its ride height based on the set vehicle height and the current speed:

- As your driving speed increases, the vehicle is lowered by increments until it reaches high-speed level.
- If you are driving with the ADS setting COMF or AUTO, the vehicle is raised back to highway level as your driving speed decreases.
- You can select the high-speed level via the ADS setting SPORT. In ADS Sport, the vehicle is lowered directly to high-speed level as your driving speed increases.

The parked vehicle begins adjusting to the set vehicle level as soon the doors and tailgate are

- unlocked
- or
- opened or closed with the vehicle unlocked

In order to operate the vehicle level control switch (▷ page 271), however, the engine must be running.

Warning!



Make sure that no one is near the wheel housing or under the vehicle when you lower the vehicle while it is standing still. Limbs could become wedged into or under the vehicle.

For safety reasons, the vehicle can only be lowered with all doors and the tailgate closed. Lowering is interrupted if a door or the tailgate is opened and will continue after the door is closed again.

Warning!

Please be aware that by raising the vehicle level, the center of gravity also rises. Therefore, always ensure that the vehicle level is as low as possible. With higher ride height the ESP® may activate earlier in certain situations.

Adapt your speed and driving to possible changed driving behavior of the vehicle after changing the vehicle level. The ESP® cannot prevent accidents, including those resulting from excessive speed. The ESP® cannot prevent the natural laws of physics from acting on the vehicle.

! *Keep in mind that in rough or uneven terrain, adjusting the vehicle to a lower level may cause the vehicle underbody to come in contact with the ground and result in damage to the vehicle underbody. Always make sure the vehicle has sufficient ground clearance before adjusting it to a lower level.*

! *Before jacking up the vehicle with equipment that lifts one or more of the wheels completely off of the ground, remove the SmartKey from the starter switch.*

! *Please also note the information in the section on towing (▷ page 518).*

For information on off-road driving, see “Off-road driving” (▷ page 333).

Setting the vehicle level

The switch is located on the lower part of the center console.



- ① Vehicle level switch
- ② Indicator lamp

Driving systems

Basic settings (all models, except ML 63 AMG)

The following vehicle chassis ride heights can be selected using the vehicle level switch in the center console:

Level	Driving situation
Raised	For off-road driving or driving in rough terrain. The indicator lamp is on.
Highway	For driving on paved roads in fair or better condition. The indicator lamp is off.

i The third available level is the high-speed level that is set automatically.

The following is the approximate change in ride height for each of the level settings:

Level	Ride height
Raised	+ 3.1 in (80 mm)
Highway	+/- 0 in (0 mm)
High-speed	- 0.6 in (-15 mm)

i Depending on the ADS setting (▷ page 269), the vehicle will be lowered to the high-speed level when traveling at higher speeds. At speeds below 40 mph (64 km/h) at the latest, it will be returned to the highway level.

i The high-speed level is not available if towing a trailer. For more information on towing a trailer, see “Trailer towing” (▷ page 342).

Basic settings (ML 63 AMG only)

The following vehicle chassis ride heights can be selected using the vehicle level switch in the center console:

Level	Driving situation
Raised	For off-road driving or driving in rough terrain. The indicator lamp is on.
Highway	For driving on paved roads in fair or better condition. The indicator lamp is off.

i The third available level is the high-speed level that is set automatically.

How much the vehicle is lowered or raised depends on the ADS setting selected. At the raised level, the vehicle is 2.9 in (73 mm) higher than at the Highway level with ADS **AUTO**.

Raised level

Only select the raised level if appropriate for the driving situation encountered.

Otherwise:

- Fuel consumption may increase.
- Handling characteristics of the vehicle may be unfavorable.

i You can select the raised level at speeds up to 40 mph (64 km/h). At higher speeds, the message  Level selection not permitted appears in the multifunction display.

- ▶ Start the engine (▷ page 40).





If indicator lamp ② (▷ page 271) is off.

- ▶ Press switch ① (▷ page 271).

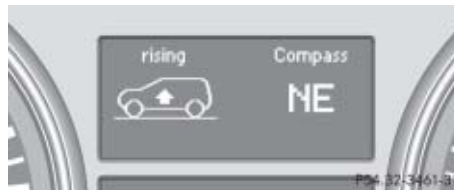
Indicator lamp ② flashes. The vehicle adjusts to the raised level.

The following message appears in the multifunction display while the level is being set:



i The message can be cleared by pressing the    or button  on the multifunction steering wheel.

When the raised level is reached, indicator lamp ② (▷ page 271) comes on continuously and the following message appears in the multifunction display for 5 seconds:



Highway level

! Keep in mind that in rough or uneven roads, adjusting the vehicle to a lower level may cause the vehicle underbody to come in contact with the road and result in damage to the vehicle underbody. Always make sure the vehicle has sufficient ground clearance before adjusting it to a lower level.

- ▶ Start the engine (▷ page 40).

If indicator lamp ② (▷ page 271) is on.





- ▶ Press switch ① (▷ page 271).

Indicator lamp ② flashes. The vehicle adjusts to the highway level.

The following message appears in the multifunction display while the level is being set:



Driving systems

▷▷ **i** The message can be cleared by pressing the    or button  on the multifunction steering wheel.

When the highway level is reached, indicator lamp ② (▷ page 271) goes out, and the following message appears in the multifunction display for 5 seconds:



i The vehicle is lowered automatically to the highway level if:

- the vehicle speed is above 55 mph (88 km/h)
- the speed stays between 40 mph (64 km/h) and 55 mph (88 km/h) for approximately 20 seconds

Parktronic system*

Warning!



Parktronic is a supplemental system. It is not intended to, nor does it replace, the need for extreme care. The responsibility during parking and other critical maneuvers always rests with the driver.

Special attention must be paid to objects with smooth surfaces or low silhouettes (e.g. trailer couplings, painted posts, or road curbs). Such objects may not be detected by the system and can damage the vehicle.

The operational function of the Parktronic system can be affected by dirty sensors, especially at times of snow and ice. See “Cleaning the Parktronic system sensors” (▷ page 408).

Interference caused by other ultrasonic signals (e.g. working jackhammers, car wash, or the air brakes of trucks) can cause the system to send erratic indications, and should be taken into consideration.

Warning!



Make sure no persons or animals are in the area in which you are maneuvering. You could otherwise injure them.

The Parktronic system is an electronic parking aid and designed to assist the driver during parking maneuvers. It visually and audibly indicates the relative distance between the vehicle and an obstacle.

The Parktronic system is automatically activated when you

- switch on the ignition or start the engine

and

- release the parking brake

and

- set the automatic transmission to position **D**, **R**, or **N**

The Parktronic system deactivates at vehicle speeds exceeding approximately 11 mph (18 km/h). At lower vehicle speeds the Parktronic system turns on again.

The Parktronic system also deactivates when you set the automatic transmission to position **P** or depress the parking brake pedal.

The Parktronic system monitors the surroundings of your vehicle with six sensors in the front bumper and four sensors in the rear bumper.

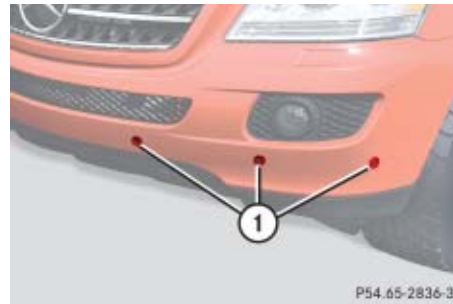

① Sensors in the front bumper

Range of the sensors

To function properly, the sensors must be free of dirt, ice, snow and slush. Clean the sensors regularly, being careful not to scratch or damaging the sensors, see “Cleaning the Parktronic* system sensors” (▷ page 408).

! During parking maneuvers, pay special attention to objects located above or below the height of the sensors (e.g. planters or trailer hitches). The Parktronic system will not detect such objects at close range and damage to your vehicle or the object may result.

Ultrasonic signals from outside sources (e.g. working jackhammers, car wash or the air brakes of trucks) may impair the operation of the Parktronic system.

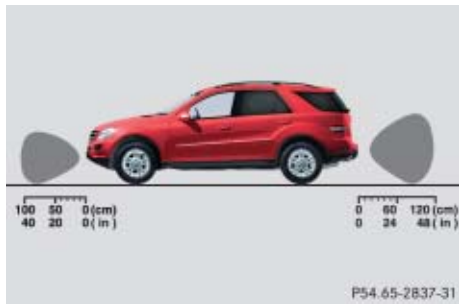

Front sensors

Center **approx. 40 in (100 cm)**

Corners **approx. 24 in (60 cm)**

Rear sensors

Center **approx. 48 in (120 cm)**

Corners **approx. 32 in (80 cm)**

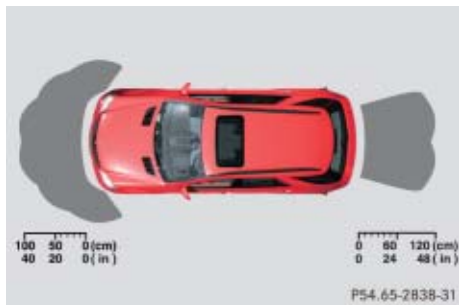

Minimum distance

Center **approx. 8 in (20 cm)**

Corners **approx. 6 in (15 cm)**

If the system detects an obstacle in this range, all the distance warning segments illuminate and you hear a warning signal. If the obstacle is closer than the minimum distance, the actual distance may no longer be indicated by the system.

Warning indicators

Visual signals indicate to the driver the relative distance between the sensors and an obstacle. The warning indicator for the front area is located above the center air vents in the dashboard. The warning indicator for the rear area is located in the rear passenger compartment under the roof.



Front area warning indicator

- ① Left side of the vehicle
- ② Right side of the vehicle
- ③ Readiness indicators

Each warning indicator is divided into five yellow and two red distance segments for either side of the vehicle. The Parktronic system is operational when the readiness indicators ③ are illuminated.

The current transmission position determines which warning indicator will be activated.

Transmission position	Warning indicator
D	Front area activated
R or N	Front and rear area activated
P	Neither activated

As your vehicle approaches an object, one or more distance segments will illuminate, depending on the distance. When the red distance segment illuminates, you have reached the minimum distance.

- **Front area:** An intermittent acoustic warning lasting a maximum of 2 seconds will sound as the first red distance segment illuminates and a constant acoustic warning lasting a maximum of 2 seconds will sound for the second red distance segment. The signal is canceled when the automatic transmission is set to position **P**, or the parking brake is set.
- **Rear area:** An intermittent acoustic warning lasting a maximum of 2 seconds will sound as the first red distance segment illuminates and a constant acoustic warning lasting a maximum of 2 seconds will sound for the second red distance segment. The signal is canceled when the automatic transmission is set to position **D**, **P**, or the parking brake is set.

Switching the Parktronic system* on/off

You can switch off the Parktronic system manually.

The Parktronic switch is located in the upper part of the center console.

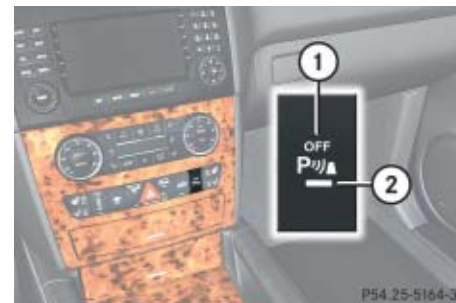

- ① Parktronic switch
- ② Indicator lamp

Driving systems

Switching off

- ▶ Press Parktronic switch ①.
Indicator lamp ② comes on.

Switching on

- ▶ Press Parktronic switch ① once more.
Indicator lamp ② goes out.

i *The Parktronic system switches on automatically when you switch on the ignition (▷ page 40).*

Vehicles with original equipment Mercedes-Benz Trailer Hitch Kit:

The rear Parktronic sensor will automatically disengage when towing a trailer.

Parktronic system* malfunction

If only the red distance segments illuminate and an acoustic warning sounds, there is a malfunction in the Parktronic system. The Parktronic system will automatically switch off after 20 seconds and the indicator lamp in the Parktronic switch comes on.

- ▶ Have the Parktronic system checked by an authorized Mercedes-Benz Light Truck Center as soon as possible.

If only the red distance segments illuminate and no acoustic warning sounds, the Parktronic system sensors are dirty (e.g. slush, snow or ice) or there is an interference from other radio or ultrasonic signals (e.g. working jackhammers, car wash or the air brakes of trucks). The Parktronic system will automatically switch off after 20 seconds and the indicator lamp in the Parktronic switch comes on.

- ▶ Switch off the ignition (▷ page 40).
 - ▶ Clean the Parktronic system sensors (▷ page 408).
 - ▶ Switch on the ignition (▷ page 40).
- or
- ▶ Check the Parktronic system operation at another location to rule out interference from outside radio or ultrasonic signals.

Rear view camera*

Warning!

The rear view camera is only an aid and may display obstacles from a distorted perspective or inaccurately, or may not display obstacles at all. The rear view camera does not relieve you of the responsibility to be cautious, take care and pay careful attention. The rear view camera may not show objects which are:

- very close to the rear bumper
- under the rear bumper
- above the tailgate handle

You are responsible for safety at all times and must continue to pay attention to the immediate surroundings when parking and maneuvering. This includes the area behind, in front of and beside the vehicle. Otherwise you could endanger yourself or others.

Warning!

Make sure that no persons or animals are in or near the area in which you are parking/maneuvering. Otherwise, they could be injured.

Warning!

The rear view camera either will not function or will not function to its full capability if:

- the tailgate is open
- it is raining very hard, snowing or foggy
- it is night or you are parking/maneuvering your vehicle in an area where it is very dark
- the camera is exposed to a very bright white light
- the immediate surroundings are illuminated with fluorescent light (the display may flicker)

- there is a sudden change in temperature, e.g. if you drive into a heated garage from the cold (lens condensation)
- the camera lens is dirty or covered
- the rear of your vehicle is damaged

In this case, have the position and setting of the camera checked by a qualified specialist workshop.

Mercedes-Benz recommends that you visit a Mercedes-Benz Light Truck Center for this purpose.

Do not use the rear view camera in these situations. Otherwise you could injure yourself or others and/or damage property including your vehicle while parking/maneuvering.

Driving systems

The rear view camera is an optical parking aid. It shows you the area behind the vehicle in the COMAND system display when reverse gear **R** is engaged, for example during parallel parking.

The rear view camera is located near the tailgate handle.



① Rear view camera

Switching the rear view camera on and off

- ▶ Switch on the ignition (▷ page 40).
- ▶ Shift the automatic transmission in position **R** (▷ page 187).

The area behind the vehicle appears in the COMAND system display.

i The area behind the vehicle is shown in the COMAND system display as a mirror image, like in the rear view mirror.

i The image from the rear view camera will no longer be displayed if you select another function on the COMAND system while reverse gear **R** is engaged. To display the image again, disengage and reengage reverse gear **R**.

- ▶ Shift the automatic transmission into **P**, **N** or **D** to switch off the rear view camera.

▼ Loading

Carriers*

Warning!



Only use carriers* when the basic carrier bars* have been completely mounted. The left and right roof rails are only stabilized by means of the basic carrier bars* mounted.

Follow the manufacturer's installation instructions. Otherwise, an improperly attached carrier system or its load could become detached from the vehicle.

Do not exceed the maximum roof load of 220 lb (100 kg).

Take into consideration that when the roof is loaded, the handling characteristics are different from those when operating the vehicles without a roof loaded.

! Load the carriers* in such a way that the vehicle cannot be damaged while driving.

Make sure

- the tailgate can be completely opened
- the tilt/sliding sunroof can be completely raised at the rear



Roof rails

For further information, contact your authorized Mercedes-Benz Light Truck Center.

Loading instructions

Warning!



Always fasten items being carried as securely as possible using cargo tie-down rings and fastening materials appropriate for the weight and size of the load.

In an accident, during hard braking or sudden maneuvers, loose items will be thrown around inside the vehicle, and can cause injury to vehicle occupants unless the items are securely fastened in the vehicle.

To help avoid personal injury during a collision or sudden maneuver, always use tie down rings, and if so equipped, always use partition net* when transporting cargo.

Never drive vehicle with the tailgate open. Deadly carbon monoxide (CO) gases may enter vehicle interior resulting in unconsciousness and death.

Loading

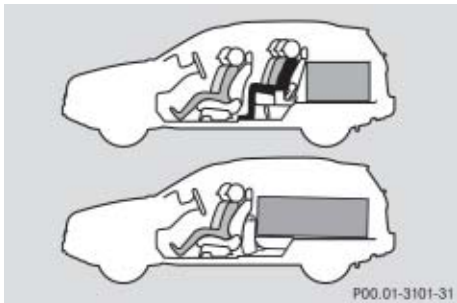

Load distribution

The gross vehicle weight which is the weight of the vehicle including fuel, tools, spare wheel, installed accessories, passengers and luggage/cargo must never exceed the load limit and Gross Vehicle Weight Rating (GVWR) for your vehicle as specified on the placard located on the driver's door B-pillar (▷ page 530). In addition, the load must be distributed in such a way so that the weight on each axle never exceeds the Gross Axle Weight Rating (GAWR) for the front and rear axle. The GVWR and GAWR for your vehicle are indi-

cated on the certification label which can be found on the driver's door B-pillar (▷ page 530).

For more information, see "Tire and Load-Information" (▷ page 369).

The handling characteristics of a fully loaded vehicle depend greatly on the load distribution. It is therefore recommended to load the vehicle according to the illustrations shown, with the heaviest items being placed towards the front of the vehicle.

Please pay attention to and comply with the following instructions when loading the vehicle and transporting cargo:

- Always place items being carried against front or rear seat backrests, and fasten them as securely as possible.
- The heaviest portion of the cargo should always be kept as low as possible against front or rear seat backrests.

For additional safety when transporting cargo while the rear seats are unoccupied, fasten the outer seat belts crosswise into the opposite side buckles.



i *The cargo compartment is the preferred place to carry objects. The expanded cargo compartment (▷ page 284) should only be used for items which do not fit in the cargo compartment alone.*

Cargo tie-down rings

Your vehicle is equipped with six cargo tie-down rings.

Carefully secure cargo by applying even load on all rings with rope of sufficient strength to hold down the cargo.

i While the partition net* (▷ page 287) will help protect you from smaller objects, it cannot prevent the movement of large, heavier objects into the passenger compartment in an accident, during hard braking or sudden maneuvers. Such items must be properly secured using the cargo tie-down rings in the cargo compartment floor.

Cargo compartment

Four cargo tie-down rings are located in the cargo compartment.



① Cargo tie-down ring

Behind front seats

Two cargo tie-down rings are located in the footwell behind the driver's and passenger seat.

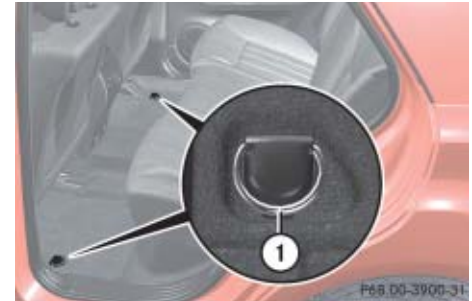

① Cargo tie-down ring

Loading

Hooks

Four hooks are located on the rear compartment trim panels, two on each side.



① Hook

Use the hooks to secure light weight items only. The maximum permissible weight per hook is 9 lbs (4 kg).

Expanding cargo compartment

You can separately fold the left and right rear seat backrests to expand the cargo compartment.

Warning!



When expanding the cargo compartment, always fully fold the corresponding seats and, if so equipped, always use the partition net* (▷ page 287) when transporting cargo.

Unless you are transporting cargo, the backrests must remain properly locked in the upright position.

In an accident, during hard braking or sudden maneuvers, loose items will be thrown around inside the vehicle, and can cause injury to vehicle occupants unless the items are securely fastened in the vehicle.

Always use the cargo tie down rings (▷ page 283).

Warning!



Never drive the vehicle with the tailgate open. Deadly carbon monoxide (CO) gases may enter vehicle interior resulting in unconsciousness and death.

Folding the rear seat backrest forward

! Always release the seat cushion and fold it up before folding the seat backrest forward. The covering on the seat backrest may otherwise be damaged.

When the seat backrest are folded forward, the front seats may not be moved to the rearmost position. Otherwise you could damage the front and second-row seats.



- ① Release handle
- ② Seat cushion

- ▶ Pull release handle ①.
- ▶ Fold seat cushion ② forward.



- ③ Release handle
- ④ Seat backrest

- ▶ Make sure the rear seat head restraints are in the lowermost position (▷ page 128).
- ▶ Pull release handle ③.

A red indicator ⑤ will be visible and the seat backrest ④ is released.



- ⑤ Indicator

- ▶ Fold seat backrest ④ forward.

Loading

Returning the rear seat backrest to original position



- ① Seat backrest
- ② Seat cushion

- ▶ Fold seat backrest ① rearward until it engages.

The red indicator ⑤ (▷ page 285) should no longer be visible.

- ▶ Fold seat cushion ② rearward until it locks into position.
- ▶ Check for secure locking by pushing and pulling on the seat backrest.

Warning!



If a red indicator is visible with the backrest up, then the backrest is not properly locked into position.

Always lock backrest in its upright position when the rear seats are occupied, or the extended cargo compartment is not in use. Check for secure locking by pushing and pulling on the backrest.

Cargo compartment cover blind

The cargo compartment cover blind can be installed behind the rear seats.

! *With the cargo compartment cover blind installed, do not pile luggage higher than the lower edges of the rear side windows.*

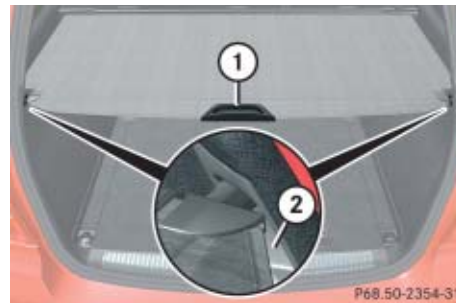

- ① Handle
- ② Mount

Rolling out blind

- ▶ Pull blind on handle ① across the cargo compartment.
- ▶ Guide blind into mounts ② and release.

Rolling up blind

- ▶ Disengage blind and guide retraction by its handle ①.

Removing blind



- ① Release button
- ② Blind

► Roll the blind up (▷ page 286).

i Before removing cargo compartment cover blind behind the rear seats, fold the left or right rear seat forward. Afterwards, return the left or right rear seat into its original position.

► Push release button ①.

- Pull blind ② to the left against the spring pressure until the spring in the cover audibly engages.
- Remove the blind.

Installing blind

i Before installing cargo compartment cover blind behind the front seats, fold the rear seats forward.

- Place left side of blind ② in left mount.
- Position right side of blind ② over right mount.
- Press release button ① and guide cover ② into mount.
- Make sure the cargo compartment cover blind is securely fastened.

Partition net*

Warning!



Make sure the partition net is properly engaged at top and bottom position and the tightening belts are securely fastened.

Never use a damaged partition net.

To help avoid personal injury from smaller objects being thrown around in the occupant compartment during a collision or sudden maneuver, always use partition net when transporting cargo.

The partition net cannot prevent the movement of large, heavier objects into the passenger compartment in an accident. Such items must be properly secured using the cargo tie-down rings (▷ page 283) in the cargo compartment floor.

Passenger use of seats behind installed partition net is restricted because of the footwell being taken up by the net.

Loading

Use of the partition net is a particularly important safety factor when the vehicle is loaded higher than the top of the seat backrests with smaller objects. For your safety, always use the partition net when transporting cargo.

The partition net can be installed in two locations:



- ① Holder in B-pillar
- ② Holder in C-pillar

- Without the cargo compartment expanded (▷ page 284), use holders above C-pillars ② and the cargo tie-down rings in the cargo compartment (▷ page 283).
- With the cargo compartment expanded (▷ page 284), use holders above B-pillars ① and the cargo tie-down rings behind the front seats (▷ page 283).

- ▶ Open the zipper on the partition net package.
 - ▶ Roll out the partition net.
 - ▶ Unfold the partition net.
- The partition net bars must audibly engage.

Installing the partition net

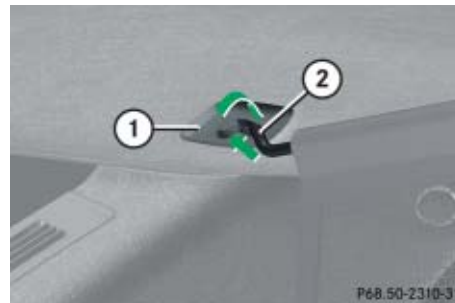

Partition net bar hung up behind the C-pillar

- ① Holder
 - ② Partition net bar
- ▶ Hang partition net bar ② on holder ① as indicated by the arrow.
 - ▶ Push partition net bar ② forward into holder ① in direction of arrow.

Pulling the partition net tight

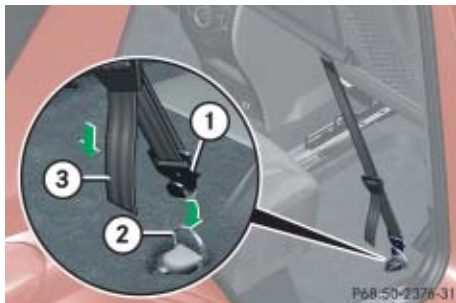

Belt hook attached behind the front seats

- ① Belt hook
 - ② Cargo tie-down ring
 - ③ Tightening belt
- ▶ Hook belt hook ① into cargo tie-down ring ② in direction of arrow.
 - ▶ Pull tightening belt ③ by the loose end in direction of arrow until the partition net is pulled tight.
 - ▶ After driving a short distance, make sure the partition net is still tight and, if necessary, pull it tight again.

Loosening the partition net



Belt hook attached behind the front seats

- ① Buckle
 - ② Belt hook
 - ③ Cargo tie-down ring
- ▶ Loosen the tightening belt by pulling buckle ① upward in direction of arrow.
 - ▶ Remove belt hook ② from cargo tie-down ring ③.

Removing and storing the partition net

- ▶ Take partition net bar ② out of holder ①, see “Installing the partition net” (▷ page 288).
- ▶ Press the red button on the upper and lower partition net bar.
- ▶ Fold the partition net.
- ▶ Roll up the partition net.
- ▶ Close the zipper on the partition net package.

Loading

Cargo management system*

Your vehicle may be equipped with a cargo management system and accompanying accessories which enables you to utilize your cargo compartment in a variety of ways. You can store the cargo management system in the pouch that comes with the vehicle.

i The pouch and the telescoping rod are located under the cargo compartment floor.



① Cargo rails

Inserting the mounting elements into the cargo rails

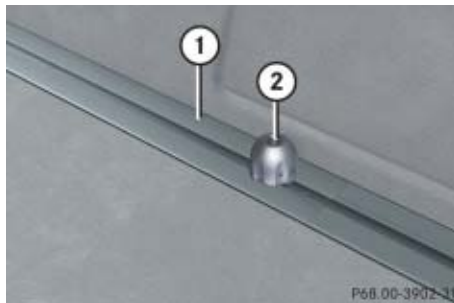







- ① Cargo rail
- ② Mounting element

You can move the mounting element ② to various engaging points on the cargo rail ① and fix it in place.

These engaging points are located 2 inches apart from one another on the cargo rail and are indicated by markings.

i You can turn the mounting element in the cargo rail to four positions:

-  To lock the mounting element.
-  To insert or remove the cargo tie-down ring, the belt reel or the telescoping rod.
-  To insert or remove the mounting element.
-  To move the mounting element to the next engaging point.

- ▶ Turn mounting element ② to .
- ▶ Insert mounting element ② in cargo rail ①.
- ▶ Turn mounting element ② until it engages in the  position. You should be able to feel the mounting element engage in the cargo rail.

Inserting the cargo tie-down ring in the mounting element

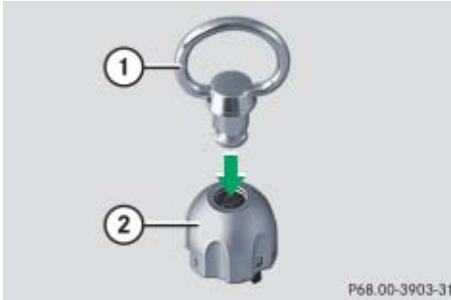



- ① Cargo tie-down ring
- ② Mounting element

Warning!



The cargo tie-down rings should be subject to equal loads. Make sure to comply with the information provided in the loading instructions (▷ page 281).

- ▶ Turn mounting element ② in the cargo rail to .

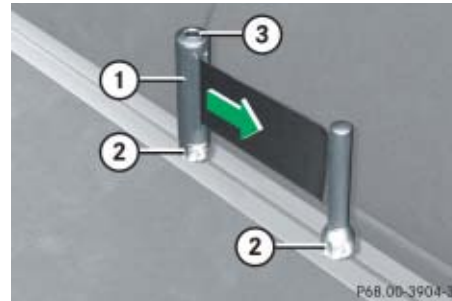

- ▶ Insert cargo tie-down ring ① into mounting element ②.
- ▶ Turn mounting element ② until it engages in the  position.
You should be able to feel the mounting element engage in the cargo rail.

Belt reel



- ① Belt reel
- ② Mounting element
- ③ Locking button

i The belt reel can be used to tighten light-weight loads against the side wall of the cargo compartment, thus securing them from slipping.

- ▶ Insert two mounting elements ② into a cargo rail.
 - ▶ Turn mounting element ② in the cargo rail to .
 - ▶ Insert belt reel ① into mounting element ②.
 - ▶ Turn mounting element ② in the cargo rail until it engages in the  position.
- You should be able to feel the mounting element engage in the cargo rail.
- ▶ Press locking button ③ on the belt reel ① and pull cargo net out in direction of arrow.



Loading

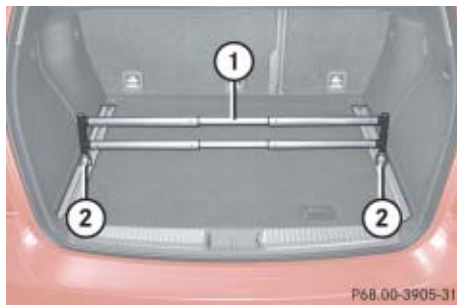

- ▷▷ Place load between the cargo net and the side wall of the cargo compartment.
- ▶ Press locking button ③ on belt reel ①. With the other hand, slowly pull net over load until it is taut.

Telescoping rod



- ① Telescoping rod
- ② Mounting element

i The telescoping rod can be used to tighten the load against the rear seats so as to secure it from slipping.

- ▶ Insert one mounting element ② into each cargo rail.
- ▶ Turn mounting element ② in cargo rail to .
- ▶ Insert telescoping rod ① into mounting element ②.
- ▶ Turn mounting element ② in cargo rail until it engages in the .

You should be able to feel the mounting element engage in the cargo rail.

Removing rear seat cushions

If your vehicle is equipped with the cargo management system* you can remove the rear seat cushions.

Removing the rear seat cushions will provide you with a larger cargo compartment.

- ▶ Fold the seat cushions forward (▷ page 285).



- ① Release lever
- ▶ Pull seat cushion release lever ① and remove the seat cushion by pulling it upward.
- ▶ Remove the head restraints (▷ page 129).

! Leave the seat cushion hinge in this position. The upholstery could be damaged if you fold the hinge back.



- ▶ Fold the seat backrest forward (▷ page 285).

Useful features

Storage compartments

Warning!



To help avoid personal injury during a collision or sudden maneuver, exercise care when storing objects in the vehicle. Put luggage or cargo in the cargo compartment if possible. Do not pile luggage or cargo higher than the seat backs.

Always use partition net* when transporting cargo. Partition net* cannot secure hard or heavy objects.

Parcel nets cannot secure hard or heavy objects.

Keep compartment lids closed. This will help to prevent stored objects from being thrown about and injuring vehicle occupants during

- braking
- vehicle maneuvers
- an accident

Glove box/CD changer*

i Depending on vehicle equipment, a CD changer* and an AUX-socket are located in the glove box.



- ① Glove box lid release
- ② Glove box lid

Opening the glove box

- ▶ Pull lid release ① in direction of arrow.
Glove box lid ② opens downward.

Closing the glove box

- ▶ Push glove box lid ② up to close.

Releasing CD changer*

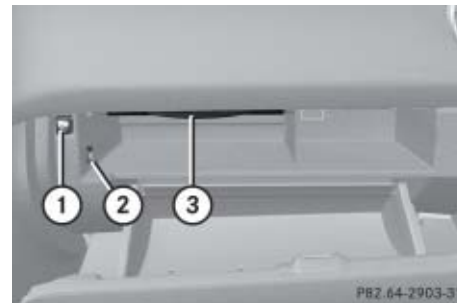

- ① Release button
- ② AUX-socket (Vehicles without Rear Seat Entertainment System*)
- ③ CD changer

- ▶ Open the glove box (▷ page 294).
- ▶ Press release button ①.

CD changer ③ is released and swings down automatically.

For information on CD changer operation, see separate COMAND system operating instructions.

Closing CD changer*

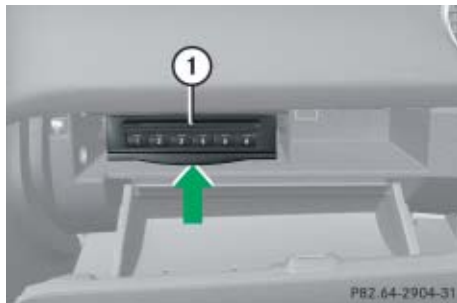

① CD changer

- ▶ Gently push CD changer ① up in direction of arrow until it engages.

For information on CD changer operation, see separate COMAND system operating instructions.

Locking and unlocking the glove box separately

You can lock the glove box separately, e.g. when the vehicle is in the shop for service.

- ▶ Take the mechanical key out of the SmartKey or SmartKey with KEYLESS-GO* (▷ page 475).



- ① Unlocking glove box
- ② Locking glove box

- ▶ Insert mechanical key into glove box lock.
- ▶ Turn mechanical key to position ② to lock the glove box.
- ▶ Turn mechanical key to position ① to unlock the glove box.

i *The glove box can only be locked or unlocked with the mechanical key.*

Useful features

Storage compartment in front center console

*Vehicles without ashtray**



- ▶ Briefly press the front of the cover.
The cover opens automatically.

Storage compartment* (depending on vehicle configuration)





- ▶ Briefly press the front of the cover.
The cover opens automatically.

Front armrest storage compartments

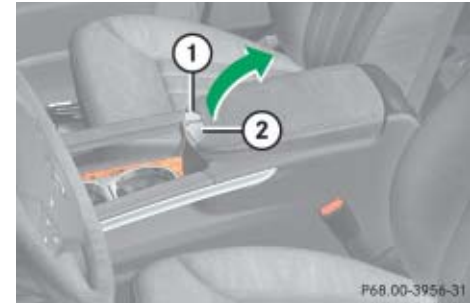
A flat storage tray with a deeper storage compartment underneath is located below the armrest. Both can be opened separately.



- ① Button to open storage tray/telephone* compartment
- ② Button to open storage compartment

i The Roadside Assistance button  (▷ page 312) and the information button  (▷ page 313) are located in the storage tray.

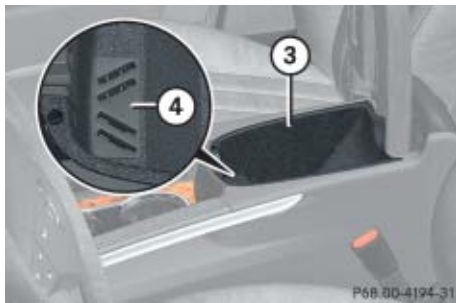

- ③ Storage compartment
- ④ Coin holder

Opening the storage tray

- ▶ Pull button ① and lift up armrest.

Opening the storage compartment

- ▶ Pull button ② and lift up armrest.

The coin holders ④ are located in front of storage compartment ③.

Rear storage compartments

Depending on the vehicle configuration, your vehicle may be equipped with two storage compartments in the front of the rear seats.

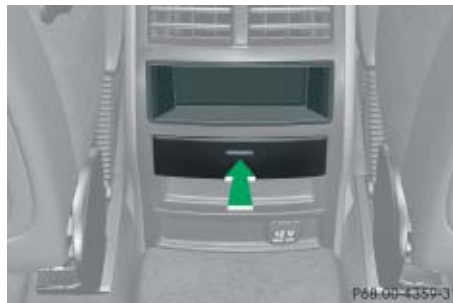

- ▶ Briefly press the front of the cover.

The storage compartment opens automatically.

i If your vehicle is equipped with a smoking package*, the storage compartment contains an ashtray (▷ page 300).

Parcel nets

Warning!



Do not place objects with a combined weight of more than 4.4 lbs (2 kg) into the parcel net on the back of the front passenger seat. Otherwise, the Occupant Classification System OCS (▷ page 85) may not be able to properly approximate the occupant weight category.

Parcel nets are intended for storing light-weight items only.

Heavy objects, objects with sharp edges or fragile objects may not be transported in the parcel nets. In an accident, during hard braking, or sudden maneuvers, they could be thrown around inside the vehicle and cause injury to vehicle occupants.

Parcel nets cannot protect transported goods in the event of an accident.

Useful features

Parcel net in front passenger footwell

A small convenience parcel net is located in the front passenger footwell. It is intended for small and light items, such as road maps, mail, etc.

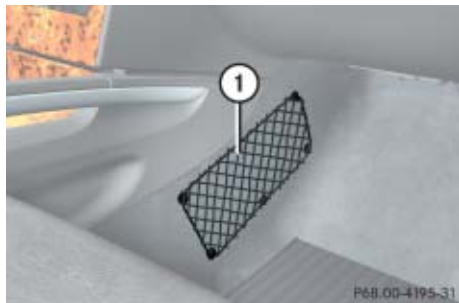

① Parcel net

Parcel nets on front seat backrests

A small convenience parcel net is located on each of the front seat backrests. It is intended for small and light items, such as road maps, mail, etc.



① Parcel net

Cup holders

Warning!



In order to help prevent spilling liquids on vehicle occupants and/or vehicle equipment, only use containers that fit into the cup holder. Use lids on open containers and do not fill containers to a height where the contents, especially hot liquids, could spill during braking, vehicle maneuvers, or an accident. Liquids spilled on vehicle occupants may cause serious personal injury. Liquids spilled on vehicle equipment may cause damage not covered by the Mercedes-Benz Limited Warranty.

When not in use, keep rear cup holder closed. An open cup holder may cause injury to you or others when contacted during braking, vehicle maneuvers, or in an accident.

Keep in mind that objects placed in a cup holder may come loose during braking, vehicle maneuvers, or an accident and be thrown around in the vehicle interior. Objects thrown around in the vehicle interior may cause an accident and/or serious personal injury.

Cup holder in front of armrest

A cup holder and a card/ticket holder are located in the front center console.

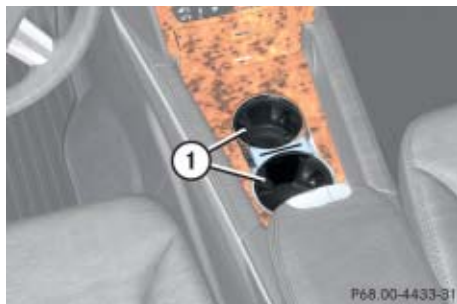

① Cup holder

i The front cup holder can be removed for cleaning purposes (▷ page 299).

Cup holder in rear armrest

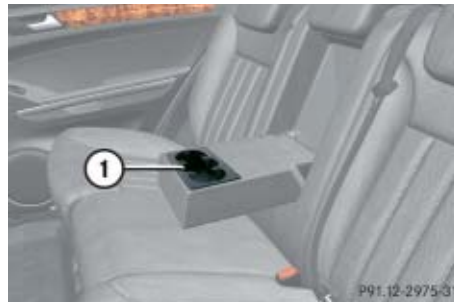

① Cup holder

► Pull the armrest down by its top.

! Close the cup holder before folding the armrest upwards.

Removing and reinstalling cup holder

The front cup holder can be removed for cleaning purposes.

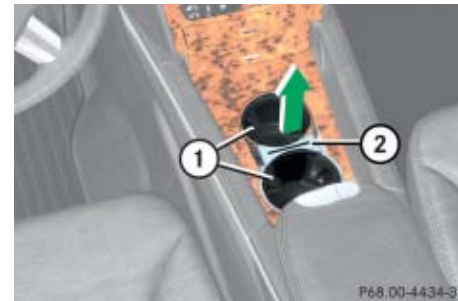

① Cup holder

② Bridge with card, ticket holder

► Hold cup holder at its bridge ② and pull out bridge in direction of arrow.

► Pull cup holder ① out in direction of arrow.

► First, insert the cup holder ① and then insert bridge ②.

Useful features

Ashtrays*

Your vehicle is equipped with an ashtray and a cigarette lighter (▷ page 301) located in the front center console and an ashtray located in front of the rear seats (▷ page 300).

i If your vehicle is not equipped with a smoking package*, it has a storage compartment (▷ page 296) with a power outlet (▷ page 302) instead.

Ashtray in the center console



- ① Ashtray insert
- ② Cover plate

Opening the ashtray

- ▶ Briefly touch cover plate ②.

The ashtray opens automatically.

Removing ashtray insert

Warning!



Remove ashtray only with vehicle standing still. Set the parking brake to secure vehicle from movement. Set automatic transmission to **P**. With the automatic transmission set to **P**, turn off the engine.

- ▶ Grip the ashtray insert ① on the sides and pull it out upwards.

Reinstalling ashtray insert

- ▶ Install ashtray insert ①.
- ▶ Close ashtray cover plate ②.

Rear center console ashtray (front of rear seats)

! Close the ashtray when not in use and before folding the rear seats

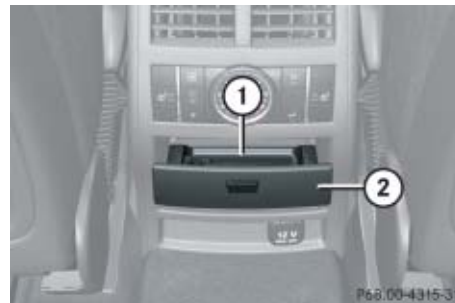

- ① Ashtray
- ② Ashtray cover

Opening rear ashtray

- ▶ Briefly press ashtray cover ②.
The ashtray ① opens automatically.

Removing rear ashtray insert

- ▶ Grip the insert on the sides and pull it out upwards.

Reinstalling rear ashtray insert

- ▶ Install ashtray insert.
- ▶ Close the ashtray.

Cigarette lighter

- ▶ Switch on the ignition (▷ page 40).
- ▶ Push in cigarette lighter.
The cigarette lighter will pop out automatically when hot.

Cigarette lighter***Warning!**

Never touch the heating element or sides of the cigarette lighter; they are extremely hot. Hold the knob only.

Make sure that any children traveling with you do not injure themselves or start a fire with the hot cigarette lighter.

When leaving the vehicle always remove the SmartKey or SmartKey with KEYLESS-GO* from the starter switch, take it with you, and lock the vehicle. Do not leave children unattended in the vehicle, or with access to an unlocked vehicle. Unsupervised use of vehicle equipment may cause an accident and/or serious personal injury.

- ▶ Switch on the ignition (▷ page 40).



① Cigarette lighter

- ▶ Open the ashtray (▷ page 300).
- ▶ Push in cigarette lighter ①.

The cigarette lighter will pop out automatically when hot.

Useful features

! *The lighter socket can accommodate 12V DC electrical accessories (up to a maximum of 180 W) designed for use with the standard “cigarette lighter” plug type. Keep in mind, however, that connecting accessories to the lighter socket (for example extensive connecting and disconnecting, or using plugs that do not fit properly) can damage the lighter socket. With the socket damaged, the lighter may no longer be able to be placed in the heating (pushed-in) position, or the lighter may pop out too early with the lighter not hot enough.*

To help avoid damaging the cigarette lighter socket, we recommend connecting 12V DC electrical accessories designed for use with the standard “cigarette lighter” plug type to the 12V power outlets (▷ page 302) in your vehicle whenever possible.

i *If the engine is off, and the cigarette lighter is being used extensively, the vehicle battery may become discharged.*

Power outlets

! *If you use all power outlets in the vehicle, make sure that the maximum current drawn does not exceed 55 A.*

i *The power outlets can be used to accommodate 12V DC electrical accessories (e.g. air pump, auxiliary lamps) up to a maximum of 240 W.*

If the engine is off, the battery may become discharged if used for long periods of time.

i *You can use the power outlet in the cargo compartment or in the front of the rear seats even if the ignition is switched off.*

An emergency shut-off feature ensures that the vehicle’s electrical voltage does not fall below a minimum level. If the voltage drops to this minimum level, the power outlets are automatically switched off. This ensures that enough power remains to start the engine.

Power outlets are located

- in the front center console (▷ page 302)
- in the rear center console (▷ page 303)
- on the right-hand side of the cargo compartment (▷ page 303)

Power outlet in front center console



① Power outlet cover

- ▶ Switch on the ignition (▷ page 40).
- ▶ Open cover plate (▷ page 296).
- ▶ Pull out cover ① and insert electrical plug (cigarette lighter type).

i If your vehicle is equipped with a smoking package*, the storage compartment contains an ashtray with cigarette lighter (▷ page 301) instead.

Power outlet in rear center console



- ▶ Switch on the ignition (▷ page 40).
- ▶ Flip up cover and insert electrical plug (cigarette lighter type).

Power outlet in cargo compartment



- ▶ Switch on the ignition (▷ page 40).
- ▶ Flip up cover and insert electrical plug (cigarette lighter type).

Floormats*

Warning!



Whenever you are using floormats, make sure there is enough clearance and that the floormats are securely fastened.

Floormats should always be securely fastened using eyelets ② and retainer pins ① (▷ page 304).

Before driving off, check that the floormats are securely in place and adjust them if necessary. A loose floormat could slip and hinder proper functioning of the pedals.

Do not place several floormats on top of each other as this may impair pedal movement.

i To install or remove the floormat more easily, move the driver's seat or front passenger seat as far to the rear as possible (▷ page 44).

Useful features

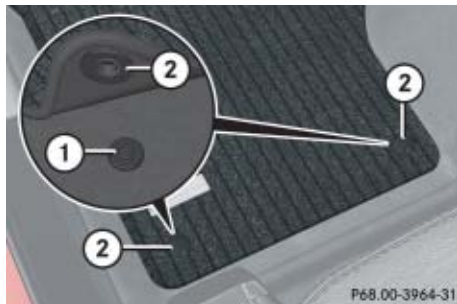

- ① Retainer pin
- ② Eyelet

Removing

- ▶ Pull floormat off of retainer pins ①.
- ▶ Remove the floormat.

Installing

- ▶ Lay down the floormat in the respective footwell.
- ▶ Press the floormat eyelets ② onto retainer pins ①.

Heated steering wheel*

The steering wheel heating warms up the leather area of the steering wheel.

The stalk is on the lower left-hand side of the steering wheel.

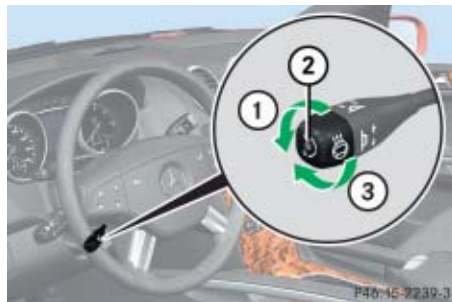

- ① Switching on
- ② Indicator lamp
- ③ Switching off

Switching on

- ▶ Switch on the ignition (▷ page 40).
- ▶ Turn switch at the tip of stalk in the direction of arrow ①.

The steering wheel is heated. Indicator lamp ② comes on.

i The steering wheel heating is turned off temporarily and the indicator lamp ② remains on when

- the temperature of the vehicle interior is above 86°F (30°C)
- the temperature of the steering wheel is above 95°F (35°C)

When these conditions do not apply anymore, steering wheel heating continues.

Switching off

- ▶ Turn switch at the tip of stalk in the direction of arrow ③.

The heated steering wheel is switched off. Indicator lamp ② goes out.

- i** Indicator lamp ② flashes or goes out
 - in case of power surge or undervoltage
 - in case of a steering wheel heating malfunction

i The steering wheel heating switches off automatically when you remove the SmartKey from the starter switch or, on vehicles with KEYLESS-GO*, when you switch off the ignition (▷ page 39) and open the driver's door.

For information on the steering wheel, see "Multifunction steering wheel" (▷ page 148).

Telephone*

Warning!



Never operate radio transmitters equipped with a built-in or attached antenna (i.e. without being connected to an external antenna) from inside the vehicle while the engine is running. Doing so could lead to a malfunction of the vehicle's electronic system, possibly resulting in an accident and/or serious personal injury.

Radio transmitters, such as a portable telephone or a citizens band unit, should only be used inside the vehicle if they are connected to an antenna that is installed on the outside of the vehicle.

The external antenna must be approved by Mercedes-Benz. Please contact an authorized Mercedes-Benz Light Truck Center for information on the installation of an approved external antenna. Refer to the radio transmitter operation instructions regarding use of an external antenna.

Warning!



Please do not forget that your primary responsibility is to drive the vehicle. A driver's attention to the road must always be his/her primary focus when driving. For your safety and the safety of others, we recommend that you pull over to a safe location and stop before placing or taking a telephone call.

If you choose to use the telephone¹ while driving, please use the hands-free device and only use the telephone when road, weather and traffic conditions permit. Some jurisdictions prohibit the driver from using a cellular telephone while driving a vehicle.

Only operate the COMAND system¹ if road, weather and traffic conditions permit.

Bear in mind that at a speed of just 30 mph (approximately 50 km/h), your vehicle is covering a distance of 44 feet (approximately 14 m) every second.



¹ Observe all legal requirements

Useful features

i Various mobile phone cradles can be installed in the front center armrest, see separate installation instructions for the mobile phone cradle. These mobile phone cradles can be obtained from an authorized Mercedes-Benz Light Truck Center.

The functions and services available to you while using the mobile phone depend on your service provider and the type of mobile phone you are using. See also separate operating manual for instructions on how to use your mobile phone.

When the mobile phone is inserted in the cradle, you can operate the telephone using the following devices:

- mobile phone keypad
- COMAND system (see separate operating instructions)
- buttons  and  on the steering wheel (▷ page 148)
- Voice Control* (see separate operating instructions)

Please note that these functions are only available with Mercedes-Benz approved mobile phones. Please contact an autho-

rized Mercedes-Benz Light Truck Center for information on features available for your mobile phone of choice.

The cradle is located in the front center armrest.

- ▶ Open telephone compartment (▷ page 296).

Inserting mobile phone in mobile phone cradle

Once the mobile phone has been inserted in the mobile phone cradle, you have to use the hands-free device to respond during phone calls.

! Do not try to remove the mobile phone along with the cradle. You could otherwise damage the mobile phone cradle.

- ▶ If applicable, remove the cover for the external antenna connection from the back of the mobile phone and store it in a safe place. Be sure to comply with the mobile phone's operating instructions as well.



Example illustration

- ① Insert the mobile phone
- ② Connector contact
- ③ Mobile phone cradle

- ▶ Slide the lower end of the mobile phone into connector contact ② on cradle ③.

- ▶ Push the top of the mobile phone in direction of arrow ①, until the lug on the mobile phone release button engages.

The mobile phone is connected to the network via the external antenna.

The mobile phone is linked to the hands-free device and the multifunction steering wheel.

The battery is charged depending on its charge status and the position of the SmartKey in the starter switch. The charge procedure will be indicated in the mobile phone's display.

You can place or receive phone calls. You can control other functions of the mobile phone via the control system (▷ page 182) or COMAND system or Voice Control*, see separate operating instructions.

i When you take the SmartKey or SmartKey with KEYLESS-GO* out of the starter switch, the mobile phone remains switched on for approx. 10 minutes. If you place or receive a call during this time, the mobile phone switches off 10 minutes after the call has been completed.

Removing mobile phone from mobile phone cradle



Example illustration

- ① Release catch for mobile phone
- ② Mobile phone cradle

i When using a flip-style mobile phone, open flip top before removing from the cradle while a call is connected. Otherwise, the call will be disconnected.

- ▶ Press release catch in direction of arrow ① and take mobile phone out of mobile phone cradle ②.

Changing mobile phone cradle

If you require a different cradle for your mobile phone, remove the present cradle before installing a new one.

Removing an existing mobile phone cradle

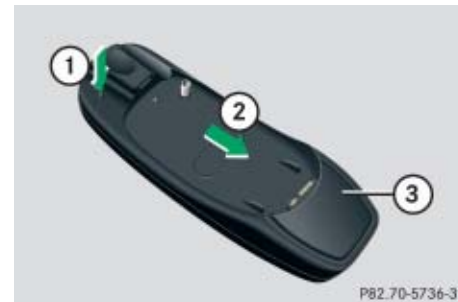

Example illustration

- ① To release the mobile phone cradle
- ② To remove the mobile phone cradle
- ③ Mobile phone cradle



Useful features

- ▷▷ Press release button in direction of arrow ① and take mobile phone cradle ③ out in direction of arrow ②.

Installing a different mobile phone cradle

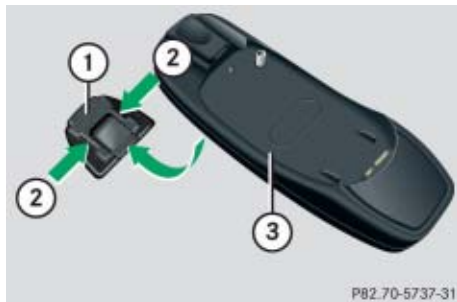

Example illustration

- ① Contact plate
 - ② Recesses
 - ③ Mobile phone cradle
- ▶ Insert mobile phone cradle ③ into recesses ② of contact plate ①.
- ▶ Push mobile phone cradle ③ forward until it engages.

Tele Aid*

! *The initial activation of the Tele Aid system may only be performed by completing the subscriber agreement and placing an acquaintance call using the **+** button. Failure to complete either of these steps will result in a system that is not activated.*

If you have any questions regarding activation, please call the Response Center at 1-800-756-9018 (in the USA) or 1-888-923-8367 (in Canada).

Shortly after the completion of your Tele Aid acquaintance call, you will receive a user ID and password. By visiting www.mbusa.com and selecting “Tele Aid” (USA only), you will have access to account information, remote door unlock and more.

The Tele Aid system



(Telematic Alarm Identification on Demand)

The Tele Aid system consists of three types of response:



- automatic and manual emergency
- roadside assistance
- information

The Tele Aid system is operational providing that the vehicle’s battery is charged, properly connected, not damaged and cellular and GPS coverage is available.

The speaker volume of a Tele Aid call can be adjusted by using the volume control on the COMAND system or on the multifunction steering wheel. To raise, turn the rotary volume control on COMAND system clockwise or press button **+** on the multifunction steering wheel. To lower, turn the rotary volume control on COMAND system control counterclockwise or press button **-** on the multifunction steering wheel.

- ▶ To activate, press the SOS button, the Roadside Assistance button  or the Information button , depending on the type of response required.



 The SOS button is located in the overhead control panel (▷ page 33).

The Roadside Assistance button  (▷ page 312) and the Information button  (▷ page 313) are located below the center arm-rest cover.

 The Tele Aid system utilizes the cellular network for communication and the GPS (Global Positioning System) satellites for vehicle location. If either of these signals are unavailable, the Tele Aid system may not function and if this occurs, assistance must be summoned by other means.

 When a Tele Aid call has been initiated, the COMAND system audio is muted and the selected mode (radio, CD etc.) pauses. The optional cellular phone (if installed) inserted in cradle switches off. If you must use this phone, we recommend that you use it only with the vehicle at a standstill in a safe location. Remove the phone from the cradle and place the call. The navigation* system (if engaged) will continue to run. The display in the instrument cluster is available for use, and spoken commands are only available by pressing the RPT button on the COMAND system. A pop-up window will appear in the COMAND system display to indicate that a Tele Aid call is in progress. After the TeleAid call has ended, the optional cellular phone inserted in the cradle switches on again. A PIN entry might be necessary.

System self-check

Initially, after switching on the ignition, malfunctions are detected and indicated (the indicator lamps in the SOS button, the Roadside Assistance button  and the Information button  stay on longer than 10 seconds or do not come on).

The message Tele Aid – inoperative appears in the multifunction display.

Warning!



If the indicator lamps on the SOS button, on the Roadside Assistance button, and/or on the Information button remain illuminated continuously in red and/or the message *Tele Aid - inoperative* is displayed in the multifunction display after the system self-check, a malfunction in the system has been detected.

If a malfunction is indicated as outlined above, the system may not operate as expected. Have the system checked at the nearest Mercedes-Benz Light Truck Center as soon as possible.

Emergency calls

An emergency call is initiated automatically following an accident in which the emergency tensioning devices (ETDs) or air bags deploy.

An emergency call can also be initiated manually by opening the cover next to the interior rear view mirror labeled SOS, then briefly pressing the button located under the cover. See (▷ page 311) for instructions on initiating an emergency call manually.

Once the emergency call is in progress, the indicator lamp on the SOS button will begin to flash. The message *Connecting call* appears in the multifunction display. When the connection is established, the message *Call connected* appears in the multifunction display. All information relevant to the emergency, such as the location of the vehicle (determined by the GPS satellite location system), vehicle model, identification number and color are generated.

A voice connection between the Response Center and the occupants of the vehicle will be established automatically soon after the emergency call has been initiated. The Response Center will attempt to determine more precisely the nature of the accident provided they can speak to an occupant of the vehicle.

The Tele Aid system is available if

- it has been activated and is operational. Activation requires a subscription for monitoring services, connection and cellular air time
- vehicle battery power is available
- the relevant cellular phone network and GPS signals are available and pass the information on to the Response Center

i Location of the vehicle on a map is only possible if the vehicle is able to receive signals from the GPS satellite network and pass the information on to the Response Center.

Warning!



If the indicator lamp in the SOS button is flashing continuously and there was no voice connection to the Response Center established, then the Tele Aid system could not initiate an emergency call (e.g. the relevant cellular phone network is not available). The message **Call failed** appears in the multifunction display for approximately 10 seconds.

Should this occur, assistance must be summoned by other means.

Initiating an emergency call manually

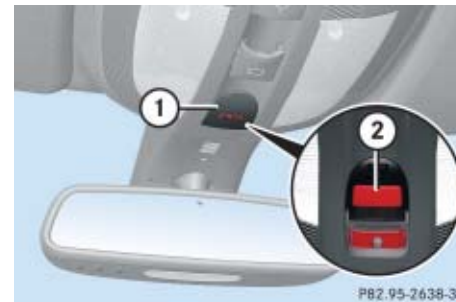

① Cover

② SOS button

- ▶ Briefly press on cover ①.

The cover opens.

- ▶ Press SOS button ② briefly.

The indicator lamp in SOS button ② will flash until the emergency call is concluded.

- ▶ Wait for a voice connection to the Response Center.
- ▶ Close cover ① after the emergency call is concluded.

Warning!



If you feel at any way in jeopardy when in the vehicle (e.g. smoke or fire in the vehicle, vehicle in a dangerous road location), please do not wait for voice contact after you have pressed the emergency button. Carefully leave the vehicle and move to a safe location. The Response Center will automatically contact local emergency officials with the vehicle's approximate location if they receive an automatic SOS signal and cannot make voice contact with the vehicle occupants.

Roadside Assistance button

The Roadside Assistance button  is located below the center armrest cover.

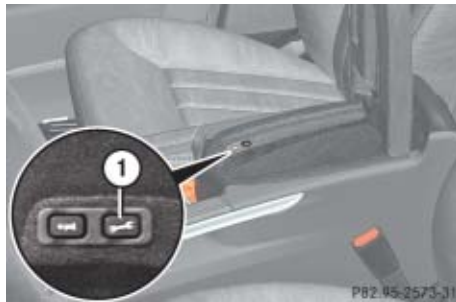

① Roadside Assistance button

- ▶ Open the storage tray (▷ page 297).
- ▶ Press and hold button ① (for longer than 2 seconds).

A call to a Mercedes-Benz Roadside Assistance dispatcher will be initiated. The button will flash while the call is in progress. The message *Connecting call* will appear in the multifunction display.

When the connection is established, the message *Call connected* appears in the multifunction display. The Tele Aid system will transmit data generating the vehicle identification number, model, color and location (subject to availability of cellular and GPS signals).

 *While the call is connected you can change to the navigation menu by pressing the NAV button on the COMAND system unit.*



A voice connection between the Roadside Assistance dispatcher and the occupants of the vehicle will be established.

- ▶ Describe the nature of the need for assistance.

The Mercedes-Benz Roadside Assistance dispatcher will either dispatch a qualified Mercedes-Benz technician or arrange to tow your vehicle to the nearest Mercedes-Benz Light Truck Center. For services such as labor and/or towing, charges may apply. Refer to the Roadside Assistance Manual for more information.

The following is only available in the USA:

- Sign and Drive services: Services such as jump start, a few gallons of fuel or the replacement of a flat tire with the vehicle spare tire are obtainable.

i *The indicator lamp on the Roadside Assistance button  remains illuminated in red for approximately 10 seconds during the system self-check after switching on the ignition (together with the SOS button and the Information button ).*

See system self-check (▷ page 309) if the indicator lamp does not come on in red or stays on longer than approximately 10 seconds.

If the indicator lamp on the Roadside Assistance button  is flashing continuously and there was no voice connection to the Response Center established, then the Tele Aid system could not initiate a Roadside Assistance call (e.g. the relevant cellular phone network was not available). The message Call failed appears in the multifunction display.

Roadside Assistance calls can be terminated using the  button on the multifunction steering wheel or the END Button on the COMAND system.

Information button

The Information button  is located below the center armrest cover.



① Information button

- ▶ Open the storage tray (▷ page 296).
- ▶ Press and hold button ① (for longer than 2 seconds).

A call to the Customer Assistance Center will be initiated. The button will flash while the call is in progress. The message Connecting call will appear in the multifunction display.



Useful features

When the connection is established, the message **Call connected** appears in the multifunction display. The Tele Aid system will transmit data generating the vehicle identification number, model, color and location (subject to availability of cellular and GPS signals).

i While the call is connected, you can change to the navigation menu by pressing the NAV button on the COMAND system.

A voice connection between the Customer Assistance Center representative and the occupants of the vehicle will be established. Information regarding the operation of your vehicle, the nearest Mercedes-Benz Light Truck Center or Mercedes-Benz USA products and services is available to you.

For more details concerning the Tele Aid system, please visit www.mbusa.com and use your ID and password (sent to you separately) to learn more (USA only).

i The indicator lamp in the Information button  remains illuminated in red for approximately 10 seconds during the system self-check after switching on the ignition (together with the SOS button and the Roadside Assistance button .

See system self-check (▷ page 309) if the indicator lamp does not come on in red or stays on longer than approximately 10 seconds.

If the indicator lamp in the Information button  is flashing continuously and there was no voice connection to the Response Center established, then the Tele Aid system could not initiate an Information call (e.g. the relevant cellular phone network is not available). The message **Call failed** appears in the multifunction display.

Information calls can be terminated using the  button on the multifunction steering wheel or the END button on the COMAND system.

! If the indicator lamps do not start flashing after pressing one of the buttons or remain illuminated (in red) at any time, the Tele Aid system has detected a malfunction or the service is not currently active, and may not initiate a call. Visit your authorized Mercedes-Benz Light Truck Center and have the system checked or contact the Response Center at 1-800-756-9018 (in the USA) or 1-888-923-8367 (in Canada) as soon as possible.

Call priority

If other service calls such as a Roadside Assistance call or Information call are active, an Emergency call is still possible. In this case, the Emergency call will take priority and override all other active calls.

i The indicator lamp in the respective button flashes until the call is concluded. Emergency calls can only be terminated by a Response Center or Customer Assistance Center representative, whereas Roadside Assistance and Information calls can also be terminated by pressing button  on the multifunction steering wheel or using the END button on the COMAND system.

! *If the indicator lamp continues to flash or the system does not reset, contact the Response Center at 1-800-756-9018 (in the USA) or 1-888-923-8367 (in Canada), or Mercedes-Benz Customer Assistance at 1-800-FOR-MERCEdes (1-800-367-6372) in the USA or Customer Service at 1-800-387-0100 in Canada.*

Remote door unlock

In case you have locked your vehicle unintentionally (e.g. SmartKey inside vehicle), and the reserve SmartKey is not handy:

- ▶ Contact the Mercedes-Benz Response Center at 1-800-756-9018 (in the USA) or 1-888-923-8367 (in Canada).

You will be asked to provide your password which you provided when you completed the subscriber agreement.

- ▶ Then return to your vehicle and pull the tailgate recessed handle for minimum of 20 seconds until the SOS button is flashing.

The message **Connecting call** appears in the multifunction display.

As an alternative, you may unlock the vehicle via Internet using the ID and password sent to you shortly after the completion of your acquaintance call.

The Response Center will then unlock your vehicle with the remote door unlocking feature.

i *The remote door unlock feature is available if the relevant cellular phone network is available.*

The SOS button will flash and the message Connecting call will appear in the multifunction display to indicate receipt of the door unlock command.

Once the vehicle is unlocked, a Response Center specialist may attempt to establish voice contact with the vehicle occupants.

If the tailgate recessed handle was pulled for more than 20 seconds before door unlock authorization was received by the Response Center, you must wait 15 minutes before pulling the tailgate recessed handle again.

Stolen Vehicle Recovery services

In the event your vehicle was stolen:

- ▶ Report the incident to the police.

The police will issue a numbered incident report.

- ▶ Pass this number on to the Mercedes-Benz Response Center along with your password issued to you when you subscribed to the service.

The Response Center will then attempt to covertly contact the vehicle's Tele Aid system. Once the vehicle is located, the Response Center will contact the local law enforcement and you. The vehicle's location will only be provided to law enforcement.

Useful features

i When the anti-theft alarm stays on for more than 30 seconds, a call is initiated automatically to the Response Center. See anti-theft alarm system (▷ page 103).

Garage door opener*

The integrated remote control is capable of operating up to three separately controlled devices. It provides a convenient way to replace up to three hand-held remote controls used to operate devices such as garage door openers, gate openers, or other devices compatible with HomeLink[®] or some other systems.

Before the integrated remote control can be used, it must be programmed to the garage door opener, gate operator or other device you wish to operate. See the following instructions for programming information.



Interior rear view mirror with integrated remote control

- ① Indicator lamp
 - ② ③ ④ Signal transmitter button
- Needed for programming (not part of vehicle equipment):
- ⑤ Hand-held remote control of garage door opener, gate operator or other device
 - ⑥ Hand-held remote control button

Warning!



Before programming the integrated remote control to a garage door opener or gate operator, make sure people and objects are out of the way of the device to prevent potential harm or damage. When programming a garage door opener, the door moves up or down. When programming a gate operator, the gate opens or closes.

Do not use the integrated remote control with any garage door opener that lacks safety stop and reverse features as required by U.S. federal safety standards (this includes any garage door opener model manufactured before April 1, 1982). A garage door that cannot detect an object – signaling the door to stop and reverse – does not meet current U.S. federal safety standards.

When programming a garage door opener, park the vehicle outside the garage.

Do not run the engine while programming the integrated remote control. Inhalation of exhaust gas is hazardous to your health.

All exhaust gas contains carbon monoxide (CO), and inhaling it can cause unconsciousness and possible death.

Programming the integrated remote control

Step 1:

- ▶ Switch on the ignition (▷ page 40).

Step 2:

- ▶ If you have previously programmed a signal transmitter button and wish to retain its programming, proceed to step 3.

If you are programming the integrated remote control for the first time, press and hold the two outer signal transmitter buttons (②) and (④) and release them only when indicator lamp (①) begins to flash after approximately 20 seconds (do not hold the button for longer than 30 seconds). This procedure erases any previous settings for all three channels and initializes the memory.

If you later wish to program a second and/or third hand-held transmitter to the remaining two signal transmitter buttons, do not repeat this step and begin directly with step 3.

Step 3:

- ▶ Hold end of the hand-held remote control (⑤) of the device you wish to train approximately 2 to 5 in (5 to 12 cm) away from the signal transmitter button (②, ③ or ④) to be programmed, while keeping the indicator lamp (①) in view.

Step 4:

- ▶ Using both hands, simultaneously press hand-held remote control button (⑥) and the desired signal transmitter button (②, ③ or ④). Do not release the buttons until step 5 is completed.

Indicator lamp (①) will flash, first slowly and then rapidly.

i Indicator lamp (①) flashes immediately the first time the signal transmitter button is programmed. If this button has already been programmed, the indicator lamp will only start flashing after 20 seconds.



Useful features

▷▷ Step 5:

- ▶ After indicator lamp ① changes from a slow to a rapidly flashing light, release the hand-held remote control button and the signal transmitter button.

Step 6:

- ▶ Press and hold the just-trained signal transmitter button (②, ③ or ④) and observe indicator lamp ①.

If indicator lamp ① stays on constantly, programming is complete and your device should activate when the respective signal transmitter button (②, ③ or ④) is pressed and released.

i If indicator lamp ① flashes rapidly for about 2 seconds and then turns to a constant light, continue with programming steps 8 through 12 as your garage door opener may be equipped with the “rolling code” feature.

Step 7:

- ▶ To program the remaining two signal transmitter buttons, repeat the steps above starting with step 3.

Rolling code programming

To train a garage door opener (or other rolling code devices) with the rolling code feature, follow these instructions after completing the “Programming” portion (steps 1 through 6) of this text. (A second person may make the following training procedures quicker and easier.)

Step 8:

- ▶ Locate “training” button on the garage door opener motor head unit.

Exact location and color of the button may vary by garage door opener brand. Depending on manufacturer, the “training” button may also be referred to as “learn” or “smart” button. If there is difficulty locating the transmitting button, refer to the garage door opener Operator’s Manual.

Step 9:

- ▶ Press the “training” button on the garage door opener motor head unit.
The “training light” is activated.

You have 30 seconds to initiate the following two steps.

Step 10:

- ▶ Return to the vehicle and firmly press, hold for 2 seconds and release the programmed signal transmitter button (②, ③ or ④).

Step 11:

- ▶ Press, hold for 2 seconds and release same signal transmitter button a second time to complete the training process.

i Some garage door openers (or other rolling code equipped devices) may require you to press, hold for 2 seconds and release the same signal transmitter button a third time to complete the training process.

Step 12:

- ▶ Confirm the garage door operation by pressing the programmed signal transmitter button (②, ③ or ④).

Step 13:

- ▶ To program the remaining two signal transmitter buttons, repeat the steps above starting with step 3.

Gate operator/Canadian programming

Canadian radio-frequency laws require transmitter signals to “time-out” (or quit) after several seconds of transmission which may not be long enough for the integrated signal transmitter to pick up the signal during programming. Similar to this Canadian law, some U.S. gate operators are designed to “time-out” in the same manner.

If you live in Canada or if you are having difficulties programming a gate operator (regardless of where you live) by using the programming procedures, replace step 4 with the following:

Step 4:

- ▶ Press and hold the signal transmitter button (②, ③ or ④). Do not release this button until it has been successfully trained.
- ▶ While still holding down the signal transmitter button (②, ③ or ④), “cycle” your hand-held remote control button ⑥ as follows: Press and hold button ⑥ for 2 seconds, then release it for 2 seconds, and again press and hold it for 2 seconds. Repeat this sequence on the hand-held remote control until the frequency signal has been learned. Upon successful training, indicator lamp ① will flash slowly and then rapidly after several seconds.
- ▶ Proceed with programming step 5 and step 6 to complete.

i Upon completion of programming the integrated remote control, make sure you retain the hand-held remote control that came with the garage door opener, gate operator or other device. You may need it for use in other vehicles, for future programming of an integrated remote control, or simply for continued use as a hand-held remote control to operate the respective device in other situations.

Reprogramming a single signal transmitter button

To program a device using a signal transmitter button previously trained, follow these steps:

- ▶ Switch on the ignition (▷ page 40).
- ▶ Press and hold the desired signal transmitter button (②, ③ or ④). Do not release the button.
- ▶ Indicator lamp ① will begin to flash after 20 seconds. Without releasing the signal transmitter button, proceed with programming starting with step 3.

Useful features

Operation of integrated remote control

- ▶ Switch on the ignition (▷ page 40).
- ▶ Select and press the appropriate integrated signal transmitter button (②, ③ or ④) to activate the remote controlled device.

The integrated remote control transmitter continues to send the signal as long as the button is pressed – up to 20 seconds.

Erasing the integrated remote control memory

- ▶ Switch on the ignition (▷ page 40).
- ▶ Simultaneously press and hold outer signal transmitter buttons ② and ④, for approximately 20 seconds, until indicator lamp ① flashes rapidly. Do not hold for longer than 30 seconds.

The codes of all three channels are erased.

i *If you sell your vehicle, erase the codes of all three channels.*

Programming tips

If you are having difficulty programming the integrated remote control, here are some helpful tips:

- Check the frequency of hand-held remote control ⑤ (typically located on the reverse side of the remote). The integrated remote control is compatible with radio-frequency devices operating between 280-390 MHz.
- Put a new battery in hand-held remote control ⑤. This will increase the likelihood of the hand-held remote control sending a faster and more accurate signal to the integrated remote control.
- While performing step 3, hold hand-held remote control ⑤ at different lengths and angles from the signal transmitter button (②, ③ or ④) you are programming. Attempt varying angles at the distance of 2 to 5 inches (5 to 12 cm) away or the same angle at varying distances.

- If another hand-held remote control is available for the same device, try the programming steps again using that other hand-held remote control. Make sure new batteries are in the hand-held remote control before beginning the procedure.
- Straighten the antenna wire from the garage door opener assembly. This may help improve transmitting and/or receiving signals.

i *Certain types of garage door openers are incompatible with the integrated remote control. If you should experience further difficulties with programming the integrated remote control, contact an authorized Mercedes-Benz Center, or call Mercedes-Benz Customer Assistance Center (in the USA only) at 1-800-FOR-MER-Cedes, or Customer Service (in Canada) at 1-800-387-0100.*

i USA only:

This device complies with Part 15 of the FCC Rules. Operation is subject to the following two conditions:

- (1) This device may not cause harmful interference, and
- (2) this device must accept any interference received, including interference that may cause undesired operation.

Any unauthorized modification to this device could void the user's authority to operate the equipment.

i Canada only:

This device complies with RSS-210 of Industry Canada. Operation is subject to the following two conditions:

- (1) This device may not cause interference, and
- (2) this device must accept any interference received, including interference that may cause undesired operation of the device.

Any unauthorized modification to this device could void the user's authority to operate the equipment.

Compass

Calling up the compass

- ▶ Press button  or  repeatedly until the AIRMATIC/Compass menu appears in the multifunction display.

The compass displays the direction into which the vehicle is currently traveling: N, NE, E, SE, S, SW, W, or NW.



- i** If your vehicle is not equipped with the air suspension package*, the multifunction display will show the compass only.

- i** The presence of buildings, bridges, power lines and large antenna masts can influence the displayed values. Metallic or magnetic objects in or on the vehicle can influence the accuracy of the compass.

To make sure the display is correct, the compass must be set to the proper geographic zone (▶ page 174). It may also be necessary to calibrate the compass (▶ page 175).

- i** If the compass is not calibrated or its function is impaired by outside influences, the message Compass - - - appears in the multifunction display.

Useful features

Infrared reflecting windshield*



① Infrared transparent areas

Your vehicle is equipped with infrared reflecting glass, which reduces the amount of radiated heat entering the vehicle interior through the windows.

The infrared reflecting glass also prevents the transmission of signals through the glass by in-vehicle electronic devices, e.g. electronic toll collection devices.

To allow the use of these devices in the vehicle, three infrared transparent areas ① are placed in the windshield.



The first 1000 miles (1500 km)

Driving instructions

At the gas station

Engine compartment

Tires and wheels

Winter driving

Maintenance

Vehicle care

The first 1000 miles (1500 km)

In the “Operation” section you will find detailed information on operating, maintaining and caring for your vehicle.

The more cautiously you treat your vehicle during the break-in period, the more satisfied you will be with its performance later on.

- Drive your vehicle during the first 1000 miles (1500 km) at varying but moderate vehicle and engine speeds.
- During this period, avoid heavy loads (full throttle driving) and excessive engine speeds (no more than $\frac{2}{3}$ of maximum rpm in each gear).
- Shift gears in a timely manner.
- Avoid accelerating by kick-down.
- Do not attempt to slow the vehicle down by shifting to a lower gear using the gear selector lever.
- Select gear ranges **3**, **2** or **1** (▷ page 193) only when driving at moderate speeds (for hill driving).

After 1000 miles (1500 km) you may gradually increase vehicle and engine speeds to the permissible maximum.

Additional instructions for ML 63 AMG:

- *During the first 1000 miles (1500 km), do not exceed a speed of 85 mph (140 km/h).*
- *During this period, avoid engine speeds above 4500 rpm in each gear.*
- *Shift gears at the correct time.*
- *Select **C** as the preferred shift program (▷ page 195) for the first 1000 miles (1500 km).*

All of the above instructions, as may apply to your vehicle type, also apply when driving the first 1000 miles (1500 km) after the engine, the transfer case, the front differential or the rear differential has been replaced.

 *Always obey applicable speed limits.*

▼ Driving instructions

Drive sensibly – save fuel

Fuel consumption, to a great extent, depends on driving habits and operating conditions.

To save fuel you should:

- Keep tires at the recommended inflation pressures.
- Remove unnecessary loads.
- Remove carriers* when not in use.
- Allow engine to warm up under low load use.
- Avoid frequent acceleration and deceleration.
- Have all maintenance work performed at the intervals specified in the Maintenance Booklet and as required by the Maintenance System (U.S. vehicles) or FSS PLUS (Canada vehicles). Contact an authorized Mercedes-Benz Light Truck Center.

Fuel consumption is also increased by driving in cold weather, in stop-and-go traffic, on short trips and in hilly areas.

Drinking and driving

Warning!



Drinking and driving and/or taking drugs and driving are a very dangerous combination. Even a small amount of alcohol or drugs can affect your reflexes, perceptions and judgment.

The possibility of a serious or even fatal accident are greatly increased when you drink or take drugs and drive.

Do not drink or take drugs and drive or allow anyone to drive who has been drinking or taking drugs.

Pedals

Warning!



Make sure that absolutely no objects are obstructing the pedal's range of movement. Keep the driver's footwell clear of all obstacles. If there are any floor mats or carpets in the footwell, make sure that the pedals still have sufficient clearance.

During sudden driving or braking maneuvers, the objects could get caught between the pedals. You could then no longer brake or accelerate. This could lead to accidents and injury.

Driving instructions

Power assistance

Warning!



With the engine not running, there is no power assistance for the brake and steering systems. In this case, it is important to keep in mind that a considerably higher degree of effort is necessary to brake and steer the vehicle.

Brakes

Warning!



After driving in heavy rain for some time without applying the brakes or through water deep enough to wet brake components, the first braking action may be somewhat reduced and increased pedal pressure may be necessary to obtain expected braking effect. Maintain a safe distance from vehicles in front.

Resting your foot on the brake pedal will cause excessive and premature wear of the brake pads.

It can also result in the brakes overheating, thereby significantly reducing their effectiveness. It may not be possible to stop the vehicle in sufficient time to avoid an accident.

! Operational or performance test must only be conducted on a two-axle dynamometer. If such tests are necessary, contact an authorized Mercedes-Benz Light Truck Center. You could otherwise seriously damage the brake system or the transfer case which is not covered by the Mercedes-Benz Limited Warranty.

! Because the ESP[®] operates automatically, the engine and ignition must be shut off (SmartKey in starter switch position **0** or **1** or KEYLESS-GO* start/stop button in position **0** or **1**) when testing the brakes on a brake test dynamometer and such testing should be no longer than 10 seconds.

Active braking action through the ESP[®] may otherwise seriously damage the brake system which is not covered by the Mercedes-Benz Limited Warranty.

To help prevent brake disk corrosion after driving on wet road surfaces (particularly salted roads), it is advisable to brake the vehicle with considerable force prior to parking. The heat generated serves to dry the brakes.

If your brake system is normally only subjected to moderate loads, you should occasionally test the effectiveness of the brakes by applying above-normal braking pressure at higher speeds. This will also enhance the grip of the brake pads.

Warning!

Make sure not to endanger any other road users when carrying out these braking maneuvers.

Refer to the description of the Brake Assist System (BAS) (▷ page 97).

Brake pad wear or a leak in the system may be the reason for low brake fluid in the reservoir.

The brake fluid level in the reservoir may be too low if the brake warning lamp in the instrument cluster comes on and an acoustic warning sounds although the parking brake is released (▷ page 415). Observe additional messages in the multi-function display that may appear (▷ page 449).

Have the brake system inspected immediately. Contact an authorized Mercedes-Benz Light Truck Center.

All checks and service work on the brake system should be carried out by qualified technicians only. Contact an authorized Mercedes-Benz Light Truck Center.

Only install brake pads and brake fluid recommended by Mercedes-Benz.

Warning!

If other than recommended brake pads are installed, or other than recommended brake fluid is used, the braking properties of the vehicle can be degraded to an extent that safe braking is substantially impaired. This could result in an accident.

! *When driving down long and steep grades, relieve the load on the brakes by shifting into a lower gear to use the engine's braking power. This helps prevent overheating of the brakes and reduces brake pad wear.*

When using the engine's braking power, a drive wheel may not spin for an extended period of time, e.g. on slippery road surfaces. This may cause serious damage to the drivetrain which is not covered by the Mercedes-Benz Limited Warranty.

After hard braking, it is advisable to drive on for some time, rather than immediately park, so that the air stream will cool down the brakes faster.

Driving instructions

High-performance brake system (ML 63 AMG only)

The high-performance brake system is designed to operate under the extremely high operating demands required to accommodate the performance capabilities of the vehicle. The brakes may produce a squeaking-type noise depending on the

- vehicle speed
- brake force applied
- ambient conditions, e.g. temperature and humidity

As with any brake system, the wear of individual brake system components such as brake pads or disks strongly depends on your driving style and the conditions under which you operate the vehicle. Thus, a driving style calling for high demand braking will cause your vehicle's brakes to wear more quickly.

Warning!



New vehicle brake pads and discs, and replacement brake pads and discs may take several hundred miles of driving until they provide optimum braking efficiency. Until that time, you may need to use increased brake pedal pressure while braking. Please be aware of this and adjust your driving and braking accordingly during this break-in period.

Excessive high demand braking will cause correspondingly high brake wear. Please be attentive to the brake warning lamp in the instrument cluster and brake condition messages in the multifunction display. Especially for high performance driving, it is important to maintain and have the brake system checked regularly.

Parking brake

When driving on wet roads or dirt covered surfaces, road salt and/or dirt can get into the parking brake. To prevent corrosion and a reduction in the braking power of the parking brake, observe the following:

- ▶ From time to time, lightly engage the parking brake before driving off.
- ▶ Drive a distance of approximately 110 yds (100 m) at a maximum speed of 12 mph (20 km/h).

Warning!



While performing this procedure please assure that the vehicle is stopped before applying the parking brake. Otherwise the rear wheels could lock up. You could lose control of the vehicle and cause an accident. In addition, the vehicle's brake lights do not light up when the parking brake is engaged. Make sure not to endanger any other road users when you engage the parking brake.

Driving off

Apply the brakes to test them briefly after driving off. Perform this procedure only when the road is clear of other traffic.

Warm up the engine smoothly. Do not place full load on the engine until the operating temperature has been reached.

! *When driving off on a slippery surface, do not allow a drive wheel to spin for an extended period with the ESP[®] switched off. Doing so may cause serious damage to the drivetrain which is not covered by the Mercedes-Benz Limited Warranty.*

! *Simultaneously depressing the accelerator pedal and applying the brake reduces engine performance and causes premature brake and drivetrain wear.*

Parking

Warning!



Do not park this vehicle in areas where combustible materials such as grass, hay or leaves can come into contact with the hot exhaust system, as these materials could be ignited and cause a vehicle fire.

To reduce the risk of personal injury, or damage to the vehicle drivetrain, as a result of vehicle movement, before turning off the engine and leaving the vehicle always:

- Keep right foot on brake pedal.
- Firmly depress parking brake pedal.
- Set the automatic transmission to position **P**.
- Slowly release brake pedal.
- When parked on an incline, turn front wheel towards the road curb.

- Turn the SmartKey to starter switch position **0** and remove, or press KEYLESS-GO* start/stop button (vehicles with KEYLESS-GO*).
- Take the SmartKey or the SmartKey with KEYLESS-GO* with you and lock vehicle when leaving.

Tires

Warning!



If you feel a sudden significant vibration or ride disturbance, or you suspect that possible damage to your vehicle has occurred, you should turn on the hazard warning flashers, carefully slow down, and drive with caution to an area which is a safe distance from the road.

Inspect the tires and the vehicle underbody for possible damage. If the vehicle or tires appear unsafe, have the vehicle towed to the nearest Mercedes-Benz Light Truck Center or tire dealer for repairs.

Driving instructions

Treadwear indicators (TWI) are required by law. These indicators are located in six places on the tread circumference and become visible at a tread depth of approximately $\frac{1}{16}$ in (1.6 mm), at which point the tire is considered worn and should be replaced.

The treadwear indicator appears as a solid band across the tread.

Warning!



Although the applicable federal motor vehicle safety laws consider a tire to be worn when the treadwear indicators (TWI) become visible at approximately $\frac{1}{16}$ in (1.6 mm), we recommend that you do not allow your tires to wear down to that level. As tread depth approaches $\frac{1}{8}$ in (3 mm), the adhesion properties on a wet road are sharply reduced.

Depending upon the weather and/or road surface (conditions), the tire traction varies widely.

Specified tire inflation pressures must be maintained. This applies particularly if the tires are subjected to high loads (e.g. high speeds, heavy loads, high ambient temperatures).

Warning!



Do not drive with a flat tire. A flat tire affects the ability to steer or brake the vehicle. You may lose control of the vehicle. Continued driving with a flat tire or driving at high speed with a flat tire will cause excessive heat build-up and possibly a fire.

For more information, see “Tires and wheels” (> page 365).

Hydroplaning

Depending on the depth of the water layer on the road, hydroplaning may occur, even at low speeds and with new tires. Reduce vehicle speed, avoid track grooves in the road and apply brakes cautiously in the rain.

Tire traction

The safe speed on a wet, snow covered or icy road is always lower than on a dry road.

You should pay particular attention to the condition of the road whenever the outside temperatures are close to the freezing point.

Warning!



If ice has formed on the road, tire traction will be substantially reduced. Under such weather conditions, drive, steer and brake with extreme caution.

Mercedes-Benz recommends winter tires (▷ page 399) with a minimum tread depth of approximately $\frac{1}{6}$ in (4 mm) on all four wheels for the winter season to make sure normal balanced handling characteristics. On packed snow, they can reduce your stopping distance compared to summer tires.

Stopping distance, however, is still considerably greater than when the road is not covered with snow or ice. Exercise appropriate caution.

! *Avoid spinning of a drive wheel. This may cause serious damage to the drivetrain which is not covered by the Mercedes-Benz Limited Warranty.*

Tire speed rating

Regardless of the tire speed rating, local speed limits should be obeyed. Use prudent driving speeds appropriate to prevailing conditions.

Warning!



Even when permitted by law, never operate a vehicle at speeds greater than the maximum speed rating of the tires.

Exceeding the maximum speed for which tires are rated can lead to sudden tire failure, causing loss of vehicle control and possibly resulting in an accident and/or serious injury and possible death, for you and for others.

ML 320 CDI

ML 350

ML 500

Your vehicle is factory equipped with “H”-rated tires, which have a speed rating of 130 mph (210 km/h).

An electronic speed limiter prevents your vehicle from exceeding a speed of 130 mph (210 km/h).

ML 320 CDI (with Sport Package*)

ML 350 (with Sport Package*)

ML 500 (with Sport Package*)

Your vehicle is factory equipped with:

- “H”-rated tires, which have a speed rating of 130 mph (210 km/h), vehicles with same size tires (▷ page 537)
- “W”-rated tires, which have a speed rating of 168 mph (270 km/h)

An electronic speed limiter prevents your vehicle from exceeding a speed of 130 mph (210 km/h).

Driving instructions

ML 63 AMG

Your vehicle is factory equipped with “Y”-rated tires, which have a speed rating of 186 mph (300 km/h).

An electronic speed limiter prevents your vehicle from exceeding a speed of 155 mph (250 km/h).

ML 63 AMG with increased top speed*

Your vehicle is factory equipped with “Y”-rated tires, which have a speed rating of 186 mph (300 km/h).

An electronic speed limiter prevents your vehicle from exceeding a speed of 171 mph (275 km/h).

i For information on speed ratings for winter tires, see “Winter tires” (▷ page 399).

For additional general information on tire speed markings on the tire sidewall, see “Tire speed rating” (▷ page 397).

Winter driving instructions

The most important rule for slippery or icy roads is to drive sensibly and to avoid abrupt acceleration, braking and steering maneuvers. Do not use the cruise control system under such conditions.

When the vehicle is in danger of skidding, shift the automatic transmission to position **N**. Try to keep the vehicle under control by corrective steering action.

i For information on driving with snow chains, see “Snow chains” (▷ page 400).

Warning!



On slippery road surfaces, never downshift in order to obtain braking action. This could result in drive wheel slip and reduced vehicle control. Your vehicle’s ABS will not prevent this type of control loss.

Road salts and chemicals can adversely affect braking efficiency. Increased pedal force may become necessary to produce the normal brake effect.

Depressing the brake pedal periodically when traveling at length on salt-strewn roads can bring road-salt-impaired braking efficiency back to normal.

If the vehicle is parked after being driven on salt-treated roads, the braking efficiency should be tested as soon as possible after driving is resumed.

Warning!



Make sure not to endanger any other road users when carrying out these braking maneuvers.

Warning!

If the vehicle becomes stuck in snow, make sure that snow is kept clear of the exhaust pipe and from around the vehicle with the engine running. Otherwise, deadly carbon monoxide (CO) gases may enter vehicle interior resulting in unconsciousness and death.

To assure sufficient fresh air ventilation, open a window slightly on the side of the vehicle not facing the wind.

Warning!

The outside temperature indicator is not designed to serve as an ice-warning device and is therefore unsuitable for that purpose. Indicated temperatures just above the freezing point do not guarantee that the road surface is free of ice.

For more information, see “Winter driving” (▷ page 399).

Standing water

! *Do not drive through flooded areas or water of unknown depth. Before driving through water, determine its depth. Never accelerate before driving into water. The bow wave could force water into the engine and auxiliary equipment, thus damaging them.*

If you must drive through standing water, drive slowly to prevent water from entering the passenger compartment or the engine compartment.

Water in these areas could cause

- *damage to electrical components*
- *wiring of the engine or transmission*

or could result

- *in water being ingested by the engine through the air intake, causing severe internal engine damage.*

Any such damage is not covered by the Mercedes-Benz Limited Warranty.

i *Vehicles with air suspension package*:
Select the raised level (▷ page 270) before driving through standing water.*

For more information, see “Driving through water” (▷ page 338).

Off-road driving**Warning!**

Do not load items on the basic carrier bars*. It may cause instability during some maneuvers which could result in an accident.

Drive slowly in unknown terrain. This will make it easier to recognize unexpected obstacles and avoid damage to the vehicle.

To help avoid the vehicle rolling over, never turn it around on steep inclines. If the vehicle cannot complete the attempted climb, back it down in reverse gear.

Do not drive along the side of a slope. The vehicle might otherwise rollover. If in doing so the vehicle begins to show a tendency to roll, immediately steer into a line of gravity (straight up or downhill).



Driving instructions

▷▷ Never let the vehicle roll backwards in idle. You may lose control of the vehicle if you use only the service brake. For information on driving downhill, see “Driving downhill” (▷ page 338).

Warning!



Sand, dirt, mud and other material having friction property can cause exceptional wear and tear as well as brake failure.

Have the brakes checked for dirt build-up and cleaned. There is otherwise a risk that full braking power may not be available in an emergency.

Warning!



Vehicles with air suspension package*:

Please be aware that by raising the vehicle level, the center of gravity also rises. Therefore, always ensure that the vehicle level is as low as possible. With higher ride height the ESP® may activate earlier in certain situations.

Read this chapter carefully before you begin off-road travel.

Familiarize yourself with the vehicle characteristics and gear changing before you attempt any difficult terrain off-road driving. We recommend that you start out with easy off-road travel.

Special driving features for off-road driving

The following driving features are available for specific kind of operation:

- Off-road – ABS (▷ page 97)
- Off-road – ESP® (▷ page 101)
- Off-road – 4-ETS (▷ page 102)
- Hill start assist system (▷ page 192)
- Downhill Speed Regulation (DSR) (▷ page 264)
- Off-road driving program (▷ page 268)
- Air suspension* (▷ page 269)

Off-road driving rules

- Engage the off-road driving program (▷ page 268) before driving under off-road conditions.
 - Vehicles with air suspension package*: Make sure you select a vehicle level (▷ page 270) appropriate to the topographical conditions. Always make sure the vehicle has enough ground clearance.
 - Fasten items being carried as securely as possible (▷ page 281).
 - Always navigate gradients with the engine on and with the transmission engaged in a gear. Switch on the DSR (▷ page 265) to help maintain a preset speed.
- !** Observe the following during off-road driving:
- *Keep doors, tailgate, windows, and tilt/sliding sunroof* closed whenever driving off-road.*
 - *Adjust vehicle speed to condition of terrain. The more uneven, rutty and steeper the terrain, the lower the speed should be. Drive through water slowly at an even speed, avoiding a bow wave.*
 - *Be especially careful when driving in unknown territory. It may be necessary to get out of the vehicle and scout the path you intend to take.*
 - *Watch out for obstacles, such as rocks, holes, tree stumps and ruts.*
 - *Before driving through water, determine its depth.*
 - *Do not stop vehicle while immersed in water, and do not shut off the engine.*
- *In sandy soil, drive at a steady speed as allowed by conditions. This helps overcome the vehicle rolling resistance and reduces the likelihood of the vehicle sinking into the ground.*
 - *Do not initiate jumps with the vehicle. It interrupts the forward momentum of the vehicle.*
 - *Always drive onto slopes with the engine running and the vehicle in gear.*
 - *Do not shift automatic transmission to position **N**.*

Warning!



Do not reduce the tire inflation pressure before driving through sand. However, if you do so, remember to correct the tire inflation pressure (▷ page 375) before continuing your trip. Driving with reduced tire inflation pressure increases the risk of losing control of the vehicle and rolling over.

Driving instructions

Checklist before off-road driving

Engine oil level

- Check the engine oil level with the control system (ML 500 only) (▷ page 358), or with the oil dipstick (except ML 500) (▷ page 360).

Only with a proper oil level can the vehicle obtain a trouble-free oil supply, even on steep gradients.

! If the engine oil level warning lamp (▷ page 453) comes on while driving, stop the vehicle in a safe location or as soon as is safe to do so. Check the engine oil level (▷ page 360).

The engine oil level warnings should not be ignored. Extended driving with the symbol displayed could result in serious engine damage that is not covered by the Mercedes-Benz Limited Warranty.

Tires

- Check the tread depth and maintain specified tire inflation pressure (a placard with the recommended tire inflation pressures is located on the driver's door B-pillar (▷ page 369)).
- Check tires for possible damage and remove foreign objects.
- Replace missing valve caps.

Rims

- Dented or bent rims can cause tire inflation pressure loss and damage the tire beads. For this reason, check and, if necessary, change rims before driving off-road.

Vehicle tool kit

- Check if the vehicle jack (▷ page 471) is functional.
- In all cases take the vehicle tool kit, a strong tow rope, a shovel and a small plank (to put under the vehicle jack on sandy soil) with you.

Driving in steep terrain



Slope angle

- ① Overhang angle, front
- ② Overhang angle, rear

Vehicles with steel suspension	①	① ¹	②
	31°	22°	29°

¹ Vehicles with AMG Sport-Package*

Vehicles with air suspension package*	①	① ¹	②
Raised level	34°	29°	31°
Highway	29°	22°	27°

¹ Vehicles with AMG Sport-Package*

ML 63 AMG	①	②
Raised level	28°	29°
Highway	23°	24°

- Comply with the warnings (▷ page 333) and rules for off-road driving (▷ page 335).
- Driving on embankments, slopes and other steep inclines should only be done straight up or downhill, i.e. in the line of gravity. Maximum vehicle climbing ability is a 100% grade which is equivalent to a slope angle of 45 degrees. Keep in mind that the climbing ability of the vehicle depends on terrain conditions.

- Shift automatic transmission to position **1** (▷ page 193).
- Drive slowly.
- Avoid excessive engine speeds – drive with moderate engine speeds (max. 3000 rpm).
- Utilize the engine’s braking power when descending a slope, observe the engine speed (do not overrev the engine). Apply the service brake as needed.

i For maximum engine speed, see “Instrument cluster” (▷ page 26) and see “Engine” (▷ page 534).

- Check the brakes after a lengthy down-grade drive.

Warning!



To help avoid the vehicle rolling over, never turn it around on steep inclines. If the vehicle cannot complete the attempted climb, back it down in reverse gear.

i The hill start assist system supports you when driving uphill.

For more information, see “Hill start assist system” (▷ page 192).

Traction in steep terrain

The maximum vehicle climbing ability is a 100% grade which is equivalent to a slope angle of 45 degrees. Keep in mind that the climbing ability of the vehicle depends on terrain conditions.

Be easy on the accelerator and watch for continuous wheel traction when driving in steep terrain.

i The 4-ETS helps greatly when starting out on a steep incline when the front wheels have then the tendency to slip due to the weight shifting towards the rear axle.

The 4-ETS recognizes the situation and limits the torque for the front wheels by braking them.

Simultaneously the torque for the rear wheels is increased.

Driving instructions

Driving across a hilltop

Decelerate just ahead of a hilltop (do not shift automatic transmission to position **N**), to prevent the vehicle from speeding up too much after climbing a hill.

Use the momentum of the vehicle to drive across the hilltop.

After climbing a hill, driving in this manner prevents the vehicle from:

- losing ground contact when cresting hills
- losing its forward momentum
- speeding up too much after climbing the hill

Driving downhill

- Drive slowly.
- Do not drive at an angle to the incline. Steer into the line of gravity and drive with the front wheels pointing straight downhill. Otherwise, the vehicle may slide sideways off the path and roll over.

- Shift automatic transmission to position **1** (▷ page 193).
- On steep inclines, use the Downhill Speed Regulation (▷ page 264).
- Utilize the engine's braking power to reduce vehicle speed.

If this is insufficient, apply the brakes gently. Make sure the vehicle is moving in the line of gravity.

- Check the brakes after a lengthy down-grade drive.

i *The special Off-road - ABS (▷ page 97) setting allows for precise and brief (cyclical) blocking of the front wheels, permitting them to dig into loose ground.*

Remember that, when stopped, the front wheels slide across a surface and thus lose their ability to steer the vehicle.

Driving through water



① Fording depth

Vehicles with steel suspension	①
	20.00 in (50 cm)
Vehicles with air suspension package* or ML 63 AMG	①
Raised level	20.00 in (50 cm)

- Before driving through water, determine its depth.

! *The water depth must not exceed the respective value listed in the table. The ground under the water might not be firm which could result the water being deeper than expected when driving the vehicle through it. Please note that the water level is correspondingly lower for flowing water.*

- Vehicles with air suspension package*: Select the highest vehicle level possible (▷ page 270).
- Switch to off-road driving program (▷ page 268) before driving through water.
- Shift automatic transmission to position **1** or **2** (▷ page 193).
- Avoid high engine speeds.
- Enter and leave the water only at a shallow spot, driving at walking speed.

! *Never accelerate before driving into the water. The bow wave could force water into the engine and auxiliary equipment, thus damaging them.*

- Drive through the water slowly and at a constant speed.

- Do not stop vehicle while immersed in water, and do not shut off the engine.

! *Do not open any of the vehicle's doors while driving through water. Water could otherwise enter the vehicle interior and damage the vehicle's electronics, as well as the interior equipment.*

- There is a very high level of driving resistance in water. The surface is slippery and may not be firm, making pulling away in water difficult and dangerous.
- Make sure that only small bow waves are formed when driving the vehicle through water.
- Clean mud off the tire tread after driving through water.
- To dry the brakes, apply pressure to the brake pedal several times while driving after leaving the water.

Crossing obstacles



! *Obstacles can damage the vehicle underbody or suspension components. If possible use the assistance of a second person outside the vehicle to scout the path you intend to take and check for adequate ground clearance when you cross obstacles with your vehicle. The person assisting you outside the vehicle should always be a safe distance away from the vehicle and positioned so that he or she cannot get hurt in case of any unexpected vehicle movement.*

After off-road driving or crossing obstacles, inspect vehicle for any damage, especially vehicle underbody and suspension components. Failure to do so can adversely affect the vehicle's future performance, including increased chance of an accident.

Driving instructions

When driving over tree stumps, big rocks and other obstacles, observe the following rules:

- Make sure the off-road driving program (▷ page 268) is switched on.
- Avoid high engine speeds.
- Shift automatic transmission to position **1** (▷ page 193).
- Check the vehicle clearance before crossing obstacles.
- Cross obstacles (e.g. tree stumps or big rocks) very slowly by aiming one of the front wheels at the center of the obstacle, and repeat same with the rear wheel.

! *Special attention is needed when you cross obstacles on a steep incline.*

The vehicle could slide sideways as a result of its possible slanted position which in turn may result in the vehicle tipping or rolling over.

Driving on sand

Warning!



Do not reduce the tire inflation pressure before driving through sand. However, if you do so, remember to correct the tire inflation pressure (▷ page 375) before continuing your trip. Driving with reduced tire inflation pressure increases the risk of losing control of the vehicle and rolling over.

When driving on sand, observe the following rules:

- Vehicles with air suspension package*: Set the raised level (▷ page 270).
- Avoid high engine speeds.
- Shift automatic transmission into a gear range that is appropriate for the terrain.

- In sandy soil, drive at a steady speed as allowed by conditions. This helps overcome the vehicle rolling resistance and reduce the likelihood of the vehicle sinking into the ground.
- Drive in tracks of other vehicles if they are not too deep and if you have sufficient clearance.

Ruts

A number of off-road tracks or other byways have deep ruts which can cause the underbody to come in contact with the ground.

- Make sure the off-road driving program (▷ page 268) is switched on.
- Vehicles with air suspension package*: Set the raised level (▷ page 270).

! Check that the ruts are not too deep and your vehicle's clearance is sufficient. Otherwise:

- your vehicle may be damaged
- the underbody of the vehicle may come in contact with the ground and you may get stuck
- Avoid high engine speeds.
- Shift automatic transmission to position **1** (▷ page 193).
- Drive next to the ruts rather than through them if at all possible.
- If the ruts are too deep to drive in, drive with one side of the vehicle on the grassy center strip if the route permits.

Returning from off-road driving

Warning!



If you feel a sudden significant vibration or ride disturbance, or you suspect that possible damage to your vehicle has occurred, you should turn on the hazard warning flashers, carefully slow down, and drive with caution to an area which is a safe distance from the roadway.

Inspect the tires and under the vehicle for possible damage. If the vehicle or tires appear unsafe, have it towed to the nearest Mercedes-Benz Light Truck Center or tire dealer for repairs.

Damage to the vehicle may influence driving comfort and pose the risk of accident to you and other drivers.

Off-road driving increases strain on the vehicle.

We recommend that you inspect the vehicle for possible damage after each off-road trip. Recognizing any damage and a subsequent timely repair reduces the chance of a possible breakdown or accident later on.

Proceed as follows:

- Switch off the off-road driving program (▷ page 268).
- Switch off the DSR (▷ page 265).
- Vehicles with air suspension package*: Lower the vehicle back to a level suitable for road conditions, e.g. Highway/High-speed level (▷ page 270).
- Clean all exterior lamps and check for possible damage.
- Clean the front and rear license plate.

Driving instructions

- Remove excessive dirt from tires, wheels, wheel housings, and underbody.

For instance, after driving in mud, clean the radiator, chassis, engine, brakes, and wheels from extreme dirt using a strong jet of water.

- Check tires for possible damage.
- Inspect vehicle underbody, oil pan, brake hoses, etc., as well as vehicle underbody for possible damage.
- Check for brush or branches caught in the underbody.

! *Brush or branches could increase the possibility of a fire, as well as cut fuel and/or brake lines, puncture rubber bellows of the axles or drive shafts.*

- After continued operation in mud, sand, water or other dirty conditions clean the brake discs, wheels, brake pads and check and clean axle joints.
- Conduct a brake test.

Trailer towing

Warning!



Failure to use proper equipment and driving technique can result in a loss of vehicle control when towing a trailer.

Improper towing or failure to follow the instructions in this manual can result in vehicle damage and/or serious personal injury. Follow the guidelines below carefully to assure safe trailer operation.

Contact an authorized Mercedes-Benz Light Truck Center should you require an explanation of information contained in this manual.

Trailer hitch*

- Only install a trailer hitch receiver approved for your vehicle.

For information on availability and installation, see an authorized Mercedes-Benz Light Truck Center.

- The bumpers on your vehicle are not designed for use with clamp-type hitches.

Do not attach rental hitches or other bumper-type hitches to them.

- To reduce the possibility of damage, remove the hitch ball adaptor from the receiver when not in use.

Electrical connections

The vehicle is prewired to accept the seven-wire harness included in the Mercedes-Benz approved trailer hitch receiver kit.

i A four-pole conversion plug is available from your authorized Mercedes-Benz Light Truck Center as a spare part.

For further information, see an authorized Mercedes-Benz Light Truck Center.

Vehicle and trailer weights and ratings

Gross Vehicle Weight Rating (GVWR) is the maximum permissible vehicle weight:

ML 350, ML 500, ML 320 CDI:
6239 lbs (2830 kg)

ML 63 AMG:
6393 lbs (2900 kg)

Gross Vehicle Weight (GVW):

Comprises weight of vehicle including fuel, tools, spare wheel, installed accessories, passengers, cargo and trailer tongue. It must never exceed the GVWR.

Gross Axle Weight Rating (GAWR) is the maximum permissible axle weight:

	ML 350, ML 320 CDI	ML 500	ML 63 AMG
Front	2943 lbs (1335 kg)	2987 lbs (1355 kg)	3175 lbs (1440 kg)
Rear	3296 lbs (1495 kg)	3252 lbs (1475 kg)	3527 lbs (1600 kg)

The **Gross Trailer Weight (GTW)** is the weight of the trailer plus the weight of all cargo, equipment, luggage etc. loaded on the trailer. The maximum permissible gross trailer weight to be towed:
4982 lbs (2260 kg)

Trailer Tongue Weight Rating (TWR) is the maximum permissible weight on the trailer tongue:
496 lbs (225 kg) limit for Mercedes-Benz approved hitch receiver.

Loading a trailer

- When loading a trailer, you should observe that neither the permissible GTW, nor the GVWR are exceeded.

Maximum permissible values are listed on the safety compliance certification labels for the vehicle and for the trailer to be towed.

The lowest value listed must be selected when determining how the vehicle and trailer are loaded.

- The tongue weight at the hitch ball must be added to the GVW to prevent exceeding your Mercedes-Benz tow vehicle's rear GAWR.

i We recommend loading the trailer in such a manner that it has a Tongue Weight (TW) between 10% and 15% of the Gross Trailer Weight (GTW).

i Maximum trailer ratings are calculated assuming a base vehicle, plus any options necessary to achieve the rating, plus driver. The weight of other equipment, passengers and cargo will reduce the maximum trailer weight your vehicle can tow.

Driving instructions

Checking weights of vehicle and trailer

- To assure that the tow vehicle and trailer are in compliance with the maximum permissible weight limits have the loaded rig (tow vehicle including driver, passengers and cargo, trailer fully loaded) weighed on a commercial scale.
- Check the vehicle's front and rear Gross Axle Weight (GAW), the Gross Trailer Weight (GTW) and Tongue Weight (TW).

The values as measures must not exceed the weight limits listed under "Vehicle and trailer weight and ratings" (> page 343).

Attaching a trailer

Warning!



While you are coupling or decoupling a trailer, make sure that you do not

- lock or unlock
- open or close

a vehicle door or the tailgate.

The vehicle's level could change and you could endanger yourself and/or others as a result.

Make sure that you do not operate the ADS button* (> page 269) or the vehicle level control system* (> page 270) when coupling/decoupling the trailer.

Observe maximum permitted trailer dimensions (width and length).

Most states and all Canadian provinces require

- safety chains between your tow vehicle and the trailer.

The chains should be criss-crossed under the trailer tongue. They must be attached to the hitch receiver, and not to the vehicle's bumper or axle.

Make sure to leave enough slack in the chains to permit turning corners.

- a separate brake system at various trailer weights.
- a break-away switch on trailers with a separate brake system. Check with your local state laws for specific requirements.

The switch activates the trailer brakes in the possible event that the trailer might separate from the tow vehicle.

! Do not connect a trailer brake system (if trailer is so equipped) directly to the vehicle's hydraulic brake system, as your vehicle is equipped with antilock brakes. If you do, neither the vehicle's brakes nor the trailer's brakes will function properly.

i The provided vehicle electrical wiring harness for trailer towing has a brake signal wire for hook-up to a brake controller.

You should consider using a trailer sway control system. For further information, see an authorized Mercedes-Benz Light Truck Center.

- ▶ Make sure the automatic transmission is set to **P** (▷ page 187).
- ▶ Set the parking brake for the vehicle (▷ page 65).
- ▶ Start the engine (▷ page 54).
- ▶ Vehicles with air suspension package*: Set the vehicle level to Highway (▷ page 270).

- ▶ Vehicles with air suspension package*: Set the ADS* to AUTO or COMFORT (▷ page 269).
- ▶ Turn off the engine (▷ page 66).
- ▶ Close all doors and the tailgate.
- ▶ Attach the trailer.
- ▶ Plug in all electrical connectors.

i Vehicles with air suspension package*:

When you are towing a trailer, the vehicle level always remains in the Highway setting.

The following applies additionally when towing a trailer:

- *The vehicle is lowered to the highway level when it reaches a speed of 5 mph (8 km/h) if not set to highway level.*
- *The high-speed level is not available.*

The restrictions that apply to towing also apply when using accessories that are connected to the trailer power socket, such as a bicycle rack.

Towing a trailer

There are many different laws, including speed limit restrictions, having to do with trailer towing. Make sure your rig will be legal, not only for where you reside, but also for where you will be driving. A good source for this information can be the police or local authorities.

Note the following points, when driving with the trailer:

- In order to gain skill and an understanding of the vehicle's behavior, you should practice turning, stopping and backing up in an area which is free from traffic.
- Before you start driving check the
 - trailer hitch
 - break-away switch
 - safety chains
 - electrical connections
 - lighting and tires

Driving instructions

- Adjust the mirrors (▷ page 49) to permit unobstructed view beyond rear of trailer.
- If the trailer has electric brakes, start your vehicle and trailer moving slowly, and then apply only the trailer brake controller by hand to make sure the brakes are working properly.
- Always secure items in the trailer to prevent load shifts while driving.
- When towing a trailer, check occasionally to make sure the load is secure, and that lighting and trailer brakes (if so equipped) are functioning properly.
- Take into consideration that when towing a trailer, the handling characteristics are different and less stable from those when operating the vehicle without a trailer.

It is important to avoid sudden maneuvers.

- The vehicle and trailer combination is heavier, and therefore is limited in acceleration and climbing ability, and requires longer stopping distances.

It is more prone to reacting to cross wind gusts, and requires more sensitive steering input.

- If possible, do not brake abruptly, but rather engage the brake slightly at first to permit the trailer to activate its brake. Then increase the braking force.

! *If the trailer should begin to sway, reduce the vehicle's speed immediately.*

In no case attempt to straighten out the tow vehicle and trailer by increasing the speed.

- If the transmission repeatedly shifts between gears on inclines, manually shift to a lower gear (select **4**, **3**, **2** or **1**) (▷ page 193).

A lower gear and reduction of speed reduces the chance of engine overloading and/or overheating.

- On very steep inclines, not manageable with automatic transmission in **1**, switch on off-road driving program (▷ page 268).

- When going down a long hill, shift into a lower gear and use the engine's braking effect.

Avoid riding the brakes, thus overheating the vehicle and trailer brakes.

- If the engine coolant rises to an extremely high temperature (coolant temperature needle approaching the red zone) when the air conditioning is on, turn off the air conditioning system.

Engine coolant heat can be additionally vented by opening the windows, switching the climate control fan speed to high and setting the temperature control to the maximum hot position.

- Extreme care must be exercised since your vehicle with a trailer will require additional passing distance ahead than when driving without a trailer.

Because your vehicle and trailer is longer than your vehicle alone, you will also need to go much farther ahead of the passed vehicle before you can return to your lane.

Uncoupling the trailer

Warning!



Vehicles with air suspension package*:

While you are coupling or decoupling a trailer, make sure that you do not

- lock or unlock
- open or close

a vehicle door or the tailgate.

The vehicle's level could change and you could endanger yourself and/or others as a result.

Make sure that you do not operate the ADS button* (▷ page 269) or the vehicle level control system* (▷ page 270) when coupling/decoupling the trailer.

- ▶ Make sure the automatic transmission is set to **P** (▷ page 187).
- ▶ Set the parking brake for the vehicle (▷ page 65).

- ▶ Start the engine (▷ page 54).
- ▶ Close all doors and the tailgate.
- ▶ Set the parking brake for the trailer.

Warning!



Vehicles with air suspension package*:

As soon as you disconnect the electrical connection between the trailer and the vehicle, the vehicle will lower. To help avoid personal injury, make sure no one is near the wheel housing or underneath the vehicle before the electrical connection is disconnected.

When you uncouple the trailer, the vehicle is temporarily raised because the springs are relieved of load. Be especially careful during this process, as you could otherwise injure yourself and/or others. Make sure that any persons remaining in the vehicle do not press the switches for vehicle level control or the ADS*.

Driving instructions

- ▶ Disconnect all electrical plug connectors.
- ▶ Uncouple the trailer.
- ▶ Make sure that the trailer coupling is free of load.
- ▶ Turn off the engine (▷ page 66).

Passenger compartment

Warning!



Always fasten items being carried as securely as possible.

In an accident, during hard braking or sudden maneuvers, loose items will be thrown around inside the vehicle, and cause injury to vehicle occupants unless the items are securely fastened in the vehicle.

The rear cargo compartment is the preferred place to carry objects. Always use tie down rings, and if so equipped, always use partition net* when transporting cargo. The partition net* cannot secure hard or heavy objects. Always fasten items being carried as securely as possible using the cargo tie-down rings in the cargo floor area and fastening materials.

Driving abroad

Abroad, there is an extensive Mercedes-Benz service network at your disposal. If you plan to drive into areas which are not listed in the index of your Mercedes-Benz Light Truck Center directory, you should request pertinent information from an authorized Mercedes-Benz Light Truck Center.

Control and operation of radio transmitters

COMAND system, radio and telephone*

Warning!



Do not forget that your primary responsibility is to drive the vehicle. Only operate the COMAND system, radio or telephone¹ if road, weather and traffic conditions permit.

Bear in mind that at a speed of just 30 mph (approximately 50 km/h), your vehicle is covering a distance of 44 feet (approximately 14 m) every second.

¹ Observe all legal requirements.

Telephones and two-way radios

Warning!



Never operate radio transmitters equipped with a built-in or attached antenna (i.e. without being connected to an external antenna) from inside the vehicle while the engine is running. Doing so could lead to a malfunction of the vehicle's electronic system, possibly resulting in an accident and/or personal injury.

Radio transmitters, such as a portable telephone or a citizens band unit should only be used inside the vehicle if they are connected to an antenna that is installed on the outside of the vehicle.

Refer to the radio transmitter operation instructions regarding use of an external antenna.

Catalytic converter (gasoline engine)

Your Mercedes-Benz is equipped with monolithic-type catalytic converters, an important element in conjunction with the oxygen sensors to achieve substantial control of the pollutants in the exhaust emissions. Keep your vehicle in proper operating condition by following our recommended maintenance instructions as outlined in your Maintenance Booklet.

! *To prevent damage to the catalytic converters, use only premium unleaded gasoline in this vehicle.*

Any noticeable irregularities in engine operation should be repaired promptly. Otherwise, excessive unburned fuel may reach the catalytic converter, causing it to overheat and potentially start a fire.

Warning!



As with any vehicle, do not idle, park or operate this vehicle in areas where combustible materials such as grass, hay or leaves can come into contact with the hot exhaust system, as these materials could be ignited and cause a vehicle fire.

Oxidation catalyst (diesel engine)

Your vehicle is equipped with an oxidation catalyst, an important element in conjunction with the oxygen sensors to achieve substantial control of the pollutants in the exhaust emissions. Keep your vehicle in proper operating condition by following our recommended maintenance instructions as outlined in your Maintenance Booklet.

Driving instructions

Warning!



As with any vehicle, do not idle, park or operate this vehicle in areas where combustible materials such as grass, hay or leaves can come into contact with the hot exhaust system, as these materials could be ignited and cause a vehicle fire.

Emission control

Certain engine systems serve to keep the toxic components of the exhaust gases within permissible limits required by law.

These systems, of course, will function properly only when maintained strictly according to factory specifications. Any adjustments on the engine should, therefore, be carried out only by qualified Mercedes-Benz Light Truck Center authorized technicians.

Engine adjustments should not be altered in any way. Moreover, the specified service jobs must be carried out regularly according to Mercedes-Benz servicing requirements. For details refer to the Maintenance Booklet.

Warning!



Inhalation of exhaust gas is hazardous to your health. All exhaust gas contains carbon monoxide (CO), and inhaling it can cause unconsciousness and possible death.

Do not run the engine in confined areas (such as a garage) which are not properly ventilated. If you think that exhaust gas fumes are entering the vehicle while driving, have the cause determined and corrected immediately. If you must drive under these conditions, drive only with at least one window fully open at all times.

Coolant temperature

During severe operating conditions, e.g. stop-and-go traffic, the coolant temperature may rise close to approximately 248°F (120°C).

The engine should not be operated with the coolant temperature above 248°F (120°C). Doing so may cause serious engine damage which is not covered by the Mercedes-Benz Limited Warranty.

Warning!

- Driving when your engine is overheated can cause some fluids, which may have leaked into the engine compartment to catch fire. You could be seriously burned.
- Steam from an overheated engine can cause serious burns which can occur just by opening the engine hood. Stay away from the engine if you see or hear steam coming from it.

Turn off the engine, get out of the vehicle and do not stand near the vehicle until the engine has cooled down.

At the gas station

Refueling

Warning!



Gasoline and diesel fuels are highly flammable and poisonous. They burn violently and can cause serious injury.

Never allow sparks, flame or smoking materials near gasoline or diesel fuel!

Turn off the engine before refueling.

Whenever you are around gasoline or diesel fuel, avoid inhaling fumes and skin or clothing contact, extinguish all smoking materials.

Direct skin contact with gasoline or diesel fuels and the inhalation of gasoline or diesel fuel vapors can damage your health.

Warning!



Do not fill diesel tanks with gasoline. Do not mix diesel fuel with gasoline. Otherwise the fuel system and engine could be damaged. In addition, the vehicle could catch fire.

! *Damage resulting from mixing gasoline with diesel is not covered by the Mercedes-Benz Limited Warranty.*

The fuel filler flap is located on the right-hand side of the vehicle towards the rear. Locking/unlocking the vehicle with the SmartKey or the SmartKey with KEYLESS-GO* automatically locks/unlocks the fuel filler flap.

! *Diesel engine: When filling the diesel fuel tank using fuel containers, place a filling filter, a suede cloth or a clean flannel cloth as a filter. Otherwise, particles from the fuel container could clog the fuel lines and/or the diesel injection system.*



- ▶ Turn off the engine
 - by turning the SmartKey to position **0** (▷ page 40). Remove the SmartKey from the starter switch.
 - by pressing the KEYLESS-GO* start/stop button (▷ page 41). Open the driver's door (with the driver's door open, starter switch is now in position **0**, same as SmartKey removed from starter switch).
- ▶ Briefly push on fuel filler flap at the position indicated by the arrow.

The fuel filler flap opens slightly.

- ▶ Open the fuel filler flap completely.
- ▶ Turn the fuel cap to the left and hold on to it until possible pressure is released.
- ▶ Take off the fuel cap.

! *The fuel filler cap is tethered to the fuel filler neck. Do not drop the cap. It could damage the vehicle paint finish.*

- ▶ To prevent fuel vapors from escaping into open air, fully insert filler nozzle unit.
- ▶ Only fill your tank until the filler nozzle unit cuts out – **do not top up or over-fill.**



Warning!



Overfilling of the fuel tank may create pressure in the system which could cause a gas discharge. This could cause the gas to spray back out when removing the fuel pump nozzle, which could cause personal injury.

- ▶ Replace the fuel cap by turning it clockwise until it audibly engages.
- ▶ Close the fuel filler flap.

You should hear the latch close shut.

i *Leaving the engine running and the fuel cap open can cause the yellow fuel tank reserve warning lamp to flash and the  malfunction indicator lamp (USA only) or the  malfunction indicator lamp (Canada only) comes on.*

For more information, see “Practical hints” (▷ page 417).

i *Gasoline engine: Only use premium unleaded gasoline with a minimum Posted Octane Rating of 91 (average of 96 RON/86 MON). Information on gasoline quality can normally be found on the fuel pump.*

For more information on gasoline, see “Premium unleaded gasoline (gasoline engine)” (▷ page 547), see “Fuel requirements” (▷ page 548), and the Factory Approved Service Products pamphlet.

i *Diesel engine: Only use commercially available vehicular diesel fuels No. 2 or No. 1 (ASTM D975 No. 2-D or No. 1-D). Information on diesel quality can normally be found on the fuel pump.*

The sulfur content in diesel fuel should not exceed 50 parts per million (ppm). When using diesel fuel with a sulfur content of above 300 ppm, the engine oil interval should be shortened.

For more information on diesel fuels, refer to the Factory Approved Service Products pamphlet or contact an authorized Mercedes-Benz Light Truck Center.

! *Diesel engine:*

The engine is more susceptible to wear and damage if you use

- marine diesel fuel
- heating oil
- additives

The use of such non-approved fuels and/or special additives is not covered by the Mercedes-Benz Limited Warranty.

At the gas station

Low outside temperatures (diesel engine)

To prevent malfunctions, diesel fuel with improved cold flow characteristics is offered in the winter months. Check with your fuel retailer.

! Do not fill the tank with gasoline. Do not blend diesel fuel with gasoline or kerosine. The fuel system and engine will otherwise be damaged, which is not covered by the Mercedes-Benz Limited Warranty.

Check regularly and before a long trip

- ▶ Open the hood (▷ page 356).



Example ML 500

- ① Brake fluid
- ② Coolant level
- ③ Windshield washer system and headlamp cleaning system*

Engine oil level

For more information on engine oil, see “Engine oil” (▷ page 358).

Brake fluid

! If you find that the brake fluid in the brake fluid reservoir has fallen to the minimum mark or below, have the brake system checked for brake pad thickness and leaks immediately. Notify an authorized Mercedes-Benz Light Truck Center immediately. Do not add brake fluid as this will not solve the problem. For more information, see “Brake fluid” (▷ page 546).

Coolant

For normal replenishing, use water (potable water quality).

For more information, see “Coolant level” (▷ page 362) and see “Fuels, coolants, lubricants” (▷ page 543).

Windshield/rear window washer system and headlamp cleaning system*

For more information on refilling the washer reservoir, see “Windshield/rear window washer system and headlamp cleaning system*” (▷ page 363).

Vehicle lighting

Check function and cleanliness. For information on replacing light bulbs, see “Replacing bulbs” (▷ page 482).

For more information, see “Exterior lamp switch” (▷ page 136).

Tire inflation pressure

For more information, see “Checking tire inflation pressure” (▷ page 375).

Engine compartment

Hood

Warning!



Do not pull the release lever while the vehicle is in motion. Otherwise the hood could be forced open by passing air flow.

This could cause the hood to come loose and injure you and/or others.

Opening

Warning!



If you see flames or smoke coming from the engine compartment, or if the coolant temperature gauge indicates that the engine is overheated, do not open the hood. Move away from vehicle and do not open the hood until the engine has cooled. If necessary, call the fire department.

Warning!



You could be injured when the hood is open – even when the engine is turned off.

Parts of the engine can become very hot. To prevent burns, only touch owner serviceable components described in the Operator's Manual and comply with all relevant safety precautions.

Warning!



To help prevent personal injury, stay clear of moving parts when the hood is open and the engine is running.

The radiator fan may continue to run for approximately 30 seconds or even restart after the engine has been turned off. Stay clear of fan blades.

Warning!



Vehicles with gasoline engine:

The engine is equipped with a transistorized ignition system. Because of the high voltage it is dangerous to touch any components (ignition coils, spark plug sockets, diagnostic socket) of the ignition system

- with the engine running
- while starting the engine
- if ignition is “on” and the engine is turned manually

Warning!

Vehicles with diesel engine:
The engine is equipped with a high-voltage electronic control unit for the injection system. Because of the high voltage it is dangerous to touch any components of the injection system (injectors, electrical wires)

- with the engine running
- while starting the engine
- when the ignition is switched on

The hood lock release lever is located in the driver's footwell.



① Release lever

- ▶ Pull release lever ① downwards.

The hood is unlocked. Handle ② protrudes slightly from the radiator grille. If not, lift the hood slightly.

! *To avoid damage to the windshield wipers or hood, never open the hood if the wiper arms are folded forward away from the windshield.*



② Handle for opening the hood

- ▶ Press and hold handle ②.

The hood is unlocked.

- ▶ Pull up on the hood in direction of arrow and then release it.

The hood will be automatically held open at shoulder height by gas-filled struts.

Engine compartment

Closing

Warning!



When closing the hood, use extreme caution not to catch hands or fingers. Be careful that you do not close the hood on anyone.

Make sure that the hood is securely engaged before driving off. Do not continue driving if the hood can no longer engage after an accident, for example. The hood could otherwise come loose while the vehicle is in motion and injure you and/or others.

- ▶ Let the hood drop from a height of approximately 1 ft (30 cm).

The hood will lock audibly.

- ▶ Check to make sure the hood is fully closed.

If you can raise the hood at a point above the headlamps, then it is not properly closed. Open it again and let it drop with somewhat greater force.

Engine oil

The amount of oil your engine needs will depend on a number of factors, including driving style. Increased oil consumption can occur when

- the vehicle is new
- the vehicle is driven frequently at higher engine speeds

Engine oil consumption checks should only be made after the vehicle break-in period.

i *Do not use any special lubricant additives, as these may damage the drive assemblies. Using special additives not approved by Mercedes-Benz may cause damage not covered by the Mercedes-Benz Limited Warranty.*

More information on this subject is available at any Mercedes-Benz Light Truck Center.



Checking engine oil level with the control system (ML 500 only)

When checking the oil level

- the vehicle must be parked on level ground
- with the engine at operating temperature, the vehicle must have been stationary for at least 5 minutes with the engine turned off
- with the engine not at operating temperature yet, the vehicle must have been stationary for at least 30 minutes with the engine turned off

To check the engine oil level via the multifunction display, do the following:

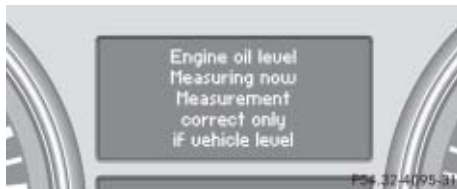

- ▶ Switch on the ignition (▷ page 40).
The standard display (▷ page 154) should appear in the multifunction display.

- ▶ Press button  or  on the multifunction steering wheel until the following message appears in the multifunction display:



One of the following messages will subsequently appear in the multifunction display:

- Engine oil level OK
- Add 1.0 qt. to reach max. oil level
(Canada: 1.0 liter)
- Add 1.5 qts. to reach max. oil level
(Canada: 1.5 liters)
- Add 2.0 qts. to reach max. oil level
(Canada: 2.0 liters)

i If you want to interrupt the checking procedure, press the  or  button on the multifunction steering wheel.

- ▶ If necessary, add engine oil (▷ page 361).

For information on adding engine oil, see (▷ page 361).

For more information on engine oil, see “Technical data” section (▷ page 543) and (▷ page 546).

Other display messages

If the SmartKey or KEYLESS-GO* start/stop button is not in position **2**, the following message will appear:

Switch ignition on
to check engine oil level

- ▶ Switch on the ignition (▷ page 40).

If you see the message:

Observe waiting period

- ▶ If the engine is at operating temperature, wait 5 minutes before repeating check procedure.
- ▶ If the engine is not at operating temperature, wait 30 minutes before repeating check procedure.

If you see the message:

Engine oil level
Not when engine on

- ▶ Turn off the engine.
- ▶ If the engine is at operating temperature, wait 5 minutes before checking oil.
- ▶ If the engine is not at operating temperature yet, you must wait 30 minutes before checking oil.

If there is excess engine oil with the engine at operating temperature, the following message will appear:

Engine oil level
Reduce oil level

Engine compartment

- ▶ Have excess oil siphoned or drained off. Contact an authorized Mercedes-Benz Light Truck Center.

! *Excess oil must be siphoned or drained off. It could cause damage to the engine and/or catalytic converter (gasoline engine) or the oxidation catalyst (diesel engine) not covered by the Mercedes-Benz Limited Warranty.*

For more information on messages in the multifunction display concerning engine oil, see “Practical hints” (▷ page 413).

Checking engine oil level with the oil dipstick (except ML 500)

When checking the oil level

- the vehicle must be parked on level ground
- the vehicle must have been stationary for at least 5 minutes with the engine turned off



- ① Oil dipstick
- ② Upper mark
- ③ Lower mark

- ▶ Open the hood (▷ page 356).
- ▶ Pull out oil dipstick ①.
- ▶ Wipe oil dipstick ① clean.
- ▶ Fully insert oil dipstick ① into the dipstick guide tube.

- ▶ Pull out oil dipstick ① again after approximately 3 seconds to obtain accurate reading.

The oil level is correct when it is between lower mark ③ (min.) and upper mark ② (max.) of the oil dipstick.

i *All models (except ML 63 AMG):
The filling quantity between the upper and lower marks on the oil dipstick is approximately 2.1 US qt. (2.0 l).*

ML 63 AMG:

The filling quantity between the upper and lower marks on the oil dipstick is approximately 1.6 US qt. (1.5 l).

- ▶ If necessary, add engine oil (▷ page 361).

For more information on engine oil, see “Technical data” section (▷ page 543) and (▷ page 546).

Adding engine oil

! Only use approved engine oils and oil filters required for vehicles with Maintenance System (U.S. vehicles) or FSS PLUS (Canada vehicles). For a listing of approved engine oils and oil filters, refer to the Factory Approved Service Products pamphlet in your vehicle literature portfolio, or contact an authorized Mercedes-Benz Light Truck Center.

Using engine oils and oil filters of specification other than those expressly required for the Maintenance System (U.S. vehicles) or FSS PLUS (Canada vehicles), or changing of oil and oil filter at change intervals longer than those called for by the Maintenance System (U.S. vehicles) or FSS PLUS (Canada vehicles) will result in engine or emission control system damage not covered by the Mercedes-Benz Limited Warranty.



Example ML 350 (ML 320 CDI similar)

① Filler cap



Example ML 500 (ML 63 AMG similar)

① Filler cap

- ▶ Unscrew filler cap ① from filler neck.
- ▶ Add engine oil as required. Never overfill with oil.

Be careful not to spill any oil when adding. Avoid environmental damage caused by oil entering the ground or water.

! Excess oil must be siphoned or drained off. It could cause damage to the engine and/or catalytic converter (gasoline engine) or the oxidation catalyst (diesel engine) not covered by the Mercedes-Benz Limited Warranty.

- ▶ Screw filler cap ① back on filler neck.

For more information on engine oil, see “Technical data” section (▷ page 543) and (▷ page 546).

Engine compartment

Transmission fluid level

The transmission fluid level does not need to be checked. If you notice transmission fluid loss or gear shifting malfunctions, have an authorized Mercedes-Benz Light Truck Center check the automatic transmission.

Coolant level

The engine coolant is a mixture of water and anticorrosion/antifreeze. To check the coolant level, the vehicle must be parked on level ground.

Warning!



In order to avoid potentially serious burns:

- Use extreme caution when opening the hood if there are any signs of steam or coolant leaking from the cooling system, or if the coolant temperature gauge indicates that the coolant is overheated.

- Do not remove pressure cap on coolant reservoir if coolant temperature is above 158°F (70°C). Allow engine to cool down before removing cap. The coolant reservoir contains hot fluid and is under pressure.
- Using a rag, slowly open the cap approximately $1/2$ turn to relieve excess pressure. If opened immediately, scalding hot fluid and steam will be blown out under pressure.
- Do not spill antifreeze on hot engine parts. Antifreeze contains ethylene glycol which may burn if it comes into contact with hot engine parts.

The coolant expansion tank is located on the driver's side of the engine compartment.



- ① Cap
- ② Coolant expansion tank
- ③ Indicator wall
- ④ Coolant level

- ▶ Using a rag, turn cap ① slowly approximately one half turn counterclockwise to release any excess pressure.

- ▶ Continue turning cap ① counterclockwise and remove it.

Coolant level ④ is correct if the level:

- for cold coolant: reaches the top of indicator wall ③ visible through the filling opening
 - for warm coolant: is approximately 0.6 in (1.5 cm) higher
- ▶ Add coolant as required.
 - ▶ Replace and tighten cap ①.

For more information on coolant, see “Coolants” (▷ page 549).

Windshield/rear window washer system and headlamp cleaning system*

The windshield washer reservoir is located in the engine compartment.



① Cap for windshield washer fluid reservoir

Fluid for the windshield washer system and the headlamp cleaning system* is supplied from the windshield washer reservoir. It has a capacity of 8.1 US qt (7.7 l).

During all seasons, add MB Windshield Washer Concentrate “MB SummerFit” to water. Premix the windshield washer fluid in a suitable container.

Warning!



Washer solvent/antifreeze is highly flammable. Do not spill washer solvent/antifreeze on hot engine parts, because it may ignite and burn. You could be seriously burned.

- ▶ Use the tab to pull cap ① upwards. ▷▷

Engine compartment

- ▷▷ Refill the reservoir with MB Windshield Washer Concentrate “MB SummerFit” and water (or commercially available premixed windshield washer solvent/antifreeze, depending on ambient temperatures).

! *Always use washer solvent/antifreeze where temperatures may fall below freezing point. Failure to do so could result in damage to the washer system/reservoir.*

! *Only use washer fluid which is suitable for plastic lenses. Improper washer fluid can damage the plastic lenses of the headlamps.*

For more information, see “Windshield washer and headlamp cleaning* system” (▷ page 551).

▼ Tires and wheels

See an authorized Mercedes-Benz Light Truck Center for information on tested and recommended rims and tires for summer and winter operation. They can also offer advice concerning tire service and purchase.

Warning!



Replace rims or tires with the same designation, manufacturer and type as shown on the original part. See an authorized Mercedes-Benz Light Truck Center for further information. If incorrectly sized rims and tires are mounted:

- The wheel brakes or suspension components can be damaged.
- The operating clearance of the wheels and the tires may no longer be correct.

Warning!



Worn, old tires can cause accidents. If the tire tread is badly worn, or if the tires have sustained damage, replace them.

When replacing rims, only use genuine Mercedes-Benz wheel bolts specified for the particular rim type. Failure to do so can result in the bolts loosening and possibly an accident.

Retreaded tires are not tested or recommended by Mercedes-Benz, since previous damage cannot always be recognized on re-treads. The operating safety of the vehicle cannot be assured when such tires are used.

Important guidelines

- Only use sets of tires and rims of the same type and make.
- Tires must be of the correct size for the rim.
- Break in new tires for approximately 60 miles (100 km) at moderate speeds.
- Regularly check the tires and rims for damage. Dented or bent rims can cause tire inflation pressure loss or damage to the tire beads.
- If vehicle is heavily loaded, check tire inflation pressure and correct as required.
- Do not allow your tires to wear down too far. Adhesion properties on wet roads are sharply reduced at tread depths under $\frac{1}{8}$ in (3 mm).
- When replacing individual tires, you should mount new tires on the front wheels first (on vehicles with same-sized wheels all around).

Tires and wheels

Tire care and maintenance

Warning!



Regularly check the tires for damage. Damaged tires can cause tire inflation pressure loss. As a result, you could lose control of your vehicle.

Worn, old tires can cause accidents. If the tire tread is badly worn, or if the tires have sustained damage, replace them.

Regularly check your tire inflation pressure at least once a month. For more information on checking tire inflation pressure, see “Recommended tire inflation pressure” (▷ page 374).

Tire inspection

Every time you check your tire inflation pressure, you should also inspect your tires for the following:

- excessive treadwear (▷ page 367)
- cord or fabric showing through the tire’s rubber
- bumps, bulges, cuts, cracks or splits in the tread or side of the tire

Replace the tire if you find any of the above conditions.

Make sure you also inspect the spare tire periodically for condition and inflation. Spare tires will age and become worn over time even if never used, and thus should be inspected and replaced when necessary.

Life of tire

The service life of a tire is dependent upon varying factors including but not limited to:

- Driving style
- Tire inflation pressure
- Distance driven

Warning!



Tires and spare tire should be replaced after 6 years, regardless of the remaining tread.

Tread depth

Do not allow your tires to wear down too far. Adhesion properties on wet roads are sharply reduced at tread depths under $\frac{1}{8}$ in (3 mm).

Treadwear indicators (TWI) are required by law. These indicators are located in six places on the tread circumference and become visible at a tread depth of approximately $\frac{1}{16}$ in (1.6 mm), at which point the tire is considered worn and should be replaced.

Recommended minimum tire tread depth:

- Summer tires $\frac{1}{8}$ in (3 mm)
- Winter tires $\frac{1}{6}$ in (4 mm)

Warning!



Although the applicable federal motor safety laws consider a tire to be worn when the treadwear indicators (TWI) become visible at approximately $\frac{1}{16}$ in (1.6 mm), we recommend that you do not allow your tires

to wear down to that level. As tread depth approaches $\frac{1}{8}$ in (3 mm), the adhesion properties on a wet road are sharply reduced.

Depending upon the weather and/or road surface (conditions), the tire traction varies widely.

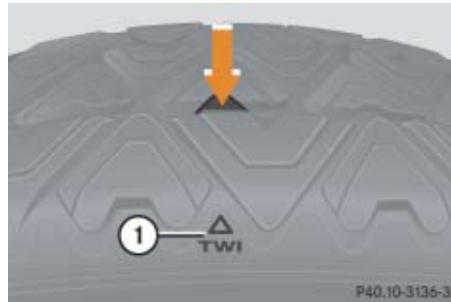

① TWI (Tread Wear Indicator)

The treadwear indicator appears as a solid band across the tread.

Storing tires

! *Keep unmounted tires in a cool, dry place with as little exposure to light as possible. Protect tires from contact with oil, grease and gasoline.*

Cleaning tires

! *Never use a round nozzle to power wash tires. The intense jet of water can result in damage to the tire.*

Always replace a damaged tire.

Tires and wheels

Direction of rotation

Unidirectional tires offer added advantages, such as better hydroplaning performance. To benefit, however, you must make sure the tires rotate in the direction specified.

An arrow on the sidewall indicates the intended direction of rotation (spinning) of the tire.

i *Spare wheels may be mounted against the direction of rotation (spinning) even with a unidirectional tire for temporary use only until the regular drive wheel has been repaired or replaced. Always observe and follow applicable temporary use restrictions and speed limitations indicated on the spare wheel.*

Loading the vehicle

Two labels on your vehicle show how much weight it may properly carry.

- The Tire and Loading Information placard can be found on the driver's door B-pillar. This placard tells you important information about the number of people that can be in the vehicle and the total weight that can be carried in the vehicle. It also contains information on the proper size and recommended tire inflation pressures for the original equipment tires on your vehicle.

- The certification label found on the driver's door B-pillar tells you about the gross weight capacity of your vehicle, called the Gross Vehicle Weight Rating (GVWR). The GVWR includes the weight of the vehicle, all occupants, fuel and cargo. The certification label also tells you about the front and rear axle weight capacity, called the Gross Axle Weight Rating (GAWR). The GAWR is the total allowable weight that can be carried by a single axle (front or rear). Never exceed the GVWR or GAWR for either the front axle or rear axle.



① Driver's door B-pillar

Following is a discussion on how to work with the information contained on the placard with regards to loading your vehicle.

Tire and Loading Information

Warning!



Do not overload the tires by exceeding the specified load limit indicated on the placard on the driver's door B-pillar. Overloading the tires can overheat them, possibly causing a blowout. Overloading the tires can also result in handling or steering problems, or brake failure.

Your vehicle is equipped with a Tire and Loading Information placard.

i Data shown on placard example are for illustration purposes only. Load limit data are specific to each vehicle and may vary from data shown in the illustration below. Refer to placard on vehicle for actual data specific to your vehicle.

Tire and Loading Information placard

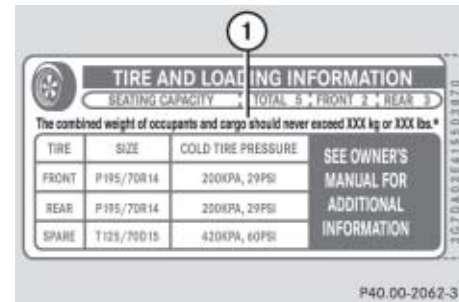

① Load limit information on the Tire and Loading Information placard

The placard showing the load limit information is located on the driver's door B-pillar.

- ▶ Locate the statement “The combined weight of occupants and cargo should never exceed XXX kilograms or XXX lbs.” on this placard.

The combined weight of all occupants, cargo/luggage and trailer tongue load (if applicable) should never exceed the weight referenced in that statement.

Tires and wheels

Seating capacity

The seating capacity gives you important information on the number of occupants that can be in the vehicle. Observe front and rear seating capacity. The placard showing the seating capacity is located on the driver's door B-pillar (▷ page 369).

i Data shown on placard example are for illustration purposes only. Seating data are specific to each vehicle and may vary from data shown in the illustration below. Refer to placard on vehicle for actual data specific to your vehicle.

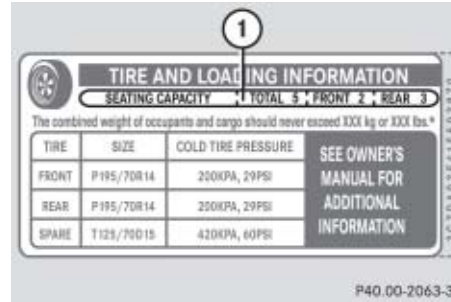

① Seating capacity information on the Tire and Loading Information placard.

Steps for determining correct load limit

The following steps have been developed as required of all manufacturers under Title 49, Code of U.S. Federal Regulations, Part 575 pursuant to the “National Traffic and Motor Vehicle Safety Act of 1966”.

Step 1

- ▶ Locate the statement “The combined weight of occupants and cargo should never exceed XXX kg or XXX lbs.” on your vehicle’s placard.

Step 2

- ▶ Determine the combined weight of the driver and passengers that will be riding in your vehicle.

Step 3

- ▶ Subtract the combined weight of the driver and passengers from XXX kilograms or XXX lbs.

Step 4

- ▶ The resulting figure equals the available amount of cargo and luggage load capacity. For example, if the “XXX” amount equals 1400 lbs and there will be five 150 lbs passengers in your vehicle, the amount of available cargo and luggage load capacity is 650 lbs ($1400 - 750 (5 \times 150) = 650$ lbs).

Step 5

- ▶ Determine the combined weight of luggage and cargo being loaded on the vehicle. That weight may not safely exceed the available cargo and luggage load capacity calculated in step 4.

Step 6 (if applicable)

- ▶ If your vehicle will be towing a trailer, load from your trailer will be transferred to your vehicle. Consult this manual to determine how this reduces the available cargo and luggage load capacity of your vehicle (▷ page 373).

The following table shows examples on how to calculate total and cargo load capacities with varying seating configurations and number and size of occupants. The following examples use a load limit of 1500 lbs. **This is for illustration purposes only.** Make sure you are using the actual load limit for your vehicle stated on the vehicle’s placard (▷ page 369).

Tires and wheels

Example	Combined weight limit of occupants and cargo from placard	Number of occupants (driver and passengers)	Seating configuration	Occupants weight	Combined weight of all occupants	Available cargo/luggage and trailer tongue weight (total load limit from placard minus combined weight of all occupants)
1	1500 lbs	5	front: 2 rear: 3	Occupant 1: 150 lbs Occupant 2: 180 lbs Occupant 3: 160 lbs Occupant 4: 140 lbs Occupant 5: 120 lbs	750 lbs	1500 lbs - 750 lbs = 750 lbs
2	1500 lbs	3	front: 1 rear: 2	Occupant 1: 200 lbs Occupant 2: 190 lbs Occupant 3: 150 lbs	540 lbs	1500 lbs - 540 lbs = 960 lbs
3	1500 lbs	1	front: 1	Occupant 1: 150 lbs	150 lbs	1500 lbs - 150 lbs = 1350 lbs

The higher the weight of all occupants, the less cargo and luggage load capacity is available.

For more information, see “Trailer tongue load” (> page 373).

Certification label

Even after careful determination of the combined weight of all occupants, cargo and the trailer tongue load (if applicable) (▷ page 373) as to not exceed the permissible load limit, you must make sure that your vehicle never exceeds the Gross Vehicle Weight Rating (GVWR) and the Gross Axle Weight Rating (GAWR) for either the front or rear axle. You can obtain the GVWR and GAWR from the certification label. The certification label can be found on the driver's door B-pillar, see "Technical data" (▷ page 527).

Gross Vehicle Weight Rating (GVWR): The total weight of the vehicle, all occupants, all cargo, and the trailer tongue load (▷ page 373) must never exceed the GVWR.

Gross Axle Weight Rating (GAWR): The total allowable weight that can be carried by a single axle (front or rear).

To assure that your vehicle does not exceed the maximum permissible weight limits (GVWR and GAWR for front and rear axle), have the loaded vehicle (including driver, passengers and all cargo and, if applicable, trailer fully loaded) weighed on a suitable commercial scale.

Trailer tongue load

The tongue load of any trailer is an important weight to measure because it affects the load you can carry in your vehicle. If a trailer is towed, the tongue load must be added to the weight of all occupants riding and any cargo you are carrying in the vehicle. The tongue load typically is between 10% and 15% of the trailer weight and everything loaded in it.

For more information on trailer tongue load, see "Loading a trailer" (▷ page 343).

Tires and wheels

Recommended tire inflation pressure

Warning!



Follow recommended tire inflation pressures.

Do not underinflate tires. Underinflated tires wear excessively and/or unevenly, adversely affect handling and fuel economy, and are more likely to fail from being overheated.

Do not overinflate tires. Overinflated tires can adversely affect handling and ride comfort, wear unevenly, increase stopping distance, and result in sudden deflation (blowout) because they are more likely to become punctured or damaged by road debris, potholes etc.

Your vehicle is equipped with the Tire and Loading Information placard located on the driver's door B-pillar (▷ page 369).

The tire inflation pressure should be checked regularly and should only be adjusted on cold tires. The tires can be considered cold if the vehicle has been parked for at least 3 hours or driven less than 1 mile (1.6 km).

Follow recommended cold tire inflation pressures listed on placard.

Keeping the tires properly inflated provides the best handling, tread life and riding comfort.

In addition to the tire placard on the driver's door B-pillar, also consult the fuel filler flap for any additional information pertaining to special driving situations. For more information, see "Important notes on tire inflation pressure" (▷ page 375).

i Data shown on placard example are for illustration purposes only. Tire data are specific to each vehicle and may vary from data shown in the illustration below. Refer to placard on vehicle for actual data specific to your vehicle.

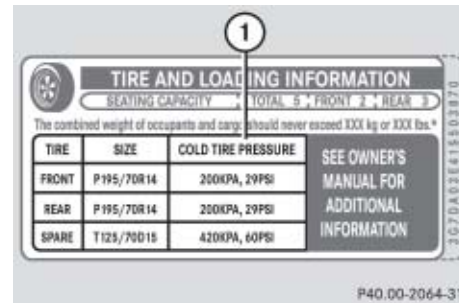

1 Tire and Loading Information placard with recommended cold tire inflation pressures

The Tire and Loading Information placard lists the recommended cold tire inflation pressures for maximum loaded vehicle weight. The tire inflation pressures listed apply to the tires installed as original equipment.

Important notes on tire inflation pressure

Warning!



If the tire inflation pressure repeatedly drops:

- Check the tires for punctures from foreign objects.
- Check to see whether air is leaking from the valves or from around the rim.

Tire temperature and tire inflation pressure are also increased while driving, depending on the driving speed and the tire load.

If you will be driving your vehicle at high speeds of 100 mph (160 km/h) or higher, where it is legal and conditions allow, consult the placard on the inside of the fuel filler flap on how to adjust the cold tire inflation pressure. If you do not adjust the tire inflation pressure, excessive heat can build up and result in sudden tire failure.

Be sure to readjust the tire inflation pressure for normal driving speeds. You should wait until the tires are cold before adjusting the tire inflation pressure.

i *Driving comfort may be reduced when the tire inflation pressure is adjusted to the value for speeds above 100 mph (160 km/h) as specified on the placard located on the inside of the fuel filler flap.*

Some vehicles may have supplemental tire inflation pressure information for vehicle loads less than the maximum loaded vehicle condition. If such information is provided, it can be found on the placard located on the inside of the fuel filler flap.

Tire inflation pressure changes by approximately 1.5 psi (0.1 bar) per 18°F (10°C) of air temperature change. Keep this in mind when checking tire inflation pressure where the temperature is different from the outside temperature.

Checking tire inflation pressure

Regularly check your tire inflation pressure at least once a month.

Check and adjust the tire inflation pressure when the tires are cold. The tires can be considered cold if the vehicle has been parked for at least 3 hours or driven less than 1 mile (1.6 km).

If you check the tire inflation pressure when the tires are warm (the vehicle has been driven for several miles or sitting less than 3 hours), the reading will be approximately 4 psi (0.3 bar) higher than the cold reading. This is normal. Do not let air out to match the specified cold tire inflation pressure. Otherwise, the tire will be underinflated.

Tires and wheels

Warning!



Follow recommended tire inflation pressures.

Do not underinflate tires. Underinflated tires wear excessively and/or unevenly, adversely affect handling and fuel economy, and are more likely to fail from being overheated.

Do not overinflate tires. Overinflated tires can adversely affect handling and ride comfort, wear unevenly, increase stopping distance, and result in sudden deflation (blowout) because they are more likely to become punctured or damaged by road debris, potholes etc.

Do not overload the tires by exceeding the specified load limit as indicated on the placard on the driver's door B-pillar. Overloading the tires can overheat them, possibly causing a blowout. Overloading the tires can also result in handling or steering problems, or brake failure.

Checking tire inflation pressure manually

Follow the steps below to achieve correct tire inflation pressure:

- ▶ Remove the cap from the valve on one tire.
- ▶ Firmly press a tire gauge onto the valve.
- ▶ Read tire inflation pressure on tire gauge and check against the recommended tire inflation pressure on the placard on the driver's door B-pillar (▷ page 369) or, if available, the inside of the fuel filler flap. If necessary, add air to achieve the recommended tire inflation pressure.

i *If you have overfilled the tire, release tire inflation pressure by pushing the metal stem of the valve with e.g. a tip of a pen. Then recheck the tire inflation pressure with the tire gauge.*

- ▶ Install the valve cap.
- ▶ Repeat this procedure for each tire.

Run Flat Indicator (Canada only)

While the vehicle is being driven, the Run Flat Indicator monitors the set tire inflation pressures by evaluating each wheel's rotational speed. This allows the system to detect a significant loss of pressure in a tire. If a wheel's rotational speed changes due to falling tire inflation pressure, you will see a corresponding warning message in the multifunction display.

The Run Flat Indicator may function in a restricted manner or with a delay

- if snow chains are mounted to the vehicle
- in presence of ice and snow
- if you are driving on a loose surface (e.g. sand or gravel)
- if you are driving in a very sporty manner (involving rapid acceleration or high speeds in curves)

Warning!



When the multifunction display shows the message **Tire pressure Check tires**, one or more of your tires is significantly underinflated. You should stop and check your tires as soon as possible, and inflate them to the proper tire inflation pressure as indicated on the vehicle's tire information placard. Driving on a significantly underinflated tire causes the tire to overheat and can lead to tire failure. Underinflation also reduces fuel efficiency and tire tread life, and may affect the vehicle's handling and stopping ability. Each tire, including the spare, should be checked monthly when cold and set to the recommended tire inflation pressure as specified on the Tire and Loading Information placard (▷ page 369) or on the tire inflation pressure label (▷ page 369).

Warning!



The Run Flat Indicator does not provide a warning for wrongly selected tire inflation pressures. Always adjust tire inflation pressure according to the placard on the driver's door B-pillar or fuel filler flap.

The Run Flat Indicator does not replace regular checks of the tire inflation pressures since a gradual pressure loss in all four tires cannot be detected by the Run Flat Indicator.

The Run Flat Indicator is not able to issue a warning due to a sudden dramatic loss of tire inflation pressure (e.g. tire blowout caused by a foreign object). In this case bring the vehicle to a halt by carefully applying the brakes and avoiding abrupt steering maneuvers.

Tires and wheels

Reactivating the Run Flat Indicator

The tire inflation pressure monitor must be reactivated in the following situations:



- If you have changed the tire inflation pressure
- If you have replaced the wheels or tires
- If you have installed new wheels or tires
- ▶ Using the tire placard on the driver's door B-pillar or, if available, the inside of the fuel filler flap, make sure the tire inflation pressure of all four tires is correct.

Warning!



The Run Flat Indicator can only warn you in a reliable manner if you have set the correct tire inflation pressures for each tire.

If an incorrect tire inflation pressure was set, the system will monitor the pressure according to the incorrect value.

- ▶ Switch on the ignition (▷ page 40).
Make sure the standard display menu appears in the multifunction display (▷ page 147).
- ▶ Press button  or  repeatedly until the following message appears in the multifunction display:



- ▶ Press the reset button on the instrument cluster (▷ page 145).

The following message will appear in the multifunction display:

Restart
Run Flat Indicator?
Yes
Cancel

If you wish to confirm activation:

- ▶ Press button .

The following message will appear in the multifunction display:

Run Flat Indicator
restarted

After a certain “learning phase”, the Run Flat Indicator checks the set pressure values for all four tires.

If you wish to cancel activation:

- ▶ Press button .

or

- ▶ Wait until the message
Restart
Run Flat Indicator?
Yes
Cancel
disappears.

Checking tire pressure electronically with the Tire Pressure Monitoring System (TPMS), (USA only)

 The Tire Pressure Monitoring System (TPMS) is equipped with a combination low tire pressure/TPMS malfunction telltale in the instrument cluster (▷ page 27). Depending on how the telltale illuminates, it indicates a low tire pressure condition or a malfunction in the TPMS system itself:

- If the telltale illuminates continuously, one or more of your tires is significantly underinflated. There is no malfunction in the TPMS.
- If the telltale flashes for 60 seconds and then stays illuminated, the TPMS system itself is not operating properly.

The TPMS only functions on wheels that are equipped with the proper electronic sensors. It monitors the tire inflation pressure, as selected by the driver, in all four tires. A warning is issued to alert you to a decrease in pressure in one or more of the tires.

Warning!



The TPMS does not indicate a warning for wrongly selected inflation pressures. Always adjust tire inflation pressure according to the placard on the driver's door B-pillar or, if available, the supplemental tire pressure information on the inside of the fuel filler flap.

The TPMS is not able to issue a warning due to a sudden dramatic loss of pressure (e.g. tire blowout caused by a foreign object). In this case bring the vehicle to a halt by carefully applying the brakes and avoiding abrupt steering maneuvers.

Warning!



Each tire, including the spare (if provided), should be checked monthly when cold and inflated to the inflation pressure recommended by the vehicle manufacturer on the vehicle placard or the tire inflation pressure label. (If your vehicle has tires of a different size than the size indicated on the vehicle placard or the tire inflation pressure label, you should determine the proper tire inflation pressure for those tires).

As an added safety feature, your vehicle has been equipped with a tire pressure monitoring system (TPMS) that illuminates a low tire pressure telltale when one or more of your tires is significantly underinflated. Accordingly, when the low tire pressure telltale illuminates, you should stop and check your tires as soon as possible, and inflate them to the proper pressure. Driving on a significantly underinflated tire causes the tire to overheat and can lead to tire failure.



Tires and wheels



Underinflation also reduces fuel efficiency and tire tread life, and may affect the vehicle's handling and stopping ability. Please note that the TPMS is not a substitute for proper tire maintenance, and it is the driver's responsibility to maintain correct tire pressure, even if underinflation has not reached the level to trigger illumination of the TPMS low tire pressure telltale.

Your vehicle has also been equipped with a TPMS malfunction indicator to indicate when the system is not operating properly. The TPMS malfunction indicator is combined with the low tire pressure telltale. When the system detects a malfunction, the telltale will flash for approximately 1 minute and then remain continuously illuminated. This sequence will continue upon subsequent vehicle start-ups as long as the malfunction exists. When the malfunction indicator is illuminated, the system may not be able to detect or signal low tire pressure as intended.

TPMS malfunctions may occur for a variety of reasons, including the installation of incompatible replacement or alternate tires or wheels on the vehicle that prevent the TPMS from functioning properly. Always check the TPMS malfunction telltale after replacing one or more tires or wheels on your vehicle to ensure that the replacement or alternate tires and wheels allow the TPMS to continue to function properly.

i *If a condition causing the TPMS to malfunction develops, it may take up to 10 minutes for the system to signal a malfunction using the TPMS telltale flashing and illumination sequence.*

The telltale extinguishes after a few minutes driving if the malfunction has been corrected.

i *Operating radio transmission equipment (e.g. wireless headsets, two-way radios) in or near the vehicle could cause the TPMS to malfunction.*

Reactivating the TPMS

Warning!







It is the driver's responsibility to calibrate the TPMS on the recommended cold inflation pressure. Underinflated tires affect the ability to steer or brake the vehicle. You might lose control over the vehicle.

The TPMS must be reactivated when you have adjusted the tire inflation pressure to a new level (e.g. because of different load or driving conditions). The TPMS is then recalibrated to the current tire inflation pressures.

- ▶ Using the tire placard on the driver's door B-pillar (▷ page 369) or, if available, the supplemental tire pressure information on the inside of the fuel filler flap (▷ page 374), make sure the tire inflation pressure of all four tires is correct.

i Reactivate the TPMS after adjusting the tire inflation pressure to the inflation pressure recommended for the vehicle operating condition. Tire pressure should only be adjusted on cold tires. Observe the recommended tire inflation pressure on the placard on the driver's door B-pillar (▷ page 369). Some vehicles may have supplemental tire pressure information for driving at high speeds (▷ page 375) or for vehicle loads less than the maximum loaded vehicle condition (▷ page 375). If such information is provided, it can be found on the inside of the fuel filler flap.

- ▶ Press button  or  on the multifunction steering wheel repeatedly until the standard display menu appears in the multifunction display (▷ page 147).
- ▶ Press the  or  button repeatedly until you see the following message:
Tire pressure monitor
active
Menu: R-Button

- ▶ Press the reset button (▷ page 145).

The following message will appear in the multifunction display:

Restart tire
pressure monitor?

- ▶ Press the  button.

The following message will appear in the multifunction display:

Tire pressure monitor
restarted

After driving a few minutes the system verifies that the current tire inflation pressures are within the system's specified range. Afterwards the current tire inflation pressures are accepted as reference pressures and then monitored.

If you wish to cancel activation:

- ▶ Press the  button.



Checking tire pressure electronically with the Advanced Tire Pressure Monitoring System (Advanced TPMS)*, (Canada only)

The TPMS only functions on wheels that are equipped with the proper electronic sensors. It monitors the tire inflation pressure, as selected by the driver, in all four tires. A warning is issued to alert you to a decrease in pressure in one or more of the tires.

Tire pressure inquiries are made using the multifunction display. The present inflation pressures are displayed only after a few minutes' travel time.

i Possible differences between the readings of a tire pressure gauge of an air hose, e.g. gas station equipment, and the vehicle's control system can occur. Usually the readings issued by the control system are more precise.

Tires and wheels

- ▶ Switch on the ignition (▷ page 40).
- ▶ Press the  or  button on the multifunction steering wheel until the current inflation pressures for each tire appear in the multifunction display.



i When the message Tire pressure displayed after driving for a few minutes *appears in the multifunction display, the individual inflation pressure values are matched with the tires. The individual values are displayed after a few minutes driving.*

Warning!



It is the driver's responsibility to calibrate the TPMS on the recommended cold inflation pressure. Underinflated tires affect the ability to steer or brake the vehicle. You might lose control over the vehicle.

i *With a spare wheel without wheel sensor mounted, the system may still indicate the tire inflation pressure of the removed wheel for some minutes. If this happens, keep in mind that the indicated value where the spare wheel is mounted does not reflect the actual spare tire inflation pressure.*

Warning!



The TPMS does not indicate a warning for wrongly selected inflation pressures. Always adjust tire inflation pressure according to the placard on the driver's door B-pillar or, if available, the supplemental tire pressure information on the inside of the fuel filler flap.

The TPMS is not able to issue a warning due to a sudden dramatic loss of pressure (e.g. tire blowout caused by a foreign object). In this case bring the vehicle to a halt by carefully applying the brakes and avoiding abrupt steering maneuvers.

Warning!



Each tire, including the spare (if provided), should be checked monthly when cold and inflated to the inflation pressure recommended by the vehicle manufacturer on the vehicle placard or the tire inflation pressure label. (If your vehicle has tires of a different size than the size indicated on the vehicle placard or the tire inflation pressure label, you should determine the proper tire inflation pressure for those tires).

As an added safety feature, your vehicle has been equipped with a tire pressure monitoring system (TPMS) that illuminates a low tire pressure telltale when one or more of your tires are significantly underinflated. Accordingly, when the low tire pressure telltale illuminates, you should stop and check your tires as soon as possible. Driving on a significantly underinflated tire causes the tire to overheat and can lead to tire failure.

Underinflation also reduces fuel efficiency and tire tread life, and may effect the vehicle's handling and stopping ability. Please note that the TPMS is not a substitute for proper tire maintenance, and it is the driver's responsibility to maintain correct tire pressure, even if under-inflation has not reached the level to trigger illumination of the TPMS low tire pressure telltale.

i Operating radio transmission equipment (e.g. wireless headsets, two-way radios) in or near the vehicle could cause the TPMS to malfunction.

Reactivating Advanced TPMS*

The TPMS must be reactivated when you have adjusted the tire inflation pressure to a new level (e.g. because of different load or driving conditions). The TPMS is then recalibrated to the current tire inflation pressures.





Warning!



It is the driver's responsibility to calibrate the TPMS on the recommended cold inflation pressure. Underinflated tires affect the ability to steer or brake the vehicle. You might lose control over the vehicle.

- ▶ Using the tire placard on the driver's door B-pillar (▷ page 369) or, if available, the supplemental tire pressure information on the inside of the fuel filler flap (▷ page 374), make sure the tire inflation pressure of all four tires is correct.

i Reactivate the TPMS after adjusting the tire inflation pressure to the inflation pressure recommended for the vehicle operating condition. Tire pressure should only be adjusted on cold tires. Observe the recommended tire inflation pressure on the placard on the driver's door B-pillar (▷ page 369). Some vehicles may have supplemental tire pressure information for driving at high speeds (▷ page 375) or for vehicle loads less than the maximum loaded vehicle condition (▷ page 375). If such information is provided, it can be found on the inside of the fuel filler flap.

- ▶ Press button  or  on the multifunction steering wheel repeatedly until the standard display menu appears in the multifunction display (▷ page 147).
- ▶ Press the  or  button repeatedly until you see the current inflation pressures for each tire appear in the display or the following message appears in the display
Tire pressure displayed after driving for a few minutes



Tires and wheels

▷▷ Press the reset button (▷ page 145).

The following message will appear in the multifunction display:

Restart tire
pressure monitor?

▶ Press the **+** button.

The following message will appear in the multifunction display:

Tire pressure monitor
restarted

After a few minutes driving, the current tire inflation pressure values are accepted as reference values and then monitored.

If you wish to cancel activation:

▶ Press the **-** button.

Potential problems associated with underinflated and overinflated tires

Underinflated tires

Underinflated tires can:

- cause excessive and uneven tire wear
- adversely affect fuel economy
- lead to tire failure from being overheated
- adversely affect handling characteristics

Warning!



Follow recommended tire inflation pressures.

Do not underinflate tires. Underinflated tires wear excessively and/or unevenly, adversely affect handling and fuel economy, and are more likely to fail from being overheated.

Overinflated tires

Overinflated tires can:

- adversely affect handling characteristics
- cause uneven tire wear
- be more prone to damage from road hazards
- adversely affect ride comfort
- increase stopping distance

Warning!



Follow recommended tire inflation pressures.

Do not overinflate tires. Overinflated tires can adversely affect handling and ride comfort, wear unevenly, increase stopping distance, and result in sudden deflation (blowout) because they are more likely to become punctured or damaged by road debris, potholes etc.

Tire labeling

Besides tire name (sales designation) and manufacturer name, a number of markings can be found on a tire.

Following are some explanations for the markings on your vehicle's tires:

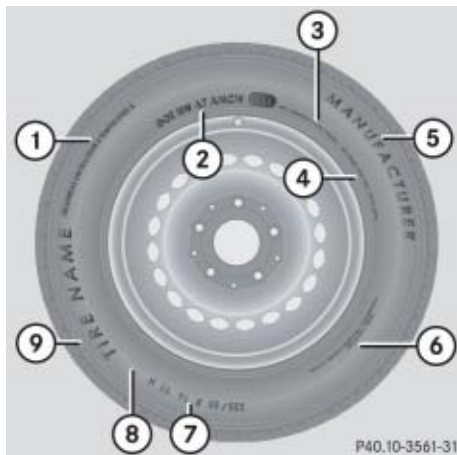

- ① Uniform Quality Grading Standards (▷ page 392)
- ② DOT, Tire Identification Number (TIN) (▷ page 389)
- ③ Maximum tire load (▷ page 391)
- ④ Maximum tire inflation pressure (▷ page 391)
- ⑤ Manufacturer
- ⑥ Tire ply material (▷ page 394)
- ⑦ Tire size designation, load and speed rating (▷ page 385)
- ⑧ Load identification (▷ page 389)
- ⑨ Tire name

i For illustration purposes only. Actual data on tires are specific to each vehicle and may vary from data shown in above illustration.

For more information, see "Rims and tires" (▷ page 536).

Tire size designation, load and speed rating

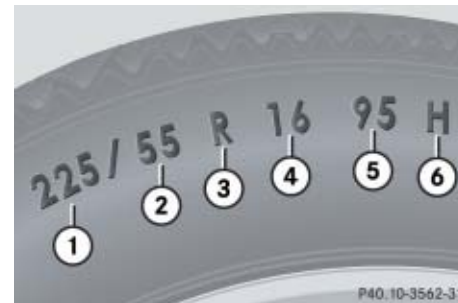

- ① Tire width
- ② Aspect ratio in %
- ③ Radial tire code
- ④ Rim diameter
- ⑤ Tire load rating
- ⑥ Tire speed rating

i For illustration purposes only. Actual data on tires are specific to each vehicle and may vary from data shown in above illustration.

Tires and wheels

General:

Depending on the design standards used, the tire size molded into the sidewall may have no letter or a letter preceding the tire size designation.

No letter preceding the size designation (as illustrated above): Passenger car tire based on European design standards.

Letter “P” preceding the size designation: Passenger car tire based on U.S. design standards.

Letter “LT” preceding the size designation: Light Truck tire based on U.S. design standards.

Letter “T” preceding the size designation: Temporary spare tires which are high pressure compact spares designed for temporary emergency use only.

Tire width

The tire width ① (▷ page 385) indicates the nominal tire width in mm.

Aspect ratio

The aspect ratio ② (▷ page 385) is the dimensional relationship between tire section height and section width and is expressed in percentage. The aspect ratio is arrived at by dividing section height by section width.

Tire code

The tire code ③ (▷ page 385) indicates the tire construction type. The “R” stands for radial tire type. Letter “D” means diagonal or bias ply construction; letter “B” means belted-bias ply construction.

At the tire manufacturer’s option, any tire with a speed capability above 149 mph (240 km/h) can include a “ZR” in the size designation (for example: 245/40 ZR 18). For additional information, see “Tire speed rating” (▷ page 387).

Rim diameter

The rim diameter ④ (▷ page 385) is the diameter of the bead seat, not the diameter of the rim edge. Rim diameter is indicated in inches (in).

Tire load rating

The tire load rating ⑤ (▷ page 385) is a numerical code associated with the maximum load a tire can support.

For example, a load rating of 91 corresponds to a maximum load of 1356 lbs (615 kg) the tire is designed to support. See also “Maximum tire load” (▷ page 391) where the maximum load associated with the load index is indicated in kilograms and lbs.

Warning!



The tire load rating must always be at least half of the GAWR (▷ page 395) of your vehicle. Otherwise, tire failure may be the result which may cause an accident and/or serious personal injury to you or others.

Always replace rims and tires with the same designation, manufacturer and type as shown on the original part.

For additional information on tire load rating, see “Load identification” (▷ page 389).

i *Tire load rating* ⑤ (▷ page 385) and *Tire speed rating* ⑥ (▷ page 385) are also referred to as “service description”.

Tire speed rating

The tire speed rating ⑥ (▷ page 385) indicates the approved maximum speed for the tire.

Warning!



Do not overload the tires by exceeding the specified load limit as indicated on the placard located on the driver’s door B-pillar. Overloading the tires can overheat them, possibly causing a blowout. Overloading the tires can also result in handling or steering problems, or brake failure.

Warning!



Even when permitted by law, never operate a vehicle at speeds greater than the maximum speed rating of the tires.

Exceeding the maximum speed for which tires are rated can lead to sudden tire failure, causing loss of vehicle control and possibly resulting in an accident and/or personal injury and possible death, for you and for others.

i *Tire load rating* ⑤ (▷ page 385) and *Tire speed rating* ⑥ (▷ page 385) are also referred to as “service description”.

Summer tires

Index	Speed rating
Q	up to 100 mph (160 km/h)
R	up to 106 mph (170 km/h)
S	up to 112 mph (180 km/h)
T	up to 118 mph (190 km/h)
H	up to 130 mph (210 km/h)
V	up to 149 mph (240 km/h)
W	up to 168 mph (270 km/h)
Y	up to 186 mph (300 km/h)
(Y)	above 186 mph (300 km/h)
ZR	above 149 mph (240 km/h)

Tires and wheels

- At the tire manufacturer's option, any tire with a speed capability above 149 mph (240 km/h) can include a "ZR" in the size designation (for example: 245/40 ZR18). To determine the maximum speed capability of the tire, the service description for the tire must be referred to. The service description is comprised of the tire load rating ⑤ (▷ page 385) and the tire speed rating ⑥ (▷ page 385).

If your tire includes "ZR" in the size designation and no service description ⑤ and ⑥ (▷ page 385) is given, the tire manufacturer must be consulted for the maximum speed capability.

If a service description ⑤ and ⑥ (▷ page 385) is given, the speed capability is limited by the speed symbol in the service description.

Example: 245/40 ZR18 97Y.

In this example, "97Y" is the service description. The letter "Y" designates



the speed rating and the speed capability of the tire is limited to 186 mph (300 km/h).

- Any tire with a speed capability above 186 mph (300 km/h) must include a "ZR" in the size designation AND the service description must be placed in parenthesis. Example: 275/40 ZR 18 (99Y). The "(Y)" speed rating in parenthesis designates the maximum speed capability of the tire as being above 186 mph (300 km/h). Consult the tire manufacturer for the actual maximum permissible speed of the tire.

All-season and winter tires

Index	Speed rating
Q M+S ¹	up to 100 mph (160 km/h)
T M+S ¹	up to 118 mph (190 km/h)
H M+S ¹	up to 130 mph (210 km/h)
V M+S ¹	up to 149 mph (240 km/h)

¹ or M+S  for winter tires

 *Not all M+S rated tires provide special winter performance. Make sure the tires you use show M+S and the mountain/snowflake  marking on the tire sidewall. These tires meet specific snow traction performance requirements of the Rubber Manufacturers Association (RMA) and the Rubber Association of Canada (RAC) and have been designed specifically for use in snow conditions.*

Load identification



① Load identification

i For illustration purposes only. Actual data on tires are specific to each vehicle and may vary from data shown in above illustration.

In addition to tire load rating, special load information may be molded into the tire sidewall following the letter designating the tire speed rating ① (▷ page 385).

No specification given: absence of any text (like in above example) indicates a standard load (SL) tire.

XL or Extra Load: designates an extra load (or reinforced) tire.

Light Load: designates a light load tire.

C, D, E: designates load range associated with the maximum load a tire can carry at a specified pressure.

DOT, Tire Identification Number (TIN)

U.S. tire regulations require each new tire manufacturer or tire retreader to mold a TIN into or onto a sidewall of each tire produced.

The TIN is a unique identifier which facilitates efforts by tire manufacturers to notify purchasers in recall situations or other safety matters concerning tires and gives purchasers the means to easily identify such tires.

The TIN is comprised of “Manufacturer’s identification mark”, “Tire size”, “Tire type code” and “Date of manufacture”.

Tires and wheels

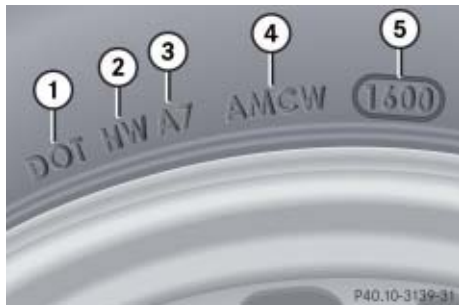

- ① DOT
- ② Manufacturer's identification mark
- ③ Tire size
- ④ Tire type code (at the option of the tire manufacturer)
- ⑤ Date of manufacture

i For illustration purposes only. Actual data on tires are specific to each vehicle and may vary from data shown in above illustration.

DOT (Department of Transportation)

A tire branding symbol ① (▷ page 390) which denotes the tire meets requirements of the U.S. Department of Transportation.

Manufacturer's identification mark

The manufacturer's identification mark ② (▷ page 390) denotes the tire manufacturer.

New tires have a mark with two symbols.

Retreaded tires have a mark with four symbols. For more information on retreaded tires, see (▷ page 365).

Tire size

The code ③ (▷ page 390) indicates the tire size.

Tire type code

The code ④ (▷ page 390) may, at the option of the manufacturer, be used as a descriptive code for identifying significant characteristics of the tire.

Date of manufacture

The date of manufacture ⑤ (▷ page 390) identifies the week and year of manufacture.

The first two figures identify the week, starting with "01" to represent the first full week of the calendar year. The second two figures represent the year.

For example, "3202" represents the 32nd week of 2002.

Maximum tire load



① Maximum tire load rating

i For illustration purposes only. Actual data on tires are specific to each vehicle and may vary from data shown in above illustration.

The maximum tire load is the maximum weight the tires are designed to support.

Warning!



Do not overload the tires by exceeding the specified load limit as indicated on the placard located on the driver's door B-pillar. Overloading the tires can overheat them, possibly causing a blowout. Overloading the tires can also result in handling or steering problems, or brake failure.

For more information on tire load rating (▷ page 386).

For information on calculating total and cargo load capacities (▷ page 370).

Maximum tire inflation pressure



① Maximum permissible tire inflation pressure

i For illustration purposes only. Actual data on tires are specific to each vehicle and may vary from data shown in above illustration.

This is the maximum permissible tire inflation pressure for the tire.

Tires and wheels

Always follow the recommended tire inflation pressure (▷ page 374) for proper tire inflation.

Warning!



Never exceed the max. tire inflation pressure. Follow recommended tire inflation pressures.

Do not underinflate tires. Underinflated tires wear excessively and/or unevenly, adversely affect handling and fuel economy, and are more likely to fail from being overheated.

Do not overinflate tires. Overinflated tires can adversely affect handling and ride comfort, wear unevenly, increase stopping distance, and result in sudden deflation (blowout) because they are more likely to become punctured or damaged by road debris, potholes etc.

Uniform Tire Quality Grading Standards (U.S. vehicles)

Tire manufacturers are required to grade tires based on three performance factors: treadwear, traction and temperature resistance.

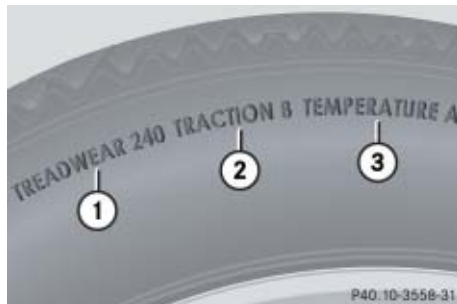

- ① Treadwear
- ② Traction
- ③ Temperature resistance

i For illustration purposes only. Actual data on tires are specific to each vehicle and may vary from data shown in above illustration.

Quality grades can be found, where applicable, on the tire sidewall between tread shoulder and maximum section width. For example:

Treadwear	Traction	Temperature
200	AA	A

All passenger car tires must conform to federal safety requirements in addition to these grades.

Treadwear

The treadwear grade is a comparative rating based on the wear rate of the tire when tested under controlled conditions on a specified government test course. For example, a tire graded 150 would wear one and one-half ($1\frac{1}{2}$) times as well on the government course as a tire graded 100. The relative performance of tires depends upon the actual conditions of their use, however, and may depart significantly from the norm due to variations in driving habits, service practices and differences in road characteristics and climate.

Traction

The traction grades, from highest to lowest, are AA, A, B, and C. Those grades represent the tire's ability to stop on wet pavement as measured under controlled conditions on specified government test surfaces of asphalt and concrete. A tire marked C may have poor traction performance.

Warning!



The traction grade assigned to this tire is based on straight-ahead braking traction tests, and does not include acceleration, cornering, hydroplaning, or peak traction characteristics.

Temperature

The temperature grades are A (the highest), B, and C, representing the tire's resistance to the generation of heat and its ability to dissipate heat when tested under controlled conditions on a specified indoor laboratory test wheel. Sustained high temperature can cause the material of the tire to degenerate and reduce tire life, and excessive temperature can lead to sudden tire failure. The grade C corresponds to a level of performance which all passenger car tires must meet under the Federal Motor Vehicle Safety Standard No. 109. Grades B and A represent higher levels of performance on the laboratory test wheel than the minimum required by law.

Tires and wheels

Warning!



The temperature grade for this tire is established for a tire that is properly inflated and not overloaded. Excessive speed, underinflation, or excessive loading, either separately or in combination, can cause excessive heat build-up and possible tire failure.

Tire ply material

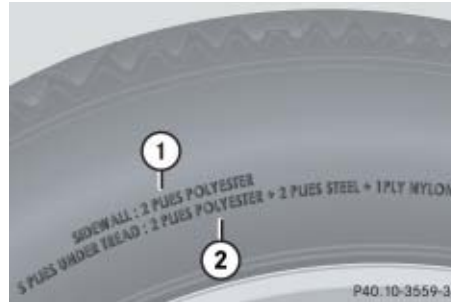

- ① Pliers in sidewall
- ② Pliers under tread

i For illustration purposes only. Actual data on tires are specific to each vehicle and may vary from data shown in above illustration.

This marking tells you about the type of cord and number of plies in the sidewall and under the tread.

Tire and loading terminology

Accessory weight

The combined weight (in excess of those standard items which may be replaced) of automatic transmission, power steering, power brakes, power windows, power seats, radio, and heater, to the extent that these items are available as factory-installed equipment (whether installed or not).

Air pressure

The amount of air inside the tire pressing outward on each square inch of the tire. Air pressure is expressed in pounds per square inch (psi), or kilopascal (kPa) or bars.

Aspect ratio

Dimensional relationship between tire section height and section width expressed in percentage.

Bar

Another metric unit for air pressure. There are 14.5038 pounds per square inch (psi) to 1 bar; there are 100 kilopascals (kPa) to 1 bar.

Bead

The tire bead contains steel wires wrapped by steel cords that hold the tire onto the rim.

Cold tire inflation pressure

Tire inflation pressure when your vehicle has been sitting for at least 3 hours or driven no more than 1 mile (1.6 km).

Curb weight

The weight of a motor vehicle with standard equipment including the maximum capacity of fuel, oil, and coolant, and, if so equipped, air conditioning and additional optional equipment, but without passengers and cargo.

DOT (Department of Transportation)

A tire branding symbol which denotes the tire meets requirements of the U.S. Department of Transportation.

GAWR (Gross Axle Weight Rating)

The GAWR is the maximum permissible axle weight. The gross vehicle weight on each axle must never exceed the GAWR for the front and rear axle indicated on the certification label located on the driver's door B-pillar.

GTW (Gross Trailer Weight)

The GTW is the weight of the trailer plus the weight of all cargo, equipment, luggage etc. loaded on the trailer.

GVW (Gross Vehicle Weight)

The GVW comprises the weight of the vehicle including fuel, tools, spare wheel, installed accessories, passengers and cargo and, if applicable, trailer tongue load. The GVW must never exceed the GVWR indicated on the certification label located on the driver's door B-pillar.

GVWR (Gross Vehicle Weight Rating)

This is the maximum permissible vehicle weight of the fully loaded vehicle (weight of the vehicle including all options, passengers, fuel, and cargo and, if applicable, trailer tongue load). It is indicated on certification label located on the driver's door B-pillar.

Kilopascal (kPa)

The metric unit for air pressure. There are 6.9 kPa to 1 psi; another metric unit for air pressure is bars. There are 100 kilopascals (kPa) to 1 bar.

Tires and wheels

Maximum load rating

The maximum load in kilograms and pounds that can be carried by the tire.

Maximum loaded vehicle weight

The sum of curb weight, accessory weight, total load limit, and production options weight.

Maximum tire inflation pressure

This number is the greatest amount of air pressure that should ever be put in the tire under normal driving conditions.

Normal occupant weight

The number of occupants the vehicle is designed to seat, multiplied by 68 kilograms (150 lbs).

Occupant distribution

The distribution of occupants in a vehicle at their designated seating positions.

Production options weight

The combined weight of those installed regular production options weighing over 5 lbs (2.3 kilograms) in excess of those standard items which they replace, not previously considered in curb weight or accessory weight, including heavy duty brakes, ride levelers, roof rack, heavy duty battery, and special trim.

PSI (Pounds per square inch)

A standard unit of measure for air pressure -> bar, kilopascal (kPa).

Recommended tire inflation pressure

Recommended tire inflation pressure listed on placard located on driver's door B-pillar for normal driving conditions. Provides best handling, tread life and riding comfort.

Rim

A metal support for a tire or a tire and tube assembly upon which the tire beads are seated.

Sidewall

The portion of a tire between the tread and the bead.

TIN (Tire Identification Number)

Unique identifier which facilitates efforts by tire manufacturers to notify purchasers in recall situations or other safety matters concerning tires and gives purchases the means to easily identify such tires. The TIN is comprised of "Manufacturer's identification mark", "Tire size", "Tire type code" and "Date of manufacture".

Tire load rating

Numerical code associated with the maximum load a tire can support.

Tire ply composition and material used

This indicates the number of plies or the number of layers of rubber-coated fabric in the tire tread and sidewall. Tire manufacturers also must indicate the ply materials in the tire and sidewall, which include steel, nylon, polyester, and others.

Tire speed rating

Part of tire designation; indicates the speed range for which a tire is approved.

Traction

Force exerted by the vehicle on the road via the tires. The amount of grip provided.

Tread

The portion of a tire that comes into contact with the road.

Treadwear indicators

Narrow bands, sometimes called “wear bars” that show across the tread of a tire when only $1/16$ in (1.6 mm) of tread remains.

TWR (Tongue Weight Rating)

Maximum permissible weight on trailer tongue.

Uniform Tire Quality Grading Standards

A tire information system that provides consumers with ratings for a tire’s traction, temperature and treadwear. Ratings are determined by tire manufacturers using government testing procedures. The ratings are molded into the sidewall of the tire.

Vehicle maximum load on the tire

Load on an individual tire that is determined by distributing to each axle its share of the maximum loaded vehicle weight and dividing it by two.

Rotating tires

Warning!



Rotate front and rear wheels only if they are of the same dimension.

If your vehicle is equipped with mixed-size tires (different tire dimensions front vs. rear), tire rotation is not possible.

Tire rotation can be performed on vehicles with tires of the same dimension all around. If your vehicle is equipped with tires of the same dimension all around, tires can be rotated, observing a front-to-rear rotation pattern that will maintain the intended rotation (spinning) direction of the tire (▷ page 368).

Tires and wheels

In some cases, such as when your vehicle is equipped with mixed-size tires (different tire dimension front vs. rear), tire rotation is not possible.

If applicable to your vehicle's tire configuration, tires can be rotated according to the tire manufacturer's recommended intervals in the tire manufacturer's warranty pamphlet located in your vehicle literature portfolio. If none is available, tires should be rotated every 3000 to 6000 miles (5000 to 10000 km), or sooner if necessary, according to the degree of tire wear. The same rotation (spinning) direction must be maintained (▷ page 368).

Rotate tires before the characteristic tire wear pattern becomes visible (shoulder wear on front tires and tread center wear on rear tires).

Thoroughly clean the mounting face of wheels and brake disks, i.e. the inner side of the wheels/tires, during each rotation. Check for and ensure proper tire inflation pressure.

Warning!



Have the tightening torque checked after changing a wheel. Wheels could become loose if not tightened with a torque of 110 lb-ft (150 Nm).

Only use genuine Mercedes-Benz wheel bolts specified for your vehicle's rims.

For information on wheel change, see the "Practical hints" section (▷ page 469) and (▷ page 497).

▼ Winter driving

Before the onset of winter, have your vehicle winterized at an authorized Mercedes-Benz Light Truck Center. This service includes:

- Check of anticorrosion and antifreeze concentration.
- Addition of cleaning concentrate to the water of the windshield and headlamp cleaning system. Add MB Concentrate “MB SummerFit” to a premixed windshield washer solvent/antifreeze which is formulated for temperatures below freezing point (▷ page 551).
- Battery test. Battery capacity drops with decreasing ambient temperature. A well charged battery helps to make sure that the engine can be started even at low ambient temperatures.
- Tire change. Mercedes-Benz recommends M+S rated radial-ply tires with a minimum tread depth of approximately $\frac{1}{8}$ in (4 mm) on all four wheels for the winter season.

Winter tires

Always use winter tires at temperatures below 45°F (7°C) and whenever wintry road conditions prevail. Not all M+S rated tires provide special winter performance. Make sure the tires you use show the mountain/snowflake  marking on the tire sidewall. These tires meet specific snow traction performance requirements of the Rubber Manufacturers Association (RMA) and The Rubber Association of Canada (RAC) and have been designed specifically for use in snow conditions. Use of winter tires is the only way to achieve the maximum effectiveness of the ABS, ESP®, 4-ETS, and EBP in winter operation.

For safe handling, make sure all mounted winter tires are of the same make and have the same tread design.

Warning!



Winter tires with a tread depth under $\frac{1}{8}$ in (4 mm) must be replaced. They are no longer suitable for winter operation.

Always observe the speed rating of the winter tires installed on your vehicle. If the maximum speed for which your tires are rated is below the speed rating of your vehicle, you must place a notice to this effect where it will be seen by the driver. Such notices are available from your tire dealer or from any authorized Mercedes-Benz Light Truck Center.

Winter driving

Warning!



If you use your spare tire when winter tires are fitted on the other wheels, be aware that the difference in tire characteristics may very well impair turning stability and that overall driving stability may be reduced. Adapt your driving style accordingly.

Have the spare tire replaced with a winter tire at the nearest authorized Mercedes-Benz Light Truck Center.

Block heater (Canada only)

The engine is equipped with a block heater.

The electrical cable may be installed at an authorized Mercedes-Benz Light Truck Center.

Snow chains

! *Even on vehicles with all-wheel-drive use snow chains on rear tires only.*

Some tire sizes do not leave adequate clearance for snow chains. To help avoid serious damage to your vehicle or tires, use of snow chains is not permissible with the spare wheel.

! *Vehicles with air suspension package*:
When driving with snow chains, do not select **SPORT** mode (▷ page 269).*

i *When driving with snow chains, you may wish to deactivate the ESP® (▷ page 99) before setting the vehicle in motion. This will improve the vehicle's traction.*

Snow chains should only be driven on snow-covered roads at speeds not to exceed 30 mph (50 km/h). Remove chains as soon as possible when driving on roads without snow.

Please observe the following guidelines when using snow chains:

- Use of snow chains is not permissible with all wheel/tire combinations (▷ page 536).
- Snow chains should only be used on the rear wheels. Follow the manufacturer's mounting instructions.
- Only use snow chains that are approved by Mercedes-Benz. Your authorized Mercedes-Benz Light Truck Center will be glad to advise you on this subject.
- Use of snow chains may be prohibited depending on location. Always check local and state laws before installing snow chains.
- Do not use snow chains on the spare wheel (▷ page 538).

▼ Maintenance

We strongly recommend that you have your vehicle serviced by an authorized Mercedes-Benz Light Truck Center, in accordance with the Maintenance Booklet at the times called for by the maintenance service indicator display.

Failure to have the vehicle maintained in accordance with the Maintenance Booklet and maintenance service indicator at the designated times/mileage will result in vehicle damage not covered by the Mercedes-Benz Limited Warranty.

Maintenance service indicator message

The maintenance service indicator message will notify you when your next maintenance service is due.

Starting approximately 1 month before your next maintenance service is due, one of the following messages will appear in the multifunction display while you are driving or when you switch on the ignition (example service A):

Service A in XXXXX miles (km)
 Service A in XXX days
 Service A in X day
 Service A due now

The maintenance services will be indicated by showing a service type A through type H in the multifunction display. Types A through H are classified based on estimated time needed to perform the maintenance service, ranging:

from Service A
 (approx. 1 hour)
 to Service H
 (approx. 8 hours)

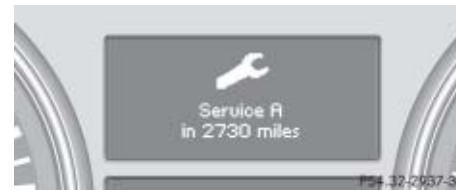

Refer to Maintenance Booklet for a listing of maintenance services and intervals they need to be performed at.

i *Vehicles equipped with Vehicle Maintenance System only (U.S. vehicles): The Vehicle Maintenance System in your vehicle tracks distance driven and the time elapsed since your last maintenance service and calculates other maintenance service work required.*

Maintenance

i Vehicles equipped with FSS PLUS (Flexible Service System PLUS) only (Canada vehicles):

- FSS PLUS evaluates engine temperature, oil level, vehicle speed, engine speed, distance driven and the time elapsed since your last service and calculates other maintenance service work required.
- The interval between maintenance services depends on your driving habits. A gentle driving style, moderate engine speeds and the avoidance of short-distance trips will lengthen the interval between services.

Clearing the maintenance service indicator message

The maintenance service indicator message is automatically cleared

- after approximately 10 seconds when you switch on the ignition or when reaching the maintenance service threshold while driving
- after approximately 30 seconds, once the suggested maintenance service term has passed

You can also clear it yourself:



① Reset button

- ▶ Press reset button ① on the instrument cluster.

The maintenance service indicator message is cleared and the standard display appears in the multifunction display (▷ page 154).

Maintenance service term exceeded

If you have exceeded the suggested maintenance service term, you will see the following message in the multifunction display:





Service A exceeded by XXXXX miles (km)
Service A exceeded by XXX days
Service A exceeded by X day

In addition, a signal sounds when the message appears.

Any authorized Mercedes-Benz Light Truck Center will reset the maintenance service indicator following a completed maintenance service.

Calling up the maintenance service indicator display

You can call up the maintenance service indicator display at any time to check when the next maintenance service is due.

- ▶ Switch on the ignition (▷ page 40).
- ▶ Press button  or  on the multifunction steering wheel repeatedly until the standard display appears in the multifunction display (▷ page 154).
- ▶ Press button  or  until the maintenance service indicator display with the service symbol  and the service deadline appears in the multifunction display.

i *If the battery is disconnected, the days of disconnection will not be included in the count shown by the maintenance service indicator.*

To arrive at the true maintenance service deadline, you will need to subtract these days from the days shown in the maintenance service indicator message or maintenance service indicator display.

Do not confuse the maintenance service indicator with the engine oil level indicator .

Resetting the maintenance service indicator

In the event that the maintenance service on your vehicle is not carried out by an authorized Mercedes-Benz Light Truck Center, you can have the maintenance service indicator reset. The automotive maintenance facility carrying out the maintenance service will find the information for resetting the maintenance service indicator in the maintenance-relevant information for your vehicle. Such information is available from either your authorized Mercedes-Benz Light Truck Center or directly from Mercedes-Benz.

i *If the maintenance service indicator was inadvertently reset, have an authorized Mercedes-Benz Light Truck Center correct it.*

Only reset if the proper maintenance service has been performed. Resetting the system without performing the proper service as called for by the maintenance service indicator will result in engine damage and/or other vehicle damage not covered by the Mercedes-Benz Limited Warranty.

Cleaning and care of the vehicle

Regular and proper care will help to maintain the value of your vehicle. The best way to protect your vehicle from harmful environmental influences is to wash it and use protective treatments regularly.

Warning!



Many cleaning products can be hazardous. Some are poisonous, others are flammable. Always follow the instructions on the particular container. Always open your vehicle's doors or windows when cleaning the inside.

Never use fluids or solvents that are not designed for cleaning your vehicle.

Always lock away cleaning products and keep them out of reach of children.

While in operation, even while parked, your vehicle is subjected to varying external influences which, if gone unchecked, can attack the paintwork as well as the underbody and cause lasting damage.

Such damage is caused not only by extreme and varying climatic conditions, but also by:

- Air pollution
- Road salt
- Tar
- Gravel and stone chipping

To avoid paint damage, you should immediately remove:

- Grease and oil
- Fuel
- Coolant
- Brake fluid
- Bird droppings
- Insects
- Tree resins, etc.

Frequent washing reduces and/or eliminates the aggressiveness and potency of the above adverse influences.

More frequent washings are necessary to deal with unfavorable conditions:

- near the ocean
- in industrial areas (smoke, exhaust emissions)
- during winter operation

You should check your vehicle from time to time for stone chipping or other damage. Any damage should be repaired as soon as possible to prevent corrosion.

In doing so, do not neglect the underbody of the vehicle. A prerequisite for a thorough check is a washing of the underbody followed by a thorough inspection. Damaged areas need to be re-undercoated.

Your vehicle has been treated at the factory with a wax-base rustproofing in the body cavities which will last for the lifetime of the vehicle. Post-production treatment is neither necessary nor recommended by Mercedes-Benz because of the possibility of incompatibility between materials used in the production process and others applied later.

We have selected car-care products and compiled recommendations which are specially matched to our vehicles and which always reflect the latest technology. You can obtain Mercedes-Benz approved car-care products at an authorized Mercedes-Benz Light Truck Center.

Scratches, corrosive deposits, corrosion or damage due to negligent or incorrect care cannot always be removed or repaired with the car-care products recommended here. In such cases it is best to seek aid at an authorized Mercedes-Benz Light Truck Center.

The following topics deal with the cleaning and care of your vehicle and give important “how-to” information as well as references to Mercedes-Benz approved car-care products.

Power washer

! Follow the instructions provided by the power washer manufacturer on maintaining a distance between the vehicle and the nozzle of the power washer.

Never use a round nozzle to power-wash tires. The intense jet of water can result in damage to the tire.

Always replace a damaged tire.

Always keep the jet of water moving across the surface. Do not aim directly at electrical parts, electrical connectors, seals, or other rubber parts.

i Vehicles with KEYLESS-GO*: *If a door handle is hit by a strong jet of water, and a SmartKey with KEYLESS-GO* is in close proximity, i.e. within approximately 3 ft (approximately 1 m), the vehicle could be inadvertently locked or unlocked.*

Tar stains

Quickly remove tar stains before they dry and become more difficult to remove. A tar remover is recommended.

Paintwork, painted body components

! Affixing stickers, magnets, adhesive tape or similar materials to painted body components may damage the paintwork.

Mercedes-Benz approved Paint Care should be applied when water drops on the paint surface do not “bead up”. This should normally be done every 3 to 5 months, depending on the climate and washing detergent used.

Mercedes-Benz approved Paint Cleaner should be applied if the paint surface shows signs of dirt embedding (i.e. loss of gloss).

Vehicle care

Do not apply any of these products or wax if your vehicle is parked in the sun or if the hood is still hot.

- ▶ Use the appropriate MB-Touch-Up Stick for quick and provisional repairs of minor paint damage (i.e. chips from stones, vehicle doors, etc.).

Engine cleaning

Prior to cleaning the engine compartment make sure to protect electrical components and connectors from the intrusion of water and cleaning agents.

Corrosion protection, such as MB Anticorrosion Wax, should be applied to the engine compartment after every engine cleaning. Before applying, all control linkage bushings and joints should be lubricated. The poly-V-belt and all pulleys should be protected from any wax.

Vehicle washing

In the winter, thoroughly remove all traces of road salt as soon as possible.

When washing the vehicle underbody, do not forget to clean the inner sides of the wheels.

i *Vehicles with KEYLESS-GO*:*
If a door handle is hit by a strong jet of water, and a SmartKey with KEYLESS-GO is in close proximity, i.e. within approximately 3 ft (approximately 1 m), the vehicle could be inadvertently locked or unlocked.*

Hand-wash

Do not use hot water or wash your vehicle in direct sunlight.

- ▶ Only use a mild car wash detergent, such as Mercedes-Benz approved Car Shampoo.

- ▶ Thoroughly spray the vehicle with a diffused jet of water.

Direct only a very weak spray towards the ventilation intake.

- ▶ Use plenty of water and rinse the sponge and chamois frequently.
- ▶ Rinse with clean water and thoroughly dry with a chamois.

Do not allow cleaning agents to dry on the finish.

- !** *Do not use scouring agents on these parts. Never apply strong force and only use a soft, non-scratching cloth when cleaning the vehicle. Do not attempt to wipe the surface with a dry cloth or sponge. Otherwise you may scratch or damage the paint.*

Automatic car wash

You can have your car washed in an automatic car wash from the start. Automatic car washes without brushes are preferable.

- ▶ To protect the filter system, switch the climate control (▷ page 208) or the automatic climate control (▷ page 222) to air recirculation mode.

! Do not clean your vehicle in an automatic touchless car wash which use caustic spray. Otherwise the caustic spray will damage the paint or ornamental moldings.

If the vehicle is very dirty, prewash it before running it through the automatic car wash.

! If you want the gear position to remain in **N** (for example when the vehicle is pulled through a car wash)

- do not remove the SmartKey from the starter switch
- or, when using KEYLESS-GO*
- do not turn off the engine using the KEYLESS-GO start/stop button* and open the driver's door.

Otherwise, the transmission will shift to **P** and lock the wheels, preventing the vehicle from being pulled through a car wash.

! Make sure that the windshield wiper switch is set to **0** (▷ page 61). Otherwise, e.g. the rain sensor could activate and cause the wipers to move unintentionally. This may lead to vehicle damage.

Due to the width of the vehicle, fold in exterior rear view mirrors prior to running the vehicle through an automatic car wash to prevent damage to the mirrors.

i After running the vehicle through an automatic car wash, wipe any wax off of the windshield (▷ page 410). This will prevent smears and reduce wiping noise which can be caused by residual wax on the windshield.

When leaving the car wash, make sure that the mirrors are folded out. Otherwise they may vibrate.

Ornamental moldings

For regular cleaning and care of ornamental moldings, use a damp cloth.

! Do not use chrome cleaner on ornamental moldings. Although ornamental moldings may have chrome appearance, they could be made of anodized aluminum that will be damaged when cleaned with chrome cleaner. Instead, use a damp cloth to clean those ornamental moldings.

For very dirty ornamental moldings of which you are sure are chrome-plated, use a chrome cleaner. If in doubt whether an ornamental molding is chrome-plated, contact an authorized Mercedes-Benz Light Truck Center.

Vehicle care

Headlamps, brake lamps, tail lamps, side markers, turn signal lenses

- ▶ Use a mild car wash detergent, such as Mercedes-Benz approved Car Shampoo, with plenty of water.

! Only use window cleaning solutions that are suitable for plastic lamp lenses. Window cleaning solutions which are not suitable may damage the plastic lamp lenses of the headlamps. Therefore, do not use abrasives, solvents or cleaners that contain solvents.

Never apply strong force and only use a soft, non-scratching cloth when cleaning the lenses. Do not attempt to wipe dirty lenses with a dry cloth or sponge.

Otherwise you may scratch or damage the lens surface.

Cleaning the DISTRONIC* system sensor cover



① DISTRONIC* system sensor cover

- ▶ Switch off the ignition (▷ page 40).
- ▶ Use a mild car wash detergent, such as Mercedes-Benz approved Car Shampoo, with plenty of water and a non-scratching cloth to clean sensor cover ①.

! To prevent scratches or damage, never apply strong force and only use a soft, non-scratching cloth when cleaning the sensor cover ①. Do not attempt to wipe dirty sensors with a dry cloth or sponge.

- ▶ Restart the engine after cleaning sensor cover ①.

Cleaning the Parktronic* system sensors

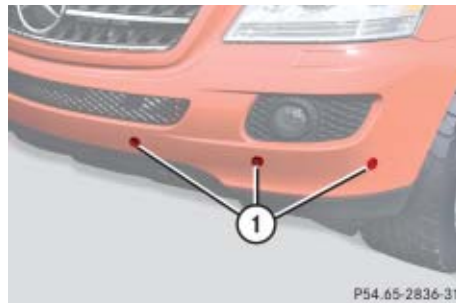

① Parktronic* system sensors in front bumper

- ▶ Use a mild car wash detergent, such as Mercedes-Benz approved Car Shampoo, with plenty of water and a soft, non-scratching cloth to clean sensors ① on the bumpers.

! Do not apply strong pressure to the sensor covers. Applying strong pressure may damage the sensor covers.

Follow the instructions provided by the power washer manufacturer on maintaining a distance between the vehicle and the nozzle of the power washer.

! To prevent scratches, never apply strong force and only use a soft, non-scratching cloth when cleaning the sensors. Do not attempt to wipe dirty sensors with a dry cloth or sponge.

Cleaning the Rear View Camera lens*



① Camera lens

- ▶ Only use clean water and a soft, non-scratching cloth to clean the camera lens ①.

Be careful not to apply wax to camera lens ① when waxing the vehicle. If necessary, remove the wax using the Mercedes-Benz approved Car Shampoo with plenty of water.

! Do not clean the camera and the area around the camera:

- with a high-pressure cleaner
- with a dry cloth and high pressure
- with aggressive cleaning agents

You could otherwise damage the camera.

Vehicle care

Cleaning the windows and the wiper blades

Warning!



For safety reasons, switch off wipers and remove SmartKey from starter switch (vehicles with KEYLESS-GO*: Make sure the vehicle's on-board electronics have status **0**) before cleaning the windshield and/or the wiper blades. Otherwise, the wiper motor could suddenly turn on and cause injury.

- ▶ Fold the wiper arms forward until they engage.

! Do not pull on the wiper blade inserts. They could tear.

- ▶ Clean the wiper blade inserts with a clean cloth and detergent solution.

- ▶ Use a soft, clean cloth and a mild window cleaning solution on all outside and inside glass surfaces.

An automotive glass cleaner is recommended.

! Fold the windshield wiper arms back onto the windshield before turning the SmartKey in the starter switch or pressing the KEYLESS-GO start/stop button (vehicles with KEYLESS-GO*).

Hold on to the wiper when folding the wiper arm back. If released, the force of the impact from the tensioning spring could crack the windshield.

! To clean the window interior, do not use a dry cloth, abrasives, solvents or cleaners containing solvents. Do not touch the inside of the front, rear or side windows and the power tilt/sliding sunroof* or rear panorama roof with hard objects such as an ice scraper or ring. Doing so may damage the windows.

Light alloy wheels

If possible, clean wheels once a week.

- ▶ Use Mercedes-Benz approved Wheel Care, a soft bristle brush and a strong spray of water for cleaning the light alloy wheels.

! Only use acid-free cleaning materials. Acid may cause corrosion or damage the clear coat.

! The vehicle should not be parked for an extended period of time immediately after it has been cleaned, especially not after the wheel rims have been cleaned with wheel rim cleaner. Wheel rim cleaners can lead to increased corrosion of the brake disks and brake pads. Non-approved wheel cleaners may also damage the wheel paint if the car is not driven after cleaning. Therefore, the vehicle's brake system should always be warmed-up before it is parked after cleaning. To do so, please drive your vehicle for several minutes to allow the brakes to dry. When applying Mercedes-Benz approved Tire Care and Mercedes-Benz approved Wheel Care products, take care not to spray them on the brake disks.

Plastic and rubber parts

- ▶ Use a gentle dishwashing detergent or mild detergent for delicate fabrics as a washing solution.
- ▶ Wipe with a cloth moistened in a lukewarm solution.

The surface may temporarily change color. If this is the case, wait for it to dry.

Warning!



Do not use cleaners containing solvents or cockpit care sprays to clean the cockpit or the steering wheel. Cleaners containing solvents will make the surface porous and vehicle occupants could suffer serious injuries from plastic parts coming loose in the event of air bag deployment.

! Do not use oil, wax or scouring agents on these parts.

Never apply strong force and only use a soft, non-scratching cloth when cleaning the surface. Do not attempt to wipe the surface with a dry cloth or sponge.

Otherwise you may scratch or damage the surface.

Hard plastic trim items

- ▶ Use Mercedes-Benz approved Interior Care, a soft, lint-free cloth and apply with light pressure.

! *Never apply strong force and only use a soft, non-scratching cloth when cleaning the surface. Do not attempt to wipe the surface with a dry cloth or sponge.*

Otherwise you may scratch or damage the surface.

Steering wheel

- ▶ Wipe with a damp cloth and dry thoroughly or clean with Mercedes-Benz approved Leather Care.

Carpets

- ▶ Use Mercedes-Benz approved Carpet and Fabric Care for cleaning the carpets.

Headliner

- ▶ Use a soft bristle brush or a dry-shampoo cleaner in case of excessive dirt.

Vehicle care

Seat belts

- ▶ Only use clear, lukewarm water and soap.

! *The seat belts must not be treated with chemical cleaning agents. Do not dry the seat belts at temperatures above 176 °F (80 °C) or in direct sunlight.*

Warning!



Do not bleach or dye seat belts as this may severely weaken them. In a crash they may not be able to provide adequate protection.

Upholstery

Using aftermarket seat covers or wearing clothing that have the tendency to give off coloring (e.g. when wet, etc.) may cause the upholstery to become permanently discolored. By lining the seats with a proper intermediate cover, contact-discoloration will be prevented.

Warning!



Only use seat or head restraint covers which have been tested and approved by Mercedes-Benz for your vehicle model. Using other seat or head restraint covers may interfere with or prevent the activation of the active head restraints. Contact an authorized Mercedes-Benz Light Truck Center for availability.

Leather upholstery*

Please note that leather upholstery is a natural product and is therefore subject to a natural aging process. Leather upholstery may also react to certain ambient influences such as high humidity or high temperature by showing wrinkles for example.

- ▶ Wipe leather upholstery with a damp cloth and dry thoroughly or clean with Mercedes-Benz approved Leather Care.

! *Wipe with light pressure to avoid damage to the upholstery.*

Exercise particular care when cleaning perforated leather as its underside should not become wet.

MB Tex upholstery

- ▶ Use Mercedes-Benz approved Interior Care onto a soft, lint-free cloth and apply with light pressure for cleaning the upholstery.

Wood trims

- ▶ Dampen cloth using water and use damp cloth to clean wood trims in your vehicle.

! *Do not use solvents like tar remover or wheel cleaner nor polishes or waxes as these may be abrasive.*



What to do if ...

Where will I find ...?

Unlocking/locking in an emergency

Opening/closing in an emergency

Resetting activated head restraints

Replacing SmartKey batteries

Replacing bulbs

Replacing wiper blades

Flat tire

**Bleeding the fuel system
(diesel engine only)**

Battery

Jump starting

Towing the vehicle

Fuses

What to do if ...

Lamps in instrument cluster

General information:

If any of the following lamps in the instrument cluster fails to come on during the

bulb self-check when switching on the ignition, have the respective bulb checked and replaced if necessary.

Problem	Possible cause/consequence	Suggested solution
 <p>The yellow ABS indicator lamp comes on while the engine is running.</p>	<p>ABS has detected a malfunction and has switched off. The BAS, ESP®, EBP and 4-ETS are also switched off (see messages in multifunction display).</p> <p>The brake system is still functioning normally but without the ABS available.</p> <p>If the ABS control unit is malfunctioning, other systems such as the navigation system* or the automatic transmission may also be malfunctioning.</p> <p>The charging voltage has fallen below 10 volts. The ABS has switched off.</p> <p>The battery might not be charged sufficiently.</p>	<ul style="list-style-type: none"> ▶ Continue driving with added caution. Wheels may lock during hard braking, reducing steering capability. ▶ Read and observe messages in the multifunction display (▷ page 428). ▶ Have the system checked at an authorized Mercedes-Benz Light Truck Center as soon as possible. <p>Failure to follow these instructions increases the risk of an accident.</p> <p>When the voltage is above this value again, the ABS is operational again and the ABS indicator lamp should go out.</p> <p>If the ABS indicator lamp should go out:</p> <ul style="list-style-type: none"> ▶ Have the generator (alternator) and the battery checked.

Problem			Possible cause/consequence	Suggested solution
BRAKE	(USA only)	The red brake warning lamp comes on while driving and you hear a warning sound.	You are driving with the parking brake set.	▶ Release the parking brake (▷ page 57).
	(Canada only)		There is insufficient brake fluid in the reservoir.	▶ Risk of accident! Carefully stop the vehicle in a safe location or as soon it is safe to do so. ▶ Apply the parking brake (▷ page 65). ▶ Notify an authorized Mercedes-Benz Light Truck Center. Do not add brake fluid! This will not solve the problem.

Warning!







Driving with the brake warning lamp illuminated can result in an accident. Have your brake system checked immediately if the brake warning lamp stays on.

Do not add brake fluid before checking the brake system. Overfilling the brake fluid reservoir can result in spilling brake fluid on hot engine parts and the brake fluid catching fire. You can be seriously burned.

! *If you find that the brake fluid in the brake fluid reservoir has fallen to the minimum mark or below, have the brake system checked for brake pad thickness and leaks.*



What to do if ...

Problem		Possible cause/consequence	Suggested solution
   	<p>(USA only)</p> <p>(Canada only)</p>	<p>The red brake warning lamp comes on while driving. In addition, the yellow ABS malfunction indicator lamp, and the yellow ESP[®] warning lamp come on and a warning will sound.</p>	<p>A malfunction in the Electronic Brake Proportioning (> page 101) was detected.</p> <p>► Have the system checked at an authorized Mercedes-Benz Light Truck Center as soon as possible.</p> <p>Failure to follow these instructions increases the risk of an accident.</p>

Problem	Possible cause/consequence	Suggested solution
<p>CHECK ENGINE</p> <p>(USA only) The yellow engine malfunction indicator lamp comes on while driving.</p> <p> (Canada only)</p>	<p>There is a malfunction in:</p> <ul style="list-style-type: none"> • The fuel management system • The ignition system • The emission control system • Systems which affect emissions <p>Such malfunctions may result in excessive emissions values and may switch the engine to its limp-home (emergency operation) mode (> page 198).</p>	<p>▶ Have the vehicle checked as soon as possible by an authorized Mercedes-Benz Light Truck Center. An on-board diagnostic connector is used by the service station to link the vehicle to the shop diagnostics system. It allows the accurate identification of system malfunctions through the readout of diagnostic trouble codes. It is located in the front left area of the footwell next to the parking brake pedal.</p>

 *Some states may by law require you to visit a workshop immediately as soon as the engine malfunction indicator lamp comes on. Check local requirements.*



What to do if ...

Problem			Possible cause/consequence	Suggested solution
 (USA only)  (Canada only)	The yellow engine malfunction indicator lamp comes on while driving.	A loss of pressure has been detected in the fuel system. The fuel cap may not be closed properly. The fuel system may be leaky.	<ul style="list-style-type: none"> ▶ Check the fuel cap (▷ page 352). If it is not closed properly: <ul style="list-style-type: none"> ▶ Close the fuel cap. If it is closed properly: <ul style="list-style-type: none"> ▶ Have the fuel system checked by an authorized Mercedes-Benz Light Truck Center. 	
		Your fuel tank is empty.	<ul style="list-style-type: none"> ▶ After refueling start, turn off and restart the engine three or four times in succession. The limp-home mode is canceled. You do not need to have your vehicle checked.	



Problem	Possible cause/consequence	Suggested solution
<p> The yellow ABS/ESP® warning lamp comes on while driving.</p>	<p>The ESP® has been switched off. Risk of accident!</p> <p>When the ESP® is switched off it will not stabilize the vehicle if the system recognizes that the vehicle starts to skid or that a wheel is spinning.</p> <p>The ESP® is not operational due to a malfunction. Risk of accident!</p>	<ul style="list-style-type: none"> ▶ Switch the ESP® back on (▷ page 100). Exceptions: (▷ page 99). ▶ If leaving the ESP® switched off, adapt your speed and driving to the prevailing road and weather conditions. <p>If the ESP® cannot be switched on:</p> <ul style="list-style-type: none"> ▶ Have the system checked at an authorized Mercedes-Benz Light Truck Center as soon as possible. <ul style="list-style-type: none"> ▶ Observe additional messages in the multifunction display. ▶ Continue driving with added caution. ▶ Adapt your speed and driving to the prevailing road and weather conditions. ▶ Have the system checked at an authorized Mercedes-Benz Light Truck Center as soon as possible.

What to do if ...

Problem	Possible cause/consequence	Suggested solution
 <p>The yellow ABS/ESP[®] warning lamp flashes while driving.</p>	<p>The ESP[®], ABS, or traction control has come into operation because of detected traction loss in at least one tire.</p> <p>The cruise control and the Distronic* system are deactivated.</p>	<ul style="list-style-type: none"> ▶ When driving off, apply as little throttle as possible. ▶ While driving, ease up on the accelerator. ▶ Adapt your speed and driving to the prevailing road and weather conditions. ▶ Do not deactivate the ESP[®]. Exceptions: (▷ page 99). <p>Failure to follow these instructions increases the risk of an accident.</p>
<p>The yellow fuel tank reserve warning lamp in the fuel gauge comes on while driving.</p>	<p>The fuel level has gone below the reserve mark.</p>	<ul style="list-style-type: none"> ▶ Refuel at the next gas station (▷ page 352).



Problem	Possible cause/consequence	Suggested solution
 <p>The red seat belt telltale comes on for a maximum of 6 seconds after starting the engine.</p>	<p>The seat belt telltale reminds you and your passengers to fasten your seat belts before driving off.</p>	<p>► Fasten your seat belts.</p> <p>Regardless of whether the seat belts are fastened or not, the seat belt telltale always comes on and remains lit for 6 seconds after starting the engine.</p>
 <p>You hear a warning chime for a maximum of 6 seconds after starting the engine.</p>	<p>You have forgotten to fasten your seat belt.</p>	<p>► Fasten your seat belts.</p> <p>The warning chime stops sounding.</p>

What to do if ...

Problem	Possible cause/consequence	Suggested solution
 The red seat belt telltale comes on while the vehicle is standing still and the engine is running or during driving.	You and/or your front passenger have forgotten to fasten your seat belts.	<ul style="list-style-type: none"> ▶ Fasten your seat belts. <p>The seat belt telltale goes out.</p>
	There are items placed on the front passenger seat and therefore the system senses the front passenger seat as being occupied.	<ul style="list-style-type: none"> ▶ Remove the items from the front passenger seat and put them in a safe place. <p>The seat belt telltale goes out.</p>
 During driving the red seat belt telltale flashes and you additionally hear an intermittent warning chime with increasing intensity.	The vehicle's speed once exceeded 15 mph (25 km/h) and you and/or your front passenger have forgotten to fasten your seat belts.	<ul style="list-style-type: none"> ▶ Fasten your seat belts. <p>The seat belt telltale goes out and the warning chime stops sounding.</p>
	There are items placed on the front passenger seat and therefore the system senses the front passenger seat as being occupied.	<ul style="list-style-type: none"> ▶ Remove the items from the front passenger seat and put them in a safe place. <p>The seat belt telltale goes out and the warning chime stops sounding.</p>

 After 60 seconds with an unfastened seat belt the warning chime stops sounding and the seat belt telltale illuminates continuously.

The seat belt telltale will only go out if both, the driver's and front passenger's seat belt are fastened, or the vehicle is standing still and a front door is opened.

Problem	Possible cause/consequence	Suggested solution
 The red distance warning lamp comes on while driving and you hear a warning chime sound.	<ul style="list-style-type: none"> You are gaining too rapidly on the vehicle ahead of you. The distance warning system has recognized a stationary obstacle on your probable line of travel. 	<ul style="list-style-type: none"> ▶ Apply the brakes immediately. ▶ Carefully observe the traffic situation. You may need to brake or maneuver to avoid hitting an obstacle.
 The red SRS indicator lamp comes on while driving.	<p>There is a malfunction in the restraint systems. The air bags or emergency tensioning device (ETDs) could deploy unexpectedly or fail to deploy unexpectedly in an accident.</p>	<ul style="list-style-type: none"> ▶ Drive with added caution to the nearest authorized Mercedes-Benz Light Truck Center.



Warning!



In the event a malfunction of the SRS is indicated as outlined above, the SRS may not be operational. For your safety, we strongly recommend that you visit an authorized Mercedes-Benz Light Truck Center immediately to have the system checked, otherwise

the SRS may not be activated when needed in an accident, which could result in serious or fatal injury, or it might deploy unexpectedly and unnecessarily which could result in an accident and/or injury to you or to others.

What to do if ...

Problem	Possible cause/consequence	Suggested solution
<p> USA only: Combination low tire pressure/TPMS malfunction telltale for the TPMS illuminates continuously.</p> <p>Canada only: Low tire pressure telltale for the Advanced TPMS* illuminates continuously.</p>	<p>The TPMS (USA only) or Advanced TPMS* (Canada only) detects a loss of pressure in at least one tire.</p>	<ul style="list-style-type: none"> ▶ Carefully bring the vehicle to a halt, avoiding abrupt steering and braking maneuvers. Observe the traffic situation around you. ▶ Read and observe messages in the multifunction display. <p>If the tire inflation pressure in the respective tire(s) has (have) been corrected, the combination low tire pressure/TPMS malfunction telltale goes out after few minutes driving.</p>
<p> USA only: Combination low tire pressure/TPMS malfunction telltale for the TPMS flashes 60 seconds and then stays illuminated.</p>	<p>There is a malfunction in the TPMS.</p>	<ul style="list-style-type: none"> ▶ Read and observe messages in the multifunction display. ▶ Have the TPMS checked by an authorized Mercedes-Benz Light Truck Center. <p>After the malfunction has been remedied the combination low tire pressure/TPMS malfunction telltale goes out after few minutes driving.</p>

Warning!

Each tire, including the spare (if provided), should be checked monthly when cold and inflated to the inflation pressure recommended by the vehicle manufacturer on the vehicle placard or the tire inflation pressure label. (If your vehicle has tires of a different size than the size indicated on the vehicle placard or the tire inflation pressure label, you should determine the proper tire inflation pressure for those tires).

As an added safety feature, your vehicle has been equipped with a tire pressure monitoring system (TPMS) that illuminates a low tire pressure telltale when one or more of your tires is significantly underinflated. Accordingly, when the low tire pressure telltale illuminates, you should stop and check your tires as soon as possible, and inflate them to the proper pressure. Driving on a significantly underinflated tire causes the tire to overheat and can lead to tire failure.

Underinflation also reduces fuel efficiency and tire tread life, and may affect the vehicle's handling and stopping ability. Please note that the TPMS is not a substitute for proper tire maintenance, and it is the driver's responsibility to maintain correct tire pressure, even if underinflation has not reached the level to trigger illumination of the TPMS low tire pressure telltale.

USA only:

Your vehicle has also been equipped with a TPMS malfunction indicator to indicate when the system is not operating properly. The TPMS malfunction indicator is combined with the low tire pressure telltale. When the system detects a malfunction, the telltale will flash for approximately 1 minute and then remain continuously illuminated. This sequence will continue upon subsequent vehicle start-ups as long as the malfunction exists. When the malfunction indicator is illuminated, the system may not be able to detect or signal low tire pressure as intended.

TPMS malfunctions may occur for a variety of reasons, including the installation of incompatible replacement or alternate tires or wheels on the vehicle that prevent the TPMS from functioning properly. Always check the TPMS malfunction telltale after replacing one or more tires or wheels on your vehicle to ensure that the replacement or alternate tires and wheels allow the TPMS to continue to function properly.

What to do if ...

Lamp in center console

Problem	Possible cause/consequence	Suggested solution
 PASS AIR BAG OFF The front passenger front air bag off indicator lamp illuminates and remains illuminated with the weight of a typical adult or someone larger than a small individual on the front passenger seat.	The system is malfunctioning.	<ul style="list-style-type: none">▶ Have the system checked as soon as possible by an authorized Mercedes-Benz Light Truck Center.▶ Also read and observe messages in the multifunction display and follow corrective steps (> page 440).

Warning!



If the  **PASS AIR BAG OFF** indicator lamp illuminates and remains illuminated with the weight of a typical adult or someone larger than a small individual on the front passenger seat, do not have any passenger use the front passenger seat until the system has been repaired.

Problem	Possible cause/consequence	Suggested solution
<p> PASS AIR BAG OFF The front passenger front air bag off indicator lamp does not illuminate and/or does not remain illuminated with the weight of a typical 12-month-old child in a standard child restraint or less on the front passenger seat.</p>	<p>The system is malfunctioning.</p>	<ul style="list-style-type: none"> ▶ Make sure there is nothing between seat cushion and child seat and check installation of the child seat. ▶ Make sure no objects applying supplemental weight onto the seat are present. ▶ Make sure no objects which apply forces to the seat are present (e.g. objects such as books, briefcases etc. lodged behind or around the seat, head restraints pushing against roof etc.). The system may recognize such forces as supplemental weight. ▶ If the front passenger front air bag off indicator lamp remains out, have the system checked as soon as possible by an authorized Mercedes-Benz Light Truck Center. Do not transport a child on the front passenger seat until the system has been repaired. ▶ Also note any messages in the multifunction display and follow corrective steps (> page 440).

Warning!



If the  **PASS AIR BAG OFF** indicator lamp does not illuminate or remains out with the

weight of a typical 12-month-old child in a standard child restraint or less on the front passenger seat, do not transport a child on

the front passenger seat until the system has been repaired.

What to do if ...

Vehicle status messages in the multifunction display





Warning and malfunction messages appear in the multifunction display located in the instrument cluster.





Certain warning and malfunction messages are accompanied by an audible signal.

Address these messages accordingly and follow the additional instructions given in this Operator's Manual.

Selecting the vehicle status message memory menu in the control system (▷ page 163) displays both cleared and uncleared messages.

High-priority messages appear in the multifunction display in red color.

Certain messages of high priority cannot be cleared from the multifunction display using the reset button (▷ page 145) or button , , , or  on the multifunction steering wheel.

Other messages of high priority and messages of less immediate priority can be cleared from the multifunction display using the reset button (▷ page 145) or button , , , or  on the multifunction steering wheel. They are then stored in the vehicle status message memory (▷ page 163). Remember that clearing a message will only make the message disappear. Clearing a message will not correct the condition that caused the message to appear.

Warning!



All categories of messages contain important information which should be taken note of and, where a malfunction is indicated, addressed as soon as possible at an authorized Mercedes-Benz Light Truck Center.

Failure to repair condition noted may cause damage not covered by the Mercedes-Benz Limited Warranty, or result in property damage or personal injury.

Warning!

No messages will be displayed if either the instrument cluster or the multifunction display is inoperative.

As a result, you will not be able to see information about your driving conditions, such as speed or outside temperature, warning/indicator lamps, malfunction/warning messages or the failure of any systems. Driving characteristics may be impaired.

If you must continue to drive, please do so with added caution. Visit an authorized Mercedes-Benz Light Truck Center as soon as possible.

i *Switching on the ignition causes all instrument cluster lamps (except high beam headlamp indicator lamp, and turn signal indicator lamps unless activated) as well as the multifunction display to come on. Make sure the lamps and multifunction display are in working order before starting your journey.*

On the pages that follow, you will find a compilation of the most important warning and malfunction messages that may appear in the multifunction display.



For your convenience the messages are divided into two sections:

- Text messages (▷ page 430)
- Symbol messages (▷ page 446)

What to do if ...

Text messages

Display message	Possible cause/consequence	Possible solution
<p>ABS</p> <p>inoperative See Operator's Manual</p>	<p>The ABS has detected a malfunction and has switched off.</p> <p>The ESP® and the BAS are also deactivated.</p> <p>The brake system is still functioning normally but without the ABS available.</p>	<ul style="list-style-type: none"> ▶ Continue driving with added caution. Wheels may lock during hard braking, reducing steering capability. ▶ Have the system checked at an authorized Mercedes-Benz Light Truck Center as soon as possible. <p>Failure to follow these instructions increases the risk of accident.</p>
<p>unavailable See Operator's Manual</p>	<p>The ABS was deactivated because of insufficient power supply. The charging voltage has fallen below 10 volts.</p> <p>The brake system is still functioning normally but without the ABS available.</p>	<p>When the voltage is above this value again, the ABS is operational again and the message in the multifunction display should disappear.</p> <p>If the message in the multifunction display does not disappear:</p> <ul style="list-style-type: none"> ▶ Have the generator (alternator) and the battery checked.

Display message	Possible cause/consequence	Possible solution
ABS unavailable See Operator's Manual	If the yellow ESP® warning lamp  flashes while driving and this message appears, the electronic traction system has switched off to prevent overheating of the drive wheel brakes.	As soon as the brakes have cooled off, the electronic traction system switches on again. The message in the multifunction display disappears and the ESP® warning lamp  goes out.
	The self-diagnosis has not yet been completed yet.	The display will clear after driving a short distance at a vehicle speed of above 12 mph (20 km/h).
Cruise control and SPEEDTRONIC inoperative	The cruise control is malfunctioning.	► Have cruise control checked by an authorized Mercedes-Benz Light Truck Center.
Cruise control --- mph	You have attempted to set a speed while driving below 20 mph (30 km/h).	► Accelerate to a speed exceeding 20 mph (30 km/h) and set the speed (▷ page 245).
	The ESP® is switched off.	► Switch on the ESP® (▷ page 98).
	The automatic transmission is set to position P , R , or N .	► Set the automatic transmission to position D (▷ page 187).
	The vehicle is secured with the parking brake.	► Release the parking brake (▷ page 57).

What to do if ...

Display message	Possible cause/consequence	Possible solution
DISTRONIC --- mph	You have attempted to set a speed while driving below 20 mph (30 km/h).	▶ Accelerate to a speed exceeding 20 mph (30 km/h) and set the speed (▷ page 250).
	The ESP® is switched off.	▶ Switch on the ESP® (▷ page 98).
	The automatic transmission is set to position P , R , or N .	▶ Set the automatic transmission to position D (▷ page 187).
	The vehicle is secured with the parking brake.	▶ Release the parking brake (▷ page 57).
inoperative Override	The DISTRONIC* or the DISTRONIC* display are malfunctioning.	▶ Have the system checked by an authorized Mercedes-Benz Light Truck Center.
	You have accelerated. The DISTRONIC* has switched off.	▶ Stop accelerating.



Display message	Possible cause/consequence	Possible solution
<p>DISTRONIC available again</p>	<p>Distronic* had been deactivated and is available again.</p>	<p>▶ Activate Distronic* (▷ page 256).</p>
<p>currently unavailable See Operator's Manual</p>	<p>Distronic* is deactivated because the functionality is impaired by external interferences, e.g. high-frequency sources such as toll stations, speed measuring systems etc.</p>	<p>▶ Leave the area of the external interference. ▶ Activate the Distronic* again (▷ page 256), when the message DISTRONIC available again appears.</p>
	<p>Distronic* is deactivated because the Distronic* sensor has not sensed any other vehicles or objects, e.g. road sign or such, for a long time.</p>	<p>▶ Try to activate Distronic* again (▷ page 256), when the message DISTRONIC available again appears.</p>



What to do if ...

Display message	Possible cause/consequence	Possible solution
<p>DISTRONIC currently unavailable See Operator's Manual</p>	<p>Distronic* is deactivated because</p> <ul style="list-style-type: none"> • the Distronic* cover in the radiator grille is dirty • the functionality is impaired by heavy precipitation or fog 	<ul style="list-style-type: none"> ▶ Clean the Distronic* cover in the radiator grille (▷ page 408). ▶ Restart the vehicle. <p>Distronic* becomes operational again without the engine being restarted when</p> <ul style="list-style-type: none"> • dirt on the radiator grille has fallen off while driving (e.g. slush or snow) • the system recognizes full sensor availability due to lessening rain or because the road is drying, for example • the message in the multifunction display disappears <p>You can then operate Distronic* as usual again.</p>

Display message	Possible cause/consequence	Possible solution
Depress brake to shift out of Park	You have tried to shift the automatic transmission into position D , R or N using the gear selector lever without depressing the brake pedal.	▶ Depress the brake pedal.
Door Open Vehicle not in Park	You have opened the driver's door and the transmission is still in position D , R or N .	▶ Before you leave the vehicle, make sure that the automatic transmission is set to position P and that the parking brake is engaged.
Drive to workshop without shifting gears	The automatic transmission cannot be shifted out of the set position because of a malfunction.	<p>If the automatic transmission is set to position D:</p> <p>▶ Without changing the automatic transmission from position D, drive to an authorized Mercedes-Benz Light Truck Center.</p> <p>If the automatic transmission is set to position N, R or P:</p> <p>▶ Do not drive.</p> <p>▶ Contact an authorized Mercedes-Benz Light Truck Center.</p>

What to do if ...

Display message	Possible cause/consequence	Possible solution
ESP inoperative See Operator's Manual	In addition, the yellow ESP [®] warning lamp  comes on. The ESP [®] has detected a malfunction and switched off. The ABS may still be operational.	<ul style="list-style-type: none"> ▶ Continue driving with added caution. ▶ Have the system checked at an authorized Mercedes-Benz Light Truck Center as soon as possible. <p>Failure to follow these instructions increases the risk of an accident.</p>
	In addition, the yellow ESP [®] warning lamp  comes on. The ESP [®] or the ESP [®] display is malfunctioning.	<ul style="list-style-type: none"> ▶ Continue driving with added caution. ▶ Have the system checked at an authorized Mercedes-Benz Light Truck Center as soon as possible. <p>Failure to follow these instructions increases the risk of an accident.</p>
	In addition, the yellow ESP [®] warning lamp  comes on. The ESP [®] is deactivated because of a malfunction or interrupted power supply.	<ul style="list-style-type: none"> ▶ Continue driving with added caution. ▶ Visit an authorized Mercedes-Benz Light Truck Center as soon as possible. <p>Failure to follow these instructions increases the risk of accident.</p>

Display message	Possible cause/consequence	Possible solution
<p>ESP unavailable See Operator's Manual</p>	<p>The ESP® was deactivated because of insufficient power supply. The charging voltage has fallen below 10 volts.</p> <p>The brake system is still functioning normally but without the ABS available.</p> <p>If the yellow ESP® warning lamp  flashes while driving and this message appears, the electronic traction system has switched off to prevent overheating of the drive wheel brakes.</p> <p>The self-diagnosis has not been completed yet.</p>	<p>When the voltage is above this value again, the ABS is operational again and the message in the multifunction display should disappear.</p> <p>If the message in the multifunction display does not disappear:</p> <ul style="list-style-type: none"> ▶ Have the generator (alternator) and the battery checked. <p>As soon as the brakes have cooled off, the electronic traction system switches on again.</p> <p>The message in the multifunction display disappears and the ESP® warning lamp  goes out.</p> <p>The display will clear after driving a short distance at a vehicle speed of above 12 mph (20 km/h).</p>

What to do if ...

Display message	Possible cause/consequence	Possible solution
P	Shift to P	<ul style="list-style-type: none"> ▶ Set the automatic transmission to position P. <p>or</p> <ul style="list-style-type: none"> ▶ Close the driver's door.
	Shift to P or N to start engine	<ul style="list-style-type: none"> ▶ Set the automatic transmission to position P or N. <p>Make sure the brake pedal is depressed when attempting to start the engine with the KEYLESS-GO* start/stop button.</p>
	Only shift to Park when vehicle is stationary	<ul style="list-style-type: none"> ▶ Stop the vehicle. ▶ Apply the parking brake (▷ page 65).

Display message	Possible cause/consequence	Possible solution
SRS Restraint sys. malfunction Visit workshop	The system is malfunctioning.	► Drive with added caution to the nearest authorized Mercedes-Benz Light Truck Center.

Warning!





In the event a malfunction of the SRS is indicated as outlined above, the SRS may not be operational.

For your safety, we strongly recommend that you visit an authorized Mercedes-Benz Light Truck Center immediately to have the

system checked; otherwise the SRS may not be activated when needed in an accident, which could result in serious or fatal injury, or it might deploy unexpectedly and unnecessarily which could also result in injury.

What to do if ...

Display message	Possible cause/consequence	Possible solution
<p>Front passenger airbag enabled See Operator's Manual</p>	<p>Front passenger front air bag is activated while driving even though a child, small individual, or object below the system's weight threshold is on the front passenger seat, or the front passenger seat is empty. Objects on the seat or forces acting on the seat may make the system sense supplemental weight.</p>	<p>Stop the vehicle in a safe location as soon as possible and check the front passenger seat for the following:</p> <ul style="list-style-type: none"> ▶ Apply the parking brake (▷ page 65). ▶ Switch off the ignition (▷ page 40). ▶ Remove child and child restraint from front passenger seat and properly secure the child in rear seat employing the child restraint if necessary. ▶ Remove any other items from on and around the front passenger seat and make sure the storage bag on the back of the front passenger seat is empty. ▶ Make sure that no objects which apply forces to the seat are present (e.g. objects such as books, briefcases etc. lodged behind or around the seat, head restraints pushing against roof etc.). The system may recognize such forces as supplemental weight and sense that an occupant on the front passenger seat is of a greater weight than actually present. ▶ Keep the seat unoccupied, close the front passenger door and switch on the ignition (▷ page 40). <p>(Continued on next page)</p>

Display message	Possible cause/consequence	Possible solution
		<p>Monitor the  PASS AIR BAG OFF indicator lamp on the center console (▷ page 89) and the multifunction display in the instrument cluster (▷ page 26) for the following:</p> <p>With the seat unoccupied and the ignition turned on,</p> <ul style="list-style-type: none"> the  PASS AIR BAG OFF indicator lamp on the center console should illuminate and remain illuminated, indicating that the OCS (▷ page 85) has deactivated the air bag. the message Front passenger airbag enabled See Operator's Manual or the message Front passenger airbag disabled See Operator's Manual should not appear in the multifunction display at any time the seat is unoccupied. Wait at last 60 seconds for the system to complete the necessary check cycles and to make sure neither message appears in the multifunction display. <p>If above conditions are met, you can occupy the front passenger seat again. Depending on the front passenger classification sensed by the OCS (▷ page 85), the  PASS AIR BAG OFF indicator lamp will remain illuminated or go out.</p> <p>If above conditions are not met, the system is not working properly. Have the system checked as soon as possible by an authorized Mercedes-Benz Light Truck Center.</p>

Warning!





If the  **PASS AIR BAG OFF** indicator lamp

remains out even after performing the above corrective steps, do not have any children 12 years old and under and other small

individuals use the front passenger seat until the system has been repaired.

What to do if ...

Display message	Possible cause/consequence	Possible solution
Front passenger airbag disabled See Operator's Manual	Front passenger front air bag is deactivated while driving even though an adult or someone larger than a small individual is occupying the front passenger seat. Forces acting on the seat may make the system sense a decrease in weight.	<p>Stop the vehicle in a safe location as soon as possible and check the front passenger seat for the following:</p> <ul style="list-style-type: none">▶ Apply the parking brake (▷ page 65).▶ Switch off the ignition (▷ page 40).▶ Have the front passenger vacate the seat and exit the vehicle.▶ Adjust the seat in a height position (▷ page 44).▶ Make sure that no objects which apply forces to the seat are present (e.g. objects such as books, briefcases etc. lodged underneath, behind or around the seat). Such forces may cause the system to sense that an occupant of a lesser weight than actually present is on the front passenger seat.▶ Keep the seat unoccupied, close the front passenger door and switch on the ignition (▷ page 40). <p>(Continued on next page)</p>

Display message	Possible cause/consequence	Possible solution
		<p>Monitor the  PASS AIR BAG OFF indicator lamp on the center console (▷ page 89) and the multifunction display in the instrument cluster (▷ page 26) for the following:</p> <p>With the seat unoccupied and the ignition turned on,</p> <ul style="list-style-type: none"> the  PASS AIR BAG OFF indicator lamp on the center console should illuminate and remain illuminated, indicating that the OCS (▷ page 85) has deactivated the air bag. the message Front passenger airbag enabled See Operator's Manual or the message Front passenger airbag disabled See Operator's Manual should not appear in the multifunction display at any time the seat is unoccupied. Wait at last 60 seconds for the system to complete the necessary check cycles and to make sure neither message appears in the multifunction display. <p>If above conditions are met, you can occupy the front passenger seat again. Depending on the front passenger classification sensed by the OCS (▷ page 85), the  PASS AIR BAG OFF indicator lamp will remain illuminated or go out.</p> <p>If above conditions are not met, the system is not working properly. Have the system checked as soon as possible by an authorized Mercedes-Benz Light Truck Center.</p>

Warning!



If the  **PASS AIR BAG OFF** indicator lamp

remains illuminated with an adult occupant on the front passenger seat even after performing the above corrective steps, do not

have any passenger use the front passenger seat until the system has been repaired.

What to do if ...



Display message	Possible cause/consequence	Possible solution
Check tires Then restart Run Flat Indicator	There was a warning message about a loss in the tire inflation pressure and the Run Flat Indicator has not been reactivated yet.	<ul style="list-style-type: none"> ▶ Make sure that the correct tire inflation pressure is set for each tire. ▶ Then reactivate the Run Flat Indicator (▷ page 378).
Run Flat Indicator inoperative	The Run Flat Indicator is malfunctioning.	▶ Have the Run Flat Indicator checked by an authorized Mercedes-Benz Light Truck Center.
Tire pressure Check tires	The Run Flat Indicator indicates that the pressure is too low in one or more tires.	<ul style="list-style-type: none"> ▶ Carefully bring the vehicle to a halt, avoiding abrupt steering and braking maneuvers. Observe the traffic situation around you. ▶ Check and adjust tire inflation pressure as required (▷ page 375). ▶ If necessary, replace the wheel (▷ page 497). ▶ Reactivate the Run Flat Indicator after adjusting the tire inflation pressure values (▷ page 378).
Tire pressure displayed after driving for a few minutes	Vehicles with Advanced TPMS*: The tire inflation pressure is being checked.	▶ Drive the vehicle for a few minutes.

Display message	Possible cause/consequence	Possible solution
Tire pressure monitor inoperative	The TPMS or Advanced TPMS* is malfunctioning.	▶ Have the TPMS or Advanced TPMS* checked by an authorized Mercedes-Benz Light Truck Center.
Tire pressure monitor inoperative No wheel sensors	There are wheels without appropriate wheel sensors mounted (e.g. winter tires).	▶ Have the TPMS or Advanced TPMS* checked by an authorized Mercedes-Benz Light Truck Center. ▶ Have the wheel sensors installed by an authorized Mercedes-Benz Light Truck Center.
Tire pressure monitor Wheel sensor missing	One or more sensors defect (e.g. battery is empty). One or more wheels without appropriate wheel sensors mounted (e.g. spare tire).	▶ Have the TPMS or Advanced TPMS* checked by an authorized Mercedes-Benz Light Truck Center. ▶ Have the wheel sensors installed by an authorized Mercedes-Benz Light Truck Center. Vehicles with Advanced TPMS*: The tire pressure for the respective tire is shown in the multifunction display.
Tire pressure monitor currently unavailable	The TPMS or Advanced TPMS* is unable to monitor the tire pressure due to <ul style="list-style-type: none"> • a nearby radio interference source. • excessive wheel sensor temperatures. 	▶ As soon as the causes of the malfunction have been removed, the TPMS or Advanced TPMS* automatically becomes active again after a few minutes driving.

What to do if ...





Symbol messages



Display symbol	Display messages	Possible cause/consequence	Possible solution
		<p>The battery is no longer charging. Possible causes:</p> <ul style="list-style-type: none"> • alternator malfunctioning • broken poly-V-belt <p>Do not forget that the brake system requires electrical energy and may be operating with restricted capability. Considerably greater brake pedal force is required and the stopping distance is increased.</p>	<ul style="list-style-type: none"> ▶ Stop the vehicle in a safe location or as soon as it is safe to do so. ▶ Apply the parking brake (▷ page 65). ▶ Check the poly-V-belt. <p>If it is broken:</p> <ul style="list-style-type: none"> ▶ Do not continue to drive. Otherwise the engine will overheat due to an inoperative water pump which may result in damage to the engine. Notify an authorized Mercedes-Benz Light Truck Center. <p>If it is intact:</p> <ul style="list-style-type: none"> ▶ Drive immediately to the nearest authorized Mercedes-Benz Light Truck Center. Adjust driving to be consistent with reduced braking responsiveness.

Display symbol	Display message	Possible cause/consequence	Possible solution
	Battery/Alternator Stop vehicle	The battery is defective.	<ul style="list-style-type: none"> ▶ Stop the vehicle in a safe location or as soon as it is safe to do so. ▶ Apply the parking brake (▷ page 65). ▶ Do not continue to drive. ▶ Notify an authorized Mercedes-Benz Light Truck Center.
	inoperative	Downhill Speed Regulation is malfunctioning.	<ul style="list-style-type: none"> ▶ Have the Downhill Speed Regulation checked by an authorized Mercedes-Benz Light Truck Center.
	Brake wear	The brake pads have reached their wear limit.	<ul style="list-style-type: none"> ▶ Have the brake pads replaced as soon as possible.

! Brake pad thickness must be visually inspected by a qualified technician at the intervals specified in the Maintenance Booklet.

What to do if ...

Display symbol	Display message	Possible cause/consequence	Possible solution
 (USA only)  (Canada only)	Release parking brake	You are driving with the parking brake set.	<ul style="list-style-type: none"> ▶ Release the parking brake (▷ page 57).
 (USA only)  (Canada only)	EBV, ABS, ESP inoperative See Operator's Manual	<p>The EBP, the ABS, and the ESP[®] have switched off due to a malfunction. The BAS is also switched off.</p> <p>The brake system is still functional but without the EBP, the ABS, and the ESP[®] available.</p>	<ul style="list-style-type: none"> ▶ Continue driving with added caution. Wheels may lock during hard braking, reducing steering capability. ▶ Have the system checked at an authorized Mercedes-Benz Light Truck Center as soon as possible. <p>Failure to follow these instructions increases the risk of an accident.</p>

Display symbol	Display messages	Possible cause/consequence	Possible solution
BRAKE (USA only)  (Canada only)	Check brake fluid level	There is insufficient brake fluid in the reservoir.	<ul style="list-style-type: none"> ▶ Risk of accident! Stop the vehicle in a safe location or as soon as it is safe to do so. ▶ Apply the parking brake (▷ page 65). ▶ Notify an authorized Mercedes-Benz Light Truck Center. Do not add brake fluid! This will not solve the problem.
CHECK ENGINE (USA only)  (Canada only)	Engine Service	There may be a malfunction in the <ul style="list-style-type: none"> • fuel injection system • ignition system • exhaust system • fuel system 	<ul style="list-style-type: none"> ▶ Have the engine checked by an authorized Mercedes-Benz Light Truck Center.

Warning!



Driving with the message **Check brake fluid level** displayed can result in an accident. Have your brake system checked immediately. Do not add brake fluid before

checking the brake system. Overfilling the brake fluid reservoir can result in spilling brake fluid on hot engine parts and the brake fluid catching fire. You could be seriously burned.

! *If you find that the brake fluid in the brake fluid reservoir has fallen to the minimum mark or below, have the brake system checked for brake pad thickness and leaks.*

What to do if ...

Display symbol	Display messages	Possible cause/consequence	Possible solution
	Coolant level Stop car, switch engine off	The coolant is too hot. Among other possible causes (the cooling fan could be malfunctioning), the poly-V-belt could be broken.	<ul style="list-style-type: none"> ▶ Stop the vehicle in safe location or as soon as it safe to do so. ▶ Apply the parking brake (▷ page 65). ▶ Turn off the engine. ▶ Check the poly-V-belt. <p>If it is broken:</p> <ul style="list-style-type: none"> ▶ Do not continue to drive. Otherwise, the engine will overheat due to an inoperative water pump which may result in damage to the engine. Contact an authorized Mercedes-Benz Light Truck Center. <p>If it is intact:</p> <ul style="list-style-type: none"> ▶ Do not continue to drive the vehicle with this message displayed. Doing so could result in serious engine damage that is not covered by the Mercedes-Benz Limited Warranty. <p>(Continued on next page)</p>

Display symbol	Display messages	Possible cause/consequence	Possible solution
			<ul style="list-style-type: none"> ▶ Observe the coolant temperature in the multifunction display (▷ page 154). If the temperature raises again: ▶ Contact an authorized Mercedes-Benz Light Truck Center immediately.

Warning!



Driving when your engine is overheated can cause some fluids which may have leaked into the engine compartment to catch fire. You could be seriously burned.

Steam from an overheated engine can cause serious burns which can occur just by opening the engine hood. Stay away from the engine if you see or hear steam coming from it.

Turn off the engine, get out of the vehicle and do not stand near the vehicle until the engine has cooled down.

During severe operation conditions and stop-and-go city traffic, the coolant temperature may rise close to 248°F (120°C).

! *The engine should not be operated with the coolant temperature above 248°F (120°C). Doing so may cause serious damage which is not covered by the Mercedes-Benz Limited Warranty.*

What to do if ...

Display symbol	Display messages	Possible cause/consequence	Possible solution
	Top up Coolant See Oper. Manual	The coolant level is too low.	<ul style="list-style-type: none"> ▶ Add coolant (▷ page 362). ▶ If you have to add coolant frequently, have the cooling system checked by an authorized Mercedes-Benz Light Truck Center.

Warning!



Do not spill antifreeze on hot engine parts. Antifreeze contains ethylene glycol which may burn if it comes into contact with hot engine parts. You could be seriously burned.

Warning!



In order to avoid potentially serious burns:

- Use extreme caution when opening the hood if there are any signs of steam or coolant leaking from the cooling system, or if the coolant temperature gauge indicates that the coolant is overheated.

- Do not remove pressure cap on coolant reservoir if coolant temperature is above 158°F (70°C). Allow engine to cool down before removing cap. The coolant reservoir contains hot fluid and is under pressure.
- Using a rag, slowly open the cap approximately $1/2$ turn to relieve excess pressure. If opened immediately, scalding hot fluid and steam will be blown out under pressure.
- Do not spill antifreeze on hot engine parts. Antifreeze contains ethylene glycol which may burn if it comes into contact with hot engine parts.

! Do not ignore the low engine coolant level warning. Extended driving with the message and symbol displayed may cause serious engine damage not covered by the Mercedes-Benz Limited Warranty.

Do not drive without sufficient amount of coolant in the cooling system. The engine will overheat causing major engine damage.

Display symbol	Display messages	Possible cause/consequence	Possible solution
	Check eng. oil level at next refueling	The engine oil level is too low.	► Check the engine oil level (▷ page 360) (except ML 500), or (▷ page 358) (ML 500 only).
	USA only: Add 1 qt. engine oil at next refueling Canada only: Add 1 liter engine oil at next refueling	The engine oil level is too low.	► Add engine oil (▷ page 361) and check the engine oil level (▷ page 360) (except ML 500), or (▷ page 358) (ML 500 only).
	Engine oil level cannot be measured	The measuring system is malfunctioning.	► Have the measuring system checked by an authorized Mercedes-Benz Light Truck Center.

When the message Add 1 qt. engine oil at next refueling (Canada: 1 liter) appears while the engine is running and at operating temperature, the engine oil level has dropped to approximately the minimum level.

When this occurs, the warning will first come on intermittently and then stay on if the oil level drops further.



Visually check for oil leaks. If no obvious oil leaks are noted, drive to the nearest service station where the engine oil should be topped to the required level with an approved oil specified in the Factory Approved Service Products pamphlet.

What to do if ...

Display symbol	Display messages	Possible cause/consequence	Possible solution
	Engine oil level Stop car, turn engine off	There is no oil in the engine. There is a danger of engine damage.	<ul style="list-style-type: none"> ▶ Carefully bring the vehicle to a halt as soon as it is safe to do so in a safe location. ▶ Turn off the engine. ▶ Add engine oil (▷ page 361) and check the engine oil level (▷ page 360) (except ML 500), or (▷ page 358) (ML 500 only).
	Engine oil level Reduce oil level	You have added too much engine oil. There is a risk of damaging the engine and/or the catalytic converter (gasoline engine) or the oxidation catalyst (diesel engine).	<ul style="list-style-type: none"> ▶ Have oil siphoned or drained off. Observe all legal requirements with respect to its disposal.
	Engine oil level Visit workshop	The engine oil has dropped to a critical level.	<ul style="list-style-type: none"> ▶ Check the engine oil level (▷ page 360) (except ML 500), or (▷ page 358) (ML 500 only) and add oil as required (▷ page 361). ▶ If you must add engine oil frequently, have the engine checked for possible leaks.

! The engine oil level warnings should not be ignored. Extended driving with the symbol displayed could result in serious engine damage

that is not covered by the Mercedes-Benz Limited Warranty.

Display symbol	Display messages	Possible cause/consequence	Possible solution
		You are driving with one or more doors open.	<ul style="list-style-type: none"> ▶ Stop the vehicle in a safe location or as soon as it is safe to do so. ▶ Close the door(s).
	Gas cap is open	A loss of pressure has been detected in the fuel system. The fuel cap may not be closed properly or the fuel system may be leaky.	<ul style="list-style-type: none"> ▶ Check the fuel cap (▷ page 352). <p>If it is not closed properly:</p> <ul style="list-style-type: none"> ▶ Close the fuel cap. <p>If it is closed properly:</p> <ul style="list-style-type: none"> ▶ Have the fuel system checked by an authorized Mercedes-Benz Light Truck Center.
		You are driving with the hood or the tailgate open.	<ul style="list-style-type: none"> ▶ Carefully bring the vehicle to a halt as soon as it is safe to do so in a safe location. ▶ Close the hood (▷ page 356) or the tailgate (▷ page 121).
		You are trying to lock the vehicle with the KEYLESS-GO* function with a door or the tailgate open.	<ul style="list-style-type: none"> ▶ Close all doors and/or the tailgate (▷ page 121).

What to do if ...

Display symbol	Display messages	Possible cause/consequence	Possible solution
	Key not detected	The SmartKey with KEYLESS-GO* is not recognized while the engine is running because <ul style="list-style-type: none"> the SmartKey with KEYLESS-GO* is not in the vehicle there is strong radio-frequency interference 	<ul style="list-style-type: none"> ▶ Stop the vehicle in a safe location or as soon as it is safe to do so. ▶ Apply the parking brake (▷ page 65). ▶ Search for the SmartKey with KEYLESS-GO*. Otherwise the vehicle cannot be centrally locked nor can the engine be started again after the engine is stopped.
		The SmartKey with KEYLESS-GO* is momentarily not recognized.	<ul style="list-style-type: none"> ▶ Change the position of the SmartKey with KEYLESS-GO* in the vehicle. ▶ Operate the vehicle with the SmartKey in the starter switch if necessary.
	Key not detected	The SmartKey with KEYLESS-GO* is not recognized while the ignition is switched on (▷ page 40) and a door is opened or closed and the SmartKey with KEYLESS-GO* is not in the vehicle.	<ul style="list-style-type: none"> ▶ Search for the SmartKey with KEYLESS-GO*. ▶ Change the position of the SmartKey with KEYLESS-GO* in the vehicle. Otherwise the vehicle cannot be locked nor can the engine be started.

Display symbol	Display messages	Possible cause/consequence	Possible solution
	Key detected in vehicle	A SmartKey with KEYLESS-GO* left in the vehicle was detected while trying to lock the vehicle from the outside.	▶ Take the SmartKey with KEYLESS-GO* out of the vehicle.
	Remove key	You have forgotten to remove the SmartKey.	▶ Remove the SmartKey from the starter switch.
	You need a new key	There is no additional code available for SmartKey or SmartKey with KEYLESS-GO*.	▶ Visit an authorized Mercedes-Benz Light Truck Center as soon as possible.
	Change key batteries	The batteries in the SmartKey with KEYLESS-GO* are discharged.	▶ Replace the batteries (▷ page 480).
	Don't forget your key	This message appears for a maximum of 60 seconds if the driver's door is opened with the engine shut off and no SmartKey in the starter switch. This message is only a reminder.	▶ Insert the SmartKey in the starter switch (▷ page 40). or ▶ Take the SmartKey with KEYLESS-GO* with you when leaving the vehicle.

What to do if ...

Display symbol	Display messages	Possible cause/consequence	Possible solution
	3rd brake lamp	The high mounted brake lamp is malfunctioning. This message will only appear if a number of critical LEDs have stopped working.	► Contact an authorized Mercedes-Benz Light Truck Center as soon as possible.
	Active headlamps inoperative	The active Bi-Xenon* headlamps system is malfunctioning.	► Contact an authorized Mercedes-Benz Light Truck Center as soon as possible.
	Brake lamp Left	The left brake lamp is malfunctioning. A substitute bulb is being used.	► Replace the bulb as soon as possible (▷ page 490).
	Brake lamp Right	The right brake lamp is malfunctioning. A substitute bulb is being used.	► Replace the bulb as soon as possible (▷ page 490).
	Display malfunction Visit workshop	The display for the lamps or the system is malfunctioning.	► Contact an authorized Mercedes-Benz Light Truck Center as soon as possible.
	Front foglamp Left	The left front fog lamp is malfunctioning.	► Replace the bulb as soon as possible (▷ page 488).
	Front foglamp Right	The right front fog lamp is malfunctioning.	► Replace the bulb as soon as possible (▷ page 488).

Display symbol	Display messages	Possible cause/consequence	Possible solution
	Parking lamp Front Left	The front left parking lamp is malfunctioning. A substitute bulb is being used.	▶ Replace the bulb as soon as possible (▷ page 487).
	Parking lamp Front Right	The right front parking lamp is malfunctioning. A substitute bulb is being used.	▶ Replace the bulb as soon as possible (▷ page 487).
	High beam Left	The left high beam lamp is malfunctioning.	Halogen headlamp: ▶ Replace the bulb as soon as possible (▷ page 486). Bi-Xenon* headlamp: ▶ Contact an authorized Mercedes-Benz Light Truck Center as soon as possible.
	High beam Right	The right high beam lamp is malfunctioning.	Halogen headlamp: ▶ Replace the bulb as soon as possible (▷ page 486). Bi-Xenon* headlamp: ▶ Contact an authorized Mercedes-Benz Light Truck Center as soon as possible.

What to do if ...

Display symbol	Display messages	Possible cause/consequence	Possible solution
	License plate lamp Left	The left license plate lamp is malfunctioning.	▶ Replace the bulb as soon as possible (▷ page 492).
	License plate lamp Right	The right license plate lamp is malfunctioning.	▶ Replace the bulb as soon as possible (▷ page 492).
	AUTO Light inoperative	The light sensor is malfunctioning. The headlamps do not switch on automatically.	▶ In the control system, set lamp operation to manual mode (▷ page 137). ▶ Switch on headlamps using the exterior lamp switch. ▶ Contact an authorized Mercedes-Benz Light Truck Center as soon as possible.
	Low beam Left	The left low beam lamp is malfunctioning.	Halogen headlamp: ▶ Replace the bulb as soon as possible (▷ page 485). Bi-Xenon* headlamp: ▶ Contact an authorized Mercedes-Benz Light Truck Center as soon as possible.





Display symbol	Display messages	Possible cause/consequence	Possible solution
	Low beam Right	The right low beam lamp is malfunctioning.	Halogen headlamp: ▶ Replace the bulb as soon as possible (▷ page 485). Bi-Xenon* headlamp: ▶ Contact an authorized Mercedes-Benz Light Truck Center as soon as possible.
	Marker lamp Front Left	The left front side marker lamp is malfunctioning.	▶ Replace the bulb as soon as possible (▷ page 488).
	Marker lamp Front Right	The right front side marker lamp is malfunctioning.	▶ Replace the bulb as soon as possible (▷ page 488).
	Fog lamp Rear Left	The left rear fog lamp is malfunctioning.	▶ Replace the bulb as soon as possible (▷ page 490).
	Reverse lamp Left	The left backup lamp is malfunctioning.	▶ Replace the bulb as soon as possible (▷ page 490).
	Reverse lamp Right	The right backup lamp is malfunctioning.	▶ Replace the bulb as soon as possible (▷ page 490).

What to do if ...

Display symbol	Display messages	Possible cause/consequence	Possible solution
	Switch off lights	You have removed the SmartKey from the starter switch, opened the driver's door and left the headlamps on or removed the SmartKey with KEYLESS-GO* from the vehicle and left the headlamps on.	▶ Switch off the headlamps (▷ page 66).
	Switch off lights or remove key	You have opened the driver's door while the exterior lamp switch is in position AUTO and the SmartKey is still in the starter switch. The parking lamps are still on.	▶ Switch off the headlamps (▷ page 66). or ▶ Remove the SmartKey from the starter switch.
	Tail lamp Left	The left tail lamp is malfunctioning. A substitute bulb is being used.	▶ Replace the bulb as soon as possible (▷ page 490).
	Tail lamp Right	The right tail lamp is malfunctioning. A substitute bulb is being used.	▶ Replace the bulb as soon as possible (▷ page 490).

Display symbol	Display messages	Possible cause/consequence	Possible solution
	Turn signal Front Left	The left front turn signal lamp is malfunctioning. A substitute bulb is being used.	► Replace the bulb as soon as possible (▷ page 487).
	Turn signal Front Right	The right front turn signal lamp is malfunctioning. A substitute bulb is being used.	► Replace the bulb as soon as possible (▷ page 487).
	Turn signal Rear Left	The left rear turn signal lamp is malfunctioning. A substitute bulb is being used.	► Replace the bulb as soon as possible (▷ page 490).
	Turn signal Rear Right	The right rear turn signal lamp is malfunctioning. A substitute bulb is being used.	► Replace the bulb as soon as possible (▷ page 490).
	Turn signal Left mirror	The turn signal in the left exterior rear view mirror is malfunctioning. This message will only appear if a number of critical LEDs have stopped working.	► Contact an authorized Mercedes-Benz Light Truck Center as soon as possible.
	Turn signal Right mirror	The turn signal in the right exterior rear view mirror is malfunctioning. This message will only appear if a number of critical LEDs have stopped working.	► Contact an authorized Mercedes-Benz Light Truck Center as soon as possible.

What to do if ...

Display symbol	Display messages	Possible cause/consequence	Possible solution
	Tele Aid inoperative	One or more main functions of the Tele Aid* system are malfunctioning.	▶ Have the Tele Aid* system checked by an authorized Mercedes-Benz Light Truck Center.
	Tele Aid battery	The emergency power battery for the Tele Aid* system is malfunctioning. If the vehicle battery is also malfunctioning or drained, Tele Aid* will not be operational.	▶ Have the Tele Aid* system checked by an authorized Mercedes-Benz Light Truck Center.
	Function unavailable	This display appears if button  or  on the multifunction steering wheel is pressed and the vehicle is not equipped with a telephone.	
	Top up washer fluid	The fluid level has dropped to about $\frac{1}{3}$ of total reservoir capacity.	▶ Add washer fluid (▷ page 363).

Display symbol	Display messages	Possible cause/consequence	Possible solution
	Tire pressure Check tires	The pressure is too low in one or more tires.	▶ Check and correct tire inflation pressure as required.
	Tire pressure Caution - tire defect	One or more tires are deflating.	▶ Carefully bring the vehicle to a halt, avoiding abrupt steering and braking maneuvers. ▶ If necessary, change the wheel.
	Caution - tire defect	Vehicles with Advanced TPMS*: One or more tires are deflating. The respective tire is shown in the multifunction display.	▶ Carefully bring the vehicle to a halt, avoiding abrupt steering and braking maneuvers. ▶ If necessary, change the wheel.

Warning!



Do not drive with a flat tire. A flat tire affects the ability to steer or brake the vehicle. You may lose control of the vehicle. Continued driving with a flat tire will cause excessive heat build-up and possibly a fire.

What to do if ...



Display symbol	Display messages	Possible cause/consequence	Possible solution
	Tire pressure Check tires	The tire pressure in one or more tires is already below the minimum value.	<ul style="list-style-type: none"> ▶ Carefully bring the vehicle to a halt, avoiding abrupt steering and braking maneuvers. ▶ Check and adjust tire pressure as required. ▶ If necessary, change the wheel.
	Check tires	<p>Vehicles with Advanced TPMS*:</p> <p>The tire pressure in one or more tires is already below the minimum value.</p> <p>The respective tire is shown in the multifunction display.</p>	<ul style="list-style-type: none"> ▶ Carefully bring the vehicle to a halt, avoiding abrupt steering and braking maneuvers. ▶ Check and adjust tire pressure as required. ▶ If necessary, change the wheel.

Warning!



Do not drive with a flat tire. A flat tire affects the ability to steer or brake the vehicle.

You may lose control of the vehicle. Continued driving with a flat tire will cause excessive heat build-up and possibly a fire.

Display symbol	Display messages	Possible cause/consequence	Possible solution
	Level selection not permitted	You are driving too fast for the desired vehicle level*.	<ul style="list-style-type: none"> ▶ Reduce vehicle speed. ▶ Set the desired vehicle level again (▷ page 271).
		You are towing a trailer or using accessories that are connected to the trailer power socket, e.g. a bicycle rack.	
	Leveling cancelled	You have selected another vehicle level*.	
	Reduce speed to under 20 mph	You are driving too fast for the set vehicle level*.	▶ Do not drive faster than 20 mph (30 km/h).
	Visit workshop	The air suspension* functional only to a limited extent.	<ul style="list-style-type: none"> ▶ Do not drive faster than 50 mph (80 km/h) depending on the set vehicle level. ▶ Have the vehicle checked at an authorized Mercedes-Benz Light Truck Center.

What to do if ...

Display symbol	Display messages	Possible cause/consequence	Possible solution
	Visit workshop	The air suspension* is malfunctioning.	<ul style="list-style-type: none"> ▶ Do not drive faster than 50 mph (80 km/h) depending on the set vehicle level. ▶ Have the vehicle checked at an authorized Mercedes-Benz Light Truck Center.
	Compressor cooling down	You have selected a higher vehicle level*. Due to frequent level changes within a short period, the compressor must first cool down.	<ul style="list-style-type: none"> ▶ Let the compressor cool until the message disappears. <p>The selected level will be set once the compressor has cooled.</p>

! *When the message Compressor cooling down appears in the multifunction display, driving is still possible. Keep in mind that the ride height of the vehicle is not yet reached, so you can damage the underbody of the vehicle. The selected level will be set once the compressor has cooled.*

▼ Where will I find ...?

First aid kit

i Check expiration dates and contents for completeness at least once a year and replace missing/expired items.

The first aid kit is located on the driver's side in the cargo compartment behind the cover.

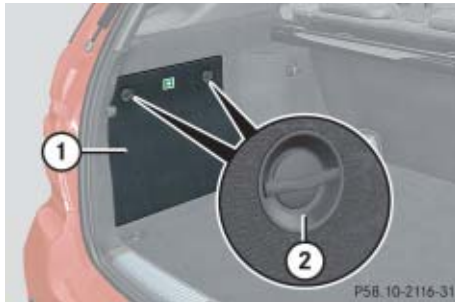

- ① Cover in left side trim panel
- ② Lock

- ▶ Turn lock ② 90°.
- ▶ Fold down cover ①.

The first aid kit can be removed.

Vehicle tool kit

The vehicle tool kit is stored under the cargo compartment floor.

The vehicle tool kit includes:

- Towing eye bolt
- Wheel wrench
- Alignment bolt
- Vehicle jack
- Fuse chart
- Spare fuses
- Fuse extractor
- Collapsible wheel chock
- Wheel bolts for spare wheel



- ① Cargo compartment floor, lowered
- ② Handle cover

- ▶ Open the tailgate (▷ page 119).
- ▶ Push in handle cover ② and pull handle in direction of arrow.
- ▶ Lift cargo compartment floor ①. ▷▷

Where will I find ...?

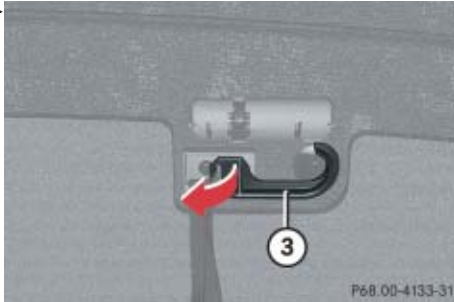

③ Securing hook

- ▶ Release securing hook ③ (located below the floor handle) from holder.

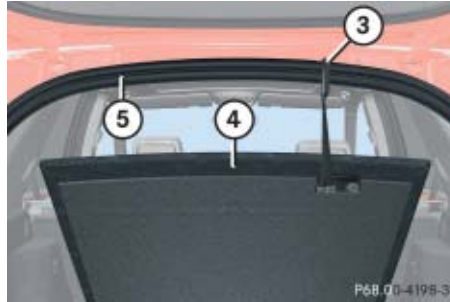

③ Securing hook

- ④ Cargo compartment floor, raised
- ⑤ Upper cargo compartment lip

- ▶ Engage securing hook ③ on upper cargo compartment lip ⑤.

! *With the cargo compartment cover blind installed behind the rear seats (▷ page 286), disengage cargo compartment cover blind and flip it forward. Otherwise the strap of the securing hook could damage the cargo compartment cover blind.*

- ▶ Remove the Minispare wheel (▷ page 473).

or

ML 63 AMG:

- ▶ Remove the collapsible tire (▷ page 474).

You can now access the vehicle tool kit.



⑥ Wheel bolt wrench

⑦ Vehicle jack

⑧ Collapsible wheel chock

⑨ Spare fuses, fuse chart, fuse extractor

⑩ Towing eye bolt

⑪ Alignment bolt

⑫ Spare wheel bolts

! **Vehicles with factory-mounted running-boards*:**

Your vehicle is equipped with a scissors-type jack (located under the cargo compartment floor) designed for use with factory-mounted running boards. Only use this jack when jacking up vehicles with factory-mounted running boards as otherwise the vehicle's underbody can be damaged. See separate instructions for scissors-type jack.

! To prevent damage, always disengage the strap of the securing hook and lower the cargo compartment floor (▷ page 469) before closing the tailgate.

Vehicle jack

Warning!



The jack is designed exclusively for jacking up the vehicle at the jack take-up brackets built into both sides of the vehicle. To help avoid personal injury, use the jack only to lift the vehicle during a wheel change. Never get beneath the vehicle while it is supported by the jack. Keep hands and feet away from the area under the lifted vehicle. Always firmly set parking brake and block wheels before raising vehicle with jack.

Do not disengage the parking brake while the vehicle is raised. Be certain that the jack is always vertical (plumb line) when in use, especially on hills. Always try to use the jack on a level surface.

Make sure that the jack arm is fully seated in the jack take-up bracket. Always lower the vehicle onto jackstands of sufficient capacity before working under the vehicle.

The vehicle jack is located underneath the cargo compartment floor.

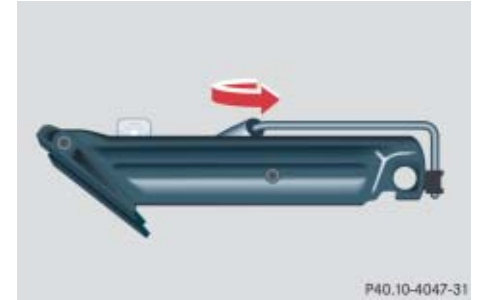

Storage position

- ▶ Remove vehicle jack from its storage compartment (▷ page 470).
- ▶ Turn crank handle in the direction of arrow as far as it will go. ▷▷

Where will I find ...?

▷▷



Operational position

- ▶ Turn crank handle clockwise.

Before storing the vehicle jack in its storage compartment:

- The vehicle jack should be fully collapsed.
- The handle must be folded in (storage position).

Setting up the collapsible wheel chock

The collapsible wheel chock serves to additionally secure the vehicle, e.g. while changing the wheel.

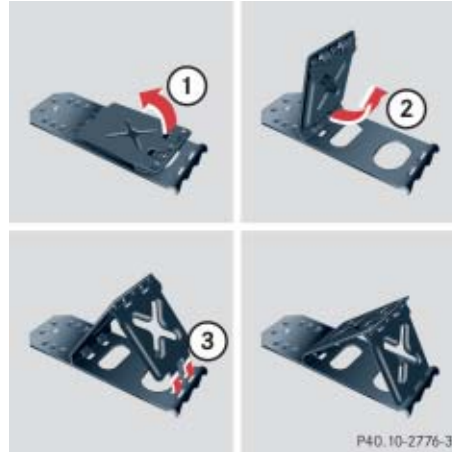

- ① Tilt the plate upward
- ② Fold the lower plate outward
- ③ Insert the plate

- ▶ Tilt both plates upward ①.
- ▶ Fold the lower plate outward ②.
- ▶ Guide the tabs of the lower plate all the way into the openings of base plate ③.

For information on where to place wheel chocks when changing a wheel, see “Lifting the vehicle” (▷ page 498).

Minispare wheel (except ML 63 AMG)**Warning!**

The dimensions of the Minispare wheel are different from those of the road wheels. As a result, the vehicle handling characteristics change when driving with a Minispare wheel mounted. Adapt your driving style accordingly.

The Minispare wheel is for temporary use only. When driving with a Minispare wheel mounted, ensure proper tire inflation pressure and do not exceed a vehicle speed of 50 mph (80 km/h).

Drive to the nearest Mercedes-Benz Light Truck Center as soon as possible to have the Minispare wheel replaced with a regular road wheel.

Never operate the vehicle with more than one spare wheel mounted.

Do not switch off the ESP® when a Minispare wheel is mounted.

The Minispare wheel is located underneath the cargo compartment floor (▷ page 469).

i For information on how to mount the Minispare wheel, see “Mounting the spare wheel” (▷ page 498).

Removing Minispare wheel

- ① Minispare wheel
- ② Towing eye bolt
- ③ Alignment bolt
- ④ Retaining screw
- ⑤ Wheel bolt wrench

i Remove Minispare wheel to gain access to remaining tools in the vehicle tool kit (▷ page 469).

For access the minispare wheel, see “Vehicle tool kit” (▷ page 469).

- ▶ Loosen retaining screw ④ by turning it counterclockwise.
- ▶ Remove Minispare wheel ①.

Where will I find ...?

Collapsible tire (ML 63 AMG only)

Warning!



The dimensions of the collapsible tire are different from those of the road wheels. As a result, the vehicle handling characteristics change when driving with a collapsible tire mounted. Adapt your driving style accordingly.

The collapsible tire is for temporary use only. When driving with a collapsible tire mounted, ensure proper tire inflation pressure and do not exceed a vehicle speed of 50 mph (80 km/h).

Drive to the nearest Mercedes-Benz Light Truck Center as soon as possible to have the collapsible tire replaced with a regular road wheel.

Never operate the vehicle with more than one collapsible tire mounted.

Do not switch off the ESP® when a collapsible tire is mounted.

The collapsible tire is located underneath the cargo compartment floor (▷ page 469).

i For information on how to mount the collapsible tire, see “Mounting the spare wheel” (▷ page 498).

Removing the collapsible tire

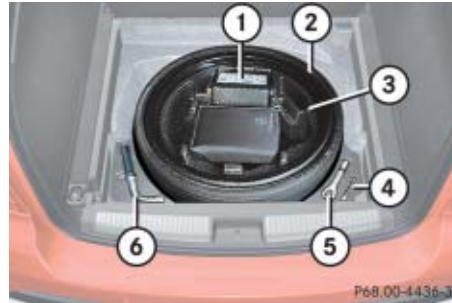

- ① Electric air pump
- ② Collapsible tire
- ③ Vehicle tool kit storage well casing
- ④ Alignment bolt
- ⑤ Towing eye bolt
- ⑥ Wheel bolt wrench

i Remove collapsible tire to gain access to remaining tools in the vehicle tool kit (▷ page 469).

For access the collapsible tire, see “Vehicle tool kit” (▷ page 469).

- ▶ Remove the vehicle tool kit storage well casing ③.



- ⑦ Retaining screw
- ▶ Loosen retaining screw ⑦ by turning it counterclockwise.
 - ▶ Remove collapsible tire ②.

Unlocking/locking in an emergency



▼ Unlocking/locking in an emergency

Unlocking the vehicle

If you cannot unlock the vehicle with the SmartKey or KEYLESS-GO*, open the driver's door using the mechanical key.

i Unlocking the driver's door with the mechanical key will trigger the anti-theft alarm system.

To cancel the alarm:

- Press button  or  on the SmartKey.

- Insert the SmartKey in the starter switch.

Vehicles with KEYLESS-GO*:

- Grasp an outside door handle.

The SmartKey with KEYLESS-GO must be within 3 ft (1 m) of the vehicle.

- Press the KEYLESS-GO* start/stop button (▷ page 41).

The SmartKey with KEYLESS-GO must be inside the vehicle.

Removing the mechanical key

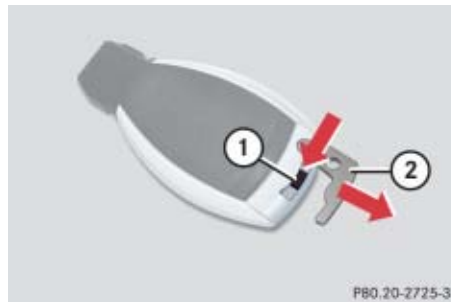

- ① Mechanical key locking tab
- ② Mechanical key

- ▶ Move locking tab ① in direction of arrow.

The mechanical key ② comes out.

- ▶ Slide mechanical key ② out of the housing.

Unlocking the driver's door



- ① Unlocking
- ② Mechanical key

- ▶ Insert mechanical key ② into the driver's door lock until it stops.
- ▶ Turn mechanical key ② counterclockwise to position ① and hold it there.
- ▶ Pull the door handle until the locking knob moves up (▷ page 118).
The driver's door is unlocked.
- ▶ Pull the door handle once more to open the driver's door.

Unlocking/locking in an emergency

Locking the vehicle

If you cannot lock the vehicle with the SmartKey or KEYLESS-GO*, lock the vehicle carrying out the following steps.

- ▶ Close the front passenger door, the rear right door and the tailgate.
- ▶ Open the driver's door and the rear left door.
- ▶ Press the central locking switch on the driver's door (▷ page 126).

The locking knobs of the front passenger door and the rear doors move down.

If the vehicle battery is disconnected or drained:

- ▶ Press down the locking knobs of the front passenger door and the rear doors manually.

- ▶ Exit the vehicle.
 - ▶ Close the driver's door.
 - ▶ Enter the vehicle through the rear left door.
 - ▶ Press down the locking knob of the driver's door.
- !** *To prevent inadvertent lockout, make sure to have the SmartKey or SmartKey with KEYLESS-GO* with you before proceeding with the next step. The next step will lock the vehicle.*
- ▶ Exit the vehicle.
 - ▶ Close the rear left door.
- The vehicle is locked.

i *This procedure does not arm the anti-theft alarm system, nor does it lock the fuel filler flap.*

Unlocking and opening the tailgate

A minimum height clearance of 7.2 ft (2.20 m) is required to open the tailgate.

If the tailgate can no longer be unlocked and opened using the  button on the SmartKey or the KEYLESS-GO* function, use the manual release to unlock and open the tailgate.

The manual release is located on the inside of the tailgate.

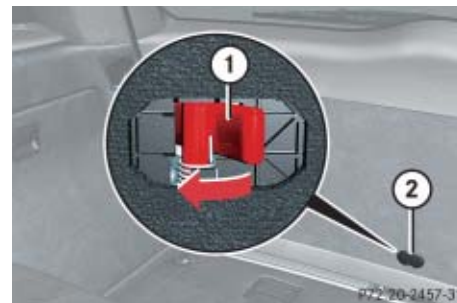

- ① Release lever
- ② Cover

- ▶ Remove cover ② from the trim on the tailgate.
- ▶ Push release lever ① all the way to the left.
- ▶ Lift the tailgate.



Unlocking/locking in an emergency

! Always make sure there is sufficient overhead clearance.

i If the vehicle has previously been locked from the outside using the SmartKey or SmartKey with KEYLESS-GO*, opening the tailgate from the inside will trigger the anti-theft alarm system.

To cancel the alarm, do one of the following:

With the SmartKey:

- Press button  or  on the SmartKey.
- Insert the SmartKey in the starter switch.

With KEYLESS-GO*:

- Grasp an outside door handle. The SmartKey with KEYLESS-GO must be within 3 ft (1 m) of the vehicle.
or
- Press the KEYLESS-GO start/stop button. The SmartKey with KEYLESS-GO must be inside the vehicle.

Fuel filler flap

- ▶ Open the tailgate (▷ page 119).

The fuel filler flap release is located behind a cover in the right side trim panel of the cargo compartment.

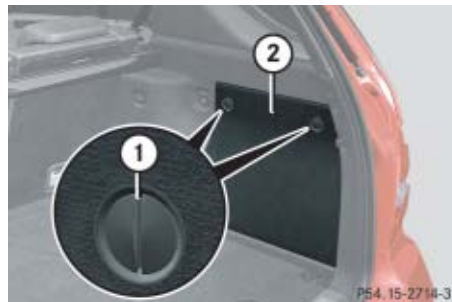

- ① Lock
 - ② Cover
- ▶ Insert a suitable object such as a coin into the slot of lock ①.
 - ▶ Turn lock ① counterclockwise by 90° in direction of arrow.
 - ▶ Remove cover ②.



- ③ Fuel filler flap release
- ▶ Pull red fuel filler flap release ③ in direction of arrow.
The fuel filler flap is unlocked.
 - ▶ Open the fuel filler flap (▷ page 352).

Opening/closing in an emergency

Power tilt/sliding sunroof*

You can open or close the tilt/sliding sunroof manually should an electrical malfunction occur.

The tilt/sliding sunroof drive is located behind a cover on the overhead control panel.



① Cover

- ▶ Remove the SmartKey from the starter switch.

Vehicles with KEYLESS-GO*:

- ▶ Turn off the engine by pressing the KEYLESS-GO* start/stop button (▷ page 67).
- ▶ Open the driver's door (this puts the starter switch in position **0**, same as with the SmartKey removed from the starter switch). The driver's door can then be closed again.
- ▶ Press on cover ① at the position indicated by the arrow.
- ▶ Take off cover ①.



② Crank

- ▶ Take crank ② out of the Operator's Manual pouch.
- ▶ Insert crank ② into hole.
- ▶ Turn crank ② clockwise to
 - slide sunroof closed
 - raise sunroof at the rear
- ▶ Turn crank ② counterclockwise to
 - slide sunroof open
 - lower sunroof at the rear

i Turn crank ② slowly and smoothly.

The tilt/sliding sunroof must be synchronized if it has been operated manually (▷ page 244).

Resetting activated head restraints

▼ Resetting activated head restraints

If the active head restraints have been triggered in a rear-end collision, the active head restraints must be reset. Otherwise, the active head restraints cannot offer any additional protection in the event of another rear-end collision.

You can tell that the head restraints have been activated when they have been moved forward and cannot be adjusted.

i For your convenience, we recommend that you have this work carried out by an authorized Mercedes-Benz Light Truck Center.

You will find the reset tool for manually operating the active head restraints in the Mercedes-Benz vehicle literature pouch.

Warning!



For safety reasons, have the active head restraints checked by an authorized Mercedes-Benz Light Truck Center after a rear-end collision.

Warning!



When pushing back the head restraint cushion, take care that your fingers do not become caught between the head restraint cushion and the cover. Failing to do so may lead to injury.

! Be careful not to damage upholstery.



① Reset tool

② Active head restraint

- ▶ Take the reset tool ① out of the Mercedes-Benz vehicle literature pouch.

- ▶ Guide reset tool ① into the rectangular opening of the active head restraint ②.
- ▶ Press reset tool ① downward in direction of arrow until you hear the head restraint release mechanism audibly disengage.
- ▶ Pull out reset tool ①.
- ▶ Firmly press the active head restraint cushion backward towards the head restraint cover in direction of arrow until it engages.
- ▶ Repeat this procedure on the active head restraint for the second front seat.
- ▶ After resetting the active head restraints store the reset tool ① in the Mercedes-Benz vehicle literature pouch.

For information on active head restraints, see “Active head restraint” (▷ page 80).

For information on head restraint adjustment, see “Seats” (▷ page 43).

Replacing SmartKey batteries

If the batteries in the SmartKey or the SmartKey with KEYLESS-GO* are discharged, the vehicle can no longer be locked or unlocked. It is recommended to have the batteries replaced at an authorized Mercedes-Benz Light Truck Center.

Warning!



Keep the batteries out of reach of children.
If a battery is swallowed, seek medical help immediately.

Batteries contain materials that can harm the environment if disposed of improperly. Recycling of batteries is the preferred method of disposal. Many states require sellers of batteries to accept old batteries for recycling.

i When inserting the batteries, make sure they are clean and free of lint.

i When replacing batteries, always replace both batteries.

The required replacement batteries are available at any Mercedes-Benz Light Truck Center.

Replacement batteries: Lithium, type CR 2025 or equivalent.

- ▶ Remove mechanical key ① from the SmartKey or SmartKey with KEYLESS-GO* (▷ page 475).

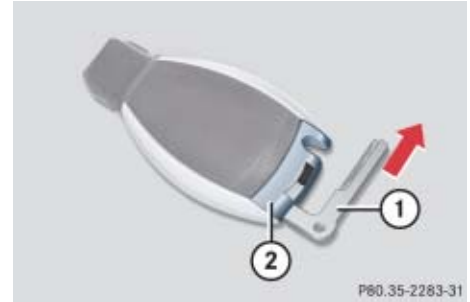

- ① Mechanical key
- ② Battery compartment

- ▶ Insert mechanical key ① into opening.
- ▶ Press mechanical key ① in direction of arrow.

The battery compartment ② is unlatched.

- ▶ Pull battery compartment ② out of the SmartKey housing.

Replacing SmartKey batteries

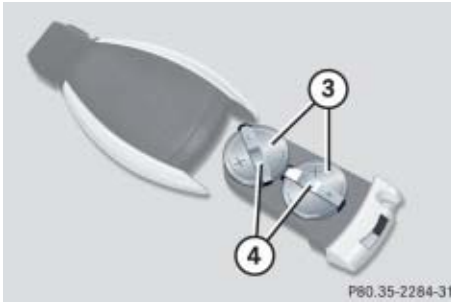

- ③ Batteries
- ④ Contact spring

- ▶ Pull out batteries ③.
- ▶ Using a line-free cloth, insert new batteries ③ under contact springs ④ with the positive terminal (+) side facing up.
- ▶ Return battery compartment ② into housing until it locks into place.
- ▶ Slide mechanical key ① back into the SmartKey or SmartKey with KEYLESS-GO*.
- ▶ Check the operation of the SmartKey or SmartKey with KEYLESS-GO*.

Replacing bulbs

Bulbs

Safe vehicle operation depends on proper exterior lighting and signaling. It is therefore essential that all bulbs and lamp assemblies are in good working order at all times.

Correct headlamp adjustment is extremely important. Have headlamps checked and readjusted at regular intervals and when a bulb has been replaced. See an authorized Mercedes-Benz Light Truck Center for headlamp adjustment.

i *If the headlamps or front fog lamps are fogged up on the inside as a result of high humidity, driving the vehicle a distance with the lights on should clear up the fogging.*

i *Substitute bulbs will be brought into use when the following lamps malfunction:*

- *Turn signal lamps*
- *Brake lamps*
- *Parking lamps*
- *Tail lamps*

Read and observe the messages in the multi-function display (▷ page 458).

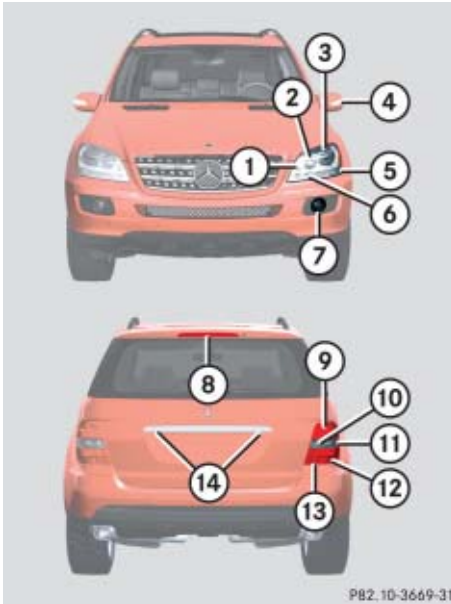

P82.10-3669-31

Front lamps

	Lamp	Type
①	Parking and standing lamp	W 5 W
②	Headlamps: High beam/high beam flasher	H7 (55 W)
	Bi-Xenon headlamps*: High beam/high beam flasher spot lamp	H7 (55 W)
③	Headlamps: Low beam	H7 (55 W)
	Bi-Xenon headlamps*: Low beam ¹	D2S-35 W
④	Additional turn signal lamp	LED
⑤	Side marker lamp	WY 5 W

¹ Vehicles with Bi-Xenon* headlamps: Do not replace the Bi-Xenon bulbs yourself. Contact an authorized Mercedes-Benz Light Truck Center.

	Lamp	Type
⑥	Turn signal lamp	3457 AK S-8 (30/2.2 cp bulb)
⑦	Front fog lamp	H11 (55 W)
	Corner-illuminating front fog lamp*	H11 (55 W)

Rear lamps

	Lamp	Type
⑧	High mounted brake lamp	LED
⑨	Brake lamp	P 21 W
⑩	Backup lamp	P 21 W
⑪	Turn signal lamp	PY 21 W
⑫	Side marker lamp	P 21/4 W
⑬	Tail, parking, standing lamp, rear fog lamp (only driver's side)	P 21/4 W
⑭	License plate lamps	C 5 W

Replacing bulbs

Warning!



Bulbs and bulb sockets can be very hot. Allow the lamp to cool down before changing a bulb.

Keep bulbs out of reach of children.

Halogen lamps contain pressurized gas.

A bulb can explode if you:

- touch or move it when hot
- drop the bulb
- scratch the bulb

Wear eye and hand protection.

Because of high voltage in Xenon lamps, it is dangerous to replace the bulb or repair the lamp and its components. We recommend that you have such work done by a qualified technician.

Notes on bulb replacement

- Only use 12-volt bulbs of the same type and with the specified watt rating.
- Switch lights off before changing a bulb to prevent short circuits.
- Always use a clean lint-free cloth when handling bulbs.
- Your hands should be dry and free of oil and grease.
- If the newly installed bulb does not come on, visit an authorized Mercedes-Benz Light Truck Center.

Have the LEDs and bulbs for the following lamps replaced by an authorized Mercedes-Benz Light Truck Center:

- the additional turn signal lamps in the exterior rear view mirrors
- the high mounted brake lamp
- the Bi-Xenon* low beam lamps
- the Bi-Xenon high beam flasher spotlight*

! *Do not replace the LEDs yourself. You could otherwise damage the LEDs or parts of the vehicle. Only have the LEDs replaced by a qualified specialist workshop having the necessary skills and tools for carrying out the work required.*

i *Replacing the bulbs for the front lamps is a technically complex process. For your convenience, we recommend that you have this work carried out by an authorized Mercedes-Benz Light Truck Center.*

Have the headlamp adjustment checked regularly.

Replacing bulbs for front lamps

i ML 500 only:

Before replacing a bulb in the right headlamp, the fusebox in the engine compartment must be removed. This should be performed by a qualified specialist workshop, for instance by an authorized Mercedes-Benz Light Truck Center.

Before you start to replace a bulb for a front lamp, do the following first:

- ▶ Turn the exterior lamp switch to position **0** (▷ page 136).
- ▶ Open the hood (▷ page 356).

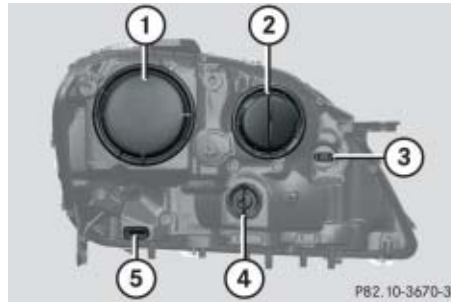

- ① Housing cover for low beam halogen headlamp
- ② Housing cover for high beam halogen bulb (high beam and high beam flasher)
- ③ Bulb socket for parking and standing lamp bulb
- ④ Bulb socket for turn signal lamp bulb
- ⑤ Bulb socket for side marker lamp bulb

Low beam bulb (halogen headlamp)



- ① Low beam headlamp cover

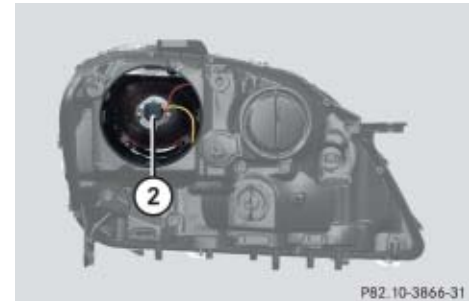

- ② Bulb socket for low beam headlamp

Replacing bulbs

- ▶ Turn cover ① counterclockwise.
- ▶ Remove cover ①.
- ▶ Turn bulb socket ② counterclockwise.
- ▶ Pull bulb socket ② out of the headlamp housing.
- ▶ Pull the low beam bulb out of bulb socket ②.
- ▶ Insert the new low beam bulb into bulb socket ②.
- ▶ Insert bulb socket ② into the headlamp housing.
- ▶ Turn bulb socket ② clockwise until it engages.
- ▶ Place cover ① on the opening in the headlamp housing.
- ▶ Turn cover ① clockwise until it engages.

Bi-Xenon* low beam/high beam headlamp

Warning!



Do not remove the low beam/high beam cover for the Bi-Xenon* headlamp. Because of high voltage in Xenon* lamps, it is dangerous to replace the bulb or repair the lamp and its components. We recommend that you have such work done by a qualified technician.

High beam bulb (halogen headlamp)



① High beam headlamp cover

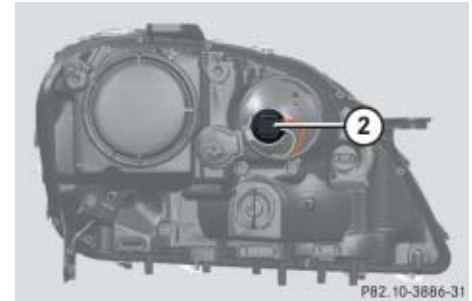

② Bulb socket for high beam headlamp

- ▶ Turn cover ① counterclockwise.
- ▶ Remove cover ①.
- ▶ Turn bulb socket ② counterclockwise.
- ▶ Pull bulb socket ② out of the headlamp housing.
- ▶ Pull the high beam bulb out of bulb socket ②.
- ▶ Insert the new high beam bulb into bulb socket ②.
- ▶ Insert bulb socket ② into the headlamp housing.
- ▶ Turn bulb socket ② clockwise until it engages.
- ▶ Place cover ① on the opening in the headlamp housing.
- ▶ Turn cover ① clockwise until it engages.

Turn signal lamp bulb

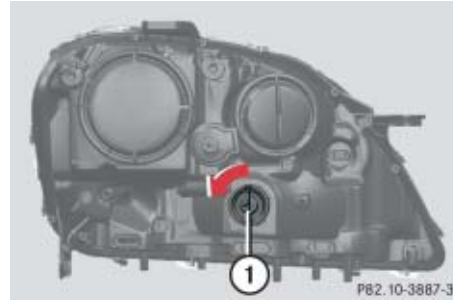

- ① Bulb socket for turn signal lamp
- ▶ Turn bulb socket ① counterclockwise.
- ▶ Pull bulb socket ① out of the headlamp housing.
- ▶ Pull the turn signal bulb out of bulb socket ①.
- ▶ Insert the new turn signal bulb into bulb socket ①.
- ▶ Insert bulb socket ① into the headlamp housing.
- ▶ Turn bulb socket ① clockwise until it engages.

Parking and standing lamp bulb

- ▶ Turn bulb socket ③ (▷ page 485) counterclockwise.
- ▶ Pull bulb socket ③ out of the headlamp housing.
- ▶ Pull the bulb out of bulb socket ③.
- ▶ Insert the new bulb into bulb socket ③.
- ▶ Insert bulb socket ③ into the headlamp housing.
- ▶ Turn bulb socket ③ clockwise until it engages.

Replacing bulbs

Side marker lamp bulb

- ▶ Turn bulb socket ⑤ (▷ page 485) counterclockwise.
- ▶ Pull bulb socket ⑤ out of the headlamp housing.
- ▶ Pull the side marker bulb out of bulb socket ⑤.
- ▶ Insert the new side marker bulb into bulb socket ⑤.
- ▶ Insert bulb socket ⑤ into the headlamp housing.
- ▶ Turn bulb socket ⑤ clockwise until it engages.

Front fog lamp bulbs

! *If not done carefully and properly, damage to the bumper can result. We therefore recommend that you have this work carried out by an authorized Mercedes-Benz Light Truck Center.*

Removing front fog lamp cover:



- ① Cover
- ② Front fog lamp or corner-illuminating front fog lamp*

- ▶ Insert a suitable object (e.g. screwdriver) at point indicated by the arrow and pry out cover ①.

Cover ① is released.

- ▶ Swing cover ① outwards and take it off.

Removing front fog lamp cover (Vehicles with AMG Sport Package* or ML 63 AMG):



- ① Cover
- ② Front fog lamp

- ▶ Use a suitable object (e.g. hook or a screwdriver) and place the hook or screwdriver carefully between lower end of cover and bumper.

- ▶ Turn the hook or screwdriver 90°.
- ▶ Hold the cover ① and pull the hook or screwdriver outwards.

You can now access the front fog lamp.



Example ML 350, ML 500 without Sport Package; Sport Package similar

- ③ Retaining screws
- ▶ Turn retaining screws ③ counterclockwise.
- ▶ Remove front fog lamp ② out of the bumper.
- ▶ Pull electrical connector off.



- ④ Bulb socket of front fog lamp bulb
- ▶ Turn bulb socket ④ counterclockwise.
- ▶ Pull bulb socket ④ out of the housing.
- ▶ Pull the front fog lamp bulb out of bulb socket ④.
- ▶ Insert the new front fog lamp bulb into bulb socket ④.
- ▶ Insert bulb socket ④ into the housing.

- ▶ Turn bulb socket ④ clockwise until it engages.
- ▶ Plug in the electrical connector.
- ▶ Insert front fog lamp ② back into bumper.
- ▶ Fasten retaining screws ③.
- ▶ Reinsert cover ① and press it in until it engages.

Additional turn signal lamps bulbs

The additional turn signal lamps in the exterior rear view mirrors have LEDs.

If a malfunction occurs or LEDs fail to function, the entire turn signal unit must be replaced. Have the turn signal unit replaced by an authorized Mercedes-Benz Light Truck Center.

Replacing bulbs

Replacing bulbs for rear lamps

Before you start to replace a bulb for a rear lamp, do the following first:

- ▶ Turn the exterior lamp switch to position **0** (▷ page 136).

Tail lamp unit

i To access the bulb socket, you have to remove the cover in the corresponding side trim panel of the cargo compartment.

- ▶ Open the tailgate (▷ page 119).

Opening the side trim panels

Opening the driver's side trim panel:

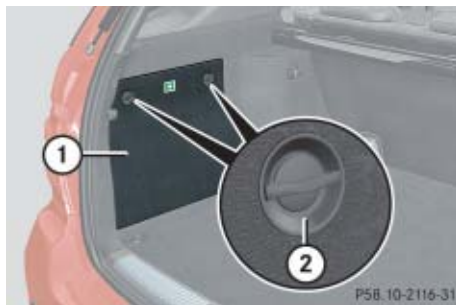

- ① Cover in left side trim panel
- ② Lock
- ▶ Turn lock ② 90°.
- ▶ Fold down the cover ①.

Vehicles without sound system*:

- ▶ Remove the storage compartment on the driver's side.



- ① Lock
- ② Storage compartment
- ▶ Insert a suitable object such as a coin into the slot of lock ①.
- ▶ Turn lock ① counterclockwise by 90°.
- ▶ Remove storage compartment ②.

Opening the passenger side trim panel:

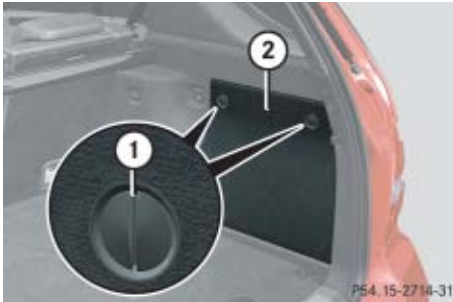

- ① Lock
- ② Cover in right side trim panel
- ▶ Insert a suitable object such as a coin into the slot of lock ①.
- ▶ Turn lock ① counterclockwise by 90°.
- ▶ Remove cover ②.

Replacing bulbs

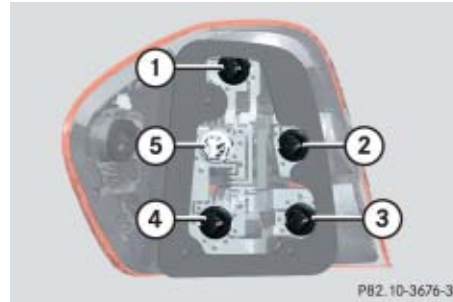

Example rear lamp passenger-side

- ① Brake lamp
- ② Backup lamp
- ③ Rear fog lamp (only driver's side), tail lamp, parking and standing lamp
- ④ Side marker lamp
- ⑤ Turn signal lamp
- ▶ Depending on which bulb needs to be replaced, turn the respective bulb socket ① - ⑤ counterclockwise.

- ▶ Press gently onto the respective bulb and turn counterclockwise out of its bulb socket.
- ▶ Press the new bulb gently into its bulb socket and turn clockwise until it engages.
- ▶ Align the respective bulb socket ① - ⑤ and turn it clockwise.
- ▶ Make sure bulb socket is attached properly.
- ▶ Close the respective cover in the cargo compartment.
- ▶ Close the tailgate (▶ page 121).

Replacing bulbs

License plate lamp

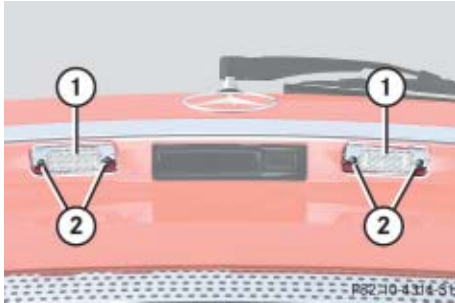

① License plate lamp cover

② Screws

- ▶ Loosen screws ②.
- ▶ Remove license plate lamp cover ①.
- ▶ Replace the tubular bulb.
- ▶ Reinstall license plate lamp cover ①.
- ▶ Retighten screws ②.

Adjusting headlamp aim

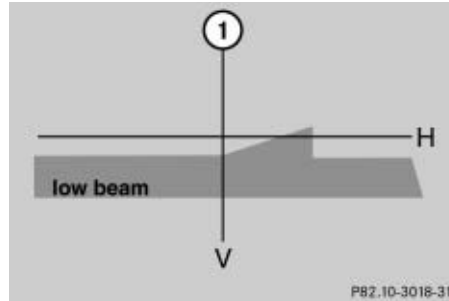

V Vertical centerline

H Headlamp mounting high, measured from the center

i High beam adjustments simultaneously aim the low beam.

Vehicle should have a normal tailgate load.

Correct headlamp adjustment is extremely important. To check and readjust a headlamp, follow the steps described:

- ▶ Park the vehicle on a level surface 25 feet (7.6 m) from a vertical test screen or wall.
- ▶ Switch the headlamps on (▷ page 136).

If the beam does not show a beam pattern as indicated in the figure left, then follow the steps below:

- ▶ Open hood (▷ page 356).



Example headlamp, driver's side

- ② Headlamp vertical adjustment screw
- ③ Headlamp vertical adjustment screw

- ▶ Always turn adjustment screws ② and ③ simultaneously for vertical adjustment until the headlamp is adjusted as shown ① (▷ page 492). Turn clockwise for upward movement and counterclockwise for downward movement.

Graduations:

screw ②: 0.50° pitch

screw ③: 0.67° pitch

The left and right headlamps must be adjusted individually.

i *If it is not possible to obtain a proper headlamp adjustment, have the system checked at an authorized Mercedes-Benz Light Truck Center.*

Replacing wiper blades

Front wiper blades

Warning!



For safety reasons, switch off wipers and remove SmartKey from starter switch (vehicles with KEYLESS-GO*: Make sure the vehicle's on-board electronics have status **0**) before replacing a wiper blade. Otherwise the motor could suddenly turn on and cause injury.

Warning!



Wiper blades are components that are subject to wear and tear. Change the wiper blades twice a year, preferably in the spring and fall. Otherwise the windows will not be properly wiped. As a result, you may not be able to observe surrounding traffic conditions and could cause an accident.

! *Never open the hood when the wiper arms are folded forward.*

Hold on to the wiper when folding the wiper arm back. If released, the force of the impact from the tensioning spring could crack the windshield.

Do not allow the wiper arms to contact the windshield glass without a wiper blade inserted.

Make sure the wiper blades are properly installed. Improperly installed wiper blades may cause windshield damage.

For your convenience, we recommend that you have this work carried out by an authorized Mercedes-Benz Light Truck Center.

Removing

- ▶ Remove the SmartKey from the starter switch.

Vehicles with KEYLESS-GO*:

- ▶ Make sure the vehicle's on-board electronics have status **0** (▷ page 42).

! *Do not pull on the wiper blade inserts. They could tear.*

- ▶ Fold the wiper arms forward until they engage.

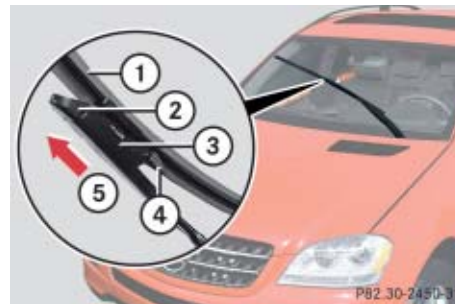

- ① Wiper blade
- ② Cover
- ③ Attachment
- ④ Tab
- ⑤ Removing

- ▶ Press tabs ④ together and tilt wiper blade ① to detach tabs ④ on both recesses of attachment ③.

Wiper blade ① is released on one end.

- ▶ Maintaining its tilted position, slide wiper blade ① out of attachment ③ in direction of arrow ⑤.

Replacing wiper blades

Installing



- ① Installing
- ② Tab
- ③ Attachment
- ④ Guide tab
- ⑤ Cover

- ▶ Slide the wiper blade into attachment ③ in direction of arrow ①.
- ▶ Make sure guide tab ④ will be placed under cover ⑤ when fully inserting the wiper blade into attachment.
- ▶ Let tab ② latch into both recesses of attachment ③.

- ▶ Check if the wiper blade is securely fastened.
- ▶ Fold the wiper arm backward to rest on the windshield.

Make sure you hold on to the wiper arm when folding it back.

Rear wiper blade

Warning!



For safety reasons, switch off wipers and remove SmartKey from starter switch (vehicles with KEYLESS-GO*: Make sure the vehicle's on-board electronics have status **0**) before replacing a wiper blade. Otherwise the motor could suddenly turn on and cause injury.

! Hold on to the wiper when folding the wiper arm back. If released, the force of the impact from the tensioning spring could crack the rear window.

Do not allow the wiper arm to contact the rear window glass without a wiper blade inserted.

Make sure the wiper blade is properly installed. Improperly installed wiper blades may cause rear window damage.

For your convenience, we recommend that you have this work carried out by an authorized Mercedes-Benz Light Truck Center.

Replacing wiper blades

Removing

- ▶ Remove the SmartKey from the starter switch.

Vehicles with KEYLESS-GO*:

- ▶ Make sure the vehicle's on-board electronics have status **0** (▷ page 42).

! Do not pull on the wiper blade insert. It could tear.

- ▶ Fold wiper arm ① away from the rear window until it engages.



- ① Wiper arm
- ② Wiper blade

- ▶ Turn wiper blade ② to form a right angle with wiper arm ① as shown.
- ▶ Hold wiper arm ① and disengage wiper blade ② by carefully sliding it in direction of arrow.
- ▶ Remove wiper blade ②.

Installing



- ① Wiper arm
- ② Wiper blade

- ▶ Insert wiper blade ② into wiper arm ①.

- ▶ Hold wiper arm ① and engage wiper blade ② by pushing it in direction of arrow until it locks into place.
- ▶ Check whether the wiper blade is securely fastened.
- ▶ Fold the wiper arm to rest on the rear window.

Make sure to hold on to the wiper when folding the wiper arm back.

▼ Flat tire

Warning!

The dimensions of the spare wheel (Minispare wheel or collapsible tire) are different from those of the road wheels. As a result, the vehicle handling characteristics change when driving with a spare wheel mounted. Adapt your driving style accordingly.

The spare wheel is for temporary use only. When driving with a spare wheel mounted, ensure proper tire pressure and do not exceed a vehicle speed of 50 mph (80 km/h).

Drive to the nearest Mercedes-Benz Light Truck Center as soon as possible to have the spare wheel replaced with a regular road wheel.

Never operate the vehicle with more than one spare wheel mounted.

Do not switch off the ESP® when a Minispare wheel is mounted.

Preparing the vehicle**Warning!**

Vehicles with air suspension package*:

Do not open or close any doors or the tailgate while mounting a spare wheel. The vehicle could rise or lower to a previously selected level. You or others could be injured as a result.

- ▶ Park the vehicle in a safe distance from moving traffic on a hard, flat surface when possible.
- ▶ Turn on the hazard warning flasher (▷ page 142).
- ▶ Turn the steering wheel so that the front wheels are in a straight-ahead position.
- ▶ Set the parking brake (▷ page 57).

- ▶ Set the automatic transmission to park position **P** (▷ page 187).
- ▶ Turn off the engine (▷ page 39).
- ▶ Remove the SmartKey from the starter switch.

Vehicles with KEYLESS-GO*:

- ▶ Turn off the engine by pressing the KEYLESS-GO* button once (▷ page 67).
- ▶ Open the driver's door (this puts the starter switch in position **0**, same as with the SmartKey removed from the starter switch). The driver's door then can be closed again.
- ▶ Have any passenger exit the vehicle at a safe distance from the roadway.

 *Open door only when conditions are safe to do so.*



Flat tire

▷▷ Vehicles with collapsible tire:

You can use the power outlet in the cargo compartment or in the front of the rear seats to operate the electric air pump even when the ignition is switched off, e.g. in order to inflate the collapsible emergency spare tire.

An emergency shut-off feature ensures that the vehicle's electrical voltage does not fall below a minimum level. If the voltage drops to this minimum level, the power outlets are automatically switched off. This ensures that enough power remains to start the engine.

Mounting the spare wheel

Preparing the vehicle

- ▶ Prepare the vehicle as described (▷ page 497).

Vehicles with Minispare wheel:

- ▶ Take the wheel wrench, the collapsible wheel chock, and the vehicle jack out of the cargo compartment (▷ page 469).
- ▶ Take the Minispare wheel out of the cargo compartment (▷ page 473).

Vehicles with collapsible tire (ML 63 AMG only):

- ▶ Take the collapsible tire, wheel wrench, wheel bolts, jack, and electric air pump out of the cargo compartment (▷ page 474).

Vehicles with factory-mounted running-boards*:

Your vehicle is equipped with a scissors-type jack (located under the cargo compartment floor) designed for use with factory-mounted running boards. Only use this jack when jacking up vehicles with factory-mounted running boards as otherwise the vehicle's underbody can be damaged. See separate instructions for scissors-type jack.

Lifting the vehicle

Warning!



The jack is designed exclusively for jacking up the vehicle at the jack take-up brackets built into both sides of the vehicle. To help avoid personal injury, use the jack only to lift the vehicle during a wheel change. Never get beneath the vehicle while it is supported by the jack. Keep hands and feet away from the area under the lifted vehicle. Always firmly set parking brake and block wheels before raising vehicle with jack.

Do not disengage parking brake while the vehicle is raised. Be certain that the jack is always vertical (plumb line) when in use, especially on hills. Always try to use the jack on level surface. Make sure that the jack arm is fully seated in the jack take-up bracket. Always lower the vehicle onto sufficient capacity jackstands before working under the vehicle.

- ▶ Prevent the vehicle from rolling away by blocking wheels with wheel chocks or other sizable objects.

One collapsible wheel chock is included with the vehicle tool kit (▷ page 469). For information on setting up the collapsible wheel chock, see (▷ page 472).

When changing wheel on a level surface:

- ▶ Place one wheel chock in front of and another sizeable object behind the wheel that is diagonally opposite to the wheel being changed.

Always try lifting the vehicle using the jack on a level surface. However, should circumstances require you to do so on a hill, place the wheel chock and another sizeable object as follows:

- ▶ Place the wheel chock and another sizable object on the downhill side blocking both wheels of the axle not being worked on.



① Wheel wrench

- ▶ On wheel to be changed, loosen but do not yet remove the wheel bolts (approximately one full turn with wheel wrench ①).

The jack take-up brackets are located directly behind the front wheel housings and in front of the rear wheel housings.

! Do not position the jack on the body of the vehicle, as this may cause damage to the vehicle.

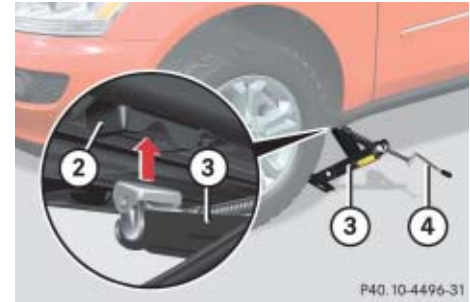

② Take-up bracket

③ Jack

④ Crank

! **Vehicles with factory-mounted running-boards*:**

Your vehicle is equipped with a scissors-type jack (located under the cargo compartment floor) designed for use with factory-mounted running boards. Only use this jack when jacking up vehicles with factory-mounted running boards as otherwise the vehicle's underbody can be damaged. See separate instructions for scissors-type jack.

- ▶ Place jack ③ on firm ground.



Flat tire

- ▷▷▶ Position jack ③ under the take-up bracket ② so that it is always vertical (plumb-line) as seen from the side, even if the vehicle is parked on an incline.

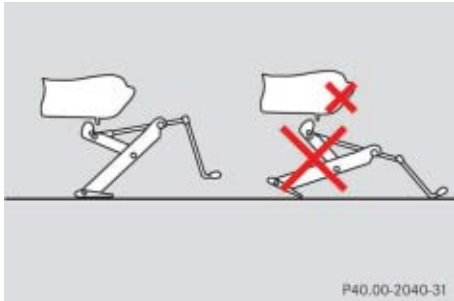

- ▶ Turn crank ④ clockwise until jack ③ is fully seated in take-up bracket ② and the jack base evenly meets the ground.
- ▶ Continue to turn crank ④ until the wheel is a maximum of 1.2 in (3 cm) from the ground.

Warning!



The jack is intended only for lifting the vehicle briefly for wheel changes. It is not suited for performing maintenance work under the vehicle.

- Never start the engine when the vehicle is raised.
- Never lie down under the raised vehicle.

Removing the wheel



① Alignment bolt

- ▶ Unscrew upper-most wheel bolt and remove it.
- ▶ Replace this wheel bolt with alignment bolt ① supplied with the tool kit (▷ page 469).
- ▶ Remove the remaining bolts.
- ▶ **!** Do not place wheel bolts in sand or dirt. This could result in damage to the bolts and wheel hub threads.
- ▶ Remove the wheel.

Mounting the new wheel

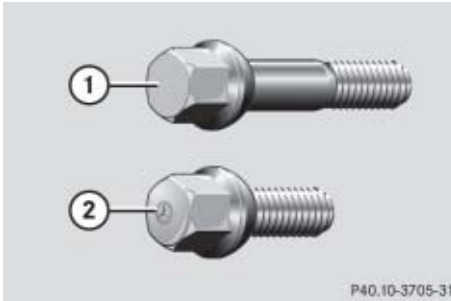

- ① Wheel bolt for 18", 19" and 20" light alloy wheels and collapsible tire (AMG vehicles)
- ② Wheel bolt for 17" light alloy wheels or Minispare wheel (located in vehicle tool kit (> page 469))

! Wheel bolts ② must be used when mounting 17" light alloy rims or the Minispare wheel. The use of any wheel bolts other than wheel bolts ② for 17" light alloy rims or the Minispare wheel will damage the vehicle's brakes.

- ▶ Clean contact surfaces of wheel and wheel hub.

! To avoid paint damage, place wheel flat against hub and hold it there while installing first wheel bolt.

Warning!



Always replace wheel bolts that are damaged or rusted.

Never apply oil or grease to wheel bolts.

Damaged wheel hub threads should be repaired immediately. Do not continue to drive under these circumstances! Contact an authorized Mercedes-Benz Light Truck Center or call Roadside Assistance.

Incorrect wheel bolts or improperly tightened wheel bolts can cause the wheel to come off. This could cause an accident. Make sure to use the correct wheel bolts.



- ▶ Guide spare wheel onto the alignment bolt and push it on the wheel hub.
- ▶ Insert wheel bolts and tighten them slightly.
- ▶ Unscrew the alignment bolt.
- ▶ Insert the remaining wheel bolt and tighten it slightly.

Flat tire

Warning!



Only use genuine equipment Mercedes-Benz wheel bolts. Other wheel bolts may come loose.

Do not tighten the wheel bolts when the vehicle is raised. Otherwise the vehicle could fall off the jack.

Inflating the collapsible tire (ML 63 AMG only)

Warning!



Vehicles with collapsible tire (ML 63 AMG only):

Inflate collapsible tire only after the wheel is properly mounted.

Inflate the collapsible tire using the electric pump (▷ page 502) before lowering the vehicle.

Warning!



Observe instructions on air pump label.

! Do not lower the vehicle before inflating the collapsible tire. Otherwise the rim may be damaged.

- ▶ Take the electric air pump out of the cargo compartment (▷ page 474).

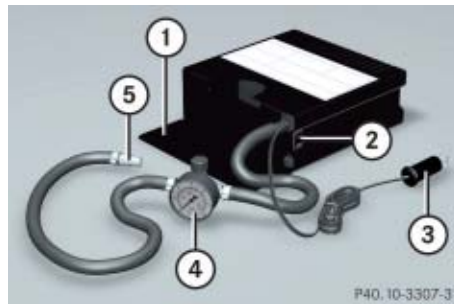

Electric air pump

- ① Flap
 - ② On/off switch
 - ③ Electrical plug
 - ④ Air hose with pressure gauge and vent screw
 - ⑤ Union nut
- ▶ Open flap ① on electric air pump.
 - ▶ Pull out electrical plug ③ and air hose with pressure gauge ④.
 - ▶ Remove the valve cap from the collapsible tire valve.

- ▶ Screw union nut ⑤ onto the collapsible tire valve.
- ▶ Insert electrical plug ③ into a power outlet (▷ page 302).

! *The cigarette lighter* (▷ page 300) or the power outlet in the front center console (▷ page 302) is not designed for use with the electric air pump. Use the power outlet in the rear center console or in the cargo compartment (▷ page 303) for electric air pump operation.*

- ▶ Turn the SmartKey in the starter switch to position **1**.

or

- ▶ Vehicles with KEYLESS-GO*: Press the KEYLESS-GO start/stop button once without depressing the brake pedal.
- ▶ Press I on electric air pump switch ②.

The electric air pump should now switch on and inflate the collapsible tire.

- ▶ Inflate the collapsible tire to the recommended tire inflation pressure given in the “Technical data” section (▷ page 536).

This takes about 5 minutes for the collapsible tire.

Warning!



Air hose ④ and union nut ⑤ can become hot during inflation. Exercise proper caution to avoid burning yourself when using the equipment.

! *Do not operate the electric air pump longer than 8 minutes without interruption. Otherwise it may overheat.*

You may operate the electric air pump again after it has cooled off.

! *Please compare the recommended tire inflation pressure for your vehicle with the tire inflation pressure on the yellow label located on the spare wheel rim.*

If the tire inflation pressure on the yellow label on the spare wheel rim differs from the values given in this Operator’s Manual, inflate the tire to the recommended tire inflation pressure given on the yellow label on the spare wheel rim.

- ▶ Press 0 on electric air pump switch ②.
- ▶ Turn the SmartKey in the starter switch to position **0**.

or

- ▶ Vehicles with KEYLESS-GO*: Press the KEYLESS-GO start/stop button twice without depressing the brake pedal.
- ▶ If the tire inflation pressure is above the recommended tire inflation pressure given in this Operator’s Manual, release excess tire inflation pressure using the vent screw.



Flat tire



Warning!



Follow recommend inflation pressures.

Do not overinflate tires. Overinflated tires can result in sudden deflation (blowout) because they are more likely to become punctured or damaged by road debris, potholes, etc.

Do not underinflate tires. Underinflated tires wear unevenly, adversely affect handling and fuel economy, and are more likely to fail from being overheated.

- ▶ Detach the electric air pump.
- ▶ Store the electrical plug and the air hose behind the flap and place the electric air pump back in the cargo compartment.

Lowering the vehicle

Warning!



Vehicles with collapsible tire (ML 63 AMG only):

Inflate collapsible tire only after the wheel is properly mounted.

Inflate the collapsible tire using the electric pump (▶ page 502) before lowering the vehicle.

- ▶ Lower vehicle by turning crank counterclockwise until vehicle is resting fully on its own weight.
- ▶ Remove the jack.

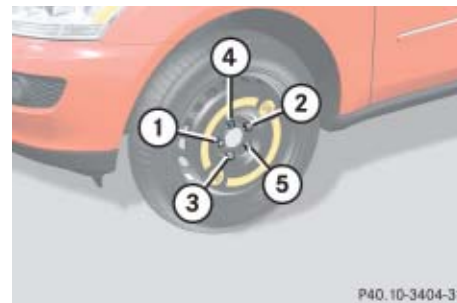

P40.10-3404-31

①-⑤ Wheel bolts

- ▶ Tighten the five wheel bolts evenly, following the diagonal sequence illustrated (1 to 5), until all bolts are tight. Observe a tightening torque of 110 lb-ft (150 Nm).

Warning!





Have the tightening torque checked after changing a wheel. The wheels could come loose if they are not tightened to a torque of 110 lb-ft (150 Nm).

- ▶ Store jack and all other vehicle tool kit items back into the storage well.

 *The removed road wheel cannot be stored in the spare wheel well under the cargo compartment floor, but should be transported in the cargo compartment wrapped in a protective cover.*

Vehicles with TPMS or Advanced TPMS:
Do not activate the tire inflation pressure monitor until a full size wheel/tire with functioning sensor has been placed back into service on the vehicle.*

Bleeding the fuel system (diesel engine only)

Driving the vehicle until the fuel tank is empty is not recommended. Otherwise, air may be sucked into the fuel system. If this happens, the  malfunction indicator lamp (USA only) or the  malfunction indicator lamp (Canada only) comes on and the engine may not start immediately after refueling the vehicle.

After refueling:

- ▶ Make sure the automatic transmission is set to **P**.

The gear position indicator in the multi-function display should be on **P**.

- ▶ Do not depress the accelerator.

 *Vehicles with KEYLESS-GO*: If necessary, remove the KEYLESS-GO start/stop button from the starter switch (▷ page 40).*



- ▶ Turn the SmartKey in the starter switch to position **2** for at least 10 seconds (▷ page 40).
- ▶ Return the SmartKey in the starter switch to position **0** (▷ page 40).

- ▶ Turn the SmartKey in the starter switch to position **3** (▷ page 40) and hold it there for a maximum of 40 seconds or until the engine runs surge-free.

If the engine does not start:

- ▶ Wait for approximately 2 minutes.
- ▶ Turn the SmartKey in the starter switch to position **3** (▷ page 40) and hold it there for a maximum of 40 seconds or until the engine runs surge-free.

If the engine still does not start, do not make any further attempts to start the engine. Contact an authorized Mercedes-Benz Light truck Center or call Roadside Assistance (▷ page 312).

 *When the  malfunction indicator lamp (USA only) or the  malfunction indicator lamp (Canada only) has been illuminated for the above condition, it will remain illuminated until the engine was cycled on and off four times in a row.*

▼ Battery

The battery is located under the front passenger seat.

i Mercedes-Benz recommends to have the battery replaced at an authorized Mercedes-Benz Light Truck Center.

The battery should always be sufficiently charged in order to achieve its rated service life.

If you use your vehicle mostly for short-distance trips, you will need to have the battery charge checked more frequently.

When replacing the battery, always use batteries approved by Mercedes-Benz.

If you do not intend to operate your vehicle for an extended period of time, consult an authorized Mercedes-Benz Light Truck Center about steps you need to observe.

Warning!



Observe all safety instructions and precautions when handling automotive batteries.



Risk of explosion.



Fire, open flames and smoking are prohibited when handling batteries. Avoid creating sparks.



Battery acid is caustic. Do not allow it to come into contact with skin, eyes or clothing.

Wear suitable protective clothing, especially gloves, apron and faceguard.



Wear eye protection.

Rinse any acid spills immediately with clear water. Contact a physician if necessary.



Keep children away.



Follow the instructions in this Operator's Manual.

Batteries contain materials that can harm the environment if disposed of improperly. Recycling of batteries is the preferred method of disposal. Many states require sellers of batteries to accept old batteries for recycling.

Battery

! *The battery is a valve-regulated lead acid (VRLA) battery, also referred to as “fleece” battery. Such batteries do not require topping-up of the electrolyte level. VRLA batteries therefore do not have cell caps and the battery cover is non-removable. Do not attempt to open the battery as otherwise the battery will be damaged.*

Even though VRLA batteries do not require topping-up of the electrolyte level and cannot be opened to check the electrolyte level, the battery condition must be checked periodically by performing a battery conductance test. Refer to Maintenance Booklet for battery condition testing intervals.

As with any other battery, the battery may discharge if the vehicle is not operated for an extended period of time. You can connect a battery maintenance charge unit tested and approved for use on your vehicle model or disconnect the battery to prevent battery discharge. Contact an authorized Mercedes-Benz Light Truck Center for more information.

! *The factory-equipped VRLA battery is leak-proofed. Only use a battery as replacement that has the same security features and is of identical size, voltage, and capacity as the factory-equipped battery.*

The battery, the battery ventilation hose (▷ page 513) and the lateral plug (▷ page 513) must always be securely installed when the vehicle is in operation.

Warning!



Jump starting must only be done using the jump-start contacts located in the engine compartment (▷ page 515).

Warning!



Failure to follow these instructions can result in severe injury or death.

Observe all safety instructions and precautions when handling automotive batteries (▷ page 507).

Never lean over batteries while connecting, you might get injured.

Battery fluid contains sulfuric acid. Do not allow this fluid to come in contact with eyes, skin or clothing. In case it does, immediately flush affected area with water and seek medical help if necessary.

A battery will also produce hydrogen gas, which is flammable and explosive. Keep flames or sparks away from battery, avoid improper connection of jumper cables, smoking etc.

! Never loosen or detach battery terminal clamps while the engine is running or the SmartKey is in the starter switch. Otherwise the alternator and other electronic components could be severely damaged.

Have the battery checked regularly by an authorized Mercedes-Benz Light Truck Center. Contact your authorized Mercedes-Benz Light Truck Center for further information.

Warning!



Do not place metal objects on the battery as this could result in a short circuit.

Use leak-proof battery only to avoid the risk of acid burns in the event of an accident.

Disconnecting, removing, reinstalling and reconnecting the battery

Warning!



Disconnecting, removing, reinstalling and reconnecting the battery is a complicated and technically demanding procedure that also requires safety precautions to avoid the risk of injury. We strongly recommend that it be performed by a qualified technician or an authorized Mercedes-Benz Light Truck Center only. Please read the instructions fully before beginning operation and only undertake it if you feel fully capable of performing all of the tasks involved as described in these instructions. Observe all safety instructions and precautions when handling automotive batteries (▷ page 507). Performing the tasks involved incorrectly can cause damage to the vehicle and impair the operating safety of the vehicle, and/or cause severe injury to you or others.

i With a disconnected battery you will no longer be able to turn the SmartKey in the starter switch and pressing the KEYLESS-GO* start/stop button will have no effect.

Step 1 (Disconnecting)

i If your battery is discharged, the vehicle must be jump started (▷ page 515) using the jump start contacts in the engine compartment, or an accessory battery charge unit* approved by Mercedes-Benz must be connected using the jump start contacts in the engine compartment (see separate instructions for the accessory battery charge unit*) before any of the following steps can be performed. If the battery cannot be jumped or charged, please contact an authorized Mercedes-Benz Light Truck Center.

- ▶ Set the automatic transmission to position **P** (▷ page 187).
- ▶ Firmly depress the parking brake (▷ page 65).
- ▶ Turn off the engine (▷ page 66).
- ▶ Leave the ignition switched on (▷ page 40).



Battery

▷▷ **i** If the vehicle battery is discharged and you had the vehicle jump started:

- Leave the engine running.
- Complete step 1, starting with switching off all electrical consumers.
- Continue with step 2.
- When the front passenger seat is in the most forward position, turn off the engine.

- ▶ Switch off all electrical consumers.
- ▶ Read and observe safety instructions and precautions (▷ page 507).
- ▶ Open the front passenger door.

i Open doors only when conditions are safe to do so.

- ▶ Move the front passenger seat to the most forward position (▷ page 44).

Step 2 (Disconnecting)

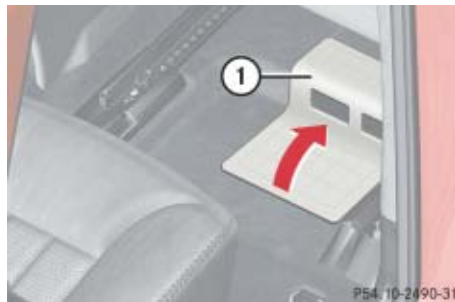

① Battery cover

- ▶ Enter the rear passenger compartment and remove main battery cover ①.

Step 3 (Disconnecting)

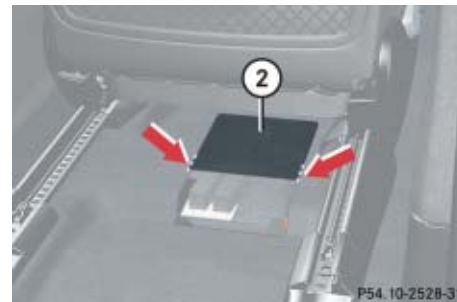

② Perforated floor carpet

- ▶ Cut the floor carpet ② along the dotted white line (see illustration) until you reach the perforated part. Start cutting at the point indicated by the arrows. Cut carpet using a sharp object (knife etc.).
- ▶ Enter the front passenger compartment.
- ▶ Move the front passenger seat to the most rearward position (▷ page 44).

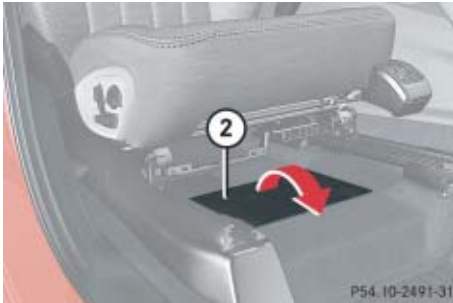

- ② Perforated floor carpet, unfolded
- ▶ Fold the floor carpet piece ② in direction of the arrow.
 - ▶ Move the front passenger seat to the most forward and upward position again (▷ page 44).
 - ▶ Switch off the ignition (▷ page 40).

i If the vehicle battery is discharged and you had the vehicle jump started, turn off the engine.

- ▶ Remove SmartKey from starter switch.
- Vehicles with KEYLESS-GO*:
- ▶ Make sure the vehicle's on-board electronics have status **0** (Turn off the engine or all electrical systems using the KEYLESS-GO start/stop button. Open the driver's door. With the driver's door open, the vehicle's on-board electronics have status **0**, same as with the SmartKey removed from the starter switch).
 - ▶ Enter the rear passenger compartment again.

Step 4 (Disconnecting)

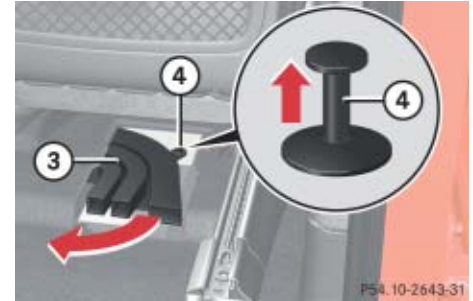

- ③ Air channel
④ Clip with pin insert
- ▶ Pull pin out of clip ④ in direction of arrow.
 - ▶ Pull clip with pin ④ outwards.
 - ▶ Remove air channel ③ by pulling it out in direction of arrow.

Battery

Step 5 (Disconnecting)

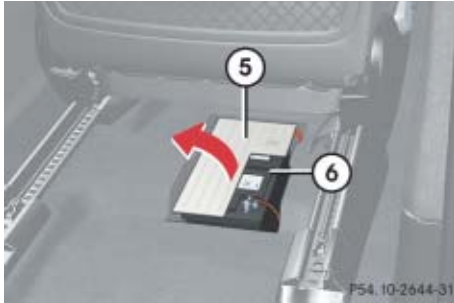

- ⑤ Protection cover
- ⑥ Battery

- ▶ Unclip protection cover ⑤ from battery ⑥ and remove it.

Step 6 (Disconnecting)

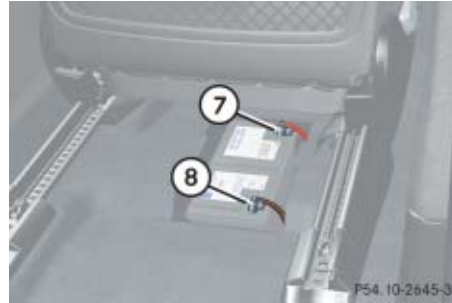

- ⑦ Positive terminal
- ⑧ Negative terminal

- ▶ Disconnect battery negative lead ⑧ from negative terminal.
- ▶ Remove positive terminal cover.
- ▶ Disconnect the battery positive lead ⑦.

Step 7 (Removing)

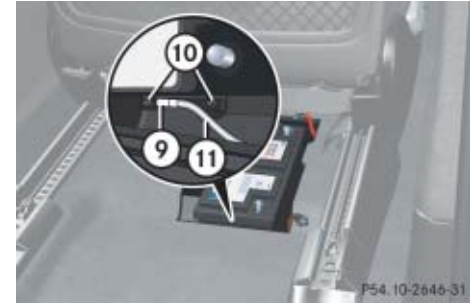

- ⑨ Battery ventilation hose
- ⑩ Attachment nut
- ⑪ Mounting

- ▶ Remove the battery ventilation hose ⑨ by pulling it out.
- ▶ Unfasten and remove attachment nuts ⑩.
- ▶ Remove mounting ⑪.

Step 8 (Removing)

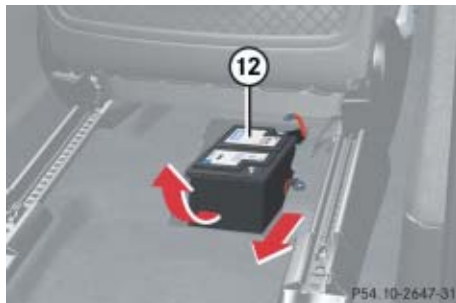

⑫ Battery

- ▶ Tilt the battery ⑫ with the negative terminal side upwards.
- ▶ Take out the battery maintaining its tilted position in the direction of the arrow.

Step 9 (Reinstalling)

- ▶ Carry out step 8 in reverse order (▷ page 513).

! The battery, the battery ventilation hose ⑨ and the lateral plug ⑬ (▷ page 513) must always be securely installed when the vehicle is in operation.

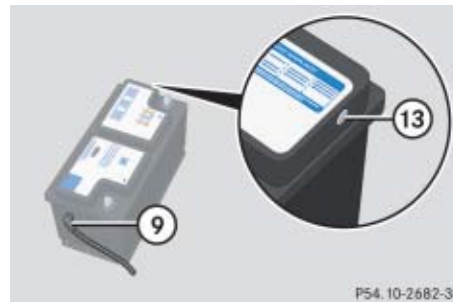

Battery, shown removed for illustration

- ⑨ Battery ventilation hose
- ⑬ Vent plug

- ▶ Carry out step 10 to reconnect the battery (▷ page 513).
- ▶ Follow steps 5 to 1 in reverse order to completely reinstall the battery (▷ page 512) to (▷ page 509).

Step 10 (Reconnecting)

- ▶ If the battery has been removed, first carry out step 8 in reverse order (▷ page 513).
- ▶ Open the driver's door.
- ▶ Make sure all electrical consumers are turned off.
- ▶ Make sure the SmartKey is removed from the starter switch.

Vehicles with KEYLESS-GO*:

- ▶ Make sure the vehicle's on-board electronics have status **0** (Open the driver's door. With the driver's door open, the vehicle's on-board electronics have status **0**, same as with the SmartKey removed from the starter switch (▷ page 39)).



Battery

- ▷▷ Connect the positive lead to the positive terminal and fasten it's cover (▷ page 512).
- ▶ Connect the negative lead to the negative terminal (▷ page 512).

! *Never invert the terminal connections!*

i *The following procedures must be carried out following any interruption of battery power (e.g. due to reconnection):*

- *Set the clock (▷ page 169).*
Vehicles with COMAND system with navigation module: Time and date are set automatically.*
- *Synchronize the door windows (▷ page 238).*
- *Synchronize the power tilt/sliding sunroof* (▷ page 244).*
- *Synchronize the power folding exterior rear view mirrors* (▷ page 202).*

Charging the battery

If the battery is discharged, the battery can be charged using the jump-start contacts located in the engine compartment (▷ page 516).

Warning!



Never charge a battery while still installed in the vehicle unless the accessory battery charge unit approved by Mercedes-Benz is being used. Gases may escape during charging and cause explosions that may result in paint damage, corrosion or personal injury.

An accessory battery charge unit specially adapted for Mercedes-Benz vehicles and tested and approved by Mercedes-Benz is available, permitting the charging of the battery in its installed position. Contact an authorized Mercedes-Benz Light Truck Center for information and availability. Charge battery in accordance with the separate instructions for the accessory battery charger.

- ▶ Charge the battery in accordance with the instructions of the battery charger manufacturer.

Batteries contain materials that can harm the environment if disposed of improperly. Large 12-volt storage batteries contain lead. Recycling of batteries is the preferred method of disposal. Many states require sellers of batteries to accept old batteries for recycling.

▼ Jump starting

Warning!

Failure to follow these directions will cause damage to the electronic components, and can lead to a battery explosion and severe injury or death.

Never lean over batteries while connecting or jump starting, you might get injured.

Battery fluid contains sulfuric acid. Do not allow this fluid to come in contact with eyes, skin or clothing. In case it does, immediately flush affected area with water, and seek medical help if necessary.

A battery will also produce hydrogen gas, which is flammable and very explosive. Keep flames or sparks away from battery, avoid improper connection of jumper cables, smoking, etc.

Attempting to jump start a frozen battery can result in it exploding, causing personal injury.

Read all instructions before proceeding.

If the battery is discharged, the engine can be started with jumper cables and the battery of another vehicle. Observe the following:

- Jump starting should only be performed using the jump-start contacts located in the engine compartment (▷ page 516).
- Jump starting should only be performed when the engine and catalytic converter¹ are cold.
- Do not start the engine if the battery is frozen. Let the battery thaw out first.
- Only jump start from batteries with the same voltage rating (12 V). Jump starting with a more powerful battery could damage the vehicle's electrical system, which will not be covered by the Mercedes-Benz Limited Warranty.
- Only use jumper cables with sufficient cross-section and insulated terminal clamps.

- Always make sure the jumper cables are not on or near pulleys, fans or other parts that move when the engine is started or running.

! Do not tow-start the vehicle.

! Avoid repeated and lengthy starting attempts.

Do not attempt to start the engine using a battery quick charge unit.

If the engine does not run after several unsuccessful starting attempts, have it checked at the nearest authorized Mercedes-Benz Light Truck Center.

Excessive unburned fuel generated by repeated failed starting attempts may damage the catalytic converter¹.

Make sure the jumper cables do not have loose or missing insulation.

Make sure the cable clamps do not touch any other metal part while the other end is still attached to a battery.

¹ Vehicles with gasoline engine only.

Jump starting

Warning!



Keep flames or sparks away from battery.
Do not smoke.

Observe all safety instructions and precautions when handling automotive batteries (▷ page 507).

The jump-start contacts are located in the engine compartment.



- ① Negative (-) terminal
 - ② Positive (+) terminal
- ▶ Make sure the two vehicles do not touch.
 - ▶ Turn off all electrical consumers.
 - ▶ Apply parking brake.
 - ▶ Set automatic transmission to position **P**.
 - ▶ Open the hood (▷ page 356).
 - ▶ Open cover of positive terminal ②.

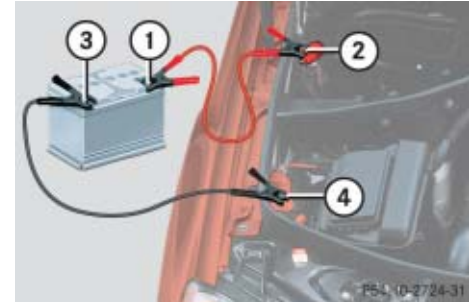

- ① Positive terminal of charged battery
- ② Positive terminal of discharged battery
- ③ Negative terminal of charged battery
- ④ Negative terminal of discharged battery

- ▶ Connect positive terminal ① and ② with the jumper cable. Clamp cable to charged battery ① first.
- ▶ Start engine of the vehicle with the charged battery and run at idle speed.
- ▶ Connect negative terminals ③ and ④ of the batteries with the second jumper cable. Clamp the cable to negative terminal ③ of the charged battery first.

! *Never invert the terminal connections!*

- ▶ Start the engine of the disabled vehicle.

You can now turn on the electrical consumers. Do not switch on the headlamps under any circumstances.

- ▶ Remove the jumper cables first from negative terminals ④ and ③ and then from positive terminals ② and ①.

You can now switch on the headlamps.

- ▶ Have the battery checked at the nearest authorized Mercedes-Benz Light Truck Center.

Towing the vehicle

Mercedes-Benz recommends that the vehicle be transported with all wheels off the ground using flatbed or appropriate wheel lift/dolly equipment. This method is preferable to other types of towing.

! Use flatbed or wheel lift/dolly equipment, with the SmartKey in starter switch turned to position **0**.

Do not tow with sling-type equipment. Towing with sling-type equipment over bumpy roads will damage radiator and supports.

To prevent damage during transport, do not tie down vehicle by its chassis or suspension parts. Use the towing eyes.

Switch off the ESP® (▷ page 99) and the automatic central locking (▷ page 126).

! Do not tow-start the vehicle.

When circumstances do not permit the recommended towing methods, the vehicle may be towed with all wheels on the ground only so far as necessary to have the vehicle moved to a safe location where the recommended towing methods can be employed.

! Do not tow with one axle raised. Doing so could damage the transfer case, which is not covered by the Mercedes-Benz Limited Warranty.

All wheels must be on or off the ground. Observe instructions for towing the vehicle with all wheels on the ground.

! When towing the vehicle with all wheels on the ground, the automatic transmission must be in position **N** and the starter switch must be in position **2** (▷ page 40).

When towing the vehicle with all wheels on the ground, the vehicle may be towed only for distances up to 30 miles (50 km) and at a speed not to exceed 30 mph (50 km/h).

Keep in mind that it is important for the SmartKey to be in the respective starter switch positions as described above. As soon as the SmartKey is removed from the starter switch or the SmartKey with KEYLESS-GO is removed from the vehicle, the automatic transmission will shift to park position **P** see “Starter switch positions” (▷ page 39).*

Warning!

If circumstances require towing the vehicle with all wheels on the ground, always tow with a tow bar if:

- the engine will not run
- there is a malfunction in the power supply or in the vehicle's electrical system

Prior to towing the vehicle with all wheels on the ground, make sure the starter switch is in position **2** (▷ page 40).

i To signal turns while being towed with hazard warning flasher in use, set the starter switch to position **2** and activate combination switch for left or right turn signal in usual manner – only the selected turn signal will operate.

Upon canceling the turn signal, the hazard warning flasher will operate again.

i If the battery is disconnected or discharged, the automatic transmission will remain locked in position **P** and the SmartKey will not turn in the starter switch. For more information, see “Battery” (▷ page 507) and “Jump starting” (▷ page 515).

! When towing the vehicle with all wheels on the ground, note the following:

With the automatic central locking activated and the ignition in position **2** (▷ page 40), the vehicle doors lock if the left front wheel is turning at a speed of approximately 9 mph (15 km/h) or above.

To prevent the vehicle doors from locking, deactivate the automatic central locking (▷ page 126).

Towing of the vehicle should only be done using the towing eye bolt. Never attach tow cable, tow rope or tow rod to vehicle chassis, frame or suspension parts.

Warning!

With the engine not running, there is no power assistance for the brake and steering systems. In this case, it is important to keep in mind that a considerably higher degree of effort is necessary to brake and steer the vehicle. Adapt your driving accordingly.

Towing the vehicle

Installing towing eye bolt

Depending on whether you are towing a vehicle or you are being towed, the towing eye bolt can be screwed into threaded holes which are located behind covers on the right-hand side of each bumper.

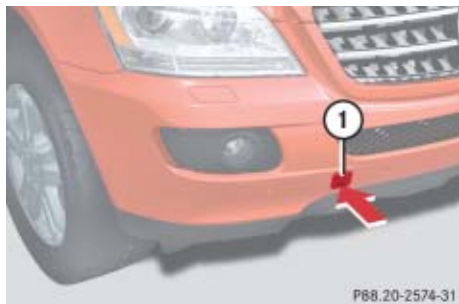

① Cover

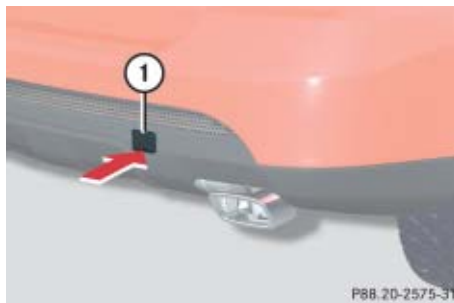

① Cover

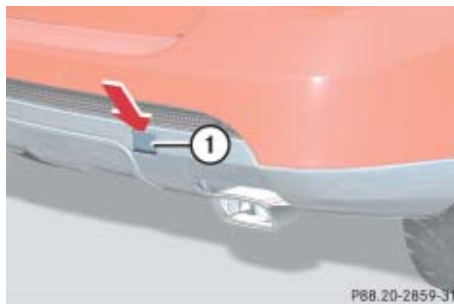

Vehicles with Sport Package*

① Cover

Warning!



In order to avoid possible serious burns or injury, use extreme caution when removing the rear cover, because the rear exhaust pipe is extremely hot.

Removing cover

i The cover ① is secured to the bumper by a plastic cord.

- ▶ Press mark on cover ① as indicated by the arrow.

Vehicles with Sport Package*:

- ▶ Pry cover ① with a screwdriver or similar tool at point indicated by the arrow.
- ▶ Lift off cover ① to reveal the threaded hole for towing eye bolt.

Installing towing eye bolt

- ▶ Take the towing eye bolt and wheel bolt wrench from the vehicle tool kit (▷ page 469).
- ▶ Screw towing eye bolt in clockwise to its stop and tighten with wheel wrench.

Removing towing eye bolt

- ▶ Loosen towing eye bolt counterclockwise with wheel wrench.
- ▶ Unscrew towing eye bolt.
- ▶ Store the towing eye bolt and wheel bolt wrench back into the vehicle tool kit (▷ page 469).

Installing cover

- ▶ Engage cover ① at top and press at bottom.

Stranded vehicle

Freeing a stranded vehicle, on which the wheels are dug into sand or mud, should be done with the greatest of care, especially if the vehicle is heavily loaded.

Avoid pulling the vehicle abruptly or diagonally, since it could result in damage to the chassis alignment.

Never try to free a vehicle that is still coupled to a trailer.

If possible, a vehicle equipped with trailer hitch receiver should be pulled backward in its own previously made tracks.

Fuses

The electrical fuses in your vehicle serve to switch off malfunctioning power circuits.

If a fuse is blown, the components and systems secured by that fuse will stop operating.

Warning!



Only use fuses approved by Mercedes-Benz with the specified amperage for the system in question and do not attempt to repair or bridge a blown fuse. Using other than approved fuses or using repaired or bridged fuses may cause an overload leading to a fire, and/or cause damage to electrical components and/or systems. Have the cause determined and remedied by an authorized Mercedes-Benz Light Truck Center.

i A blown fuse must be replaced by an appropriate spare fuse (recognizable by its color or the fuse rating given on the fuse) of the amperage recommended in the fuse chart. Any Mercedes-Light Truck Center will be glad to advise you on this subject.

If a newly inserted fuse blows again, have the cause determined and rectified by an authorized Mercedes-Benz Light Truck Center.

The following aids are available to help you replace fuses. They are included with the vehicle tool kit (▷ page 469):

- Fuse chart
The fuse chart explains the fuse allocation and fuse amperages.
- Spare fuses
- Fuse extractor

The electrical fuses are located in different fuse boxes:

- Fuse box in engine compartment (▷ page 523)
- Fuse box in cargo compartment (▷ page 523)
- Fuse box in passenger compartment (▷ page 524)

Before replacing fuses:

- ▶ Apply parking brake (▷ page 65).
- ▶ Make sure the automatic transmission is set to **P** (▷ page 187).

The gear position indicator in the multi-function display should be on **P**.

- ▶ Turn off all electrical consumers.
- ▶ Turn off the engine (▷ page 40).
- ▶ Remove the SmartKey from the starter switch.

Vehicles with KEYLESS-GO*:

- ▶ Open the driver's door (this puts the starter switch in position **0**, same as with the SmartKey removed from the starter switch). The driver's door then can be closed again.

Fuse box in engine compartment

The fuse box is located on the passenger side of the engine compartment.

- ▶ Open the hood (▷ page 356).



Example fuse box ML 350 (ML 320 CDI, ML 63 AMG similar)

- ① Clamp
- ② Fuse box cover

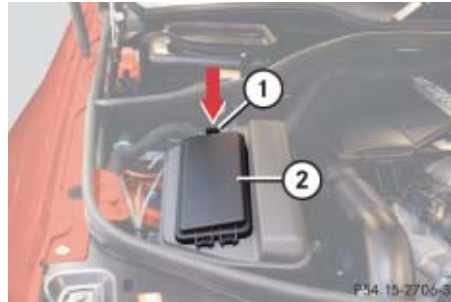

Fuse box ML 500

- ① Clamp
- ② Fuse box cover

- ▶ Pull clamp ① in direction of arrow.
- ▶ Lift fuse box cover ② up.
- ▶ Install fuse box cover in reverse order.

! *The fuse box cover must be installed properly to prevent moisture and/or dirt from entering the fuse box and possibly impairing fuse operation.*

- ▶ Close the hood after checking or replacing fuses (▷ page 358).

Fuse box in cargo compartment

The fuse box is located in the cargo compartment behind the passenger side trim panel.

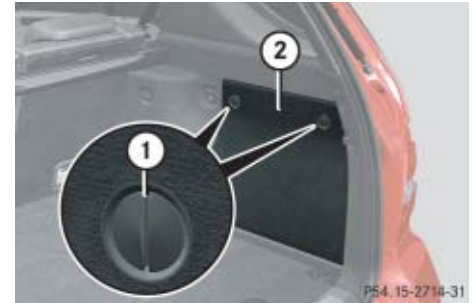

- ① Lock
- ② Cover

Fuses

Removing/installing cover

- ▶ Open the tailgate (▷ page 119).
- ▶ Insert a suitable object such as a coin into the slot of lock ① (▷ page 523).
- ▶ Turn lock ① counterclockwise by 90° in direction of arrow.
- ▶ Remove cover ②.
- ▶ Install cover ② in reverse order.

Fuse box in passenger compartment

The fuse box is located behind a cover in the dashboard on the front passenger side.



① Cover

! Do not use sharp objects such as a screwdriver to open the fuse box cover ① in the dashboard, as this could damage the fuse box cover or the dashboard.

Opening

- ▶ Open the front passenger door.
- ▶ Open the glove box (▷ page 294).
- ▶ Insert flat, blunt object as a lever into the edge of the cover ① at the position indicated by the arrow.
- ▶ Loosen cover ① from dashboard using lever.
- ▶ Using your hands, pull cover ① out and remove.

Closing

- ▶ Hook cover ① into the opening at the front.
- ▶ Press cover ① back on until it engages.

Emergency engine shut-down

If the engine cannot be turned off as described in the “Getting started” section (▷ page 66), you may use the following emergency procedure.

- ▶ Take the fuse chart from the vehicle tool kit (▷ page 470).
- ▶ Open the fuse box in engine compartment (▷ page 523).
- ▶ Use the fuse extractor to remove fuse 120. Find its location in the fuse chart.

i *ML 500: Remove fuse 114 to shut-down the engine. Find its location in the fuse chart.*



Parts service

Warranty coverage

Identification labels

Layout of poly-V-belt drive

Engine

Rims and tires

Electrical system

Main Dimensions

Weights

Fuels, coolants, lubricants

Parts service

The “Technical data” section provides the necessary technical data for your vehicle.

All authorized Mercedes-Benz Centers maintain a stock of Genuine Mercedes-Benz parts required for maintenance and repair work. In addition, strategically located parts distribution centers provide quick and reliable parts service.

More than 300 000 different parts for Mercedes-Benz models are available.

Genuine Mercedes-Benz parts are subjected to stringent quality inspections. Each part has been specifically developed, manufactured or selected for and adapted to Mercedes-Benz vehicles.

Therefore, Genuine Mercedes-Benz parts should be installed.

! *The use of non-genuine Mercedes-Benz parts and accessories not authorized by Mercedes-Benz could damage the vehicle, which is not covered by the Mercedes-Benz Limited Warranty, or could compromise the vehicle's durability or safety.*

▼ Warranty coverage

Your vehicle is covered under the terms of the warranties printed in the Service and Warranty Information booklet. Your authorized Mercedes-Benz Light Truck Center will exchange or repair any defective parts originally installed on the vehicle in accordance with the terms of the following warranties:

- New Vehicle Limited Warranty
- Emission System Warranty
- Emission Performance Warranty
- California, Maine, Massachusetts, and Vermont Emission Control Systems Warranty

Replacement parts and accessories are covered by the Mercedes-Benz Parts and Accessories warranties, copies of which are available at any authorized Mercedes-Benz Light Truck Center.

Loss of Service and Warranty Information Booklet

Should you lose your Service and Warranty Information booklet, have an authorized Mercedes-Benz Light Truck Center arrange for a replacement. It will be mailed to you.

Identification labels

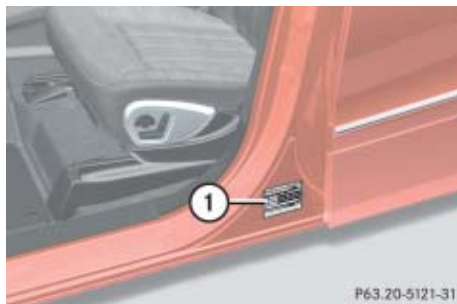

① Certification label (on driver's B-pillar)

The Vehicle Identification Number (VIN) can be found in the following locations:

- on the certification label
- embossed underneath the passenger-side rear seat (▷ page 531)
- on the lower edge of the windshield (▷ page 531)



Example certification label (U.S. vehicles)

- ② Paintwork code
- ③ VIN

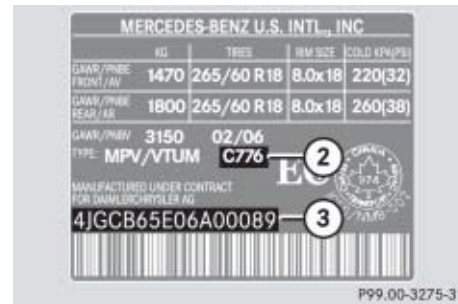

Example certification label (Canada vehicles)

- ② Paintwork code
- ③ VIN

i Data shown on certification label are for illustration purpose only. These data are specific to each vehicle and may vary from data shown in the illustration. Refer to certification label on vehicle for actual data specific to your vehicle.

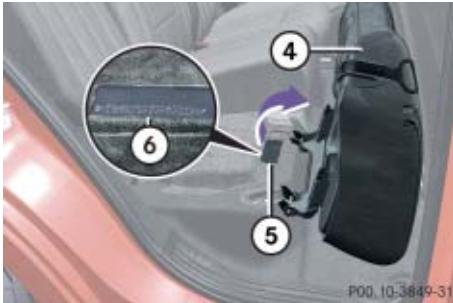

- ④ Seat cushion
- ⑤ Floor cover
- ⑥ VIN

- ▶ Fold the seat cushion ④ forward (▷ page 285).
- ▶ Fold floor cover ⑤ in direction of the arrow.

The VIN ⑥ is now visible.

i When ordering parts, please specify vehicle identification and engine numbers.

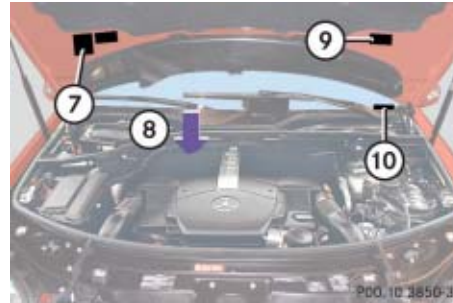

- ⑦ Emission control information label, includes both federal and California certification exhaust emission standards
- ⑧ Engine number (engraved on engine)
- ⑨ Vacuum line routing diagram label
- ⑩ VIN (lower edge of windshield)

Layout of poly-V-belt drive

ML 350

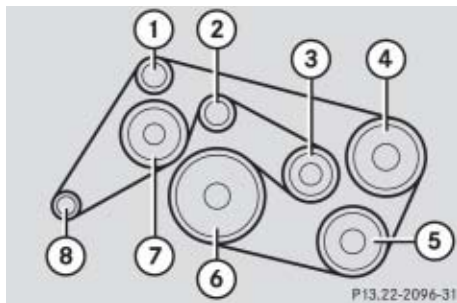

- ① Idler pulley
- ② Idler pulley
- ③ Automatic belt tensioner
- ④ Power steering pump
- ⑤ Air conditioning compressor
- ⑥ Crankshaft
- ⑦ Coolant pump
- ⑧ Generator (alternator)

ML 320 CDI

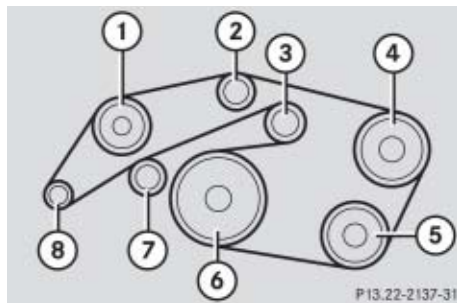

- ① Coolant pump
- ② Idler pulley
- ③ Automatic belt tensioner
- ④ Power steering pump
- ⑤ Air conditioning compressor
- ⑥ Crankshaft
- ⑦ Idler pulley
- ⑧ Generator (alternator)

ML 500

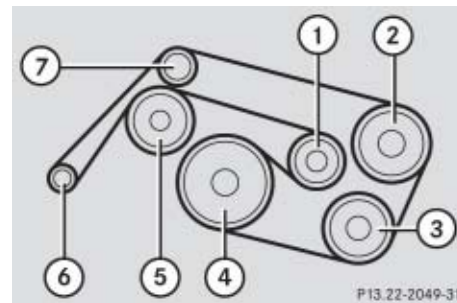

- ① Automatic belt tensioner
- ② Power steering pump
- ③ Air conditioning compressor
- ④ Crankshaft
- ⑤ Coolant pump
- ⑥ Generator (alternator)
- ⑦ Idler pulley

ML 63 AMG

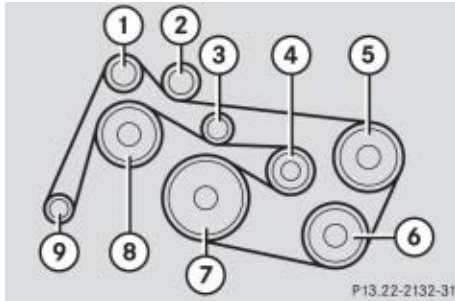

- ① Idler pulley
- ② Idler pulley
- ③ Idler pulley
- ④ Automatic belt tensioner
- ⑤ Power steering pump
- ⑥ Air conditioning compressor
- ⑦ Crankshaft
- ⑧ Coolant pump
- ⑨ Generator (alternator)

Engine

Model	ML 320 CDI (164.122 ¹)	ML 350 (164.186 ¹)
Engine	642	272
Mode of operation	Diesel 4-stroke engine	4-stroke engine, gasoline injection
No. of cylinders	6	6
Bore	3.27 in (83.00 mm)	3.66 in (92.90 mm)
Stroke	3.62 in (92.00 mm)	3.38 in (86.00 mm)
Total piston displacement	182 cu in (2987 cm ³)	213 cu in (3498 cm ³)
Compression ratio	16.5:1	10.7:1
Output acc. to SAE J 1349	221 hp/3800 rpm (165 kW/3800 rpm)	268 hp/6000 rpm ² (200 kW/6000 rpm)
Maximum torque acc. to SAE J 1349	398 lb-ft/1600-2400 rpm (540 Nm/1600-2400 rpm)	258 lb-ft/2400-5000 rpm (350 Nm/2400-5000 rpm)
Maximum engine speed	4500 rpm	6500 rpm
Firing order	1-4-2-5-3-6	1-4-3-6-2-5
Poly-V-belt	2035 mm	2404 mm

¹ The quoted data apply only to the standard vehicle. See an authorized Mercedes-Benz Light Truck Center for the corresponding data of all special bodies and special equipment.

² Premium fuel required. Performance may vary with fuel octane rating.

Model	ML 500 (164.175 ¹)	ML 63 AMG (164.177 ¹)
Engine	113	156
Mode of operation	4-stroke engine, gasoline injection	4-stroke engine, gasoline injection
No. of cylinders	8	8
Bore	3.82 in (97.00 mm)	4.02 in (102.20 mm)
Stroke	3.31 in (84.00 mm)	3.72 in (94.60 mm)
Total piston displacement	303 cu in (4966 cm ³)	378.8 cu in (6208 cm ³)
Compression ratio	10:1	11.3:1
Output acc. to SAE J 1349	302 hp/5600 rpm ² (225 kW/5600 rpm)	503 hp/6800 rpm ² (375 kW/6800 rpm)
Maximum torque acc. to SAE J 1349	339 lb-ft/2700-4750 rpm (460 Nm/2700-4750 rpm)	465 lb-ft/5200 rpm (630 Nm/5200 rpm)
Maximum engine speed	6300 rpm	7200 rpm
Firing order	1-5-4-2-6-3-7-8	1-5-4-2-6-3-7-8
Poly-V-belt	2370 mm	2369 mm

¹ The quoted data apply only to the standard vehicle. See an authorized Mercedes-Benz Light Truck Center for the corresponding data of all special bodies and special equipment.

² Premium fuel required. Performance may vary with fuel octane rating.

Rims and tires

! Only use tires which have been tested and approved by Mercedes-Benz. Tires approved by Mercedes-Benz are developed to provide best possible performance in conjunction with the driving safety systems on your vehicle such as ABS or ESP®. Tires specially developed for your vehicle and tested and approved by Mercedes-Benz can be identified by finding the following on the tire's sidewall:

- MO = Mercedes-Benz Original equipment tires

AMG vehicles:

Does not apply to all approved tires on AMG vehicles. For information on tested and approved tires for AMG vehicles, contact an authorized Mercedes-Benz Light Truck Center.

Using tires other than those approved by Mercedes-Benz may result in damage that is not covered by the Mercedes-Benz Limited Warranty.

! Using tires other than those approved by Mercedes-Benz can have detrimental effects, such as

- poor handling characteristics
- increased noise
- increased fuel consumption

Moreover, tires and rims not approved by Mercedes-Benz may, under load, exhibit dimensional variations and different tire deformation characteristics that could cause them to come into contact with the vehicle body or axle parts. Damage to the tires or the vehicle may be the result.

i Further information on tires and rims is available at any authorized Mercedes-Benz Light Truck Center. A placard with the recommended tire inflation pressure is located on the driver's door B-pillar (▷ page 530). Some vehicles may have supplemental tire inflation pressure information for driving at high speeds (▷ page 375) or for vehicle loads less than the maximum loaded vehicle condition (▷ page 375). If such information is provided, it can be found on the placard located on the inside of the fuel filler flap.



The tire inflation pressure should be checked regularly and should only be adjusted on cold tires. Follow tire manufacturer's maintenance recommendation included with vehicle.

i The following pages also list the approved wheel rim and tire sizes for equipping your vehicles with winter tires. Winter tires are not available as standard or optional factory equipment, but can be purchased from an authorized Mercedes-Benz Light Truck Center.

Depending on vehicle model and the standard or optional factory-equipped wheel rim/tire configuration on your vehicle (Appearance Package, Sport Package etc.), equipping your vehicle with winter tires approved for your vehicle model may also require the purchase of two or four wheel rims of the recommended size for use with these winter tires. See an authorized Mercedes-Benz Light Truck Center for more information.

Same size tires

	ML 320 CDI ML 350	ML 320 CDI* ML 350* ML 500	ML 320 CDI (Sport Package*) ML 350 (Sport Package*) ML 500 (Sport Package*)
Rims (light alloy)	7.5 J x 17 H2	8 J x 18 H2	8 J x 19 H2
Wheel offset	2.20 in (56 mm)	2.36 in (60 mm)	2.36 in (60 mm)
All-season tires¹	235/65 R17 104H M+S	255/55 R18 105H M+S	255/50 R19 107H XL (Extra Load) M+S
Winter tires^{1,3}	235/65 R17 104H M+S 	255/55 R18 105H M+S 	255/50 R19 107H XL (Extra Load) M+S 

	ML 63 AMG	ML 63 AMG*	ML 320 CDI (Sport Package*) ML 350 (Sport Package*) ML 500 (Sport Package*)
AMG rims (light alloy)	9.5 J x 19 H2	10 J x 20 H2	8.5 J x 19 H2
Wheel offset	1.81 in (46 mm)	1.81 in (46 mm)	2.28 in (58 mm)
All-season tires¹	-	-	255/50 R19 107H XL (Extra Load) M+S
Summer tires^{1,2}	295/45 ZR19 109Y	295/40 ZR20 106Y	-
Winter tires^{1,3}	285/45 R19 107V M+S 	-	255/50 R19 107H XL (Extra Load) M+S 

¹ Radial-ply tires

² Must not be used with snow chains.

³ Not available as factory equipment.

Rims and tires

Spare wheel

Minispare wheel

	ML 320 CDI ML 350 ML 500
Rim	4.0B x 18 H2
Wheel offset	1.58 in (40 mm)
Minispare tire ¹	T 155/90-18 113M
Recommended tire inflation pressure	61 psi (4.2 bar)

¹ Must not be used with snow chains.

Spare wheel with collapsible tire

	ML 63 AMG
Rim	5.5 B x 19 H2
Wheel offset	0.51 in (13 mm)
Collapsible tire ¹	185/65-19 104P
Recommended tire inflation pressure	51 psi (3.5 bar)

¹ Must not be used with snow chains.

! Please compare the recommended tire inflation pressure for your vehicle with the tire inflation pressure on the yellow label located on the spare wheel rim.

If the tire inflation pressure on the yellow label on the spare wheel rim differs from the values given in this Operator's Manual, inflate the collapsible tire to the recommended tire inflation pressure given on the yellow label on the spare wheel rim.

i Please note that the tire inflation pressure of the collapsible tire differs from the tire inflation pressure of the road tires.

Electrical system

Model	ML 350	ML 500	ML 63 AMG
Generator (alternator)	14 V/180 A	14 V/180 A	14 V/180 A
Starter motor	12 V/1.4 kW	12 V/1.7 kW	12 V/2.2 kW
Battery	12 V/70 Ah	12 V/95 Ah	12 V/95 Ah
Spark plugs	NGK PLKR 6A	NGK PFR 5R-11	NGK T200 36N
Electrode gap	0.031 in (0.8 mm)	0.039 in (1.0 mm)	0.039 in (1.0 mm)
Tightening torque	15 – 22 lb-ft (20 – 30 Nm)	15 – 22 lb-ft (20 – 30 Nm)	15 – 22 lb-ft (20 – 30 Nm)

Model	ML 320 CDI
Generator (alternator)	14 V/220 A
Starter motor	12 V/2.2 kW
Battery	12 V/95 Ah

▼ Main Dimensions

Model	ML 320 CDI, ML 350, ML 500	ML 63 AMG
Overall vehicle length	188.5 in (4788 mm)	189.5 in (4812 mm)
Vehicle width (exterior rear view mirrors folded out)	83.7 in (2127 mm)	83.7 in (2127 mm)
Vehicle width (exterior rear view mirrors folded in)	76.0 in (1930 mm)	76.8 in (1951 mm)
Overall vehicle height (vehicles with steel suspension)	71.5 in (1815 mm)	-
Overall vehicle height, depending on set vehicle level (vehicles with air suspension package*)	69.8 in-73.0 in (1774 mm-1854 mm)	69.5 in-72.6 in (1764 mm-1844 mm)
Wheelbase	114.8 in (2915 mm)	114.8 in (2915 mm)
Ground clearance (vehicles with steel suspension)	8.3 in (210 mm)	-
Ground clearance, depending on set vehicle level (vehicles with air suspension package*)	7.1 in-10.3 in (181 mm-261 mm)	6.7 in-9.5 in (169 mm-242 mm)
Turning circle	39 ft (11.6 m)	39 ft (11.6 m)
Track, front	64.0 in (1627 mm)	64.8 in-65.5 in (1647 mm-1664 mm)
Track, rear	64.1 in (1629 mm)	64.9 in-65.3 in (1649 mm-1667 mm)

Weights

Roof load max.	220 lb (100 kg)
----------------	-----------------

▼ Fuels, coolants, lubricants

Capacities

Vehicle components and their respective lubricants must match. Therefore only use products tested and approved by Mercedes-Benz.

Please refer to the Factory Approved Service Products pamphlet, or inquire at your Mercedes-Benz Light Truck Center.

Warning!



Comply with all valid regulations with respect to handling, storing and disposing of service fluids. Otherwise you could endanger persons or the environment.

Keep service fluids out of the reach of children.

If a service fluid is swallowed, contact a physician immediately.

	Model	Capacity	Fuels, coolants, lubricants, etc.
Engine with oil filter	ML 320 CDI	9.5 US qt (9.0 l)	Approved engine oils
	ML 350	8.5 US qt (8.0 l)	Approved engine oils
	ML 500	9.0 US qt (8.5 l)	Approved engine oils
	ML 63 AMG	10.3 US qt (9.7 l)	Approved engine oils
Automatic transmission	All models	9.5 US qt (9.0 l)	MB Automatic Transmission Fluid
Transfer case single speed	All models	0.53 US qt (0.5 l)	MB Automatic Transmission Fluid

Fuels, coolants, lubricants

	Model	Capacity	Fuels, coolants, lubricants, etc.
Front axle	All models	1.2 US qt (1.1 l)	Hypoid gear oil
Rear axle	All models	1.2 US qt (1.1 l)	Hypoid gear oil
Power steering	All models	approx. 1.3 US qt (1.2 l)	MB Power Steering Fluid
Front wheel hubs	All models	approx. 1.5 oz (43 g) each	High temperature roller bearing grease
Brake system	All models	-	MB Brake Fluid (DOT 4+)
Cooling system	ML 320 CDI, ML 350	approx. 10.0 US qt (9.5 l)	MB Anticorrosion/Antifreeze
	ML 500	approx. 10.6 US qt (10.0 l)	MB Anticorrosion/Antifreeze
	ML 63 AMG	approx. 12.2 US qt (11.5 l)	MB Anticorrosion/Antifreeze

	Model	Capacity	Fuels, coolants, lubricants etc.
Fuel tank	All models	25.1 US gal (95.0 l)	Gasoline engines: Premium unleaded gasoline Minimum Posted Octane 91 (Avg. of 96 RON/86 MON) Diesel engines: Diesel fuels according to ASTM D 975 grades No. 2-D or No. 1-D
including a reserve of	All except ML 63 AMG	approx. 3.5 US gal (13.0 l)	
including a reserve of	ML 63 AMG	approx. 4.0 US gal (15.3 l)	
Air conditioning system			R-134a refrigerant and special PAG lubricant oil (never R-12)
Windshield washer and head-lamp cleaning* system	All models	8.1 US qt (7.7 l)	MB Windshield Washer Concentrate ¹

¹ Use MB Windshield Washer Concentrate “MB SummerFit” and water for temperatures above freezing or MB Windshield Washer Concentrate “MB SummerFit” and commercially available premixed windshield washer solvent/antifreeze for temperatures below freezing point. Follow suggested mixing ratios (▷ page 551).

Fuels, coolants, lubricants

Engine oils

Engine oils are specifically tested for their suitability in our engines and durability for our service intervals. Therefore, only use approved engine oils and oil filters required for vehicles with Maintenance System (U.S. vehicles) or FSS PLUS (Canada vehicles). For a listing of approved engine oils and oil filters, refer to the Factory Approved Service Products pamphlet, or contact an authorized Mercedes-Benz Light Truck Center.

! *Using engine oils and oil filters of specification other than those expressly required for the Maintenance System (U.S. vehicles) or FSS PLUS (Canada vehicles), or changing of oil and oil filter at change intervals longer than those called for by the Maintenance System (U.S. vehicles) or FSS PLUS (Canada vehicles) will result in engine or emission control system damage not covered by the Mercedes-Benz Limited Warranty.*

Please follow Maintenance System (U.S. vehicles) or FSS PLUS (Canada vehicles) recommendations for scheduled oil changes. Failure to do so could result in engine or emission control system damage not covered by the Mercedes-Benz Limited Warranty.

Engine oil additives

Do not blend oil additives with engine oil. They may damage the engine.

Damage or malfunctions resulting from blending oil additives are not covered by the Mercedes-Benz Limited Warranty.

Air conditioning refrigerant

R-134a (HFC) refrigerant and special PAG lubricating oil are used in the air conditioning system.

Never use R-12 (CFC) or mineral-based lubricating oil. Otherwise damage to the system will occur.

Brake fluid

Warning!



During vehicle operation, the boiling point of the brake fluid is continuously reduced through the absorption of moisture from the atmosphere. Under extremely strenuous operating conditions, this moisture content can lead to the formation of bubbles in the system, thus reducing the system's efficiency.

Therefore, the brake fluid must be replaced regularly. Refer to your vehicle's Maintenance Booklet for replacement interval.

Only brake fluid approved by Mercedes-Benz is recommended. Your authorized Mercedes-Benz Light Truck Center will provide you with additional information.

Premium unleaded gasoline (gasoline engine)

Warning!



Gasoline is highly flammable and poisonous. It burns violently and can cause serious injury.

Never allow sparks, flame or smoking materials near gasoline!

Turn off the engine before refueling.

Whenever you are around gasoline, avoid inhaling fumes and skin or clothing contact, extinguish all smoking materials.

Direct skin contact with fuels and the inhalation of fuel vapors can damage your health.

! *To maintain the engine's durability and performance, premium unleaded gasoline must be used. If premium unleaded is not available and low octane fuel is used, follow these precautions:*

- *Have the fuel tank only partially filled with unleaded regular and fill up with premium unleaded as soon as possible.*
- *Avoid full throttle driving and abrupt acceleration.*
- *Do not exceed an engine speed of 3000 rpm if the vehicle is loaded with a light load such as two persons and no luggage.*
- *Do not exceed $\frac{2}{3}$ of maximum accelerator pedal position if the vehicle is fully loaded or operating in mountainous terrain.*

Gasoline additives (gasoline engine)

A major concern among engine manufacturers is carbon build-up caused by gasoline. Mercedes-Benz recommends only the use of quality gasoline containing additives that prevent the build-up of carbon deposits.

After an extended period of using fuels without such additives carbon deposits can build up, especially on the intake valves and in the combustion area, leading to engine performance problems such as:

- Warm-up hesitation
- Unstable idle
- Knocking/pinging
- Misfire
- Power loss

Fuels, coolants, lubricants

In areas where carbon deposits may be encountered due to lack of availability of gasolines which contain these additives, Mercedes-Benz recommends the use of additives approved by us for use on Mercedes-Benz vehicles. Refer to Factory Approved Service Products pamphlet for a listing of approved product(s). Follow directions on product label.

Do not blend other fuel additives with fuel. This only results in unnecessary costs and may be harmful to the engine operation.

Damage or malfunction resulting from poor fuel quality or from blending additional fuel additives other than those tested and approved by us for use on Mercedes-Benz vehicles listed in the Factory Approved Service Products pamphlet are not covered by the Mercedes-Benz Limited Warranty.

Fuel requirements

Gasoline engine

Only use premium unleaded fuel.

- The octane number (posted at the pump) must be 91 min. It is an average of both the Research (R) octane number and the Motor (M) octane number: $(R+M)/2$. This is also known as the ANTI-KNOCK INDEX.

Unleaded gasoline containing oxygenates such as ethanol, IPA, IBA and TBA can be used provided the ratio of any one of these oxygenates to gasoline does not exceed 10%; MTBE must not exceed 15%.

The ratio of methanol to gasoline must not exceed 3% plus additional cosolvents.

Using mixtures of ethanol and methanol is not allowed. Gasohol, which contains 10% ethanol and 90% unleaded gasoline, can be used.

These blends must also meet all other fuel requirements, such as resistance to spark knock, boiling range, vapor pressure, etc.

Diesel engine

Only use commercially available vehicular diesel fuels No. 2 or No. 1 (ASTM D975 No. 2-D or No. 1-D).

To prevent malfunctions, diesel fuel with improved cold flow characteristics is offered in the winter months. Check with your fuel retailer.

! *Do not fill the tank with gasoline. Do not blend diesel fuel with gasoline or kerosine. The fuel system and engine will otherwise be damaged, which is not covered by the Mercedes-Benz Limited Warranty.*

Coolants

The engine coolant is a mixture of water and anticorrosion/antifreeze, which provides:

- Corrosion protection
- Freeze protection
- Boiling protection (by increasing the boiling point)

The cooling system was filled at the factory with a coolant providing freeze protection to approximately -35°F (-37°C) and corrosion protection.

! *Add premixed coolant solution only. Adding water and MB 325.0 Anticorrosion/Antifreeze separately from each other, could cause engine damage not covered by the Mercedes-Benz Limited Warranty.*

If the antifreeze mixture is effective to -22°F (-30°C), the boiling point of the coolant in the pressurized cooling system is reached at approximately 266°F (130°C).

The coolant solution must be used year round to provide the necessary corrosion protection and increase boil-over protection. Refer to Maintenance Booklet for replacement interval.

Coolant system design and coolant used determine the replacement interval. The replacement interval published in the Maintenance booklet is only applicable if MB 325.0 anticorrosion/antifreeze solution or other Mercedes-Benz approved products of equal specification (see Factory Approved Service Products pamphlet) are used to renew the coolant concentration or bring it back up to the proper level.

To provide important corrosion protection, the solution must be at least 45% anticorrosion/antifreeze (equivalent to freeze protection to approx. -22°F [-30°C]). If you use a solution that is more than 55% anticorrosion/antifreeze (freeze protection to approx. -49°F [-45°C]), the engine temperature will increase due to the lower heat transfer capability of the solution. Therefore, do not use more than this amount of anticorrosion/antifreeze.

If the coolant level is low, water and MB 325.0 anticorrosion/antifreeze should be used to bring it up to the proper level (have cooling system checked for signs of leakage). Please make sure the mixture is in accordance with label instructions.

The water in the cooling system must meet minimum requirements, which are usually satisfied by normal drinking water. If you are not sure about the water quality, consult an authorized Mercedes-Benz Light Truck Center.

Fuels, coolants, lubricants

Anticorrosion/antifreeze

Your vehicle contains a number of aluminum parts. The use of aluminum components in motor vehicle engines necessitates that anticorrosion/antifreeze coolant used in such engines be specifically formulated to protect the

aluminum parts. (Failure to use such anticorrosion/antifreeze coolant will result in a significantly shortened service life.)

Therefore, the following product is strongly recommended for use in your vehicle: Mercedes-Benz 325.0 anticorrosion/antifreeze agent.

Before the start of the winter season (or once a year in hot southern regions), you should have the anticorrosion/antifreeze concentration checked. The coolant is also regularly checked each time you bring your vehicle to an authorized Mercedes-Benz Light Truck Center for service.

Anticorrosion/antifreeze quantity

Model	Approx. freeze protection	
	- 35°F (- 37°C)	- 49°F (- 45°C)
ML 320 CDI	5.1 US qt (4.75 l)	5.5 US qt (5.2 l)
ML 350	5.1 US qt (4.75 l)	5.5 US qt (5.2 l)
ML 500	5.4 US qt (5.0 l)	5.8 US qt (5.5 l)
ML 63 AMG	6.0 US qt (5.75 l)	6.7 US qt (6.3 l)

Windshield washer and headlamp cleaning* system

Both the windshield washer and headlamp cleaning* system are supplied from the windshield washer fluid reservoir.

The windshield and headlamp washer fluid reservoir has a capacity of approximately 8.1 US qt (7.7 l).

- ▶ Refill the reservoir with MB Windshield Washer Concentrate and water (or concentrate and commercially available premixed windshield washer solvent/antifreeze, depending on ambient temperatures).

Warning!



Washer solvent/antifreeze is highly flammable. Do not spill washer solvent/antifreeze on hot engine parts, because it may ignite and burn. You could be seriously burned.

Windshield and headlamp washer fluid mixing ration

For temperatures above freezing point, use MB Windshield Washer Concentrate “MB SummerFit” and water:

- 1 part “MB SummerFit” to 100 parts water
(1.34 fl oz [40 ml] “MB SummerFit” to 1 gal [4.0 l] water)

For temperatures below freezing point, use MB Windshield Washer Concentrate “MB SummerFit ” and commercially available premixed windshield washer solvent/antifreeze:

- 1 part “MB SummerFit” to 100 parts solvent
(1.34 fl oz [40 ml] “MB SummerFit” to 1 gal [4.0 l] solvent)

- A**
- ABS 96
 - Indicator lamp 414
 - Messages in the multifunction display 430
 - Off-road - ABS 97
 - Accelerator position, automatic transmission 191
 - Accessory weight 394
 - Accident 64
 - Active head restraint 80, 128, 479
 - Adaptive Damping System (ADS)* 269
 - Air bags 71
 - Children 73, 82
 - Front passenger front air bag off indicator lamp 31, 89, 426
 - Front, Driver 75
 - Front, Passenger 75
 - Occupant Classification System (OCS) 85
 - Safety guidelines 73
 - Side impact (front and rear*) 76
 - Window curtain 76
 - Air conditioning refrigerant 546
 - Air conditioning system see Climate control or Automatic climate control (3-zone)*
 - Air conditioning, Cooling 216, 230
 - Air distribution, Front 212, 226
 - Air distribution, Rear 219, 234
 - Air pressure see Tire inflation pressure
 - Air pump, electric (ML 63 AMG) 502
 - Air recirculation mode 214, 228
 - Air suspension package* 269
 - Adaptive Damping System (ADS)* 269
 - Messages in the multifunction display 467
 - Vehicle level control* 270
 - Air vents 219
 - Air vents, Front 212, 226
 - Air vents, Rear 235
 - Air volume 212, 227
 - Alarm system see Anti-theft systems
 - Alignment bolt (vehicle tool kit) 470, 500
 - Anticorrosion/antifreeze 550
 - Antiglare, Interior rear view mirror 200
 - Antiglare, Rear view mirrors* 201
 - Antilock Brake System see ABS
 - Anti-theft systems 104
 - Anti-theft alarm system 103, 104
 - Immobilizer 103
 - Aquaplaning see Hydroplaning
 - Armrest storage compartments
 - Front 296
 - Ashtrays* 300
 - Aspect ratio 394
 - ATF 362
 - Attaching a trailer 344
 - Audio menu 159
 - CD operation 161
 - Radio operation 160
 - Satellite radio* operation (USA only) 160
 - Auto-dimming*, Rear view mirrors 201
 - Automatic central locking, Control system 176

- Automatic climate control (3-zone)* 220
 - Air conditioning, Cooling 230, 231
 - Air distribution, Front 226
 - Air distribution, Rear 234
 - Air recirculation mode 228
 - Air vents, Front 226
 - Air volume 227
 - Control panel, Front 222
 - Control panel, Rear 232
 - Deactivating system 224
 - Defogging 227
 - Defrosting 227
 - Maximum cooling, MAX COOL 228
 - Rear passenger compartment 232
 - Rear window defroster 205
 - Residual engine heat (REST) 232
 - Using driver-side settings for all temperature zones 231
- Automatic headlamp mode 137
- Automatic lighting control, Interior lighting 143
- Automatic locking when driving 126
- Automatic shift program (ML 63 AMG only) 196
- Automatic transmission 54
 - Accelerator position 191
 - Automatic shift program (ML 63 AMG only) 196
 - Emergency operation (Limp-Home Mode) 198
 - Gear ranges 193
 - Gear selector lever 54, 185
 - Gear shifting malfunctions 198
 - Hill start assist system 192
 - Kickdown 191
 - Kickdown, manual shift program (ML 63 AMG only) 198
 - Manual shift program (ML 63 AMG only) 196
 - Program mode selector switch (ML 63 AMG only) 195
 - Shift program (ML 63 AMG only) 195
 - Shifting procedure 188
 - Starting the engine 54
 - Steering wheel gearshift control 194
 - Towing a trailer 192
 - Transmission fluid level 362
 - Transmission positions 189
- Automatic Transmission Fluid see ATF
- B**
- Backrest
 - Seat 44
 - Seat, Lumbar support 130
 - Seat, Multicontour* 130
- Backup lamps
 - Messages in the multifunction display 458
 - Replacing bulbs 490
- Bar 395
- BAS 97
 - Lamps in instrument cluster 414
 - Messages in the multifunction display 430
- Basic carrier bars* 281
- Batteries, SmartKey
 - Check lamp 108, 112
 - Checking battery condition 111
 - Messages in the multifunction display 446
 - Replacing 480
- Battery, Vehicle 507
 - Charging 514
 - Disconnecting and connecting 509
 - Jump starting 515
 - Removing and installing 509

- Bead 395
 - Belt reel 291
 - Beverage holder see Cup holder
 - Block heater (Canada only) 400
 - Bolts, Collapsible tire
 - (ML 63 AMG only) 474
 - Bolts, Minispare wheel
 - (except ML 63 AMG) 473
 - Brake fluid 546
 - Checking 354
 - Messages in the multifunction display 449
 - Brake lamp
 - Cleaning lenses 408
 - Messages in the multifunction display 458
 - Replacing bulbs 490
 - Brake pads 326
 - Messages in the multifunction display 447
 - Brakes 326
 - Warning lamp 415
 - Break-in period 324
 - Bulbs, replacing see Replacing bulbs
 - Button for Voice control*
 - system 30, 148
- C**
- California retail buyers and lessees,
 - Important notice for 11
 - Camera see Rear view camera*
 - Can holder see Cup holder
 - Capacities and recommended
 - fuel/lubricants 543
 - Card holder 32, 35, 299
 - Cargo compartment cover blind 286
 - Cargo tie-down rings 283
 - Carpets, Cleaning 411
 - Catalytic converter
 - (gasoline engine) 349
 - CD changer* 161, 294
 - CD player 161
 - Center console
 - Lower part 32
 - Upper part 31
 - Central locking
 - Automatic 126
 - Locking/unlocking from the inside 126
 - Switch 126
 - Certification label 530
 - CHECK ENGINE malfunction
 - indicator lamp 417, 418
 - Checking tire pressure electronically with the Advanced Tire Pressure Monitoring System (Advanced TPMS)*, (Canada only) 381
 - Checking tire pressure electronically with the Tire Pressure Monitoring System (TPMS), (USA only) 379
 - Checklist
 - Off-road driving 336
 - Returning from off-road driving 341
 - Children in the vehicle 82
 - Air bags 73, 82
 - Blocking rear door window operation 93
 - Indicator lamp, Front passenger front air bag 89
 - Infant and child restraint systems 77, 82
 - LATCH-type child seat anchors 91
 - Occupant Classification System (OCS) 85
 - Cigarette lighter* 301

- Climate control 206
 - Air conditioning, Cooling 216
 - Air distribution, Front 212
 - Air distribution, Rear 219
 - Air recirculation mode 214
 - Air vents, Front 212
 - Air volume 212
 - Control panel*, Rear 217
 - Control panel, Front 208
 - Deactivating system 210
 - Defogging 213
 - Defrosting 213
 - Rear window defroster 205
 - Residual engine heat (REST) 216
- Clock 27, 169
 - Setting time 169
- Cloth upholstery,
 - Cleaning and care of 412
- Cockpit 24
- Cockpit Management and Data System
 - see COMAND system
- Cold tire inflation pressure 395
- Collapsible tire 538
- Collapsible tire (ML 63 AMG only) 474
- Collapsible wheel chock 472
- COMAND system see separate operating instructions
- Combination switch 59, 60, 62, 140
- Compass 321
 - Adjustment 174
 - Calibration 175
 - Calling up the compass 321
- Control and operation of radio transmitters 348
- Control system 147
 - Multifunction display 147
 - Multifunction steering wheel 148
 - Resetting to factory default 165
- Control system menus 147
 - AIRMATIC*/Compass 162
 - AMG menu 156
 - Audio 159
 - DISTRONIC* 162
 - Nav* 161
 - Settings 164
 - Standard display 154
 - Tel* 182
 - Trip computer 180
 - Vehicle configuration 178
 - Vehicle status message memory 163
- Control system submenus 151, 153, 166
 - Comfort* 177
 - Instrument cluster 167, 168
 - Lighting 171
 - Time/Date 169
 - Vehicle 174
- Coolant 362, 549
 - Anticorrosion/antifreeze
 - mixing ratio and quantity 550
 - Capacities 543
 - Checking coolant level 354, 362
 - Messages in the multifunction display 450, 452
 - Temperature 350
 - Temperature display 154
- Corner-illuminating front fog lamps* 140
 - Messages in the multifunction display 458
 - Replacing bulbs 488
- Crossing obstacles 339
- Cruise control 245
 - Activating 247
 - Messages in the multifunction display 431

- Cup holders 298
 - Cleaning 299
 - Front center console 299
 - Front center console,
 - Removing/Installing 299
 - Rear armrest 299
- Curb weight 395
- Current transmission program
 - mode (AMG vehicles only) 147
- D**
- Date display, Setting 169, 170
- Daytime running lamp mode 138
 - Setting 171
- Deep water see Standing water
- Defogging windshield 213, 227
- Defrosting, Front 213, 227
- Defrosting, Rear 205
- Delayed shut-off
 - Exterior lamps 172
 - Interior lighting 173
- Department of Transportation see DOT
- Diesel engine
 - Preglow indicator lamp 29
- Difficulties
 - While driving 63
 - While starting 57
- Digital clock see Clock
- Digital speedometer 147, 155
- Dimensions, Vehicle 541
- Direction of rotation (tires) 368
- Displays
 - Digital speedometer 147, 155
 - Distronic* 253
 - Maintenance service indicator 401
 - Messages in the
 - multifunction display 428
 - Multifunction display 147
 - Outside temperature 147, 155
 - Selecting 168
 - Symbol messages 446
 - Text messages 430
 - Vehicle status message 163, 428
 - Vehicle system settings,
 - Control system 151, 153, 164
- Distance to empty (range), Trip
 - Computer 180
- Distronic* 250
 - Activating 256
 - Cleaning system sensor 408
 - Control system 255
 - Deactivating 259
 - Distance warning function* 179, 263
 - Driving hints 261
 - Messages in the
 - multifunction display 432
 - Sensor cover 408
 - Warning and indicator lamps 253
- Door
 - Entry lamps 144
 - Locking, In an emergency 476
 - Locking/unlocking,
 - KEYLESS-GO* 39, 68
 - Locking/unlocking, SmartKey 38, 68
 - Messages in the
 - multifunction display 455
 - Opening from inside/outside 109, 118
 - Remote door unlock (Tele Aid*) 315
 - Unlocking, Mechanical key 475

- Door control panel 36
 - Door handle 36
 - Door windows see Power windows
 - DOT 389, 395
 - Downhill driving
 - Cruise control 247
 - Downhill Speed Regulation (DSR) 264
 - Messages in the multifunction display 447
 - Drinking and driving 325
 - Driving 51, 325
 - Abroad 348
 - Hydroplaning 330
 - In winter 332, 399
 - Instructions 51, 325
 - Problems 63
 - Safety systems 96
 - Systems 245
 - Through standing water 333
 - Through water 338
 - With DISTRONIC* 261
 - Driving off 58
 - Driving safety systems
 - 4-ETS 102
 - ABS 96
 - BAS 97
 - EBP 101
 - ESP® 98
 - Driving systems 245
 - Adaptive Damping System (ADS)* 269
 - Air suspension package* 269
 - Cruise control 245
 - DISTRONIC* 250
 - Downhill Speed Regulation (DSR) 264
 - Off-road driving program 268
 - Parktronic system* 274
 - Rear view camera* 279
 - Vehicle level control* 270
 - Driving tips 191
 - Accelerator position 191
 - Kickdown 191
- E**
- Easy-entry/exit feature
 - Activating (driver's seat)* 177
 - Easy-entry/exit feature* 46
 - EBP 101
 - Indicator and warning lamps 416, 448
 - Electrical connections
 - Trailer 343
 - Electrical fuses see Fuses
 - Electrical system, Technical data 540
 - Electronic Brake Proportioning see EBP
 - Electronic Stability Program see ESP®
 - Electronic Traction System see 4-ETS
 - Emergency calls
 - Tele Aid* 310
 - Emergency operation
 - Fuel filler flap 477
 - Locking/unlocking the vehicle 475, 476
 - Power tilt/sliding sunroof*, Manual operation 478
 - Emergency operation (Limp-Home Mode) 198

- Emergency operations
 - Remote door unlock, Tele Aid* 315
 - Unlocking/opening the tailgate 476
- Emergency Tensioning Device see ETD
- Emergency, In case of
 - Battery, Jump starting 515
 - Engine shut-down 525
 - First aid kit 469
 - Flat tire 497
 - Fuses 522
 - Hazard warning flasher 142
 - Instrument cluster, Indicator lamps 414, 415, 416, 417, 418, 419, 420, 421, 422, 423, 424
 - Roadside Assistance 12, 312
 - Towing the vehicle 518
- Emission control 350
 - Information label 531
 - System warranties 10
 - Vacuum line routing diagram label 531
- Engine
 - Belt layout (ML 320 CDI) 532
 - Belt layout (ML 350) 532
 - Belt layout (ML 500) 532
 - Belt layout (ML 63 AMG) 533
 - Block heater (Canada only) 400
 - Break-in recommendations 358
 - Cleaning 406
 - Compartment 356
 - Emergency engine shut-down 525
 - Malfunction indicator lamp 29, 449
 - Maximum engine speed 146, 534, 535
 - Messages in the multifunction display 449
 - Number 531
 - Starting 54
 - Starting with KEYLESS-GO* 55
 - Starting with the SmartKey 55
 - Tachometer 29, 146
 - Technical data 534
 - Turning off with KEYLESS-GO* 67
 - Turning off with the SmartKey 67
- Engine coolant see Coolant
- Engine oil 358, 546
 - Adding 361, 546
 - Additives 546
 - Changing 361, 546
 - Checking level 358
 - Checking level with the control system (ML 500 only) 358
 - Checking with the oil dipstick (except ML 500) 360
 - Consumption 358
 - Filler neck (ML 350, ML 320 CDI) 361
 - Filler neck (ML 500, ML 63 AMG) 361
 - Messages in display 359, 453
 - Messages in the multifunction display 453
 - Recommended engine oils and oil filters 546
- Engine oil level 358
- ESP® 27, 98
 - Four wheel electronic traction system with ESP® 98
 - Messages in the multifunction display 436, 437
 - Off-road-ESP® 101
 - Warning lamp 27, 419, 420

- ETD 80, 423
 - Safety guidelines 73
- Expanding cargo compartment 284
- Exterior rear view mirrors 49, 201
 - Folding 202
 - Power folding* 202
 - Synchronizing 202
- F**
- Fastening the seat belts 51
- Filler neck, Engine oil
 - (ML 350, ML 320 CDI) 361
- Filler neck, Engine oil
 - (ML 500, ML 63 AMG) 361
- First aid kit 469
- Flat tire 497
 - Collapsible tire
 - (ML 63 AMG only) 474, 538
 - Lifting the vehicle 498
 - Lowering the vehicle 504
 - Minispare wheel
 - (except ML 63 AMG) 473
 - Mounting the spare wheel 498
 - Preparing the vehicle 498
 - Spare wheel 538
- Flexible Service System PLUS see FSS PLUS
- Floormats* 303
- Fluids
 - Automatic transmission fluid 362
 - Brake fluid 354, 544, 546
 - Capacities 543
 - Engine coolant 354, 362, 549
 - Engine oil 358, 546
 - Power steering fluid 544
 - Windshield washer and headlamp cleaning system* 355, 545, 551
- Fog lamps 139
 - Corner-illuminating front fog lamps* 140
 - Messages in the multifunction display 458
 - Rear fog lamp 139
 - Replacing bulbs 488
- 4-ETS 102
 - Off-road - 4-ETS 102
- Front air bags 75
- Front defroster 213, 227
- Front lamps see Headlamps
- Front passenger front air bag 70, 75
 - Messages in the multifunction display 440, 441, 442, 443
- Front passenger front air bag off indicator lamp 31, 89, 426, 427
- Front seat heat restraints see Head restraints
- Front towing eye 520
- FSS PLUS (Canada vehicles) 361, 402
- Fuel 353
 - Additives 547
 - Capacities, Fuel tank 545
 - Consumption statistics 180, 181
 - Diesel fuel 545
 - Filling the tank 352
 - Fuel filler flap and cap 352, 477
 - Fuel gauge 29
 - Fuel tank reserve warning lamp 29, 420
 - Premium unleaded gasoline 353, 547, 548
 - Requirements, Octane rating 548

- Fuel cap
 - Messages in the multifunction display 455
 - Fuel consumption statistics
 - After start 180
 - Since last reset 181
 - Fuel filler flap 352
 - Locking/unlocking 352
 - Opening 352
 - Opening in an emergency 477
 - Fuel tank
 - Capacity 545
 - Filler flap 352
 - Fuel, Premium unleaded gasoline 545
 - Fuels, coolants, lubricants etc. 543
 - Fuses 522
 - Fuse box in cargo compartment 523
 - Fuse box in engine compartment 523
 - Fuse box in passenger compartment 524
 - Fuse chart 469, 522
 - Fuse extractor 469, 522
 - Replacing 522
 - Spare fuses 469, 522
- G**
- Garage door opener* 316
 - Gasoline see Fuel
 - GAWR 395
 - Gear range
 - Automatic transmission 193
 - Limiting 193
 - Shifting into optimal 195
 - Gear selector lever 25, 54, 185
 - Cleaning 411
 - Gearshift pattern 185
 - Messages in the multifunction display 438
 - Position 188
 - Shifting procedure 188
 - Transmission position 189
 - Global locking/unlocking see Key, SmartKey
 - Glove box 294
 - Good visibility 200
 - Gross Axle Weight Rating see GAWR
 - Gross Trailer Weight see GTW
 - Gross Vehicle Weight Rating see GVWR
- Gross Vehicle Weight see GVW**
- GTW 395
 - GVW 395
 - GVWR 395
- H**
- Halogen headlamp see Headlamps
 - Hands-free microphone 33
 - Hard plastic trim items, cleaning 411
 - Hazard warning flasher 142
 - Head restraints 44, 128
 - Active head restraint 80, 128
 - Front seats, Adjusting 44
 - Rear seats 81
 - Rear seats, Adjusting 129
 - Rear seats, Removing and installing 129
 - Headlamp aim
 - Adjusting 492
 - Headlamp cleaning system* 200, 363
 - Headlamp shut-off delay see Delayed shut-off, Exterior lamps

Headlamps

- Automatic headlamp mode 137
 - Bi-Xenon* 458, 486
 - Cleaning lenses 408
 - Cleaning system* 200, 363
 - Halogen 485
 - High beam see High beam flasher
 - High beam see High beam headlamps
 - Light sensor, Messages in the
 - multifunction display 460
 - Low beam see Low beam headlamps
 - Manual headlamp mode 137
 - Messages in the
 - multifunction display 458, 459, 460, 461, 462, 463
 - Replacing bulbs 482, 483
 - Switch 59, 136
- Heated seats see Seat heating*
- Heated steering wheel* 304
- Height adjustment
- Vehicle level control (Vehicles with Air suspension package*) 271

- High beam flasher 59, 140
- High beam headlamps
 - Indicator lamp 29
 - Messages in the
 - multifunction display 459
 - Replacing bulbs 483, 485, 486
 - Switching on 59, 140
- High mounted brake lamp 483
- Hood 356
 - Messages in the
 - multifunction display 455
 - Opening 356
- Hooks
 - Loading 284
- Horn 25
- HVAC see Climate control or automatic climate control (3-zone)*
- Hydroplaning 330

I

- Identification labels see Labels
- Ignition 40, 42, 55
- Immobilizer 103
- Indicator lamps see Lamps, Indicator and warning
- Infant and child restraint systems see Children in the vehicle
- Inflation pressure see Tires, Inflation pressures
- Information button see Tele Aid*
- Infrared reflecting windshield* 322
- Inside door handle 118
- Instrument cluster 26, 28, 145
 - Illumination brightness 145
 - Lamps 414
 - Messages in display see Multifunction display messages
 - Multifunction display 147
 - Outside temperature indicator 146
 - Selecting language 167
- Instrument lighting see Instrument cluster, Illumination brightness 145
- Instrument panel see Instrument cluster
- Instruments and controls see Cockpit

- Interior lighting 142
 - Delayed shut-off 173
- Interior rear view mirror 49
 - Antiglare positions 200
 - Auto-dimming mirrors* 201
- Interior storage spaces see
 - Storage compartments
- Intermittent wiping
 - Windshield wipers 61
- J**
- Jack 471
 - Lifting the vehicle 498
- Jump starting 515
- K**
- Key, Mechanical 475
- Key, SmartKey 108
 - Batteries 111, 480
 - Battery check lamp 108
 - Checking battery condition 111
 - Closing the power windows
 - (Convenience closing feature) 239
 - Closing the tilt/sliding sunroof*
 - (Convenience closing feature) 239
 - Closing, Power tailgate* 123
 - Factory setting 109
- Locking/unlocking 38, 68, 108
- Locking/unlocking, Global
 - setting 109
- Loss of 111
- Messages in the
 - multifunction display 457
- Opening the power windows
 - (Summer opening feature) 239
- Opening the tilt/sliding sunroof*
 - (Summer opening feature) 239
- Remote control 108
- Replacing batteries 480
- Selective setting 110
- Starter switch positions 40
- Starting the engine 54
- Turning off the engine 67
- Unlocking and opening,
 - Power tailgate* 111
- Key, SmartKey with KEYLESS-GO*
 - Batteries 116, 480
 - Battery check lamp 112
 - Checking battery condition 116
 - Closing the power windows
 - (Convenience closing feature) 239
 - Closing the tilt/sliding sunroof*
 - (Convenience closing feature) 239
- Closing, Power tailgate* 124
- Closing/locking, Power
 - tailgate* 125
- Factory setting 115
- Important notes 113
- Locking/unlocking 39, 68, 112
- Locking/unlocking, Global
 - setting 115
- Loss of 117
- Messages in the
 - multifunction display 456, 457
- Opening the power windows
 - (Summer opening feature) 239
- Opening the tilt/sliding sunroof*
 - (Summer opening feature) 239
- Remote control 112
- Replacing batteries 480
- Selective setting 115
- Start/stop button 41
- Starter switch positions 40, 41
- Starting the engine 55
- Turning off the engine 67
- Unlocking and opening,
 - Power tailgate* 117

- Kickdown 191
- Kilopascal 395
- L**
- Labels 530
 - Certification 530
 - Emission control information 531
 - Engine number 531
 - Paintwork code 530
 - Vacuum line routing diagram 531
 - Vehicle Identification Number (VIN) 530
- Lamp sensor see Light sensor
- Lamps, exterior 483
 - Front 483
 - Light sensor, Messages in the multifunction display 460
 - Messages in display 458
 - Messages in the multifunction display 458, 460, 462
 - Rear 483
 - Switch 136
- Lamps, indicator and warning
 - ABS 27, 414
 - Adaptive Damping System (ADS)* 269
 - Alarm system 104
 - Battery (SmartKey with KEYLESS-GO*) 115
 - Battery (SmartKey) 110
 - Brakes 27, 415, 416
 - Center console 31, 426
 - CHECK ENGINE 29, 417, 418
 - Distance warning lamp* 254
 - Downhill Speed Regulation 265
 - Engine diagnostics 29, 417, 418
 - ESP® 27, 419, 420
 - Fog lamps, Front/rear 136
 - Front passenger front air bag off 31, 75, 426, 427
 - Fuel reserve 29, 420
 - High beam headlamps 29
 - Instrument cluster 26, 28, 414, 415, 416, 417, 418, 419, 420, 421, 422, 423, 424
 - Off-road driving program 268
 - Parktronic* 276
- Preglow indicator, Diesel engine 29
- Seat belt telltale 29, 79, 421
- Seat belts 422
- Seat heating* 131
- Seat ventilation* 132
- SRS 29, 70, 80, 423
- Turn signals 27
 - Vehicle level control* 271
- Language, Setting 167
- LATCH-type child seat anchors see Children in the vehicle
- Layout of poly-V-belt drive (ML 320 CDI) 532
- Layout of poly-V-belt drive (ML 350) 532
- Layout of poly-V-belt drive (ML 500) 532
- Layout of poly-V-belt drive (ML 63 AMG) 533
- Leather upholstery*, Cleaning and care of 412
- Lever for cruise control 245
- License plate lamps 492
 - Messages in the multifunction display 460
 - Replacing bulbs 483, 492
- Light alloy wheels, Cleaning 410

- Light sensor
 - Messages in the multifunction display 460
 - Lighter see Cigarette lighter*
 - Lighting, Exterior and interior 136
 - Limp-Home Mode 198, 417, 418
 - Loading see Vehicle loading
 - Locator lighting 139, 172
 - Lock buttons, KEYLESS-GO*
 - Outside door handle 68
 - Locking the vehicle see Key
 - Loss of keys, Mechanical key 111
 - Loss of keys, SmartKey 111
 - Loss of keys, SmartKey with KEYLESS-GO* 117
 - Loss of Service and Warranty Information Booklet 529
 - Low beam headlamps
 - Messages in the multifunction display 460
 - Replacing bulbs 483
 - Switching on 59, 136
 - Lubricants 543
 - Lumbar support 130
- M**
- Main dimensions 541
 - Maintenance 12, 401
 - Calling up service indicator display 403
 - Clearing service indicator message 402
 - FSS PLUS (Canada vehicles) 402
 - Maintenance System (U.S. vehicles) 401
 - Resetting service indicator 403
 - Service indicator message 401
 - Service term exceeded 402
 - Vehicle Maintenance System (U.S. vehicles) 401
 - Manual headlamp mode see Headlamps
 - Manual shift program (ML 63 AMG only) 196
 - Manual shift program (ML 63 AMG)
 - Activating 196
 - Deactivating 198
 - Maximum cooling, MAX COOL* see Automatic climate control (3-zone)* 228
 - Maximum load rating, Tires 396
 - Maximum loaded vehicle weight, Tires 396
 - MB Tex upholstery, Cleaning and care of 412
 - Mechanical key 475
 - Memory function* see Seats
 - Menus see Control system menus
 - Messages in display see Multifunction display messages
 - Microphone, Hands-free 33
 - Minispare wheel see Spare wheel
 - Mirrors
 - Adjusting 49
 - Auto-dimming rear view mirrors* 201
 - Exterior rear view mirror 49
 - Interior rear view mirror 49, 200

- MON 353, 548
 - Multicontour seat* 130
 - Multifunction display 147
 - Changing settings see Control system menus and Control system submenus
 - Selecting display 168
 - Selecting language 167
 - Multifunction display messages 428
 - ABS 430
 - Air suspension package* 467
 - Brake fluid 449
 - Brake lamps 458
 - Brake pads 447
 - Check engine 449
 - Coolant 452
 - Cruise control 431
 - Distronic* 432
 - Doors 455
 - Downhill Speed Regulation 447
 - EBP 448
 - Engine coolant 450, 452
 - Engine oil 453
 - ESP® 419
 - Fog lamps, Front 458
 - Fog lamps, Rear 461
 - Front passenger front air bag 440, 441, 442, 443
 - Fuel cap 455
 - Gear selector lever 438
 - Headlamps 458, 460, 461, 463
 - Hood 455
 - Key, SmartKey 457
 - Key, SmartKey with KEYLESS-GO* 456, 457
 - Lamps 458, 460, 461, 463
 - Low tire pressure 444, 465, 466
 - Parking brake 438, 448
 - Parking lamps 459
 - Tele Aid* 464
 - Telephone* 464
 - Turn signals 463
 - Vehicle battery 446
 - Windshield washer fluid 464
 - Multifunction steering wheel 30, 148
 - Button operation 148
- N**
- Navigation system* 161
 - See separate COMAND system operating instructions
 - Net, Parcel 297
 - Net, Partition* 287
 - Neutral gear position, Automatic transmission 185, 189
 - New vehicle, Break-in period 324
 - Night security illumination 139, 172
 - Normal occupant weight 396
 - Number, Vehicle Identification (VIN) 530
- O**
- Occupant distribution 396
 - Occupant safety 70
 - Active head restraint 80
 - Air bags 71
 - Children and air bags 73, 82, 84
 - Children in the vehicle 82
 - Fastening the seat belt 51
 - Front passenger front air bag off indicator lamp 86, 89, 90
 - Infant and child restraint systems 82

- LATCH-type child seat anchors 91
- OCS 85
- OCS, Messages in the multifunction display 440, 441, 442, 443
- Seat belts 51, 73
- OCS 85
 - Self-test 90
- Odometer 146, 147, 154
- Off-road - 4-ETS 102
- Off-road - ABS 97
- Off-road - ESP® 101
- Off-road driving
 - Checklist 336, 341
 - Crossing obstacles 339
 - Driving instructions for off-road driving 333
 - Driving through water 338
 - Returning 341
 - Rules 335
 - Special driving features 334
 - Steep terrain 336
- Off-road driving program 268
- Oil level see Engine oil, Checking level
- One-touch gearshifting 194
- Operating safety 17
- Operator's Manual 10
- Ornamental moldings, Cleaning 407
- Outside temperature see Displays
- Overdue maintenance service term 402
- Overhead control panel 33
- Oxidation catalyst (diesel engine) 349
- P**
- Paintwork code 530
- Paintwork, Cleaning 405
- Panic alarm 95
- Parcel net
 - Front passenger footwell 298
 - Front seat backrests 298
- Parking 65, 329
 - On hills 65
 - Over things that burn, Potential consequences 65, 349
- Parking brake 57, 65
 - Lamps, Indicator and warning 415
 - Messages in the multifunction display 448
 - Releasing 57
- Parking lamps
 - Messages in the multifunction display 459
 - Replacing bulbs 487
- Parking position*
 - Exterior rear view mirrors 178, 202
- Parktronic* 31, 274
 - Cleaning system sensors 408
 - Minimum distance 276
 - Range 275
 - Switching on/off 277
 - System malfunction 278
 - System sensors 275
 - System sensors, Cleaning 408
 - Warning indicators 25, 276
- Partition net* 287
- Parts service 528
- PASS AIR BAG OFF indicator lamp see Front passenger front air bag off indicator lamp
- Passenger compartment 348
 - Fuse box 524
 - Interior lighting 142
 - Interior rear view mirror 33
 - Parcel net in front passenger footwell 298
- Passenger safety see Occupant safety
- Pedals 325
- Phone see Telephone*
- Plastic and rubber parts, cleaning 411

- Poly-V-belt drive
 - Layout (ML 320 CDI) 532
 - Layout (ML 350) 532
 - Layout (ML 500) 532
 - Layout (ML 63 AMG) 533
 - Positions (Memory function*) see Seats
 - Pounds per square inch see PSI
 - Power assistance 326
 - Power outlets 302
 - Power seat see Seats, Power
 - Power tilt/sliding sunroof* 241
 - Convenience closing feature 239
 - Opening/closing 241
 - Opening/closing in an emergency 478
 - Stopping 239
 - Summer opening feature 239
 - Synchronizing 244
 - Power washer 405
 - Power windows 236
 - Cleaning 410
 - Convenience closing feature 239
 - Door windows 236
 - Opening/closing 236
 - Rear door windows, Blocking operation 93
 - Summer opening feature 239
 - Synchronizing, Door windows 238
 - Practical hints 469
 - Premium unleaded gasoline 547
 - Problems
 - While driving 63
 - With starting see Starting difficulties
 - With the vehicle 18
 - Product information 9
 - Production options weight 396
 - Program mode selector switch (ML 63 AMG only) 195
 - PSI 396
 - Push-starting see Tow-starting
- R**
- Radio
 - Audio menu, Control system 159
 - Selecting station 160
 - Selecting station (satellite*) 160
 - Radio transmitters 348
 - Range (distance to empty) 181
 - Range of the sensors
 - Parktronic* 275
 - Reading lamp, front 142
 - Reading lamp, rear interior 144
 - Rear automatic climate control 232, 235
 - Rear center console ashtray see Ashtray*
 - Rear climate control* 217
 - Rear door windows
 - Blocking operation 93
 - Rear fog lamp see Fog lamps
 - Rear lamps see Tail lamps
 - Rear seat head restraints see Head restraints
 - Rear towing eye 520

- Rear towing eye, Vehicles with Sport Package* 520
 - Rear view camera* 279
 - Rear view mirrors see Mirrors
 - Rear window defroster 205
 - Rear window wiper/washer 62
 - Rear windows see Power windows
 - Rear wiper blade 495
 - Recommended tire inflation pressure 396
 - Recovery services, Stolen vehicle (Tele Aid*) 315
 - Refrigerant, Air conditioning 546
 - Refueling 352
 - Regular checks 354
 - Reminder, Seat belt see Seat belts, Telltale
 - Remote control
 - SmartKey 108
 - SmartKey with KEYLESS-GO* 112
 - Remote door unlock, Tele Aid* 315
 - Removing rear seat cushions (Vehicles with cargo management system*) 292
 - Replacing bulbs 482
 - Additional turn signals, Exterior rear view mirrors 489
 - Backup lamps 482, 490
 - Brake lamps 482, 490
 - Corner-illuminating front fog lamps* 482, 483, 488
 - Fog lamp, Rear 482, 490
 - Fog lamps, Front 482, 483, 488
 - High beam headlamps 482, 483, 486
 - License plate lamps 482, 492
 - Low beam headlamps 482, 483, 485
 - Parking/standing lamps 482, 487, 490, 491
 - Side marker lamps, Front 482, 483, 485, 488
 - Side marker lamps, Rear 482, 490
 - Tail lamps 482, 483, 490, 491
 - Turn signal lamps, Front 482, 483, 487
 - Turn signal lamps, Rear 482, 490
 - Reporting safety defects 19
 - Reset button, In instrument cluster 165
 - Reset tool
 - Active head restraints, Depository 479
 - Residual heat and ventilation 216, 232
 - Reverse gear position, Automatic transmission 185, 189
 - Rims 396, 536
 - Roadside Assistance 12
 - Roadside Assistance button see Tele Aid*
 - RON 353, 548
 - Roof rails 281
 - Rubber parts, Cleaning 411
 - Run Flat Indicator (Canada only) 377
- S**
- Safety
 - Driving safety systems 96
 - Occupant safety 70
 - Reporting safety defects 19
 - Safety belts see Seat belts
 - Satellite radio* 160
 - Seat belt force limiter 80

- Seat belts 77
 - Children in the vehicle 82
 - Cleaning 412
 - Fastening 51
 - Height adjustment 53
 - Messages in the
 - multifunction display 421, 422
 - Proper use of 53, 78
 - Safety guidelines 73
 - Telltale 29, 77, 421
 - Warning lamp 422
- Seat cushion depth see Seats
- Seat heating* see Seats
- Seat ventilation* see Seats
- Seating capacity 370
- Seats 43, 128
 - Adjusting 43
 - Cushion depth, Multicontour seat* 130
 - Folding the backrest forward 284
 - Heating* 131
 - Lumbar support 130
 - Memory function* 134
 - Multicontour seat* 130
 - Returning seat backrest to original position 286
 - Ventilation* 132
- Securing cargo 283
 - Cargo tie-down rings 283
 - Hooks 284
- Selector lever see Gear selector lever
- Self-test
 - Lamps in the instrument cluster 414
 - OCS 90
 - Tele Aid* 309
 - Vehicle battery 507
- Service and warranty information 10
- Service intervals see Maintenance, Service indicator
- Service life
 - Tires 366
- Service see Maintenance
- Service system see FSS PLUS (Canada vehicles) or Maintenance System (US vehicles)
- Service, Parts 528
- Settings
 - Adaptive Damping System (ADS)* 269
 - Air suspension* 269
 - Clock 169
 - Comfort functions* 177
 - Control system menus 150, 152
 - Control system submenus 151, 153, 166
 - Date 153, 166, 169
 - Daytime running lamp mode 171
 - Factory, SmartKey 109
 - Factory, SmartKey with KEYLESS-GO* 115
 - Individual, Vehicle 164
 - Instrument cluster 167
 - Language, multifunction display 167, 168
 - Lighting 171
 - Memory function* 135
 - Resetting all, Control system 165
 - Selective, SmartKey 110
 - Selective, SmartKey with KEYLESS-GO* 115
 - Time 169
 - Vehicle configuration 178

- Vehicle level control* 270
- Shift program (ML 63 AMG only) 195
- Shifting
 - Automatic transmission 54
- Shifting, Automatic transmission 185
- Side impact air bags 76
- Side marker lamps
 - Cleaning lenses 408
 - Messages in the multifunction display 461
 - Replacing bulbs 483, 488, 491
- Side windows see Power windows
- Sidewall 396
- SmartKey see Key, SmartKey
- SmartKey see Key, SmartKey with KEYLESS-GO*
- Snow chains 400
- Snow tires see Winter tires
- Spare fuses 469
- Spare wheel 538
 - Bolts 470
 - Mounting 498
 - Wheel bolts 501
- Spare wheel (except ML 63 AMG) 473
- Speed settings
 - Cruise control 247
 - DISTRONIC* 256
- Speedometer 27, 253
- Spinning see Tires, Direction of rotation
- SRS 78
 - Indicator lamp 29, 423
 - Messages in the multifunction display 423
- Standing lamps 136
 - Replacing bulbs 482, 483, 487, 490
- Standing water, Driving through 338
- Starter switch 25, 40
 - Positions 40
- Starting difficulties, Engine 57
- Starting, Engine 54
- Steep terrain, Driving 336
- Steering column 47, 48
- Steering wheel 46
 - Adjustment, Electrically* 48
 - Adjustment, Manually 47
 - Buttons 30, 148
 - Cleaning 411
- Steering wheel gearshift control
 - Automatic transmission 194
- Stolen Vehicle Recovery services 315
- Storage compartments 34, 294
 - Armrest, Front 296
 - Cup holder 299
 - Cup holders 299
 - Door pockets 34
 - Front center console 296
 - Glove box 294
 - Parcel net, Front passenger footwell 298
 - Parcel nets, Front seat backrest 298
 - Rear seats, In front of 297
- Storing tires 367
- Stranded vehicle 521
- Submenus see Control system submenus
- Sun visors 203
- Sunroof see Power tilt/sliding sunroof*
- Suspension tuning see Air suspension package*
- Symbols used in this Operator's Manual 16

- T**
- Tachometer 29, 146
 - Overspeed range 146
 - Tail lamps 490
 - Cleaning lenses 408
 - Messages in the
 - multifunction display 462
 - Replacing bulbs 483, 491
 - Tailgate
 - Closing 121
 - Closing from the inside,
 - Electrically* 121
 - Closing from the outside
 - (vehicles without KEYLESS-GO*) 123
 - Opening 119
 - Opening from the inside,
 - Electrically* 119
 - Opening from the outside 119
 - Unlocking and opening the tailgate in
 - an emergency 476
 - Unlocking and opening with
 - KEYLESS-GO*, Power tailgate* 117
 - Unlocking and opening with SmartKey,
 - Power tailgate* 111
 - Tar stains 405
 - Technical data 527
 - Air conditioning refrigerant 546
 - Brake fluid 544, 546
 - Capacities fuels, coolants, lubricants
 - etc. 543, 544
 - Coolant 549
 - Dimensions, Vehicle 541
 - Electrical system 540
 - Engine 534
 - Engine oil 546
 - Engine oil additives 546
 - Fuel requirements 548
 - Fuels, coolants, lubricants, etc. 543
 - Gasoline additives 547
 - Main dimensions 541
 - Premium unleaded gasoline 547
 - Rims 536
 - Tires 536
 - Weights 542
 - Windshield washer and headlamp
 - cleaning system* 545
 - Windshield washer and headlamp
 - cleaning* system 551
 - Tele Aid* 308
 - Call priority 314
 - Emergency calls 310
 - Hands-free microphone 33
 - Information 313
 - Initiating an emergency call
 - manually 311
 - Messages in the
 - multifunction display 464
 - Remote door unlock 315
 - Roadside Assistance 312
 - SOS button 311
 - Stolen Vehicle Recovery
 - services 315
 - System self-check 309
 - Telephone cradle*
 - Changing 307

- Telephone* 305
 - Answering/ending a call 183
 - Changing mobile phone cradle 307
 - Dialing a number from the phone book 183
 - Ending a call 183
 - Hands-free microphone 33
 - Inserting in cradle 306
 - Installing a different mobile phone cradle 308
 - Messages in the multifunction display 464
 - Operation 182
 - Phone book 183
 - Redialing 184
 - Removing from cradle 307
- Telescoping rod 292
- Temperature
 - Coolant 154
 - Display mode, Status indicator 168
 - Interior temperature 211
 - Interior temperature, setting see
 - Climate control or Automatic climate control (3-zone)*
 - Outside temperature 155
 - Sensor, Interior temperature 208, 222
 - Sensor, Outside temperature 146
 - Setting display unit 155
- Tether attachment points, see Children in the vehicle
- Three-zone Automatic climate control see Automatic climate control (3-zone) *
- Ticket holder 299
- Tie-down rings 283
- Tightening torque
 - Wheel bolts 504
- Tilt/sliding sunroof* see Power tilt/sliding sunroof*
- Time 169
- TIN 389, 396
- Tire and Loading Information
 - Placard 369
 - Terminology 394
- Tire Identification Number see TIN
- Tire inflation pressure
 - Checking manually 375
 - Checking tire pressure electronically with the Advanced Tire Pressure Monitoring System (Advanced TPMS)*, (Canada only) 381
 - Checking tire pressure electronically with the Tire Pressure Monitoring System (TPMS), (USA only) 379
 - Recommended tire inflation pressure 374

- Tires 365, 536
 - Advanced Tire Pressure Monitoring System (Advanced TPMS)*, (Canada only) 381
 - Air pressure 394
 - Care and maintenance 366
 - Chains 400
 - Cleaning 367
 - Collapsible tire
 - (ML 63 AMG only) 474
 - Collapsible tire, Spare wheel 538
 - Combination low tire pressure/TPMS malfunction telltale, USA only 27
 - Direction of rotation, Spinning 368
 - Driving instructions 329
 - Hydroplaning 330
 - Important guidelines 365
 - Important notes, Tire inflation pressure 375
 - Inflation pressure 355, 374, 375
 - Information placard 369
 - Inspection 366
 - Load rating 385, 386, 396
 - Loading Information 369
 - Loading terminology 394
 - Loading the vehicle 368
 - Low tire pressure telltale 424
 - Low tire pressure telltale, Canada only 27
 - Maximum load 397
 - Messages in the multifunction display 424
 - Minispare wheel (except ML 63 AMG) 473
 - Ply composition and material used 397
 - Problems under-/overinflation 384
 - Retreads 365
 - Rims and tires 536
 - Rotating 368
 - Run Flat Indicator (Canada only) 377
 - Service life 366
 - Sizes 385
 - Snow chains 400
 - Spare wheel 498
 - Spare wheel, Collapsible tire 538
 - Speed rating 331, 387, 397
 - Storing 367
 - Temperature 375, 393
 - Terminology 394
 - TIN 389, 396
 - Tire Identification Number see TIN
 - Tire Pressure Monitoring System (TPMS), (USA only) 379
 - TPMS malfunction telltale 424
 - Traction 330, 393, 397
 - Tread 397
 - Tread depth 367, 399
 - Treadwear indicators 397
 - Vehicle maximum load on 397
 - Wear pattern 398
 - Winter tires 399
- Tongue Weight Rating see TWR
- Tools 469
- Top tether
 - Children in the vehicle 92
- Towing
 - Trailer 192, 342, 345
- Towing eye bolt 520

Towing the vehicle 520, 521
 Tow-starting 515, 518
 Traction 393, 397
 4-ETS, Driving safety systems 96,
 102
 Trailer
 Attaching 344
 Checking weights 344
 Electrical connections 343
 Hitch* 342
 Loading 343
 Towing 342, 345
 Weights and ratings 343
 Transfer case 199
 Transmission position indicator 147
 Transmission see Automatic transmission
 Traveling abroad 348
 Tread 397
 Tread depth 367, 399
 Treadwear indicators 397
 Trip computer 180

Trip odometer, resetting 146
 Turn signal lamps
 Cleaning lenses 408
 Messages in the
 multifunction display 463
 Replacing bulbs 483
 Turn signals 60
 Additional in mirrors 483
 Bulbs 483, 491
 Cleaning lenses 408
 Indicator lamps 27
 Turning off the engine 67
 TWR (Tongue Weight Rating) 397

U

Uniform Tire Quality Grading
 Standards 397
 Units, Settings
 Speedometer 168
 Temperature 168
 Unlocking the vehicle see Key
 Uphill driving
 Cruise control 247
 Upholstery
 Cleaning and care of 412
 Useful features 294

V

Vacuum line routing diagram label 531
 Vehicle
 Battery 507
 Break-in period 324
 Care 404
 Control system, Settings menu 164
 Dimensions 541
 Locking/unlocking 38, 65, 108
 Locking/unlocking in an
 emergency 475
 Modifications and alterations,
 Operating safety 17
 Proper use of 17
 Towing 518
 Washing 404
 Weights 542
 Vehicle and trailer weights and
 ratings 343
 Vehicle care 404

- Vehicle Identification Number see VIN
- Vehicle jack 470, 471
- Vehicle level control* 270
 - Messages in the multifunction display 467
- Vehicle lighting 355
- Vehicle loading
 - Cargo compartment cover blind 286
 - Cargo tie-down rings 283
 - Expanding cargo compartment 284
 - Hooks 284
 - Load limit 370
 - Loading instructions 281
 - Loading terminology 394
 - Parcel nets 297
 - Partition net* 287
 - Roof rails 281
 - Terminology 394
- Vehicle Maintenance System (U.S. vehicles) 401
- Vehicle maximum load on the tire 397
- Vehicle Recovery services, Stolen (Tele Aid*) 315
- Vehicle status message memory menu 163
- Vehicle tool kit 469
- Vehicle washing 406
- VIN 531
- Voice control system*
 - Button on multifunction steering wheel 30, 148
 - Hands-free microphone 33
- W**
- Warning indicators
 - Parktronic* 276
- Warning lamps see Lamps, Indicator and warning
- Warning sounds
 - Distance warning function* 263
 - Distronic* 254
 - Exterior lamps 136
 - Parking brake 58
 - Parktronic* 278
 - Seat belt telltale 77
- Warranty coverage 10, 529
- Washer fluid see Windshield washer fluid
- Washer reservoir level 551
- Washing the vehicle 404
- Wear pattern, Tires 398
- Weights, Vehicle 542
- Wheel
 - Bolts 470
 - Change 498
 - Removing 500
 - Spare 498, 538
 - Tightening torque 504
- Wheel, Tires and 365
- Window curtain air bags 76
- Windows see Power windows
- Windows, cleaning 410
- Windshield
 - Cleaning 410
 - Cleaning wiper blades 410
 - Cleaning, Windshield washer fluid 62
 - Defogging 213, 228
 - Infrared reflecting* 322
 - Washer fluid 363, 551

- Windshield washer fluid
 - Messages in the multifunction display 464
 - Mixing ratio 551
 - Refilling 363
 - Reservoir level 363
 - Wiping with 62
- Windshield washer system 363, 551
- Windshield wipers 60
 - Cleaning wiper blades 410
 - Fast continuous wiping 61
 - Fast intermittent wiping 61
 - Rear window wiper/washer 62
 - Replacing wiper blades 494
 - Slow continuous wiping 61
 - Slow intermittent wiping 61
- Winter driving 399
 - Block heater (Canada only) 400
 - Snow chains 400
 - Tires 399
- Winter driving instructions 332
- Winter tires 399
- Wood trims, cleaning 412

Service and Literature

Your authorized Mercedes-Benz Light Truck Center has trained technicians and original Mercedes-Benz parts to service your vehicle properly. For expert advice and quality service, contact your authorized Mercedes-Benz Light Truck Center.

If you are interested in obtaining service literature for your vehicle, please contact your authorized Mercedes-Benz Light Truck Center. We consider this the best way for you to obtain accurate information for your vehicle.

For further information you can find us on the Mercedes-Benz web-site *www.mbusa.com* or *www.mercedes-benz.ca*.

Warning!



To help avoid personal injury, be extremely careful when performing any service work or repairs. Improper or incomplete service or the use of incorrect or inappropriate parts or materials may damage the vehicle or its equipment, which may in turn result in personal injury.

If you have questions about carrying out any type of service, turn to the advice of an authorized Mercedes-Benz Light Truck Center.

We reserve the right to make changes in design and equipment. Therefore, information, illustrations and descriptions in this Operator's Manual might differ from your vehicle. Reprinting, translation and copying, even of excerpts, is not permitted without our prior authorization in writing.

Press time March 24, 2006

GSP/TIP

Printed in Germany

