



Mercedes-Benz

C-Class

Operator's Manual

Symbols

Trademarks®:

- Bluetooth® is a registered trademark of Bluetooth SIG Inc.
- ESP® is a registered trademark of Daimler.
- HomeLink® is a registered trademark of Prince, a Johnson Controls Company.
- LOGIC7® is a registered trademark of Harman International Industries, Incorporated.
- SIRIUS and related marks are trademarks of SIRIUS Satellite Radio Inc.

The following symbols are found in this Operator's Manual:

Warning!

Warning notices draw your attention to hazards that may endanger your health or life, or the health or life of others.

 Highlights hazards that may result in damage to your vehicle.

 Helpful hints or further information you may find useful.

▶ This symbol points to instructions for you to follow.

▶ A number of these symbols appearing in succession indicates a multiple-step procedure.

▷ page This symbol tells you where to look for further information on a topic.

▷▷ This continuation symbol marks a warning or procedure which is continued on the next page.

Display Text in displays, such as the control system, are printed in the type shown here.

Our company and staff congratulate you on the purchase of your new Mercedes-Benz.

Your selection of our product is a demonstration of your trust in our company name. Furthermore, it exemplifies your desire to own an automobile that will be as easy as possible to operate and provide years of service.

Your Mercedes-Benz represents the efforts of many skilled engineers and craftsmen. To help assure your driving pleasure, and also the safety of you and your passengers, we ask you to make a small investment of time:

- Please read this manual carefully, then return it to your vehicle where it will be handy for your reference.
- Please follow the recommendations contained in this manual. They are designed to acquaint you with the operation of your Mercedes-Benz.
- Please pay attention to the warnings and cautions contained in this manual. They are designed to help improve the safety of the vehicle operator and occupants.

We extend our best wishes for many miles of safe, pleasurable driving.

Mercedes-Benz USA, LLC

A Daimler Company

Index 3

Introduction 18

At a glance 25

Safety and security 41

Controls in detail 75

Operation 251

Practical hints 301

Technical data 375

- 1, 2, 3 ...
- 4-ETS**
see ETS/4-ETS
- 4MATIC**
see All-wheel drive (4MATIC)
- 911 Emergency calls** 196
- A**
- ABS (Antilock Brake System)** 67
Indicator lamp 337
Messages in the multifunction
display 317, 318
- Accessory weight** 280
- Accidents** 117
Active head restraints 57
Air bag deployment 43
Emergency calls (Tele Aid) 241
Emergency calls (Telephone) 196
- Active Bi-Xenon headlamps**
see Headlamps
- Active head restraints** 57
Resetting 353
- Adaptive Brake** 68
- Additives**
Engine oil 395
Gasoline 397
- Address change** 20
- Air bags** 43
Children 43
Emergency call upon deployment 241
Front, driver and passenger 46
Front passenger front air bag off
indicator lamp 36, 52, 348
Messages in the multifunction
display 309
Pelvic air bags 48
Safety guidelines 45
Side impact 47
Window curtain 49
- Air conditioning refrigerant and
lubricant** 395
- Air distribution** 219
- Air pressure**
see Tire inflation pressure
- Air pressure (tires)** 280
- Air recirculation mode** 221
- Air volume** 220
- Alarm system**
see Anti-theft systems
- All-wheel drive (4MATIC)** 207
- Alternator** 387
Messages in the multifunction
display 327
- AMG menu** 137
- Anticorrosion/antifreeze** 398
- Antiglare, Interior rear view mirror** 94
- Antilock Brake System**
see ABS
- Anti-theft systems** 73
Anti-theft alarm system 73
Immobilizer 73
- Aquaplaning**
see Hydroplaning
- Ashtrays** 237
- Aspect ratio (tires)** 281
- Audio menu** 140
- Audio system** 152
Audio and telephone operation 152
Audio AUX mode 188
Bluetooth® settings 166
CD mode 179
Components 153
MP3 mode 179
Operating safety 153
Radio operation 167
Satellite radio 172
System settings 165
Telephone 189
- Auto-dimming rear view mirrors** 95
- Automatic central locking** 80, 150
- Automatic climate control**
see Climate control system
- Automatic headlamp mode** 100
- Automatic interior lighting control** 105
- Automatic locking when driving** 150
- Automatic shift program** 124
- Automatic transmission** 121
Automatic shift program 124

- Emergency operation (limp-home mode) 128
- Gear range indicator 124
- Gear ranges 124
- Gear selector lever 121
- Gearshifting malfunctions (limp-home mode) 128
- Hill start assist system 207
- Kickdown 124
- Kickdown (manual shift program) 128
- Manual shift program 127
- One-touch gearshifting 125
- Program mode indicator 125
- Program mode selector switch 124, 125, 127
- Shifting procedure 122
- Steering wheel gearshift control 126
- Transmission position indicator 122
- Transmission positions 122
- AUX socket** 188
- Axle oils** 392
- B**
- Back button** 159
- Backrest**
see Seats
- Backup lamps**
Messages in the multifunction display 332
- Replacing bulbs 355
- Bar (air pressure unit)** 281
- BAS (Brake Assist System)** 67
- Batteries, SmartKey**
Checking condition 79
- Replacing 353
- Battery, Vehicle**
Charging 366
- Jump starting 366
- Messages in the multifunction display 327
- Bead (tire)** 281
- Beverage holders**
see Cup holders
- Bluetooth® settings** 166
- Brake fluid**
Messages in the multifunction display 316
- Brake lamps**
Cleaning lenses 296
- High-mounted brake lamp 355
- Replacing bulbs 355
- Brake pads**
Messages in the multifunction display 317
- Brakes** 286
- High-performance brake system 288
- Parking brake 118
- Warning lamp 339
- Break-in period** 252
- Bulbs**
see Replacing bulbs
- C**
- CAC (Customer Assistance Center)** 22
- California retail buyers and lessees, important notice for** 19
- Calls (phone)** 142, 189
- Can holders**
see Cup holders
- Capacities and recommended fuel/lubricants** 391
- Carpets, cleaning** 298
- CD player** 179
- Center console**
Lower part 37
- Upper part 36
- Central locking**
Automatic 80, 150
- Locking/unlocking from inside 81
- Central locking/unlocking switch** 81
- Certification label** 377
- Children in the vehicle**
Air bags 43
- Blocking of rear window operation 65
- Child safety locks (rear doors) 64
- Child seat anchors – LATCH-type 63
- Indicator lamp, front passenger front air bag 52

- Infant and child restraint systems . . . 60
 - Occupant Classification System (OCS) 49
 - Safety notes 59
 - Tether anchorage points 62
 - Top tether 59
 - Child safety**
 - see Children in the vehicle
 - Child seat anchors – LATCH-type**
 - see Children in the vehicle
 - Chrome-plated exhaust tip, cleaning** 299
 - Cigarette lighter** 238
 - Clear button** 159
 - Climate control**
 - see Climate control system
 - Climate control system** 210
 - Air conditioning, cooling 216
 - Air conditioning refrigerant 395
 - Air distribution 219
 - Air recirculation mode 221
 - Air volume 220
 - Automatic mode 216
 - Deactivating system 216
 - Front defroster 220
 - Maximum cooling MAX COOL 220
 - Residual engine heat (REST) 221
 - Temperature 217
 - Clock** 31, 147
 - Cockpit** 28
 - Cold tire inflation pressure** 281
 - Collapsible wheel chock** 302
 - COMAND system**
 - see separate COMAND system
 - operating instructions
 - Combination gauge** 31
 - Combination switch** 102
 - Comfort submenu**
 - Fold-in function for exterior rear view mirrors 151
 - Compass** 239
 - Control system** 131
 - Multifunction display 133
 - Multifunction steering wheel 131
 - Resetting to factory settings 145
 - Control system menus** 134
 - AMG 137
 - Audio 140
 - Navigation 140
 - Service 144
 - Settings 145
 - Telephone 142
 - Trip computer 135
 - Control system submenus**
 - Convenience 150
 - Instrument cluster 146
 - Lighting 148
 - Time/Date 147
 - Vehicle 150
 - Convenience submenu**
 - Easy-entry/exit feature 151
 - Coolant**
 - Anticorrosion/antifreeze 398
 - Capacities 392
 - Checking level 258
 - Messages in the multifunction display 324, 325, 326
 - Temperature gauge 130
 - Warning lamp 346
 - Coolant temperature gauge** 31
 - Corner-illuminating front fog lamps** 104
 - Cruise control** 204
 - Last stored speed 207
 - Resume function 207
 - Cup holders** 235
 - Curb weight** 281
 - Customer Assistance Center (CAC)** . . . 22
- D**
- Dashboard**
 - see Instrument cluster
 - Data recording** 23
 - Date, Setting** 148
 - Daytime running lamp mode** . . . 101, 148
 - Deep water**
 - see Standing water
 - Defogging (windshield)** 220

- Defroster**
 Rear window 222
 Windshield 220
- Delayed shut-off**
 Exterior lamps 149
 Interior lighting 150
- Department of Transportation**
 see DOT
- Difficulties**
 While driving 117
 With starting 115
- Digital clock**
 see Clock
- Dimensions (vehicle)** 388
- Direction of rotation (tires)** 262
- Displays**
 Maintenance service indicator 291
 Messages in the multifunction display 305
 Multifunction display 133
 Text messages 307
 Trip computer 135
 Vehicle status message memory 144
 Vehicle system settings 145
- Door control panel** 39
- Door handles** 39
- Doors**
 Child safety locks 64
 Locking/unlocking (KEYLESS-GO) 77
 Locking/unlocking (SmartKey) 76
 Locking/unlocking from outside 76
 Messages in the multifunction display 320
 Opening from inside 80
 Remote door unlock (Tele Aid) 245
 Unlocking (Mechanical key) 350
- DOT (Department of Transportation)** 281
- Drinking and driving** 286
- Driving**
 Abroad 290
 Hydroplaning 289
 Instructions 113, 286
 In winter 285
 Problems 117
 Safety systems 66
 Systems 204
 Through standing water 289
- Driving and parking**
 Safety notes 113
- Driving off** 115, 289
- Driving safety systems** 66
 ABS 67
 Adaptive Brake 68
 BAS 67
 EBP 68
 ESP® 68
 ETS/4-ETS 69
- Driving systems**
 All-wheel drive (4MATIC) 207
 Cruise control 204
 Dynamic handling package with sport driving mode 208
 Hill start assist 207
- Driving tips, automatic transmission** 124
- Dynamic handling package with sport driving mode** 208

E

- E85 (ethanol fuel)** 396
- Easy-entry/exit feature** 93, 151
- EBP (Electronic Brake Proportioning)** 68
- Electrical system**
 Improper work on or modifications 21
 Power outlets 238
 Technical data 387
- Electronic Stability Program**
 see ESP®
- Electronic Traction System**
 see ETS/4-ETS
- Emergency, in case of**
 Battery, jump starting 366
 First aid kit 302
 Flat tire 360
 Hazard warning flasher 103

- Roadside Assistance 20
 - Towing the vehicle 368
 - Emergency calls**
 - Tele Aid 241
 - Telephone 196
 - Emergency operations**
 - Gear selector lever, unlocking 352
 - Limp-home mode 128
 - Locking/unlocking the vehicle 350
 - Remote door unlock 245
 - Trunk lid, emergency release 83
 - Trunk lid, unlocking 350
 - Emergency Tensioning Device**
 - see ETD
 - Emission control** 290
 - Information label 378
 - System warranties 19
 - Engine**
 - Brake-in recommendations 252
 - Cleaning 295
 - Compartment 255
 - Malfunction indicator lamp 345
 - Maximum engine speed 379
 - Messages in the multifunction display 324
 - Number 378
 - Starting 113
 - Technical data 379
 - Turning off 118
 - Engine coolant**
 - see Coolant
 - Engine oil**
 - Adding 257
 - Additives 395
 - Checking level 257
 - Consumption 256
 - Oil dipstick 257
 - Recommended engine oils and oil filter 394
 - ESP® (Electronic Stability Program)** . . 68
 - ETS 69
 - Messages in the multifunction display 307, 317
 - Warning lamp 343
 - ETD (Emergency Tensioning Device)** 56
 - Safety guidelines 45
 - Ethanol fuel (E85)** 396
 - ETS/4-ETS (Electronic Traction System)** 69
 - Express operation**
 - Panorama roof 226
 - Power windows 109
 - Tilt/sliding sunroof 223
 - Exterior lamp switch** 100
 - Exterior rear view mirrors** 95
 - Fold-in function 151
 - Parking position 97, 98
 - Power folding 96
 - Exterior view of vehicle** 26
- F
- Fastening the seat belts** 55
 - First aid kit** 302
 - Flat tire** 360
 - Lowering the vehicle 363
 - Mounting the spare wheel 361
 - Preparing the vehicle 361
 - Spare wheel 360, 386
 - Flexible Fuel Vehicles** 396
 - Floormats** 250
 - Fluids**
 - Automatic transmission fluid 392
 - Brake fluid 392
 - Capacities 391
 - Engine coolant 392
 - Engine oil 391
 - Manual transmission oil 391
 - Power steering fluid 392
 - Washer and headlamp cleaning system 393
 - Fog lamps** 102
 - Messages in the multifunction display 331
 - Replacing bulbs 355
 - Fold-in function for exterior rear view mirrors** 151

- Four-wheel drive**
 - see All-wheel drive (4MATIC)
 - Front air bags**
 - see Air bags
 - Front axle oil** 392
 - Front lamps**
 - see Headlamps
 - Front passenger front air bag** 46
 - Messages in the multifunction display 309
 - Front passenger front air bag off indicator lamp** 36, 47, 348
 - Front seat head restraints**
 - see Head restraints
 - Fuel** 286
 - Additives 397
 - Capacity, fuel tank 393
 - Ethanol fuel (E85) 396
 - Fuel consumption (Flexible Fuel Vehicle) 396
 - Fuel consumption statistics 135
 - Fuel filler flap and cap 254
 - Fuel tank reserve warning lamp . . . 344
 - Premium unleaded gasoline 253, 393, 395
 - Refueling 253
 - Requirements 396
 - Switching (Flexible Fuel Vehicle) . . 396
 - Fuel filler flap** 254
 - Opening manually 351
 - Fuel gauge** 31, 130
 - Fuels, coolants, lubricants etc.**
 - Capacities 391
 - Fuel tank**
 - Capacity 393
 - Fuel filler flap and cap 254
 - Refueling 253
 - Fuses** 372
- G**
- Garage door opener** 38, 246
 - Gasoline**
 - see Fuel
 - GAWR (Gross Axle Weight Rating)** . . 281
 - Gear range**
 - Automatic transmission 124
 - Indicator 124
 - Limiting 126
 - Shifting into optimal 126
 - Gear selector lever** 121
 - Cleaning 298
 - Gearshift pattern 121
 - Lock 114, 121
 - Shifting procedure 122
 - Transmission position indicator . . 122
 - Transmission positions 122
 - Unlocking in an emergency 352
 - Gearshift lever** 120
 - Gearshift pattern 120
 - Generator**
 - see Alternator
 - Global locking/unlocking**
 - see Key, SmartKey
 - Glove box** 233
 - Gross Axle Weight Rating**
 - see GAWR
 - Gross Vehicle Weight**
 - see GVW
 - Gross Vehicle Weight Rating**
 - see GVWR
 - GVW (Gross Vehicle Weight)** 281
 - GVWR (Gross Vehicle Weight Rating)** 281
- H**
- Halogen headlamps**
 - see Headlamps
 - Hard plastic trim items, cleaning** . . 297
 - Hazard warning flasher** 103
 - Headlamp cleaning system** 103
 - Headlamps**
 - Active Bi-Xenon headlamps 99
 - Automatic headlamp mode 100
 - Bi-Xenon 99, 355
 - Cleaning lenses 296
 - Cleaning system 103
 - Delayed shut-off 149
 - Halogen 356

High-beam flasher 103
 High-beam headlamps 102
 Low-beam headlamps 100
 Replacing bulbs 355
 Switch 100

Headliner and shelf below rear window, cleaning and care of 298

Head restraints 86
 Active head restraints 57, 353
 Adjusting 89
 Folding back 90
 Rear seat, removing and installing . . 90

Heated seats 92

Height adjustment
 Seat belt outlet 55
 Seats 87

High-beam flasher 103

High-beam headlamps 102, 355
 Replacing bulbs 355

High-mounted brake lamp 355
 Replacing bulbs 355

High-performance brake system . . . 288

Hill start assist system 207

Hood 255
 Messages in the multifunction display 320

Horn 29

Hydroplaning 289

I

Identification labels 377

Identification number, vehicle (VIN) 377

Ignition 84, 86, 113, 114

Immobilizer 73

Infant and child restraint systems
 see Children in the vehicle

Inflation pressure
 see Tires, Inflation pressure

Inside door handle 80

Instrument cluster 30, 129
 Illumination 129
 Lamps 336
 Multifunction display 133

Instrument lighting
 see Instrument cluster, Illumination

Instrument panel
 see Instrument cluster

Instruments and controls
 see Cockpit

Interior lighting
 Delayed shut-off 150
 Emergency lighting 105
 Front 105
 Front reading lamps 105
 Rear 106
 Rear reading lamps 106

Interior rear view mirror 94
 Auto-dimming rear view mirrors 95

Interior storage spaces
 see Storage compartments

Intermittent wiping
 Windshield wipers 107

J

Jack 303

Jump starting 366

K

Key, Mechanical 350
 Loss of 80
 Valet locking 83

Key, SmartKey
 Battery check lamp 77
 Checking batteries 79
 Factory setting 77, 79
 Global locking (KEYLESS-GO) 79
 Global locking (SmartKey) 77
 Global unlocking (KEYLESS-GO) 79
 Global unlocking (SmartKey) 77
 Important notes on KEYLESS-GO 78
 Locking/unlocking 76
 Loss of 80

- Messages in the multifunction display 320
 - Opening, Trunk 81
 - Opening and closing the power tilt/sliding sunroof or panorama roof with power tilt/sliding panel 111
 - Opening and closing the windows 111
 - Remote control 76
 - Replacing batteries 353
 - Restoring to factory setting 77, 79
 - Selective setting 77, 79
 - Starter switch positions 84
 - KEYLESS-GO**
 - Starter switch positions 85
 - Kickdown** 124
 - Kickdown (manual shift program)** 128
 - Kilopascal (air pressure unit)** 281
- L**
- Labels**
 - Certification 377
 - Emission control information 378
 - Lamps, exterior**
 - Exterior lamp switch 100
 - Front 355
 - Messages in the multifunction display 329
 - Rear 355
 - Switching on/off 100
 - Lamps, indicator and warning**
 - ABS 31, 337
 - Battery (SmartKey) 77
 - Brakes 339
 - Center console 36
 - Coolant 31, 346
 - Engine malfunction 31, 345
 - ESP® 31, 343
 - Fog lamps 102
 - Front passenger front air bag off 36, 47, 348
 - Fuel tank reserve 31, 344
 - Instrument cluster 336
 - Low tire pressure/TPMS malfunction telltale 347
 - Seat belt telltale 56, 340
 - SRS 31, 43, 342
 - Turn signals 31
 - LATCH-type child seat anchors**
 - see Children in the vehicle
 - License plate lamps** 355
 - Messages in the multifunction display 331
 - Replacing bulbs 355
 - Light alloy wheels, cleaning** 297
 - Lighter**
 - see Cigarette lighter
 - Lighting** 99
 - Daytime running lamp mode 101
 - Exterior 100
 - Interior 105
 - Limp-home mode** 128
 - Loading**
 - see Vehicle loading
 - Locator lighting** 149
 - Locking the vehicle** 76, 77
 - Manually 351
 - Loss of**
 - Key 80
 - Service and Warranty Information booklet 377
 - Low-beam headlamps** 100
 - Exterior lamp switch 100
 - Replacing bulbs 355
 - Switching on 100
 - Lubricants** 391
 - Lumbar support** 89
- M**
- Maintenance** 19
 - Maintenance System** 291
 - Service indicator 291
 - Service indicator, resetting 292
 - Service indicator display 292
 - Service indicator message 291
 - Service indicator message, clearing 292
 - Service term exceeded 292

Manual headlamp mode (Low-beam headlamps) 100

Manual shift program 127

Manual transmission 119

 Gearshift lever 120

 Hill start assist system 207

Maximum loaded vehicle weight . . . 281

Maximum load rating (tires) 281

Maximum permissible tire inflation pressure 281

Mechanical key 350

Memory function 39, 98

Menus

 see Control system menus

Minispare wheel

 see Spare wheel

Mirrors

 Auto-dimming rear view mirrors 95

 Exterior rear view mirror parking positions 97, 98

 Exterior rear view mirrors 95

 Interior rear view mirror 94

 Memory function 98

MON (Motor Octane Number) 396

Motor Octane Number

 see MON

MP3 179

Multifunction display 133

 Text messages 307

 Vehicle status messages 305

Multifunction display messages

 ABS 317, 318

 Air bags 309

 Alternator 327

 Battery 327

 Brake fluid 316

 Brake pads 317

 Coolant 324, 325, 326

 Corner-illuminating front fog lamps 329

 Cruise control 313

 Display malfunction 305

 Doors 320

 EBP 317

 ESP® 307, 317

 Fog lamps 331

 Front passenger front air bag 309

 Gas cap 328

 High-beam lamps 331

 Hood 320

 License plate lamps 331

 Light sensor 329

 Low-beam lamps 329

 Parking brake 317

 Parking lamps 332

 Power steering 323

 Reserve fuel 328

 Reverse lamp 332

 Run Flat Indicator 314

 Side marker lamps 332

 SmartKey 321

 SmartKey with KEYLESS-GO 320

 SRS 319

 Tele Aid 318

 Tire pressure 314, 334

 Tire pressure monitor 314

 Tires 314, 334

 TPMS 334

 Trunk 320

 Turn signals 330

Multifunction steering wheel

 Adjusting 92

 Buttons 131

 Cleaning 298

 Easy-entry/exit feature 93, 151

 Gearshift control 126

 Memory function 98

 Overview 34

N

Navigation menu 140

Nets, parcel 230

Night security illumination 102, 149

Normal occupant weight 282

Number, vehicle identification (VIN) 377

- O**
- Occupant Classification System**
see OCS
 - Occupant distribution** 282
 - Occupant safety** 42
 - Air bags 43
 - Children and air bags 43
 - Children in the vehicle 59
 - Child seat anchors – LATCH-type . . . 63
 - Fastening the seat belts 55
 - Front passenger front air bag off indicator lamp 49, 348
 - Infant and child restraint systems . . . 60
 - OCS 49
 - Seat belts 45, 53
 - OCS (Occupant Classification System)** 49
 - Self-test 52
 - Odometer** 135
 - Oil**
see Engine oil
 - Oil level**
see Engine oil, Checking level
 - On-board computer**
see Control system
 - One-touch gearshifting** 125
 - Operating safety** 21
 - Ornamental moldings, cleaning** 295
 - Overhead control panel** 38
- P**
- Paintwork, cleaning** 294
 - Paintwork code** 377
 - Panic alarm** 65
 - Panorama roof with power tilt/sliding panel** 226
 - Cleaning 297
 - Operation 226
 - Roller sunblinds 226
 - Synchronizing 228
 - Parcel nets** 230
 - Parking** 117
 - Parking brake** 118
 - Messages in the multifunction display 317
 - Parking position**
Exterior rear view mirrors 97, 98
Transmission position 122
 - Parts service** 376
 - PASS AIR BAG OFF indicator lamp**
see Front passenger front air bag off indicator lamp
 - Passenger safety**
see Occupant safety
 - Pedals** 286
 - Pelvic air bags** 48
 - Phone**
see Telephone
 - Plastic parts, cleaning** 297
 - Power assistance** 286
 - Power outlets** 238
 - Power seats**
see Seats
 - Power steering**
messages in the multifunction display 323
 - Power tilt/sliding sunroof**
Operation 223
Synchronizing 225
 - Power washer** 294
 - Power windows** 109
 - Cleaning 296
 - Operation 109
 - Rear door window, Blocking operation 65
 - Synchronizing 110
 - Practical hints** 302
 - Problems**
While driving 117
With vehicle 22
 - Product information** 18
 - Production options weight** 282
 - Program mode selector switch**
Automatic shift program 124, 125
Manual shift program 127
 - Proximity key**
see Key, SmartKey
 - PSI (air pressure unit)** 282

Push-start

see Tow-start

R**RACETIMER** 138**Radio** 167

Satellite radio 172

Selecting stations 140

Radio transmitters 290**Rain sensor** 107**Rear axle oil** 392**Rear center console ashtray**

see Ashtrays

Rear doors

Child safety locks 64

Rear door window

Blocking operation 65

Rear fog lamp

see Fog lamps

Rear lamps

see Tail lamps

Rear seat head restraints

see Head restraints

Rear window defroster 222**Recommended tire inflation****pressure** 266, 282**Recovery services, Stolen vehicle****(Tele Aid)** 245**Refrigerant, air conditioning** 395**Refueling** 253**Regular checks** 254**Reminder, Seat belt**

see Seat belts, Telltale

Remote control

see Key, SmartKey

Remote door unlock (Tele Aid) 245**Replacing bulbs** 355**Reporting safety defects** 22**Research Octane Number**

see RON

Reserve fuel

Messages in the multifunction

display 328

Warning lamp 344

Restraint systems

see Occupant safety

Retaining hooks 231**Rims** 282, 382**Roadside Assistance** 20, 243**RON (Research Octane Number)** 396**Roof rack** 230**Route guidance**

see Navigation system

Rubber parts, cleaning 297**Run Flat Indicator** 269**S****Safety**

Driving safety systems 66

Occupant safety 42

Reporting defects 22

Safety belts

see Seat belts

Satellite radio 172**Seat belt force limiter** 56**Seat belts** 53

Children in the vehicle 59

Cleaning 298

Fastening 55

Height adjustment 55

Proper use of 54

Safety guidelines 45

Safety notes 53

Telltale 340

Warning lamp 340

Seating capacity 263**Seats** 86

Adjusting 39, 87

Easy-entry/exit feature 93

Heating 92

Memory function 98

Split rear seat bench 231

Securing cargo

Cargo tie-down rings 231

- Selective setting**
 - see Key, SmartKey
 - Selector lever**
 - see Gear selector lever
 - Self-test**
 - OCS 52
 - Tele Aid 241
 - Service**
 - see Maintenance
 - Service, parts** 376
 - Service and warranty information** . . . 19
 - Service intervals**
 - see Maintenance System, Service indicator
 - Service life (tires)** 261
 - Service menu** 144
 - Settings**
 - Date 148
 - Factory setting (SmartKey) 77, 79
 - Individual (vehicle) 145
 - Memory function 98
 - Menu 145
 - Selective setting (SmartKey) . . . 77, 79
 - Time 147
 - Shelf below rear window, cleaning** . 298
 - Side impact air bags** 47
 - Side marker lamps**
 - Cleaning lenses 296
 - Messages in the multifunction display 332
 - Replacing bulbs 355
 - Sidewall (tires)** 282
 - Side windows**
 - see Power windows
 - SmartKey**
 - see Key, SmartKey
 - SmartKey with KEYLESS-GO**
 - see Key, SmartKey
 - Snow chains** 284
 - Snow tires**
 - see Winter tires
 - Spare wheel** 304, 382
 - Mounting 361
 - Speedometer** 31
 - SRS** 43
 - Indicator lamp 43, 342
 - Messages in the multifunction display 319
 - Standing water, driving through** . . . 289
 - Starter switch positions** 84, 85
 - Starting difficulties (engine)** 115
 - Starting the engine** 113
 - Steering column**
 - see Multifunction steering wheel, Adjusting
 - Steering wheel**
 - see Multifunction steering wheel
 - Steering wheel gearshift control** . . . 126
 - Stolen Vehicle Recovery services** . . . 245
 - Storage compartments** 32, 233
 - Storing tires** 262
 - Sunroof**
 - see Power tilt/sliding sunroof
 - Sunshade, rear window** 236
 - Sun visors** 236
- T**
- Tachometer** 31, 130
 - Overspeed range 130
 - Tail lamps** 355
 - Cleaning lenses 296
 - Replacing bulbs 355
 - Tar stains** 294
 - Technical data**
 - Air conditioning refrigerant . . . 393, 395
 - Brake fluid 392, 395
 - Capacities fuels, coolants, lubricants etc. 391
 - Coolant 392, 397
 - Dimensions 388
 - Electrical system 387
 - Engine 379
 - Engine oil additives 395
 - Engine oils 391, 394

- Fuel requirements 396
- Gasoline additives 397
- Identification labels 377
- Premium unleaded gasoline 395
- Rims and tires 382
- Spare wheel 386
- Washer and headlamp cleaning system 393, 400
- Weights 390
- Tele Aid** 240
 - Emergency calls 241
 - Information button 244
 - Initiating an emergency call manually 242
 - Messages in the multifunction display 318
 - Remote door unlock 245
 - Roadside Assistance button 243
 - SOS button 242
 - Stolen Vehicle Recovery services 245
 - System self-test 241
- Telephone** 34, 189
 - Answering/ending a call 143
 - Call lists 200
 - Emergency calls “911” 196
 - Hands-free microphone 38
 - Making calls 201
 - Menu 142
 - Operation 142
 - Phone book 143, 197
 - Redialing 143
- Temperature**
 - Coolant 130
 - Interior temperature 217
 - Outside 130
- Tether anchorage points**
 - see Children in the vehicle
- Tie-down rings** 231
- Tightening torque**
 - Spark plugs 387
 - Wheels 364
- Time setting** 147
- TIN (Tire Identification Number)** 282
- Tire and Loading Information Placard** 262
- Tire and loading terminology** 280
- Tire Identification Number**
 - see TIN
- Tire inflation pressure**
 - Checking 268
 - Important notes on 267
 - Placard on driver’s door B-pillar 262
- Tire labeling** 273
- Tire load rating** 282
- Tire ply composition and material used** 282
- Tire Pressure Monitoring System (TPMS)** 270
 - Messages in the multifunction display 334
- Tires** 260, 382
 - Air pressure 266
 - Care and maintenance 261
 - Cleaning 262
 - Direction of rotation, spinning 262
 - Important notes on tire inflation pressure 267
 - Inflation pressure 267, 268
 - Information placard 262
 - Inspection 261
 - Labeling 273
 - Load rating 282
 - Messages in the multifunction display 314, 334
 - Ply composition and material used 282
 - Problems under-/overinflation 267
 - Retreads 260
 - Rims and tires (technical data) 382
 - Rotation 283
 - Run Flat Indicator 269
 - Service life 261
 - Sizes 382
 - Snow chains 284
 - Speed rating 275, 282
 - Storing 262
 - Temperature 267, 280

- Terminology 280
 - Tire Identification Number 282
 - Tire Pressure Monitoring System (TPMS) 270
 - TPMS low tire pressure/malfunction telltale 347
 - Traction 279, 282
 - Tread 283
 - Tread depth 261, 284
 - Treadwear indicators 261, 283
 - Vehicle maximum load on 283
 - Wear pattern 283
 - Winter tires 284, 382
 - Tire speed rating** 275, 282
 - Top tether**
see Children in the vehicle
 - Total load limit** 282
 - Towing eye bolt** 369
 - Towing the vehicle** 368
 - Tow-start** 366, 368
 - Traction** 282
 - Transmission**
see Automatic transmission or Manual transmission
 - Transmission fluid level** 258
 - Transmission gear selector lever**
see Gear selector lever
 - Transmission positions** 122
 - Traveling abroad** 290
 - Tread (tires)** 283
 - Tread depth (tires)** 261, 284
 - Treadwear indicators (tires)** 261, 283
 - Trip computer menu** 135
 - Trunk**
Closing 82
Fuse box 373
Messages in the multifunction display 320
Opening 81
Tie-down rings 231
Trunk lid emergency release 83
Unlocking in an emergency 350
Valet locking 83
 - Turning off the engine** 118
 - Turn signals** 103
Additional in mirrors 355
Bulbs 355
Cleaning lenses 296
Indicator lamps 31
Messages in the multifunction display 330
Replacing bulbs 355
- U**
- Uniform Tire Quality Grading Standards** 279, 283
 - Units, Settings**
Speedometer 146
 - Unleaded gasoline, premium** 395
 - Unlocking the vehicle** 76, 77
Manually 350
 - Upholstery, cleaning** 298
 - Useful features** 235
- V**
- Valet locking** 83
 - Vehicle**
Battery 364
Care 293
Control system 131
Dimensions 388
Individual settings 145
Locking/unlocking 76, 77
Locking/unlocking manually 350
Lowering (wheel change) 363
Modifications and alterations, Operating safety 21
Towing 368
 - Vehicle jack**
see Jack
 - Vehicle lighting** 99
 - Vehicle loading**
Cargo tie-down rings 231
Instructions 229
Load limit 264
Roof rack 230
Split rear seat bench 231
Terminology 280

- Vehicle maximum load on the tire** . . . 283
 - Vehicle Recovery services, Stolen (Tele Aid)** 245
 - Vehicle status message memory** . . . 144
 - Vehicle tool kit** 302
 - Vehicle washing**
 - see Vehicle care
- W**
- Warning sounds**
 - Driver's or passenger's seat belt . . . 56
 - Parking brake 317
 - Seat belt telltale 340
 - Warranty coverage** 376
 - Washer and headlamp cleaning system** 400
 - Washer fluid**
 - Mixing ratio 400
 - Refilling 259
 - Wiping 108
 - Washing the vehicle** 293
 - Wear pattern (tires)** 283
 - Wheel**
 - Changing 360
 - Removing 363
 - Spare 360
 - Tightening torque 364
 - Wheels, sizes** 382
 - Wheels, Tires and** 260
 - Window curtain air bags** 49
 - Windows**
 - see Power windows
 - Windows, cleaning** 296
 - Windshield**
 - Cleaning wiper blades 296
 - Defogging 220
 - Washer fluid 108, 400
 - Wipers 107
 - Windshield wipers**
 - Rain sensor 107
 - Replacing wiper blades 359
 - Winter driving**
 - Snow chains 284
 - Tires 284
 - Winter driving instructions** 285
 - Winter tires** 284, 382
 - Wood trims, cleaning** 298

Operator's Manual

Product Information

Please observe the following in your own best interest:

We recommend using Genuine Mercedes-Benz Parts as well as conversion parts and accessories explicitly approved by us for your vehicle model.

We have tested these parts to determine their reliability, safety and special suitability for Mercedes-Benz vehicles.

We are unable to make an assessment for other products and therefore cannot be held responsible for them, even if in individual cases an official approval or authorization by governmental or other agencies should exist. Use of such parts and accessories could adversely affect the safety, performance or reliability of your vehicle. Please do not use them.

Genuine Mercedes-Benz Parts and pre-approved conversion parts and accessories are available at any authorized Mercedes-Benz Center. In addition, you will receive comprehensive information on permissible technical modifications and expert installations.

Operator's Manual

Notes

This Operator's Manual contains a great deal of useful information. We urge you to read it carefully and familiarize yourself with the vehicle before driving.

For your own safety and longer service life of the vehicle, we urge you to follow the instructions and warnings contained in this Operator's Manual. Ignoring them could result in damage to the vehicle or personal injury to you or others. Vehicle damage caused by failure to follow instructions is not covered by the Mercedes-Benz Limited Warranty.

We continuously strive to improve our product, and ask for your understanding that we reserve the right to make changes in design and equipment. Therefore, information, illustrations and descriptions in this Operator's Manual might differ from your vehicle.

Vehicle equipment

Your vehicle may have some or all of the equipment described in this manual. Therefore, you may find explanations for optional equipment not installed in your vehicle. If you have any questions about operating any equipment, any authorized Mercedes-Benz Center will be glad to demonstrate the proper procedures.

Optional equipment is also described in this manual, including operating instructions wherever necessary. Since they are special-order items, the descriptions and illustrations herein may vary slightly from the actual equipment of your vehicle.

If there are any equipment details that are not shown or described in this Operator's Manual, any authorized Mercedes-Benz Center will be glad to inform you of correct care and operating procedures. The Operator's Manual and Maintenance Booklet are important documents and should be kept with the vehicle.

Service and warranty information

The Service and Warranty Information booklet contains detailed information about the warranties covering your Mercedes-Benz, including:

- New Car Limited Warranty
- Emission System Warranty
- Emission Performance Warranty
- California, Connecticut, Maine, Massachusetts, New York, Pennsylvania, Rhode Island, and Vermont Emission Control System Warranty
- State Warranty Enforcement Laws (Lemon Laws)

Important notice for California retail buyers and lessees of Mercedes-Benz automobiles

Under California law you may be entitled to a replacement of your vehicle or a refund of the purchase price or lease price, if after a reasonable number of repair attempts Mercedes-Benz USA, LLC and/or its authorized repair or service facilities fail to fix one or more substantial defects or malfunctions in the vehicle that are covered by its express warranty. During the period of 18 months from original delivery of the vehicle or the accumulation of 18 000 miles (approximately 29 000 km) on the odometer of the vehicle, whichever occurs first, a reasonable number of repair attempts is presumed for a retail buyer or lessee if one or more of the following occurs:

- (1) the same substantial defect or malfunction results in a condition that is likely to cause death or serious bodily injury if the vehicle is driven, that defect or malfunction has been subject to repair two or more times, and you have directly notified Mercedes-Benz USA, LLC in writing of the need for its repair,
- (2) the same substantial defect or malfunction of a less serious nature than

category (1) has been subject to repair four or more times and you have directly notified us in writing of the need for its repair, or

- (3) the vehicle is out of service by reason of repair of the same or different substantial defects or malfunctions for a cumulative total of more than 30 calendar days.

Written notification should not be sent to a dealer, it should be addressed to Mercedes-Benz USA, LLC Customer Assistance Center One Mercedes Drive Montvale, NJ 07645-0350

Maintenance

The Maintenance Booklet describes all the necessary maintenance work which should be performed at regular intervals.

Always have the Maintenance Booklet with you when you take the vehicle to an authorized Mercedes-Benz Center for service. The service advisor will record each service in the booklet for you.

Operator's Manual

Roadside Assistance

The Mercedes-Benz Roadside Assistance Program provides factory-trained technical help in the event of a breakdown. Calls to the toll-free Roadside Assistance number

1-800-FOR-MERCEdes (in the USA)
1-800-387-0100 (in Canada)

will be answered by Mercedes-Benz Customer Assistance Representatives 24 hours a day, 365 days a year.

For additional information refer to the Mercedes-Benz Roadside Assistance Program brochure (in the USA) or the Roadside Assistance section of the Service and Warranty Information Booklet (in Canada) in your vehicle literature portfolio.

Change of address or ownership

If you change your address, be sure to send in the "Change of Address Notice" found in the Service and Warranty Information Booklet, or simply call the Mercedes-Benz Customer Assistance Center (in the USA) at 1-800-FOR-MERCEdes, or Customer Service (in Canada) at 1-800-387-0100. This will assist us in contacting you in a timely manner should the need arise.

If you sell your Mercedes, please leave all literature with the vehicle to make it available to the next operator.

If you bought this vehicle used, be sure to send in the "Notice of Purchase of Used Car" found in the Service and Warranty Information Booklet, or call the Mercedes-Benz Customer Assistance Center (in the USA) at 1-800-FOR-MERCEdes, or Customer Service (in Canada) at 1-800-387-0100.

Operating your vehicle outside the USA or Canada

If you plan to operate your vehicle in foreign countries, please be aware that:

- service facilities or replacement parts may not be readily available,
- unleaded gasoline for vehicles with catalytic converters may not be available; the use of leaded fuels will damage the catalyts,
- gasoline may have a considerably lower octane rating, and improper fuel can cause engine damage.

Certain Mercedes-Benz models are available for delivery in Europe under our European Delivery Program. For details, consult an authorized Mercedes-Benz Center or write to:

In the USA:

Mercedes-Benz USA, LLC
European Delivery Department
One Mercedes Drive
Montvale, NJ 07645-0350

In Canada:

Mercedes-Benz Canada, Inc.
European Delivery Department
98 Vanderhoof Avenue
Toronto, Ontario M4G 4C9

Operating safety

Warning!

Work improperly carried out on electronic components and associated software could cause them to cease functioning. Because the vehicle's electronic components are interconnected, any modifications made may produce an undesired effect on other systems. Electronic malfunctions could seriously impair the operating safety of your vehicle. Contact an authorized Mercedes-Benz Center for repairs or modifications to electronic components.

Other improper work or modifications on the vehicle could also have a negative impact on the operating safety of the vehicle.

Some safety systems only function while the engine is running. You should therefore never turn off the engine while driving.

Warning!

Heavy blows against the vehicle underbody or tires/wheels, for example when running over an obstacle, road debris or a pothole,

may cause serious damage and impair the operating safety of your vehicle. If you feel a sudden significant vibration or ride disturbance, or you suspect that damage to your vehicle has occurred, you should turn on your hazard warning flashers, carefully slow down, and drive with caution to an area which is a safe distance from the road. Inspect the vehicle underbody and tires/wheels for possible damage. If the vehicle appears unsafe, have it towed to the nearest authorized Mercedes-Benz Center or other qualified maintenance or repair facility for further inspection or repairs.

Proper use of the vehicle

Proper use of the vehicle requires that you are familiar with the following information and rules:

- the safety precautions in this manual
- the “Technical data” section in this manual
- traffic rules and regulations
- motor vehicle laws and safety standards

Warning!

Various warning labels are attached to your vehicle. These warning labels are intended

to make you and others aware of various risks. You should not remove any of these warning labels unless explicitly instructed to do so by information on the label itself. Removal of any of these labels may cause you and others to be unaware of certain risks which may result in an accident and/or personal injury.

Reporting safety defects

Problems with your vehicle

If you should experience a problem with your vehicle, particularly one that you believe may affect its safe operation, we urge you to contact an authorized Mercedes-Benz Center immediately to have the problem diagnosed and corrected if required. If the matter is not handled to your satisfaction, please discuss the problem with the Mercedes-Benz Center management or, if necessary, contact us at one of the following addresses:

In the USA:

Customer Assistance Center
Mercedes-Benz USA, LLC
One Mercedes Drive
Montvale, NJ 07645-0350

In Canada:

Customer Relations Department
Mercedes-Benz Canada, Inc.
98 Vanderhoof Avenue
Toronto, Ontario M4G 4C9

Reporting safety defects

For the USA only:

The following text is published as required of manufacturers under Title 49, Code of U.S. Federal Regulations, Part 575 pursuant to the “National Traffic and Motor Vehicle Safety Act of 1966”.

Reporting safety defects

If you believe that your vehicle has a defect which could cause a crash or could cause injury or death, you should immediately inform the National Highway Traffic Safety Administration (NHTSA) in addition to notifying Mercedes-Benz USA, LLC.

If NHTSA receives similar complaints, it may open an investigation, and if it finds that a safety defect exists in a group of vehicles, it may order a recall and remedy campaign. However, NHTSA cannot become involved in individual problems between you, your dealer, or Mercedes-Benz USA, LLC.

To contact NHTSA, you may call the Vehicle Safety Hotline toll-free at 1-888-327-4236 (TTY: 1-800-424-9153); go to

www.safercar.gov; or write to:
Administrator, NHTSA Headquarters,

1200 New Jersey Avenue, SE, West Building,
Washington, DC 20590.

You can also obtain other information about motor vehicle safety from
www.safercar.gov.

Vehicle data recording

Information regarding electronic recording devices

(Including notice pursuant to California Code § 9951)

Please note that your vehicle is equipped with devices that can record vehicle systems data and, if equipped with the Tele Aid system, may transmit some data in certain accidents.

This information helps, for example, to diagnose vehicle systems after a collision and to continuously improve vehicle safety.

Daimler may access the information and share it with others

- for safety research or vehicle diagnosis purposes
- with the consent of the vehicle owner or lessee
- in response to an official request by law enforcement or other government agency
- for use in dispute resolution involving Daimler, its affiliates or sales/service organization and/or
- as otherwise required or permitted by law.

Please check the Tele Aid subscription service agreement for details regarding the

information that may be recorded or transmitted via that system.

Exterior view	26
Cockpit	28
Instrument cluster	30
Storage compartments	32
Multifunction steering wheel	34
Center console	36
Overhead control panel	38
Door control panel, seat adjustment	39



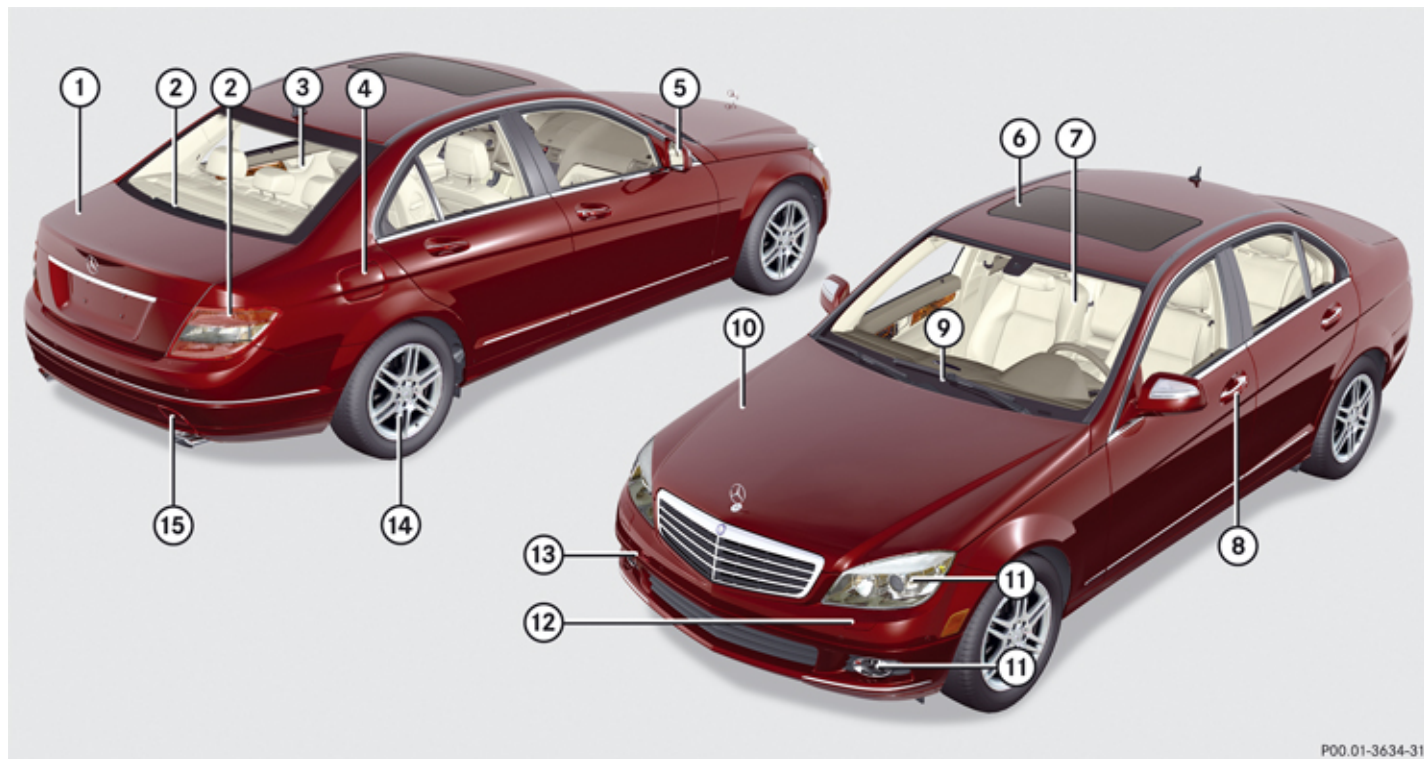

P00.01-3634-31

Exterior view

i This Operator's Manual describes all features, standard or optional, potentially available for your vehicle at the time of purchase. Please be aware that your vehicle might not be equipped with all features described in this manual.

	Function	Page
①	Trunk:	
	Locking and unlocking	76, 350
	Opening and closing	81, 82
	Valet locking	83
②	Rear lamps	356
③	Rear window defroster	222
④	Fuel filler flap	253
	Fuel requirements	396
⑤	Exterior rear view mirrors	95
	Parking position	97
	Power folding, Canada only	96
⑥	Power tilt/sliding sunroof	223

	Function	Page
	Panorama roof with power tilt/sliding panel	226
⑦	Windshield:	
	Front window, defrosting	220
	Cleaning with washer fluid	108
	Cleaning	296
⑧	Doors:	
	Locking and unlocking	76
	Opening	80
	Unlocking/locking manually	350
⑨	Wipers	106
	Wiper blades, replacing	359
	Wiper blades, cleaning	296

	Function	Page
⑩	Hood	255
	Engine oil	256
	Coolant	258
⑪	Front lamps	355
⑫	Headlamp cleaning system	103
⑬	Front towing eye	369
⑭	Tires and wheels	260, 382
	Checking tire inflation pressure	268
	Spare wheel	304
	Flat tire	360
	Rear towing eye	369
⑮	Rear towing eye	369

Cockpit

Cockpit

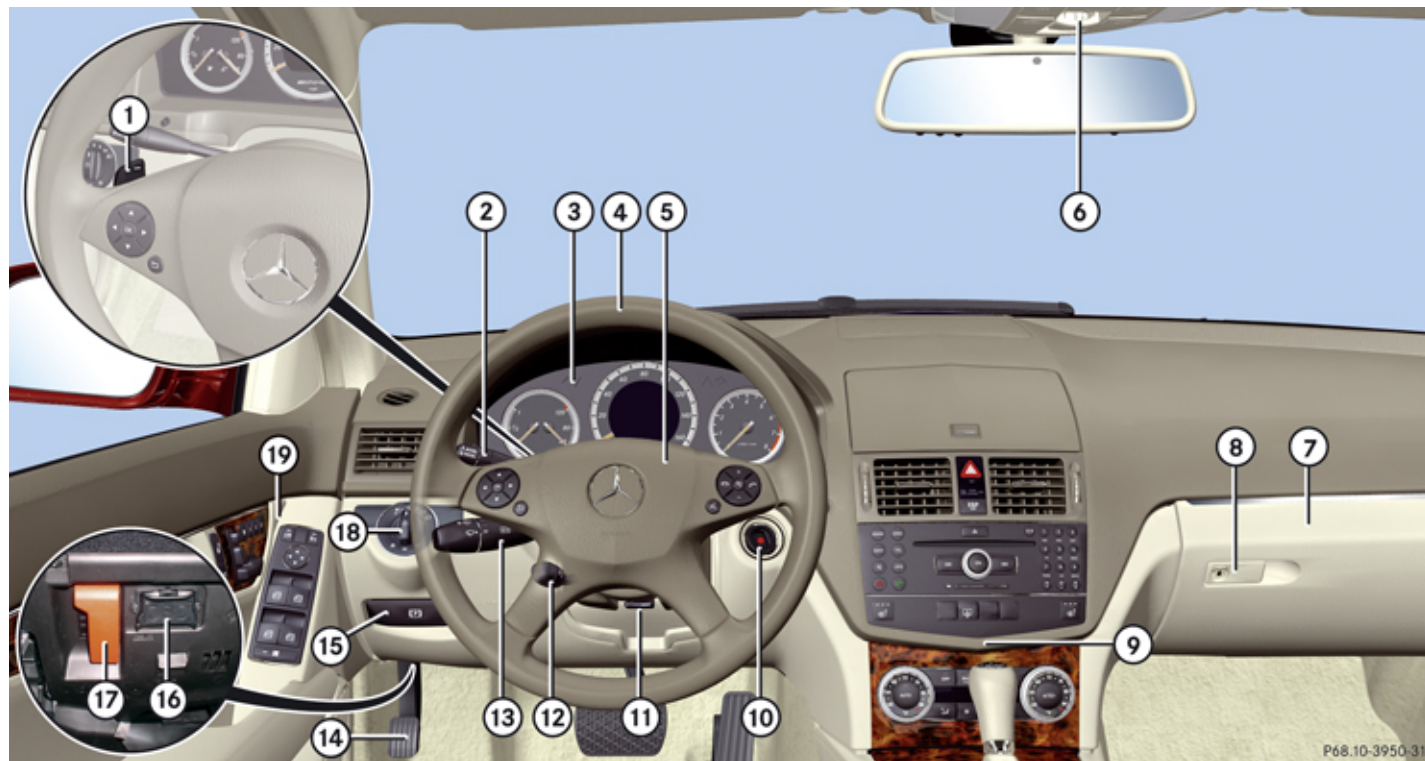

P68.10-3950-31

Cockpit







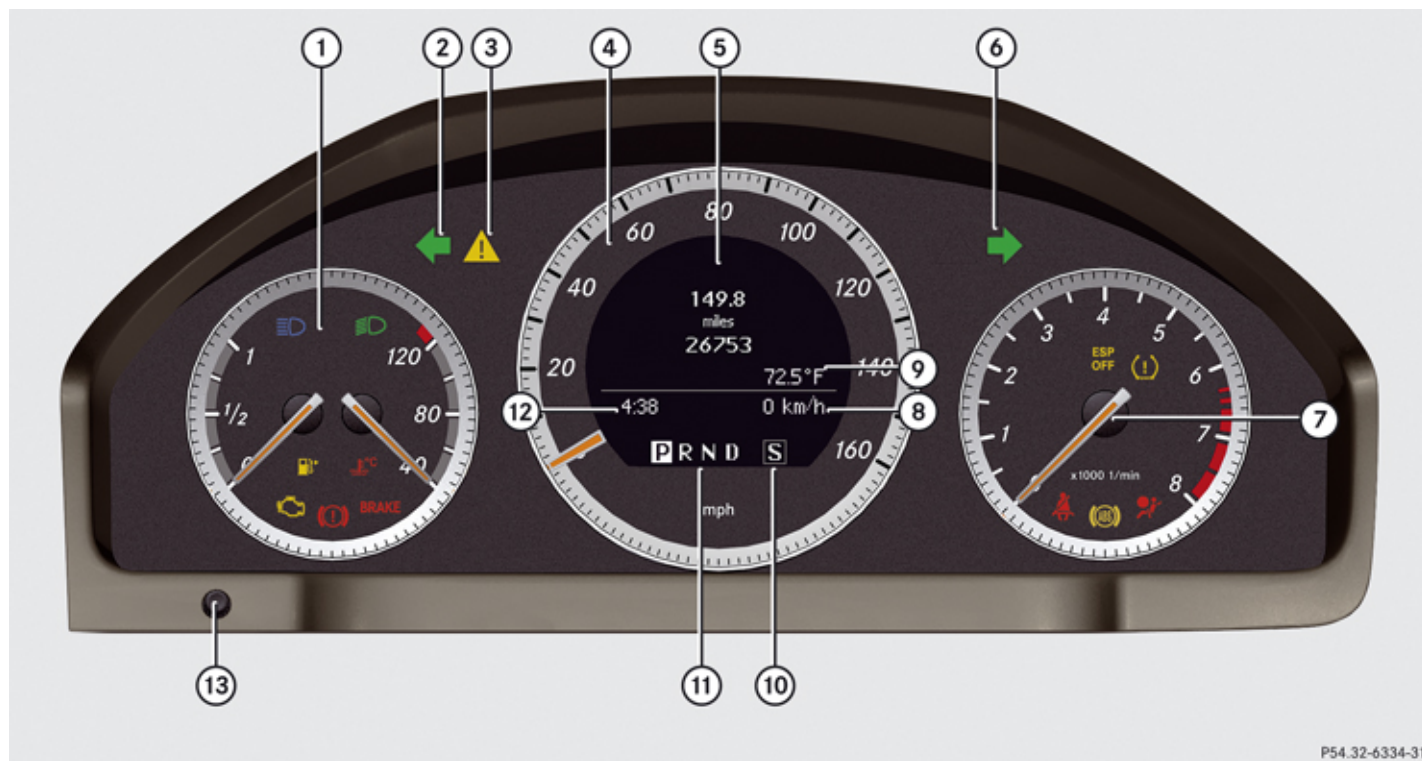

	Function	Page
①	Steering wheel gearshift control	125
②	Cruise control lever	204
③	Instrument cluster	30, 129
④	Multifunction steering wheel	34, 131
⑤	Horn	
⑥	Overhead control panel	38
⑦	Glove box	233
⑧	Glove box lock	233







	Function	Page
⑨	Center console	36
⑩	Starter switch KEYLESS-GO start/stop button	84 85
⑪	Steering wheel release handle (manual)	93
⑫	Steering wheel adjustment stalk (electrical)	93
⑬	Combination switch Turn signals	102 103

	Function	Page
	Wipers High beam	106 102
⑭	Parking brake pedal	118
⑮	Parking brake release	118
⑯	On-board diagnostics (OBD) socket	
⑰	Hood lock release	255
⑱	Exterior lamp switch	100
⑲	Door control panel and seat adjustment/memory	39



Instrument cluster

	Function	Page
①	Combination gauge with:	
	Fuel gauge	
	 Fuel tank reserve warning lamp	344
	Coolant temperature gauge	
	 Coolant temperature warning lamp	346
	Indicator/warning lamps:	
	 High-beam headlamp indicator lamp	102
	 Low-beam headlamp indicator lamp	100
	 Engine malfunction indicator lamp	345
	 Brake warning lamp, USA only	339
	 Brake warning lamp, Canada only	339
②	 Left turn signal indicator lamp	103

	Function	Page
③	 ESP® warning lamp	343
④	Speedometer	
⑤	Multifunction display	133
⑥	 Right turn signal indicator lamp	103
⑦	Tachometer with:	
	 ESP OFF warning lamp, C 63 AMG only	70, 343
	 Combination low tire pressure/TPMS malfunction telltale, USA only	270, 347
	 Supplemental Restraint System (SRS) indicator lamp	43, 342
	 Antilock Brake System (ABS) indicator lamp	337

	Function	Page
	 Seat belt telltale	56, 340
⑧	Outside temperature (manual transmission)	130
	Outside temperature/ additional speedometer (automatic transmission)	130, 147
⑨	Outside temperature (automatic transmission)	130, 147
⑩	Program mode indicator (automatic transmission)	124
⑪	Transmission position indicator/ gear range indicator (automatic transmission)	122, 124
	Additional speedometer (manual transmission)	146
⑫	Digital clock	147
⑬	Instrument cluster illumination	129

Storage compartments

Storage compartments

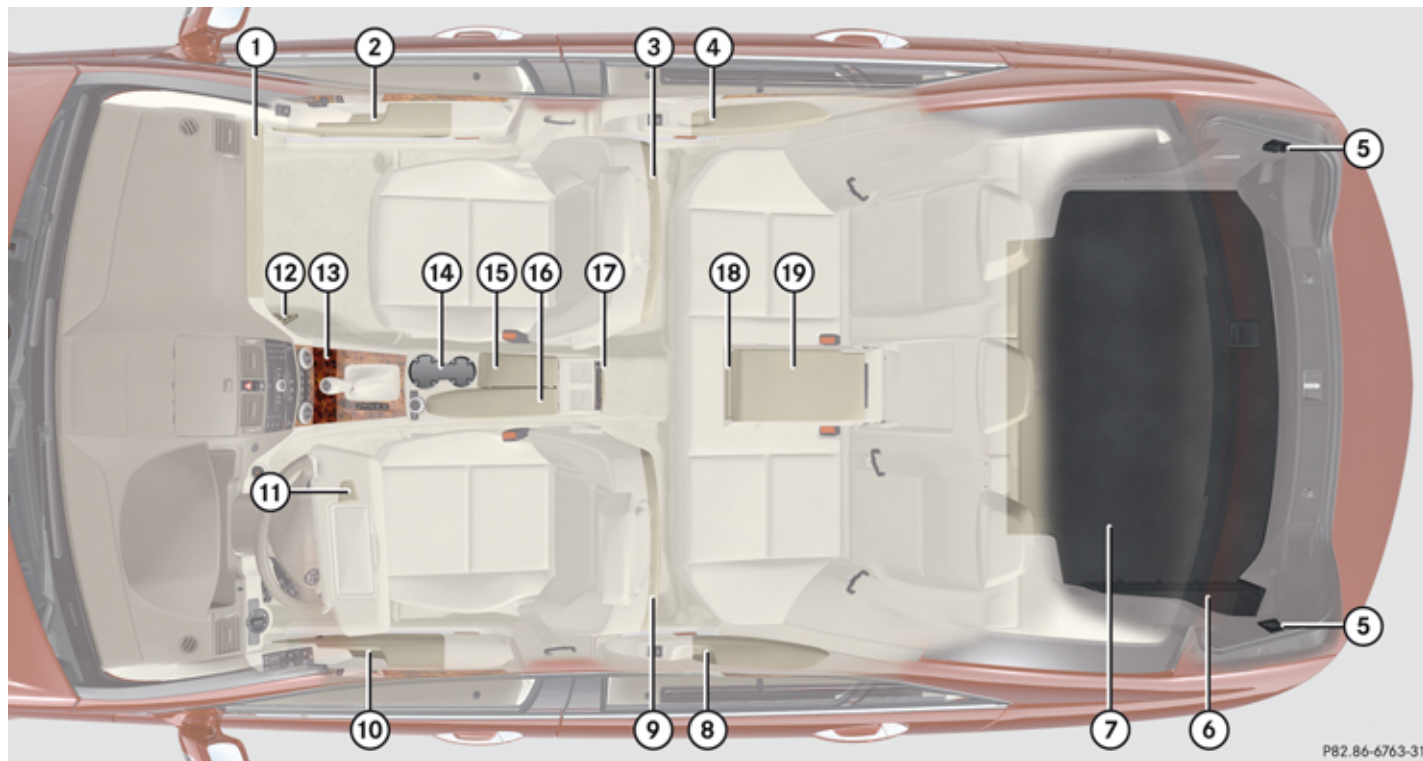

Storage compartments





	Function	Page
①	Glove box	233
	Power outlet	238
	Aux socket	188
②	Door pocket	
③	Storage bag on front passenger seat backrest	234
④	Door pocket	
⑤	Hooks on left and right side in trunk	231
⑥	Parcel net on left side in trunk	230
⑦	Storage space for Minispare wheel and vehicle tool kit in trunk	304, 302
⑧	Door pocket	
⑨	Storage bag on driver's seat backrest	234
⑩	Door pocket	
⑪	Document holder in sun visor	236



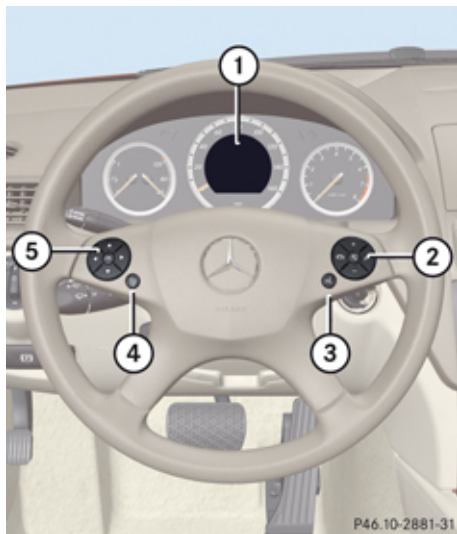

	Function	Page
⑫	Parcel net in front passenger footwell	230
⑬	Ashtray	237
	Cigarette lighter	238
⑭	Cup holder	235
⑮	Right storage compartment in front center armrest	233
⑯	Left storage compartment in front center armrest	233
⑰	Ashtray in rear passenger compartment	237
	Power outlet	238
⑱	Cup holder in rear center armrest	235
⑲	Rear center armrest with storage compartment	234

Multifunction steering wheel

Multifunction steering wheel



	Function	Page
①	Multifunction display	133
②	Press button + or - <ul style="list-style-type: none"> to set the volume to operate the RACETIMER¹ Press button  <ul style="list-style-type: none"> to take a call to dial² to redial² Press button  <ul style="list-style-type: none"> to end a call to reject an incoming call Press button  to mute	140 138 143 143 143 143 143
③	Press button  to activate the Voice Control System ³	





	Function	Page
④	Press button  briefly <ul style="list-style-type: none"> to go to the next higher menu level to confirm display message to cancel the Voice Control System³ Press and hold button  to select the standard display	132 132
⑤	Press button  or  <ul style="list-style-type: none"> to call up line for menus to scroll to the left or right to select menus 	132

¹ AMG vehicles only.

² Function only available in telephone menu.

³ The Voice Control System is only available with the COMAND system. Refer to separate operating instructions.

Multifunction steering wheel

Function	Page
Press button  or  briefly <ul style="list-style-type: none"> to select submenus to scroll up or down through lists to select previous or next track, scene, or stored station within Audio menu to switch to the phone book and select a name or number within Te1 menu 	132
Press and hold button  or  <ul style="list-style-type: none"> to select previous or next track or scene with quick search or to select previous or next station in waveband (if no station list is 	140

Function	Page
available) within Audio menu <ul style="list-style-type: none"> to start the quick search in the phone book within Te1 menu 	142
Press button  <ul style="list-style-type: none"> to confirm selection or message to switch to the phone book² to dial a selected phone number² 	133

² Function only available in telephone menu.

Center console

Center console

Upper part



P68.20-3904-31

	Function	Page
①	Audio display cover	156
②	Hazard warning flasher switch	103
③	Alarm system indicator lamp	73
④	Front passenger front air bag off indicator lamp	49, 348
⑤	Electronic Stability Program (ESP®) switch	69
⑥	Audio system or COMAND system, see separate operating instructions	153
⑦	Seat heating, front passenger side	92
⑧	Rear window sunshade switch	236
⑨	Sport driving mode on/off button, Canada only	208

	Function	Page
⑩	Dual-zone automatic climate control	211
	3-zone automatic climate control, Canada only	213
	Rear window defroster	222
⑪	Seat heating, driver's side	92

Center console

Lower part



P68.20/3728-31

	Function	Page
①	Ashtray	237
	Cigarette lighter	238
②	Gear shift lever for manual transmission	119
	Gear selector lever for automatic transmission	121
③	Cup holder	235
④	Split storage compartment, left and right side of the center armrest	233
⑤	Audio controller	157

	Function	Page
	COMAND controller (see separate operating instructions)	
⑥	Program mode selector switch for automatic transmission	124

Overhead control panel

Overhead control panel



P82.00-2630-31

	Function	Page
①	Rear interior lighting on/off	105
②	Interior lighting control	105
③	Right reading lamp on/off	105
④	Power tilt/sliding sunroof switch or Power tilt/sliding panel switch	223 226
⑤	Information button	244
⑥	Tele Aid (emergency call system) button	242
⑦	Interior rear view mirror	94
⑧	Integrated electronic compass	239
⑨	Garage door opener	246
⑩	Hands-free microphone for Tele Aid (emergency call system), telephone and Voice Control System ⁴	

	Function	Page
⑪	Roadside Assistance button	243
⑫	Left reading lamp on/off	105
⑬	Front interior lighting on/off	105

⁴ The Voice Control System is only available with the COMAND system. Refer to separate operating instructions.

Door control panel, seat adjustment



Door control panel, with memory function

	Function	Page
①	Inside door handle	80
②	Central unlocking switch	81
③	Seat adjustment	87
④	Memory function for storing seat, exterior mirror, and steering wheel settings	98
⑤	Exterior rear view mirrors adjustment	95
	Power-folding exterior rear view mirrors, Canada only	96
⑥	Switches for opening/closing front and rear door windows	109
⑦	Rear door window override switch	65
⑧	Remote trunk opening switch	81
⑨	Central locking switch	81

Door control panel, seat adjustment



Seat adjustment, vehicles without memory function

Vehicle equipment	42
Occupant safety	42
Panic alarm	65
Driving safety systems	66
Anti-theft systems	73



Occupant safety

Vehicle equipment

i This Operator's Manual describes all features, standard or optional, potentially available for your vehicle at the time of purchase. Please be aware that your vehicle might not be equipped with all features described in this manual.

Occupant safety

Introduction

In this section you will learn the most important facts about the restraint system components of the vehicle.

The restraint systems are

- Seat belts
- Child restraints
- Lower Anchors and Iethers for Children (LATCH)

Additional protection potential is provided by:

- Supplemental Restraint System (SRS) with
 - Air bags
 - Air bag control unit (with crash sensors)
 - Emergency Intensioning Device (ETD) for seat belts
 - Seat belt force limiter
- Active head restraints
- Air bag system components with
 - Front passenger front air bag off indicator lamp
 - Front passenger seat with Occupant Classification System (OCS)

Although the systems are independent, their protective functions work in conjunction with each other.

Warning!



Modifications to or work improperly conducted on restraint system components or their wiring, as well as tampering with interconnected electronic systems, can lead to the restraint systems no longer functioning as intended.

Air bags or Emergency Tensioning Devices (ETDs), for example, could deploy inadvertently or fail to deploy in accidents although the deceleration threshold for air bag deployment is exceeded. Therefore, never modify the restraint systems. Do not tamper with electronic components or their software.

i For information on infants and children traveling with you in the vehicle and restraint systems for infants and children, see "Children in the vehicle" (▷ page 59).

SRS indicator lamp

The SRS system conducts a self-test when the ignition is switched on and in regular intervals while the engine is running. This facilitates detection of system malfunctions.

The  indicator lamp in the instrument cluster comes on when the ignition is switched on and goes out no later than a few seconds after the engine has been started. The SRS components are in operational readiness if the  indicator lamp is not lit when the engine is running.

A malfunction in the system has been detected if the  indicator lamp

- fails to go out after approximately 4 seconds after the engine is started
- does not come on at all
- comes on after the engine was started or while driving

Warning!

In the event that the  indicator lamp comes on while driving or does not come on at all, the SRS self-check has detected a malfunction. For your safety, we strongly recommend that you contact an authorized Mercedes-Benz Center immediately to have the system checked; otherwise the

SRS may not deploy when needed in an accident, which could result in serious or fatal injury, or it might deploy unexpectedly and unnecessarily which could also result in injury.

In addition, improper work on the SRS creates a risk of rendering the SRS inoperative or causing unintended air bag deployment. Work on the SRS must therefore only be performed by qualified technicians. Contact an authorized Mercedes-Benz Center.

If it is necessary to modify an air bag system to accommodate a person with disabilities, contact an authorized Mercedes-Benz Center or call our Customer Assistance Center at 1-800-FOR-MERCEdes (1-800-367-6372) for details.

Air bags

Warning!

Air bags are designed to reduce the potential of injury and fatality in certain frontal impacts (front air bags), side impacts (side impact air bags, window curtain air bags and pelvic air bags), or rollovers (window curtain air bags). However, no system available today can completely eliminate injuries and fatalities. The deployment of the air bags temporarily releases a small amount of dust from the air bags. This dust, however, is neither injurious to your health, nor does it indicate a fire in the vehicle. The dust might cause some temporary breathing difficulty for people with asthma or other breathing trouble. To avoid this, you may wish to get out of the vehicle as soon as it is safe to do so. If you have any breathing difficulty but cannot get out of the vehicle after the air bag inflates, then get fresh air by opening a window or door.

Warning!

To reduce the risk of injury when the front air bags inflate, it is very important for the driver and front passenger to always be in



Occupant safety

a properly seated position and to wear their respective seat belt.

For maximum protection in the event of a collision always be in normal seated position with your back against the seat backrest. Fasten your seat belt and make sure it is properly positioned on your body. Since the air bag inflates with considerable speed and force, a proper seating position and correct positioning of the hands on the steering wheel will help to keep you at a safe distance from the air bag. Occupants who are not wearing their seat belt, are not seated properly or are too close to the air bag can be seriously injured or killed by an air bag as it inflates with great force instantaneously:

- Sit with the seat belt properly fastened in a position that is as upright as possible with your back against the seat backrest.
- Move the driver seat as far back as possible, still permitting proper operation of vehicle controls. The distance from the center of the driver's chest to the center of the air bag cover on the steering wheel must be at least 10 inches (25 cm) or more. You should be able to accomplish this by adjusting

the seat and steering wheel. If you have any difficulties, please contact an authorized Mercedes-Benz Center.

- Do not lean your head or chest close to the steering wheel or dashboard.
- Keep hands on the outside of the steering wheel rim. Placing hands and arms inside the rim can increase the risk and potential severity of hand/arm injury when the driver front air bag inflates.
- Adjust the front passenger seat as far as possible rearward from the dashboard when the seat is occupied.
- Occupants, especially children, should never place their bodies or lean their heads in the area of the door where the side impact air bag inflates. This could result in serious injuries or death should the side impact air bag be deployed. Always sit as upright as possible, wear the seat belt properly and use an appropriately sized infant restraint, toddler restraint, or booster seat recommended for the size and weight of the child.

Failure to follow these instructions can result in severe injuries to you or other occupants.

If you sell your vehicle, it is important that you make the buyer aware of this safety information. Be sure to give the buyer this Operator's Manual.

Warning!

Accident research shows that the safest place for children in an automobile is in the rear seat.

There is a possibility for a side impact air bag-related injury if occupants, especially children, are not properly seated or restrained when next to a side impact air bag which needs to deploy rapidly in a side impact in order to do its job.

To help avoid the possibility of injury, please follow these guidelines:

- (1) Always sit as upright as possible, properly use the seat belts, and for children 12 years old and under, use an appropriately sized infant restraint, toddler restraint, or booster seat

recommended for the size and weight of the child.

- (2) Always wear seat belts properly.

Air bags are designed to deploy only in certain frontal impacts (front air bags), side impacts (side impact air bags, pelvic air bags and window curtain air bags) which exceed preset deployment thresholds, and in certain rollovers (window curtain air bags). Only in the event of such a situation will they provide their supplemental protection.

The driver and passengers should always wear their seat belts. Otherwise it is not possible for the air bags to provide their supplemental protection.

In case of other types of impacts and impacts below air bag deployment thresholds, air bags will not deploy. The driver and passengers will then be protected to the extent possible by a properly fastened seat belt. A properly fastened seat belt is also needed to provide the best possible protection in a rollover.

Air bags are not a substitute for seat belts. Always wear your seat belt, regardless of whether or not your vehicle is equipped with air bags.

It is important to your safety and that of your passengers that you replace deployed air bags and repair any malfunctioning air bags to make sure the vehicle will continue to provide supplemental crash protection for occupants.

Safety guidelines for the seat belt, Emergency Tensioning Device (ETD) and air bag

Warning!

- Damaged seat belts or seat belts that have been subjected to stress in an accident must be replaced and their anchoring points must also be checked. Only use seat belts installed or supplied by an authorized Mercedes-Benz Center.
 - Air bags and pyrotechnic Emergency Tensioning Devices (ETDs) contain perchlorate material, which may require special handling and regard for the environment. Check with your local government's disposal guidelines. California residents, see www.dtsc.ca.gov/HazardousWaste/Perchlorate/index.cfm.
- Air bags and ETDs are designed to function on a one-time-only basis. An air bag or ETD that is deployed must be replaced.
 - Do not pass seat belts over sharp edges. They could tear.
 - Do not make any modification that could change the effectiveness of the seat belts.
 - Do not bleach or dye seat belts as this may severely weaken them. In a crash they may not be able to provide adequate protection.
 - No modifications of any kind may be made to any components or wiring of the SRS. This includes changing or removing any component or part of the SRS, the installation of additional trim material, seat covers, badges, etc. over the steering wheel hub, front passenger front air bag cover, outboard sides of the seat backrests, door trim panels, or door frame trims, and installation of additional electrical/electronic equipment on or near SRS components and wiring. Keep area between air bags and occupants

Occupant safety

free of objects (e.g. packages, purses, umbrellas, etc.).

- Do not hang items such as coat hangers from the coat hooks or handles over the door. These items may be thrown around in the vehicle and cause head and other injuries when the window curtain air bag is deployed.
- Air bag system components will be hot after an air bag has inflated. Do not touch them.
- Never place your feet on the instrument panel, dashboard, or on the seat. Always keep both feet on the floor in front of the seat.
- In addition, improper repair work on the SRS creates a risk of rendering the SRS inoperative or causing unintended air bag deployment. Work on the SRS must therefore only be performed by qualified technicians. Contact an authorized Mercedes-Benz Center.
- For your protection and the protection of others, when scrapping the air bag unit or ETD, our safety instructions must be followed. These instructions are available

from any authorized Mercedes-Benz Center.

- Given the considerable deployment speed, required inflation volume, and the material of the air bags, there is the possibility of abrasions or other, potentially more serious injuries resulting from air bag deployment.

If you sell your vehicle, we strongly recommend that you inform the subsequent owner that the vehicle is equipped with SRS and refer them to the applicable section in the Operator's Manual.

Front air bags

 **Observe Safety notes, see page 45.**



① Driver front air bag

② Front passenger front air bag

The front air bags are designed to provide increased protection for the driver and front passenger against the risk of injuries to the head and thorax.

Driver and front passenger front air bags are deployed

- in the event of certain frontal impacts
- if impact exceeds a preset deployment threshold

- if the system determines that air bag deployment can offer additional protection to that provided by the seat belt
- depending on whether the seat belt is in use
- independently of the side impact air bags, pelvic air bags and/or the window curtain air bags

The front air bags in this vehicle have been designed to inflate in two stages. This allows the air bags to have different rates of inflation that are based on the vehicle deceleration rate as assessed by the air bag control unit.

On the front passenger side, front air bag ② deployment is additionally influenced by the passenger's weight category as identified by the Occupant Classification System (OCS) (▷ page 49).

The lighter the front passenger side occupant, the higher the vehicle deceleration rate required for second stage inflation of front air bag ②.

The air bags will not deploy in impacts which do not exceed the system's preset deployment thresholds. You will then be protected by the fastened seat belts.

The front air bags will not deploy in the event of a rollover unless the vehicle's rate of

longitudinal deceleration or acceleration exceeds the preset deployment threshold for the front air bags.

The front passenger front air bag ② will only be deployed if

- the system, based on OCS weight sensor readings, detects that the front passenger seat is occupied
- the  indicator lamp in the center console is not lit (▷ page 52)
- the impact exceeds a preset deployment threshold

Side impact air bags

 **Observe Safety notes, see page 45.**



① Side impact air bag

When deployed, side impact air bags ① are designed to provide increased protection for the thorax (but not the head, neck and arms) of the driver or front passenger on the side of the vehicle on which the impact occurs.

The side impact air bags ① are deployed

- on the impacted side of the vehicle
- in side impacts exceeding a preset deployment threshold
- regardless of whether the seat belt is in use
- independently of the front air bags
- independently of the ETDs



Occupant safety

The front passenger side impact air bag will not deploy if the OCS senses that the front passenger seat is empty and the front passenger seat belt is not fastened (latch plate is not inserted into the buckle). With an empty front passenger seat and the seat belt fastened (latch plate properly inserted into buckle) the front passenger side impact air bag will deploy independently of the empty seat.

Side impact air bags ① are not deployed in side impacts which do not exceed the system's deployment threshold.

Side air bags ① will not deploy in the event of a rollover unless the vehicle's rate of lateral deceleration or acceleration exceeds the preset deployment threshold for side air bags ①.

⚠ Warning!

Only use seat covers which have been tested and approved by Mercedes-Benz for your vehicle model. Using other seat covers may interfere with or prevent the deployment of the side impact air bags and/or pelvic air bags. Contact an authorized Mercedes-Benz Center for availability.

Pelvic air bags

⚠ Observe Safety notes, see page 45.

Pelvic air bags are not available on C 63 AMG.



① Pelvic air bag (except C 63 AMG)

When deployed, pelvic air bags ① are designed to provide increased protection for the pelvis of the occupants on the side of the vehicle on which the impact occurs.

Pelvic air bags ① are deployed

- in side impacts exceeding a preset deployment threshold
- on the impacted side of the vehicle
- independently of whether the seat belt is in use

- independently of the front air bags
- independently of the ETDs

The front passenger pelvic air bag ① will not deploy if the OCS senses that the front passenger seat is empty and the front passenger seat belt is not fastened (latch plate is not inserted into the buckle). With an empty front passenger seat and the seat belt fastened (latch plate properly inserted into buckle) the front passenger pelvic air bag ① will deploy independently of the empty seat.

Pelvic air bags ① are not deployed in side impacts which do not exceed the system's deployment threshold.

Pelvic air bags ① will not deploy in the event of a rollover unless the vehicle's rate of lateral deceleration or acceleration exceeds the preset deployment threshold for pelvic air bags ①.

⚠ Warning!

Only use seat covers which have been tested and approved by Mercedes-Benz for your vehicle model. Using other seat covers may interfere with or prevent the deployment of the side impact air bags and/or pelvic air bags. Contact an

Occupant safety

authorized Mercedes-Benz Center for availability.

Window curtain air bags

⚠ Observe Safety notes, see page 45.

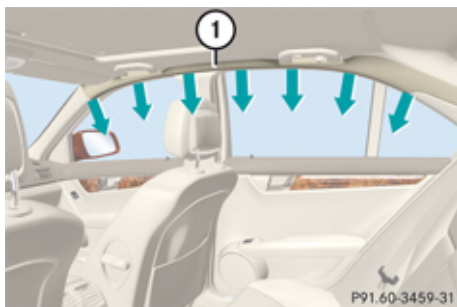

① Window curtain air bag

When deployed, window curtain air bags ① are designed to provide increased protection for the head (but not the chest or arms) of the occupants on the side of the vehicle on which the impact occurs.

Window curtain air bags ① are deployed

- on the impacted side of the vehicle
- in side impacts exceeding a preset deployment threshold

- independently of the front air bags
- regardless of whether the front passenger seat is occupied
- regardless of whether the seat belt is in use
- in certain vehicle rollovers, if the system determines that air bag deployment can offer additional protection to that provided by the seat belt

Window curtain air bags ① are not deployed in impacts which do not exceed the system's deployment threshold.

Window curtain air bags ① deploy in the area indicated by the arrows.

Occupant Classification System

The Occupant Classification System (OCS) automatically turns the front passenger front air bag on or off based on the classified occupant weight category determined by weight sensor readings from the front passenger seat.

The system does not deactivate the front passenger side impact air bag, the pelvic air bag, the window curtain air bag and the Emergency Tensioning Devices (ETDs).

Occupants must sit with the seat belt properly fastened in a position that is as



upright as possible with their back against the seat backrest and feet on the floor to be correctly classified. If the occupant's weight is transferred to another object in the vehicle (e.g. by leaning on armrests), the OCS may not be able to properly approximate the occupant's weight category.

i If your seat, including the trim cover and cushion, needs to be serviced in any way, take the vehicle to an authorized Mercedes-Benz Center.

Only seat accessories approved by Mercedes-Benz may be used.

Both the driver and the front passenger should always use the  indicator lamp as an indication of whether or not the front passenger is properly positioned.

⚠ Warning!



If the  indicator lamp illuminates when an adult or someone larger than a small individual is in the front passenger seat, have the front passenger re-position himself or herself in the seat until the  indicator lamp goes out.



In the event of a collision, the air bag control unit will not allow front passenger front air bag deployment when the OCS has





Occupant safety

classified the front passenger seat occupant as weighting as much as or less than a typical 12-month-old child in a standard child restraint or if the front passenger seat is classified as being empty. When the OCS senses that the front passenger seat occupant is classified as being up to or less than the weight of a typical 12-month-old child in a standard child restraint, the  indicator lamp will illuminate when the engine is started and remain illuminated, indicating that the front passenger front air bag is deactivated.

When the OCS senses that the front passenger seat is classified as being empty, the  indicator lamp will illuminate when the engine is started and remain illuminated, indicating that the front passenger front air bag is deactivated. When the OCS senses that the front passenger seat occupant is classified as being heavier than the weight of a typical 12-month-old child seated in a standard child restraint or as being a small individual (such as a young teenager or a small adult), the  indicator lamp will illuminate for approximately 6 seconds when the

engine is started and then, depending on occupant weight sensor readings from the seat, remain illuminated or go out. With the  indicator lamp illuminated, the front passenger front air bag is deactivated. With the  indicator lamp out, the front passenger front air bag is activated. When the OCS senses that the front passenger seat occupant is classified as an adult or someone larger than a small individual, the  indicator lamp will illuminate for approximately 6 seconds when the engine is started and then go out, indicating that the front passenger front air bag is activated.

If the  indicator lamp is illuminated, the front passenger front air bag is deactivated and will not be deployed.

If the  indicator lamp is not illuminated, the front passenger front air bag is activated and will be deployed

- in the event of certain frontal impacts
- if impact exceeds a preset deployment threshold
- independently of the side impact air bags or pelvic air bag

If the front passenger front air bag is deployed, the rate of inflation will be influenced by

- the rate of relevant vehicle deceleration as assessed by the air bag control unit
- the front passenger's weight category as identified by the OCS

For more information on air bag display messages, see (▷ page 309).

Warning!

According to accident statistics, children are safer when properly restrained in the rear seating positions than in the front seating position. Thus, we strongly recommend that children be placed in the rear seats whenever possible. Regardless of seating position, children 12 years old and under must be seated and properly secured in an appropriate infant restraint, toddler restraint, or booster seat recommended for the size and weight of the child.

The infant or child restraint must be properly secured with the vehicle's seat belt, the seat belt and top tether strap, or lower anchors and top tether strap, fully in





accordance with the child seat manufacturer's instructions.

Occupants, especially children, should always sit as upright as possible, wear the seat belt properly and use an appropriately sized infant restraint, toddler restraint, or booster seat recommended for the size and weight of the child.

Children can be killed or seriously injured by an inflating air bag. Note the following important information when circumstances require you to place a child in the front passenger seat:

- Your vehicle is equipped with air bag technology designed to deactivate the front passenger front air bag in your vehicle when the system senses the weight of a typical 12-month-old child or less along with the weight of a standard appropriate child restraint on the front passenger seat.
- A child in a rear-facing child restraint on the front passenger seat will be seriously injured or even killed if the front passenger front air bag inflates in a collision which could occur under some circumstances, even with the air bag technology installed in your vehicle. The

only means to completely eliminate this risk is to never place a child in a rear-facing child restraint in the front seat. We therefore strongly recommend that you always place a child in a rear-facing child restraint in a backseat.

- If you must install a rear-facing child restraint on the front passenger seat because circumstances require you to do so, make sure the  indicator lamp is illuminated, indicating that the front passenger front air bag is deactivated. Should the  indicator lamp not illuminate or go out while the restraint is installed, please check installation. Periodically check the  indicator lamp while driving to make sure the  indicator lamp is illuminated. If the  indicator lamp goes out or remains out, do not transport a child on the front passenger seat until the system has been repaired. A child in a rear-facing child restraint on the front passenger seat will be seriously injured or even killed if the front passenger front air bag inflates.
- If you have to place a child in a forward-facing child restraint on the front

passenger seat, move the seat as far back as possible, use the proper child restraint recommended for the age, size and weight of the child, and secure child restraint with the vehicle's seat belt according to the child seat manufacturer's instructions. For children larger than the typical 12-month-old child, the front passenger front air bag may or may not be activated.

Deployment of the driver front air bag does not mean that the front passenger front air bag also should have deployed.

The OCS may have determined:

- that the seat was empty or occupied by the weight up to or less than that of a typical 12-month-old child seated in a standard child restraint – both instances where the system suppresses deployment of the front passenger front air bag even though the impact met the criteria and was of sufficient severity to deploy the driver front air bag
- that the seat was occupied by a small individual (such as a young teenager or a small adult) or a child who weighs more than the weight of a typical 12-month-old child in a standard child restraint – both of



Occupant safety



which are instances where the system may suppress deployment of the front passenger front air bag even though the impact met the criteria and was of sufficient severity to deploy the driver front air bag



① Front passenger front air bag off indicator lamp

The  indicator lamp ① will be illuminated, except with the SmartKey removed from the starter switch or with the starter switch in position **0**.

Warning!

If the  indicator lamp and the  indicator lamp are lit at the same time, there is a malfunction in the OCS. The

front passenger front air bag will be deactivated in this case. Have the system checked as soon as possible by qualified technicians. Contact an authorized Mercedes-Benz Center.



Only have the seat repaired or replaced at an authorized Mercedes-Benz Center.

In order to ensure proper operation of the air bag system and OCS:

- Sit with the seat belt properly fastened in a position that is as upright as possible with your back against the seat backrest.
- While seated, an occupant should not position him/herself in such a way as to cause the occupant's weight to be lifted from the seat bottom as this may result in the OCS being unable to correctly approximate the occupant's weight category.
- Read and observe all warnings in this chapter.

Occupant Classification System Self-test

After turning the SmartKey in the starter switch to position **1** or **2** or pressing the KEYLESS-GO start/stop button once or

twice, the  indicator lamp illuminates. If an adult occupant is properly sitting on the front passenger seat and the system classifies the occupant as an adult, the  indicator lamp will illuminate and go out after approximately 6 seconds. If the seat is not occupied and the system classifies the front passenger seat as being empty, the  indicator lamp will illuminate and not go out.

Warning!

If the  indicator lamp does not illuminate, the system is not functioning. You must contact an authorized Mercedes-Benz Center before seating any child on the front passenger seat.

For more information, see the “Practical hints” section (▷ page 348).

Warning!

Never place anything between seat cushion and child seat (e.g. pillow), since it reduces the effectiveness of the OCS. The bottom and back of the child seat must make full contact with the passenger seat cushion and backrest.

If necessary, adjust the tilt of the passenger seat backrest.

An incorrectly mounted child seat could cause injuries to the child in case of an accident, instead of increasing protection for the child.

Follow the manufacturer's instructions for installation of child seats.

Seat belts

Safety notes

The use of seat belts and infant and child restraint systems is required by law in all 50 states, the District of Columbia, the U.S. territories and all Canadian provinces.

Even where this is not the case, all vehicle occupants should have their seat belts fastened whenever the vehicle is in motion.

For information on infants and children traveling with you in the vehicle and restraint systems for infants and children, see "Children in the vehicle" (▷ page 59).

Warning!

Always fasten your seat belt before driving off. Always make sure all of your passengers are properly restrained. You and your passengers should always wear seat belts.

Failure to wear and properly fasten and position your seat belt greatly increases your risk of injuries and their likely severity in an accident.

If you are ever in an accident, your injuries can be considerably more severe without your seat belt properly buckled. Without your seat belt buckled, you are much more likely to hit the interior of the vehicle or be ejected from it. You can be seriously injured or killed.

In the same crash, the possibility of injury or death is lessened if you are properly wearing your seat belt. The air bags can only protect as intended if the occupants are properly wearing their seat belts.

Warning!

Never ride in a moving vehicle with the seat backrest in an excessively reclined position as this can be dangerous. You could slide under the seat belt in a collision. If you slide under it, the seat belt would apply force at the abdomen or neck. That could cause serious or even fatal injuries. The seat backrest and seat belt provide the best restraint when the wearer is in a position that is as upright as possible and the seat belt is properly positioned on the body.

Warning!

Never let more people ride in the vehicle than there are seat belts available. Make sure everyone riding in the vehicle is correctly restrained with a separate seat belt. Never use a seat belt for more than one person at a time.

Warning!

Damaged seat belts or seat belts that have been subjected to stress in an accident must be replaced and their anchoring points must also be checked.

Only use seat belts which have been approved by Mercedes-Benz.

Do not make any modifications to the seat belts. This can lead to unintended activation of the ETDs or to their failure to activate when necessary.

Do not bleach or dye seat belts as this may severely weaken them. In a crash they may not be able to provide adequate protection.

Have all work carried out only by qualified technicians. Contact an authorized Mercedes-Benz Center.

Occupant safety

Proper use of seat belts

Warning!

USE SEAT BELTS PROPERLY

- Seat belts can only work when used properly. Never wear seat belts in any other way than as described in this section, as that could result in serious injuries in case of an accident.
- Each occupant should wear their seat belt at all times, because seat belts help reduce the likelihood of and potential severity of injuries in accidents, including rollovers. The integrated restraint system includes SRS (driver front air bag, front passenger front air bag, side impact air bags, pelvic air bags, window curtain air bags for side windows), Emergency Tensioning Devices (ETDs), seat belt force limiters, and front seat knee bolsters.

The system is designed to enhance the protection offered to properly belted occupants in certain frontal (front air bags and ETDs) and side (side impact air bags, pelvic air bags, window curtain air bags, and ETDs) impacts which exceed preset deployment thresholds and in

certain rollovers (window curtain air bags and ETDs).

- Never wear the shoulder belt under your arm, against your neck or off your shoulder. In a frontal crash, your body would move too far forward. That would increase the chance of head and neck injuries. The seat belt would also apply too much force to the ribs or abdomen, which could severely injure internal organs such as your liver or spleen. Adjust the seat belt so that the shoulder section is located as close as possible to the middle of the shoulder (it should not touch the neck). Never pass the shoulder portion of the seat belt under your arm. For this purpose, you can adjust the height of the seat belt outlet.
- Position the lap belt as low as possible on your hips and not across the abdomen. If the lap belt is positioned across your abdomen, it could cause serious injuries in a crash.
- Never wear seat belts over rigid or breakable objects in or on your clothing, such as eyeglasses, pens, keys etc., as these might cause injuries.

- Make sure the seat belt is always fitted snugly. Take special care of this when wearing loose clothing.
- Never use a seat belt for more than one person at a time. Do not fasten a seat belt around a person and another person or other objects at the same time.
- Seat belts should not be worn twisted. In a crash, you would not have the full width of the seat belt to distribute impact forces. The twisted seat belt against your body could cause injuries.
- Pregnant women should also always use a lap/shoulder belt. The lap belt portion should be positioned as low as possible on the hips to avoid any possible pressure on the abdomen.
- Place the seat backrest in a position that is as upright as possible.
- Check your seat belt during travel to make sure it is properly positioned.
- Never place your feet on the instrument panel, dashboard, or on the seat. Always keep both feet on the floor in front of the seat.
- When using a seat belt to secure infant restraints, toddler restraints, or children

Occupant safety

in booster seats, always follow the child seat manufacturer's instructions.

Warning!

Do not pass seat belts over sharp edges. They could tear.

Do not allow the seat belt to get caught in the door or in the seat adjustment mechanism. This could damage the seat belt.

Never attempt to make modifications to seat belts. This could impair the effectiveness of the seat belts.

Fastening the seat belts

Warning!

According to accident statistics, children are safer when properly restrained in the rear seating positions than in the front seating position. Thus, we strongly recommend that children be placed in the rear seats whenever possible. Regardless of seating position, children 12 years old and under must be seated and properly secured in an appropriately sized infant restraint, toddler restraint, or booster seat recommended for the size and weight of the

child. For additional information, see "Children in the vehicle".

A child's risk of serious or fatal injuries is significantly increased if the child restraints are not properly secured in the vehicle and/or the child is not properly secured in the child restraint.

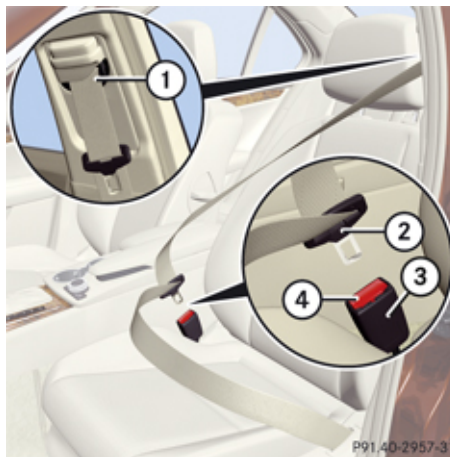

- ① Seat belt outlet
- ② Latch plate
- ③ Buckle
- ④ Seat belt release button

- ▶ With a smooth motion, pull the seat belt out of seat belt outlet ①.
- ▶ Place the shoulder portion of the seat belt across the top of your shoulder and the lap portion across your hips.
- ▶ Push latch plate ② into buckle ③ until it clicks.
- ▶ If necessary, adjust the seat belt to the correct height.
- ▶ If necessary, tighten the lap portion to a snug fit by pulling shoulder portion up.

Seat belt outlet height adjustment

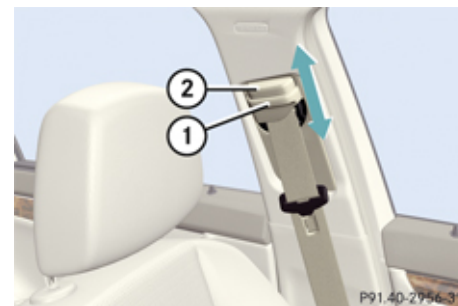

- ① Seat belt height adjuster
- ② Release button

Occupant safety

- ▶ **Raising:** Slide seat belt height adjuster ① upward.
Seat belt height adjuster ① engages in different positions.
- ▶ **Lowering:** Press and hold release button ②.
- ▶ Slide seat belt height adjuster ① downward.
- ▶ Release button ② and make sure seat belt height adjuster ① engages into place.

Releasing the seat belts

- ▶ Press seat belt release button ④ (▷ page 55).
Allow the retractor to completely rewind the seat belt by guiding latch plate ② (▷ page 55).
- ❗ Make sure the seat belt retracts fully so that the seat belt and/or latch plate cannot get caught or pinched in the door or in the seat mechanism. This can damage the seat belt and impair its effectiveness, and/or cause damage to the door and/or door trim panel. Such damage is not covered by the Mercedes-Benz Limited Warranty.



Damaged seat belts must be replaced. Contact an authorized Mercedes-Benz Center.

Enhanced seat belt reminder system

When the engine is started, the seat belt telltale  will always illuminate for 6 seconds to remind you and your passengers to fasten your seat belts.

If the driver's seat belt is not fastened when the engine is started, an additional warning chime will also sound for a maximum of 6 seconds or until the driver's seat belt is fastened.

If after these 6 seconds the driver's or the front passenger's seat belt (with the front passenger seat occupied) is not fastened with front doors closed,

- the seat belt telltale  remains illuminated for as long as either the driver's or front passenger's seat belt is not fastened.
- and if the vehicle speed once exceeds 15 mph (25 km/h), the seat belt telltale  starts flashing and a warning chime sounds with increasing intensity for a maximum of 60 seconds or until the

driver's and front passenger's seat belt are fastened.

If you and/or your passenger release the seat belt during driving, the seat belt telltale  starts flashing and the warning chime sounds as described before.

If the driver's or the front passenger's seat belt remains unfastened after 60 seconds, the warning chime stops sounding, the seat belt telltale  stops flashing but continues to be illuminated.

After a vehicle standstill, the warning chime is reactivated and the seat belt telltale  is flashing again if the vehicle speed once exceeds 15 mph (25 km/h).

The seat belt telltale  will only go out if both the driver's and the front passenger's seat belt (with the front passenger seat occupied) are fastened, or the vehicle is standing still and a front door is opened.

For more information, see "Practical hints" (▷ page 340).

Emergency Tensioning Device (ETD), seat belt force limiter

The seat belts are equipped with ETDs and seat belt force limiters.

The ETDs are designed to activate in the following cases:

- in frontal or rear-end impacts exceeding the system's preset deployment threshold
- in certain vehicle rollovers
- if the restraint systems are operational and functioning correctly, see  indicator lamp (▷ page 43)

The ETDs for the front seats will only activate if the front seat belts are fastened (latch plate properly inserted into buckle).

The ETDs for the rear seats will activate with or without the respective seat belts fastened. In an impact, the ETDs remove slack from the seat belts in such a way that the seat belts fit more snugly against the body. Seat belt force limiters, when activated, are employed to help reduce the peak force exerted by the seat belts on occupants during a crash.

- i** The ETDs do not correct an incorrect seat position or incorrectly worn seat belts. The ETDs do not pull occupants back toward the seat backrest.

Warning!

Pyrotechnic ETDs that were activated must be replaced.

For your safety, when disposing of the pyrotechnic ETDs always follow our safety instructions. These are available at any authorized Mercedes-Benz Center.

Active head restraints (except C 63 AMG)

The active head restraints are intended to offer the driver and front passenger increased protection from whiplash-type injuries. In the event of a rear-end collision, the active head restraints on the driver's and front passenger's seat are designed to move forward in the direction of travel, providing the head with increased support earlier on in the collision sequence. The active head restraints move forward whether the seat is occupied or not.

Warning!

Do not attach any objects (e.g. hangers) to the head restraint posts. Otherwise, the active head restraints may not be able to function properly or offer the intended degree of protection they were designed for in the event of a rear-end collision.

If the active head restraints have been triggered in an accident, the active head

restraints must be reset. Otherwise, the active head restraints cannot offer any additional protection in the event of another rear-end collision.

For information on resetting the activated active head restraints, see "Resetting activated head restraints" (▷ page 353).

You cannot remove the active head restraint on the driver's and front passenger's seats.

Warning!

Only use seat or head restraint covers which have been tested and approved by Mercedes-Benz for your vehicle model. Using other seat or head restraint covers may interfere with or prevent the activation of the active head restraints and/or the deployment of the front side impact air bags.

Contact an authorized Mercedes-Benz Center for availability.

Warning!

For your protection, drive only with properly positioned head restraints. Adjust the head restraint so that it is as close to the head as possible and the center of the head restraint supports the back of the head at eye level. This will reduce the

Occupant safety

potential for injury to the head and neck in the event of an accident or similar situation.

For information on head restraint adjustment, see “Head restraints” (▷ page 89).

Correct driver seat adjustment

⚠ Warning!

In order to avoid possible loss of vehicle control, all seat, head restraint, steering wheel, and rear view mirror adjustments, as well as fastening of seat belts, must be done before the vehicle is put into motion.

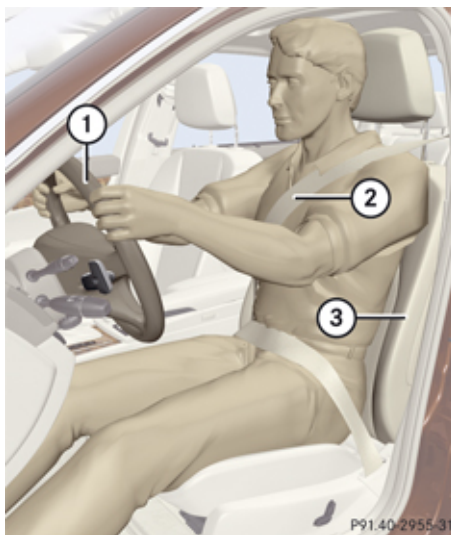

- ① Steering wheel
- ② Seat belt
- ③ Seat

Steering wheel

⚠ Observe Safety notes, see page 92.

- ▶ Position steering wheel ① properly. See (▷ page 93) for manual adjustment and (▷ page 93) for electrical adjustment.

Make sure:

- You can reach steering wheel ① with your arms slightly bent at the elbows.
- You can move your legs freely.
- All displays (including malfunction and indicator lamps) on the instrument cluster are clearly visible.

Seat belt

⚠ Observe Safety notes, see page 53.

- ▶ Fasten and position your seat belt ② (▷ page 55) correctly.

Make sure:

- Seat belt ② is always fitted snugly.
- Adjust seat belt ② so that the shoulder section is located as close as possible to the middle of the shoulder.
- Place the lap portion of seat belt ② as low as possible on your hips.

Seat and head restraint

⚠ Observe Safety notes, see page 86.

- ▶ Position seat ③ (▷ page 87) and head restraint properly (▷ page 89).

Observe the following points:

- Always be in a properly seated position.
- The position should be as far rearward from the front air bag in steering wheel ① as possible, while still permitting proper operation of vehicle controls.
- Adjust seat ③ to a comfortable seating position that still allows you to reach the accelerator/brake pedal safely.
- Seat ③ must be adjusted so that you can correctly fasten and position your seat belt ②.
- The seat backrest must be in a position that is as nearly upright as possible.
- Adjust the seat cushion so that the front edge of the seat cushion lightly supports your legs.
- Adjust the head restraint so that it is as close to the head as possible and the center of the head restraint supports the back of the head at eye level.
- Never place hands under seat ③ or near any moving parts while seat ③ is being adjusted.

Children in the vehicle

Safety notes

If an infant or child is traveling with you in the vehicle:

- ▶ Secure the child using an infant or child restraint appropriate to the age and size of the child.
- ▶ Make sure the infant or child is properly secured at all times while the vehicle is in motion.

Warning!

When leaving the vehicle, always remove the SmartKey from the starter switch. Always take the SmartKey with you and lock the vehicle. Do not leave children unattended in the vehicle, even if they are secured in a child restraint system, or with access to an unlocked vehicle. A child's unsupervised access to a vehicle could result in an accident and/or serious personal injury. The children could

- injure themselves on parts of the vehicle
- be seriously or fatally injured through excessive exposure to extreme heat or cold
- injure themselves or cause an accident with vehicle equipment that can be operated even if the SmartKey is removed from the starter switch or removed from the vehicle, such as seat adjustment, steering wheel adjustment, or the memory function.

If children open a door, they could injure other persons or get out of the vehicle and injure themselves or be injured by following traffic.



Occupant safety

Do not expose the child restraint system to direct sunlight. The child restraint system's metal parts, for example, could become very hot, and the child could be burned on these parts.

Warning!

Do not carry heavy or hard objects in the passenger compartment or trunk unless they are firmly secured in place.

Unsecured or improperly positioned cargo increases a child's risk of injury in the event of

- strong braking maneuvers
- sudden changes of direction
- an accident

For more information on loading, please refer to the "Loading and storing" (> page 229) chapter.

Infant and child restraint systems

Observe Safety notes, see page 59.

We recommend all infants and children be properly restrained at all times while the vehicle is in motion.

All lap/shoulder belts except the driver's seat belt have special seat belt retractors for secure fastening of child restraints.

To fasten a child restraint, follow child restraint instructions for mounting. Then pull the shoulder belt out completely and let it retract. During seat belt retraction, a ratcheting sound can be heard to indicate that the special seat belt retractor is activated. The seat belt is now locked. Push down on child restraint to take up any slack. To deactivate, release the seat belt buckle and let the seat belt retract completely. To deactivate the special seat belt retractor for the front passenger seat, the front passenger seat must be in the most backward position. The seat belt can again be used in the usual manner.

Warning!

Never release the seat belt buckle while the vehicle is in motion, since the special seat belt retractor will be deactivated.

-  Information on child seats with mounting fittings for tether anchorages (> page 62).

For information on LATCH-type child seat anchors (> page 63).

The use of infant or child restraints is required by law in all 50 states, the District of Columbia, the U.S. territories and all Canadian provinces.

Infants and small children should be seated in an appropriate infant or child restraint system, properly secured in accordance with the manufacturer's instructions for the child restraint, that complies with U.S. Federal Motor Vehicle Safety Standards 213 and 225 and Canadian Motor Vehicle Safety Standards 213 and 210.2.

A statement by the child restraint manufacturer of compliance with these standards can be found on the instruction label on the restraint and in the instruction manual provided with the restraint.

When using any infant restraint, toddler restraint, or booster seat, make sure to carefully read and follow all manufacturer's instructions for installation and use.

Please read and observe warning labels affixed to the inside of the vehicle and to infant or child restraints.

Warning!

According to accident statistics, children are safer when properly restrained in the rear seating positions than in the front

Occupant safety

seating position. Thus, we strongly recommend that children be placed in the rear seats whenever possible. Regardless of seating position, children 12 years old and under must be seated and properly secured in an appropriate infant restraint, toddler restraint, or booster seat recommended for the size and weight of the child.



The infant or child restraint must be properly secured with the vehicle's seat belt, the seat belt and top tether strap, or lower anchors and top tether strap, fully in accordance with the child seat manufacturer's instructions.

Occupants, especially children, should always sit as upright as possible, wear the seat belt properly and use an appropriately sized infant restraint, toddler restraint, or booster seat recommended for the size and weight of the child.

Children can be killed or seriously injured by an inflating air bag. Note the following important information when circumstances require you to place a child in the front passenger seat:

- Your vehicle is equipped with air bag technology designed to deactivate the

front passenger front air bag in your vehicle when the system senses the weight of a typical 12-month-old child or less along with the weight of a standard appropriate child restraint on the front passenger seat.

- A child in a rear-facing child restraint on the front passenger seat will be seriously injured or even killed if the front passenger front air bag inflates in a collision which could occur under some circumstances, even with the air bag technology installed in your vehicle. The only means to completely eliminate this risk is to never place a child in a rear-facing child restraint in the front seat. We therefore strongly recommend that you always place a child in a rear-facing child restraint in a backseat.
- If you must install a rear-facing child restraint on the front passenger seat because circumstances require you to do so, make sure the  indicator lamp is illuminated, indicating that the front passenger front air bag is deactivated. Should the  indicator lamp not illuminate or go out while the restraint is installed, please

check installation. Periodically check the



PASS. FRONT AIR BAG OFF

indicator lamp while driving to

make sure the  indicator lamp



PASS. FRONT AIR BAG OFF

is illuminated. If the  indicator



PASS. FRONT AIR BAG OFF

lamp goes out or remains out, do not

transport a child on the front passenger seat until the system has been repaired.

A child in a rear-facing child restraint on the front passenger seat will be seriously injured or even killed if the front passenger front air bag inflates.

- If you have to place a child in a forward-facing child restraint on the front passenger seat, move the seat as far back as possible, use the proper child restraint recommended for the age, size and weight of the child, and secure child restraint with the vehicle's seat belt according to the child seat manufacturer's instructions. For children larger than the typical 12-month-old child, the front passenger front air bag may or may not be activated.

Warning!

Infants and small children should never share a seat belt with another occupant. During an accident, they could be crushed between the occupant and seat belt.



Occupant safety

A child's risk of serious or fatal injuries is significantly increased if the child restraints are not properly secured in the vehicle and/or the child is not properly secured in the child restraint.

Children too big for a toddler restraint must ride in seats using regular seat belts. Position shoulder belt across chest and shoulder, not face or neck. A booster seat may be necessary to achieve proper seat belt positioning for children over 41 lb (18 kg) until they reach a height where a lap/shoulder belt fits properly without a booster.

When the child restraint is not in use, remove it from the vehicle or secure it with the seat belt to prevent the child restraint from becoming a projectile in the event of an accident.

Installation of infant and child restraint systems

⚠ Observe Safety notes, see page 59.

⚠ Warning!

Always lock the seat backrests in their upright position when the rear seats are

occupied by passengers, before installing top tether straps, or the extended cargo compartment is not in use. Make sure that seat backrests are secured properly by pushing and pulling on the seat backrests. If a seat backrest is not locked properly, the seat backrest could fold. The child seat would no longer be supported properly or positioned to provide its intended benefit. That could cause serious or even fatal injuries.

This vehicle is equipped with tether anchorages for a top tether strap at each of the rear seating positions.

Top tether straps enable an additional connection to be made between child restraint systems secured with LATCH-type anchors and rear seats. This can further reduce the risk of injury.

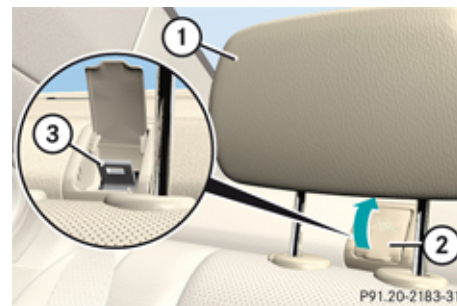

- ① Rear seat head restraint
- ② Anchorage ring cover
- ③ Anchorage ring

- ▶ Move the respective head restraint ① to its uppermost position (▷ page 91).
- ▶ Lift up anchorage ring cover ② from anchorage ring ③.

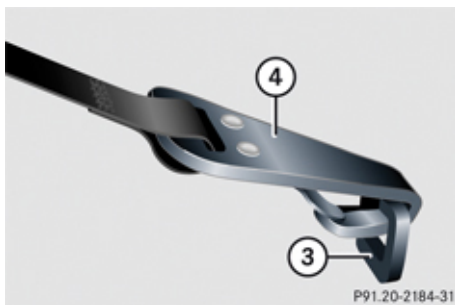

③ Anchorage ring

④ Hook

- ▶ Guide the top tether strap between head restraint ① and top of the seat backrest.
- ▶ Make sure the top tether strap is not twisted.
- ▶ Securely fasten hook ④, which is part of the top tether strap, to anchorage ring ③.
- ▶ For safety, make sure hook ④ is attached to anchorage ring ③ beyond the safety catch, as illustrated.
- ▶ Lower head restraint ① if necessary (▷ page 91).
Make sure the top tether strap can pass freely between head restraint ① and top of the seat backrest.

Once hook ④ is attached, the child restraint itself can be secured.

- ▶ Install the child restraint system and tighten the top tether strap according to the child restraint manufacturer's instructions.

After removing the child restraint system and the top tether strap.

- ▶ Pull down and close anchorage ring cover ② from respective anchorage ring ③.

Child seat anchors – LATCH-type

⚠ Observe Safety notes, see page 59.

This vehicle is equipped with two LATCH-type anchors (at each of the rear outer seats) for the installation of a LATCH-type child seat with matching mounting fittings.

⚠ Warning!

Children too big for a toddler restraint must ride in seats using regular seat belts. Position shoulder belt across chest and shoulder, not face or neck.

A booster seat may be necessary to achieve proper seat belt positioning for children over 41 lb (18 kg) until they reach a height

where a lap/shoulder belt fits properly without a booster.

Install child seat according to manufacturer's instructions.

The child seat must be firmly attached to the right and left side anchors.

An incorrectly mounted child seat may come loose during an accident which could result in serious injury or death to the child.

Damaged or impact damaged child seats or child seat mounting fittings must be replaced.

Non-LATCH-type child seats may also be used and can be installed using the vehicle's seat belt system. Install child seat according to the manufacturer's instructions.

Vehicles with non-foldable rear bench seat: The LATCH-type anchors are blended with covers. Vehicles with split rear bench seat: The LATCH-type anchors are located between the seat cushion and the backrest.

Occupant safety

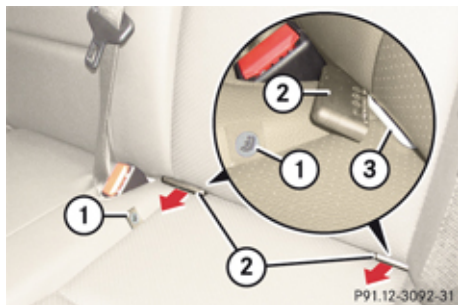

Non-foldable rear bench seat

- ① Indicates the position of the anchors
- ② Anchorage ring covers
- ③ Anchors

- ▶ Remove anchorage ring covers ② from anchors ③ by pulling it in direction of arrow.
- ▶ Store anchorage ring covers ②, for example in the storage compartment of the rear center armrest.



Split rear bench seat, child seat anchors

- ▶ Install a LATCH-type child seat according to the manufacturer's instructions. A rigid connection between the child seat and the body of the vehicle is established.

! Make sure the seat belt for the center seat can operate freely with a child seat installed.

Child safety

Child safety locks

! Observe Safety notes, see page 59.

! Warning!

Children could open a rear door from the inside. This may cause serious personal

injury or an accident. Therefore, secure the rear doors with the child safety locks whenever children are riding in the back seats of the vehicle.

The child safety locks on the rear doors enable you to secure each rear door individually. You cannot open a secured rear door from the inside. You can open the rear door from the outside when the vehicle is unlocked.

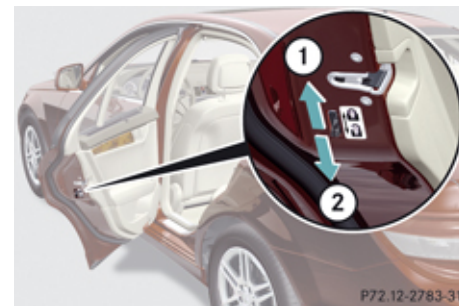

- ① Securing
- ② Releasing

- ▶ **Securing:** Press the lever up in direction of arrow ①.
- ▶ Check to make sure the child safety locks are working properly.

- ▶ **Releasing:** Press the lever down in direction of arrow ②.

Override switch

⚠ Observe Safety notes, see page 59.

With the override switch you can disable the rear door window switches in the rear door panels.

⚠ Warning!

Activate the override switch when children are riding in the back seats of the vehicle. The children may otherwise injure themselves, e.g. by becoming trapped in the window opening.



- ① Override switch
- ② Indicator lamp

- ▶ **Activating:** Press override switch ①. Indicator lamp ② comes on.

The rear door windows can no longer be operated using the respective switch located in the rear doors.

It is still possible to operate the rear door windows using the switches located on the door control panel of the driver's door.

- ▶ **Deactivating:** Press override switch ① again.

The rear door windows can again be operated using the respective switch located in the rear doors.

For more information on power windows, see the "Controls in detail" section (> page 109).

Panic alarm



- ① **PANIC** button

i USA only:

This device complies with Part 15 of the FCC Rules. Operation is subject to the following two conditions:

1. This device may not cause harmful interference, and
2. this device must accept any interference received, including interference that may cause undesired operation.

Any unauthorized modification to this device could void the user's authority to operate the equipment.

Driving safety systems

i Canada only:

This device complies with RSS-210 of Industry Canada. Operation is subject to the following two conditions:

1. This device may not cause interference, and
2. this device must accept any interference received, including interference that may cause undesired operation of the device.

Any unauthorized modification to this device could void the user's authority to operate the equipment.

- ▶ **Activating:** Press and hold button ① for at least 1 second.

An audible alarm and flashing exterior lamps will operate briefly.

- ▶ **Deactivating:** Press button ① again.

or

- ▶ Insert the SmartKey in the starter switch.

or

- ▶ Press the KEYLESS-GO start/stop button. The SmartKey with KEYLESS-GO must be inside the vehicle.

Driving safety systems

Introduction

This section contains information about the following driving safety systems:

- ABS (Antilock Brake System)
- Adaptive Brake
- BAS (Brake Assist System)
- EBP (Electronic Brake Proportioning)
- ESP® (Electronic Stability Program)

- i** In winter operation, the maximum effectiveness of most of the driving systems described in this section is only achieved with winter tires, or snow chains as required.

Safety notes

Warning!

The following factors increase the risk of accidents:

- Excessive speed, especially in turns
- Wet and slippery road surfaces
- Following another vehicle too closely

The driving safety systems described in this section cannot reduce these risks or

prevent the natural laws of physics from acting on the vehicle. They cannot increase braking or steering efficiency beyond that afforded by the condition of the vehicle brakes and tires or the traction afforded.

Only a safe, attentive, and skillful driver can prevent accidents.

The capabilities of a vehicle equipped with the driving safety systems described in this section must never be exploited in a reckless or dangerous manner which could jeopardize the user's safety or the safety of others.

Always adjust your driving style to the prevailing road and weather conditions and keep a safe distance to other road users and objects on the street.

If a driving system malfunctions, other driving safety systems may also switch off. Observe indicator and warning lamps that may come on as well as messages in the multifunction display that may appear.

Driving safety systems

ABS

 **Observe Safety notes, see page 66.**

 **Warning!**

Do not pump the brake pedal. Use firm, steady brake pedal pressure instead. Pumping the brake pedal defeats the purpose of the ABS and significantly reduces braking effectiveness.

The Antilock Brake System (ABS) regulates the brake pressure so that the wheels do not lock during braking. This allows you to maintain the ability to steer your vehicle.

The ABS is functional above a speed of approximately 5 mph (8 km/h) independent of road surface conditions.

On slippery road surfaces, the ABS will respond even to light brake pressure.

The  indicator lamp in the instrument cluster comes on when you switch on the ignition. It goes out when the engine is running.

Braking

At the instant one of the wheels is about to lock up, a slight pulsation can be felt in the

brake pedal, indicating that the ABS is in the regulating mode.

- ▶ Keep firm and steady pressure on the brake pedal while you feel the pulsation.

Continuous, steady brake pedal pressure yields the advantages provided by the ABS, namely braking power and the ability to steer the vehicle.

The pulsating brake pedal can be an indication of hazardous road conditions and functions as a reminder to take extra care while driving.

Emergency brake maneuver

- ▶ Keep continuous full pressure on the brake pedal.

 **Warning!**

If the ABS malfunctions, other driving safety systems such as the BAS or the ESP® are also switched off. Observe indicator and warning lamps that may come on as well as messages in the multifunction display that may appear.

If the ABS malfunctions, the wheels may lock during hard braking, reducing steering capability and extending the braking distance.

For more information, see “What to do if ...?” (▷ page 337).

BAS

 **Observe Safety notes, see page 66.**

The Brake Assist System (BAS) operates in emergency situations. If you apply the brakes very quickly, the BAS automatically provides full brake boost, thereby potentially reducing the braking distance.

- ▶ Apply continuous full braking pressure until the emergency braking situation is over. The ABS will prevent the wheels from locking.

When you release the brake pedal, the brakes function again as normal. The BAS is then deactivated.

 **Warning!**

If the BAS malfunctions, the brake system still functions, but without the additional brake boost available that the BAS would normally provide in an emergency braking maneuver. Therefore, the braking distance may increase.

Driving safety systems

Adaptive Brake

Adaptive Brake provides a high level of braking safety as well as increased braking comfort. It is coupled with the ABS, the ESP® and the BAS. Adaptive Brake takes driver and vehicle characteristics into consideration, thus achieving an optimal braking effect.

For more information on the brake system, see (▷ page 286).

EBP

 **Observe Safety notes, see page 66.**

The Electronic Brake Proportioning (EBP) enhances braking effectiveness by allowing the rear brakes to supply a greater proportion of the braking effort in straight line braking without a loss of vehicle stability.

 **Warning!**

If the EBP malfunctions, the brake system will still function with full brake boost. However, the rear wheels could lock up during emergency braking situations, for example. You could lose control of the vehicle and cause an accident.

Adapt your driving style to the changed driving characteristics.

ESP®

 **Observe Safety notes, see page 66.**

The Electronic Stability Program (ESP®) is operational as soon as the engine is running and monitors the vehicle's traction (force of adhesive friction between the tires and the road surface) and handling.

The ESP® recognizes when a wheel is spinning or if the vehicle starts to skid. By applying brakes to individual wheels and by limiting the engine output, the ESP® works to stabilize the vehicle. The ESP® is especially useful while driving off and on wet or slippery road surfaces. The ESP® also stabilizes the vehicle during braking and steering maneuvers.

The ESP® warning lamp  in the instrument cluster comes on when you switch on the ignition. It goes out when the engine is running.

The ESP® warning lamp  in the instrument cluster flashes when the ESP® is engaged.

 **Warning!**

Never switch off the ESP® when you see the ESP® warning lamp  flashing in the instrument cluster. In this case proceed as follows:

- When driving off, apply as little throttle as possible.
- While driving, ease up on the accelerator pedal.
- Adapt your speed and driving style to the prevailing road conditions.

Failure to observe these guidelines could cause the vehicle to skid. The ESP® cannot prevent accidents resulting from excessive speed.

 **Vehicles with 4MATIC:**

Only conduct operational or performance tests on a two-axle dynamometer. If such tests are necessary, contact an authorized Mercedes-Benz Center. You could otherwise seriously damage the brake system or the transfer case which is not covered by the Mercedes-Benz Limited Warranty.

 **Vehicles with 4MATIC:**

Driving safety systems

Because the ESP® operates automatically, the engine and ignition must be shut off (SmartKey in starter switch position **0** or **1** or KEYLESS-GO start/stop button in position **0** or **1**) when the parking brake is being tested on a brake test dynamometer.

Active braking action through the ESP® may otherwise seriously damage the brake system which is not covered by the Mercedes-Benz Limited Warranty.

❗ Vehicles without 4MATIC:

Because the ESP® operates automatically, the engine and ignition must be shut off (SmartKey in starter switch position **0** or **1** or KEYLESS-GO start/stop button in position **0** or **1**) when the parking brake is being tested on a brake test dynamometer or the vehicle is being towed with the front axle raised.

Active braking action through the ESP® may otherwise seriously damage the brake system which is not covered by the Mercedes-Benz Limited Warranty.

❗ The ESP® will only function properly if you use wheels of the recommended tire size as specified in the “Technical data” section of this Operator’s Manual.

- 1 The cruise control switches off automatically when the ESP® engages.

Electronic Traction System (ETS/4-ETS)

 **Observe Safety notes, see page 66.**

The ETS (Electronic Traction System) and 4-ETS (four-wheel Electronic Traction System, vehicles with 4MATIC only) are components of the ESP®. The ETS/4-ETS improves the vehicle’s ability to utilize available traction, especially under slippery road conditions by applying the brakes to a spinning wheel. Vehicles with 4MATIC also transfer more power to the wheel(s) with traction.

When you switch off the ESP®, the ETS/4-ETS is still enabled.

Switching the ESP® off or on (except C 63 AMG)

 **Warning!**

The ESP® should not be switched off during normal driving other than in the circumstances described below. Disabling

the system will reduce vehicle stability in driving maneuvers.

Do not switch off the ESP® when a spare wheel is mounted.

To improve the vehicle’s traction, switch off the ESP® in driving situations in which it would be advantageous to have the drive wheels spin and thus cut into surfaces for better grip such as:

- when driving with snow chains
- in deep snow
- in sand or gravel

 **Warning!**

Switch on the ESP® immediately if the aforementioned circumstances do not apply anymore. Otherwise the ESP® will not stabilize the vehicle when it is starting to skid or a wheel is spinning.

When you switch off the ESP®,

- the ESP® will not stabilize the vehicle
- the engine output is not limited, which allows the drive wheels to spin and thus cut into surfaces for better grip
- the ETS will still apply the brakes to a spinning wheel

Driving safety systems

- the ESP® continues to operate when you are braking
- you cannot activate the cruise control
- the cruise control switches off if activated

i When the ESP® is switched off and one or more drive wheels are spinning, the ESP® warning lamp  in the instrument cluster flashes. However, the ESP® will then not stabilize the vehicle.



① ESP® switch

- **Switching off:** With the engine running, press ESP® switch ① until the ESP® warning lamp  in the instrument cluster comes on. The ESP® is switched off.

Warning!

When the ESP® warning lamp  is illuminated continuously, the ESP® is switched off or is not operational due to a malfunction. Vehicle stability in standard driving maneuvers is reduced.

Adapt your speed and driving to the prevailing road conditions and to the non-operating status of the ESP®.

- !** Avoid spinning of a drive wheel for an extended period with the ESP® switched off. This may cause serious damage to the drivetrain which is not covered by the Mercedes-Benz Limited Warranty.

- **Switching on:** Press ESP® switch ① until the ESP® warning lamp  in the instrument cluster goes out. You are now again in normal driving mode with the ESP® switched on.

C 63 AMG

Switching ESP® SPORT on or off

Warning!

ESP® SPORT should not be switched on during normal driving.

Switching ESP® SPORT on will result in the following:

- no restriction to engine torque
- system supported traction control is limited

ESP® SPORT is designed for driving on closed tracks when the vehicle's natural oversteer and understeer characteristics are desired and requires a highly skilled and experienced driver able to handle these critical driving situations.

You could lose control of your vehicle and cause an accident.

Please be aware of these limits when you switch on ESP® SPORT.

Do not switch on ESP® SPORT when a spare wheel is mounted.

Driving safety systems

To improve the vehicle's traction, switch on ESP® SPORT in driving situations in which it would be advantageous to have the drive wheels spin and thus cut into surfaces for better grip such as:

- when driving with snow chains
- in deep snow
- in sand or gravel

Warning!

Switch off ESP® SPORT and switch on the ESP® immediately if the aforementioned circumstances do not apply anymore. Otherwise ESP® SPORT will only stabilize the vehicle to a limited extent when it is starting to skid or a wheel is spinning.

When you switch on ESP® SPORT

- the ESP® stabilizes the vehicle only to a limited extent
- the engine output is limited, but only to the extent that allows the drive wheels to spin and thus cut into surfaces for better grip
- the ETS will still apply the brakes to a spinning wheel
- the ESP® continues to operate when you are braking hard

- you cannot activate the cruise control
- the cruise control switches off if activated

i When ESP® SPORT is switched on and one or more drive wheels are spinning, the ESP® warning lamp  in the instrument cluster flashes. However, the ESP® will then stabilize the vehicle only to a limited extent.



1 ESP® SPORT switch

► **Switching on:** With the engine running, press ESP® SPORT switch **1** briefly. The ESP® warning lamp  in the instrument cluster comes on. The message

ESP SPORT appears in the multifunction display.

► **Switching off:** With the engine running, press ESP® SPORT switch **1** briefly. The ESP® warning lamp  in the instrument cluster goes out. The message ESP On appears in the multifunction display.

ESP® SPORT switches off automatically when you turn off the engine. When starting the engine, the ESP® is activated automatically.

Switching the ESP® off or on

Warning!

The ESP® should not be switched off during normal driving.

Disabling of the system will result in the following:

- no restriction to engine torque
- loss of system supported traction control

“ESP® OFF” is designed for driving on closed tracks when the vehicle's natural oversteer and understeer characteristics are desired and requires a highly skilled and experienced driver able to handle these critical driving situations.



Driving safety systems

You could lose control of your vehicle and cause an accident.

Please be aware of these limits when you switch off the ESP®.

Do not switch off the ESP® when a spare wheel is mounted.

To improve the vehicle's traction, switch off the ESP® in driving situations in which it would be advantageous to have the drive wheels spin and thus cut into surfaces for better grip such as:

- when driving with snow chains
- in deep snow
- in sand or gravel



Warning!

Switch on the ESP® immediately if the aforementioned circumstances do not apply anymore. Otherwise the ESP® will not stabilize the vehicle when it is starting to skid or a wheel is spinning.

When you switch off the ESP®,

- the ESP® will not stabilize the vehicle
- the engine output is not limited, which allows the drive wheels to spin and thus cut into surfaces for better grip

- the ETS will still apply the brakes to a spinning wheel
- the ESP® continues to operate when you are braking hard
- you cannot activate the cruise control
- the cruise control switches off if activated

 When the ESP® is switched off and one or more drive wheels are spinning, the ESP® warning lamp  in the instrument cluster does not flash. The ESP® will then not stabilize the vehicle.





① ESP® SPORT switch

► **Switching off:** With the engine running, press ESP® SPORT switch ① until the ESP® warning lamp  and the ESP OFF

warning lamp  in the instrument cluster come on.



The message ESP Off appears in the multifunction display.

Warning!

When the ESP® warning lamp  and the ESP OFF warning lamp  are illuminated continuously, the ESP® is switched off. Vehicle stability in standard driving maneuvers is reduced.

Adapt your speed and driving to the prevailing road conditions and to the non-operating status of the ESP®.

 **!** Avoid spinning of a drive wheel for an extended period with the ESP® switched off. This may cause serious damage to the drivetrain which is not covered by the Mercedes-Benz Limited Warranty.

► **Switching on:** With the engine running, press ESP® SPORT switch ① briefly. The ESP® warning lamp  and the ESP OFF warning lamp  in the instrument cluster go out. The message ESP On appears in the multifunction display.

Anti-theft systems

Anti-theft systems

Immobilizer

The immobilizer prevents unauthorized persons from starting your vehicle.

When leaving the vehicle, always take the SmartKey with you and lock the vehicle. The engine can be started by anyone with a valid SmartKey that is left inside the vehicle.

Activating

- ▶ **With SmartKey:** Remove the SmartKey from the starter switch.
- ▶ **With KEYLESS-GO:** Turn off the engine and open the driver's door.

Deactivating

- ▶ Switch on the ignition.

i Starting the engine will also deactivate the immobilizer.

In the event that the engine cannot be started (yet the vehicle's battery is charged), the system is not operational. Contact an authorized Mercedes-Benz Center or call 1-800-FOR-MERCEdes (in the USA), or 1-800-387-0100 (in Canada).

Anti-theft alarm system

Once the alarm system has been armed, a visual and audible alarm is triggered when someone opens

- a door
- the trunk
- the hood

The alarm will stay on even if the activating element (a door, for example) is immediately closed.

The alarm system will also be triggered when

- the vehicle is opened with the mechanical key
- a door is opened from the inside
- the trunk is opened with the emergency release button

To cancel the alarm after it has been triggered, see "Canceling the alarm" (▷ page 74).

i If the alarm stays on for more than 30 seconds, a call to the Response Center is initiated automatically by the Tele Aid system provided that you have subscribed to the Tele Aid service and that it has been activated properly, and that the necessary

mobile phone, power supply and GPS coverage are available.



① Indicator lamp

▶ **Arming:** Lock the vehicle with the SmartKey or with KEYLESS-GO. The turn signal lamps flash three times and an acoustic warning sounds three times to indicate that the vehicle is locked. Indicator lamp ① flashes to indicate that the alarm system is armed.

i If the turn signal lamps do not flash three times and the acoustic warning does not sound three times, a door or the trunk may not be properly closed.



Anti-theft systems



Close the respective element.

- ▶ **Disarming:** Unlock the vehicle with the SmartKey or with KEYLESS-GO. The turn signal lamps flash once and an acoustic warning sounds once to indicate that the alarm system is disarmed.

- i** The vehicle will lock and the alarm system will rearm automatically again after approximately 40 seconds unless you open a door or the trunk.

Canceling the alarm

To cancel the alarm, do one of the following:

- ▶ Insert the SmartKey in the starter switch.
- ▶ Press button  or  on the SmartKey.

In vehicles with KEYLESS-GO:

- ▶ Grasp an outside door handle.
The SmartKey must be within 3 ft (1 m) of the vehicle.
- ▶ Press the KEYLESS-GO start/stop button.
The SmartKey must be inside the vehicle.

Vehicle equipment	76	Automatic transmission	121
Locking and unlocking	76	Instrument cluster	129
Starter switch positions	84	Control system	131
Seats	86	Audio system	152
Multifunction steering wheel	92	Driving systems	204
Mirrors	94	Climate control system	210
Memory function	98	Rear window defroster	222
Lighting	99	Power tilt/sliding sunroof	223
Wipers	106	Panorama roof with power tilt/ sliding panel	226
Power windows	109	Loading and storing	229
Driving and parking	113	Useful features	235
Manual transmission	119		

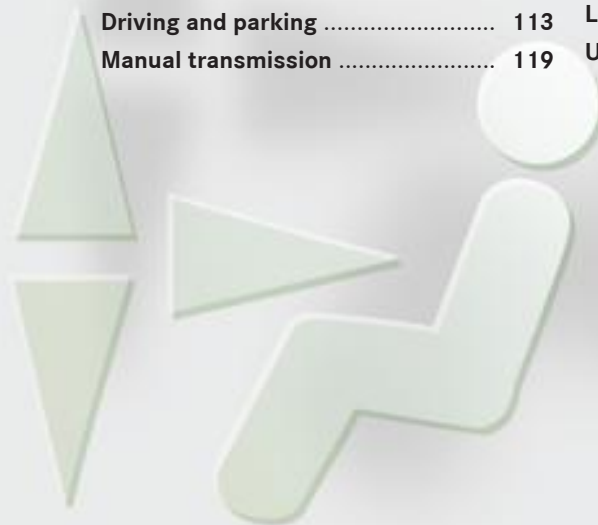

Locking and unlocking

Vehicle equipment

i This Operator's Manual describes all features, standard or optional, potentially available for your vehicle at the time of purchase. Please be aware that your vehicle might not be equipped with all features described in this manual.

Locking and unlocking

Notes

⚠ Observe Safety notes, see page 59.

When unlocking or locking the vehicle with the SmartKey an acoustic signal sounds. The acoustic signal is activated at the factory. If you wish to deactivate the feature, or adjust its signal volume, contact an authorized Mercedes-Benz Center.

When unlocking the vehicle, all turn signal lamps flash once, an acoustic signal sounds once, the locking knobs in the doors move up, and the anti-theft alarm system is disarmed.

When locking the vehicle, all turn signal lamps flash three times, an acoustic signal sounds three times, the locking knobs in the doors move down, and the anti-theft alarm system is armed.

All doors and the trunk must be closed.

! If you cannot lock or unlock the vehicle with the SmartKey, the batteries in the SmartKey are discharged, the SmartKey is malfunctioning, or the vehicle battery is drained.

- Check the batteries in the SmartKey and replace them if necessary.
- Use the mechanical key to unlock the driver's door and the trunk.
- Use the mechanical key to lock the vehicle.
- Have the vehicle battery and the vehicle battery connections checked at an authorized Mercedes-Benz Center.

If the SmartKey is malfunctioning, contact Roadside Assistance or an authorized Mercedes-Benz Center.

SmartKey

Your vehicle comes supplied with two SmartKeys, each with remote control and a removable mechanical key.

The SmartKey centrally locks and unlocks:

- the doors
- the trunk lid
- the fuel filler flap

Locking and unlocking



- ① Lock button
- ② Unlock button for trunk lid
- ③ Unlock button
- ④ Battery check lamp

i USA only:

This device complies with Part 15 of the FCC Rules. Operation is subject to the following two conditions:

1. This device may not cause harmful interference, and
2. this device must accept any interference received, including interference that may cause undesired operation.

Any unauthorized modification to this device could void the user's authority to operate the equipment.

i Canada only:

This device complies with RSS-210 of Industry Canada. Operation is subject to the following two conditions:

1. This device may not cause interference, and
2. this device must accept any interference received, including interference that may cause undesired operation of the device.

Any unauthorized modification to this device could void the user's authority to operate the equipment.

Factory setting

- ▶ **Global unlocking:** Press button . The vehicle will lock again automatically and rearm the anti-theft alarm system within approximately 40 seconds of unlocking if neither door nor trunk is opened.
- ▶ **Global locking:** Press button .

Selective setting

If you frequently travel alone, you may wish to reprogramm the SmartKey so that pressing

button only unlocks the driver's door and the fuel filler flap.

- ▶ **Switching on/off:** Press and hold buttons and simultaneously for approximately 6 seconds until battery check lamp ④ (▷ page 77) flashes twice.

The SmartKey will then function as follows:

- ▶ **Unlocking driver's door and fuel filler flap:** Press button once.
- ▶ **Global unlocking:** Press button twice.
- ▶ **Global locking:** Press button .

KEYLESS-GO

The KEYLESS-GO feature is available on Canada vehicles only.

Vehicles equipped with KEYLESS-GO come with two SmartKeys with KEYLESS-GO, each with remote control and a removable mechanical key.

The KEYLESS-GO function is integrated into the SmartKey. The validity of the SmartKey is checked every time you grasp an outside door handle.

Locking and unlocking

When the SmartKey is valid, your vehicle unlocks

- the doors
- the fuel filler flap
- the trunk lid

i This device complies with RSS-210 of Industry Canada. Operation is subject to the following two conditions:

1. This device may not cause interference, and
2. this device must accept any interference received, including interference that may cause undesired operation of the device.

Important notes on using KEYLESS-GO

- You can also use the SmartKey with KEYLESS-GO like a normal SmartKey (> page 76).
- You can combine KEYLESS-GO functions with normal SmartKey functions (e.g. unlocking with KEYLESS-GO and locking with button ).
- Always carry the SmartKey with you.
- Never store the SmartKey together with:

- Electronic items such as a mobile phone or another SmartKey
- Metallic objects such as coins or metal foil

Doing so could impair the function of the KEYLESS-GO system.

- To lock or unlock the vehicle, the SmartKey must be located outside the vehicle within approximately 3 ft (1 m) of a door or the trunk.
- If the SmartKey is positioned farther away from the vehicle, the system may no longer recognize the SmartKey. The vehicle cannot be locked or the engine started via the KEYLESS-GO system.
- If the SmartKey is removed from the vehicle (e.g. if a passenger exits the vehicle with the SmartKey)
 - when pressing the KEYLESS-GO start/stop button or trying to lock the vehicle with the outside door handle the message **Key Not Detected** appears in the multifunction display
 - with the engine running, the message **Key Not Detected** appears in the multifunction display while driving off

Find the SmartKey or change its present location immediately (e.g. place it on the front passenger seat or insert it in shirt pocket).

- If you have started the engine with the KEYLESS-GO start/stop button, you can turn it off again by
 - pressing the KEYLESS-GO start/stop button
 - inserting the SmartKey into the starter switch when the vehicle is at a standstill and the automatic transmission is in park position **P**
 - The vehicle could be inadvertently unlocked if the SmartKey is within 3 ft (1 m) of the vehicle and
 - an outside door handle is splashed with water or
 - you attempt to clean an outside door handle
 - Remember that the engine can be started by anyone with a SmartKey that is left inside the vehicle.
- Possibility 1** (One SmartKey in the vehicle, one SmartKey outside the vehicle):

If you leave the SmartKey behind when exiting and locking the vehicle, no message appears in the multifunction display.

Possibility 2 (One SmartKey in the vehicle, no SmartKey outside the vehicle):

When exiting and trying to lock the vehicle, the message **Key Detected In Vehicle** appears in the multifunction display. The vehicle will not be locked.

Factory setting

- ▶ **Global unlocking:** Pull an outside door handle.

The vehicle will lock again automatically and rearm the anti-theft alarm system within approximately 40 seconds if neither door nor trunk is opened.

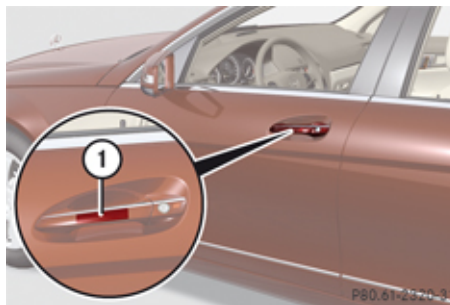



① Outside door handle

- ▶ **Global locking:** Touch outside of door handle ①.

Selective setting

If you frequently travel alone, you may wish to reprogram the SmartKey so when you pull the driver's outside door handle, only the driver's door and the fuel filler flap unlock.



- ▶ **Switching on/off:** Press and hold buttons  and  simultaneously for approximately 6 seconds until battery check lamp ④ (▷ page 77) flashes twice.

The SmartKey will then function as follows:

Locking and unlocking



- ▶ **Unlocking driver's door and fuel filler flap:** Pull the driver's outside door handle.
- ▶ **Global unlocking:** Pull any outside door handle other than the driver's outside door handle.
- ▶ **Global locking:** Touch outside of door handle ①.

Checking SmartKey batteries

- ▶ Press button  or  on the SmartKey. Battery check lamp ④ (▷ page 77) comes on briefly to indicate that the SmartKey batteries are in order.

If the battery check lamp does not come on briefly during check, the SmartKey batteries are discharged.

- ▶ Replace the batteries (▷ page 353).

- i** You can obtain the required batteries at any authorized Mercedes-Benz Center.
- i** If the batteries are checked within signal range of the vehicle, pressing button  or  will lock or unlock the vehicle accordingly.

Locking and unlocking

Loss of the SmartKey

If you lose your SmartKey or mechanical key, you should do the following:

- ▶ Have the SmartKey deactivated by an authorized Mercedes-Benz Center.
- ▶ Report the loss of the SmartKey or the mechanical key to your car insurance company immediately.
- ▶ Have the mechanical lock replaced if necessary.

Any authorized Mercedes-Benz Center will be glad to supply you with a replacement.

Opening the doors from the inside

You can open a locked door from the inside. Open door only when conditions are safe to do so.

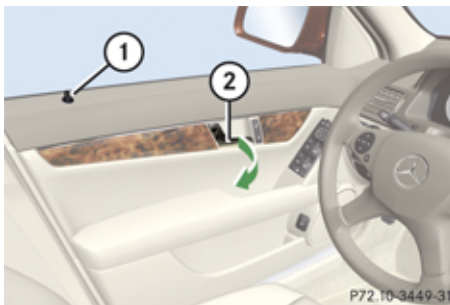

Example illustration driver's door

- ① Locking knob
- ② Inside door handle

If the vehicle has previously been locked with the SmartKey or with KEYLESS-GO, opening a door from the inside will trigger the anti-theft alarm system.

To cancel the alarm, see (> page 74).

- ▶ **Front doors:** Pull on inside door handle ② on the respective front door to open door.
If the door was locked, locking knob ① will move up.
- ▶ **Rear doors:** Pull up locking knob on the respective rear door to unlock door.
- ▶ Pull on inside door handle on the respective rear door to open door.

Automatic central locking

The doors and the trunk lock automatically when the vehicle is set into motion.

You can open a locked door from the inside. Open door only when conditions are safe to do so.

The doors are designed to unlock automatically after an accident if the force of the impact exceeds a preset threshold.

The vehicle locks automatically when the ignition is switched on and the wheels are turning at vehicle speeds of approximately 9 mph (15 km/h) or more. You could therefore lock yourself out when the vehicle is pushed or towed or is on a test stand.

Locking and unlocking

You can deactivate the automatic central locking using the control system (▷ page 150).

Automatic central locking activating/deactivating

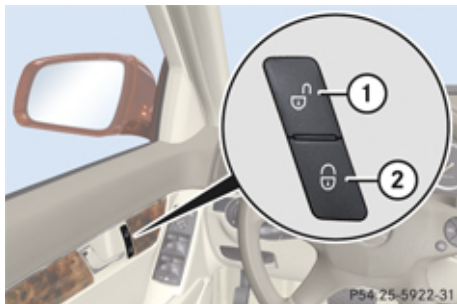

- ① Central unlocking switch
- ② Central locking switch

- ▶ **Activating:** Press and hold central locking switch ② until an acoustic signal sounds.
- ▶ **Deactivating:** Press and hold central unlocking switch ① until an acoustic signal sounds.

i If you press and hold either switch and no acoustic signal sounds, the respective setting has already been selected.

Locking and unlocking from the inside

⚠ Observe Safety notes, see page 59.

You can lock or unlock the vehicle from inside using the central locking switches. This can be useful, for example, if you want to lock the vehicle before starting to drive.

The central locking switches do not lock or unlock the fuel filler flap.



- ① Central unlocking switch
- ② Central locking switch

- ▶ **Locking:** Press central locking switch ②. If the front passenger door is closed, the vehicle locks.
- ▶ **Unlocking:** Press central unlocking switch ①.

You can open a locked door from inside at any time. Open door only when conditions are safe to do so.

If the vehicle was previously locked with the central locking switch:

- and the SmartKey is set to factory settings, the complete vehicle is unlocked when a door is opened from the inside
- and the SmartKey is set to selective settings, only the door opened from inside is unlocked

Opening the trunk

⚠ Warning!

Make sure the trunk is closed when the engine is running and while driving. Among other dangers, deadly carbon monoxide (CO) gases may enter vehicle interior resulting in unconsciousness and death.

You can open the trunk when the vehicle is stationary.

A minimum height clearance of 5.90 ft (1.80 m) is required to open the trunk lid.



Locking and unlocking

❗ The trunk lid swings open upwards automatically. Always make sure there is sufficient overhead clearance.

Opening the trunk from the outside

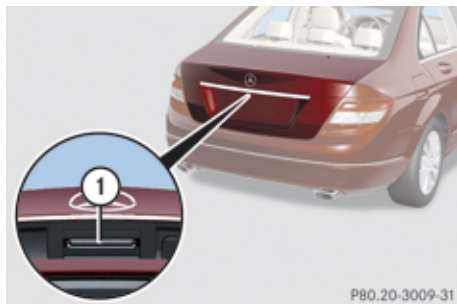

① Handle

▶ Press and hold button  on the SmartKey until the trunk unlocks and begins to open.

or

▶ Pull on handle ①.

In vehicles without KEYLESS-GO: The vehicle must be unlocked.

If the trunk does not open, it is still locked separately (▷ page 83).

Opening the trunk from the inside



① Remote trunk opening switch

▶ Press switch ① until the trunk begins to open.

Closing the trunk

⚠ Warning!

Make sure the trunk is closed when the engine is running and while driving. Among other dangers, deadly carbon monoxide (CO) gases may enter vehicle interior resulting in unconsciousness and death.

⚠ Warning!

To prevent possible personal injury, always keep hands and fingers away from the trunk

opening when closing the trunk lid. Be especially careful when small children are around.

⚠ **Observe Safety notes, see page 59.**

Do not leave the SmartKey in the open trunk. You may lock yourself out.

If the vehicle was previously centrally locked with the SmartKey or KEYLESS-GO, the trunk lid will lock automatically when closed. All turn signal lamps flash three times and an acoustic signal sounds three times to confirm locking.

Vehicles with KEYLESS-GO:

To prevent a possible inadvertent lockout, the trunk lid will open automatically if a SmartKey with KEYLESS-GO is recognized inside the vehicle or in the trunk.

The vehicle is only locked when the turn signal lamps flash three times and an acoustic signal sounds three times. If you are carrying a second SmartKey with KEYLESS-GO with you, you can still lock the vehicle.

Locking and unlocking

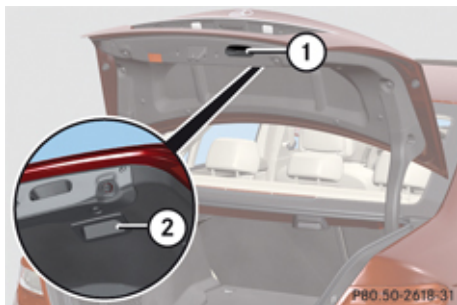

- ① Handle
- ② Handle

- ▶ Lower the trunk lid using handle ① or ②.
- ▶ Close trunk lid with hands placed flat on trunk lid.

Trunk lid emergency release

With the emergency release button, the trunk lid can be opened from inside the trunk.



- ① Emergency release button

- ▶ Briefly press emergency release button ①.

The trunk lid unlocks and opens.

The emergency release button unlocks and opens the trunk while the vehicle is standing still or in motion.

Illumination of the emergency release button:

- The button flashes for 30 minutes after opening the trunk.
- The button flashes for 60 minutes after closing the trunk.

The emergency release button does not open the trunk, if the vehicle battery is discharged or disconnected.

Valet locking

To deny any unauthorized person access to the trunk, e.g. when you valet park the vehicle, lock it separately with the mechanical key. Leave only the SmartKey less its mechanical key with the vehicle.

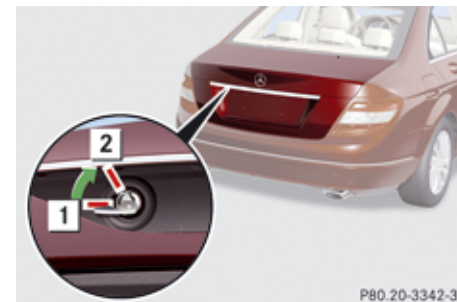

- ① Neutral position
- ② Locked

- ▶ **Valet locking:** Close the trunk.
- ▶ Remove the mechanical key from the SmartKey (▶ page 350).

Starter switch positions

- ▶ Insert the mechanical key in the trunk lid lock.
- ▶ Turn the mechanical key clockwise to position **2** and remove the mechanical key in that position to lock the trunk.

The trunk remains locked even when the vehicle is centrally unlocked.

You can only cancel the separate trunk locking mode by means of the mechanical key.

- ▶ **Canceling:** Insert the mechanical key in the trunk lid lock.
- ▶ Turn the mechanical key counterclockwise to neutral position **1** and remove the mechanical key in that position to unlock the trunk.
You can now open the trunk.

Starter switch positions

SmartKey

⚠ Observe Safety notes, see page 59.



Starter switch

- 0** For removing SmartKey
Vehicles with automatic transmission:
Gear selector lever must be in park position **P**.
- 1** Power supply for some electrical consumers, e.g. radio
- 2** Ignition (power supply for all electrical consumers) and driving position
- 3** Starting position

When you switch on the ignition, all lamps (except high-beam headlamp indicator lamp,

and turn signal indicator lamps unless activated) in the instrument cluster come on. If a lamp in the instrument cluster fails to come on when the ignition is switched on, have it checked and replaced if necessary. If a lamp in the instrument cluster remains on after starting the engine or comes on while driving, refer to “Lamps in instrument cluster” (▷ page 336).

If the SmartKey is left in starter switch position **0** for an extended period of time, it can no longer be turned in the starter switch. In this case, the steering is locked. To unlock, remove SmartKey from the starter switch and reinsert.

The steering is locked when the SmartKey is removed from the starter switch.

! If the SmartKey cannot be turned in the starter switch, the vehicle battery may not be sufficiently charged.

- Check the vehicle battery and charge it if necessary.
- Get a jump start.

To prevent accelerated vehicle battery discharge or a completely discharged vehicle battery, always remove the

SmartKey from the starter switch when the engine is not in operation.

KEYLESS-GO

⚠ Observe Safety notes, see page 59.

The KEYLESS-GO feature is available on Canada vehicles only.

Vehicles equipped with the KEYLESS-GO feature are supplied with a SmartKey with integrated KEYLESS-GO function and a removable KEYLESS-GO start/stop button.

With the KEYLESS-GO start/stop button inserted in the starter switch and the SmartKey present in the vehicle, pressing the KEYLESS-GO start/stop button

- without the brake pedal depressed corresponds to the various starter switch positions (▷ page 84)
- with the brake pedal firmly depressed will start the engine (▷ page 113)

If you wish or should there be the need to insert the SmartKey in the starter switch, the KEYLESS-GO start/stop button can be easily removed by pulling it out of the starter switch.

- ① The KEYLESS-GO start/stop button does not need to be removed from the starter switch when you leave the vehicle. However, always take the SmartKey with you when you leave the vehicle. As long as the SmartKey is in the vehicle, the vehicle's electrical systems can be switched on or the engine can be started using the KEYLESS-GO start/stop button.

The function of the SmartKey overrides the KEYLESS-GO function.

The SmartKey must be located in the vehicle.



- ① KEYLESS-GO start/stop button
② Starter switch

Starter switch positions

- ▶ Insert KEYLESS-GO start/stop button ① into starter switch ② (if not inserted already).
- ① When you switch from SmartKey mode back to KEYLESS-GO mode, the system requires 2 seconds of detection time before you can use the KEYLESS-GO button as usual.
- ▶ Make sure the automatic transmission is in park position **P**.
- ▶ Do not depress the brake pedal.



KEYLESS-GO start/stop button

Seats

Position 0

Before you press the KEYLESS-GO start/stop button, the vehicle's on-board electronics have status **0** (as with SmartKey removed).

Position 1

- ▶ Press the KEYLESS-GO start/stop button once.

This supplies power for some electrical consumers, such as radio functions.

- i** If you now press the KEYLESS-GO start/stop button

- once more, the ignition (position **2**) is switched on
- twice more the power supply is again switched off

Ignition (or position 2)

- ▶ Press the KEYLESS-GO start/stop button twice.

This supplies power for all electrical consumers.

All lamps (except high-beam headlamp indicator lamp and turn signal indicator lamps unless activated) in the instrument cluster come on. If a lamp in the instrument cluster fails to come on when the ignition

is switched on, have it checked and replaced if necessary. If a lamp in the instrument cluster remains on after starting the engine or comes on while driving, refer to "Lamps in instrument cluster" (> page 336).

- i** If you now press the KEYLESS-GO start/stop button once, the power supply is again switched off.

Seats

Safety notes

Warning!

In order to avoid possible loss of vehicle control, all seat, head restraint, steering wheel, and rear view mirror adjustments, as well as fastening of seat belts, must be done before the vehicle is put into motion.

Warning!

Do not adjust the driver's seat while driving. Adjusting the seat while driving could cause the driver to lose control of the vehicle.

Never ride in a moving vehicle with the seat backrest in an excessively reclined position as this can be dangerous. You could slide under the seat belt in a collision. If you slide under it, the seat belt would apply force at the abdomen or neck. That could cause serious or fatal injuries. The seat backrest and seat belts provide the best restraint when the wearer is in a position that is as upright as possible and seat belts are properly positioned on the body.

⚠ Warning!

Your seat must be adjusted so that you can correctly fasten your seat belt.

Observe the following points:

- Adjust the seat backrest until your arms are slightly angled when holding the steering wheel.
- Adjust the seat to a comfortable seating position that still allows you to reach the accelerator/brake pedal safely. The position should be as far back as possible with the driver still able to operate the controls properly.
- Adjust the head restraint so that it is as close to the head as possible and the center of the head restraint supports the back of the head at eye level.
- Never place hands under the seat or near any moving parts while a seat is being adjusted.

Failure to do so could result in an accident and/or serious personal injury.

⚠ Warning!

The power seats can be operated at any time. Therefore, do not leave children unattended in the vehicle, or with access to

an unlocked vehicle. A child's unsupervised access to a vehicle could result in an accident and/or serious personal injury.

⚠ Warning!

According to accident statistics, children are safer when properly restrained in the rear seating positions than in the front seating position. Thus, we strongly recommend that children be placed in the rear seats whenever possible. Regardless of seating position, children 12 years old and under must be seated and properly secured in an appropriately sized infant restraint, toddler restraint, or booster seat recommended for the size and weight of the child. For additional information, see "Children in the vehicle".

A child's risk of serious or fatal injuries is significantly increased if the child restraints are not properly secured in the vehicle and/or the child is not properly secured in the child restraint.

⚠ Warning!

For your protection, drive only with properly positioned head restraints.

Adjust the head restraint so that it is as close to the head as possible and the center

of the head restraint supports the back of the head at eye level. This will reduce the potential for injury to the head and neck in the event of an accident or similar situation.

Do not drive the vehicle without the seat head restraints. Head restraints are intended to help reduce injuries during an accident.

Seat adjustment

- ❗ When moving the seats, make sure there are no items in the footwell or behind the seats. Otherwise, you could damage the seats.

Semi-electrical seat adjustment

This seat adjustment is only available on C 63 AMG.

Seats

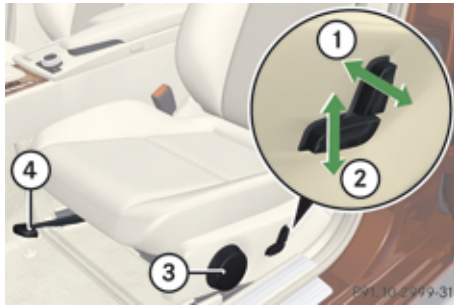

- ① Seat backrest tilt
- ② Seat height
- ③ Handwheel for seat cushion tilt
- ④ Handle for seat fore and aft adjustment

i AMG vehicles are equipped with a seat with an integrated head restraint. It is therefore not possible to set the height and angle of the head restraint.

- ▶ **Seat backrest tilt:** Press the switch forward or backward in direction of arrow ①.
- ▶ **Seat height:** Press the switch up or down in direction of arrow ②.
- ▶ **Seat cushion tilt:** Turn handwheel ③ forward or backward until your upper legs are lightly supported.

- ▶ **Seat fore and aft adjustment:** Lift handle ④.
- ▶ Slide the seat to the desired position.
- ▶ Allow handle ④ to reengage with an audible click.
- ▶ Check for proper engagement before driving.

Power seats

The seat adjustment switch is located on the entry side of each front seat base. The seat adjustment switch for vehicles with memory function are located on the front doors.

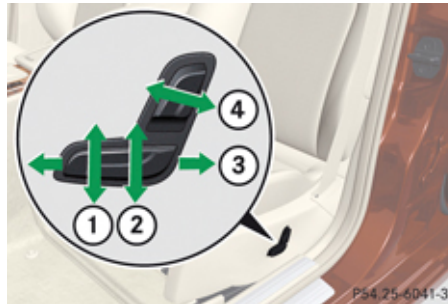

Vehicles without memory function

- ① Seat cushion tilt
- ② Seat height

- ③ Seat fore and aft adjustment
- ④ Seat backrest tilt

i AMG vehicles are equipped with a seat with an integrated head restraint. It is therefore not possible to set the height and angle of the head restraint.

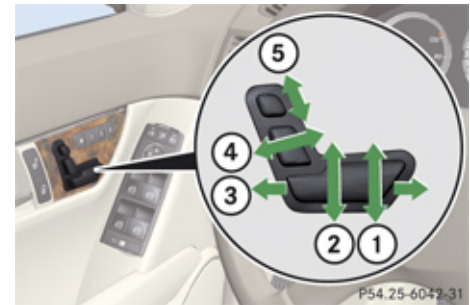

Vehicles with memory function

- ① Seat cushion tilt
- ② Seat height
- ③ Seat fore and aft adjustment
- ④ Seat backrest tilt
- ⑤ Head restraint height

i Vehicles without memory function:

The seats can be adjusted within 5 minutes after either front door has been opened. The counter resets each time

- you open or close a front door
- you insert the SmartKey into the starter switch
- you remove the SmartKey from the starter switch
- you switch the ignition on or off

Just like in vehicles with memory function, the power seats can be operated at any time when the ignition is switched on.

i Vehicles with memory function:

The memory function (> page 98) lets you store the settings for the seat position together with the settings for the steering wheel and the exterior rear view mirrors.

- ▶ **Seat fore and aft adjustment:** Press the switch forward or backward in direction of arrow ③.
- ▶ **Seat backrest tilt:** Press the switch forward or backward in direction of arrow ④.
- ▶ **Seat height:** Press the switch up or down in direction of arrow ②.

- ▶ **Seat cushion tilt:** Press the switch up or down in direction of arrow ① until your upper legs are lightly supported.
- ▶ **Head restraint height:** Press the switch up or down in direction of arrow ⑤.

Head restraint height adjustment, manual

This feature is only available in vehicles without memory function.

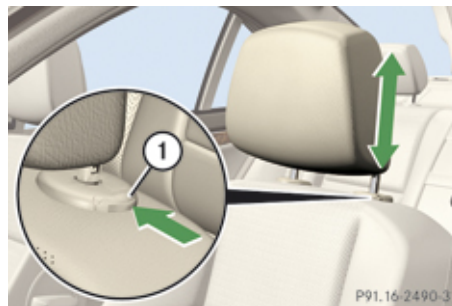

① Release button

- ▶ **Raising:** Adjust the height of the head restraint manually by pulling it upward.
- ▶ **Lowering:** Push release button ① and push down on the head restraint.

Head restraint fore and aft adjustment



- ▶ Adjust the head restraint to the desired position by pushing or pulling on the lower edge of the head restraint cushion.

Lumbar support

You can adjust the contour of the front seat's lumbar support to help enhance support to your spine.

Seats

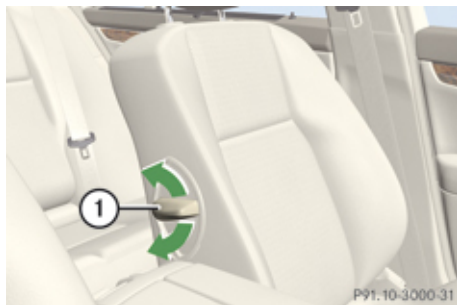

① Adjustment lever

- ▶ Move adjustment lever ① in direction of the arrows until you have reached a comfortable seating position.

Seat with adaptive backrest

This feature is only available on C 63 AMG. The contour of the front seat backrests can be individually adjusted to provide optimum support for your back.



- ① Upper back support
- ② Lumbar region support
- ③ Seat backrest side cushions

- ▶ Switch on the ignition.
- ▶ **Upper back support:** Use button ① to adjust the upper back support to the desired position.
- ▶ **Lumbar region support:** Use button ② to adjust the lumbar region support to the desired position.
- ▶ **Lateral support:** Use button ③ to adjust the lateral support to the desired position.

- ① If, after a period of time, the seat no longer provides the desired contour, then repeat the adjustment procedure.

Rear seat head restraints

⚠ Warning!

For your protection, drive only with properly positioned head restraints.

Adjust the head restraint in such a way that it is as close to the head as possible and the center of the head restraint supports the back of the head at eye level. This will reduce the potential for injury to the head and neck in the event of an accident or similar situation.

With a rear seat occupied, make sure to move the respective head restraint up from the lowest non-use position and have the occupant adjust the head restraint properly.

Do not drive the vehicle without the seat head restraints installed when the rear seats are occupied. Head restraints are intended to help reduce injuries during an accident.

Rear seat head restraint height

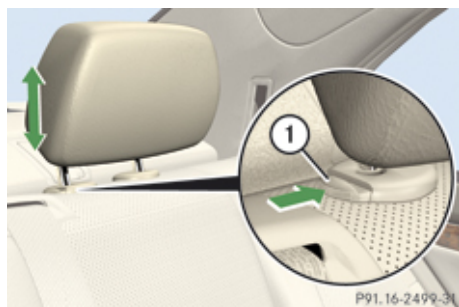

① Release button

- ▶ **Raising:** Pull head restraint upward to the desired position.
- ▶ **Lowering:** Press release button ① and push down on head restraint.

Rear seat head restraint fore and aft adjustment



- ▶ Adjust the head restraint to the desired position by pushing or pulling on the lower edge of the head restraint cushion.

Rear seat head restraints, removing and installing (vehicles with split foldable rear seat)

- ▶ **i** The rear head restraints cannot be removed on vehicles which do not have the split foldable rear seat.

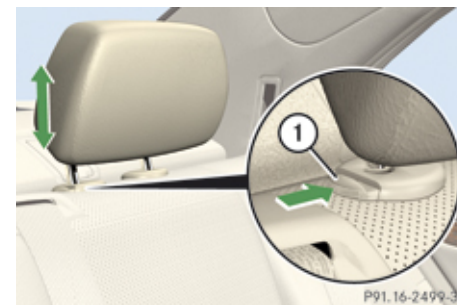

① Release button

- ▶ **Removing:** Unlock the rear seat backrest and fold it slightly forward.
- ▶ Pull head restraint to its highest position.
- ▶ Push release button ① and pull out head restraint.
- ▶ **Installing:** Position the head restraints so that the notches on the rod are on the left when looking in the direction of travel.
- ▶ Insert head restraint and push it down until it engages.
- ▶ Fold the rear seat backrest back until it engages.
- ▶ Push release button ① and adjust head restraint to desired position.

Multifunction steering wheel

Seat heating



① Seat heating switch

The red indicator lamps in switch ① come on to show which heating level you have selected.

The seat heating switches from level **3** (high) to level **2** after approximately 5 minutes.

The seat heating switches from level **2** to level **1** (low) after approximately 10 minutes.

The seat heating automatically switches off from level **1** after approximately 20 minutes.

▶ Switch on the ignition.

▶ **Switching on:** Press switch ①.

Three red indicator lamps in switch ① come on.

- ▶ Continue pressing switch ① until desired seat heating level is reached.
- ▶ **Switching off:** Press switch ① repeatedly until all indicator lamps go out.

If one or more of the indicator lamps in seat heating switch ① are flashing, there is insufficient voltage available since too many electrical consumers are turned on. The seat heating switches off automatically.

The seat heating will switch back on again automatically as soon as sufficient voltage is available.

Multifunction steering wheel

Safety notes

⚠ Warning!

Do not adjust the steering wheel while driving. Adjusting the steering wheel while driving, or driving without the steering wheel adjustment feature locked could cause the driver to lose control of the vehicle.

The electrical steering wheel adjustment feature can be operated at any time. Therefore, do not leave children unattended in the vehicle, or with access to an unlocked vehicle. A child's unsupervised access to a vehicle could result in an accident and/or serious personal injury.

Make sure

- you can reach the steering wheel with your arms slightly bent at the elbows
- you can move your legs freely
- all displays (including malfunction and indicator lamps) on the instrument cluster are clearly visible

Multifunction steering wheel

Steering wheel adjustment, manual

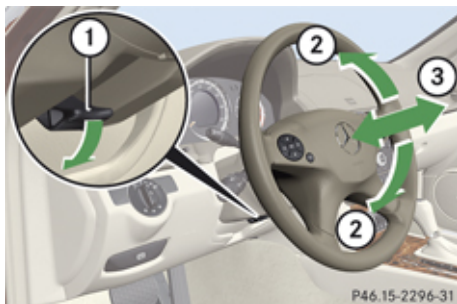

- ① Release handle
 - ② Adjusting steering wheel, up or down
 - ③ Adjusting steering wheel, in or out
- ▶ **Unlocking:** Pull release handle ① out to its stop limit.
 - ▶ Move steering wheel to the desired position.
 - ▶ **Locking:** Push release handle ① all the way up until it engages.
 - ▶ Make sure the steering wheel is securely locked by trying to move it up and down as well as in and out before driving off.

Steering wheel adjustment, electrical

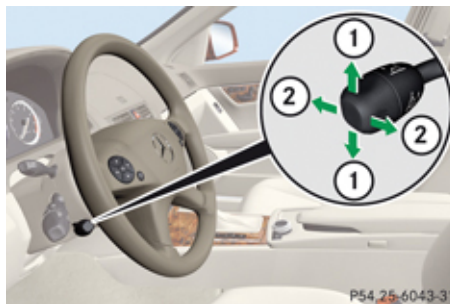

- ① Adjusting steering wheel, up or down
 - ② Adjusting steering wheel, in or out
- ▶ **Adjusting steering wheel up or down:** Move stalk in direction of arrows ①.
 - ▶ **Adjusting steering wheel in or out:** Move stalk in direction of arrows ②.
- ① The memory function (▷ page 98) lets you store the settings for the steering wheel together with the settings for the seat position and the exterior rear view mirrors.

Easy-entry/exit feature

This feature allows the driver an easier entry into and exit from the vehicle. When entering and exiting the vehicle, the steering wheel is in its uppermost position.

The easy-entry/exit feature can be activated or deactivated in the Convenience submenu of the control system (▷ page 150).

⚠ Warning!

You must make sure no one can become trapped or injured by the moving steering wheel when the easy-entry/exit feature is activated.

To stop steering wheel movement do one of the following:

- Move steering wheel adjustment stalk.
- Press one of the memory position buttons.
- Press memory button **M**.

Do not leave children unattended in the vehicle, or with access to an unlocked vehicle. Children could open the driver's door and unintentionally activate the easy-entry/exit feature, which could result in an accident and/or serious personal injury.

Mirrors

With the easy-entry/exit feature activated, the steering wheel will return to its last set position when you close the driver's door with the ignition switched on. The steering wheel will also return to its last set position when you insert the SmartKey into the starter switch or press the KEYLESS-GO start/stop button once with the driver's door closed.

- ① The last set steering wheel position is stored when the ignition is switched off or the position is stored in memory (> page 98).

With the easy-entry/exit feature activated, the steering wheel tilts upwards when you remove the SmartKey from the starter switch. The steering wheel also tilts upwards when you open the driver's door with the SmartKey in starter switch position **0** or **1** or the KEYLESS-GO start/stop button in position **1**.

- ① When the current position for the steering wheel is in the uppermost tilt position, the steering wheel will no longer be able to move upward when the easy-entry/exit feature is activated.
The adjustment procedure is briefly interrupted when the engine is started.

Warning!

Let the system complete the adjustment procedure before setting the vehicle in motion. All steering wheel adjustment must be completed before setting the vehicle in motion. Driving off with the steering wheel still adjusting could cause the driver to lose control of the vehicle.

Mirrors

Notes

Adjust the interior and exterior rear view mirrors before driving so that you have a good view of the road and traffic conditions.

Interior rear view mirror

- ▶ Adjust the interior rear view mirror manually.

Interior rear view mirror, antiglare position



- ① Lever

Mirrors

- ▶ Tilt the mirror to the antiglare position by moving lever ① towards the windshield. The interior rear view mirror is dimmed. For more information, see “Auto-dimming rear view mirrors” (▶ page 95).

Exterior rear view mirrors

⚠ Warning!

Exercise care when using the passenger-side exterior rear view mirror. The mirror surface is convex (outwardly curved surface for a wider field of view). Objects in mirror are closer than they appear. Check your interior rear view mirror and glance over your shoulder before changing lanes.



- ① Driver's side exterior rear view mirror button
- ② Passenger-side exterior rear view mirror button
- ③ Adjustment button

- ▶ Switch on the ignition.
- ▶ Press button ① for the driver's side exterior rear view mirror or button ② for the passenger-side exterior rear view mirror. The indicator lamp in the respective button comes on.

If you do not make adjustments to the selected exterior rear view mirror within 15 seconds, the indicator lamp goes out. You will then have to select the desired exterior rear view mirror again before adjustments can be made. Adjustments

can only be made with the indicator lamp for the respective exterior rear view mirror button illuminated.

- ▶ Press adjustment button ③ up, down, left or right according to the desired setting.

! If an exterior rear view mirror was forcibly hit from the front, manually snap it back into place.

- i** At low ambient temperatures, the exterior rear view mirrors will be heated automatically.

Auto-dimming rear view mirrors

The exterior rear view mirror on the driver's side and the interior rear view mirror will respond automatically to glare when the ignition is switched on and incoming light from headlamps falls on the sensor in the interior rear view mirror.

The rear view mirrors will not react if the automatic transmission is set to reverse gear **R** or the interior lighting is switched on.

⚠ Warning!

The auto dimming function does not react if incoming light is not aimed directly at sensors in the interior rear view mirror.



Mirrors

The interior rear view mirror and the exterior rear view mirror on the driver's side do not react, for example, if the rear window sunshade is in raised position.

Light hitting the mirror(s) at certain angles (incident light) could blind you. As a result, you may not be able to observe traffic conditions and could cause an accident.

Power folding exterior rear view mirrors

This feature is only available in Canada vehicles.

! Before you drive the vehicle through an automatic car wash, fold in the exterior rear view mirrors. Otherwise they may get damaged.

Folding in and out automatically

When the corresponding function in the control system is activated (▷ page 151):

- The exterior rear view mirrors fold in automatically as soon as the vehicle is locked from the outside.
- The exterior rear view mirrors fold out automatically as soon as the vehicle is

unlocked and the driver's or front passenger door are subsequently opened.

Resetting the automatic exterior rear view mirror fold in function

You need to reset the automatic exterior rear view mirror fold in function whenever the battery was disconnected or discharged.

- ▶ Switch on the ignition.
- ▶ Briefly press button ①.

i You need to manually fold in the mirrors once, so that the automatic fold in function will work, see "Setting fold-in function for exterior rear view mirrors" (▷ page 151).

Folding in and out manually

The exterior rear view mirrors can vibrate if they are not folded out completely.

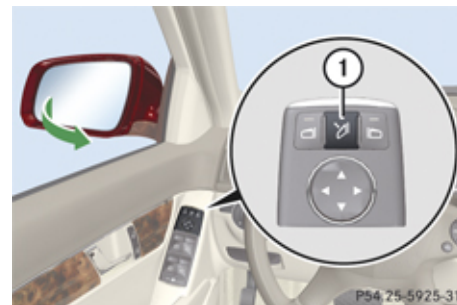

① Button for folding exterior rear view mirrors in and out

- ▶ Switch on the ignition.
- ▶ **Folding in:** Briefly press button ①. Both exterior rear view mirrors fold in.

i If you are driving at more than approximately 9 mph (15 km/h), you will not be able to fold the exterior mirrors in.

- ▶ **Folding out:** Briefly press button ①. Both exterior rear view mirrors fold out.

! If an exterior rear view mirror housing is forcibly pushed forward (hit from the rear), reposition it manually by applying firm pressure until it snaps back into place. If an exterior rear view mirror housing is forcibly pushed rearward (hit from the

Mirrors

front), press button ① to fold mirrors in, then press button ① again to fold mirrors out. Do not force mirrors by hand as this may damage the adjustment mechanism. The mirror housing is then properly positioned and you can adjust the mirror in the usual manner.

Activating exterior rear view mirror parking position

Follow these steps to activate the mirror parking position so that the passenger-side exterior rear view mirror will be turned downward to the stored position.



- ① Driver's side exterior rear view mirror button
 - ② Passenger-side exterior rear view mirror button
 - ③ Adjustment button
- ▶ Make sure you have stored a parking position for the passenger-side exterior rear view mirror (> page 98).
 - ▶ Switch on the ignition.
 - ▶ Shift the automatic transmission into reverse gear **R** (manual transmission to reverse gear).

The previously selected exterior rear view mirror is activated, and the indicator lamp

in the respective button ① or ② comes on.

- ▶ Press button ②, to select the front passenger side exterior rear view mirror. The indicator lamp in button ② comes on and the passenger-side exterior rear view mirror will be turned downward to the stored position.

The exterior rear view mirror returns to its previously stored driving position:

- 10 seconds after you have put the transmission out of reverse
- immediately once your vehicle exceeds a speed of approximately 6 mph (10 km/h)
- immediately when you press button ① for driver's side exterior rear view mirror.

Memory function

Memory function

Notes

With the memory function you can store up to three different configurations per front seat.

Each memory position button on the driver's side can store all of the following settings:

- Seat position
- Steering wheel position
- Exterior rear view mirrors' position

Warning!

Do not activate the memory function while driving. Activating the memory function while driving could cause the driver to lose control of the vehicle.

Each stored position on the passenger side includes the setting of the seat position.



M Memory button
1, 2, 3 Memory position button

Storing positions into memory

- ▶ Adjust the seats.
- ▶ On the driver's side, additionally adjust the steering wheel and exterior rear view mirrors to the desired positions.
- ▶ Press memory button **M**.
- ▶ Release memory button **M** and press memory position button **1**, **2** or **3** within 3 seconds.

When the settings are stored to the selected position, an acknowledgement signal sounds.

Recalling positions from memory

- ▶ Press and hold desired memory position button **1**, **2** or **3** until the seat has completely moved to the stored position. On the driver's side, also wait for the steering wheel and exterior rear view mirrors to move to the stored position.

 Releasing the memory position button stops movement to the stored positions immediately.

Storing exterior rear view mirror parking position

For easier parking, you can adjust the passenger-side exterior rear view mirror so that you can see the right rear wheel as soon as you engage reverse gear **R**.

For information on activating the parking position, see (▶ page 97).

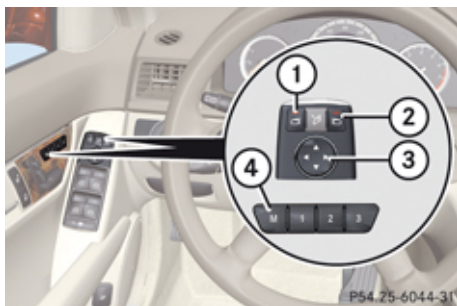

- ① Driver's side exterior rear view mirror button
- ② Passenger side exterior rear view mirror button
- ③ Adjustment button
- ④ Memory button **M**

- ▶ Stop the vehicle.
- ▶ Switch on the ignition.
- ▶ Press button ②.
The passenger-side exterior rear view mirror is selected.
- ▶ Adjust the passenger-side exterior rear view mirror with adjustment button ③ so that you see the rear wheel and the road curb.

- ▶ Press memory button **M** ④.
- ▶ Within 3 seconds, press one of the arrows of adjustment button ③.
The parking position is stored if the mirror does not move.

- ❗ If the mirror does move, repeat the above steps. After the setting is stored, you can move the mirror again.

Lighting

Notes

- ❗ If you drive in countries where vehicles drive on the other side of the road than the country where the vehicle is registered, you must have the headlamps modified for symmetrical low beams. Relevant information can be obtained at any authorized Mercedes-Benz Center.
- ❗ Vehicles equipped with active Bi-Xenon headlamps:
The active Bi-Xenon headlamps monitor the vehicle's steering angle and speed, then automatically shift their beams to either side to better follow the curvature of the road ahead, increasing usable illumination over conventional headlamps.

Lighting

Exterior lamp switch



- 1 **P** ← Standing lamps, left
- 2 **P** → Standing lamps, right
- 3 **0** Off
Daytime running lamp mode
- 4 **A** Automatic headlamp mode
Daytime running lamp mode
- 5 **☰** Parking lamps (also tail lamps, license plate lamps, side marker lamps and instrument panel lamps)
- 6 **☷** Low-beam headlamps or high-beam headlamps
- 7 **☼** Front fog lamps
- 8 **☼** Rear fog lamp

i The exterior lamps go out automatically when you remove the SmartKey from the

starter switch or open the driver's door with the ignition switched off.

When the parking lamps or the rear fog lamp are switched on and you remove the SmartKey from the starter switch and open the driver's door, an acoustic signal sounds.

In addition the message Switch Off Lights appears in the multifunction display.

Switch off the parking lamps or the rear fog lamp manually.

! Failure to switch off the parking lamps when leaving the vehicle may result in a discharged battery.

Low-beam headlamps

The low-beam headlamps can be switched on and off with the exterior lamp switch.

- ▶ Switch on the ignition.
- ▶ **Switching on:** Turn the exterior lamp switch to position **☷**.
The following lamps come on:
 - Low-beam headlamps
 - Tail lamps
 - Parking lamps

- License plate lamps
- Side marker lamps
- Instrument panel lamps
- Green indicator lamp **☷** in the instrument cluster

▶ **Switching off:** Turn the exterior lamp switch to position **0**.

Automatic headlamp mode

The following lamps come on and go out automatically depending on the brightness of the ambient light:



- Low-beam headlamps
- Tail lamps
- Parking lamps
- License plate lamps
- Side marker lamps

Warning!

If the exterior lamp switch is set to **A**, the headlamps will not automatically come on under foggy conditions.

To minimize risk to you and to others, activate headlamps by turning exterior lamp switch to **☷** when driving or when

traffic and/or ambient lighting conditions require you to do so.

In low ambient lighting conditions, only switch from position **A** to  with the vehicle at a standstill in a safe location. Switching from **A** to  will briefly switch off the headlamps. Doing so while driving in low ambient lighting conditions may result in an accident.

The automatic headlamp feature is only an aid to the driver. The driver is responsible for the operation of the vehicle's lights at all times.

- ▶ **Switching on:** Turn the exterior lamp switch to position **A**.
With the SmartKey in starter switch position **1** or the KEYLESS-GO start/stop button (Canada only) pressed once, the tail and parking lamps, the license plate lamps and the side marker lamps will come on and go out depending on the brightness of the ambient light.
When the engine is running the low-beam headlamps, the tail and parking lamps, the license plate lamps and the side marker lamps will come on and go out depending on the brightness of the ambient light.

Canada only: High-beam headlamps are only available in low ambient lighting conditions.

Daytime running lamp mode



In Canada, the daytime running lamp mode is mandatory and therefore in a constant mode. In the USA, the daytime running lamp mode is deactivated by default. Activate the daytime running lamp mode using the control system, see "Setting daytime running lamp mode (USA only)" (▷ page 148).

- ▶ Turn the exterior lamp switch to position **0** or **A**.
When the engine is running, the low-beam headlamps come on.
In low ambient lighting conditions, the following lamps will come on additionally:
 - Tail lamps
 - Parking lamps
 - License plate lamps
 - Side marker lamps

With the daytime running lamp mode activated and the engine running, you cannot switch off the low-beam headlamps manually.

Canada only

You can only switch on the high-beam headlamps in low ambient lighting conditions. The high-beam flasher is available at all times. When the engine is running, and you

- shift from a driving position to park position **P** with the vehicle at a standstill (vehicles with automatic transmission) or the parking brake is engaged, the low-beam headlamps will go out with a delay of 3 minutes
- turn the exterior lamp switch to position , the low-beam headlamps, the tail and parking lamps, the license plate lamps and the side marker lamps come on
- turn the exterior lamp switch to position , the manual headlamp mode has priority over the daytime running lamp mode
The corresponding exterior lamps come on (▷ page 100).

USA only

You can only switch on the high-beam headlamps in low ambient lighting conditions. The high-beam flasher is available at all times. When the engine is running, and you turn the exterior lamp switch to position  or



Lighting

 , the manual headlamp mode has priority over the daytime running lamp mode. The corresponding exterior lamps come on (\triangleright page 100).

Fog lamps





Fog lamps cannot be switched on with the exterior lamp switch in position **A** . To switch on the fog lamps, turn the exterior lamp switch to position  first.

Warning!

In low ambient lighting or foggy conditions, only switch from position **A** to  with the vehicle at a standstill in a safe location.

Switching from **A** to  will briefly switch off the headlamps. Doing so while driving in low ambient lighting conditions may result in an accident.

Fog lamps will operate with the parking lamps and/or the low-beam headlamps on. Fog lamps should only be used in conjunction with low-beam headlamps. Consult your State or Province Motor Vehicle Regulations regarding permissible lamp operation.

- \triangleright Switch on the ignition.
- \triangleright Turn the exterior lamp switch to position  or  (\triangleright page 100).
- \triangleright **Switching on front fog lamps:** Pull out the exterior lamp switch to first stop. The green indicator lamp  in the exterior lamp switch comes on.
- \triangleright **Switching on rear fog lamp:** Pull out the exterior lamp switch to second stop. The rear fog lamp, the front fog lamps and the yellow indicator lamp  in the exterior lamp switch come on.
- \triangleright **Switching off front fog lamps/rear fog lamp:** Push in the exterior lamp switch to its stop.

Locator lighting and night security illumination



Locator lighting and night security illumination are described in the “Control system” section, see “Setting locator lighting and night security illumination (Headlamps delayed shut-off feature)” (\triangleright page 149).

Combination switch



- ① High beam
- ② High-beam flasher

High beam

- \triangleright Turn the exterior lamp switch to position  (\triangleright page 100).
- \triangleright **Switching on:** Push the combination switch in direction of arrow ①. The high-beam headlamp indicator lamp  in the instrument cluster comes on.
- \triangleright **Switching off:** Pull the combination switch in direction of arrow ② to its original position.



High-beam flasher

- ▶ **Switching on:** Pull the combination switch briefly in direction of arrow ②.

Turn signals



- ① Turn signals, right
- ② Turn signals, left

- ▶ Press the combination switch in direction of arrow ① or ②. The corresponding turn signal indicator lamp  or  in the instrument cluster flashes.

The combination switch resets automatically after major steering wheel movements.

- i** To signal minor directional changes such as changing lanes, press combination

switch only to point of resistance and release. The corresponding turn signal lamps will flash three times.

Hazard warning flasher

The hazard warning flasher can be switched on at all times, even with the SmartKey removed from the starter switch.

The hazard warning flasher comes on automatically when an air bag deploys.



- ① Hazard warning flasher switch

- ▶ **Switching on:** Press hazard warning flasher switch ①. All turn signal lamps are flashing.

- i** With the hazard warning flasher activated and the combination switch set for either

left or right turn, only the respective left or right turn signals will operate when the ignition is switched on.

- ▶ **Switching off:** Press hazard warning flasher switch ① again.

- i** If the hazard warning flasher was activated automatically, press hazard warning flasher switch ① twice to switch off the hazard warning flasher. The hazard warning flasher is switched off automatically at vehicle speeds of approximately 6 mph (10 km/h) or higher.

Headlamp cleaning system

The headlamps will be cleaned with a high-pressure water jet automatically when the engine is running and you have

- switched on the headlamps and
- the windshield wipers have wiped the windshield with washer fluid for the first time

The headlamps are cleaned every tenth time the windshield is washed with washer fluid.

When you switch off the headlamps or the ignition, the automatic function is reset and



Lighting

will start counting the next time from the beginning.

For information on filling up the washer reservoir, see “Washer system and headlamp cleaning system” (▷ page 259).

Corner-illuminating front fog lamps

The corner-illuminating front fog lamps improve illumination of the area in the direction into which you are turning.

The corner-illuminating front fog lamps will only operate

- in low ambient lighting conditions
- at vehicle speeds below 25 mph (40 km/h)
- with the front fog lamps switched off
- with the engine is running

Switching on

- ▶ Turn the exterior lamp switch to position  or **A**.

or

- ▶ Activate the daytime running lamp mode (▷ page 101).

- ▶ Switch on the left or right turn signal, depending on whether you are turning left or right. The respective front fog lamp comes on. If you have switched on the turn signal for one side but turn the steering wheel in the other direction, the corner-illuminating front fog lamp comes on on the side of the turn signal.

or

- ▶ Turn steering wheel in the desired direction. Driving forward: The front fog lamp on the side of your steering direction comes on. Driving in reverse: The front fog lamp opposite to your steering direction comes on.

The corner-illuminating front fog lamps will come on automatically depending on the steering angle, even if you did not switch on either turn signal. If the corner-illuminating front fog lamps came on automatically, they will also go out automatically depending on the steering angle and vehicle speed.

The corner-illuminating front fog lamps temporarily come on on both sides of the vehicle if you turn the steering wheel in one direction and then again in the other direction shortly thereafter.

The corner-illuminating front fog lamp remains lit for a maximum of 3 minutes. Afterward, it goes out even if the turn signal is still switched on.

Switching off

- ▶ Switch off the left or right turn signal.
- or
- ▶ Steer straight ahead.

i There may be a brief delay before the corner-illuminating front fog lamps go out.

Interior lighting in the front

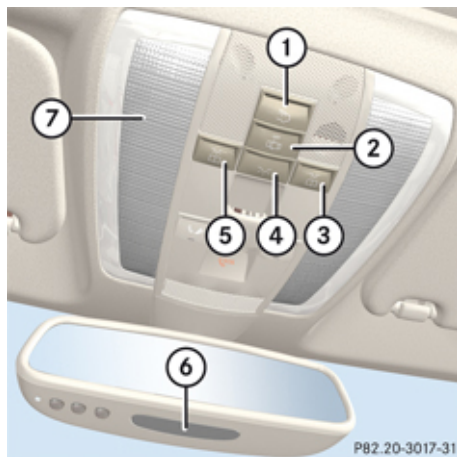

- ① Rear interior lighting on/off
- ② Automatic control on/off
- ③ Right front reading lamp on/off
- ④ Front interior lighting on/off
- ⑤ Left front reading lamp on/off
- ⑥ Front reading lamps
- ⑦ Front interior lighting

Automatic control

- ▶ **Activating:** Press button .
Button disengages and sits flush with the other buttons.
The interior lighting comes on in darkness, when you:
 - unlock the vehicle
 - remove the SmartKey from the starter switch
 - open a door

- ▶ **Deactivating:** Press button .
Button engages.

The interior lighting goes out after a preset time (▷ page 150).

- ❗ If a door remains open, the interior lamps go out automatically after approximately 5 minutes.

Manual control

- ❗ An interior lamp switched on manually does not go out automatically.
Leaving an interior lamp switch in the ON position for extended periods of time with the engine turned off could result in a discharged battery.

- ▶ **Switching on/off front interior lighting:** Press switch .
- ▶ **Switching on/off rear interior lighting:** Press switch .
- ▶ **Switching on/off front reading lamps:** Press respective button .

Emergency lighting

When the interior lighting is set to automatic mode, the interior lighting is activated automatically if the vehicle is involved in an accident.

- ▶ **Switching off:** Press button .
- or
- ▶ Press hazard warning flasher switch (▷ page 103).

Wipers





Interior lighting in the rear

! An interior lamp switched on manually does not go out automatically.

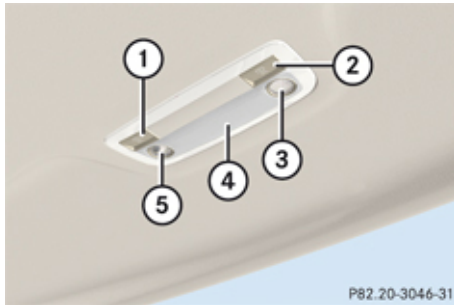
Leaving an interior lamp switch in the ON position for extended periods of time with the engine turned off could result in a discharged battery.

The overhead control panel is located above the rear seat bench.



- ①  Right rear reading lamp on/off
- ②  Left rear reading lamp on/off
- ③  Left reading lamp
- ④  Rear interior lamp
- ⑤  Right reading lamp

▶ Switching on/off rear reading lamps:

Press respective reading lamp switch



Wipers

Notes

! Do not operate the wipers when the windshield is dry. Dust that accumulates on a windshield might scratch the glass and/or damage the wiper blades when wiping occurs on a dry windshield. If it is necessary to operate the wipers in dry weather conditions, always operate the wipers with washer fluid.

! If the windshield wipers leave smears on the windshield after the car has been driven through an automatic car wash, then wax or other residue is on the windshield. Shortly after washing the car in an automatic car wash, clean the windshield with washer fluid.

Wipers



Combination switch

- ① Single wipe
Wiping with washer fluid
- ② Switching on windshield wipers

► Switch on the ignition.

Windshield wipers

Switching on/off

0	Windshield wipers off
...	Slow intermittent wiping Rain sensor operation with low sensitivity.
....	Fast intermittent wiping Rain sensor operation with high sensitivity.
—	Slow continuous wiping
≡	Fast continuous wiping

► Turn the combination switch in direction of arrow ② to the desired position, depending on the intensity of the rain.

i When the windshield wipers are switched on and you brake the vehicle to a stop, the wipers operate more slowly.

Intermittent wiping

! Vehicles with rain sensor: Do not leave windshield wipers on an intermittent setting when the vehicle is taken to an automatic car wash or during windshield

cleaning. Windshield wipers will operate in the presence of water sprayed on the windshield, and windshield wipers may be damaged as a result.

! Vehicles with rain sensor: If you have set intermittent wiping, dirt on the surface of the rain sensor or optical effects may cause the windshield wipers to wipe in an undesired fashion. This could then damage the windshield wiper blades or scratch the windshield. You should therefore switch off the windshield wipers when weather conditions are dry.

Vehicles with rain sensor: Intermittent wiping interval is dependent on wetness of windshield. After the initial wipe, pauses between wipes are controlled by the rain sensor automatically.

► Turn the combination switch to position **...** or **....**.
Intermittent wiping starts with selected wiping interval.

Intermittent wiping is interrupted when the vehicle is at a standstill and a front door is opened. This protects persons getting into or out of the vehicle from being sprayed.

Intermittent wiping will be continued when all doors are closed and



Wipers

- the clutch pedal is depressed (vehicles with manual transmission)
or
- the automatic transmission is in drive position **D** or reverse gear **R** (vehicles with automatic transmission)
or
- the wiper setting is changed using the combination switch

Single wipe

- ▶ Press the combination switch briefly in direction of arrow ① to the resistance point.
The windshield wipers wipe one time without washer fluid.

Wiping with washer fluid

- ▶ Press the combination switch in direction of arrow ① past the resistance point.
The windshield wipers operate with washer fluid.
- i** To prevent smears on the windshield or noisy/chattering wiper blades, wipe with washer fluid every now and then even when it is raining.

For information on filling up the washer reservoir, see “Washer system and headlamp cleaning system” (▷ page 259).

For information on cleaning the headlamps with washer fluid, see “Headlamp cleaning system” (▷ page 103).

Problems with wipers

! If anything blocks the windshield wipers (leaves, snow, etc.), switch them off immediately.

For safety reasons, stop the vehicle in a safe location, and

- - remove the SmartKey from the starter switch
or
- turn off the engine by pressing the KEYLESS-GO start/stop button and open the driver’s door (with the driver’s door open, starter switch is in position **0**, same as with SmartKey removed from starter switch)
- engage the parking brake

before attempting to remove any blockage.

- Remove blockage.
- Turn the windshield wipers on again.

If the windshield wipers fail to function at all with the combination switch in position

... or **....**,

- set the combination switch to the next higher wiper speed
- have the windshield wipers checked at the nearest authorized Mercedes-Benz Center

Power windows

Power windows

Opening and closing

The door windows are opened and closed electrically. The switches for all door windows are located on the driver's door control panel. The switches for the respective door windows are located on the front passenger door and on the rear doors.

- i** Operating the rear door windows from the rear is not possible when you activate the override switch (▷ page 65).

⚠ Warning!

When opening or closing the door windows, make sure there is no danger of anyone being harmed by the opening/closing procedure.

The door windows are equipped with the express operation and automatic reversal function. If in express operation mode a door window encounters an obstruction that blocks its path, the automatic reversal function will stop the door window and open it slightly.

The door windows operate differently when the switch is pressed and held. See the

“Closing when a door window is blocked” section in this chapter for details.

The closing of the door windows can be immediately halted by releasing the switch or, if the switch was pulled past the resistance point and released, by either pressing or pulling the respective switch. If a door window encounters an obstruction that blocks its path in a circumstance where you are closing the door windows by pressing and holding button  on the SmartKey or by pressing and holding the sensor surface (vehicles with KEYLESS-GO) on an outside door handle, the automatic reversal function will not operate.

Activate the override switch when children are riding in the back seats of the vehicle. The children may otherwise injure themselves, e.g. by becoming trapped in the door window opening.

⚠ Observe Safety notes, see page 59.

⚠ Warning!

Do not keep any part of your body up against the window pane when opening a window. The downward motion of the pane may pull that part of your body down

between the window pane and the door frame and trap it there. If there is a risk of entrapment, release the switch and pull it to close the window.

- i** You can also open or close the door windows using the SmartKey, see “Summer opening feature” (▷ page 111) and “Convenience closing feature” (▷ page 111).
- i** After switching off the ignition or removing the SmartKey from the starter switch, you can operate the door windows until you open the driver's or front passenger door. If no door was opened you can operate the door windows for up to 5 minutes.

Power windows

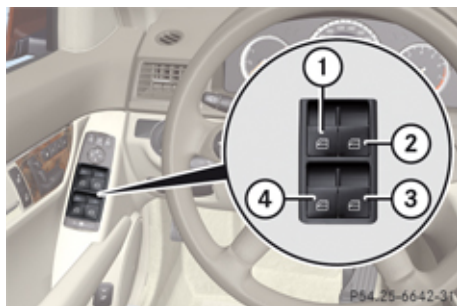

- ① Left front door window
- ② Right front door window
- ③ Right rear door window
- ④ Left rear door window

► Switch on the ignition.

► **Opening/Closing:** Press or pull and hold switch ① to ④ to the resistance point. The corresponding door window will move downwards or upwards until you release the switch.

- **Express operation:** Press or pull switch ① to ④ past the resistance point and release. The corresponding door window opens or closes completely.
- **Stopping during express operation:** Press or pull the respective switch again.

Closing when a door window is blocked

Warning!

Make sure that nobody can become trapped and be seriously or even fatally injured when closing a door window with greater force or without automatic reversal function.

If the upward movement of a door window is blocked during the closing procedure, the door window will stop and open slightly. However, the door window will exert greater force before reversing than when the door window is closed in express operation. Please exercise caution!

- Immediately after the door window has stopped because it was blocked, pull the respective switch upwards until the door window is fully closed.

If the door window is blocked again and opens slightly:

- Immediately after the door window was blocked, pull the respective switch upwards until the door window is fully closed.

Warning!

Pressing and holding the switch to close the door window immediately after it had been blocked two times will cause the door window to close without any reversal function for as long as you hold the switch.

Synchronizing door windows

The door windows must be synchronized if they cannot be fully closed (express operation).

Each door window must be synchronized separately.

- Close all doors.
- Switch on the ignition.
- Pull and hold switch ①, ②, ③ or ④ (> page 110) until the respective door window is closed. The door window opens again slightly.

Power windows

- ▶ Pull and hold the respective switch once more immediately until the door window is completely closed.
- ▶ Hold the respective switch for approximately 1 second. The door window is synchronized.

Summer opening feature

If the weather is warm, you can ventilate the vehicle before driving off by simultaneously:

- opening the door windows
- opening the tilt/sliding sunroof
- opening the panorama roof and roller sunblinds

The summer opening feature can only be activated via the remote control of the SmartKey. The SmartKey must be in close proximity to the driver's outside door handle.

- ▶ Aim transmitter eye of the SmartKey at the driver's outside door handle.

Vehicles with tilt/sliding sunroof

- ▶ Press and hold button  on the SmartKey until the door windows and the



tilt/sliding sunroof have reached the desired position.

The vehicle unlocks.



- ▶ Release button  on the SmartKey to interrupt the opening procedure.

Vehicles with panorama roof

When roller sunblinds are extended:

- ▶ Press and hold button  on the SmartKey. The vehicle unlocks. The door windows open and the roller sunblinds begin to retract after approximately 1 second.
- ▶ With the door windows opened and the roller sunblinds fully retracted, press and hold button  on the SmartKey again. The tilt/sliding panel opens.
- ▶ Release button  on the SmartKey to interrupt the opening procedure.

When roller sunblinds are retracted:

- ▶ Press and hold button  on the SmartKey. The door windows and the tilt/sliding panel opens after approximately 1 second.
- ▶ Release button  on the SmartKey to interrupt the opening procedure.

Convenience closing feature

When locking the vehicle, you can simultaneously close

- the door windows
- the tilt/sliding sunroof
- the panorama roof



Afterward, you can extend the roller sunblinds of the panorama roof.

Warning!

When closing the door windows and the tilt/sliding sunroof or panorama roof, make sure there is no danger of anyone being harmed by the closing procedure.

Power windows

If potential danger exists, proceed as follows:

- Release button  to stop the closing procedure. To open, press and hold button . To continue the closing procedure after making sure that there is no danger of anyone being harmed by the closing procedure, press and hold button .

Vehicles with KEYLESS-GO:



- Release the sensor surface on the outside door handle to stop the closing procedure.
- Immediately pull on the same outside door handle and hold firmly. The door windows and the tilt/sliding sunroof or panorama roof will open for as long as the door handle is held but the door not opened.

With SmartKey

The SmartKey must be in close proximity to the driver's outside door handle.

- ▶ Aim transmitter eye of the SmartKey at the driver's outside door handle.
- ▶ Press and hold button  on the SmartKey until the door windows and the

tilt/sliding sunroof or panorama roof are completely closed.

- ▶ Release button  on the SmartKey to interrupt the closing procedure.
- ▶ **Vehicles with panorama roof:** Press and hold button  on the SmartKey once more. The roller sunblinds extend.
- ▶ Release button  on the SmartKey to interrupt the extending procedure.

With KEYLESS-GO

The KEYLESS-GO feature is available on Canada vehicles only.

The SmartKey with KEYLESS-GO must be located outside the vehicle within approximately 3 ft (1 m) of a door.

- ▶ Close all doors.
- ▶ Touch and hold the sensor surface on an outside door handle (▶ page 77) until the door windows and the tilt/sliding sunroof or panorama roof are completely closed.

-  Make sure you are only touching the sensor surface.
- ▶ Release the sensor surface to interrupt the closing procedure.

- ▶ **Vehicles with panorama roof:** Touch and hold the sensor surface once more. The roller sunblinds extend.
- ▶ Release the sensor surface to interrupt the extending procedure.

Driving and parking

Safety notes

⚠ Warning!

Make sure absolutely no objects are obstructing the pedals' range of movement. Keep the driver's footwell clear of all obstacles. If there are any floor mats or carpets in the footwell, make sure the pedals still have sufficient clearance. During sudden driving or braking maneuvers the objects could get caught between the pedals. You could then no longer brake or accelerate. This could lead to accidents and injury.

⚠ Warning!

With the engine not running, there is no power assistance for the brake and steering systems. In this case, it is important to keep in mind that a considerably higher degree of effort is necessary to brake and steer the vehicle. Adapt your driving accordingly.

Starting the engine

⚠ Warning!

Inhalation of exhaust gas is hazardous to your health. All exhaust gas contains carbon monoxide (CO), and inhaling it can cause unconsciousness and possible death.

Do not run the engine in confined areas (such as a garage) which are not properly ventilated. If you think that exhaust gas fumes are entering the vehicle while driving, have the cause determined and corrected immediately. If you must drive under these conditions, drive only with at least one window fully open at all times.

Manual transmission

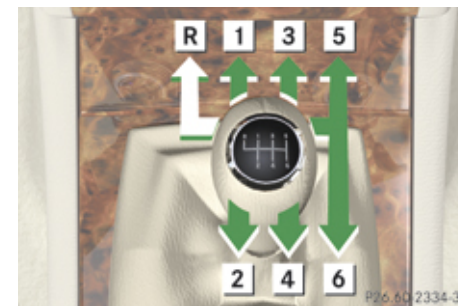

Gearshift pattern for manual transmission

- R** Reverse gear
- 1** to **6** Forward gears

For more information, see “Manual transmission” (> page 119).

- ▶ Depress the brake pedal.
- ▶ Make sure the manual transmission is in the neutral position (no gear selected).
- ▶ Fully depress the clutch pedal. Otherwise the engine cannot be started due to the integrated safety interlock.
- ▶ Do not depress the accelerator pedal.
- ▶ Turn the SmartKey in the starter switch to position **3** (> page 84) and hold until the engine starts.

Driving and parking

Automatic transmission



Gearshift pattern for automatic transmission

- P** Park position with gear selector lever lock
- R** Reverse gear
- N** Neutral position
- D** Drive position

For more information, see “Automatic transmission” (▷ page 121).

- ▶ Make sure the automatic transmission is in park position **P**.

With SmartKey

- ▶ Do not depress the accelerator pedal.
- ▶ Turn the SmartKey in the starter switch to position **3** (▷ page 84) and release it. The engine starts automatically.

With KEYLESS-GO

The KEYLESS-GO feature is available on Canada vehicles only.

Warning!

As long as the SmartKey is in your vehicle, the vehicle can be started. Therefore, never leave children unattended in the vehicle, as they could otherwise accidentally start the engine.

When leaving the vehicle, always take the SmartKey with you and lock the vehicle. Do not leave children unattended in the vehicle, or with access to an unlocked vehicle. A child's unsupervised access to a vehicle could result in an accident and/or serious personal injury.

You can start your vehicle without the SmartKey in the starter switch using the KEYLESS-GO start/stop button in the starter switch.

The SmartKey must be located in the vehicle.



KEYLESS-GO start/stop button

- ▶ Make sure the KEYLESS-GO start/stop button is inserted in the starter switch.
- i** If you wish to start the engine with the SmartKey instead of the KEYLESS-GO function, remove the KEYLESS-GO start/stop button from the starter switch and proceed as described in “With SmartKey” (▷ page 114).
- ▶ Depress the brake pedal during the starting procedure.
- ▶ Do not depress the accelerator pedal.
- ▶ Press the KEYLESS-GO start/stop button once. The engine starts automatically.

Starting difficulties

- ❗ Remember that extended starting attempts can drain the battery.

The engine does not start. You can hear the starter.

There could be a malfunction in the engine electronics or in the fuel supply system.

Carry out the following steps:

- ▶ If you are starting the engine with the SmartKey: Turn the SmartKey in the starter switch to position **0** and repeat the starting procedure.
- ▶ If you are starting the engine with KEYLESS-GO: Close any doors that may be open to allow for better detection of the SmartKey.

or

- ▶ Remove the KEYLESS-GO start/stop button from the starter switch.
- ▶ Start the engine with the SmartKey as radio signals from another source may be interfering with the KEYLESS-GO function.
- ▶ Repeat the starting procedure.

If the engine does not start after several starting attempts:

- ▶ Contact an authorized Mercedes-Benz Center or call Roadside Assistance.

The engine does not start. You cannot hear the starter.

The battery may not be sufficiently charged.

- ▶ Get a jump start (▷ page 366).

If the engine will not start despite a jump start:

- ▶ Contact an authorized Mercedes-Benz Center or call Roadside Assistance.

The starter has been exposed to excessive temperatures.

- ▶ Let the starter cool for about 2 minutes.
- ▶ Repeat the starting procedure.

If the engine does not start after several starting attempts:

- ▶ Contact an authorized Mercedes-Benz Center or call Roadside Assistance.

Driving off

⚠ Warning!

On slippery road surfaces, never downshift in order to obtain braking action. This could result in drive wheel slip and reduced vehicle control. Your vehicle's ABS will not prevent this type of loss of control.

- ❗ Do not run cold engine at high engine speeds. Running a cold engine at high engine speeds may shorten the service life of the engine. This is not covered by the Mercedes-Benz Limited Warranty.

C 63 AMG: At engine temperatures below 68°F (20°C), the engine's maximum speed is restricted in order to protect it from damage. Avoid driving your vehicle at full speed when the engine is cold to prevent premature engine wear and/or diminished comfort.

- ❗ If an acoustic warning sounds and the message **Release Parking Brake** appears in the multifunction display when driving off, you have forgotten to release the parking brake.
Release the parking brake.

Driving and parking

! Avoid spinning of a drive wheel. This may cause serious damage to the drivetrain which is not covered by the Mercedes-Benz Limited Warranty.

! Simultaneously depressing the accelerator pedal and applying the brakes reduces engine performance and causes premature brake and drivetrain wear which is not covered by the Mercedes-Benz Limited Warranty.

i Once the vehicle is in motion, the automatic central locking system engages and the locking knobs in the doors move down.

The automatic door lock feature can be deactivated (> page 150).

Manual transmission

- ▶ Depress the brake pedal.
- ▶ Fully depress the clutch pedal.

! Only shift the manual transmission into reverse gear **R** when the vehicle is stopped. Otherwise the manual transmission could be damaged.

- ▶ Shift the manual transmission into **1st** gear or reverse gear **R**.
- ▶ Release the brake pedal.
- ▶ If engaged, release the parking brake.
- ▶ Simultaneously slowly release the clutch pedal and carefully depress the accelerator pedal.

! Avoid driving at excessive engine speeds. This may result in serious engine damage that is not covered by the Mercedes-Benz Limited Warranty.
Shift gear in a timely manner.

For more information on driving, see “Driving instructions” (> page 286).

Automatic transmission

⚠ Warning!

It is dangerous to shift the automatic transmission out of park position **P** or neutral position **N** if the engine speed is higher than idle speed. If your foot is not firmly on the brake pedal, the vehicle could accelerate quickly forward or in reverse. You could lose control of the vehicle and hit someone or something. Only shift into gear when the engine is idling normally and

when your right foot is firmly on the brake pedal.

! Only shift the automatic transmission into reverse gear **R** or park position **P** when the vehicle is stopped. Otherwise the automatic transmission could be damaged.

- ▶ Depress the brake pedal. The gear selector lever lock is released.
- ▶ Shift the automatic transmission into drive position **D** or reverse gear **R**.

i Shifting the automatic transmission out of park position **P** is only possible with the brake pedal depressed.

Only depressing the brake pedal releases the gear selector lever lock.

- ▶ Wait for the gear selection process to complete before setting the vehicle in motion.
- ▶ Release the brake pedal.
- ▶ If engaged, release the parking brake.
- ▶ Carefully depress the accelerator pedal.

After a cold start, the automatic transmission shifts at a higher engine revolution. This allows the catalytic converter to reach its operating temperature earlier.

For more information on driving, see “Driving instructions” (▷ page 286).

Problems while driving

The engine runs erratically and misfires

- An ignition cable may be damaged.
 - The engine electronics may not be operating properly.
 - Unburned gasoline may have entered the catalytic converter and damaged it.
- ▶ Give very little gas.
 - ▶ Have the problem checked at an authorized Mercedes-Benz Center as soon as possible.

The coolant temperature is above 248°F (120°C)

The coolant is too hot and is no longer cooling the engine.

- ▶ Stop the vehicle in a safe location as soon as possible.
- ▶ Turn off the engine immediately.
- ▶ Allow the engine and coolant to cool off.
- ▶ Check the coolant level and add coolant if necessary (▷ page 258).

In case of accident

If the vehicle is leaking fuel:

- ▶ Do not start the engine under any circumstances.
- ▶ Exit the vehicle at a safe distance from the roadway.
- ▶ Notify local fire and/or police authorities.

If the extent of the damage cannot be determined:

- ▶ Contact an authorized Mercedes-Benz Center or call Roadside Assistance.

If no damage on major assemblies, fuel system, and engine mount can be determined:

- ▶ Start the engine in the usual manner.

Parking

Warning!

Do not park this vehicle in areas where combustible materials such as grass, hay or leaves can come into contact with the hot exhaust system, as these materials could be ignited and cause a vehicle fire.

To reduce the risk of serious personal injury, or damage to the vehicle or the vehicle drivetrain, as a result of vehicle movement, always do the following before turning off the engine and leaving the vehicle:

- Keep right foot on the brake pedal.
- Engage the parking brake.
- Manual transmission: Shift the manual transmission into **1st** gear or reverse gear **R**.
- Automatic transmission: Shift the automatic transmission into park position **P**.
- Slowly release the brake pedal.
- When parked on an incline, always turn the front wheels towards the road curb.

Driving and parking

- Turn the SmartKey in the starter switch to position **0** and remove the SmartKey from the starter switch, or press the KEYLESS-GO start/stop button.
- Take the SmartKey with you and lock the vehicle when leaving.

Warning!

Manual transmission:

Wait until the vehicle is stationary before removing the SmartKey from the starter switch. The vehicle cannot be steered when the SmartKey is removed from the starter switch.

Parking brake

Warning!

Engaging the parking brake while the vehicle is in motion can cause the rear wheels to lock up. You could lose control of the vehicle and cause an accident. In addition, the vehicle's brake lights do not light up when the parking brake is engaged.

Warning!

When leaving the vehicle, always remove the SmartKey from the starter switch, take it with you, and lock the vehicle. Do not

leave children unattended in the vehicle, or with access to an unlocked vehicle. Children could release the parking brake and/or shift the automatic transmission out of park position **P** (manual transmission: shift into the neutral position), either of which could result in an accident and/or serious personal injury.

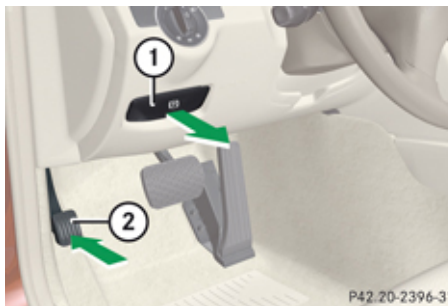

- ① Release handle
- ② Parking brake pedal

- ▶ **Releasing:** Pull on release handle ①. When the ignition is switched on or the engine is running, the brake warning

lamp **BRAKE** (USA only) or  (Canada only) in the instrument cluster goes out.

- ▶ **Engaging:** Step firmly on parking brake pedal ②.

When the engine is running, the brake warning lamp **BRAKE** (USA only) or  (Canada only) in the instrument cluster comes on.

Turning off the engine

Warning!

Do not turn off the engine before the vehicle has come to a complete stop. With the engine not running, there is no power assistance for the brake and steering systems. In this case, it is important to keep in mind that a considerably higher degree of effort is necessary to brake and steer the vehicle.

- ▶ Manual transmission: Shift the manual transmission into **1st** gear or reverse gear **R**.
- ▶ Automatic transmission: Shift the automatic transmission into park position **P**.
- ▶ Engage the parking brake.

Manual transmission

- i** Always engage the parking brake in addition to shifting the automatic transmission into park position **P** (manual transmission: shifting into **1st** gear or reverse gear **R**).

When parked on an incline, also turn the front wheels towards the road curb.

With SmartKey

- ▶ Turn the SmartKey in the starter switch to position **O**.
- ▶ Remove the SmartKey from the starter switch.
The immobilizer is activated.

Automatic transmission: The SmartKey can only be removed from the starter switch with the automatic transmission in park position **P**.

With KEYLESS-GO

The KEYLESS-GO feature is available on Canada vehicles only.

- ▶ Press the KEYLESS-GO start/stop button. With the driver's door closed, the starter switch is now in position **1**. With the driver's door opened, the starter switch is set to position **O**, same as the SmartKey removed from the starter switch (> page 84).

If an acoustic warning sounds, you have tried to turn off the engine with the KEYLESS-GO start/stop button while the automatic transmission was not in park position **P**.

Read and observe messages that may appear in the multifunction display (> page 313).

- i** In an emergency you can turn off the engine while driving by pressing and holding the KEYLESS-GO start/stop button for approximately 3 seconds.

If you have started the engine with the KEYLESS-GO start/stop button and cannot turn it off as described above:

- ▶ Remove the KEYLESS-GO start/stop button from the starter switch.
- ▶ Insert the SmartKey into the starter switch. The engine turns off. The starter switch is in position **O** (> page 84).

Manual transmission

Introduction

For information on driving with a manual transmission, see “Driving and parking” (> page 113).

Warning!

Make sure absolutely no objects are obstructing the pedals' range of movement. Keep the driver's footwell clear of all obstacles. If there are any floor mats or carpets in the footwell, make sure the pedals still have sufficient clearance.

During sudden driving or braking maneuvers the objects could get caught between the pedals. You could then no longer brake or accelerate. This could lead to accidents and injury.

Warning!

When working on the vehicle, engage the parking brake and shift the manual transmission into **1st** gear or reverse gear **R**. Otherwise the vehicle could roll away which could result in an accident and/or serious personal injury.

- !** Allow engine to warm up under low load use. Do not place full load on the engine



Manual transmission

until the operating temperature has been reached.

Avoid spinning of a drive wheel for an extended period when driving off on slippery road surfaces.

This may cause serious damage to the engine and the drivetrain which is not covered by the Mercedes-Benz Limited Warranty.

Gearshift lever

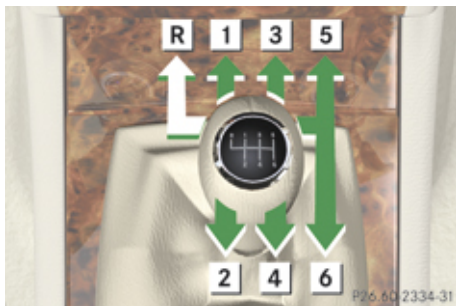

Gearshift pattern for manual transmission

- R** Reverse gear
- 1** to **6** Forward gears

⚠ Warning!

On slippery road surfaces, never downshift in order to obtain braking action. This could result in drive wheel slip and reduced vehicle control. Your vehicle's ABS will not prevent this type of loss of control.

! When you are shifting the manual transmission into the **5th** or **6th** gear, make sure you move the gearshift lever to the right. Otherwise, you could accidentally shift into the **3rd** or **4th** gear and damage the manual transmission.

Downshifting gears leading to overrevving the engine can result in engine damage that is not covered by the Mercedes-Benz Limited Warranty.

Never hold the vehicle stopped on a hill by using the clutch pedal. The clutch may be damaged which is not covered by the Mercedes-Benz Limited Warranty.

! Avoid driving at excessive engine speeds. This may result in serious engine damage that is not covered by the Mercedes-Benz Limited Warranty.
Shift gear in a timely manner.

Shifting into reverse gear R

! Only shift the manual transmission into reverse gear **R** when the vehicle is stopped. Otherwise the manual transmission could be damaged.

- ▶ Stop the vehicle completely.
- ▶ Fully depress the clutch pedal.
- ▶ Shift the manual transmission into the neutral position (no gear selected).
- ▶ Move the gearshift lever to the left until you feel a certain resistance.
- ▶ Push the gearshift lever past this resistance and hold.
- ▶ Move the gearshift lever forward to select reverse gear **R**.

Automatic transmission

Automatic transmission

Introduction

For information on driving with an automatic transmission, see “Driving and parking” (▷ page 113).

Warning!

Make sure absolutely no objects are obstructing the pedals’ range of movement. Keep the driver’s footwell clear of all obstacles. If there are any floor mats or carpets in the footwell, make sure the pedals still have sufficient clearance.

During sudden driving or braking maneuvers the objects could get caught between the pedals. You could then no longer brake or accelerate. This could lead to accidents and injury.

! Allow engine to warm up under low load use. Do not place full load on the engine until the operating temperature has been reached.

Avoid spinning of a drive wheel for an extended period when driving off on slippery road surfaces.

This may cause serious damage to the engine and the drivetrain which is not

covered by the Mercedes-Benz Limited Warranty.

- i** During the brief warm-up, transmission upshifting is delayed. This allows the catalytic converter to heat up more quickly to operating temperature.

Gear selector lever



Gearshift pattern for automatic transmission

- P** Park position with gear selector lever lock
- R** Reverse gear
- N** Neutral position
- D** Drive position

Warning!

It is dangerous to shift the automatic transmission out of park position **P** or neutral position **N** if the engine speed is higher than idle speed. If your foot is not firmly on the brake pedal, the vehicle could accelerate quickly forward or in reverse. You could lose control of the vehicle and hit someone or something. Only shift into gear when the engine is idling normally and when your right foot is firmly on the brake pedal.

! Only shift the automatic transmission into reverse gear **R** or park position **P** when the vehicle is stopped. Otherwise the automatic transmission could be damaged.

i Shifting the automatic transmission out of park position **P** is only possible with the brake pedal depressed.

Only depressing the brake pedal releases the gear selector lever lock.

i The current gear selector lever position corresponds with the current transmission position.

Automatic transmission

The current transmission position **P**, **R**, **N**, or **D** appears in the multifunction display (▷ page 122).

There are additional indicators on the cover of the shifting gate showing the current gear selector lever position.

The indicators come on when you insert the SmartKey into the starter switch, and go out when you remove the SmartKey from the starter switch.

Shifting procedure

The automatic transmission selects individual gears automatically, depending on:

- the selected gear range (▷ page 124)
- the selected program mode:
 - C/S** (▷ page 124)
 - or
 - M** (C 63 AMG only) (▷ page 127)
- the position of the accelerator pedal
- the vehicle speed

With drive position **D** selected, you can influence transmission shifting by:

- limiting the gear range
- extending the gear range
- changing the gears manually (C 63 AMG only)

C 63 AMG:

Double-clutching is active when downshifting in all program modes. Double-clutching reduces load-alteration effects and supports sporty driving. The degree to which you perceive double-clutching acoustically varies depending on the selected program mode.

Transmission positions

The current transmission position appears in the multifunction display.



① Transmission position indicator

Automatic transmission

	Effect
P	<p>Park position</p> <p>Shift the automatic transmission into park position P only when the vehicle is stopped. The park position is not intended to serve as a brake when the vehicle is parked. Rather, the driver should always engage the parking brake in addition to shifting the automatic transmission into park position P to secure the vehicle.</p> <p>The SmartKey can only be removed from the starter switch with the gear selector lever in park position P. With the SmartKey removed from the starter switch, the gear selector lever is locked in park position P.</p> <p>If the vehicle's electrical system is malfunctioning, the gear selector lever could remain locked in park position P. To unlock the gear selector lever manually, see "Manually unlocking the gear selector lever" (> page 352).</p>
R	<p>Reverse gear</p>

	Effect
	<p>Shift the automatic transmission into reverse gear R only when the vehicle is stopped.</p>

	Effect
N	<p>Neutral position</p> <p>No power is transmitted from the engine to the drive axle. When the brakes are released, the vehicle can be moved freely (pushed or towed).</p> <p>To avoid damage to the transmission, never shift the automatic transmission into neutral position N while driving.</p> <p>Exception: If the ESP® is deactivated or malfunctioning, shift the automatic transmission into neutral position N if the vehicle is in danger of skidding.</p> <p>! Coasting the vehicle, or driving for any other reason with the automatic transmission in neutral position N can result in transmission damage that is not covered by the Mercedes-Benz Limited Warranty.</p>
D	<p>Drive position</p>



Automatic transmission

	Effect
	The automatic transmission shifts automatically. All forward gears are available.

Driving tips

Kickdown

Use the kickdown when you want maximum acceleration.

- ▶ Fully depress the accelerator pedal. Depending on the engine speed the automatic transmission shifts into a lower gear.

Canada vehicles and AMG vehicles only:

- ▶ Depress the accelerator pedal past the point of resistance to use the kickdown.

Working on the vehicle

Warning!

When working on the vehicle, engage the parking brake and shift the automatic transmission into park position **P**. Otherwise the vehicle could roll away which

could result in an accident and/or serious personal injury.

Gear ranges

With the automatic transmission in drive position **D** and driving in automatic program mode **C** or **S**, you can limit or extend the gear range, see “One-touch gearshifting” (▷ page 125).

The current gear range appears in the multifunction display.



① Gear range indicator

	Effect
3	With this selection you can use the braking effect of the engine.
2	Allows the use of engine's braking power when driving <ul style="list-style-type: none"> • on steep downgrades • in mountainous regions • under extreme operating conditions
1	For maximum use of engine's braking effect on very steep or lengthy downgrades.

Automatic shift program



Program mode selector switch

Automatic transmission

C Comfort	For comfort driving
S Sport	For standard driving



Program mode selector switch on C 63 AMG

C Comfort	For standard driving
S Sport	For sporty driving
M Manual	For manual gearshifting (▷ page 127)

The current program mode appears in the multifunction display.



① Program mode indicator

You should only change the program mode when the automatic transmission is in park position **P**.

i The last selected program mode (**C** or **S**) is switched on when the engine is restarted.

▶ Press the program mode selector switch repeatedly until the letter of the desired program mode appears in the multifunction display.

Selecting program mode **C** means:

- The vehicle starts out more gentle, both forward and reverse, except when driving off with full throttle.
- Traction and driving stability are improved on icy roads.
- Upshifts occur earlier even when you give more gas. The engine then operates at lower revolutions and the wheels are less likely to spin.

Selecting program mode **S** means that upshifts occur later.

One-touch gearshifting

With the automatic transmission in drive position **D** and driving in automatic program mode **C** or **S**, you can limit or extend the gear range using the gear selector lever or the steering wheel gearshift control.

C 63 AMG: For information on using the gear selector lever or the steering wheel gearshift control in manual program mode **M**, see “Manual shift program” (▷ page 127).

Automatic transmission



Steering wheel gearshift control (example illustration)

- ① Limiting gear range
Downshift (in manual program mode **M**)
- ② Extending gear range
Upshift (in manual program mode **M**)

i You cannot shift with the steering wheel gearshift control when the automatic transmission is in park position **P**, neutral position **N**, or reverse gear **R**.

Limiting gear range

Warning!

On slippery road surfaces, never downshift in order to obtain braking action. This could result in drive wheel slip and reduced

vehicle control. Your vehicle's ABS will not prevent this type of loss of control.

- ▶ Briefly press the gear selector lever to the left in the **D-** direction.

or

- ▶ Briefly pull left gearshift control ①.
The automatic transmission will shift into the next lower gear as permitted by the shift program. This action simultaneously limits the gear range of the automatic transmission.

i To avoid overrevving the engine when downshifting, the automatic transmission will not shift into a lower gear if the engine's maximum speed would be exceeded.

Extending gear range

- ▶ Briefly press the gear selector lever to the right in the **D+** direction.

or

- ▶ Briefly pull right gearshift control ②.
The automatic transmission will shift into the next higher gear as permitted by the shift program. This action simultaneously extends the gear range of the automatic transmission.

i If you press on the accelerator pedal when the engine has reached the revolution limit of the current gear range, the automatic transmission will upshift beyond any gear range limit selected.

Canceling gear range limit

- ▶ Press and hold the gear selector lever to the right in the **D+** direction until the gear range indicator disappears from the multifunction display.

or

- ▶ Pull and hold right gearshift control ② until the gear range indicator disappears from the multifunction display.
The automatic transmission will shift from the current gear range directly into drive position **D**.

Shifting into optimal gear range

- ▶ Press and hold the gear selector lever to the left in the **D-** direction.

or

- ▶ Pull and hold left gearshift control ①.
The automatic transmission will select the gear range suited for optimal acceleration

and deceleration automatically. This will involve shifting down one or more gears.

Manual shift program

The manual shift program is available on C 63 AMG only.

Manual program mode **M** differs with regard to spontaneity, response time, and shifting smoothness from automatic program mode **S**.

In manual program mode **M**, system-controlled automatic gearshifting is switched off. You need to change the gears by manually upshifting or downshifting using the gear selector lever or the steering wheel gearshift control.



Program mode selector switch

C Comfort	For standard driving
S Sport	For sporty driving
M Manual	For manual gearshifting

The current program mode appears in the multifunction display (▷ page 125).

For information on automatic program mode (**C** or **S**), see “Automatic shift program” (▷ page 124) and “One-touch gearshifting” (▷ page 125).

Activating manual shift program

- ▶ Press the program mode selector switch repeatedly until **M** appears in the multifunction display. The automatic transmission switches to manual program mode **M**. Automatic shifting is switched off. The gear range is not limited.

You can change the gears manually with drive position **D** selected. You can upshift or downshift through the gears in succession.

- i** Manual program mode **M** will not be stored. When the engine is turned off with manual program mode **M** selected, the automatic transmission will go to

Automatic transmission

automatic program mode (**C** or **S**) when the engine is restarted.

Upshifting

! In manual program mode **M**, the automatic transmission will not upshift, even if the engine has reached its overrevving range. Shift up into the next gear before the engine has reached its overrevving range. Make absolutely certain that the engine speed does not reach the red marking on the tachometer. Otherwise the engine could be damaged which is not covered by the Mercedes-Benz Limited Warranty.

- ▶ Briefly press the gear selector lever to the right in the **D+** direction.

or

- ▶ Briefly pull right gearshift control ② (▷ page 126).

The automatic transmission shifts into the next higher gear.

Automatic transmission

Upshift indicator



- ① Current gear
- ② Upshift indicator

In manual program mode **M**, upshift indicator ② in the multifunction display advises you to upshift before the engine reaches the overspeed range. Thus you can drive at the maximum engine speed for each gear without overrevving the engine.

- ▶ Shift the automatic transmission from current gear ① into the next higher gear. The fuel supply will otherwise be interrupted to prevent the engine from overrevving.

Downshifting

⚠ Warning!

On slippery road surfaces, never downshift in order to obtain braking action. This could result in drive wheel slip and reduced vehicle control. Your vehicle's ABS will not prevent this type of loss of control.

- ▶ Briefly press the gear selector lever to the left in the **D**-direction.

or

- ▶ Briefly pull left gearshift control ① (▶ page 126).
The automatic transmission shifts into the next lower gear.

i For maximum acceleration, press and hold the gear selector lever to the left in the **D**-direction or pull and hold the left gearshift control. Depending on the engine speed the automatic transmission selects the optimal gear for maximum acceleration.

i When you brake or stop, the automatic transmission shifts down into a gear from which you can easily accelerate or take off.

Kickdown

Using the kickdown when driving in manual program mode **M** is not possible.

Deactivating manual shift program

- ▶ Press the program mode selector switch repeatedly until **C** or **S** appears in the multifunction display.

or

- ▶ Restart the engine.
The automatic transmission will go to automatic program mode (**C** or **S**).

Manual program mode **M** is not stored.

Emergency operation (limp-home mode)

If vehicle acceleration becomes less responsive or sluggish or the automatic transmission no longer shifts, the automatic transmission is most likely operating in limp-home (emergency operation) mode. In this mode only second gear and reverse gear **R** can be selected.

- ▶ Stop the vehicle in a safe location.
- ▶ Shift the automatic transmission into park position **P**.

Instrument cluster

- ▶ Turn off the engine.
- ▶ Wait at least 10 seconds before restarting.
- ▶ Restart the engine.
- ▶ Shift the automatic transmission into drive position **D** (for second gear) or reverse gear **R**.
- ▶ Have the automatic transmission checked at an authorized Mercedes-Benz Center as soon as possible.

Instrument cluster

Introduction

For a full view illustration of the instrument cluster, see “Instrument cluster” (▶ page 30).

⚠ Warning!

No messages will be displayed if either the instrument cluster or the multifunction display is inoperative.

As a result, you will not be able to see information about your driving conditions, such as speed or outside temperature, warning/indicator lamps, malfunction/warning messages or the failure of any systems. Driving characteristics may be impaired.

If you must continue to drive, please do so with added caution. Contact an authorized Mercedes-Benz Center as soon as possible.

The language setting for the multifunction display can be changed with the Audio system (▶ page 166) or with the COMAND system. Vehicles with COMAND system: Refer to separate operating instructions.

Activating the instrument cluster

The instrument cluster is activated when you

- open the driver’s door
- switch on the ignition
- switch on the exterior lamps

Adjusting the instrument cluster illumination



① Dimmer

i The instrument cluster illumination is dimmed or brightened automatically to suit ambient light conditions.

The instrument cluster illumination will also be adjusted automatically when you switch on the vehicle’s exterior lamps.

Instrument cluster

- ▶ **To brighten illumination:** Turn dimmer ① clockwise.
- ▶ **To dim illumination:** Turn dimmer ① counterclockwise.

Coolant temperature gauge

The coolant temperature gauge is located on the left side in the instrument cluster (▷ page 30).

Warning!

Driving when your engine is overheated can cause some fluids which may have leaked into the engine compartment to catch fire. You could be seriously burned.

Steam from an overheated engine can cause serious burns which can occur just by opening the engine hood. Stay away from the engine if you see or hear steam coming from it.

Stop the vehicle in a safe location away from other traffic. Turn off the engine, get out of the vehicle and do not stand near the vehicle until the engine has cooled down.

During severe operating conditions, e.g. stop-and-go traffic, the coolant temperature may rise close to 248°F (120°C), i.e. close to the red zone of the temperature gauge.

 Excessive coolant temperature triggers a warning in the multifunction display.

The engine should not be operated with a coolant temperature above 248°F (120°C), i.e. in the red zone of the coolant temperature gauge. Doing so may cause serious engine damage which is not covered by the Mercedes-Benz Limited Warranty.

Tachometer

The red marking on the tachometer (▷ page 30) denotes excessive engine speed.

 Avoid driving at excessive engine speeds, as it may result in serious engine damage that is not covered by the Mercedes-Benz Limited Warranty.

To help protect the engine, the fuel supply is interrupted if the engine is operated within the red marking.

Outside temperature indicator

The outside temperature indicator is displayed in the multifunction display (▷ page 133).

Warning!

The outside temperature indicator is not designed to serve as an ice-warning device and is therefore unsuitable for that purpose.

Indicated temperatures just above the freezing point do not guarantee that the road surface is free of ice. The road may still be icy, especially in wooded areas or on bridges.

Fuel gauge

The fuel gauge is on the left-hand side of the instrument cluster (▷ page 30). Once the fuel level has fallen below the reserve mark, the yellow fuel tank reserve warning lamp  for the fuel reserve comes on.

Control system

Introduction

The control system is activated as soon as the starter switch is in position **2** (▷ page 84).

The control system enables you to call up information about your vehicle and to change vehicle settings.

For example, you can use the control system to find out when your vehicle is next due for maintenance service, to call up statistical data on your vehicle, and much more.

Warning!

A driver's attention to the road and traffic conditions must always be his/her primary focus when driving.

For your safety and the safety of others, selecting features through the multifunction steering wheel should only be done by the driver when traffic and road conditions permit it to be done safely.







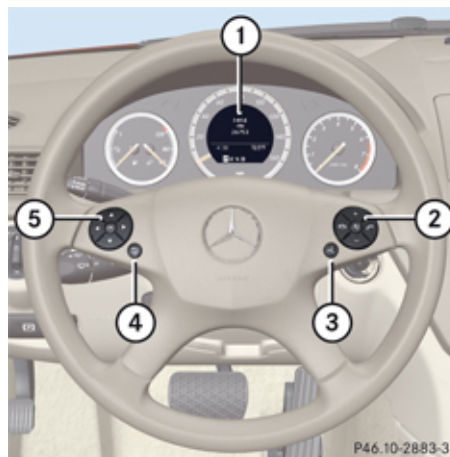

Bear in mind that at a speed of just 30 mph (approximately 50 km/h), your vehicle is covering a distance of 44 feet (approximately 14 m) every second.

The control system relays information to the multifunction display.

Multifunction steering wheel





The displays in the multifunction display and the settings in the control system are controlled by the buttons on the multifunction steering wheel.





①	Multifunction display
②	Press button  to take a call to dial ⁵  to redial ⁵  to end a call to reject an incoming call  to mute Press button  to set the volume  to operate the RACETIMER ⁶
③	Press button  to activate the Voice Control System ⁷
④	Press button briefly  to cancel the Voice Control System, back, confirm messages ⁷
	Press and hold button  to select the standard display

⁵ Function only available in telephone menu.

Control system

⑤	<p>Press button</p> <p> to call up line for menus and to</p> <p> select menus</p>
	<p>Press button briefly</p> <p> to select submenu or scroll</p> <p> through lists</p> <p>within Audio menu to select previous or next track, scene or stored station</p> <p>within Te1 menu to switch to the phone book and select a name or number</p>

<p>Press and hold button</p> <p> within Audio menu to select a track or scene with quick search or to select previous or next station in station list or wave band</p> <p> within Te1 menu to start the quick search in the phone book</p>
<p>Press button</p> <p> to confirm selection or messages</p>

Depending on the selected menu, pressing the buttons on the multifunction steering wheel will alter what appears in the multifunction display.

The information available in the multifunction display is arranged in menus and accompanying functions and submenus.







The individual functions are then found within the relevant menu (radio or CD operations under **Audio**, for example). These functions serve to call up relevant information or to customize the settings for your vehicle.

It is helpful to think of the menus, and the functions within each menu, as being arranged in a circular pattern.

In the **Settings** menu, instead of functions, you will find a number of submenus for calling up and changing settings. For instructions on using these submenus, see “Settings menu” (▷ page 145).

The number of menus available in the system depends on which optional equipment is installed in your vehicle.

Using the control system

- ▶ **To select a menu:** Press button  or .
- ▶ **To select a submenu:** Press button  or .
- ▶ **To go to the next higher menu level:** Press button .
- ▶ **To select the standard display:** Press button  repeatedly until the standard

⁶ AMG vehicles only.

⁷ The Voice Control System is only available with the COMAND system. Refer to separate operating instructions.

Control system

display featuring the odometer and speedometer appears.

or

▶ Press and hold button  until the standard display featuring the odometer and speedometer appears.

▶ **To confirm selection:** Press button .

▶ **To confirm display message:** Press button  or .

The control system saves certain display messages (▷ page 144).

For information about warning and malfunction messages appearing in the multifunction display (▷ page 305).

Multifunction display



- ① Text field
- ② Line for main menus
- ③ Outside temperature indicator

- ④ Automatic transmission program mode indicator
- ⑤ Transmission position/gear range indicator (automatic transmission)
Additional speedometer (manual transmission)
- ⑥ Digital clock

Settings, functions, submenus as well as any malfunctions appear in the text field.

For more information on menus displayed in the multifunction display, see “Menus and submenus” (▷ page 134).

Control system

Menus and submenus

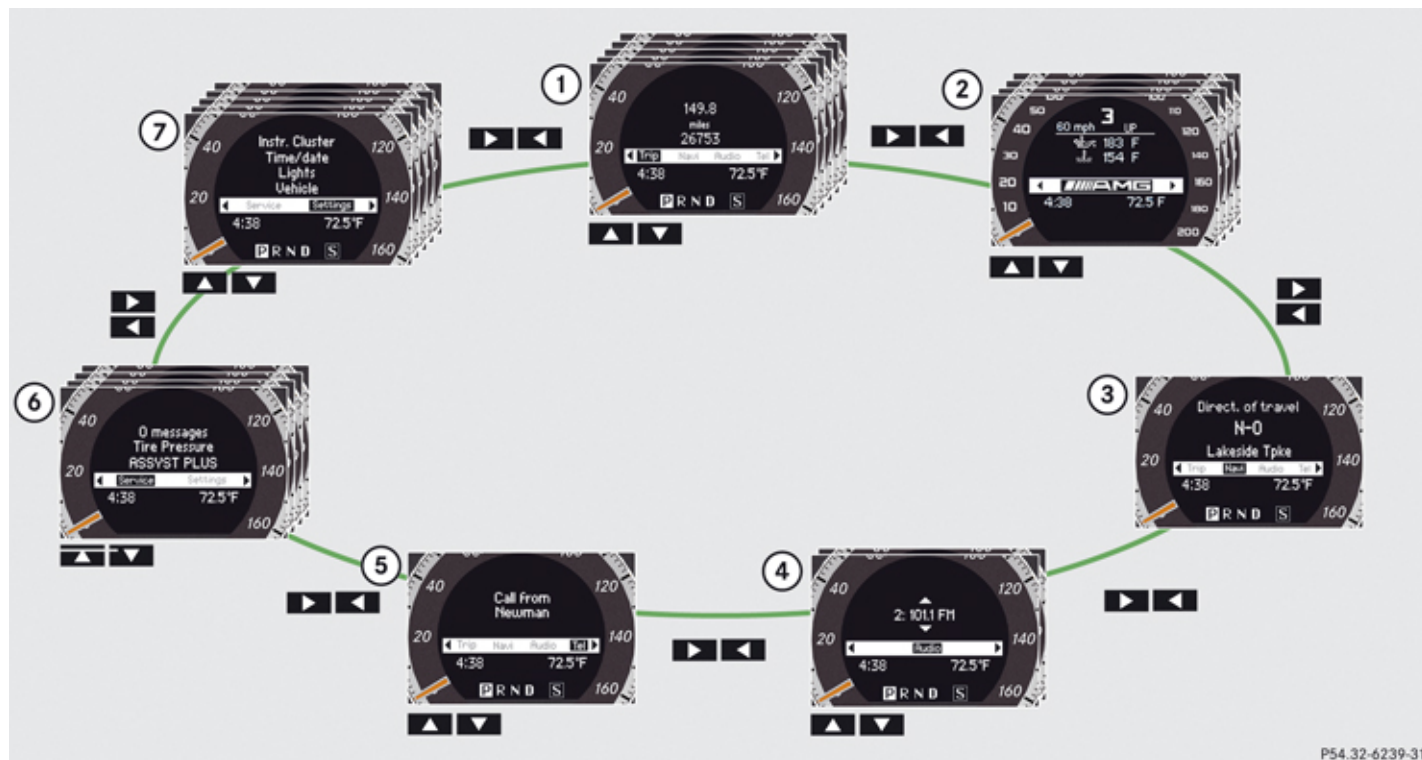

PS4.32-6239-31

	Function
①	Trip menu (▷ page 135)
②	AMG menu (▷ page 137)
③	Navi menu (▷ page 140)
④	Audio menu (▷ page 140)
⑤	Tel menu (▷ page 142)
⑥	Service menu (▷ page 144)
⑦	Settings menu (▷ page 145)

Trip menu

In the Trip menu, you can show an additional display for the speedometer and call up or reset your vehicle's statistical data.

The following information is available:

- Standard display (▷ page 135)
- Fuel consumption statistics since start (▷ page 135)
- Fuel consumption statistics since last reset (▷ page 136)
- Resetting values (▷ page 136)

- Distance to empty and current fuel consumption (▷ page 136)
- Digital Speedometer (▷ page 137)

Standard display

In the standard display, the trip odometer and the main odometer appear in the multifunction display.

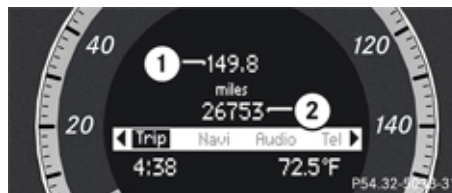

- ① Trip odometer
- ② Main odometer

If another display appears instead of the standard display:

- ▶ Press ◀ or ▶ to select the Trip menu.
- or
- ▶ Press button  repeatedly until the standard display appears.

or

- ▶ Press and hold button  until the standard display appears.

Fuel consumption statistics since start

- ▶ Press ◀ or ▶ to select the Trip menu.
- ▶ Press ▼ or ▲ to select From Start.

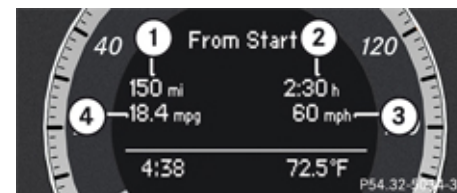

- ① Distance driven since start
- ② Time elapsed since start
- ③ Average speed since start
- ④ Average fuel consumption since start

All statistics stored since the last engine start will be reset approximately 4 hours after the SmartKey in the starter switch is turned to position 0 or removed from the starter switch.

Control system

Resetting will not occur if you turn the SmartKey back to position **1** or **2** within this time period.

Fuel consumption statistics since last reset

- ▶ Press or to select the Trip menu.
- ▶ Press or to select Since Reset.



- ① Distance driven since last reset
- ② Time elapsed since last reset
- ③ Average speed since last reset
- ④ Average fuel consumption since last reset

Resetting values

You can reset the values for the following functions:

- Trip odometer
 - Fuel consumption statistics since start
 - Fuel consumption statistics since last reset
- ▶ Press or to select the Trip menu.
 - ▶ Press or to select the function you wish to reset.
 - ▶ Press .

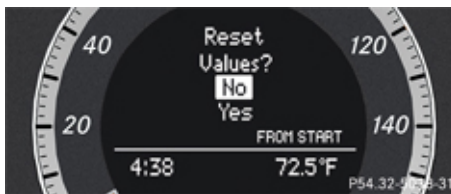

Example illustration: Reset fuel consumption statistics since start

- ▶ Press to select Yes.
- ▶ Press to confirm.

- ① The fuel consumption statistics reset automatically to 0 after 99 999 miles or 9 999 hours, whichever occurs first.

Distance to empty and current fuel consumption



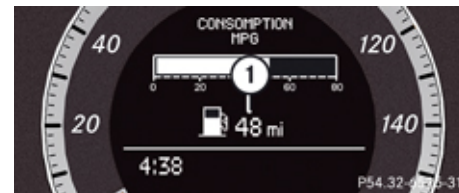

- ▶ Press or to select the Trip menu.
 - ▶ Press or to select the calculated remaining driving range and current fuel consumption display.
- The calculated remaining driving range based on the current fuel tank level and the current driving style appears in the multifunction display.

If only very little fuel is left in the tank, a vehicle at the fuel pump appears instead of the calculated remaining driving range.



- ① Calculated remaining driving range

Digital speedometer

- ▶ Press  or  to select the Trip menu.
- ▶ Press  or  to select the digital speedometer.

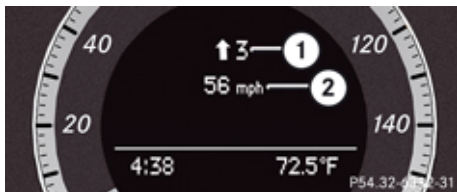

Example illustration for upshift indicator

- ① Upshift indicator⁸
- ② Digital speedometer

The shift indicator is meant as a recommendation for an economical driving style. Always observe traffic conditions, as your driving style is determined in the first instance by the traffic situation.

AMG menu

This function is only available in AMG vehicles.



- ▶ Press button  or  to select the AMG menu.



- ① Digital speedometer
- ② Gear indicator
- ③ Upshift indicator
- ④ Engine oil temperature indicator
- ⑤ Coolant temperature indicator



The engine oil temperature flashes if the engine oil temperature has not yet reached 176°F (80°C). During this time, avoid driving at full engine speed.

The upshift instruction **UP** ③ indicates that the engine has reached the overrevving range. The upshift instruction **UP** blocks other messages in the multifunction display until you have shifted up.

Use buttons  or  to select the following functions in the AMG menu:

- SETUP (▷ page 137)
- RACETIMER (▷ page 138)
- Overall analysis (▷ page 139)
- Lap analysis (▷ page 139)

SETUP

- ▶ Press button  or  to select the AMG menu.
- ▶ Press  to select SETUP.

⁸ Vehicles with manual transmission only

Control system



- ① Automatic transmission program mode indicator
- ② ESP mode indicator

RACETIMER

Warning!

The RACETIMER feature is only for use on roads and in conditions where high speed driving is permitted. Racing on public roads is prohibited under all circumstances and the driver is and must always remain responsible for following posted speed limits.

The RACETIMER allows you to time and save driving stretches.

- ▶ Press button or to select the AMG menu.
- ▶ Press button repeatedly until the RACETIMER appears in the multifunction display.



- ① Digital speedometer
- ② Gear indicator
- ③ RACETIMER
- ④ Lap number

You can start the RACETIMER when the engine is running or the starter switch is in position 2 (▷ page 84).

While the RACETIMER is being displayed, you cannot adjust the audio volume using buttons or .

- ▶ **Starting:** Press button .
- ▶ **Displaying intermediate time:** Press button while the timer is running. The intermediate time is shown for 5 seconds.

- ▶ **Stopping:** Press button .

When you stop the vehicle and turn the SmartKey to position 1 (▷ page 84), the RACETIMER stops timing. Timing is resumed when you switch the ignition back on or restart the engine and then press the button.

Saving lap time and starting a new lap

You can save up to 16 laps.

- ▶ Press button while the timer is running. The intermediate time will be shown for 5 seconds.
- ▶ Press button within 5 seconds. The intermediate time shown will be saved as a lap time. The RACETIMER begins timing the new lap. The new lap begins to be timed as soon as the intermediate time is called up.

Control system



P54.32-6036-31

- ① Gear indicator
- ② RACETIMER
- ③ Best lap time
- ④ Lap number

Resetting current lap

- ▶ Press button **+** while the timer is running.
The timer stops.
- ▶ Press button **-**.
The lap time is reset to “0”.

Deleting all laps

It is not possible to delete a single saved lap.

- ▶ Press button **+** while the timer is running.
The timer stops.
- ▶ Press **OK**.
The reset menu appears in the multifunction display.



P54.32-6037-31

- ▶ Press **▼** to select Yes and confirm with **OK**.
The saved laps are deleted.

Overall analysis

This function is only available if you have saved at least one lap and have stopped the RACETIMER.

- ▶ Press button **◀** or **▶** to select the AMG menu.
- ▶ Press button **▲** repeatedly until the overall analysis appears in the multifunction display.



P54.32-6038-31



- ① Overall analysis of RACETIMER
- ② Overall driving time
- ③ Average speed
- ④ Overall distance driven
- ⑤ Maximum speed

Lap analysis

This function is only available if you have saved at least two laps and have stopped the RACETIMER.





Control system

- ▶ Press button  or  to select the AMG menu.
- ▶ Press button  repeatedly until the lap analysis appears in the multifunction display.

Each lap is shown in its own submenu. The fastest lap is indicated by flashing symbol ①.



- ① Lap number
- ② Lap time
- ③ Average speed during lap
- ④ Lap length
- ⑤ Maximum speed during lap

- ▶ Press button  or  to see other lap analyses.

Navi menu

The Navi menu contains the functions needed to operate your navigation system.

- ▶ Press  or  to select the Navi menu.

The message shown in the multifunction display depends on the status of the navigation system:

- With the COMAND system switched off, the message **Navi Off** appears in the multifunction display.
- With the COMAND system switched on but route guidance not activated, the direction of travel and, if applicable, the name of the street currently traveled on appear in the multifunction display.
- With the COMAND system switched on and route guidance activated, the direction of travel and maneuver instructions appear in the multifunction display.

Please refer to separate COMAND system operating instructions for instructions on how to activate the route guidance system.

Audio menu

The functions in the Audio menu operate the audio equipment which you have currently switched on.

The following functions are available:

- Selecting radio station (▷ page 140)
- Operating audio devices/audio media (▷ page 141)
- Operating video DVD (▷ page 141)

If the audio system or the COMAND system is currently switched off, the message **Audio Off** appears in the multifunction display.

- ▶ **To adjust the volume:** Press  or  on the multifunction steering wheel.

Selecting radio station

The SIRIUS Satellite Radio is treated as a radio application.

Additional optional satellite radio equipment and a subscription to satellite radio service provider are required for satellite radio operation. Contact an authorized Mercedes-Benz Center for details and availability for your vehicle.

Control system

For more information on satellite radio operation, see “Satellite radio” (▷ page 172).

Vehicles with COMAND system:

Refer to separate COMAND system operating instructions.

- ▶ Switch on the audio system (▷ page 162) and select radio mode.

Vehicles with COMAND system:

Refer to separate COMAND system operating instructions.

- ▶ Press ◀ or ▶ to select the Audio menu.

The currently tuned station appears in the multifunction display.

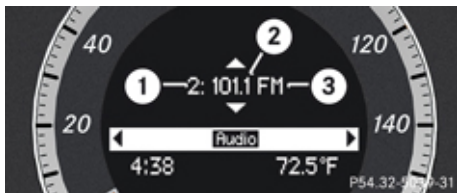

Example illustration for FM radio

- ① Stored memory position
- ② Station frequency
- ③ Wave band setting

- ▶ **Select next or previous stored station:** Press button ▼ or ▲ briefly to select a stored station.

- ▶ **Select next or previous station in wave band:** Press and hold button ▼ or ▲ to select a station.

You can only store new stations using the corresponding feature on the radio (▷ page 167).

Vehicles with COMAND system:

Refer to separate COMAND system operating instructions.

You can also operate the radio in the usual manner.

Operating audio devices/audio media

- ▶ Switch on the radio and select the CD or MP3 mode (▷ page 179).

Vehicles with COMAND system:

Refer to separate COMAND system operating instructions.

- ▶ Press ◀ or ▶ to select the Audio menu. The settings for the currently being played audio device/audio media appear in the multifunction display.

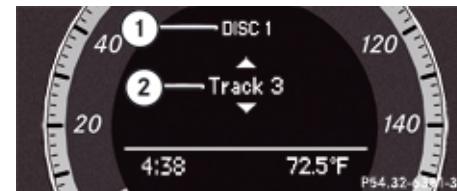

Example illustration

- ① Disc number
- ② Current track

- ▶ **Selecting previous or next track:** Press button ▼ or ▲ briefly.

- ▶ **Selecting a track from the track list (quick search):** Press and hold button ▼ or ▲.

The current track does not appear during Audio AUX mode operation.





Operating video DVD

- ▶ Switch on the COMAND system and select DVD-Video. Refer to separate COMAND system operating instructions.
- ▶ Press ◀ or ▶ to select the Audio menu.

Control system



① Current scene

- ▶ **Selecting previous or next scene:** Press button  or  briefly.
- ▶ **Selecting a scene from the scene list (quick search):** Press and hold button  or .

TEL menu

The functions available in the system and the messages in the multifunction display depend on which optional equipment is installed in your vehicle.

Warning!

A driver's attention to the road must always be his/her primary focus when driving. For your safety and the safety of others, we recommend that you pull over to a safe location and stop before placing or taking a telephone call. If you choose to use the



telephone while driving, please use the hands-free device and only use the telephone when weather, road and traffic conditions permit.

Some jurisdictions prohibit the driver from using a mobile phone while driving a vehicle.

Bear in mind that at a speed of just 30 mph (approximately 50 km/h), your vehicle is covering a distance of 44 feet (approximately 14 m) every second.

Never operate radio transmitters equipped with a built-in or attached antenna (i.e. without being connected to an external antenna) from inside the vehicle while the engine is running. Doing so could lead to a malfunction of the vehicle's electronic system, possibly resulting in an accident and/or personal injury.

You can connect your telephone to the audio system (> page 189) or to the COMAND system via Bluetooth®, see separate COMAND system operating instructions.

- ▶ Switch on the audio system (> page 152) or the COMAND system, see separate COMAND system operating instructions.
- ▶ Press button  or  to select the Tel menu.

One of the following messages will appear in the multifunction display:

- No Service: No network is available.
- Ready for Bluetooth Telephony...: The telephone has not been connected to the audio system or COMAND system via Bluetooth® yet.
 - ▶ Connect the telephone to the audio system or COMAND system via Bluetooth®.
- Phone READY or name of the network provider (if available): The telephone has found a network and is ready for use. You can operate it using the control system.

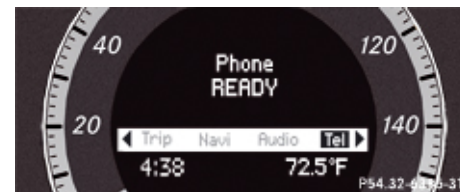

Control system

Answering a call

When your telephone is ready to receive calls, you can answer a call at any time. In the multifunction display you will then see the following message, or if available, the caller ID (number or name):

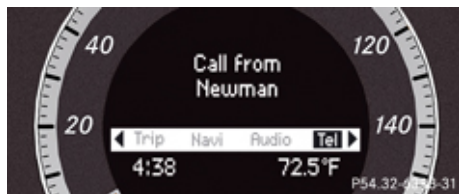

- ▶ Press button .

Ending a call or rejecting an incoming call







- ▶ Press button .





Dialing a number from the phone book

When your telephone is ready to receive calls, you may select and dial a number from the phone book at any time.

- i** For using the phone book of the audio system you can import business cards (vCards) from external Bluetooth® phones

into your audio system's phone book (▶ page 197).

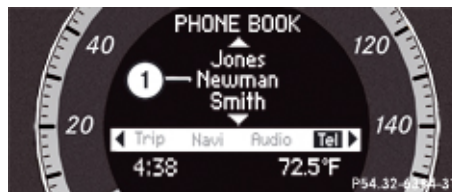

- ▶ Press button  or  to select the Tel menu.
- ▶ Press button  or  or  to switch to the phone book. The stored names are displayed in ascending alphabetical order.
- ▶ Press button  or  to select the desired entry.

If you press and hold button  or  the system scrolls rapidly through the list of names (quick search). After holding button  or  for a short while the scrolling speed increases. Release the button to stop the quick search. The search stops automatically at the end of the list.



- ① Selected name from the phone book

- ▶ Press button  or .

If several entries are present for the same name, they are all shown. Select the desired entry and press button  or  again.

The control system dials the selected phone number.

If the connection is successful and this feature is supported by your network provider, the name of the party (if stored in your phone book) you are calling will appear in the multifunction display.

The control system stores the dialed number in the redial memory.

or

- ▶ Press button  or  if you do not want to make the call.

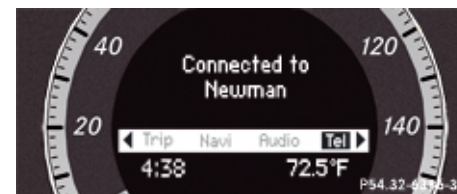







Redialing

The control system stores the most recently dialed phone numbers. This eliminates the



Control system

need to search through your entire phone book.

- ▶ Press button  or  to select the Tel menu.
- ▶ Press button .
- ▶ Press button  or  to select the desired number and/or name.
- ▶ Press button  or **OK**.
The control system dials the selected phone number.

Service menu

In the Service menu the following functions are available:

- Calling up messages (▷ page 144)
- Restarting the TPMS (USA only) (▷ page 272)
- Restarting the Run Flat Indicator (Canada only) (▷ page 270)
- Calling up the maintenance service indicator display (▷ page 292)

Calling up vehicle malfunction, warning and system status messages stored in memory

Use the vehicle status message memory function to scan malfunction and warning messages that may be stored in the system. Such messages appear in the multifunction display and are based on conditions or system status the vehicle's system has recorded.





Warning!

Malfunction and warning messages are only indicated for certain systems and are intentionally not very detailed. The malfunction and warning messages are simply a reminder with respect to the operation of certain systems. They do not replace the owner's and/or driver's responsibility to maintain the vehicle's operating safety. Have all required maintenance and safety checks performed on the vehicle. Bring the vehicle to an authorized Mercedes-Benz Center to address the malfunction and warning messages.

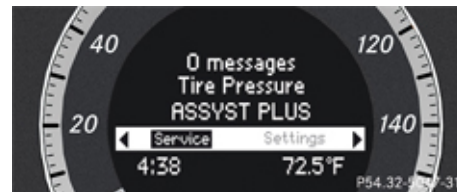
- ▶ Press  or  to select the Service menu.

If conditions have occurred causing status messages to be recorded, the number of messages appears in the multifunction display:



- ▶ Press  or  to select the messages function.
- ▶ Press **OK** to confirm.
The stored messages will now be displayed in the order in which they have occurred. For malfunction and warning messages, see "Vehicle status messages in the multifunction display" (▷ page 305).
- ▶ Use  or  to scroll through the messages.

If you turn the SmartKey in the starter switch to position **0** and then back to position **2**, all messages will be deleted from the message memory.

Control system

Settings menu

Introduction

In the Settings menu there are two functions: The function Factory Setting (▷ page 145), with which you can reset all the settings to the original factory settings and a collection of submenus (▷ page 145) with which you can make individual settings for your vehicle.

Resetting to factory settings

You can reset most of the functions of the submenus to the factory settings.

For safety reasons, the function Daytime Running Lamps in the Lights submenu cannot be reset while driving.

- ▶ Press **◀** or **▶** to select the Settings menu.
 - ▶ Press **▼** or **▲** to select the Factory Setting function.
 - ▶ Press **OK**.
- The function Reset All Settings? appears in the multifunction display.

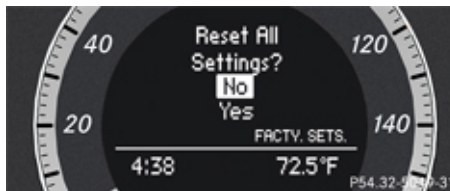

- ▶ Press **▼** or **▲** to select Yes or No. Select Yes if you want to reset to factory settings.
- ▶ Press **OK** to confirm. The confirmation message appears in the multifunction display. The functions of all the submenus will be reset to factory settings.

Submenus in the Settings menu

- ▶ Press **◀** or **▶** to select the Settings menu.

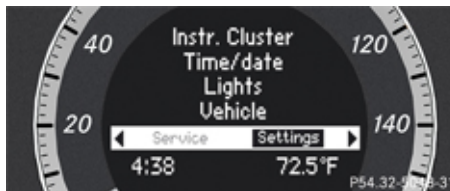

- ▶ Press **▼** or **▲** to select a submenu.

The submenus are arranged by hierarchy. Scroll down with **▼**, scroll up with **▲**.

With the selection marker on the desired submenu, use the **OK** to access the individual functions within that submenu.

Once within the submenu, you can use **▲** to move to the next function or **▼** to move to the previous function within that submenu.

The following lists show what settings can be changed within the various menus. Detailed instructions on making individual settings can be found on the following pages.

Instrument cluster submenu

- Selecting speedometer display mode (▷ page 146)
- Showing or hiding additional speedometer⁹ (▷ page 146)
- Permanent display¹⁰ (speed display or outside temperature) (▷ page 147)

Time/Date submenu

- Setting the time (▷ page 147)
- Setting the date (▷ page 148)

⁹ Vehicles with manual transmission

¹⁰ Vehicles with automatic transmission

Control system

Lighting submenu

- Setting daytime running lamp mode (USA only) (▷ page 148)
- Setting locator lighting and night security illumination (Headlamps delayed shut-off feature) (▷ page 149)
- Setting interior lighting delayed shut-off (▷ page 150)

Vehicle submenu

- Setting automatic central locking (▷ page 150)

Convenience submenu

- Activating easy-entry/exit feature (▷ page 151)
- Setting fold-in function for exterior rear view mirrors (Canada only) (▷ page 151)





Instrument cluster submenu

Access the Instr. Cluster submenu via the Settings menu. Use the Instr. Cluster submenu to change the instrument cluster display settings.

The following functions are available:

- Selecting speedometer display mode (▷ page 146)
- Showing or hiding additional speedometer¹¹ (▷ page 146)
- Permanent display¹² (speed display or outside temperature) (▷ page 147)

Selecting speedometer display mode

- ▶ Press  or  to select the Instr. Cluster submenu.
- ▶ Press .
- ▶ Press  or  to select Display Unit Speed-/Odometer: function. The current setting is shown.







- ▶ Press  to change the setting. Depending on the previous setting the Display Unit Speed-/Odometer: will be set to miles or km.

The selected display unit is valid for:

- Odometer and trip odometer
- Trip computer
- Digital speedometer in the trip menu
- Cruise control
- Navigation displays

Showing or hiding additional speedometer (vehicles with manual transmission)

You can have an additional digital speedometer shown on the multifunction display. The speed is shown in the unit of kilometers/hour (USA) or miles/hour (Canada).

- ▶ Press  or  to select the Instr. Cluster submenu.
- ▶ Press .
- ▶ Press  or  to select Additional Speedometer function. The current setting is shown.

¹¹ Vehicles with manual transmission

¹² Vehicles with automatic transmission



- ▶ Press **OK** to change the current status. Depending on the previous status, the additional speedometer will be switched On or Off.

Permanent display (vehicles with automatic transmission)

You can use the Permanent Display function to choose to display either the outside temperature or the speed in kilometers (USA) or miles (Canada) permanently.

- ▶ Press **▼** or **▲** to select the Instr. Cluster submenu.
- ▶ Press **OK**.
- ▶ Press **▼** or **▲** to select Permanent Display: function. The current setting is shown.



- ▶ Press **OK** to change the current status. Depending on the previous status, the Permanent Display: will be switched between Outside temperature or Speedometer (km/h) (USA)/ Speedometer (miles) (Canada). The selected display is then shown continuously in the lower display.

Time/Date submenu

Access the Time/Date submenu via the Settings menu. Use the Time/Date submenu to change the time and date display settings.

The following functions are available:

- Setting the time (▶ page 147)
- Setting the date (▶ page 148)

Setting the time

This function is not available if your vehicle is equipped with the COMAND system and navigation module.

Vehicles with COMAND system:

For information on setting the time in the COMAND system, refer to the separate COMAND system operating instructions.

- ▶ Press **▼** or **▲** to select the Time/date submenu.
- ▶ Press **OK**.
- ▶ Press **▼** or **▲** to select the Time function.
- ▶ Press **OK**. The current time appears in the multifunction display.
- ▶ To set a new time press **OK** again.
- ▶ Press button **◀** or **▶** to select the setting you wish to change: hours or minutes.

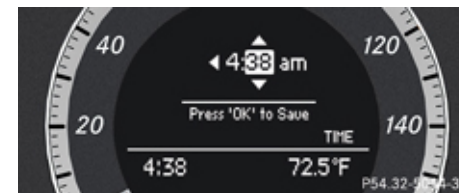

Control system

- ▶ Press button **▼** or **▲** to change the setting which is highlighted.
- ▶ Press **OK** to store the entry.

Setting the date

This function is not available if your vehicle is equipped with the COMAND system and navigation module.

Vehicles with COMAND system:

For information on setting the date in the COMAND system, refer to the separate COMAND system operating instructions.

- ▶ Press **▼** or **▲** to select the Time/date submenu.
- ▶ Press **OK**.
- ▶ Press **▼** or **▲** to select the Date function.
- ▶ Press **OK**.
The current date appears in the multifunction display.
- ▶ To set a new date press **OK** again.
- ▶ Press button **◀** or **▶** to select the setting you wish to change: month, day or year.

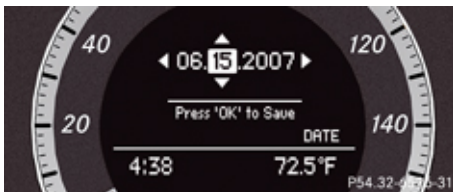

- ▶ Press button **▼** or **▲** to change the setting which is highlighted.
- ▶ Press **OK** to store the entry.

Lights submenu

Access the Lights submenu via the Settings menu. Use the Lights submenu to change the lamp and lighting settings on your vehicle.

The following functions are available:

- Setting daytime running lamp mode (USA only) (▶ page 148)
- Setting locator lighting and night security illumination (Headlamps delayed shut-off feature) (▶ page 149)
- Setting interior lighting delayed shut-off (▶ page 150)

Setting daytime running lamp mode (USA only)

- ▶ Press **▼** or **▲** to select the Lights submenu.
- ▶ Press **OK**.
- ▶ Press **▼** or **▲** to select the Daytime Running Lamps: function.
The current setting Enabled or Disabled is shown.

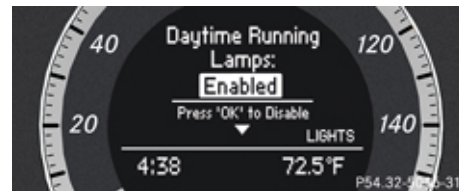

- ▶ Press **OK** to change the current status.
Depending on the previous status, the daytime running lamps feature will be Enabled or Disabled.

With Daytime Running Lamps mode Enabled selected and the exterior lamp switch at position **0** or **A**, the low-beam headlamps are switched on when the engine is running.

Control system

In low ambient light conditions the following lamps will come on additionally:

- Parking lamps
- Tail lamps
- License plate lamps
- Side marker lamps

For more information on the daytime running lamp mode, see “Lighting” (▷ page 101).

- i** Make sure the light switch is set to  or **A** when you switch off the daytime running lamps while driving at night.

For safety reasons, resetting all the functions of all submenus to the factory settings while driving (▷ page 145) will not deactivate the daytime running lamp mode.

The following message appears in the multifunction display:

Cannot Be Completely Reset to Factory Settings while Driving..

Setting locator lighting and night security illumination (Headlamps delayed shut-off feature)

With the Surround Lighting: function activated and the exterior lamp switch in position **A**

- the exterior lamps will come on during darkness when the vehicle is unlocked with the SmartKey.

The lamps will go out when the driver’s door is opened.





If you do not open the driver’s door after unlocking the vehicle with the SmartKey, the lamps will go out automatically after approximately 40 seconds.

- the exterior lamps will remain on for 15 seconds during darkness after exiting the vehicle and closing all doors.

If, after turning off the engine, you do not open a door or do not close an opened door, the lamps will automatically go out after 60 seconds.

The following lamps will come on

- Parking lamps
- Tail lamps
- License plate lamps
- Side marker lamps
- Front fog lamps

- ▶ Press  or  to select the Lights submenu.
- ▶ Press **OK**.
- ▶ Press  or  to select the Surround Lighting: function. The current setting Enabled or Disabled is shown.



- ▶ Press **OK** to change the current status. Depending on the previous status, the locator lighting feature and the headlamps delayed shut-off feature will be Enabled or Disabled.





Control system

You can temporarily deactivate the headlamps delayed shut-off feature:

- ▶ Before exiting the vehicle, turn the SmartKey in the starter switch to position **0**.
- ▶ Then turn it to position **2** and back to position **0**.
The headlamps delayed shut-off feature is deactivated. It will reactivate as soon as you start the engine.

Setting interior lighting delayed shut-off

Use this function to set whether you would like the interior lighting to remain on for 10 seconds during darkness after you have removed the SmartKey from the starter switch.

- ▶ Press  or  to select the Lights submenu.
- ▶ Press .
- ▶ Press  or  to select the Interior Lighting Delay: function.
The current setting Enabled or Disabled is shown.

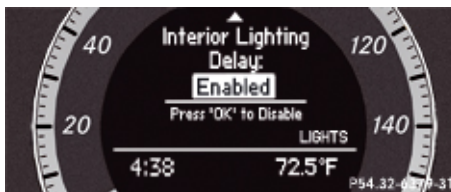





- ▶ Press  to change the current status. Depending on the previous status, the interior lighting delayed shut-off feature will be Enabled or Disabled.

Vehicle submenu

Access the Vehicle submenu via the Settings menu. Use the Vehicle submenu to set the automatic central locking.

Setting automatic central locking

Use this function to activate or deactivate the automatic central locking. With the automatic central locking system activated, the vehicle is centrally locked at a vehicle speed of approximately 9 mph (15 km/h).

- ▶ Press  or  to select the Vehicle submenu.
- ▶ Press .
- ▶ Press  or  to select the Automatic Door Lock: function.
The current setting Enabled or Disabled is shown.



- ▶ Press  to change the current status. Depending on the previous status, the automatic central locking feature will be Enabled or Disabled.

Convenience submenu

Access the Convenience submenu via the Settings menu. Use the Convenience submenu to activate the easy-entry/exit feature (▷ page 151) or to set the fold-in function for exterior rear view mirrors (▷ page 151).

Control system

Activating easy-entry/exit feature

Use this function to activate and deactivate the easy-entry/exit feature (▷ page 93).

⚠ Warning!

You must make sure no one can become trapped or injured by the moving steering wheel when the easy-entry/exit feature is activated.

To stop steering wheel movement do one of the following:

- Move steering wheel adjustment stalk.
- Press one of the memory position buttons.
- Press memory button **M**.

Do not leave children unattended in the vehicle, or with access to an unlocked vehicle. Children could open the driver's door and unintentionally activate the easy-entry/exit feature, which could result in an accident and/or serious personal injury.

- ▶ Press **▼** or **▲** to select the Convenience submenu.
- ▶ Press **OK**.
- ▶ Press **▼** or **▲** to select the Easy Entry/Exit: function. The current setting Enabled or Disabled is shown.

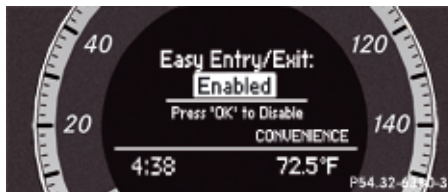

- ▶ Press **OK** to change the current status. Depending on the previous status, the easy-entry/exit feature will be Enabled or Disabled.

Setting fold-in function for exterior rear view mirrors (Canada only)

Use this function to set the exterior rear view mirrors to be automatically folded in when you lock your vehicle.

With this function set to Enabled and the exterior rear view mirrors folded in using the button on the door control panel (▷ page 96), the exterior rear view mirrors will

not fold out when you switch on the ignition. You will then have to fold out the exterior rear view mirrors using the button on the door control panel (▷ page 96).

Make sure both exterior rear view mirrors are folded out completely before driving off.

- ▶ Press **▼** or **▲** to select the Convenience submenu.
- ▶ Press **OK**.
- ▶ Press **▼** or **▲** to select the Fold Mirrors in when Locking: function. The current setting Enabled or Disabled is shown.



- ▶ Press **OK** to change the current status. Depending on the previous status, the automatic fold-in function for exterior rear view mirrors will be Enabled or Disabled.

Audio system

Audio system

Audio and telephone operation

These instructions are intended to help you become familiar with your Mercedes-Benz audio system. They contain useful tips and a detailed description of the user functions.

⚠ Warning!

In order to avoid distraction which could lead to an accident, the driver should enter system settings with the vehicle at a standstill and operate the system only when road and traffic conditions permit. Always pay full attention to traffic conditions first before operating system controls while driving.

Bear in mind that at a speed of just 30 mph (approximately 50 km/h), your vehicle is covering a distance of 44 feet (approximately 14 m) every second.

Audio system overview



Item
① Audio display (▷ page 156)
② Opening button (▷ page 156)
③ Audio control unit (▷ page 153)



Item
④ Clear button (▷ page 159)
⑤ Audio controller (▷ page 157)
⑥ Back button (▷ page 159)

Operating safety

Warning!

Any alterations made to electronic components can cause malfunctions.

The radio, amplifier, CD changer, satellite radio, and telephone are interconnected.

When one of the components is not operational or has not been removed/replaced properly, the function of other components may be impaired.

This condition might seriously impair the operating safety of your vehicle.

We recommend that you have any service work on electronic components carried out at an authorized Mercedes-Benz Center.

Audio system components

With the audio system you can operate the following main functions:

- audio function with the radio, Satellite radio, disc (CD audio or MP3 mode) and Audio AUX
- the mobile phone with the phone book
- various system settings

The audio system consists of the following:

- audio control unit
- audio display
- audio controller with **BACK** and **CLR** button

In addition, the audio system can also be operated with the multifunction steering wheel (▷ page 131).

In these instructions, the keypad (right side of audio control unit) and the function buttons are referred to as “buttons”.

Audio control unit

With the audio control unit you can:

- switch the audio system on/off
- adjust the volume
- select the operating modes
- enter telephone numbers and accept, reject, initiate and end telephone calls
- load and eject CDs

Audio system

Audio control unit overview



	Item
①	Switching to radio mode (▷ page 168) Calling up wave bands (▷ page 169) Switching on Sat mode (▷ page 174)
②	Switching to CD audio or MP3 mode (▷ page 179)
③	Disc slot
④	Load/eject button (▷ page 182)
⑤	Clear button for deleting digits or entire entries (▷ page 201) Entering a passcode (▷ page 194) Entering a telephone number (▷ page 201)

⑥	Keypad Tuning to a station via the station memory (▷ page 170) Storing stations manually (▷ page 170) Entering a passcode (▷ page 194) Entering a phone number (▷ page 201) Sending DTMF tones (▷ page 203) CD changer: Selecting a CD (▷ page 183) CD: Selecting a track (▷ page 186) Switching to a popup screen of satellite radio (▷ page 177)
⑦	Tuning to a station via station search (▷ page 169) Fast forward (▷ page 187) Skipping forwards to a track (▷ page 187)
⑧	Switching audio system on/off (▷ page 162)
⑨	Adjusting the volume (▷ page 163)

⑩	Tuning to a station via station search (▷ page 169) Fast rewind (▷ page 187) Skipping backwards to a track (▷ page 187)
⑪	Confirming a passcode (▷ page 193) Accepting a call (▷ page 202) Initiating a call (▷ page 201) Redial (▷ page 202)
⑫	Rejecting a call (▷ page 202) Ending an active call (▷ page 202)
⑬	Opening system settings menu (▷ page 165)
⑭	Switching sound on/off (▷ page 163) Switching hands-free microphone on/off (▷ page 203)
⑮	Switching to telephone mode (▷ page 189)
⑯	Sound settings (▷ page 163)

Audio system

Audio display

The audio display has a protective cover.

! Do not place any objects on the cover of the audio display. This may obstruct the movement when the cover is being opened/closed. The cover could be damaged. Do not place any objects in front of the audio display and/or secure any objects to the audio display itself. The audio display could be damaged.

Avoid touching the audio display at all times. The display has a very sensitive high-gloss surface, there is a risk of it being scratched. Do not press directly in the display face. Otherwise, the audio display will be damaged.

i For information about cleaning and care of the audio display, see “Audio or COMAND display” (> page 297).

Audio display cover



① Opening button

▶ **Opening:** Press opening button ①. The audio display cover opens, the audio display is visible, and the audio system switched on.

▶ **Closing:** Press the audio display cover down until it engages. If the audio system is still switched on, you can continue to listen to the radio or a CD and operate the device via the buttons on the audio control panel as well as the buttons on the multifunction steering wheel.

! You cannot operate the audio system via the audio controller when the display cover is closed.

Display

The currently selected mode and the associated menus are shown on the audio display. The audio display is divided into several areas.

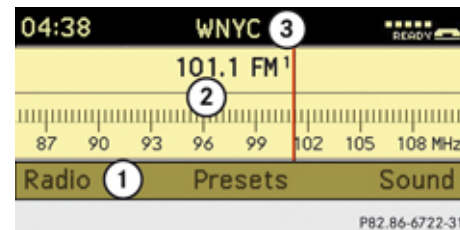

Example illustration: radio selected

- ① Menu bar
- ② Main area
- ③ Status line



Status line ③ displays the time and the current settings for radio and telephone mode.

You can request the required function using menu bar ①.

The selection is made using the audio controller.

Audio system

Mobile phone readiness is indicated by additional information being shown in the status line:

- In the telephone main menu: Name of the Bluetooth® device (calls made and received via the Bluetooth® interface) (> page 195).
- Mobile phone network signal strength . This information will only be shown with suitable mobile phones.
- Receiver symbol  

In this example, the audio main function is set to the FM radio mode and the main area ② is active.

- i** The layout of the menus may vary depending on your vehicle's equipment. This manual shows the menus for a fully equipped vehicle.

Instrument cluster multifunction display

Please refer to the “Control system” section of this manual (> page 131) for function

descriptions and operation of the instrument cluster multifunction display and multifunction steering wheel buttons as they relate to audio functions described in this section.

Audio controller



① Audio controller





The menu functions are selected on the audio display using the audio controller. For this purpose, a selected item is highlighted.

In this way, you can open menus or lists, move within menus or lists, and quit menus or lists.







Operating audio controller

The audio controller features the following options:

- press briefly or press and hold 
- rotate to the left or right 
- slide to the left or right 
- slide up or down 

- i** You cannot operate the audio system via the audio controller when the display cover is closed.

Audio system

Symbol	How to use the audio controller	Function
	▶ Press briefly.	• Confirming the selection of a menu item or list entry.
	▶ Press and hold until the selected action has been carried out.	• Saving a station.
	▶ Rotate.	<ul style="list-style-type: none"> • Moving through vertical or horizontal menus or through lists. • Selecting program settings.
	▶ Slide.	<ul style="list-style-type: none"> • Moving through vertical menus or lists. • Exiting horizontal menus.
	▶ Slide.	<ul style="list-style-type: none"> • Moving through horizontal menus. • Exiting vertical menus.
	▶ Slide and hold.	• Fast forward or reverse for audio CD playback.

Back button



① Back button **BACK**

► **Switching to the next highest menu:**

Press button **BACK** briefly.

The audio system switches to the next highest menu level within the currently active mode.

i You can also exit a menu or list by sliding the audio controller ←⊙→ or ↑⊙↓.

► **Switching to the main menu:** Press and hold button **BACK**.

The audio system switches to the basic menu of the currently active mode.

Clear button

Use clear button **CLR** for deleting individual digits or an entire phone number (▷ page 201).



① Clear button **CLR**

► **Deleting an individual digit:** Briefly press button **CLR**.

► **Deleting an entire phone number:** Press and hold button **CLR** until the entry is deleted.

Menu

The table below shows the structure of the modes and their menus. Each mode has a basic menu. Each menu item in turn has several submenu items.

Button	Mode/Menu
RADIO	Radio mode
	Radio (FM/AM) (▷ page 167)
	Weather Band (▷ page 169)
	Satellite radio (▷ page 172)
	Presets (▷ page 170)
DISC	Disc mode
	CD/MP3 (▷ page 179)
	Track list/folder list (▷ page 187)
	CD Changer (▷ page 183)
	Sound (▷ page 163)
TEL	Telephone mode
	Telephone (▷ page 189)



Audio system

Button	Mode/Menu
	Name (▷ page 197)
	Call lists (▷ page 200)
sys	System settings menu
	System (▷ page 165)
	Language (▷ page 166)

Calling up an operating mode

- ▶ Press the respective button (**RADIO**, **DISC**, **TEL**, or **sys**) on the audio control unit. The basic menu of the selected mode appears in the audio display. The main area is active. The active area is highlighted.

i The following screens show the audio display's day design. The appearance of the highlighted items in the menu will vary depending on the display design.

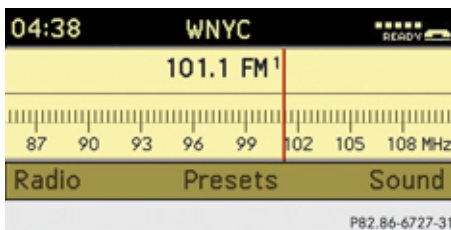
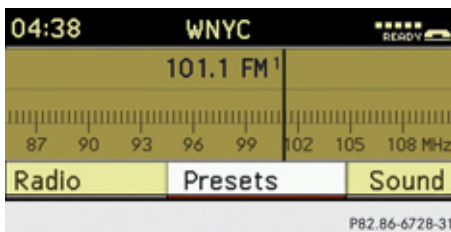

Illustration: radio function basic menu

- ▶ **Moving to the menu bar:** Slide $\odot \downarrow$.

Horizontal menus



- ▶ **Moving through the menu bar:** Slide $\leftarrow \odot \rightarrow$ or rotate $\{\odot\}$. The currently selected item is highlighted.
- ▶ **Confirming the selected menu item:** Press \odot .

- ▶ **Exiting the menu bar without confirming a selection:** Slide $\uparrow \odot$ in the opposite direction of the list orientation.

or

- ▶ Press button **BACK**.

Vertical submenus

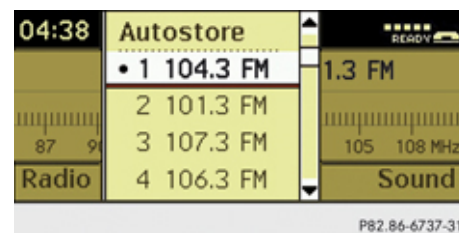

- ▶ **Moving through the menu:** Slide $\uparrow \odot \downarrow$ or rotate $\{\odot\}$. The currently selected item is highlighted.
- ▶ **Confirming the selected submenu item:** Press \odot .
- ▶ **Exiting a menu without confirming a selection:** Slide $\leftarrow \odot \rightarrow$ in the opposite direction of the list orientation.

or

- ▶ Press button **BACK**.

Example of how to use the audio system

Example: direct frequency input, FM 104.5 MHz.

In the descriptions below, the mode always serve as the starting point for locating the individual menu items.



Example:

RADIO → Radio → Enter Frequency

The individual steps for the above-mentioned example are described below.

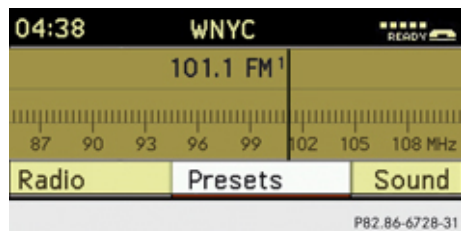
- ▶ Press button **RADIO** on audio control unit repeatedly until desired wave band FM has been selected.
- ▶ **Switching to the menu bar:** Slide .



- ▶ **Selecting Radio in the menu bar:** Slide  or rotate .

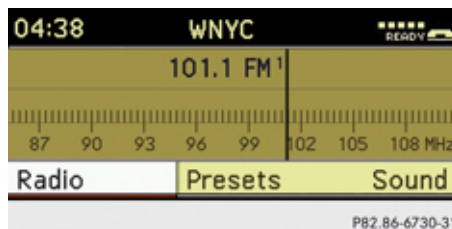

- ▶ **Confirming selection:** Press . The Radio menu is selected and a list of submenus appears.

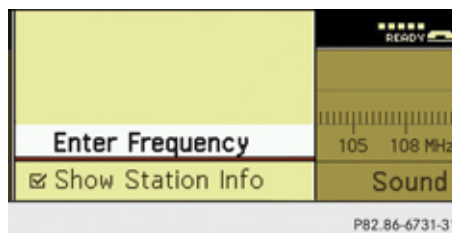

- ▶ Enter Frequency is selected.
- ▶ **Confirming selection:** Press . The Enter Frequency submenu appears.

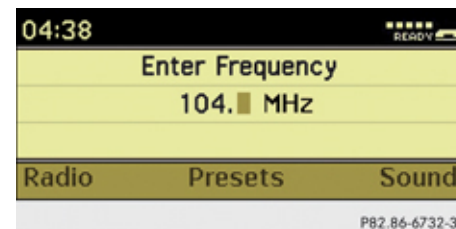

- ▶ **Information:** It is not possible to enter a frequency in the respective wave band which is outside the frequency range. Frequencies within the current frequency range, but outside the current frequency step width are rounded to the next lower allowed frequency.
- ▶ Enter 1045 with the keypad on the audio control unit. The audio system tunes in to the frequency entered.

Audio system



Operation

In the following descriptions, an operation step is described as in example below.

▶ **RADIO** → Radio → Enter Frequency is the short for

▶ Press button **RADIO** on audio control unit repeatedly until desired wave band has been selected.

▶ Slide .

▶ Slide  or rotate  the audio controller to select Radio.

▶ Press the audio controller .

The Radio menu is selected and a list of submenus appears.

▶ Slide  or rotate  the audio controller to select Enter Frequency.

▶ Press the audio controller .

The Enter Frequency submenu appears in the audio display.

Switching audio system on or off



① Push button **ON**.

② Rotary control

▶ **Switching on:** Press push button **ON**.

or

▶ Open the audio display cover.

or

▶ If the audio system was on as you switched off the ignition, turn the SmartKey in the starter switch to position **1**.
The audio system will come back on with the last selected function.

i If the audio system is switched on without the SmartKey in the starter switch, it will automatically switch off again after approximately 30 minutes.

▶ **Switching off:** Press push button **ON**.

or

▶ Turn the SmartKey in the starter switch to position **0** and remove SmartKey from starter switch.

i Should excessively high temperatures occur while the audio system is being operated, Temperature Too High-Device switching off now. will appear in the audio display, after which the audio system will be switched off for a cooling-down period.

i When you switch off the audio system, you also switch off the currently playing audio source and the telephone operating via audio control unit is not possible.

Adjusting volume



- ① Push button **ON**
- ② Rotary control

- ▶ **Adjusting:** Turn rotary control ②.
The volume will increase or decrease depending on the direction turned.

Adjusting volume for telephone calls

In hands-free mode, you can adjust the volume of a telephone call while the call is currently active.

During a telephone call:

- ▶ Turn rotary control ②.
The volume will increase or decrease depending on the direction turned.
- i** The volume of the audio system or a telephone call can also be adjusted by

pressing the button **+** or **-** on the multifunction steering wheel (▶ page 131).

Sound

- ▶ **Switching on/off:** Press button  on the audio control unit (▶ page 154). The sound of the current audio source is switched on or off.

- i** When the sound is switched off, the symbol  appears in the status line.
If you change the audio source, or alter the volume, the sound is automatically switched on again.

Selecting sound settings

For bass and treble, you can select different sound settings for each individual audio source. The particular Sound menu can be opened from the basic menu for the desired operating mode, or by pressing the button **TONE** on the audio control unit.

Example:

RADIO → Sound → Bass

Adjusting bass or treble





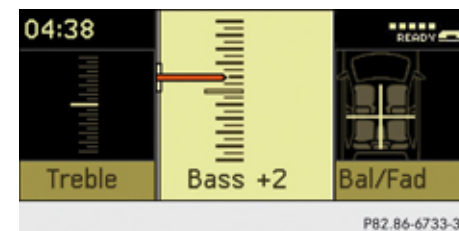

- ▶ Press button **TONE** and select Bass or Treble.

or

- ▶ Select Sound → Bass or Treble.
A longer and brighter bar indicates the previously stored setting. The red pointer indicates the currently selected setting.



Example for adjusting bass

- ▶ **Changing setting:** Slide    or rotate  until desired treble or bass setting is reached.
 - ▶ **Exiting menu:** Press button **BACK** or slide   .
- The setting is stored.

Audio system

Adjusting balance or fader

Balance is used to determine whether the sound focus should be shifted toward the driver's side or the passenger side.

Fader is used to determine whether the sound focus should be shifted toward the front or rear of the vehicle.

▶ Press button **TONE** repeatedly until Bal/Fad appears in the audio display.

or

▶ Select Sound → Bal/Fad.

The current setting is indicated by a red cross-hair symbol.

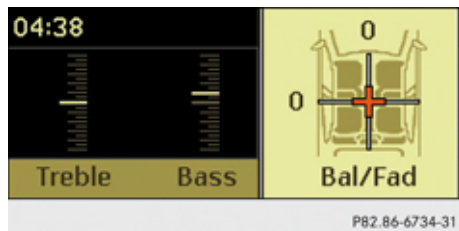

Adjusting balance and fader

▶ **Changing setting:** Slide ↓⊙↑ or ←⊙→ until desired balance/fader setting is achieved.

▶ **Exiting menu:** Press ⊞ or button **BACK**. The balance/fader setting is stored for all audio sources.

Surround sound

If your vehicle is equipped with the harman/kardon LOGIC 7[®] Surround Sound system, you can choose between LOGIC 7[®] On and LOGIC 7[®] Off for surround sound.

Harman/kardon LOGIC 7[®] Surround Sound is available for the following operating modes:

- Radio (FM only)
- Satellite radio
- CD audio
- MP3
- AUX

i The LOGIC 7[®] On function of the harman/kardon LOGIC 7[®] Surround Sound system permits the playback of discrete 5.1 and stereo recordings with an optimal surround sound platform for each passenger.

The LOGIC 7[®] distributes the 5.1 surround information over the 13-channel system

architecture to provide the optimum sound experience from all seats. This produces the sound characteristic as intended by the sound engineer during the original recording.

Harman/kardon LOGIC 7[®] converts all two-channel stereo sound material into multi-channel surround sound. The surround information stored during the original recording is read out using LOGIC 7[®] and likewise distributed over the 13 channels. No effects are created during this process; only that which was already there becomes audible.

In addition, harman/kardon LOGIC 7[®] moves the perceived sound source away from the individual loudspeakers, thus generating a natural 360° sound experience for each passenger.

i By selecting LOGIC 7[®] Off, all compatible formats are played back as they are present on the medium. Due to the vehicle's spatial characteristics, an optimal sound experience is not ensured from all seats.

Adjusting surround sound

With surround sound, you can choose between LOGIC 7® On and LOGIC 7® Off.

▶ Press button **Ⓣ** repeatedly until Sound appears in the audio display.

or

▶ Select Sound → Sound.

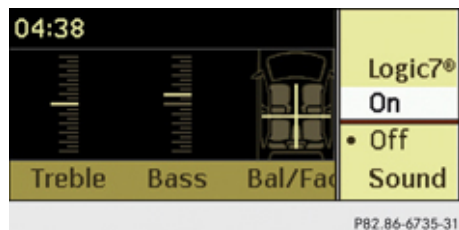

A dot • indicates the current setting.

▶ **Selecting setting:** Slide **⏮** or rotate **⏪**.

▶ **Saving setting:** Press **⏹**.
The setting is stored and the menu is exited.

▶ **Exiting menu without saving:** Press button **⏮** or slide **⏪**.

i Balance and fader will be set to the default value (0/0) automatically by activating or deactivating LOGIC 7®.

i Please note the following:

- For an optimal sound experience from all seats, the balance and fader should be adjusted to the center of the passenger compartment with LOGIC 7® switched on.
- The best sound results are achieved when playing high-quality audio CDs.
- For MP3 tracks, the bit rate should be at least 128 kbit/s.
- Surround playback cannot be activated in mono-signal sources as AM or Weatherband. It will not function for mono-signal sources as, e.g. mono audio tracks on some specific audio CDs.
- In the case of poor radio reception quality, e.g. in tunnels, LOGIC 7® should be switched off, as otherwise a dynamic switchover from stereo to mono and thus temporary sound characteristic shifts can occur.
- With certain stereo recordings, the resulting sound characteristic may deviate from conventional stereo playback.

SYS menu

System settings menu overview

Menu
System
Display (▶ page 165)
Brightness
Day Mode
Night Mode
Automatic
Activate Bluetooth® (▶ page 166)
Reset (▶ page 166)
Language (▶ page 166)

Display settings

You can adapt the brightness of the audio display to the prevailing light conditions.

Setting the display design

- ▶ **Ⓢ** → System → Display.
- ▶ Select Brightness, Day Mode, Night Mode or Automatic.

Audio system

i When you select Brightness, a scale appears on which you can set the brightness manually.

In the Automatic setting, the audio system analyzes the automatic vehicle light sensor and switches between the display designs automatically.

Bluetooth® settings

General information about Bluetooth®

Bluetooth® technology is the standard for short-range wireless technologies, suitable for transmitting voice and data. It is possible to connect Bluetooth® devices wirelessly. Bluetooth® can be used to exchange vCards or make calls using a hands-free device.

Bluetooth® technology uses the freely available ISM (Industrial Scientific Medical) wireless network that works at 2.45 GHz. Ranges of up to ten meters are possible with Bluetooth®.

Activate or deactivate Bluetooth®

▶ **sys** → System → Activate Bluetooth.

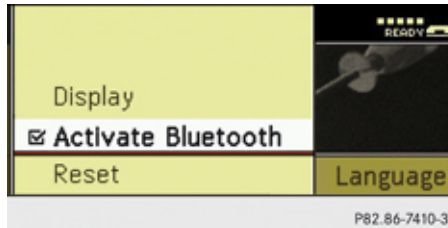

You have activated or deactivated Bluetooth®. A checkmark appears when Bluetooth® is activated.

Reset

i You can reset the audio system back to its factory settings. In this case, all personal data (e.g. address book entries, call lists, paired mobile phones, and presets) are deleted. We recommend that you reset the values, for example, before selling your vehicle.

▶ **sys** → System → Reset.

A prompt appears asking whether you really want to reset.

▶ Select Yes or No.

If you select Yes another prompt will appear asking whether you really want to reset.

▶ Select Yes or No.

If you select Yes, the audio system will be reset and restarted.

Setting the system language

▶ **sys** → Language.



The language list appears. A dot • in front of an entry indicates the current setting.

- ▶ **Changing setting:** Slide or rotate and select desired language.
 - ▶ **Saving setting:** Press . The setting is stored and the menu is exited.
 - ▶ **Exiting menu without saving:** Press button **BACK** or slide .
- i** The language selected in the Audio system is also used for the displays and messages in the multifunction display.

Radio operation

Warning!

Please devote your attention first and foremost to the traffic situation you are in.

Before your journey, please familiarize yourself with the radio functions.

Only use the audio system when road and traffic conditions permit you to do so. Otherwise you could be involved in an accident in which you or others could be injured.

! Do not attach metallic window tinting film to the inside or outside of windows which are fitted with an aerial. Obstructing the metallic aerial structure on the window will interfere with radio reception. Cutting the film on the window can permanently damage the aerial wires.

i The radio mode is interrupted by an incoming call on the mobile phone (▷ page 189).

(▷ page 153) and (▷ page 161). Information about sound settings can be found on (▷ page 163).

Menu overview

i The components and operating principles of the audio system can be found on

Audio system

Radio (except Weather Band/satellite radio)	Presets (except Weather Band)	Channel (only Weather Band)	Sound
Enter frequency	Autostore (except satellite radio)	List of channels	Treble
Station information (in FM wave band only)	List of stored stations		Bass
			Balance/Fader
			Surround Sound

Switching to radio mode

- ▶ Press button **RADIO** on audio control unit. The radio basic menu appears in the audio display once you have switched to radio mode. You will hear the frequency last tuned in the previously selected wave band.

Weather Band will automatically tune to the strongest station in the area.

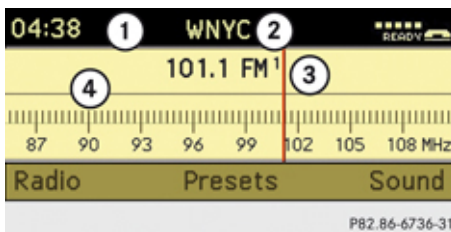

Illustration: radio mode in FM wave band

- ① Status line
 - ② Station name or other information from the station
 - ③ Store position of station
 - ④ Main area with wave band
- i** Station name or other information ②, available for the FM wave band, can only be

seen when the station transmits the name or other information and the function Show Station Info in the Radio menu is activated.

- ▶ **RADIO** → Radio → Show Station Info



In the WB wave band, the audio system displays the channel number, e.g. Channel 6, instead of the station names and/or frequency.

Information displayed in the status line (example)

The following information is displayed in the status line:

- Time (04:38)
- Station name (WNYC)

Mobile phone readiness is indicated by additional information being shown:

- Mobile phone network signal strength 
- Receiver symbol  

Calling up wave bands

You can choose from among the FM, AM and WB wave bands and then request the Sat mode (▷ page 172). Pressing again button **RADIO** will switch back to FM radio mode.

Wave band	Frequency
WB (Weather Band)	Weather channels
FM	87.7..... 107.9 MHz
AM	530..... 1710 KHz

- ▶ Press button **RADIO** on audio control unit repeatedly until desired wave band has been selected. The FM, AM, and WB wave bands and the satellite radio mode are called up one after another. The wave band currently selected appears in the status line of the audio display. The last selected station in the selected wave band is heard.

Selecting a station/channel

You have the following selection options:



- The station search function
- The channel list (Weather Band/satellite radio)
- Station memory (except Weather Band)
- The manual frequency entry (except Weather Band/satellite radio)

For using satellite radio see (▷ page 172).

The station search proceeds in the following frequency increments:

- 200 kHz in FM range
- 10 kHz in AM range

Tuning to a station/channel via station/channel search function

- ▶ **i** The search function searches for the next receivable station in the FM or AM wave band. In Weather Band (WB) the search function switches to the next channel in the channel list. For tuning to a station/channel you can also use the buttons on the multifunction steering wheel, see “Audio menu” (▷ page 140).
 - ▶ Press button **RADIO** on audio control unit repeatedly until the FM/AM/WB wave band is selected.
 - ▶ Slide  or rotate  when the main area in the basic menu is active. Depending on the direction in which the controller is being slid or rotated, the system searches upward or downward and stops at the next station/channel.
- or
- ▶ Press button **<<<** or **>>>** on audio control unit. Depending on the pressed button, the system searches upward or downward and stops at the next station/channel.

Audio system

Selecting a station using station memory

i This function is not available for Weather Band.

▶ Press button **RADIO** on audio control unit repeatedly until desired wave band has been selected.

▶ Select Presets.

or

▶ Press **MEMO** when the main area is selected. The memory menu appears. The dot • in front of a memory position indicates that the currently selected station is saved there.

▶ Select station in memory by rotating **MEMO** or sliding **MEMO** and press **MEMO**.

or

▶ Press desired station button **1** to **0**, with the keypad in audio control unit briefly.

Tuning to a station by entering the frequency manually

i This function is not available for Weather Band/satellite radio.

▶ **RADIO** → Radio → Enter Frequency
The menu for manual frequency entry appears.

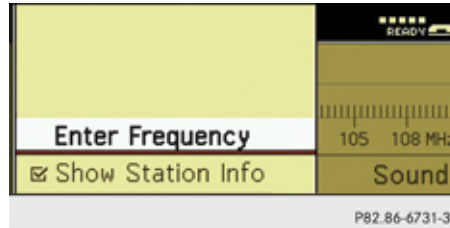

or

▶ Press button ***+**, on the keypad in audio control unit briefly.

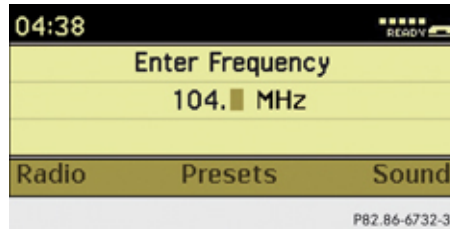

▶ **Entering frequency with keypad:** Enter desired frequency with buttons **1** to

0, with the keypad in audio control unit briefly.

The audio system tunes in to the frequency entered.

i It is not possible to enter a frequency in the respective wave band which is outside the frequency range.

▶ **Exiting menu without making an entry:** Press button **BACK** in the center console (> page 159).

Storing stations

You can store ten AM and ten FM stations in the memory.

i If you select a memory preset which is already in use, it will be overwritten by the new station.

Storing stations manually with keypad

▶ Tune in desired station. Basic menu is shown in the audio display.

▶ Press and hold desired station button **1** to **0** until a brief signal tone sounds.

The station is stored.

Audio system

Storing stations manually with station memory menu

- ▶ Tune in desired station.
Basic menu is shown in the audio display.
- ▶ Press when the main area is active.

or

- ▶ Select Presets.
The station memory display appears in the audio display.

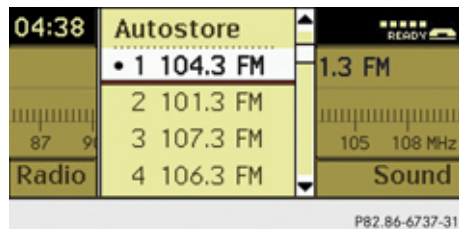

The dot • in front of a memory position indicates that the currently tuned station is stored there.

- ▶ **Selecting a memory position:** Slide or rotate .
- ▶ **Storing a station to a selected memory position:** Press and hold until a brief signal tone sounds.

or

- ▶ Press and hold desired station button to on keypad, until a brief signal tone sounds.
The station is stored.

Autostore – automatic station memory

- 1 This function is not available for Weather Band/satellite radio. The autostore function automatically assigns receivable stations to the memory, sorted according to reception quality at the moment of performing the autostore. The stations which were stored in the station memory manually are completely lost in this process. If less than ten stations are found, the remaining entries are left empty.

- ▶ Press button on audio control unit repeatedly until desired wave band has been selected.
Basic menu is shown in the audio display.
- ▶ Press when the main area is active.

or

- ▶ Select Presets.
The station memory display appears in the audio display.
- ▶ Slide or rotate to select Autostore.
- ▶ Press .
- ▶ The audio system searches for receivable stations. A corresponding message is displayed. The available stations are automatically stored in memory. The first received station will be automatically played.
- ▶ **Canceling storage procedure:** Select Cancel and press while the message Rewriting memory... is being displayed.

Audio system

Satellite radio

Warning!

Please devote your attention first and foremost to the traffic situation you are in.

Before your journey, please familiarize yourself with the radio functions.

Only use the audio system when road and traffic conditions permit you to do so. Otherwise you could be involved in an accident in which you or others could be injured.

Submenu overview

 The components and operating principles of the audio system can be found on (> page 153) and (> page 161).

Sat	Presets	Info	Category (Cat.)	Sound
Channel List	Station presets	Show program info	All channels	Treble
Channel Entry			Select category	Bass
Service				Balance/Fader
				Surround Sound

Satellite radio

 Additional satellite radio equipment and a subscription to SIRIUS Satellite Radio service provider are required for the satellite radio operation described in this chapter.

Contact an authorized Mercedes-Benz Center for details and availability for your vehicle.

SIRIUS Satellite Radio provides over 130 channels of digital-quality radio, including 100% commercial-free music, sports, news and entertainment. SIRIUS Satellite Radio uses a fleet of high-power

satellites to broadcast 24 hours per day, coast to coast, in the contiguous U.S. and Canada.

This diverse, satellite-delivered programming is available for a monthly subscription fee.

For more information and service availability call the SIRIUS Service Center at 1-888-539-7474 (> page 177), or contact

Audio system

www.sirius.com (USA) or
www.siriuscanada.com (Canada).

i Note that categories and channels shown in illustrations are dependent on programming content delivered by the service provider. Programming content is subject to change. Therefore, channels and categories shown in illustrations and descriptions contained in this manual may differ from the channels and categories delivered by the service provider.

i Satellite radio service may be unavailable or interrupted from time to time for a variety of reasons, such as environmental or topographic conditions and other things we cannot control. Service might also not be available in certain places (e. g., in tunnels, parking garages, under leafy trees, or within or next to buildings) or near other technologies. In such situations, the satellite radio's main menu shows the **Acquiring Signal...** screen. At this point, the radio's functions are restricted.

Subscribing to satellite radio

▶ Press button **RADIO** on audio control unit repeatedly until satellite radio **Sat** is selected.

The following conditions are possible:

- Satellite radio service is not activated (only the preview channel is displayed).
- Satellite radio service is activated.

i If a satellite receiver is not installed or not properly installed:

The message **Device Unavailable** will appear.

If the satellite radio service is not activated, the "SIRIUS Preview" display appears.

Satellite radio service is not activated

The telephone number of the SIRIUS Service Center and the twelve-digit electronic serial number (SIRIUS-ID) of the particular receiver are required when calling the SIRIUS Service Center for an activation request.

▶ **RADIO** (repeatedly, if necessary) → **Sat** → **Service**.

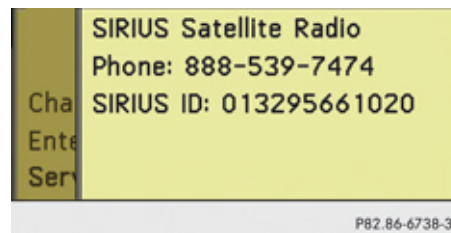

▶ **Closing screen:** Press **⏪** or button **BACK** or slide **←⊙→**.

▶ **Activating satellite radio service:** Contact satellite radio service provider at the telephone number displayed in the service display.

After the connection is made:

▶ Follow the instructions given by the operator. The activation process may take up to 10 minutes. If it is successful, you will see the display with the message **Updating Channels...** followed by the satellite radio basic menu.

i Activating the satellite radio service might not be available in certain places (e. g., in tunnels, parking garages, under leafy trees, or within or next to buildings). If a subscription is not included with system purchase, credit card information is required to activate your account.

The activation process takes approximately 5 to 10 minutes after calling the SIRIUS Service Center.

If a satellite receiver is not installed or not properly installed: The message **Device Unavailable** will appear.

Audio system

- i** It is also possible to activate the satellite radio service online. To do so please visit SIRIUS Satellite Radio's website at www.sirius.com (USA) or www.siriuscanada.com (Canada).

Preview Channel

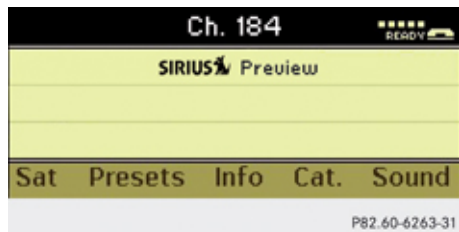

- i** If the satellite radio service has not been subscribed to, only the preview channel is available. You cannot tune in another channel. If you try to do this, the message Call SIRIUS to activate: appears.

Satellite radio service is activated

The basic satellite radio menu appears. You will hear the channel last tuned in, provided that it can be received.

Switching on

For important subscription information see “Subscribing to satellite radio” (▷ page 173).

- ▶ Press button **RADIO** on audio control unit repeatedly until satellite radio Sat is selected.

The message Acquiring Signal... will appear when the signal is not available. After the audio system acquires the signal, the satellite radio basic menu will appear. The station last tuned to will begin to play.

Main satellite radio menu

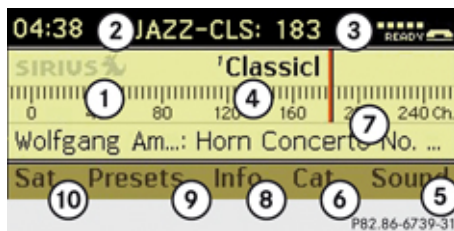

- 1 Main area with channel display
- 2 Selected program category
- 3 Number of selected channel
- 4 Selected channel
- 5 Sound settings
- 6 Selecting program category
- 7 Current artist and title

- 8 Channel information
- 9 Preset options
- 10 Satellite radio options

- i** Main area ① displays only channels that you have subscribed to. Which channels are shown depends on the selected program category ②. Only the currently selected channel ④ is displayed. Note that categories and channels shown in illustrations are dependent on programming content delivered by the service provider. Programming content is subject to change. Therefore, channel and categories shown in illustrations and descriptions contained in this manual may differ from the channels and categories delivered by the service provider.

Selecting program category

- i** The channels are categorized. Categories allow you to tune to stations broadcasting a certain type of program.

Satellite radio channels are split up into categories such as News, Sports, Rock, or Country, if available. The category list is sorted alphabetically.

- ▶ **Calling up category list:** **RADIO** (repeatedly, if necessary) → Cat.

or

- ▶ Slide **←** or rotate **⤵** until Cat. is highlighted and press **⏪**. The category list appears.
- ▶ **Selecting a category:** Slide **↑** or rotate **⤴**.
- ▶ **Setting the selected category:** Press **⏪**. The selected program category (alphabetical order) will appear in the audio display. The channel last tuned in the new category will begin to play. When searching, tuning in, or selecting from the channel list, the **All Channels** option accesses all of your subscribed channels.

i When you select the category **All Channels**, you have access to all the channels you subscribe to, regardless of category.

Tuning in channels

You have the following selection options:

- The channel scan function
- The manual channel number entry

- The channel list
- The channel presets

Tuning in channels using channel search function

- ▶ Slide **←** or rotate **⤵** when the main area in the basic menu is active. Depending on the direction in which the controller is being slid or rotated, the system scans upward or downward and stops at the next subscribed channel.

or

- ▶ Press button **⏮** or **⏭** on audio control unit. Depending on the pressed button, the system searches upward or downward and stops at the next receivable channel.

i Which channels are available depends on which channels you have subscribed to and the program category you have selected (▷ page 174). For tuning in channels you can also use the buttons on the multifunction steering wheel, see “Audio menu” (▷ page 140).

Tuning in channels using manual channel number entry

- ▶ **RADIO** (repeatedly, if necessary) → Sat → Enter Channel.

The menu for manual channel number entry appears.

or

- ▶ Press button ***+**, on the keypad in audio control unit briefly.
- ▶ **Channel number entry with keypad:** Enter desired channel number with buttons **1** to **0**, with the keypad in audio control unit briefly.

Further operation depends on whether the selected channel number is valid or if the channel is included in your subscription.

- ▶ **Exiting menu without making an entry:** Press button **BACK** in the center console (▷ page 159).

Channel number is valid and channel is included in subscription: The audio system tunes in the channel entered.

Channel number is invalid: The message **Invalid Channel** appears in the audio display.

- ▶ The message disappears automatically or press **⏪** to close the message.

Audio system

Channel number is valid, but channel is not included in subscription: The message **Call SIRIUS to activate:** appears (▷ page 173).

- ▶ Press to close the message in the audio display.

Tuning in channels using the satellite radio channel list

- ▶ (repeatedly, if necessary) → Sat → Channel List.

The channel list appears. The dot • in front of a list entry indicates the currently selected channel.

- ▶ Select channel by rotating or sliding .
- ▶ Press to confirm.

i The contents of the channel list depends on which channels are included in your subscription and which program category you have selected (▷ page 174). The channel list contains only the preview channel if the satellite radio service has not been subscribed to.

Tuning in channels using satellite radio channel presets

- ▶ (repeatedly, if necessary) → Presets.

or

- ▶ Press when the main area is selected. The preset menu appears. The dot • in front of a preset position indicates that this is the channel currently selected and being listened to.

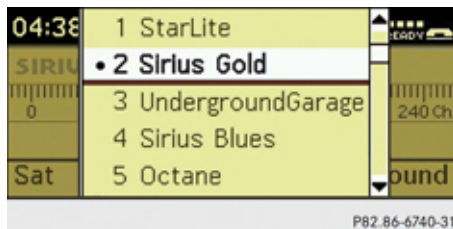

- ▶ Select station in memory by rotating or sliding .
 - ▶ Press to confirm.
- or
- ▶ Press desired station button to , with the keypad in audio control unit briefly.

The audio system tunes in the corresponding channel as long as it is included in your subscription and is still available.

If the channel is not included in your subscription, the message **Call SIRIUS to activate:** appears.

If the channel is no longer available, the message **Invalid Channel** appears.

- ▶ **Closing message:** Press .

Storing channels

i There are ten preset positions available.

- ▶ Press when the main area is selected.

or

- ▶ (repeatedly, if necessary) → Presets.

In both cases, the preset menu will appear in the audio display. The dot • in front of a preset position indicates that the channel currently selected is stored there.

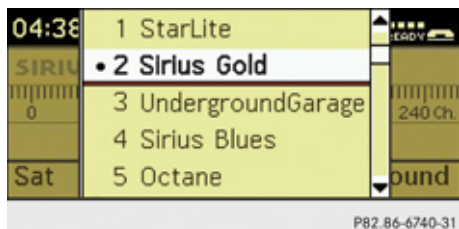

▶ **Selecting a preset position:** Slide \uparrow \odot \downarrow or rotate \odot .

▶ **Storing a preset position:** Press and hold \odot until you hear a signal. The channel is stored.

or

▶ Press and hold desired channel button $\mathbf{1}$ to $\mathbf{0}$ on keypad, until a brief signal tone sounds. The channel is stored.

Show program info

▶ **RADIO** (repeatedly, if necessary) \rightarrow Info.

i If the program provider does not offer any information, the Info menu item cannot be selected.

You will see a screen that may contain the following information (if available):

- Selected program category
- Selected channel
- Artist of the track currently being played
- Name of current track

i SIRIUS determines what information is displayed on the screen. The audio system shows no more than two lines per item of information. If an item of information is too long, the audio system shortens it.

With the telephone keypad button $\mathbf{\#}$ you can call up a popup screen, if provided by SIRIUS, that shows the artist and title of the current track being played on the selected channel.

The popup screen disappears automatically.

▶ **Closing screen manually:** Slide \leftarrow \odot \rightarrow , rotate \odot , press \odot or press button **BACK**.

Calling SIRIUS Service Center

i It may be necessary to call the SIRIUS Service Center if, for example:

- You want to cancel the subscription or re-subscribe at a later date.
- You forget to pay the bill.
- You sell the car to another person.

▶ **RADIO** (repeatedly, if necessary) \rightarrow Sat \rightarrow Service.

The telephone number of the SIRIUS Service Center and the twelve-digit electronic serial number (SIRIUS-ID) of the particular receiver are displayed.

▶ **Closing screen:** Slide \leftarrow \odot \rightarrow , press \odot or press button **BACK**.

Channel update

The service provider may conduct a channel update.

During the update, the message Updating Channels . . . will appear on the audio display.

The channel last tuned will be muted until the update is completed. You cannot operate the satellite radio during the update.

Audio system

After completion of the update, the satellite radio basic menu will appear. The station last tuned to will begin to play. If not available, the next subscribed channel starts beginning with channel 1.

Sound settings

For sound adjusting see:

- Volume (▷ page 163)
- Balance control and fader (▷ page 164)

- Bass and treble control (▷ page 163)
- Surround sound (▷ page 164)

CD and MP3 mode

Submenu overview

CD or MP3	Track list (Audio CD) or Folder (MP3)	Changer (with CD-changer only)	Sound
Normal Track Sequence	Select track (CD mode only)	Select medium	Treble
Random Tracks	Select folder and/or tracks (MP3 mode only)	Eject all	Bass
Random Folders (MP3 mode only)		Fill empty slots	Balance/Fader
AUX			Surround sound

i The components and operating principles of the audio system can be found on (> page 153) and (> page 161).

The audio system will be fitted with either a single CD drive or a CD changer.

The single CD player and the CD changer can play audio CDs as well as CDs with MP3 or WMA files.

The available menu options will vary depending on the equipment and the type of CD.

Safety precautions

⚠ Warning!

The single CD player and the CD changer are classified as a Class 1 laser product. You must not open the casing. There is a risk of exposure to invisible laser radiation if you open the casing, or if the casing is faulty or damaged.

The single CD player and the CD changer do not contain any parts that you are able to maintain yourself. For safety reasons, all maintenance work must be carried out by qualified technicians.

⚠ Warning!

In order to avoid distraction which could lead to an accident, the driver should insert or eject CDs with the vehicle at a standstill and operate the audio system only if permitted by road, weather and traffic conditions.

Bear in mind that at a speed of just 30 mph (approximately 50 km/h), your vehicle is covering a distance of 44 feet (approximately 14 m) every second.

Audio system

General notes

i Audio CDs with copy protection are not compatible with the CD audio standard and therefore may not be able to be played by the single CD player and/or the CD changer. There may be playback problems when playing copied discs.

There is a large variety of discs, disc-writing software and writers available. This variety means that there is no guarantee that the system will be able to play discs that you have written/copied yourself.

There may be playback problems if you use CD-R or CD-RW type discs you have copied yourself with a storage capacity of more than 700 MB. These CDs are not compatible with currently applicable standards.

! Do not affix stickers or labels to the CDs, they can become warped due to the heat that develops in the CD drive or CD changer.

In certain situations, the CDs can then no longer be ejected and cause damage to the drive. Such damage is not covered by the Mercedes-Benz Limited Warranty.

! Your CD drive or CD changer has been designed to play CDs which correspond to the IEC 60908 standard. You can therefore only use CDs with a maximum thickness of 1.3 mm.

If you insert thicker discs, e.g. ones that have data on both sides (one side with DVD data, the other side with audio data), they cannot be ejected and will damage the drive.

Do not use CDs with a diameter of 8 cm. Attempting to play CDs with a diameter of 8 cm or playing such CDs with an adapter may cause damage to the CD drive. Such damage is not covered by the Mercedes-Benz Limited Warranty.

Only use round discs with a diameter of 12 cm.

Should excessively high or low temperatures occur while in CD changer mode, a message will appear in the display, and the CD will be muted until the temperature has reached an acceptable level for the system to continue operation.

Tips on handling CDs

- Only touch the CDs at the edges.
- Handle CDs carefully to prevent interference during playback.

- Avoid scratches, fingerprints and dust on the CDs.
- The CDs must only be labeled using pens specially designed for this purpose.
- Clean CDs from time to time with a commercially available cleaning cloth. Never wipe the CD in a circular motion; instead, wipe it in a straight line starting in the center and moving outward. Do not use solvents, anti-static sprays, etc. for cleaning.
- Replace the CD in its case after use.
- Protect CDs from heat and direct sunlight.

Notes about MP3 mode

The single CD player and the CD changer can play audio CDs as well as CDs with MP3/WMA files.

i Due to the branched data structure, playback of the first track may be delayed slightly.

Permissible media for MP3/WMA files

- CD-R
- CD-RW

Permissible file systems

- ISO9660/Joliet for CDs

Multisession CDs

For multisession CDs, the first session type of the CD determines how the audio system will process the CD.

For example, if the first session type is according to the audio CD standard and the second session type is according to the data CD standard containing MP3/WMA tracks, the audio system will treat the CD as a conventional audio CD. This means that it is only possible to access the audio CD tracks. Access to the MP3/WMA tracks is not possible.

Similarly, if the first session type is according to the data CD standard containing MP3/WMA tracks and the second session type is according to the audio CD standard, the audio system will treat the CD as a data CD. This means that it is only possible to access the MP3/WMA tracks. Access to the audio CD tracks is not possible.

File structure on a disc

When you create an MP3/WMA disc, the MP3/WMA tracks can be organized in folders. A folder can also contain other folders. A disc can contain a maximum of

255 folders. Each folder can contain a maximum of 255 tracks and 255 folders.

A data medium may contain a maximum of 500 tracks.

Track and folder names

When you create an MP3/WMA disc, you can assign names to the MP3/WMA tracks and folders.

The audio system uses these names for the corresponding display in MP3 mode. Empty folders or folders which contain data other than MP3/WMA tracks are not displayed by the audio system.

If MP3/WMA files are saved in the root directory itself (uppermost directory on storage medium), the root directory will also be treated as a folder. The audio system will then show the name of the root directory as the folder name.

You must observe the following when assigning track names:

- Track names must have at least one character.
- Track names must have the extension “mp3” or “wma”.
- There must be a period between the track name and the extension.

Example of a correct track name:

Track1.mp3

The audio system is unable to recognize an MP3/WMA track if:

- there is no period between the track title and the extension
- there is no extension

i The audio system does not support ID3 tags.

Compatible file systems and compression methods

The following compression methods are compatible:

- MP3
- WMA

i If music files created using different compression methods other than MP3 are stored together on a disc, the loading process may take longer.

Permissible MP3 formats

The audio system supports the MPEG1 Audio Layer 3 format.

i This format is generally known as “MP3”.

Audio system

Permissible bit and sampling rates

- Fixed and variable bit rates up to 320 kbit/s
- Sampling rates of 24 kHz – 48 kHz

i Only use MP3 tracks with a bit rate of at least 128 kbit/s or higher and a sampling rate of at least 44.1 kHz or higher. Smaller rates can cause a noticeable deterioration in sound quality. This is especially the case if you have activated the surround sound function.

WMA (Windows Media Audio)

Windows Media Audio (WMA) is an audio data compression technology developed by Microsoft.

The audio system supports the following types of audio files:

- fixed bit rates of 5 kbit/s up to 384 kbit/s
- sampling rates from 8 kHz to 48 kHz

The audio system does not support the following WMA files:

- DRM (Digital Rights Management) coded files
- variable bit rates

- WMA Pro
- 5.1 Surround

Notes on copyright

The music tracks that you create and play back in the MP3 and WMA format are generally subject to copyright protection in accordance with the applicable international and national regulations.

In many countries, reproductions are not permitted without the prior consent of the copyright holder, not even for private use.

Make sure you know the applicable copyright regulations and that you comply with these.

If you own these rights yourself, e. g. for your own compositions and recordings, or the copyright holder has granted you permission, these restrictions do not apply.

Operating the CD player

The single CD drive and the CD changer have the same controls.



- ① CD slot
- ② Load/eject button
- ③ Forward
- ④ Rewind

Single CD player

► **Switching to CD mode:** Press button **DISC** on the audio control unit.

The CD display appears when you switch to CD mode. CDs start to play automatically when they are inserted. The following message will appear if no CD is inserted.

Audio system

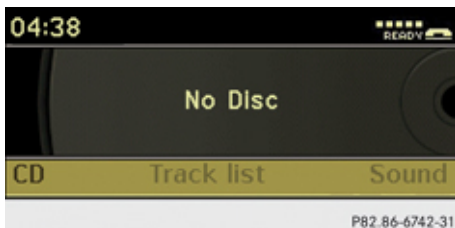

⚠ Warning!

In order to avoid distraction which could lead to an accident, the driver should insert or eject CDs with the vehicle at a standstill and operate the audio system only if permitted by road, weather and traffic conditions.

Bear in mind that at a speed of just 30 mph (approximately 50 km/h), your vehicle is covering a distance of 44 feet (approximately 14 m) every second.

- ❗ If a CD is already loaded, it must be ejected before inserting a new CD. Inserting a second CD in the slot with another CD still loaded will cause damage to the CD drive not covered by the Mercedes-Benz Limited Warranty.

- ▶ **Ejecting a CD:** Press load/eject button ②.
The system ejects the CD. Please Remove Disc appears in the display.
- ▶ Remove CD from CD slot ①.
NO Disc appears in the display.

- ① If you do not take the CD out of the CD slot ① within approximately 15 seconds, the system automatically pulls the CD back in and plays it.

If you change modes (e.g. Radio) when the CD is being ejected, the CD will be reinserted automatically as well.

If a CD is pulled back in, press load/eject button ② again; the CD will then be ejected.

- ① If the audio CD is printed on one side, this side must face upwards when loaded. If neither side is printed, the side to be played must face downwards.

If a CD has been inserted incorrectly or cannot be read, Disc Unreadable appears in the display.

- ▶ **Loading a CD:** Insert CD into CD slot ①.
The system automatically pulls the CD into the CD slot ① and starts to play the audio

CD if it has been inserted correctly and is permissible.

CD changer

The CD changer can hold up to a total of six audio CDs.

- ▶ **Switching to CD mode:** Press button **DISC** on the audio control unit.

The CD changer display appears when you switch to CD changer mode. If there is a CD in one of the magazine trays, it will start to play automatically. The following message will appear if no CDs are inserted.

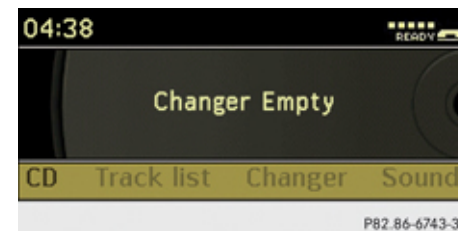

⚠ Warning!

In order to avoid distraction which could lead to an accident, the driver should insert or eject CDs with the vehicle at a standstill and operate the audio system only if permitted by road, weather and traffic conditions.



Audio system

Bear in mind that at a speed of just 30 mph (approximately 50 km/h), your vehicle is covering a distance of 44 feet (approximately 14 m) every second.

- i** If the audio CD is printed on one side, this side must face upwards when loaded. If neither side is printed, the side to be played must face downwards.

If a CD has been inserted incorrectly or cannot be read, Disc Unreadable appears in the display.

▶ Loading an individual magazine

compartment: Press load/eject button ②.

A menu indicates which magazine compartments are currently loaded. The first available magazine compartment is indicated by a red number.

- ▶ Press desired button **1** to **6 MNO**, in the keypad to select a magazine compartment.

or

- ▶ Slide **←⊙→** or rotate **⏪⊙⏩** to select a magazine compartment.
- ▶ Press **⊙** to confirm.

The CD changer will switch to the selected magazine compartment. The message Please Wait... appears in the display.

- i** Only insert a CD after the audio system has prompted you to do so with the message Please Insert Disc <X>. Only insert one CD per magazine compartment.

- ▶ Insert CD into CD slot ①.
The CD changer automatically pulls the CD into the CD slot ① and places it in the selected magazine compartment. The message Loading Disc <X> appears in the display.

- i** The loading process may take a while, depending on the type of disc. If you do not insert a disc, the display will switch back to the CD changer menu after approximately 20 seconds.

- ▶ Press button **DISC**, or the load/eject button ② on the audio control unit to finish the loading process.
The CD changer plays the disc if it has been inserted correctly and is permissible.

- ▶ **Interrupting loading procedure:** Press the load/eject button again.

or

- ▶ Press button **BACK** in the center console (▷ page 159).

▶ Filling an empty magazine

compartment: Press load/eject button ②.

A menu indicates which magazine compartments are currently loaded. The first available magazine compartment is indicated by a red number.

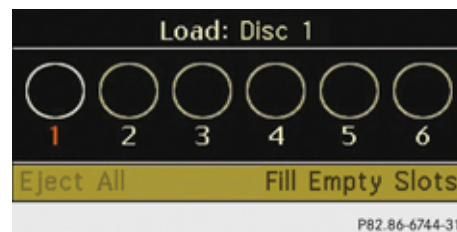

- ▶ Slide **⊙↓** to select the menu bar.
- ▶ Slide **←⊙→** or rotate **⏪⊙⏩** the audio controller to select Fill Empty Slots.
- ▶ Press the audio controller **⊙**.
The message Please Insert Disc <X> appears in the display.

- i** Only insert a CD after the audio system has prompted you to do so with the message Please Insert Disc <X>. Only insert one CD per magazine compartment.

Audio system

- ▶ Insert CD into CD slot ①.

The CD changer automatically pulls the CD into the CD slot ① and places it in an empty magazine compartment. The message *Please Wait...* appears in the display. If the CD is loaded, the CD changer will switch to the next empty magazine compartment. The message *Please Insert Disc <X>* appears in the display.

- ▶ Repeat the steps until all compartments have been loaded.
- ▶ Press load/eject button ② on the audio control unit to finish the loading process. The CD changer plays the last loaded disc if it has been inserted correctly and is permissible.
- ▶ **Interrupting loading procedure:** Press load/eject button ② again.

or

- ▶ Press button **BACK** in the center console (> page 159). The loading process has not been completed, the audio system will play the last inserted CD.

Ejecting CDs from CD changer

⚠ Warning!

In order to avoid distraction which could lead to an accident, the driver should insert or eject CDs with the vehicle at a standstill and operate the audio system only if permitted by road, weather and traffic conditions.

Bear in mind that at a speed of just 30 mph (approximately 50 km/h), your vehicle is covering a distance of 44 feet (approximately 14 m) every second.

- ① If you eject a CD while another is being played, the audio system interrupts playback. Playback will continue once the CD has been ejected completely.
- ▶ **Ejecting one CD:** Press load/eject button ②. The magazine menu with active main area appears in the audio display. The magazine compartment with the current CD is highlighted.

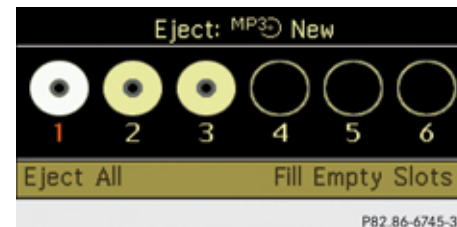

- ▶ Press desired button **1** to **6**, in the keypad to select a magazine compartment.
- or
- ▶ Slide **←** or **→** or rotate **⏪** or **⏩** the audio controller to select the desired CD.
 - ▶ Press **⏹** to confirm.
 - ▶ Remove the CD from CD slot. If you do not remove the CD from the CD slot, the CD changer will automatically pull the CD back in after a short while.
- ① If audio source is changed during eject procedure (e.g. pressing button **RADIO**) the eject procedure will be aborted and any CDs being ejected will be drawn back into the unit.
 - ▶ **Ejecting all CDs:** Press load/eject button ②. The magazine menu with active main area appears in the audio display. The magazine



Audio system

compartment with the current CD is highlighted.

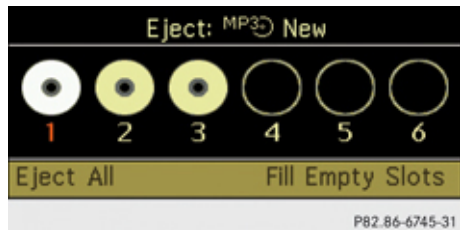

- ▶ Slide to select the menu bar.
 - ▶ Slide or rotate the audio controller to select Eject All.
 - ▶ Press to confirm.
The CDs are ejected one after the other.
 - ▶ Remove the CD from CD slot.
The CD changer switches to the next occupied magazine compartment and ejects the CD.
If you do not remove the CD from the CD slot, the CD changer will automatically pull the CD back in after a short while.
- i** If audio source is changed during eject procedure (e. g. pressing button **RADIO**) the eject procedure will be aborted and any

CDs being ejected will be drawn back into the unit.

- ▶ Repeat the last step until the magazine is empty.

Selecting a CD

- ▶ **DISC** → Changer
The magazine menu with active main area appears in the audio display. The magazine compartment with the current CD is highlighted.
- ▶ Slide or rotate the audio controller to select the desired CD.
- ▶ Press to confirm.

Playing CDs

- i** The following section is valid for the single CD player and the CD changer. The illustrations show the audio display of the CD changer.

Additional button functions

In CD mode, you can use two additional buttons on the telephone keypad:

- #** displays information about the track, if this has been saved with the track on the CD.
- *** enables you to enter the track number directly.

Example display in audio CD mode

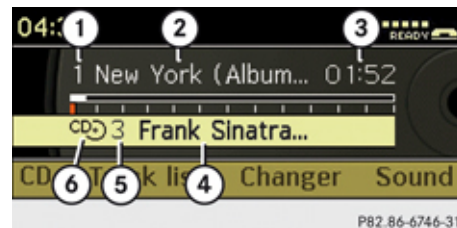

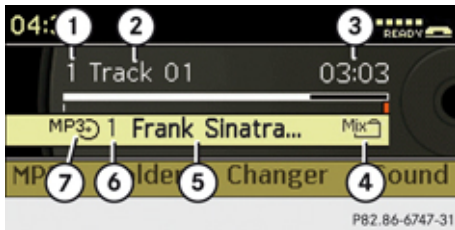

- ① Track number
- ② Track name (only if saved on the disc)
- ③ Elapsed track time
- ④ Disc name (only if saved on the disc)
- ⑤ Disc number (CD changer)
- ⑥ Disc type

Example display in MP3 mode





- ① Track number
- ② File name
- ③ Elapsed track time
- ④ Mode
- ⑤ Folder name (only if saved on the disc)
- ⑥ Disc number (CD changer)
- ⑦ Disc type

Pause function

- ▶ **Pausing playback:** Press button  briefly.
- ▶ **Continuing playback:** Press button  again briefly.

Selecting a track

- ▶ **Skipping forwards or backwards to a track:** Rotate  or slide .





or

- ▶ Briefly press button  or  on audio control unit.

- ① Skipping forwards through the tracks skips to the next track. Skipping backwards through the tracks skips to the beginning of the current track if the track has been playing for more than 8 seconds. If the track has been playing for less than 8 seconds, it skips to the start of the previous track. If you have switched on the Random Tracks playback option, the order of the tracks is random.

- ▶ **Selecting from the track list:**  → Track List.

or



- ▶ Press  when the main area is selected. The track list appears. In MP3 mode, the track list of the current folder appears. The dot ● indicates the current track.
- ▶ Select a track by rotating  or sliding .
- ▶ Press  to confirm.

- ① In MP3 mode, the list shows all the tracks in alphabetical order.

Fast forward/rewind

- ▶ Select main area.
- ▶ Slide and hold  until desired place is reached.

or





- ▶ Press and hold button  or  on audio control unit.

Selecting a folder

- ① This function is only available in audio MP3 mode.

- ▶  → Folder.

or

- ▶ Press  when the main area is selected. The track list of the current folder appears.
- ▶ **Move to the superordinate folder:** Select the  symbol. The display now shows the next higher folder level.
- ▶ **Selecting a folder:** Slide  or rotate  the audio controller, to select the desired folder.
- ▶ Press  to confirm. You will see the tracks in the folder.

Audio system

- i** Due to the large amount of information found on an MP3 disc it may take a while before all folder and track information becomes available. During this time the folder list may be unavailable or slow.
- ▶ Select a track by sliding or rotating the audio controller.
- ▶ Press to confirm.
The track is played and the corresponding folder is now the active folder.

Playback options

The following options are available:

- Normal Track Sequence
Tracks playback in the order on the disc (e.g. track 1, 2, 3, etc.).
- Random Tracks
Tracks playback in a random order (e.g. track 3, 8, 5, etc.).
- Random Folder (in MP3 mode only)
Tracks in the active folder and any subfolders playback in random order.

- ▶ **Selecting an option:** → CD/MP3.
The option list appears. A dot indicates which option is switched on.
- ▶ Select an option and press .
- The option is switched on. For all options except Normal Track Sequence, you will see a corresponding indicator in the main area.
- i** The Normal Track Sequence option is automatically activated when you select a different medium. If an option is activated, it remains activated after the audio system is switched on/off.

Audio AUX mode

An external audio source can be connected to the AUX socket of the audio system. The AUX socket is located in the glove box. Please contact an authorized Mercedes-Benz Center for more information.

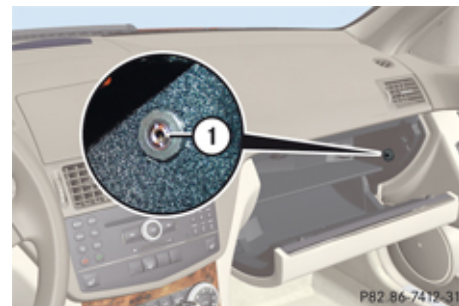

- ① AUX socket: Socket for 3.5 mm stereo jack, for devices with dedicated analog audio output or connection via headphone port, e.g. MP3 or tape player

Warning!

Only operate an external audio source when the vehicle is stationary. There is a risk of accident by being distracted from road and traffic conditions if you operate an external audio source while the vehicle is in motion.

Bear in mind that at a speed of just 30 mph (approximately 50 km/h), your vehicle is covering a distance of 44 feet (approximately 14 m) every second.

Calling up AUX mode

Warning!

Due to the different volumes of the external audio sources, system messages of the vehicle may be much louder. You may need to disable these system messages or adjust the volume of these messages manually.

▶ **Selecting audio AUX mode:**

Press button **DISC** repeatedly until the main menu for AUX operation appears.

or

▶ In CD mode: Select CD/MP3 → Aux.

The audio AUX menu appears. The medium in the external audio source is heard, provided it is connected and switched to playback.

 Please refer to the relevant operating guide for operation of the external audio source.

The following settings can be made in the audio AUX mode:

- Volume (▷ page 163)
- Balance control and fader (▷ page 164)
- Bass and treble control (▷ page 163)
- Surround sound (▷ page 164)

¹³ Observe all legal requirements.

 The volume of external audio sources is extremely variable. It is possible that a device connected as an external audio source will sound quieter or louder in the vehicle or that the usual maximum volume cannot be achieved. On certain devices the volume can be set separately. In this case, start at a moderate volume and increase it slowly. In this way, you can determine whether the system is capable of playback without distortion, even at high volume.

Switch back to CD mode

▶ Press button **DISC**.

or

▶ Select Back To Disc in the audio AUX menu.

Telephone

Safety precautions

Warning!

Please do not forget that your primary responsibility is to drive the vehicle. A driver's attention to the road must always be his/her primary focus when driving. For your safety and the safety of others, we recommend that you pull over to a safe location and stop before placing or taking a telephone call.

If you choose to use the mobile phone¹³ while driving, please use the hands-free device and only use the mobile phone when road, weather and traffic conditions permit. Some jurisdictions prohibit the driver from using a mobile phone while driving a vehicle.

Bear in mind that at a speed of just 30 mph (approximately 50 km/h), your vehicle is covering a distance of 44 feet (approximately 14 m) every second.

Warning!

Never operate radio transmitters equipped with a built-in or attached antenna (i.e.

Audio system



without being connected to an external antenna) from inside the vehicle while the engine is running. Doing so could lead to a malfunction of the vehicle's electronic system, possibly resulting in an accident and/or serious personal injury.

i The functions and services available to you while using the mobile phone depend on your service provider and the type of

mobile phone you are using. See also separate operating manual of your mobile phone for instructions on how to use your mobile phone.

When the mobile phone is connected via the Bluetooth® interface to the audio system, you can operate the mobile phone using the following devices:

- audio system (▷ page 201)

- Audio controller
- Audio control unit
- buttons  and  on the multifunction steering wheel (▷ page 131)
- mobile phone keypad

Please note that these functions are only available with Mercedes-Benz approved mobile phones.

TEL Menu

Telephone	Name	Call lists Microphone off/on
Bluetooth® Phones	Phone book	Call Lists or Mic On/Mic Off
Receive Business Card(s) (vCards) Delete external data		Delete Call Lists

General notes

Making calls via Bluetooth® interface

The audio system telephone function via the Bluetooth® interface is available in conjunction with a Bluetooth® enabled mobile phone.

With a suitable mobile phone, you can use the hands-free device and receive electronic business cards (vCards) via the Bluetooth® interface.

Further information on suitable mobile phones and on connecting Bluetooth® enabled mobile phones to the audio system

are available at an authorized Mercedes-Benz Center.

Calls disconnected while the vehicle is in motion



Interruptions to the connection may occur if

- there is insufficient mobile network coverage.
- you move from one mobile network transmitter/receiver area (mobile network cell) into another and no channels are free or the cell is full.
- you are using a SIM card that is not compatible with the available network.
- when using a mobile phone with “Twincard”, the mobile phone is simultaneously logged into the network with the second SIM card.

Operating options

- i** The components and operating principles of the audio system can be found on (▷ page 153) and (▷ page 161).

When the mobile phone is connected via the Bluetooth® interface to the audio system, you can operate the mobile phone using the following devices:

- buttons  and  and keypad on audio control unit
- audio controller in center console
- multifunction steering wheel

Please note that these functions are only available with Mercedes-Benz approved mobile phones. Please contact an authorized Mercedes-Benz Center for information on features available for your mobile phone of choice.

- i** In order for the functions described in this section to work correctly, the Bluetooth® telephone must be linked to the audio system (▷ page 166). Please make sure any other Bluetooth® device linked with the mobile phone is switched off before you use the telephone functions with the audio system.

Changes or modifications not expressly approved by the party responsible for compliance could void the user's authority to operate the equipment.

The head unit internal Bluetooth® transmitter must not be co-located or operated in conjunction with any other antenna or transmitter.

This equipment complies with FCC/IC radiation exposure limits set forth for uncontrolled equipment and meets the FCC radio frequency (RF) Exposure Guidelines in Supplement C to OET65 and RSS-102 of the IC radio frequency (RF) Exposure rules. This equipment has very low levels of RF energy that it is deemed to comply without testing of specific absorption ratio (SAR).

Unless otherwise indicated, the descriptions and illustrations in this section refer to audio system.

Caller ID

The audio system can display the telephone number and the name of the caller, e. g. for an incoming call and also in other menus or displays.

For the telephone number to be displayed, the caller must transmit their telephone number. Otherwise Unknown will be shown on the audio display.

This is also the case for name displays. For this, the telephone number and the name of



Audio system

the caller must also be saved in the telephone book.

Functional restrictions

You will not be able to use the mobile phone, or you may have to wait a while, in the following situations:

- If the mobile phone is switched off.
- If the mobile phone is not connected via the Bluetooth® interface to the audio system.
- The mobile phone must not be locked.
- If the mobile phone has not yet acquired a network signal.

The mobile phone automatically tries to log into a network. If no network is available, you will also not be able to make a “911” emergency call. If you attempt to make an outgoing call, the No Service message will appear for a short while.

- If you switch off the audio system in the middle of a call, e. g. by switching off the ignition, that call will be cut off. You can prevent this from happening as follows:
 - Switch the mobile phone to “private mode” before switching the audio system off (see mobile phone operating instructions).

Activating the mobile phone

Prerequisites for the mobile phone

For making calls using the audio system via the Bluetooth® interface, you will need a Bluetooth® enabled mobile phone.

Before attempting to make or receive calls via the Bluetooth® interface, check your mobile phone’s hands-free profile. It must support version 1.0 or higher (see mobile phone operating instructions).

i Not all mobile phones on the market are suitable. Further information on suitable mobile phones and on connecting Bluetooth® enabled mobile phones to the audio system are available from an authorized Mercedes-Benz Center.

Activating Bluetooth®

- ▶ Switch on the mobile phone (see mobile phone operating instructions).
- ▶ Enter the PIN (not necessary with some mobile phones or network).
- ▶ Activate Bluetooth® connection on the mobile phone (see mobile phone operating instructions).
- ▶ Press button **TEL** on the audio control unit to call up the telephone mode.

i On certain mobile phones, not only do you have to activate the Bluetooth® function but your own device must additionally be made “visible” for other devices.

Each Bluetooth® device has a Bluetooth® device name. It is recommended to give your mobile phone a personal name, by which you can clearly recognize your mobile phone.

i If the Bluetooth® function on the audio system is disabled, the message Bluetooth not activated in system settings appears.

▶ Activate Bluetooth® connection on the audio system (▷ page 166).

▶ **sys** → System → Activate Bluetooth.

You have activated or deactivated Bluetooth®. A checkmark appears when Bluetooth® is activated.

Registering a mobile phone (authorizing)

When you use your mobile phone in conjunction with the audio system for the first time, you must register (authorize) it.

It is possible to register up to 15 mobile phone. The connection is always established to the last activated mobile phones in signal range. When you authorize a new mobile phone, it is activated automatically. You can switch between the authorized mobile phones.

Searching for a mobile phone

- ▶ **TEL** → Tel → Bluetooth Phones → Update.

The audio system searches for suitable Bluetooth® telephones within range and enters them in the telephone list.

Authorized Bluetooth® telephones will be identified by a telephone-symbol  in front of the list entry once the telephone list has been updated (The symbol will be grayed out if the authorized mobile phone is not located in the Bluetooth® range.).

- i** The duration of the search procedure depends on the number and type of Bluetooth® telephones. The search may take a few minutes.
- i** If the telephone list is already full (15 entries), you must de-authorize one of the authorized devices, and start the

search again. Otherwise a new device you are looking for will not appear in the list.

If the audio system does not find your mobile phone, external authorization may be necessary (▷ page 194).

Authorizing a Bluetooth® device

- ▶ Select the desired unauthorized device from the telephone list by pushing the audio controller.
- or
- ▶ Select Options → Authorize.
The input menu for the passcode appears.

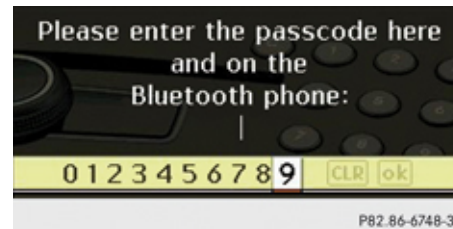







- i** The passcode is any one- to sixteen-digit number, which you can set yourself. For the quality of coding of the connection it is recommend to use a passcode of at least four digits. You must enter the same number in the audio system and also in the device to be authorized. Please also refer



to the instructions in the mobile phone operating guide.

On the audio system, you can enter the passcode via the digits in the on-screen menu bar or via the telephone keypad in the audio control unit.

With the audio controller:

- ▶ **Entering passcode:** Select the digits in the menu bar one by one, by sliding   or rotating  the audio controller.
- ▶ Press  to confirm each digit.
- ▶ **Confirming passcode:** Select **OK** in the menu bar and press  to confirm.
- ▶ **Deleting digits:** Select **CLR** in the menu bar and briefly press  to delete one digit, or press and hold  to delete all entered digits.
- ▶ **Canceling entry:** Press button **BACK** in the center console (▷ page 159).

With keypad on audio control unit:

- ▶ **Entering passcode:** Press the desired numbers on the keypad.
- ▶ **Confirming passcode:** Press button  or button  in the audio control unit to confirm.

Audio system

- ▶ **Deleting digits:** Briefly press button **CLR** in the audio control unit to delete one number, or press and hold button **CLR** to delete all entered numbers.
- ▶ **Canceling entry:** Press button **BACK** in the center console (▷ page 159).

Entering passcode into the mobile phone

If a Bluetooth® connection is established successfully, you will be prompted to enter a code into the mobile phone (see the operating instructions for the mobile phone).

- ▶ Enter the same passcode on the mobile phone as you did on the audio system.

i You may need to enter a confirmation once you have entered the passcode on your mobile phone. Check your mobile phone display.

If the message *Authorization Procedure Unsuccessful* appears on the audio system display, you may have exceeded the preset period for authorization. Repeat the process.

The device is authorized. You can now make calls via the audio system hands-free device using the authorized mobile phone.

External authorization

If the audio system cannot find your mobile phone, this may be due to special security settings on your mobile phone. In this case, you can check whether, conversely, your mobile phone can find the audio system. The audio system's Bluetooth® device name is "MB Bluetooth".



- ▶ **TEL** → Tel → Bluetooth Phones → Update → Options → External Authorization.
The message *Ready for External Authorization* appears.
- ▶ Start Bluetooth® search procedure on the mobile phone (see the operating instructions for the mobile phone).
- ▶ Select the audio system ("MB Bluetooth") at your mobile phone.
- ▶ When prompted to do so, enter the passcode on the mobile phone and then on the audio system.

Displaying details on a mobile phone

- ▶ **TEL** → Tel → Bluetooth Phones.
- ▶ Select the mobile phone from the list.

- ▶ Select Options → Details.

The details screen for the device is shown in the audio display.

- ▶ **Closing details screen:** Slide , rotate , or press , or press button **BACK**.

De-authorizing a Bluetooth® device

- ▶ **TEL** → Tel → Bluetooth Phones.

- ▶ Select authorized device.

- ▶ Select Options → De-Authorize.

A prompt appears asking whether you really want to de-authorize this device.

- ▶ Select Yes or No.

If you select Yes, the device will be de-authorized.

i If you de-authorize a device which has been authorized in the past and which is not detected in the search, this device will no longer be displayed in the device list.

Devices which have been authorized in the past but which are not detected in the search are either not switched on or not in the vehicle.

Activating another mobile phone

If you have several authorized mobile phones, you can switch between the individual mobile phones.

Audio system

- i** You cannot switch to another authorized mobile phone during a call.

When you authorize a new mobile phone, it is automatically activated. Only one mobile phone can be active at a time.

- ▶ **TEL** → Tel → Bluetooth Phones.
- ▶ Select an authorized mobile phone from the list.
- ▶ Press  to confirm.

The selected mobile phone will be searched for and connected if it is located in the Bluetooth® range and Bluetooth® is activated on the corresponding device.

The selected mobile phone is activated.

A dot • in front of the entry, indicates the current active mobile phone in the phone list.

Receiving business cards

You can import business cards (vCards) into the address book from external Bluetooth® devices (▶ page 197).

TEL-Basic display

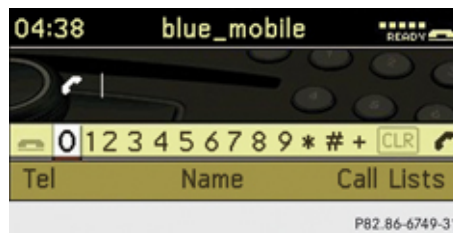

- ▶ Press button **TEL** on the audio control unit to call up the telephone mode.

When the connected mobile phone is ready for operation, the display will look like this:





The following information is displayed in the status bar:



- Actual time: 04:38
- Bluetooth® device name of the connected mobile phone, in this case: blue_mobile
- Mobile phone network signal strength . This information will only be shown with suitable mobile phones.

The bars indicate the current signal strength of the mobile phone network for reception. Optimum reception is indicated by all bars full. All bars empty indicates very poor or no reception.
- Receiver symbol  or . The receiver symbol indicates whether a call is being connected or is in progress:
 -  - not active

- READY indicates that a call is possible.
- NO SERVICE indicates that the mobile network is not available.

Setting transmit and receive volume

- i** These settings should normally not be changed as the factory settings are matched to most mobile phones. Find out about the optimum settings for your mobile phone at an authorized Mercedes-Benz Center.
- i** Changes may result in significant impairments to the transmission quality. These settings may not be changed during an active phone call.
- ▶ **TEL** → Tel → Bluetooth Phones.
- ▶ Select a mobile phone from the list.
- ▶ Select Options → Reception Volume or Transmission Volume.
- ▶ **Setting the volume:** Slide  or rotate  the audio controller.

The volume bar moves up or down.
- ▶ **Exiting menu:** Press  or slide  the audio controller or press button **BACK**.

Audio system

Emergency calls “911”

i The “911” emergency call system is a public service. Using it without due cause is a criminal offense.

i This function places a call to the local “911” provider. It does not initiate a Tele Aid call.

The following describes how to dial a “911” emergency call using the audio system head unit when a Mercedes-Benz specified mobile phone is connected via the Bluetooth® interface to the audio system. Unless otherwise specified, the descriptions refer to the audio system head unit.

Consult the separate mobile phone operating instructions that came with your mobile phone for information on how to place a “911” emergency call on the mobile phone.

The following conditions must be met for a “911” emergency call via the audio system:

- Mobile phone must be switched on.
- The corresponding mobile communications network must be available.

i Emergency calls may not be possible with all telephone networks or if certain network

services and/or telephone functions are active. Check with your local service providers.

If you cannot make an emergency call, you will have to initiate rescue measures yourself.

GSM network phones

Placing a “911” emergency call using audio control unit with the mobile phone unlocked

- ▶ Press button **TEL** to switch to telephone mode.
- ▶ Enter 911 using the number keypad on the audio control unit.
- ▶ Press button .

or

- ▶ Press  for dialing to begin. Connecting... appears in the audio display while the mobile phone establishes the connection.
- ▶ Wait until the emergency call center answers, then describe the emergency.

i If no SIM card is in the mobile phone, with a few types of mobile phones NO SERVICE appears in the audio display. In that case, you only can make an emergency

call on the mobile phone itself, without the use of the audio control unit.

Placing a “911” emergency call with the mobile phone locked

i If the mobile phone is locked, you only can make an emergency call on the mobile phone itself, without the use of the audio control unit.

CDMA network phones

Placing a “911” emergency call using audio control unit with the mobile phone unlocked

- ▶ Press button **TEL** to switch to telephone mode.
- ▶ Enter 911 using the number keypad on the audio control unit.
- ▶ Press button .

or

- ▶ Press  for dialing to begin. Connecting... appears in the audio display while the mobile phone establishes the connection.
- ▶ Wait until the emergency call center answers, then describe the emergency.

Placing a “911” emergency call with the mobile phone locked

- i** If the mobile phone is locked, you only can make an emergency call on the mobile phone itself, without the use of the audio control unit.

Phone book

You can save telephone numbers in the audio system’s phone book.

- i** These entries are retained even if you use the audio system with another mobile phone. You should delete these entries before handing over or selling your vehicle.

Receiving business cards (vCards)

You can import business cards (vCards) from external Bluetooth® phones into your audio system’s phone book. To do this:

- Bluetooth® must be activated on the audio system and on the external Bluetooth® phone (see the operating instructions for the mobile phone).
- The external Bluetooth® phone must be able to send vCards via Bluetooth® (see the

operating instructions for the mobile phone).

- The external Bluetooth® phone in the vehicle must be switched on and authorized.
- i** If you switch to a different mode while vCards are being received (e. g., press button **RADIO**), reception of vCards will be aborted.
- ▶ **TEL** → Tel → Receive Business Cards.
- ▶ Press **☺** to confirm.
- ▶ Wait until the message Ready to Receive - Received: 0 appears.
- ▶ **Importing:** Start the data transfer on the external Bluetooth® phone (“Export business cards (vCards)”, see the operating instructions for the mobile phone). The audio system imports the data for the business cards and displays the number of business cards received.
- i** Select Back or switch to a different mode to abort reception.

▶ **Ending reception:** Press **☺**.

or

- ▶ Press button **BACK** in the center console (▷ page 159).

Deleting external Data

- ▶ **TEL** → Tel → Delete External Data.
A prompt appears asking whether the data should be deleted.
- ▶ Select Yes or No.
If you select Yes all personal data are then deleted from the phone book.

Opening the phone book

- ▶ **TEL** → Name.
Entries in the phone book are displayed in alphabetical order. The search speller is active when more multiple entries are available. The search speller appears on the lower edge of the display.
You can use the search speller to reduce the number of entries you need to make.

Audio system

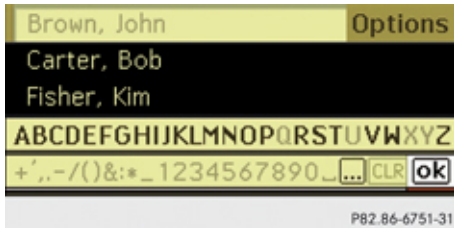

Symbol indicates that an entry contains more than one phone number. You can select these subentries (▷ page 199).

▶ **Switching from the search speller to the list:** Slide repeatedly.

or

▶ Select .

▶ **Switching from the list to the search speller:** Press button .

Selecting an entry

Selecting via search speller

▶ Switch if necessary from the list to the search speller.

▶ **Switching search speller character set:** Select .

Depending on the previous setting, this switches it to letters with special

characters or numbers with special characters.

▶ **Entering characters:** Slide or rotate the audio controller to select the characters for the required entry.

The first letters you enter determine the first letters of the word you are looking for.

▶ Press to confirm.

The first entry containing the selected initial letters is highlighted in the list. If there are a number of similar entries, the next different character is displayed.

Example:

In the example, the first letters of the names Fisher, Bob and Fisher, Kim are the same. The first possible distinct letter is the B or the K.

Therefore, B and K are offered as possibilities.

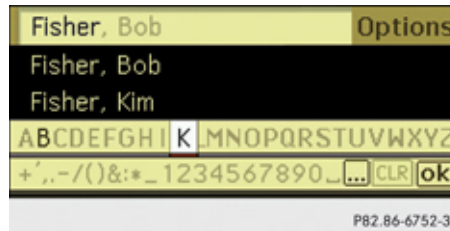

▶ Select the characters for the required entry one after another.

As soon as the selection has been narrowed down to a single entry, the audio system will switch to the list automatically.

▶ **Deleting an individual character:** Select and briefly press .

or

▶ Press button next to the audio controller.

After entering each character or after each deletion of a character, the closest matching entry is given at the top of the list.

▶ **Deleting an entire entry:** Select and press and hold until the entire entry has been deleted.

or

▶ Press and hold button until the entire entry has been deleted.

▶ **Ending search:** Switch from the search speller to the list.

The top list entry is highlighted automatically.

Selecting via list

▶ Switch if necessary from the search speller to the list.

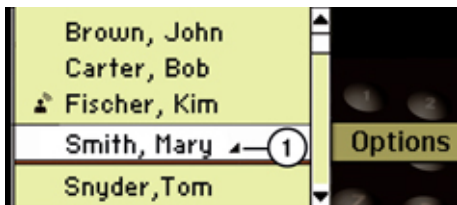

P82.70-6637-31

Phone book list

Entries with symbol ① have additional options available, e.g. more phone numbers.

- ▶ Slide ↑⊙↓ or rotate Ⓜ the audio controller until the desired entry is highlighted.
- ▶ Press Ⓜ to confirm and a call will be initiated.

Selecting subentries

- ▶ Select an entry with the symbol ▢ from the list and press Ⓜ.
- Symbol ▢ changes to ▣ and the subentries appear.

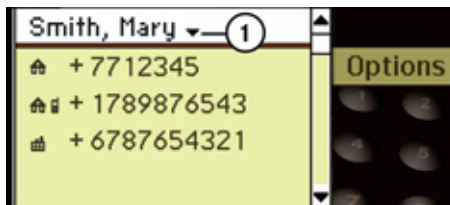

P82.70-6638-31

① Phone book entry with subentries

- ▶ Slide ↑⊙↓ or rotate Ⓜ the audio controller until the desired subentry is highlighted.
- ▶ Press Ⓜ to confirm and a call will be initiated.

Displaying details on an entry

The audio system can also fully display an abbreviated entry.

- ▶ Select entry.
- ▶ Slide ⊙→ to select Options.
- ▶ Press Ⓜ to confirm.

▶ Select Details.

A popup screen with the details of the selected entry appears.

▶ **Closing popup screen:** Slide ↑⊙↓, ←⊙→, rotate Ⓜ, press Ⓜ, or press button

CLR OR BACK.

Deleting entry

- ▶ Select entry.
- ▶ Slide ⊙→ to select Options.
- ▶ Press Ⓜ to confirm.
- ▶ Select Delete. You will be prompted to confirm that you really want to delete the entry.
- ▶ Select Yes or No. If you select Yes the actual entry is deleted from the phone book.

Audio system

Call lists

The audio system displays the calls received (including missed calls) or made during phone mode in their own lists.

- i** The particular menu item can only be selected if calls have already been received or made from audio system.

The display of missed calls in the audio system display is not possible with all mobile phones.

The control system displays the list of dialed numbers in the multifunction display.

- i** The audio system's call lists are not synchronized with the call lists on your mobile phone. If you make a call from your mobile phone and only use the audio system's hands-free device, these calls will not be listed.

Calling up the list

- ▶ **TEL** → Call Lists.
- ▶ Select Calls Received or Calls Dialed.
The appropriate list appears.



- i** If there is a symbol with a telephone receiver in front of the phone number or the name, then you have missed this call (e.g. in the highlighted line of the following figure).



- ▶ Slide or rotate the audio controller until the desired entry is highlighted.
- ▶ **Initiating call:** Press button or .
- ▶ **To close the lists:** Press button **BACK**.

Deleting call lists

- i** The saved call lists are retained in the audio system, even if you use the audio system with another mobile phone. For this reason you should delete any call lists before handing over or selling the vehicle.

- ▶ In the phone main menu select Call Lists.
- ▶ Select Delete Call Lists. You will be prompted to confirm that you really want to delete the entry. The question Do you want to delete the call lists appears in the display.
- ▶ Select Yes or No.
- ▶ Press to confirm.
If you select Yes both lists are deleted.

Audio system

Making calls

- ▶ Press button **TEL** on the audio control unit to call up the telephone mode.

When the mobile phone is ready for operation, the display will look like this:

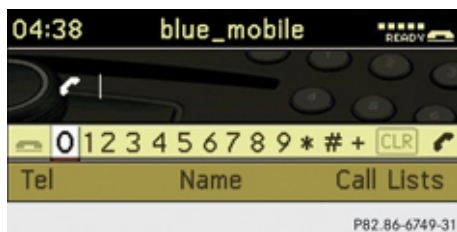

Initiating an outgoing call

Entering phone number via the audio control unit

You can enter numbers and special characters via the telephone keypad.

- ▶ **Entering:** Use **0** to **9**, **#** and ***** to enter characters.

You can enter the * character by pressing button ***+** once. You can enter the +

character by pressing button ***+** once and then again within approx. 1.5 seconds.

- ▶ **Initiating a call:** Press button **[Call]**.
- ▶ **Deleting individual digits:** Briefly press button **CLR** in the audio control unit.
- ▶ **Deleting an entire entry:** Press and hold button **CLR** until the entire entry has been deleted.

or

- ▶ Press button **[Call]**.

Entering phone number via the audio controller

In addition to the actual menu bar, the telephone main menu features a second bar containing numbers, the number menu.

When the bar is active (highlighted), you can select elements.

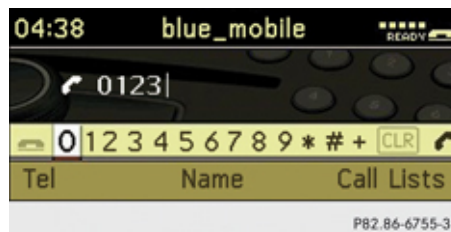

- ▶ **Entering digits:** Slide **←→** or rotate **[Left/Right]** the audio controller to select the required digit.
- ▶ Press **[Enter]** to confirm.
- ▶ Repeat the procedure, until you have select all digits for the necessary phone number.
- ▶ **Deleting individual digits:** Slide **←→** or rotate **[Left/Right]** to select **CLR** and briefly press **[Enter]**.

or



- ▶ Press button **CLR** next to the audio controller.
 - ▶ **Deleting entire phone number:** Slide **←→** or rotate **[Left/Right]** to select **CLR**, press and hold **[Enter]** until the phone number has been deleted.
- or
- ▶ Press and hold button **CLR** until the entire entry has been deleted.

or



- ▶ Press button **[Call]**.
 - ▶ **Initiating a call:** Slide **←→** or rotate **[Left/Right]** the audio controller to select **[Call]**.
 - ▶ Press **[Enter]** to confirm.
- or
- ▶ Press button **[Call]**.

Audio system

Initiating a call to a phone book entry

- ▶ **TEL** → Name.
- ▶ Select entry (▷ page 198).
- ▶ Press button  or .







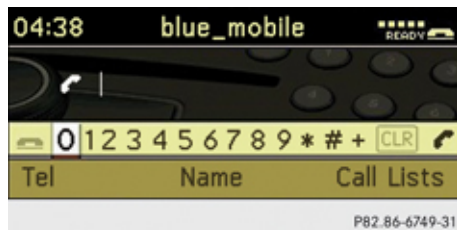

Initiating a call to a call list entry

- ▶ **TEL** → Call Lists.
- ▶ Select Calls Received or Calls Dialed.
The appropriate list appears.
- ▶ Select entry (▷ page 200).
- ▶ Press button  or .



Redialing



- i** In order to use the redial function, no numbers may have been entered.

- ▶ Press button .
- or
- ▶ Select  and press .
- The dialed calls list appears. The call dialed last will be at the top of the list.
- ▶ **Selecting a call:** Slide   or rotate  the audio controller until the desired entry is highlighted.
- ▶ **Initiating call:** Press button  or .

Aborting dialing or ending a call

- ▶ **TEL** →  and press .
- or
- ▶ Press button  on the audio control unit or on the multifunction steering wheel.

Rejecting or accepting calls

You will be notified of an incoming call by the ringing tone and a message on the display.

- i** Depending on the mobile phone you are using, the audio system's ringing tone may differ from the one you have set on your mobile phone. You may hear
 - the ringing tone set on the mobile phone
 - the audio system's preset ringing tone
 - the audio system's preset ringing tone and the ringing tone set on the mobile phone.

If the caller's name and number are among the entries in the audio system's phone book and the caller has not withheld this information, it will appear on the display. If the caller withholds this information, you will see:

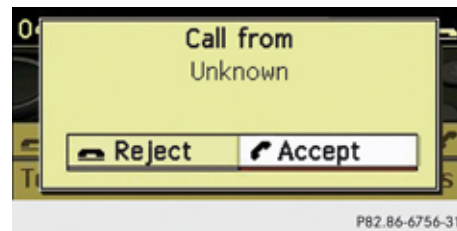



- ▶ **Accepting:** Press button  on audio control unit or on the multifunction steering wheel.

or

- ▶ Press .

- ▶ **Rejecting:** Press button  on audio control unit.

or

- ▶ Slide  or rotate  the audio controller to select **Reject**, and press  to confirm.

The call is rejected.

If you have accepted the call using the audio control unit, audio controller, or the multifunction steering wheel, the call will be conducted via the hands-free system. The volume of the call can be adjusted (▷ page 163).

Further operating functions can be found in the “Functions during a single-call” section (▷ page 203).

You can also accept a call if the audio display is showing a screen other than the telephone mode screen. After accepting the call, the display switches to the phone display. Once the call is over, the display for the previous mode will appear again.

Functions during a single call

Switching hands-free microphone on or off

The menu bar changes when you make or receive a call. Instead of the **Call Lists** menu item, **Mic Off** or **Mic On** will appear.

- ▶ **Switching off:** Select **Mic Off**.

The following message will flash up on the display: The microphone is off.

When the microphone is switched off the symbol  appears in the main area.

- ▶ **Switching on:** Select **Mic On**.

The following message will flash up on the display: The microphone is on.

The microphone is switched on and the symbol  disappears in the main area.

- i** You can also switch the microphone on or off by pressing button .

Sending DTMF tones

- i** This function is not possible with all mobile phones.

Answering machines or other devices can be controlled via DTMF tones, e. g. for remote query functions.

- ▶ **Transmitting individual characters:**

During a call select the required characters.

or

- ▶ Press the corresponding button on the audio control unit. Every selected character is transmitted immediately.

- ▶ **Transmitting a phone number of a phone book entry as a sequence of characters:** Select **Name**.

- ▶ Select the desired phone book entry. The entry is transmitted immediately as a sequence of characters.

- ▶ **Switching back to call display:** Select **Back**.

Driving systems

Driving systems

Introduction

This section describes the following driving systems of your vehicle:

- Cruise control
- Hill start assist system
- All-wheel drive (4MATIC)
- Dynamic handling package with sport driving mode, Canada only

The ABS, Adaptive Brake, BAS, EBP and ESP® driving safety systems are described in the “Safety and security” section (> page 66).

Cruise control

The cruise control automatically maintains the speed you set for your vehicle.

The use of the cruise control is recommended for driving at a constant speed for extended periods of time.

The currently set speed or last set speed (“Resume” function) appears in the multifunction display for approximately 5 seconds. The corresponding cruise control speed segments from the selected speed to

the vehicle maximum speed in the multifunction display are illuminated.



① Cruise control speed segments

Warning!

The cruise control is a convenience system designed to assist the driver during vehicle operation. The driver is and must always remain responsible for the vehicle's speed and for safe brake operation.

Only use the cruise control if the road, traffic, and weather conditions make it advisable to travel at a constant speed.

- The use of the cruise control can be dangerous on winding roads or in heavy

traffic because conditions do not allow safe driving at a constant speed.

- The use of the cruise control can be dangerous on slippery roads. Rapid changes in tire traction can result in wheel spin and loss of control.
- Deactivate the cruise control when driving in fog.

The “Resume” function should only be operated if the driver is fully aware of the previously set speed and wishes to resume this particular preset speed.

Warning!

The cruise control brakes automatically so that the set speed is not exceeded. The brake pedal depresses automatically when the cruise control engages the brakes.

Keep the driver's footwell clear at all times, including the area under the brake pedal. Objects stored in this area may impair pedal movement which could interfere with the braking ability of the cruise control system.

Do not place your foot under the brake pedal – your foot could become caught.

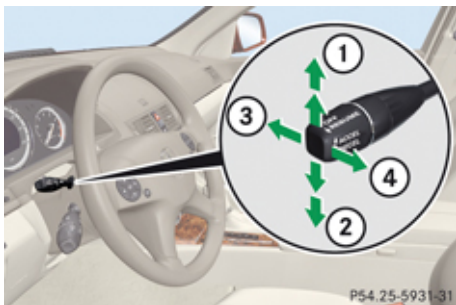

- ① Setting current or higher speed
- ② Setting current or lower speed
- ③ Canceling the cruise control
- ④ Activating the cruise control or resuming to last set speed

Activating cruise control

You can activate the cruise control at a vehicle speed above 20 mph (30 km/h).

You cannot activate the cruise control:

- when you brake
- when you have engaged the parking brake

- when the automatic transmission is in park position **P**, reverse gear **R**, or neutral position **N**
- the ESP[®] is switched off or has switched off due to a malfunction

The vehicle speed displayed in the speedometer can briefly vary from the speed setting for the cruise control system.

Setting current speed

- ▶ Accelerate or decelerate to the desired speed.
- ▶ Briefly lift the cruise control lever in direction of arrow ① or press in direction of arrow ②.
- ▶ Remove your foot from the accelerator pedal.

- ① On uphill grades, the cruise control may not be able to maintain the set speed. Once the grade eases, the set speed will be resumed.

On downhill grades, the cruise control maintains the set speed by braking with the vehicle's brake system.

Vehicles with automatic transmission:

In addition, on longer downhill grades the automatic transmission will downshift automatically.

- ① Vehicles with manual transmission: If you depress the clutch pedal when shifting into another gear, the engine speed may increase.
 - Always drive with sufficient, but not excessive, engine speed.
 - Shift the gear in a timely manner.
 - Avoid shifting down more than one gear if at all possible.

Canceling cruise control

- ▶ Depress the brake pedal.

or

- ▶ Briefly push the cruise control lever in direction of arrow ③.

The last set speed is stored for later use.

The last stored speed is deleted from memory when the engine is turned off.

The cruise control switches off automatically when you depress the brake pedal or you engage the parking brake. In this case, the cruise control speed segments in the multifunction display will go out.

Driving systems

The cruise control also switches off automatically when

- the vehicle speed falls below 20 mph (30 km/h)
- the ESP® is in operation
- the ESP® is switched off with the ESP® switch
- the ESP® has switched off due to a malfunction
- Vehicles with manual transmission: you engage neutral or depress the clutch pedal for more than 6 seconds during shifting into another gear
- Vehicles with automatic transmission: you shift the automatic transmission into neutral position **N** while driving

The cruise control speed segments in the multifunction display goes out and an acoustic warning will sound. Observe additional messages in the multifunction display that may appear.

Depressing the accelerator pedal does not deactivate the cruise control. After a brief acceleration (e.g. for passing), the cruise control will resume the last set speed.

Changing the set speed

Warning!

Keep in mind that it may take a brief moment until the vehicle has made the necessary adjustments.

Increase or decrease the set vehicle speed to a value that the prevailing road conditions and legal speed limits permit. Otherwise, sudden and unexpected acceleration or deceleration of the vehicle could cause an accident and/or serious injury to you and others.

You can increase or decrease the set speed in 1 mph (Canada: 1 km/h) increments or in 5 mph (Canada: 10 km/h) increments.

When you use the cruise control lever to decelerate, the brake system will brake the vehicle automatically if the engine's braking power does not brake the vehicle sufficiently.

Adjustment in 1 mph (Canada: 1 km/h) increments

- ① The set speed value is increased or decreased in 1 mph (Canada: 1 km/h) increments each time you lift or press the cruise control lever up or down to the resistance point.

- ▶ Briefly lift the cruise control lever up to the resistance point in direction of arrow ① to increase or press the cruise control lever down to the resistance point in direction of arrow ② to decrease.
- ▶ Release the cruise control lever. The new speed is set and the vehicle will accelerate or decelerate.

Adjustment in 5 mph (Canada: 10 km/h) increments

- ① The set speed value is increased or decreased in 5 mph (Canada: 10 km/h) increments each time you lift or press the cruise control lever up or down past the resistance point.
- ▶ Briefly lift the cruise control lever up past the resistance point in direction of arrow ① to increase or press the cruise control lever down past the resistance point in direction of arrow ② to decrease.
- ▶ Release the cruise control lever. The new speed is set and the vehicle will accelerate or decelerate. Keep in mind that it may take a brief moment until the vehicle has reached the set speed.

Resume last stored speed

Warning!

The set speed stored in memory should only be set again if prevailing road conditions and legal speed limits permit. Possible acceleration or deceleration differences arising from returning to the preset speed could cause an accident and/or serious injury to you and others.

- ▶ Briefly pull the cruise control lever in direction of arrow .
- If no speed is stored, the current speed is set and stored.
- ▶ Remove your foot from the accelerator pedal.

The last stored speed is deleted from memory when the engine is turned off.

Hill start assist system

Warning!

The hill start assist system is not designed to function as a parking brake and does not prevent the vehicle from moving when parked on an incline.

Always engage the parking brake in addition to shifting the automatic transmission into park position **P** (manual transmission: shift into **1st** gear or reverse gear **R**).

On uphill grades with a gradient angle of more than 5°, the hill start assist system maintains the pressure in the brake system for approximately 1 second after you have released the brake pedal. Therefore, you can start off smoothly without the vehicle moving immediately after releasing the brake pedal.

- ▶ Depress the brake pedal.
- ▶ **Manual transmission:** Shift into **1st** gear or reverse gear **R**.
- ▶ Slowly release the clutch pedal, removing your foot from the brake pedal at the same time, and carefully depress the accelerator pedal.

- ▶ **Automatic transmission:** Shift into drive position **D** or reverse position **R**.
 - ▶ Release the brake pedal.
 - ▶ Carefully depress the accelerator pedal.
- The hill start assist system is inactive
- when starting off on a level road or downhill grades
 - with the automatic transmission in neutral position **N**
 - with the parking brake engaged
 - if the ESP[®] has switched off due to a malfunction

All-wheel drive (4MATIC)

Your vehicle is equipped with all-wheel drive (4MATIC). Both, the front and rear axles, are powered at all times when the vehicle is being operated. The 4MATIC improves traction in conjunction with the ESP[®] (▷ page 68) and the Electronic Traction System (ETS/4-ETS) (▷ page 69).

Driving systems

⚠ Warning!

If a drive wheel is spinning due to insufficient traction:

- While driving off, apply as little throttle as possible.
- While driving, ease up on the accelerator pedal.
- Adapt your speed and driving style to the prevailing road conditions.

Failure to observe these guidelines could cause the vehicle to skid.

The 4MATIC cannot prevent accidents resulting from excessive speed.

! Do not tow with one axle raised. Doing so could damage the transfer case, which is not covered by the Mercedes-Benz Limited Warranty. All wheels must be on or off the ground. Observe instructions for towing the vehicle with all wheels on the ground.

! Only conduct operational or performance tests on a two-axle dynamometer. If such tests are necessary, contact an authorized Mercedes-Benz Center. You could otherwise seriously damage the brake system and/or the transfer case which is

not covered by the Mercedes-Benz Limited Warranty.

i In winter operation, the maximum effectiveness of the 4MATIC is only achieved with winter tires (▷ page 284) or snow chains as required.

Dynamic handling package with sport driving mode

This feature is only available in Canada vehicles.

The most important part of the dynamic handling package with sport driving mode is the variable damping system. It adjusts damping to the respective driving condition automatically.

The damping adjustment depends on

- your driving style
- the road condition
- your individual selection, see the following description

Vehicles with automatic transmission: The sport driving mode button selects the automatic shift programs **C/S**. For information on the automatic shift programs, see “Automatic shift

programs” (▷ page 124). The automatic transmission with dynamic handling package with sport driving mode contains additional steering wheel gearshift controls, see “One-touch gearshifting” (▷ page 125).



- ① Indicator lamp
- ② Sport driving mode button

▶ Start the engine.

The settings remain stored until you turn off the engine.

Sporty damping adjustment

The firmer suspension tuning in a sport driving mode provides enhanced road contact. Select this mode for sporty driving style, for example on winding highways.

- ▶ Press button ②.
Indicator lamp ① comes on. The sporty suspension tuning is selected. Depending on engine version, the accelerator pedal may respond more immediate. In vehicles with automatic transmission, automatic program mode **S** is selected and will be

displayed in the multifunction display (▷ page 125).

Comfort damping adjustment

Vehicle handling in comfort driving mode is softer. Select this mode when you prefer a

more comfortable driving style on straight freeways.

- ▶ Press button ②.
Indicator lamp ① goes out. The comfortable suspension tuning is selected. In vehicles with automatic transmission, automatic program mode **C** is selected and will be displayed in the multifunction display (▷ page 125).

Climate control system

Climate control system

Overview of climate control system functions

Your vehicle is equipped with either of the following climate control systems:

Dual-zone automatic climate control



The dual-zone automatic climate control combines an automatic heating and ventilation system with a cooling system. You can adjust the dual-zone automatic climate control separately for the driver's and passenger side.

3-zone automatic climate control



Canada only

The 3-zone automatic climate control combines an automatic heating and ventilation system with a cooling system. You can adjust the 3-zone automatic climate control separately for each zone in the vehicle.

Rear climate control



Canada only

The rear climate control allows separate climate settings for the rear compartment.

Control panels

Dual-zone automatic climate control



















P83.40-3755-31

Function	Recommendation/Notes	
① Temperature control, driver's side	<p>i Set the temperature to 72°F (22°C).</p>	<p>▷ page 217</p>
② OFF Climate control on/off	<p>i Switches on the climate control system. Display ⑪ comes on.</p>	<p>▷ page 216</p>
<p>③ MAX COOL on/off (USA only)</p> <p>MONO Adopting driver's side settings for all zones (Canada only)</p>		<p>▷ page 220</p>

▷▷

Climate control system

	Function	Recommendation/Notes	
④	 AC cooling on/off	 Switches on the air conditioning. The indicator lamp in button  comes on.	(▷ page 216)
⑤	 Front defroster	 Keep this setting selected only until the windshield or the side windows are clear again.	(▷ page 220)
⑥	Temperature control, passenger side	 Set the temperature to 72°F (22°C).	(▷ page 217)
⑦	 Air recirculation	 Only use this function for a short time, e.g. in a tunnel. Otherwise, the windows can fog up due to lack of fresh air.	(▷ page 221)
⑧	 Rear window defroster	 At very low temperatures, rear window defroster operation is delayed until the vehicle interior has warmed up.	(▷ page 222)
⑨	 Increasing air volume		(▷ page 220)
⑩	 Decreasing air volume		(▷ page 220)
⑪	Display		
⑫	 Air distribution		(▷ page 219)
⑬	 Air distribution and air volume (automatic mode)	 Switches on the automatic mode. The indicator lamp in button  comes on.	(▷ page 216)

3-zone automatic climate control













P83.40-3801-31

Canada only

	Function	Recommendation/Notes	
①	Temperature control, driver's side	i Set the temperature to 72°F (22°C).	(▷ page 217)
②	AUTO Air distribution and air volume (automatic mode)	i Switches on the automatic mode. The indicator lamp in button AUTO comes on.	(▷ page 216)
③	OFF Climate control on/off	i Switches on the climate control system. Display ⑬ comes on.	(▷ page 216)
④	MONO Adopting driver's side settings for passenger side		(▷ page 222)



Climate control system

	Function	Recommendation/Notes	
⑤	 AC cooling on/off	i Switches on the air conditioning. The indicator lamp in button  comes on.	(▷ page 216)
⑥	 Residual heat/ventilation	i With the engine turned off, it is possible to continue to heat or ventilate the interior.	(▷ page 221)
⑦	 Front defroster	i Keep this setting selected only until the windshield or the side windows are clear again.	(▷ page 220)
⑧	Temperature control, passenger side	i Set the temperature to 72°F (22°C).	(▷ page 217)
⑨	 Rear window defroster	i At very low temperatures, rear window defroster operation is delayed until the vehicle interior has warmed up.	(▷ page 222)
⑩	 Air distribution, passenger side		(▷ page 219)
⑪	 Increasing air volume		(▷ page 220)
⑫	 Decreasing air volume		(▷ page 220)
⑬	Display		
⑭	 Air distribution, driver's side		(▷ page 219)
⑮	 Air recirculation	i Only use this function for a short time, e.g. in a tunnel. Otherwise, the windows can fog up due to lack of fresh air.	(▷ page 221)

Climate control system

Rear climate control

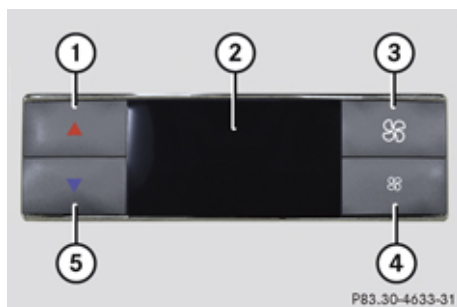

P83_30-4633-31

- ① ▲ Temperature control, raising
- ② Display
- ③ ☪ Increasing air volume
- ④ ☪ Decreasing air volume
- ⑤ ▼ Temperature control, lowering

Notes on climate control system

The climate control system is operational whenever the engine is running. You can operate the climate control system in either the automatic or manual mode. The system cools or heats the interior depending on the selected interior temperature and the current outside temperature.

It can only function optimally when you are driving with the windows and the tilt/sliding sunroof closed.

Nearly all dust particles, pollutants and odors are filtered out before outside air enters the passenger compartment through the air distribution system.

⚠ Warning!

Severe conditions (e.g. strong air pollution) may require replacement of the filter before its scheduled replacement interval. A clogged filter will reduce the air volume to the interior and the windows could fog up, impairing visibility and endangering you and others. Have a clogged filter replaced as soon as possible at an authorized Mercedes-Benz Center.

The air conditioning will not engage (no cooling) if the **A/C** mode (▷ page 216) is deactivated.

⚠ Warning!

Follow the recommended settings for heating and cooling given on the following pages. Otherwise the windows could fog up, impairing visibility and endangering you and others.

- ▶ Keep the air intake grille in front of the windshield free of snow and debris. Do not obstruct air flow by placing objects on the air flow-through exhaust slots below the rear window.
- ⓘ If the vehicle interior is hot, ventilate the interior before driving off, see “Summer opening feature” (▷ page 111). The climate control will then adjust the interior temperature to the set value much faster.

Climate control system

Deactivating the climate control system

Warning!

When the climate control system is switched off, the outside air supply and circulation are also switched off. Only choose this setting for a short time.

Otherwise the windows could fog up, impairing visibility and endangering you and others.

▶ **Deactivating:** Press button **OFF**.
The indicator lamp in the button comes on.

▶ **Reactivating:** Press button **OFF**.
The indicator lamp in the button goes out.
The previous settings are once again in effect.

or

▶ Press button **AUTO**.
The indicator lamp in the button comes on.
Air volume and air distribution are adjusted automatically.

Air conditioning

The air conditioning is operational while the engine is running and cools the interior air to the temperature set by the operator. In addition, the air conditioning dehumidifies the interior air and helps prevent window fogging.

Warning!

If you switch off the cooling function, the vehicle will not be cooled when weather conditions are warm. The windows can fog up more quickly. Window fogging may impair visibility and endanger you and others.

i Condensation may drip out from underneath the vehicle. This is normal and not an indication of a malfunction.

Deactivating

It is possible to deactivate the air conditioning. The interior air will then no longer be cooled or dehumidified.

▶ Press button **A/C**.
The indicator lamp in the button goes out.

The cooling function switches off after a short delay.

Activating

Moist air can fog up the windows. You can dehumidify the interior air with the air conditioning.

▶ Press button **A/C**.

The indicator lamp in the button comes on.
The air conditioning uses the refrigerant R134a. This refrigerant is free of CFCs which are harmful to the ozone layer.

Automatic mode

When operating the climate control system in automatic mode, the interior air temperature, air volume and air distribution are adjusted automatically.

In automatic mode, cooling with dehumidification is switched on. This function can be switched off if necessary.

Warning!

If you switch off the cooling function, the vehicle will not be cooled when weather conditions are warm. The windows can fog up more quickly. Window fogging may

Climate control system

impair visibility and endanger you and others.

Dual-zone automatic climate control

- ▶ Set the desired temperature (▷ page 217).
- ▶ **Activating:** Press button **AUTO**.
The indicator lamp in the button comes on. The air volume and air distribution are adjusted automatically.
- ▶ **Deactivating:** Press button **AUTO**.
The indicator lamp in the button goes out. The automatic operation of air volume and air distribution switches off. The symbols of air distribution and air volume appear in display ⑪ (▷ page 211).
- ▶ Adjust air distribution (▷ page 219).
- ▶ Adjust air volume (▷ page 220).

3-zone automatic climate control

- ▶ Set the desired temperature (▷ page 217).
- ▶ **Activating:** Press button **AUTO**.
The indicator lamp in the button comes on. The air volume and air distribution are adjusted automatically.

- ▶ **Deactivating:** Press button **AUTO**.
The indicator lamp in the button goes out. The automatic operation of air volume and air distribution switches off. The symbols of air distribution and air volume appear in display ⑬ (▷ page 213).
- ▶ Adjust air distribution (▷ page 219).
- ▶ Adjust air volume (▷ page 220).

Setting temperature

You can adjust the air temperature on each side of the passenger compartment. You should raise or lower the temperature setting in small increments, preferably starting at 72°F (22°C).

Dual-zone automatic climate control

- ▶ **Increasing/decreasing:** Turn temperature controls ① and ⑥ (▷ page 211) slightly clockwise or counterclockwise.

3-zone automatic climate control

- ▶ **Increasing/decreasing:** Turn temperature controls ① and ⑧ (▷ page 213) slightly clockwise or counterclockwise.

- ▶ **i** If you turn the temperature control fully clockwise for one side of the vehicle, you are increasing the temperature for the other side of the vehicle as well.
If you turn the temperature control fully counterclockwise for one side of the vehicle, you are decreasing the temperature for the other side of the vehicle as well.

Rear climate control panel

You can adjust the air temperature on each side of the rear passenger compartment. You should raise or lower the temperature setting in small increments, preferably starting at 72°F (22°C).

- ▶ **Increasing/decreasing:** Press button **▲** or **▼** until the desired temperature appears in display ② (▷ page 215).

Climate control system

Adjusting air vents

⚠ Warning!

When operating the climate control, the air that enters the passenger compartment through the air vents can be very hot or very cold (depending on the set temperature). This may cause burns or frostbite to unprotected skin in the immediate area of the air vents.

Always keep sufficient distance between unprotected parts of the body and the air vents. If necessary, use the air distribution adjustment to direct the air to air vents in the vehicle interior that are not in the immediate area of unprotected skin.

For best possible performance of the climate control:

- ▶ Keep the air intake grille in front of the windshield free of snow, leaves, sticks, and any other debris.
- ▶ Always keep all air vents and grilles in the passenger compartment free from obstruction.
- i** For draft-free ventilation, move the adjustable center and side air vents to the middle position.

Center air vents

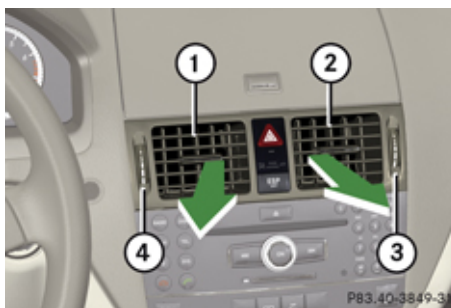

- ① Left center air vent, adjustable
 - ② Right center air vent, adjustable
 - ③ Thumbwheel for air volume control for adjustable right center air vent
 - ④ Thumbwheel for air volume control for adjustable left center air vent
- ▶ **Opening/closing:** Turn thumbwheels ③ and ④ upward or downward.

Side air vents

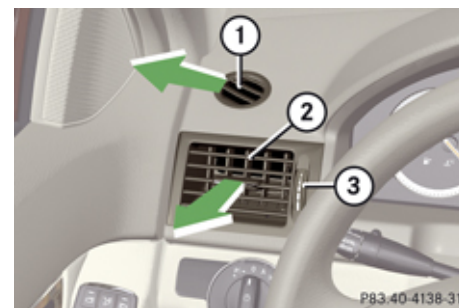

Example illustration driver's side

- ① Left side defroster air vent, fixed
 - ② Left side air vent, adjustable
 - ③ Thumbwheel for air volume control for adjustable left side air vent
- ▶ **Opening/closing:** Turn thumbwheel ③ upward or downward.

Ventilated glove box

The glove box can be ventilated, for instance to cool its contents, when the climate control system is activated. The level of airflow to the glove box depends on the airflow and air distribution settings. The temperature of the air is approximately the same as that of the air flowing from the center air vents.

Climate control system

! Close the glove box air vent when heating the vehicle interior. Activate the air conditioning (cooling function) when the outside temperature is high. Otherwise, temperature-sensitive items stored in the glove box could be damaged.

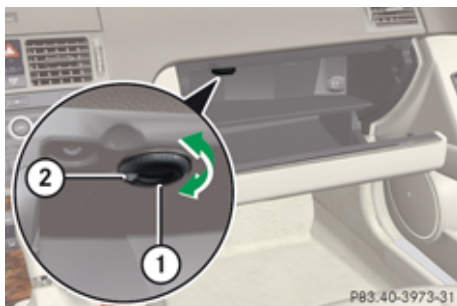

- ① Thumbwheel
- ② Air vent

► **Opening/closing:** Turn thumbwheel ① clockwise or counterclockwise.

Rear center console air vents



Example illustration: Rear climate control

- ① Thumbwheel for air volume control for rear center air vents
- ② Right rear center air vent, adjustable
- ③ Rear climate control panel
- ④ Left rear center air vent, adjustable

Adjusting air distribution

The air distribution can be adjusted separately on each side of the passenger compartment¹⁴.

The symbols shown in display ⑪ (► page 211) or ⑬ (► page 213) on the climate control panel represent the following functions:



Symbol	Function
	Directs air through the defroster air vents to the windshield and side windows
	Directs air through the center and side air vents
	Directs air to the footwells
	Directs air through the center and side air vents and to the footwells
	Directs air into the entire vehicle interior
	Directs air through the center, side and defroster air vents to the windshield and side windows
	Directs air through the defroster air vents to the windshield and side windows and to the footwells

► Press button repeatedly until you have select the desired setting and the

¹⁴ Vehicles with 3-zone automatic climate control



Climate control system

corresponding symbol is shown in display  or .

Adjusting air volume

▶ **Decrease/increase:** Press button  or .

Front defroster

You can use this setting to defrost the windshield, for example if it is iced up.

You can also defog the windshield and the side windows.

 Keep this setting selected only until the windshield or the side windows are clear again.

▶ **Activating:** Press button . The indicator lamp in the button comes on.

The climate control switches to the following functions automatically:

- cooling on to dehumidify
- most efficient blower speed and heating power, depending on outside temperature



- air flows onto the windshield and the front side windows
- the air recirculation mode is switched off

 You can adjust the air distribution when the front defroster is switched on.

▶ **Deactivating:** Press button  again. The indicator lamp in the button goes out. The previous settings are once again in effect. The cooling remains switched on. The air recirculation remains switched off.

or

▶ Press button **AUTO**. The indicator lamp in button  goes out. Air volume and air distribution are adjusted automatically.





 To deactivate defrosting, you can also press button **OFF**, ,  or turn temperature controls.

Windshield fogged on the outside

▶ Switch the windshield wipers on (▷ page 107).

If the automatic mode of the climate control is switched off:

▶ Press button  repeatedly until one of the following symbols appears in display

 (▷ page 211) or  (▷ page 213)  or .

Maximum cooling MAX COOL

MAX COOL is only operational when the engine is running.

MAX COOL is only available in U.S. vehicles. You can use this setting to provide the fastest possible cooling of the vehicle interior (when windows and tilt/sliding sunroof or tilt/sliding panel are closed).

▶ **Activating:** Press button  (▷ page 211). The indicator lamp in the button comes on.

The climate control switches automatically to the following functions:

- maximum cooling
- maximum blowing power
- the air recirculation mode is switched on

Climate control system

- ▶ **Deactivating:** Press button  again.
The indicator lamp in the button goes out.
The previous settings are once again in effect.

- i** To switch the maximum cooling function off, you can also press button **OFF**, **AUTO** or .

Air recirculation mode

Switch to air recirculation mode to prevent unpleasant odors from entering the vehicle from the outside (e.g. before driving through a tunnel). This setting cuts off the intake of outside air and recirculates the air in the passenger compartment.

 **Warning!**

Fogged windows impair visibility, endangering you and others. If the windows begin to fog on the inside, switching off the air recirculation mode immediately should clear interior window fogging. If interior window fogging persists, make sure the air conditioning is activated, or press button



- ▶ **Activating:** Press button .
- The indicator lamp in the button comes on.

- i** The air recirculation mode is activated automatically at high outside temperatures.
The indicator lamp in button  is not lit when the air recirculation mode is switched on automatically.
A quantity of outside air is added after approximately 30 minutes.

- ▶ **Deactivating:** Press button  again.
The indicator lamp in the button goes out.

- i** The manually selected air recirculation mode is deactivated automatically:
 - after 5 minutes if the outside temperature is below approximately 41°F (5°C)
 - after 5 minutes if the air conditioning is turned off
 - after 30 minutes if the outside temperature is above approximately 41°F (5°C)

Residual heat and ventilation

This feature is only available in Canada vehicles. With the engine switched off, it is possible to continue to heat or ventilate the interior for up to 30 minutes. This feature makes use of the residual heat produced by the engine.

- i** If you switch on the residual heat function when outside temperatures are high, only the ventilation will be switched on.
- i** Regardless of the selected air volume, the blower operates at low speed when heating. In case of ventilation the blower operates at higher speed.
- i** How long the system will provide heating depends on the coolant temperature and the selected temperature.
- ▶ **Activating:** Switch off the ignition.
- ▶ Press button **REST**.
The indicator lamp in the button comes on.
- ▶ **Deactivating:** Press button **REST**.
The indicator lamp in the button goes out.

Rear window defroster

The residual heat is deactivated automatically:

- when the ignition is switched on
- after approximately 30 minutes
- if the battery voltage drops
- if the coolant temperature is too low

Using driver-side settings for passenger side

This feature is only available in Canada vehicles.¹⁵

You can use the settings of the driver's side, such as temperature, air volume and air distribution, for the passenger side.

▶ **Activating:** Adjust the air temperature, air volume and air distribution.

▶ Press button .

The indicator lamp in the button comes on.

The driver-side settings are used for the passenger side.

▶ **Deactivating:** Press button  again.

The indicator lamp in the button goes out.

Rear window defroster

Warning!

Any accumulation of snow and ice should be removed from the rear window before driving. Visibility could otherwise be impaired, endangering you and others.

The rear window defroster uses a large amount of power. To keep the battery drain to a minimum, switch off the defroster as soon as the rear window is clear. The defroster is switched off automatically after some time of operation depending on the outside temperature.

▶ Switch on the ignition.

▶ **Switching on:** Press button  on the respective climate control panel. The indicator lamp in the button comes on.

▶ **Switching off:** Press button  again.

 If the rear window defroster switches off too soon and the indicator lamp starts flashing, too many electrical consumers are operating simultaneously and there is insufficient voltage in the battery. The system responds automatically by switching the rear window defroster off.

As soon as the battery has sufficient voltage, the rear window defroster switches back on automatically.

¹⁵ Vehicles with 3-zone automatic climate control

Power tilt/sliding sunroof

Opening and closing

Warning!

When opening or closing the tilt/sliding sunroof, make sure there is no danger of anyone being harmed by the opening/closing procedure.

The tilt/sliding sunroof is equipped with the express operation and automatic reversal function. If the movement of the tilt/sliding sunroof is blocked during the closing procedure, the tilt/sliding sunroof will stop and open slightly.

The tilt/sliding sunroof operates differently when the sunroof switch is pressed and held. See the “Closing when the tilt/sliding sunroof is blocked” section for details.

The opening/closing procedure of the tilt/sliding sunroof can be immediately halted by releasing the sunroof switch or, if the sunroof switch was moved past the resistance point and released, by moving the sunroof switch in any direction.

 **Observe Safety notes, see page 59.**

Warning!

The tilt/sliding sunroof is made out of glass. In the event of an accident, the glass may shatter. This may result in an opening in the roof.

In a vehicle rollover, occupants not wearing their seat belts or not wearing them properly may be thrown out of the opening. Such an opening also presents a potential for injury for occupants wearing their seat belts properly as entire body parts or portions of them may protrude from the passenger compartment.

 To avoid damaging the seals, do not transport any objects with sharp edges which can stick out of the tilt/sliding sunroof.

Do not open the tilt/sliding sunroof if there is snow or ice on the roof, as this could result in malfunctions.

If you cannot open or close the tilt/sliding sunroof due to a malfunction contact Roadside Assistance or an authorized Mercedes-Benz Center.

Power tilt/sliding sunroof

 Please keep in mind that weather conditions can sometimes change rapidly. Make sure to close the tilt/sliding sunroof when leaving the vehicle. If water enters the vehicle interior, vehicle electronics could be damaged which is not covered by the Mercedes-Benz Limited Warranty.

 You can also open or close the tilt/sliding sunroof using the SmartKey or the KEYLESS-GO function, see “Summer opening feature” (> page 111) and “Convenience closing feature” (> page 111).

 After switching off the ignition or removing the SmartKey from the starter switch, you can operate the tilt/sliding sunroof until you open the driver’s or front passenger door. If no door was opened you can operate the tilt/sliding sunroof for up to 5 minutes.

Power tilt/sliding sunroof

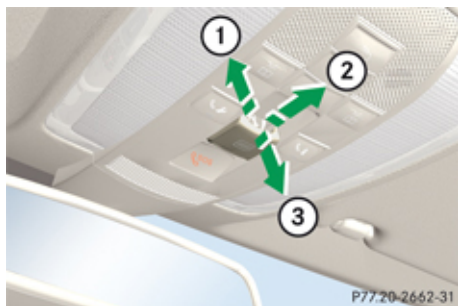

Sunroof switch

- ① Raising
- ② Opening
- ③ Closing



Sunroof screen

- ▶ Switch on the ignition.

Opening

- ▶ **Opening manually:** Press and hold the sunroof switch to the resistance point in direction of arrow ②.
- ▶ Release the sunroof switch when the desired position is reached.
- ▶ **Express operation:** To open the tilt/sliding sunroof completely, press the sunroof switch past the resistance point in direction of arrow ② and release.
- ▶ **Stopping during express operation:** Move the sunroof switch in any direction.

i Express opening is not available when the tilt/sliding sunroof is raised. The tilt/sliding sunroof must be closed first.

i When the tilt/sliding sunroof is open, resonance noises may result in addition to the usual wind noises. They are caused by minimal pressure changes in the passenger compartment. To reduce or eliminate these noises, change the position of the tilt/sliding sunroof or open a window slightly.

Raising

- ▶ **Raising manually:** Press and hold the sunroof switch to the resistance point in direction of arrow ①.
- ▶ Release the sunroof switch when the desired position is reached.
- ▶ **Express operation:** To raise the tilt/sliding sunroof completely, press the sunroof switch past the resistance point in direction of arrow ① and release.
- ▶ **Stopping during express operation:** Move the sunroof switch in any direction.

i Express raising is not available when the tilt/sliding sunroof is open. The tilt/sliding sunroof must be closed first.

Closing

- ▶ **Closing manually:** Pull and hold the sunroof switch to the resistance point in direction of arrow ③.
- ▶ Release the sunroof switch when the desired position is reached.
- ▶ **Express operation:** To close the tilt/sliding sunroof completely, pull the sunroof

switch past the resistance point in direction of arrow ③ and release.

- ▶ **Stopping during express operation:**
Move the sunroof switch in any direction.

Closing when the tilt/sliding sunroof is blocked

Warning!

Make sure that nobody can become trapped and be seriously or even fatally injured when closing the tilt/sliding sunroof with greater force or without automatic reversal function.

If the movement of the tilt/sliding sunroof is blocked during the closing procedure (e. g. by ice or pollution), the tilt/sliding sunroof will stop and open slightly. However, the tilt/sliding sunroof will exert greater force before reversing than when the tilt/sliding sunroof is closed in express operation. Please exercise caution!

- ▶ Immediately after the tilt/sliding sunroof has stopped because it was blocked, pull the sunroof switch in direction of arrow ③ until the tilt/sliding sunroof is fully closed.

If the tilt/sliding sunroof is blocked again and opens slightly:

- ▶ Immediately after the tilt/sliding sunroof was blocked, pull the sunroof switch in direction of arrow ③ until the tilt/sliding sunroof is fully closed.

Warning!

Pulling and holding the sunroof switch to close the tilt/sliding sunroof immediately after it had been blocked two times will cause the tilt/sliding sunroof to close without any reversal function for as long as you hold the sunroof switch.

Synchronizing

The tilt/sliding sunroof must be synchronized after a malfunction or if it does not open smoothly.

- ❗ If the tilt/sliding sunroof cannot be closed or synchronized, contact an authorized Mercedes-Benz Center or call Roadside Assistance.
- ▶ Switch on the ignition.
- ▶ Press and hold the sunroof switch in direction of arrow ① (▷ page 224) until the

tilt/sliding sunroof is fully raised at the rear.

- ▶ Keep holding the sunroof switch in direction of arrow ① for approximately 1 second.
- ▶ Check the express operation feature (▷ page 224).
If the tilt/sliding sunroof opens and closes completely, the roof is synchronized. Otherwise repeat the above steps.

Panorama roof with power tilt/sliding panel

Panorama roof with power tilt/sliding panel

Extending and retracting the roller sunblinds

The roller sunblinds only operate with the tilt/sliding panel closed. The front and rear roller sunblind cannot be operated individually.

⚠ Warning!

When extending the roller sunblinds, make sure no one is in danger of being injured by the extending procedure.

The roller sunblinds are equipped with the express operation and automatic reversal function. If the movement of the roller sunblinds is blocked during the extending procedure, the roller sunblinds will stop and retract slightly.

The extending of the roller sunblinds can be immediately halted by releasing the roof panel switch or, if the roof panel switch was moved past the resistance point and released, by moving the roof panel switch in any direction.

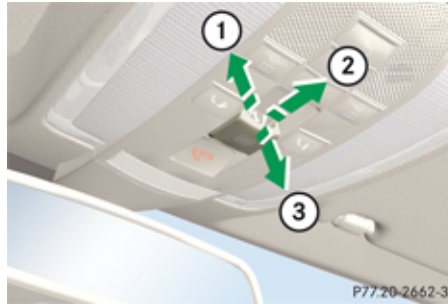

Roof panel switch

- ① Retracting
- ② Retracting
- ③ Extending

- ▶ Switch on the ignition.
- ▶ **Retracting/Extending:** Move the roof panel switch to the resistance point in the required direction of arrow ①, ② or ③

until the roller sunblinds have reached their desired position.

- ▶ **Express operation:** Move the roof panel switch past the resistance point in direction of arrow ①, ② or ③ and release. The roller sunblinds retract/extend completely.
- ▶ **Stopping during express operation:** Move the roof panel switch in any direction.

Opening and closing the panorama roof with power tilt/sliding panel

⚠ Warning!

When opening or closing the tilt/sliding panel, make sure there is no danger of anyone being harmed by the opening/closing procedure.

The tilt/sliding panel is equipped with the express operation and automatic reversal function. If the movement of the tilt/sliding panel is blocked during the closing procedure, the tilt/sliding panel will stop and open slightly.

The tilt/sliding panel operates differently when the roof panel switch is pressed and held. See the “Closing when the tilt/sliding

Panorama roof with power tilt/sliding panel

panel is blocked” section in this chapter for details.

The opening/closing procedure of the tilt/sliding panel can be immediately halted by releasing the roof panel switch or, if the roof panel switch was moved past the resistance point and released, by moving the roof panel switch in any direction.

⚠ Observe Safety notes, see page 59.

⚠ Warning!

The panorama roof with tilt/sliding panel is made out of glass. In the event of an accident, the glass may shatter. This may result in an opening in the roof.

In a vehicle rollover, occupants not wearing their seat belts or not wearing them properly may be thrown out of the opening. Such an opening also presents a potential for injury for occupants wearing their seat belts properly as entire body parts or portions of them may protrude from the passenger compartment.

! To avoid damaging the seals, do not transport any objects with sharp edges which can stick out of the tilt/sliding panel.

Do not open the tilt/sliding panel if there is snow or ice on the roof, as this could result in malfunctions.

! Please keep in mind that weather conditions can sometimes change rapidly. Make sure to close the tilt/sliding panel when leaving the vehicle. If water enters the vehicle interior, vehicle electronics could be damaged which is not covered by the Mercedes-Benz Limited Warranty.

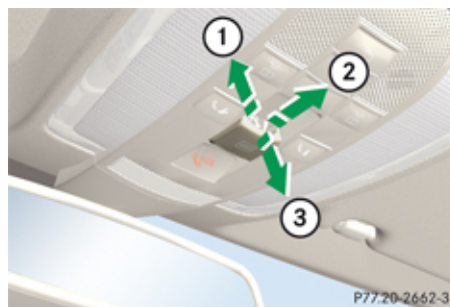

Roof panel switch

- ① Raising
- ② Opening
- ③ Closing

The tilt/sliding panel only operates with the roller sunblinds retracted.

i You can also open or close the tilt/sliding panel using the SmartKey, see “Summer opening feature” (▷ page 111) or see “Convenience closing feature” (▷ page 111).

▶ Switch on the ignition.

Opening

▶ **Opening manually:** Press and hold the roof panel switch to the resistance point in direction of arrow ②.

▶ Release the roof panel switch when the desired position is reached.

▶ **Express operation:** To open the tilt/sliding panel completely, press the roof panel switch past the resistance point in direction of arrow ② and release.

▶ **Stopping during express operation:** Move the roof panel switch in any direction.

i Express opening is not available when the tilt/sliding panel is raised. The tilt/sliding panel must be closed first.

i When the tilt/sliding panel is open, resonance noises may result in addition to the usual wind noises. They are caused by minimal pressure changes in the passenger



Panorama roof with power tilt/sliding panel

compartment. To reduce or eliminate these noises, change the position of the tilt/sliding panel or open a window slightly.

Raising

- ▶ **Raising manually:** Press and hold the roof panel switch to the resistance point in direction of arrow ①.
- ▶ Release the roof panel switch when the desired position is reached.
- ▶ **Express operation:** To raise the tilt/sliding panel completely, press the roof panel switch past the resistance point in direction of arrow ① and release.
- ▶ **Stopping during express operation:** Move the roof panel switch in any direction.

i Express raising is not available when the tilt/sliding panel is open. The tilt/sliding panel must be closed first.

Closing

- ▶ **Closing manually:** Pull and hold the roof panel switch to the resistance point in direction of arrow ③.
- ▶ Release the roof panel switch when the desired position is reached.

- ▶ **Express operation:** To close the tilt/sliding panel completely, pull the roof panel switch past the resistance point in direction of arrow ③ and release.
- ▶ **Stopping during express operation:** Move the roof panel switch in any direction.

Closing when the tilt/sliding panel is blocked

⚠ Warning!

Make sure that nobody can become trapped and be seriously or even fatally injured when closing the tilt/sliding panel without automatic reversal function.

If the movement of the tilt/sliding panel is blocked during the closing procedure (e. g. by ice or pollution), the tilt/sliding panel will stop and open slightly.

- ▶ Immediately after the tilt/sliding panel has stopped because it was blocked, pull the roof panel switch in direction of arrow ③ until the tilt/sliding panel is fully closed.

If the tilt/sliding panel is blocked again and opens slightly:

- ▶ Immediately after the tilt/sliding panel was blocked, pull the roof panel switch in

direction of arrow ③ until the tilt/sliding panel is fully closed.

⚠ Warning!

Pulling and holding the roof panel switch to close the tilt/sliding panel immediately after it had been blocked two times will cause the tilt/sliding panel to close without any reversal function for as long as you hold the roof panel switch.

Synchronizing

The tilt/sliding panel and front roller sunblinds must be synchronized after a malfunction or if the tilt/sliding panel does not open smoothly.

⚠ Do not attempt to open the tilt/sliding panel before the tilt/sliding panel is properly synchronized. The tilt/sliding panel could otherwise lock-up in the open position.

If the tilt/sliding panel cannot be closed or synchronized, contact an authorized Mercedes-Benz Center or call Roadside Assistance.

- ▶ Switch on the ignition.
- ▶ Pull and hold the roof panel switch in direction of arrow ③ (▷ page 227) until the roller sunblinds are fully extended.
- ▶ Keep holding the roof panel switch in direction of arrow ③ for approximately 1 second.
- ▶ Push and hold the roof panel switch in direction of arrow ② (▷ page 227) until the roller sunblinds are fully retracted.
- ▶ Push and hold the roof panel switch in direction of arrow ② until the tilt/sliding panel is opened approximately 4 inch (10 cm).
- ▶ Pull and hold the roof panel switch in direction of arrow ③ until the tilt/sliding panel is fully closed.
- ▶ Keep holding the roof panel switch in direction of arrow ③ for approximately 1 second.
- ▶ Check the express operation feature of the tilt/sliding panel (▷ page 226). If the tilt/sliding panel opens completely, the roof is synchronized. Otherwise repeat the above steps.

Loading and storing

Loading instructions

Warning!

Always fasten items being carried as securely as possible using fastening materials appropriate for the weight and size of the load.

In an accident, during hard braking or sudden maneuvers, loose items will be thrown around inside the vehicle and can cause injury to vehicle occupants unless the items are securely fastened in the vehicle.

To help avoid personal injury during a collision or sudden maneuver, exercise care when transporting cargo. Do not pile luggage or cargo higher than the seat backrests.

The trunk is the preferred place to carry objects. Do not place anything on the rear-window shelf.

Never drive vehicle with the trunk open. Deadly carbon monoxide (CO) gases may enter vehicle interior resulting in unconsciousness and death.

Load distribution

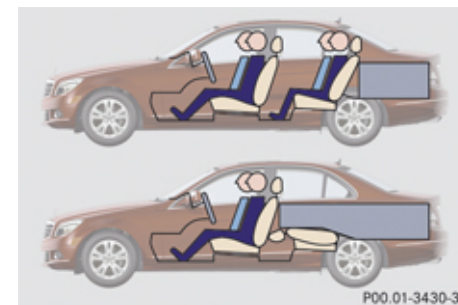

The total load weight including vehicle occupants and luggage/cargo should not exceed the total load limit indicated on the corresponding Tire and Loading Information placard located on the driver's door B-pillar (▷ page 263).

The handling characteristics of a fully loaded vehicle depend greatly on the load distribution. It is therefore recommended to load the vehicle according to the illustration shown, with the heaviest items being placed towards the front of the vehicle.

Loading and storing

Please pay attention to and comply with the following instructions when loading the vehicle and transporting cargo:

- Always place items being carried against front or rear seat backrests, and fasten them as securely as possible.
- The heaviest portion of the cargo should always be kept as low as possible against front or rear seat backrests.

i The enlarged cargo area should only be used for items which do not fit in the trunk alone.

Roof rack

For information about further roof rack equipment, contact an authorized Mercedes-Benz Center.

⚠ Warning!

Only use roof racks approved by Mercedes-Benz for your vehicle model to avoid damage to the vehicle.

Follow the manufacturer's installation instructions. Otherwise, an improperly attached roof rack system or its load could become detached from the vehicle.

Do not exceed the maximum roof load of 220 lb (100 kg).

Take into consideration that when the roof rack is loaded, the handling characteristics are different from those when operating the vehicles without the roof rack loaded.

Make sure

- you can raise the tilt/sliding sunroof or the panorama roof with tilt/sliding panel completely
- you can open the trunk completely

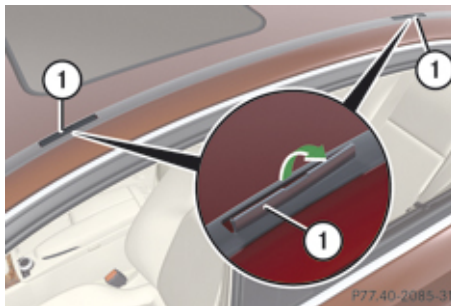

① Trim cover

- ▶ Flip trim covers ① open.
- ▶ Only attach the roof rack to the anchorage points under trim covers ①.
- ▶ Observe manufacturer's instructions for installation.

Parcel nets

⚠ Warning!

The parcel net is intended for storing light-weight items only, such as road maps, mail, etc.

Heavy objects, objects with sharp edges or fragile objects may not be transported in the parcel net. In an accident, during hard braking, or sudden maneuvers, they could be thrown around inside the vehicle and cause injury to vehicle occupants.

The parcel net cannot protect transported goods in the event of an accident.

Parcel nets are located in the front passenger footwell and on the left trunk side wall.

Cargo tie-down rings

Vehicles with split rear seat bench are equipped with four cargo tie-down rings.

Carefully secure cargo by applying even load on all rings ① with rope of sufficient strength to hold down the cargo.

Always follow loading instructions (▷ page 229).



① Cargo tie-down ring

Hooks

Two retaining hooks can be used to attach cargo items such as bags.

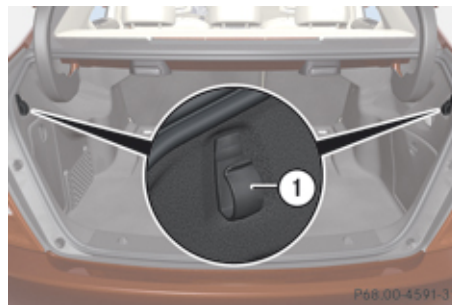

① Retaining hook

Use the hooks to secure light-weight items only. The maximum permissible weight per hook is 9 lbs (4 kg).

! Do not use the retaining hook to tie down cargo.

Split rear seat bench

To expand the cargo volume, you can fold down the left and right rear seat backrests. The two sections can be folded down separately.

⚠ Warning!

When expanding the cargo volume, always fold the seat cushions fully forward.

Unless you are transporting cargo, the seat backrests must remain properly locked in the upright position.

In an accident, during hard braking or sudden maneuvers, loose items will be thrown around inside the vehicle, and cause injury to vehicle occupants unless the items are securely fastened in the vehicle.

Loading and storing

Folding seat backrest forward

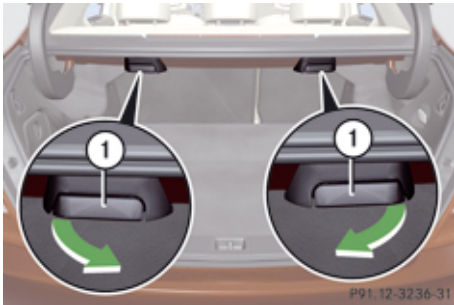

① Release handle

- ▶ Open the trunk.
- ▶ Pull on left and/or right release handle ①.
- ▶ Fully retract the head restraints (▷ page 90).
- ▶ If necessary, pull the driver's and/or front passenger seat forward.

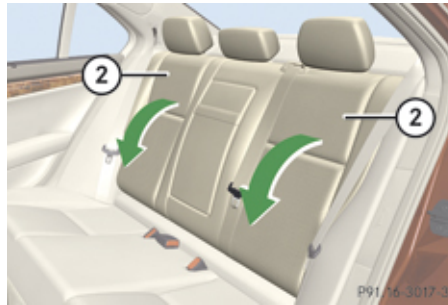

② Seat backrests

- ▶ Fold seat backrests ② forward.

Setting up seat backrest

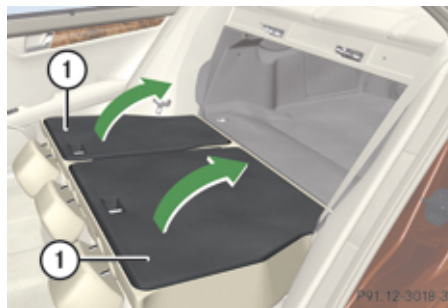

① Seat backrests

- ▶ Fold seat backrest ① rearward until it engages.

⚠ Make sure that the seat belt is not pinched.

- ▶ Adjust head restraints, if necessary.
- ▶ Adjust front seats to desired position.
- ▶ Check for secure locking by pushing and pulling on the seat backrest.

⚠ Warning!

Always lock seat backrest in its upright position when rear seat bench is occupied, or the extended cargo volume is not in use.

Check for secure locking by pushing and pulling on the seat backrest.

In an accident, during hard braking or sudden maneuvers, loose items will be thrown around inside the vehicle, and cause injury to vehicle occupants unless the items are securely fastened in the vehicle.

To help avoid personal injury during a collision or sudden maneuver, exercise care when transporting cargo.

- ⓘ To prevent unauthorized persons from access to the trunk, always lock seat backrest in its upright position.

Storage compartments

Warning!

To help avoid personal injury during a collision or sudden maneuver, exercise care when storing objects in the vehicle. Put luggage or cargo in the trunk if possible.

Do not pile luggage or cargo higher than the seat backrests.

Parcel nets cannot secure hard or heavy objects.

Keep compartment lids closed. This will help to prevent stored objects from being thrown about and injuring vehicle occupants during

- braking
- vehicle maneuvers
- an accident

Glove box

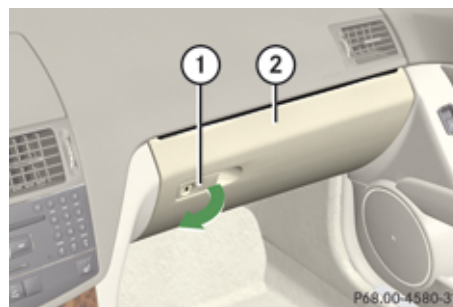

- ① Glove box lid release
- ② Glove box lid

- ▶ **Opening:** Pull glove box lid release ①.
- ▶ **Closing:** Push glove box lid ② up until it engages.

Locking and unlocking the glove box separately

You can lock the glove box separately, e.g. when the vehicle is in the shop for service.

The glove box can only be locked or unlocked with the mechanical key.

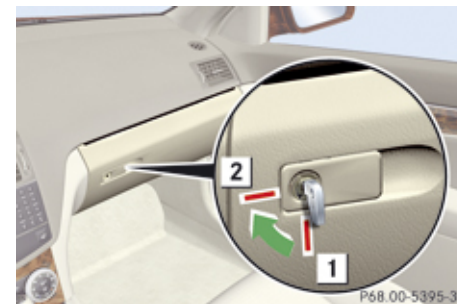

- ① Unlocking glove box
- ② Locking glove box

Front armrest storage compartments



- ① Right button for storage compartments
- ② Left button for storage compartments

Loading and storing

- ▶ **Opening storage compartments:** Press button ① or ②.

The armrests opens automatically to the left and the right side.

- ❗ There is a small and a large storage compartment located underneath the armrest. The small storage compartment can be removed for the purpose of emptying.

- ▶ **Closing storage compartments:** Swing the left and/or right armrest backward until it engages.

Storage bags

⚠ Warning!

The storage bag is intended for storing light-weight items only.

Heavy objects, objects with sharp edges or fragile objects may not be transported in the storage bag. In an accident, during hard braking, or sudden maneuvers, they could be thrown around inside the vehicle and cause injury to vehicle occupants.

The storage bag cannot protect transported goods in the event of an accident.

Storage bags are located on the back of the front seats.

Rear storage compartments

Armrest with integrated storage compartment

- ❗ Before storing the armrest in the seat backrest, close the storage compartment cover.
- ❗ Do not sit on or lean your body weight against the armrest when it is folded down, as you could otherwise damage it.

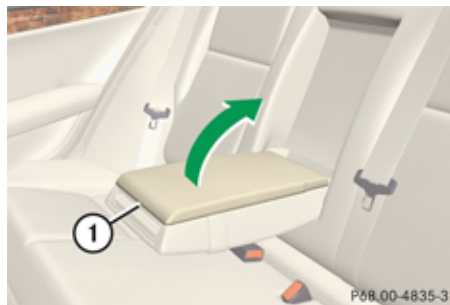

- ① Release catch

- ▶ **Opening:** Pull down the armrest.
- ▶ Pull release catch ① and swing the storage compartment cover upward in direction of arrow.

Useful features

Cup holders

⚠ Warning!

In order to help prevent spilling liquids on vehicle occupants and/or vehicle equipment, only use containers that fit into the cup holder. Use lids on open containers and do not fill containers to a height where the contents, especially hot liquids, could spill during braking, vehicle maneuvers, or in an accident. Liquids spilled on vehicle occupants may cause serious personal injury. Liquids spilled on vehicle equipment may cause damage not covered by the Mercedes-Benz Limited Warranty.

When not in use, keep the cup holder closed. An open cup holder may cause injury to you or others when contacted during braking, vehicle maneuvers, or in an accident.

Keep in mind that objects placed in the cup holder may come loose during braking, vehicle maneuvers, or in an accident and be thrown around in the vehicle interior. Objects thrown around in the vehicle interior may cause an accident and/or serious personal injury.

Cup holder in front center console



① Cup holder

Cup holder in rear armrest



① Release button

② Cup holder

- ▶ **Opening:** Open armrest storage compartment (▷ page 234).
- ▶ Press release button ①.
- ▶ Cup holder ② swing out and opens automatically.
- ▶ Close the armrest storage compartment.
- ▶ **Closing:** Open the armrest storage compartment (▷ page 234).
- ▶ Swing cup holder ② backward until it engages.

! Do not sit on or lean your body weight against the armrest when it is folded down, as you could otherwise damage it.

! Close the cup holder before folding the armrest upwards. Otherwise you could damage the cup holder.

Useful features

Sun visors

⚠ Warning!

Do not use the vanity mirror while driving. Keep the vanity mirrors in the sun visors closed while vehicle is in motion. Reflected glare can endanger you and others.

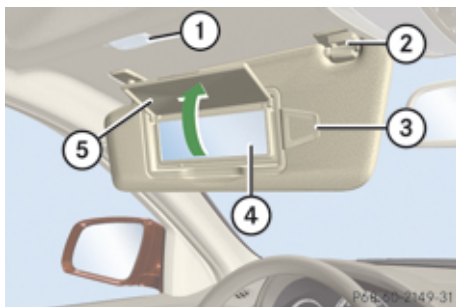

- ① Vanity mirror lamp
- ② Mounting
- ③ Holder, e.g. for gas cards
- ④ Vanity mirror
- ⑤ Vanity mirror cover

Glare through the windshield

- ▶ Flip sun visor down when you experience glare.

Glare through a door window

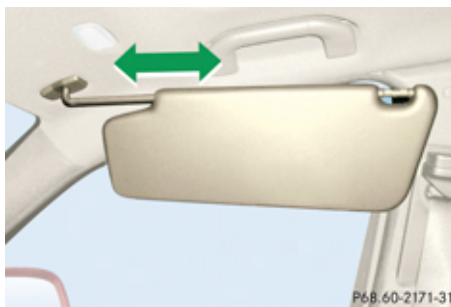

- ▶ Close vanity mirror cover ⑤ if opened.
- ▶ Disengage sun visor from mounting ②.
- ▶ Pivot sun visor to the side.
- ▶ Adjust sun visor by pushing or pulling in direction of arrows.

Vanity mirror

The mirror lamp only functions when the sun visor is engaged in mounting.

- ▶ Lift up vanity mirror cover ⑤.
Vanity mirror lamp ① comes on.

Rear window sunshade

⚠ Warning!

When operating the rear window sunshade make sure there is no danger of anyone being harmed by the extending or retracting procedure.

The extending or retracting procedure can be immediately halted by briefly pressing rear window sunshade switch. To reverse direction of movement, press rear window sunshade switch again.

⚠ Observe Safety notes, see page 59.



- ① Rear window sunshade switch

Always extend the sunshade fully for its support against the window frame.

- ▶ Switch on the ignition.
- ▶ **Extending/Retracting:** Press rear window sunshade switch ① briefly.

Ashtrays

Center console ashtray

Warning!

Remove front ashtray insert only with vehicle standing still.

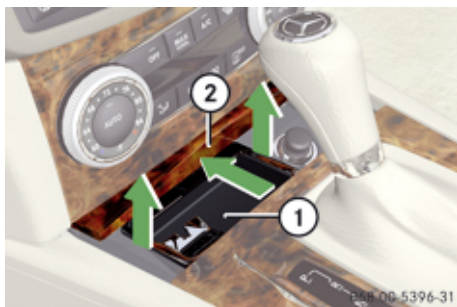

- ① Ashtray insert
- ② Cover plate

- i** A storage compartment is located under the ashtray insert.

! The storage compartment is not heat-proof. Therefore, do not stub cigarettes in the storage compartment.

- ▶ **Opening:** Press cover plate ② forward until it engages.
- ▶ **Removing ashtray insert:** Grab ashtray insert ① on the grooved side and pull it up and out in the direction indicated by arrows.
- ▶ **Reinstalling ashtray insert:** Push ashtray insert ① back into the frame until it engages.
- ▶ **Closing:** Tap the front of cover plate ②.

Rear center console ashtray



- ① Ashtray insert
- ② Cover
- ③ Button

- ▶ **Opening:** Pull at top of cover ②.
- ▶ **Removing ashtray insert:** Push button ③ to disengage ashtray insert ① and remove it.
- ▶ **Reinstalling ashtray insert:** Push ashtray insert ① down into the retainer until it engages.
- ▶ **Closing:** Push at top of cover ②.

Useful features

Cigarette lighter

⚠ Observe Safety notes, see page 59.

⚠ Warning!

Never touch the heating element or sides of the lighter; they are extremely hot. Hold the knob only.

Make sure any children traveling with you do not injure themselves or start a fire with the hot cigarette lighter.

If the engine is off and the cigarette lighter is being used extensively, the vehicle battery may become discharged.

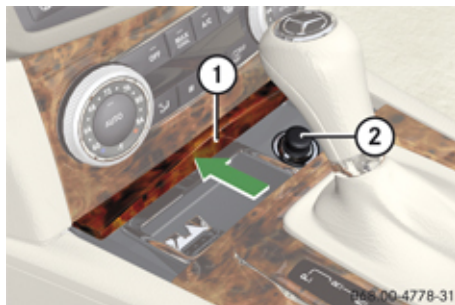

- ① Cover
- ② Cigarette lighter

- ▶ Switch on the ignition.
- ▶ Open cover ① (▷ page 237).
- ▶ Push in cigarette lighter ②. Cigarette lighter ② will pop out automatically when hot.
- ▶ Take out cigarette lighter ②.
- ▶ Reinsert cigarette lighter ② in its socket after use.

! The lighter socket can be used to accommodate 12V DC electrical accessories (up to a maximum of 85 W) designed for use with the standard “cigarette lighter” plug type. Keep in mind, however, that connecting accessories to the lighter socket (for example extensive connecting and disconnecting, or using plugs that do not fit properly) can damage the lighter socket. With the socket damaged, the lighter may not function properly any longer.

Power outlets

The power outlets can be used to accommodate 12V DC electrical accessories (e.g. auxiliary lamps, mobile phone chargers) up to a maximum of 15 A (180 W).

If the engine is off and the power outlets are being used extensively, the vehicle battery may become discharged.

- ▶ Switch on the ignition.



- ① Power outlet



Rear passenger compartment

- ① Power outlet
- ② Cover



- ① Interior rear view mirror
- ② Compass display
- ③ Button

► **Calling up the compass:** Press button ③ briefly.

The compass displays the direction into which the vehicle is currently traveling: N, NE, E, SE, S, SW, W, or NW.

► **Compass adjustment:** Determine your location on the basis of the following zone maps.

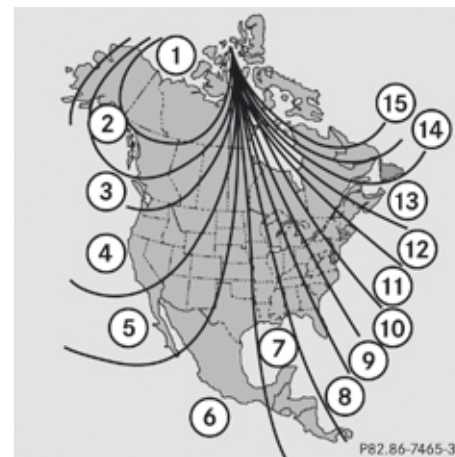

Zone map North America

Compass

i In order to receive an accurate reading in the interior rear view mirror, the compass must be calibrated and the magnetic field zone set.

Useful features

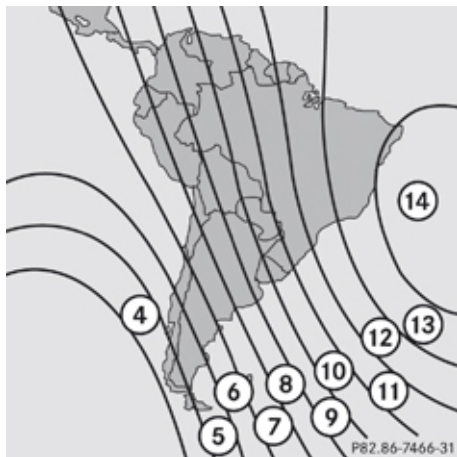

Zone map South America

- ▶ Press button ③ approximately 3 seconds. The currently selected zone appears in compass display ②.
- ▶ **Selecting zone:** Press button ③ until the desired zone is selected. Do not press the button again until the direction is indicated.
- ▶ **Compass calibration:** Make sure you are in an area where you can drive a full circle with your vehicle without disturbing traffic in order to calibrate the compass.

In order to calibrate the compass properly, mind the following:

- Calibrate the compass in open terrain. Nearby buildings, bridges, power lines and large antenna masts, for example, could impair compass calibration.
 - Switch off electrical consumers (e.g. climate control, windshield wipers, or rear window defroster).
 - Close all doors and the trunk.
- ▶ Start the engine
 - ▶ Press button ③ approximately 6 seconds until symbol C appears in compass display ②.
 - ▶ Drive a full circle at a vehicle speed of between 3 mph (5 km/h) and 6 mph (10 km/h). When calibration was successful, the current direction appears in compass display ②.

Tele Aid

- ! In order to activate the Tele Aid system, a subscriber agreement must be completed. To ensure your system is activated and operational, please press the  button to perform the acquaintance call. Failure to complete either of these steps may result in a system that is not activated. If you have any questions regarding activation, please call the Response Center at 1-800-756-9018 (in the USA) or 1-888-923-8367 (in Canada).

Shortly after the completion of your Tele Aid acquaintance call, you will receive a user ID and password in the mail. You may use this password to access the Tele Aid section in “Owner’s Online” at www.mbusa.com (USA only). The “My Tele Aid” section will give you access to account information, remote door unlock and more.

The Tele Aid system is available if

- it has been activated and is operational. Activation requires a subscription for

monitoring services, connection and cellular air time.

- vehicle battery power is available.
- the relevant cellular phone network and GPS signals are available and pass the information on to the Response Center.

i Location of the vehicle on a map is only possible if the vehicle is able to receive signals from the GPS satellite network and pass the information on to the Response Center.

The Tele Aid system

(Telematic Alarm Identification on Demand)
The Tele Aid system consists of three types of response:

- Automatic and manual emergency
- Roadside Assistance
- Information

The Tele Aid system is operational providing that the vehicle's battery is charged, properly connected, not damaged, and cellular and GPS coverage is available. The Tele Aid system utilizes the cellular network for communication and the GPS (Global Positioning System) satellites for vehicle

location. If either of these signals are unavailable, the Tele Aid system may not function and if this occurs, assistance must be summoned by other means.



To adjust the speaker volume during a Tele Aid call do the following:

- ▶ Press button **+** or **-** on the multifunction steering wheel.
- or
- ▶ Use the audio system rotary control button.

System self-test

The system performs a self-test after you have switched on the ignition.

⚠ Warning!

If the indicator lamps in the SOS button, in the Roadside Assistance button  and/or in the Information button  do not come on during the system self-test, or if any of these indicators remain illuminated constantly in red and/or the message Tele Aid Not Activated or Tele Aid Inoperative is displayed in the multifunction display after the system self-test, a malfunction in the system has been detected.

If a malfunction is indicated as outlined above, the system may not operate as expected. In case of an emergency, help will have to be summoned by other means.

Have the system checked at the nearest Mercedes-Benz Center or contact the Response Center at 1-800-756-9018 (in the USA) or 1-888-923-8367 (in Canada) as soon as possible.

Emergency calls

! In order to activate the Tele Aid system, a subscriber agreement must be completed. To ensure your system is activated and operational, please press the  button to perform the acquaintance call. Failure to complete either of these steps may result in a system that is not activated. If you have any questions regarding activation, please call the Response Center at 1-800-756-9018 (in the USA) or 1-888-923-8367 (in Canada).

An emergency call is initiated automatically following an accident in which the Emergency Tensioning Devices (ETDs) or air bags deploy. An emergency call can also be initiated manually (▷ page 242).

Useful features

Once the emergency call is in progress, the indicator lamp in the SOS button will begin to flash. The message **Connecting Call** appears in the multifunction display and the COMAND system is muted. When the connection is established, the message **Call Connected** appears in the multifunction display.

All information relevant to the emergency, such as the location of the vehicle (determined by the GPS satellite location system), vehicle model, identification number and color are generated.

i During the emergency call message **Emergency Call Activated** is displayed, operation from audio system or COMAND system is not possible. The automatic climate control can be still adjusted using the switches on the climate control panel.

i During the emergency call message is displayed, operation from audio system or COMAND system is not possible. The climate control can be still adjusted using the switches on the climate control panel.

A voice connection between the Response Center and the occupants of the vehicle will be established automatically soon after the emergency call has been initiated. The

Response Center will attempt to determine more precisely the nature of the emergency provided they can speak to an occupant of the vehicle.

i If no vehicle occupant responds, an ambulance will be sent to the vehicle immediately.

⚠ Warning!

If the indicator lamp in the SOS button is flashing continuously and there was no voice connection to the Response Center established, then the Tele Aid system could not initiate an emergency call (e.g. the relevant cellular phone network is not available).

The message **Call Failed** appears in the multifunction display for approximately 10 seconds.

Should this occur, assistance must be summoned by other means.

i During the emergency call the telephone is switched off automatically and must be switched back on to make a call.

i The “911” emergency call system is a public service. Using it without due cause is a criminal offense.

Initiating an emergency call manually

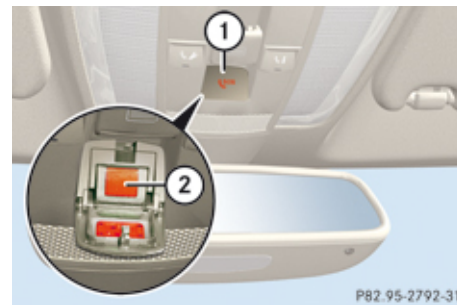

- ① Cover
- ② SOS button

- ▶ Briefly press on cover ① to open.
- ▶ Press SOS button ② briefly. The indicator lamp in SOS button ② will flash until the emergency call is concluded.
- ▶ Wait for a voice connection to the Response Center.
- ▶ Close cover ① after the emergency call is concluded.

⚠ Warning!



If you feel at any way in jeopardy when in the vehicle (e.g. smoke or fire in the vehicle, vehicle in a dangerous road location), please do not wait for voice contact after you have pressed the emergency button.

Useful features

Carefully leave the vehicle and move to a safe location. The Response Center will automatically contact local emergency officials with the vehicle's approximate location if they receive an automatic SOS signal and cannot make voice contact with the vehicle occupants.

Roadside Assistance button

① Roadside Assistance button 

- ▶ Press and hold Roadside Assistance button  for longer than 2 seconds. A call to a Mercedes-Benz Roadside Assistance dispatcher will be initiated. The indicator lamp in the Roadside Assistance button  will flash while the call is in progress. The message *Connecting*

Call will appear in the multifunction display and the audio system or the COMAND system is muted.

When the connection is established, the message *Call Connected* appears in the multifunction display. The Tele Aid system will transmit data generating the vehicle identification number, model, color and location (subject to availability of cellular and GPS signals).

A voice connection between the Roadside Assistance dispatcher and the occupants of the vehicle will be established.

- ▶ Describe the nature of the need for assistance.

The Mercedes-Benz Roadside Assistance dispatcher will either dispatch a qualified Mercedes-Benz technician or arrange to tow your vehicle to the nearest authorized Mercedes-Benz Center. For services such as labor and/or towing, charges may apply. Refer to the Roadside Assistance manual for more information.

The following is only available in the USA:
Sign and Drive services: Services such as a jump start, a few gallons of fuel or the replacement of a flat tire with the vehicle spare tire are obtainable at no charge.

- ❗ If the indicator lamp in the Roadside Assistance button  is flashing continuously and there was no voice connection to the Response Center established, then the Tele Aid system could not initiate a Roadside Assistance call (e.g. the relevant cellular phone network is not available). The message *Call Failed* appears in the multifunction display for approximately 10 seconds.

- ▶ **Terminating calls:** Press button  on the multifunction steering wheel.

or



- ▶ Press the respective button for ending a telephone call on the audio system or the COMAND system.



Useful features

Information button



① Information button

- ▶ Press and hold Information button   for longer than 2 seconds.



A call to the Customer Assistance Center will be initiated. The indicator lamp in the Information button   will flash while the call is in progress. The message Connecting Call will appear in the multifunction display and the audio system or the COMAND system is muted.

-  The audio system or COMAND system display indicates that a Tele Aid call is in progress. While the call is connected you can change to the navigation menu by pressing the NAV button on the COMAND

system. Spoken commands are not available.

A voice connection between the Customer Assistance Center representative and the occupants of the vehicle will be established. Information regarding the operation of your vehicle, the nearest authorized Mercedes-Benz Center or Mercedes-Benz USA products and services is available to you.

For more details concerning the Tele Aid system, please visit www.mbusa.com (USA only), log in to “Owner’s Online” and visit the “My Tele Aid” section to learn more.

-  If the indicator lamp in the Information button   is flashing continuously and there was no voice connection to the Response Center established, then the Tele Aid system could not initiate an Information call (e.g. the relevant cellular phone network is not available). The message Call Failed appears in the multifunction display for approximately 10 seconds.

- ▶ **Terminating calls:** Press button  on the multifunction steering wheel.

or

- ▶ Press the respective button for ending a telephone call on the audio system or the COMAND system.

Call priority

If other service calls such as a Roadside Assistance call or Information call are active, an emergency call is still possible. In this case, the emergency call will take priority and override all other active calls.

The indicator lamp in the respective button flashes until the call is concluded. Emergency calls can only be terminated by a Response Center or Customer Assistance Center representative. All other calls can be terminated by pressing button  on the multifunction steering wheel or the respective button for ending a telephone call on the audio system or the COMAND system.

-  When a Tele Aid call has been initiated, the audio system is muted. The optional mobile phone (if installed) switches off. If you must use this phone, we recommend that you use it only with the vehicle at a standstill in a safe location. Unplug the

Useful features

telephone, switch it on and place the call. The navigation system (if engaged) will continue to run. The multifunction display in the instrument cluster is available for use, but spoken commands are not available.

Remote door unlock

In case you have locked your vehicle unintentionally (e.g. SmartKey inside vehicle), and the reserve SmartKey is not available:

- ▶ Contact the Response Center at 1-800-756-9018 (in the USA) or 1-888-923-8367 (in Canada). You will be asked to provide your password.
- ▶ Then return to your vehicle at the time arranged with the Response Center and pull the trunk lid handle for a minimum of 20 seconds until the indicator lamp in the SOS button is flashing. The message **Connecting Call** appears in the multifunction display.

As an alternative, you may unlock the vehicle via Internet in the “My Tele Aid” section of “Owner’s Online”, using your ID and password (USA only).

The Response Center will then unlock your vehicle with the remote door unlocking feature.

- 1 The remote door unlock feature is available if the relevant cellular phone network is available.

The SOS button will flash and the message **Connecting Call** will appear in the multifunction display to indicate receipt of the door unlock command.

Once the vehicle is unlocked, a Response Center specialist will attempt to establish voice contact with the vehicle occupants.

If the trunk lid handle was pulled for more than 20 seconds before door unlock authorization was received by the Response Center, you must wait 15 minutes before pulling the trunk lid handle again.

Remote door lock

If you have forgotten to lock your vehicle and are no longer near it, you can have it locked remotely through the Response Center.

The vehicle can be remotely locked within 4 days after the ignition has been switched off.

- ▶ Contact the Response Center at 1-800-756-9018 (in the USA) or 1-888-923-8367 (in Canada). You will be asked to provide your password.

When you are inside your vehicle the next time and switch on the ignition, the message **Tele Aid Doors locked by remote control** will appear on the multifunction display.

- 1 The remote door lock feature is available if the relevant telephone network is available and data connection is possible.

Stolen Vehicle Recovery services

In the event your vehicle was stolen:

- ▶ Report the incident to the police. The police will issue a numbered incident report.
- ▶ Pass this number on to the Response Center along with your password. The Response Center will then attempt to covertly contact the vehicle’s Tele Aid system. Once the vehicle is located, the Response Center will contact the local law enforcement and you. The vehicle’s location will only be provided to law enforcement.

- 1 If the anti-theft alarm stays on for more than 30 seconds, a call to the Response Center is initiated automatically by the Tele Aid system provided Tele Aid service was subscribed to and properly activated, and



Useful features

that necessary cellular service and GPS coverage are available. See “Anti-theft alarm system” (► page 73).

Garage door opener

The integrated remote control can operate up to three separately controlled devices compatible with HomeLink® or some other systems.

Warning!

Before programming the integrated remote control to a garage door opener or gate operator, make sure people and objects are out of the way of the device to prevent potential harm or damage. When programming a garage door opener, the door moves up or down. When programming a gate operator, the gate opens or closes.

Do not use the integrated remote control with any garage door opener that lacks safety stop and reverse features as required by U.S. federal safety standards (this includes any garage door opener model manufactured before April 1, 1982). A garage door that cannot detect an object - signaling the door to stop and reverse -

does not meet current U.S. federal safety standards.

When programming a garage door opener, park vehicle outside the garage.

Do not run the engine while programming the integrated remote control. Inhalation of exhaust gas is hazardous to your health. All exhaust gas contains carbon monoxide (CO), and inhaling it can cause unconsciousness and possible death.

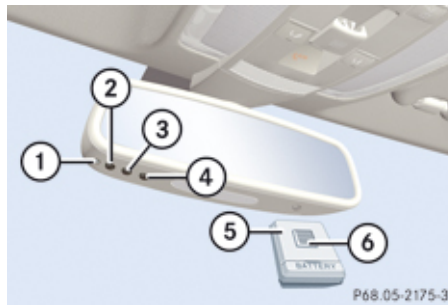

Interior rear view mirror with integrated remote control

- ① Indicator lamp
- ②③④ Signal transmitter button

- ⑤ Hand-held remote control (not part of vehicle equipment)
- ⑥ Hand-held remote control button

Programming the integrated remote control

- **Step 1:** Switch on the ignition.
- **Step 2:** If you have previously programmed a signal transmitter button and wish to retain its programming, proceed to step 3.

or

- If you are programming the integrated remote control for the first time, press and hold the two outer signal transmitter buttons ② and ④ and release them when indicator lamp ① begins to flash after approximately 20 seconds.

Do not hold the button for longer than 30 seconds.

This procedure erases any previous settings for all three channels and initializes the memory. If you later wish to program a second and/or third hand-held transmitter to the remaining two signal transmitter buttons, do not repeat this step and begin directly with step 3.

- **Step 3:** Hold the end of hand-held remote control ⑤ of the device you wish to train

Useful features

approximately 2 to 12 in (5 to 30 cm) away from the signal transmitter button (②, ③ or ④) to be programmed, while keeping indicator lamp ① in view.

- ▶ **Step 4:** Using both hands, simultaneously press hand-held remote control button ⑥ and the desired signal transmitter button (②, ③ or ④). Do not release the buttons until step 5 is completed.

Indicator lamp ① will flash, first slowly and then rapidly.

- ❗ Indicator lamp ① flashes immediately the first time the signal transmitter button is programmed. If this button has already been programmed, the indicator lamp will start flashing after 20 seconds.

- ▶ **Step 5:** After indicator lamp ① changes from a slow to a rapidly flashing light, release the hand-held remote control button and the signal transmitter button.
- ▶ **Step 6:** Press and hold the just-trained signal transmitter button (②, ③ or ④) and observe indicator lamp ①. If indicator lamp ① stays on constantly, programming is complete and your device should activate when the respective signal

transmitter button (②, ③ or ④) is pressed and released.

- ❗ If indicator lamp ① flashes rapidly for approximately 2 seconds and then turns to a constant light, continue with programming steps 8 through 12 as your garage door opener may be equipped with the “rolling code” feature.
- ▶ **Step 7:** To program the remaining two signal transmitter buttons, repeat the steps above starting with step 3.

Rolling code programming

To train a garage door opener (or other rolling code devices) with the rolling code feature, follow these instructions after completing the “Programming” portion (steps 1 through 6) of this text. A second person may make the following training procedures quicker and easier.

- ▶ **Step 8:** Locate the “training” button on the garage door opener motor head unit.

- ❗ Exact location and color of the button may vary by garage door opener brand. Depending on manufacturer, the “training” button may also be referred to as “learn” or “smart” button. If there is difficulty locating

the transmitting button, refer to the garage door opener Operator’s Manual.

- ▶ **Step 9:** Press the “training” button on the garage door opener motor head unit. The “training light” is activated. You have 30 seconds to initiate the following two steps.
- ▶ **Step 10:** Return to the vehicle and firmly press, hold for 2 seconds and release the programmed signal transmitter button (②, ③ or ④).
- ▶ **Step 11:** Press, hold for 2 seconds and release same signal transmitter button a second time to complete the training process.
- ❗ Some garage door openers (or other rolling code equipped devices) may require you to press, hold for 2 seconds and release the same signal transmitter button a third time to complete the training process.
- ▶ **Step 12:** Confirm the garage door operation by pressing the programmed signal transmitter button (②, ③ or ④).
- ▶ **Step 13:** To program the remaining two signal transmitter buttons, repeat the steps above starting with step 3.

Useful features

Gate operator/Canadian programming

Canadian radio-frequency laws require transmitter signals to “time-out” (or quit) after several seconds of transmission which may not be long enough for the integrated signal transmitter to pick up the signal during programming. Similar to this Canadian law, some U.S. gate operators are designed to “time-out” in the same manner.

If you live in Canada or if you are having difficulties programming a gate operator (regardless of where you live) by using the programming procedures, replace step 4 with the following:

- ▶ **Step 4:** Press and hold the signal transmitter button (②, ③ or ④). Do not release this button until it has been successfully trained.
- ▶ While still holding down the signal transmitter button (②, ③ or ④), “cycle” your hand-held remote control button ⑥ as follows: Press and hold button ⑥ for 2 seconds, then release it for 2 seconds, and again press and hold it for 2 seconds. Repeat this sequence on the hand-held

remote control until the frequency signal has been learned.

Upon successful training, indicator lamp ① will flash slowly and then rapidly after several seconds.

- ▶ Proceed with programming step 5 and step 6 to complete.
- ▶ **i** Upon completion of programming the integrated remote control, make sure you retain the hand-held remote control that came with the garage door opener, gate operator or other device. You may need it for use in other vehicles, for future programming of an integrated remote control, or simply for continued use as a hand-held remote control to operate the respective device in other situations.

Reprogramming a single signal transmitter button

To program a device using a signal transmitter button previously trained, follow these steps:

- ▶ Switch on the ignition.
- ▶ Press and hold the desired signal transmitter button (②, ③ or ④). Do not release the button. Indicator lamp ① will begin to flash after 20 seconds.
- ▶ Without releasing the signal transmitter button, proceed with programming starting with step 3.

Operation of integrated remote control

- ▶ Switch on the ignition.
- ▶ Select and press the appropriate integrated signal transmitter button (②, ③ or ④) to activate the remote controlled device. The integrated remote control transmitter continues to send the signal as long as the button is pressed – up to 20 seconds.

Erasing the integrated remote control memory

- ▶ **i** If you sell your vehicle, erase the codes of all three channels.
- ▶ Switch on the ignition.
- ▶ Simultaneously press and hold outer signal transmitter buttons ② and ④, for

Useful features

approximately 20 seconds, until indicator lamp ① flashes rapidly. Do not hold for longer than 30 seconds.
The codes of all three channels are erased.

Programming tips

If you are having difficulty programming the integrated remote control, here are some helpful tips:

- Check the frequency of hand-held remote control ⑤ (typically located on the reverse side of the remote). The integrated remote control is compatible with radio-frequency devices operating between 280-390 MHz.
- Put a new battery in hand-held remote control ⑤. This will increase the likelihood of the hand-held remote control sending a faster and more accurate signal to the integrated remote control.
- While performing step 3, hold hand-held remote control ⑤ at different lengths and angles from the signal transmitter button (②, ③ or ④) you are programming. Attempt varying angles at the distance of 2 to 12 inches (5 to 30 cm) away or the same angle at varying distances.
- If another hand-held remote control is available for the same device, try the programming steps again using that other hand-held remote control. Make sure new batteries are in the hand-held remote control before beginning the procedure.
- Straighten the antenna wire from the garage door opener assembly. This may help improve transmitting and/or receiving signals.

i Certain types of garage door openers are incompatible with the integrated remote control. If you should experience further difficulties with programming the integrated remote control, contact an authorized Mercedes-Benz Center, or call the Mercedes-Benz Customer Assistance Center (in the USA) at 1-800-FOR-MERcedes, or Customer Service (in Canada) at 1-800-387-0100.

i USA only:
This device complies with Part 15 of the FCC Rules. Operation is subject to the following two conditions:

1. This device may not cause harmful interference, and
2. this device must accept any interference received, including interference that may cause undesired operation.

Any unauthorized modification to this device could void the user's authority to operate the equipment.

- i** Canada only:
This device complies with RSS-210 of Industry Canada. Operation is subject to the following two conditions:
1. This device may not cause interference, and
 2. this device must accept any interference received, including interference that may cause undesired operation of the device.

Any unauthorized modification to this device could void the user's authority to operate the equipment.

Useful features

Floormats

Warning!

Whenever you are using floormats, make sure there is enough clearance and that the floormats are securely fastened.

Floormats should always be securely fastened using the fastening equipment.

Before driving off, check that the floormats are securely in place and adjust them if necessary. A loose floormat could slip and hinder proper functioning of the pedals.

Do not place several floormats on top of each other as this may impair pedal movement.

 To install or remove the floormat more easily, move the driver's seat or front passenger seat as far to the rear as possible.

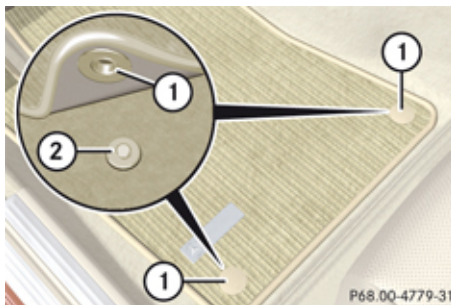

- ① Eyelet
- ② Retainer pin

- ▶ **Removing:** Pull floormat off of retainer pins ②.
- ▶ **Installing:** Press floormat eyelets ① onto retainer pins ②.

Vehicle equipment 252
The first 1000 miles (1500 km) 252
At the gas station 253
Engine compartment 255
Tires and wheels 260
Winter driving 284
Driving instructions 286
Maintenance 291
Vehicle care 293



The first 1000 miles (1500 km)

Vehicle equipment

i This Operator's Manual describes all features, standard or optional, potentially available for your vehicle at the time of purchase. Please be aware that your vehicle might not be equipped with all features described in this manual.

The first 1000 miles (1500 km)

The more cautiously you treat your vehicle during the break-in period, the more satisfied you will be with its performance later on.

- Drive your vehicle during the first 1000 miles (1500 km) at varying but moderate vehicle and engine speeds.
- During this period, avoid heavy loads (full throttle driving) and excessive engine speeds (no more than $\frac{2}{3}$ of maximum rpm in each gear).
- Vehicles with automatic transmission:
 - Select **C** as the preferred shift program (\triangleright page 124) for the first 1000 miles (1500 km).
 - Do not attempt to slow the vehicle down by shifting to a lower gear using the gear selector lever.
 - Select gear ranges **3**, **2** or **1** (\triangleright page 124) only when driving at moderate speeds (for hill driving).
 - Avoid accelerating by kickdown.
- Vehicles with manual transmission:
Shift gears in a timely manner.

After 1000 miles (1500 km) you may gradually increase vehicle and engine speeds to the permissible maximum.

! Additional instructions for AMG vehicles:

- During the first 1000 miles (1500 km), do not exceed a speed of 85 mph (140 km/h).
- During this period, avoid engine speeds above 4500 rpm in each gear.
- Shift gears in a timely manner.

All of the above instructions, as may apply to your vehicle type, also apply when driving the first 1000 miles (1500 km) after the engine or the rear differential has been replaced.

i Always obey applicable speed limits.

At the gas station

At the gas station

Refueling

 **Warning!**

Gasoline is highly flammable and poisonous. It burns violently and can cause serious personal injury.

Never allow sparks, flames or smoking materials near gasoline!

Turn off the engine before refueling.

Whenever you are around gasoline, avoid inhaling fumes and any skin or clothing contact. Extinguish all smoking materials.

Direct skin contact with fuels and the inhalation of fuel vapors are damaging your health.

 **Warning!**

Overfilling of the fuel tank may create pressure in the system which could cause a gas discharge. This could cause the gas to spray back out when removing the fuel pump nozzle, which could cause personal injury.

 **Warning!**

C 300 and C 300 Sport with automatic transmission:

Flexible Fuel Vehicles (identified by a label reading **Premium gasoline or E85 only!** on the fuel filler flap):

Ethanol fuel (E85) and its fumes are highly flammable, poisonous and burn easily. Ethanol fuel can cause serious injuries if ignited or if you come into contact with it or inhale fumes of it. Avoid inhalation of ethanol fumes and skin contact with ethanol. Extinguish all open flames before refueling. Never smoke or create sparks close to ethanol.

 Never refuel vehicles with gasoline engine with diesel fuel. Even small amounts of diesel fuel will damage the fuel system and engine. Damage resulting from the use of non-approved fuels or fuel additives or resulting from mixing gasoline with diesel fuel is not covered by the Mercedes-Benz Limited Warranty.

 If you have accidentally filled the tank with incorrect or non-approved fuel, do not switch on the ignition. Otherwise the incorrect or non-approved fuel will get into the fuel lines. The fuel system must be drained completely. Contact an authorized

Mercedes-Benz Center to have the fuel system drained completely.

 To prevent damage to the catalytic converters, only use premium unleaded gasoline in this vehicle.

Any noticeable irregularities in engine operation should be repaired promptly.

Otherwise, excessive unburned fuel may reach the catalytic converter, causing it to overheat and potentially start a fire.

 Only use premium unleaded gasoline with a minimum Posted Octane Rating of 91 (average of 96 RON/86 MON). Information on gasoline quality can normally be found on the fuel pump. Please contact gas station personnel in case labels on the pump cannot be found.

C 300 and C 300 Sport with automatic transmission:

Flexible Fuel Vehicles are identified by a label reading **Premium gasoline or E85 only!** on the fuel filler flap.

For more information on gasoline or E85, see “Premium unleaded gasoline” (▷ page 395), see “Flexible Fuel Vehicles” (▷ page 396), see “Fuel requirements” (▷ page 396), or contact an



At the gas station

authorized Mercedes-Benz Center, or visit www.mbusa.com (USA only).

The fuel filler flap is located on the right-hand side of the vehicle towards the rear.

Locking/unlocking the vehicle with the SmartKey automatically locks/unlocks the fuel filler flap.

i In case the central locking system does not release the fuel filler flap, or the opening mechanism is clamping, contact Roadside Assistance or an authorized Mercedes-Benz Center.

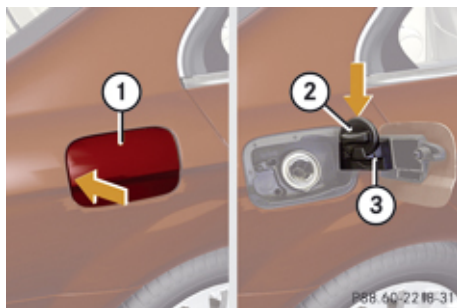

- ① Fuel filler flap
- ② Fuel filler cap
- ③ Holder

▶ Turn off the engine.

i Leaving the engine running and the fuel filler cap open can cause the yellow engine malfunction indicator lamp  to illuminate.

For more information, see also “Practical hints” (▷ page 345).

▶ Remove the SmartKey from the starter switch.

KEYLESS-GO: Open the driver’s door (this puts the starter switch in position **O**, same as with the SmartKey removed from the starter switch). The driver’s door then can be closed again.

▶ **Opening:** Press fuel filler flap ① at the point indicated by the arrow.

▶ Turn fuel filler cap ② counterclockwise.

▶ Take off fuel filler cap ②.

▶ Place fuel filler cap ② in direction of arrow into holder ③.

▶ Fully insert filler nozzle unit and refuel.

▶ Only fill your tank until the filler nozzle unit cuts out – **do not top off or overfill.**

▶ **Closing:** Turn fuel filler cap ② clockwise until it audibly engages.

i Make sure to close the fuel filler flap before locking your vehicle as the flap

locking pin prevents closing after you have locked the vehicle.

▶ Close fuel filler flap ①.

Check regularly and before a long trip

For information on quantities and requirements of operating agents, see “Fuels, coolants, lubricants, etc.” (▷ page 391).

Check the following:

- Engine oil level (▷ page 256)
- Tire inflation pressure (▷ page 268)
- Coolant level (▷ page 258)
- Vehicle lighting (▷ page 355)
- Washer system and headlamp cleaning system (▷ page 259)
- Brake fluid (▷ page 287), (▷ page 316), (▷ page 339)

Engine compartment

Engine compartment

Hood

⚠ Warning!

Do not pull the release lever while the vehicle is in motion. Otherwise the hood could be forced open by passing air flow. This could cause the hood to come loose and injure you and/or others.

Opening**⚠ Warning!**

If you see flames or smoke coming from the engine compartment, or if the coolant temperature gauge indicates that the engine is overheated, do not open the hood. Move away from vehicle and do not open the hood until the engine has cooled. If necessary, call the fire department.

⚠ Warning!

You could be injured when the hood is open – even when the engine is turned off. Parts of the engine can become very hot. To prevent burns, let the engine cool off completely before touching any components on the vehicle. Comply with all relevant safety precautions.

⚠ Warning!

To help prevent personal injury, stay clear of moving parts when the hood is open and the engine is running.

The radiator fan may continue to run for approximately 30 seconds or may even restart after the engine has been turned off. Stay clear of fan blades.

⚠ Warning!

The engine is equipped with a transistorized ignition system. Because of the high voltage it is dangerous to touch any components (ignition coils, spark plug sockets, diagnostic socket) of the ignition system

- with the engine running
- while starting the engine
- when the ignition is switched on and the engine is turned manually



① Hood lock release lever

- ▶ Pull release lever ①. The hood is unlocked.

! To avoid damage to the windshield wipers or hood, never open the hood if the wiper arms are folded forward away from the windshield.

Engine compartment



② Handle

- ▶ Push handle ② under the hood upwards.
- ▶ Pull up on the hood and then release it. The hood will be automatically held open at shoulder height by gas-filled struts.

Closing

Warning!

When closing the hood, use extreme caution not to catch hands or fingers. Be careful that you do not close the hood on anyone.

Make sure the hood is securely engaged before driving off. Do not continue driving if the hood can no longer engage after an accident, for example. The hood could

otherwise come loose while the vehicle is in motion and injure you and/or others.

- ▶ Let the hood drop from a height of approximately 1 ft (30 cm).
- ▶ Check to make sure the hood is fully closed.

If you can raise the hood at a point above the headlamps, then it is not properly closed. Open it again and let it drop with somewhat greater force.

Engine oil

The amount of oil your engine needs will depend on a number of factors, including driving style. Increased oil consumption can occur when the vehicle is new or the vehicle is driven frequently at higher engine speeds.

Engine oil consumption checks should only be made after the vehicle break-in period.

- !** Do not use any special lubricant additives, as these may damage the drive assemblies. Using special additives not approved by Mercedes-Benz may cause damage not covered by the Mercedes-Benz Limited Warranty.

For further information contact an authorized Mercedes-Benz Center.

Notes on checking engine oil level

When checking the oil level

- the vehicle must be parked on level ground
- with the engine at operating temperature, the vehicle must have been stationary for at least 5 minutes with the engine turned off
- with the engine not at operating temperature, the vehicle must have been stationary for at least 30 minutes with the engine turned off

Engine compartment

Checking engine oil level

► Open the hood (► page 255).

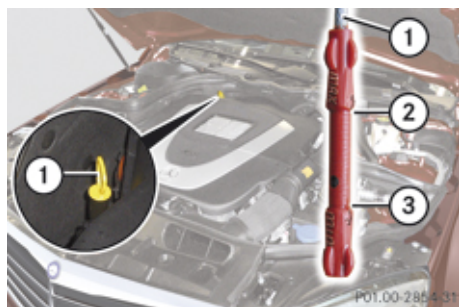

- ① Oil dipstick
- ② Upper (max) mark
- ③ Lower (min) mark

- Pull out oil dipstick ①.
 - Wipe oil dipstick ① clean.
 - Fully insert oil dipstick ① into the dipstick guide tube.
 - Pull out oil dipstick ① again after approximately 5 seconds to obtain accurate reading.
- The oil level is correct when it is between lower (min) mark ③ and upper (max) mark ② of oil dipstick ①.

i All models (except C 63 AMG):

The filling quantity between the upper and lower marks on the oil dipstick is approximately 2.1 US qt. (2.0 l).

C 63 AMG:

The filling quantity between the upper and lower marks on the oil dipstick is approximately 1.6 US qt. (1.5 l).

- If necessary, add engine oil.
- For more information on engine oil, see “Fuels, coolants, lubricants etc.” (► page 391).

For information on messages in the multifunction display concerning engine oil, see the “Practical hints” section (► page 327).

Adding engine oil

! Only use approved engine oils and oil filters required for vehicles with Maintenance System. For a listing of approved engine oils and oil filters, contact an authorized Mercedes-Benz Center or visit www.mbusa.com (USA only).

Using engine oils and oil filters of specification other than those expressly required for the Maintenance System, or changing of oil and oil filter at change intervals longer than those called for by the

Maintenance System will result in engine or emission control system damage not covered by the Mercedes-Benz Limited Warranty.



- ① Filler cap

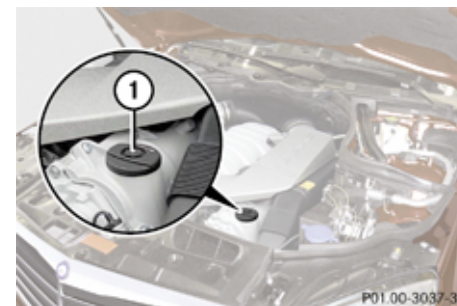

C 63 AMG

- ① Filler cap

Engine compartment

- ▶ Unscrew filler cap ① from filler neck.
- ▶ Add engine oil as required. Be careful not to overfill with oil.

Be careful not to spill any oil when adding. Avoid environmental damage caused by oil entering the ground or water.

! Excess oil must be siphoned or drained off. It could cause damage to the engine and emission control system not covered by the Mercedes-Benz Limited Warranty.

- ▶ Screw filler cap ① back on filler neck.

For more information on engine oil, see the “Technical data” section (▷ page 391) and (▷ page 394).

Transmission fluid level

Vehicles with automatic transmission: The transmission fluid level does not need to be checked. If you notice transmission fluid loss or gearshifting malfunctions, have an authorized Mercedes-Benz Center check the transmission.

Coolant level

The engine coolant is a mixture of water and anticorrosion/antifreeze.

When checking the coolant level, the vehicle must be parked on level ground, and the coolant temperature must be below 158°F (70°C).

⚠ Warning!

In order to avoid any potentially serious burns:

- Use extreme caution when opening the hood if there are any signs of steam or coolant leaking from the cooling system, or if the coolant temperature gauge indicates that the coolant is overheated.
- Do not remove pressure cap on coolant reservoir if coolant temperature is above 158°F (70°C). Allow engine to cool down before removing cap. The coolant reservoir contains hot fluid and is under pressure.
- Using a rag, slowly open the cap approximately $1/2$ turn to relieve excess pressure. If opened immediately,

scalding hot fluid and steam will be blown out under pressure.

- Do not spill antifreeze on hot engine parts. Antifreeze contains ethylene glycol which may burn if it comes into contact with hot engine parts.



- ① Cap
- ② Coolant expansion tank
- ③ Marking bar in the expansion tank

- ▶ Using a rag, turn cap ① slowly approximately $1/2$ turn counterclockwise to release any excess pressure.
- ▶ Continue turning cap ① counterclockwise and remove it.

Engine compartment

The coolant level is correct if the level

- for cold coolant: reaches marking bar ③ in coolant expansion tank ②
 - for warm coolant: is approximately 0.6 in (1.5 cm) higher
- ▶ Add coolant as required.
 - ▶ Replace and tighten cap ①.

For more information on coolant, see the “Technical data” section (▷ page 392) and (▷ page 397).

Washer system and headlamp cleaning system

Warning!

Washer solvent/antifreeze is highly flammable. Do not spill washer solvent/antifreeze on hot engine parts, because it may ignite and burn. You could be seriously burned.

- ❗ Always use washer solvent/antifreeze where temperatures may fall below freezing point. Failure to do so could result in damage to the washer system/fluid reservoir.

❗ Only use washer fluid which is suitable for plastic lenses. Improper washer fluid can damage the plastic lenses of the headlamps.

❗ Do not use distilled or deionized water in the washer fluid reservoir. Otherwise, the washer fluid level sensor could be damaged.



① Cap for washer fluid reservoir

Fluid for the washer system and the headlamp cleaning system is supplied from the washer fluid reservoir.

During all seasons, add MB Windshield Washer Concentrate “MB SummerFit” to water. Premix the washer fluid in a suitable container.

▶ **Opening washer fluid reservoir:** Pull tab of cap ① upwards.

▶ Refill the washer fluid reservoir with MB Windshield Washer Concentrate “MB SummerFit” and water (or commercially available premixed washer solvent/antifreeze, depending on ambient temperatures) (▷ page 400).

▶ **Closing washer fluid reservoir:** Press cap ① onto filler hole until it engages.

For more information, see “Washer system and headlamp cleaning system” (▷ page 393).

Tires and wheels

Tires and wheels

Safety notes

Contact an authorized Mercedes-Benz Center for information on tested and recommended rims and tires for summer and winter operation. They can also offer advice concerning tire service and purchase.

Warning!

Replace rims or tires with the same designation, manufacturer and type as shown on the original part. For further information contact an authorized Mercedes-Benz Center. If incorrectly sized rims and tires are mounted, the wheel brakes or suspension components can be damaged. Also, the correct operating clearance of the wheels and the tires may no longer be correct.

Warning!

Worn, old tires can cause accidents. If the tire tread is worn to minimum tread depth, or if the tires have sustained damage, replace them.

When replacing rims, only use genuine Mercedes-Benz wheel bolts specified for the particular rim type. Failure to do so can

result in the bolts loosening and possibly an accident.

Retreaded tires are not tested or recommended by Mercedes-Benz, since previous damage cannot always be recognized on retreads. The operating safety of the vehicle cannot be assured when such tires are used.

Warning!

If you feel a sudden significant vibration or ride disturbance, or you suspect that possible damage to your vehicle has occurred, you should turn on the hazard warning flashers, carefully slow down, and drive with caution to an area which is a safe distance from the road.

Inspect the tires and the vehicle underbody for possible damage. If the vehicle or tires appear unsafe, have the vehicle towed to the nearest authorized Mercedes-Benz Center or tire dealer for repairs.

Warning!

Do not drive with a flat tire. A flat tire affects the ability to steer or brake the vehicle. You could lose control of the vehicle. Continued driving with a flat tire or driving at high

speed with a flat tire will cause excessive heat build-up and possibly a fire.

Important guidelines

- Only use sets of tires and rims of the same type and make.
- Tires must be of the correct size for the rim.
- Break in new tires for approximately 60 miles (100 km) at moderate speeds.
- Regularly check the tires and rims for damage. Dented or bent rims can cause tire inflation pressure loss and damage to the tire beads.
- If vehicle is heavily loaded, check tire inflation pressure and correct as required.
- Do not allow your tires to wear down too far. Adhesion properties on wet roads are sharply reduced at tread depths of less than $\frac{1}{8}$ in (3 mm).
- When replacing individual tires, you should mount new tires on the front wheels first (on vehicles with same-sized wheels all around).

Tires and wheels

Tire care and maintenance**⚠ Warning!**

Regularly check the tires for damage. Damaged tires can cause tire inflation pressure loss. As a result, you could lose control of your vehicle.

Worn, old tires can cause accidents. If the tire tread is worn to minimum tread depth, or if the tires have sustained damage, replace them.

Check the tire inflation pressure at least every other week. For more information on checking tire inflation pressure, see “Recommended tire inflation pressure” (▷ page 266).

Tire inspection

Every time you check the tire inflation pressure, you should also inspect your tires for the following:

- excessive treadwear (▷ page 261)
- cord or fabric showing through the tire’s rubber
- bumps, bulges, cuts, cracks or splits in the tread or side of the tire

Replace the tire if you find any of the above conditions.

Make sure you also inspect the spare tire periodically for condition and inflation. Spare tires will age and become worn over time even if never used, and thus should be inspected and replaced when necessary.

Life of tire**⚠ Warning!**

Tires and spare tire should be replaced after 6 years, regardless of the remaining tread.

The service life of a tire is dependent upon varying factors including but not limited to:

- Driving style
- Tire inflation pressure
- Distance driven

Tread depth**⚠ Warning!**

Although the applicable federal motor vehicle safety laws consider a tire to be worn when the treadwear indicators (TWI) become visible at approximately $\frac{1}{16}$ in

(1.6 mm), we recommend that you do not allow your tires to wear down to that level. As tread depth approaches $\frac{1}{8}$ in (3 mm), the adhesion properties on a wet road are sharply reduced.

Depending upon the weather and/or road surface (conditions), the tire traction varies widely.

Do not allow your tires to wear down too far. Adhesion properties on wet roads are sharply reduced at tread depths of less than $\frac{1}{8}$ in (3 mm).

Treadwear indicators (TWI) are required by law. These indicators are located in six places on the tread circumference and become visible at a tread depth of approximately $\frac{1}{16}$ in (1.6 mm), at which point the tire is considered worn and should be replaced.

The recommended minimum tire tread depth for summer tires is $\frac{1}{8}$ in (3 mm). The recommended minimum tire tread depth for winter tires is $\frac{1}{6}$ in (4 mm).

Tires and wheels

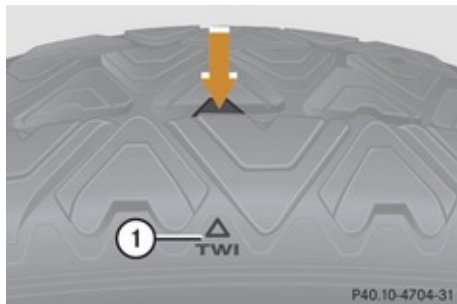

① TWI (Tread Wear Indicator)

The treadwear indicator appears as a solid band across the tread.

Storing tires

! Keep unmounted tires in a cool, dry place with as little exposure to light as possible. Protect tires from contact with oil, grease and fuels.

Cleaning tires

! Never use a round nozzle to power wash tires. The intense jet of water can result in damage to the tire.
Always replace a damaged tire.

Direction of rotation

Unidirectional tires offer added advantages, such as better hydroplaning performance. To benefit, however, you must make sure the tires rotate in the direction specified.

An arrow on the sidewall indicates the intended direction of rotation (spinning) of the tire.

Spare wheels may be mounted against the direction of rotation (spinning) even with a unidirectional tire for temporary use only until the regular drive wheel has been repaired or replaced. Always observe and follow applicable temporary use restrictions and speed limitations indicated on the spare wheel.

Loading the vehicle

Two labels on your vehicle show how much weight it may properly carry.

- (1) The Tire and Loading Information placard can be found on the driver's door B-pillar. This placard tells you important information about the number of people that can be in the vehicle and the total weight that can be carried in the vehicle. It also contains information on the proper size and recommended tire inflation pressures for the original equipment tires on your vehicle.
- (2) The certification label, also found on the driver's door B-pillar. It tells you about the gross weight capacity of your vehicle, called the Gross Vehicle Weight Rating (GVWR). The GVWR includes the weight of the vehicle, all occupants, fuel and cargo. The certification label also tells you about the front and rear axle weight capacity, called the Gross Axle Weight Rating (GAWR).

The GAWR is the total allowable weight that can be carried by a single axle (front or rear). Never exceed the GVWR or GAWR for either the front axle or rear axle.

Tires and wheels



① Driver's door B-pillar

Following is a discussion on how to work with the information contained on the Tire and Loading Information placard with regards to loading your vehicle.

Tire and Loading Information

⚠ Warning!

Do not overload the tires by exceeding the specified load limit as indicated on the Tire and Loading Information placard on the driver's door B-pillar. Overloading the tires can overheat them, possibly causing a blowout. Overloading the tires can also result in handling or steering problems, or brake failure.

Tire and Loading Information placard

① Data shown on Tire and Loading Information placard example are for illustration purposes only. Load limit data are specific to each vehicle and may vary from data shown in the following illustration. Refer to Tire and Loading Information placard on vehicle for actual data specific to your vehicle.

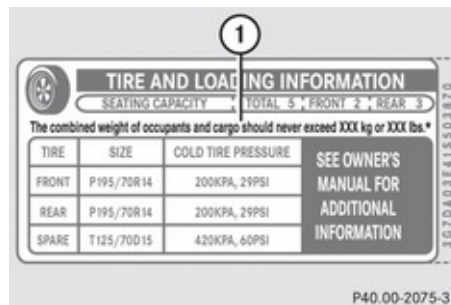

① Load limit information on the Tire and Loading Information placard

The Tire and Loading Information placard showing the load limit information is located on the driver's door B-pillar (▷ page 263).

▶ Locate the statement “The combined weight of occupants and cargo should never exceed XXX kilograms or XXX lbs.”

on the Tire and Loading Information placard.

The combined weight of all occupants, cargo/luggage and trailer tongue load (if applicable) should never exceed the weight referenced in that statement.

Seating capacity

The seating capacity gives you important information on the number of occupants that can be in the vehicle. Observe front and rear seating capacity. The Tire and Loading Information placard showing the seating capacity is located on the driver's door B-pillar (▷ page 263).

① Data shown on Tire and Loading Information placard example are for illustration purposes only. Seating capacity data are specific to each vehicle and may vary from data shown in the following illustration. Refer to Tire and Loading Information placard on vehicle for actual data specific to your vehicle.

Tires and wheels

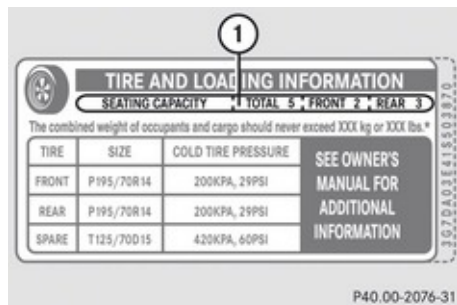

- ① Seating capacity information on the Tire and Loading Information placard

Steps for determining correct load limit

The following steps have been developed as required of all manufacturers under Title 49, Code of U.S. Federal Regulations, Part 575 pursuant to the “National Traffic and Motor Vehicle Safety Act of 1966”.

- ▶ **Step 1:** Locate the statement “The combined weight of occupants and cargo should never exceed XXX kg or XXX lbs.” on your vehicle’s Tire and Loading Information placard.
 - ▶ **Step 2:** Determine the combined weight of the driver and passengers that will be riding in your vehicle.
 - ▶ **Step 3:** Subtract the combined weight of the driver and passengers from XXX kilograms or XXX lbs.
 - ▶ **Step 4:** The resulting figure equals the available amount of cargo and luggage load capacity. For example, if the “XXX” amount equals 1 400 lbs and there will be five 150 lbs passengers in your vehicle, the amount of available cargo and luggage load capacity is 650 lbs (1 400 - 750 (5 x 150) = 650 lbs).
 - ▶ **Step 5:** Determine the combined weight of luggage and cargo being loaded on the vehicle. That weight may not safely exceed the available cargo and luggage load capacity calculated in step 4.
 - ▶ **Step 6 (if applicable):** If your vehicle will be towing a trailer, load from your trailer will be transferred to your vehicle. Consult this manual to determine how this reduces the available cargo and luggage load capacity of your vehicle (▷ page 266).
- The following table shows examples on how to calculate total and cargo load capacities with varying seating configurations and number and size of occupants. The following examples use a load limit of 1 500 lbs. **This is for illustration purposes only.** Make sure you are using the actual load limit for your vehicle stated on the vehicle’s Tire and Loading Information placard (▷ page 263).

Tires and wheels

Example	Combined weight limit of occupants and cargo from Tire and Loading Information placard	Number of occupants (driver and passengers)	Seating configuration	Occupants weight	Combined weight of all occupants	Available cargo/luggage and trailer tongue weight (total load limit from Tire and Loading Information placard minus combined weight of all occupants)
1	1 500 lbs	5	front: 2 rear: 3	Occupant 1: 150 lbs Occupant 2: 180 lbs Occupant 3: 160 lbs Occupant 4: 140 lbs Occupant 5: 120 lbs	750 lbs	1 500 lbs - 750 lbs = 750 lbs
2	1 500 lbs	3	front: 1 rear: 2	Occupant 1: 200 lbs Occupant 2: 190 lbs Occupant 3: 150 lbs	540 lbs	1 500 lbs - 540 lbs = 960 lbs
3	1 500 lbs	1	front: 1	Occupant 1: 150 lbs	150 lbs	1 500 lbs - 150 lbs = 1 350 lbs

The higher the weight of all occupants, the less cargo and luggage load capacity is available.

For more information, see “Trailer tongue load” (▷ page 266).

Certification label

Even after careful determination of the combined weight of all occupants, cargo and the trailer tongue load (if applicable)

(▷ page 266) as to not exceed the permissible load limit, you must make sure your vehicle never exceeds the Gross Vehicle Weight Rating (GVWR) and the Gross Axle Weight Rating (GAWR) for either the front or rear axle. You can obtain the GVWR and GAWR from the certification label. The certification label can be found on the driver’s door B-pillar, see the “Technical data” section (▷ page 377).

Gross Vehicle Weight Rating (GVWR): The total weight of the vehicle, all occupants, all cargo, and the trailer tongue load (if applicable) must never exceed the GVWR.

Gross Axle Weight Rating (GAWR): The total allowable weight that can be carried by a single axle (front or rear).

To assure that your vehicle does not exceed the maximum permissible weight limits (GVWR and GAWR for front and rear axle),



Tires and wheels

have the loaded vehicle (including driver, passengers and all cargo and, if applicable, trailer fully loaded) weighed on a suitable commercial scale.

Trailer tongue load

The tongue load of any trailer is an important weight to measure because it affects the load you can carry in your vehicle. If a trailer is towed, the tongue load must be added to the weight of all occupants riding and any cargo you are carrying in the vehicle. The tongue load typically is 10% of the trailer weight and everything loaded in it.

Your Mercedes-Benz has been designed primarily to carry passengers and their cargo. Mercedes-Benz does not recommend trailer towing with your vehicle.

Recommended tire inflation pressure

Warning!

Follow recommended tire inflation pressures.

Do not underinflate tires. Underinflated tires wear excessively and/or unevenly, adversely affect handling and fuel economy, and are more likely to fail from being overheated.

Do not overinflate tires. Overinflated tires can adversely affect handling and ride comfort, wear unevenly, increase stopping distance, and result in sudden deflation (blowout) because they are more likely to become punctured or damaged by road debris, potholes etc.

Do not overload the tires by exceeding the specified load limit as indicated on the Tire and Loading Information placard on the driver's door B-pillar. Overloading the tires can overheat them, possibly causing a blowout. Overloading the tires can also result in handling or steering problems, or brake failure.

Your vehicle is equipped with the Tire and Loading Information placard located on the driver's door B-pillar (▷ page 262).

The tire inflation pressure should be checked regularly and should only be adjusted on cold tires. The tires can be considered cold if the vehicle has been parked for at least 3 hours or driven less than 1 mile (1.6 km).

Follow recommended cold tire inflation pressures listed on Tire and Loading Information placard on the driver's door B-pillar.

Keeping the tires properly inflated provides the best handling, tread life and riding comfort.

In addition to the Tire and Loading Information placard on the driver's door B-pillar, also consult the tire inflation pressure label (if available) on the inside of the filler flap for any additional information pertaining to special driving situations. For more information, see "Important notes on tire inflation pressure" (▷ page 267).

 Data shown on Tire and Loading Information placard example are for illustration purposes only. Tire data are specific to each vehicle and may vary from data shown in the following illustration. Refer to Tire and Loading Information placard on vehicle for actual data specific to your vehicle.

Tires and wheels

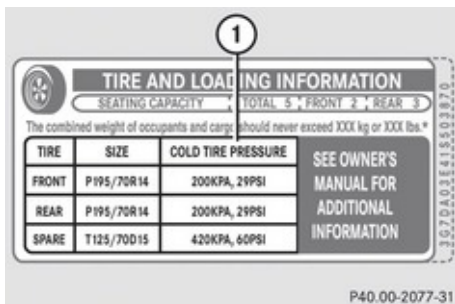

- ① Tire and Loading Information placard with recommended cold tire inflation pressures

The Tire and Loading Information placard lists the recommended cold tire inflation pressures for maximum loaded vehicle weight. The tire inflation pressures listed apply to the tires installed as original equipment.

Important notes on tire inflation pressure

⚠ Warning!

If the tire inflation pressure drops repeatedly, check the tires for punctures from foreign objects and/or whether air is

leaking from the valves or from around the rim.

Tire temperature and tire inflation pressure are also increased while driving, depending on the driving speed and the tire load.

If you will be driving your vehicle at high speeds of 100 mph (160 km/h) or higher, where it is legal and conditions allow, consult the tire inflation pressure label on the inside of the fuel filler flap (if available) on how to adjust the cold tire inflation pressure. If you do not adjust the tire inflation pressure, excessive heat can build up and result in sudden tire failure.

If your vehicle is not equipped with the tire inflation pressure label on the inside of the fuel filler flap, contact an authorized Mercedes-Benz Center for proper tire inflation pressure.

- ① Driving comfort may be reduced when the tire inflation pressure is adjusted to the value for speeds above 100 mph (160 km/h) as specified on the tire inflation pressure label located on the inside of the fuel filler flap.

Make sure to readjust the tire inflation pressure for normal driving speeds. You

should wait until the tires are cold before adjusting the tire inflation pressure.

Some vehicles may have supplemental tire inflation pressure information for vehicle loads less than the maximum loaded vehicle condition. If such information is provided, it can be found on the tire inflation pressure label located on the inside of the fuel filler flap.

Tire inflation pressure changes by approximately 1.5 psi (0.1 bar) per 18°F (10°C) of air temperature change. Keep this in mind when checking tire inflation pressure where the temperature is different from the outside temperature.

Potential problems associated with underinflated and overinflated tires

Underinflated tires

⚠ Warning!

Follow recommended tire inflation pressures.

Do not underinflate tires. Underinflated tires wear excessively and/or unevenly, adversely affect handling and fuel economy, and are more likely to fail from being overheated.

Tires and wheels

Underinflated tires can

- cause excessive and uneven tire wear
- adversely affect fuel economy
- lead to tire failure from being overheated
- adversely affect handling characteristics

Overinflated tires

Warning!

Follow recommended tire inflation pressures.

Do not overinflate tires. Overinflated tires can adversely affect handling and ride comfort, wear unevenly, increase stopping distance, and result in sudden deflation (blowout) because they are more likely to become punctured or damaged by road debris, potholes etc.

Overinflated tires can

- adversely affect handling characteristics
- cause uneven tire wear
- be more prone to damage from road hazards
- adversely affect ride comfort
- increase stopping distance

Checking tire inflation pressure

Safety notes

Warning!

Follow recommended tire inflation pressures.

Do not underinflate tires. Underinflated tires wear excessively and/or unevenly, adversely affect handling and fuel economy, and are more likely to fail from being overheated.

Do not overinflate tires. Overinflated tires can adversely affect handling and ride comfort, wear unevenly, increase stopping distance, and result in sudden deflation (blowout) because they are more likely to become punctured or damaged by road debris, potholes etc.

Do not overload the tires by exceeding the specified load limit as indicated on the Tire and Loading Information placard on the driver's door B-pillar. Overloading the tires can overheat them, possibly causing a blowout. Overloading the tires can also result in handling or steering problems, or brake failure.

Check the tire inflation pressure at least every other week.

Check and adjust the tire inflation pressure when the tires are cold. The tires can be considered cold if the vehicle has been parked for at least 3 hours or driven less than 1 mile (1.6 km).

If you check the tire inflation pressure when the tires are warm (the vehicle has been driven for several miles or sitting less than 3 hours), the reading will be approximately 4 psi (0.3 bar) higher than the cold reading. This is normal. Do not let air out to match the specified cold tire inflation pressure. Otherwise, the tire will be underinflated.

Checking tire inflation pressure manually

Follow the steps below to achieve correct tire inflation pressure:

- ▶ Remove the cap from the valve on one tire.
- ▶ Firmly press a tire gauge onto the valve.
- ▶ Read the tire inflation pressure on the tire gauge and check against the recommended tire inflation pressure on the Tire and Loading Information placard on the driver's door B-pillar (▷ page 263). If necessary, add air to achieve the recommended tire inflation pressure.
- ▶ If you have overfilled the tire, release tire inflation pressure by pushing the metal

Tires and wheels

stem of the valve with e.g. a tip of a pen. Then recheck the tire inflation pressure with the tire gauge.

- ▶ Install the valve cap.
- ▶ Repeat this procedure for each tire.

Run Flat Indicator (Canada only)

While the vehicle is being driven, the Run Flat Indicator monitors the set tire inflation pressures by evaluating each wheel's rotational speed. This allows the system to detect a significant loss of pressure in a tire. If a wheel's rotational speed changes due to falling tire inflation pressure, you will see a corresponding warning message in the multifunction display.

The Run Flat Indicator may function in a restricted manner or with a delay

- when snow chains are mounted to the vehicle
- in the presence of ice and snow
- when you are driving on a loose surface (e.g. sand or gravel)

- when you are driving in a very sporty manner (involving rapid acceleration or high speeds in curves)
- when you are driving with a loaded roof rack or heavily laden vehicle

Warning!

When the multifunction display shows the message **Check Tire Pressure Soon**, one or more of your tires are significantly underinflated. You should stop and check your tires as soon as possible, and inflate them to the proper tire inflation pressure as indicated on the vehicle's Tire and Loading Information placard or, if available, on the tire inflation pressure label.

Driving on a significantly underinflated tire causes the tire to overheat and can lead to tire failure. Underinflation also reduces fuel efficiency and tire tread life, and may affect the vehicle's handling and stopping ability. Each tire, including the spare, should be checked every other week when cold and set to the recommended tire inflation pressure as specified on the Tire and Loading Information placard on the driver's door B-pillar or, if available, on the tire inflation pressure label located on the inside of the fuel filler flap.

-  The recommended tire inflation pressures for your vehicle can be found on the Tire and Loading Information placard located on the driver's door B-pillar (▶ page 263) or, if available, on the tire inflation pressure label on the inside of the fuel filler flap. The tire inflation pressures are not listed in the Operator's Manual.

Warning!

The Run Flat Indicator does not provide a warning for wrongly selected tire inflation pressures. Always adjust tire inflation pressure according to the Tire and Loading Information placard on the driver's door B-pillar or, if available, on the tire inflation pressure label located on the inside of the fuel filler flap.

The Run Flat Indicator does not replace regular checks of the tire inflation pressures since a gradual pressure loss in more than one tire cannot be detected by the Run Flat Indicator.

The Run Flat Indicator is not able to issue a warning due to a sudden dramatic loss of tire inflation pressure (e.g. tire blowout caused by a foreign object). In this case bring the vehicle to a halt by carefully



Tires and wheels

applying the brakes and avoiding abrupt steering maneuvers.

Restarting the Run Flat Indicator









The Run Flat Indicator must be restarted in the following situations:

- after you have changed the tire inflation pressure
 - after you have replaced the wheels or tires
 - after you have installed new wheels or tires
- ▶ Using the Tire and Loading Information placard on the driver's door B-pillar or, if available, the tire inflation pressure label on the inside of the fuel filler flap, make sure the tire inflation pressure of all four tires is correct.



Warning!

The Run Flat Indicator can only warn you in a reliable manner if you have set the correct tire inflation pressures for each tire.

If an incorrect tire inflation pressure was set, the system will monitor the pressure according to the incorrect value.

- ▶ Switch on the ignition.
- ▶ Press button  or  on the multifunction steering wheel to select the Service menu.
- ▶ Press button  or  on the multifunction steering wheel to select TIRE PRESS..
- ▶ Press button  on the multifunction steering wheel to confirm.
The following message appears in the multifunction display:
Run Flat Indicator
Active
Press 'OK' to Restart
- ▶ Press button .
The following message will appear in the multifunction display:
Tire Pressure
Now OK?
Cancel
Yes
- ▶ **If you wish to confirm:** Press button  or  to select Yes.
- ▶ Press button .
The following message will appear in the multifunction display:
Run Flat Indicator
Restarted

After a certain “learning phase”, the Run Flat Indicator checks the set pressure values for all four tires.

- ▶ **If you wish to cancel:** Press button  or  to select Cancel.
- ▶ Press button  to confirm.
The previous settings remain unchanged.

Tire Pressure Monitoring System (TPMS), (USA only)

Your vehicle is equipped with a Tire Pressure Monitoring System (TPMS). It measures the tire inflation pressure in the vehicle's tires and issues warnings in case of pressure loss. The Tire Pressure Monitoring System (TPMS) is equipped with a combination low tire pressure/TPMS malfunction telltale in the instrument cluster. Depending on how the telltale illuminates, it indicates a low tire pressure condition or a malfunction in the TPMS system itself:

- If the telltale illuminates continuously, one or more of your tires are significantly

Tires and wheels

underinflated. There is no malfunction in the TPMS.

- If the telltale flashes for 60 seconds and then stays illuminated, the TPMS system itself is not operating properly.

The TPMS only functions on wheels that are equipped with the proper electronic sensors. It monitors the tire inflation pressure, as selected by the driver, in all four tires. A warning is issued to alert you to a decrease in pressure in one or more of the tires.

Warning!

The TPMS does not indicate a warning for wrongly selected inflation pressures. Always adjust tire inflation pressure according to the Tire and Loading Information placard or, if available, on the supplemental tire inflation pressure information on the inside of the fuel filler flap.

The TPMS is not able to issue a warning due to a sudden dramatic loss of pressure (e.g. tire blowout caused by a foreign object). In this case bring the vehicle to a halt by carefully applying the brakes and avoiding abrupt steering maneuvers.

Warning!

Each tire, including the spare (if provided), should be checked every other week when cold and inflated to the inflation pressure recommended by the vehicle manufacturer on the Tire and Loading Information placard on the driver's door B-pillar or, if available, the tire inflation pressure label on the inside of the fuel filler flap. If your vehicle has tires of a different size than the size indicated on the Tire and Loading Information placard or, if available, the tire inflation pressure label, you should determine the proper tire inflation pressure for those tires.

As an added safety feature, your vehicle has been equipped with a tire pressure monitoring system (TPMS) that illuminates a low tire pressure telltale when one or more of your tires are significantly underinflated. Accordingly, when the low tire pressure telltale illuminates, you should stop and check your tires as soon as possible, and inflate them to the proper pressure. Driving on a significantly underinflated tire causes the tire to overheat and can lead to tire failure. Underinflation also reduces fuel efficiency and tire tread life, and may affect the

vehicle's handling and stopping ability. Please note that the TPMS is not a substitute for proper tire maintenance, and it is the driver's responsibility to maintain correct tire pressure, even if underinflation has not reached the level to trigger illumination of the TPMS low tire pressure telltale.

Your vehicle has also been equipped with a TPMS malfunction indicator to indicate when the system is not operating properly. The TPMS malfunction indicator is combined with the low tire pressure telltale. When the system detects a malfunction, the telltale will flash for approximately 1 minute and then remain continuously illuminated. This sequence will continue upon subsequent vehicle start-ups as long as the malfunction exists. When the malfunction indicator is illuminated, the system may not be able to detect or signal low tire pressure as intended.

TPMS malfunctions may occur for a variety of reasons, including the installation of incompatible replacement or alternate tires or wheels on the vehicle that prevent the TPMS from functioning properly. Always check the TPMS malfunction telltale after



Tires and wheels

replacing one or more tires or wheels on your vehicle to ensure that the replacement or alternate tires and wheels allow the TPMS to continue to function properly.

- i** If a condition causing the TPMS to malfunction develops, it may take up to 10 minutes for the system to signal a malfunction using the TPMS telltale flashing and illumination sequence. The telltale extinguishes after a few minutes driving if the malfunction has been corrected.
- i** Operating radio transmission equipment (e.g. wireless headsets, two-way radios) in or near the vehicle could cause the TPMS to malfunction.
- i** This device complies with Part 15 of the FCC Rules. Operation is subject to the following two conditions:
 1. This device may not cause harmful interference, and
 2. this device must accept any interference received, including interference that may cause undesired.

Any unauthorized modification to this device could void the user's authority to operate the equipment.

Tire inflation pressure warnings

If the system detects a significant loss of tire inflation pressure in one or more than one tire, a message appears in the multifunction display. In addition, an acoustic warning sounds and the low tire pressure telltale in the instrument cluster comes on.

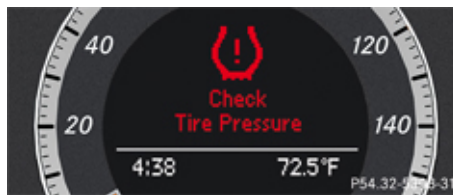

Example illustration

Restarting the TPMS

⚠ Warning!

It is the driver's responsibility to set the tire inflation pressure to the recommended cold tire inflation pressure. Underinflated tires affect the ability to steer or brake the vehicle. You might lose control over the vehicle.





When you restart the TPMS, the system sets new reference values for each tire.

The TPMS must be restarted when you have adjusted the tire inflation pressure to a new level (e.g. because of different load or driving conditions). The TPMS is then recalibrated to the current tire inflation pressures.

Restart the TPMS after adjusting the tire inflation pressure to the inflation pressure recommended for the vehicle operating condition. Tire pressure should only be adjusted on cold tires. Observe the recommended tire inflation pressure on the Tire and Loading Information placard on the driver's door B-pillar. Some vehicles may have supplemental tire pressure information for driving at high speeds or for vehicle loads less than the maximum loaded vehicle condition. If such information is provided, it can be found on the inside of the fuel filler flap.

- ▶ Using the Tire and Loading Information placard on the driver's door B-pillar (▷ page 263) or, if available, the supplemental tire inflation pressure information on the inside of the fuel filler flap, make sure the tire inflation pressure of all four tires is correct.
- ▶ Switch on the ignition.

Tires and wheels

- ▶ Press button  or  on the multifunction steering wheel to select the Service menu (▷ page 144).
- ▶ Press the button  or  on the multifunction steering wheel to select Tire Pressure.

- ▶ Press button  on the multifunction steering wheel to confirm. The following message appears in the multifunction display:
Tire Pressure
Monitor
Active

- ▶ Press button .
The following message appears in the multifunction display:
Use Current
Pressures as New
Reference Values
Press 'OK' to Confirm

- ▶ **If you wish to confirm:** Press button .

The following message appears in the multifunction display:
Tire Press. Monitor
Restarted

After driving a few minutes the system verifies that the current tire inflation

pressures are within the system's specified range. Afterwards, the current tire inflation pressures are accepted as reference values and then monitored.

- ▶ **If you wish to cancel:** Press button .

Tire labeling

Besides tire name (sales designation) and manufacturer name, a number of markings can be found on a tire.

Following are some explanations for the markings on your vehicle's tires:

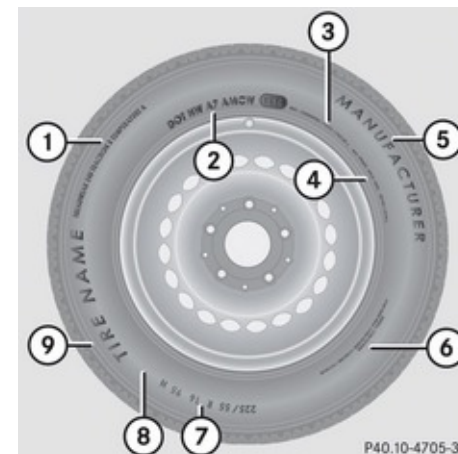

- ① Uniform Tire Quality Grading Standards (▷ page 279)
- ② DOT, Tire Identification Number (▷ page 277)
- ③ Maximum tire load (▷ page 278)
- ④ Maximum tire inflation pressure (▷ page 278)
- ⑤ Manufacturer
- ⑥ Tire ply material (▷ page 280)
- ⑦ Tire size designation, load and speed rating (▷ page 274)
- ⑧ Load identification (▷ page 276)
- ⑨ Tire name

Tires and wheels

i For illustration purposes only. Actual data on tires are specific to each vehicle and may vary from data shown in above illustration.

For more information, see “Rims and tires” (▷ page 382).

Tire size designation, load and speed rating

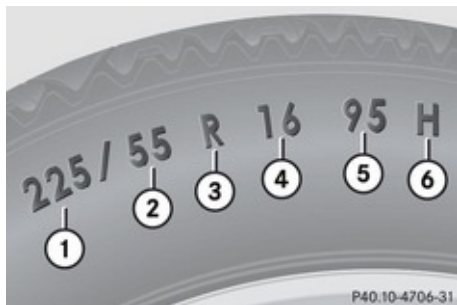

- ① Tire width
- ② Aspect ratio in %
- ③ Radial tire code
- ④ Rim diameter
- ⑤ Tire load rating
- ⑥ Tire speed rating

i For illustration purposes only. Actual data on tires are specific to each vehicle and may vary from data shown in above illustration.

General: Depending on the design standards used, the tire size molded into the sidewall may have no letter or a letter preceding the tire size designation.

No letter preceding the size designation (as illustrated above): Passenger car tire based on European design standards.

Letter “P” preceding the size designation: Passenger car tire based on U.S. design standards.

Letter “LT” preceding the size designation: Light Truck tire based on U.S. design standards.

Letter “T” preceding the size designation: Temporary spare tires which are high pressure compact spares designed for temporary emergency use only.

Tire width

Tire width ① indicates the nominal tire width in millimeters.

Aspect ratio

Aspect ratio ② is the dimensional relationship between tire section height and section width and is expressed in percentage. The aspect ratio is arrived at by dividing section height by section width.

Tire code

Tire code ③ indicates the tire construction type. The “R” stands for radial tire type. Letter “D” means diagonal or bias ply construction; letter “B” means belted-bias ply construction.

At the tire manufacturer’s option, any tire with a speed capability above 149 mph (240 km/h) can include a “ZR” in the size designation (for example: 245/40 ZR 18). For additional information, see “Tire speed rating” (▷ page 275).

Rim diameter

Rim diameter ④ is the diameter of the bead seat, not the diameter of the rim edge. The rim diameter is indicated in inches (in).

Tire load rating

Warning!

The tire load rating must always be at least half of the GAWR of your vehicle. Otherwise, tire failure may be the result

Tires and wheels

which may cause an accident and/or serious injury to you or others.

Always replace rims and tires with the same designation, manufacturer and type as shown on the original part.

Warning!

Do not overload the tires by exceeding the specified load limit as indicated on the Tire and Loading Information placard on the driver's door B-pillar. Overloading the tires can overheat them, possibly causing a blowout. Overloading the tires can also result in handling or steering problems, or brake failure.

Tire load rating ^⑤ is a numerical code associated with the maximum load a tire can support.

For example, a load rating of 91 corresponds to a maximum load of 1356 lb (615 kg) the tire is designed to support. See also "Maximum tire load" (▷ page 278) where the maximum load associated with the load index is indicated in kilograms and lbs.

For additional information on tire load rating, see "Load identification" (▷ page 276).

Tire speed rating

Warning!

Even when permitted by law, never operate a vehicle at speeds greater than the maximum speed rating of the tires.

Exceeding the maximum speed for which tires are rated can lead to sudden tire failure, causing loss of vehicle control and possibly resulting in an accident and/or serious personal injury and possible death, for you and for others.

Regardless of the tire speed rating, local speed limits should be obeyed. Use prudent driving speeds appropriate to prevailing conditions.

Tire speed rating ^⑥ indicates the approved maximum speed for the tire.

Summer tires

Index	Speed rating
Q	up to 100 mph (160 km/h)
R	up to 106 mph (170 km/h)
S	up to 112 mph (180 km/h)
T	up to 118 mph (190 km/h)
H	up to 130 mph (210 km/h)

Index	Speed rating
V	up to 149 mph (240 km/h)
W	up to 168 mph (270 km/h)
Y	up to 186 mph (300 km/h)
ZR...Y	up to 186 mph (300 km/h)
ZR...(..Y)	above 186 mph (300 km/h)
ZR	above 149 mph (240 km/h)

- At the tire manufacturer's option, any tire with a speed capability above 149 mph (240 km/h) can include a "ZR" in the size designation (for example: 245/40 ZR18). To determine the maximum speed capability of the tire, the service description for the tire must be referred to.

The service description is comprised of tire load rating ^⑤ and tire speed rating ^⑥.

If your tire includes "ZR" in the size designation and no service description is given, the tire manufacturer must be consulted for the maximum speed capability.

If a service description is given, the speed capability is limited by the speed symbol in the service description. Example:

Tires and wheels

245/40 ZR18 97Y. In this example, “97Y” is the service description. The letter “Y” designates the speed rating and the speed capability of the tire is limited to 186 mph (300 km/h).

- Any tire with a speed capability above 186 mph (300 km/h) must include a “ZR” in the size designation AND the service description must be placed in parenthesis. Example: 275/40 ZR 18 (99Y). The “(Y)” speed rating in parenthesis designates the maximum speed capability of the tire as being above 186 mph (300 km/h). Consult the tire manufacturer for the actual maximum permissible speed of the tire.

All-season and winter tires

Index	Speed rating
Q M+S ¹⁶	up to 100 mph (160 km/h)
T M+S ¹⁶	up to 118 mph (190 km/h)
H M+S ¹⁶	up to 130 mph (210 km/h)
V M+S ¹⁶	up to 149 mph (240 km/h)

- i** Not all M+S rated tires provide special winter performance. Make sure the tires

¹⁶ or M+S  for winter tires

you use show M+S and the mountain/snowflake  marking on the tire sidewall. These tires meet specific snow traction performance requirements of the Rubber Manufacturers Association (RMA) and the Rubber Association of Canada (RAC) and have been designed specifically for use in snow conditions.

An electronic speed limiter prevents your vehicle from exceeding a speed of:

- All models except C 63 AMG:
130 mph (210 km/h)
- C 63 AMG:
155 mph (250 km/h)
- C 63 AMG with increased top speed:
174 mph (280 km/h)

The factory equipped tires on your vehicle may have a tire speed rating above the maximum speed permitted by the electronic speed limiter.

Make sure your tires have the required tire speed rating as specified for your vehicle in the “Technical data” section (> page 382), for example when purchasing new tires.

If you are uncertain about the correct reading of the information given on a tire’s sidewall,

any authorized Mercedes-Benz Center will be glad to assist you.

Load identification



① Load identification

- i** For illustration purposes only. Actual data on tires are specific to each vehicle and may vary from data shown in above illustration.

In addition to tire load rating, special load identification ① may be molded into the tire sidewall following the letter designating the tire speed rating ⑥ (> page 274).

Tires and wheels

- No specification given: absence of any text (like in above example) indicates a standard load (SL) tire.
- XL or Extra Load: designates an extra load (or reinforced) tire.
- Light Load: designates a light load tire.
- C, D, E: designates load range associated with the maximum load a tire can carry at a specified pressure.



- ① DOT
 - ② Manufacturer's identification mark
 - ③ Tire size
 - ④ Tire type code (at the option of the tire manufacturer)
 - ⑤ Date of manufacture
- i** For illustration purposes only. Actual data on tires are specific to each vehicle and may vary from data shown in above illustration.

DOT (Department of Transportation)

Tire branding symbol ① denotes that the tire meets requirements of the U.S. Department of Transportation.

DOT, Tire Identification Number (TIN)

U.S. tire regulations require each new tire manufacturer or tire retreader to mold a TIN into or onto a sidewall of each tire produced. The TIN is a unique identifier which facilitates efforts by tire manufacturers to notify purchasers in recall situations or other safety matters concerning tires and gives purchasers the means to easily identify such tires.

The TIN is comprised of “Manufacturer’s identification mark”, “Tire size”, “Tire type code” and “Date of manufacture”.

Manufacturer's identification mark

Manufacturer's identification mark ② denotes the tire manufacturer.

New tires have a mark with two symbols.

Retreaded tires have a mark with four symbols. For more information on retreaded tires, see (▷ page 260).

Tire size

Code ③ indicates the tire size.

Tire type code

Tire type code ④ may, at the option of the manufacturer, be used as a descriptive code for identifying significant characteristics of the tire.

Date of manufacture

The date of manufacture ⑤ identifies the week and year of manufacture.

The first two figures identify the week, starting with “01” to represent the first full week of the calendar year. The second two figures represent the year.

Tires and wheels

For example, “3202” represents the 32nd week of 2002.

Maximum tire load

Warning!

Do not overload the tires by exceeding the specified load limit as indicated on the Tire and Loading Information placard on the driver’s door B-pillar. Overloading the tires can overheat them, possibly causing a blowout. Overloading the tires can also result in handling or steering problems, or brake failure.



① Maximum tire load rating

 For illustration purposes only. Actual data on tires are specific to each vehicle and

may vary from data shown in above illustration.

The maximum tire load is the maximum weight the tires are designed to support.

For more information on tire load rating, see (> page 274).

For information on calculating total and cargo load capacities, see (> page 264).

Maximum tire inflation pressure

Warning!

Never exceed the maximum tire inflation pressure. Follow recommended tire inflation pressures.

Do not underinflate tires. Underinflated tires wear excessively and/or unevenly, adversely affect handling and fuel economy, and are more likely to fail from being overheated.

Do not overinflate tires. Overinflated tires can adversely affect handling and ride comfort, wear unevenly, increase stopping distance, and result in sudden deflation (blowout) because they are more likely to become punctured or damaged by road debris, potholes etc.



① Maximum permissible tire inflation pressure

 For illustration purposes only. Actual data on tires are specific to each vehicle and may vary from data shown in above illustration.

This is the maximum permissible tire inflation pressure for the tire.

Always follow the recommended tire inflation pressure (> page 266) for proper tire inflation.

Tires and wheels

Uniform Tire Quality Grading Standards

The Uniform Tire Quality Grading is a U.S. Government requirement designed to give drivers consistent and reliable information regarding tire performance. Tire manufacturers are required to grade tires based on three performance factors: treadwear, traction, and temperature resistance. Although not a Government of Canada requirement, all tires made for sale in North America have these grades branded on the sidewall.

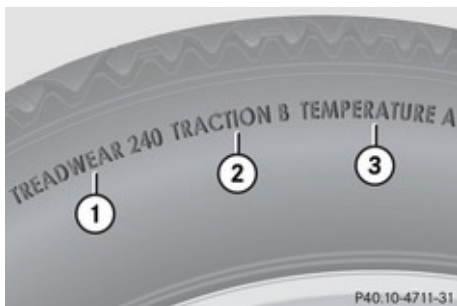

- ① Treadwear
- ② Traction
- ③ Temperature resistance

① For illustration purposes only. Actual data on tires are specific to each vehicle and may vary from data shown in above illustration.

Quality grades can be found, where applicable, on the tire sidewall between tread shoulder and maximum section width. For example:

Treadwear	Traction	Temperature
200	AA	A

All passenger car tires must conform to federal safety requirements in addition to these grades.

Treadwear

The treadwear grade is a comparative rating based on the wear rate of the tire when tested under controlled conditions on a specified U.S. Government test course. For example, a tire graded 150 would wear one and one-half (1 1/2) times as well on the government course as a tire graded 100.

The relative performance of tires depends upon the actual conditions of their use, however, and may depart significantly from the norm due to variations in driving habits,

service practices and differences in road characteristics and climate.

Traction

⚠ Warning!

The traction grade assigned to this tire is based on straight-ahead braking traction tests, and does not include acceleration, cornering, hydroplaning, or peak traction characteristics.

The traction grades, from highest to lowest, are AA, A, B, and C. Those grades represent the tire’s ability to stop on wet pavement as measured under controlled conditions on specified government test surfaces of asphalt and concrete. A tire marked C may have poor traction performance.

⚠ Warning!

If ice has formed on the road, tire traction will be substantially reduced. Under such weather conditions, drive, steer and brake with extreme caution.

The safe speed on a wet, snow covered or icy road is always lower than on a dry road.

You should pay particular attention to the condition of the road whenever the outside temperature is close to the freezing point.



Tires and wheels

Mercedes-Benz recommends winter tires (> page 284) with a minimum tread depth of approximately $\frac{1}{6}$ in (4 mm) on all four wheels for the winter season to ensure normal balanced handling characteristics. On packed snow, they can reduce your stopping distance compared to summer tires. Stopping distance, however, is still considerably greater than when the road is not covered with snow or ice. Exercise appropriate caution.

! Avoid spinning of a drive wheel. This may cause serious damage to the drivetrain which is not covered by the Mercedes-Benz Limited Warranty.

Temperature

Warning!

The temperature grade for this tire is established for a tire that is properly inflated and not overloaded. Excessive speed, underinflation, or excessive loading, either separately or in combination, can cause excessive heat build-up and possible tire failure.

The temperature grades are A (the highest), B, and C, representing the tire's resistance to the generation of heat and its ability to

dissipate heat when tested under controlled conditions on a specified indoor laboratory test wheel. Sustained high temperature can cause the material of the tire to degenerate and reduce tire life, and excessive temperature can lead to sudden tire failure. The grade C corresponds to a level of performance which all passenger car tires must meet under the Federal Motor Vehicle Safety Standard No. 109. Grades B and A represent higher levels of performance on the laboratory test wheel than the minimum required by law.

Tire ply material

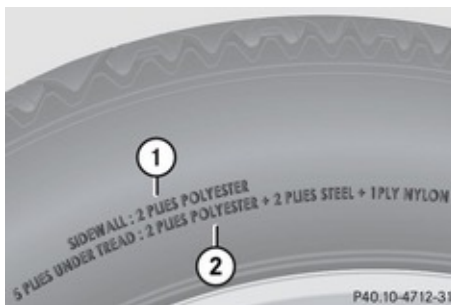

- ① Plies in sidewall
- ② Plies under tread

i For illustration purposes only. Actual data on tires are specific to each vehicle and may vary from data shown in above illustration.

This marking tells you about the type of cord and number of plies in the sidewall and under the tread.

Tire and loading terminology

Accessory weight

The combined weight (in excess of those standard items which may be replaced) of automatic transmission, power steering, power brakes, power windows, power seats, radio, and heater, to the extent that these items are available as factory-installed equipment (whether installed or not).

Air pressure

The amount of air inside the tire pressing outward on each square inch of the tire. Air pressure is expressed in pounds per square inch (psi), or kilopascal (kPa) or bar.

Tires and wheels**Aspect ratio**

Dimensional relationship between tire section height and section width expressed in percentage.

Bar

Another metric unit for air pressure. There are 14.5038 pounds per square inch (psi) to 1 bar; there are 100 kilopascals (kPa) to 1 bar.

Bead

The tire bead contains steel wires wrapped by steel cords that hold the tire onto the rim.

Cold tire inflation pressure

Tire inflation pressure when your vehicle has been sitting for at least 3 hours or driven no more than 1 mile (1.6 km).

Curb weight

The weight of a motor vehicle with standard equipment including the maximum capacity of fuel, oil, and coolant, and, if so equipped, air conditioning and additional optional equipment, but without passengers and cargo.

DOT (Department of Transportation)

A tire branding symbol which denotes the tire meets requirements of the U.S. Department of Transportation.

GAWR (Gross Axle Weight Rating)

The GAWR is the maximum permissible axle weight. The gross vehicle weight on each axle must never exceed the GAWR for the front and rear axle indicated on the certification label located on the driver's door B-pillar.

GVW (Gross Vehicle Weight)

The GVW comprises the weight of the vehicle including fuel, tools, spare wheel, installed accessories, passengers and cargo and, if applicable, trailer tongue load. The GVW must never exceed the GVWR indicated on the certification label located on the driver's door B-pillar.

GVWR (Gross Vehicle Weight Rating)

This is the maximum permissible vehicle weight of the fully loaded vehicle (weight of the vehicle including all options, passengers, fuel, and cargo and, if applicable, trailer

tongue load). It is indicated on certification label located on the driver's door B-pillar.

Kilopascal (kPa)

The metric unit for air pressure. There are 6.9 kPa to 1 psi; another metric unit for air pressure is bar. There are 100 kilopascals (kPa) to 1 bar.

Maximum load rating

The maximum load in kilograms and pounds that can be carried by the tire.

Maximum loaded vehicle weight

The sum of curb weight, accessory weight, total load limit, and production options weight.

Maximum permissible tire inflation pressure

This number is the greatest amount of air pressure that should ever be put in the tire.

Tires and wheels

Normal occupant weight

The number of occupants the vehicle is designed to seat, multiplied by 68 kilograms (150 lb).

Occupant distribution

The distribution of occupants in a vehicle at their designated seating positions.

Production options weight

The combined weight of those installed regular production options weighing over 5 lbs (2.3 kilograms) in excess of those standard items which they replace, not previously considered in curb weight or accessory weight, including heavy duty brakes, ride levelers, roof rack, heavy duty battery, and special trim.

PSI (Pounds per square inch)

A standard unit of measure for air pressure.

Recommended tire inflation pressure

The recommended tire inflation pressure for normal driving conditions is listed on the Tire and Loading Information placard located on the driver's door B-pillar and provides best

handling, tread life and riding comfort. If so equipped, supplemental information pertaining to special driving situations can be found on the tire inflation pressure label on the inside of the fuel filler flap.

Rim

A metal support for a tire or a tire and tube assembly upon which the tire beads are seated.

Sidewall

The portion of a tire between the tread and the bead.

TIN (Tire Identification Number)

Unique identifier which facilitates efforts by tire manufacturers to notify purchasers in recall situations or other safety matters concerning tires and gives purchasers the means to easily identify such tires. The TIN is comprised of "Manufacturer's identification mark", "Tire size", "Tire type code" and "Date of manufacture".

Tire load rating

Numerical code associated with the maximum load a tire can support.

Tire ply composition and material used

This indicates the number of plies or the number of layers of rubber-coated fabric in the tire tread and sidewall. Tire manufacturers also must indicate the ply materials in the tire and sidewall, which include steel, nylon, polyester, and others.

Tire speed rating

Part of tire designation; indicates the speed range for which a tire is approved.

Total load limit

Rated cargo and luggage load plus 68 kilograms (150 lb) times the vehicle's designated seating capacity.

Traction

Force exerted by the vehicle on the road via the tires. The amount of grip provided.

Tread

The portion of a tire that comes into contact with the road.

Treadwear indicators

Narrow bands, sometimes called “wear bars” that show across the tread of a tire when only $\frac{1}{16}$ in (1.6 mm) of tread remains.

Uniform Tire Quality Grading Standards

A tire information system that provides consumers with ratings for a tire’s traction, temperature and treadwear. Ratings are determined by tire manufacturers using U.S. government testing procedures. The ratings are molded into the sidewall of the tire.

Vehicle maximum load on the tire

Load on an individual tire that is determined by distributing to each axle its share of the maximum loaded vehicle weight and dividing it by two.

Rotating tires

Warning!

Rotate front and rear wheels only if the tires are of the same dimension.

If your vehicle is equipped with mixed-size tires (different tire dimensions front vs. rear), tire rotation is not possible.

Warning!

Have the tightening torque checked after changing a wheel. Wheels could become loose if not tightened with a torque of 96 lb-ft (130 Nm).

Only use genuine Mercedes-Benz wheel bolts specified for your vehicle’s rims.

Tire rotation can be performed on vehicles with tires of the same dimension all around. If your vehicle is equipped with tires of the same dimension all around, tires can be rotated, observing a front-to-rear rotation pattern that will maintain the intended rotation (spinning) direction of the tire (> page 262).

In some cases, such as when your vehicle is equipped with mixed-size tires (different tire dimension front vs. rear), tire rotation is not possible.

If applicable to your vehicle’s tire configuration, tires can be rotated according to the tire manufacturer’s recommended intervals in the tire manufacturer’s warranty pamphlet located in your vehicle literature portfolio. If none is available, tires should be rotated every 3 000 to 6 000 miles (5 000 to 10 000 km), or sooner if necessary, according to the degree of tire wear. The same rotation (spinning) direction must be maintained.

Rotate tires before the characteristic tire wear pattern becomes visible (shoulder wear on front tires and tread center wear on rear tires).

Thoroughly clean the mounting face of wheels and brake disks, i.e. the inner side of the wheels/tires, during each rotation. Check for and ensure proper tire inflation pressure. For information on wheel change, see “Flat tire” (> page 360).

Winter driving

Winter driving

General information

Have your vehicle winterized at an authorized Mercedes-Benz Center.

Winter tires

Warning!

Winter tires with a tread depth of less than $\frac{1}{6}$ in (4 mm) must be replaced. They are no longer suitable for winter operation.

Warning!

If you use your spare wheel when winter tires are fitted on the other wheels, be aware that the difference in tire characteristics may very well impair turning stability and that overall driving stability may be reduced. Adapt your driving style accordingly.

Have the spare wheel replaced by regular road wheel with a winter tire at the nearest authorized Mercedes-Benz Center.

Always use winter tires at temperatures below 45°F (7°C) and whenever wintry road conditions prevail. Not all M+S rated tires provide special winter performance. Make

sure the tires you use show the mountain/snowflake  marking on the tire sidewall.

These tires meet specific snow traction performance requirements of the Rubber Manufacturers Association (RMA) and the Rubber Association of Canada (RAC) and have been designed specifically for use in snow conditions. Use of winter tires is the only way to achieve the maximum effectiveness of your vehicle's driving safety systems such as the ABS and the ESP® in winter operation.

For safe handling, make sure all mounted winter tires are of the same make and have the same tread design.

For information on winter tires for your vehicle model, see the "Technical data" section (> page 382).

Always observe the speed rating of the winter tires installed on your vehicle. If the maximum speed for which your tires are rated is below the speed rating of your vehicle, you must place a notice to this effect where it will be seen by the driver. Such notices are available at your tire dealer or any authorized Mercedes-Benz Center.

Snow chains

 Some tire sizes do not leave adequate clearance for snow chains. To help avoid serious damage to your vehicle or tires, make sure the use of snow chains is permissible as specified in the "Technical data" section of this Operator's Manual.

Snow chains should only be driven on snow-covered roads at speeds not to exceed 30 mph (50 km/h). Remove chains as soon as possible when driving on roads without snow.

Observe the following guidelines when using snow chains:

- Use of snow chains is not permissible with all wheel/tire combinations (> page 382).
 - Use snow chains in pairs and on rear wheels only. Follow the manufacturer's mounting instructions.
-  If snow chains are mounted to the front wheels, they may scrape against the body or axle components. The tires or the vehicle could be damaged as a result.
- Only use snow chains that are approved by Mercedes-Benz. Any authorized Mercedes-

Winter driving

Benz Center will be glad to advise you on this subject.

- Use of snow chains may be prohibited depending on location. Always check local and state laws before installing snow chains.
 - Do not use snow chains on the spare wheel.
- i** When driving with snow chains, you may wish to switch off the ESP® (▷ page 68) before setting the vehicle in motion. This will improve the vehicle's traction.

Winter driving instructions

Warning!

If the vehicle becomes stuck in snow, make sure snow is kept clear of the exhaust pipe and from around the vehicle with the engine running. Otherwise, deadly carbon monoxide (CO) gases may enter vehicle interior resulting in unconsciousness and death.

To assure sufficient fresh air ventilation, open a window slightly on the side of the vehicle not facing the wind.

Warning!

The outside temperature indicator is not designed to serve as an ice-warning device and is therefore unsuitable for that purpose.

Indicated temperatures just above the freezing point do not guarantee that the road surface is free of ice. The road may still be icy, especially in wooded areas or on bridges.

Warning!

On slippery road surfaces, never downshift in order to obtain braking action. This could result in drive wheel slip and reduced vehicle control. Your vehicle's ABS will not prevent this type of loss of control.

The most important rule for slippery or icy roads is to drive sensibly and to avoid abrupt acceleration, braking and steering maneuvers. Do not use the cruise control system under such conditions.

When the vehicle is in danger of skidding, shift the automatic transmission to neutral position **N** or declutch in case of manual transmission. Try to keep the vehicle under control by corrective steering action.

- i** For information on driving with snow chains, see "Snow chains" (▷ page 284).

Road salts and chemicals can adversely affect braking efficiency. Increased pedal force may become necessary to produce the normal brake effect.

Depressing the brake pedal periodically when traveling at length on salt-strewn roads can bring road-salt-impaired braking efficiency back to normal.

If the vehicle is parked after being driven on salt-treated roads, the braking efficiency should be tested as soon as possible after driving is resumed.

Warning!

Make sure not to endanger any other road users when carrying out these braking maneuvers.

Driving instructions

Driving instructions

Drive sensibly – save fuel

To save fuel you should:

- Keep tires at the recommended inflation pressures.
- Remove unnecessary loads.
- Remove roof rack when not in use.
- Allow engine to warm up under low load use.
- Avoid frequent acceleration and deceleration.
- Have all maintenance work performed at the intervals specified in the Maintenance Booklet and as required by the Maintenance system. Contact an authorized Mercedes-Benz Center.

Fuel consumption is also increased by driving in cold weather, in stop-and-go traffic, on short trips and in mountainous areas.

Drinking and driving

Warning!

Drinking and driving and/or taking drugs and driving are very dangerous combinations. Even a small amount of alcohol or drugs can affect your reflexes, perceptions and judgment.

The possibility of a serious or even fatal accident are greatly increased when you drink or take drugs and drive.

Do not drink or take drugs and drive or allow anyone to drive who has been drinking or taking drugs.

Pedals

Warning!

Make sure absolutely no objects are obstructing the pedals' range of movement. Keep the driver's footwell clear of all obstacles. If there are any floor mats or carpets in the footwell, make sure that the pedals still have sufficient clearance.

During sudden driving or braking maneuvers, the objects could get caught between the pedals. You could then no

longer brake or accelerate. This could lead to accidents and injury.

Power assistance

Warning!

There is no power assistance for the steering and the service brake when the engine is not running.

Steering and braking requires significantly more effort and you could lose control of the vehicle and cause an accident as a result.

Do not turn off the engine while the vehicle is in motion.

Brakes

Downhill grades

 When driving down long and steep grades, relieve the load on the brakes by shifting into a lower gear to use the engine's braking power. This helps prevent overheating of the brakes and reduces wear.

When using the engine's braking power, a drive wheel may not spin for an extended period of time, e.g. on slippery road

Driving instructions

surfaces. This may cause serious damage to the drivetrain which is not covered by the Mercedes-Benz Limited Warranty.

Continuous or hard braking

Warning!

Resting your foot on the brake pedal will cause excessive and premature wear of the brake pads.

It can also result in the brakes overheating, thereby significantly reducing their effectiveness. It may not be possible to stop the vehicle in sufficient time to avoid an accident.

After hard braking, it is advisable to drive on for some time, rather than immediately park, so that the air stream will cool down the brakes faster.

Wet roads

Warning!

After driving in heavy rain for some time without applying the brakes or through water deep enough to wet brake components, the first braking action may be somewhat reduced and increased pedal pressure may be necessary to obtain

expected brake effect. Maintain a safe distance from vehicles in front.

To help prevent brake disk corrosion after driving on wet or salt-covered roads, it is advisable to brake the vehicle with considerable force prior to parking. The heat generated serves to dry the brakes.

Salt-covered roads

Warning!

A layer of salt on the brake discs and the brake linings may cause a delay in the braking effect, resulting in a significantly increased braking distance, which could lead to an accident.

To avoid this danger, you should:

- occasionally brake carefully when you are driving on salt-covered roads, so that any layer of salt that may have built up on the brake discs and the brake linings is removed without putting other road users at risk
- maintain a greater distance to the vehicle ahead and drive with particular care
- carefully apply the brakes at the end of a trip and immediately after commencing a

new trip, so that salt residues are removed from the brake disc

Brake service

 The brake fluid level in the reservoir may be too low if the red brake warning lamp in the instrument cluster comes on while the engine is running and an acoustic warning sounds. Observe additional messages in the multifunction display that may appear. Brake pad wear or a leak in the system may be the reason for low brake fluid in the reservoir.

Have the brake system inspected immediately. Contact an authorized Mercedes-Benz Center.

All checks and service work on the brake system should be carried out by qualified technicians only. Contact an authorized Mercedes-Benz Center.

Only install brake pads and use brake fluid recommended by Mercedes-Benz.

Warning!

If other than recommended brake pads are installed, or other than recommended brake fluid is used, the braking properties of the vehicle can be degraded to an extent



Driving instructions

that safe braking is substantially impaired. This could result in an accident.

! Vehicles with 4MATIC:

Only conduct operational or performance tests on a two-axle dynamometer. If such tests are necessary, contact an authorized Mercedes-Benz Center. You could otherwise seriously damage the brake system or the transfer case which is not covered by the Mercedes-Benz Limited Warranty.

! Vehicles with 4MATIC:

Because the ESP[®] operates automatically, the engine and ignition must be shut off (SmartKey in starter switch position **0** or **1** or KEYLESS-GO start/stop button in position **0** or **1**) when the parking brake is being tested on a brake test dynamometer.

Active braking action through the ESP[®] may otherwise seriously damage the brake system which is not covered by the Mercedes-Benz Limited Warranty.

! Vehicles without 4MATIC:

Because the ESP[®] operates automatically, the engine and ignition must be shut off (SmartKey in starter switch position **0** or

1 or KEYLESS-GO start/stop button in position **0** or **1**) when the parking brake is being tested on a brake test dynamometer or the vehicle is being towed with the front axle raised.

Active braking action through the ESP[®] may otherwise seriously damage the brake system which is not covered by the Mercedes-Benz Limited Warranty.

If your brake system is normally only subjected to moderate loads, you should occasionally test the effectiveness of the brakes by applying above-normal braking pressure at higher speeds. This will also enhance the grip of the brake pads.

! Warning!

Make sure not to endanger any other road users when carrying out these braking maneuvers.

Refer to the description of the Brake Assist System (BAS) (▷ page 67).

High-performance brake system

The high-performance brake system is only available on C 63 AMG.

! Warning!

New vehicle brake pads and discs, and replacement brake pads and discs may take several hundred miles of driving until they provide optimum braking efficiency. Until that time, you may need to use increased brake pedal pressure while braking. Please be aware of this and adjust your driving and braking accordingly during this break-in period.

Excessive high-demand braking will cause correspondingly high brake wear. Please be attentive to the brake warning lamp in the instrument cluster and brake condition messages in the multifunction display. Especially for high performance driving, it is important to maintain and have the brake system checked regularly.

The high-performance brake system is designed to operate under the extremely high operating demands required to accommodate the performance capabilities of the vehicle.

Driving instructions

The brakes may produce a squeaking-type noise depending on the

- vehicle speed
- brake force applied
- ambient conditions, e.g. temperature and humidity

As with any brake system, the wear of individual brake system components such as brake pads or disks strongly depends on your driving style and the conditions under which you operate the vehicle. Thus, a driving style calling for high-demand braking will cause your vehicle's brakes to wear more quickly.

Driving off

Warm up the engine smoothly. Do not place full load on the engine until the operating temperature has been reached.

! When driving off on a slippery surface, do not allow a drive wheel to spin for an extended period with the ESP® switched off. Doing so may cause serious damage to the drivetrain which is not covered by the Mercedes-Benz Limited Warranty.

! Simultaneously depressing the accelerator pedal and applying the brakes reduces engine performance and causes premature brake and drivetrain wear which is not covered by the Mercedes-Benz Limited Warranty.

Hydroplaning

Depending on the depth of the water layer on the road, hydroplaning may occur, even at low speeds and with new tires. In heavy rain or when conditions indicate possible hydroplaning:

- ▶ Reduce vehicle speed.
- ▶ Avoid track grooves in the road.
- ▶ Apply brakes cautiously.

Standing water

! Do not drive through flooded areas. Before driving through water, determine its depth.

If you must drive through standing water, drive slowly to prevent water from entering the passenger compartment or the engine compartment. Water in these areas could cause damage to electrical components or wiring of the engine or transmission, or could result in water being ingested by the engine through the air intake causing severe internal engine damage. Any such damage is not covered by the Mercedes-Benz Limited Warranty.

Driving instructions

Driving abroad

If you plan to drive the vehicle outside the U.S. or Canada, you should request dealer network information for your destination from any authorized Mercedes-Benz Center.

Control and operation of radio transmitter

Safety notes

Warning!

Please do not forget that your primary responsibility is to drive the vehicle. A driver's attention to the road must always be his/her primary focus when driving. For your safety and the safety of others, we recommend that you pull over to a safe location and stop before placing or taking a telephone call.

If you choose to use the telephone¹⁷ while driving, please use the hands-free device and only use the telephone when road, weather and traffic conditions permit. Some jurisdictions prohibit the driver from using a mobile telephone while driving a vehicle.

¹⁷ Observe all legal requirements.

Only operate the audio system or COMAND¹⁷ (Cockpit Management and Data System) if road, weather and traffic conditions permit. Otherwise, you may not be able to observe traffic conditions and could endanger yourself and others.

Bear in mind that at a speed of just 30 mph (approximately 50 km/h), your vehicle is covering a distance of 44 feet (approximately 14 m) every second.

Telephones and two-way radios

Warning!

Never operate radio transmitters equipped with a built-in or attached antenna, such as a portable telephone or a citizens band unit, from inside the vehicle while the engine is running. Doing so could lead to a malfunction of the vehicle's electronic system, possibly resulting in an accident and/or serious personal injury. Radio transmitters should only be used inside the vehicle if they are connected to an antenna that is installed on the outside of the vehicle.

Refer to the radio transmitter operation instructions regarding use of an external antenna.

Emission control

Certain systems of the engine serve to keep the toxic components of the exhaust gases within permissible limits required by law.

These systems will function properly only when maintained strictly according to factory specifications. Any adjustments on the engine should, therefore, be carried out only by qualified Mercedes-Benz Center authorized technicians.

Engine adjustments should not be altered in any way. Moreover, the specified service procedures must be carried out regularly according to Mercedes-Benz servicing requirements. For details refer to the Maintenance Booklet.

Warning!

Inhalation of exhaust gas is hazardous to your health. All exhaust gas contains carbon monoxide (CO), and inhaling it can cause unconsciousness and possible death.

Do not run the engine in confined areas (such as a garage) which are not properly ventilated. If you think that exhaust gas fumes are entering the vehicle while driving, have the cause determined and corrected immediately. If you must drive under these conditions, drive only with at least one window fully open at all times.

Maintenance

Notes

The Maintenance System in your vehicle tracks the distance driven and the time elapsed since the last maintenance service, calculates other maintenance service work required, and calls for the next maintenance service accordingly.

We strongly recommend that you have your vehicle serviced at an authorized Mercedes-Benz Center, in accordance with the Maintenance Booklet at the times called for by the maintenance service indicator.

- i** Failure to have the vehicle maintained in accordance with the Maintenance Booklet and maintenance service indicator at the designated times/mileage will result in vehicle damage not covered by the Mercedes-Benz Limited Warranty.

Maintenance service indicator message

The maintenance service indicator message will notify you when the next maintenance service is due.

Starting approximately 1 month before the next maintenance service is due, one of the following messages will appear in the multifunction display while you are driving or when you switch on the ignition (example service A):

Next Service A in XXX miles (km)

Next Service A in XXX days

Service A Due

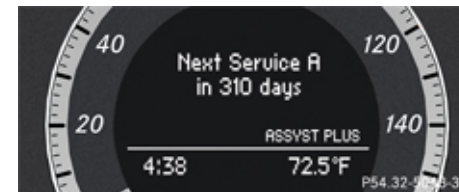

The type of maintenance service due is indicated in the multifunction display:

- A Basic service
(approximately 1 hour)
- B Extended service
(approximately 8 hours)





Maintenance

An additional number or a further letter in combination with the maintenance type can be indicated. This indicates that further auxiliary maintenance work is required. Contact an authorized Mercedes-Benz Center for more information.

Clearing the maintenance service indicator message

The maintenance service indicator message is cleared automatically

- after approximately 10 seconds when you switch on the ignition
 - after approximately 10 seconds when reaching the service threshold while driving
 - after approximately 30 seconds, once the suggested maintenance service term has passed
- ▶ **Clearing the maintenance service indicator message manually:** Press button  or button  on the multifunction steering wheel. The standard display appears in the multifunction display.

Maintenance service term exceeded

If you have exceeded the suggested maintenance service term, you will see the following message in the multifunction display:

Service A Exceeded by XXXX miles (km)

Service A Exceeded By XXX days



In addition, a signal sounds when the message appears.





Any authorized Mercedes-Benz Center will reset the maintenance service indicator following a completed maintenance service.

Calling up the maintenance service indicator display

-  The menu overview can be found on (▶ page 134).

You can call up the maintenance service indicator display at any time to check when the next maintenance service is due.

- ▶ Switch on the ignition. The standard display of the control system appears (▶ page 135).
- ▶ Press button  or  on the multifunction steering wheel to select the Service menu.

- ▶ Press button  or  to select ASSYST PLUS.
 - ▶ Press button  on the multifunction steering wheel to confirm. The maintenance service indicator display with the maintenance service deadline appears in the multifunction display.
-  If the battery is disconnected, the days of disconnection will not be included in the count shown by the maintenance service indicator. To arrive at the true maintenance service deadline, you will need to subtract these days from the days shown in the maintenance service indicator message or maintenance service indicator display.

Resetting the maintenance service indicator

In the event that the maintenance service on your vehicle is not carried out at an authorized Mercedes-Benz Center, you can have the maintenance service indicator reset.

The automotive maintenance facility carrying out the maintenance service will find the information for resetting the maintenance service indicator in the maintenance-relevant literature for your vehicle.

Such literature is available from any authorized Mercedes-Benz Center or directly from Mercedes-Benz.

! If the maintenance service indicator was inadvertently reset, have an authorized Mercedes-Benz Center correct it.

Only reset if the proper maintenance service has been performed. Resetting the system without performing the proper maintenance service as called for by the maintenance service indicator will result in engine damage and/or other vehicle damage not covered by the Mercedes-Benz Limited Warranty.

Vehicle care

Cleaning and care of the vehicle

Notes

Regular and proper care will help to maintain the value of your vehicle.

! Warning!

Many cleaning products can be hazardous. Some are poisonous, others are flammable. Always follow the instructions on the particular container. Always open your vehicle's doors or windows when cleaning the inside.

Never use fluids or solvents that are not designed for cleaning your vehicle.

Always lock away cleaning products and keep them out of reach of children.

! When cleaning the vehicle, do not use scouring agents. Never apply strong force and only use a soft, wet cloth or sponge. Otherwise you may scratch or damage the surface to be cleaned.

While in operation, even while parked, your vehicle is subjected to varying external influences which, if gone unchecked, can attack the paintwork as well as the vehicle underbody and cause lasting damage.

Such damage is caused not only by extreme and varying climatic conditions, but also by:

- Air pollution
- Road salt
- Tar
- Gravel and stone chipping

To avoid paint damage, you should immediately remove:

- Grease and oil
- Fuel
- Coolant
- Brake fluid
- Bird droppings
- Insects
- Tree resins etc.

Frequent washing reduces and/or eliminates the aggressiveness and potency of the above adverse influences.

More frequent washings are necessary to deal with unfavorable conditions:

- near the ocean
- in industrial areas (smoke, exhaust emissions)
- during winter operation



Vehicle care

You should check your vehicle from time to time for stone chipping or other damage. Any damage should be repaired as soon as possible to prevent corrosion.

In doing so, do not neglect the underbody of the vehicle. A prerequisite for a thorough check is a washing of the underbody followed by a thorough inspection. Damaged areas need to be re-undercoated.

Your vehicle has been treated at the factory with a wax-base rustproofing in the body cavities which will last for the lifetime of the vehicle. Post-production treatment is neither necessary nor recommended by Mercedes-Benz because of the possibility of incompatibility between materials used in the production process and others applied later.

We have selected vehicle-care products and compiled recommendations which are specially matched to our vehicles and which always reflect the latest technology. You can obtain Mercedes-Benz approved vehicle-care products at an authorized Mercedes-Benz Center.

Scratches, corrosive deposits, corrosion or damage due to negligent or incorrect care cannot always be removed or repaired with the vehicle-care products recommended

here. In such cases it is best to seek aid at an authorized Mercedes-Benz Center.

The following topics deal with the cleaning and care of your vehicle and give important “how-to” information as well as references to Mercedes-Benz approved vehicle-care products.

Power washer

! Follow the instructions provided by the power washer manufacturer on maintaining a distance between the vehicle and the nozzle of the power washer.

Never use a round nozzle to power-wash tires. The intense jet of water can result in damage to the tire.

Always replace a damaged tire.

Always keep the jet of water moving across the surface. Do not aim directly at electrical parts, electrical connectors, seals, or other rubber parts.

i Vehicles with KEYLESS-GO: If a door handle is hit by a strong jet of water, and a SmartKey is within approximately 3 ft (1 m) of the vehicle, it could be inadvertently locked or unlocked.

Tar stains

Quickly remove tar stains before they dry and become more difficult to remove. A tar remover is recommended.

Paintwork, painted body components

! Affixing stickers, magnets, adhesive tape or similar materials to painted body components may damage the paintwork.

Mercedes-Benz approved Paint Care should be applied when water drops on the paint surface do not “bead up”. This should normally be done every 3 to 5 months, depending on the climate and washing detergent used.

Mercedes-Benz approved Paint Cleaner should be applied if the paint surface shows signs of embedded dirt (i.e. loss of gloss).

Do not apply any of these products or wax if your vehicle is parked in the sun or if the hood is still hot.

► Use the appropriate MB-Touch-Up Stick for quick and provisional repairs of minor paint damage (i.e. chips from stones, vehicle doors, etc.).

Engine cleaning

Prior to cleaning the engine compartment, make sure to protect electrical components and connectors from contact with water and cleaning agents.

Corrosion protection, such as MB Anticorrosion Wax should be applied to the engine compartment after every engine cleaning. Before applying, all control linkage bushings and joints should be lubricated. The poly-V-belt and all pulleys should be protected from any wax.

Vehicle washing

In the winter, thoroughly remove all traces of road salt as soon as possible.

When washing the vehicle underbody, do not forget to clean the inner sides of the wheels.

- i** Vehicles with KEYLESS-GO:
If a door handle is hit by a strong jet of water, and a SmartKey is within approximately 3 ft (1 m) of the vehicle, it could be inadvertently locked or unlocked.

Hand-wash

- ▶ Do not use hot water or wash your vehicle in direct sunlight.
 - ▶ Only use a soft, wet cloth or sponge to clean the vehicle.
 - ▶ Only use a mild vehicle wash detergent, such as Mercedes-Benz approved Car Shampoo.
 - ▶ Thoroughly spray the vehicle with a diffused jet of water.
 - ▶ Do not spray directly towards the ventilation intake.
 - ▶ Use plenty of water and rinse the sponge and chamois frequently.
 - ▶ Rinse with clean water and thoroughly dry with a chamois.
- Do not allow cleaning agents to dry on the finish.

Automatic car wash

You can have your vehicle washed in an automatic car wash from the start. Brushless car washes are preferable.

- ▶ To protect the filter system, activate the air recirculation mode using button  on the climate control panel.

- !** Do not clean your vehicle in an automatic touchless car wash which uses caustic spray. Caustic spray will damage the paint or ornamental moldings.

If the vehicle is very dirty, prewash it before running it through the automatic car wash.

- !** Make sure the combination switch is set to wiper setting **0**. Otherwise, the rain sensor could activate and cause the wipers to move unintentionally. This may lead to vehicle damage.

Due to the width of the vehicle, fold in exterior rear view mirrors prior to running the vehicle through an automatic car wash to prevent damage to the mirrors.

When leaving the automatic car wash, make sure the mirrors are folded out.

After running the vehicle through an automatic car wash, wipe any wax off of the windshield and the wiper blade inserts. This will prevent smears and reduce wiping noise which can be caused by residual wax on the windshield.

Ornamental moldings

- ▶ For regular cleaning and care of ornamental moldings, use a damp cloth.

Vehicle care

! Do not use chrome cleaner on ornamental moldings. Although ornamental moldings may have chrome appearance, they could be made of anodized aluminum that will be damaged when cleaned with chrome cleaner. Instead, use a damp cloth to clean those ornamental moldings.

For very dirty ornamental moldings of which you are sure are chrome-plated, use a chrome cleaner. If in doubt whether an ornamental molding is chrome-plated, contact an authorized Mercedes-Benz Center.

Headlamps, brake lamps, tail lamps, side markers, turn signal lenses

▶ Use a mild vehicle wash detergent, such as Mercedes-Benz approved Car Shampoo, with plenty of water.

! Only use window cleaning solutions that are suitable for plastic lamp lenses. Window cleaning solutions which are not suitable may damage the plastic lamp lenses of the headlamps. Therefore, do not use abrasives, solvents or cleaners that contain solvents.

Cleaning the windows and the wiper blades

! The windshield wipers must be in a vertical position before folding them away from the windshield. They could otherwise damage the hood.

Never open the hood when the wiper arms are folded forward.

- ▶ Make sure the hood is fully closed.
- ▶ Switch on the ignition.
- ▶ Turn combination switch to wiper setting  (▷ page 107).
- ▶ With wiper arms in vertical position, switch off the ignition.

Warning!

For safety reasons, switch off wipers and remove SmartKey from starter switch (vehicles with KEYLESS-GO: Make sure the vehicle's on-board electronics have status **O**) before cleaning the windshield and/or the wiper blades. Otherwise, the wiper motor could suddenly turn on and cause injury.

! Do not pull on the wiper blade inserts. They could tear.

▶ Fold the wiper arms forward until they snap into place.

▶ Clean the windshield and the wiper blade inserts with a clean cloth and mild detergent solution.

▶ Use a soft, clean cloth and a mild window cleaning solution on all outside and inside glass surfaces.

An automotive glass cleaner is recommended.

! Fold the windshield wiper arms back onto the windshield before turning the SmartKey in the starter switch or pressing the KEYLESS-GO start/stop button (vehicles with KEYLESS-GO).

Hold on to the wiper when folding the wiper arm back. If released, the force of the impact from the tensioning spring could crack the windshield.

! To clean the window interior, do not use a dry cloth, abrasives, solvents or cleaners containing solvents. Do not touch the inside of the front, rear or side windows with hard objects such as an ice scraper or ring. Doing so may damage the windows.

Cleaning the panorama roof with power tilt/sliding panel

The rear part of the tilt/sliding panel has a protective layer on the inside.

- ▶ Use a soft, clean cloth and a mild window cleaning solution.

An automotive glass cleaner is recommended.

- ❗ Do not use a dry cloth, abrasives, solvents or cleaners containing solvents. Do not touch the protective layer with hard objects such as an ice scraper or ring. Never apply strong force and only use a soft, non-scratching cloth when cleaning the rear part of the tilt/sliding panel.

Otherwise you may scratch or damage the protective layer.

Light alloy wheels

If possible, clean wheels once a week.

- ▶ Use Mercedes-Benz approved Wheel Care, a soft bristle brush and a strong spray of water for cleaning the light alloy wheels.

- ❗ Only use acid-free cleaning materials. Acid may cause corrosion or damage the clear coat.

- ❗ The vehicle should not be parked for an extended period of time immediately after it has been cleaned, especially not after the wheel rims have been cleaned with wheel rim cleaner. Wheel rim cleaners can lead to increased corrosion of the brake disks and brake pads. Non-approved wheel cleaners may also damage the wheel paint if the vehicle is not driven after cleaning.

Therefore, the vehicle's brake system should always be warmed-up before it is parked after cleaning. Drive your vehicle for several minutes to allow the brakes to dry. When applying Mercedes-Benz approved Tire Care and Mercedes-Benz approved Wheel Care products, take care not to spray them on the brake disks.

Plastic and rubber parts

- ▶ Use a gentle dishwashing detergent or mild detergent for delicate fabrics as a washing solution.
- ▶ Wipe with a cloth moistened in a lukewarm solution. The surface may temporarily change color. If this is the case, wait for it to dry.

⚠ Warning!

Do not use cleaners or cockpit care sprays containing solvents to clean the cockpit or the steering wheel. Cleaners containing solvents will make the surface porous and vehicle occupants could suffer serious injuries from plastic parts coming loose in the event of air bag deployment.

- ❗ Do not use oil, wax or scouring agents. Otherwise you may scratch or damage the surface.

Hard plastic trim items

- ▶ Use Mercedes-Benz approved Interior Care on a soft, lint-free cloth and apply with light pressure.

Audio or COMAND display

- ❗ You must switch off the audio or COMAND display and allow it to cool prior to cleaning.
- ❗ Do not use any liquids or cleaning agents. These can damage or even destroy the audio display screen.

Vehicle care

- ▶ Use a standard microfiber cloth and apply with light pressure.

Steering wheel and gear selector lever

- ▶ Wipe with a damp cloth and dry thoroughly or clean with Mercedes-Benz approved Leather Care.

Carpets

- ▶ Use Mercedes-Benz approved Carpet and Fabric Care for cleaning the carpets.

Headliner and shelf below rear window

- ▶ Use a soft bristle brush or a dry-shampoo cleaner in case of excessive dirt.

Seat belts

- ▶ Only use clear, lukewarm water and soap.

! The seat belts must not be treated with chemical cleaning agents. Do not dry the seat belts at temperatures above 176°F (80°C) or in direct sunlight.

⚠ Warning!

Do not bleach or dye seat belts as this may severely weaken them. In a crash they may not be able to provide adequate protection.

Upholstery

Using aftermarket seat covers or wearing clothing that have the tendency to give off coloring (e.g. when wet, etc.) may cause the upholstery to become permanently discolored. By lining the seats with a proper intermediate cover, contact-discoloration will be prevented.

⚠ Warning!

Only use seat or head restraint covers which have been tested and approved by Mercedes-Benz for your vehicle model.

Using other seat or head restraint covers may interfere with or prevent the activation of the active head restraints and/or the deployment of the front side impact air bags.

Contact an authorized Mercedes-Benz Center for availability.

Leather upholstery

Please note that leather upholstery is a natural product and is therefore subject to a natural aging process. Leather upholstery may also react to certain ambient influences such as high humidity or high temperature by showing wrinkles for example.

- ▶ Wipe leather upholstery with a damp cloth and dry thoroughly or clean with Mercedes-Benz approved Leather Care.

! To avoid damage to leather upholstery:

- Wipe with light pressure only.
- Do not clean with abrasive cleaning agents such as scouring milk or powder.
- Do not soak the leather upholstery.
As leather is a natural product, it could otherwise harden or become porous.
- Exercise particular care when cleaning perforated leather as its underside should not become wet.

Wood trims

- ▶ Only use water and a damp cloth to clean wood trims in your vehicle.

! Do not use solvents like tar remover or wheel cleaner nor polishes or waxes as these may be abrasive.

Chrome-plated exhaust tip

Regular cleaning and care of chrome-plated exhaust tips will help to maintain their shine and the classy appearance.

► Use Mercedes-Benz approved Chrome Polishing Paste each time the vehicle has been washed, especially during the winter.

! Do not use alkaline cleaners such as wheel cleaners as they could cause corrosion.

Vehicle equipment	302
Where will I find ...?	302
Vehicle status messages in the multifunction display	305
What to do if	336
Unlocking/locking manually	350
Resetting activated head restraints	353
Replacing SmartKey batteries	353
Replacing bulbs	355
Replacing wiper blades	359
Flat tire	360
Battery	364
Jump starting	366
Towing the vehicle	368
Fuses	372



Where will I find ...?

Vehicle equipment

- i** This Operator's Manual describes all features, standard or optional, potentially available for your vehicle at the time of purchase. Please be aware that your vehicle might not be equipped with all features described in this manual.

Where will I find ...?

First aid kit

- i** Check expiration dates and contents for completeness at least once a year and replace missing/expired items.

Depending on the equipment configuration, the first-aid kit will be located either in the open storage department in the trunk or behind the cover panel on the left-hand side of the trunk.

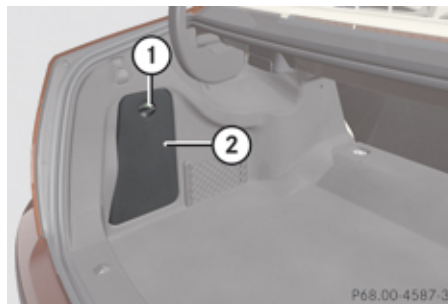

- ① Lock
② Cover

- ▶ Turn lock ① counterclockwise.
▶ Fold down cover ②.
The first aid kit can be removed.

Vehicle tool kit

The vehicle tool kit is located in the space underneath the trunk floor.

The vehicle tool kit includes:

- Collapsible wheel chock
 - Fuse chart
 - Jack
 - Pair of gloves
 - Towing eye bolt
 - Wheel wrench
- ▶ Open the trunk (▷ page 81).
- ▶ Lift the trunk floor using the floor handle.
- ▶ Engage the floor handle on the upper trunk lip.
- !** To prevent damage, always disengage the floor handle from the upper trunk lip and lower the trunk floor before closing the trunk.

Where will I find ...?

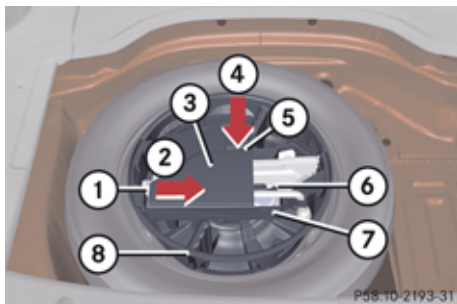

- ① Tab
 - ② Removing vehicle tool kit box
 - ③ Vehicle tool kit box cover
 - ④ Opening vehicle tool kit box cover
 - ⑤ Tab
 - ⑥ Vehicle tool kit
 - ⑦ Vehicle tool kit box
 - ⑧ Luggage bowl
- ▶ **Removing vehicle tool kit box:** Pull tab ① in direction of arrow ② and lift vehicle tool kit box ⑦.
 - ▶ Remove vehicle tool kit box ⑦ from luggage bowl ⑧.
 - ▶ **Opening vehicle tool kit box cover:** Pull tab ⑤ in direction of arrow ④ and open vehicle tool kit box cover ③.

- ▶ **Closing vehicle tool kit box cover:** Push vehicle tool kit box cover ③ downward until it engages into vehicle tool kit box ⑦.
- ▶ **Installing vehicle tool kit box:** Slide vehicle tool kit box ⑦ into the recess of luggage bowl ⑧.
- ▶ Push vehicle tool kit box ⑦ downward until it engages into luggage bowl ⑧.

Collapsible wheel chock

- The collapsible wheel chock serves to secure the vehicle, e.g. while changing a wheel.
- ▶ Take the collapsible wheel chock from the vehicle tool kit (▷ page 302).

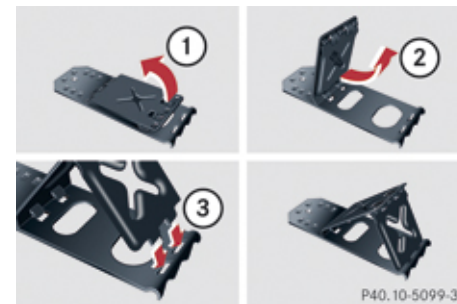

- ① Tilt the plates upward
 - ② Fold the lower plate outward
 - ③ Insert the plate
- ▶ **Setting up:** Tilt both plates upward ①.
 - ▶ Fold the lower plate outward ②.
 - ▶ Guide the tabs of the lower plate all the way into the openings of base plate ③.

For information on where to place wheel chocks when changing a wheel, see “Lifting the vehicle” (▷ page 361).

Jack

⚠ Warning!

Only use the jack supplied with your vehicle to lift the vehicle briefly for wheel changes. If you use the jack for any other purpose,



Where will I find ...?

you or others could be injured, as the jack is designed only for the purpose of changing a wheel.

When using the jack, observe the safety notes in the “Mounting the spare wheel” section and the notes on the jack.

- ▶ Take the jack from the vehicle tool kit (> page 302).

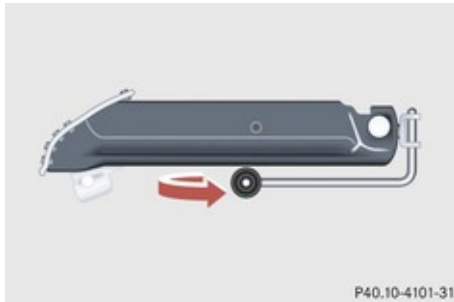

Storage position

- ▶ Turn the crank handle in the direction of arrow as far as it will go.



Operational position

- ▶ Turn the crank handle clockwise.

Before placing the jack back into the vehicle tool kit:

- ▶ Fully collapse the jack.
- ▶ Fold in the crank handle (storage position).

Spare wheel

⚠ Observe Safety notes, see page 360.

The spare wheel is located in the space underneath the trunk floor.

- ▶ **Removing:** Open the trunk (> page 81).
- ▶ Lift the trunk floor using the floor handle.
- ▶ Engage the floor handle on the upper trunk lip.

! To prevent damage, always disengage the floor handle from the upper trunk lip and lower the trunk floor before closing the trunk.

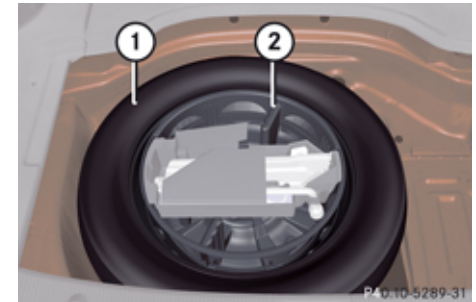

- ① Spare wheel
- ② Luggage bowl

Vehicle status messages in the multifunction display

- ▶ Remove luggage bowl ② by turning it counterclockwise.
- ▶ Remove spare wheel ①.

Storing the spare wheel after use

- ▶ Place spare wheel ① into the spare wheel well (▷ page 304).
- ▶ Secure spare wheel ① by turning luggage bowl ② clockwise (▷ page 304).

Vehicle status messages in the multifunction display

Notes

Warning and malfunction messages appear in the multifunction display located in the instrument cluster.

Certain warning and malfunction messages are accompanied by an audible signal.

Address these messages accordingly and follow the additional instructions given in this Operator's Manual.

High-priority messages appear in the multifunction display in red color.

Certain messages of high priority cannot be cleared from the multifunction display using **OK** or  on the multifunction steering wheel (▷ page 131).

Other messages of high priority and messages of less immediate priority can be cleared from the multifunction display using **OK** or . They are then stored in the Vehicle status message memory (▷ page 144). Remember that clearing a message will only make the message disappear. Clearing a message will not correct the condition that caused the message to appear.

Warning!

All categories of messages contain important information which should be taken note of and, where a malfunction is indicated, addressed as soon as possible at an authorized Mercedes-Benz Center.

Failure to repair the condition noted may cause damage not covered by the Mercedes-Benz Limited Warranty, or result in property damage or personal injury.

Warning!

No messages will be displayed if either the instrument cluster or the multifunction display is inoperative.

As a result, you will not be able to see information about your driving conditions, such as speed or outside temperature, warning/indicator lamps, malfunction/warning messages or the failure of any systems. Driving characteristics may be impaired.

If you must continue to drive, please do so with added caution. Contact an authorized Mercedes-Benz Center as soon as possible.

On the pages that follow, you will find a compilation of the most important warning



Vehicle status messages in the multifunction display



and malfunction messages that may appear in the multifunction display.

For your convenience the messages are divided into text messages (▷ page 307) and symbol messages (▷ page 316).



Vehicle status messages in the multifunction display

Text messages



Safety systems

Display messages		Possible cause/consequence	Possible solution
ESP	Inoperative See Operator's Manual	In addition, the yellow ESP [®] warning lamp  comes on. The brake system is still functioning normally but due to a malfunction, the BAS, the ESP [®] and the hill start assist system are unavailable.	<ul style="list-style-type: none"> ▶ Continue driving with added caution. ▶ Have the system checked at an authorized Mercedes-Benz Center as soon as possible.
ESP	Currently Unavailable See Operator's Manual	In addition, the yellow ESP [®] warning lamp  comes on. The self-diagnosis might not be completed yet. The brake system is still functioning normally but without th BAS, the ESP [®] and the hill start assist system available.	<ul style="list-style-type: none"> ▶ Drive a short distance with added caution at a vehicle speed of above 12 mph (20 km/h). When the message disappears, the ESP[®] is available again. <p>If the message does not disappear:</p> <ul style="list-style-type: none"> ▶ Continue driving with added caution. ▶ Have the system checked at an authorized Mercedes-Benz Center as soon as possible. <p>Failure to follow these instructions increases the risk of an accident.</p>

Vehicle status messages in the multifunction display

Display messages	Possible cause/consequence	Possible solution
<p>ESP Currently Unavailable See Operator's Manual</p>	<p>In addition, the yellow ESP® warning lamp  comes on. The brake system still functions normally but due to insufficient power supply the BAS, the ESP® and the hill start assist system are not available.</p>	<p>► Continue driving with added caution. When the voltage is above the required value again, the ESP® is operational again and the message in the multifunction display should disappear. If the message in the multifunction display does not disappear: ► Have the alternator and the battery checked. ► Have the system checked at an authorized Mercedes-Benz Center as soon as possible.</p>
<p>ESP Currently Unavailable See Operator's Manual</p>	<p>If the yellow ESP® warning lamp  flashes while driving and this message appears, the Electronic Traction System has switched off to prevent overheating of the drive wheel brakes.</p>	<p>As soon as the brakes have cooled off, the Electronic Traction System switches on again. The message in the multifunction display disappears and the ESP® warning lamp  goes out.</p>

Vehicle status messages in the multifunction display

Display messages	Possible cause/consequence	Possible solution
<p>Front Passenger Airbag Enabled See Operator's Manual</p>	<p>The front passenger front air bag is activated while driving even though a child, small individual, or object below the system's weight threshold is on the front passenger seat, or the front passenger seat is empty. Objects on the seat or forces acting on the seat may make the system sense supplemental weight.</p>	<ul style="list-style-type: none"> ▶ Stop the vehicle in a safe location as soon as possible. ▶ Engage the parking brake. ▶ Switch off the ignition. ▶ Open the front passenger door. ▶ Remove child and child restraint from front passenger seat and properly secure the child in rear seat employing the child restraint if necessary. ▶ Make sure no objects which apply supplemental weight to the seat are present. The system may recognize such supplemental weight and sense that an occupant on the front passenger seat is of a greater weight than actually present. ▶ Keep the seat unoccupied, close the front passenger door and switch on the ignition. <p>Monitor the  PASS AIR BAG OFF indicator lamp in the center console (▷ page 52) and the multifunction display in the instrument cluster (▷ page 30) for the following:</p> <p>With the seat unoccupied and the ignition switched on,</p> <ul style="list-style-type: none"> • the  PASS AIR BAG OFF indicator lamp in the center console should illuminate and remain illuminated, indicating that the OCS



Vehicle status messages in the multifunction display

Display messages	Possible cause/consequence	Possible solution
		<p>(▷ page 49) has deactivated the passenger front air bag.</p> <ul style="list-style-type: none"> the message Front Passenger Airbag Enabled See Operator's Manual or the message Front Passenger Airbag Disabled See Operator's Manual should not appear in the multifunction display at any time the seat is unoccupied. Wait at least 60 seconds for the system to complete the necessary check cycles and to make sure neither message appears in the multifunction display. <p>If above conditions are met, you can occupy the passenger seat again. Depending on the passenger classification sensed by the OCS, the  indicator lamp will remain illuminated or go out.</p> <p>If above conditions are not met, the system is not working properly. Have the system checked as soon as possible at an authorized Mercedes-Benz Center.</p>



Warning!

If the  indicator lamp remains out even after performing the above corrective

steps, do not have any children 12 years old and under and other small individuals use

the passenger seat until the system has been repaired.

Vehicle status messages in the multifunction display

Display messages	Possible cause/consequence	Possible solution
<p>Front Passenger Airbag Disabled See Operator's Manual</p>	<p>The front passenger front air bag is deactivated while driving even though an adult or someone larger than a small individual is occupying the front passenger seat. Forces acting on the seat may make the system sense a decrease in weight.</p>	<ul style="list-style-type: none"> ▶ Stop the vehicle in a safe location as soon as possible. ▶ Engage the parking brake. ▶ Switch off the ignition. ▶ Have the front passenger vacate the seat and exit the vehicle. ▶ Keep the seat unoccupied, close the front passenger door and switch on the ignition. <p>Monitor the  indicator lamp in the center console (▷ page 52) and the multifunction display in the instrument cluster (▷ page 30) for the following:</p> <p>With the seat unoccupied and the ignition switched on,</p> <ul style="list-style-type: none"> • the  indicator lamp in the center console should illuminate and remain illuminated, indicating that the OCS (▷ page 49) has deactivated the front passenger front air bag. • the message Front Passenger Airbag Enabled See Operator's Manual or the message Front Passenger Airbag Disabled See Operator's Manual should not appear in the multifunction display at any time the seat is unoccupied. Wait at least 60 seconds for the system to complete the



Vehicle status messages in the multifunction display

Display messages	Possible cause/consequence	Possible solution
		<p>necessary check cycles and to make sure neither message appears in the multifunction display.</p> <p>If above conditions are met, you can occupy the passenger seat again. Depending on the passenger classification sensed by the OCS, the  indicator lamp will remain illuminated or go out.</p> <p>If above conditions are not met, the system is not working properly. Have the system checked as soon as possible at an authorized Mercedes-Benz Center.</p>

Warning!

If the  indicator lamp remains illuminated with an adult occupant on the

front passenger seat even after performing the above corrective steps, do not have any

passenger use the front passenger seat until the system has been repaired.

Vehicle status messages in the multifunction display

Driving systems

Display messages	Possible cause/consequence	Possible solution
Cruise Control - - - mph	One of the activation conditions for the cruise control has not been fulfilled. For example, you have attempted to set a speed below 20 mph (30 km/h).	<ul style="list-style-type: none"> ▶ Drive faster than 20 mph (30 km/h), if the situation allows, and set the speed. ▶ Check the activation conditions for the cruise control (▷ page 205).
Cruise Control Inoperative and Speedtronic	The cruise control is malfunctioning. In addition an acoustic warning sounds.	<ul style="list-style-type: none"> ▶ Have the cruise control checked at an authorized Mercedes-Benz Center.

Vehicle

Display messages	Possible cause/consequence	Possible solution
Shift to P	<p>You have turned off the engine with the KEYLESS-GO start/stop button with the automatic transmission in neutral position N and opened the driver's door.</p> <p>or</p> <p>You have attempted to switch off the engine with the KEYLESS-GO start/stop button with the automatic transmission in reverse gear R or drive position D.</p>	<ul style="list-style-type: none"> ▶ Shift the automatic transmission to park position P.
Shift to P or N To Start Engine	You have attempted to start the engine while the automatic transmission was in reverse gear R or drive position D .	<ul style="list-style-type: none"> ▶ Shift the automatic transmission into park position P or neutral position N.

Vehicle status messages in the multifunction display

Tires

Display messages	Possible cause/consequence	Possible solution
Check, Tire Pressure (Canada only) Then Restart Run Flat Indicator	There has been a warning message about a loss in the tire inflation pressure and the Run Flat Indicator was not restarted yet.	<ul style="list-style-type: none"> ▶ Make sure the correct tire inflation pressure is set for each tire. ▶ Then restart the Run Flat Indicator (> page 269).
Run Flat Indicator (Canada only) Inoperative	The Run Flat Indicator is malfunctioning.	▶ Have the Run Flat Indicator checked at an authorized Mercedes-Benz Center.
Check (Canada only) Tire Pressure Soon	The Run Flat Indicator indicates that the pressure is too low in one or more tires.	<ul style="list-style-type: none"> ▶ Carefully bring the vehicle to a halt, avoiding abrupt steering and braking maneuvers. Observe the traffic situation around you. ▶ Check the tires and, if necessary, change the wheel (> page 360). ▶ Check and adjust tire inflation pressure as required (> page 268). ▶ Restart the Run Flat Indicator after adjusting the tire inflation pressure values (> page 269).
Tire Press. Monitor (USA only) Inoperative	The TPMS is malfunctioning.	▶ Have the TPMS checked at an authorized Mercedes-Benz Center.

Vehicle status messages in the multifunction display

Display messages		Possible cause/consequence	Possible solution
Tire Pressure Monitor Inoperative (USA only)	No Wheel Sensors	There are wheels without appropriate wheel sensors mounted (e.g. winter tires).	<ul style="list-style-type: none"> ▶ Have the TPMS checked at an authorized Mercedes-Benz Center. ▶ Have the appropriate wheel sensors installed at an authorized Mercedes-Benz Center.
Tire Press. Monitor (USA only)	Currently Unavailable	The TPMS is unable to monitor the tire inflation pressure due to a nearby radio interference source.	As soon as the causes of the malfunction have been removed, the TPMS becomes active again automatically after a few minutes driving.

 **Warning!**

Do not drive with a flat tire. A flat tire affects the ability to steer or brake the vehicle. You may lose control of the vehicle. Continued driving with a flat tire will cause excessive heat build-up and possibly a fire.

 **Warning!**

Follow recommended tire inflation pressures.



Do not underinflate tires. Underinflated tires wear excessively and/or unevenly, adversely affect handling and fuel economy, and are more likely to fail from being overheated.

Do not overinflate tires. Overinflated tires can adversely affect handling and ride comfort, wear unevenly, increase stopping distance, and result in sudden deflation (blowout) because they are more likely to become punctured or damaged by road debris, potholes etc.

Vehicle status messages in the multifunction display

Symbol messages

Brake





Display messages	Possible cause/consequence	Possible solution
 (USA only)  (Canada only)	Check Brake Fluid Level There is insufficient brake fluid in the reservoir.	Risk of accident! <ul style="list-style-type: none"> ▶ Stop the vehicle in a safe location or as soon as it is safe to do so. ▶ Engage the parking brake. ▶ Do not drive any further. ▶ Contact an authorized Mercedes-Benz Center or call Roadside Assistance. Do not add brake fluid! This will not solve the problem.

Warning!

Driving with the message **Check Brake Fluid Level** displayed can result in an accident. Have your brake system checked immediately. Do not add brake fluid before checking the brake system. Overfilling the brake fluid reservoir can result in spilling brake fluid on hot engine parts and the brake fluid catching fire. You can be seriously burned.

! If you find that the brake fluid in the brake fluid reservoir has fallen to the minimum mark or below, have the brake system checked for brake pad thickness and leaks.

Vehicle status messages in the multifunction display





Display messages	Possible cause/consequence	Possible solution
 (USA only)  (Canada only)	EBR, ABS, and ESP Inoperative See Operator's Manual	The brake system is still functioning normally but due to a malfunction, the ABS, the BAS, the EBP and the ESP® are unavailable. ► Continue driving with added caution. Wheels may lock during hard braking, reducing steering capability. ► Have the system checked at an authorized Mercedes-Benz Center as soon as possible. Failure to follow these instructions increases the risk of an accident.
 (USA only)  (Canada only)	Release Parking Brake	You are driving with the parking brake engaged. ► Release the parking brake.
	Check Brake Pad Wear	The brake pads have reached their wear limit. ► Have the brake pads replaced as soon as possible.

! Brake pad thickness must be visually inspected by a qualified technician at the







intervals specified in the Maintenance Booklet.

Vehicle status messages in the multifunction display

Safety systems

Display messages	Possible cause/consequence	Possible solution
 <p>ABS and ESP Inoperative See Operator's Manual</p>	<p>The brake system is still functioning normally but due to a malfunction, the ABS, the BAS, the ESP® and the hill start assist system are unavailable.</p>	<ul style="list-style-type: none"> ▶ Continue driving with added caution. Wheels may lock during hard braking, reducing steering capability. ▶ Have the system checked at an authorized Mercedes-Benz Center as soon as possible. <p>Failure to follow these instructions increases the risk of an accident.</p>
 <p>ABS and ESP Currently Unavailable See Operator's Manual</p>	<p>The brake system is still functioning normally but due to a malfunction, the ABS, the BAS, the ESP® and the hill start assist system are unavailable.</p> <p>The self-diagnosis may not be completed yet.</p>	<ul style="list-style-type: none"> ▶ Drive a short distance with added caution at a vehicle speed of above 12 mph (20 km/h). When the message disappears, the ABS and the ESP® are available again.
 <p>ABS and ESP Currently Unavailable See Operator's Manual</p>	<p>The brake system still functions normally but due to insufficient power supply, the ABS, the BAS, the ESP® and the hill start assist system are not available.</p>	<p>When the voltage is above the required value again, the ABS, the BAS, the ESP® and the hill start assist system are operational again and the message should disappear.</p> <p>If the message does not disappear:</p> <ul style="list-style-type: none"> ▶ Have the alternator and the battery checked.
 <p>Tele Aid Inoperative</p>	<p>One or more main functions of the Tele Aid system are malfunctioning.</p>	<ul style="list-style-type: none"> ▶ Have the Tele Aid system checked at an authorized Mercedes-Benz Center.

Vehicle status messages in the multifunction display

Display messages	Possible cause/consequence	Possible solution
 SRS Malfunction Service Required	There is a malfunction in the supplemental restraint systems. The air bags or Emergency Tensioning Devices (ETDs) could deploy unexpectedly or fail to activate in an accident.	▶ Drive with added caution to the nearest authorized Mercedes-Benz Center.
 Front Left SRS Malfunction Service Required	Components of the driver's supplemental restraint system may not work properly.	▶ Drive with added caution to the nearest authorized Mercedes-Benz Center.
 Front Right SRS Malfunction Service Required	Components of the front passenger's supplemental restraint system may not work properly.	▶ Drive with added caution to the nearest authorized Mercedes-Benz Center.
 Rear Left SRS Malfunction Service Required	Components of the left rear passenger's supplemental restraint system may not work properly.	▶ Drive with added caution to the nearest authorized Mercedes-Benz Center.
 Rear Center SRS Malfunction Service Required	Components of the center rear passenger's supplemental restraint system may not work properly.	▶ Drive with added caution to the nearest authorized Mercedes-Benz Center.
 Rear Right SRS Malfunction Service Required	Components of the right rear passenger's supplemental restraint system may not work properly.	▶ Drive with added caution to the nearest authorized Mercedes-Benz Center.
 Left Side Curtain Airbag Malfunction Service Required	The left window curtain air bag may not work properly.	▶ Drive with added caution to the nearest authorized Mercedes-Benz Center.



Vehicle status messages in the multifunction display





Display messages	Possible cause/consequence	Possible solution
 Right Side Curtain Airbag Malfunction Service Required	The right window curtain air bag may not work properly.	▶ Drive with added caution to the nearest authorized Mercedes-Benz Center.

Warning!







In the event a malfunction of the SRS is indicated as outlined above, the SRS may not be operational.

For your safety, we strongly recommend that you contact an authorized Mercedes-Benz Center immediately to have the system checked. Otherwise the SRS may not be activated when needed in an accident, which could result in serious or fatal injury, or it might deploy unexpectedly and unnecessarily which could also result in injury.





Vehicle

Display messages	Possible cause/consequence	Possible solution
	You are driving with the hood open.	▶ Close the hood (▷ page 256).
	You are driving with the trunk open.	▶ Close the trunk.
	You are driving with at least one door open. The display symbol shows you which doors are open.	▶ Close all doors.
 Key Not Detected	The SmartKey with KEYLESS-GO is not detected while the engine is running because the SmartKey is not in the vehicle.	▶ Stop the vehicle as soon as it is safe to do so. ▶ Search for the SmartKey. Otherwise the vehicle cannot be locked centrally nor can the engine be started again after the engine is stopped.



Vehicle status messages in the multifunction display

Display messages	Possible cause/consequence	Possible solution
 <p>Key Not Detected</p>	The SmartKey with KEYLESS-GO is not detected while the engine is running because there is strong radio-frequency interference.	<ul style="list-style-type: none"> ▶ Stop the vehicle as soon as it is safe to do so. ▶ Remove KEYLESS-GO button from the starter switch (▷ page 85). ▶ Operate the vehicle with the SmartKey in the starter switch.
 <p>Key Not Detected</p>	The SmartKey with KEYLESS-GO is momentarily not detected.	<ul style="list-style-type: none"> ▶ Change the position of the SmartKey in the vehicle. ▶ If necessary, remove KEYLESS-GO button from the starter switch (▷ page 85). ▶ Operate the vehicle with the SmartKey in the starter switch.
 <p>Close Doors To Lock Vehicle</p>	You wanted to lock the vehicle but not all doors were closed.	▶ Close doors and lock vehicle again.
 <p>Don't Forget Your Key</p>	This display appears for a maximum of 60 seconds if the driver's door is opened with the engine turned off and no SmartKey in the starter switch. This message is only a reminder.	▶ Take the SmartKey with you when leaving the vehicle.
 <p>Take Your Key From Ignition</p>	You have forgotten to remove the SmartKey from the starter switch.	▶ Remove the SmartKey from the starter switch.
 <p>Replace Key Battery</p>	The batteries in the SmartKey with KEYLESS-GO are discharged.	▶ Replace the batteries (▷ page 353).

Vehicle status messages in the multifunction display

Display messages	Possible cause/consequence	Possible solution
 Key Detected In Vehicle	A SmartKey with KEYLESS-GO left in the vehicle was recognized while trying to lock the vehicle from the outside.	▶ Take the SmartKey out of the vehicle.
 Remove "START" Button And Insert Key	The KEYLESS-GO system is malfunctioning.	▶ Remove KEYLESS-GO button from the starter switch (▶ page 85). ▶ Operate the vehicle with the SmartKey in the starter switch.
 Obtain A New Key	The SmartKey with KEYLESS-GO must be replaced.	▶ Contact an authorized Mercedes-Benz Center as soon as possible.
 Key Does Not Belong to Vehicle	The SmartKey or SmartKey with KEYLESS-GO in the starter switch does not belong to the vehicle.	▶ Remove the SmartKey from the starter switch.

Vehicle status messages in the multifunction display

Display messages	Possible cause/consequence	Possible solution
 <p>Power Steering Malfunction See Operator's Manual</p>	<p>Power assistance for the steering system is not available. A considerably higher degree of effort is necessary to steer the vehicle.</p>	<ul style="list-style-type: none"> ▶ Check whether you are capable to apply the higher degree of effort necessary to safely steer the vehicle. <p>If you are able to steer the vehicle safely:</p> <ul style="list-style-type: none"> ▶ Continue driving with added caution. ▶ Have the system checked at an authorized Mercedes-Benz Center. <p>If, in any way, you feel that you are not able to steer the vehicle safely:</p> <ul style="list-style-type: none"> ▶ Stop the vehicle in a safe location as soon as it is safe to do so. ▶ Apply the parking brake. ▶ Do not continue to drive. ▶ Contact an authorized Mercedes-Benz Center.
 <p>Check Washer Fluid</p>	<p>The water level has dropped to approx. 1.1 US qts (1.0 l).</p>	<ul style="list-style-type: none"> ▶ Add washer fluid (> page 259).

Vehicle status messages in the multifunction display

Engine

Display messages	Possible cause/consequence	Possible solution
 <p>Check Coolant Level See Operator's Manual</p>	The coolant level is too low.	<ul style="list-style-type: none"> ▶ Add coolant (▷ page 258). ▶ If you have to add coolant frequently, have the cooling system checked at an authorized Mercedes-Benz Center.

Warning!

Do not spill antifreeze on hot engine parts. Antifreeze contains ethylene glycol which may burn if it comes into contact with hot engine parts. You could be seriously burned.

! Do not ignore the low engine coolant level warning. Extended driving with the message and symbol displayed may cause serious engine damage not covered by the Mercedes-Benz Limited Warranty.

Do not drive without sufficient amount of coolant in the cooling system. The engine will overheat causing major engine damage.

Vehicle status messages in the multifunction display

Display messages	Possible cause/consequence	Possible solution
 <p>Coolant Low Stop Vehicle! Turn Engine Off</p>	The coolant is too hot.	<ul style="list-style-type: none"> ▶ Stop the vehicle immediately as soon as it is safe to do so. ▶ Turn off the engine immediately. ▶ Only start the engine again after the message disappears. You could otherwise damage the engine. ▶ Observe the coolant temperature gauge in the instrument cluster. <p>During severe operation conditions and stop-and-go city traffic, the coolant temperature may rise close to 248°F (120°C).</p>

 **Warning!**

Driving when your engine is overheated can cause some fluids which may have leaked into the engine compartment to catch fire. You could be seriously burned.

Steam from an overheated engine can cause serious burns which can occur just by opening the engine hood. Stay away from the engine if you see or hear steam coming from it.



Stop the vehicle in a safe location away from other traffic. Turn off the engine, get out of the vehicle and do not stand near the vehicle until the engine has cooled down.

! The engine should not be operated with the coolant temperature above 248°F (120°C). Doing so may cause serious damage which is not covered by the Mercedes-Benz Limited Warranty.

Vehicle status messages in the multifunction display

Display messages	Possible cause/consequence	Possible solution
 <p>Coolant Low Stop Vehicle! Turn Engine Off</p>	<p>The poly-V-belt could be broken.</p>	<ul style="list-style-type: none"> ▶ Stop the vehicle immediately as soon as it is safe to do so. ▶ Turn off the engine immediately. ▶ Engage the parking brake. ▶ Check the poly-V-belt. ▶ If it is broken: Do not continue to drive. Otherwise the engine will overheat due to an inoperative water pump which may result in damage to the engine. Contact an authorized Mercedes-Benz Center. ▶ If it is intact: Do not continue to drive the vehicle with this message displayed. Doing so could result in serious engine damage that is not covered by the Mercedes-Benz Limited Warranty. ▶ Observe the coolant temperature gauge in the instrument cluster. ▶ Restart the engine. <p>If this message disappears from the multifunction display:</p> <ul style="list-style-type: none"> ▶ Drive to the nearest authorized Mercedes-Benz Center immediately. <p>If this message does not disappear from the multifunction display:</p> <ul style="list-style-type: none"> ▶ Call Roadside Assistance.

Vehicle status messages in the multifunction display

Display messages	Possible cause/consequence	Possible solution
	<p>The cooling fan for the coolant is malfunctioning.</p>	<ul style="list-style-type: none"> ▶ Observe the coolant temperature gauge in the instrument cluster. If the coolant temperature is below 248°F (120°C), you may continue driving to an authorized Mercedes-Benz Center. ▶ Avoid placing heavy loads on the engine (e.g. by driving uphill) as well as stop-and-go traffic. ▶ Have the fan replaced as soon as possible.
	<p>The battery is no longer charging. Possible causes:</p> <ul style="list-style-type: none"> • alternator malfunctioning • broken poly-V-belt • a malfunction in the electronic system 	<ul style="list-style-type: none"> ▶ Stop immediately in a safe location or as soon as it is safe to do so and check the poly-V-belt. ▶ If it is broken: Do not continue to drive. Otherwise the engine will overheat due to an inoperative water pump which may result in damage to the engine. Contact an authorized Mercedes-Benz Center. ▶ If it is intact: Drive to the nearest authorized Mercedes-Benz Center immediately. Adjust driving to be consistent with reduced braking responsiveness.
 <p>Check Engine Oil At Next Refueling</p>	<p>The engine oil level has dropped to approximately the minimum level.</p>	<ul style="list-style-type: none"> ▶ Check the engine oil level (> page 256) and add engine oil as required (> page 257). ▶ If you must add engine oil frequently, have the engine checked for possible leaks.

Vehicle status messages in the multifunction display



When the message Check Engine Oil At Next Refueling appears while the engine is running and at operating temperature, the engine oil level has dropped to approximately the minimum level.

The message will be stored in the vehicle status message memory after you have cleared it from the multifunction display.

Visually check for oil leaks. If there are no obvious oil leaks, drive to the nearest service station to refill your engine oil to the required level.





For information on approved engine oils contact an authorized Mercedes-Benz Center or visit www.mbusa.com (USA only).

! Engine oil level warnings should not be ignored. Extended driving with the symbol displayed could result in serious engine damage that is not covered by the Mercedes-Benz Limited Warranty.



Display messages	Possible cause/consequence	Possible solution
 Reserve Fuel Level	The fuel level has dropped below the reserve mark.	▶ Refuel at the next gas station.
 Gas Cap Loose	A loss of pressure has been detected in the fuel system. The fuel cap may not be closed properly or the fuel system may be leaky.	<ul style="list-style-type: none"> ▶ Check the fuel cap (▷ page 253). ▶ If it is not closed properly: Close the fuel cap. ▶ If it is closed properly: Have the fuel system checked at an authorized Mercedes-Benz Center.

Vehicle status messages in the multifunction display







Lamps

Display messages	Possible cause/consequence	Possible solution
 Check Center Brake Lamp	The high mounted brake lamp is malfunctioning. This message will only appear if a critical number of LEDs have stopped working.	▶ Contact an authorized Mercedes-Benz Center as soon as possible.
 Check Left Cornering Light or Check Right Cornering Light	The left or right corner-illuminating front fog lamp is malfunctioning.	▶ Contact an authorized Mercedes-Benz Center as soon as possible.
 Check Left Low Beam or Check Right Low Beam	The left or right low-beam lamp is malfunctioning.	▶ Halogen headlamps: Replace the bulb as soon as possible (▷ page 355). ▶ Bi-Xenon headlamps: Contact an authorized Mercedes-Benz Center as soon as possible.
 Auto Lamp Function Inoperative	The light sensor is malfunctioning. Daytime driving lamps come on automatically.	▶ Contact an authorized Mercedes-Benz Center as soon as possible. To switch off the headlamps (U.S. vehicles only): ▶ In the instrument cluster control system, set lamp operation to manual mode (▷ page 148). ▶ Switch on headlamps using the exterior lamp switch (▷ page 100).



Vehicle status messages in the multifunction display

Display messages	Possible cause/consequence	Possible solution
 <p>Check Rear Left Turn Signal or Check Rear Right Turn Signal</p>	<p>The left or right rear turn signal lamp is malfunctioning.</p>	<p>► Replace the bulb as soon as possible (▷ page 355).</p>
 <p>Check Left Mirror Turn Signal or Check Right Mirror Turn Signal</p>	<p>The turn signal in the left or right exterior rear view mirror is malfunctioning. This message will only appear if a critical number of LEDs have stopped working.</p>	<p>► Have the LEDs replaced as soon as possible.</p>
 <p>Check Front Left Turn Signal or Check Front Right Turn Signal</p>	<p>The left or right front turn signal lamp is malfunctioning.</p>	<p>► Replace the bulb as soon as possible (▷ page 355).</p>





Vehicle status messages in the multifunction display

Display messages	Possible cause/consequence	Possible solution
 <p>Check Left High Beam or Check Right High Beam</p>	<p>The left or right high-beam lamp is malfunctioning.</p>	<p>► Contact an authorized Mercedes-Benz Center as soon as possible.</p>
 <p>Check Left License Plate Lamp or Check Right License Plate Lamp</p>	<p>The left or right license plate lamp is malfunctioning.</p>	<p>► Contact an authorized Mercedes-Benz Center as soon as possible.</p>
 <p>Switch Off Lights</p>	<p>You are getting out of the vehicle and the lights are still switched on.</p>	<p>► Turn the exterior lamp switch to  or  (▷ page 100). or ► With the rear fog lamp switched on: Push in the exterior lamp switch to its stop.</p>
 <p>Check Left Fog Lamp or Check Right Fog Lamp</p>	<p>The left or right front fog lamp is malfunctioning.</p>	<p>► Contact an authorized Mercedes-Benz Center as soon as possible.</p>
 <p>Check Rear Left Fog Lamp</p>	<p>The rear fog lamp is malfunctioning.</p>	<p>► Replace the bulb as soon as possible (▷ page 355).</p>

Vehicle status messages in the multifunction display



Display messages	Possible cause/consequence	Possible solution
 <p>Check Front Left Parking Lamp or Check Front Right Parking Lamp</p>	The left or right front parking lamp is malfunctioning.	▶ Contact an authorized Mercedes-Benz Center as soon as possible.
 <p>Check Left Reverse Lamp or Check Right Reverse Lamp</p>	The left or right backup lamp is malfunctioning.	▶ Replace the bulb as soon as possible (▷ page 355).
 <p>Check Front Left Sidemarkers Lamp or Check Front Right Sidemarkers Lamp</p>	The front left or right side marker lamp is malfunctioning.	▶ Contact an authorized Mercedes-Benz Center as soon as possible.

Vehicle status messages in the multifunction display

Display messages	Possible cause/consequence	Possible solution
 Check Rear Left Sidemarkers Lamp or Check Rear Right Sidemarkers Lamp	The rear left or right side marker lamp is malfunctioning.	▶ Replace the bulb as soon as possible (▷ page 355).
 Check Left Tail and Brake Lamps or Check Right Tail and Brake Lamps	The left or right tail lamp/brake lamp is malfunctioning.	▶ Replace the bulb as soon as possible (▷ page 355).
 Check Left Brake Lamp or Check Right Brake Lamp	The left or right brake lamp is malfunctioning.	▶ Replace the bulb as soon as possible (▷ page 355).
 Check Left Tail Lamp or Check Right Tail Lamp	The left or right tail lamp is malfunctioning.	▶ Replace the bulb as soon as possible (▷ page 355).

Vehicle status messages in the multifunction display

Tires

Display messages	Possible cause/consequence	Possible solution
 <p>Correct Tire Pressure (USA only)</p>	<p>The tire pressure is too low in one or more tires.</p> <p>or</p> <p>The tire pressure of the individual tires differ from each other significantly.</p>	<p>▶ Check and correct tire inflation pressure as required (▷ page 268).</p>
 <p>Tire Press. Warning Caution Tire Malfunction (USA only)</p>	<p>One or more tires are deflating.</p>	<p>▶ Carefully bring the vehicle to a halt, avoiding abrupt steering and braking maneuvers.</p> <p>▶ If necessary, change the wheel (▷ page 360).</p>
 <p>Check Tire Pressure (USA only)</p>	<p>The tire pressure in one or more tires is already below the minimum value.</p>	<p>▶ Carefully bring the vehicle to a halt, avoiding abrupt steering and braking maneuvers.</p> <p>▶ Check and adjust tire pressure as required.</p> <p>▶ If necessary, change the wheel (▷ page 360).</p>

Warning!

Do not drive with a flat tire. A flat tire affects the ability to steer or brake the vehicle. You may lose control of the vehicle. Continued driving with a flat tire will cause excessive heat build-up and possibly a fire.

Warning!

Follow recommended tire inflation pressures.

Do not underinflate tires. Underinflated tires wear excessively and/or unevenly, adversely affect handling and fuel economy, and are more likely to fail from being overheated.

Vehicle status messages in the multifunction display

Do not overinflate tires. Overinflated tires can adversely affect handling and ride comfort, wear unevenly, increase stopping distance, and result in sudden deflation (blowout) because they are more likely to become punctured or damaged by road debris, potholes etc.

What to do if ...

What to do if ...

Lamps in instrument cluster



Notes

If any of the following lamps in the instrument cluster fails to come on during the bulb self-



check when switching on the ignition, have the respective bulb checked and replaced if necessary.









When you switch on the ignition, all lamps (except high-beam headlamp indicator lamp, and turn signal indicator lamps unless activated) in the instrument cluster come on. If a lamp in the instrument cluster fails to come on when the ignition is switched on, have it checked and replaced if necessary.

Brake

Problem	Possible cause/consequence	Suggested solutions
 The yellow ABS indicator lamp comes on while the engine is running.	<p>The ABS has detected a malfunction and switched off. The BAS, ESP® and EBP are also switched off (see messages in multifunction display).</p> <p>The brake system is still functioning normally but without the systems specified above available.</p> <p>If the ABS control unit is malfunctioning, other systems such as the navigation system or the automatic transmission may also be malfunctioning.</p>	<ul style="list-style-type: none"> ▶ Continue driving with added caution. Wheels may lock during hard braking, reducing steering capability. ▶ Read and observe messages that may appear in the multifunction display (▷ page 305). ▶ Have the system checked at an authorized Mercedes-Benz Center as soon as possible. <p>Failure to follow these instructions increases the risk of an accident.</p>
 The yellow ABS indicator lamp comes on while the engine is running.	<p>The ABS has switched off due to insufficient power supply.</p> <p>The battery might not be charged sufficiently.</p>	<p>When the voltage is above the required value again, the ABS is operational again and the ABS indicator lamp should go out.</p> <ul style="list-style-type: none"> ▶ Switch off electrical consumers that are currently not needed, e.g. seat heating. ▶ If necessary, have the alternator and battery checked.

What to do if ...

Problem	Possible cause/consequence	Suggested solutions
 The yellow ABS indicator lamp comes on while the engine is running.	<p>The ABS is temporarily not available. The ESP[®], the BAS and the EBP are also unavailable.</p> <p>The self-diagnosis has not been completed yet.</p> <p>The brake system is still functioning normally but without the systems specified above.</p>	<p>The indicator lamp will go out after driving a short distance at a vehicle speed of above 12 mph (20 km/h).</p> <p>If the ABS indicator lamp does not go out:</p> <ul style="list-style-type: none"> ▶ Continue driving with added caution. ▶ Have the system checked at an authorized Mercedes-Benz Center as soon as possible. <p>Failure to follow these instructions increases the risk of an accident.</p>
  The yellow ABS malfunction indicator lamp and the yellow ESP [®] warning lamp come on while the engine is running and an acoustic warning sounds.	<p>The brake system is still functioning normally but due to a malfunction, the ABS, the BAS, the EBP and the ESP[®] are unavailable.</p>	<ul style="list-style-type: none"> ▶ Continue driving with added caution. Wheels may lock during hard braking, reducing steering capability. ▶ Read and observe messages in the multifunction display (▷ page 305). ▶ Have the system checked at an authorized Mercedes-Benz Center as soon as possible. <p>Failure to follow these instructions increases the risk of an accident.</p>

Problem	Possible cause/consequence	Suggested solutions
<p> (USA only)  (Canada only)   </p> <p>The red brake warning lamp comes on while driving. In addition, the yellow ABS malfunction indicator lamp, and the yellow ESP[®] warning lamp come on and an acoustic warning sounds.</p>	<p>The Electronic Brake Proportioning (EBP) switched off due to a malfunction.</p> <p>The ABS, the BAS, and the ESP[®] are also switched off.</p> <p>The brake system continues to function normally, but without electronic support.</p>	<ul style="list-style-type: none"> ▶ Continue driving with added caution. Wheels may lock during hard braking, reducing steering capability. ▶ Read and observe messages that may appear in the multifunction display (▷ page 305). ▶ Have the system checked at an authorized Mercedes-Benz Center as soon as possible. <p>Failure to follow these instructions increases the risk of an accident.</p>
<p> (USA only) </p> <p>The red brake warning lamp comes on while driving and an acoustic warning sounds.</p>	<p>You are driving with the parking brake engaged.</p>	<ul style="list-style-type: none"> ▶ Release the parking brake.
<p> (USA only) </p> <p>The red brake warning lamp comes on while the engine is running.</p>	<p>There is insufficient brake fluid in the reservoir.</p>	<ul style="list-style-type: none"> ▶ Risk of accident! Do not drive any further. Stop the vehicle in a safe location as soon as it is safe to do so. ▶ Engage the parking brake. ▶ Read and observe messages that may appear in the multifunction display (▷ page 305). ▶ Contact an authorized Mercedes-Benz Center. Do not add brake fluid! This will not solve the problem.

What to do if ...



Warning!



Driving with the brake warning lamp illuminated can result in an accident. Have your brake system checked immediately if the brake warning lamp stays on. Do not add brake fluid before checking the brake system.

Overfilling the brake fluid reservoir can result in spilling brake fluid on hot engine parts and the brake fluid catching fire. You can be seriously burned.

! If you find that the brake fluid in the brake fluid reservoir has fallen to the minimum mark or below, have the brake system checked for brake pad thickness and leaks.

Safety systems

Problem	Possible cause/consequence	Suggested solutions
 The red seat belt telltale comes on for a maximum of 6 seconds after starting the engine.	The seat belt telltale reminds you and your passengers to fasten your seat belts before driving off.	<ul style="list-style-type: none"> ▶ Fasten your seat belts. Regardless of whether the seat belts are fastened or not, the seat belt telltale always comes on and remains lit for 6 seconds after starting the engine.
 You hear a warning chime for a maximum of 6 seconds after starting the engine.	You have forgotten to fasten your seat belt.	<ul style="list-style-type: none"> ▶ Fasten your seat belt. The warning chime stops sounding.

Problem	Possible cause/consequence	Suggested solutions
<p> The red seat belt telltale comes on while the vehicle is standing still and the engine is running or during driving.</p>	<p>You and/or your front passenger have forgotten to fasten your seat belts.</p>	<p>▶ Fasten your seat belts. The seat belt telltale goes out.</p>
	<p>There are items placed on the front passenger seat and therefore the system senses the front passenger seat as being occupied.</p>	<p>▶ Remove the items from the front passenger seat and put them in a safe place. The seat belt telltale goes out.</p>
<p> During driving the red seat belt telltale flashes and you additionally hear an intermittent warning chime with increasing intensity.</p>	<p>The vehicle's speed once exceeded 15 mph (25 km/h) and you and/or your front passenger have forgotten to fasten your seat belts.</p>	<p>▶ Fasten your seat belts. The seat belt telltale goes out and the warning chime stops sounding.</p>
	<p>There are items placed on the front passenger seat and therefore the system senses the front passenger seat as being occupied.</p>	<p>▶ Remove the items from the front passenger seat and put them in a safe place. The seat belt telltale goes out and the warning chime stops sounding.</p>

-  After 60 seconds with an unfastened seat belt the warning chime stops sounding and the seat belt telltale illuminates continuously. The seat belt telltale will only go out if both, the driver and front passenger's seat belt are fastened, or the vehicle is standing still and a front door is opened.





What to do if ...

Problem	Possible cause/consequence	Suggested solutions
 The red SRS indicator lamp comes on while driving.	There is a malfunction in the restraint systems. The air bags or Emergency Tensioning Devices (ETDs) could deploy unexpectedly or fail to activate in an accident.	► Drive with added caution to the nearest authorized Mercedes-Benz Center.



Warning!

In the event a malfunction of the SRS is indicated as outlined above, the SRS may not be operational.

For your safety, we strongly recommend that you contact an authorized Mercedes-Benz Center immediately to have the system checked. Otherwise the SRS may not be activated when needed in an accident, which could result in serious or fatal injury, or it might deploy unexpectedly and unnecessarily which could also result in injury.

Problem	Possible cause/consequence	Suggested solutions
<p> All models, except C 63 AMG: The yellow ESP® warning lamp comes on while the engine is running.</p>	<p>The ESP® has been switched off. Risk of accident! When the ESP® is switched off it will not stabilize the vehicle if the system recognizes that the vehicle starts to skid or that a wheel is spinning. The cruise control is deactivated and cannot be switched on.</p>	<ul style="list-style-type: none"> ▶ Switch the ESP® back on. Exceptions: (▷ page 69). ▶ If leaving the ESP® switched off, adapt your speed and driving to the prevailing road and weather conditions. ▶ If the ESP® cannot be switched back on: Have the system checked at an authorized Mercedes-Benz Center as soon as possible.
<p> C 63 AMG only: The yellow ESP® warning lamp comes on while the engine is running.</p>	<p>ESP® SPORT is activated. Risk of accident! When ESP® SPORT is activated it will only stabilize the vehicle to a limited extent if the system recognizes that the vehicle starts to skid or that a wheel is spinning.</p>	<ul style="list-style-type: none"> ▶ Switch the ESP® SPORT off (▷ page 70). The message ESP On appears in the multifunction display.
<p>  C 63 AMG only: The yellow ESP® warning lamp and the yellow ESP® OFF warning lamp come on while the engine is running.</p>	<p>The ESP® has been switched off. Risk of accident! When the ESP® is switched off it will not stabilize the vehicle if the system recognizes that the vehicle starts to skid or that a wheel is spinning.</p>	<ul style="list-style-type: none"> ▶ Switch the ESP® back on. Exceptions: (▷ page 70). ▶ If leaving the ESP® switched off, adapt your speed and driving to the prevailing road and weather conditions. ▶ If the ESP® cannot be switched back on: Have the system checked at an authorized Mercedes-Benz Center as soon as possible.



What to do if ...

Problem	Possible cause/consequence	Suggested solutions
 The yellow ESP® warning lamp comes on while the engine is running.	The ESP® is not operational due to a malfunction. Risk of accident!	<ul style="list-style-type: none"> ▶ Read and observe additional messages that may appear in the multifunction display. ▶ Continue driving with added caution. ▶ Adapt your speed and driving to the prevailing road and weather conditions. ▶ Have the system checked at an authorized Mercedes-Benz Center as soon as possible.
 The yellow ESP® warning lamp flashes while driving.	The ESP® or Electronic Traction System (ETS/4-ETS) has come into operation because of detected traction loss in at least one tire. The cruise control is deactivated.	<ul style="list-style-type: none"> ▶ When driving off, apply as little throttle as possible. ▶ While driving, ease up on the accelerator pedal. ▶ Adapt your speed and driving to the prevailing road and weather conditions. ▶ Do not deactivate the ESP®. Exceptions: (▶ page 69). <p>Failure to follow these instructions increases the risk of an accident.</p>



Vehicle

Problem	Possible cause/consequence	Suggested solutions
 The yellow fuel tank reserve warning lamp comes on when the engine is running.	The fuel level has gone below the reserve mark.	<ul style="list-style-type: none"> ▶ Refuel at the next gas station.

Engine

Problem	Possible cause/consequence	Suggested solutions
 <p>The yellow engine malfunction indicator lamp comes on when the engine is running.</p>	<p>There may be a malfunction in:</p> <ul style="list-style-type: none"> • The fuel management system • The ignition system • The emission control system • Systems which affect emissions <p>Such malfunctions may result in excessive emissions values and may switch the engine to limp-home (emergency operation) mode.</p>	<ul style="list-style-type: none"> ▶ Have the vehicle checked as soon as possible at an authorized Mercedes-Benz Center. ▶  Some states may by law require you to visit a workshop as soon as the engine malfunction indicator lamp comes on. Check local requirements.
 <p>The yellow engine malfunction indicator lamp comes on when the engine is running.</p>	<p>A loss of pressure has been detected in the fuel system. The fuel cap may not be closed properly or the fuel system may be leaky.</p>	<ul style="list-style-type: none"> ▶ Check the fuel cap (▷ page 253). ▶ If it is not closed properly: Close the fuel cap. ▶ If it is closed properly: Have the fuel system checked by an authorized Mercedes-Benz Center.

What to do if ...

Problem	Possible cause/consequence	Suggested solutions
 The red coolant temperature warning lamp comes on when the engine is running.	<p>There is insufficient coolant in the reservoir.</p> <p>If this warning lamp comes on frequently, there is a leak in the cooling system.</p> <p>If the coolant level is correct, the electric radiator fan may be broken.</p>	<ul style="list-style-type: none"> ▶ Immediately add coolant to prevent engine from overheating (▷ page 258). ▶ Have the cooling system checked. ▶ If the coolant temperature is below 248°F (120°C), you can continue driving to the nearest authorized Mercedes-Benz Center. ▶ Avoid high engine loads (e.g. driving uphill) and stop-and-go driving.
 The red coolant temperature warning lamp comes on when the engine is running and an acoustic warning sounds.	<p>The coolant temperature has exceeded 248°F (120°C).</p>	<ul style="list-style-type: none"> ▶ Stop in a safe location as soon as possible and allow the engine and coolant to cool down.

Warning!

Driving when your engine is overheated can cause some fluids which may have leaked into the engine compartment to catch fire. You could be seriously burned.



Steam from an overheated engine can cause serious burns which can occur just

by opening the engine hood. Stay away from the engine if you see or hear steam coming from it.

Stop the vehicle in a safe location away from other traffic. Turn off the engine, get out of the vehicle and do not stand near the vehicle until the engine has cooled down.

! The engine should not be operated with the coolant temperature above 248°F (120°C). Doing so may cause serious damage which is not covered by the Mercedes-Benz Limited Warranty.

Tires

Problem	Possible cause/consequence	Suggested solutions
 Combination low tire pressure telltale/TPMS malfunction telltale for the TPMS illuminates continuously.	The TPMS detects a loss of pressure in at least one tire.	<ul style="list-style-type: none"> ▶ Carefully bring the vehicle to a halt, avoiding abrupt steering and braking maneuvers. Observe the traffic situation around you. ▶ Read and observe messages in the multifunction display (▷ page 305). <p>If the tire inflation pressure in the respective tire(s) has (have) been corrected, the combination low tire pressure/TPMS malfunction telltale goes out after a few minutes of driving.</p>
 Combination low tire pressure telltale/TPMS malfunction telltale for the TPMS flashes 60 seconds and then stays illuminated.	There is a malfunction in the TPMS.	<ul style="list-style-type: none"> ▶ Read and observe messages in the multifunction display (▷ page 305). ▶ Have the TPMS checked by an authorized Mercedes-Benz Center. <p>After the malfunction has been remedied, the combination low tire pressure/TPMS malfunction telltale goes out after a few minutes of driving.</p>

 **Warning!**

Each tire, including the spare (if provided), should be checked every other week when cold and inflated to the inflation pressure recommended by the vehicle manufacturer on the Tire and Loading Information placard on the driver's door B-pillar or, if available, the tire inflation pressure label on the inside of the fuel filler flap. If your vehicle has tires of a different size than the size indicated on

the Tire and Loading Information placard or, if available, the tire inflation pressure label, you should determine the proper tire inflation pressure for those tires.

As an added safety feature, your vehicle has been equipped with a tire pressure monitoring system (TPMS) that illuminates a low tire pressure telltale when one or more of your tires are significantly underinflated. Accordingly, when the low

tire pressure telltale illuminates, you should stop and check your tires as soon as possible, and inflate them to the proper pressure. Driving on a significantly underinflated tire causes the tire to overheat and can lead to tire failure. Underinflation also reduces fuel efficiency and tire tread life, and may affect the vehicle's handling and stopping ability. Please note that the TPMS is not a



What to do if ...

substitute for proper tire maintenance, and it is the driver's responsibility to maintain correct tire pressure, even if underinflation has not reached the level to trigger illumination of the TPMS low tire pressure telltale.

Your vehicle has also been equipped with a TPMS malfunction indicator to indicate when the system is not operating properly. The TPMS malfunction indicator is

combined with the low tire pressure telltale. When the system detects a malfunction, the telltale will flash for approximately 1 minute and then remain continuously illuminated. This sequence will continue upon subsequent vehicle start-ups as long as the malfunction exists. When the malfunction indicator is illuminated, the system may not be able to

detect or signal low tire pressure as intended.

TPMS malfunctions may occur for a variety of reasons, including the installation of incompatible replacement or alternate tires or wheels on the vehicle that prevent the TPMS from functioning properly. Always check the TPMS malfunction telltale after replacing one or more tires or wheels on your vehicle to ensure that the replacement or alternate tires and wheels allow the TPMS to continue to function properly.

Lamp in center console

Problem	Possible cause/consequence	Suggested solutions
 <p>The front passenger front air bag off indicator lamp illuminates and remains illuminated with the weight of a typical adult or someone larger than a small individual on the front passenger seat.</p>	<p>The system is malfunctioning.</p>	<ul style="list-style-type: none"> ▶ Have the system checked as soon as possible at an authorized Mercedes-Benz Center. ▶ Read and observe messages in the multifunction display and follow corrective steps (> page 305).

Warning!

If the  indicator lamp illuminates and remains illuminated with the weight of a typical adult or someone larger than a small individual on the front passenger seat, do not have any passenger use the front passenger seat until the system has been repaired.

Problem	Possible cause/consequence	Suggested solutions
<p> The front passenger front air bag off indicator lamp does not illuminate and/or does not remain illuminated with the weight of a typical 12-month-old child in a standard child restraint or less on the front passenger seat.</p>	<p>The system is malfunctioning.</p>	<ul style="list-style-type: none"> ▶ Make sure there is nothing between seat cushion and child seat and check installation of the child seat. ▶ Make sure no objects applying supplemental weight onto the seat are present. ▶ If the front passenger front air bag off indicator lamp remains out, have the system checked as soon as possible at an authorized Mercedes-Benz Center. Do not transport a child on the front passenger seat until the system has been repaired. ▶ Read and observe messages in the multifunction display and follow corrective steps (▷ page 305).

Warning!

If the  indicator lamp does not illuminate or remains out with the weight of a typical 12-month-old child in a standard child restraint or less on the front passenger seat, do not transport a child on

the front passenger seat until the system has been repaired.

Unlocking/locking manually

Unlocking/locking manually

Unlocking the vehicle

If you cannot unlock the vehicle with the SmartKey or with KEYLESS-GO, unlock the driver's door and the trunk using the mechanical key.

- 1 Unlocking the vehicle with the mechanical key and opening the driver's door or the trunk will trigger the anti-theft alarm system.

To cancel the alarm, insert the SmartKey in the starter switch.

Removing the mechanical key

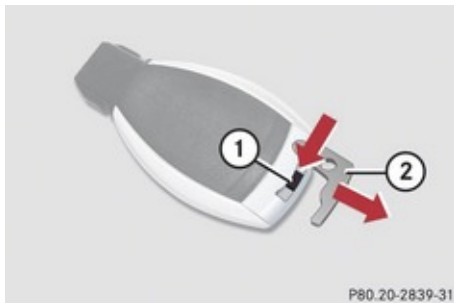

- 1 Mechanical key locking tab
- 2 Mechanical key

- ▶ Move locking tab 1 in direction of arrow.
- ▶ Slide mechanical key 2 out of the housing.

Unlocking the driver's door

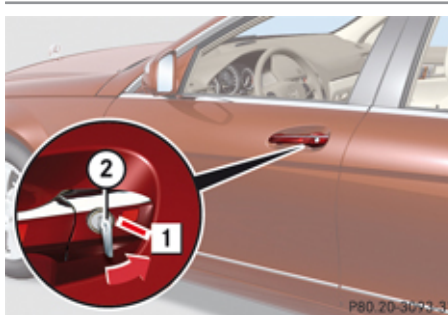

- 1 Unlocking
 - 2 Mechanical key
- ▶ Insert mechanical key 2 into the driver's door lock until it stops.
 - ▶ Turn mechanical key 2 counterclockwise to position 1.
 - ▶ Pull the door handle to open the driver's door.
 - ▶ Turn mechanical key 2 back and remove it from the driver's door lock.

Unlocking the trunk

A minimum height clearance of 5.9 ft (1.8 m) is required to open the trunk lid.

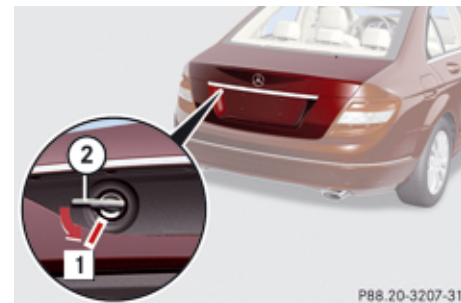

- 1 Unlocking
 - 2 Mechanical key
- ▶ Insert mechanical key 2 into the trunk lid lock until it stops.
 - ▶ Turn mechanical key 2 all the way counterclockwise to position 1.
- ! The trunk lid swings open upwards automatically. Always make sure there is sufficient overhead clearance.
- ▶ Turn mechanical key 2 back and remove it from the trunk lid lock.

Locking the vehicle

If you cannot lock the vehicle with the SmartKey or with KEYLESS-GO, lock it as follows:

- ▶ Close the front passenger door, the rear doors and the trunk.
- ▶ Open the driver's door.
- ▶ Press the central locking switch (▷ page 81).
The locking knobs of the front passenger door and the rear doors move down.
- ▶ **If the vehicle battery is disconnected or drained:** Press down the locking knobs of the front passenger door and the rear doors manually.
- ▶ Exit the vehicle.
- ▶ Close the driver's door.



- ① Locking
- ② Mechanical key

- ▶ Insert mechanical key ② into the driver's door lock until it stops.
- ▶ Turn mechanical key ② clockwise to position ①.
The vehicle is locked.
- ▶ Turn mechanical key ② back and remove it from the driver's door lock.
- ▶ Check whether the doors and the trunk are locked.
- ▶ If necessary, lock the trunk with the mechanical key (▷ page 83).

Unlocking/locking manually

- ❗ This procedure does not arm the anti-theft alarm system, nor does it lock the fuel filler flap.

Fuel filler flap

⚠ Warning!

Avoid contact with the vehicle walls as they may contain sharp edges. Otherwise, you could injure yourself while releasing the fuel filler flap.

In case the central locking system does not release the fuel filler flap, you can open it manually.

The fuel filler flap release is located behind a cover in the right side trim panel of the trunk.

- ▶ Open the trunk (▷ page 81).
- ▶ Open the fuse box in the trunk (▷ page 373).

Unlocking/locking manually

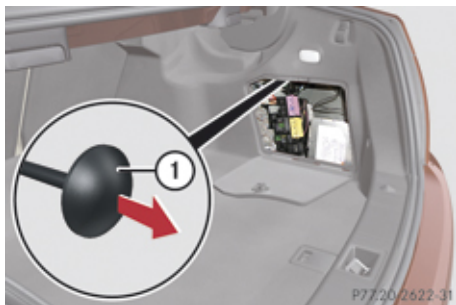

① Fuel filler flap release

- ▶ Pull fuel filler flap release ① in direction of arrow.
The fuel filler flap is unlocked.
- ▶ Open the fuel filler flap (▷ page 253).

Manually unlocking the gear selector lever

If the vehicle's electrical system is malfunctioning, the gear selector lever could remain locked in park position **P**. In this case the gear selector lever can be unlocked manually, e.g. to tow the vehicle.



① Gear selector lever cover

② Release

- ▶ Engage the parking brake.

! Do not use sharp objects to loosen the gear selector lever cover in the center console, as this could damage the gear selector lever cover or the center console.

- ▶ Insert a flat, blunt object into the right edge of gear selector lever cover ① at the positions indicated by the arrows.
- ▶ Loosen gear selector lever cover ① using this object.
- ▶ Pull gear selector lever cover ① out and remove.
- ▶ Simultaneously push down release ② and move the gear selector lever out of park position **P**.
The gear selector lever is unlocked.

i The gear selector lever is locked again as soon as you move it back to park position **P**.

Resetting activated head restraints

If the active head restraints have been triggered in a rear-end collision, the active head restraints must be reset.

You can tell that the active head restraints have been triggered when they have been moved forward and cannot be adjusted.

Warning!

For safety reasons, have the active head restraints checked at an authorized Mercedes-Benz Center after a rear-end collision.

Warning!

When pushing back the head restraint cushion, make sure your fingers do not become caught between the head restraint cushion and the cover. Failing to do so may lead to injury.

- i** Pressing the head restraint cushion back requires high force. If you encounter difficulties when pushing the head restraint back, please have the procedure performed at an authorized Mercedes-Benz Center.



- ① Fold back
- ② Push back
- ③ Push down

- ▶ Push the head restraint cushion by the bottom, back as far as it will go ②.
- ▶ Push the head restraint cushion down into the guide as far as it will go ③.
- ▶ Fold the head restraint cushion by the top, back firmly until it engages ①.
- ▶ Repeat this procedure on the active head restraint for the second front seat.

For information on active head restraints, see “Active head restraints” (▷ page 57).

For information on head restraint adjustment, see “Seats” (▷ page 86).

Replacing SmartKey batteries

Replacing SmartKey batteries

If the batteries in the SmartKey are discharged, the vehicle can no longer be locked or unlocked. It is recommended to have the batteries replaced at an authorized Mercedes-Benz Center.

Warning!

Batteries contain poisonous and corrosive substances. Therefore, keep the batteries out of reach of children.

If a battery is swallowed, seek medical help immediately.

Warning!

SmartKey batteries contain perchlorate material, which may require special handling and regard for the environment. Check with your local government’s disposal guidelines. California residents, see www.dtsc.ca.gov/HazardousWaste/Perchlorate/index.cfm.

Batteries contain materials that can harm the environment if disposed of improperly. Recycling of batteries is the preferred method of disposal. Many states/provinces require



Replacing SmartKey batteries

sellers of batteries to accept old batteries for recycling.

When inserting the batteries, make sure they are clean and free of lint.

When replacing batteries, always replace both batteries.

i The required replacement batteries are available at any authorized Mercedes-Benz Center.

Replacement batteries: Lithium, type CR 2025 or equivalent.

▶ Remove the mechanical key from the SmartKey (> page 350).

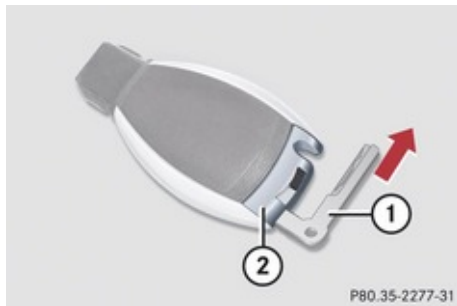

- ① Mechanical key
- ② Battery compartment

- ▶ Insert mechanical key ① into opening.
- ▶ Press mechanical key ① in direction of arrow. Battery compartment ② is unlatched.
- ▶ Pull battery compartment ② out of the SmartKey housing.

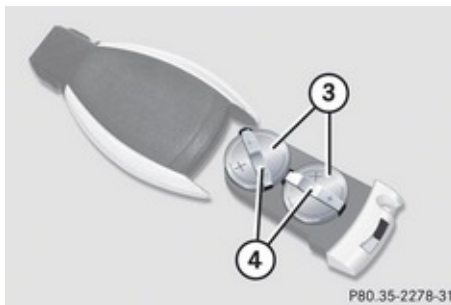

- ③ Batteries
- ④ Contact springs

- ▶ Pull out batteries ③.
- ▶ Insert new batteries ③ under contact springs ④ with the positive terminal (+) side facing up.
- ▶ Return battery compartment ② into SmartKey housing until it locks into place.

- ▶ Slide mechanical key ① back into the SmartKey.
- ▶ Check the operation of the SmartKey as well as the KEYLESS-GO function.

Replacing bulbs

Safety notes

Safe vehicle operation depends on proper exterior lighting and signaling to a large degree.

Correct headlamp adjustment is extremely important. Have headlamps checked and readjusted at regular intervals and when a bulb has been replaced. Contact an authorized Mercedes-Benz Center for headlamp adjustment.

Warning!

Bulbs and bulb sockets can be very hot. Allow the lamp to cool down before changing a bulb.

Keep bulbs out of reach of children.

Halogen lamps contain pressurized gas. A bulb can explode if you:

- touch or move it when hot
- drop the bulb
- scratch the bulb

Wear eye and hand protection.

Because of high voltage in Xenon lamps, it is dangerous to replace the bulb or repair

the lamp and its components. We recommend that you have such work done by a qualified technician.

- 1 Since replacing bulbs is a technically highly demanding process, we recommend to have them replaced at an authorized Mercedes-Benz Center.
- 1 If the headlamps or front fog lamps are fogged up on the inside as a result of high humidity, driving the vehicle a distance with the lights on should clear up the fogging.

Bulbs

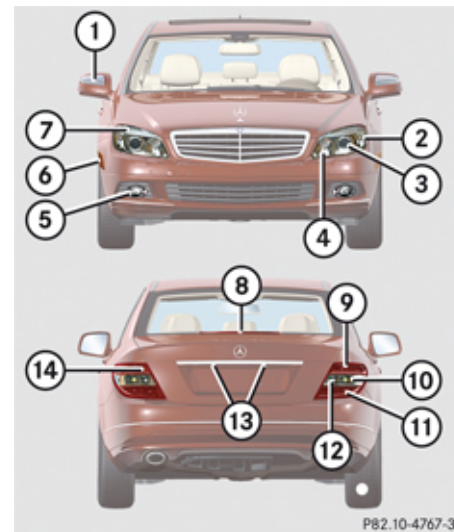

P82.10-4767-31

Front lamps

	Lamp	Type
①	Additional turn signal lamp	LED
②	Turn signal lamp	3457 A

Replacing bulbs

	Lamp	Type
③	Halogen headlamp: Low beam	H7 (55 W)
	Bi-Xenon headlamp: Low and high beam ¹⁸	D1S-35 W
④	Halogen headlamp: High beam/high-beam flasher	H7 (55 W)
	Bi-Xenon headlamp: High-beam flasher	H7 (55 W)
⑤	Front fog lamp	H11 (55 W)
	Corner-illuminating front fog lamp	H11 (55 W)
⑥	Side marker lamp	W 5 W
⑦	Parking and standing lamp	2 x W 5 W-BV

Rear lamps

	Lamp	Type
⑧	High-mounted brake lamp	LED
⑨	Side marker lamp	W 5 W
⑩	Turn signal lamp	PY 21 W
⑪	Brake lamp, parking and standing lamp, tail lamp	2 x P 21 W
⑫	Backup lamp	P 21 W
⑬	License plate lamps	W 5 W
⑭	Rear fog lamp (driver's side only)	P 21 W

Notes on bulb replacement

- Only use 12-volt bulbs of the same type and with the specified watt rating.
- Switch the lights off before changing a bulb to prevent short circuits.
- Always use a clean lint-free cloth when handling bulbs.

- Your hands should be dry and free of oil and grease.
- If the newly installed bulb does not come on, contact an authorized Mercedes-Benz Center.

i Mercedes-Benz recommends using Longlife (LL) bulbs.

Have the LEDs and bulbs for the following lamps replaced at an authorized Mercedes-Benz Center:

- Additional turn signal lamps in the exterior rear view mirrors
- Bi-Xenon lamps
- Front fog lamps
- Front side marker lamps
- High-beam bulbs in the halogen-type and Bi-Xenon front lamps
- License plate lamps
- Front parking and standing lamps
- High-mounted brake lamp

! Do not replace the LEDs yourself. You could otherwise damage the LEDs or parts

¹⁸ Vehicles with Bi-Xenon headlamps: Low beam and high beam use the same D1S-35 W lamp. Do not replace the Bi-Xenon bulbs yourself. Contact an authorized Mercedes-Benz Center.

of the vehicle. Only have the LEDs replaced at an authorized Mercedes-Benz Center.

Replacing bulbs for front lamps

- ▶ Switch off the ignition.
- ▶ Turn the exterior lamp switch to position **0**.
- ▶ Open the hood (▶ page 255).

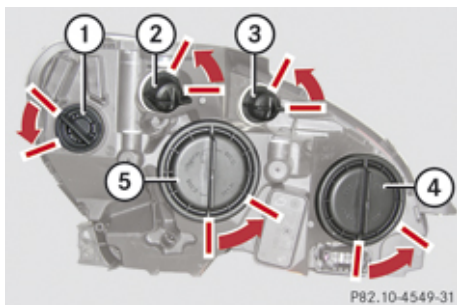

- ① Bulb socket for front turn signal lamp bulb
- ② Housing cover for parking and standing lamp
- ③ Housing cover for parking and standing lamp
- ④ Housing cover for high-beam headlamp
- ⑤ Housing cover for low-beam halogen or Bi-Xenon headlamp

Warning!

Do not remove the cover for the Bi-Xenon headlamp. Because of high voltage in Xenon lamps, it is dangerous to replace the bulb or repair the lamp and its components. It is recommended to have such work done by a qualified technician.

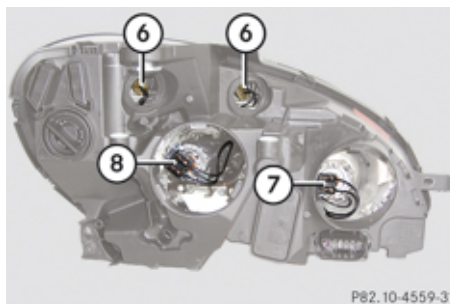

- ⑥ Bulb socket for parking and standing lamp bulb
- ⑦ Bulb holder for high-beam bulb
- ⑧ Bulb holder for low-beam bulb (halogen headlamps only)

Low-beam bulb (halogen headlamps only)

- ▶ Turn housing cover ⑤ counterclockwise and remove it.
- ▶ Pull electric plug off the bulb.
- ▶ Remove wire clip from bulb holder ⑧ by pushing down and release from arrestor hook.
- ▶ Pull the bulb at its socket out of bulb holder ⑧.
- ▶ Insert the new bulb so that its socket locates in the recess of bulb holder ⑧ and is level to it.
- ▶ Fold wire clip back and press it down on bulb holder ⑧ to engage it in the arrestor hook.
- ▶ Connect electric plug on the bulb.
- ▶ Align housing cover ⑤ and turn it clockwise.

Replacing bulbs

Front turn signal lamp bulb

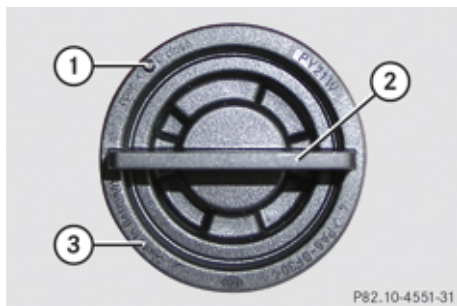

- ① Mark
- ② Handle
- ③ Bulb socket

- ▶ Turn bulb socket ③ with handle ② counterclockwise and remove it.
- ▶ Pull bulb out of bulb socket ③.
- ▶ Gently press the new bulb into bulb socket ③ until the bulb engages.
- ▶ Place bulb socket ③ back into the housing. Handle ② must be in a horizontal line and mark ① must be on the upper part (driver's

side headlamp) or lower part (passenger-side headlamp).

- ▶ Turn bulb socket ③ clockwise until it engages.

Replacing bulbs for rear lamps

Before you start to replace a bulb for a rear lamp, do the following:

- ▶ Switch off the ignition.
- ▶ Turn the exterior lamp switch to position **0**.
- ▶ Open the trunk.

Tail lamp unit

- ▶ Driver's side: Lift up the bottom and pull out the trim panel covering the driver side rear light.
- ▶ Passenger side: Open the fuse box in the trunk (▶ page 373).

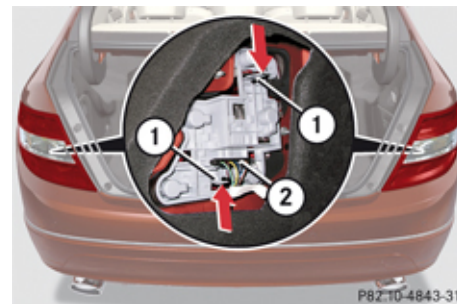

- ① Tabs
- ② Connector

- ▶ Disconnect electrical connector ②.
- ▶ Pull tabs ① in direction of arrows.
- ▶ Remove the bulb carrier.

Replacing wiper blades

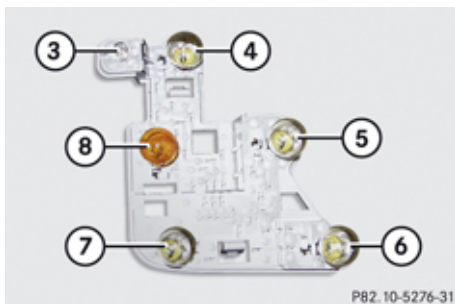

Bulb carrier

- ③ Side marker lamp
- ④ Rear fog lamp (driver's side only), side marker lamp
- ⑤ Backup lamp
- ⑥ Tail lamp, brake lamp
- ⑦ Tail lamp, brake lamp, parking and standing lamp
- ⑧ Turn signal lamp

Side marker lamp

- ▶ Turn the bulb socket on backside of tail lamp unit counterclockwise and remove side marker lamp ③ with bulb socket.
- ▶ Turn the new bulb with socket on backside of tail lamp unit clockwise until it engages.

Other lamps

- ▶ Depending on which bulb needs to be replaced, press gently onto the respective bulb and turn it counterclockwise out of its bulb socket.
- ▶ Gently press the new bulb into its bulb socket and turn it clockwise until it engages.

Reinstall bulb carrier

- ▶ Reinstall the bulb carrier and let tabs ① (▷ page 358) engage.
- ▶ Connect the electrical connector ② (▷ page 358) until it engages.
- ▶ Reinstall trim panel.

Replacing wiper blades

Safety notes

⚠ Warning!

For safety reasons, switch off wipers and remove SmartKey from starter switch (vehicles with KEYLESS-GO: Make sure the vehicle's on-board electronics have status **0**) before replacing a wiper blade. Otherwise, the wiper motor could suddenly turn on and cause injury.

⚠ Warning!

Wiper blades are components that are subject to wear and tear. Replace the wiper blades twice a year, preferably in the spring and fall. Otherwise the windows will not be properly wiped. As a result, you may not be able to observe surrounding traffic conditions and could cause an accident.

❗ Never open the hood when a wiper arm is folded forward.

Hold on to the wiper when folding a wiper arm back. If released, the force of the impact from the tensioning spring could crack the windshield.



Flat tire

Do not allow a wiper arm to contact the windshield glass without a wiper blade inserted.

Mercedes-Benz recommends that you have this work carried out at an authorized Mercedes-Benz Center.

Removing wiper blades

- ❗ Do not pull on the wiper blade inserts. They could tear.
- ▶ Fold the wiper arm forward until it snaps into place.

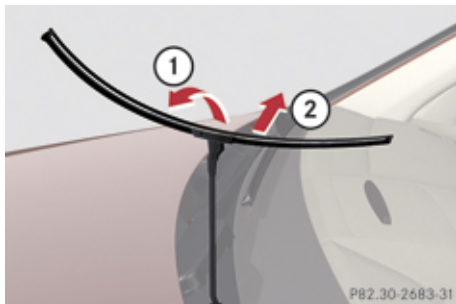

- ① Turning wiper blade
- ② Removing

- ▶ Turn the wiper blade in direction of arrow ①.
- ▶ Slide the wiper blade sideways out of the retainer in the direction of arrow ②.

Installing wiper blades

- ▶ Slide the wiper blade onto wiper arm until it locks in place.
 - ▶ Rotate the wiper blade into position parallel to the wiper arm.
 - ▶ Fold the wiper arm backward to rest on the windshield. Make sure you hold on to the wiper when folding the wiper arm back.
- ❗ Make sure the wiper blades are properly installed. Improperly installed wiper blades may cause windshield damage.

Flat tire

Safety notes

⚠ Warning!

The dimensions of the spare wheel are different from those of the road wheels. As a result, the vehicle handling characteristics change when driving with a spare wheel mounted. Adapt your driving style accordingly.

The spare wheel is for temporary use only. When driving with spare wheel mounted, ensure proper tire inflation pressure and do not exceed a vehicle speed of 50 mph (80 km/h).

Contact the nearest authorized Mercedes-Benz Center as soon as possible to have the spare wheel replaced with a regular road wheel.

Never operate the vehicle with more than one spare wheel mounted.

Do not switch off the ESP® when a spare wheel is mounted.

Preparing the vehicle

- ▶ Park the vehicle in a safe distance from moving traffic on a hard, flat surface when possible.
- ▶ Turn on the hazard warning flasher.
- ▶ Turn the steering wheel so that the front wheels are in a straight-ahead position.
- ▶ Engage the parking brake.
- ▶ Shift the automatic transmission into park position **P** (manual transmission to **1st** or reverse gear **R**).
- ▶ Turn off the engine.
- ▶ Remove the SmartKey from the starter switch.

or

- ▶ Vehicles with KEYLESS-GO: Open the driver's door (this puts the starter switch in position **O**, same as with the SmartKey removed from the starter switch). The driver's door can then be closed again. Open doors only when conditions are safe to do so.
- ▶ Vehicles with KEYLESS-GO: Remove the KEYLESS-GO start/stop button from the starter switch.
- ▶ Have any passenger exit the vehicle at a safe distance from the roadway. Open

doors only when conditions are safe to do so.

Mounting the spare wheel

Introduction

- ▶ Prepare the vehicle as described (▷ page 361).
- ▶ Take the following out of the vehicle:
 - spare wheel
 - jack
 - vehicle tool kit box

For information on where to find the respective items, see “Where will I find ...?” (▷ page 302) and (▷ page 304).

Lifting the vehicle

Warning!

When jacking up the vehicle, only use the jack which has been specifically approved by Mercedes-Benz for your vehicle.

The jack is designed exclusively for jacking up the vehicle at the jack take-up brackets built into both sides of the vehicle. Make sure the jack arm is fully seated in the jack take-up bracket. The jack must always be

vertical when in use, especially on inclines or declines.

The jack is intended only for lifting the vehicle briefly for wheel changes. It is not suited for performing maintenance work under the vehicle. To help avoid personal injury, use the jack only to lift the vehicle during a wheel change.

Never get beneath the vehicle while it is supported by the jack. Keep hands and feet away from the area under the lifted vehicle. Always lower the vehicle onto sufficient capacity jackstands before working under the vehicle.

Always firmly set the parking brake and block the wheels with wheel chocks or other sizeable objects before raising the vehicle with the jack. Do not disengage the parking brake while the vehicle is raised.

Make sure that the ground on which the vehicle is standing and where you place the jack is solid, level and not slippery. If necessary, use a large underlay. On slippery surfaces, such as tiled floors, you should use a non-slip underlay, for example a rubber mat.

Do not use wooden blocks or similar objects to support the jack. Otherwise the

▷▷

Flat tire

jack may not be able to achieve its load-bearing capacity if it is not at its full height. Never start the engine when the vehicle is raised.

Also observe the notes on the jack.

- ▶ Prevent the vehicle from rolling away by blocking wheels with wheel chocks or other sizeable objects.

One wheel chock is included with the vehicle tool kit (▷ page 302). For information on setting up the collapsible wheel chock, see (▷ page 303).

When changing wheel on a level surface:

- ▶ Place the wheel chock in front of and another wheel chock or other sizeable object behind the wheel that is diagonally opposite to the wheel being changed.

Always try lifting the vehicle using the jack on a level surface. However, should circumstances require you to do so on a hill, place the wheel chock and another sizeable object as follows:

- ▶ Place wheel chocks or other sizeable objects on the downhill side blocking both wheels of the axle not being worked on.

⚠ Warning!

Only jack up the vehicle on level ground or on slight inclines/declines. Otherwise, the vehicle could fall off the jack and injure you or others.



① Wheel wrench

- ▶ On wheel to be changed, loosen but do not yet remove the wheel bolts (approximately one full turn with wrench ①).

The jack take-up brackets are located directly behind the front wheel housings and in front of the rear wheel housings.

⚠ Warning!

The jack is designed exclusively for jacking up the vehicle at the jack take-up brackets.

Make sure the jack arm is fully seated in the jack take-up bracket.

If you do not position the jack correctly in the jack take-up bracket, the vehicle can fall off the jack and seriously or fatally injure you or others.

- !** Do not position the jack on the body of the vehicle, as this may cause damage to the vehicle.

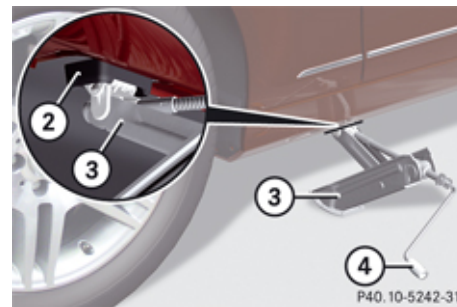

② Take-up bracket

③ Jack

④ Crank

- ▶ Place jack ③ on firm ground.
- ▶ Position jack ③ under take-up bracket ② so that it is always vertical as seen from

Flat tire

the side, even if the vehicle is parked on an incline.

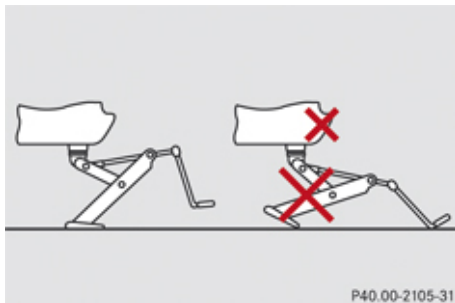

- ▶ Turn crank ④ clockwise until jack ③ is fully seated in take-up bracket ② and the jack base evenly meets the ground.
- ▶ Jack up the vehicle until the wheel is a maximum of 1.2 in (3 cm) from the ground.

Removing the wheel

- ▶ Unscrew and remove the wheel bolts.
- !** Do not place wheel bolts in sand or dirt. This could result in damage to the wheel bolts and wheel hub threads.
- ▶ Remove the wheel.

Attaching the spare wheel

⚠ Warning!

Always replace wheel bolts that are damaged or rusted. Never apply oil or grease to wheel bolts. Damaged wheel hub threads should be repaired immediately. Do not continue to drive under these circumstances! Contact an authorized Mercedes-Benz Center or call Roadside Assistance.

Incorrect wheel bolts or improperly tightened wheel bolts can cause the wheel to come off. This could cause an accident. Be sure to use the correct wheel bolts.

⚠ Warning!

Only use genuine Mercedes-Benz wheel bolts. Other wheel bolts may come loose. Do not tighten the wheel bolts when the vehicle is raised. Otherwise the vehicle could fall off the jack.

- ▶ Clean contact surfaces of wheel and wheel hub.
- !** To avoid paint damage, place wheel flat against hub and hold it there while installing first wheel bolt.



- ▶ Guide the spare wheel onto the wheel hub and push it on.
- ▶ Insert the wheel bolts and tighten them slightly.

Lowering the vehicle

- ▶ Lower the vehicle by turning crank counterclockwise until the vehicle is resting fully on its own weight.
- ▶ Remove the jack.

Battery

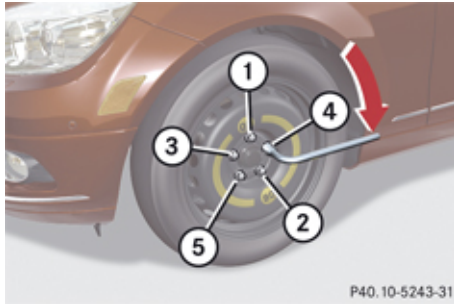

① - ⑤ Wheel bolts

- ▶ Tighten the five wheel bolts evenly, following the diagonal sequence illustrated (① to ⑤), until all bolts are tight. Observe a tightening torque of 96 lb-ft (130 Nm).

Warning!

Have the tightening torque checked after changing a wheel. The wheels could come loose if they are not tightened to a torque of 96 lb-ft (130 Nm).

- ▶ Fully collapse the jack, with handle folded in (storage position), see (▷ page 303).
- ▶ Store the jack and the other vehicle tools in the designated storage space.

For information on storing the spare wheel after it has been replaced by a regular road wheel, see (▷ page 304).

1 Vehicles with TPMS:

Do not restart the tire inflation pressure monitor until a full size wheel/tire with functioning sensor has been placed back into service on the vehicle.

Battery

Safety notes

A battery should always be sufficiently charged in order to achieve its rated service life. Refer to Maintenance Booklet for battery maintenance intervals.

If you use your vehicle mostly for short-distance trips, you will need to have the battery charge checked more frequently.

When replacing a battery, always use a battery approved by Mercedes-Benz.

If you do not intend to operate your vehicle for an extended period of time, contact an authorized Mercedes-Benz Center about steps you need to observe.

Warning!

Observe all safety instructions and precautions when handling automotive batteries.



Risk of explosion.



Fire, open flames and smoking are prohibited when handling batteries. Avoid creating sparks.

Battery



Battery acid is caustic. Do not allow it to come into contact with skin, eyes or clothing.

Wear suitable protective clothing, especially gloves, apron and faceguard.



Wear eye protection.

Rinse any acid spills immediately with clear water. Contact a physician if necessary.



Keep children away.



Follow the instructions in this Operator's Manual.

Batteries contain materials that can harm the environment if disposed of improperly. Large 12-volt storage batteries contain lead. Recycling of batteries is the preferred method of disposal. Many states (USA only) or provinces (Canada only) require sellers of batteries to accept old batteries for recycling.

Warning!

Failure to follow these instructions can result in severe injury or death.

Never lean over batteries while connecting. You might get injured.

Battery fluid contains sulfuric acid. Do not allow this fluid to come in contact with eyes, skin or clothing. In case it does, immediately flush affected area with water and seek medical help if necessary.

A battery will also produce hydrogen gas, which is flammable and explosive. Keep flames or sparks away from battery, avoid improper connection of jumper cables, smoking etc.

Warning!

Do not place metal objects on the battery as this could result in a short circuit.

Use leak-proof batteries only to avoid the risk of acid burns in the event of an accident.

Take care that you do not become statically charged, e.g. by wearing synthetic clothing or rubbing against textiles. For this reason, you also should not pull or push the battery over carpets or other synthetic materials.

Never touch the battery first. First touch the outside body of the vehicle in order to release any possible electrostatic charges.

Do not rub the battery with rags or cloths. The battery could explode if touched due to electrostatic charge or due to spark formation.

! As with any other battery, have the battery disconnect at a qualified workshop or an authorized Mercedes-Benz Center if you do not intend to operate your vehicle for an extended period of time to prevent battery discharge. You may also connect an accessory battery charge unit expressly approved by Mercedes-Benz for your vehicle model to maintain the battery charge. Contact an authorized Mercedes-Benz Center for further information.

The battery, the battery ventilation hose and the lateral plug must always be securely installed when the vehicle is in operation.

! Never loosen or detach battery terminal clamps while the engine is running or the SmartKey is in the starter switch or KEYLESS-GO button is in position 1. Otherwise the alternator and other



Jump starting

electronic components could be severely damaged.

Have the battery checked regularly at an authorized Mercedes-Benz Center.

Refer to Maintenance Booklet for maintenance intervals or contact an authorized Mercedes-Benz Center for further information.

i After battery power was interrupted, do the following:

- Reset the automatic exterior mirror fold in function (▷ page 96).
- Set the clock (▷ page 147). Vehicles with COMAND: see separate COMAND operating instructions.

Charging the battery

⚠ Warning!

Never charge a battery while still installed in the vehicle unless the accessory battery charge unit approved by Mercedes-Benz is being used. Gases may escape during charging and cause explosions that may result in paint damage, corrosion or personal injury.

An accessory battery charge unit specially adapted for Mercedes-Benz vehicles and tested and approved by Mercedes-Benz is available, permitting the charging of the battery in its installed position. Contact an authorized Mercedes-Benz Center for information and availability.

Charge battery in accordance with the separate instructions for the accessory battery charger.

Have batteries charged at an authorized Mercedes-Benz Center. If you charge the batteries yourself, follow the operating instructions for your charging device.

Only use a battery charge unit with a maximum charging voltage of 14.8 V.

- ▶ Charge battery in accordance with the instructions of the battery charger manufacturer.

Jump starting

⚠ Warning!

Failure to follow these directions will cause damage to the electronic components, and can lead to a battery explosion and severe injury or death.

Never lean over batteries while connecting or jump starting. You might get injured.

Battery fluid contains sulfuric acid. Do not allow this fluid to come in contact with eyes, skin or clothing. In case it does, immediately flush affected area with water, and seek medical help if necessary.

A battery will also produce hydrogen gas, which is flammable and explosive. Keep flames or sparks away from battery, avoid improper connection of jumper cables, smoking, etc.

Attempting to jump start a frozen battery can result in it exploding, causing personal injury.

Read all instructions before proceeding.

! Vehicles with automatic transmission and/or 4MATIC:

Do not tow-start the vehicle. You could otherwise seriously damage the automatic

Jump starting

transmission which is not covered by the Mercedes-Benz Limited Warranty.

! Jump starting should only be performed using the jump-start terminals located in the engine compartment.

Avoid repeated and lengthy starting attempts.

Do not attempt to start the engine using a battery quick-charge unit.

If the engine does not run after several unsuccessful starting attempts, have it checked at the nearest authorized Mercedes-Benz Center.

Excessive unburned fuel generated by repeated failed starting attempts may damage the catalytic converter and may present a fire risk.

Make sure the jumper cables do not have loose or missing insulation.

Make sure the cable clamps do not touch any other metal part while the other end is still attached to a battery.

If the battery is discharged, the engine can be started with jumper cables and the fully charged battery of another vehicle or an equivalent starter pack. Observe the following:

- Access to the battery is not possible on all vehicles. If you cannot access the battery in your vehicle provide jump start power by an external battery or starter pack.
- Jump starting should only be performed when the engine and catalytic converter are cold.
- Do not start the engine if the battery is frozen. Let the battery thaw out first.
- Only jump start from batteries with the same voltage rating (12 V). Jump starting with a more powerful battery could damage the vehicle's electrical system, which will not be covered by the Mercedes-Benz Limited Warranty.
- Only use jumper cables with sufficient cross-section and insulated terminal clamps.
- Always make sure the jumper cables are not on or near pulleys, fans or other parts

that move when an engine is started or running.

- Should the battery be drained completely, let the donating power source charge the vehicle for several minutes before reattempting the starting process.
- ▶ Make sure the two vehicles do not touch.
- ▶ Switch off all electrical consumers.
- ▶ Engage the parking brake.
- ▶ Make sure the automatic transmission is in park position **P** (manual transmission to Neutral).
- ▶ Open the hood.
- ▶ Slide cover ② from positive under hood terminal ③ in direction of arrow.

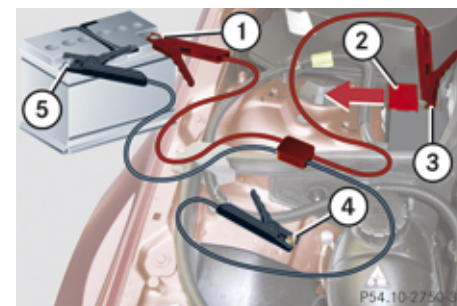

- ① Positive terminal of charged battery
- ② Positive terminal cover



Towing the vehicle

- ③ Positive terminal
- ④ Negative terminal
- ⑤ Negative terminal of charged battery

! Never invert the terminal connections!

- ▶ Connect positive terminal ① of the charged battery with positive terminal ③ with a jumper cable. Clamp the cable to positive terminal ① of the charged battery first.
- ▶ Start engine of the vehicle with the charged battery and run at idle speed.
- ▶ Connect negative terminal ⑤ of the charged battery with negative terminal ④ with a jumper cable. Clamp the cable to negative terminal ⑤ of the charged battery first.
- ▶ Start engine of the vehicle with the discharged battery and run at idle speed. You can now turn on the electrical consumers. Do not switch on the headlamps under any circumstances.
- ▶ Remove the jumper cables first from negative terminals ④ and ⑤ and then from positive terminals ③ and ①. You can now switch on the headlamps.

- ▶ Slide cover ② from positive under hood terminal ③ back.
- ▶ Have the battery checked at the nearest authorized Mercedes-Benz Center.

Towing the vehicle

Safety notes

Mercedes-Benz recommends that the vehicle be transported with all wheels off the ground using flatbed or appropriate wheel lift/dolly equipment. This method is preferable to other types of towing.

! To prevent damage during transport, do not tie down vehicle by its chassis or suspension parts.

If circumstances do not permit the recommended towing methods, the vehicle may be towed with all wheels on the ground or front axle raised (except vehicles with 4MATIC) only so far as necessary to have the vehicle moved to a safe location where the recommended towing methods can be employed.

! Before towing the vehicle observe the following instructions:

- Vehicles with automatic transmission and/or 4MATIC: Do not tow-start the vehicle. You could otherwise seriously damage the automatic transmission

Towing the vehicle

which is not covered by the Mercedes-Benz Limited Warranty.

- Do not tow with sling-type equipment. Towing with sling-type equipment over bumpy roads will damage radiator and supports.
- Towing of the vehicle should only be done using the properly installed towing eye bolt. Never attach a tow cable, tow rope or tow rod to the vehicle chassis, frame or suspension parts.

i If the battery is disconnected or discharged

- the SmartKey will not turn in the starter switch
- Vehicles with automatic transmission: the automatic transmission will remain in park position **P**
- For more information see “Battery” (▷ page 364) or “Jump starting” (▷ page 366).
- Vehicles with automatic transmission: For information on manually unlocking the gear selector lever, see (▷ page 352)

Installing towing eye bolt

Depending on whether you are towing a vehicle or you are being towed, the towing eye bolt can be screwed into threaded holes which are located behind covers on each bumper.

The towing eye bolt is supplied with the vehicle tool kit, located underneath the trunk floor (▷ page 302).

- ▶ Take the vehicle tool kit out of the trunk.

Removing cover in front bumper



① Cover

- ▶ Press mark on cover ① as indicated by the arrow.
- ▶ Lift cover ① off to reveal the threaded hole for the towing eye bolt.

Removing cover in rear bumper

Warning!

In order to avoid possible serious burns or injury, use extreme caution when removing the rear cover, because the rear exhaust pipe is extremely hot.



① Cover

Towing the vehicle

- ▶ Press mark on cover ① as indicated by the arrow.
- ▶ Lift cover ① off to reveal the threaded hole for the towing eye bolt.

Fixing towing eye bolt



① Towing eye bolt

- ▶ Take the towing eye bolt and the wheel wrench from the vehicle tool kit.
- ▶ Screw towing eye bolt ① clockwise into threaded hole to its stop.
- ▶ Insert wheel wrench into towing eye and tighten towing eye bolt ① by turning it clockwise.

Removing towing eye bolt

- ▶ Loosen towing eye bolt ① counterclockwise with wheel wrench.
- ▶ Unscrew towing eye bolt ①.
- ▶ Store the towing eye bolt and wheel wrench back into the vehicle tool kit.

Towing with all wheels on the ground

⚠ Warning!

If circumstances require towing the vehicle with all wheels on the ground, always tow with a tow bar if:

- the engine will not run
- there is a malfunction in the brake system
- there is a malfunction in the power supply or in the vehicle's electrical system

This is necessary to adequately control the towed vehicle.

Prior to towing the vehicle with all wheels on the ground, make sure the SmartKey is in starter switch position **2**.

If the SmartKey is left in the starter switch position **0** for an extended period of time,

it can no longer be turned in the switch. In this case, the steering is locked. To unlock, remove SmartKey from starter switch and reinsert.

⚠ Warning!

With the engine not running, there is no power assistance for the brake and steering systems. In this case, it is important to keep in mind that a considerably higher degree of effort is necessary to brake and steer the vehicle. Adapt your driving accordingly.

- ▶ Make sure the ignition is switched on.
- ▶ With the vehicle at a standstill, depress the brake pedal and keep it pressed.
- ▶ Vehicles with manual transmission: Shift the manual transmission into the neutral position (no gear selected).

or

- ▶ Vehicles with automatic transmission: Shift the automatic transmission into neutral position **N**.
- ▶ Release the brake pedal.
- ▶ If engaged, release the parking brake.
- ▶ Switch on the hazard warning flasher (> page 103).

Towing the vehicle

! The vehicle may be towed only for distances up to 30 miles (50 km) and at a speed not to exceed 30 mph (50 km/h).

i To signal turns while being towed with the hazard warning flasher in use you can activate the combination switch for the left or right turn signal in the usual manner – only the selected turn signal will operate. Upon canceling the turn signal, the hazard warning flasher will operate again.

Towing with front axle raised

! Vehicles with 4MATIC: Do not tow with the front axle raised. Doing so could damage the transfer case, which is not covered by the Mercedes-Benz Limited Warranty.

All wheels must be on or off the ground. Observe instructions for towing the vehicle with all wheels on the ground.

When towing the vehicle with the front axle raised, the wheels on the ground have to move freely.

- ▶ Make sure the ignition is switched on.
- ▶ With the vehicle at a standstill, depress the brake pedal and keep it pressed.

▶ Vehicles with manual transmission: Shift the manual transmission into the neutral position (no gear selected).

or

- ▶ Vehicles with automatic transmission: Shift the automatic transmission into neutral position **N**.
- ▶ Release the brake pedal.
- ▶ If engaged, release the parking brake.
- ▶ Switch off the automatic central locking (▷ page 150).
- ▶ Switch off the ignition and leave the SmartKey in the starter switch.
- ▶ Switch on the hazard warning flasher (▷ page 103).

! Vehicles without 4MATIC:
Because the ESP[®] operates automatically, the engine and ignition must be shut off (SmartKey in starter switch position **0** or **1** or KEYLESS-GO start/stop button in position **0** or **1**) when the vehicle is being towed with the front axle raised.

Active braking action through the ESP[®] may otherwise seriously damage the brake system which is not covered by the Mercedes-Benz Limited Warranty.

! The vehicle may be towed only for distances up to 30 miles (50 km) and at a speed not to exceed 30 mph (50 km/h).

Fuses

Fuses

Introduction

The electrical fuses in your vehicle serve to switch off malfunctioning power circuits.

If a fuse is blown, the components and systems secured by that fuse will stop operating.

Warning!

Only use fuses approved by Mercedes-Benz with the specified amperage for the system in question and do not attempt to repair or bridge a blown fuse. Using other than approved fuses or using repaired or bridged fuses may cause an overload leading to a fire, and/or cause damage to electrical components and/or systems. Have the cause determined and remedied by an authorized Mercedes-Benz Center.

A blown fuse must be replaced by an appropriate spare fuse (recognizable by its color or the fuse rating given on the fuse) of the amperage recommended in the fuse chart. Any Mercedes-Benz Center will be glad to advise you on this subject.

 In case of a blown fuse contact Roadside Assistance or an authorized Mercedes-Benz Center.

If a newly inserted fuse blows again, have the cause determined and rectified by an authorized Mercedes-Benz Center.

A fuse chart is located in the trunk with the vehicle tool kit (▷ page 302). The fuse chart explains the fuse allocation and fuse amperages.

Before replacing fuses

- ▶ Engage the parking brake.
- ▶ Make sure the automatic transmission is in park position **P** (manual transmission to Neutral).
- ▶ Switch off all electrical consumers.
- ▶ Turn off the engine.
- ▶ Remove the SmartKey from the starter switch.
- ▶ Vehicles with KEYLESS-GO: Open the driver's door (this puts the starter switch in position **0**, same as with the SmartKey removed from the starter switch). The driver's door then can be closed again.

Fuse box in passenger compartment

 Do not use sharp objects such as a screwdriver to open the fuse box cover in the dashboard. You could damage the fuse box cover or the dashboard.

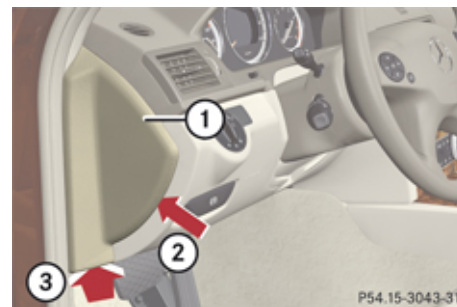

- ① Fuse box cover
- ② Remove cover
- ③ Release cover

- ▶ Open the driver's door.
- ▶ **Opening:** Using your hands, pull cover ① in direction of arrow ③ and remove ②.
- ▶ **Closing:** Hook cover ① into the opening at the front.
- ▶ Press cover ① back on until it engages.

 The fuse box cover must be properly positioned as described to prevent

moisture or dirt from entering the fuse box and possibly impairing fuse operation.

Fuse box in trunk

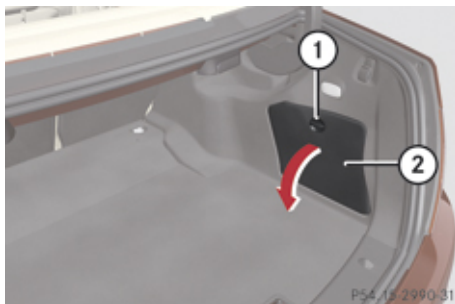

- ① Lock
- ② Cover

- ▶ Open the trunk.
- ▶ **Opening:** Turn lock ① clockwise.
- ▶ Pull cover ② downward in direction of arrow.
- ▶ **Closing:** Press cover ② backward.
- ▶ Turn lock ① counterclockwise.

Fuse box in engine compartment

- ▶ Open the hood.

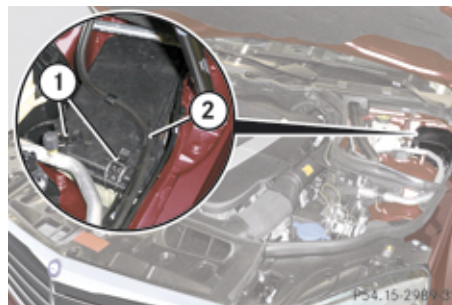

- ① Clamps
- ② Wire

- ▶ With a dry cloth, remove any moisture from the fuse box ①.
- ▶ **Opening:** Release wire ② from fuse box cover.
- ▶ **Opening:** Release clamps ①.
- ▶ Remove fuse box cover.
- ▶ **Closing:** Make sure the sealing rubber is positioned properly.
- ▶ Press fuse box cover down and secure with clamps ①.
- ▶ Fasten wire ② on fuse box cover.

❗ The fuse box cover must be installed properly to prevent moisture and/or dirt from entering the fuse box and possibly impairing fuse operation.

- ▶ Close the hood after checking or replacing fuses.

Vehicle equipment 376
Parts service 376
Warranty coverage 376
Identification labels 377
Engine 379
Rims and tires 382
Electrical system 387
Main dimensions 388
Weights 390
Fuels, coolants, lubricants etc. 391



Warranty coverage

Vehicle equipment

i This Operator's Manual describes all features, standard or optional, potentially available for your vehicle at the time of purchase. Please be aware that your vehicle might not be equipped with all features described in this manual.

Parts service

All authorized Mercedes-Benz Centers maintain a stock of Genuine Mercedes-Benz Parts required for maintenance and repair work. In addition, strategically located parts distribution centers provide quick and reliable parts service.

More than 300 000 different parts for Mercedes-Benz models are available.

Genuine Mercedes-Benz Parts are subjected to stringent quality inspections. Each part has been specifically developed, manufactured or selected for and adapted to Mercedes-Benz vehicles.

Therefore, Genuine Mercedes-Benz Parts should be installed.

! Do not use non-genuine Mercedes-Benz parts and accessories not authorized by Mercedes-Benz. Doing so could damage the vehicle, which is not covered by the Mercedes-Benz Limited Warranty. Also, it could compromise the vehicle's durability or safety.

Warranty coverage

Your vehicle is covered under the terms of the warranties printed in the Service and Warranty Information booklet.

Your authorized Mercedes-Benz Center will exchange or repair any defective parts originally installed in the vehicle in accordance with the terms of the following warranties:

- New Car Limited Warranty
- Emission System Warranty
- Emission Performance Warranty
- California, Connecticut, Maine, Massachusetts, New York, Pennsylvania, Rhode Island, and Vermont Emission Control Systems Warranty
- State Warranty Enforcement Laws (Lemon Laws)

Replacement parts and accessories are covered by the Mercedes-Benz Parts and Accessories warranties, copies of which are available at any authorized Mercedes-Benz Center.

Identification labels

Loss of Service and Warranty Information booklet

Should you lose your Service and Warranty Information booklet, have an authorized Mercedes-Benz Center arrange for a replacement. It will be mailed to you.

Identification labels



- ① Certification label (on driver's door B-pillar)

The Vehicle Identification Number (VIN) can be found in the following locations:

- on the certification label
- embossed underneath the carpet in the front passenger footwell (▷ page 378)
- on the lower edge of the windshield (▷ page 378)

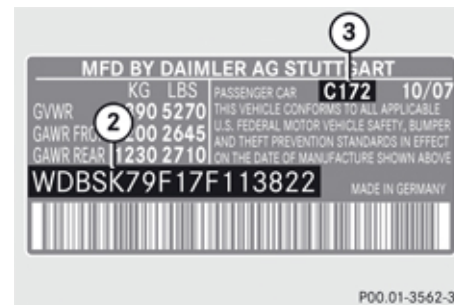

Example certification label (U.S. vehicles)

- ② VIN
- ③ Paintwork code

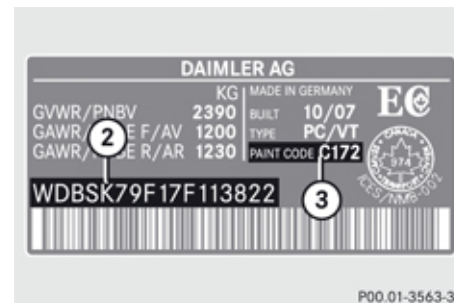

Example certification label (Canada vehicles)

- ② VIN
- ③ Paintwork code

Identification labels

i Data shown on certification label are for illustration purposes only. These data are specific to each vehicle and may vary from data shown in the illustration. Refer to certification label on vehicle for actual data specific to your vehicle.

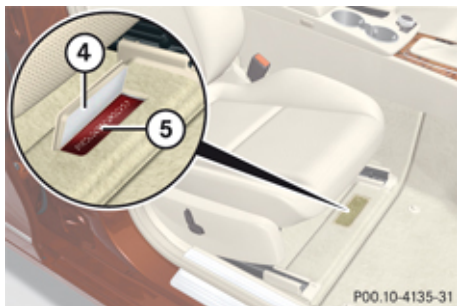

- ④ Carpet
- ⑤ VIN

- ▶ Move the front passenger seat backward as far as possible (▶ page 87).
- ▶ Fold carpet ④ backward. VIN ⑤ is now visible.

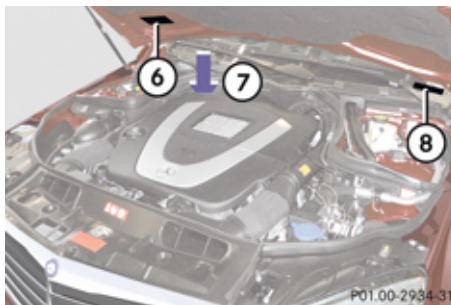

- ⑥ Emission control information label, includes both federal and California certification exhaust emission standards
- ⑦ Engine number (engraved on engine)
- ⑧ VIN (on lower edge of windshield)

i When ordering parts, please specify vehicle identification and engine number.

Engine

Model	C 230 (204.052) ^{19,20} C 230 Sport (204.052) ^{19,20} C 230 4MATIC (204.085) ^{19,20} C 230 4MATIC Sport (204.085) ^{19,20}	C 300 (204.054) ¹⁹ C 300 Sport (204.054) ^{19,21} C 300 4MATIC (204.081) ¹⁹ C 300 4MATIC Sport (204.081) ^{19,21}
Engine	272	272
Mode of operation	4-stroke engine, gasoline injection	4-stroke engine, gasoline injection
No. of cylinders	6	6
Bore	3.46 in (88.00 mm)	3.46 in (88.00 mm)
Stroke	2.69 in (68.40 mm)	3.23 in (82.10 mm)
Total piston displacement	152.3 cu in (2 496 cm ³)	182.8 cu in (2 996 cm ³)
Compression ratio	11.4:1	11.3:1
Output acc. to SAE J 1349	201 hp/6 100 rpm (150 kW/6 100 rpm) ²²	228 hp/6 000 rpm (170 kW/6 000 rpm) ²²
Maximum torque acc. to SAE J 1349	181 lb-ft/2 900 rpm - 5 500 rpm (245 Nm/2 900 rpm - 5 500 rpm)	221 lb-ft/2 500 rpm - 5 000 rpm (300 Nm/2 500 rpm - 5 000 rpm)
Maximum engine speed	6 500 rpm	6 500 rpm

¹⁹ The quoted data apply only to the standard vehicle. Contact an authorized Mercedes-Benz Center for the corresponding data of all special bodies and special equipment.

²⁰ Canada only.

²¹ USA only.

²² Premium fuel required. Performance may vary with fuel octane rating.

Engine

Model	C 230 (204.052)^{19,20} C 230 Sport (204.052)^{19,20} C 230 4MATIC (204.085)^{19,20} C 230 4MATIC Sport (204.085)^{19,20}	C 300 (204.054)¹⁹ C 300 Sport (204.054)^{19,21} C 300 4MATIC (204.081)¹⁹ C 300 4MATIC Sport (204.081)^{19,21}
Firing order	1-4-3-6-2-5	1-4-3-6-2-5
Poly-V-belt	2 404 mm	2 404 mm

Engine

Model	C 350 (204.056) ^{23,24} C 350 Sport (204.056) ^{23,25} C 350 4MATIC (204.087) ^{23,24}	C 63 AMG (204.077) ²³
Engine	272	156
Mode of operation	4-stroke engine, gasoline injection	4-stroke engine, gasoline injection
No. of cylinders	6	8
Bore	3.66 in (92.90 mm)	4.02 in (102.20 mm)
Stroke	3.39 in (86.00 mm)	3.72 in (94.60 mm)
Total piston displacement	213.5 cu in (3 498 cm ³)	378.8 cu in (6 208 cm ³)
Compression ratio	10.7:1	11.3:1
Output acc. to SAE J 1349	268 hp/6 000 rpm (200 kW/6 000 rpm) ²⁶	450 hp/6 800 rpm (336 kW/6 800 rpm) ²⁶
Maximum torque acc. to SAE J 1349	258 lb-ft/2 400 rpm - 5 000 rpm (350 Nm/2 400 rpm - 5 000 rpm)	443 lb-ft/5 000 rpm (600 Nm/5 000 rpm)
Maximum engine speed	6 500 rpm	7 200 rpm
Firing order	1-4-3-6-2-5	1-5-4-2-6-3-7-8
Poly-V-belt	2 404 mm	2 360 mm

²³ The quoted data apply only to the standard vehicle. Contact an authorized Mercedes-Benz Center for the corresponding data of all special bodies and special equipment.

²⁴ Canada only.

²⁵ USA only.

²⁶ Premium fuel required. Performance may vary with fuel octane rating.

Rims and tires

Rims and tires

Notes

! Only use tires which have been tested and approved by Mercedes-Benz. Tires approved by Mercedes-Benz are developed to provide best possible performance in conjunction with the driving safety systems on your vehicle such as the ABS or the ESP®. Tires specially developed for your vehicle and tested and approved by Mercedes-Benz can be identified by finding the following on the tire's sidewall:

- MO = Mercedes-Benz Original equipment tires

Using tires other than those approved by Mercedes-Benz may result in damage that is not covered by the Mercedes-Benz Limited Warranty.

! Using tires other than those approved by Mercedes-Benz can have detrimental effects, such as

- poor handling characteristics
- increased noise
- increased fuel consumption

Moreover, tires and rims not approved by Mercedes-Benz may, under load, exhibit

dimensional variations and different tire deformation characteristics that could cause them to come into contact with the vehicle body or axle parts. Damage to the tires or the vehicle may be the result.

- i** Further information on tires and rims is available at any authorized Mercedes-Benz Center. A placard with the recommended tire inflation pressures is located on the driver's door B-pillar. Some vehicles may have supplemental tire inflation pressure information for driving at high speeds or for vehicle loads less than the maximum loaded vehicle condition. If such information is provided, it can be found on the placard located on the inside of the fuel filler flap. The tire inflation pressure should be checked regularly and should only be adjusted on cold tires. Follow tire manufacturer's maintenance recommendation included with the vehicle.

For information on recommended tire inflation pressure and supplemental tire inflation pressure information for special driving situations, see (▷ page 266).

- i** The following pages also list the approved wheel rim and tire sizes for equipping your vehicles with winter tires. Winter tires are

not available as standard or optional factory equipment, but can be purchased from an authorized Mercedes-Benz Center. Equipping your vehicle with winter tires approved for your vehicle model may require the purchase of two or four wheel rims of the recommended size for use with these winter tires. This depends on vehicle model and the standard or optional factory-equipped wheel rim/tire configuration on your vehicle. For more information contact an authorized Mercedes-Benz Center.

Same size tires

Model	C 230 ²⁷ C 230 4MATIC ²⁷	C 300 ²⁸ C 300 4MATIC ²⁸	C 350 ²⁷ C 350 4MATIC ²⁷	C 63 AMG
Rims (light alloy)	7 J x 16 H2	7.5 J x 17 H2	7.5 J x 17 H2	8 J x 18 H2
Wheel offset	1.69 in (43 mm)	1.85 in (47 mm)	1.85 in (47 mm)	1.77 in (45 mm)
All-season tires ²⁹	205/55 R16 91H M+S	225/45 R17 91H M+S	—	—
Winter tires ^{29,30}	205/55 R16 91H M+S 	225/45 R17 91H M+S 	225/45 R17 91H M+S 	225/40 R18 92H XL (Extra Load) M+S 

²⁷ Canada only.

²⁸ USA only.

²⁹ Radial-ply tires.

³⁰ Not available as factory equipment.

Rims and tires

Mixed size tires

	Model	C 230 Sport ³¹ C 230 4MATIC Sport ³¹ C 300 ³¹ C 300 Sport ³² C 300 4MATIC ³¹ C 300 4MATIC Sport ³²	C 350 ³¹ C 350 Sport ³² C 350 4MATIC ³¹
Front axle	Rims (light alloy)	7.5 J x 17 H2	—
	AMG rims (light alloy)	—	7.5 J x 17 H2
	Wheel offset	1.85 in (47 mm)	1.85 in (47 mm)
	All-season tires ³³	225/45 R17 91H M+S	225/45 R17 91H M+S
Rear axle	Rims (light alloy)	8.5 J x 17 H2	—
	AMG rims (light alloy)	—	8.5 J x 17 H2
	Wheel offset	2.28 in (58 mm)	2.28 in (58 mm)
	All-season tires ^{33,34}	245/40 R17 91H M+S	245/40 R17 91H M+S

³¹ Canada only.

³² USA only.

³³ Radial-ply tires.

³⁴ Must not be used with snow chains.

	Model	C 300 ³⁵ C 300 Sport ³⁶ C 300 4MATIC ³⁵ C 300 4MATIC Sport ³⁶ C 350 ³⁵ C 350 Sport ³⁶ C 350 4MATIC ³⁵	C 63 AMG
Front axle	AMG rims (light alloy)	8 J x 18 H2	8 J x 18 H2
	Wheel offset	1.97 in (50 mm)	1.77 in (45 mm)
	Summer tires ³⁷	225/40 ZR18 92Y XL (Extra Load)	235/40 ZR18 95Y XL (Extra Load)
Rear axle	AMG rims (light alloy)	8.5 J x 18 H2	9 J x 18 H2
	Wheel offset	2.13 in (54 mm)	2.13 in (54 mm)
	Summer tires ^{37,38}	255/35 ZR18 94Y XL (Extra Load)	255/35 ZR18 94Y XL (Extra Load)

³⁵ Canada only.

³⁶ USA only.

³⁷ Radial-ply tires.

³⁸ Must not be used with snow chains.

Rims and tires

Spare wheel

! Compare the recommended tire inflation pressure for your vehicle with the tire inflation pressure on the yellow label located on the spare wheel rim.

If the tire inflation pressure on the yellow label on the spare wheel rim differs from the values given in this Operator's Manual, inflate the tire to the recommended tire inflation pressure given on the yellow label on the spare wheel rim.

i Please note that the tire inflation pressure of the spare wheel differs from the tire inflation pressure of the road tires.

Model	C 230 (all models) ³⁹ C 300 (all models)	C 350 (all models)	C 63 AMG
Rim (steel)	3.5 B x 16 H2	3.5 B x 17 H2	3.5 B x 18
Wheel offset	0.79 in (20 mm)	0.79 in (20 mm)	0.79 in (20 mm)
Minispare tire ⁴⁰	T 125/90 R16 98M	T 125/80 R17 99M	T 125/70 R18 99M
Recommended tire inflation pressure	61 psi (4.2 bar)	61 psi (4.2 bar)	61 psi (4.2 bar)

³⁹ Canada only.

⁴⁰ Must not be used with snow chains.

Electrical system

Model		All models except C 63 AMG	C 63 AMG
Alternator		14 V/150 A	14 V/180 A
Starter motor		12 V/1.4 kW	12 V/1.7 kW
Battery		12 V/74 Ah	12 V/95 Ah
Spark plugs	Type	Bosch Y 7 MPP33	NGK ILZKAR 7A10
	Electrode gap	0.031 in (0.8 mm)	0.039 in (1.0 mm)
	Tightening torque	15 lb-ft - 18 lb-ft (20 Nm - 25 Nm)	14 lb-ft - 18 lb-ft (19.5 Nm - 24.5 Nm)

Main dimensions

Main dimensions

Model	C 230 ⁴¹ C 300 ⁴²	C 230 4MATIC ⁴¹ C 300 4MATIC ⁴²
Overall vehicle length	180.4 in (4 581 mm)	180.4 in (4 581 mm)
Overall vehicle width, exterior rear view mirrors folded out	79.5 in (2 020 mm)	79.5 in (2 020 mm)
Overall vehicle height	56.9 in (1 444 mm)	56.9 in (1 445 mm)
Wheelbase	108.7 in (2 760 mm)	108.7 in (2 760 mm)
Track, front	60.7 in (1 541 mm)	60.7 in (1 541 mm)
Track, rear	60.8 in (1 544 mm)	60.8 in (1 544 mm)

⁴¹ Canada only.

⁴² USA only.

Main dimensions

Model	C 230 Sport ⁴³ C 230 4MATIC Sport ⁴³ C 300 ⁴³ C 300 Sport ⁴⁴ C 300 4MATIC ⁴³ C 300 4MATIC Sport ⁴⁴ C 350 (all models)	C 63 AMG
Overall vehicle length	180.4 in (4 581 mm)	186.1 in (4 726 mm)
Overall vehicle width, exterior rear view mirrors folded out	79.5 in (2 020 mm)	79.5 in (2 020 mm)
Overall vehicle height	56.3 in (1 429 mm)	56.6 in (1 438 mm)
Wheelbase	108.7 in (2 760 mm)	108.9 in (2 765 mm)
Track, front	60.4 in (1 533 mm)	61.8 in (1 569 mm)
Track, rear	59.6 in (1 514 mm)	60.0 in (1 525 mm)

⁴³ Canada only.

⁴⁴ USA only.

Weights

Weights

Model	All models
Roof load	max. 220 lb (100 kg)
Trunk load	max. 220 lb (100 kg)

Fuels, coolants, lubricants etc.

Capacities

Vehicle components and their respective lubricants must match. Therefore only use products tested and approved by Mercedes-Benz.

For information on tested and approved products, contact an authorized Mercedes-Benz Center or visit www.mbusa.com (USA only).

 **Warning!**

Comply with all valid regulations with respect to handling, storing, and disposing of service fluids. Otherwise you could endanger persons or the environment. Keep service fluids out of the reach of children.

Fuels, coolants, lubricants etc.

For health reasons, you should prevent service fluids from coming into direct contact with your skin or clothing.

If a service fluid is swallowed, contact a physician immediately.

	Model	Capacity	Fuels, coolants, lubricants, etc.
Engine with oil filter	All models except C 63 AMG	8.5 US qt (8.0 l)	Approved engine oils
	C 63 AMG ⁴⁵	9.0 US qt (8.5 l)	
Manual transmission	C 230 (all models except 4MATIC) ⁴⁶	1.3 US qt (1.2 l)	MB Manual Transmission Oil
	C 300 (all models except 4MATIC)	1.6 US qt (1.5 l)	

⁴⁵ Engine with oil cooler.

⁴⁶ Canada only.

Fuels, coolants, lubricants etc.

	Model	Capacity	Fuels, coolants, lubricants, etc.
Automatic transmission	C 230 (all models) ⁴⁶ C 300 (all models except 4MATIC) C 350 (all models)	9.5 US qt (9.0 l)	MB Automatic Transmission Fluid
	C 300 4MATIC (all models)	10.3 US qt (9.7 l)	
	C 63 AMG ⁴⁷	9.6 US qt (9.1 l)	
Front axle	C 230 4MATIC (all models) ⁴⁶	0.63 US qt (0.6 l)	Hypoid gear oil SAE 85 W 90
	C 300 4MATIC (all models) C 350 4MATIC ⁴⁶	1.2 US qt (1.1 l)	
Rear axle	C 230 (all models) ⁴⁶ C 300 (all models)	1.1 US qt (1.0 l)	Hypoid gear oil SAE 85 W 90
	C 350 (all models)	1.2 US qt (1.1 l)	
	C 63 AMG	1.3 US qt (1.2 l)	Fuchs Titan EG 5010 D
Power steering		0.9 US qt (0.8 l)	MB Power Steering Fluid (Chevron Texaco PSF 9109)
Brake system		0.53 US qt (0.5 l)	MB Brake Fluid (DOT 4+)
Cooling system	All models except C 63 AMG	approx. 5.1 US qt (4.8 l)	MB 325.0 Anticorrosion/Antifreeze
	C 63 AMG	approx. 12.4 US qt (11.7 l)	

⁴⁶ Canada only.

⁴⁷ Automatic transmission with oil cooler.

Fuels, coolants, lubricants etc.

	Model	Capacity	Fuels, coolants, lubricants, etc.
Fuel tank, including a reserve of		17.4 US gal (66.0 l)	Premium unleaded gasoline (Minimum Posted Octane 91 [Avg. of 96 RON/86 MON])
	All models except C 63 AMG	2.1 US gal (8.0 l)	
	C 63 AMG	3.7 US gal (14.0 l)	C 300 and C 300 Sport ⁴⁸ with automatic transmission: Flexible Fuel Vehicles (identified by a label reading Premium gasoline or E85 only! on the fuel filler flap). Alternative fuel: Ethanol fuel (E85)
Air conditioning system		–	R134a refrigerant and special PAG lubricant oil (never R 12)
Washer system		3.7 US qt (3.5 l)	MB Windshield Washer Concentrate ⁴⁹ (▷ page 400)
Washer system and headlamp cleaning system		6.3 US qt (6.0 l)	Washer fluid mixing ratio (▷ page 400)

⁴⁸ USA only.

⁴⁹ Mixed with water or commercially available premixed washer solvent/antifreeze.

Fuels, coolants, lubricants etc.

Approved engine oils

Engine oils are specifically tested for their suitability in our engines and durability for our service intervals. Therefore, only use approved engine oils and oil filters required for vehicles with Maintenance System.

For a listing of approved engine oils and oil filters, contact an authorized Mercedes-Benz Center or visit www.mbusa.com (USA only).

! Using engine oils and oil filters of a specification other than those expressly required for the Maintenance System, or changing of oil and oil filter at change intervals longer than those called for by the Maintenance System will result in engine or emission control system damage not covered by the Mercedes-Benz Limited Warranty.

Please follow Maintenance System recommendations for scheduled oil changes. Failure to do so will result in engine or emission control system damage not covered by the Mercedes-Benz Limited Warranty.

Mercedes-Benz recommends MOBIL OIL.

⁵⁰ Canada only.

⁵¹ Restriction: Only SAE 0W-40/SAE 5W-40 engine oils may be used.

Use the table below to determine the MB sheet number.

Model	Engine type	MB sheet number
C 230 (all models) ⁵⁰	272	229.5
C 300 (all models)	272	229.5
C 350 (all models)	272	229.5
C 63 AMG	156	229.5 ⁵¹

i MB sheet numbers are printed on the outside of oil containers.

Viscosity grades for engine oils

Using the chart below, select oil viscosity according to the lowest air temperature expected before the next oil change.

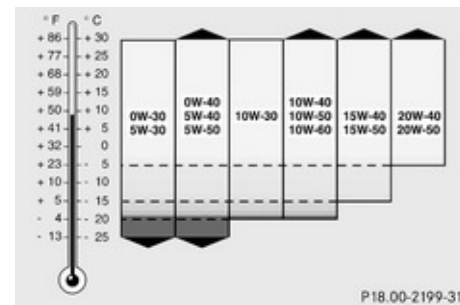

Fuels, coolants, lubricants etc.

Engine oil additives

! Do not blend oil additives with engine oil. They may damage the engine. Damage or malfunctions resulting from blending oil additives are not covered by the Mercedes-Benz Limited Warranty.

Air conditioning refrigerant

R134a (HFC) refrigerant and special PAG lubricating oil are used in the air conditioning system.

! Never use R 12 (CFC) or mineral-based lubricating oil. Otherwise damage to the system will occur.

Brake fluid

⚠ Warning!

During vehicle operation, the boiling point of the brake fluid is continuously reduced through the absorption of moisture from the atmosphere.

Under extremely strenuous operating conditions, this moisture content can lead to the formation of bubbles in the system, thus reducing the system's efficiency.

Therefore, the brake fluid must be replaced regularly. Refer to your vehicle's Maintenance Booklet for replacement interval.

Only brake fluid approved by Mercedes-Benz is recommended. Any authorized Mercedes-Benz Center will provide you with additional information.

Premium unleaded gasoline

⚠ Warning!

Gasoline is highly flammable and poisonous. It burns violently and can cause serious personal injury.

Never allow sparks, flames or smoking materials near gasoline!

Turn off the engine before refueling.

Whenever you are around gasoline, avoid inhaling fumes and any skin or clothing contact. Extinguish all smoking materials.

Direct skin contact with fuels and the inhalation of fuel vapors are damaging your health.

! To maintain the engine's durability and performance, premium unleaded gasoline must be used.

If premium unleaded gasoline is not available and low octane gasoline is used, follow these precautions:

- Have the fuel tank only partially filled with unleaded regular gasoline and fill up with premium unleaded gasoline as soon as possible.
- Avoid full throttle driving and abrupt acceleration.
- Do not exceed an engine speed of 3000 rpm if the vehicle is loaded with a light load such as two persons and no luggage.
- Do not exceed $\frac{2}{3}$ of maximum accelerator pedal position if the vehicle is fully loaded or operating in mountainous terrain.

Fuels, coolants, lubricants etc.

Fuel requirements

Only use premium unleaded gasoline. The octane number (posted at the pump) must be 91 min. It is an average of both the Research Octane Number (RON) and the Motor Octane Number (MON): $(RON+MON)/2$. This is also known as the ANTI-KNOCK INDEX.

Reformulated gasolines (RFG) and/or unleaded gasoline containing oxygenates such as ethanol, TAME, ETBE, IPA, IBA, and TBA can be used provided the ratio of any one of these oxygenates to gasoline does not exceed 10%; MTBE must not exceed 15%.

The ratio of methanol to gasoline must not exceed 3% plus additional cosolvents.

Using mixtures of ethanol and methanol is not allowed. Gasohol, which contains 10% ethanol and 90% unleaded gasoline, can be used.

These blends must also meet all other fuel requirements, such as resistance to spark knock, boiling range, vapor pressure, etc.

Flexible Fuel Vehicles

C 300 and C 300 Sport⁵² with automatic transmission are Flexible Fuel Vehicles.

Flexible Fuel Vehicles are identified by a label reading **Premium gasoline or E85 only!** on the fuel filler flap.

These vehicles are designed to operate on premium unleaded gasoline or ethanol fuel (E85), or on any mixture of these two. Ethanol fuel (E85) is a mixture of approximately 85% ethanol and 15% unleaded gasoline.

Warning!

Ethanol fuel (E85) and its fumes are highly flammable, poisonous and burn easily. Ethanol fuel can cause serious injuries if ignited or if you come into contact with it or inhale fumes of it. Avoid inhalation of ethanol fumes and skin contact with ethanol. Extinguish all open flames before refueling. Never smoke or create sparks close to ethanol.

Switching fuels

For best performance and driveability it is recommended to use either one or the other fuel. A refueling pattern that alternates

between the two different fuels should be avoided if possible.

When switching fuels, make sure:

- Fuel level is below half full.
- Fuel level is above reserve (fuel tank reserve warning lamp is not lit).
- Amount of added fuel is more than 5 gallons (20 liters).
- Ignition is off during refill.
- Immediately after refueling engine is started and operated for at least 5 minutes.

These precautions and recommendations are supposed to prevent any difficulties when starting and operating the engine which otherwise may be experienced before the engine has fully adapted to the different fuel.

If in spite of these recommendations the engine does not perform properly, adding more gasoline (at least 3 gallons [12 liters]) to the fuel may improve the engine behavior.

Fuel consumption

E85 fuel contains less energy per gallon than gasoline. To ensure that engine performance with ethanol fuel is similar to that when using gasoline, the engine must burn more ethanol

⁵² USA only.

fuel. As a result, it is to be expected that the fuel consumption will increase when using E85 compared to gasoline operation.

Maintenance

Please inform your authorized Mercedes-Benz Center if you use or have used E85 fuel when your vehicle is delivered for maintenance or repairs.

Cold weather performance

It is possible that starting times will significantly increase at temperatures below 32°F (0°C). At low temperatures the use of a block heater is recommended (contact an authorized Mercedes-Benz Center for further information). Rough idling may also be experienced at such temperatures before the engine is fully warmed up.

! E85 fuel is unsuitable for use when ambient temperatures fall below 14°F (-10°C).

Hot weather performance

At ambient temperatures above 95°F (35°C) start times may increase and be

accompanied by a rough idle following the start.

Gasoline additives

A major concern among engine manufacturers is carbon build-up caused by gasoline. Mercedes-Benz recommends only the use of quality gasoline containing additives that prevent the build-up of carbon deposits.

After an extended period of using fuels without such additives carbon deposits can build up, especially on the intake valves and in the combustion area, leading to engine performance problems such as:

- Warm-up hesitation
- Unstable idle
- Knocking/pinging
- Misfire
- Power loss

In areas where carbon deposits may be encountered due to lack of availability of gasoline which contains these additives, Mercedes-Benz recommends the use of additives approved by us for use on Mercedes-Benz vehicles.

Fuels, coolants, lubricants etc.

Contact an authorized Mercedes-Benz Center or visit **www.mbusa.com** (USA only) for a listing of approved product(s). Follow directions on product label.

Do not blend other fuel additives with fuel. This only results in unnecessary cost and may be harmful to the engine operation.

! Damage or malfunction resulting from poor fuel quality or from blending additional fuel additives other than those tested and approved by us for use on Mercedes-Benz vehicles are not covered by the Mercedes-Benz Limited Warranty or by any pre-owned or Extended Limited warranties.

Coolants

The engine coolant is a mixture of water and anticorrosion/antifreeze, which provides:

- Corrosion protection
- Freeze protection
- Boiling protection (by increasing the boiling point)

The cooling system was filled at the factory with a coolant providing freeze protection to approximately -35°F (-37°C) and corrosion protection.



Fuels, coolants, lubricants etc.

! Add premixed coolant solution only. Adding water and MB 325.0 Anticorrosion/Antifreeze separately from each other, could cause engine damage not covered by the Mercedes-Benz Limited Warranty.

If the antifreeze mixture is effective to -35°F (-37°C), the boiling point of the coolant in the pressurized cooling system is reached at approximately 266°F (130°C).

The coolant solution must be used year round to provide the necessary corrosion protection and increase boil-over protection. Refer to the Maintenance Booklet for replacement interval.

Coolant system design and coolant used determine the replacement interval. The replacement interval published in the Maintenance Booklet is only applicable if MB 325.0 Anticorrosion/Antifreeze solution or other Mercedes-Benz approved products of equal specification are used to renew the coolant concentration or bring it back up to the proper level.

For information on other Mercedes-Benz approved products of equal specification,

contact an authorized Mercedes-Benz Center or visit www.mbusa.com (USA only).

To provide important corrosion protection, the solution must be at least 50% anticorrosion/antifreeze (equivalent to freeze protection to approximately -35°F [-37°C]).

If you use a solution that is more than 55% anticorrosion/antifreeze (freeze protection to approximately -49°F [-45°C]), the engine temperature will increase due to the lower heat transfer capability of the solution. Therefore, do not use more than this amount of anticorrosion/antifreeze.

If the coolant level is low, water and MB 325.0 Anticorrosion/Antifreeze should be used to bring it up to the proper level (have cooling system checked for signs of leakage). Please make sure the mixture is in accordance with label instructions.

The water in the cooling system must meet minimum requirements, which are usually satisfied by normal drinking water.

If you are not sure about the water quality, contact an authorized Mercedes-Benz Center.

Anticorrosion/antifreeze

Your vehicle contains a number of aluminum parts. The use of aluminum components in motor vehicle engines necessitates that anticorrosion/antifreeze coolant used in such engines be specifically formulated to protect the aluminum parts. Failure to use such anticorrosion/antifreeze coolant will result in a significantly shortened service life.

Therefore, the following product is strongly recommended for use in your vehicle: MB 325.0 Anticorrosion/Antifreeze agent.

Before the start of the winter season (or once a year in hot southern regions), you should have the anticorrosion/antifreeze concentration checked.

The coolant is also regularly checked each time you bring your vehicle to an authorized Mercedes-Benz Center for service.

Fuels, coolants, lubricants etc.

	Model	Approximate freeze protection	
		-35°F (-37°C)	-49°F (-45°C)
Cooling system	All models except C 63 AMG	2.5 US qt (2.4 l)	2.8 US qt (2.6 l)
	C 63 AMG	6.2 US qt (5.85 l)	6.8 US qt (6.4 l)

Fuels, coolants, lubricants etc.

Washer system and headlamp cleaning system

Warning!

Washer solvent/antifreeze is highly flammable. Do not spill washer solvent/antifreeze on hot engine parts, because it may ignite and burn. You could be seriously burned.

- ▶ Use MB Windshield Washer Concentrate “MB SummerFit”.
- ▶ Mix with water for temperatures above freezing point.
- ▶ Mix with commercially available premixed washer solvent/antifreeze for temperatures below freezing point.

Washer fluid mixing ratio

For temperatures above freezing point:

1 part “MB SummerFit” to 100 parts water
(1.34 fl oz [40 ml] “MB SummerFit” to 1 gal [4.0 l] water)

For temperatures below freezing point:

1 part “MB SummerFit” to 100 parts solvent
(1.34 fl oz [40 ml] “MB SummerFit” to 1 gal [4.0 l] solvent)

Service and Literature

Your authorized Mercedes-Benz Center has trained technicians and Genuine Mercedes-Benz Parts to service your vehicle properly. For expert advice and quality service, contact an authorized Mercedes-Benz Center.

If you are interested in obtaining service literature for your vehicle, please contact an authorized Mercedes-Benz Center.

We consider this the best way for you to obtain accurate information for your vehicle.

For further information you can find us on the Mercedes-Benz web-site **www.mbusa.com** (USA only) or **www.mercedes-benz.ca** (Canada only).

Warning!

To help avoid personal injury, be extremely careful when performing any service work or repairs. Improper or incomplete service or the use of incorrect or inappropriate parts or materials may damage the vehicle or its equipment, which may in turn result in personal injury.

If you have any questions about carrying out any type of service, turn to the advice of an authorized Mercedes-Benz Center.

We reserve the right to make changes in design and equipment.

Therefore, information, illustrations and descriptions in this Operator's Manual might differ from your vehicle.

Reprinting, translation and copying, even of excerpts, is not permitted without our prior authorization in writing.

Press time May 26, 2008

GSP/OIS

Printed in U. S. A.



2045844581

Order no. 6515 0642 13 Part no. 204 584 45 81 Edition 2009 A