



CL

Operator's Manual



Mercedes-Benz

Nur für internen Gebrauch / For internal use only

Symbols

Registered trademarks:

- Bluetooth® is a registered trademark of Bluetooth SIG Inc.
- DTS is a registered trademark of DTS, Inc.
- Dolby and MLP are registered trademarks of DOLBY Laboratories.
- BabySmart™, ESP® and PRE-SAFE® are registered trademarks of Daimler AG.
- HomeLink® is a registered trademark of Johnson Controls.
- iPod® and iTunes® are registered trademarks of Apple Inc.
- Microsoft® and Windows media® are registered trademarks of Microsoft Corporation.
- SIRIUS is a registered trademark of Sirius XM Radio Inc.
- HD Radio is a registered trademark of iBiquity Digital Corporation.
- Gracenote® is a registered trademark of Gracenote, Inc.
- ZAGATSurvey® and related brands are registered trademarks of ZagatSurvey, LLC.

In this Operator's Manual you will find the following symbols:

WARNING

Warning notes draw your attention to hazards that endanger your health or life, or the health or life of others.

Environmental note

Environmental notes provide you with information on environmentally aware actions or disposal.

 Notes on material damage alert you to dangers that could lead to damage to your vehicle.

 Practical tips or further information that could be helpful to you.

▶ This symbol indicates an instruction that must be followed.

▶ Several of these symbols in succession indicate an instruction with several steps.

(▷ page) This symbol tells you where you can find more information about a topic.

▷▷ This symbol indicates a warning or an instruction that is continued on the next page.

Display This font indicates a display in the multifunction display/COMAND display.

Parts of the software in the vehicle are protected by copyright © 2005 The FreeType Project <http://www.freetype.org>. All rights reserved.

Welcome to the world of Mercedes-Benz

Before you drive off, please familiarize yourself with your vehicle and read this manual, especially the safety and warning notes. This will help you to obtain the maximum pleasure from your vehicle and avoid endangering yourself and others.

The equipment or model designation of your vehicle may differ according to:

- model
- order
- country variant
- availability

Mercedes-Benz is constantly updating its vehicles to the state of the art.

Mercedes-Benz therefore reserves the right to introduce changes in the following areas:

- design
- equipment
- technical features

The equipment in your vehicle may therefore differ from that shown in the descriptions and illustrations.

The following are integral components of the vehicle:

- Operator's Manual
- Maintenance Booklet
- Equipment-dependent supplements

Keep these documents in the vehicle at all times. If you sell the vehicle, always pass the documents on to the new owner.

The technical documentation team at Daimler AG wishes you safe and pleasant motoring.

Mercedes-Benz USA, LLC

Mercedes-Benz Canada, Inc.

A Daimler Company

Index	4	At a glance	33
Introduction	26	Safety	43
		Opening and closing	73
		Seats, steering wheel and mirrors	95
		COMAND	109
		Lights and windshield wipers	249
		Climate control	261
		Driving and parking	271
		On-board computer and displays	335
		Stowage and features	399
		Maintenance and care	419
		Breakdown assistance	435
		Wheels and tires	453
		Technical data	481

- 1, 2, 3 ...**
- 12 V socket**
see Sockets
- 4ETS**
see ETS/4ETS (Electronic Traction System)
- 4MATIC (permanent four-wheel drive)** 311
- A**
- ABC**
see Active Body Control (ABC)
- ABS (Anti-lock Braking System)**
Display message 353
Function/notes 65
Important safety notes 65
Warning lamp 391
- Activating/deactivating cooling with air dehumidification** 264
- Activating/deactivating Night View Assist Plus**
Without spotlight function 325
With spotlight function 323
- Active Blind Spot Assist**
Activating/deactivating (on-board computer) 348
Display message 379
Function/information 327
- Active Body Control (ABC)**
Display message 377
Function/notes 310
- Active Driving Assistance package** 327
- Active Lane Keeping Assist**
Activating/deactivating (on-board computer) 349
Display message 378
Function/information 330
- Active multicontour seat** 101, 245
- Active service system PLUS**
see ASSYST PLUS service interval display
- ADAPTIVE BRAKE** 68
- Adaptive Damping System (ADS)** 309
- Adaptive Highbeam Assist**
Display message 370
Function/notes 254
Switching on/off (on-board computer) 350
- Additional speedometer** 350
- Additives (engine oil)** 487
- Address**
Entering (example) 141
see Address book
- Address book**
Calling up 193
Connecting a call 196
Creating an entry 194
Deleting an entry 195
Entering characters 125
Entry as a home address 166
Importing contacts 192
Introduction 191
Starting route guidance 196
Voice tag 197
- Air bags**
Display message 364
Front air bag (driver, front passenger) 48
Important safety notes 46
Knee bag 48
PASSENGER AIR BAG OFF indicator lamp 50
Safety guidelines 45
Side impact air bag 49
Window curtain air bag 50
- Air-conditioning system**
see Climate control
- Air distribution**
Setting 265
Setting (COMAND) 240
- Airflow**
Setting 265
Setting (COMAND) 241
- AIRMATIC**
Display message 376
Function/notes 309
- Air pressure**
see Tire pressure
- Air vents**
Glove box 269
Important safety notes 268

- Rear 269
- Setting 268
- Setting the center air vents 268
- Setting the side air vents 268
- Stowage compartment 268
- Alarm system**
 - see ATA (Anti-Theft Alarm system)
- Alertness Assistant**
 - see ATTENTION ASSIST
- Alternative route** 159
- Ambient light setting (COMAND)** 238
- AMG menu (on-board computer)** 343
- Anticipatory occupant protection**
 - see PRE-SAFE® (anticipatory occupant protection)
- Anti-lock Braking System**
 - see ABS (Anti-lock Braking System)
- Anti-Theft Alarm system**
 - see ATA (Anti-Theft Alarm system)
- Ashtray** 405
- Assistance menu (on-board computer)** 347
- ATA (Anti-Theft Alarm system)**
 - Activating/deactivating 70
 - Function 70
 - Switching off the alarm 70
- ATTENTION ASSIST**
 - Activating/deactivating 348
 - Display message 375
 - Function/notes 321
- Audio**
 - Radio mode 199
- Audio database**
 - see MUSIC REGISTER
- Audio DVD**
 - Mode, switching to 210
 - Pause function 211
 - Playback options 216
 - Safety notes 209
 - Setting the audio format 216
 - Stop function 212
- Audio format, setting**
 - Audio DVD 216
 - Video DVD 233
- Audio menu (on-board computer)** 342
- Authorized Mercedes-Benz Center**
 - see Qualified specialist workshop
- Authorized workshop**
 - see Qualified specialist workshop
- AUTO lights**
 - Display message 370
 - see Lights
- Automatic engine start (ECO start/stop function)** 277
- Automatic engine switch-off (ECO start/stop function)** 276
- Automatic headlamp mode** 251
- Automatic transmission**
 - Automatic drive program 283
 - Changing gear 282
 - DIRECT SELECT lever 279
 - Display message 385
 - Drive position (ECO start/stop function) 280
 - Driving tips 282
 - Emergency running mode 286
 - Engaging drive position 280
 - Engaging neutral 280
 - Engaging reverse gear 279
 - Engaging the park position 279
 - Kickdown 282
 - Manual drive program 284
 - Neutral (ECO start/stop function) . 280
 - Problem (malfunction) 286
 - Program selector button 282
 - Pulling away 275
 - Shift ranges 283
 - Starting the engine 274
 - Steering wheel paddle shifters 283
 - Transmission position display 280
 - Transmission positions 281
- Automatic transmission emergency mode** 286
- Autostore** 201
 - see Station memory (radio)
- AUX (audio)**
 - Notes/socket 227
 - Switching to 228
- AUX (video)**
 - Setting the picture 228
 - Setting the volume and sound 234
 - Showing/hiding the menu 234
 - Switching to 234

- B**
- Back button** 113
 - Back support**
 - see Lumbar support
 - Bag hook** 403
 - Balance, adjusting** 128
 - BAS (Brake Assist System)** 65
 - Basic settings**
 - see Settings
 - BAS PLUS (Brake Assist System PLUS)** 66
 - Bass, setting** 128
 - Battery**
 - Checking (SmartKey) 78
 - Important safety guidelines (SmartKey) 78
 - Replacing (SmartKey) 78
 - Battery (vehicle)**
 - Charging 444
 - Display message 373
 - Important safety notes 442
 - Jump starting 445
 - Belt**
 - see Seat belts
 - Bird's-eye view (navigation)** 172
 - Blind**
 - see Roller sunblind
 - Blind Spot Assist**
 - see Active Blind Spot Assist
 - Bluetooth®**
 - Activating/deactivating 135
 - Authorizing a device (registering) . . 135
 - Conditions (general) 134
 - Conditions (telephone) 183
 - Connecting another mobile phone . 185
 - Connecting devices 135
 - De-authorizing (de-registering) a device 137
 - External authorization (general) 136
 - External authorization (telephone) . 185
 - General information 134
 - Introduction 181
 - Receiving vCards 192
 - Searching for devices 135
 - Settings 134
 - Telephone basic menu 186
 - Telephony 183
 - Telephony notes 181
 - Bluetooth® interface**
 - Telephony 181
 - Brake Assist System**
 - see BAS (Brake Assist System)
 - Brake fluid**
 - Display message 361
 - Notes 487
 - Brake fluid level** 425
 - Brake lamps**
 - Display message 368
 - Brakes**
 - ABS 65
 - BAS 65
 - BAS PLUS 66
 - Brake fluid (notes) 487
 - Display message 353
 - Driving tips 293
 - High-performance brake system 295
 - Important safety notes 293
 - Maintenance 294
 - Parking brake 290
 - Warning lamp 390
 - Breakdown**
 - see Flat tire
 - see Towing away
 - Brightness, setting (TV, video)** 228
 - Bulbs**
 - see Replacing bulbs
- C**
- California**
 - Important notice for retail customers and lessees 27
 - Call**
 - Accepting/ending/rejecting 187
 - see Telephone
 - Calling up a malfunction**
 - see Display messages
 - Calling voicemail** 189
 - Call lists**
 - Displaying details 193
 - Introduction 197
 - Opening and selecting an entry 197
 - Saving an entry in the address book 198

- Car**
 - see Vehicle
- Care**
 - Carpets 433
 - Car wash 427
 - Display 431
 - Exterior lights 430
 - Gear or selector lever 433
 - Interior 431
 - Matte finish 429
 - Night View Assist Plus 432
 - Notes 427
 - Paint 429
 - Plastic trim 432
 - Power washer 428
 - Rear view camera 431
 - Roof lining 433
 - Seat belt 433
 - Seat cover 433
 - Sensors 431
 - Steering wheel 433
 - Tail pipes 431
 - Trim pieces 433
 - Washing by hand 428
 - Wheels 429
 - Windows 430
 - Wiper blades 430
 - Wooden trim 433
- Cargo tie down rings** 402
- Car pool lanes** 157
- Car wash (care)** 427
- Category**
 - Satellite radio 206
- CD**
 - Copy protection 218
 - Fast forward/fast rewind 214
 - General information 218
 - Inserting 209
 - Mode, switching to 210
 - Multisession 217
 - Notes on discs 218
 - Operating the player/changer (on-board computer) 343
 - Pause function 211
 - Playback options 216
 - Player/changer operation (COMAND) 209
 - Safety notes 209
 - Selecting a media type 212
 - Selecting a track 213
 - Sound settings (balance, bass, fader, treble) 128
- Cell phone**
 - see Mobile phone
- Center console** 39
- Central locking**
 - Automatic locking feature (COMAND) 239
 - SmartKey 74
- Changing bulbs**
 - High-beam headlamps 257
 - Important safety notes 256
 - Overview of bulb types 257
- Changing direction**
 - Announcement phase 154
 - Change of direction phase 155
 - Preparation phase 154
- Changing the programming**
 - SmartKey 77
- Character bar** 122
- Characters**
 - Entering 123
 - Entering (address book, phone book) 125
 - Entering (navigation) 122
- Child-proof locks**
 - Important safety notes 63
- Children**
 - In the vehicle 59
 - Restraint systems 59
- Child seat**
 - LATCH-type (ISOFIX) child seat anchors 62
 - Special seat belt retractor 61
 - Top Tether 63
- Cigarette lighter** 406
- Cleaning**
 - Mirror turn signal 431
- Climate control**
 - Automatic climate control 263
 - COMAND 239
 - Controlling automatically 264
 - Controlling centrally (COMAND) 242
 - Cooling with air dehumidification . . 264
 - Cooling with air dehumidification (COMAND) 241

- Defrosting the windows 266
- Defrosting the windshield 265
- Important safety notes 262
- Indicator lamp 264
- Main menu 241
- Maximum cooling 266
- Notes on using automatic climate control 263
- Overview of systems 262
- Problems with cooling with air dehumidification 264
- Problem with the rear window defroster 266
- Refrigerant 489
- Refrigerant filling capacity 489
- Setting the air distribution 265
- Setting the airflow 265
- Setting the airflow (COMAND) 242
- Setting the air vents 268
- Setting the footwell temperature (COMAND) 242
- Setting the temperature 265
- Switching air-recirculation mode on/off 267
- Switching on/off 263
- Switching residual heat on/off 267
- Switching the rear window defroster on/off 266
- Cockpit**
 - Overview 34
 - see Instrument cluster
- Color, setting (TV, video)** 228
- COMAND**
 - At a glance (overview) 112
 - Back button 113
 - Basic functions 126
 - Components 112
 - Display 115
 - Example of operation 121
 - Function buttons 113
 - Menu overview 115
 - Remote control 119
 - Switching on/off 126
 - System settings 130
- COMAND controller** 112
- COMAND display**
 - Cleaning instructions 118
 - Folding in and swiveling 118
 - Setting 130
- COMAND operating system** 112
- Combination switch** 252
- Compass function** 176
- Conference connection** 189
- Consumption statistics (on-board computer)** 340
- Contrast, setting (TV, video)** 228
- Convenience closing feature** 89
- Convenience opening feature** 89
- Convenience telephone**
 - Importing contacts 192
- Convenience telephony** 181
 - Introduction 181
- Coolant (engine)**
 - Checking the level 424
 - Display message 371
 - Filling capacity 488
 - Notes 487
 - Temperature (on-board computer) . 343
 - Temperature gauge 336
- Cooling**
 - see Climate control
- Copy protection (CD/DVD)** 218
- Cornering light function**
 - Display message 367
 - Function/notes 254
- Cruise control**
 - Cruise control lever 297
 - Deactivating 298
 - Display message 382
 - Driving system 296
 - Function/notes 296
 - Important safety notes 296
 - Setting a speed 297
 - Storing and maintaining current speed 297
- Cup holder**
 - Center console 403
 - Important safety notes 403
 - Rear compartment 404
- Customer Assistance Center (CAC)** ... 30
- Customer Relations Department** 30

D	
Dashboard	
see Cockpit	
Data	
see Technical data	
Data medium	
Audio DVD	217
CD/DVD	218
MP3	217
MUSIC REGISTER	218
Date format, setting	131
Day design, setting	130
Daytime running lamps	
Display message	370
Switching on/off (on-board computer)	349
Switching on/off (switch)	251
Dealership	
see Qualified specialist workshop	
Delayed switch-off	
Exterior lighting (COMAND)	237
Interior lighting (COMAND)	237
Destination (navigation)	
Displaying information	160
Entering a destination by address ..	141
Entering a destination using the map	147
Entering an intermediate stop	148
Entering a point of interest	150
Saving	167
Selecting from the destination memory	146
Selecting from the list of last destinations	146
Destination memory (navigation)	
Deleting an entry	169
Entering/saving your home address	144
Previous destinations	169
Diagnostics connection	29
Dialing a number (telephone)	188
Digital speedometer	340
DIRECT SELECT lever	
see Automatic transmission	
Display	
Selecting the design	130
Settings	130
Display (cleaning instructions)	431
Displaying the arrival time	160
Displaying the distance to the destination	160
Display messages	
Calling up (on-board computer)	352
Driving systems	375
Engine	371
General notes	352
Hiding (on-board computer)	352
Lights	367
Safety systems	353
Service interval display	426
SmartKey	387
Tires	382
Vehicle	385
Distance	
see Navigation, route overview	
Distance display (on-board computer)	347
Distance recorder	340
see Odometer	
see Trip odometer	
Distance warning (warning lamp)	397
DISTRONIC PLUS	
Deactivating	305
Display message	380
Displays in the multifunction display	305
Driving tips	306
Function/notes	298
Important safety notes	298
Setting the specified minimum distance	304
Warning lamp	397
Dolby® Digital	129
Doors	
Automatic locking	82
Control panel	41
Display message	387
Emergency locking	83
Emergency unlocking	83
Important safety notes	81
Opening (from inside)	82
Power closing feature	83
Drinking and driving	292

- Drinks holder**
see Cup holder
- Drive program**
Automatic 283
Manual 284
- Driver's seat**
see Seats
- Driving abroad**
Mercedes-Benz Service 427
Symmetrical low beam 250
- Driving lamps**
see Daytime running lamps
- Driving safety systems**
ABS (Anti-lock Braking System) 65
ADAPTIVE BRAKE 68
BAS (Brake Assist System) 65
BAS PLUS (Brake Assist System PLUS) 66
Electronic brake force distribution ... 68
ESP® (Electronic Stability Program) . 67
ETS/4ETS (Electronic Traction System) 67
Important safety information 64
Overview 64
PRE-SAFE® Brake 68
- Driving systems**
Active Blind Spot Assist 327
Active Body Control 310
Active Driving Assistance package 327
Active Lane Keeping Assist 330
AIRMATIC 309
ATTENTION ASSIST 321
Cruise control 296
Display message 375
DISTRONIC PLUS 298
HOLD function 308
Night View Assist Plus 322
Parking Guidance 315
PARKTRONIC 312
Rear view camera 319
Spotlight function 322
- Driving tips**
Automatic transmission 282
Brakes 293
Break-in period 272
DISTRONIC PLUS 306
Downhill gradient 293
Drinking and driving 292
Driving abroad 250
Driving in winter 296
Driving on flooded roads 295
Driving on wet roads 295
Exhaust check 293
Fuel 292
General 292
Hydroplaning 295
Icy road surfaces 296
Limited braking efficiency on salted roads 294
Pedals 292
Snow chains 457
Symmetrical low beam 250
Wet road surface 293
- DVD**
Changer 209
Copy protection 218
Fast forward/fast rewind 214
Handling 177
Inserting 209
Notes on discs 218
Selecting a media type 212
Selecting a track 213
Sound settings (balance, bass, fader, treble) 128
- DVD audio**
Operating (on-board computer) 343
- DVD video**
Operating (on-board computer) 343
- E**
- EASY-ENTRY feature**
Activating (COMAND) 236
Function/notes 103
- EASY-EXIT feature**
Activating (COMAND) 236
Crash-responsive 104
Function/notes 103
- EBD (electronic brake force distribution)**
Display message 357
Function/notes 68
- ECO function** 235

ECO start/stop function	
Deactivating/activating	277
General information	276
Electrical fuses	
see Fuses	
Electronic brake force distribution	
see EBD (electronic brake force distribution)	
Electronic Stability Program	
see ESP® (Electronic Stability Program)	
Electronic Traction System	
see ETS/4ETS (Electronic Traction System)	
Emergency locking	
Vehicle	83
Emergency release	
Trunk	87
Vehicle	83
Emergency spare wheel	
Storage location	436
Emergency Tensioning Devices	
Function	59
Safety guidelines	45
Emissions control	
Service and warranty information	26
Engine	
Check Engine warning lamp	396
Display message	371
ECO start/stop function	276
Engine number	483
Irregular running	278
Jump-starting	445
Starting problems	278
Starting the engine with the	
SmartKey	274
Starting with KEYLESS-GO	275
Switching off	289
Tow-starting (vehicle)	449
Engine electronics	
Problem (malfunction)	278
Engine emergency stop	451
Engine oil	
Adding	423
Additives	487
Checking the oil level	421
Checking the oil level using the	
dipstick	421
Checking the oil level using the	
on-board computer	422
Display message	373
Filling capacity	486
Notes about oil grades	486
Notes on oil level/consumption	421
Temperature (on-board computer) .	343
Viscosity	487
Entering the frequency	201
Entry	
Deleting	124
Saving	126
ESP® (Electronic Stability Program)	
Deactivating/activating	348
Deactivating/activating (notes)	67
Display message	353
ETS/4ETS	67
Function/notes	67
Important safety information	67
Warning lamp	393
ETS/4ETS (Electronic Traction System)	67
Exhaust check	293
Exhaust tail pipe (cleaning instructions)	431
Exterior lighting	
see Exterior lighting	
Exterior mirror parking position	
Adjusting (COMAND)	236
Exterior mirrors	
Adjusting	104
Dipping (automatic)	105
Folding in/out (automatically)	105
Folding in/out (electrically)	105
Out of position (troubleshooting) ...	105
Storing settings (memory function)	106
Storing the parking position	105
Eyeglasses compartment	401
F	
Factory setting (reset function)	137
Fader, setting	128

- Fast forward**
 Audio mode (CD, DVD, MP3) 214
 Video DVD 231
- Fast rewind**
 Audio mode (CD, DVD, MP3) 214
 Video DVD 231
- Favorites (COMAND)** 113
- Filler cap**
 see Fuel filler flap
- Filling capacities (Technical data)** ... 484
- First-aid kit** 436
- Flat tire**
 Changing a wheel/mounting the
 spare wheel 437
 MOExtended run-flat system 441
 Preparing the vehicle 437
 Raising the vehicle 438
- Floormats** 417
- Freeway information** 175
- Front fog lamps** 252
 Display message 369
 Switching on/off 252
- Front-passenger seat**
 Adjusting from the driver's seat 98
- Front windshield**
 see Windshield
- Fuel**
 Additives 486
 Displaying the current
 consumption 340
 Displaying the range 340
 Driving tips 292
 Fuel gauge 35
 Grade (gasoline) 485
 Important safety notes 484
 Premium-grade unleaded gasoline . 485
 Problem (malfunction) 289
 Refueling 286
 Tank content/reserve fuel 485
- Fuel filler flap, opening/closing** 287
- Fuel level**
 Calling up the range (on-board
 computer) 340
- Fuel tank**
 Capacity 485
 Problem (malfunction) 289
- Function buttons (COMAND)** 113
- Fuses**
 Allocation chart 449
 Before changing 449
 Dashboard fuse box 450
 Engine emergency stop 451
 Fuse box in the engine
 compartment 450
 Fuse box in the rear compartment . 450
 Important safety notes 449
- G**
- Garage door opener**
 Clearing the memory 417
 Important safety notes 414
 Opening/closing the garage door .. 416
 Programming (button in the rear-
 view mirror) 415
- Gear indicator (on-board computer)** 343
- Gear or selector lever (cleaning
 guidelines)** 433
- Glove box** 400
- GPS reception** 138
- Gracenote Media Database** 215
- H**
- Handbrake**
 see Parking brake
- Harman/kardon® Logic 7®
 surround sound system**
 see Surround sound (harman/
 kardon® surround sound system)
- Hazard warning lamps** 253
- HD Radio™** 203
- Heading up (navigation)** 172
- Headlamp cleaning system**
 Notes 488
- Headlamps**
 Adding fluid to cleaning system 425
 Cleaning system (function) 252
 Fogging up 255
 see Automatic headlamp mode
- Head restraints**
 Adjusting 99
 Adjusting (electrically) 99
 Adjusting (rear) 99

- Heating**
see Climate control
- High-beam headlamps**
Changing bulbs 257
Display message 368
Switching Adaptive Highbeam
Assist on/off 254
Switching on/off 253
- Hill start assist** 275
- HOLD function**
Display message 377
Function/notes 308
- Home**
see Home address
- Home address**
Entering and saving 144
Selecting from the destination
memory 146
- Hood**
Closing 421
Display message 386
Opening 420
- Hydroplaning** 295
- I**
- Ignition lock**
see Key positions
- Immobilizer** 70
- In-car hotspot**
see separate operating instructions
- Incident (traffic report)** 162
- Indicator lamps**
see Warning and indicator lamps
- Indicators**
see Turn signals
- Instrument cluster**
Overview 35
Warning and indicator lamps 36
- Instrument lighting**
see Instrument cluster lighting
- Interface (USB, iPod®)**
see Media Interface
- Interior lighting** 237, 255
Ambient light (COMAND) 238
Automatic control 256
Manual control 256
- Overview 255
Reading lamp 255
- Intermediate stop**
Deleting 149
Entering 148
- iPod®**
Alphabetical track selection 226
Connecting to the Media Interface 222
Selecting a category/playlist 225
Supported variants 222
- J**
- Jack**
Storage location 436
Using 438
- Jump starting (engine)** 445
- K**
- Key**
see SmartKey
- KEYLESS-GO**
Convenience closing feature 90
Locking 75
Start/Stop button 273
Starting the engine 275
Unlocking 75
- Key positions**
KEYLESS-GO 273
SmartKey 273
- Kickdown**
Driving tips 282
Manual drive program 285
- Knee bag** 48
- L**
- Lamps**
see Warning and indicator lamps
- Lane detection (automatic)**
see Lane Keeping Assist
- Lap time (RACETIMER)** 344
- LATCH-type (ISOFIX) child seat anchors** 62
- Letter bar**
see Character bar
- License plate lamp (display message)** 368

- Light function, active**
 Display message 370
- Lighting**
 Light switch 250
 see Lights
- Lights**
 Automatic headlamp mode 251
 Cornering light function 254
 Display message 367
 Driving abroad 250
 Fog lamps 252
 Hazard warning lamps 253
 High beam flasher 253
 High-beam headlamps 253
 Low-beam headlamps 251
 Rear fog lamp 252
 Standing lamps 250
 Switching Adaptive Highbeam Assist on/off 350
 Switching the daytime running lamps on/off (on-board computer) 349
 Switching the daytime running lamps on/off (switch) 251
 Turn signals 252
 see Changing bulbs
 see Interior lighting
- Light sensor (display message) 370**
- Loading guidelines 400**
- Locator lighting setting (COMAND) . 238**
- Locking**
 Automatic 82
 Emergency locking 83
 From inside the vehicle (central locking button) 82
- Locking verification signal (on-board computer) 350**
- Logic 7® (Harman Kardon® surround sound system)**
 see 3D sound (Harman Kardon® surround sound system)
- Low-beam headlamps**
 Display message 367
 Setting for driving abroad (symmetrical) 250
 Switching on/off 251
- Lubricant additives**
 see Additives
- Lumbar support**
 Adjusting 101
- Lumbar support (COMAND) 243**
- M**
- M+S tires 456**
- Maintenance**
 see ASSYST PLUS service interval display
- Malfunction message**
 see Display messages
- Map (navigation)**
 Adjusting the scale 170
 Arrival time/distance to the destination 173
 City model 174
 Display 172
 Geo-coordinate display 174
 Heading 172
 Information in the display 173
 Moving 171
 North orientation 172
 Notes 170
 Point of interest symbols 172
 Road display 173
 Saving the crosshair position 171
 Setting to the vehicle destination . . 171
 Topographical map 174
- Map display (also see navigation)**
 Traffic reports 163
- Massage function (PULSE) 246**
- Matte finish (cleaning instructions) 429**
- mbrace**
 Automatic retrieval of vehicle data (service due date) 413
 Call priority 411
 Display message 361
 Downloading destinations (COMAND) 411
 Emergency call 408
 Important safety notes 407
 Locating a stolen vehicle 414
 MB info call button 410
 Remote vehicle locking 413
 Roadside Assistance button 409
 Search & Send 412
 Self-test 408

- System 407
- Vehicle remote unlocking 413
- Mechanical key**
 - Function/notes 77
- Media Interface**
 - Active partition 226
 - Alphabetical track selection 226
 - Connecting an external audio source 222
 - Connection options 222
 - iPod® 222
 - Mode 222
 - Notes on USB devices 227
 - Playback options 226
 - Selecting categories 225
 - Selecting folders 225
 - Selecting music files 224
 - Selecting playlists 225
 - Switching to 222
 - USB mass storage device 222
- Media list**
 - Audio mode (CD, DVD, MP3) 212
 - Video DVD 231
- Memory card (audio)** 343
- Memory function** 106
- Menu item**
 - Selecting 119
- Message memory (on-board computer)** 352
- Messages**
 - see Display messages
- Microphone, switching on/off** 189
- Mirrors**
 - see Exterior mirrors
 - see Rear-view mirror
 - see Vanity mirror
- Mobile phone**
 - Menu (on-board computer) 346
 - see Phone
- MOExtended run-flat system** 441
- MP3**
 - Bit/sampling rates 217
 - Copyright 218
 - Data medium 217
 - Fast forward/fast rewind 214
 - File systems 217
 - Formats 217
- Mode, switching to 210
- Notes 217
- Operation 343
- Pause function 211
- Playback options 216
- Safety notes 209
- Selecting a media type 212
- Selecting a track 213
- Sound settings (balance, bass, fader, treble) 128
- Multicontour seat**
 - Front 243
- Multifunction display**
 - Function/notes 338
 - Lane recommendations 157
- Multifunction steering wheel**
 - Adjusting the volume 127
 - Operating the on-board computer . 337
 - Overview 37
 - Using the telephone 187
- Multisession CD** 217
- Music files**
 - Recording 214
- MUSIC REGISTER**
 - Copying music data 219
 - Deleting all music files 220
 - Deleting individual music files 221
 - Disk space information 220
 - Folder functions 221
 - General notes 218
 - Playback options 221
 - Switching to 218
- Music search** 214
- Music storage**
 - see MUSIC REGISTER
- Mute** 127

N

Navigation

- Adjusting the volume of the navigation announcements 127
- Alternative route 159
- Basic settings 139
- Blocking a route section affected by a traffic jam 159
- Compass function 176
- Destination memory 166

Displaying destination information (arrival time, distance to destination)	160
Entering/saving your home address	144
Entering a destination	140
Entering a destination by address ..	141
Entering a destination using the map	147
Entering an intermediate stop	148
Entering a point of interest	150
Entering characters (character bar)	122
Freeway information	175
General notes	138
GPS reception	138
Installing map software	176
Lane recommendation	155
Map settings	170
Off-road/off-map (off-road destination)	161
On-board computer	341
Previous destinations	169
Repeating announcements	158
Route guidance	154
Route overview	160
Safety notes	138
Selecting a destination from the destination memory	146
Selecting a destination from the list of last destinations	146
Selecting your home address	146
Setting route options (avoiding: highways, toll roads, tunnels, ferries)	139
Setting the route type (short route, fast route, dynamic route or economic route)	139
Showing/hiding the menu	139
Starting route calculation	143
Switching announcements on/off .	158
Switching to	139
Traffic report	162
Troubleshooting	180
New aluminum style carrier bars see separate installation instructions	
Night View Assist Plus	
Cleaning	432
Display message	375
Function/notes	322
Problem (malfunction)	327
North orientation (navigation)	172
Notes on breaking-in a new vehicle	272
Number keypad	122
O	
Occupant Classification System (OCS)	
Faults	54
Operation	50
System self-test	53
Occupant safety	
Children in the vehicle	59
System overview	44
OCS	
Faults	54
Operation	50
System self-test	53
Odometer	340
Off-road	161
Oil see Engine oil	
On-board computer	
AMG menu	343
Assistance menu	347
Audio menu	342
Displaying a service message	426
Display messages	352
DISTRONIC PLUS	305
Important safety notes	336
Menu overview	339
Message memory	352
Navigation menu	341
Operation	337
RACETIMER	344
Service menu	349
Settings menu	349
Standard display	340
Telephone menu	346
Trip menu	340
Video DVD operation	343
Opening height restriction for trunk lid	239
Operating safety	
Diagnostics connection	29

- Operating system**
see On-board computer
- Outside lighting**
Delayed switch-off (COMAND) 237
- Outside temperature display** 337
- Overhead control panel** 40
- Override feature**
Rear side windows 64
- Own address (navigation)**
see Home address
- P**
- Paint code number** 482
- Paintwork (cleaning instructions)** ... 429
- Panic alarm** 64
- Parcel net** 402
- Parking** 289
Important safety notes 289
Parking brake 290
Position of exterior mirror, front-passenger side 105
Rear view camera 319
see PARKTRONIC
- Parking aid**
Parking Guidance 315
see Exterior mirrors
see PARKTRONIC
- Parking brake**
Display message 357
Electric parking brake 290
- Parking Guidance**
Display message 379
Important safety notes 315
- Parking position**
Exterior mirrors (COMAND) 236
- PARKTRONIC**
Deactivating/activating 314
Driving system 312
Function/notes 312
Important safety notes 312
Problem (malfunction) 315
Range of the sensors 312
Warning display 313
- PASSENGER AIR BAG OFF**
Problems (malfunction) 364
- PASSENGER AIR BAG OFF indicator lamp** 50
- Pause function**
Audio mode (CD, DVD, MP3) 211
Video DVD 231
- Pedals** 292
- Permanent four-wheel drive**
see 4MATIC (permanent four-wheel drive)
- Phone book**
Calling up 193
Creating an entry 194
Deleting an entry 195
Entering characters 125
Introduction 191
- Picture settings (TV, video)** 228
- Plastic trim (cleaning instructions)** . 432
- Playback options**
Audio mode (CD, DVD, MP3) 216
- POI (navigation)**
Entering 150
Entering a point of interest using the map 153
List 151
ZAGAT® survey service 152
- Point of interest (navigation)**
Assigning a category 151
- Power closing feature** 83
- Power washers** 428
- Power windows**
see Side windows
- PRE-SAFE® (anticipatory occupant protection)**
Display message 361
Operation 55
- PRE-SAFE® Brake**
Activating/deactivating 348
Display message 362
Function/notes 68
Warning lamp 397
- Previous destinations (navigation)** .. 169
- Product information** 26
- Programmable button** 113
- Program selector button** 282
- Pulling away (automatic transmission)** 275
- PULSE**
see Massage function (PULSE)

Q	
Qualified specialist workshop	29
R	
RACETIMER (on-board computer)	344
Radar sensor system	
Activating/deactivating	350
Display message	378
Radio	
HD Radio™	203
Selecting a station	342
Setting a station	200
Sound settings (balance, bass, fader, treble)	128
Storing stations	201
Switching on	199
Switching wavebands	200
Radio-controlled devices (installing)	417
Read-aloud function	162
Reading lamp	255
Real-time traffic reports	162
Rear compartment	
Setting the air vents	269
Rear fog lamp	
Display message	369
Switching on/off	252
Rear view camera	
Cleaning instructions	431
Function/notes	319
Rear-view mirror	105
Rear window blind	405
see Rear window roller sunblind	
see Roller sunblind	
Rear window defroster	
Problem (malfunction)	266
Switching on/off	266
Redialing (telephone)	188
Refrigerant (air-conditioning system)	
Important safety notes	489
Refueling	
Fuel gauge	35
Important safety notes	286
Refueling process	287
see Fuel	
Remote control	
Garage door opener	414
Programming (garage door opener)	415
Reporting safety defects	30
Reserve (fuel tank)	
see Fuel	
Reserve fuel	
Display message	374
Warning lamp	396
see Fuel	
Reset function	137
Resetting (factory settings)	137
Residual heat (climate control)	267
Restraint system	
see SRS (Supplemental Restraint System)	
Reversing lamps (display message)	369
Road map	
see Map	
Roadside Assistance (breakdown)	27
Roller sunblind	
Rear window	405
Rear window (COMAND)	236
Roof lining and carpets (cleaning guidelines)	433
Roof load (maximum)	490
Route (navigation)	
Displaying the distance to the destination	160
Route overview	160
Selecting an alternative route	159
Setting route options (avoiding: highways, toll roads, tunnels, ferries)	139
Setting the route type (short route, fast route, dynamic route or economic route)	139
Starting calculation	143
see Route guidance (navigation)	
Route guidance	
Canceling	157
Continuing	157
Destination reached	158
Lane recommendations	155
Off-road	161
Traffic reports	162
Route guidance (navigation)	341

- Route guidance (on-board computer)** 341
- Route information**
see Dynamic route guidance/TMC
- S**
- Safety**
- Children in the vehicle 59
 - Child restraint systems 59
 - Occupant Classification System (OCS) 50
 - Overview of occupant safety systems 44
- Safety notes**
- Audio CD/DVD and MP3 mode 209
 - Operating safety 110
 - Video DVD mode 229
- Safety systems**
see Driving safety systems
- SatRadio** 205
- Displaying information 208
 - Registering 205
 - Selecting a category 206
- Screen**
see Display
- SD memory card**
- Loading 210
- Seat belts**
- Automatic comfort-fit feature 59
 - Belt force limiters 59
 - Cleaning 433
 - Correct usage 56
 - Emergency Tensioning Devices 59
 - Fastening 57
 - Important safety guidelines 55
 - Releasing 58
 - Safety guidelines 45
 - Special seat belt retractor 61
 - Warning lamp 389
 - Warning lamp (function) 58
- Seats**
- Active multicontour seat 101, 245
 - Adjusting (electrically) 98
 - Adjusting lumbar support 101
 - Adjusting the head restraint 99
 - Cleaning the cover 433
 - Correct driver's seat position 96
 - Folding the backrests forward/back 100
 - Important safety notes 97
 - Multicontour seat 101
 - Seat backrest display message 387
 - Seat heating problem 102
 - Seat ventilation problem 102
 - Selecting (COMAND) 244
 - Storing settings (memory function) 106
 - Switching seat heating on/off 101
 - Switching seat ventilation on/off . . . 102
- Selecting stations (radio)**
- Using station presets 200
 - Using station search 200
- Sending DTMF tones** 191
- Sensors (cleaning instructions)** 431
- Service Center**
see Qualified specialist workshop
- Service interval display**
- Displaying service messages 426
 - Hiding service messages 426
 - Notes 426
 - Service messages 426
- Service menu (on-board computer)** . 349
- Service products**
- Brake fluid 487
 - Coolant (engine) 487
 - Engine oil 486
 - Fuel 484
 - Important safety notes 484
 - Refrigerant (air-conditioning system) 489
 - Washer fluid 488
- Setting a station (radio)**
- Via manual frequency entry 201
- Settings**
- Display 130
 - Menu overview 115
 - On-board computer 349
 - Picture (COMAND) 228
 - Sound settings 128
 - System settings 130
- Setting the language**
- COMAND 137
- Setting the night design** 130
- Setting the text reader speed** 132
- Setting the vehicle level** 310

- Setting the volume**
 Telephone calls 127
 Video AUX 234
- Side impact air bag** 49
- Side marker lamp (display message)** 369
- Side windows**
 Cleaning 430
 Convenience closing feature 89
 Convenience opening feature 89
 Important safety information 88
 Opening/closing 89
 Resetting 90
 Troubleshooting 91
- Sliding sunroof**
 Important safety notes 91
 Opening/closing 92
 Resetting 93
 Troubleshooting 93
- SmartKey**
 Changing the battery 78
 Changing the programming 77
 Checking the battery 78
 Convenience closing feature 89
 Convenience opening feature 89
 Display message 387
 Important safety notes 74
 Malfunction 80
 Positions (ignition lock) 273
 Starting the engine 274
- SMS message**
 see Text message
- Snow chains** 457
- Socket**
 Glove box 407
- Sockets**
 Points to observe before use 406
 Trunk 407
- Sound menu** 128
- Sounds**
 see Sound settings
- Sound settings**
 Balance and fader 128
 Calling up the sound menu 128
 Surround sound 129
 Treble and bass 128
- Spare wheel**
 Notes/data 479
 Storage location 436
 see Emergency spare wheel
- Specialist workshop** 29
- Speech control**
 see Voice Control System
- Speed, controlling**
 see Cruise control
- Speedometer**
 Activating/deactivating the
 additional speedometer 350
 Digital 340
 In the Instrument cluster 35
 Selecting the unit of measurement 350
 see Instrument cluster
- SPLITVIEW** 116
- Spotlight function** 322
- SRS (Supplemental Restraint System)**
 Display message 362
 Introduction 44
 Warning lamp 395
 Warning lamp (function) 44
- Standing lamps**
 Display message 369
 Switching on/off 250
- Starting (engine)** 274
- Station memory** 201
- Steering (display message)** 387
- Steering wheel**
 Adjusting (electrically) 103
 Button overview 37
 Buttons (on-board computer) 337
 Cleaning 433
 Important safety notes 102
 Paddle shifters 283
 Steering wheel heating 103
 Storing settings (memory function) 106
- Steering wheel heating**
 Switching on/off 103
- Steering wheel paddle shifters** 283
- Stop function**
 Audio DVD 212
 Video DVD 231
- Stopwatch (RACETIMER)** 344

- Storing stations**
 - Manually 201
- Storing stations (radio)**
 - Automatically 201
- Stowage areas** 400
- Stowage compartments**
 - Armrest (under) 401
 - Cup holders 403
 - Eyeglasses compartment 401
 - Glove box 400
 - Important safety information 400
 - Parcel net 402
 - Rear 401
 - Rear seat backrest 402
 - Rear seats (between) 402
- Stowage well beneath the trunk floor** 403
- Summer opening**
 - see Convenience opening feature
- Summer tires** 456
- Sun visor** 404
- Supplemental Restraint System**
 - see SRS (Supplemental Restraint System)
- Surround sound**
 - see 3D sound (Harman Kardon® surround sound system)
- Surround sound (harman/kardon® surround sound system)**
 - Notes 129
 - Switching on/off 129
- Suspension tuning**
 - Active Body Control 311
 - AIRMATIC 309
- Switching air-recirculation mode on/off** 267
- Switching between picture formats (TV, video)** 229
- Switching between summer time and standard time** 132
- Switching off the alarm (ATA)** 70
- Switching the hands-free microphone on/off** 189
- Switching wavebands (radio)** 200
- System settings**
 - Bluetooth® 134
 - Date 131
 - Language 137
 - Programmable button (COMAND) .. 113
 - Text reader speed 132
 - Time 131
 - Time zone 132
 - Voice Control System 132

T

- TA (Traffic Announcements)**
 - see Traffic announcements
- Tachometer** 337
- Tail lamps**
 - Display message 368
- Tank**
 - see Fuel tank
- Tank content**
 - Fuel gauge 35
- Technical data**
 - Capacities 484
 - Notes 482
 - Tires/wheels 477
 - Vehicle data 490
- TELEAID**
 - Automatic retrieval of vehicle data (service due date) 413
 - Call priority 411
 - Display message 361
 - Downloading destinations (COMAND) 411
 - Emergency call 408
 - Important safety notes 407
 - Locating a stolen vehicle 414
 - MB info call button 410
 - Remote vehicle locking 413
 - Roadside Assistance button 409
 - Search & Send 412
 - Self-test 408
 - System 407
 - Vehicle remote unlocking 413
- Telephone**
 - Accepting/ending a call 187
 - Accepting a call 346
 - Adjusting the volume for calls 127
 - Basic menu (Bluetooth® interface) 186
 - Calling (outgoing call) 188
 - Calling voicemail 189
 - Conference connection 189

- Connecting a mobile phone
 - (general information) 183
 - De-authorizing a mobile phone 186
 - Ending an active call 189
 - Entering a number 188
 - External authorization (Bluetooth®) 185
 - Function restrictions 182
 - General notes 181
 - Keypad 114
 - Menu (on-board computer) 346
 - Number from the phone book 346
 - Operating options 182
 - Overview of functions 189
 - Reception and transmission
 - volume 187
 - Redialing 347
 - Rejecting/ending a call 346
 - Rejecting a call 187
 - Rejecting or accepting a waiting
 - call 189
 - Safety notes 181
 - Sending DTMF tones 191
 - Switching hands-free microphone
 - on/off 189
 - Toggleing 189
 - Using the telephone 187
 - see Bluetooth®
 - see Call lists
- Telephone mode**
 - Redialing 188
- Telephone module with Bluetooth® SIM Access Profile**
 - see separate installation instructions
- Temperature**
 - Coolant 336
 - Coolant (on-board computer) 343
 - Engine oil (on-board computer) 343
 - Outside temperature 337
 - Setting (climate control) 265
 - Setting (COMAND) 240
- Theft deterrent systems**
 - ATA (Anti-Theft Alarm system) 70
 - Immobilizer 70
- Tilt/sliding sunroof**
 - see Sliding sunroof
- Time**
 - Setting 131
 - Setting summer/standard time 132
 - Setting the format 131
 - Setting the time 131
 - Setting the time/date format 131
 - Setting the time zone 132
- Timing (RACETIMER) 344**
- Tiredness assistant**
 - see ATTENTION ASSIST
- Tire pressure**
 - Calling up (on-board computer) 461
 - Checking manually 461
 - Display message 382
 - Important safety notes 461
 - Maximum 461
 - Notes 459
 - Recommended 458
- Tire pressure monitoring system**
 - Checking the tire pressure
 - electronically 463
 - Function/notes 461
 - General notes 461
 - Important safety notes 462
 - Restarting 464
 - Warning lamp 398
 - Warning message 463
- Tires**
 - Aspect ratio (definition) 476
 - Average weight of the vehicle
 - occupants (definition) 474
 - Bar (definition) 474
 - Characteristics 474
 - Checking 455
 - Definition of terms 474
 - Direction of rotation 477
 - Display message 382
 - Distribution of the vehicle
 - occupants (definition) 476
 - DOT, Tire Identification Number (TIN) 473
 - DOT (Department of Transportation) (definition) 474
 - GAWR (Gross Axle Weight Rating) (definition) 475
 - GVW (Gross Vehicle Weight) (definition) 475

- GVWR (Gross Vehicle Weight Rating) (definition) 475
- Important safety notes 454
- Increased vehicle weight due to optional equipment (definition) 474
- Kilopascal (kPa) (definition) 475
- Labeling (overview) 470
- Load bearing index (definition) 476
- Load index 473
- Load index (definition) 475
- M+S tires 456
- Maximum loaded vehicle weight (definition) 475
- Maximum load on a tire (definition) 475
- Maximum permissible tire pressure (definition) 475
- Maximum tire load 468
- Maximum tire load (definition) 475
- MOExtended tires 456
- Optional equipment weight (definition) 476
- PSI (pounds per square inch) (definition) 475
- Replacing 477
- Service life 456
- Sidewall (definition) 476
- Speed rating (definition) 475
- Storing 477
- Structure and characteristics (definition) 474
- Temperature 470
- TIN (Tire Identification Number) (definition) 476
- Tire bead (definition) 476
- Tire pressure (definition) 476
- Tire pressures (recommended) 474
- Tire size (data) 477
- Tire size designation, load-bearing capacity, speed rating 471
- Tire tread 455
- Tire tread (definition) 476
- Total load limit (definition) 476
- Traction 469
- Traction (definition) 476
- Tread wear 469
- Uniform Tire Quality Grading Standards 469
- Uniform Tire Quality Grading Standards (definition) 474
- Unladen weight (definition) 475
- Wear indicator (definition) 476
- Wheel rim (definition) 474
see Flat tire
- Tonal properties**
see Sound settings
- Top Tether** 63
- Towing**
Important safety guidelines 446
Installing the towing eye 447
Removing the towing eye 448
With the rear axle raised 448
- Towing away**
With both axles on the ground 448
- Tow-starting**
Emergency engine starting 449
Important safety notes 446
- Track**
Selecting (CD, DVD, MP3) 213
- Traffic Announcements (TA)**
Switching off 127
- Traffic jam function** 159
- Traffic jam message**
see Dynamic route guidance/TMC
- Traffic reports**
Real-time traffic report 165
Switching on/off 162
- Transfer case** 286
- Transmission**
see Automatic transmission
- Transporting the vehicle** 448
- Treble, adjusting (sound)** 128
- Trim pieces (cleaning instructions)** . 433
- Trip computer (on-board computer)** 340
- Trip meter**
see Trip odometer
- Trip odometer**
Calling up 340
Resetting (on-board computer) 341
- Trunk**
Automatic opening 85
Emergency release 87
Important safety guidelines 84
Limiting the opening angle 239

- Locking separately 86
 - Opening automatically from inside . . 86
 - Trunk lid**
 - Display message 386
 - Power closing feature 83
 - Trunk lid opening height restriction** 239
 - Turn signals**
 - Display message 367
 - Switching on/off 252
 - TV**
 - Automatic picture shutoff 228
 - Picture settings 228
 - Type identification plate**
 - see Vehicle identification plate
- U**
- Unlocking**
 - Emergency unlocking 83
 - From inside the vehicle (central unlocking button) 82
 - USB**
 - see Media Interface
- V**
- Vanity mirror (in the sun visor)** 404
 - Vehicle**
 - Correct use 29
 - Data acquisition 30
 - Display message 385
 - Emergency locking 83
 - Emergency unlocking 83
 - Equipment 26
 - Individual settings 349
 - Limited Warranty 30
 - Loading 464
 - Lowering 441
 - Maintenance 27
 - Parking for a long period 291
 - Pulling away 275
 - Raising 438
 - Reporting problems 30
 - Towing away 446
 - Transporting 448
 - Vehicle data 490
 - Vehicle battery**
 - see Battery (vehicle)
 - Vehicle data** 490
 - Vehicle dimensions** 490
 - Vehicle identification number**
 - see VIN
 - Vehicle identification plate** 482
 - Vehicle level**
 - Active Body Control (ABC) 310
 - AIRMATIC 309
 - Display message 377
 - Vehicle level (display message)** 376
 - Vehicle tool kit** 436
 - Video**
 - see Video DVD
 - Video AUX**
 - Setting the picture 228
 - Video DVD**
 - Automatic picture shutoff 228
 - DVD menu 232
 - Fast forward/rewind 231
 - Function restrictions 230
 - Interactive content 234
 - Notes on discs 229
 - Operation 229
 - Pause function 231
 - Playing conditions 229
 - Safety notes 229
 - Selecting 231
 - Selecting a film/title 232
 - Selecting a scene/chapter 231
 - Setting the audio format 233
 - Setting the language 233
 - Setting the picture 228
 - Showing/hiding the control menu . 230
 - Showing/hiding the menu 230
 - Stop function 231
 - Subtitles 233
 - Switching to 230
 - VIN** 482
 - Voice Control System**
 - Settings 132
 - Volume, adjusting**
 - COMAND 127
 - Navigation messages 127

W

- Waiting call** 189
- Warning and indicator lamps**
 - ABS 391
 - Brakes 390
 - Check Engine 396
 - Distance warning 397
 - DISTRONIC PLUS 397
 - ESP® 393
 - ESP® OFF 393
 - Fuel tank 396
 - Overview 36
 - PASSENGER AIR BAG OFF indicator lamp 50
 - Reserve fuel 396
 - Seat belt 389
 - SRS 395
 - Tire pressure monitor 398
- Warranty** 482
- Washer fluid**
 - Display message 387
- Weather Band**
 - Searching for a channel 202
 - Switching on 202
- Wheel bolt tightening torque** 441
- Wheel chock** 438
- Wheels**
 - Changing a wheel 437
 - Checking 455
 - Cleaning 429
 - Cleaning (warning) 477
 - Important safety notes 454
 - Interchanging/changing 477
 - Mounting a new wheel 440
 - Removing a wheel 440
 - Storing 477
 - Tightening torque 441
 - Wheel size/tire size 477
- Window curtain air bag**
 - Display message 363
 - Operation 50
- Windows**
 - see Side windows
- Windshield**
 - Defrosting 265
 - Infrared reflective 417
- Windshield washer fluid**
 - see Windshield washer system
- Windshield washer system** 425
 - Notes 488
- Windshield wipers**
 - Problem (malfunction) 259
 - Replacing the wiper blades 258
 - Switching on/off 257
- Winter driving**
 - Important safety notes 456
 - Slippery road surfaces 296
 - Snow chains 457
- Winter tires**
 - M+S tires 456
- Wiper blades**
 - Cleaning 430
 - Important safety notes 258
- Wooden trim (cleaning instructions)** 433
- Workshop**
 - see Qualified specialist workshop

Product information

Mercedes-Benz recommends that you use genuine Mercedes-Benz parts, conversion parts and accessories that have been approved for the type of vehicle.

Mercedes-Benz tests genuine parts as well as conversion parts and accessories which have been specifically approved for your vehicle for their reliability, safety and suitability. Despite ongoing market research, Mercedes-Benz is unable to assess other parts. Therefore, Mercedes-Benz accepts no responsibility for the use of such parts in Mercedes-Benz vehicles, even if they have been independently or officially approved. The use of non-approved parts could affect your vehicle's operating safety. Mercedes-Benz therefore recommends that you use genuine Mercedes-Benz parts, conversion parts and accessories that have been approved for the type of vehicle. Genuine Mercedes-Benz parts, approved conversion parts and accessories are available from any authorized Mercedes-Benz Center. Here, you will receive advice about permissible technical modifications, and the parts will be professionally installed.

Operator's Manual

Notes on the Operator's Manual

This Operator's Manual contains a great deal of helpful information. We urge you to read it carefully and familiarize yourself with the vehicle before driving.

For your own safety and longer service life of the vehicle, we urge you to follow the instructions and warnings contained in this Operator's Manual. Ignoring them could result in damage to the vehicle or personal injury to you or others. Vehicle damage caused by failure to follow instructions is not covered by the Mercedes-Benz Limited Warranty.

Vehicle equipment

This Operator's Manual describes all models and all standard and optional equipment of your vehicle available at the time of going to print. Country-specific differences are possible. Please note that your vehicle may not be equipped with all features described. This also applies to safety-related systems and functions. The equipment in your vehicle may therefore differ from some of the descriptions or illustrations.

The original purchase agreement lists all systems installed in your vehicle.

Contact an authorized Mercedes-Benz Center if you have any questions about equipment or operation.

The Operator's Manual and the Maintenance Booklet are important documents and should be kept in the vehicle.

Service and vehicle operation

Service and literature

Your vehicle is covered under the terms of the warranties printed in the Service and Warranty Information booklet. Your authorized Mercedes-Benz Center will exchange or repair any defective parts originally installed in the vehicle in accordance with the terms of the following warranties:

- New Vehicle Limited Warranty
- Emission Systems Warranty
- Emission Performance Warranty
- California, Connecticut, Maine, Massachusetts, New York, Pennsylvania, Rhode Island and Vermont Emission Control Systems Warranty
- State warranty enforcement laws (lemon laws)

Information for customers in California

Under California law you may be entitled to a replacement of your vehicle or a refund of the purchase price or lease price, if after a reasonable number of repair attempts Mercedes-Benz USA, LLC and/or its authorized repair or service facilities fail to fix one or more substantial defects or malfunctions in the vehicle that are covered by its express warranty. During the period of 18 months from original delivery of the vehicle or the accumulation of 18 000 miles (approximately 29 000 km) on the odometer of the vehicle, whichever occurs first, a reasonable number of repair attempts is presumed for a retail buyer or lessee if one or more of the following occurs:

- (1) the same substantial defect or malfunction results in a condition that is likely to cause death or serious bodily injury if the vehicle is driven, that defect or malfunction has been subject to repair two or more times, and you have directly notified Mercedes-Benz USA, LLC in writing of the need for its repair.
- (2) the same substantial defect or malfunction of a less serious nature than category (1) has been subject to repair four or more times and you have directly notified Mercedes-Benz in writing of the need for its repair.
- (3) the vehicle is out of service by reason of repair of the same or different substantial defects or malfunctions for a cumulative total of more than 30 calendar days.

Please send your written notice to:
 Mercedes-Benz USA, LLC
 Customer Assistance Center
 One Mercedes Drive
 Montvale, NJ 07645-0350

Maintenance

The Service and Warranty Booklet describes all the necessary maintenance work which should be done at regular intervals.

Always have the Service and Warranty Booklet with you when you bring the vehicle to an authorized Mercedes-Benz Center. The service advisor will record every service for you in the Service and Warranty Booklet.

Roadside Assistance

The Mercedes-Benz Roadside Assistance Program offers technical help in the event of a breakdown. Calls to the toll-free Roadside Assistance Hotline are answered by our agents 24 hours a day, 365 days a year.

1-800-FOR-MERCedes(1-800-367-6372) (USA)

1-800-387-0100 (Canada)

For additional information, refer to the Mercedes-Benz Roadside Assistance Program brochure (USA) or the "Roadside Assistance" section in the Service and Warranty booklet (Canada). You will find both in your vehicle literature portfolio.

Change of address or change of ownership

In the event of a change of address, please send us the "Change of Address Notice" found in the Service and Warranty Information Booklet, or simply call the Mercedes-Benz Customer Assistance Center (in the USA) at the hotline number 1-800-FOR-MERCedes(1-800-367-6372) or Customer Service Center (in Canada) at 1-800-387-0100. This will assist us in contacting you in a timely manner should the need arise.

If you sell your Mercedes, please leave the entire literature in the vehicle so that it is available to the next owner.

If you bought this vehicle used, be sure to send in the "Notice of Purchase of Used Car" found in the Service and Warranty Information Booklet, or call the Mercedes-Benz Customer Assistance Center (in the USA) at 1-800-FOR-MERCEDES(1-800-367-6372) or Customer Service (in Canada) at 1-800-387-0100.

Vehicle operation outside the USA and Canada

If you plan to operate your vehicle in foreign countries, please be aware that:

- service facilities or replacement parts may not be readily available.
- unleaded fuel for vehicles with a catalytic converter may not be available. Leaded fuel may cause damage to the catalytic converter.
- the fuel may have a considerably lower octane rating. Unsuitable fuel can cause engine damage.

Some Mercedes-Benz models are available for delivery in Europe through our European Delivery Program. For details, consult an authorized Mercedes-Benz Center or write to one of the following addresses.

In the USA

Mercedes-Benz USA, LLC
European Delivery Department
One Mercedes Drive
Montvale, NJ 07645-0350

In Canada

Mercedes-Benz Canada, Inc.
European Delivery Department
98 Vanderhoof Avenue
Toronto, Ontario M4G 4C9

Operating safety

Important safety notes

WARNING

Work improperly carried out on electronic components and associated software could cause them to cease functioning. Because the vehicle's electronic components are interconnected, any modifications made may produce an undesired effect on other systems. Electronic malfunctions could seriously impair the operating safety of your vehicle.

Contact an authorized Mercedes-Benz Center for repairs or modifications to electronic components.

Other improper work or modifications on the vehicle could also have a negative impact on the operating safety of the vehicle.

Some safety systems only function when the engine is running. You should therefore never turn off the engine while driving.

WARNING

Heavy blows against the vehicle underbody or tires/wheels may cause serious damage and impair the operating safety of your vehicle. Such blows can be caused, for example, by running over an obstacle, road debris or a pothole.

If you feel a sudden significant vibration or ride disturbance, or you suspect that damage to your vehicle has occurred:

- turn on your hazard warning flashers.
- slow down carefully.
- drive with caution to an area which is a safe distance from the road.

Inspect the vehicle underbody and tires/wheels for possible damage. If the vehicle appears unsafe, have it towed to the nearest authorized Mercedes-Benz Center or other qualified maintenance or repair facility for further inspection or repairs.

Declarations of conformity

Vehicle components which receive and/or transmit radio waves

USA: "The wireless devices of this vehicle comply with Part 15 of the FCC Rules. Operation is subject to the following two conditions: 1) These devices may not cause harmful interference, and 2) These devices must accept any interference received, including interference that may cause undesired operation. Changes or modifications not expressly approved by the party responsible for compliance could void the user's authority to operate the equipment."

Canada: "The wireless devices of this vehicle comply with Industry Canada license-exempt RSS standard(s). Operation is subject to the following two conditions: (1) These devices may not cause interference, and (2) These devices must accept any interference, including interference that may cause undesired operation of the device."

Diagnostics connection

WARNING

If you connect equipment to the diagnostics connection, it can affect the operation of the vehicle systems. This can impair the operating safety of your vehicle while driving. There is a risk of accident.

Do not connect any equipment to the diagnostics connection.

WARNING

Loose equipment or equipment cables that are connected to the diagnostics connection can obstruct the area around the pedals. The equipment or the cables could get between the pedals in the event of sudden braking or acceleration. As a result, the movement of the pedals may be impaired. There is a risk of accident.

Do not attach any equipment or cables in the driver footwell.

-  If the engine is switched off and equipment on the diagnostics connection is used, the starter battery may discharge.

The diagnostics connection is only intended for the connection of diagnostic equipment at a qualified specialist workshop.

Connecting equipment to the diagnostics connection can, for example, lead to emissions monitoring information being reset. This may lead to the vehicle failing to meet the requirements of the next emissions test during the main inspection.

Qualified specialist workshop

An authorized Mercedes-Benz Center is a qualified specialist workshop. It has the necessary specialist knowledge, tools and qualifications to correctly carry out the work required on your vehicle. This is especially the case for work relevant to safety.

Observe the notes in the Maintenance Booklet.

Always have the following work carried out at an authorized Mercedes-Benz Center:

- work relevant to safety
- service and maintenance work
- repair work
- alterations, installation work and modifications
- work on electronic components

Correct use

WARNING

There are various warning stickers affixed to your vehicle. Their purpose is to alert you and others to various dangers. Therefore, do not remove any warning stickers unless the sticker clearly states that you may do so.

If you remove any warning stickers, you or others could fail to recognize certain dangers and be injured.

When driving your vehicle observe the following information:

- the safety notes in this manual
- the "Technical data" section in this manual
- traffic rules and regulations
- laws and safety standards pertaining to motor vehicles

Problems with your vehicle

If you should experience a problem with your vehicle, particularly one that you believe may affect its safe operation, we urge you to contact an authorized Mercedes-Benz Center immediately to have the problem diagnosed and rectified. If the problem is not resolved to your satisfaction, please discuss the problem again with a Mercedes-Benz Center or contact us at one of the following addresses.

In the USA

Customer Assistance Center
Mercedes-Benz USA, LLC
One Mercedes Drive
Montvale, NJ 07645-0350

In Canada

Customer Relations Department
Mercedes-Benz Canada, Inc.
98 Vanderhoof Avenue
Toronto, Ontario M4G 4C9

Reporting safety defects

USA only:

The following text is published as required of manufacturers under Title 49, Code of U.S. Federal Regulations, Part 575 pursuant to the

"National Traffic and Motor Vehicle Safety Act of 1966".

If you believe that your vehicle has a defect which could cause a crash or could cause injury or death, you should immediately inform the National Highway Traffic Safety Administration (NHTSA) in addition to notifying Mercedes-Benz USA, LLC.

If NHTSA receives similar complaints, it may open an investigation, and if it finds that a safety defect exists in a group of vehicles, it may order a recall and remedy campaign. However, NHTSA cannot become involved in individual problems between you, your dealer, or Mercedes-Benz USA, LLC.

To contact NHTSA, you may call the Vehicle Safety Hotline toll-free at 1-888-327-4236 (TTY: 1-800-424-9153); go to <http://www.safercar.gov>; or write to: Administrator, NHTSA, 400 Seventh Street, SW., Washington, DC 20590.

You can also obtain other information about motor vehicle safety from

<http://www.safercar.gov>

Limited Warranty

! Follow the instructions in this manual about the proper operation of your vehicle as well as about possible vehicle damage. Damage to your vehicle that arises from culpable contraventions against these instructions is not covered either by the Mercedes-Benz Limited Warranty or by the New or Used-Vehicle Warranty.

Data stored in the vehicle

Information about electronic data acquisition in the vehicle

(Including notice pursuant to California Code § 9951)

Your vehicle records electronic data. If your vehicle is equipped with mbrace¹, data is transmitted in the event of an accident.

This information helps, for example, to test vehicle systems after an accident and to continually improve vehicle safety.

Daimler AG can access this data and submit it:

- for safety research or vehicle diagnosis purposes
- with the consent of the vehicle owner
- on the instruction of prosecuting authorities
- for use in arbitration of disputes that involve Daimler AG, its affiliates or its sales and service organizations
- as otherwise required or permitted by law.

Please observe the mbrace¹ purchase agreement for further details on the recording and transfer of data by this system.

¹ The system is called TELE AID in Canada.

Dashboard	34
Instrument cluster	35
On-board computer and COMAND	37
Center console	39
Overhead control panel	40
Door control panel	41

Dashboard

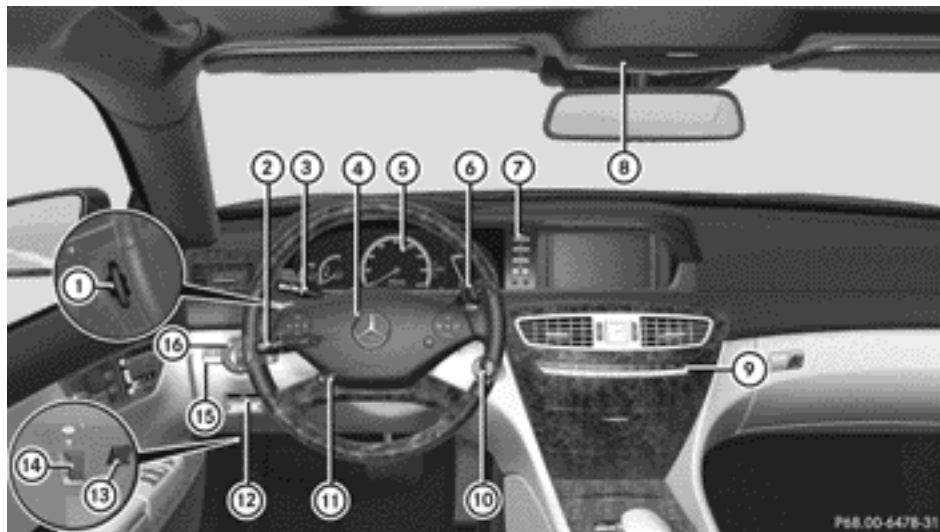

	Function	Page
①	Steering wheel paddle shifters	283
②	Combination switch	252
③	Cruise control lever	297
④	Horn	
⑤	Instrument cluster	35
⑥	DIRECT SELECT lever	279
⑦	Control panel for:	
	Vehicle level	309
	Suspension tuning	309
	PARKTRONIC	312
	Swiveling the COMAND display	118
	COMAND display brightness	118
	Instrument lighting	118

	Function	Page
⑧	Overhead control panel	40
⑨	Automatic climate control	262
⑩	Ignition lock	273
	Start/Stop button	273
⑪	Adjusts the steering wheel	102
	Steering wheel heating	103
⑫	Electric parking brake	290
⑬	Diagnostics connection	29
⑭	Opens the hood	420
⑮	Night View Assist Plus	322
⑯	Light switch	250

Instrument cluster

Displays

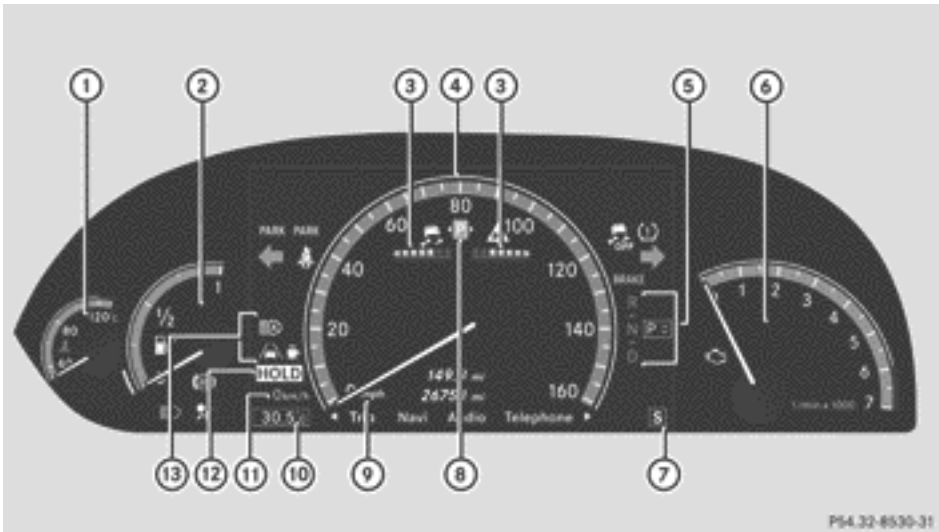

P54.32-6530-31

	Function	Page
①	Coolant temperature	336
②	Fuel gauge	
③	PARKTRONIC	312
④	Multifunction display Speedometer	338
⑤	Transmission position	280
⑥	Tachometer	337
⑦	Drive program	282
⑧	Parking Guidance	315

	Function	Page
⑨	Unit of measurement for the speedometer	350
⑩	Outside temperature	337
⑪	Additional speedometer	350
⑫	HOLD function PRE-SAFE® Brake	308 68
⑬	Adaptive Highbeam Assist Active Lane Keeping Assist ATTENTION ASSIST	254 330 321

Warning and indicator lamps

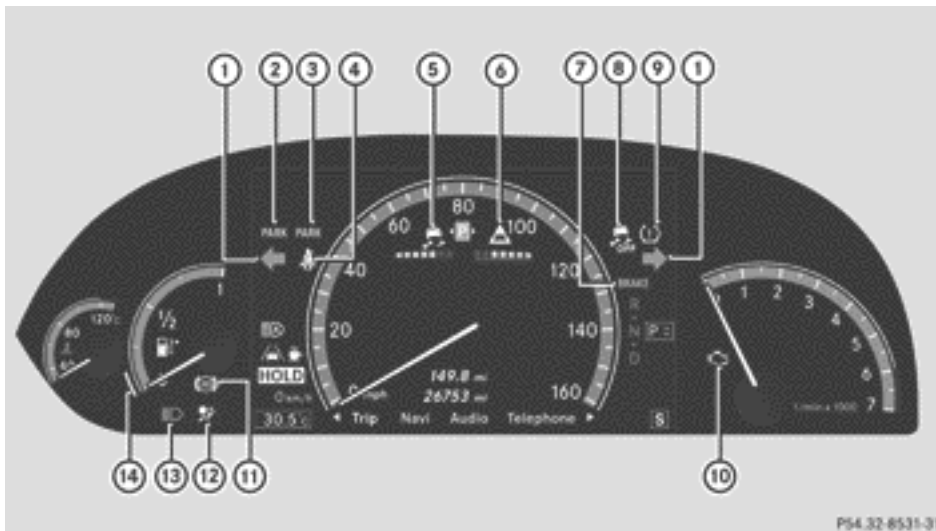

P54.32-8531-31

	Function	Page
①	Turn signal	252
②	Electric parking brake (red) PARK (USA only) Ⓟ (Canada only)	390
③	Electric parking brake (yellow) PARK (USA only) Ⓟ (Canada only)	390
④	Seat belt	389
⑤	ESP®	393
⑥	Distance warning	397

	Function	Page
⑦	Brakes BRAKE (USA only) Ⓟ (Canada only)	390
⑧	ESP® OFF	393
⑨	Tire pressure monitor	398
⑩	Check engine	396
⑪	ABS	391
⑫	SRS	395
⑬	High-beam headlamps	253
⑭	Reserve fuel	396

On-board computer and COMAND

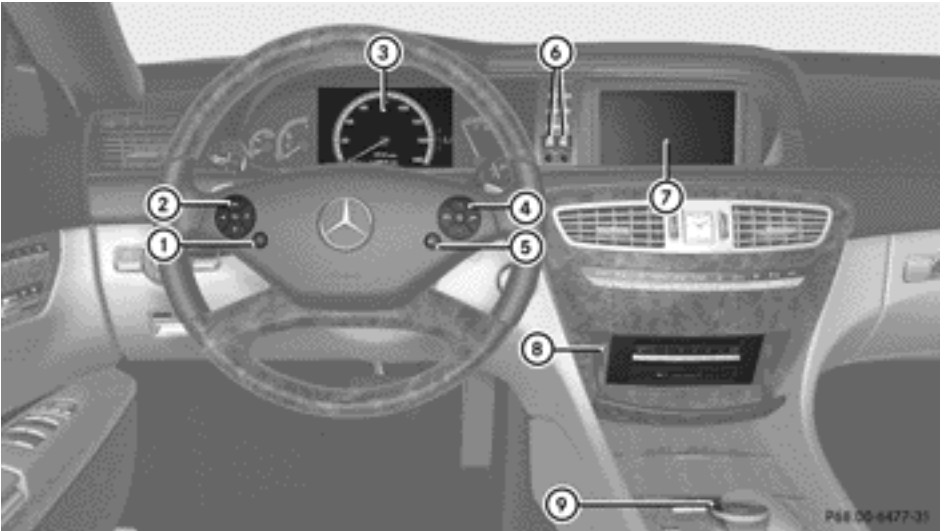

	Function	Page		Function	Page
①	Back Switches off the Voice Control System; see the separate operating instructions	337	④	Rejects or ends a call Exits phone book/redial memory Makes or accepts a call Switches to the redial memory Adjusts the volume or operates RACETIMER on AMG vehicles Mute	346 346 344
②	Selects a menu Selects a function or scrolls through lists Confirms a selection Hides display messages	337 337 337 352	⑤	Switches on the Voice Control System; see the separate operating instructions	
③	Multifunction display	338	⑥	Swivels the COMAND display Adjusts the brightness of the instrument lighting and the COMAND display	118 118

	Function	Page
⑦	COMAND display	115

	Function	Page
⑧	CD and DVD player/ changer	209
⑨	COMAND controller and COMAND function buttons	112, 113

Center console

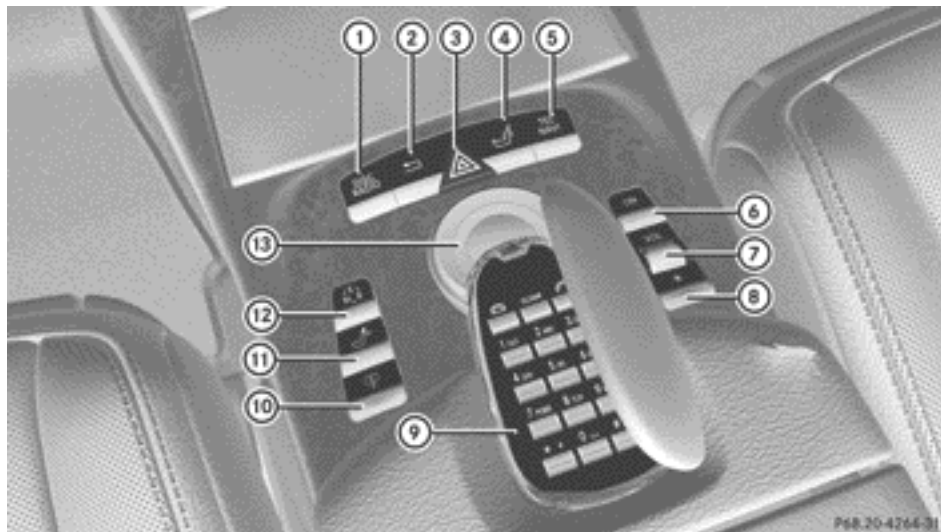

P68.20-4264-31

	Function	Page
①	Function button for the radio and CD/DVD/SD card	113
②	Back button	113
③	Hazard warning lamps	253
④	Lumbar support Multicontour seat	243 243
⑤	Function button for the telephone and navigation system	139
⑥	Switches COMAND on/off	126





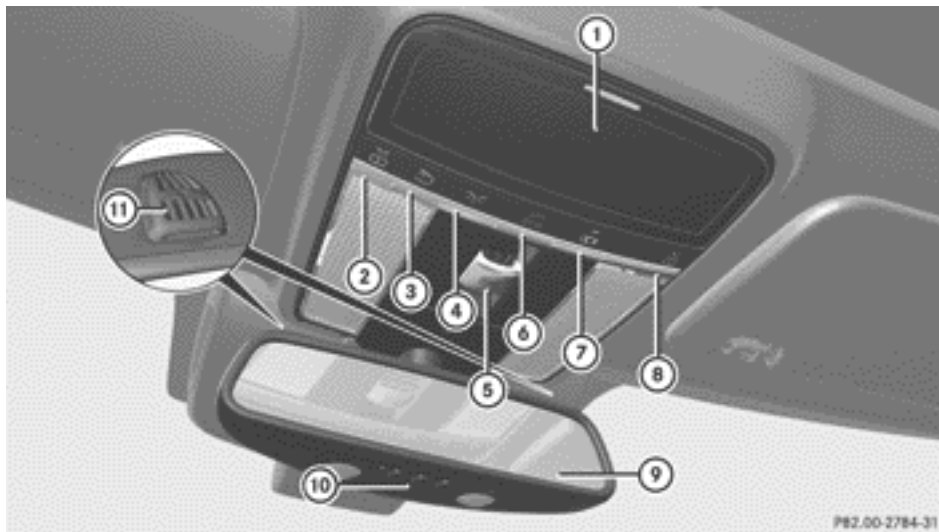

	Function	Page
⑦	Adjusts the volume	127
⑧	Programmable button	113
⑨	Telephone keypad	114
⑩	Rear window roller sunblind	405
⑪	Retracts the rear seat head restraints	99
⑫	Selects the drive program	282
⑬	COMAND controller	112

Overhead control panel

At a glance



P82.00-2784-31

	Function	Page
①	Eyeglasses compartment	401
②	 Switches the left-hand reading lamp on/off	255
③	 Switches the rear interior lighting on/off	256
④	 Switches the front interior lighting on/off	256
⑤	 Opens/closes the sliding sunroof	92
⑥	 SOS button (mbrace system)	408
⑦	 Switches the automatic interior lighting control on/off	256

	Function	Page
⑧	 Switches the right-hand reading lamp on/off	255
⑨	Rear-view mirror	
⑩	Buttons for the garage door opener	415
⑪	Microphone for mbrace (emergency call system), telephone and the Voice Control System ²	

² Observe the additional operating instructions.

Door control panel

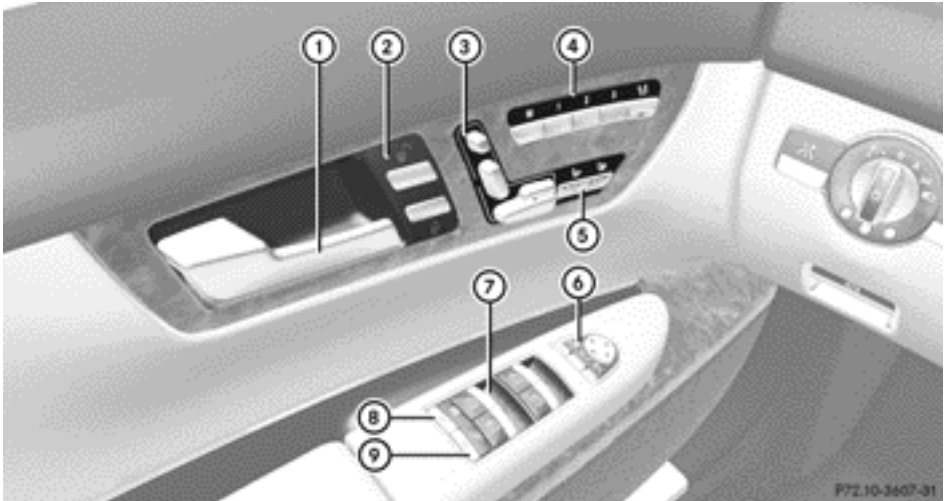

	Function	Page
①	Opens the door	82
②	Unlocks/locks the vehicle	
③	Adjusts the seat electrically	98
④	 Memory function	106
	Adjusts the front-passenger seat from the driver's seat	98
⑤	Seat heating	101
	Seat ventilation	102
⑥	 Adjusts and folds the exterior mirrors in/out electrically	104

	Function	Page
⑦	Opens/closes the side windows	88
⑧	Activates/deactivates the override feature for the side windows in the rear compartment	64
⑨	Opens/closes the trunk lid	

Useful information	44
Occupant safety	44
Children in the vehicle	59
Panic alarm	64
Driving safety systems	64
Theft deterrent locking system	70

Useful information

- i** This Operator's Manual describes all models and all standard and optional equipment of your vehicle available at the time of publication of the Operator's Manual. Country-specific differences are possible. Please note that your vehicle may not be equipped with all features described. This also applies to safety-related systems and functions.
- i** Please read the information on qualified specialist workshops (▷ page 29).

Occupant safety

Overview of occupant safety

In this section, you will learn the most important facts about the restraint system components of the vehicle.

The restraint system consists of:

- seat belts
- child restraint systems
- LATCH-type (ISOFIX) child seat anchors

Additional protection is provided by:

- SRS (Supplemental Restraint System)
- NECK-PRO head restraints
- PRE-SAFE®
- Air bag system components with:
 - PASSENGER AIR BAG OFF indicator lamp
 - front-passenger seat with Occupant Classification System (OCS)

The different air bag systems work independently of each other. The protective functions of the system work in conjunction with each other. Not all air bags are deployed in an accident.

WARNING

Modifications to or work improperly conducted on restraint system components or their wiring, as well as tampering with interconnected electronic systems, can lead

to the restraint systems no longer functioning as intended.

Air bags or Emergency Tensioning Devices (ETDs), for example, could deploy inadvertently or fail to deploy in accidents although the deceleration threshold for air bag deployment is exceeded. Therefore, never modify the restraint systems. Do not tamper with electronic components or their software.

- i** See "Children in the vehicle" (▷ page 59) for more information on infants and children traveling with you in the vehicle and restraints for infants and children.

SRS (Supplemental Restraint System)

Introduction

SRS consists of:

- the  SRS warning lamp
- air bags
- air bag control unit (with crash sensors)
- Emergency Tensioning Devices
- belt force limiters

SRS reduces the risk of occupants coming into contact with the vehicle's interior in the event of an accident. It can also reduce the effect of the forces to which occupants are subjected during an accident.

SRS warning lamp

SRS functions are checked regularly when you switch on the ignition and when the engine is running. Therefore, malfunctions can be detected in good time.

The  SRS warning lamp in the instrument cluster lights up when the ignition is switched on. It goes out no later than a few seconds after the engine is started.

The SRS components are in operational readiness if the  SRS warning lamp is not lit while the engine is running.

⚠ WARNING

The SRS self-check has detected a malfunction if the  SRS indicator lamp:

- does not light up at all
- does not go out after approximately four seconds after the engine is started
- comes on after the engine was started or while driving.

For your safety, Mercedes-Benz strongly recommends that you have the system checked as soon as possible at an authorized Mercedes-Benz Center. SRS may otherwise fail to activate when it is needed in the event of an accident, which could lead to serious or fatal injuries. SRS might also be activated unexpectedly and unnecessarily, which could also result in injury.

In addition, work carried out improperly on SRS may render SRS inoperative or cause unintended air bag deployment. Work on the SRS system should only be carried out by qualified specialist personnel. Consult an authorized Mercedes-Benz Center.

If it is necessary to modify an air bag system to accommodate a person with disabilities, contact an authorized Mercedes-Benz Center for details. USA only: for further information contact our Customer Assistance center at 1-800-FOR-MERCEdes (1-800-367-6372).

Safety guidelines for seat belts, Emergency Tensioning Devices (ETDs) and air bags

⚠ WARNING

- Damaged seat belts or seat belts that have been subjected to stress in an accident must be replaced. Their anchoring points must also be checked. Only use seat belts installed or supplied by an authorized Mercedes-Benz Center.
- Air bags and pyrotechnic Emergency Tensioning Devices (ETDs) contain perchlorate material, which may require special handling and regard for the

environment. Check your national disposal guidelines. California residents, see www.dtsc.ca.gov/HazardousWaste/Perchlorate/index.cfm.

- Air bags and ETDs are designed to function on a one-time-only basis. An air bag or ETD that has deployed must be replaced. PRE-SAFE® has electrically operated reversible belt tensioners in addition to the pyrotechnic ETDs.
- Do not pass seat belts over sharp edges. They could tear.
- Do not make any modification that could change the effectiveness of the seat belts.
- Do not bleach or dye seat belts as this may severely weaken them. In a crash they may not be able to provide adequate protection.
- No modifications of any kind may be made to any components or wiring of the SRS.
- Do not change or remove any component or part of the SRS.
- Do not install additional trim material, seat covers, badges, etc. to the:
 - padded steering wheel boss
 - knee bag covers
 - front-passenger air bag cover
 - outer side of front seat bolsters
 - side trim next to the rear seat backrest
 - roof lining trim
- Do not install additional electrical/ electronic equipment on or near SRS components and wiring.
- Keep area between air bags and occupants free of objects (e.g. packages, purses, umbrellas, etc.).
- Do not hang items such as coat hangers from the coat hooks or handles over the door. These items may be thrown around in the vehicle and cause head and other injuries when the window curtain air bag is deployed.
- Air bag system components will be hot after an air bag has inflated. Do not touch them.

- Never place your feet on the instrument panel, dashboard, or on the seat. Always keep both feet on the floor in front of the seat.
- Improper repair work on the SRS creates a risk of rendering the SRS inoperative or causing unintended air bag deployment. Work on the SRS must therefore only be performed by qualified technicians. Contact an authorized Mercedes-Benz Center.
- For your protection and the protection of others, when scrapping the air bag unit or ETD, our safety instructions must be followed. These instructions are available from any authorized Mercedes-Benz Center.
- Given the considerable deployment speed, required inflation volume, and the material of the air bags, there is the possibility of abrasions or other, potentially more serious injuries resulting from air bag deployment.

If you sell your vehicle, Mercedes-Benz strongly recommends that you inform the subsequent owner that the vehicle is equipped with SRS. Also, refer them to the applicable section in the Operator's Manual.

Air bags

Important safety notes

WARNING

Air bags are designed to reduce the incidence of injuries and fatalities in certain situations:

- frontal impacts (driver's and front-passenger front air bags and driver's knee bag)
- side impacts (side impact air bags and window curtain air bags)
- rollover (window curtain air bags)

However, no system available today can completely eliminate injuries and fatalities.

When the air bags are deployed, a small amount of powder is released. The powder generally does not constitute a health hazard and does not indicate that there is a fire in the vehicle. In order to prevent potential breathing difficulties, you should leave the vehicle as soon as it is safe to do so. If you have any breathing difficulty but cannot get out of the vehicle after the air bag inflates, then get fresh air by opening a window or door.

WARNING

In order to reduce the potential danger of injuries caused during the deployment of the front air bags, the driver and front passenger must always be correctly seated and wear their seat belts.

For maximum protection in the event of a collision, you must always be in the normal seat position with your back against the backrest. Fasten your seat belt and make sure that it is correctly positioned on your body.

As the air bag inflates with considerable speed and force, a proper seating position and correct positioning of the hands on the steering wheel will help to keep you at a safe distance from the air bag. Occupants who are not wearing their seat belt, are not seated properly or are too close to the air bag can be seriously injured or killed by an air bag, as it inflates with great force instantaneously:

- sit with the seat belt fastened correctly and in a position that is as upright as possible with your back against the backrest.
- move the driver's seat as far back as possible, still permitting proper operation of vehicle controls. The distance from the center of the driver's chest to the center of the air bag cover on the steering wheel must be at least 10 inches (25 cm). You should be able to accomplish this by adjusting the seat and steering wheel. If you have any difficulties, please contact an authorized Mercedes-Benz Center.

- do not lean your head or chest close to the steering wheel or dashboard.
- only hold the steering wheel on the outside. Placing hands and arms inside the rim can increase the risk and potential severity of hand/arm injury if the driver front air bag inflates.
- adjust the front-passenger seat as far back as possible from the dashboard when the seat is occupied.
- occupants, especially children, should never place their bodies or lean their heads in the area of the door or the rear side trim panel where the side impact air bag inflates. This could result in serious or fatal injuries should the side impact air bag be deployed. Always sit as upright as possible, wear the seat belt properly and use an appropriately sized infant restraint, toddler restraint or booster seat recommended for the size and weight of the child.

Failure to follow these instructions can result in severe injuries to you or other occupants. If you sell your vehicle, it is important that you make the buyer aware of this safety information. Be sure to give the buyer this Operator's Manual.

WARNING

Accident research shows that the safest place for children in an automobile is in a rear seat. There is a possibility for a side impact air bag-related injury if occupants, especially children, are not properly seated or restrained when next to a side impact air bag which needs to deploy rapidly in a side impact in order to do its job.

To help avoid the possibility of injury, please follow these guidelines:

- (1) Occupants, especially children, should never place their bodies or lean their heads in the area of the door where the side impact air bag inflates. This could result in serious injuries or death should

the side impact air bag be deployed.

- (2) Always sit as upright as possible, wear the seat belt properly and use an appropriately sized infant restraint, toddler restraint, or booster seat recommended for the size and weight of the child. and for children 12 years old and under, use an appropriately sized infant restraint, toddler restraint, or booster seat recommended for the size and weight of the child.
- (3) Always wear seat belts properly.

If you believe that, even with the use of these guidelines, it would be safer for your rear seat occupants to have the rear mounted side impact air bags deactivated, then deactivation can be carried out upon your written request at an authorized Mercedes-Benz Center at an additional cost.

Please contact an authorized Mercedes-Benz Center or call the Customer Assistance Center (in the USA) at 1-800-FOR-MERCEdes (1-800-367-6372), or Customer Service (in Canada) at 1-800-387-0100 for details.

The air bags are only deployed if the air bag control unit detects the need for deployment. Only in the event of such a situation will they provide their supplemental protection.

The driver and passenger should always wear their seat belts. Otherwise, it is not possible for the air bags to provide their supplemental protection.

In the event of other types of impacts and impacts below air bag deployment thresholds, the air bags will not deploy. The driver and passengers will then be protected to the extent possible by a properly fastened seat belt. A properly fastened seat belt is also needed to provide the best possible protection in a rollover.

Air bags provide additional protection; they are not, however, a substitute for seat belts. All vehicle occupants must fasten their seat

belts regardless of whether your vehicle is equipped with air bags or not.

It is important for your safety and that of your passenger to have deployed air bags replaced and to have any malfunctioning air bags repaired. This will help to make sure the air bags continue to perform their protective function for the vehicle occupants in the event of a crash.

Front air bags

The front air bags increase protection for the driver's and front passenger's head and chest.

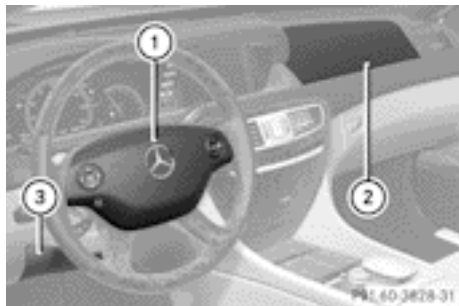

- ① Driver's air bag
- ② Front-passenger front air bag
- ③ Knee bag

Driver's air bag ① deploys in front of the steering wheel; front-passenger front air bag ② deploys in front of and above the glove box.

They are deployed:

- at the start of an accident with a high rate of vehicle acceleration or deceleration in a longitudinal direction
- if the system determines that air bag deployment can offer additional protection to that provided by the seat belt
- depending on whether the seat belt is being used
- independently of other air bags in the vehicle

If the vehicle rolls over, the front air bags are generally not deployed. If the system detects high vehicle deceleration in a longitudinal direction, the front air bags are deployed.

Your vehicle has adaptive, two-stage front air bags. In the event of a collision, the air bag control unit evaluates the vehicle deceleration. In the first deployment stage, the front air bag is filled with enough propellant gas to reduce the risk of injuries. The front air bag is fully deployed if a second deployment threshold is exceeded within a few milliseconds.

The deployment of the front-passenger front air bag is also influenced by the weight category of the front passenger, which is determined by the Occupant Classification System (OCS) (▷ page 50).

The lighter the passenger-side occupant, the higher the vehicle deceleration rate required (predicted at the start of the impact) for second stage inflation of the front-passenger front air bag. In the second stage, the front air bags are inflated with the maximum amount of propellant gas available.

The front air bags are not deployed in situations where a low impact severity is predicted. You will then be protected by the fastened seat belt.

Front-passenger front air bag ② will only be deployed if:

- the system, based on the OCS weight sensor readings, detects that the front-passenger seat is occupied
- the PASSENGER AIR BAG OFF indicator lamp on the center console is not lit (▷ page 50)
- the air bag control unit predicts a high impact severity

Driver's knee bag

Driver's knee bag ③ (▷ page 48) provides additional protection for the driver against:

- knee injuries
- thigh injuries
- lower leg injuries

Driver's knee bag ③ (▷ page 48) deploys below the steering wheel. During a frontal impact, if the system determines that air bag deployment can offer additional protection to that provided by the seat belt, driver's knee bag ③ (▷ page 48) is deployed along with the driver's air bag. Driver's knee bag ③ (▷ page 48) operates best in conjunction with a properly positioned and fastened seat belt.

Side impact air bags

WARNING

The pressure sensors for side impact air bag control are located in the doors. Do not modify any components of the doors or door trim panels including, for example, the addition of door speakers.

Improper repair work on the doors or the modification or addition of components to the doors create a risk of rendering the side impact air bags inoperative or causing unintended air bag deployment. Work on the doors must therefore only be performed by qualified technicians. Contact an authorized Mercedes-Benz Center.

WARNING

Only use seat covers which have been tested and approved by Mercedes-Benz for your vehicle model. Using other seat covers may interfere with or prevent the deployment of the side impact air bags. Contact an authorized Mercedes-Benz Center for availability.

When deployed, the side impact air bags offer additional protection for the thorax of the vehicle occupants on the side of the vehicle on which the impact occurs. However, they do not protect the:

- head
- neck
- arms

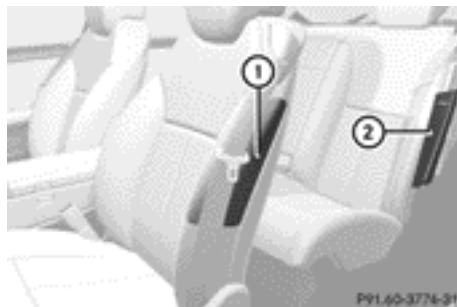

Front side impact air bags ① and rear side impact air bags ② deploy next to the outer seat cushions.

The side impact air bags are deployed:

- on the side on which an impact occurs
- at the start of an accident with a high rate of lateral vehicle deceleration or acceleration, e.g. in a side impact
- independently of the use of the seat belt
- independently of the front air bags
- independently of the ETDS

If the vehicle overturns, the side impact air bags are generally not deployed. Exception: if the system detects high vehicle deceleration or acceleration in a lateral direction and determines that deployment can offer additional protection to that provided by the seat belt.

Side impact air bags will not deploy in side impacts which do not exceed the system's preset deployment thresholds for lateral acceleration/deceleration. You will then be protected by the fastened seat belt.

The side impact air bag on the front-passenger side will not deploy under the following conditions:

- the OCS detects that the front-passenger seat is not occupied.
- the front-passenger seat belt is not fastened.

The side impact air bag on the front-passenger side will deploy if the front-passenger seat belt is fastened, regardless of whether the front-passenger seat is occupied or not.

Window curtain air bags

The window curtain air bags enhance the level of protection for the head, but not chest or arms, of the vehicle occupants on the side of the vehicle on which the impact occurs.

The window curtain air bags are integrated into the side of the roof frame and deploy in the area extending from the front door (A-pillar) to the rear sidewall (C-pillar).

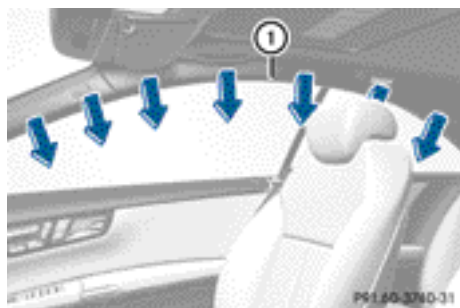

Window curtain air bags ① are deployed:

- on the side on which an impact occurs
- at the start of an accident with a high rate of lateral vehicle deceleration or acceleration, e.g. in a side impact
- regardless of whether the front-passenger seat is occupied
- independently of seat belt use
- if the vehicle overturns and the system determines that window curtain air bag



deployment can offer additional protection to that provided by the seat belt

- independently of the front air bags

Window curtain air bags ① will not deploy in impacts with deceleration rates which do not exceed the system's preset deployment thresholds for vehicle deceleration or acceleration. You will then be protected by the fastened seat belt.

Occupant Classification System (OCS)

How the Occupant Classification System works

The Occupant Classification System (OCS) categorizes the occupant on the front-passenger seat by means of a weight sensor. The front-passenger front air bag is deactivated automatically for certain weight categories. The  **PASS AIR BAG OFF** indicator lamp shows you the current status. If the  **PASS AIR BAG OFF** indicator lamp is illuminated, the front-passenger front air bag is deactivated.

The system does not deactivate:

- the side impact air bag
- the window curtain air bag
- the Emergency Tensioning Devices

To be classified correctly, the front passenger must sit:

- with the seat belt fastened correctly
- in a position that is as upright as possible with their back against the seat backrest
- with their feet on the floor



If the front-passenger's weight is transferred to another object in the vehicle (e.g. by leaning on armrests), OCS may not be able to approximate the occupant's weight category.

If the front-passenger seat, the seat cover or the seat cushion are damaged, have the necessary repair work carried out at an authorized Mercedes-Benz Center.

For safety reasons, Mercedes-Benz recommends that you only use seat accessories that have been approved by Mercedes-Benz.

Both the driver and the passenger should always use the  **PASS AIR BAG OFF** indicator lamp as an indication of whether or not the passenger is properly positioned.

WARNING



If the  **PASS AIR BAG OFF** indicator lamp lights up when an adult or someone larger than a small individual is in the front-passenger seat, have the front passenger reposition himself or herself in the seat until the  **PASS AIR BAG OFF** indicator lamp goes out.

In the event of a collision, the air bag control unit will not allow front-passenger front air bag deployment when the OCS has classified the front-passenger seat occupant as weighing as much as or less than a typical 12-month-old child in a standard child restraint or if the front-passenger seat is classified as being empty.

When the OCS senses that the front-passenger seat occupant is classified as being up to or less than the weight of a typical 12-month-old child in a standard child restraint, the  **PASS AIR BAG OFF** indicator lamp will illuminate when the engine is started and remain illuminated, indicating that the front-passenger front air bag is deactivated.

When the OCS senses that the front-passenger seat is classified as being empty, the  **PASS AIR BAG OFF** indicator lamp will illuminate when the engine is started and remain illuminated, indicating that the front-passenger front air bag is deactivated.

When the OCS senses that the front-passenger seat occupant is classified as being heavier than the weight of a typical 12-month-old child seated in a standard child restraint or as being a small individual (such as a young teenager or a small adult), the  **PASS AIR BAG OFF** indicator lamp will illuminate for approximately 6 seconds when the engine is started and then, depending on occupant

weight sensor readings from the front-passenger seat, remain illuminated or go out. With the  **PASS AIR BAG OFF** indicator lamp illuminated, the front-passenger front air bag is deactivated. With the  **PASS AIR BAG OFF** indicator lamp out, the front-passenger front air bag is activated.

When the OCS senses that the front-passenger seat occupant is classified as an adult or someone larger than a small individual, the  **PASS AIR BAG OFF** indicator lamp will illuminate for approximately 6 seconds when the engine is started and then go out, indicating that the front-passenger front air bag is activated.

If the  **PASS AIR BAG OFF** indicator lamp is illuminated, the front-passenger front air bag is deactivated and will not be deployed.

If the  **PASS AIR BAG OFF** indicator lamp is not illuminated, the front-passenger front air bag is activated and will be deployed:

- in the event of certain frontal impacts
- if impact exceeds a preset deployment threshold
- independently of the side impact air bags

If the front-passenger front air bag is deployed, the rate of inflation will be influenced by:

- the rate of vehicle deceleration as assessed by the air bag control unit
- the front passenger's weight category as identified by OCS

For further information, see "Air bag display messages" (> page 364).

WARNING



According to accident statistics, children are safer when properly restrained on the rear seats than on the front-passenger seat. Thus, we strongly recommend that children be placed in the rear seats whenever possible. Regardless of seating position, children 12 years old and under must be seated and properly secured in an appropriately sized child restraint system or booster seat

recommended for the size and weight of the child.



The infant or child restraint system must be properly secured with the vehicle's seat belt, the seat belt and Top Tether strap, or lower anchors and Top Tether strap, fully in accordance with the child seat manufacturer's instructions.

Occupants, especially children, should always sit as upright as possible, wear the seat belt properly and use an appropriate sized infant restraint, toddler restraint, or booster seat recommended for the size and weight of the child.

Children can be killed or seriously injured by an inflating air bag. Note the following important information when circumstances require you to place a child in the front-passenger seat:

- Your vehicle is equipped with air bag technology designed to deactivate the front-passenger front air bag in your vehicle when the system senses the weight of a typical 12-month-old child or less along with the weight of a standard appropriate child restraint on the front-passenger seat.
- A child in a rear-facing child restraint on the front-passenger seat will be seriously injured or even killed if the front-passenger front air bag inflates in a collision which could occur under some circumstances, even with the air bag technology installed in your vehicle. The only means to eliminate this risk completely is never to place a child in a rear-facing child restraint in the front-passenger seat. We therefore strongly recommend that you always place a child in a rear-facing child restraint on the rear seat.
- If you install a rear-facing child restraint on the front-passenger seat, make sure the  **PASS AIR BAG OFF** indicator lamp is illuminated, indicating that the front-passenger front air bag is deactivated. Should the  **PASS AIR BAG OFF** indicator lamp not illuminate or go out while the restraint

is installed, please check installation.

Periodically check the  **PASS AIR BAG OFF** indicator lamp while driving to make sure the  **PASS AIR BAG OFF** indicator lamp is illuminated. If the  **PASS AIR BAG OFF** indicator lamp goes out or remains out, do not transport a child on the front-passenger seat until the system has been repaired.

A child in a rear-facing child restraint on the front-passenger seat will be seriously injured or even killed if the front-passenger front air bag inflates.

- If you place a child in a forward-facing child restraint on the front-passenger seat:
 - move the seat as far back as possible
 - use the proper child restraint recommended for the age, size and weight of the child
 - secure child restraint with the vehicle's seat belt according to the child seat manufacturer's instructions
- For children larger than a typical 12-month-old child, the front-passenger front air bag can be activated or deactivated.

If the driver's air bag deploys, this does not mean that the front-passenger front air bag will also deploy.

The OCS may have detected that the seat:



- is either empty or occupied by a person with a weight up to that of a typical twelve-month-old child seated in a standard child restraint
- is occupied by a small individual, such as a young teenager or a small adult
- is occupied by a child in a child restraint system, whose weight is greater than that of a typical twelve-month-old child.

These are examples of when the OCS deactivates the front-passenger front air bag. Deactivation takes place although the collision fulfills the criteria for deploying the driver's air bag.



If the SmartKey has been removed from the ignition lock or is in position **0**, the  indicator lamp **1** does not light up.

WARNING

If the red SRS  indicator lamp in the instrument cluster and the  indicator lamp are lit at the same time, there is a malfunction in the OCS. The front passenger front air bag will be deactivated in this case. Have the system checked by qualified technicians as soon as possible. Contact an authorized Mercedes-Benz Center.

Only have the seat repaired or replaced at an authorized Mercedes-Benz Center.

In order to ensure proper operation of the air bag system and OCS:

- Sit with the seat belt properly fastened in a position that is as upright as possible with your back against the seat backrest.
- When seated, a passenger should not position him/herself in such a way as to cause the passenger's weight to be lifted from the seat cushion as this may result in the OCS being unable to correctly approximate the passenger's weight category.
- Read and observe all warnings in this chapter.

System self-test

The  indicator lamp illuminates when you:

- turn the SmartKey to position **1** or **2** in the ignition lock
- press the KEYLESS-GO Start/Stop button once or twice

If an adult occupant is sitting properly on the front-passenger seat and the OCS classifies the occupant as an adult, the

 indicator lamp will illuminate and go out again after approximately six seconds.

If the seat is not occupied and the OCS classifies the front passenger seat as being unoccupied, the  indicator lamp will illuminate and not go out.

WARNING

If the  indicator lamp does not illuminate, the system is not functioning. You must contact an authorized Mercedes-Benz Center before seating any child on the front passenger seat.

For more information, see "Problems with the Occupant Classification System"

(▷ page 54).

WARNING

Never place anything between seat cushion and child seat (e.g. a pillow), since it reduces the effectiveness of the OCS. The underside and rear side child restraint system must be placed entirely on the seat cushion and the backrest of the front-passenger seat backrest.

If necessary, adjust the tilt of the passenger seat backrest.

An incorrectly mounted child seat could cause injuries to the child in case of an accident, instead of increasing protection for the child.



Follow the manufacturer's instructions for installation of child restraint systems.

Problems with the Occupant Classification System

Problem	Possible causes/consequences and ► Solutions
<p>The  PASS AIR BAG OFF indicator lamp illuminates and remains illuminated.</p> <p>The person on the front-passenger seat:</p> <ul style="list-style-type: none"> • has the weight of a typical adult • has been determined by the system not to be a child 	<p>The OCS is malfunctioning.</p> <ul style="list-style-type: none"> ► Have the OCS checked as soon as possible at an authorized Mercedes-Benz Center. ► Observe the additional display messages in the multifunction display (► page 364).

WARNING

If the  **PASS AIR BAG OFF** indicator lamp illuminates and remains illuminated when the weight of a typical adult or someone larger than a small individual has been detected on the passenger seat, the system then determines the occupant cannot be a child. Do not allow any occupant to use the passenger seat until the system has been repaired.

Problem	Possible causes/consequences and ► Solutions
<p>The  PASS AIR BAG OFF indicator lamp does not illuminate and/or does not remain illuminated.</p> <p>The front-passenger seat is:</p> <ul style="list-style-type: none"> • unoccupied • occupied with a weight up to that of a typical twelve-month-old child in a standard child restraint system 	<p>The OCS is malfunctioning.</p> <ul style="list-style-type: none"> ► Make sure there is nothing between the seat cushion and the child seat. ► Check the installation of the child restraint system. ► Make sure that no objects are applying additional weight onto the seat. ► If the  PASS AIR BAG OFF indicator lamp does not illuminate, have the OCS checked as soon as possible at an authorized Mercedes-Benz Center. Do not transport a child on the front-passenger seat as long as the OCS is not functioning. ► Observe the additional display messages in the multifunction display (► page 364).

WARNING

If the  **PASS AIR BAG OFF** indicator lamp does not illuminate or remains out with the weight of a typical 12-month-old child in a standard child restraint or less, or is unoccupied, on the front-passenger seat, do not transport a child on the front-passenger seat until the system has been repaired.

PRE-SAFE® (anticipatory occupant protection system)

WARNING

The PRE-SAFE® system reduces the impact of an accident on vehicle occupants, as long as their seat belts have been fastened correctly. Although your vehicle is equipped with a PRE-SAFE® system, the possibility of injury in the event of an accident cannot be ruled out. You should therefore always drive carefully and adapt your driving style to the prevailing road, weather and traffic conditions.

PRE-SAFE® takes preemptive measures to protect occupants in certain hazardous situations.

PRE-SAFE® intervenes:

- if BAS PLUS intervenes powerfully on vehicles with DISTRONIC PLUS
- in critical driving situations, e.g. when physical limits are exceeded and the vehicle understeers or oversteers severely

PRE-SAFE® takes the following measures depending on the hazardous situation detected:

- the front-passenger seat is adjusted if it is in an unfavorable position.
- the air pressure in the side bolsters of the seat cushion and seat backrest of the front active multicontour seats is increased.
- if the vehicle skids, the side windows and sliding sunroof are closed so that only a small gap remains.

If the hazardous situation passes without resulting in an accident:

- the air pressure in the side bolsters of the active multicontour seat is reduced again.
- all settings made by PRE-SAFE® can then be reversed.

If the seat belts are not released:

- ▶ Move the backrest back slightly, but only when the vehicle is stationary. The belt pretensioning is reduced and the locking mechanism is released.

WARNING

Make sure that nobody can become trapped as you adjust the seat.

- ❗ Make sure that there are no objects in the footwell or behind the seats when resetting the seats. There is a risk that the seats and/or the objects could be damaged.

Seat belts

Important safety notes

The use of seat belts and infant and child restraint systems is required by law in all 50 states, the District of Columbia, the U.S. territories and all Canadian provinces.

Even where this is not the case, all vehicle occupants should have their seat belts fastened when the vehicle is in motion.

-  For further information on infants and children traveling in the vehicle and on infant and child restraint systems, see "Children in the vehicle" (▷ page 59).

WARNING

Always fasten your seat belt before driving off. Always make sure all of your passengers are properly restrained. You and your passengers should always wear seat belts.

Failure to wear and properly fasten and position your seat belt greatly increases your risk of injuries and their likely severity in an accident.

If you are ever in an accident, your injuries can be considerably more severe without your seat belt properly buckled. Without your seat belt buckled, you are much more likely to hit the interior of the vehicle or be ejected from it. You can be seriously injured or killed.

In the same crash, the possibility of injury or death is lessened if you are properly wearing your seat belt. The air bags can only protect as intended if the occupants are properly wearing their seat belts.

WARNING

Never ride in a moving vehicle with the seat backrest in an excessively reclined position as this can be dangerous. You could slide under the seat belt in a collision. If you slide under it, the seat belt would apply force at the abdomen or neck. That could cause serious or even fatal injuries. The seat backrest and seat belt provide the best restraint when the wearer is in a position that is as upright as possible and the seat belt is properly positioned on the body.

WARNING

Never let more people ride in the vehicle than there are seat belts available. Make sure everyone riding in the vehicle is correctly restrained with a separate seat belt. Never use a seat belt for more than one person at a time.

WARNING

Damaged seat belts or seat belts that have been subjected to stress in an accident must be replaced and their anchoring points must also be checked.

Only use seat belts which have been approved by Mercedes-Benz.

Do not make any modifications to the seat belts. This can lead to unintended activation of the ETDs or to their failure to activate when necessary.

Do not bleach or dye seat belts as this may severely weaken them. In a crash they may not be able to provide adequate protection.

Have all work carried out only by qualified technicians. Contact an authorized Mercedes-Benz Center.

Correct use of the seat belts

WARNING

USE SEAT BELTS PROPERLY

- Seat belts can only work when used properly. Never wear seat belts in any other way than as described in this section, as that could result in serious injuries in the event of an accident.
- Each occupant should wear their seat belt at all times, because seat belts help reduce the likelihood of and potential severity of injuries in accidents, including rollovers. The integrated restraint system includes SRS (driver front air bag, driver's side knee bag, front-passenger front air bag, side impact air bags, window curtain air bags for the side windows), Emergency Tensioning Devices, seat belt force limiters, and front seat knee bolsters.

The system is designed to enhance the protection offered to properly belted occupants in certain frontal (front air bags, driver's side knee bag and ETDs) and side (side impact air bags, window curtain air bags, and ETDs) impacts which exceed preset deployment thresholds and in certain rollovers (window curtain air bags and ETDs).

- Never wear the shoulder belt under your arm, across your neck or off your shoulder. In a frontal crash, your body would move too far forward. That would increase the chance of head and neck injuries. The seat belt would also apply too much force to the ribs or abdomen, which could severely injure internal organs such as your liver or spleen.

Adjust the seat belt so that the shoulder section is located as close as possible to the middle of the shoulder. It should not touch the neck. Never pass the shoulder portion of the seat belt under your arm. For this purpose, you can adjust the height of the seat belt outlet.

- Position the lap belt as low as possible on your hips and not across the abdomen. If the lap belt is positioned across your abdomen, it could cause serious injuries in a crash.
- Never wear seat belts over rigid or breakable objects in or on your clothing, such as eyeglasses, pens, keys etc., as these might cause injuries.
- Make sure the seat belt is always fitted snugly. Take special care of this when wearing loose clothing.
- Never use a seat belt for more than one person at a time. Do not fasten a seat belt around a person and another person or other objects at the same time.
- Seat belts should not be worn twisted. In a crash, you would not have the full width of the seat belt to distribute impact forces. The twisted seat belt against your body could cause injuries.
- Pregnant women should also always use a lap-shoulder belt. The lap belt portion should be positioned as low as possible on the hips to avoid any possible pressure on the abdomen.
- Place the seat backrest in a position that is as upright as possible.
- Check your seat belt during travel to make sure it is properly positioned.
- Never place your feet on the instrument panel, dashboard, or on the seat. Always keep both feet on the floor in front of the seat.
- When using a seat belt to secure infant restraints, toddler restraints, or children in booster seats, always follow the child seat manufacturer's instructions.

WARNING

Do not pass seat belts over sharp edges. They could tear.

Do not allow the seat belt to get caught in the door or in the seat adjustment mechanism. This could damage the seat belt.

Never attempt to make modifications to seat belts. This could impair the effectiveness of the seat belts.

Fastening seat belts

WARNING

According to accident statistics, children are safer when properly restrained on the rear seats than on the front-passenger seat. Thus, we strongly recommend that children be placed in the rear seat whenever possible. Regardless of seating position, children 12 years old and under must be seated and properly secured in an appropriately sized child restraint system or booster seat recommended for the size and weight of the child. For additional information, see the "Children in the vehicle" section.

A child's risk of serious or fatal injuries is significantly increased if the child restraints are not properly secured in the vehicle and/or the child is not properly secured in the child restraint.

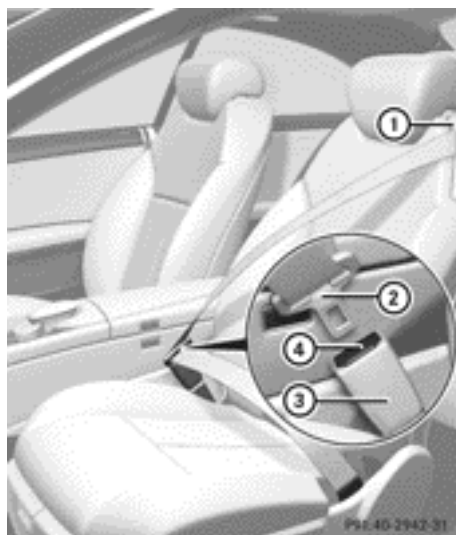

- ▶ Adjust the seat and move the backrest to an almost vertical position (▷ page 96).
- ▶ Pull the seat belt smoothly through belt sash guide ①.
- ▶ Without twisting it, guide the shoulder section of the seat belt across the middle of your shoulder and the lap section across your hips.
- ▶ Engage belt tongue ② in buckle ③.
- ▶ If necessary, pull upwards on the shoulder section of the seat belt to tighten the belt across your body.

All seat belts except the driver's seat belt are equipped with a special seat belt retractor to securely fasten child restraint systems in the vehicle. For further information about special seat belt retractors, see (▷ page 61).

For more information about releasing the seat belt with release button ④, see "Releasing seat belts" (▷ page 58).

Releasing seat belts

- ▶ Press release button ④ (▷ page 57) and guide belt tongue ② back towards belt sash guide ①.
- !** Make sure that the seat belt is fully rolled up. Otherwise, the seat belt or belt tongue will be trapped in the door or in the seat mechanism. This could damage the door, the door trim panel and the seat belt. Damaged seat belts can no longer fulfill their protective function and must be replaced. Visit a qualified specialist workshop.

Belt warning for the driver and front passenger

Regardless of whether the driver's and front-passenger seat belts have already been fastened, the  seat belt warning lamp will light up for six seconds each time the engine is started. It then goes out if the driver and the front passenger have fastened their seat belts.

If the driver's seat belt is not fastened when the engine is started, an additional warning tone will sound. The warning tone goes out after approximately six seconds or once the driver's seat belt is fastened.

If after six seconds the driver's or front-passenger seat belt is not fastened and the doors are closed, the  seat belt warning lamp will remain lit:

- until the driver's or front passenger's seat belt is fastened
- once the vehicle has exceeded a speed of 15 mph (25 km/h), in addition a warning tone will sound with increasing intensity for up to 60 seconds or until the driver's or front-passenger seat belt is fastened.

If the driver or front passenger unfastens their seat belt during the journey, the  seat belt warning lamp lights up and the warning tone sounds again.

The warning tone ceases after 60 seconds even if the driver or front passenger has still not fastened their seat belt. The  seat belt warning lamp stops flashing, but remains lit.

After the vehicle has come to a stop, the warning tone will be reactivated and the  seat belt warning lamp will flash again once the vehicle has exceeded a speed of 15 mph (25 km/h).

The  seat belt warning lamp will not go out until:

- both the driver and the front passenger have fastened their seat belts.
- or
- the vehicle is stationary and a door is open.

i For more information on the  seat belt warning lamp, see "Warning and indicator lamps in the instrument cluster, seat belt" (▷ page 389).

Emergency Tensioning Devices, seat belt force limiters

The seat belts are equipped with ETDs and seat belt force limiters.

The ETDs tighten the seat belts in an accident, pulling them close against the body.

The ETDs do not correct incorrect seat positions or incorrectly fastened seat belts.

The ETDs do not pull vehicle occupants back towards the backrest.

Seat belt force limiters, when triggered, help to reduce the peak force exerted by the seat belt on the vehicle occupant.

The seat belt force limiters for the front seats are synchronized with the front air bags.

These take on a part of the deceleration force. Thus, the force exerted on the occupant is distributed over a greater area.

The ETDs can only be activated when:

- the ignition is switched on.
- the restraint systems are operational; see "SRS warning lamp" (▷ page 44).
- the belt tongue is engaged in the buckle on each of the lap-shoulder belts in the front.
- the front-passenger seat is occupied and the belt tongue is engaged in the buckle on the front-passenger side.

The ETDs on the seats in the rear compartment are triggered independently of the lock status of the seat belts.

The ETDs are triggered depending on the type and severity of an accident:

- if, in the event of a head-on or rear-end collision, the vehicle decelerates or accelerates rapidly in a longitudinal direction during the initial stages of the impact
- if, in the event of a side impact, on the side opposite the impact the vehicle decelerates or accelerates rapidly in a lateral direction
- if, in certain situations where the vehicle overturns, the system determines that it can provide additional protection

If the air bags are deployed, you will hear a bang, and a small amount of powder may also be released. Only in rare cases will the bang affect your hearing. The powder that is released generally does not constitute a health hazard. The  SRS warning lamp lights up.

WARNING

Pyrotechnic ETDs that were activated must be replaced.

For your safety, when disposing of the pyrotechnic ETDs always follow our safety instructions. These are available at any authorized Mercedes-Benz Center.

- ❗ If the front-passenger seat is not occupied, do not engage the seat belt tongue in the buckle on the front-passenger seat. Otherwise, the Emergency Tensioning Device could be triggered in the event of an accident.

Automatic comfort-fit feature

The front seat belts have an automatic comfort-install feature. The automatic comfort-install feature reduces the retraction force of the seat belts. This results in increased seat belt comfort.

Children in the vehicle

Child restraint systems

Important safety notes

We recommend that all infants and children be properly secured in an infant or child restraint system at all times while the vehicle is in motion.

The use of seat belts and infant and child restraint systems is required by law in all 50 states, the District of Columbia, the U.S. territories and all Canadian provinces.

Infants and children must always be seated in an appropriate infant or child restraint system recommended for the size and weight of the

child. The infant or child restraint system must be properly secured in accordance with the manufacturer's instructions. All infant or child restraint systems must comply with U.S. Federal Motor Vehicle Safety Standards 213 and 225 and Canadian Motor Vehicle Safety Standards 213 and 210.2.

An information label on the child restraint system indicates whether it meets these standards. This information is also provided in the installation instructions supplied with the child restraint system.

Always read and follow the manufacturer's instructions when using an infant or child restraint system or booster seat.

Observe all warning signs in the vehicle interior and on the infant or child restraint.





WARNING

According to accident statistics, children are safer when properly restrained on the rear seats than on the front-passenger seat. Thus, we strongly recommend that children be placed in the rear seats whenever possible. Regardless of seating position, children 12 years old and under must be seated and properly secured in an appropriately sized child restraint system or booster seat recommended for the size and weight of the child.

The infant or child restraint system must be properly secured with the vehicle's seat belt, the seat belt and Top Tether strap, or lower anchors and Top Tether strap, fully in accordance with the child seat manufacturer's instructions.

Occupants, especially children, should always sit as upright as possible, wear the seat belt properly and use an appropriate sized infant restraint, toddler restraint, or booster seat recommended for the size and weight of the child.

Children can be killed or seriously injured by an inflating air bag. Note the following important information when circumstances require you to place a child in the front-passenger seat:

- Your vehicle is equipped with air bag technology designed to deactivate the front-passenger front air bag in your vehicle when the system senses the weight of a typical 12-month-old child or less along with the weight of a standard appropriate child restraint on the front-passenger seat.
- A child in a rear-facing child restraint on the front-passenger seat will be seriously injured or even killed if the front-passenger front air bag inflates in a collision which could occur under some circumstances, even with the air bag technology installed in your vehicle. The only means to eliminate this risk completely is never to place a child in a rear-facing child restraint in the front-passenger seat. We therefore strongly recommend that you always place a child in a rear-facing child restraint on the rear seat.
- If you install a rear-facing child restraint on the front-passenger seat, make sure the  **PASS AIR BAG OFF** indicator lamp is illuminated, indicating that the front-passenger front air bag is deactivated. Should the  **PASS AIR BAG OFF** indicator lamp not illuminate or go out while the restraint is installed, please check installation. Periodically check the  **PASS AIR BAG OFF** indicator lamp while driving to make sure the  **PASS AIR BAG OFF** indicator lamp is illuminated. If the  **PASS AIR BAG OFF** indicator lamp goes out or remains out, do not transport a child on the front-passenger seat until the system has been repaired. A child in a rear-facing child restraint on the front-passenger seat will be seriously injured or even killed if the front-passenger front air bag inflates.

- If you place a child in a forward-facing child restraint on the front-passenger seat:
 - move the seat as far back as possible
 - use the proper child restraint recommended for the age, size and weight of the child
 - secure child restraint with the vehicle's seat belt according to the child seat manufacturer's instructions
- For children larger than a typical 12-month-old child, the front-passenger front air bag can be activated or deactivated.

WARNING

Infants and small children should never share a seat belt with another occupant. In the event of an accident, they could be crushed between the occupant and seat belt.

A child's risk of serious or fatal injuries is significantly increased if the child restraints are not properly secured in the vehicle and/or the child is not properly secured in the child restraint.

Children that are too large for a child restraint must travel in seats using normal seat belts. Position the shoulder belt across the chest and shoulder, not face or neck. A booster seat may be necessary to achieve proper seat belt positioning for children over 41 lb (18 kg) until they reach a height where a lap-shoulder belt fits properly without a booster.

When the child restraint is not in use, remove it from the vehicle or secure it with the seat belt to prevent the child restraint from becoming a projectile in the event of an accident.

If an infant or child is traveling in the vehicle:

- ▶ Secure the infant or child with an appropriate infant or child restraint recommended for the child's age and weight.
- ▶ Make sure that the infant or child is properly secured at all times while the vehicle is in motion.

WARNING

When leaving the vehicle, always remove the SmartKey from the ignition lock. Always take the SmartKey with you and lock the vehicle. Do not leave children unattended in the vehicle, even if they are secured in a child restraint system, or with access to an unlocked vehicle. A child's unsupervised access to a vehicle could result in an accident and/or serious personal injury. The children could:

- injure themselves on parts of the vehicle
- be seriously or fatally injured through excessive exposure to extreme heat or cold
- injure themselves or cause an accident with vehicle equipment that can be operated even if the SmartKey is removed from the ignition lock or removed from the vehicle, such as seat adjustment, steering wheel adjustment, or the memory function

If children open a door, they could injure other persons or get out of the vehicle and injure themselves or be injured by following traffic.

Do not expose the child restraint system to direct sunlight. The child restraint system's metal parts, for example, could become very hot, and the child could be burned on these parts.

WARNING

Do not carry heavy or hard objects in the passenger compartment or trunk unless they are firmly secured in place.

Unsecured or improperly positioned cargo increases a child's risk of injury in the event of

- strong braking maneuvers
- sudden changes of direction
- an accident

Special seat belt retractor

All seat belts except the driver's seat belt are equipped with a special seat belt retractor. When activated, the special seat belt

retractor ensures the seat belt will not slacken once the child restraint system has been secured.

Installing a child restraint system:

- ▶ Always comply with the manufacturer's installation instructions.
- ▶ Pull the seat belt smoothly from the inertia reel.
- ▶ Engage the seat belt tongue in the belt buckle.

Activating the special seat belt retractor:

- ▶ Pull the seat belt out fully and let the inertia reel retract it again.
While the seat belt is retracting, you should hear a ratcheting sound. The special seat belt retractor is enabled.
- ▶ Push down on the child restraint system to take up any slack.

Removing a child restraint system/
deactivating the special seat belt retractor:

- ▶ Always comply with the manufacturer's installation instructions.
- ▶ Press the seat belt release button and guide the belt tongue to the belt outlet. The special seat belt retractor is deactivated.

WARNING

Never release the seat belt buckle while the vehicle is in motion, since the special seat belt retractor will be deactivated.

LATCH-type (ISOFIX) child seat anchors in the rear

WARNING

Children that are too large for a child restraint must travel in seats using normal seat belts. Position shoulder belt across the chest and shoulder, not face or neck.

A booster seat may be necessary to achieve proper seat belt positioning for children over 41 lb (18 kg) until they reach a height where

a lap/shoulder belt fits properly without a booster.

Install the child restraint system in accordance with the manufacturer's instructions.

Attach the child restraint system to both securing rings.

An incorrectly installed child restraint system could come loose during an accident and seriously or even fatally injure the child.

Child restraint systems or child seat securing rings that are malfunctioning or damaged as the result of a collision must be replaced.

ISOFIX is a standardized securing system for specially designed child restraint systems on the rear seats. Securing rings for two LATCH-type (ISOFIX) child restraint systems are installed on the left and right of the rear seats. Secure non-LATCH-type (ISOFIX) child restraint systems using the vehicle's seat belt system. Always install child restraint systems according to the manufacturer's instructions.

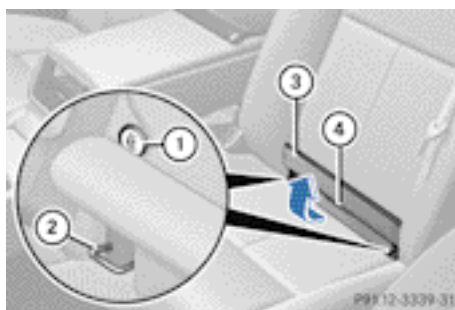

Installation instructions ① indicate the installation location of securing rings ②.

- ▶ Fold upholstery cover ③ and the Velcro fastener upwards.
- ▶ Turn installation aid ④ to a vertical position to prevent upholstery cover ③ from folding down.
- ▶ Install the LATCH-type (ISOFIX) child restraint systems on both securing rings ②. Comply with the manufacturer's

instructions when installing the LATCH-type (ISOFIX) child restraint system.

Top Tether

Top Tether provides an additional connection between the child restraint system secured with ISOFIX and the rear seat. It helps reduce the risk of injury even further.

The Top Tether anchorage points are located in the rear compartment behind the head restraints.

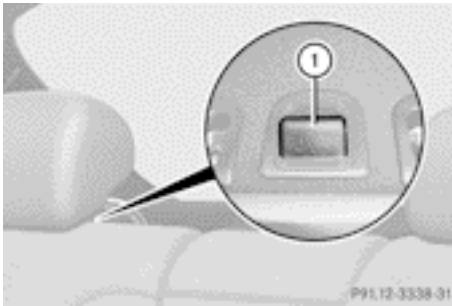

- ▶ Remove respective covering cap ① of the Top Tether anchorage.
- ▶ Place covering cap ① in a suitable place (e.g. in the glove box).

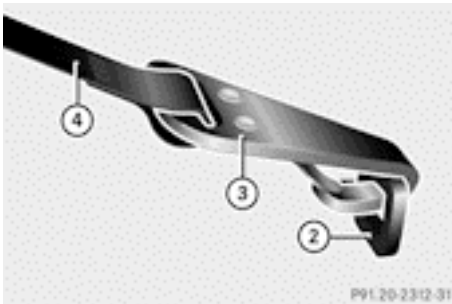

- ▶ Move the head restraint upwards.
- ▶ Route Top Tether belt ④ under the head restraint between the two head restraint bars.
- ▶ Hook Top Tether hook ③ of Top Tether belt ④ into Top Tether anchorage ②.

Ensure that:

- Top Tether hook ③ is hooked into Top Tether anchorage ② as shown.
 - Top Tether belt ④ is not twisted.
 - Top Tether belt ④ can move freely between the rear seat backrest and the head restraint.
- ▶ Install the LATCH-type (ISOFIX) child restraint system with Top Tether. Comply with the manufacturer's installation instructions when doing so. Make sure that Top Tether belt ④ is tight.

The child restraint system with Top Tether belt ④ has been removed:

- ▶ Slide covering cap ① onto Top Tether anchorage ②.

Child-proof locks

Important safety notes

WARNING

When leaving the vehicle, always remove the SmartKey from the ignition lock. Always take the SmartKey with you and lock the vehicle. Do not leave children unattended in the vehicle, even if they are secured in a child restraint system, or with access to an unlocked vehicle. A child's unsupervised access to a vehicle could result in an accident and/or serious personal injury. The children could:

- injure themselves on parts of the vehicle
- be seriously or fatally injured through excessive exposure to extreme heat or cold
- injure themselves or cause an accident with vehicle equipment that can be operated even if the SmartKey is removed from the ignition lock or removed from the vehicle, such as seat adjustment, steering wheel adjustment, or the memory function

If children open a door, they could injure other persons or get out of the vehicle and injure themselves or be injured by following traffic.

Do not expose the child restraint system to direct sunlight. The child restraint system's metal parts, for example, could become very hot, and the child could be burned on these parts.

Override feature for the rear side windows

WARNING

When children ride on the vehicle's rear seats, activate the override switch. Otherwise the children could be injured, e.g. by trapping themselves in the rear side window.

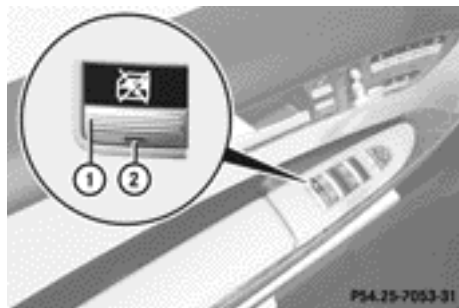

- ▶ **To activate/deactivate:** press button ①. If indicator lamp ② is lit, operation of the rear side windows is deactivated. Operation is only possible using the switches in the driver's door. If indicator lamp ② is off, operation is possible using the switches in the rear compartment.

Panic alarm



- ▶ **To activate:** press **PANIC** button ① for approximately one second. An alarm sounds and the exterior lighting flashes.
 - ▶ **To deactivate:** press **PANIC** button ① again.
- or
- ▶ Insert the SmartKey into the ignition lock.
- or
- ▶ Press the KEYLESS-GO Start/Stop button. The KEYLESS-GO key must be in the vehicle.

Driving safety systems

Overview of driving safety systems

In this section, you will find information about the following driving safety systems:

- ABS (**A**nti-**l**ock **B**raking **S**ystem)
- BAS (**B**rake **A**ssist **S**ystem)
- BAS PLUS (**B**rake **A**ssist **S**ystem Plus)
- ESP® (**E**lectronic **S**tability **P**rogram)
- EBD (**E**lectronic **B**rake force **D**istribution)
- ADAPTIVE BRAKE
- PRE-SAFE® Brake

Important safety notes

If you fail to adapt your driving style or become distracted, the driving safety

systems can neither reduce the risk of accident nor override the laws of physics. Driving safety systems are merely aids designed to assist driving. You are responsible for the distance to the vehicle in front, for vehicle speed and for braking in good time. Always adapt your driving style to suit the prevailing road and weather conditions and maintain a safe distance from the vehicle in front. Drive carefully.

- i** The driving safety systems described only work as effectively as possible when there is adequate contact between the tires and the road surface. Pay particular attention to the information regarding tires, recommended minimum tire tread depths etc. in the "Wheels and tires" section (▷ page 454).

In wintry driving conditions, always use winter tires (M+S tires) and if necessary, snow chains. Only in this way will the driving safety systems described in this section work as effectively as possible.

ABS (Anti-lock Braking System)

Important safety notes

- i** Observe the "Important safety notes" section (▷ page 64).

WARNING

If ABS is faulty, the wheels could lock when braking. The steerability and braking characteristics may be severely impaired. Additionally, further driving safety systems are deactivated. There is an increased danger of skidding and accidents.

Drive on carefully. Have ABS checked immediately at a qualified specialist workshop.

When ABS is malfunctioning, other systems, including driving safety systems, will also become inoperative. Observe the information on the ABS warning lamp (▷ page 391) and

display messages which may be shown in the instrument cluster (▷ page 353).

ABS regulates brake pressure in such a way that the wheels do not lock when you brake. This allows you to continue steering the vehicle when braking.

ABS works from a speed of about 5 mph (8 km/h) upwards, regardless of road-surface conditions. ABS works on slippery surfaces, even if you only brake gently.

The  warning lamp in the instrument cluster lights up when the ignition is switched on. It goes out when the engine is running.

Braking:

- ▶ **If ABS intervenes:** continue to depress the brake pedal vigorously until the braking situation is over.
- ▶ **To make a full brake application:** depress the brake pedal with full force.

If ABS intervenes when braking, you will feel a pulsing in the brake pedal.

The pulsating brake pedal can be an indication of hazardous road conditions and functions as a reminder to take extra care while driving.

BAS (Brake Assist System)

- i** Observe the "Important safety notes" section (▷ page 64).

WARNING

If BAS is malfunctioning, the braking distance in an emergency braking situation is increased. There is a risk of an accident.

In an emergency braking situation, depress the brake pedal with full force. ABS prevents the wheels from locking.

BAS operates in emergency braking situations. If you depress the brake pedal quickly, BAS automatically boosts the braking force, thus shortening the stopping distance.

The brakes will function as usual once you release the brake pedal. BAS is deactivated.

BAS PLUS (Brake Assist System PLUS)

BAS PLUS is only available in vehicles equipped with DISTRONIC PLUS.

- ❗ Observe the "Important safety notes" section (> page 64).

BAS PLUS provides braking assistance in hazardous situations at speeds greater than 4 mph (7 km/h) and uses radar sensor technology to assess the traffic situation. With the help of the radar sensor system, BAS PLUS can detect obstacles that are in the path of your vehicle for an extended period of time.

At speeds up to 40 mph (70 km/h), BAS PLUS may also detect stationary obstacles, for example stopped or parked vehicles.

Should you approach an obstacle and BAS PLUS has detected a risk of collision, BAS PLUS calculates the braking force necessary to avoid a rear-end collision.

- **When driving at a speed above 20 mph (30 km/h):** if you depress the brake pedal sharply, BAS PLUS automatically raises the brake pressure to a value adapted to the traffic situation.
- **When driving at a speed under 20 mph (30 km/h):** if you depress the brake pedal, BAS PLUS is activated. Braking is performed as late as possible.

If BAS PLUS demands particularly high braking force, preventative passenger protection measures (PRE-SAFE®) are activated simultaneously.

- ▶ Keep the brake pedal depressed until the emergency braking situation is over. ABS prevents the wheels from locking.

The brakes will work normally again if:

- you release the brake pedal
- there is no longer any danger of a rear-end collision
- no obstacle is detected in front of your vehicle

BAS PLUS is then deactivated.

For BAS PLUS to assist you, the radar sensor system must be operational.

WARNING

Adaptive Brake Assist cannot always clearly identify objects and complex traffic situations. In these cases, Adaptive Brake Assist may not intervene. There is a risk of an accident.

Always pay careful attention to the traffic situation and be ready to brake.

In particular, the detection of obstacles can be impaired if there is:

- dirt on the sensors or anything else covering the sensors
- snow or heavy rain
- interference by other radar sources
- there are strong radar reflections, for example in parking garages
- a narrow vehicle traveling in front, e.g. a motorbike
- a vehicle traveling in front on a different line relative to the center of your vehicle

WARNING

BAS PLUS does not react:

- to people or animals
- to oncoming vehicles
- to crossing traffic
- when cornering

As a result, BAS PLUS may not intervene in all critical situations. There is a risk of an accident.

Always pay careful attention to the traffic situation and be ready to brake.

Following damage to the front end of the vehicle, have the configuration and operation of the radar sensors checked at a qualified specialist workshop. This also applies to collisions at low speeds where there is no visible damage to the front of the vehicle.

If BAS PLUS is not available due to a malfunction in the radar sensor system, the brake system remains available with full brake boosting effect and BAS.

ESP® (Electronic Stability Program)

Important safety notes

- ⓘ Observe the "Important safety notes" section (▷ page 64).

WARNING

If ESP® is malfunctioning, ESP® is unable to stabilize the vehicle. Additionally, further driving safety systems are deactivated. This increases the risk of skidding and an accident.



Drive on carefully. Have ESP® checked at a qualified specialist workshop.

- ❗ Vehicles with 4MATIC: switch off the ignition when the parking brake is being tested on a brake dynamometer.

Application of the brakes by ESP® may otherwise destroy the brake system.

Vehicles without 4MATIC: when towing your vehicle with the rear axle raised, it is important that you observe the notes on ESP® (▷ page 448).

ESP® is deactivated if the  warning lamp in the instrument cluster lights up continuously when the engine is running.

If the  warning lamp and the  warning lamp are lit continuously, ESP® is not available due to a malfunction.

Observe the information on warning lamps (▷ page 393) and display messages which may be shown in the instrument cluster (▷ page 353).

If ESP® detects that the vehicle is deviating from the direction desired by the driver, one or more wheels are braked to stabilize the vehicle. The engine output is also modified to keep the vehicle on the desired course within physical limits. ESP® assists the driver when pulling away on wet or slippery roads. ESP® can also stabilize the vehicle during braking. If ESP® intervenes, the  ESP® warning lamp flashes in the instrument cluster.

If ESP® intervenes:

- ▶ Do not deactivate ESP® under any circumstances.
- ▶ Only depress the accelerator pedal as far as necessary when pulling away.
- ▶ Adapt your driving style to suit the prevailing road and weather conditions.

- ⓘ Only use wheels with the recommended tire sizes. Only then will ESP® function properly.

ETS/4ETS (Electronic Traction System)

Traction control is part of ESP®.

Traction control brakes the drive wheels individually if they spin. This enables you to pull away and accelerate on slippery surfaces, for example if the road surface is slippery on one side. On vehicles with 4MATIC, more drive torque is also transferred to the wheel or wheels with traction.

Traction control remains active if you deactivate ESP®.

Deactivating/activating ESP®

- ⓘ Observe the "Important safety notes" section (▷ page 64).

WARNING

If you deactivate ESP®, ESP® no longer stabilizes the vehicle. There is an increased risk of skidding and an accident.

Only deactivate ESP® in the situations described in the following.

! Avoid spinning the driven wheels for an extended period with ESP® deactivated. You could otherwise damage the drivetrain.

▶ **To deactivate:** (▷ page 348).

The  ESP® OFF warning lamp in the instrument cluster lights up.

CL 63 AMG: deactivate ESP® when driving on designated roads when the vehicle's own oversteering and understeering characteristics are desired. Driving without ESP® requires an extremely qualified and experienced driver who is able to cope with these critical driving conditions.

▶ **To activate:** (▷ page 348).

The  ESP® OFF warning lamp in the instrument cluster goes out.

ESP® is activated automatically when the engine is started.

If ESP® is deactivated and one or more wheels start to spin, the  ESP® warning lamp in the instrument cluster flashes. In such situations, ESP® will not stabilize the vehicle. It may be best to deactivate ESP® in the following situations:

- when using snow chains
- in deep snow
- on sand or gravel

If you deactivate ESP®:

- ESP® no longer improves driving stability.
- traction control is still activated.
- ESP® still provides support when you brake.
- the engine's torque is no longer limited, and the drive wheels can spin. The spinning of the wheels results in a cutting action, which provides better grip.

Vehicles with ECO start/stop function: the ECO start/stop function switches the engine off automatically when the vehicle comes to a stop. The engine starts automatically when the driver wants to pull away again. ESP® remains in its previously selected status. Example: if ESP® was deactivated before the

engine was switched off, ESP® remains deactivated when the engine is switched on again.

EBD (electronic brake force distribution)

i Observe the "Important safety notes" section (▷ page 64).

WARNING

If EBD has malfunctioned, the rear wheels can still lock, e.g. under full braking. This increases the risk of skidding and an accident. You should therefore adapt your driving style to the different handling characteristics. Have the brake system checked at a qualified specialist workshop.

Observe information regarding indicator and warning lamps (▷ page 391) as well as display messages (▷ page 357).

EBD monitors and controls the brake pressure on the rear wheels to improve driving stability while braking.

ADAPTIVE BRAKE

ADAPTIVE BRAKE enhances braking safety and offers increased braking comfort. In addition to the braking function, ADAPTIVE BRAKE also has the HOLD function (▷ page 308) and hill start assist (▷ page 275).

PRE-SAFE® Brake

i Observe the "Important safety notes" section (▷ page 64).

PRE-SAFE® Brake is only available in vehicles with DISTRONIC PLUS.

PRE-SAFE® Brake can help you to minimize the risk of a collision with a vehicle ahead or reduce the effects of such a collision. If PRE-SAFE® Brake has detected a risk of collision,

you will be warned visually and acoustically as well as by automatic braking. PRE-SAFE® Brake cannot prevent a collision without your intervention.

Starting at a speed of around 4 mph (7 km/h), this function warns you if you rapidly approach a vehicle in front. An intermittent warning tone will then sound and the  distance warning lamp will light up in the instrument cluster.

► Brake immediately in order to increase the distance from the vehicle in front.

or

► Take evasive action provided it is safe to do so.

From a speed of approximately 4 mph (7 km/h), if the driver and front passenger have fastened their seat belts, PRE-SAFE® Brake can brake the vehicle automatically at speeds up to approximately 124 mph (200 km/h).

Due to the nature of the system, particularly complicated driving conditions may cause unnecessary warnings or the unnecessary intervention of PRE-SAFE® Brake.

You can prevent the intervention of the PRE-SAFE® Brake at any time by:

- depressing the accelerator pedal further.
- activating kickdown.
- releasing the brake pedal.

The braking action of PRE-SAFE® Brake is ended automatically if:

- you maneuver to avoid the obstacle.
- there is no longer any danger of a rear-end collision.
- there is no longer an obstacle detected in front of your vehicle.

With the help of the radar sensor system, PRE-SAFE® Brake can detect obstacles that are in front of your vehicle for an extended period of time.

At speeds up to approximately 40 mph (70 km/h), PRE-SAFE® Brake can

also detect stationary obstacles such as stopped or parked vehicles.

If you approach an obstacle and PRE-SAFE® Brake detects a risk of collision, the system will initially alert you both visually and acoustically. If you do not brake or take evasive action, the system will warn you by automatically braking the vehicle gently. If there is an increased risk of collision, preventative passenger protection measures (PRE-SAFE®) are activated (▷ page 55). If a risk of collision remains at speeds of over 20 mph (30 km/h) and you do not brake, take evasive action or significantly accelerate, automatic emergency braking may be performed up to and including full brake application. Automatic emergency braking is not performed until immediately prior to an accident that can no longer be avoided.

WARNING

PRE-SAFE® Brake will initially brake your vehicle by a partial application of the brakes if a danger of collision is detected. There may be a collision unless you also brake. Automatic emergency braking cannot prevent a collision. There is a risk of an accident. Always apply the brakes yourself and try to take evasive action.

WARNING

PRE-SAFE® Brake cannot always clearly identify objects and complex traffic conditions.

In these cases, PRE-SAFE® Brake may:

- give an unnecessary warning and then brake the vehicle
- not give a warning or intervene

There is a risk of an accident.

Always pay particular attention to the traffic situation and be ready to brake, especially if PRE-SAFE® Brake warns you. Terminate the intervention in a non-critical driving situation.

In particular, the detection of obstacles can be impaired if:

- dirt on the sensors or anything else covering the sensors
- snow or heavy rain
- interference by other radar sources
- there are strong radar reflections, for example in parking garages
- a narrow vehicle traveling in front, e.g. a motorbike
- a vehicle traveling in front on a different line relative to the center of your vehicle

WARNING

PRE-SAFE® Brake does not react:

- to people or animals
- to oncoming vehicles
- to crossing traffic
- when cornering

As a result, PRE-SAFE® Brake may neither give warnings nor intervene in all critical situations. There is a risk of an accident.

Always pay careful attention to the traffic situation and be ready to brake.

In order to maintain an appropriate distance from the vehicle in front and thus prevent a collision, you must apply the brakes yourself.

- ▶ **To activate/deactivate:** activate or deactivate PRE-SAFE® Brake in the on-board computer (> page 348). After activation, the  symbol is displayed on the left in the instrument cluster.

For BAS PLUS to assist you, the radar sensor system must be operational.

Following damage to the front end of the vehicle, have the configuration and operation of the radar sensors checked at a qualified specialist workshop. This also applies to collisions at low speeds where there is no visible damage to the front of the vehicle.

Theft deterrent locking system

Immobilizer

The immobilizer prevents your vehicle from being started without the correct SmartKey. When leaving the vehicle, always take the SmartKey with you and lock the vehicle. The engine can be started by anyone with a valid SmartKey that is left inside the vehicle.

- ▶ **To activate with the SmartKey:** remove the SmartKey from the ignition lock.
- ▶ **To activate with KEYLESS-GO:** switch the ignition off and open the driver's door.
- ▶ **To deactivate:** switch on the ignition.

- i** The immobilizer is always deactivated when you start the engine.

In the event that the engine cannot be started when the starter battery is fully charged, the immobilizer may be faulty. Contact an authorized Mercedes-Benz Center or call 1-800-FOR-MERCEdes (in USA) or 1-800-387-0100 (in Canada).

ATA (anti-theft alarm system)

A visual and audible alarm is triggered if the alarm system is armed and you open:

- a door
- the vehicle with the mechanical key
- the trunk lid
- the hood

The alarm is not switched off, even if you close the open door that has triggered it, for example.

i If the alarm stays on for more than 30 seconds, the mbrace (USA only) or TELE AID (Canada only) emergency call system initiates a call to the Customer Assistance Center automatically. The emergency call system initiates the call provided that:

- you have subscribed to the mbrace/TELE AID service.
- the mbrace/TELE AID service has been activated properly.
- the required mobile phone, power supply and GPS are available.

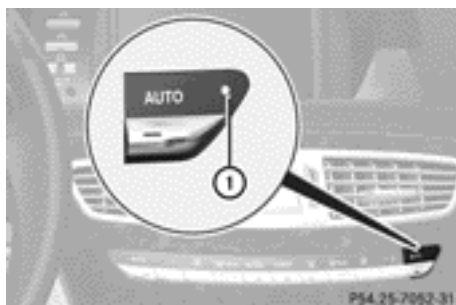



► **To arm:** lock the vehicle with the SmartKey or KEYLESS-GO.

Indicator lamp ① flashes. The alarm system is armed after approximately 30 seconds.

► **To disarm:** unlock the vehicle with the SmartKey or KEYLESS-GO.

► **To stop the alarm using the SmartKey:** insert the SmartKey into the ignition lock. The alarm is switched off.

or

► Press the  or  button on the SmartKey. The alarm is switched off.

► **To stop the alarm using KEYLESS-GO:** grasp the outside door handle. The SmartKey must be outside the vehicle. The alarm is switched off.

or

► Press the Start/Stop button on the dashboard. The SmartKey must be inside the vehicle. The alarm is switched off.

Vehicle equipment	74
SmartKey	74
Doors	81
Trunk	84
Side windows	88
Sliding sunroof	91

Vehicle equipment

- i** This Operator's Manual describes all models and all standard and optional equipment of your vehicle available at the time of publication of the Operator's Manual. Country-specific differences are possible. Please note that your vehicle may not be equipped with all features described. This also applies to safety-relevant systems and functions.

SmartKey

Important safety notes

WARNING

When leaving the vehicle, always remove the SmartKey from the starter switch. Always take the SmartKey with you and lock the vehicle. Do not leave children unattended in the vehicle, even if they are secured in a child restraint system, or with access to an unlocked vehicle. A child's unsupervised access to a vehicle could result in an accident and/or serious personal injury. The children could

- injure themselves on parts of the vehicle
- be seriously or fatally injured through excessive exposure to extreme heat or cold
- injure themselves or cause an accident with vehicle equipment that can be operated even if the SmartKey is removed from the starter switch or removed from the vehicle, such as seat adjustment, steering wheel adjustment, or the memory function

If children open a door, they could injure other persons or get out of the vehicle and injure themselves or be injured by following traffic.

Do not expose the child restraint system to direct sunlight. The child restraint system's metal parts, for example, could become very hot, and the child could be burned by these parts.

WARNING

Do not carry heavy or hard objects in the passenger compartment unless they are firmly secured in place.

Unsecured or improperly positioned cargo increases a child's risk of injury in the event of:

- strong braking maneuvers
- sudden changes of direction
- an accident

General notes

If you cannot open or lock the vehicle with the SmartKey, either the battery in the SmartKey is empty, the SmartKey is faulty, or the starter battery is discharged.

- ▶ Check the battery in the SmartKey and replace it if necessary (▷ page 78).
- ▶ Unlock the driver's door with the mechanical key (▷ page 83).
- ▶ Lock the vehicle (▷ page 83).
- ▶ Have the starter battery and battery contacts checked by an authorized Mercedes-Benz Center.

If the SmartKey is faulty, contact Roadside Assistance or an authorized Mercedes-Benz Center.

SmartKey functions

General notes

- i** Only for USA:

This device complies with Part 15 of the FCC rules. Operation is subject to the following conditions:

1. This device must not cause any interference, and
2. This device must be able to accommodate interference that is received, including interference which could cause unwanted functions.

Unapproved modifications to this device may lead to withdrawal of permission to operate it.

The product label with FCC ID and IC certification number can be found in the battery case of the SmartKey.

i Only for Canada:

This device complies with Industry Canada's RSS210 rules. Operation is subject to the following conditions:

1. This device must not cause any interference, and
2. This device must be able to accommodate interference that is received, including interference which could cause unwanted functions.

Unapproved modifications to this device may lead to withdrawal of permission to operate it.



The product label with FCC ID and IC certification number can be found in the battery case of the SmartKey.

Locking and unlocking centrally

The SmartKey centrally locks/unlocks:

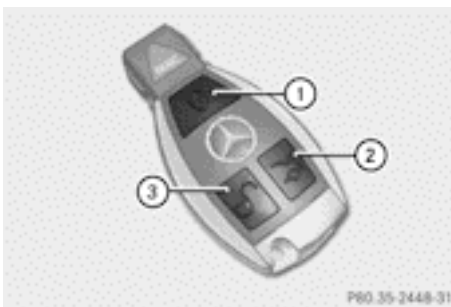
- the doors
- the trunk lid
- the fuel filler flap



- ①  To lock the vehicle
- ②  To unlock the trunk lid
- ③  To unlock the vehicle

When unlocking, the turn signals flash once.
When locking, they flash three times.

When it is dark, the surround lighting also comes on if it is activated in COMMAND.

You can also set an audible signal to confirm that the vehicle has been locked or unlocked. The audible signal can be activated and deactivated using the on-board computer (> page 350).

► **To unlock centrally:** press the  button.

If you do not open a door or the trunk lid within approximately 40 seconds of unlocking the vehicle:

- the vehicle is locked again.
- the theft deterrent locking system is activated again.

► **To lock centrally:** press the  button.

KEYLESS-GO

General notes

i Only for USA:

This device complies with Part 15 of the FCC rules. Operation is subject to the following conditions:

1. This device must not cause any interference, and
2. This device must be able to accommodate interference that is received, including interference which could cause unwanted functions.

Unapproved modifications to this device may lead to withdrawal of permission to operate it.

The product label with FCC ID and IC certification number can be found in the battery case of the SmartKey.

i Only for Canada:

This device complies with Industry Canada's RSS210 rules. Operation is subject to the following conditions:

1. This device must not cause any interference, and

2. This device must be able to accommodate interference that is received, including interference which could cause unwanted functions.

Unapproved modifications to this device may lead to withdrawal of permission to operate it.

The product label with FCC ID and IC certification number can be found in the battery case of the SmartKey.

Important information for using KEYLESS-GO

- You can use the KEYLESS-GO key as a conventional key.
- You can combine KEYLESS-GO functions with those of a conventional key, e.g. open with KEYLESS-GO and close with the  button.

- Always carry your KEYLESS-GO key on your person.

- Never keep the KEYLESS-GO key with:
 - electronic equipment, such as your mobile phone or another key
 - metal objects, such as coins or metal foil

This may impair the functioning of KEYLESS-GO.

- To open or close the vehicle, the KEYLESS-GO key should be no more than 3 ft (1 m) from the door or trunk.
- If the vehicle is parked for more than 72 hours, the KEYLESS-GO function is deactivated. Pull one of the outer door handles and turn on the ignition to reactivate the KEYLESS-GO function.
- When the KEYLESS-GO key is removed from the vehicle, it is possible that the system may not recognize it. In this case, the vehicle cannot be locked or started with KEYLESS-GO.
- If the KEYLESS-GO key has been removed from the vehicle, e.g. if a passenger leaves the vehicle with the KEYLESS-GO key:
 - while someone is holding the Start/Stop button or attempting to lock the vehicle

using the outer door handle, the **Key Not Detected** message will appear in the multifunction display.

- while the engine is running, the red **Key Not Detected** message will appear in the multifunction display as you pull away. Find the KEYLESS-GO key and change its position in the vehicle. Place the KEYLESS-GO key in a location such as the front-passenger seat, or carry it in your shirt pocket.
- If you have started the engine using the Start/Stop button, you can turn it off again by:
 - pressing the Start/Stop button again
 - inserting the KEYLESS-GO key into the ignition lock when the vehicle is stationary and the automatic transmission is in parking position **P**.
- You may accidentally unlock the vehicle if the KEYLESS-GO key is within 3 ft (1 m) of the vehicle and:
 - a jet of water splashes an outer door handle
 - or
 - you are cleaning an outer door handle.
- Note that the engine can be started by any vehicle occupant if a KEYLESS-GO key is in the vehicle.

Option 1: there is a KEYLESS-GO key in the vehicle and a KEYLESS-GO key outside the vehicle. If you leave the KEYLESS-GO key behind when you get out and lock the vehicle, a message does not appear in the multifunction display.

Option 2: there is a KEYLESS-GO key in the vehicle but no KEYLESS-GO key outside the vehicle. When you get out and try to lock the vehicle, the **Key Detected in Vehicle** message appears in the multifunction display. The vehicle is not locked in this case.

When starting the engine and while driving, KEYLESS-GO also checks whether a valid key

is in the vehicle by periodically establishing radio contact.

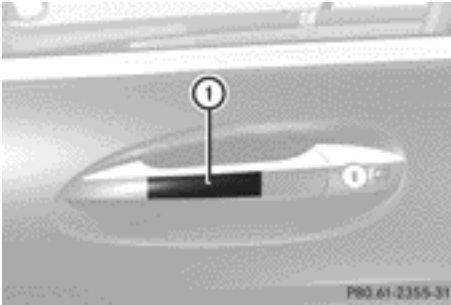



- ▶ **To unlock the vehicle:** pull the door handle.
- ▶ **To lock the vehicle:** touch sensor surface ①.



If you pull on the handle of the trunk lid, only the trunk of the vehicle is unlocked.

Changing the settings of the locking system

You can change the settings of the locking system in such a way that only the driver's door and the fuel filler flap are unlocked. This is useful if you frequently travel on your own.

- ▶ **To change the setting:** press the  and  buttons until the battery check lamp (▷ page 78) flashes twice.



The SmartKey now functions as follows:

- ▶ **To unlock the driver's door:** press the  button once.
- ▶ **To unlock centrally:** press the  button twice.
- ▶ **To lock centrally:** press the  button.

The KEYLESS-GO function is changed as follows:

- ▶ **To unlock the driver's door:** pull the door handle on the driver's door.
- ▶ **To unlock centrally:** pull the door handle on the front-passenger door.
- ▶ **To lock centrally:** touch the outer sensor surface on one of the door handles.

Restoring the factory settings



- ▶ Press the  and  buttons simultaneously for approximately six seconds until the battery check lamp flashes twice.

Mechanical key

General notes

If you use the mechanical key to unlock and open the driver's door or the trunk lid, the anti-theft alarm system will be triggered (▷ page 70).

There are several ways to turn off the alarm:

- ▶ **To stop the alarm with the SmartKey:** press the  or  button on the SmartKey.
- or
- ▶ Insert the SmartKey into the ignition lock.
- or
- ▶ **To stop the alarm with KEYLESS-GO:** press the Start/Stop button in the ignition lock. The SmartKey must be in the vehicle.
- or
- ▶ Lock or unlock the vehicle using KEYLESS-GO. The SmartKey must be outside the vehicle.

Removing the mechanical key

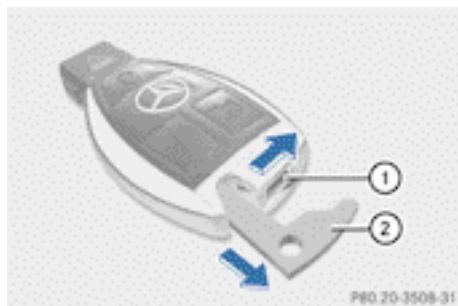

- ▶ Push release catch ① in the direction of the arrow and at the same time remove mechanical key ② from the SmartKey.

SmartKey battery

Important safety notes

It is advisable to have batteries replaced at a qualified specialist workshop, e.g. at an authorized Mercedes-Benz Center.

⚠ WARNING

Batteries contain toxic and caustic substances. For this reason, keep batteries out of the reach of children.



If a battery has been swallowed, seek medical help immediately.

⚠ WARNING

The SmartKey batteries contain perchlorate material, which may require special handling and regard for the environment. Observe government disposal guidelines. California residents, see www.dtsc.ca.gov/HazardousWaste/Perchlorate/index.cfm.

Checking the battery





- ▶ Press the  or  button. The key battery is working properly if battery check lamp ① lights up briefly.

If battery check lamp ① does not light up briefly during the test, the key battery is discharged.

- ▶ Changing the key battery (▷ page 78).

i Consult any authorized Mercedes-Benz Service Center for a key battery.

i If the key battery is tested within the signal range of the vehicle, the vehicle is opened or closed by pressing the  or  button respectively.

Replacing the battery

You require a CR 2025 3 V cell battery.

- ▶ Take the mechanical key out of the SmartKey (▷ page 77).

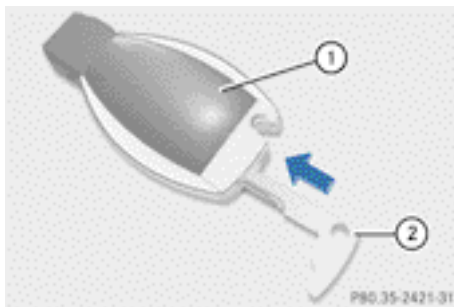



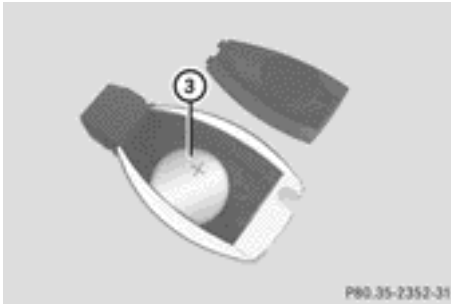

- ▶ Press mechanical key ② into the opening in the SmartKey in the direction of the

arrow until battery tray cover ① opens. Do not hold the cover closed while doing so.



- ▶ Remove the cover of the battery tray.
- ▶ Repeatedly tap the SmartKey against your palm until battery ③ falls out.
- ▶ Insert the new battery with the positive pole facing upwards. Use a lint-free cloth to do so.
- ▶ Make sure that the battery surface is free of lint, grease, or other dirt.
- ▶ Insert the front tabs of the battery tray's cover first and then press to close it.
- ▶ Replace the mechanical key in the SmartKey.
- ▶ Check the function of all SmartKey buttons on the vehicle.

Problems with the SmartKey	
Problem	Possible causes/consequences and ► Solutions
You cannot lock or unlock the vehicle using the SmartKey.	<p>The SmartKey battery is discharged or nearly discharged.</p> <ul style="list-style-type: none"> ► Point the tip of the SmartKey at the driver's door handle from a distance of approximately 1.5 ft (50 cm) and try to unlock or lock the vehicle again. <p>If this does not work:</p> <ul style="list-style-type: none"> ► Check the key battery and replace it if necessary (▷ page 78). ► Unlock (▷ page 83) or lock (▷ page 83) the vehicle with the mechanical key.
	<p>The SmartKey is faulty.</p> <ul style="list-style-type: none"> ► Unlock (▷ page 83) or lock (▷ page 83) the vehicle with the mechanical key. ► Have the SmartKey checked at a qualified specialist workshop.
You can no longer lock/unlock the vehicle using KEYLESS-GO.	<p>KEYLESS-GO is in standby mode because the vehicle has not been unlocked for an extended period.</p> <ul style="list-style-type: none"> ► Pull the door handle twice and then insert the SmartKey into the ignition lock.
	<p>There is a malfunction with KEYLESS-GO.</p> <ul style="list-style-type: none"> ► Lock/unlock the vehicle using the remote control function of the SmartKey. Point the tip of the SmartKey at the driver's door handle from close range and press the  or  button. ► Have KEYLESS-GO checked at a qualified specialist workshop.
	<p>There is interference from a powerful source of radio waves.</p> <ul style="list-style-type: none"> ► Lock/unlock the vehicle using the remote control function of the SmartKey. Point the tip of the SmartKey at the driver's door handle from close range and press the  or  button.
You have lost a SmartKey.	<ul style="list-style-type: none"> ► Have the SmartKey canceled at an authorized Mercedes-Benz Center. ► Report the loss immediately to the vehicle insurers. ► If necessary, have the locks changed as well.
You have lost the mechanical key.	<ul style="list-style-type: none"> ► Report the loss immediately to the vehicle insurers. ► If necessary, have the locks changed as well.

Problem	Possible causes/consequences and ► Solutions
The engine cannot be started using the SmartKey.	<p>The on-board voltage is too low.</p> <ul style="list-style-type: none"> ► Remove the SmartKey and re-insert it into the ignition lock. ► Start the engine within 30 seconds of inserting the SmartKey in the ignition lock. ► Repeat if necessary. <p>If the engine does not start after several attempts:</p> <ul style="list-style-type: none"> ► Check the starter battery and charge it if necessary . <p>or</p> <ul style="list-style-type: none"> ► Jump-start the vehicle . <p>or</p> <ul style="list-style-type: none"> ► Consult a qualified specialist workshop.
The engine cannot be started using KEYLESS-GO. The SmartKey is in the vehicle.	<p>A door is open. Therefore, the SmartKey cannot be detected as easily.</p> <ul style="list-style-type: none"> ► Close the door and try to start the vehicle again. <p>There is interference from a powerful source of radio waves.</p> <ul style="list-style-type: none"> ► Start your vehicle with the SmartKey in the ignition lock.

Doors

Important safety notes

WARNING

When leaving the vehicle, always remove the SmartKey from the ignition lock. Always take the SmartKey with you and lock the vehicle. Do not leave children unsupervised in the vehicle, even if they are secured in a child restraint system, and do not give them access to an unlocked vehicle. A child's unsupervised access to a vehicle could result in an accident and/or serious personal injury. They could:

- injure themselves on vehicle parts
- be seriously or fatally injured by extreme heat or cold
- injure themselves or have an accident with vehicle equipment that may still be in operation even after the SmartKey has been removed from the ignition, such as the seat adjustment, steering wheel adjustment or memory function.

If children open a door, they could cause severe or even fatal injury to other persons; if they get out of the vehicle, they could injure themselves when doing so or be seriously or even fatally injured by any passing traffic.

Do not expose the child restraint system to direct sunlight. The child restraint system's metal parts, for example, could become very hot, and a child could be burned on these parts.

WARNING

Do not carry heavy or hard objects in the passenger compartment unless they are firmly secured in place.

Unsecured or improperly positioned cargo increases a child's risk of injury in the event of:

- strong braking maneuvers
- sudden changes of direction
- an accident

Unlocking and opening doors from the inside

You can open a door from inside the vehicle even if it has been locked.

Open the door only when the traffic conditions permit.

If the vehicle has been opened with the SmartKey or KEYLESS-GO key, opening from inside triggers the anti-theft alarm system. Switch off the alarm (▷ page 70).

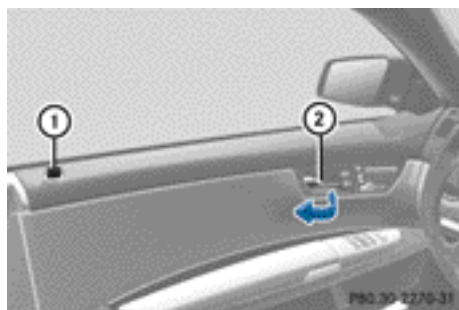

▶ Pull door handle ②.

If the door is locked, locking knob ① pops up. The door is unlocked and can be opened.

i When a door is opened, the side window on that side opens slightly. When the door is closed, the side window closes again.

! The side windows will not open/close if the battery is discharged or if the side windows have iced up. It will then not be possible to close the door. Do not attempt to force the door closed. You could otherwise damage the door or the side window.

Centrally locking and unlocking the vehicle from the inside

You can centrally lock or unlock the vehicle from the inside. This feature may be useful if, for example, you wish to unlock the front-passenger door from the inside or lock the vehicle before you pull away.

The locking or unlocking buttons of the central locking do not lock or unlock the fuel filler flap.

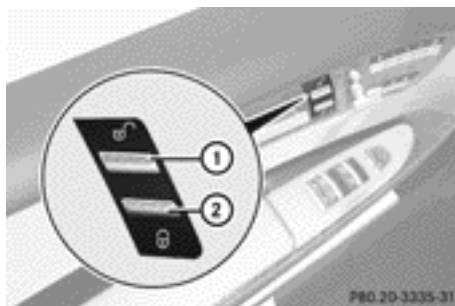

▶ **To lock:** press button ②.

The vehicle locks when all front-passenger doors are closed.

▶ **To unlock:** press button ①.

You can open a locked door from inside the vehicle. Open the door only when the traffic conditions permit.

If the vehicle has been locked with the central locking button:

- and the SmartKey is restored to the factory settings, the entire vehicle is unlocked if a door is opened from inside the vehicle.
- and the SmartKey is set to individual settings, only the door that is opened from inside the vehicle is unlocked.

If the vehicle has been locked centrally with the SmartKey or with KEYLESS-GO, it does not unlock if you use the unlocking button of the central locking.

Automatic locking feature

The vehicle locks automatically when the ignition is switched on and the wheels of the vehicle are moving at a speed of more than 9 mph (15 km/h). You may therefore lock yourself out if the vehicle is being pushed, towed, or located on a test rig.

You can switch off the automatic locking function via COMAND .

Power closing feature

The power closing feature pulls the doors and trunk lid into their locks automatically even if they are only partly closed.

WARNING

To prevent possible personal injury, always keep hands and fingers away from the door or trunk opening when closing a door or the trunk lid. Be especially careful when small children are around.

If danger threatens, pull the inside or outside door handle, or pull the trunk lid handle.

To prevent personal injury, never activate the closing assist mechanism by tampering with the door or trunk lid latch.

WARNING

Only drive with the doors closed. Otherwise, one or more of the doors could open while the vehicle is in motion, putting you and/or others at risk.

WARNING

Make sure the trunk lid is closed when the engine is running and while driving. Among other dangers, deadly carbon monoxide (CO) gases may enter the vehicle interior resulting in unconsciousness and death.

- ▶ **Power closing feature (doors):** push the door past the first detent position of the lock.
The power closing feature will pull the door fully closed.
- ▶ **Power closing feature (trunk lid):** lightly push the trunk lid closed.
The power closing feature will pull the trunk lid fully closed.

Unlocking the driver's door (mechanical key)

If the vehicle can no longer be unlocked centrally with the SmartKey or KEYLESS-GO:

- ▶ Take the mechanical key out of the key (▷ page 77).
- ▶ Insert the mechanical key into the lock of the driver's door as far as it will go.

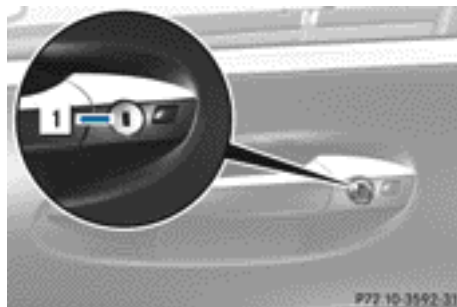

- ▶ Firmly turn the mechanical key counter-clockwise as far as it will go to position  and hold it in this position.
- ▶ Pull the door handle quickly.
The locking knob pops up.
The door is unlocked.
- ▶ Turn the mechanical key back and remove it.
- ▶ Pull the door handle again.
- ▶ Replace the mechanical key in the SmartKey.

Locking the vehicle

If the vehicle can no longer be locked centrally with the SmartKey or KEYLESS-GO: If the SmartKey is faulty, you can lock the doors and the trunk by taking the following steps. If the central locking in the vehicle is malfunctioning, you cannot lock the trunk.

- ▶ Open the front-passenger door.
- ▶ Close the driver's door and the trunk lid.
- ▶ Press down the locking knob of the driver's door inside the vehicle.
- ▶ Press down the locking knob of the open front-passenger door.

-  Make sure that you have the SmartKey on your person and that it has not been left in the vehicle.

- ▶ Close the front-passenger door.
 - ▶ Make sure that the doors and the trunk are locked.
- i** If you lock the vehicle as described above, the fuel filler flap is not locked. The anti-theft alarm system is not activated.

Trunk

Important safety notes

Do not leave the SmartKey in the trunk. You could otherwise lock yourself out.

WARNING

When leaving the vehicle, always remove the SmartKey from the ignition lock. Always take the SmartKey with you and lock the vehicle. Do not leave children unsupervised in the vehicle, even if they are secured in a child restraint system, and do not give them access to an unlocked vehicle. A child's unsupervised access to a vehicle could result in an accident and/or serious personal injury. They could:

- injure themselves on vehicle parts
- be seriously or fatally injured by extreme heat or cold
- injure themselves or have an accident with vehicle equipment that may still be in operation even after the SmartKey has been removed from the ignition, such as the seat adjustment, steering wheel adjustment or memory function.

If children open a door, they could cause severe or even fatal injury to other persons; if they get out of the vehicle, they could injure themselves when doing so or be seriously or even fatally injured by any passing traffic.

Do not expose the child restraint system to direct sunlight. The child restraint system's metal parts, for example, could become very hot, and a child could be burned on these parts.

WARNING

Do not carry heavy or hard objects in the passenger compartment or trunk unless they are firmly secured in place.

Unsecured or improperly positioned cargo increases a child's risk of injury in the event of

- strong braking maneuvers
- sudden changes of direction
- an accident

WARNING

Make sure the trunk lid is closed when the engine is running and while driving. Among other dangers, deadly carbon monoxide (CO) gases may enter the vehicle interior resulting in unconsciousness and death.

- !** The trunk lid swings upwards when opened. Therefore, make sure that there is sufficient clearance above the trunk lid.

You can limit the opening angle of the trunk lid. This could be useful, for example, if there is insufficient space above the trunk lid. You can switch the **Trunk Opening-height Restriction** function on or off via COMAND (> page 239).

To open the trunk lid completely, a minimum clearance of 5.90 ft (1.80 m) above the ground is necessary.

The trunk lid can be:

- opened and closed manually from outside
- opened and closed automatically from outside
- opened and closed automatically from inside
- locked separately
- unlocked using the mechanical key
- opened using the emergency release button inside the trunk

Opening and closing manually

Opening the trunk lid

You can only open the trunk lid after unlocking it first.

- ▶ Press the  button on the key.





- ▶ Pull handle ①.

Closing the trunk lid

WARNING

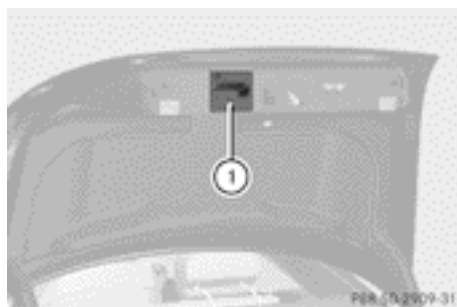
To prevent possible personal injury, always keep hands and fingers away from the trunk opening when closing the trunk lid. Be especially careful when small children are around.



- ▶ Pull the trunk lid down using recess ①.
- ▶ Lock the vehicle if necessary with the  button on the key or with KEYLESS-GO (▶ page 75).

Opening/closing automatically from outside

Important safety notes

WARNING

Make sure the trunk lid is closed when the engine is running and while driving. Among other dangers, deadly carbon monoxide (CO) gases may enter the vehicle interior resulting in unconsciousness and death.

- ❗ The trunk lid swings upwards when opened. Therefore, make sure that there is sufficient clearance above the trunk lid.

To open the trunk lid completely, a minimum clearance of 5.90 ft (1.80 m) above the ground is necessary.

Opening

You can open the trunk lid with the SmartKey.

- ▶ Press and hold the  button on the SmartKey until the trunk lid opens.

Closing

WARNING

Monitor the closing procedure carefully to make sure no one is in danger of being injured. To prevent possible personal injury, always keep hands and fingers away from the trunk opening when closing the trunk lid. Be especially careful when small children are around. To stop the closing procedure, do one of the following:

- Press button  on the SmartKey.
- Press the remote trunk opening/closing switch (on the driver's door).
- Press the trunk closing switch.
- Press the KEYLESS-GO locking/closing switch.
- Pull the trunk lid handle.

Even with the SmartKey removed from the starter switch or the SmartKey with KEYLESS-GO removed from the vehicle, the remote

trunk opening/closing switch can be operated. Therefore, do not leave children unattended in the vehicle, or with access to an unlocked vehicle. A child's unsupervised access to a vehicle could result in an accident and/or serious personal injury.

You can close the trunk lid automatically by using either the closing button or the locking button³.



- ▶ **To close:** press closing button ① in the trunk lid.
- ▶ **To close and lock simultaneously:** Press locking button ② in the trunk lid.

i The trunk lid can only be locked if there is a KEYLESS-GO key outside the vehicle.

Opening/closing automatically from inside

⚠ WARNING

Maintain sight of the area around the rear of the vehicle while operating the trunk lid with the door mounted switch. Monitor the closing procedure carefully to make sure no one is in danger of being injured.

To interrupt the closing procedure, release the door mounted remote trunk opening/closing switch again.

Even with the SmartKey removed from the starter switch or the SmartKey with KEYLESS-GO removed from the vehicle, the remote

trunk opening/closing switch can be operated. Therefore, do not leave children unattended in the vehicle, or with access to an unlocked vehicle. A child's unsupervised access to a vehicle could result in an accident and/or serious personal injury.

⚠ WARNING

Make sure the trunk lid is closed when the engine is running and while driving. Among other dangers, deadly carbon monoxide (CO) gases may enter the vehicle interior resulting in unconsciousness and death.

You can open and close the trunk lid from the driver's seat when the vehicle is stationary.

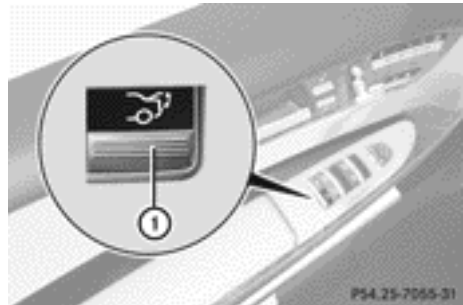

- ▶ **To open:** pull remote operating switch for trunk lid ① until the trunk lid opens.
- ▶ **To close:** press remote operating switch for trunk lid ① until the trunk lid is closed.

Locking the trunk separately

You can lock the trunk separately. If you then unlock the vehicle centrally, the trunk remains locked and cannot be opened.

- ▶ Close the trunk lid.
- ▶ Take the mechanical key out of the SmartKey (▷ page 77).

³ For vehicles with KEYLESS-GO only.

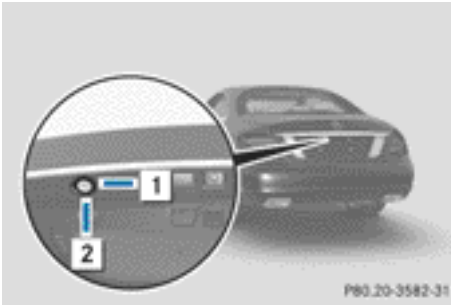

- ▶ Insert the mechanical key into the trunk lid lock as far as the stop.
- ▶ Turn the mechanical key clockwise from position 1 to position 2.
- ▶ Remove the mechanical key.
- ▶ Replace the mechanical key in the SmartKey.

Unlocking the trunk (mechanical key)

! The trunk lid swings upwards when opened. Therefore, make sure that there is sufficient clearance above the trunk lid.

If the trunk can no longer be unlocked with the SmartKey or KEYLESS-GO:

- ▶ Take the mechanical key out of the SmartKey (▷ page 77).

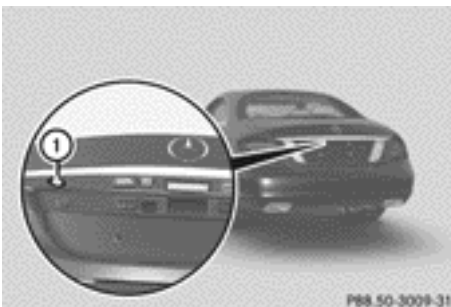

- ▶ Insert the mechanical key into trunk lid lock ① as far as the stop.
- ▶ Turn the mechanical key counter-clockwise as far as possible.
The trunk is unlocked.

- ▶ Turn the mechanical key back and remove it.
- ▶ Replace the mechanical key in the SmartKey.

Trunk emergency release

You can open the trunk lid from inside the vehicle with the emergency release button.

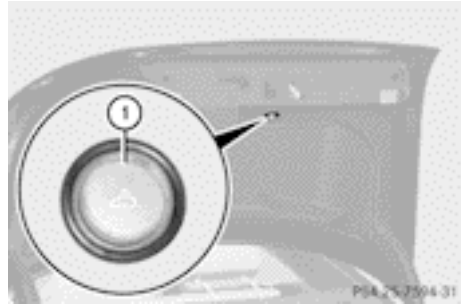

- ▶ Briefly press emergency release button ①.
The trunk lid unlocks and opens.

The trunk lid can be unlocked and opened with the trunk lid emergency release when the vehicle is stationary or while driving.

Trunk lid emergency release light:

- The button flashes for 30 minutes after the trunk lid is opened.
- The button flashes for 60 minutes after the trunk lid is closed.

The trunk lid emergency release does not open the trunk lid if the battery is disconnected or discharged.

Side windows

Important safety notes

WARNING

When leaving the vehicle, always remove the SmartKey from the ignition lock. Always take the SmartKey with you and lock the vehicle. Do not leave children unsupervised in the vehicle, even if they are secured in a child restraint system, and do not give them access to an unlocked vehicle. A child's unsupervised access to a vehicle could result in an accident and/or serious personal injury. They could:

- injure themselves on vehicle parts
- be seriously or fatally injured by extreme heat or cold
- injure themselves or have an accident with vehicle equipment that may still be in operation even after the SmartKey has been removed from the ignition, such as the seat adjustment, steering wheel adjustment or memory function.

If children open a door, they could cause severe or even fatal injury to other persons; if they get out of the vehicle, they could injure themselves when doing so or be seriously or even fatally injured by any passing traffic.

Do not expose the child restraint system to direct sunlight. The child restraint system's metal parts, for example, could become very hot, and a child could be burned on these parts.

WARNING

Do not carry heavy or hard objects in the passenger compartment unless they are firmly secured in place.

Unsecured or improperly positioned cargo increases a child's risk of injury in the event of:

- strong braking maneuvers
- sudden changes of direction
- an accident

WARNING

When opening or closing the door windows, make sure that there is no danger of anyone being harmed by the opening/closing procedure.

The front door windows are equipped with automatic operation and the anti-entrapment feature. If in automatic mode a front door window encounters an obstruction that blocks its path, the anti-entrapment feature will stop the door window and open it slightly.

The door windows operate differently when the switch is pulled. See the "Problems with door windows" section for details.

The closing of the front door windows can be immediately halted by releasing the switch or, if the switch was pulled past the resistance point and released, by either pressing or pulling the respective switch.

The closing of the rear side windows can be immediately halted by releasing the switch.

Activate the override switch when children are riding in the back seats of the vehicle. The children may otherwise injure themselves, e.g. by becoming trapped in the door window opening.

WARNING

Do not keep any part of your body up against the window pane when opening a window. The downward motion of the pane may pull that part of your body down between the window pane and the door frame and trap it there. If there is a risk of entrapment, release the switch and pull it to close the window.

Opening and closing the side windows

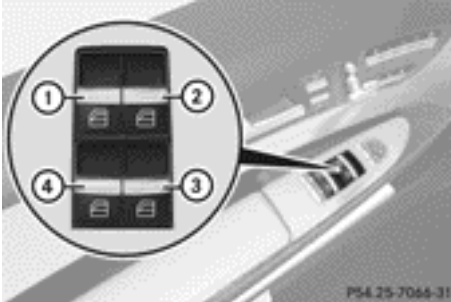

- ① Front left
- ② Front right
- ③ Rear right
- ④ Rear left

The switches for all side windows are located on the driver's door. There is also a switch on the front-passenger door as well as on the doors in the rear compartment on the left and right-hand sides for the respective side window.

- i** It is not possible to operate the door windows from the rear compartment when the override feature is activated for the door windows.



 - ▶ Turn the SmartKey to position **1** in the ignition lock.
 - ▶ **To open:** press the corresponding switch.
 - ▶ **To close:** pull the corresponding switch.
- i** You can start automatic operation when opening and closing the front door windows and when opening the rear door windows. To do so, briefly press or pull the switch to just beyond the point of resistance in the relevant direction. You can stop automatic operation by pressing or pulling again.
- i** You can continue to operate the side windows after you switch off the engine. This function remains active for five minutes or until one of the doors is opened.

Convenience opening

You can ventilate the vehicle before you start driving. To do this, you can use the SmartKey to simultaneously:

- open the side windows
- open the sliding sunroof
- switch on the seat ventilation of the driver's seat

- i** The convenience opening feature can only be operated using the SmartKey. The SmartKey must be close to the driver's door handle.

 - ▶ Point the tip of the SmartKey at the driver's door handle.
 - ▶ Unlock the vehicle by pressing the  button.
 - ▶ Press and hold the  button until the side windows and the sliding sunroof are in the desired position.
 - ▶ **To interrupt the convenience opening:** release the  button.

Convenience closing feature

General notes



When you lock the vehicle, you can simultaneously:

- close the side windows
- close the sliding sunroof

WARNING

When closing the door windows and the sliding sunroof, make sure that there is no danger of anyone being harmed by the closing procedure.

If potential danger exists, proceed as follows:



- Release the  button to stop the closing procedure. To open, press and hold the  button. To continue the closing procedure after making sure that there is no danger of anyone being harmed by the

closing procedure, press and hold the  button.

Vehicles with KEYLESS-GO:

- Release the sensor surface on the outside door handle to stop the closing procedure.
- Immediately pull on the same outside door handle and hold firmly. The door windows and the sliding sunroof will open for as long as the door handle is held but the door is not opened.

Using the SmartKey

- i** The SmartKey must be close to the driver's door handle.
- ▶ Point the tip of the SmartKey at the driver's door handle.
- ▶ Lock the vehicle by pressing the  button.
- ▶ Press and hold the  button until the side windows and the sliding sunroof are fully closed.
- ▶ Make sure that all the side windows and the sliding sunroof are closed.
- ▶ **To interrupt the convenience closing:** release the  button.

Using KEYLESS-GO

The KEYLESS-GO key must be outside the vehicle but must not be further than 3 ft (1 m) from a door.

- ▶ Close all the doors.

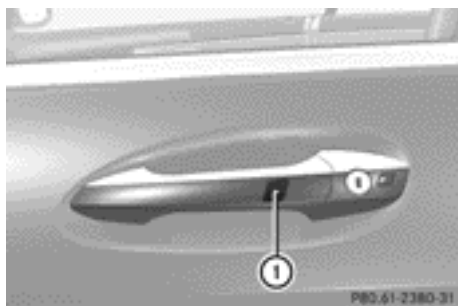

- ▶ Touch sensor surface **1** on the door handle until the side windows and the sliding sunroof are fully closed.
- i** Make sure you only touch sensor surface **1**.
- ▶ Make sure that all the side windows and the sliding sunroof are closed.
- ▶ **To interrupt convenience closing:** release sensor surface **1** on the door handle.

Resetting the side windows

You must reset each side window if:

- the front side window does not close automatically.
- the side window reopens slightly after having been closed manually.
- ▶ Close all the doors.
- ▶ Turn the SmartKey to position **1** in the ignition lock.
- ▶ Pull the corresponding switch on the door control panel until the side window is completely closed (▷ page 89).
- ▶ Hold the switch for an additional second.

If the side window opens again slightly:

- ▶ Immediately pull the corresponding switch on the door control panel until the side window is completely closed (▷ page 89).
- ▶ Hold the switch for an additional second.
- ▶ If the respective side window remains closed after the button is released, then it has been set correctly. If this is not the case, repeat the previously described steps.

Problems with the side windows

Problem: a side window cannot be closed because an object is obstructing the side window.

- ▶ Remove the object(s).
- ▶ Close the side window.

Problem: a side window cannot be closed, and you cannot see the cause.

WARNING

Closing the side windows with increased force or without the anti-entrapment feature could lead to serious or even fatal injury. Make sure that nobody can become trapped when closing the side windows.

If a side window is obstructed during closing and reopens again slightly:

- ▶ Immediately after the window blocks, pull the corresponding switch again until the side window has closed.
The side window is closed with increased force.

If a side window is obstructed again during closing and reopens again slightly:

- ▶ Immediately after the window blocks, pull the corresponding switch again until the side window has closed.
The side window is closed without the anti-entrapment feature.

WARNING

Pulling and holding the switch to close the window immediately after it had been blocked two times will cause the window to close without the anti-entrapment feature for as long as you hold the switch.

Sliding sunroof

Important safety notes

WARNING

When leaving the vehicle, always remove the SmartKey from the ignition lock. Always take the SmartKey with you and lock the vehicle. Do not leave children unsupervised in the vehicle, even if they are secured in a child restraint system, and do not give them access to an unlocked vehicle. A child's unsupervised access to a vehicle could result in an accident and/or serious personal injury. They could:

- injure themselves on vehicle parts
- be seriously or fatally injured by extreme heat or cold
- injure themselves or have an accident with vehicle equipment that may still be in operation even after the SmartKey has been removed from the ignition, such as the seat adjustment, steering wheel adjustment or memory function.

If children open a door, they could cause severe or even fatal injury to other persons; if they get out of the vehicle, they could injure themselves when doing so or be seriously or even fatally injured by any passing traffic.

Do not expose the child restraint system to direct sunlight. The child restraint system's metal parts, for example, could become very hot, and a child could be burned on these parts.

WARNING

Do not carry heavy or hard objects in the passenger compartment unless they are firmly secured in place.

Unsecured or improperly positioned cargo increases a child's risk of injury in the event of:

- strong braking maneuvers
- sudden changes of direction
- an accident

⚠ WARNING

When opening or closing the sliding sunroof, make sure that there is no danger of anyone being harmed by the opening/closing procedure.

The sliding sunroof is equipped with automatic operation and the anti-entrapment feature. If the movement of the sliding sunroof is blocked during the closing procedure, the sliding sunroof will stop and open slightly.

The sliding sunroof operates differently when the sliding sunroof switch is pressed and held. See the "Problems with the sliding sunroof" section for more details.

The opening/closing procedure of the sliding sunroof can be immediately halted by releasing the sliding sunroof switch or, if the sliding sunroof switch was moved past the resistance point and released, by moving the sliding sunroof switch in any direction.

⚠ WARNING

The sliding sunroof is made out of glass. In the event of an accident, the glass may shatter. This may result in an opening in the roof.

In a vehicle rollover, occupants not wearing their seat belts or not wearing them properly may be thrown out of the opening. Such an opening also presents a potential for injury for occupants wearing their seat belts properly, as entire body parts or portions of them may protrude from the passenger compartment.

! Only open the sliding sunroof if it is free of snow and ice. Otherwise, malfunctions may occur.

Do not allow anything to protrude from the sliding sunroof. Otherwise, the seals could be damaged.

! If the sliding sunroof cannot be opened or closed due to a malfunction, contact a qualified specialist workshop, e.g. an authorized Mercedes-Benz Center.

! Do not forget that the weather can change abruptly. Make certain that the

sliding sunroof is closed when you leave the vehicle. The vehicle electronics can be damaged if water enters the vehicle interior.

i Resonance noises can occur in addition to the usual airflow noises when the sliding sunroof is open. They are caused by minor pressure fluctuations in the vehicle interior. Change the position of the sliding sunroof or open a side window slightly to reduce or eliminate these noises.

Operating the sliding sunroof**Opening and closing**

i You can continue to operate the sliding sunroof after switching off the engine or removing the SmartKey from the ignition. This function remains active for five minutes or until one of the front doors is opened.

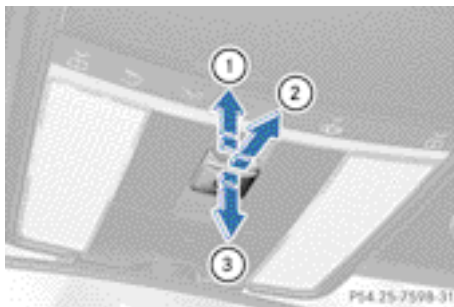

Overhead control panel

- ① To raise
- ② To open
- ③ To close

► Turn the SmartKey to position **2** in the ignition lock.

► Push or pull the  switch in the corresponding direction.

i If you press the  switch beyond the point of resistance, an automatic opening/closing process is started in the

corresponding direction. You can stop automatic operation by pressing again.

Automatic raising is only available when the sliding sunroof is closed.

Automatic opening is only available when the sliding sunroof is not raised.

You can open or close the sun protection cover by hand when the sliding sunroof is raised or closed.

Resetting

Reset the sliding sunroof if it does not open smoothly.

- ❗ If the sliding sunroof cannot be closed fully or reset, consult a qualified specialist workshop.
- ▶ Turn the SmartKey to position **2** in the ignition lock.
- ▶ Raise the sliding sunroof fully at the rear (▷ page 92).
- ▶ Keep the  switch pressed for another second.
- ▶ Make sure that the sliding sunroof can be opened or closed fully again when operated automatically (▷ page 92).
- ▶ If the sliding sunroof can be raised fully at the rear, it has been reset correctly. If this is not the case, repeat the steps above again.

Problems with the sliding sunroof

Problem: the sunroof cannot be closed and you cannot see the cause.

WARNING

You could be severely or even fatally injured when closing the sliding sunroof with increased closing force or if the anti-entrapment feature is deactivated. Make sure that nobody can become trapped when closing the sliding sunroof.

If the sliding sunroof is obstructed during closing and reopens again slightly:

- ▶ Immediately after the sliding sunroof blocks, pull the  switch in the overhead control panel down to the point of resistance and hold it until the sliding sunroof is closed.
The sliding sunroof is closed with increased force.

If the sliding sunroof is obstructed again during closing and then reopens slightly:

- ▶ Immediately after the sliding sunroof blocks, pull the  switch in the overhead control panel down to the point of resistance and hold it until the sliding sunroof is closed.
The sliding sunroof is closed without the anti-entrapment feature.

WARNING

Pressing and holding the sliding sunroof switch to close the sliding sunroof immediately after it had been blocked two times will cause the sliding sunroof to close without the anti-entrapment feature for as long as you hold the switch.

Useful information	96
Correct driver's seat position	96
Seats	97
Steering wheel	102
Mirrors	104
Memory function	106

Useful information

i This Operator's Manual describes all models and all standard and optional equipment of your vehicle available at the time of publication of the Operator's Manual. Country-specific differences are possible. Please note that your vehicle may not be equipped with all features described. This also applies to safety-related systems and functions.

i Please read the information on qualified specialist workshops (▷ page 29).

Correct driver's seat position



Observe the safety guidelines on seat adjustment (▷ page 97).

► Make sure that seat ③ is adjusted properly.

Electrical seat adjustment (▷ page 98)

When adjusting the seat, make sure that:

- you are as far away from the driver's air bag as possible.
- you are sitting in a normal upright position.

- you can fasten the seat belt properly.
- you have moved the backrest to an almost vertical position.
- you have set the seat cushion angle so that your thighs are gently supported.
- you can depress the pedals properly.

► Check whether the head restraint is adjusted properly (▷ page 99).

When doing so, make sure that you have adjusted the head restraint so that the back of your head is supported at eye level by the center of the head restraint.

Observe the safety guidelines on steering wheel adjustment (▷ page 102).

► Make sure that steering wheel ① is adjusted properly.

Adjusting the steering wheel electrically (▷ page 103)

When adjusting the steering wheel, make sure that:

- you can hold the steering wheel with your arms slightly bent.
- you can move your legs freely.
- you can see all the displays in the instrument cluster clearly.

Observe the safety guidelines for seat belts (▷ page 55).

► Check whether you have fastened seat belt ② properly (▷ page 57).

The seat belt should:

- fit snugly across your body
- be routed across the middle of your shoulder
- be routed in your pelvic area across the hip joints

► Before starting off, adjust the rear-view mirror and the exterior mirrors (▷ page 104) in such a way that you have a good view of road and traffic conditions.

► **Vehicles with a memory function:** save the seat, steering wheel and exterior mirror settings (▷ page 106).

Seats

Important safety notes

WARNING

In order to avoid possible loss of vehicle control, all seat, head restraint, steering wheel and rear view mirror adjustments, as well as fastening of seat belts, must be done before setting the vehicle in motion.

WARNING

Do not adjust the driver's seat while driving. Adjusting the seat while driving could cause the driver to lose control of the vehicle.

Never travel in a moving vehicle with the seat backrest in an excessively reclined position as this can be dangerous. You could slide under the seat belt in a collision. If you slide under it, the seat belt would apply force at the abdomen or neck. This could cause serious or fatal injuries. The seat backrest and seat belts provide the best restraint when the wearer is in a position that is as upright as possible and seat belts are properly positioned on the body.

WARNING

Your seat belt must be adjusted so that you can correctly fasten your seat belt.

Observe the following points:

- adjust the seat backrest until your arms are slightly angled when holding the steering wheel.
- adjust the seat to a comfortable seating position that still allows you to reach the accelerator/brake pedal safely. The position should be as far back as possible with the driver still able to operate the controls properly.
- adjust the head restraint so that it is as close to the head as possible and the center

of the head restraint supports the back of the head at eye level.

- never place hands under the seat or near any moving parts while a seat is being adjusted.

Failure to do so could result in an accident and/or serious personal injury.

WARNING

The electrically adjustable seats can be operated at any time. Therefore, do not leave children unattended in the vehicle, or with access to an unlocked vehicle. A child's unsupervised access to a vehicle could result in an accident and/or serious personal injury.

WARNING

According to accident statistics, children are safer when properly restrained on the rear seats than on the front-passenger seat. Thus, we strongly recommend that children be placed in the rear seat whenever possible. Regardless of seating position, children 12 years old and under must be seated and properly secured in an appropriately sized child restraint system or booster seat recommended for the size and weight of the child. For additional information, see the "Children in the vehicle" section.

A child's risk of serious or fatal injuries is significantly increased if the child restraints are not properly secured in the vehicle and/or the child is not properly secured in the child restraint.

WARNING

For your protection, drive only with properly positioned head restraints.

Adjust the head restraint so that it is as close to the head as possible and the center of the head restraint supports the back of the head at eye level. This will reduce the potential for injury to the head and neck in the event of an accident or similar situation.

Do not drive the vehicle without the seat head restraints. Head restraints are intended to help reduce injuries during an accident.

! To avoid damage to the seats and the seat heating, observe the following information:

- keep liquids from spilling on the seats. If liquid is spilled on the seats, dry them as soon as possible.
- if the seat covers are damp or wet, do not switch on the seat heating. The seat heating should also not be used to dry the seats.
- clean the seat covers as recommended; see the "Interior care" section.
- do not transport heavy loads on the seats. Do not place sharp objects on the seat cushions, e.g. knives, nails or tools. The seats should only be occupied by passengers, if possible.
- when the seat heating is in operation, do not cover the seats with insulating materials, e.g. blankets, coats, bags, seat covers, child seats or booster seats.

! Make sure that there are no objects in the footwell or behind the seats when resetting the seats. There is a risk that the seats and/or the objects could be damaged.

i The head restraints cannot be removed. For more information, contact a qualified specialist workshop.

Adjusting the seats

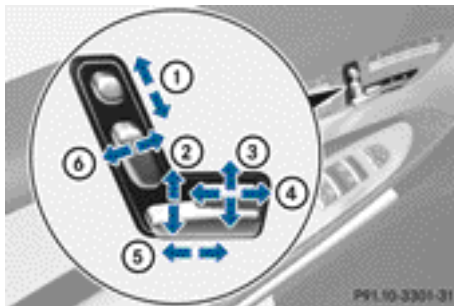

- ① Head restraint height
- ② Seat height
- ③ Seat cushion angle
- ④ Seat cushion length
- ⑤ Seat fore-and-aft adjustment
- ⑥ Backrest angle

i If PRE-SAFE® has been activated, the front-passenger seat and the electrically adjustable rear seats are moved into a more favorable position.

i You can store the seat settings using the memory function (▷ page 106).

i To ensure the largest possible range of seat settings, certain seat adjustment functions will automatically activate other seat adjustment functions.

i Depending on the seat fore-and-aft setting, the head restraint height is adjusted automatically.

Adjusting the front-passenger seat from the driver's seat

⚠ WARNING

When adjusting the front passenger seat, make sure the seat, if occupied, is as far from the front passenger front air bag as possible. Otherwise, the passenger could be seriously or even fatally injured in the event of an accident or braking maneuver.

Make sure no one is caught or injured while the seat is being adjusted.

Even with the SmartKey or SmartKey with KEYLESS-GO removed from the starter switch or the SmartKey with KEYLESS-GO removed from the vehicle, the power seats can be operated. Therefore, do not leave children unattended in the vehicle, or with access to an unlocked vehicle. A child's unsupervised access to a vehicle could result in an accident and/or serious personal injury.

! Do not move the front-passenger seat fully forwards if there are objects in the parcel net in the front-passenger footwell. The objects could otherwise be damaged.

You can use the seat switches on the driver's side to adjust the front-passenger seat.



► **To activate/deactivate:** press button ①.

If the indicator lamp in button ① is lit, you can access the following functions for the front-passenger seat:

- seat adjustment
- seat heating/ventilation
- memory function

Adjusting the head restraints

Adjusting the head restraint height electrically

► **To adjust the head restraint height:** slide the switch for head restraint adjustment

(▷ page 98) up or down in the direction of the arrow.

Rear seat head restraints

⚠ WARNING

For safety reasons, always drive with the rear head restraints in the upright position when the rear seats are occupied.

Keep the area around head restraints clear of articles (e.g. clothing) to not obstruct the folding operation of the head restraints.

⚠ WARNING

For your protection, drive only with properly positioned head restraints.

Adjust the head restraint in such a way that it is as close to the head as possible and the center of the head restraint supports the back of the head at eye level. This will reduce the potential for injury to the head and neck in the event of an accident or similar situation.

With a rear seat occupied, make sure to move the respective head restraint up from the lowest non-use position and have the occupant adjust the head restraint properly. Do not drive the vehicle without the seat head restraints installed when the rear seats are occupied. Head restraints are intended to help reduce injuries during an accident.

⚠ WARNING

Make sure the rear seat head restraints engage when placing them upright manually. Otherwise their protective function cannot be ensured.

The back of the head will not be supported in the event of a collision. That could cause serious or even fatal injuries. Rear seat occupants can be seriously injured or killed.

Folding back the rear seat head restraints from the front



- ▶ Make sure that the SmartKey is in position 1 or 2 in the ignition lock.
- ▶ Press button ①.

Folding the rear seat head restraints into position pneumatically

- ▶ Press and hold button ① until the head restraints are folded up.
- ❗ If a rear-seat passenger inserts the seat belt into the buckle, the head restraint on the corresponding seat folds up automatically.

Folding the rear seat head restraints into position manually



- ▶ Pull the head restraint up until it engages.

Folding the front seat backrests forward/back

Important safety notes

WARNING

The seat belts can only provide protection if the seat backrest is locked in the upright position. The seat backrest must therefore be locked in the upright position during the journey. Do not drive the vehicle if the seat backrest is not locked in the upright position. If the

Lock Seat Backrest Front Right

or

Lock Seat Backrest Front Left

warning message is displayed in the multifunction display, then the corresponding seat backrest is not locked. Carefully slow down and drive with caution to an area which is a safe distance from the road. Always ensure that there is sufficient space behind the seat backrest and fold the seat backrest back fully until it engages in the locking mechanism.

The warning message is no longer displayed once the seat backrest engages in the locking mechanism. If both seat backrests are locked and the warning message continues to be displayed, have the system checked by a Mercedes-Benz Center without delay.

WARNING

Always ensure that no one can become trapped or injured when the seat is moving. In case potential danger exists, the procedure can be interrupted by moving the seat adjustment switch in the door control panel or by moving the release lever again.

Folding the backrest forwards

In order to make it convenient for passengers to get in and out of the rear compartment, the driver's or front-passenger seat:

- is automatically moved forwards when the backrest is folded forwards
- is automatically moved backwards when the backrest is folded back

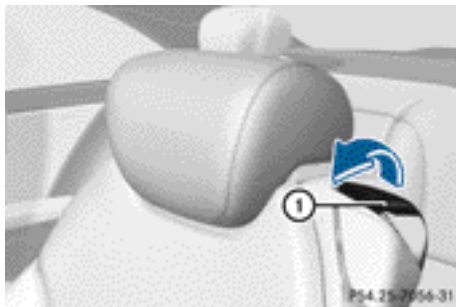

- ▶ Pull seat release handle ① in the direction of the arrow and fold the backrest forwards.
The head restraint is lowered and the seat moves forwards.

Folding back the backrest

- ▶ Fold the seat backrest back until it engages.
The seat moves to its original position. The head restraint is raised. The seat backrest is engaged again.

Adjusting the multicontour seat

You can adjust the multicontour seat using COMAND (▷ page 243).

Adjusting the active multicontour seat

You can adjust the active multicontour seat using COMAND (▷ page 245).

- ⓘ If PRE-SAFE® has been activated, the air pressure in the air chambers of the

multicontour seat or active multicontour seat is increased. These air chambers are located in the side bolsters of the seat cushion and backrest.

Adjusting the lumbar support

You can adjust the lumbar support using COMAND (▷ page 243).

Switching the seat heating on/off

Switching on/off

⚠ WARNING

Repeatedly setting the seat heating to level **3** may result in excessive seat temperatures. The health of passengers that have limited temperature sensitivity or a limited ability to react to excessively high temperatures may be affected or they may even suffer burn-like injuries. Therefore, do not use seat heating level **3** repeatedly.

The three red indicator lamps in the button indicate the heating level you have selected.

- ⓘ If the battery voltage is too low, the seat heating may switch off.



The system automatically switches down from level **3** to level **2** after approximately eight minutes.

The system automatically switches down from level **2** to level **1** after approximately ten minutes.

The system automatically switches off approximately 20 minutes after it is set to level 1.

- ▶ Make sure that the SmartKey is in position 1 or 2 in the ignition lock.
- ▶ **To switch on:** press button ① repeatedly until the desired heating level is set.
- ▶ **To switch off:** press button ① repeatedly until all the indicator lamps go out.

Problems with the seat heating

The seat heating has switched itself off prematurely. The vehicle's electrical system voltage is too low because too many electrical consumers are switched on.

- ▶ Switch off electrical consumers that you do not need, such as the rear window defroster or interior lighting.

Switching the seat ventilation on/off

Switching on/off

The three blue indicator lamps in the buttons indicate the ventilation level you have selected.

- ❗ If the battery voltage is too low, the seat ventilation may switch off.

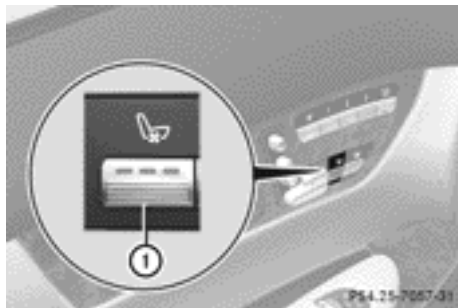

- ▶ Make sure that the SmartKey is in position 2 in the ignition lock.
- ▶ **To switch on:** press button ① repeatedly until the desired ventilation level is set.

- ❗ You can open the side windows and the sliding sunroof using the "Convenience opening" feature (▷ page 89). The seat ventilation of the driver's seat automatically switches to the highest level.

- ▶ **To switch off:** press button ① repeatedly until all the indicator lamps go out.

Problems with the seat ventilation

The seat ventilation has switched off prematurely. The vehicle's electrical system voltage is too low because too many electrical consumers are switched on.

- ▶ Switch off electrical consumers which you do not need, such as the rear window defroster or interior lighting.

Steering wheel

Important safety notes

⚠ WARNING

Do not adjust the steering wheel while driving. Adjusting the steering wheel while driving could cause the driver to lose control of the vehicle.

The electrical steering wheel adjustment feature can be operated at any time. Therefore, do not leave children unattended in the vehicle, or with access to an unlocked vehicle. A child's unsupervised access to a vehicle could result in an accident and/or serious personal injury.

Adjusting the steering wheel

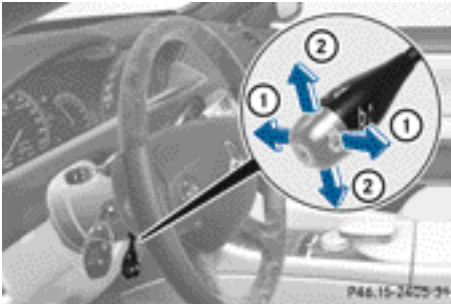

- ① To adjust the steering wheel position (fore-and-aft adjustment)
- ② To adjust the steering wheel height

i Other topics:

- EASY-ENTRY/EXIT feature (▷ page 103)
- storing settings (▷ page 106)
- operating the on-board computer (▷ page 337)

Steering wheel heating

Switching on/off

The steering-wheel heating heats the leather areas of the steering wheel.

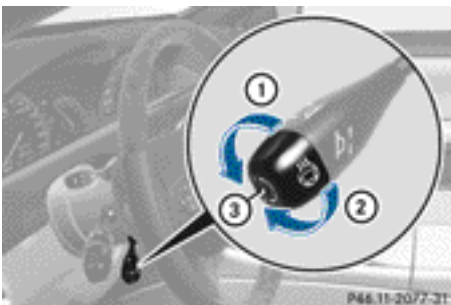

- ▶ Make sure that the SmartKey is in position 2 in the ignition lock.
- ▶ **To switch on/off:** turn the lever in the direction of arrow ① or ②. Indicator lamp ③ lights up or goes out.

Vehicles without KEYLESS-GO: when you remove the SmartKey from the ignition lock, the steering wheel heating is deactivated.

Vehicles with KEYLESS-GO: when you switch off the ignition and open the driver's door, the steering wheel heating is deactivated.

- i** The steering wheel heating is deactivated when the temperature in the vehicle interior is higher than 86 °F (30 °C).
- i** The steering wheel heating is switched off automatically after about 24 minutes.

EASY-ENTRY/EXIT feature

Important safety notes

The EASY-ENTRY/EXIT feature makes getting in and out of your vehicle easier.

You can activate and deactivate the EASY-ENTRY/EXIT feature using COMAND (▷ page 236).

⚠ WARNING

You must make sure no one can become trapped or injured by the moving steering wheel and driver's seat when the EASY-ENTRY/EXIT feature is activated.

To stop steering wheel and seat movement, do one of the following:

- move the seat adjustment switch.
- move the steering column adjustment switch.
- press one of the memory function position buttons or memory button **M**.

Do not leave children unattended in the vehicle, or with access to an unlocked vehicle. Children could open the driver's door and unintentionally activate the EASY-ENTRY/EXIT feature. This could result in an accident and/or serious personal injury.

⚠ WARNING

Let the system complete the adjustment procedure before setting the vehicle in motion. All steering wheel adjustment must

be completed before setting the vehicle in motion. Driving off with the steering wheel still adjusting could cause the driver to lose control of the vehicle.

- ❗ Do not activate the EASY-ENTRY/EXIT feature, if the seat backrest is reclined too far backwards. This can damage the front or rear seats. You must first move the backrest to a vertical position.

Position of the steering wheel and the driver's seat when the EASY-ENTRY/EXIT feature is active

The steering wheel tilts upwards and the driver's seat moves backwards if you:

- remove the SmartKey from the ignition lock
- open the driver's door when the SmartKey is in the ignition lock or KEYLESS-GO is in position 1

- ❗ The steering wheel only moves upwards if it has not already reached the upper end stop. The driver's seat only moves backwards if it is not already in the rearmost position.

Position of the steering wheel and the driver's seat for driving

If you insert the SmartKey into the ignition lock with the driver's door closed, depending on the setting, the position of the steering wheel and the driver's seat will be changed to the previously set position.

The last position of the steering wheel or seat is stored if:

- the ignition is switched off or
- the setting is stored with the memory function.

Crash-responsive EASY-EXIT feature

If the crash-responsive EASY-EXIT feature is triggered in an accident, the steering column will move upwards when the driver's door is opened. This occurs irrespective of the

position of the SmartKey in the ignition lock. This makes it easier to exit the vehicle and rescue the occupants.

The crash-responsive EASY-EXIT feature is only operational if the EASY-EXIT/ENTRY feature is activated in the on-board computer.

Mirrors

Exterior mirrors

Adjusting the exterior mirrors

WARNING

Exercise care when using the passenger-side exterior rear view mirror. The mirror surface is convex (outwardly curved surface for a wider field of view). Objects in mirror are closer than they appear. Check your interior rear view mirror and glance over your shoulder before changing lanes.

The exterior mirrors are automatically heated if the rear window defroster is switched on and the outside temperature is low.

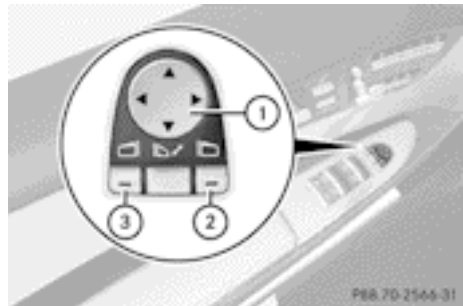

- ▶ Make sure that the SmartKey is in position 1 or 2 in the ignition lock.
- ▶ Press button ② for the right-hand exterior mirror or button ③ for the left-hand exterior mirror. The indicator lamp lights up in the button that has been pressed.
- ▶ Press adjustment button ① up, down, to the left or right until you have adjusted the exterior mirror to the correct position. You

should have a good overview of traffic conditions.

Folding the exterior mirrors in or out electrically

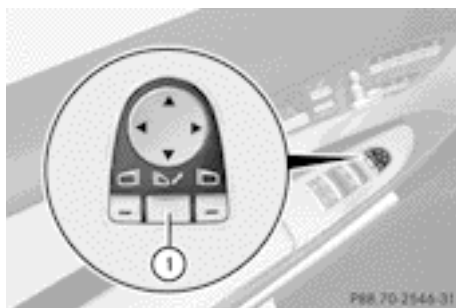

- ▶ Make sure that the SmartKey is in position **1** or **2** in the ignition lock.
- ▶ Briefly press button **1**.
Both exterior mirrors fold in or out.
- i** Make sure that the exterior mirrors are always folded out fully while driving. They could otherwise vibrate.

Folding the exterior mirrors in or out automatically

When the "Automatic mirror folding" function is activated in COMAND (▷ page 236):

- the exterior mirrors fold in automatically as soon as you lock the vehicle from the outside.
- the exterior mirrors fold out again automatically as soon as you unlock the vehicle and then open the driver's or front-passenger door.
- i** If the exterior mirrors have been folded in manually, they do not fold out.

Exterior mirror out of position

If an exterior mirror has been pushed out of position, proceed as follows:

- ▶ Press the mirror-folding button (▷ page 105) repeatedly until you hear the mirror engage in position.
The mirror housing is engaged again and you can adjust the exterior mirrors as usual (▷ page 104).

Automatic anti-glare mirrors

⚠ WARNING

If incident light from headlamps is prevented from striking the sensor in the rear-view mirror, for instance, by luggage piled too high in the vehicle, the mirror's automatic anti-glare function will not operate.

Incident light could then blind you. This may distract you from the traffic conditions and, as a result, you may cause an accident.

The rear-view mirror and the exterior mirror on the driver's side automatically go into anti-glare mode if the ignition is switched on and incident light from headlamps strikes the sensor in the rear-view mirror.

The mirrors do not go into anti-glare mode if reverse gear is engaged or the interior lighting is switched on.

Parking position for the exterior mirror on the front-passenger side

Setting and storing the parking position

You can position the front-passenger side exterior mirror in such a way that you can see the rear wheel on that side as soon as you engage reverse gear. You can store this position.

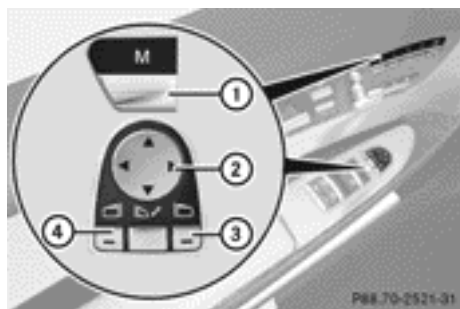

- ▶ Make sure that the vehicle is stationary and that the SmartKey is in position **2** in the ignition lock.
- ▶ Press button **③** for the exterior mirror on the front-passenger side.
- ▶ Engage reverse gear.
The exterior mirror on the front-passenger side moves to the preset parking position.
- ▶ Use adjustment button **②** to adjust the exterior mirror. You should see the rear wheel and the curb in the exterior mirror. The parking position is stored.

i If you shift the transmission to another position, the exterior mirror on the front-passenger side returns to the driving position.

i You can also store the parking position using memory button **M** **①**.

- ▶ Make sure that the SmartKey is in position **2** in the ignition lock.
- ▶ With the exterior mirror on the front-passenger side activated, use adjustment button **②** to adjust the exterior mirror. You should see the rear wheel and the curb in the exterior mirror on the front-passenger side.
- ▶ Press memory button **M** **①** and one of the arrows on adjustment button **②** within three seconds.
The parking position is stored if the exterior mirror does not move.

If the mirror moves out of position, repeat the steps.

Calling up a stored parking position setting

- ▶ Turn the SmartKey to position **2** in the ignition lock.
- ▶ Adjust the exterior mirror on the front-passenger side with the corresponding button (▷ page 104).
- ▶ Engage reverse gear.
The exterior mirror on the front-passenger side moves to the stored parking position.

The exterior mirror on the front-passenger side moves back to its original position:

- as soon as you exceed a speed of 9 mph (15 km/h)
- about ten seconds after you have disengaged reverse gear
- if you press button **④** for the exterior mirror on the driver's side

Memory function

Storing settings

⚠ WARNING

Do not activate the memory function while driving. Activating the memory function while driving could cause the driver to lose control of the vehicle.

With the memory function, you can store up to three different settings, e.g. for three different people.

The following settings are stored as a single memory preset:

- seat, backrest, head restraint position and contour of the backrest in the lumbar region
- active multicontour seat: activated/deactivated
- multicontour seat: the side bolsters of the seat cushion and the backrest as well as the contour of the backrest in the lumbar and shoulder regions

- driver's side: steering wheel position
- driver's side: position of the exterior mirrors on the driver's and front-passenger sides

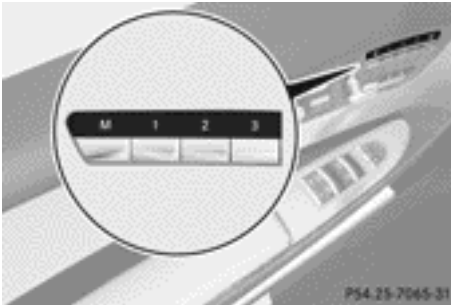

- ▶ Adjust the seat (▷ page 98).
- ▶ On the driver's side, adjust the steering wheel (▷ page 103) and the exterior mirrors (▷ page 104).
- ▶ Briefly press the **M** memory button and then press storage position button **1**, **2** or **3** within three seconds until you hear an acknowledgment tone.
The settings are stored in the selected storage position.

Calling up a stored setting

- ▶ Press and hold the relevant storage position button **1**, **2** or **3** until the seat, steering wheel and exterior mirrors are in the stored position.
- i** If you release the storage position button, the seat, steering wheel and mirror setting functions stop immediately. The multicontour seat setting or lumbar support adjustment is still carried out.

Useful information	110
Introduction	110
At a glance	112
System settings	130
Navigation	138
Telephone	181
Audio	199
Video	228
Vehicle	235

Useful information

- i** This Operator's Manual describes all models and all standard and optional equipment of your vehicle available at the time of publication of the Operator's Manual. Country-specific differences are possible. Please note that your vehicle may not be equipped with all features described. This also applies to safety-related systems and functions.
- i** Please read the information on qualified specialist workshops (▷ page 29).

Introduction

Operating safety

Important safety notes

WARNING

Making alterations to electronic components can cause malfunctions.

Radio, satellite radio, amplifier, DVD changer, navigation module, phone and voice control are networked. If one component is not functional or if it has been incorrectly removed/replaced, this could impair the operation of other components.

This could seriously jeopardize the operational safety of your vehicle.

We recommend that you always have maintenance work on electronic components carried out at an authorized Mercedes-Benz Center.

WARNING

In order to avoid distraction which could lead to an accident, the driver should enter system settings while the vehicle is at a standstill, and operate the system only when permitted by road, weather and traffic conditions.

Bear in mind that at a speed of just 30mph (approximately 50km/h), your car covers a distance of 44feet (approximately 14m) every second.

COMAND supplies you with information to help you select your route more easily and guide you conveniently and safely to your destination. For safety reasons, we encourage the driver to stop the vehicle in a safe place before answering or placing a call, or consulting the COMAND screen to read navigational maps, instructions, or downloaded information.

WARNING

While the navigation system provides directional assistance, the driver must remain focused on safe driving behavior, especially attention to traffic and street signs, and should utilize the system's audio cues while driving.

The navigation system does not supply any information on stop signs, yield signs, traffic regulations or traffic safety rules. Their observance always remains in the driver's personal responsibility. DVD maps do not cover all areas nor all routes within an area.

WARNING

This equipment complies with FCC radiation exposure limits set forth for uncontrolled equipment and meets the FCC radio frequency (RF) Exposure Guidelines in Supplement C to OET65.

This equipment has very low levels of RF energy that is deemed to comply without maximum permissive exposure evaluation (MPE). But it is desirable that it should be installed and operated with at least 8 inches (20 cm) and more between the radiator and a person's body (excluding extremities: hands, wrists, feet and legs.)

Declarations of conformity

Vehicle components which receive and/or transmit radio waves

USA only: The wireless devices of this vehicle comply with Part 15 of the FCC Rules. Operation is subject to the following two conditions: 1) These devices may not cause

harmful interference, and 2) These devices must accept any interference received, including interference that may cause undesired operation.

Changes or modifications not expressly approved by the party responsible for compliance could void the user's authority to operate the equipment.

Canada only: The wireless devices of this vehicle comply with Industry Canada license-exempt RSS standard(s). Operation is subject to the following two conditions: (1) These devices may not cause interference, and (2) These devices must accept any interference, including interference that may cause undesired operation of the device.

Correct use

Observe the following information when using COMAND:

- the safety notes in this manual
- national road traffic regulations
- i** Work improperly carried out on electronic components or systems (e.g. radio, DVD changer) and associated software could cause them to cease functioning. Even systems that have not been modified could be affected because the electronic systems are connected. Electronic malfunctions can seriously jeopardize the operational safety of your vehicle.
- i** Therefore, have all work on or modifications to electronic components carried out at a qualified specialist workshop.
- i** Protection against theft: this device is equipped with technical provisions to protect it against theft. You can obtain further information about protecting against theft from a qualified specialist workshop.

Function restrictions

For safety reasons, some COMAND functions are restricted or unavailable while the vehicle is in motion. You will notice this, for example, because you will not be able to select certain menu items. In some cases, COMAND will also display a message to this effect.

To protect the integrated hard drive against damage, COMAND deactivates it at very high temperatures. The following functions will be temporarily unavailable:

- navigation
- the Voice Control System
- the address book
- MUSIC REGISTER

At a glance

COMAND operating system

Overview



	Function	Page
①	COMAND display	116
②	COMAND controller and function buttons	112
③	Telephone keypad	114

Components of COMAND

COMAND consists of:

- the COMAND display/SPLITVIEW
- the DVD changer
- the COMAND controller
- the COMAND function buttons

- the telephone keypad
- connections in the glove box (USB, additional USB, jack plug and iPod® connection)
- a remote control for the front passenger
- cordless headphones for the front passenger

You can use COMAND to operate the following main functions:

- the navigation system
- the audio function with radio and satellite radio modes, disk (audio CD/DVD and MP3 mode), memory card (MP3 mode), MUSIC REGISTER, Media Interface and audio AUX
- the telephone and the address book
- the video function with video DVD and video AUX modes
- the system settings

You can call up the main functions:

- using the corresponding function buttons or
- using the main function bar in the COMAND display





COMAND controller

You can use the COMAND controller to select the menu items in the COMAND display.





You can call up menus or lists, scroll through menus or lists and exit menus or lists.



The COMAND controller can be:

- pressed briefly or pressed and held 
- turned clockwise or counter-clockwise 
- slid left or right 
- slid forwards or back 
- slid diagonally 

In the instructions, operating sequences are described as follows:

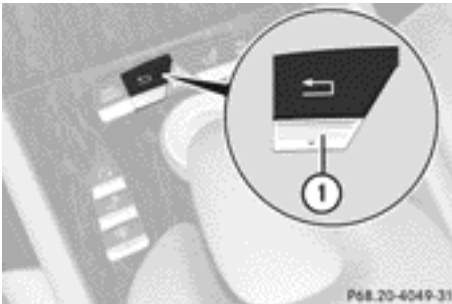

- ▶ Press the  button.
Audio mode is activated.
- ▶ Select **Audio** by sliding  and turning  the COMAND controller and press  to confirm.
The audio menu appears.

Back button



- ① Back button

- ▶ **To exit the menu:** press back button ① briefly.
COMAND changes to the next higher menu level in the current operating mode.

i You can also exit a menu by sliding  or  the COMAND controller.

- ▶ **To switch to the basic display:** press and hold back button ①.
COMAND changes to the basic display of the current operating mode.

Function buttons

The COMAND function buttons allow you to select a main function directly.

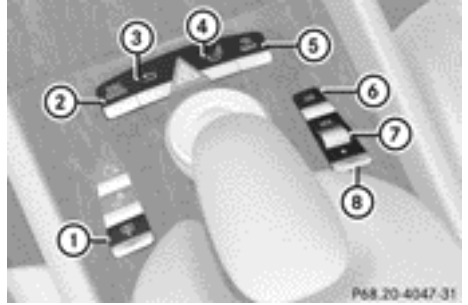

- ① Function button for roller sunblind
- ② Function button for the radio and the last audio source used
- ③ Back button
- ④ Lumbar support/multicontour seat
- ⑤ Function button for telephone and navigation system
- ⑥ Switches COMAND on/off
- ⑦ Volume control
- ⑧ Programmable button (▶ page 113)

Example:





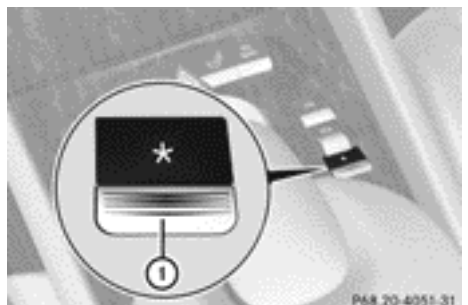

- ▶ **To select the radio or CD menu directly:** press  button ② once or twice.

Assigning the programmable button (favorites)



- ① Programmable button

You can assign the following predefined functions to the  programmable button:

- **ECO**: you can activate or deactivate the ECO start/stop function.
 - **Message, Driver's Seat**: you can switch the message function for the driver's seat on and off.
 - **Message, Front Passenger's Seat**: you can switch the message function for the front-passenger seat on and off.
 - **Message, Driver's and Front Passenger's Seat**: you can switch the message function for the driver's and front-passenger seats on and off.
 - **Display OFF**: you can switch the COMAND display off or on.
 - **Tow-away Alarm**: you can arm or deactivate the tow-away alarm.
 - **Interior Motion Sensor**: you can arm or deactivate the interior motion sensor.
 - **Tow-away Alarm and Interior Motion Sensor**: you can arm or deactivate the tow-away alarm and the interior motion sensor.
 - **Repeat Navigation Command**: you can have the most recent recommendation by the navigation system repeated.
- ▶ **To assign the programmable button:** select **Vehicle** by sliding  and turning  the COMAND controller and press  to confirm.
 - ▶ Select **System** and press  to confirm.
 - ▶ Select **Favorites Button** and press  to confirm.
The list of predefined functions appears.
The • dot in front of the list entry indicates the current setting.
 - ▶ **To change the setting:** turn  the COMAND controller and select the desired function.
 - ▶ **To store the setting and exit the menu:** press  the COMAND controller.

Telephone keypad



- ① Telephone keypad
- ② Folding cover

COMAND display

Display overview

The COMAND display shows the function currently selected and its associated menus. The COMAND display is divided into several areas.

The radio display is shown in the example.

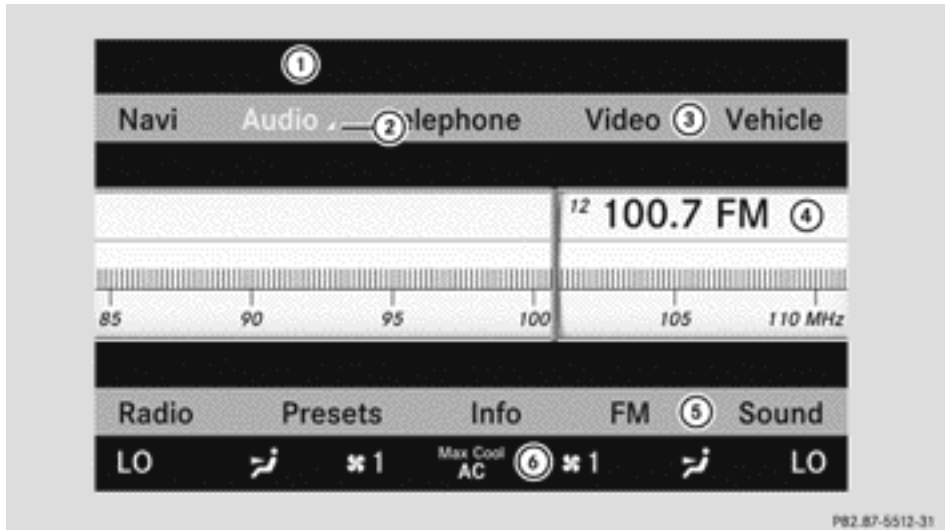

- ① Status bar
- ② To call up the audio menu
- ③ Main function bar
- ④ Display/selection window
- ⑤ Radio menu bar
- ⑥ Air-conditioning function bar

Status bar ① shows the current settings for radio and telephone operation.

The main functions navigation, audio, telephone and video feature additional menus. This is indicated by triangle ②. The following table lists the available menu items.

Main function bar ③ allows you to call up the desired main function.

In the example, the Audio main function is set to radio mode and display/selection window ④ is active.

Radio menu bar ⑤ allows you to operate the radio functions.

The air-conditioning functions can be operated in air-conditioning function bar ⑥.

Menu overview

The table lists the menus available after calling up the main navigation, audio, telephone, video or system function in the main function bar.

Navi	Audio	Telephone	Video	Vehicle
Mode	FM/AM radio		Video DVD	ECO
Map orientation	Sat radio		AUX	Multicontour seat/lumbar settings
Point of interest symbols on the map	Disc		Video off	Rear window blind
Traffic symbols on the map	Memory card			EASY-ENTRY/EXIT system
Text information on map	MUSIC REGISTER			Exterior lighting delayed switch-off
<input checked="" type="checkbox"/> Topographical map	Media Interface			Interior lighting delayed switch-off
<input checked="" type="checkbox"/> City view	USB			Ambient lighting
<input checked="" type="checkbox"/> Freeway information	AUX			<input checked="" type="checkbox"/> Automatic mirror fold-in function
<input checked="" type="checkbox"/> Volume reduction	Audio off			<input checked="" type="checkbox"/> Locator lighting
SIRIUS service				<input checked="" type="checkbox"/> Automatic locking
Map version				<input checked="" type="checkbox"/> Interior motion sensor
				<input checked="" type="checkbox"/> Tow-away alarm
				<input checked="" type="checkbox"/> Trunk lid opening height restriction

SPLITVIEW

SPLITVIEW allows you to simultaneously use different COMAND functions on the front-passenger side and on the driver's side.

Depending on the viewing angle of the display (from the driver's seat or from the front-passenger seat), you will see two different displays.

For example, the "Navi" function can be used from the driver's side while the "Video" function is used on the front-passenger side. Use the remote control to operate COMAND from the front-passenger side with SPLITVIEW.

Please bear the following in mind

- Your vehicle may be equipped with SPLITVIEW, depending on its date of production. The use of SPLITVIEW is currently not permitted in the following states: AL, AZ, CO, IL, LA, MA, MD, NH, PA, VA, VT, WA, WI, and WV or in the Canadian provinces of Manitoba, Newfoundland, New Brunswick, and Prince Edward Island. It is the driver's responsibility to observe ALL regional legally prescribed regulations. If your vehicle is registered in a state or province in which SPLITVIEW is not approved, this function must be deactivated. Please contact an authorized specialist dealer to check whether SPLITVIEW is approved in your state or province.
- Volume adjustment for the cordless headphones can be carried out on the headphones. Before putting on the headphones, make sure that the volume has not been set too high.
- The remote control can be used for the volume adjustment of corded headphones.
- You can only use media from the driver's and front-passenger sides separately if the media are from different sources. Example: on the driver's side, an audio CD is being played by the DVD changer. This means that on the front-passenger side, the DVD changer cannot be used to play a different disc type, for instance a video DVD. However, other media can be used at the same time on the front-passenger side, including radio, memory card, MUSIC REGISTER, Media Interface, USB or AUX.
- If you use the same medium on both sides, settings for this medium can be carried out from either side.

- There must be intervisibility between the headphones and the display so that COMAND can optimally transmit music and speech via the infrared signal on the front-passenger's headphones. For this reason, please also observe that the headphones have left and right sides, and use them correctly.
- Only entertainment functions, i.e. audio and video, can be used separately via SPLITVIEW.
- The multifunction steering wheel can only be used for functions which relate to the driver's side.

Switching SPLITVIEW on/off

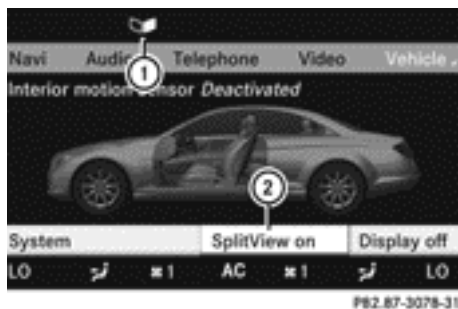

- ▶ **To switch on SPLITVIEW:** select **Vehicle** from the main function bar by turning **[⊙]** the COMAND controller and press **[⏏]** to confirm. The "Vehicle" menu appears.
- ▶ Select **SPLITVIEW ON**. SPLITVIEW symbol **①** appears in the display, and display **②** switches to **SPLITVIEW OFF**.
- ▶ **To switch off SPLITVIEW:** select **Vehicle** from the main function bar by turning **[⊙]** the COMAND controller and press **[⏏]** to confirm. The "Vehicle" menu appears.
- ▶ Select **SPLITVIEW OFF**. Display **②** switches to **SPLITVIEW ON**.
- i** If COMAND has already been switched on, you can also use the remote control to

switch SPLITVIEW on and off (▷ page 119).

The SPLITVIEW screen remains on for approximately 30 minutes after the SmartKey has been turned to position **0** in the ignition lock. After this time or after the SmartKey has been removed, the settings on the front-passenger side are saved for approximately 30 minutes longer. After this period, reactivation on the front-passenger side means that the settings from the driver's side will be used.

Swiveling the COMAND display and setting the brightness

You can swivel the COMAND display⁴. The buttons are located beside the COMAND display.

Swiveling

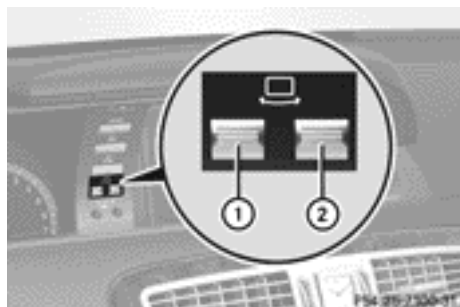

- ① To swivel the display to the left
- ② To swivel the display to the right

Setting the brightness

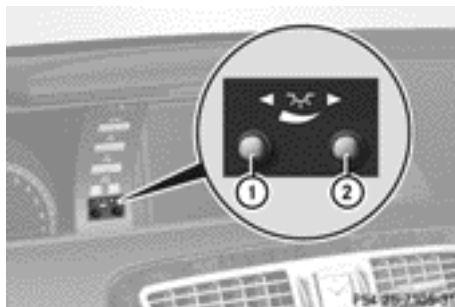

- ① Brightness of the instrument cluster lighting
- ② Brightness of the COMAND display

Brighter or dimmer:

- Turn control ① or ② clockwise or counter-clockwise.

i If Night View Assist Plus is activated, only the brightness of the multifunction display is adjusted with control ①.

Display design

When the default settings are selected, the display automatically switches between day design and night design.

You can change these settings using COMAND (▷ page 130).

Cleaning instructions

! Do not touch the COMAND display. The display has a very sensitive high-gloss surface; there is a risk of scratching. If you have to clean the screen, however, use a mild cleaning agent and a soft, lint-free cloth.

The display must be switched off and have cooled down before you start cleaning. Clean the display screen, when necessary, with a commercially available microfiber cloth and cleaning agent for TFT/LCD displays. Then, dry the surface with a dry microfiber cloth.

⁴ Not with SPLITVIEW.

Avoid using alcoholic thinners, gasoline or abrasive cleaning agents. These could damage the display surface. Do not apply pressure to the display surface when cleaning it, as this could cause irreversible damage.

Remote control

Overview

You can use the remote control to operate the COMAND display and SPLITVIEW.

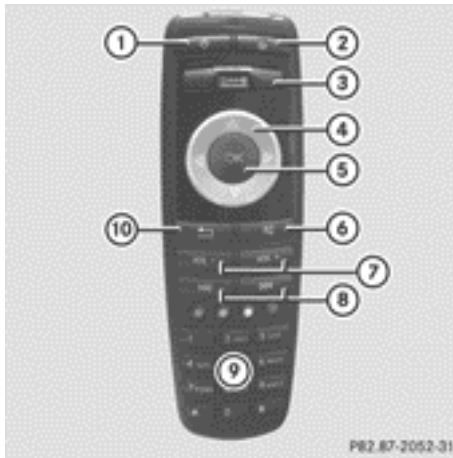

- ① To switch the screen on/off (SPLITVIEW only)
- ② To switch the button lighting on/off
- ③ To select the screen for remote control operation (**COMAND** or **SPLITVIEW** can be selected)
- ④ To select a menu or menu item
- ⑤ To confirm a selection or setting
- ⑥ Mute
- ⑦ To adjust the volume
- ⑧ To set the station, skip track, fast forward/rewind, for example
- ⑨ To select a station from presets, select a track, enter directly, enter a phone number, for example.
- ⑩ To exit a menu (back)

- ▶ Point the remote control at the corresponding screen and execute the functions by pressing the corresponding buttons.

i The remote control's function may be restricted depending on the angle at which it is pointed at the respective screen.

Selecting the screen for the remote control

- ▶ Turn thumbwheel ③ until the desired display is highlighted in the window.

Switching the button lighting on/off

- ▶ Press button ② on the remote control. Depending on the previous status, the button lighting is switched on or off.

i If you do not use the remote control for about 15 seconds, the button lighting switches off automatically.



Mute

- ▶ Press button ⑥ on the remote control. The sound is switched on/off.

Adjusting the volume

- ▶ Press one of buttons ⑦ on the remote control. The volume of the currently selected audio or video source changes. For COMAND, you can also adjust the volume for phone calls and navigation messages.

Selecting a menu/menu item and confirming your selection

- ▶ Press the     buttons to select the menu/menu item and press the  button to confirm.

Functions with the and button

You can use the remote control to execute the same functions as the COMAND control panel.

Mode	Function
Audio mode	Selects a station using the station search function (▷ page 200)
	Selects a track by skipping to a track (▷ page 213)
	Fast forward/rewind (▷ page 214)
Video mode	Selects a scene or chapter (video DVD mode) (▷ page 231)
	Fast-forward/rewind (video DVD mode) (▷ page 231)

Functions of the number keypad

You can use the remote control to execute the same functions as the COMAND control panel.



Mode	Function
Audio mode	Selects stations via the station presets (▷ page 200)
	Sets stations by entering the frequency manually (▷ page 201)
	Stores stations manually (▷ page 201)
	Selects a track (▷ page 213)
	Selects a data medium via the media list (▷ page 212)
Telephone mode	Telephone number entry (▷ page 188)
Character entry	Enters characters (direct entry) (▷ page 123)

Operating COMAND

Selecting a main function

Initial situation

You would like to change from the telephone menu to the vehicle settings, for example.

- ▶ Slide  the COMAND controller and switch to the main function bar.
- ▶ Select **Vehicle** in the main function bar by turning  the COMAND controller and press  to confirm.
The "Vehicle" menu appears.

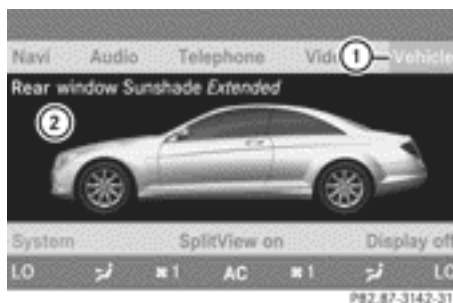

- ① "Vehicle" menu
- ② Display/selection window

Calling up the menu of a main function



- ① To call up the audio menu
- ② Main function bar

If one of the main functions navigation, audio, telephone or video is switched on, triangle ① appears next to the entry. You can now select an associated menu.

The following example illustrates how to call up the audio menu.

- ▶ Press the **DISC RADIO** function button.

or

- ▶ Select **Audio** in the main function bar by sliding **↑** the COMAND controller and press **⏏** to confirm.

The Audio menu appears.

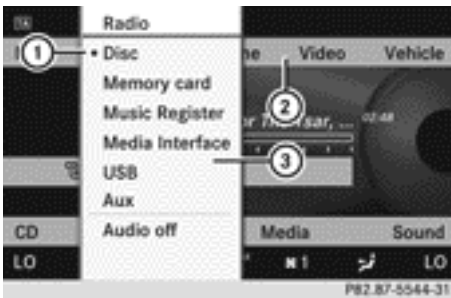

- ① Current audio operating mode
- ② Main function bar
- ③ Audio menu

The • dot indicates the current audio mode.

- ▶ Select another audio mode, e.g. **Radio**, by turning **⏏** the COMAND controller and press **⏏** to confirm.

Selecting a menu item

The following example describes how to select a station from the station presets in radio mode.

- ▶ Press the **DISC RADIO** function button.
- ▶ Select **Presets** by sliding **⏏** and turning **⏏** the COMAND controller and press **⏏** to confirm.
The station preset memory appears.

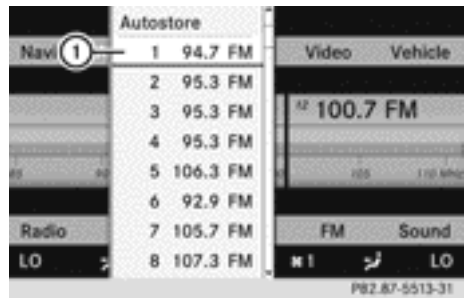

- ① Selection bar

- ▶ Select a station by turning **⏏** the COMAND controller and press **⏏** to confirm.
The station is set.

Example of operation

Initial situation

You would like to switch from the vehicle function to the radio function and select a station from the station list, for example. The following operating example describes how to:

- call up the audio function
- switch on radio mode
- set a station.

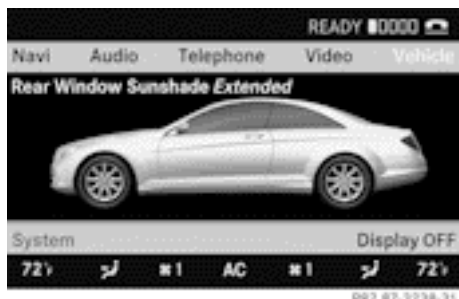

Calling up the audio function

- ▶ Select **Audio** in the main function bar by sliding \uparrow and turning the COMAND controller and press \odot to confirm.

The basic display of the current audio operating mode, e.g. audio CD, appears.



Switching to radio mode

Option 1

- ▶ Press the **DISC RADIO** function button. The radio display appears.

- i** Repeated pressing of this function button switches between radio and the most recently active audio source.

Option 2

- ▶ Select **Audio** again by sliding \uparrow and turning the COMAND controller and press \odot to confirm. The Audio menu appears.

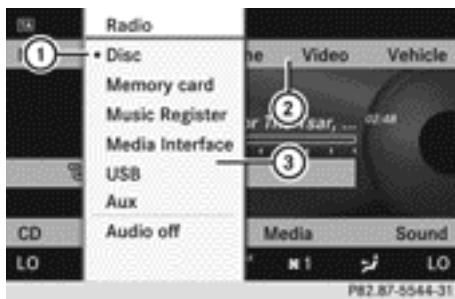

- ① Current audio operating mode
- ② Main function bar
- ③ Audio menu

- ▶ Press \odot the COMAND controller and confirm **Radio**.

The radio basic display appears with the waveband last selected.

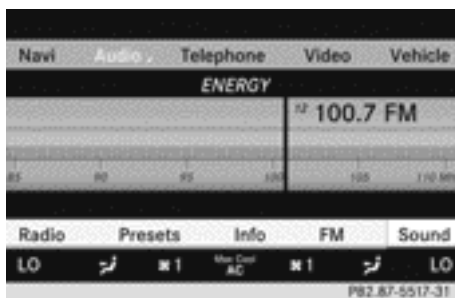

- ▶ **To set the station:** if the display/selection window is activated in the radio display, turn \odot or slide \leftarrow \rightarrow COMAND controller.

Entering characters in navigation mode (entering a city)

General information

Character entry is explained in the following sections using **NEW YORK** as an example for entering a city.

If you want to use the address entry menu (\triangleright page 140) to enter a city, a street or a house number, for example, COMAND provides either a list with a character bar (option 1) or a selection list (option 2).

You can enter the characters using either the character bar or the number keypad. In the selection list, you select an entry to copy it to the address entry menu.

Option 1: city list with character bar

- ▶ Call up the city list with character bar (▷ page 140).

The alphabetically sorted city list shows the first available entries.



Entering characters using the character bar

- ▶ Select **N** by turning COMAND controller (⊖) and confirm with (⊙).

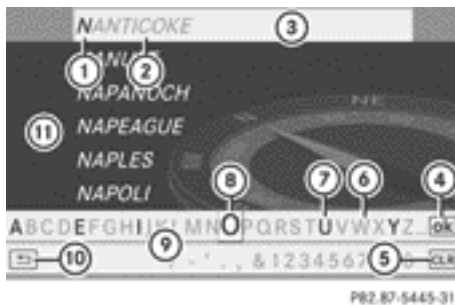

- ① **N** character entered by user
- ② **ANTICOKE** characters automatically added by COMAND
- ③ List entry that most closely resembles the current entry by the user
- ④ To switch to the selection list
- ⑤ To delete an entry
- ⑥ Characters not currently available
- ⑦ Characters currently available

- ⑧ Currently selected character
- ⑨ Character bar
- ⑩ To cancel an entry
- ⑪ List

The list ⑪ shows all available town names beginning with **N**. The list entry that is best suited to previous user entries is always highlighted in the first position ③, **NANTICOKE** in the example.

All characters that have been entered are displayed in black, the letter **N** in the example ①. The letters that are added automatically by COMAND are displayed in gray ②, **ANTICOKE** in the example.

Character bar ⑨ shows the letters still available for selection in black ⑦. These can be selected; in the example, the letter **O** is highlighted ⑧. Which characters remain available depends on the characters already entered by the user and on the data stored in the digital map. Characters that are no longer available are shown in gray ⑥.

- ▶ Select **E**, **W**, space, **Y** in order and confirm each with (⊙).

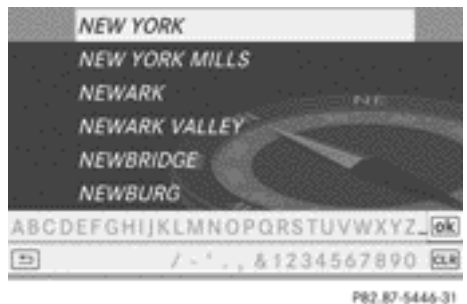



Entering characters using the number keypad

- ▶ Press the telephone keypad's number key **6** twice in quick succession, to enter the letter **N**.











The character appears at the bottom of the display when the key is pressed. The first available letter is highlighted.

You see which characters you can enter with that key. Each time the key is pressed, the next character is selected.



Example: key :

- press once = M
 - press twice = N
 - press three times = O
- Wait until the character display goes out. The entries matching your input are shown in the list.
- Enter **E**, **W**, space, **Y** with the corresponding keys.
- i** The space is entered using number key .

Further functions in the list with character bar

- **To delete characters:** select  by sliding  and turning  the COMAND controller and press  to confirm.
- **To delete an entry:** select  and press and hold  the COMAND controller until the entire entry has been deleted.
- **To switch the character set:** select  and press  to confirm.
- **To cancel an entry:** select the  symbol in the bottom left of the character bar and press  to confirm.

or

- Press the  back button. The address entry menu appears.
- **To accept the first list entry:** press and hold  the COMAND controller until the address entry menu appears. The accepted list entry is shown there.





Calling up the list as a selection list

Select the desired city from the selection list.

If there are several entries for a city or if several cities of the same name are stored, then  is highlighted in the character bar.

- Press  the COMAND controller.

It is also possible to switch the city list to the selection list at any time during character input.

- Slide  the COMAND controller repeatedly until the city list appears as a selection list.
- or
- Select  in the character bar by turning  the COMAND controller and press  to confirm.

Option 2: city list as selection list

COMAND either shows the selection list automatically or you can call up the selection list from the list with character bar.

The example shows the selection list after the city **NEW YORK** has been entered. The entry is highlighted automatically.



- Confirm **NEW YORK** with COMAND controller .
- The address entry menu appears. You can now enter a street, for example.



- i** You will find further information in the "Destination entry" section (▷ page 140).

Entering characters in the address and the phone book

Introduction

The following section describes how to enter characters in the phone book/address book when creating a new entry.

Creating a new entry in the phone book

- ▶ Call up the input menu with data fields (▷ page 194).

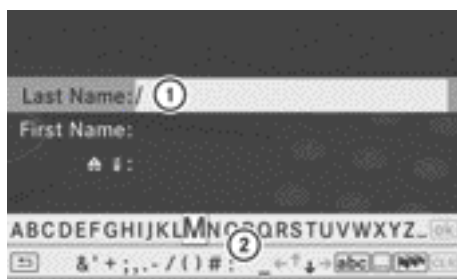

PE2.87-5449-31

Phone book: input menu with data fields

- Selected data field with cursor
- Character bar

Creating a new entry in the address book

- ▶ Call up the input menu with data fields (▷ page 194).

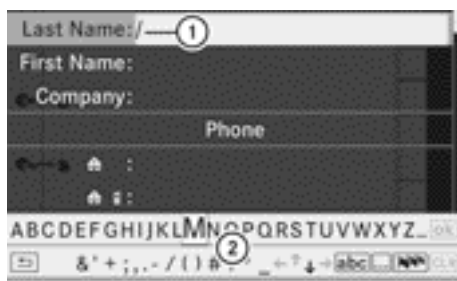

PE2.87-2142-31

Input menu with data fields

- Selected data field with cursor
- Character bar

Entering characters

The example describes how to enter the surname **Schulz**.

- ▶ Select **S** by turning **⏪** and sliding **⏩** the COMAND controller and press **⏹** to confirm.

S is entered into the data field. All characters are shown in black and can always be selected in the character bar.

The character bar offers characters corresponding to the respective data field (letters or digits).

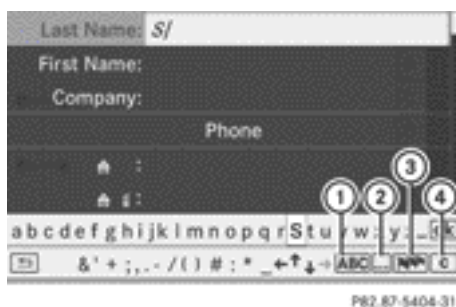

- To switch the character bar to upper-case/lower-case letters
- To switch the character bar from upper/lower-case letters to digits
- To change the language of the character bar
- To delete a character/an entry

- ▶ Select **c** and confirm by pressing **⏹** the COMAND controller. The letter **c** is added to **S** in the data field.
- ▶ Repeat the process until the name has been entered in full.
- ▶ **To enter a phone number:** select the digits one by one in the corresponding data field by turning **⏪** and sliding **⏩** the COMAND controller and press **⏹** to confirm.

Switching data fields

If you want to enter a first name after you have entered a surname, for example, proceed as follows to switch between the data fields:

Option 1

- ▶ Select or in the character bar and press to confirm.

The input menu shows the data field selected.

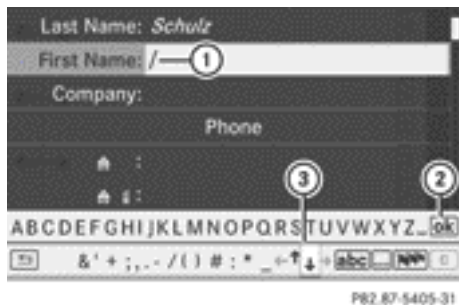

- ① Cursor in the next data field
- ② To store an entry
- ③ and icons to select a data field

Option 2

- ▶ Slide the COMAND controller repeatedly until the character bar disappears.
- ▶ Select the data field by sliding and press to confirm.

Storing an entry

- ▶ Select in the character bar by turning the COMAND controller and press to confirm.
- The entry is stored in the address book.

Further functions available in the character bar

- ▶ **To switch the character bar to upper/lower-case characters:** select or and press to confirm.
 - ▶ **To switch the character set:** select and press to confirm.
- The character set switches between upper/lower-case letters and digits.

- ▶ **To change the language of the character bar:** select and press to confirm.

- ▶ Select the language by turning the COMAND controller and press to confirm.

- ▶ **To reposition the cursor within the data field:** select or and press to confirm.

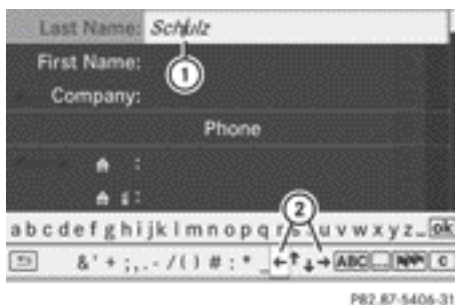

- ① Cursor (repositioned)
 - ② and icon to reposition the cursor
- ▶ Delete the character/entry (▷ page 195).

Basic functions of COMAND

Switching COMAND on/off

- ▶ Press the function button on the center console.

- ▶ **i** If you switch off COMAND, playback of the current audio or video source will also be switched off. You cannot switch off COMAND while making a call via COMAND. You can also make phone calls using the buttons on the multifunction steering wheel when COMAND is switched off (▷ page 337).

Switching the sound on or off



Switching audio and video sources on/off

- ▶ Press the  button on the multifunction steering wheel.



The sound from the respective audio or video source is switched on or off.

- i** When the sound is off, the system displays the  symbol in the status line. When you change the audio or video source, or adjust the volume, sound automatically switches on again.
- i** Even if the sound is switched off, you will still hear traffic and navigation system announcements.

Switching off traffic and navigation announcements completely

- ▶ **Traffic announcements:** press the  button until the **TA** message disappears from the status bar of the display. A confirmation tone sounds.
- ▶ **Navigation announcements:** during an announcement, press the  button on the multifunction steering wheel.

Switching traffic and navigation announcements on again

- ▶ **Traffic announcements:** press and hold down the  button until the **TA** display appears in the status bar. A confirmation tone sounds.
- ▶ **Navigation announcements:** select the  symbol in the navigation menu bar and press  to confirm.
- i** The navigation announcements are activated again if you switch COMAND off and on again or start a new route guidance.

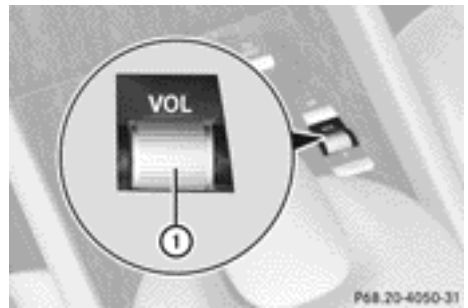

Adjusting the volume

Adjusting the volume for the audio or video source



- ▶ **To adjust:** turn thumbwheel .

or

- ▶ Press the  or  button on the multifunction steering wheel. The volume of the currently selected audio or video source changes.

You can also adjust the volume for the following:



- traffic announcements
- navigation announcements
- phone calls
- the Voice Control System (see the separate operating instructions)

Adjusting the volume for navigation announcements

During a navigation announcement:

- ▶ Turn thumbwheel .

or



- ▶ Press the  or  button on the multifunction steering wheel.

Adjusting the volume for phone calls

You can adjust the volume for hands-free mode during a telephone call.

- ▶ Turn thumbwheel .

or

- ▶ Press the  or  button on the multifunction steering wheel.

Adjusting the sound settings

Calling up the sound menu

You can make various sound settings for the different audio and video sources. This means that it is possible to set more bass for radio mode than for audio CD mode, for example. You can call up the respective sound menu from the menu of the desired mode.

The example describes how to call up the sound menu in radio mode.

- ▶ Press the **DISC RADIO** function button.

The radio display appears. You will hear the last station played on the last waveband.

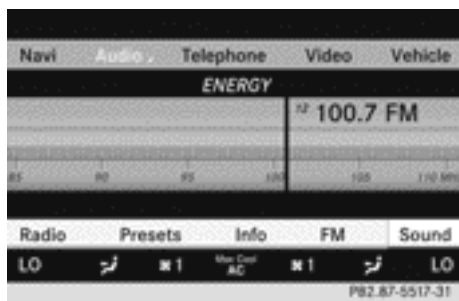

- ▶ Select **Sound** by sliding $\odot \downarrow$ and turning $\left\langle \odot \right\rangle$ the COMAND controller and press \odot to confirm.

You can now set the treble and bass or the balance and fader for radio mode.

Adjusting treble and bass

- ▶ Select **Treble** or **Bass** in the sound menu by turning $\left\langle \odot \right\rangle$ the COMAND controller and press \odot to confirm.

An adjustment scale appears.

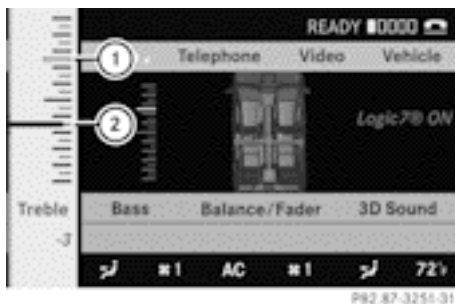

Setting the treble

- ① Last setting selected

- ② Current setting

- ▶ Select a setting by turning $\left\langle \odot \right\rangle$ the COMAND controller and press \odot to confirm.

The setting is stored and you exit the menu.

Adjusting balance and fader

With the balance function, you can control whether the sound is louder on the driver's or front-passenger side.

The fader function is used to control whether the sound is louder in the front or the rear of the vehicle.

- ▶ Select **Balance/Fader** in the sound menu by turning $\left\langle \odot \right\rangle$ and press \odot to confirm.

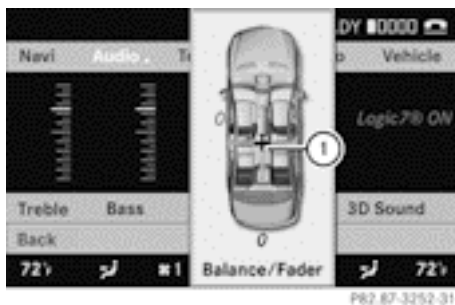

- ① Current setting

- ▶ Select a setting by sliding $\uparrow \odot \downarrow$ or $\leftarrow \odot \rightarrow$ the COMAND controller and press \odot to confirm.

The setting is stored and you exit the menu.

Surround sound

General information

If your vehicle is equipped with the harman/kardon® Logic 7® surround sound system, you can provide the optimum sound experience for every passenger.

The harman/kardon® Logic 7® surround sound system is available for the following operating modes:

- radio (FM only)
- satellite radio
- audio CD
- audio DVD (MLP™, dts™, PCM and Dolby® Digital audio formats)
- MP3
- Media Interface
- video DVD (PCM, dts™ and Dolby® Digital audio formats)
- AUX

Because some DVDs contain both stereo and multichannel audio formats, it may be necessary to set the audio format (▷ page 216).

i The **Logic7® ON** function enables playback of stereo recordings, for instance, with a surround sound experience for every passenger. It enables optimum playback of music and films on CDs, audio DVDs or video DVDs with multichannel audio formats, such as MLP™, dts™ or Dolby® Digital. This results in sound characteristics like those intended by the sound engineer when the original was recorded.

i If you select **Logic7® OFF**, the sound system plays all playable formats as stored on the medium. Due to the design of the passenger compartment, an optimum audio experience cannot be guaranteed for all passengers.

i Discs which support the audio formats mentioned have the following logos:



Dolby® Digital



dts™





Switching surround sound on/off

Example: switching on surround sound for radio mode

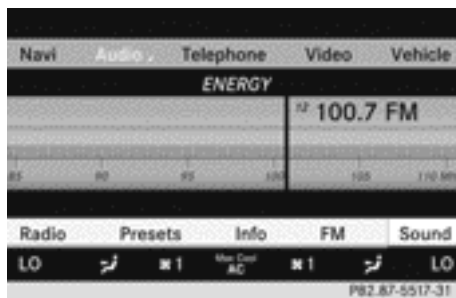
- ▶ Press the  function button.

The radio display appears. You will hear the last station played on the last waveband.



- ▶ Select **Sound** by sliding  and turning  the COMAND controller and press  to confirm.
- ▶ Select **3D Sound** and press  to confirm.

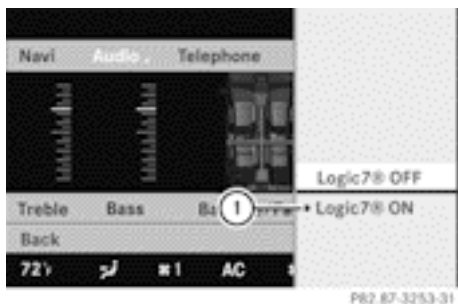

① Current setting

- ▶ Select the **Logic7® ON** or **Logic7® OFF** setting by turning **⏮** or **⏭** the COMAND controller and press **⏹** to confirm. Depending on your selection, surround sound is switched on or off and the menu is exited.
- ▶ **To exit the menu without saving:** press the **⏮** back button or slide **⏮**→ the COMAND controller.

i Please bear the following in mind:

When Logic7® is switched on, the balance and fader settings should be set to the center of the vehicle interior to provide the optimum audio experience for all passengers.

You will achieve the best sound results by playing high-quality audio and video DVDs. MP3 tracks should have a bit rate of at least 128 kbit/s.

Surround sound playback does not function for mono signal sources, such as for AM radio mode.

If radio reception is poor, e.g. in a tunnel, you should switch off Logic7®, since it may otherwise switch dynamically between stereo and mono and cause temporary sound distortions.

On some stereo recordings, the sound characteristics may differ from conventional stereo playback.

System settings

Display settings

Switching the display on/off

- ▶ Select **Vehicle** by turning **⏮** or **⏭** the COMAND controller and press **⏹** to confirm.
- ▶ Select **Display OFF** by turning **⏮** or **⏭** the COMAND controller and press **⏹** to confirm.
- ▶ **To switch on the display:** press **⏹** or **⏮** or **⏭** turn the COMAND controller.

Display design

Your COMAND display features optimized designs for operation during daytime and night-time hours. You can customize the design to suit your personal preferences by manually selecting day or night design or opt for an automatic setting.

- ▶ Select **Vehicle** by turning **⏮** or **⏭** the COMAND controller and press **⏹** to confirm.
- ▶ Select **System** by turning **⏮** or **⏭** the COMAND controller and press **⏹** to confirm.
- ▶ Select **Display** and press **⏹** to confirm.
- ▶ Select **Day Mode**, **Night Mode** or **Automatic** by turning **⏮** or **⏭** the COMAND controller and press **⏹** to confirm. The **●** icon indicates the current setting.

Design	Explanation
Day Mode	The display is set permanently to day design.
Night Mode	The display is set permanently to night design.
Automatic	The display design changes depending on the brightness around the vehicle.

- i** In the **Automatic** setting, COMAND evaluates the readings from the automatic vehicle light sensor and switches between the display designs automatically.

Time settings

General information

If COMAND is equipped with a navigation system and has GPS reception, COMAND automatically sets the time and date. You can also adjust the time yourself in 30-minute increments, but the date cannot be changed.

- i** If you set the time in 30-minute increments, any time zone settings and settings for changing between summer and standard time are lost (▷ page 132).
- i** The following navigation system functions require the time, time zone and summer/standard time to be set correctly in order to work properly:
- route guidance on routes with time-dependent traffic guidance
 - calculation of expected time of arrival

Setting the time

- ▶ Select **Vehicle** in the main function bar by turning **⏸** the COMAND controller and press **⏸** to confirm.
- ▶ Select **System** by turning **⏸** the COMAND controller and press **⏸** to confirm.
- ▶ Select **Time** by turning **⏸** the COMAND controller and press **⏸** to confirm.
- ▶ Select **Time** and press **⏸** to confirm.

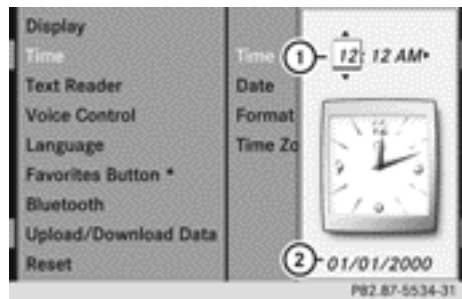

- ① Setting the time
- ② Current date (set automatically by COMAND)

- ▶ Set the time by turning **⏸** the COMAND controller and press **⏸** to confirm.

Setting the time/date format

- ▶ Select **Vehicle** in the main function bar by turning **⏸** the COMAND controller and press **⏸** to confirm.
- ▶ Select **System** by turning **⏸** the COMAND controller and press **⏸** to confirm.
- ▶ Select **Time** by turning **⏸** the COMAND controller and press **⏸** to confirm.
- ▶ Select **Format** and press **⏸** to confirm.
The • symbols show the current settings.

Abbreviation	Meaning
DD/MM/YYYY	Day/Month/Year (date format)
HH/MM	Hours/Minutes (time format)

You can set the 24-hour or the AM/PM format.

- ▶ Set the format by turning **[⏸]** the COMAND controller and press **[⏹]** to confirm.

Setting the time zone and switching between summer and standard time

- ▶ Select **Vehicle** in the main function bar by turning **[⏸]** the COMAND controller and press **[⏹]** to confirm.
- ▶ Select **System** by turning **[⏸]** the COMAND controller and press **[⏹]** to confirm.
- ▶ Select **Time** by turning **[⏸]** the COMAND controller and press **[⏹]** to confirm.
- ▶ Select **Time Zone** and press **[⏹]** to confirm. You will see a list of time zones. The **•** dot indicates the current setting.
- ▶ Select the time zone and press **[⏹]** to confirm.
- ▶ **To switch automatic changeover on/off:** select **Automatic Daylight Savings Time** or **Automatic Daylight Savings Time** by turning **[⏸]** the COMAND controller and press **[⏹]** to confirm. The **•** dot indicates the current setting.

Text reader settings

Setting the text reader speed

- ▶ Select **Vehicle** by turning **[⏸]** the COMAND controller and press **[⏹]** to confirm.
- ▶ Select **System** and press **[⏹]** to confirm.
- ▶ Select **Text Reader** and press **[⏹]** to confirm.
- ▶ Select **Set text reader speed** and press **[⏹]** to confirm. A list appears. The **•** dot indicates the current setting.
- ▶ Select a setting by turning **[⏸]** the COMAND controller and press **[⏹]** to confirm.

Voice Control System settings

Opening/closing the help window

In addition to the audible instructions, the help window will show you other information during voice control operation and the individualization process.

- ▶ Select **Vehicle** in the main function bar by turning **[⏸]** the COMAND controller and press **[⏹]** to confirm.
- ▶ Select **System** by turning **[⏸]** the COMAND controller and press **[⏹]** to confirm.
- ▶ Select **Voice Control** by turning **[⏸]** the COMAND controller and press **[⏹]** to confirm.
- ▶ Select **Help Window** and press **[⏹]** to confirm. You have switched the help window on or off .

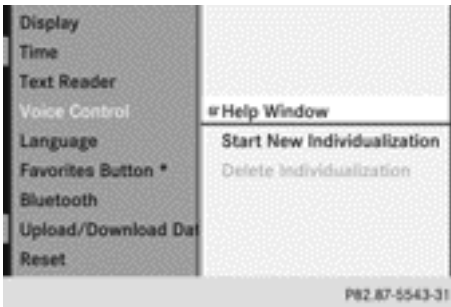





Individualization



Introduction

You can use the individualization function to fine tune the Voice Control System to your voice and therefore improve voice recognition. This means that other users' voices will not be recognized as easily. For this reason this function can be switched off. Individualization comprises two parts and takes approximately 5 minutes. It consists of training the system to recognize a certain number of digit sequences and voice commands.

Starting new individualization

Individualization can only be started when the vehicle is stationary. Before starting, switch off all devices or functions which could interfere, such as the radio or the navigation system. After starting the session, the system guides you through the training with spoken instructions.

- ▶ Select **Vehicle** in the main function bar by turning  the COMAND controller and press  to confirm.
- ▶ Select **System** by turning  the COMAND controller and press  to confirm.
- ▶ Select **Voice Control** and press  to confirm.

- ▶ Select **Start New Individualization** and press  to confirm. You see and hear a prompt asking whether you would like further information.
- ▶ Select **Yes** or **No** and press  to confirm. If you select **No**, the first part of individualization begins. You will be asked whether you would like to train digits or voice commands. If you select **Yes**, you will see and hear information on the individualization process. The first part of individualization then begins automatically.
- ▶ **To close the display:** press  the COMAND controller. You will be asked whether you would like to train digits or voice commands.

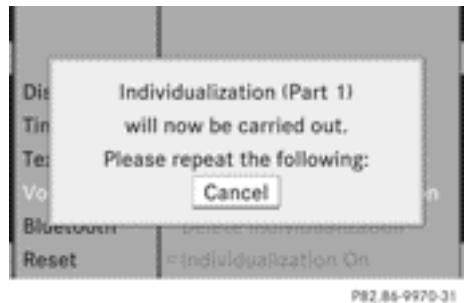

At the end of the first part, a prompt will appear asking whether you wish to begin the second part.

- ▶ Select **Yes** or **No** and press  to confirm. If you select **No**, individualization will be canceled. The data from the first part is stored automatically. If you select **Yes**, the second part will begin. Individualization is completed at the end of the second part. You will see a message to this effect. The data from the second part is stored automatically.

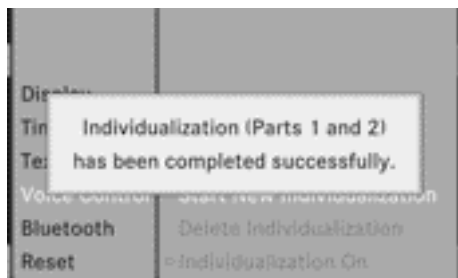

P82.86-9771-31

Canceling the first or second part of individualization

- ▶ Confirm **Cancel** by pressing the COMAND controller.
A prompt appears asking whether you really wish to cancel.
- ▶ Select **Yes** or **No** and press to confirm.
If you select **Yes**, individualization will be canceled. The data from the part during which you exited is not stored.
If you select **No**, the current part begins again.

Deleting existing individualization data

- ▶ Select **Vehicle** by turning the COMAND controller and press to confirm.
- ▶ Select **System** and press to confirm.
- ▶ Select **Voice Control** and press to confirm.
- ▶ Select **Delete Individualization** and press to confirm.
A prompt appears asking whether you really wish to delete.
- ▶ Select **Yes** or **No** and press to confirm.
If you select **No**, the process will be aborted.
If you select **Yes**, the individualization is deleted. You will see a message to this effect.

Bluetooth® settings

General information about Bluetooth®

Bluetooth® technology is the standard for short-range wireless data transmission of up to approximately 10 meters. Bluetooth® allows, for example, the exchange of vCards. Bluetooth® is a registered trademark of Bluetooth Special Interest Group (SIG) Inc.



P82.86-9790-31

Requirements for a Bluetooth® connection

You can connect mobile phones and notebooks to COMAND.

To do so, the following conditions need to be met:

- Bluetooth®-capable devices, e.g. mobile phones, must comply with a certain profile in order to be connected to COMAND. Every Bluetooth® device has its own specific Bluetooth® name.
 - Bluetooth® must be activated in COMAND and on the respective Bluetooth® device; see the separate operating instructions.
 - the Bluetooth® device must be "visible" to COMAND in order for COMAND to find and display it. For the setting procedures, please see the operating instructions for the Bluetooth® device.
- i** Once a mobile phone has been connected, reception and transmission volume may change.

Activating/deactivating Bluetooth®

- ▶ Select **Vehicle** in the main function bar by turning **Ⓜ** the COMAND controller and press **Ⓜ** to confirm.
- ▶ Select **System** by turning **Ⓜ** the COMAND controller and press **Ⓜ** to confirm.
- ▶ Select **Bluetooth** by turning **Ⓜ** the COMAND controller and press **Ⓜ** to confirm.
- ▶ Select **Bluetooth activated** and press **Ⓜ** to confirm.
This switches Bluetooth® on or off .

Connecting Bluetooth® devices

General information

Before using your Bluetooth® device with COMAND for the first time, you will need to connect it.

Connecting comprises:

- searching for a Bluetooth® device
- subsequently authorizing it

i A maximum of 15 devices can be available for selection from the device list.

More detailed information on suitable mobile phones and on connecting Bluetooth®-capable mobile phones to COMAND can be found on the Internet at <http://www.mbusa-mobile.com>. Or call the Mercedes-Benz Customer Assistance Center on 1-800-FOR-MERCEDES(1-800-367-6372) (for the USA) or Customer Relations on 1-800-387-0100 (for Canada).

Searching for Bluetooth® devices

- ▶ Activate Bluetooth® (▷ page 135).
- ▶ Select **Vehicle** in the main function bar by turning **Ⓜ** the COMAND controller and press **Ⓜ** to confirm.

- ▶ Select **System** by turning **Ⓜ** the COMAND controller and press **Ⓜ** to confirm.
- ▶ Select **Bluetooth** by turning **Ⓜ** the COMAND controller and press **Ⓜ** to confirm.
- ▶ Select **Search for Bluetooth Devices** and press **Ⓜ** to confirm.
- ▶ Select **Update** and press **Ⓜ** to confirm. COMAND searches for Bluetooth® devices within range. After a short while, the Bluetooth® device list appears.

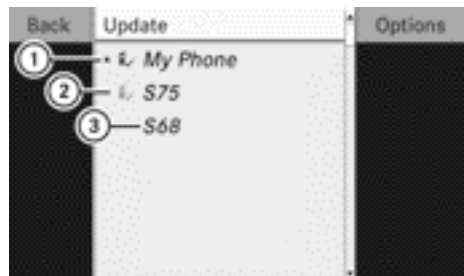

PR2.86-9972-31

Example of display: Bluetooth® device list

- ① Currently connected • and authorized device (✓ icon)
- ② Device not within range but previously authorized (✓ appears in gray)
- ③ Newly detected device in range, not yet authorized (✓)

The Bluetooth® device list shows all devices within range and all previously authorized devices, whether or not they are in range.

If the Bluetooth® device list is already full, you will be requested to de-authorize a device. If COMAND does not detect your Bluetooth® device, external authorization may be necessary (▷ page 136).

Authorizing a Bluetooth® device (registering)

- ▶ In the Bluetooth® device list, select not yet authorized device ③ by turning **Ⓜ** the COMAND controller.

- ▶ Select **Options** by sliding $\odot \rightarrow$ the COMAND controller and press \odot to confirm.
- ▶ Select **Authorize** and press \odot to confirm.

or

- ▶ Press \odot to confirm the selected device. The input menu for the passcode appears.

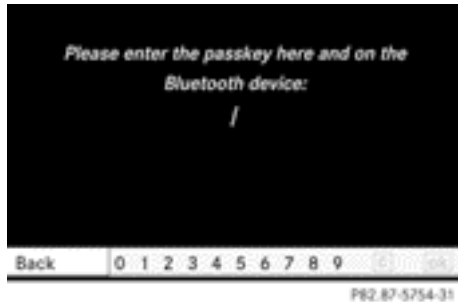

The passcode is any one to sixteen-digit number combination which you can choose yourself. You must enter the same number combination in COMAND and in the Bluetooth® device to be authorized (see mobile phone operating instructions).

- i** Some mobile phones require a passcode with four or more digits.
- i** If you want to reauthorize a device following de-authorization (▶ page 137), you can select a different passcode.
- ▶ **To enter a passcode in COMAND:** press the number keys in sequence. **OK** can be selected after the first number has been entered.

or

- ▶ Select the digits one by one by turning $\left\{ \odot \right\}$ the COMAND controller and press \odot to confirm.
- ▶ **To confirm an entry in COMAND:** select **OK** using the COMAND controller and press \odot to confirm.

or

- ▶ Select **SEND** on the telephone keypad.

- ▶ Enter the same passcode into the Bluetooth® device (see the operating instructions for the respective device). The device is authorized.

External authorization

If COMAND does not detect your Bluetooth® device, this may be due to particular security settings on your Bluetooth® device. In this case, you can test if your Bluetooth® device can find COMAND. The Bluetooth® device name of COMAND is "MB Bluetooth".

- ▶ Select **Update**.
- ▶ Select **Options** by sliding $\odot \rightarrow$ the COMAND controller and press \odot to confirm.
- ▶ Select **External Authorization** and press \odot to confirm.
- ▶ Start the Bluetooth® scan process on the Bluetooth® device (see separate operating instructions of the respective device).
- ▶ Select COMAND ("MB Bluetooth").
- i** The order in which the passkey is entered depends on the mobile phone.
- ▶ Enter the passkey on the Bluetooth® device when prompted.
- ▶ Confirm the **Do you want to authorize XX?** question in COMAND with **Yes**.
- ▶ Enter the passkey in COMAND.

Displaying the details of a Bluetooth® device

- ▶ In the Bluetooth® device list, select the desired device by turning $\left\{ \odot \right\}$ the COMAND controller.
- ▶ Select **Options** by sliding $\odot \rightarrow$ the COMAND controller and press \odot to confirm.

- ▶ Select **Details** and press to confirm. The detailed display for this device appears.
- ▶ **To close the detailed view:** turn or slide the COMAND controller.

De-authorizing (de-registering) a Bluetooth® device

Mercedes-Benz USA, LLC recommends de-authorization in both COMAND and the Bluetooth® device, e.g. the mobile phone. Subsequent authorization may otherwise fail.

- ▶ In the Bluetooth® device list, select the authorized device by turning the COMAND controller.
- ▶ Select **Options** by sliding the COMAND controller and press to confirm.
- ▶ Select **De-authorize** and press to confirm. A prompt appears asking whether you really wish to de-authorize this device.
- ▶ Select **Yes** or **No** and press to confirm. If you select **Yes**, the authorization for the device will be revoked. If you select **No**, the process will be aborted.

- i** If a Bluetooth® device has been de-authorized and is out of range, when a new search is carried out it will not appear in the Bluetooth® device list.

System language settings

This function allows you to determine the language for the menu displays and the navigation messages. The selected language affects the characters available for entry.

When you set the system language, the language of the Voice Control System will change accordingly. If the selected language is not supported by the Voice Control System, "English" will be selected.

- ▶ Select **Vehicle** by turning the COMAND controller and press to confirm.
- ▶ Select **System** and press to confirm.
- ▶ Select **Language** and press to confirm. The list of languages appears. The • dot indicates the current setting.
- ▶ Select the language by turning the COMAND controller and press to confirm. COMAND loads the selected language and sets it.

Reset function

You can reset COMAND to the factory settings. Amongst other things, this will delete all personal data (e.g. station presets, address book entries, entries in the destination memory and in the list of previous destinations in the navigation system). Resetting is recommended before selling or transferring ownership of your vehicle, for example.

- ▶ Select **Vehicle** in the main function bar by turning the COMAND controller and press to confirm.
- ▶ Select **System** by turning the COMAND controller and press to confirm.
- ▶ Select **Reset** and press to confirm. A prompt appears asking whether you wish to reset.
- ▶ Select **Yes** or **No** and press to confirm. If you select **No**, the process will be aborted. If you select **Yes**, another prompt appears asking whether you really wish to reset.
- ▶ Select **Yes** or **No** and press to confirm. If you select **Yes**, a message will be shown. COMAND is reset and restarted. If you select **No**, the process will be aborted.

Navigation

Introduction

Safety notes

WARNING

For safety reasons, only enter a destination when the vehicle is stationary. When the vehicle is in motion, a passenger should enter the destination. Study manual and select route before driving.

Bear in mind that at a speed of just 30 mph (approximately 50 km/h), your vehicle is covering a distance of 44 feet (approximately 14 m) every second.

COMAND calculates the route to the destination without taking account of the following:

- Traffic lights
- Stop and right-of-way-signs
- Lane merging
- Parking or stopping prohibited areas
- Other road and traffic rules and regulations
- Narrow bridges

WARNING

COMAND may give incorrect navigation commands if the data in the digital map does not correspond with the actual road/traffic situation. Digital maps do not cover all areas nor all routes within an area. For example, if the traffic routing has been changed or the direction of a one-way road has been reversed.

For this reason, you must always observe applicable road and traffic rules and regulations during your journey. Road and traffic rules and regulations always have priority over the navigation commands generated by the system.

WARNING

Navigation announcements are intended to direct you while driving without diverting your attention from the road and driving.

Please always use this feature instead of consulting the map display for directions. Looking at the icons or map display can distract you from traffic conditions and driving, and increase the risk of an accident.

General information

Operational readiness of the navigation system

The navigation system must determine the position of the vehicle before first use or whenever operational status is restored. Therefore, you may have to drive for a while before precise route guidance is possible.

GPS reception

Correct functioning of the navigation system depends, amongst other things, on GPS reception. In certain situations, GPS reception may be impaired, there may be interference or there may be no reception at all, e.g. in tunnels or parking garages.

Entry restriction

On vehicles for certain countries, there is a restriction on entering data.

The restriction is active from a vehicle speed of over approximately 3 mph (5 km/h). As soon as speed falls below approximately 2 mph (3 km/h), the restriction becomes inactive.

When the restriction is active, certain entries cannot be made. This will be indicated by the fact that certain menu items are grayed out and cannot be selected.



The following functions, for example, may therefore not be available while the vehicle is in motion:

- entering the destination city and street
- entering a destination via the map
- entering points of interest in the vicinity of a city or via a name search
- editing entries
- using the number keypad for direct entry

Switching to navigation mode

- ▶ Press the  function button once or twice.

or

- ▶ Select **Navi** in the main function bar by sliding  and turning  the COMAND controller and press  to confirm. In both cases, you will see the map either with or without the menu shown.



PE2 87-3256-31

Map showing the menu; route guidance inactive

- ① Current vehicle position



PE2 87-2268-31

Map without the menu; route guidance inactive



- ① Current vehicle position
- ② Map orientation selected
- ③ Map scale selected

"Route guidance active" means that you have entered a destination and that COMAND has calculated the route. The display then shows the route, changes of direction and lane recommendations. Navigation announcements guide you to your destination.

⁵ Traffic reports are not available in all countries.

"Route guidance inactive" means that no destination has been entered and that no route has been calculated.

Showing/hiding the menu

- ▶ **To hide the menu:** slide  the COMAND controller over the map. The **Full Screen** menu item is shown.
- ▶ Confirm the **Full Screen** menu item shown by pressing . The map can be seen in the full-screen display.
- ▶ **To show the menu:** press  the COMAND controller when the map is shown in full-screen.

Basic settings

Route mode

Setting route type and route options

You can select the following route types:







- **Fast Route:** COMAND calculates the route with the shortest (minimized) journey time.
- **Dynamic Route:** same route type as **Fast Route**. In addition, COMAND takes traffic reports into account during route guidance⁵. Thus, the navigation system is able to guide you around a blocked section, for example. If a faster route is determined due to a received RDS-TMC traffic announcement, the navigation system changes the route. If possible, it will bypass blocked roads.
- **Eco Route:** the ECO route is an economical route that takes traffic announcements into account (see dynamic route).
- **Short Route:** COMAND calculates the route with the shortest possible (minimized) route distance.

In addition to route types, route options can also be set.



You can select the following route options:

- Use Carpool Lanes
- Minimize highways
- Minimize Toll Roads
- Minimize Tunnels
- Minimize Ferries
- Minimize Motorail Trains

If you select route options with a tick, the corresponding types of roads will be avoided in the route guidance where possible.

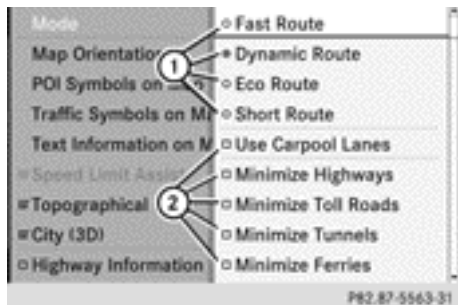
- ▶ **To activate navigation mode:** press the  function button once or twice.
- ▶ **To show the menu:** press  the COMAND controller.
- ▶ Select **Navi** in the main function bar by sliding  and turning  the COMAND controller and press  to confirm.
- ▶ Select **Mode** and press  to confirm.



- ① To select the route type
- ② To set route options
- ▶ Select a route type and press  to confirm. The  icon indicates the current setting.
- ▶ Select the route option(s) and press  to confirm. The route options are switched on or off , depending on the previous status.
- i** If you change the route type and/or the route options while route guidance is active (the route has been calculated), COMAND will calculate a new route.

If you change the route type and/or the route options while route guidance is inactive (no destination has been entered yet), COMAND uses the new setting for the next route guidance.

- i** The route calculated may, for example, include ferry connections, even if the **Minimize Ferries** route option is switched on.

In some cases, e.g. when calculating particularly long routes, COMAND may not be able to take all the selected route options into account. A note then appears in the COMAND display.

- ▶ **To exit the menu:** slide  the COMAND controller.

Destination input

Introduction to destination entry

WARNING

For safety reasons, only enter a new destination when the vehicle is stationary. You could otherwise be distracted from the traffic conditions, cause an accident and injure yourself and others.

The following destination entry options are available:

- entering a destination by address
- entering a destination from the destination memory
- entering a destination from the list of last destinations
- entering a destination using the map
- entering an intermediate stop
- entering a point of interest

Entering a destination by address

Introduction

When entering an address as the destination, you have the following options:

- entering the state/province, city/ZIP code and street
- entering the state/province, city/zip code and center
- entering the state/province, city/zip code, street and house number
- entering the state/province, city/zip code, street and intersection
- entering the state/province, street, city and house number
- entering the state/province, street, house number and city
- entering the state/province, street, intersection and city

i You can only enter those cities, streets, zip codes etc. that are stored in the digital map. This means that for some countries, you cannot enter zip codes, for example.

Example: entering an address

The following is a step-by-step example of how to enter an address. The destination address is as follows:





New York (state)

New York City

40 Broadway

You can of course enter any country, city, street and house number desired and enter, for example, your home address (My address).

Calling up the address entry menu

- ▶ **To activate navigation mode:** press the  function button once or twice.
- ▶ **To show the menu:** press  the COMAND controller.
- ▶ Select **Destination** by turning  the COMAND controller and pressing  to confirm.

- ▶ Select **Address Entry** and press  to confirm.
The address entry menu appears. If you have previously entered a destination, this will be shown in the display.





Address entry menu

Depending on the sequence in which you enter the address and on the data status of the digital map, some menu items may not be available at all or may not yet be available.

Example: after you have entered the state/province, the **No.**, **Center**, **Intersection**, **Save** and **Start** menu items are not yet available; the **Zip Code** menu item is not available if the digital map does not contain ZIP codes.

Selecting a state/province

- ▶ Select **State/Prov.** in the address entry menu by turning  the COMAND controller and press  to confirm.
A menu with the available lists appears. The state/province in which the vehicle is located is selected by default.

- Last States/Provinces
- States (U.S.)
- Provinces (Canada)

- ▶ **To select a list:** turn **[⊙]** the COMAND controller and press **[⊙]** to confirm. The list of selected states/provinces appears.
- ▶ **To select a state/province:** turn **[⊙]** the COMAND controller and press **[⊙]** to confirm. The address entry menu appears again. The state/province selected has now been entered.

Entering the city

- ▶ Select **City** in the address entry menu by turning **[⊙]** the COMAND controller and press **[⊙]** to confirm. You will see the city list either with the character bar (option 1) or as a selection list (option 2).

Option 1: city list with character bar

- ▶ Enter **NEW YORK CITY**. Instructions for entering characters can be found in the "Entering characters in navigation mode (entering a city)" section (▷ page 122).



Option 2: city list as selection list



City list

- ▶ Select an entry by turning **[⊙]** the COMAND controller.
- ▶ Irrespective of the option, press **[⊙]** to confirm your selection. The address entry menu appears again. The city has now been entered.

Entering a street name

- ▶ Select **Street** in the address entry menu by turning **[⊙]** and sliding **↑⊙↓** the COMAND controller and press **[⊙]** to confirm. You will see the street list either with the character bar (option 1) or as a selection list (option 2).

Option 1: street list with character bar

- ▶ Enter **BROADWAY**. Instructions for entering characters using city input as an example can be found in the "Entering characters in navigation mode (entering a city)" section (▷ page 122).

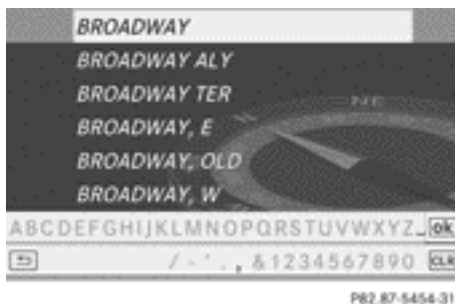

Option 2: street list as selection list



P82.87-5455-31

Street list

- ▶ Select a street by turning **⏪** the COMAND controller and press **⏩** to confirm.
- ▶ Irrespective of the option, press **⏩** to confirm your selection. The address entry menu appears again. The street has now been entered.

Entering the house number

It is not possible to enter a house number until a street has been entered.

- ▶ Select **No.** in the address entry menu by turning **⏪** and sliding **↑** the COMAND controller and press **⏩** to confirm. The character bar appears.
- ▶ Enter a house number. Instructions for entering characters using city input as an example can be found in the "Entering characters in navigation mode (entering a city)" section (▷ page 122).
- ▶ Confirm the entry with **⏩**. The address entry menu appears again. The house number has now been entered.

Ambiguity of city names

If several cities share the same name, you can also directly input or select a street name. COMAND then selects the city where the respective street is found.

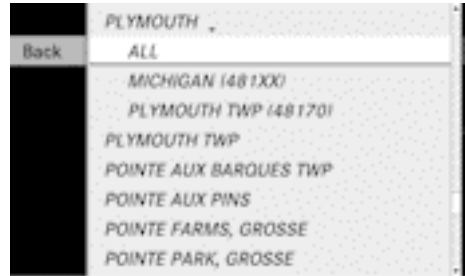

P82.87-3657-31

- ▶ Enter a city as described above (▷ page 141).
- ▶ Select **ALL**.
- ▶ Enter or select the street name.
- ▶ Select the appropriate city.

If you know the city well, you can continue directly after selecting the city from the list.

Starting route calculation

You can now have COMAND calculate the route to the address entered or save the address first, e.g. as your home address (My address) (▷ page 144).

COMAND checks whether the destination is unambiguous. If the destination is ambiguous, further information is requested to define the destination unambiguously, e.g. an area of city or a zip code.



P82.87-5567-31

Address entry menu with destination address

- ① Destination address
- ② To start route calculation

- ▶ In the address entry menu, confirm **Start** by pressing .

If no other route has been calculated, route calculation starts immediately (Option 1). If another route has already been calculated (route guidance is active), a prompt appears (option 2).

Option 1 – no route guidance active: route calculation starts. While route calculation is in progress, an arrow will indicate the direction to your destination. Below this, you will see a message, e.g. **Fast route is being calculated**.

Once the route has been calculated, route guidance begins. If the vehicle is traveling on a non-digitized road, the system displays the linear distance to the destination, the direction of the destination and the **Street Unknown** message. In this case, the display will be grayed out.

Option 2 – route guidance is already active: if route guidance is already active, a prompt will appear asking whether you wish to terminate the currently active route guidance.





- ▶ Select **Yes** or **No** and press  to confirm. If you select **Yes**, COMAND will stop route guidance and start route calculation for the new destination. If you select **No**, COMAND will continue with the active route guidance.

i Route calculation takes a certain amount of time. The time depends on the distance from the destination, for example. COMAND calculates the route using the digital map data.

The calculated route may differ from the ideal route, e.g. due to roadwork or incomplete map data. Please also refer to the notes about the digital map (▷ page 176).



Entering and saving your home address

You can either enter your home address for the first time (option 1) or edit a previously stored home address (option 2).

- ▶ **Option 1:** enter the address, e.g. a city, street and house number (▷ page 141).
- ▶ Once you have entered the address, select **Save** in the address entry menu by turning  and sliding  the COMAND controller and press  to confirm.
- ▶ Select **Save as "My Address"** and press  to confirm. COMAND stores your home address as **My Address** in the destination memory.
- ▶ **Option 2:** proceed as described under "Option 1". A prompt appears asking whether the current home address should be overwritten.
- ▶ Select **Yes** and press  to confirm. After selecting **Yes**, the **Save successful** message appears.

Entering a ZIP code

Entering a ZIP code will delete a previously entered city.

- ▶ Select **Zip Code** in the address entry menu by turning  and sliding  the COMAND controller and press  to confirm. You see the list of zip codes with the character bar.
- ▶ Enter a ZIP code. Instructions for entering characters using city input as an example can be found in the "Entering characters in navigation mode (entering a city)" section (▷ page 122).

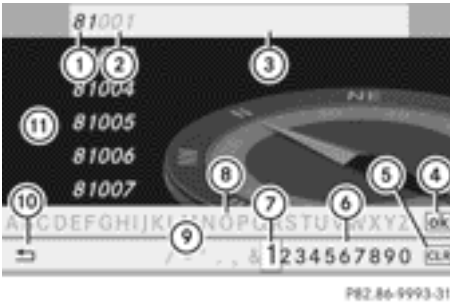

- ① Digits entered by the user
- ② Digits automatically added by the system
- ③ List entry most closely resembling the characters entered so far
- ④ To switch to the list without the character bar
- ⑤ To delete the entire entry: press and hold; to delete the last character: press briefly
- ⑥ Available characters
- ⑦ Selected character
- ⑧ Unavailable characters
- ⑨ Character bar
- ⑩ To cancel an entry
- ⑪ List

- ▶ Confirm the entry with

If COMAND is able to assign the ZIP code unambiguously to a specific address, the address entry menu appears again. The ZIP code appears in place of the city's name.

If COMAND cannot assign the ZIP code unambiguously to a specific address, the address entry menu also appears again. The ZIP code is automatically entered. For a more precise location, you can now enter, for example, the street, a city, a center or a POI.

- ▶ Start route calculation (▷ page 143).

Entering a center

Entering a center will, for example, delete a previously entered street.

- ▶ Select **Center** (center) in the address entry menu by turning and sliding

COMAND controller and press to confirm.

You will see the center list either with the character bar (option 1) or as a selection list (option 2).

Option 1: center list with character bar

- ▶ Enter a center. Instructions for entering characters using city input as an example can be found in the "Entering characters in navigation mode (entering a city)" section (▷ page 122).

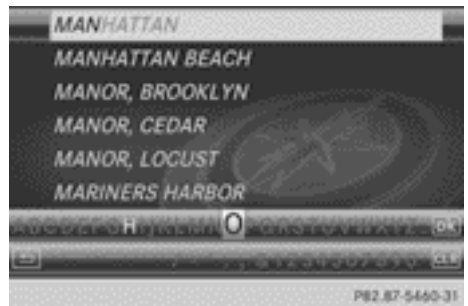

Option 2: center list as selection list



- ▶ Select a center by turning the COMAND controller.
- ▶ Irrespective of the option, press to confirm your selection. The address entry menu appears again. The center selected has been entered.
- ▶ Start route calculation (▷ page 143).

Entering an intersection name

Entering an intersection will delete a previously entered house number.

- ▶ Select **Intersection** (intersection) in the address entry menu by turning **[⏪]** and sliding **↑/↓** the COMAND controller and press **[✓]** to confirm.
You will see the intersection list either with the character bar (option 1) or as a selection list (option 2).

Option 1: intersection list with character bar

- ▶ Enter an intersection. Instructions for entering characters using city input as an example can be found in the "Entering characters in navigation mode (entering a city)" section (▶ page 122).



- ① List entry most closely resembling the characters entered so far
- ② List
- ③ Character bar

Option 2: intersection list as selection list

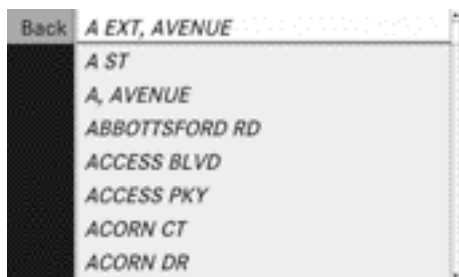

- ▶ Select an intersection by turning **[⏪]** the COMAND controller.
- ▶ Irrespective of the option, press **[✓]** to confirm your selection.
The address entry menu appears again. The intersection selected has been entered.
- ▶ Start route calculation (▶ page 143).

Selecting a destination from the destination memory (e.g. My address)





Introduction

The destination memory always contains an entry named "My address". You may wish to assign your home address to this entry, for example (▶ page 144), and select it for route guidance. This entry is always located at the top of the list in the destination memory.

- ▶ **To activate navigation mode:** press the **[TEL NAVI]** function button once or twice.
- ▶ **To show the menu:** press **[⏪]** the COMAND controller.
- ▶ Select **Destination** in the navigation system menu bar by turning **[⏪]** the COMAND controller and pressing **[✓]** to confirm.
- ▶ Select **From Memory** and press **[✓]** to confirm.
- ▶ Select **My Address** by turning **[⏪]** the COMAND controller.
- ▶ Irrespective of the option, press **[✓]** to confirm your selection.
"My address" has been entered.
- ▶ **To start route calculation:** select **Start** and press **[✓]** to confirm.



Entering a destination from the list of last destinations

- ▶ **To activate navigation mode:** press the **[TEL NAVI]** function button once or twice.



- ▶ **To show the menu:** press  the COMAND controller.
- ▶ Select **Destination** in the navigation system menu bar by turning  the COMAND controller and pressing  to confirm.
- ▶ Select **From Last Destinations** and press  to confirm.



"Last destinations" list





- ① Last destination
- ▶ Select the desired destination by turning  the COMAND controller and pressing  to confirm.
The destination address selected has been entered.
- ▶ **To start route calculation:** select **Start** and press  to confirm.
Once the route has been calculated, route guidance begins (▷ page 154).
- ❗ Further information on the "Last destinations" memory can be found on (▷ page 169).
- ▶ **To navigate to another street in the same city or to another house number**

on the same street: call up an address destination from the last destinations.

- ▶ Select **Change** by turning  and sliding  the COMAND controller and press  to confirm.
All destination entry functions are available.
- ▶ Edit/enter the destination as described for destination entry (▷ page 140).

Entering a destination using the map

Calling up the map

- ▶ **To activate navigation mode:** press the  function button once or twice.
- ▶ **To show the menu:** press  the COMAND controller.
- ▶ Select **Destination** in the navigation system menu bar by turning  the COMAND controller and pressing  to confirm.
- ▶ Select **Via Map** and press  to confirm.
You see the map with the crosshair.



- ① Current vehicle position
- ② Crosshair
- ③ Details of the crosshair position
- ④ Map scale selected

Display ③ depends on the settings selected in "Map information in the display" (▷ page 173). The current street name can be shown, provided the digital map contains the necessary data, or the coordinates of the crosshair if the geo-coordinate display is

switched on and the GPS signal is strong enough.

Moving the map and selecting the destination

- ▶ **To scroll the map:** slide ←⊙→, ↑⊙↓ or ↻⊙↻ the COMAND controller.
- ▶ **To set the map scale:** as soon as you turn ⊙ the COMAND controller, the scale bar appears.
- ▶ Turn ⊙ until the desired scale is set. Turning clockwise zooms out from the map; turning counter-clockwise zooms in.
- ▶ **To select a destination:** press ⊙ the COMAND controller once or several times. You will see either the address entry menu with the destination address or, if COMAND is unable to assign a unique address, a selection list.

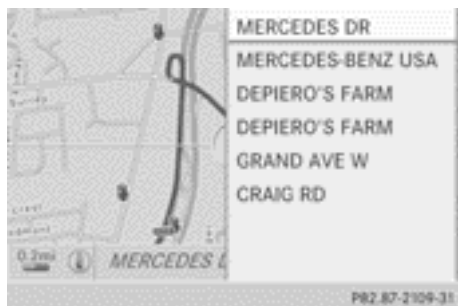

- ▶ Select a destination by turning ⊙ the COMAND controller and press ⊙ to confirm. If the destination is within the limits of the digital map, COMAND attempts to assign the destination to the map. If the destination can be assigned, you will see the address entry menu with the address of the destination. If not, you will see the entry [Destination from Map](#).
- ▶ **To start route calculation:** select [Start](#) and press ⊙ to confirm.

Entering an intermediate stop

Introduction

When route guidance is active, you can enter an intermediate stop. Intermediate stops can be predefined destinations from the following categories that COMAND offers for selection:

- [Mercedes-Benz Service Center](#)
- [Hospital](#)
- [Gas Station](#)
- [Parking Lot](#)
- [Restaurant](#)

However, you can also enter destinations other than the predefined ones. To do this select the menu item [Other](#).

You can use the intermediate stop function to influence route guidance to the main destination. When you have reached your intermediate stop, COMAND automatically recalculates the route to the main destination.

Entering predefined destinations

- ▶ **To activate navigation mode:** press the  function button once or twice.
- ▶ **To show the menu:** press ⊙ the COMAND controller.
- ▶ Select [Destination](#) in the navigation system menu bar by turning ⊙ the COMAND controller and pressing ⊙ to confirm.
- ▶ Select [Stopover](#) and press ⊙ to confirm.

Option 1: no intermediate stop has been entered yet.

- ▶ Select a category; see option 2.

Option 2: an intermediate stop has already been entered.

- ▶ Select [Change Stopover](#) and press ⊙ to confirm.

- ▶ **To select a category:** select a category by turning the COMAND controller and pressing to confirm.

COMAND first searches in the selected category for destinations along the route. If there are no destinations available there, COMAND searches for destinations within a radius of up to 100 km of the vehicle position.

If COMAND finds destinations, a list appears on the right-hand side of the display. The currently selected point of interest is highlighted on the left-hand side of the map.

The intermediate stops are listed according to increasing distance from the current vehicle position. They are displayed in the form of a name and their position in relation to the route and your direction of travel.

If COMAND does not find any destinations, you will see a message to this effect.

- ▶ Confirm **OK** by pressing .
- ▶ Select a different category.
- ▶ Select the intermediate stop by turning the COMAND controller and pressing to confirm.
- ▶ **To start route calculation:** select **Start** and press to confirm.

Entering another destination as an intermediate stop

- ▶ **To activate navigation mode:** press the function button once or twice.
- ▶ **To show the menu:** press the COMAND controller.
- ▶ Select **Destination** in the navigation system menu bar by turning the COMAND controller and pressing to confirm.
- ▶ Select **Stopover** and press to confirm.
- ▶ Select **Other** and press to confirm.

- ▶ Select **Address Entry**, **From Memory**, **From Last Destinations** or **From POIs**.

Selection	Step
Address Entry	▶ Enter a destination by address (▷ page 141).
From Memory	▶ Select a destination from the destination memory (▷ page 146).
From Last Destinations	▶ Select a destination from the list of last destinations (▷ page 146).
From POIs	▶ Enter a point of interest (▷ page 150).

- ▶ **To start route calculation:** once you have entered a destination, select **Start** and press to confirm.

Deleting an intermediate stop





If an intermediate stop has already been entered, you can delete it.

- ▶ **To activate navigation mode:** press the function button once or twice.
- ▶ **To show the menu:** press the COMAND controller.
- ▶ Select **Destination** in the navigation system menu bar by turning the COMAND controller and pressing to confirm.
- ▶ Select **Stopover** and press to confirm.

- ▶ Select **Delete Stopover** and press  to confirm.
COMAND deletes the intermediate stop and recalculates the route to the main destination.

Entering a POI

Initiating point of interest entry

- ▶ **To activate navigation mode:** press the  function button once or twice.
- ▶ **To show the menu:** press  the COMAND controller.
- ▶ Select **Destination** in the navigation system menu bar by turning  the COMAND controller and press  to confirm.
- ▶ Select **From POIs** and press  to confirm.
A menu appears.

Entering a point of interest in the vicinity of the destination

Entering a point of interest in the vicinity of the destination is only possible when route guidance is active.



- ▶ Select **Destination Area** from the menu and press  to confirm.
- ▶ Continue with assigning the point of interest category (▷ page 151).

Entering a point of interest in the vicinity of the current position

- ▶ Select **Current Position** and press  to confirm.
- ▶ Continue with assigning the point of interest category (▷ page 151).

Entering a point of interest in the vicinity of a specific city

Option 1



- ▶ Select **Other City** in the menu and press  to confirm.
- ▶ If desired, select the state/province (▷ page 140).
- ▶ **To enter a city:** select **City** and press  to confirm.
Proceed as described in the "Entering a city" section (▷ page 140).
- ▶ After entering the city, select the point of interest category (▷ page 151).

Option 2

- ▶ Enter an address in the address entry menu, e.g. a city, street and house number (▷ page 140).
- ▶ Select **POI** and press  to confirm.
- ▶ Select the point of interest category (▷ page 151).

Entering a point of interest using name search

This function allows you to access all the points of interest available on the digital map.

- ▶ Select **By Name** from the menu and press  to confirm.
You will see a list of further selection options.
- ▶ Select the desired option and press  to confirm.
- ▶ Enter the name using the character bar.

Entering a point of interest using the phone number search

This function gives you access to all points of interest that have a phone number.

- ▶ Select **By Telephone Number** and press  to confirm.
You will see a list of phone numbers.

- ▶ Enter the phone number using the character bar.

Assigning a point of interest category

Introduction

The categories and points of interest available depend on the distance from the vehicle position you have set for the point of interest.

- point of interest in the vicinity of the destination:
Alphabetically sorted categories, as well as points of interest in the vicinity of the target destination and sorted by distance are available.
- point of interest in the vicinity of the current position:
Alphabetically sorted categories are available, as well as points of interest in the vicinity of the vehicle position arranged by distance.
- point of interest within a given city:
If you have entered only the state/province and the city, the system will return alphabetically sorted categories and points of interest within the city limits.
If you have entered more than the state/province and the city, the system will return alphabetically sorted categories and points of interest sorted by distance, all in the vicinity of the address you entered.
- point of interest using name search:
An alphabetically sorted list of all points of interest is available.
The list sorts points of interest with the same name and in the same category according to distance, starting with those nearest to you.

Selecting a category

- ▶ Select a main category by turning **Ⓢ** the COMAND controller.

- ▶ Confirm the entry with **Ⓢ**.

If the selected main category does not contain any sub-categories, the point of interest list appears.

If the selected main category contains subcategories, a list of the subcategories appears with the input speller.

- ▶ Select a category by turning **Ⓢ** the COMAND controller.

- ▶ Confirm the entry with **Ⓢ**.

The point of interest list appears. It contains the points of interest available in the sub-category that are within the search radius.

- i** Search radius means: COMAND searches within a radius of 100 km.

If COMAND does not find any points of interest within this radius, it extends its search range to approximately 200 km. If COMAND finds one point of interest within this radius, it finishes the search.

- i** If you select the **ALL** list item, the point of interest list contains all points of interest for all subcategories in the **Restaurant** main category which lie within the search radius.

Point of interest list

Introduction

The illustration below shows an example of the point of interest list for the **Restaurant** main category in the vicinity of the current position.



P82.87-5637-31



P82.87-5938-31

Example display

- ① Point of interest category
- ② Direction display to point of interest starting from the current position
- ③ Linear distance to the point of interest
- ④ Point of interest
- ⑤ Selected category or sub-category
- ❗ Depending on the point of interest selected, COMAND uses different reference points in determining the linear distance to the destination:
 - vicinity of current position: the linear distance is the distance of the point of interest from the current vehicle position.
 - vicinity of destination: the linear distance is the distance from the destination entered to the point of interest.

Selecting a point of interest

- ▶ Select a point of interest by turning the COMAND controller and press to confirm. The complete address of the point of interest selected is shown.

- ① Point of interest with address
- ② To start route calculation
- ③ To store an address in the destination memory
- ④ To display details
- ⑤ Phone call
- ⑥ To display a point of interest's position on the map

- ▶ **To start route calculation:** select **Start** and press to confirm.
- ▶ **To store an address in the destination memory:** select **Save** and press to confirm. You can now select storage options (▷ page 167).
- ▶ **To show the detailed view:** select **Details** and press to confirm.
- ▶ **To make a call:** select **Call** and press to confirm (only available if the point of interest contains a telephone book entry and a telephone is connected to COMAND). COMAND switches to telephone mode (▷ page 187).
- ▶ **To call up the map:** select **Map** and press to confirm.
- ▶ You can move the map and select the destination (▷ page 147).

ZAGAT® Survey service

Entries with the Z icon contain additional ZAGAT information. ZAGAT rates restaurants, for instance, in regard to the quality of the food, furnishing, service, and provides an average pricing level as well as a general description.



PB2.87-2118-31

- ▶ Select the entry with the Z icon by turning the COMAND controller and press to confirm. The ZAGAT evaluations appear.



PB2.87-2119-31

- ① ZAGAT ratings
- ② To display details
- ▶ **To show a description:** select **Details** and press to confirm.

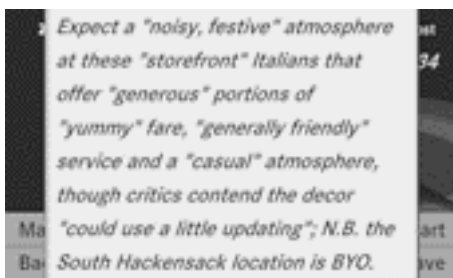

PB2.87-2120-31

ZAGAT example description

Selecting a point of interest using the map

You can select points of interest that are available in the selected (visible) section of the map.

- ▶ **To activate navigation mode:** press the function button once or twice.
- ▶ **To show the menu:** press the COMAND controller.



PB2.87-5516-31

- ① Highlighted point of interest
- ▶ Slide the COMAND controller forwards and thereby activate the display window. The map with highlighted point of interest ① is shown.
- ▶ **To highlight the next point of interest:** select **Next** in the menu bar by turning and sliding the COMAND controller and press to confirm.
- ▶ **To highlight the previous point of interest:** select **Previous** in the menu bar by turning and sliding the COMAND controller and press to confirm.
- ▶ **To display details of a point of interest:** select **Details** in the menu bar by turning and sliding the COMAND controller and press to confirm.

Route guidance

General notes

WARNING

COMAND calculates the route to the destination without taking into account the following, for example:

- Traffic lights
- Stop and right-of-way signs
- Lane merging
- Parking or stopping prohibited areas
- Other road and traffic rules and regulations
- Narrow bridges

COMAND may give incorrect navigation commands if the data in the digital map does not correspond with the actual road/ traffic situation. For example, if the traffic routing has been changed or the direction of a one-way road has been reversed.

For this reason, you must always observe applicable road and traffic rules and regulations during your journey. Road and traffic rules and regulations always have priority over the navigation commands generated by the system.

Route guidance begins once a route has been calculated (▷ page 143).

COMAND guides you to your destination by means of navigation commands in the form of audible navigation announcements and route guidance displays.

The route guidance displays can only be seen if the display is switched to navigation mode.

If you do not follow the navigation announcements or if you leave the calculated route, COMAND automatically calculates a new route to the destination.

If the digital map contains the corresponding information, the following applies:

- when selecting a route, COMAND tries to avoid roads that only have limited access,

e.g. roads closed to through traffic and non-residents.

- roads that have time restrictions (e.g. closed on Sundays and public holidays) are avoided for route guidance.

Change of direction

Introduction

Changes of direction have three phases:

- preparation phase
- announcement phase
- change-of-direction phase

Preparation phase

COMAND prepares you for the upcoming change of direction. Based on the example display below, the change of direction is announced with a message. You see the full-screen map.

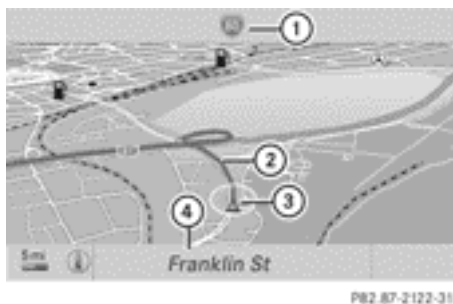

Example display: preparation phase

- ① Next road
- ② Route
- ③ Current vehicle position (the tip of the triangle indicates the vehicle's direction of travel)
- ④ Current road

The display in ④ depends on the setting selected under "Text information on the map" (▷ page 173).

Announcement phase

COMAND announces the imminent change of direction. With reference to the following example display, the announcement is given

before the change of direction with the request **Please turn right in 900 ft.**

The announced distance to the next change of direction depends on the type of road and its permissible speed limit.

The display is now split into two sectors. In the left half, you see the normal map view. The right half shows an enlarged section of the area around the intersection (Crossing Zoom) or a 3D image of the road's course with the route indicating the next maneuver.

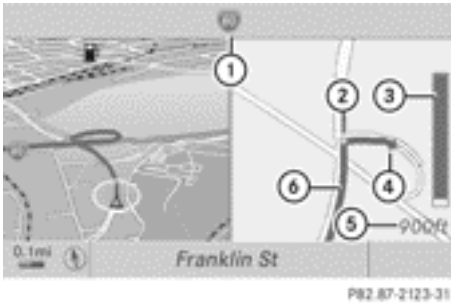

Example display: announcement phase

- ① Next road
 - ② Point at which the change of direction takes place (light blue dot, shown in both the left and right displays)
 - ③ Graphic representation of the distance to the next change of direction
 - ④ Change of direction (turn right here)
 - ⑤ Distance to the next change of direction
 - ⑥ Route (highlighted in blue, shown in both the left and right displays)
- i** The filled-in section of visual display for distance ③ gets shorter, the nearer you get to the announced change of direction.

Change-of-direction phase

COMAND announces the imminent change of direction. In the example, the **Now turn right** announcement is made 100 ft. before the change of direction. The display is split into two halves, as in the announcement phase.

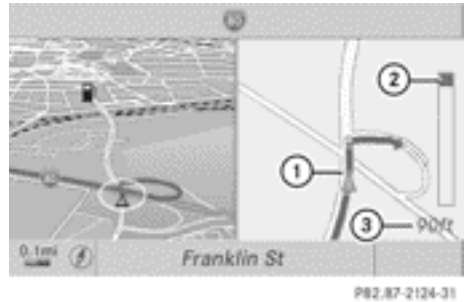

Example display: change-of-direction phase

- ① Current vehicle position: the tip of the triangle indicates the vehicle's direction of travel
- ② Graphic representation of the distance to the next change of direction
- ③ Distance to the next change of direction

Once the change of direction is completed, COMAND automatically switches back to full-screen display.

Lane recommendations

Overview

On multilane roads, COMAND can display lane recommendations for the next change of direction. The corresponding data must be available in the digital map.

COMAND displays lane recommendations ⑥, based on the next two changes of direction. The number of lanes applies to the point at which the next change of direction is required.

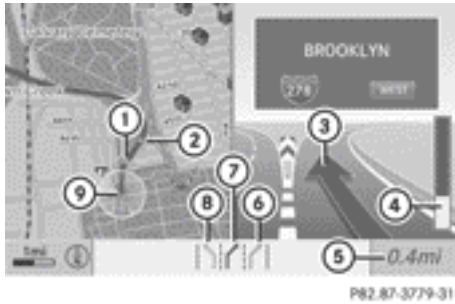

Example display

- ① Point of the next change in direction (light blue circle)
 - ② Point of the change of direction after next
 - ③ Next change of direction (in this case, turn off to the right)
 - ④ Graphic representation of the distance to the next change of direction
 - ⑤ Distance to the next change of direction
 - ⑥ Possible lane (light blue)
 - ⑦ Recommended lane (dark blue)
 - ⑧ Lane not recommended (gray)
 - ⑨ Current vehicle position: the tip of the triangle indicates the vehicle's direction of travel
- i** The multifunction display also shows lane recommendations. Only the recommended lanes are displayed here. (▷ page 341).

Display and description of lane recommendations

The colors used in the lane recommendation display vary depending on whether day or night design is switched on.

Lane	Day design	Night design
Recommended lane ⑦ In this lane, you will be able to complete the next two changes of direction without changing lanes.	Dark blue	Light blue
Possible lane ⑥ In this lane, you will only be able to complete the next change of direction without changing lanes.	Light blue	Dark blue
Lane not recommended ⑧ In this lane, you will not be able to complete the next change of direction without changing lane.	Gray	Gray

Display in the multifunction display

The lane recommendations are also shown in the multifunction display. You will find further information in the "On-board computer" section (▷ page 341).

Using car pool lanes

COMAND displays car pool lanes if you have selected this option in the route options (▷ page 139).

If this is the case, COMAND checks whether there are any car pool lanes on the route. If there are, they are taken into account during route calculation. Route guidance will then include car pool lanes.

Car pool lanes may only be used under certain conditions. Please observe the relevant legal requirements.

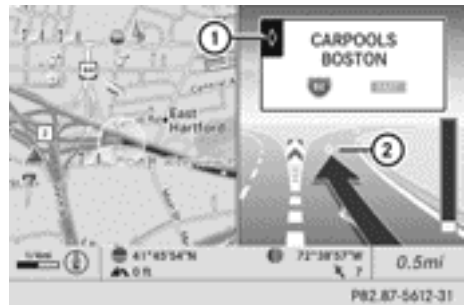





Example: display, car pool lane

- ① Identification marking on the road
- ② Identification marking in COMAND





Canceling or continuing route guidance

Canceling route guidance

- ▶ **To activate navigation mode:** press the  function button once or twice.
- ▶ **To show the menu:** press  the COMAND controller.
- ▶ Select **Destination** in the navigation system menu bar by turning  the COMAND controller and press  to confirm.

- ▶ Select **Cancel Route Guidance** and press  to confirm.

Continuing route guidance

- ▶ **To activate navigation mode:** press the  function button once or twice.
- ▶ **To show the menu:** press  the COMAND controller.
- ▶ Select **Destination** in the navigation system menu bar by turning  the COMAND controller and press  to confirm.
- ▶ Select **Continue Route Guidance** and press  to confirm. COMAND calculates the route.

Destination or area of destination reached

When you reach your destination, COMAND displays a checkered flag and route guidance is automatically ended.

For certain points of interest (e.g. airports), the **Destination Reached** display is shown as well as the checkered flag.

Navigation announcements

Repeating navigation announcements

WARNING

Navigation announcements are intended to direct you while driving without diverting your attention from the road and driving.

Please always use this feature instead of consulting the map display for directions. Looking at the icons or map display can distract you from traffic conditions and driving, and increase the risk of an accident.

-  Audible navigation announcements are muted during a telephone call.

If you have missed an announcement, you can call up the current announcement at any time.

- ▶ **To show the menu:** press  the COMAND controller.



- ▶ In the navigation menu bar, confirm **RPT** with .

Switching navigation announcements on/off

- ▶ **To switch off:** during the announcement, press the  button on the multifunction steering wheel.

You will briefly see the message: **The driving instructions have been muted.**

- ▶ **To switch on:** press  the COMAND controller.





- ▶ In the  navigation menu bar, press  to confirm.

-  COMAND automatically switches the navigation announcements back on when:

- you have a new route calculated.
- you start the engine again after having left the vehicle.

Reducing volume during a navigation announcement

The volume of an active audio or video source can be automatically reduced during a navigation announcement.

- ▶ Select **Navi** in the main function bar by sliding  and turning  the COMAND controller and press  to confirm.
- ▶ Select **Audio Fadeout** and press  to confirm. The function is switched on or off , depending on the previous status.

Setting the volume manually









- ▶ Set the volume during a navigation announcement.

or

- ▶ In the map display when the menu is shown, select  and adjust the volume.





Avoiding a section of the route blocked by a traffic jam

This function blocks a section of the route ahead of you. You can set the length of the blocked route section. If possible, COMAND calculates a detour around the blocked section of the route.

- ▶ **To activate navigation mode:** press the  function button once or twice.
- ▶ **To show the menu:** press  the COMAND controller.
- ▶ Select **Route** in the navigation system menu bar by turning  the COMAND controller and press  to confirm.
- ▶ Select **Detour** and press  to confirm.
- ▶ **To block a section of the route:** select **More** or **Less** repeatedly and confirm using  until the desired section has been selected.
- i** The total length of the section that can be blocked is defined by the digital map. The menu items are available accordingly.
- ▶ **To start route calculation:** select **Start** and press  to confirm.
- ▶ **To delete the blocked section:** select **Delete** while the message is shown and press  to confirm.
COMAND calculates the route without the block.

Selecting an alternative route



With the "Alternative route" function, routes other than the original one can be calculated.

- ▶ **To activate navigation mode:** press the  function button once or twice.
- ▶ **To show the menu:** press  the COMAND controller.
- ▶ Select **Route** in the navigation system menu bar by turning  the COMAND controller and press  to confirm.

- ▶ Select **Alternative Route** and press  to confirm.
You see the selected route. The display now shows a split-screen view. On the left-hand side, one or more alternative routes are shown from start to destination. The current route is highlighted dark blue; other alternative routes appear light blue.



- ① Distance, expected arrival time and expected journey duration
- ② Displays incidents which are on the route
- ③ Displays the selected route settings

- ▶ **To select the next or previous alternative route:** select **Next** or **Previous** and press  to confirm.
Possible alternative routes are shown in the following order: **Current Route**, **Fast Route**, **Eco Route**, **Short Route** and **Alternative Route**.
- ▶ **To select the original route:** select **Back** a corresponding number of times and press  to confirm.

- ▶ **To start route guidance using the selected alternative route:** select **Start** and press  to confirm.
COMAND accepts the alternative route.

- i** The change of route mode in the alternative route menu only applies to the current route guidance. For example, if the original route was a short route, the next route will also be calculated as a short route. This is also the case if a dynamic route is selected in the alternative route menu.

Displaying destination information

Prerequisite: you have entered a destination (▷ page 140) and possibly an intermediate stop (▷ page 148).

► **To activate navigation mode:** press the



function button once or twice.

► **To show the menu:** press the COMAND controller.

► Select **Info** in the menu bar by turning the COMAND controller and press to confirm.

Destination information is displayed.

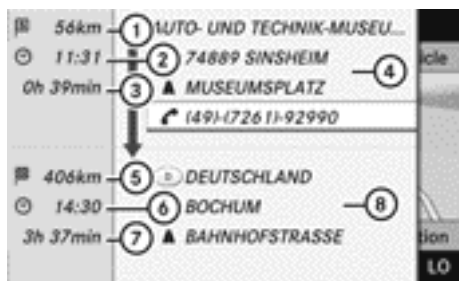

P82.87-3188-31

Example display: destination information

- ① Distance to intermediate stop
- ② Estimated time of arrival at the intermediate stop
- ③ Expected remaining journey time to intermediate stop
- ④ Intermediate stop
- ⑤ Distance to main destination
- ⑥ Estimated time of arrival at the main destination
- ⑦ Expected remaining journey time to main destination
- ⑧ Main destination

If a telephone number is entered for the address displayed, you can also select and call the number using COMAND.

► **To call the destination:** select the telephone number using the COMAND controller and press to confirm.

► **To close the destination information:** slide to the COMAND controller or press the back button.

Route overview

You can use the overview of the route to move along the route section by section and to see details of the route sections.

You have entered a destination (▷ page 140) or a point of interest (▷ page 150) and possibly an intermediate stop (▷ page 148).

► **To activate navigation mode:** press the



function button once or twice.

► **To show the menu:** press the COMAND controller.

► Select **Route** in the navigation system menu bar by turning the COMAND controller and press to confirm.

► Select **Route Info** and press to confirm.



P82.87-5083-31



Example display: route overview

- ① Marked route sections

At the top of the display, you will see information about the highlighted route section, for example the distance to be driven on the road and road designation. The highlighted route section is marked in white with a red border on the map.

► **To view the next or previous route section:** select **Next** or **Previous** and press to confirm.

i If the first or last route section is highlighted, you cannot select **Previous** or **Next**.

► **To zoom in or out of the map:** select  or  and press  to confirm.

► **To close the route overview:** select **Back** and press  to confirm.

Where am I?

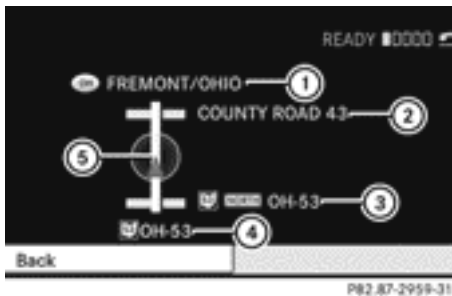

You can view your current position whether or not route guidance has been interrupted.



- ① Current position
- ② Next intersection or exit
- ③ Most recent intersection or exit
- ④ Current street

► **To activate navigation mode:** press the  function button once or twice.

► **To show the menu:** press  the COMAND controller.

► Select **Position** in the navigation system menu bar by turning  the COMAND controller and press  to confirm.

► Select **Where am I?** and press  to confirm.

Off-road

Important safety note

WARNING

The COMAND navigation system may direct you to off-road routes that your vehicle may

not be capable of traversing through without damaging your tires, wheels or vehicle. It is the driver's sole responsibility to determine the suitability of the route. Off-road routes may be of varying conditions and their appropriateness for use may be affected by various factors such as time of day, time of year and immediate weather conditions that cannot be judged or taken into consideration by the COMAND system.

Route guidance to a destination that is not on a digitized road

COMAND can guide you to destinations which are within the area covered by the digital map, but which are not themselves recorded on the map.

These destinations are known as off-road destinations, which you can enter using the map, for example. In these cases, COMAND guides you for as long as possible with navigation announcements and displays on roads known to the system.



Example display: route guidance to an off-road destination

- ① Off-road destination
- ② Off-road route section (dashed blue)
- ③ Current vehicle position (the tip of the triangle indicates the vehicle's direction of travel)
- ④ Off-road (no street names available)

If the vehicle reaches an area which is not part of the digital map, the display appears as a split-screen view. On the right-hand side, an arrow appears which points to off-road

destination ①. You will hear the announcement: "Please follow the arrow on the display".

Route guidance from an off-road location to a destination

If the vehicle position is within the area covered by the digital map, but the map does not contain any information about that location, the vehicle is in an off-road location. COMAND is also able to guide you to a destination even from an off-road location.

At the start of the route guidance, you will see the [Street unknown](#) message, an arrow and the distance to the destination. The direction arrow shows the linear direction to the actual destination.

The continuous blue line on the map starts at the street which you left last.

As soon as the vehicle is back on a road known to the system, route guidance continues in the usual way.

Off-road during route guidance

Due to roadworks, for example, there may be differences between the data on the digital map and the actual course of the road.

In such cases, the system will temporarily be unable to locate the vehicle position on the digital map and thus considers the vehicle to be in an off-road position.

In the display, you will see the [Street unknown](#) message, an arrow and the distance to the destination. The arrow shows the compass heading to the last road you were driving on.

As soon as the system can assign the vehicle position to the map again, route guidance continues in the usual way.

Route guidance on roads that are not completely digitalized

COMAND attempts to avoid roads that have not been completely digitalized. If the vehicle's position or the destination is located in an area that has not been completely

digitalized, then no active route guidance is performed. Instead, the map shows a dashed route along the roads and the target direction is shown with an arrow. You hear the announcement: "You will enter an area, where turn-by-turn guidance can not be provided. Please follow the arrow on the display". Once these roads have been left, regular route guidance is resumed.

Traffic reports

Prerequisite

i The SatRadio mode described below requires optional satellite radio equipment and a subscription to SIRIUS XM Satellite Radio Traffic Message Service. Further details on SatRadio are available in the "SatRadio" section (▷ page 205).

COMAND can receive traffic reports via SatRadio and incorporate them in the navigation system. Traffic messages and map symbols can then be shown in the COMAND display.

COMAND uses high quality traffic data. Nevertheless, there may be differences between the traffic reports received and the actual road and traffic conditions.

Switching traffic reports on/off

► **To switch on:** set the route type to [Dynamic Route](#)⁶(▷ page 139).

► **To switch off:** select the [Fast Route](#) or [Short Route](#) route type (▷ page 139).

i COMAND calculates a new route if you change the route type setting with route guidance active. If you change the route type setting when route guidance is inactive, COMAND uses the new setting for the next route guidance.

⁶ Traffic reports are not available in all countries.

Real-time traffic reports on the map







COMAND can show certain traffic incidents on the map. The incidents are shown on the map at a scale from 1/16 mi to 20 mi.

► Set the map scale (► page 170).



- ①② Icon display for the section of route affected
 - ③ Icon for incident on the route
 - ④ Current position and direction of travel
 - ⑤ Map scale
- i** COMAND uses corresponding icons to highlight the entire section of the affected route, regardless of how long the incident actually is. The icons are placed on the side of the road affected by the incident.

Icon for real-time traffic reports

Icon	Description	Traffic reports in the map display
	Warning (red)	A warning appears, for example, relating to lost cargo.
	Caution (yellow)	A warning appears, for example, relating to roadwork that does not affect the flow of traffic.
	Slow-moving traffic	This appears at the beginning of a traffic jam (average speed 25 - 45 mph) if route guidance is active and the route leads through an area of congested traffic. Yellow car icons may appear in conjunction with this icon.
	Traffic jam on the route	This appears at the beginning of a traffic jam (average speed 5 - 20 mph) if route guidance is active and the route leads through an area of congested traffic. Red car icons may appear in conjunction with this icon.
	Blocked route section on the route	Appears at the beginning of a blocked route section if route guidance is active and the route leads through the blocked section. The XXXX icons may appear in conjunction with this icon.
Yellow line with arrows	Incidents	Possible traffic blocks (e.g. roadwork) Appears on the side of the road affected (direction of travel)
Green line with arrows	Unimpeded traffic flow	No delays Only appears on the side of the road (direction of travel) on which traffic flow is unimpeded
	Slow-moving traffic (stop/start traffic) (yellow vehicle)	High volume of traffic, average speed 40 - 72 km/h (25 - 45 mph). In order to indicate the volume of traffic, more than one symbol may appear.
	Traffic jam on the route (stop/start traffic) (red vehicle)	Very high volume of traffic, average speed 8 - 32 km/h (5 - 20 mph).
XXXX	Blocked route section	Unusable section of road. In order to indicate the length of the blocked section, more than one symbol may appear.

Displaying real-time traffic reports

- ▶ If necessary, switch to navigation mode and show the menu (▷ page 139).
- ▶ Select **Traffic** in the navigation system menu bar by turning the COMAND controller and press to confirm.

If you see the **No traffic messages.** message:

This means that:

- no traffic reports have been received yet.
- no traffic reports are available.
- ▶ **To cancel the search:** select **Cancel**.
- ▶ **To close the message window:** select **OK**.

If there are any traffic reports, a list is shown. The content of the list varies depending on whether route guidance is active or not.

List of traffic reports

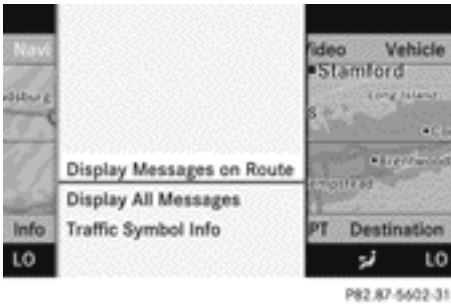

- ▶ **To show the traffic report list:** select **Display All Messages** by turning the COMAND controller and press to confirm.

The list shows all the roads, areas or regions for which traffic reports are available.

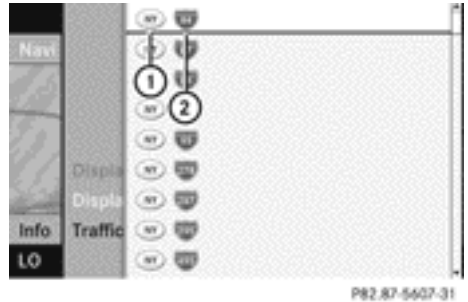

- ① State or province recognition
- ② Road affected

i A traffic report may refer to an area or a region, e.g. if visibility is impaired due to fog.

- ▶ **To read a traffic report:** select a road, an area or a region.
- ▶ **To show a traffic report:** select a road, an area or a region and press to confirm. You will find an example of a traffic report below.
- ▶ **To exit the list:** slide to the COMAND controller once or several times.

Example: traffic report

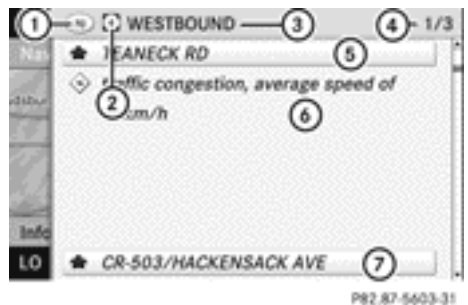

- ① Country code
- ② Road, area or region affected by traffic reports
- ③ Direction
- ④ Report 1 of 8 for the road affected
- ⑤ Last exit/intersection before the affected route section starts

- ⑥ Report text
- ⑦ First exit/intersection after the affected route section ends

- ▶ **To scroll within a report or to access the next report:** turn the COMAND controller.
- ▶ **To return to the list of messages:** press or slide the COMAND controller.

Showing icon information

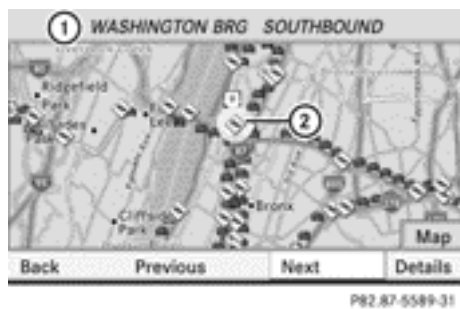

Example display

- ① Affected section of freeway
- ② Icon for an event
- ▶ **To show the next/previous incident:** select **Next** or **Previous** (if available) and press to confirm.
- ▶ **To show the detailed view:** select **Details** and press to confirm.
- ▶ **To scroll the map:** select **Map** and press to confirm.
You can move the map (> page 147) to enable further traffic reports to be displayed.

Destination memory

Home address (My address)

Entering the home address via address entry

- ▶ Enter the home address as a destination, e.g. as a city, street and house number (> page 140). Then, save the home address

without starting route guidance (> page 144).

Adopting an address book entry as a home address

- ▶ **To activate navigation mode:** press the function button once or twice.
- ▶ **To show the menu:** press the COMAND controller.
- ▶ Select **Destination** in the navigation system menu bar by turning the COMAND controller and press to confirm.
- ▶ Select **From Memory** and press to confirm.
- ▶ Slide the COMAND controller repeatedly until the destination memory list appears as a selection list.

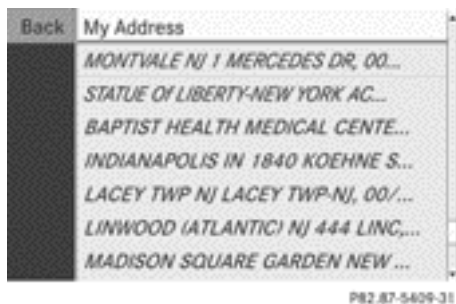







- ▶ Select **My Address** by turning the COMAND controller and press to confirm.
- ❗ If you have not yet entered any characters, the **My Address** entry is automatically highlighted in the selection list.

If no home address has been stored yet, you can now assign an address book entry. If a home address already exists, it is displayed and you can alter it.

- ❗ If you select **New Entry**, you are also offered the option of entering the home address for the first time. You can then

save the home address without starting route guidance.

- ▶ **To enter the home address for the first time:** select **Assign Address Book Entry** and press  to confirm.
- ▶ Select **Home** or **Work** and press  to confirm.
- ▶ **To change the home address:** select **Change** and press  to confirm.
- ▶ Select **Assign Address Book Entry** and press  to confirm.
- ▶ **i** If you select **New Entry**, you are also offered the option of changing the home address by entering an address. You can then save the home address without starting route guidance.
- ▶ Select **Home** or **Work** and press  to confirm.
In both cases, you will see the address book either with the character bar or as a selection list.
- ▶ **To select an address book entry:** proceed as described in the "Searching for an address book entry" section (▷ page 193).
- ▶ **To confirm the selection:** press  the COMAND controller.
If no home address has been stored, COMAND saves the entry. You will see a message and then the address menu with the selected address. **Start** is highlighted automatically.
If a home address has already been stored, you will see a prompt asking you whether the **My Address** entry should be overwritten.
- ▶ Select **Yes** or **No** and press  to confirm.
If you select **Yes**, COMAND overwrites the destination. You will see a message and then the address menu with the selected address. **Start** is highlighted automatically.
If you select **No**, the list will reappear.

Selecting the home address for route guidance



- ▶ Proceed as described in the "Selecting a destination from the destination memory" section (▷ page 146).

Storing a destination in the destination memory





Note

This function also stores the destination in the address book.





After destination entry



- ▶ The destination has been entered and is shown in the address entry menu (▷ page 143).
- ▶ Select **Save** by sliding  and turning  the COMAND controller and press  to confirm.
You can now select storage options.

During route guidance







- ▶ **To show the menu:** press  the COMAND controller.
- ▶ Select **Destination** in the navigation system menu bar by turning  the COMAND controller and press  to confirm.
- ▶ Select **Save Destination** and press  to confirm.
You can now select storage options.

From the list of previous destinations

- ▶ **To show the menu:** press  the COMAND controller.
- ▶ Select **Destination** in the navigation system menu bar by turning  the COMAND controller and press  to confirm.
- ▶ Select **From Last Destinations** and press  to confirm.
The list of last destinations appears.



- ▶ Select a destination by turning  the COMAND controller and press  to confirm.
The destination address is shown.
- ▶ Select **Save** and press  to confirm.
You can now select storage options.

Selecting storing options

- ▶ **To save the destination without a name:** select **Save without Name** and press  to confirm.
COMAND stores the destination in the destination memory and uses the address as the destination name.
- ▶ **To save the destination as My address:** select **Save as "My Address"** and press  to confirm.
COMAND stores the destination in the destination memory as **My Address**. If the entry already contains navigable data (symbol ) , a prompt appears asking you whether the entry should be overwritten.
- ▶ Select **Yes** or **No** and press  to confirm.
If you select **Yes**, the entry is overwritten.
If you select **No**, the process will be aborted.
- ▶ **To save the destination with a name:** select **Save with Name** and press  to confirm.
- ▶ Select a category, e.g. **Home**, and press  to confirm.
The input menu appears with data fields and the character bar.





Example display: saving a destination with a name

- ① Selected data field with cursor
 - ② Character bar
- ▶ Proceed as described under "Entering characters using the character bar" in the "Entering characters in navigation mode (entering a city)" section (▷ page 140).
 - ▶ Then, select  and press  to confirm.
COMAND stores the destination under the name entered.

Assigning a destination to an address book entry









An address with complete address data that is suitable for navigation can be assigned to a pre-existing address book entry. You can then later start route guidance to this address straight from the address book (▷ page 196).

- ▶ Select **Assign Address Book Entry** and press  to confirm.
- ▶ Select a category, e.g. **Home**, and press  to confirm.
You will see the address book either with the character bar or as a selection list.
- ▶ **To select an address book entry:** proceed as described in the "Searching for an address book entry" section (▷ page 193).
COMAND stores the data if the address book entry selected does not yet contain navigable address data.
If the selected address book entry already contains navigable address data, a prompt

will appear asking whether you wish to overwrite the existing data.

- ▶ Select **Yes** or **No** and press  to confirm. If you select **Yes**, COMAND stores the data.

Deleting a destination or the home address from the destination memory

- ▶ **To activate navigation mode:** press the  function button once or twice.
- ▶ **To show the menu:** press  the COMAND controller.
- ▶ Select **Destination** in the navigation system menu bar by turning  the COMAND controller and press  to confirm.
- ▶ Select **From Memory** and press  to confirm. You will see the destination memory list either with the character bar (option 1) or as a selection list (option 2).
- ▶ **Option 1: destination memory list with character bar:** proceed as described in the "Entering characters using the character bar" section (▷ page 122).
- ▶ **Option 2: destination memory list as selection list:** select a destination by turning  the COMAND controller and press  to confirm. You see the address data of the selected entry.
- ▶ Select **Delete** and press  to confirm. A prompt appears asking whether you wish to delete the destination.
- ▶ Select **Yes** or **No** and press  to confirm. If you select **Yes**, COMAND deletes the destination. You will see a message to this effect. If you select **No**, the process is aborted.

- i** If the navigable address data for the destination being deleted is also assigned to an address book entry, COMAND will also delete this data from there. If the

corresponding address book entry does not contain any further data, such as telephone numbers, COMAND deletes the entire address book entry.

Previous destinations





Introduction

COMAND automatically stores the previous destinations for which the route calculation has been started. If the memory is full, COMAND deletes the oldest destination. You can also save a destination from the list of previous destinations in the destination memory. It will be stored there permanently.

Storing a destination permanently in the destination memory

- ▶ Proceed as described in the "From the list of previous destinations" section (▷ page 167).





Storing the vehicle position in the list of previous destinations

- ▶ **To activate navigation mode:** press the  function button once or twice.
- ▶ **To show the menu:** press  the COMAND controller.
- ▶ Select **Position** in the navigation system menu bar by turning  the COMAND controller and press  to confirm.
- ▶ Select **Store Vehicle Position** and press  to confirm. COMAND stores the current vehicle position as a destination in the list of previous destinations.



Storing the crosshair position in the list of previous destinations

Route guidance not active







A crosshair appears on the map if you have moved the map manually. You can store the crosshair position as a destination in the list of previous destinations.



- ▶ **To show the menu:** press  the COMAND controller.
- ▶ Select **Position** in the navigation system menu bar by turning  the COMAND controller and press  to confirm.
- ▶ Select **Save Crosshair Position** and press  to confirm.

Route guidance is active

- ▶ Select **Destination** in the navigation system menu bar by turning  the COMAND controller and press  to confirm.
- ▶ Select **Save Destination** and press  to confirm.

Deleting one of the previous destinations

- ▶ **To activate navigation mode:** press the  function button once or twice.
- ▶ **To show the menu:** press  the COMAND controller.
- ▶ Select **Destination** in the navigation system menu bar by turning  the COMAND controller and press  to confirm.
- ▶ Select **From Last Destinations** and press  to confirm.
The list of last destinations appears.
- ▶ Select the desired destination and press  to confirm.
The destination address appears.





- ▶ Select **Delete** and press  to confirm.
A prompt appears asking whether the entry should be deleted.
- ▶ Select **Yes** or **No** and press  to confirm.
If you select **Yes**, the entry is deleted.
If you select **No**, the process is aborted.

Map operation and settings

Note

Company logos displayed on the map are trademarks of the respective companies and used solely for the purpose of indicating the location of these companies. The use of such logos on the map does not indicate approval of, support of or advertising by these companies for the navigation system itself.

Setting the map scale

- ▶ **To hide the menu:** slide  the COMAND controller and, when the **Full screen** menu item is shown, press .
- ▶ **To call up the scale bar:** as soon as you turn  the COMAND controller, scale bar  appears.
- ▶ Turn  until the desired scale is set.



- ① Set map scale as a number with unit
- ② Currently set map scale as indicated by the needle on the scale bar
- ③ Scale bar

Unit of measurement ① in the COMAND display depends on the selection made for the instrument cluster.

Moving the map

Showing the crosshair

- ▶ **To hide the menu:** slide \uparrow \odot the COMAND controller and, when the **Full screen** menu item is shown, press \odot .
- ▶ **To move the map:** slide \leftarrow \odot \rightarrow , \uparrow \odot \downarrow or \swarrow \odot \nwarrow the COMAND controller. A crosshair appears on the map. If you slide it again, the map moves in the corresponding direction under the crosshair.



Map with crosshair

- ① Current vehicle position
- ② Crosshair
- ③ Details of the crosshair position
- ④ Map scale selected

Display ③ may be the name of a street, for example, provided the digital map contains the necessary data. Or it may show the geo-coordinate position of the crosshair if the **Geo-coordinates** display is switched on (▷ page 174).

Hiding the crosshair and centering the map on the vehicle position or destination

- ▶ Press the \leftarrow back button. The crosshair disappears and the map is set to the vehicle position.
- or
- ▶ Set the map to the vehicle position; see the explanation below.

Setting the map to the vehicle position, intermediate stop or destination position

Centering the map on the vehicle position

- ▶ **To show the menu:** press \odot the COMAND controller.
- ▶ Select **Position** in the navigation system menu bar by sliding \odot \downarrow and turning \swarrow \odot \nwarrow the COMAND controller and press \odot to confirm.
- ▶ Select **Vehicle Position Map** and press \odot to confirm or, if the crosshair is shown, press the \leftarrow back button. This hides the crosshair.

Centering on an intermediate stop

This function requires that a route to an intermediate stop has been calculated.

- ▶ **To show the menu:** press \odot the COMAND controller.
- ▶ Select **Position** in the navigation system menu bar by sliding \odot \downarrow and turning \swarrow \odot \nwarrow the COMAND controller and press \odot to confirm.
- ▶ Select **Stopover Map** and press \odot to confirm. The crosshair is centered on the destination.

Centering on the destination

This function requires that a route to a destination has been calculated.

- ▶ **To show the menu:** press \odot the COMAND controller.
- ▶ Select **Position** in the navigation system menu bar by sliding \odot \downarrow and turning \swarrow \odot \nwarrow the COMAND controller and press \odot to confirm.
- ▶ Select **Destination Map** and press \odot to confirm. The crosshair is centered on the destination.

Map display





Setting the map orientation



Map orientation

① Current map orientation

The following display modes are possible:

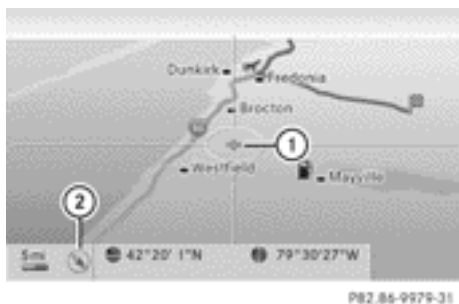

-  North orientation (the map view is displayed so that north is always up).
-  Orientation in direction of travel (the map is displayed so that the direction of travel is always up; the orange point of the icon points north).
-  Bird's-eye view (the map is displayed so that the direction of travel is always up; the map projection reproduces the curvature of the earth and the orange point of the icon points north).
-  3D map (the map is displayed in the direction of travel with elevation and terrain modeling. The orange point of the icon points north).



Example display: Bird's-eye view

- ① Current crosshair position
- ② Current map orientation



► **To show the menu:** press  the COMAND controller.

► Select **Navi** in the main function bar by sliding  and turning  the COMAND controller and press  to confirm.

► Select **Map Orientation** and press  to confirm.

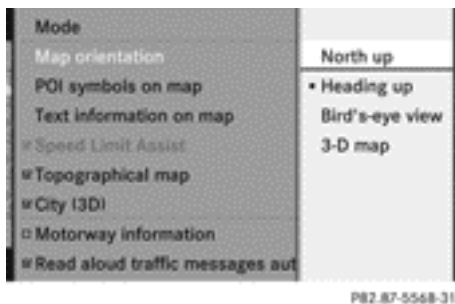
A • dot indicates the current setting.



► Select **North Up, Heading Up, Bird's-eye View** or **3-D Map** by turning  the COMAND controller and press  to confirm.

► **To exit the menu:** slide  the COMAND controller.
The map orientation changes accordingly.

Setting the point of interest icons in the map

You can set the points of interest you wish to have displayed as symbols on the map. Points of interest are, for example, gas stations, hotels, cinemas and restaurants.

The following settings are possible:

• Standard Symbols

Symbol display determined by the factory settings.

• Personal Symbols

You can determine the symbols yourself.

• No Symbols

The map does not show any symbols.

► **To show the menu:** press  the COMAND controller.

- ▶ Select **Navi** in the main function bar by sliding $\uparrow \odot$ and turning $\left[\odot \right]$ the COMAND controller and press \odot to confirm.
- ▶ Select **POI Symbols on Map** and press \odot to confirm.
- ▶ Select **Standard Symbols, Personal Symbols** or **No Symbols**.
If you select **Personal Symbols**, the list of points of interest appears.
- ▶ **To switch the icon display on/off:** select a point of interest by turning $\left[\odot \right]$ the COMAND controller and press \odot to confirm.
Depending on the previous state of the symbols, they will either be shown or hidden . You can switch on the symbol displays for more than one point of interest.

i The list shows all symbols that are contained on the digital map across all countries. However, not all points of interest are available in all countries. As a result, certain point of interest symbols may not be displayed on the map, even if the symbol display is switched on.

- ▶ **To exit the menu:** press the $\left[\leftarrow \right]$ back button.

Map information in the display

Showing text information

During route guidance, you can have map information displayed at the bottom edge of the display.

- ▶ **To show the menu:** press \odot the COMAND controller.
- ▶ Select **Navi** in the main function bar by sliding $\uparrow \odot$ and turning $\left[\odot \right]$ the COMAND controller and press \odot to confirm.
The main area is active.
- ▶ Select **Navi** again and press \odot to confirm.
The navigation menu opens.

- ▶ Select **Text Information on Map** and press \odot to confirm.
A \bullet dot indicates the current setting.
- ▶ Select **Arrival Time/Distance, Current Street, Geo-Coordinates** or **None** and press \odot to confirm.
- ▶ **To exit the menu:** slide $\leftarrow \odot \rightarrow$ the COMAND controller.

Arrival time/distance to the destination



Arrival time/distance display switched on

- ① Icon for destination
- ② Distance to the destination
- ③ Icon for estimated time of arrival
- ④ Estimated time of arrival

You can only see this display during route guidance. While scrolling the map (\triangleright page 171), you will see additional data, e.g. road names, depending on the crosshair position, if the digital map supports this data.

Road display



Road display active

- ① Road names or numbers, e.g. for highways

Geo-coordinate display



Geo-coordinate display active

- ① Current height above average sea level, rounded
- ② Current vehicle position: latitude coordinates
- ③ Current vehicle position: longitude coordinates
- ④ Number of GPS satellites currently being used

There must be sufficient GPS reception for all displays to be shown. If this is not the case, the display will be grayed out. Height display ① may vary from the actual value, because the navigation system uses the GPS signals for the calculation.

While scrolling the map (▷ page 171), you will see the geo-coordinates of the crosshair position. Height display ① and number of satellites used ④ are not displayed.

"None" menu option



Display switched off

- ① Current map orientation
- i** During the "Move map" function you can see additional information depending on the position of the crosshair, such as a road name, if the digital map supports this data.

Switching the topographical map on/off

The topographical map uses different colors to depict elevation. The color key generally reflects the topography's dominant vegetation or the ground's perceived color when seen from the air, for example:

- green for lowland
- yellow or brown for hills
- gray or white for mountains

- ▶ **To show the menu:** press the COMAND controller.
- ▶ Select **Navi** in the main function bar by sliding and turning the COMAND controller and press to confirm.
- ▶ Select **Topographical Map** and confirm with .
 - Depending on the previous state, switch the option on or off .

Switching the city model on/off

When the city model is switched on, the map shows buildings as 3D models.

- i** The city model is only shown in the "3D map" map orientation. It is available for map scales 50 m and 100 m.

The data required for displaying buildings is not available for all cities.

- ▶ **To show the menu:** press the COMAND controller.
- ▶ Select **Navi** in the main function bar by sliding and turning the COMAND controller and press to confirm.
- ▶ Select **City (3D)** and press to confirm.
 - Depending on the previous state, switch the option on or off .



- ① Hills
- ② Buildings
- ③ Important buildings

Showing the map data version

- ▶ **To show the menu:** press the COMAND controller.
- ▶ Select **Navi** in the main function bar by sliding and turning the COMAND controller and press to confirm.
- ▶ Select **Map Version** and press to confirm.
The map data version number is shown. Information about new versions of the digital map can be obtained from an authorized Mercedes-Benz Center.

Traffic information on the map

If you subscribe to the SIRIUS XM Satellite Radio Traffic Message Service, traffic information can be displayed on the map. You can select three categories for the display.

- ▶ **To switch the displays on/off:** press the COMAND controller to show the menu.
- ▶ Select **Navi** in the main function bar by sliding and turning the COMAND controller and press to confirm.
- ▶ Select **Traffic Information On Map** and press to confirm.
- ▶ Select a category and press to confirm. Depending on the previous state, switch the option on or off .

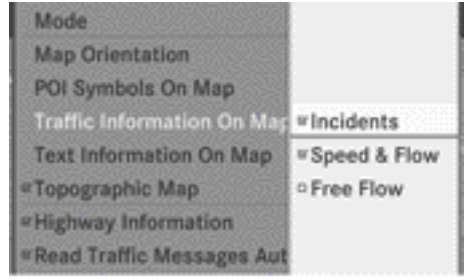

• Traffic incidents

Road sections are illustrated with a yellow line and arrows.

Warning messages or traffic incidents are represented on the map by appropriate symbols and/or yellow/red arrows. Explanation of symbols (▷ page 163).

• Speed & Flow

Road sections are represented by yellow or red car icons.

Green arrows: free-flowing traffic

Yellow car icons: congested traffic, average speed 25 - 45 mph

Red car icons: traffic jam, average speed 5 - 20 mph

• Free Flow

Road sections are illustrated with a green line and arrows.

Additional settings

Freeway information

When driving on highways, you can have the nearest gas stations, rest areas, etc. shown on the right-hand side of the display. Your current distance to them is also shown on the right-hand side of the display.

- ▶ **To activate navigation mode:** press the function button once or twice.
- ▶ **To show the menu:** press the COMAND controller.

- ▶ Select **Navi** in the main function bar by sliding $\uparrow \odot$ and turning $\left\{ \odot \right\}$ the COMAND controller and press \odot to confirm.
- ▶ Select **Highway information** and press \odot to confirm.
Depending on the previous state, switch the option on or off .

SIRIUS XM service

Displaying SIRIUS XM service information

You can display the SIRIUS XM service information.

- ▶ **To show the menu:** press \odot the COMAND controller.
- ▶ Select **Navi** in the main function bar by sliding $\uparrow \odot$ and turning $\left\{ \odot \right\}$ the COMAND controller and press \odot to confirm.
- ▶ Select **SIRIUS Service** and press \odot to confirm.

Registering for the SIRIUS XM traffic report service

- ▶ Call the traffic report provider's phone number shown on the screen.
- i** You can also have the satellite service activated online. To do so, visit the SIRIUS XM Radio website at <http://www.sirius.com> (USA) or <http://www.siriuscanada.com> (Canada).

Once the connection has been established:

- ▶ Follow the instructions of the operator.
The activation process may take up to ten minutes.

If registration is not included when purchasing the system, your credit card details will be required to activate your account.

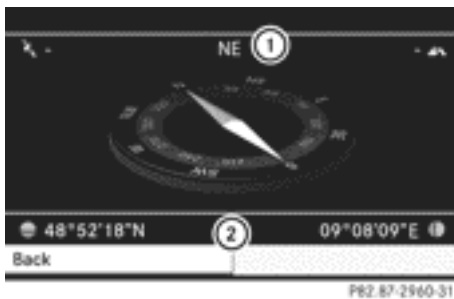

Compass function

You can display the current compass direction heading in which the front of the vehicle is facing.



- ① Current compass heading
- ② Geo-coordinates

In the compass view, you can see the current direction of travel, the current height above sea level and the coordinates of the vehicle position, for example.

- ▶ **To activate navigation mode:** press the  function button once or twice.
- ▶ **To show the menu:** press \odot the COMAND controller.
- ▶ Select **Position** in the navigation system menu bar by sliding $\odot \downarrow$ and turning $\left\{ \odot \right\}$ the COMAND controller and press \odot to confirm.
- ▶ Select **Compass** and press \odot to confirm.
- ▶ **To exit the display:** confirm **Back** by pressing \odot or press the  button.

Installing new map software

Digital map data

The maps generated by the map software become outdated in the same way as conventional road maps. Optimal route guidance can only be provided by the navigation system in conjunction with the most up-to-date map software.

Information about new versions of map software can be obtained from an authorized Mercedes-Benz Center.

You can have your map software updated there with a DVD, or you can update it yourself.

Updating process







WARNING

Never leave the engine running in enclosed spaces. The exhaust gases contain toxic carbon monoxide. Breathing in exhaust fumes is a health hazard and can lead to unconsciousness or death.

The update process can take a long time (over an hour), depending on the size of the digital map. During this time, you will only be able to switch on radio mode and to accept incoming calls. The update will be completed more quickly if the vehicle is stationary.

If the starter battery is not sufficiently charged, COMAND may end the process automatically. This protects the battery. If this occurs, restart the update with the engine running.

Displaying information on the map version currently in use

- ▶ **To activate navigation mode:** press the  function button once or twice.
- ▶ **To show the menu:** press  the COMAND controller.
- ▶ Select **Navi** in the main function bar by sliding  and turning  the COMAND controller and press  to confirm.
- ▶ Select **Map version** and press  to confirm.

Notes on handling DVDs

- Only hold DVDs by the edge.
- Handle DVDs carefully to prevent reading errors.
- Avoid getting scratches, fingerprints and dust on DVDs.

- Use a commercially-available cleaning cloth to clean discs. When cleaning CDs, you should wipe in straight lines from the center outwards rather than in a circular motion.
- Place DVDs back in their cases after use.
- Protect DVDs from heat and direct sunlight.

Map software copy protection

Map software for COMAND is subject to a charge. The map software has just one activation code which is usable in one vehicle only, and is not transferable. You can obtain the six-digit activation code from an authorized Mercedes-Benz Center. If you have lost the activation code, contact an authorized Mercedes-Benz Center. If COMAND does not accept the activation code that you have received, also contact an authorized Mercedes-Benz Center.

Your vehicle is supplied with map software at the factory. Depending on the country, map software for your region is either pre-installed or the map software is supplied as a DVD. You do not require an activation code for the map software that is provided with your vehicle.

If the map software on your vehicle has been installed at the factory and you wish to reinstall it, this also does not necessitate entry of the activation code.

Installation process

- ▶ Load the map software DVD in the DVD drive (▷ page 209).
COMAND checks the DVD and shows a corresponding message in the display.

Map software is not compatible with the navigation system

You will see a message that the map software cannot be installed.

- ▶ **To confirm the message:** press .
COMAND ejects the DVD.
- ▶ Take the DVD out of the slot.
- ▶ Insert a DVD which is compatible with the vehicle's navigation system.

Map software is not compatible with the current system software

You will see a message that the system software and the map software are not compatible.

- ▶ **To confirm the message:** press . COMAND ejects the DVD.
- ▶ Take the DVD out of the slot.
- ▶ Have the system software updated at an authorized Mercedes-Benz Center.

The map software cannot be installed until the system software has been updated.

Map software compatible with the navigation system and the current system software

COMAND checks whether the map data on the DVD is already installed.

Map data is already installed

You will see a message that the map data is already installed. A prompt will also appear asking you whether you wish to continue with the map software installation.

- ▶ Select **Yes** or **No**.
If you select **Yes**, the existing map data is overwritten.
- If you select **No**, COMAND automatically ejects the DVD and the installation of the map software is canceled.
- ▶ Take the DVD out of the slot.

Map data is not installed yet

In the display, you will see a comparison of the version statuses of the map software DVD and the map software installed in COMAND. A prompt then appears asking whether the map software installation should be carried out.

- ▶ Select **Yes** or **No**.
If you select **Yes**, the map data is installed.
- If you select **No**, COMAND automatically ejects the DVD and the installation of the map software is canceled.
- ▶ Take the DVD out of the slot.

If an activation code is required for the map software, a prompt appears in the display requesting the code to be entered.



- ▶ Enter the activation code and confirm the entry with **ok**.
The map software is installed.

If you enter an incorrect activation code, the prompt to enter the activation code appears again. If the activation code is entered incorrectly three times, the prompt asking you to enter the activation code appears after a time delay. The time delay increases every time the activation code is entered incorrectly, from five minutes up to a maximum of five hours.

Installing map data

Just before the copying process starts, COMAND restarts the system.

While the installation is running, you will see a message to this effect and a progress bar.

- ▶ **To cancel the installation process:** eject the DVD.
- ▶ Take the DVD out of the slot.

i If you interrupt the installation process, the navigation system will not be operational. You can continue an interrupted installation process at a later date.

- ▶ **Installation process with multi-DVD map data:** once the content of the first DVD has been installed, a message appears

prompting you to insert the second DVD.
Follow the instructions on the display.

- ▶ **To allow the installation to run to the end without canceling:** take no further action.

When the installation process is successfully completed, you will see a message to this effect.

- ▶ **To confirm the message:** press .
COMAND ejects the DVD.
- ▶ Take the DVD out of the slot.
The installation is complete.

When the installation process is not successfully completed, you will see a message to this effect.

- ▶ **To confirm the message:** press .
COMAND ejects the DVD.
- ▶ Take the DVD out of the slot.

Problems with the navigation system

Problem	Possible causes/consequences and ► Solutions
<p>COMAND is unable to continue route guidance after the journey has been interrupted.</p>	<p>Route guidance is canceled if you interrupt the journey for more than two hours.</p> <p>"Interrupting the journey" refers to stopping the vehicle and switching off COMAND. "Continuing route guidance" refers to switching COMAND back on and driving on.</p> <p>► Continue route guidance (▷ page 157).</p> <p>COMAND determines the vehicle's position. Depending on the driving situation, this may take some time.</p> <p>Route guidance may be restricted during the determination of the vehicle's location.</p> <p>When positioning is complete, route guidance is resumed with navigation announcements and route guidance displays.</p>
<p>COMAND is unable to determine the vehicle's position.</p>	<p>COMAND has to redetermine the position of the vehicle if the vehicle has been transported (e.g. by ferry, by motorail or after towing).</p> <p>► Start the vehicle and pull away.</p> <p>COMAND determines the vehicle's position. Depending on the driving situation, this may take some time.</p> <p>Route guidance may be restricted during the determination of the vehicle's location.</p> <p>When positioning is complete, route guidance is resumed with navigation announcements and route guidance displays.</p>
<p>The Navigation function unavailable message appears.</p>	<p>COMAND has an integrated hard drive on which the digital map is stored.</p> <p>To protect the hard drive from damage, COMAND switches it off at very high temperatures. The navigation system will then be temporarily unavailable.</p> <p>► Let the vehicle and COMAND cool down.</p> <p>► To hide the message: switch COMAND off and then on again.</p> <p>If an area of the hard disk has a malfunction, COMAND can no longer access the map data in this area, for example when calculating a route.</p> <p>► To hide the message: switch COMAND off and then on again.</p> <p>The navigation system will be operational again until it has to access the faulty area of the hard drive once more. The message will then reappear.</p> <p>► Consult an authorized Mercedes-Benz Center.</p>

Problem	Possible causes/consequences and ► Solutions
You see a message informing you that the DVD containing the digital map is incompatible with the system software.	<p>The DVD containing the digital map cannot be used for the update.</p> <ul style="list-style-type: none"> ► To confirm the message: press  the COMAND controller. ► Eject the DVD. ► Have the system software updated at an authorized Mercedes-Benz Center.
The installation of the map software has failed.	<p>The DVD is dirty or scratched.</p> <ul style="list-style-type: none"> ► Clean the DVD. ► Restart installation.
	<p>There is overheating due to excessive temperatures in the vehicle interior.</p> <ul style="list-style-type: none"> ► Wait until the vehicle interior has cooled down. ► Restart installation.
	<p>COMAND's integral hard drive is faulty.</p> <ul style="list-style-type: none"> ► Consult an authorized Mercedes-Benz Center.

Telephone

General notes

Introduction

COMAND, in conjunction with a Bluetooth®-capable mobile phone, enables you to make calls via the Bluetooth® interface.

Using the Bluetooth® interface and a suitable mobile phone, you can use the hands-free system, import contacts from the mobile phone and receive vCards.

More detailed information on suitable mobile phones and on connecting Bluetooth®-capable mobile phones to COMAND can be found on the Internet at

<http://www.mbusa-mobile.com>. Or call the Mercedes-Benz Customer Assistance Center on 1-800-FOR-MERCEdes(1-800-367-6372) for the USA or on 1-800-387-0100 for Canada.

Safety notes

WARNING

A driver's attention to the road must always be his/her primary focus when driving. For your safety and the safety of others, we recommend that you pull over to a safe location and stop before placing or taking a telephone call. If you choose to use the mobile phone while driving, please use the handsfree facility and only use the mobile phone when weather, road, and traffic conditions permit.

Some jurisdictions prohibit the driver from using a mobile phone while driving a vehicle. Bear in mind that at a speed of just 30 mph (approximately 50 km/h), your vehicle is covering a distance of 44 feet (approximately 14 m) every second.









Call disconnection while the vehicle is in motion

A call may be disconnected if:

- there is insufficient network coverage in certain areas.
- you move from one transmitter/receiver area (cell) into another and no channels are free.
- you use a SIM card which is not compatible with the network available.
- you are using a mobile phone with "Twincard" and the mobile phone with the second SIM card is already logged into the network.

Operating options

You can operate the telephone by:

- using the COMAND controller:
 - turn .
 - slide  or .
 - press .
- the  or  button on the telephone keypad on the center console
- the  or  button on the multifunction steering wheel
- using the Voice Control System (see the separate Voice Control System operating instructions)

Unless otherwise indicated, the descriptions and illustrations in this section refer to COMAND and the telephone keypad. This also means that to carry out the functions described here, you must always be in the Telephone menu. The fastest way to access the Telephone menu is to press the  function button.

Function restrictions

You will not be able to use the telephone, will no longer be able to use the telephone, or you may have to wait before using it, in the following situations:

- when the mobile phone is switched off
- when the "Bluetooth®" function is switched off in COMAND
- when the "Bluetooth®" function is switched off on the mobile phone
- if the mobile phone is not logged into a mobile phone network

i The telephone automatically tries to log on to a network. If no network is available, you will not be able to make a "911" emergency call. If you attempt to make an outgoing call, the **NO SERVICE** message will appear for a short while.

- if you remove the SmartKey from the ignition lock during an active conversation in hands-free mode, the conversation may be continued for up to 30 minutes. After that time, it will be interrupted.

You can prevent this interruption by switching to "private call" ("private mode") on the mobile phone before deactivating COMAND (see mobile phone operating instructions).

If you wish to switch off COMAND during an active conversation in hands-free mode, the following message will appear: **You cannot shut off COMAND until you have finished your telephone call**

911 emergency call

WARNING

The 911 emergency call system is a public service. Using it without due cause is a criminal offense.

The following requirements must be fulfilled for a **911** emergency call:

- the mobile phone must be switched on.
- a network must be available.

- a valid and operational SIM card must be inserted in the mobile phone.
- the mobile phone is connected to COMAND via Bluetooth®.

If you cannot make an emergency call, you must arrange rescue measures yourself.

- ▶ Enter numbers using the number keypad (▷ page 188).
- ▶ Press the  button.
The telephone makes the connection.
- ▶ Wait for the emergency call center to respond and then describe the emergency.

- i** If no SIM card has been inserted in a GSM phone or if there is no service available for a CDMA phone, the **NO SERVICE** message appears in COMAND. In this case, an emergency call can only be transmitted via the mobile phone itself and not via COMAND.

Telephony via the Bluetooth® interface

Conditions

On the mobile phone

For telephony via COMAND's Bluetooth® interface, a Bluetooth®-capable mobile phone is required.

- i** Not all mobile phones available on the market are equally suitable. More detailed information on suitable mobile phones and on connecting Bluetooth®-capable mobile phones with COMAND can be found on the Internet at

http://www.mbusa-mobile.com. Or call the Mercedes-Benz Customer Assistance Center on 1-800-FOR-MERcedes(1-800-367-6372) (for the USA) or Customer Relations on 1-800-387-0100 (for Canada).

The battery of the mobile phone should always be kept sufficiently charged in order to prevent malfunctions.

In preparation for telephoning via the Bluetooth® interface, you should check the following items on your mobile phone (see the mobile phone operating instructions):

- ▶ **Hands-Free Profile**
The mobile phone must support Hands-Free Profile 1.0 or above.
- i** Certain displays and functions (e.g. signal strength display, conference connection) are available, depending on the supported version of the Hands-Free Profile.
- ▶ **Bluetooth® visibility**
On certain mobile phones, the device itself must be made "visible" for other devices, as well as activating the Bluetooth® function (see the mobile phone operating instructions).
- ▶ **Bluetooth® device name**
Every Bluetooth® device has its own Bluetooth® device name. This device name is freely definable, but can be identical for all devices from the same manufacturer. It is therefore recommended that you change this name so that you can easily recognize your mobile phone (see the mobile phone operating instructions).
- ▶ Switch on the mobile phone and enter the PIN when prompted to do so (see the mobile phone operating instructions).
- ▶ Activate Bluetooth® functions and, where necessary, Bluetooth® visibility on the mobile phone (see the mobile phone operating instructions).

In COMAND

- ▶ Activate the Bluetooth® function in COMAND (▷ page 135).

Connecting a mobile phone

General information

Before using your mobile phone with COMAND for the first time, you will need to connect it.

When you authorize a new mobile phone, it is connected automatically.



Connecting comprises:

- searching for a Bluetooth®-capable mobile phone
- subsequently authorizing it

You can connect up to 15 mobile phones.

Searching for a mobile phone

► **To call up the telephone menu:** press the  function button once or twice.

► Select **Data/Connections** in the telephone basic menu by sliding  and turning  the COMAND controller and press  to confirm.



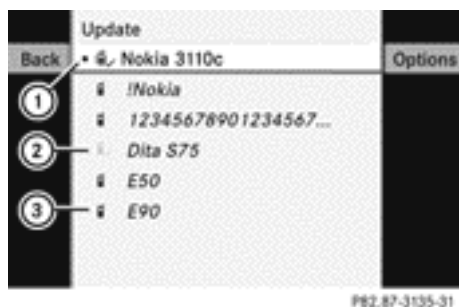

► Select **Bluetooth Telephones** and press  to confirm.

► Select **Update** and press  to confirm. COMAND searches for Bluetooth® telephones within range and adds them to the Bluetooth® telephone list.

The duration of the search depends on the number of Bluetooth® telephones within range and their characteristics.



Example of display: Bluetooth® telephones list



- ① Currently connected  and authorized mobile phone 
- ② Mobile phone not within range but previously authorized ( symbol appears in gray)
- ③ Newly detected mobile phone in range, not yet authorized 

The Bluetooth® telephones list shows all mobile phones within range and all previously authorized mobile phones, whether or not they are in range.

i If the Bluetooth® telephones list is already full, you will be requested to de-authorize a mobile phone (► page 186). If COMAND does not find your mobile phone, external authorization (► page 185) may be necessary.

Authorizing (registering) a mobile phone

► In the Bluetooth® telephones list, select the not yet authorized mobile phone by turning  the COMAND controller.

► Select **Options** by sliding  the COMAND controller and press  to confirm.

► Select **Authorize** and press  to confirm. or

► Press  to confirm the selected mobile phone.

The input menu for the passcode appears.

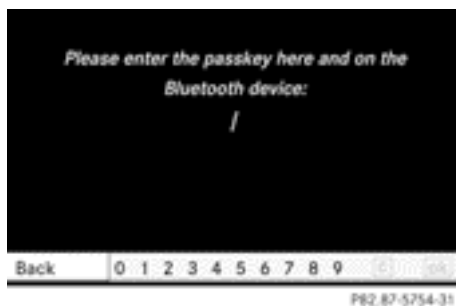

The passcode is any one to sixteen-digit number combination which you can choose yourself. You must enter the same number combination in COMAND and in the Bluetooth®-capable mobile phone (see the operating instructions of the mobile phone).



i Some mobile phones require the input of a four-digit passcode or longer number combinations.

If you want to reauthorize a mobile phone following de-authorization, you can select a different passcode.



- ▶ **To enter a passcode in COMAND:** press the number keys in sequence.

 is available for selection after the first number has been entered.

or

- ▶ Select the digits one by one by turning  the COMAND controller and press  to confirm.

- ▶ **To confirm an entry in COMAND:** select

 using the COMAND controller and press  to confirm.

or

- ▶ Select **SEND** on the telephone keypad.
- ▶ Now enter the same passcode in the mobile phone.

To make entries on the mobile phone: if the Bluetooth® connection is successful, you will be requested to enter the passcode (see mobile phone operating instructions).

- ▶ Enter the same passcode on the mobile phone that you entered in COMAND.

- i** After entering the passcode, you may also need to enter a confirmation in your mobile phone to connect calls. Please check your mobile phone display.









If the **Error during authorization process** message appears on the COMAND display, you may have exceeded the allowed time. Repeat the procedure.

The mobile phone is connected to COMAND (authorized). You can now make phone calls using the COMAND hands-free system.

External authorization

If COMAND does not detect your mobile phone, this may be due to particular security settings on your mobile phone. In this case, you can test if your mobile phone can find COMAND. The Bluetooth® device name of COMAND is **MB Bluetooth**.

Observe the following: some mobile phones require that you reconnect to COMAND after you have entered the passcode (see the mobile phone operating instructions). The mobile phone cannot otherwise be authorized.

- ▶ Press the  function button on the COMAND controller once or twice.
- ▶ Select **Data/Connections** in the telephone basic menu by sliding  and turning  the COMAND controller and press  to confirm.
- ▶ Select **Bluetooth Telephones** and press  to confirm.
- ▶ Select **Update**.
- ▶ Select **Options** by sliding  and press  to confirm.
- ▶ Select **External Authorization** and press  to confirm.
- ▶ Start the Bluetooth® search on the mobile phone (see the mobile phone operating instructions).
- ▶ Select COMAND (**MB Bluetooth**) on the mobile phone.
- i** The order in which the passkey is entered depends on the mobile phone.
- ▶ Enter the passkey on the mobile phone when prompted.
- ▶ Confirm the **Do you want to authorize XX?** question in COMAND with **Yes**.
- ▶ Enter the passkey in COMAND.

Connecting another mobile phone

If you have authorized more than one mobile phone, you can switch between the individual phones.









- i** You can only switch to another authorized phone if you are not currently making a call.
- ▶ Select the mobile phone in the Bluetooth® telephones list by turning  the

COMAND controller and press  to confirm.

The selected mobile phone is searched for and connected if it is within Bluetooth® range and if Bluetooth® is activated.

Only one mobile phone can be connected at any one time. The currently connected mobile phone is indicated by the  dot in the Bluetooth® telephones list (> page 183).







Displaying details

- ▶ Select **Data/Connections** in the telephone basic menu by sliding  and turning  the COMAND controller and press  to confirm.
- ▶ Select **Bluetooth Telephones** and press  to confirm.
- ▶ Select the desired mobile phone in the Bluetooth® telephones list.
- ▶ Select **Options** by sliding  and press  to confirm.
- ▶ Select **Details** and press  to confirm. The following information concerning the selected mobile phone is shown:
 - Bluetooth® name
 - Bluetooth® address
 - equipment class, e.g. telephone, computer
 - availability
 - authorization status
- ▶ **To close the detailed view:** turn  or slide  the COMAND controller.

De-registering (de-authorizing) a mobile phone

Mercedes-Benz USA, LLC recommends deauthorizing in both COMAND and the mobile phone. Subsequent authorization may otherwise fail.

- ▶ **To call up the telephone menu:** press the  function button once or twice.

- ▶ Select **Data/Connections** in the telephone basic menu by sliding  and turning  the COMAND controller and press  to confirm.
- ▶ Select **Bluetooth Telephones** and press  to confirm.
- ▶ Select the desired mobile phone in the Bluetooth® telephones list.
- ▶ Select **Options** by sliding  and press  to confirm.
- ▶ Select **De-authorize** and press  to confirm. A prompt appears asking whether you really wish to de-authorize this device.
- ▶ Select **Yes** or **No**. If you select **Yes**, the device will be deleted from the Bluetooth® telephones list. If you select **No**, the process will be aborted.

- ▶ **i** Before re-authorizing the mobile phone, you should also delete the device name **MB Bluetooth** from your mobile phone's Bluetooth® list.

Basic telephone menu (Bluetooth® interface)

- ▶ **To call up the telephone menu:** press the  function button once or twice.

If the mobile phone is ready for use, the following display appears:

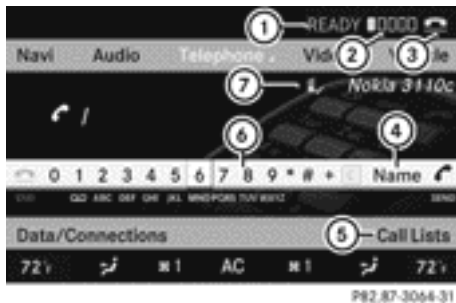

Example display: telephone basic menu (Bluetooth® interface)

- ① Network provider icon
- ② Signal strength of mobile phone network
- ③ Receiver icon
- ④ To display the COMAND phone book
- ⑤ To display call lists
- ⑥ Character bar with characters for phone number entry
- ⑦ Bluetooth® name of the currently connected mobile phone

i Displays ① and ② are shown, depending on the mobile phone connected.

Bars ② display the current signal strength of the mobile phone network. If all bars are filled, you have optimum reception. If all bars are empty, there is very poor reception or none at all.

Receiver icon ③ shows whether a call is active/being connected or not

Reception and transmission volume

Once the mobile phone has been authorized, you can optimize the transmission and reception volume settings. Find information on the optimal setting for your mobile phone on the Internet at

<http://www.mbusa-mobile.com>. Or call the Mercedes-Benz Customer Assistance Center on 1-800-FOR-MERCEdes(1-800-367-6372) (for

the USA) or Customer Relations on 1-800-387-0100 (for Canada).

i Incorrect settings may have a significant impact on the quality of calls.

- ▶ Press the function button.
- ▶ Select **Data/Connections** in the telephone basic menu by sliding and turning the COMAND controller and press to confirm.
- ▶ Select **Bluetooth Telephones** and press to confirm.
- ▶ Select an authorized mobile phone from the list by turning .
- ▶ Select **Options** by sliding and press to confirm.
- ▶ Select **Reception Volume** or **Transmission Volume** and press to confirm.

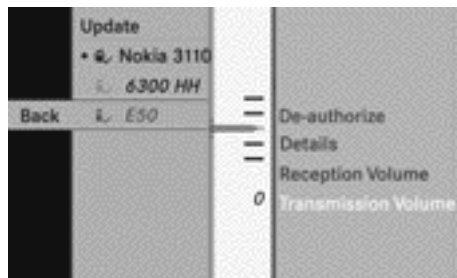

- ▶ **To set the volume on scale:** select by sliding the COMAND controller and press to confirm.

Using the telephone

Incoming call

Rejecting or accepting a call

When there is an incoming call, you see a corresponding window in the display.



- ▶ **To reject:** select **Reject** by turning the COMAND controller and press to confirm.

or

- ▶ Press the button on the telephone keypad or on the multifunction steering wheel.

- ▶ **To accept:** confirm **Accept** by pressing .

or

- ▶ Press the button on the telephone keypad.

or

- ▶ Press the or button on the multifunction steering wheel.

Once you have accepted the call, you can use hands-free mode. The call volume can be adjusted (▷ page 127). For more information, see the "Functions available during a call" section (▷ page 189).

The display shows the phone number or the name and phone number (if the entry is stored in the address book) or shows the **Unknown** (phone number withheld) message.

- i** You can also accept a call as described above when COMAND is showing the display of a different main application. The display switches to the telephone display after a call is accepted using the COMAND controller or the telephone keypad. After the call is finished, you see the display of the previous main application again.

Making a call

Entering a telephone number using the telephone keypad

- ▶ Call up the telephone basic menu (▷ page 186).

- ▶ Enter all the digits of the phone number using the telephone keypad.

- ▶ **To make a call:** press the button on the telephone keypad or on the multifunction steering wheel.

Entering a telephone number using the telephone basic menu

- ▶ Call up the telephone basic menu (▷ page 186).

- ▶ Select the digits one by one by turning and sliding the COMAND controller and press to confirm.

- ▶ **To make a call:** select **SEND** from the telephone basic menu and press to confirm.

or

- ▶ Press the button on the telephone keypad or on the multifunction steering wheel.

Redialing

- ▶ Call up the telephone basic menu (▷ page 186).

- ▶ Press the button on the telephone keypad.

or

- ▶ Select **SEND** from the telephone basic menu and press to confirm.

In both cases, the calls dialed list appears. The most recently dialed number is at the top.

- ▶ **To select a call:** select an entry by turning the COMAND controller and press to confirm.

- i** The redialing function is also available using the on-board computer (▷ page 347).

Calling voicemail

This function is only available if it is supported by the mobile phone network provider.

You can only call voicemail if the voicemail number is stored as preset 1 on the SIM card.

- ▶ Press and hold the **1** button on the telephone keypad.

or

- ▶ Use the COMAND controller to select 1 and confirm until dialing commences.

Connecting a call to an entry in a call list or in the COMAND phone book

- ▶ Open a call list and select an entry (▷ page 197).

or

- ▶ Call up the COMAND phone book and select an entry (▷ page 193).

Functions available during a call

Overview

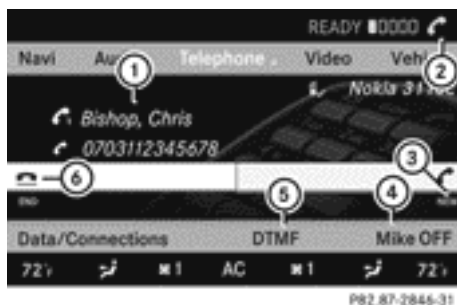

Telephone operation with a single call

- 1 Person you are calling
- 2 Icon for active telephone connection
- 3 **NEW** to call other parties⁷
- 4 To switch hands-free microphone on/off

- 5 To send DTMF tones (not possible with all mobile phones)
- 6 To end a call

Switching the hands-free microphone on/off

This function is also available during an active phone call.

- ▶ To call up the telephone basic menu (▷ page 186).

- ▶ **To switch off:** select **Mike OFF** and press to confirm.

or

- ▶ Press the button on the multifunction steering wheel.

If the microphone is switched off, the display shows the symbol and the **The microphone is turned OFF** message appears for a short period.

- ▶ **To switch on:** select **Mike ON** and press to confirm.

or

- ▶ Press the button on the multifunction steering wheel.

The symbol disappears. You will briefly see the **The microphone is ON** message.

Ending an active call

- ▶ Select in the telephone basic menu and press to confirm.

or

- ▶ Press the button on the telephone keypad or on the multifunction steering wheel.

Call waiting, toggling and conference connections with several people

These functions are only available if they are supported by the mobile phone network provider. Furthermore, they are only available if the mobile phone supports HFP 1.5 or higher.

⁷ This function is only available if the telephone supports HFP1.5 and above.

You can be called by more than one person (call waiting) while you are making a telephone call. In the same way, you can call another party while already on the phone with someone.

You can either toggle between these two conversations or interconnect them to create a conference call.

You can simultaneously switch back and forth between two parties or conduct a conference call with up to five others.

Call Waiting⁸

If you are on the telephone and you receive another call, the call waiting display will appear. You also hear a tone.

► **To reject:** select **Reject** and press  to confirm.

or

► Press the  button on the telephone keypad or on the multifunction steering wheel.

► **To accept:** select **Accept** and press  to confirm.

or

► Press the  button on the telephone keypad or on the multifunction steering wheel.

This will put the active call on hold. You now have two calls. The accepted call is active and the first call is on hold.

i If your mobile phone does not support HFP 1.5 or above, then the call which was active is canceled as soon as the second call is accepted.

Calling additional parties

You can call a second person while on the phone with someone else. This action puts the previous call on hold.

► Select **NEW** from the telephone basic menu and press  to confirm.

or

► Select **SEND** on the telephone keypad.

► Enter the phone number manually (▷ page 188) or via the phone book (▷ page 196) or from the call lists (▷ page 197).



Switching between two parties (toggling)

If you have added another party to your previously active call, the telephone menu then looks like this:



① Active party

② Party on hold

► **To switch to the other party:** select ② by turning  the COMAND controller and press  to confirm.

or

► Select **SEND** on the telephone keypad.

or

► Press the  button on the multifunction steering wheel.

Interconnecting to create a conference

You can interconnect calls which are active and those which are on hold. This permits several parties to hear one another and speak with one another.

⁸ This function is only available if Call Waiting has been activated on the mobile phone.

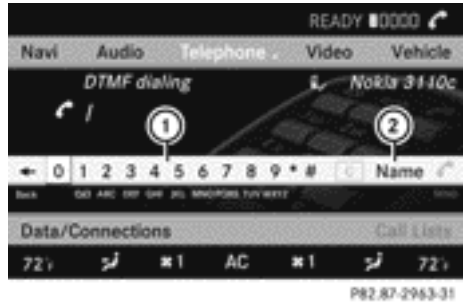
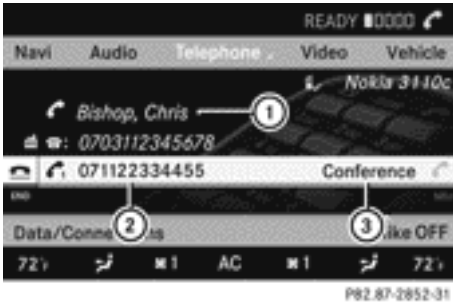

- ① Active party
- ② Party on hold
- ③ To interconnect parties by creating a conference connection

► **To interconnect parties by creating a conference connection:** select **Conference** ③ by turning **[COMAND]** the COMAND controller and press **[ENTER]** to confirm.

Sending DTMF tones

This function is not supported by all mobile phones.

Answering machines or other devices can be controlled by DTMF tones, e.g. for remote query functions.

If you would like to listen to the messages on your answering machine, for example, select the corresponding number.

► Select **DTMF** from the telephone basic menu during a conversation.

- ① To transmit individual characters using the character bar
- ② To transmit a phone book entry as a character string

► **To transmit individual characters:** once a connection has been established to the answer phone, select the desired characters in the character bar and press **[ENTER]** to confirm.

or

► **To send a phone book entry as a DTMF sequence:** select **Name** by turning **[COMAND]** the COMAND controller and press **[ENTER]** to confirm.

► Select the desired phone book entry and press **[ENTER]** to confirm.
The entry is sent as a DTMF character string.

► **To switch back to the call display:** select **[LEFT]**.

i You can also send DTMF tones by pressing the corresponding button on the telephone keypad or using the Voice Control System (see the separate operating instructions).

Using the phone book and address book

The COMAND phone book is an extract of those entries from the address book which contain at least one telephone number.



The address book organizes and stores entries that are entered from different sources (mobile phone, SD memory card, Bluetooth® import, COMAND phone book, navigation). You can use these entries to make telephone calls and for navigation. You can create a maximum of 3000 address book entries.

Importing contacts automatically

COMAND automatically imports contacts from a mobile phone to the phone book.

In this case, the mobile phone must be active via the Bluetooth® interface.

Depending on the mobile phone, this process may take some time. Depending on the mobile phone used, only the phone book entries in the mobile phone or these entries and the phone book entries from the SIM card are imported.

Automatically imported contacts in COMAND can be identified by the / symbol.

These are available to you in COMAND only when the mobile phone is active via the Bluetooth® interface.



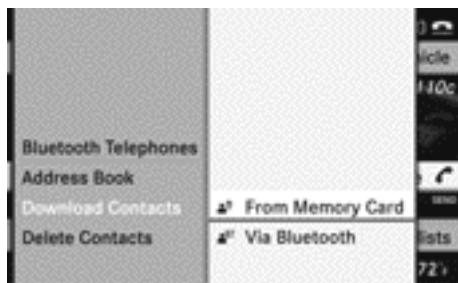



Importing contacts manually



i All the manually imported contacts remain in COMAND even if you use COMAND with a different mobile phone. The entries can be viewed without a mobile phone. Contacts created in COMAND can also be viewed without a mobile phone. For this reason, delete the phone book before

selling or transferring ownership of your vehicle.

Existing contact data can be imported from the memory card manually.

- ▶ **To import data:** load the memory card.
- ▶ Select **Data/Connections** in the telephone basic menu by sliding  and turning  the COMAND controller and press  to confirm.
- ▶ Select **Download Contacts** and press  to confirm.
- ▶ Select **From Memory Card** and press  to confirm.
- ▶ Select **Add or Overwrite** and press  to confirm.

If the data has been imported, the **Import successful** message is displayed.

If the COMAND phone book memory is full, this message appears in the display: **Memory full. Contacts could not be imported completely.**

- i** After the data has been imported, COMAND has to process it. The entries are only visible in the address/phone book when this is completed.

Receiving vCards via Bluetooth®

You can receive vCards from devices that support the sending of vCards via Bluetooth®. Such devices include PCs.

This requires the device to be authorized in COMAND. PCs have to be authorized via the Bluetooth® device list (▷ page 135).

Received vCards are imported into the address book.

Please bear the following in mind:

- ▶ Bluetooth® must be activated in COMAND and on the Bluetooth® device (▷ operating instructions of the device).
- ▶ the Bluetooth® device must be able to send vCards via Bluetooth® (▷ operating instructions of the device).
- ▶ the Bluetooth® device in the vehicle must be switched on.

i If you switch to another main function, e.g. navigation, while receiving vCards, the reception of vCards will be terminated.

- ▶ Select **Data/Connections** in the telephone basic menu by sliding and turning the COMAND controller and press to confirm.
- ▶ Select **Download Contacts** and press to confirm.
- ▶ Select **Via Bluetooth** and press to confirm.

This interrupts the Bluetooth® connection between COMAND and your active mobile phone. In turn, COMAND is ready to receive vCards from another Bluetooth® device.

- ▶ Start data transfer on the external Bluetooth device (▷ operating instructions of the device).

The data on the vCards is automatically transferred to the address book. The number of vCards received is displayed.

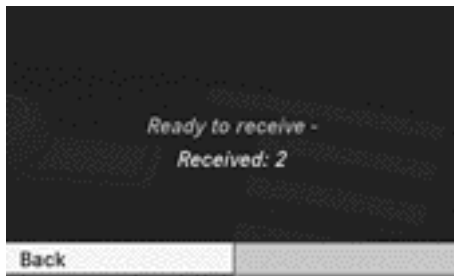

P82.87-2006-31

- ▶ **To cancel reception:** press .

or

- ▶ Press the back button on the center console.

Calling up contacts/details

You can call up contacts with the list or by using the character bar.



Phone book/address book basic display

① List

- Entry with navigable data
- Entry with voice tag; see the separate operating instructions for the Voice Control System
- Address book entry
- Mobile phone entry
- SIM card entry
- Entry imported via Bluetooth®
- Entry imported via memory card
- Entry with multiple phone numbers





② Two-line character bar

- To change the language of the characters
- To select the character set
- To delete your selection
- To confirm your selection
- Back





Calling up contacts from a list

- ▶ Phone book: select **Name** in the telephone basic menu by sliding and turning

☞ the COMAND controller and press  to confirm.











- ▶ Address book: select **Data/Connections** in the telephone basic menu by sliding  and turning  the COMAND controller and press  to confirm.
- ▶ Select **Address Book** and press  to confirm.
- ▶ **To switch from the character bar to the list:** slide  the COMAND controller until the character bar is hidden.

or

- ▶ Select  .
- ▶ **To call a contact:** select by sliding  or turning  the COMAND controller and press  to confirm.

 The phone book is also available via the on-board computer (▷ page 346).

Calling up contacts using the character bar

- ▶ Phone book: select **Name** in the telephone basic menu by sliding  and turning  the COMAND controller and press  to confirm.
- ▶ Address book: select **Data/Connections** in the telephone basic menu by sliding  and turning  the COMAND controller and press  to confirm.
- ▶ Select **Address Book** and press  to confirm.
- ▶ **To select a character:** select by sliding  or  the COMAND controller and press  to confirm. Repeat this procedure until COMAND automatically switches over to the list.
You determine the first letter of the entry you are looking for with the first character you enter. If there are similar entries, the next character which is different will be displayed and offered for selection.

 You can also use the telephone number keypad to enter characters.





Creating new contacts/changing contacts

 In certain countries, this function stops being available from a vehicle speed of more than approximately 3 mph (5 km/h). As soon as the speed falls below approximately 2 mph (3 km/h), the function becomes available again.

 You can enter address data directly into the address book. If you store contacts in the phone book, these are also saved in the address book.

 Automatically imported contacts cannot be edited. They have to be saved first before being copied to the COMAND address book.



- ▶ Call up the contact (▷ page 193)⁹.
- ▶ Select **Options** by sliding  and turning  the COMAND controller and press  to confirm.
- ▶ Select **New Entry** or **Change** and press  to confirm.
The input menu with data fields appears.

⁹ Only available with the "Change contact" function.



① Entry mark (cursor)

② Data field

③ Two-line character bar

To select the language

To select the character set

To select uppercase and lowercase letters

Back

To delete your selection

To confirm your selection

④ Preset phone category

► Enter the respective data in the data fields.

► **To enter data in the data field:** select the respective characters from character bar ③.

► **To move the cursor in the data field:** select the respective characters from character bar ③.

► **To change data fields:** slide the COMAND controller until the character bar is hidden.

► Slide the COMAND controller and press to confirm.

or

► Press in the character bar.

► **To cancel data entry:** select the symbol in character bar ③ and press to confirm.

If one of the data fields contains data, a prompt will appear asking whether you wish to store the entry.

► **To save data entry:** select the symbol in character bar ③ and press to confirm.

The entry is created in the phone book and in the address book.

Deleting contacts



► **To delete a group of contacts:** select **Data/Connections** in the telephone basic menu by sliding and turning the COMAND controller and press to confirm.

► Select **Delete Contacts** and press to confirm.

You can select and delete the following types of contact here:

- **Internal Contacts**
- **Imported from memory card**
- **Imported via Bluetooth**
- **Delete All**

► Confirm the selection by pressing .

A prompt appears asking whether the data should be deleted.

► Select **Yes** and press to confirm.

- ▶ **To delete an individual contact:** select the entry (▷ page 193).
- ▶ Select **Options** by sliding and the COMAND controller and press to confirm.
- ▶ Select **Delete** and press to confirm. A prompt appears asking whether the data should be deleted.
- ▶ Select **Yes** and press to confirm.

i Automatically imported contacts cannot be deleted (▷ page 192).

Calling a number stored in an entry

Using the phone book

- ▶ Select **Name** in the telephone basic menu by sliding and turning the COMAND controller and press to confirm.
- ▶ Call up the contact (▷ page 193).
- ▶ **Contact with multiple telephone numbers (with the symbol):** press .

or

- ▶ Press **SEND** on the telephone keypad. A list of all telephone numbers is opened.
- ▶ Select the desired number by turning the COMAND controller.
- ▶ Press .

or

- ▶ Press **SEND** on the telephone keypad. The number is dialed.
- ▶ **Contact with one telephone number (without the symbol):** press .

or

- ▶ Press **SEND** on the telephone keypad. The number is dialed.

i You can also use the phone book in the on-board computer to make a call (▷ page 346).

Using the address book



- ▶ Select **Data/Connections** in the telephone basic menu by sliding and turning the COMAND controller and press to confirm.
- ▶ Select **Address Book** and press to confirm.
- ▶ Call contact (▷ page 193) and press to confirm.
- ▶ Select the telephone number by turning the COMAND controller and press to confirm.

Starting route guidance to an entry

i This function is available as soon as you have stored a destination in the destination memory (▷ page 167). COMAND also stores the destination in the address book with the complete navigable address data. In this case, navigation can be started without any further data input.

If the contact entry contains a postal address, e.g. as a result of importing a vCard, the system can also navigate to this address. If the data is incomplete or unclear, COMAND asks the user to enter the relevant address data. After the entry has been completed and navigation has been started, COMAND replaces the existing address with the navigable address if necessary.







- ▶ Search for an address book entry using the symbol.
 - ▶ Confirm the entry by pressing . Telephone numbers and addresses are displayed.
 - ▶ Select the address data field.
 - ▶ Press the COMAND controller.
- or
- ▶ Select **Options** by sliding the COMAND controller and press to confirm.

- ▶ Select **Navigate** and press  to confirm.
- ▶ Select **Start** and press  to confirm.





Voice tags

- i** Voice tags are entered via the Voice Control System; see the separate operating instructions for the Voice Control System.



Adding or changing a voice tag



- i** You can add one voice tag per address book entry.
- ▶ Search for an address book entry with or without a voice tag ( symbol).
- ▶ Select **Options** by sliding  and turning  the COMAND controller and press  to confirm.
- ▶ Select **Voice Name** and press  to confirm.
- ▶ Select **Add or Change** and press  to confirm.
Subsequent operation is voice-controlled. The Voice Control System guides you through the menus.

Deleting a voice tag

- ▶ Search for an address book entry with a voice tag.
- ▶ Select **Options** by sliding  and turning  the COMAND controller and press  to confirm.
- ▶ Select **Voice Name** and press  to confirm.
- ▶ Select **Delete** and press  to confirm.
A deletion prompt appears.

Listening to a voice tag

- ▶ Search for an address book entry with a voice tag.
- ▶ Select **Options** by sliding  and turning  the COMAND controller and press  to confirm.

- ▶ Select **Voice Name** and press  to confirm.
- ▶ Select **Listen** and press  to confirm.
You will hear the voice tag.

Using call lists





Introduction

COMAND displays lists of calls received (including missed calls) and made during phone operation.

The respective menu item can only be selected if:

- calls have already been made or received in COMAND.
- the call lists have been imported from the telephone.

Opening the call list and selecting an entry

- ▶ **To call up the telephone menu:** press the  function button.
- ▶ Select **Call Lists** in the telephone basic menu by sliding  and turning  the COMAND controller and press  to confirm.
A menu appears.
- ▶ Select **Calls Received** or **Calls Dialed** and press  to confirm.
The corresponding list appears.
- i** The list of calls made can also be opened by pressing the SEND button in the menu or on the telephone keyboard. This is possible as long as no phone numbers have been entered in the basic menu. The list of calls made can also be opened in the on-board computer.



P82.87-3110-31

Example display: list of calls made

- ① To close the list
 - ② Telephone number / name if known
 - ③ To call up options (e.g. save)
- ▶ Select an entry by sliding the COMAND controller.
 - ▶ **To dial a phone number:** press the button.

or

- ▶ Press to confirm.

Unanswered incoming calls have the symbol in front of the name or phone number.

Storing a phone number which has not yet been stored

Introduction

For incoming calls from a person who is not in the address book, COMAND displays the phone number in the call list. You can save this entry.

Storing as a new entry in the address book

- ▶ Open a call list and select an entry (> page 197).
- ▶ Select **Options** by sliding the COMAND controller and press to confirm.
- ▶ Select **Save Number** and press to confirm.
- ▶ Select **New Entry** and press to confirm.

- ▶ Select a category for the number, e.g. **Home**, and press to confirm.
- ▶ Select a category for the phone, e.g. **Cellular Phone Number**, and press to confirm.

Number category	Display (phone book and address book)
Unclassified	No symbol
Home	
Work	

Telephone category	Display (phone book and address book)
Unclassified	No symbol
Cellular Phone Number	
Pager	
Car	
Landline	
Preferred	

- i** If you have not entered the phone number in a number and telephone category, the symbol will appear in the display.
- ▶ Select **Next (save)** and press to confirm.
An input menu with data fields is shown. The data field for the telephone number is filled in automatically.

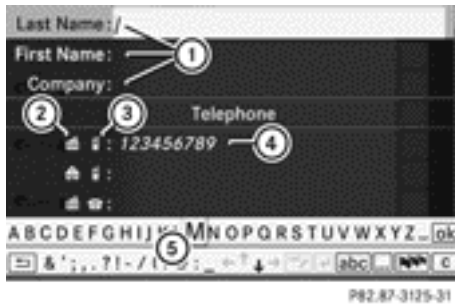

- ① Data fields for surname, first name and company
 - ② Number category
 - ③ Telephone category
 - ④ Data field for the telephone number, filled in automatically
 - ⑤ Two-line character bar
- ▶ Proceed as described under "Entering characters" in the "Entering characters in the address and phone books" section (▷ page 125).

Adding a phone number to an address book entry

- ▶ Open a call list and select an entry (▷ page 197).
- ▶ Select **Options** by sliding $\odot \rightarrow$ the COMAND controller and press \odot to confirm.
- ▶ Select **Save Number** and press \odot to confirm.
- ▶ Select **Add** and press \odot to confirm.
The search menu for address book entries appears.
- ▶ Search for the desired entry (▷ page 193).
- ▶ Press \odot when you have finished searching.
- ▶ Select a category for the number, e.g. **Home**, and press \odot to confirm.

- ▶ Select a category for the phone, e.g. **Cellular Phone Number**, and press \odot to confirm.

- ▶ Select **Next (save)** and press \odot to confirm.
COMAND stores the data if there are fewer than five numbers assigned to the entry you are searching for.

You will see a message to this effect.

If five numbers are stored for the entry you are searching for, a prompt will appear asking whether you wish to overwrite one of the existing numbers.

- ▶ Select **Yes** or **No** and press \odot to confirm.
If you select **Yes**, a selection list with the five existing numbers appears.
If you select **No**, the process is canceled.
- ▶ Select the number to be overwritten in the list by turning $\left\{ \odot \right\}$ the COMAND controller and press \odot to confirm.
COMAND overwrites the selected number with the new data.

Audio

Radio mode

General information

- i** Portable electronic devices in the vehicle may seriously impair radio reception.

Switching to radio mode

Option 1

- ▶ Press $\left[\text{DISC RADIO} \right]$ the function button.
The radio display appears. You will hear the last station played on the last waveband.

Option 2

- ▶ Select **Audio** in the main function bar by sliding $\left\{ \odot \right\}$ and turning $\left\{ \odot \right\}$ the COMAND controller and press \odot to confirm.
If radio mode was the last mode selected, it will now be active.

If another audio mode is switched on, you can now switch to radio mode in the audio menu.

- ▶ Select **Audio** by sliding $\uparrow \odot$ the COMAND controller and pressing \odot to confirm. The audio menu appears.

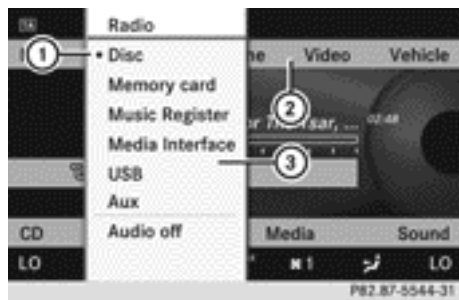

Example display: audio menu

- ① Current audio operating mode
- ② Main function bar
- ③ Audio menu

- ▶ Select **FM/AM radio** by turning $\left\{ \odot \right\}$ the COMAND controller and press \odot to confirm.

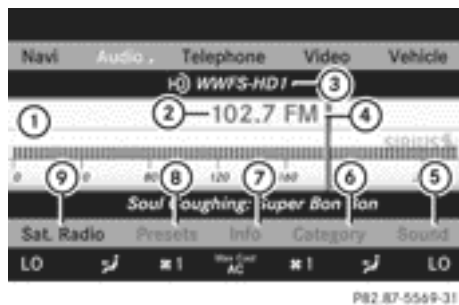

Example display, FM radio

- ① Display window with station settings
- ② Frequency of the selected station
- ③ Name of the selected station
- ④ Display bar for frequency setting
- ⑤ Sound settings
- ⑥ Waveband
- ⑦ Station information

- ⑧ Preset functions
- ⑨ Radio functions

Switching wavebands

- ▶ Select **FM, AM** or **WB** in the radio display by sliding $\odot \uparrow$ and turning $\left\{ \odot \right\}$ the COMAND controller and press \odot to confirm. Waveband submenu is opened.

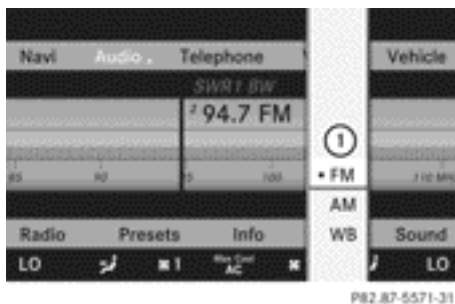

- ① The waveband submenu (the \bullet dot shows the waveband currently set)
- ▶ Select a waveband and press \odot to confirm. You will hear the last station played on the selected waveband.

Selecting a station

Selecting a station using the station search function

- ▶ Turn $\left\{ \odot \right\}$ or slide $\leftarrow \odot \rightarrow$ the COMAND controller while the display/selection window in the radio display is active. Station search scans up or down and stops at the next station found.

Using the multifunction steering wheel

- ▶ Press \leftarrow or \rightarrow to select the **Audio** menu.
- ▶ Press \blacktriangle or \blacktriangledown briefly.

Selecting stations via the station presets

- ▶ **Quick setting:** press a number key, e.g.



- ▶ **Directly in the station presets:** select **Presets** by sliding $\odot \updownarrow$ and turning $\{\odot\}$ the COMAND controller and press \odot to confirm.

or

- ▶ Press \odot the COMAND controller when the display/selection window is active. The station preset memory appears. The
 - dot indicates under which preset the currently selected station is stored.
- ▶ Select a station by turning $\{\odot\}$ and pressing \odot to confirm or press a number key, e.g. $\boxed{2}$.

Using the multifunction steering wheel

- ▶ Press \leftarrow or \rightarrow to select the **Audio** menu.
- ▶ Press \blacktriangle or \blacktriangledown briefly.

Selecting stations by entering the frequency manually

- ▶ **Option 1:** press the $\boxed{* +}$ button.
- ▶ **Option 2:** select **Radio** in the radio display by sliding $\odot \updownarrow$ and turning $\{\odot\}$ the COMAND controller and press \odot to confirm.
- ▶ Select **Enter Frequency** and press \odot to confirm. Irrespective of the option chosen, an input menu will appear.
- ▶ Enter a frequency using the number keys. COMAND tunes in to the frequency entered.

Waveband	Frequency
AM (MF)	530 – 1700 kHz
FM (VHF)	87.7 – 107.9 MHz
WB (Weather Band)	Weather report channels

i You can only enter currently permitted numbers.

i If you enter a frequency in the FM or AM wavebands which is outside the frequency range, COMAND tunes in to the next lower frequency.

Storing stations

Storing stations manually

There are twenty presets available for the FM and AM wavebands.

- ▶ **Quick save:** press and hold a number key, e.g. $\boxed{2}$, until you hear a tone. The station is stored.
 - ▶ **Directly in the station presets:** press \odot the COMAND controller when the display/selection window is active.
- or
- ▶ Select **Presets** by sliding $\odot \updownarrow$ and turning $\{\odot\}$ the COMAND controller and press \odot to confirm. In both cases, the station presets appear. The • dot indicates under which preset the currently selected station is stored.

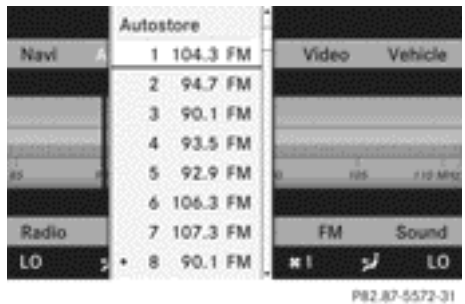

Example display: station presets

- ▶ Select a preset by turning $\{\odot\}$ the COMAND controller and press and hold \odot until you hear a tone. The station is stored under the preset.



Storing stations automatically

This function automatically stores stations with adequate reception under the presets. The search starts at the lowest frequency. COMAND stores any stations found,

beginning with preset 1. The storing process ends once the highest frequency has been reached or once ten stations have been found. Any stations stored manually under the presets will be lost. COMAND may not occupy all memory slots when storing.

► **Option 1:** press  the COMAND controller when the display/selection window is active.

The station preset memory appears.

► **Option 2:** select **Presets** by sliding  and turning  the COMAND controller and press  to confirm.





The station preset memory appears.

► Irrespective of the option, select **Autostore** and press  to confirm. In both cases, COMAND searches for stations that can be received. You will see a message to this effect. The available stations are automatically stored in the preset positions.

► **To cancel storing:** select **Cancel** and press  to confirm.

Weather Band

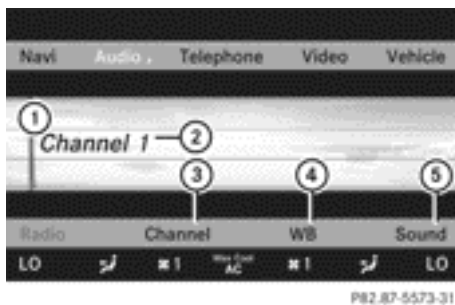

Switching on

- Select the currently set waveband **FM** or **AM** by sliding  and turning  the COMAND controller and press  to confirm.
- Select **WB** from the menu and press  to confirm.







- ① Display window with the channel setting
- ② Currently received channel
- ③ Channel list
- ④ Weather Band switched on
- ⑤ Sound settings



Searching for a channel

- **Quick select:** turn  or slide  or  the COMAND controller while the display/selection window is active. Channel search scans up or down and stops at the next channel found.

Using the multifunction steering wheel

- Press  or  to select the **Audio** menu.
- Press  or .

Selecting a channel from the channel list

- Select **Channel 1** by sliding  and turning  the COMAND controller and press  to confirm. The channel list appears.

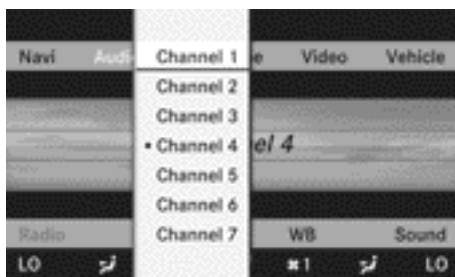

- ▶ Select a channel by turning **[⊙]** the COMAND controller and press **[⊙]** to confirm.

or

- ▶ Press a number key on the telephone keypad, e.g. **4**, at any time.

Displaying station information

This function is only available for analog FM and digital AM/FM programs (HD Radio). Information relevant to the current station is shown below the main function bar.

- ▶ Select **Radio** in the radio display by sliding **[⊙]** and turning **[⊙]** the COMAND controller and press **[⊙]** to confirm.

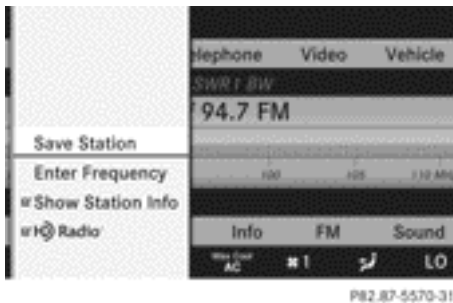

- ▶ Select **Show Station Info** by sliding **[⊙]** and turning **[⊙]** the COMAND controller and press **[⊙]** to confirm. Depending on the previous status, switch **Show Station Info** on or off .

Displaying program information

This function is only available for analog FM and digital AM/FM programs (HD Radio). Information relevant to the current station is shown in the display window.

- ▶ Select **Info** in the radio display by sliding **[⊙]** and turning **[⊙]** the COMAND controller and press **[⊙]** to confirm. Information on the currently selected station is displayed. The contents and

purpose of the information depend on the HD Radio station.

HD Radio

Important notes

The "HD Radio" section provides detailed information on the following:

- special functions available exclusively for HD Radio when compared with analog AM and FM radio
 - selecting an HD Radio station
 - displaying program information
- i** Optional HD Radio equipment is required to make use of the HD Radio functions described here. Registration is not required.

- i** HD Radio functions offer:

- digital transmission on the same wavebands as analog AM/FM. The analog AM/FM stations remain in the same position when selecting a station.
- the ability to broadcast several program streams over a single AM/FM frequency (e.g. HD1, HD2 etc.)
- clear, interference free reception
- on FM stations: CD quality sound; on AM stations: analog FM station sound quality
- a wide range of data services, text-based information – name of artist, name of song etc. – on the display.

For further information on HD Radio, visit <http://www.hdradio.com>.

- i** Please note that sub-programs and program information shown in the illustrations are dependent on the program broadcast by the respective radio station. The program contents may vary. The sub-programs and programs shown in the illustrations in this manual may therefore differ from the sub-programs and programs broadcast by radio stations.

Switching on HD Radio

i As HD Radio stations are broadcast in the AM/FM wavebands, operating HD Radio is very similar to operating analog AM/FM radio. This section describes only those functions that differ from standard FM radio functions.

Operating analog FM/AM radio is described in the "Radio" section (▷ page 199).

You can deactivate HD Radio for the selected frequency in the radio submenu.



- ▶ Select **Audio** in the main function bar by sliding and turning the COMAND controller and press to confirm.
- ▶ Select **FM/AM Radio** by sliding the COMAND controller and press to confirm. The audio menu appears.
- ▶ Select **Radio** by sliding the COMAND controller and press to confirm. HD Radio is deactivated if the check box is empty. You hear the analog program of this frequency. As soon as you change to another HD Radio frequency, the HD Radio is reactivated.

HD Radio display

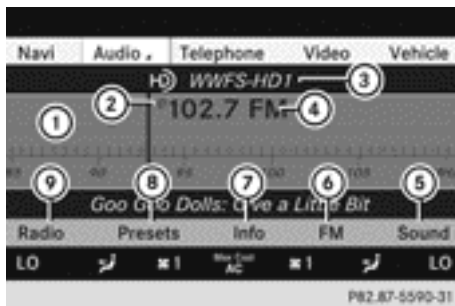

- ① Display/selection window with frequency display
- ② Preset number
- ③ Name of the selected station with HD icon and program number
- ④ Station frequency
- ⑤ Sound settings
- ⑥ FM, AM or WB radio
- ⑦ Program information
- ⑧ Station presets
- ⑨ Radio functions

Switching wavebands

See "Switching wavebands" in the radio mode section (▷ page 200).

Selecting a station

You can select an HD Radio station in the same way as selecting a standard FM radio station. After setting an HD Radio frequency, you will briefly hear the analog station until the digital data has been decoded. You will then be listening to digital radio and be able to switch to a sub-program (-HD2).

See "Selecting stations" in the Radio mode section (▷ page 200).

Storing stations

See "Storing stations" in the Radio mode section (▷ page 201).

Displaying program information

- ▶ Select **Audio** in the main function bar by sliding \uparrow and turning the COMAND controller and press to confirm.
- ▶ Select **Audio** by sliding the COMAND controller and pressing to confirm. The audio menu appears.
- ▶ Select **HD Radio** by sliding the COMAND controller and press to confirm.
- ▶ Select **Info** in the HD Radio display by sliding the COMAND controller and press to confirm. Information on the currently selected station is displayed. The contents and purpose of the information depend on the HD Radio station.

Satellite radio

Important notes

This section provides detailed information on the following topics:

- selecting a channel and program category
- memory functions
- sound settings

i The satellite radio mode described below requires optionally available satellite radio equipment and registration with a satellite radio provider.

i Note that the categories and channels shown in the illustrations depend on the program content offered by the provider. The program contents may vary. The illustrations and descriptions in these operating instructions may therefore differ from the channels and categories offered by the provider.

Satellite radio mode may be temporarily unavailable or interrupted for a variety of reasons. These reasons include environmental or topographical conditions as well as other issues beyond the control

of Mercedes-Benz USA, LLC. Operation may also be impaired in certain locations (e.g. tunnels, multi-storey car parks or within as well as close to buildings).

i SIRIUS XM Radio offers more than 130 digital-quality radio channels providing 100% commercial-free music, sport, news and entertainment.

SIRIUS XM Radio employs a fleet of high-performance satellites to broadcast around the clock throughout the USA and Canada.

The satellite radio program is available for a monthly fee. Details are available from the SIRIUS XM Service Center and at

http://www.sirius.com (USA) or

http://www.siriuscanada.com

(Canada).

Registering satellite radio

- ▶ Select **Audio** in the main function bar by sliding \uparrow and turning the COMAND controller and press to confirm.
- ▶ Select **Sat. Radio** and press to confirm.

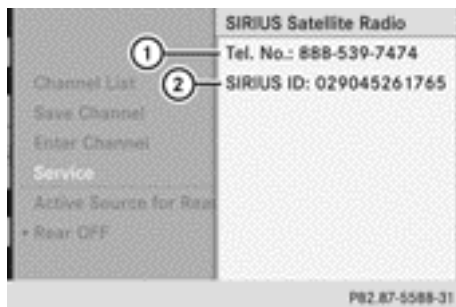

Service information screen

- ① Provider's phone number (SIRIUS XM)
- ② SIRIUS XM ID of your satellite receiver

▶ Call the phone number of your satellite radio provider shown on the screen.

i You can also have the satellite service activated online. To do so, visit the SIRIUS XM Radio website at **http://www.sirius.com** (USA) or

<http://www.siriuscanada.com>
(Canada).

Once the connection has been established:

- ▶ Follow the instructions of the service staff. The activation process may take up to ten minutes. If the activation is completed successfully, the **No Service** message appears in the display, followed by the satellite radio main menu.

i If registration is not included when purchasing the system, your credit card details will be required to activate your account.

If the satellite receiver is not installed or is not installed correctly, the **Device not available** message will appear.

Switching on satellite radio mode

Notes

Important notes on registration, see "Registering satellite radio" (▶ page 205).

Switching on satellite radio mode

- ▶ Select **Audio** in the main function bar by sliding $\uparrow \odot$ and turning $\left[\odot \right]$ the COMAND controller and press \odot to confirm. If satellite radio mode was the last mode selected, it will now be active.

If another audio mode is switched on, you can now switch to satellite radio mode in the audio menu.

- ▶ Select **Audio** by sliding $\uparrow \odot$ the COMAND controller and pressing \odot to confirm. The audio menu appears.
- ▶ Select **Sat. Radio** and press \odot to confirm. The **No Service** message appears when starting up or if no signal is being received. If the satellite receiver is not installed or is not installed correctly, the **Device not available** message will appear.

Once COMAND receives the signal, the satellite radio display appears. The station last selected is played.

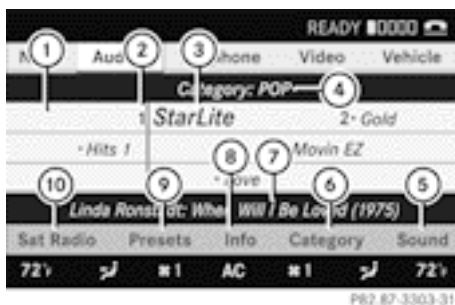

Satellite radio main menu





- ① Satellite radio main display
- ② Preset
- ③ Channel name
- ④ Selected category/channel number
- ⑤ Sound settings
- ⑥ Category list
- ⑦ Channel information (in brief)
- ⑧ Channel information (in detail)
- ⑨ Channel preset list
- ⑩ SatRadio menu

Channel information ⑦ can be viewed in detail (▶ page 208).

Changing the category



Satellite radio stations are sorted into various categories. You can choose between the different categories, such as news/talk shows, sports or country, if they are available. The category list is sorted alphabetically.

Selecting a category





- ▶ **To call up the category list:** select **Category** by turning  the COMAND controller and press  to confirm. The category list appears.
- ▶ **To select a category:** select a category by turning  the COMAND controller and pressing  to confirm. The category selected is shown in the display. You hear the station last selected for this category. The **All Channels** category is at the top of the category list. This category is sorted by channel number and allows you to browse all available channels.

Selecting a channel



Channel search

- ▶ Turn  or slide  the COMAND controller while the display/selection window in the SatRadio display is active. COMAND searches in both directions (ascending and descending) and stops at the next channel found in the selected category.

Using the multifunction steering wheel

- ▶ Press  or  to select the **Audio** menu.
- ▶ Press and hold  or .

SatRadio menu



- ▶ Select **Sat. Radio** in the submenu bar by turning  the COMAND controller and press  to confirm. The SatRadio menu appears.

Entering channel numbers directly

Option 1





- ▶ Press the  button. An input menu appears.

Option 2

- ▶ Select **Sat. Radio** in the submenu bar by turning  the COMAND controller and press  to confirm.
- ▶ Select **Enter Channel** and press  to confirm. An input menu appears.
- ▶ **To enter a channel:** irrespective of the option, press the corresponding number keys on the control panel one after the other. COMAND sets the selected channel.





-  You can only select currently permitted digits.



Selecting a channel from the SatRadio channel list

- ▶ Select **Sat. Radio** in the submenu bar by turning  the COMAND controller and press  to confirm.
- ▶ Select **Channel List** and press  to confirm. The channel list appears.
- ▶ Select a channel by turning  the COMAND controller and press  to confirm.

Memory functions

Storing channels

-  There are ten presets available.
- ▶ Press  the COMAND controller when the display/selection window is active. or
- ▶ Select **Presets** in the submenu bar by turning  the COMAND controller and press  to confirm. In both cases, the channel presets appear. The  dot in front of a preset position indicates that the currently selected channel is stored there.









- ▶ Select a preset by turning  the COMAND controller and press and hold  until you hear a tone.

or





- ▶ Press and hold a number button, e.g. **4**, until you hear a tone.
The channel is stored under the preset.

Storing channels automatically

This function automatically stores channels with adequate reception in the preset memory. Channels stored manually in the preset memory will be overwritten.

- ▶ **Option 1:** press  the COMAND controller when the display/selection window is active.
- ▶ Select **Autostore** in the presets by turning  the COMAND controller and press  to confirm.
- ▶ **Option 2:** select **Presets** in the submenu bar by sliding  and turning  the COMAND controller and press  to confirm.
- ▶ Select **Autostore** and press  to confirm.
In both cases, COMAND searches for channels that can be received. You will see a message to this effect. The available channels are automatically stored in the preset positions.
- ▶ **To cancel storing:** select **Cancel** and press  to confirm.

Selecting a channel from the preset list

- ▶ **To call up the channel list:** select **Presets** by turning  the COMAND controller and press  to confirm.
The channel preset list appears.
- ▶ **To set a channel:** select a preset by turning  the COMAND controller and press  to confirm.



or

- ▶ Press a number key, e.g. **4**.

Using the multifunction steering wheel





- ▶ Press  or  to select the **Audio** menu.
- ▶ Press  or  briefly.

Displaying information

- ▶ Select **Info** in the submenu bar by turning  the COMAND controller and press  to confirm.
Information on the currently received program is displayed.
- ▶ **To return to the SatRadio main display:** slide  the COMAND controller.

Displaying service information

The provider's customer service center is available by phone at any time to answer any general questions or questions on the versions available.

- ▶ Select **Sat. Radio** in the submenu bar by turning  the COMAND controller and press  to confirm.
- ▶ Select **Service** and press  to confirm.
The provider's details appear.
- ▶ **To return to the SatRadio main display:** slide  the COMAND controller.

Channel list updates

When receiving a new channel list, the display shows the **Updating channel...** message. The station last selected is switched to mute until the update has been completed. Satellite radio mode is not available during this process.

Once the update has been completed, the satellite radio main menu appears. The station last selected is played.

Sound settings

You will find details on the sound settings in the "At a glance" section (> page 128).

CD/audio DVD and MP3 mode

Important safety notes

WARNING

COMAND is classified as a Class 1 laser product. You must not open the casing. If you open the casing, or if the casing is faulty or damaged, there is a risk of exposure to invisible laser radiation. This may damage your eyes, or those of others.

COMAND does not contain any parts that can be serviced by the user. For safety reasons, all maintenance work must be carried out by qualified aftersales technicians.

WARNING

Only when the vehicle is stationary should you:

- load a disc
- eject a disc

There is a risk of being distracted from the road and traffic conditions if this is done while the vehicle is in motion.

Inserting/ejecting CDs/DVDs





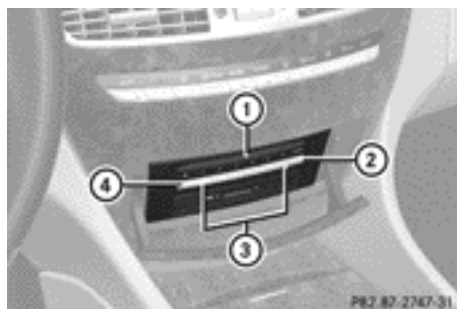

DVD changer

The DVD changer has a fixed magazine with six trays.







Magazine tray status :

- Indicator lamp off: magazine tray is empty.
- Indicator lamp constantly lit: magazine tray is loaded.

- ▶ **To load a single magazine tray:** press respective button .
- ▶ Remove any CD/DVD which may be in slot .
- ▶ Wait until the indicator lamp for button  which has been pressed flashes quickly.
- ▶ Insert the CD/DVD to be loaded into slot .
- If the CD/DVD has been inserted properly and it is a permissible type, the last CD/DVD loaded will be played.
- ▶ **To load all six magazine trays:** press button .
- The DVD changer checks the load status of all magazine trays and switches to the first empty tray.
- ▶ Wait until the indicator lamp for the respective button flashes quickly.
- ▶ Insert a disc into slot .
- The DVD changer switches to the next empty magazine tray.
- ▶ Repeat the last two steps until all trays are loaded.
- If the CD/DVD has been inserted properly and it is a permissible type, the last CD/DVD loaded will be played.

 If you remove one disc while playing another disc, the DVD changer interrupts playback. Playback continues once the disc has been removed.

- ▶ **To remove a disc:** press respective button .
- ▶ Remove the CD/DVD from slot .
- If the CD/DVD is not removed from slot , it will be automatically drawn in again after a short while.
- ▶ **To remove all discs:** press button .
- The DVD changer ejects the CD/DVD from the tray currently in use.

- ▶ Remove the CD/DVD from slot ①.
The DVD changer switches to the next loaded magazine tray and ejects the CD/DVD.
- ▶ Repeat the last step until the magazine is empty.

Loading and removing SD cards

i Not all SD memory cards are designed for the temperatures which may be reached in the vehicle.

Due to the wide range of SD cards available on the market, Mercedes-Benz cannot guarantee playback for all brands of SD memory card.



- ▶ **To load an SD card:** press the SD card into slot ①. The tapered side must point towards the right.
If the SD card contains MP3 tracks, COMAND will play them back.
- ▶ **To remove the SD card:** press the SD card into slot ① as far as it will go and then release it again.
- ▶ Pull out the card.

Activating audio CD/DVD or MP3 mode



Option 1

- ▶ Insert a CD/DVD (▷ page 209) or an SD card (▷ page 210) or connect a USB device (▷ page 222).
COMAND loads the medium inserted and starts to play it.





Option 2

- ▶ Press the  function button once or twice.
- ▶ Select an audio medium from the media list (▷ page 212).

Option 3

- ▶ Select **Audio** in the main function bar by sliding  and turning  the COMAND controller and press  to confirm.
The last active audio source is now activated.

If another audio source is switched on, you can now switch to disc mode in the audio menu.

- ▶ Select **Audio** by sliding  and turning  the COMAND controller and press  to confirm.
The audio menu appears.
- ▶ Select **Disc, Memory Card, MUSIC REGISTER, Media Interface** or **USB** and press  to confirm.
This switches to the desired audio source.
- ▶ Select an audio medium from the media list (▷ page 212).

Example display: audio CD mode

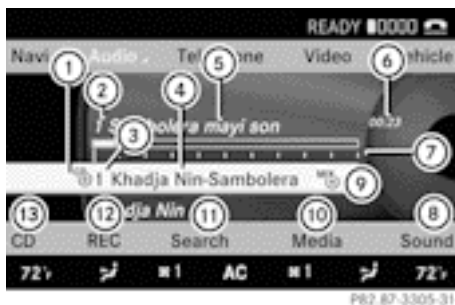

- ① Disc type
- ② Track number
- ③ Disc number
- ④ Disc name (only if stored on the disc)
- ⑤ Track name (only if stored on the disc)
- ⑥ Track time

- ⑦ Graphic time and track display
- ⑧ Sound settings
- ⑨ Current playback option
- ⑩ Media selection
- ⑪ Music search
- ⑫ Recording (saving) music
- ⑬ CD functions

Example display: audio DVD mode

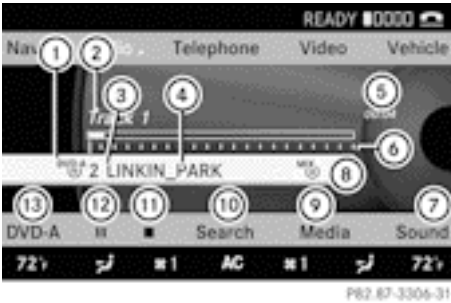

- ① Disc type
- ② Track name
- ③ Disc number
- ④ Disc name (only if stored on the disc)
- ⑤ Track time
- ⑥ Graphic time and track display
- ⑦ Sound settings
- ⑧ Current playback option
- ⑨ Media selection
- ⑩ Music search
- ⑪ Stop function
- ⑫ Pause function
- ⑬ Audio DVD mode

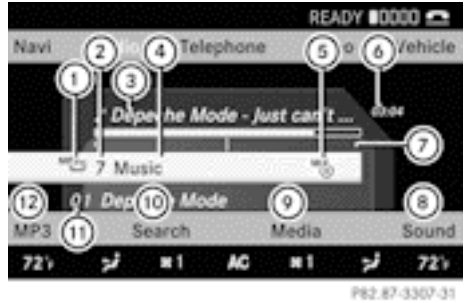

Example display: MP3 mode



- ① Disc type
- ② Disc number
- ③ File or track name (ID3 tags)
- ④ Disc or directory name
- ⑤ Current playback option
- ⑥ Track time
- ⑦ Graphic time and track display
- ⑧ Sound settings
- ⑨ Media selection
- ⑩ Music search
- ⑪ Artist (ID3 tags)
- ⑫ MP3 functions





Pause function

In audio CD/DVD and MP3 mode



- ▶ **To pause playback:** briefly press the  button on the multifunction steering wheel.
- ▶ **To continue playback:** briefly press the  button on the multifunction steering wheel again.

Only in audio DVD mode

► **To pause playback:** switch on audio DVD mode (▷ page 210).

► Select  by sliding  and turning  the COMAND controller and press  to confirm.

The  display changes to .





► **To continue playback:** select  and press  to confirm.



Playback continues from the point where it was interrupted. The  display changes to .



Stop function

This function is only available in audio DVD mode.



► Switch on audio DVD mode (▷ page 210).

► **To interrupt playback:** select  by sliding  and turning  the COMAND controller and press  to confirm.



The  display changes to .  remains highlighted.

► **To continue playback:** select  and press  to confirm.



Playback continues from the point where it was interrupted.

► **To stop playback:** while playback is interrupted, select  again and press  to confirm.

or

► Select  and confirm by pressing  twice in rapid succession.



 is highlighted.

► **To restart playback:** select  and press  to confirm.

Playback starts at the beginning of the DVD.

Selecting CD/audio DVD/MP3 discs

Selecting via the media list

► **In CD/audio DVD and MP3 mode:** select **Media** by sliding  or turning  the COMAND controller and press  to confirm.

The media list appears. The  dot indicates the currently selected medium.

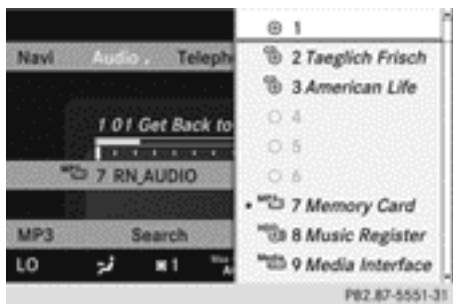

Media list

The media list shows the discs currently available.

Media list (when equipped with a DVD changer)

Magazine trays, positions 1 to 6: readable data media are audio CDs, MP3 CDs or MP3 DVDs, audio DVDs and video DVDs.

Memory card, position 7

MUSIC REGISTER, position 8

Media Interface, position 9

USB, position 10

 If a disc cannot be read, an entry appears after the display in the magazine tray.

Equipped with a single DVD drive

DVD drive, position 1: readable data media are audio CDs, MP3 CDs or MP3 DVDs, audio DVDs and video DVDs.

Memory card, position 2

MUSIC REGISTER, position 3

Media Interface, position 4

USB, position 5

- ▶ Select the data medium by turning the COMAND controller and press to confirm.

i If you select a video DVD, the system switches to video DVD mode (▷ page 229).

Selecting a track using the number keypad

- ▶ Press a number button, e.g. , when the display/selection window is active. The medium at the corresponding position in the media list is loaded and then played.

Selects a track

Selecting by skipping to a track

- ▶ **To skip forwards or back to a track:** slide or turn the COMAND controller when the display/selection window is active.

The skip forward function skips to the next track.

Skipping backwards restarts the current track (if it has been playing for more than 8 seconds) or starts the previous track (if the current track has only been playing for a shorter time).

If you activate the **Medium Mix** or **Track List Mix** playback option (MP3 mode only), the track order is random.

- ▶ **On the multifunction steering wheel:** switch COMAND to audio CD, audio DVD or MP3 mode (▷ page 210).
- ▶ Press or to select the **Audio** menu.
- ▶ Press the or button on the multifunction steering wheel.

Selecting by track list

- ▶ In audio mode, select **Search** by sliding or turning the COMAND controller and press to confirm.

- ▶ Select **Current Track List**.

or

- ▶ Press the COMAND controller in audio mode when the display/selection window is active.

- ▶ Select **Current Track List** by turning the COMAND controller and press to confirm.

- ▶ Select the track by turning and press to confirm.

i In MP3 mode, the list shows all the tracks in alphabetical order.

- ▶ **On the multifunction steering wheel:** switch COMAND to audio CD, audio DVD or MP3 mode (▷ page 210).

- ▶ Press or to select the **Audio** menu.

- ▶ Press and hold the or button until the desired track has been reached.

If you hold down or , the system runs through the list more quickly. Not all audio drives or data carriers support this function.

If track information is stored on the audio drive or data storage device, the multifunction display shows the number and name of the track.

Selecting a track using the number keypad

- ▶ Press the button on the number keypad.

A numerical entry field appears. The number of positions offered corresponds to the number of tracks on the CD/DVD. Only numbers that correspond to a track number on the CD/DVD can be entered.

- ▶ Enter the desired track number using the number keys.

Fast forward/rewind

- ▶ While the display/selection window is active, slide ◀Ⓞ▶ and hold the COMAND controller until the desired position has been reached.

Music search

You can use the following characteristics to search music:

- Keyword search
- Playlist
- Artists
- Albums
- Tracks
- Genres
- Year

- ▶ In audio mode, select **Search** by sliding Ⓞ↕ or turning ⓄⓄ the COMAND controller and press Ⓞ to confirm. A selection list appears.
- ▶ Select the desired characteristic by sliding Ⓞ↕ and turning ⓄⓄ the COMAND controller and press Ⓞ to confirm.

For the search, the media inserted is scanned and the music track data is stored in a COMAND database. A medium that has already been scanned is not scanned again if another search is carried out. The scanning process may take some time for media with a large capacity. The search can be carried out after the scanning process is finished.

Selecting a folder

This function is only available in MP3 mode.

- ▶ Switch on MP3 mode (▷ page 210).
- ▶ Select **Search** by sliding Ⓞ↕ and turning ⓄⓄ the COMAND controller and press Ⓞ to confirm.
- ▶ Select **Folder** by sliding Ⓞ↕ and turning ⓄⓄ the COMAND controller and press Ⓞ to confirm. You will see the tracks in the folder.



- ▶ Select a track by turning ⓄⓄ and press Ⓞ to confirm. The track is played and the corresponding folder is now the active folder.











Copying music files from audio CDs to the hard disk

Audio files can be copied from CD to COMAND's hard disk.

- ▶ Select **Audio** by sliding Ⓞ↕ and turning ⓄⓄ the COMAND controller and press Ⓞ to confirm.
- ▶ Switch on CD/audio DVD or MP3 mode (▷ page 210).
- ▶ Select a medium (▷ page 212). The audio CD is played.
- ▶ **To copy all music tracks:** select **REC** by sliding Ⓞ↕ and turning ⓄⓄ and confirm with Ⓞ.



- ① Audio source
- ② Destination
- ③ Total length of all tracks from the audio source

- ④ Title selection
 - ⑤ To start the copying process
 - ⑥ Name of the copied data
 - ⑦ Cancel procedure without copying files
 - ⑧ Media position in the media list
- ▶ Select **START** by sliding  and turning  and confirm with .
 - All music tracks from the audio CD are copied to COMAND's MUSIC REGISTER as MP3 files.
 - ▶ **To copy individual music tracks:** select **Track Select.** by sliding  and turning  and confirm with .
 - The track list appears.
 - ▶ Select individual tracks by turning  and confirm with .
 - ▶ Select **START** by turning  and confirm with .
 - The selected music tracks from the audio CD are copied to COMAND's MUSIC REGISTER as MP3 files.

If the audio CD contains CD text or Gracenote® data, this will be used for naming when the tracks are copied. The data is then copied to the MUSIC REGISTER in the following structure: artist/album/track. The copied titles can then be selected and played using the music search in the MUSIC REGISTER.

- ▶ **To delete music files:**(▶ page 221).

Gracenote Media Database

Introduction

This function is only available in audio CD mode.

There is a version of the music recognition software from Gracenote®, Emeryville, California, USA on the hard disk. You will recognize this by the logo which can be seen in the bottom right-hand corner of certain audio displays.

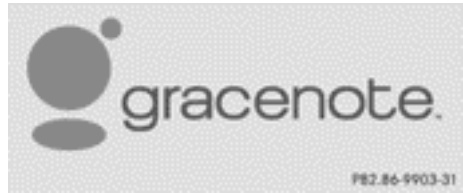

Many audio CDs contain CD text. COMAND uses the information contained therein to display the artist, album and track name.

If the audio CD does not contain any CD text information, COMAND can use the Gracenote Media Database to identify unknown audio tracks when running in audio CD mode. This is only possible if the relevant information is saved in the Gracenote Media Database and if the "Gracenote Media Database" function is activated.

If this is the case, COMAND will display the corresponding data such as artist, album and track name in the relevant displays and lists. If COMAND accesses the Gracenote Media Database when reading an audio CD, you will see the following message:



Selecting Gracenote® data to be displayed

If the inserted CD does not contain any Gracenote® data, the **Gracenote Media Database** menu item is shown in gray and cannot be selected.

- ▶ Switch on audio CD mode (▷ page 210).
- ▶ Select **CD** by sliding and turning the COMAND controller and press to confirm.
- ▶ Select **Gracenote Media Database** by turning the COMAND controller and press to confirm.
Switch the function on or off .

Updating Gracenote® music recognition technology and the Gracenote Media Database

The digital data on the Gracenote Media Database becomes obsolete due to the release of new CDs. Optimum functionality can only be attained with up-to-date Gracenote® music recognition technology. Information about new versions can be obtained from an authorized Mercedes-Benz Center.

You can have your music recognition software updated there with a DVD, or you can update it yourself.

- i** The Gracenote Media Database is updated in conjunction with the navigation system's digital map (▷ page 176).

Setting the audio format

You can only set the audio format in audio DVD mode. The number of audio formats available depends on the DVD. The content of an audio DVD is called an "album", and this can be divided into up to nine groups. A group can contain music in different sound qualities (stereo and multichannel formats, for example), or bonus tracks. Each group can contain up to 99 tracks. If an audio DVD only contains one audio format, the "Group" menu item(s) cannot be selected.

- ▶ Switch on audio DVD mode (▷ page 210).
- ▶ Select **DVD-A** by sliding and turning the COMAND controller and press to confirm.

- ▶ Select **Group** by turning and press to confirm.
The list of available groups appears. The
 - dot indicates the group currently selected.
- ▶ **To exit the menu:** slide the COMAND controller or press the button.

Playback options

The following options are available to you:

- **Normal Track Sequence**
The tracks are played in the normal order (e.g. track 1, 2, 3, etc.).
In MP3 mode, the track order is determined by the order in which the tracks are written to the MP3 data carrier when it is created. Alphabetical order is the most common. Once all the tracks in a folder have been played, the tracks in the next folder are played.
- **Medium Mix**
All the tracks on the medium are played in random order (e.g. track 3, 8, 5 etc.).
- **Track List Mix** (MP3 mode only)
All the tracks that are listed in the current track list are played in random order.
- ▶ **To select options:** switch on audio CD/DVD or MP3 mode (▷ page 210).
- ▶ Select **CD**, **DVD-A** or **MP3** by sliding and turning the COMAND controller and press to confirm.
The options list appears. The • dot indicates the option selected.
- ▶ Select an option by turning and press to confirm.
The option is switched on. For all options except "Normal track sequence", you will see a corresponding display in the display/selection window. See the example of the display in audio CD mode (▷ page 210).
- i** The "Normal track sequence" option is automatically selected when you change the medium you are currently listening to

or when you select a different medium. If an option is selected, it remains selected after COMAND is switched on or off.

Notes on MP3 mode

Permissible discs

- CD-R and CD-RW
- DVD+R and DVD+RW
- DVD-R and DVD-RW
- SD memory card:
- USB stick
- iPod®
- MP3 player

Permissible file systems

- ISO 9660/Joliet standard for CDs
- UDF for audio and video DVDs
- FAT 16 or FAT32 for storage media

Multisession CDs

For multisession CDs, the content of the first session determines how COMAND will process the CD. COMAND plays only one session and gives priority to the audio CD session.

If possible, use COMAND to play only CDs which have been written in one session.

File structure of a data carrier

When you create a disc with compressed music files, the tracks can be organized in folders. A folder may also contain subfolders. A disc can contain a maximum of 255 folders. Each folder can contain a maximum of 255 tracks and 255 subfolders.

The disc may contain no more than eight directory levels. Files beyond the eighth level will not be recognized by the system.

Track and file names

When you create a disc with compressed music files, you can assign names to the tracks and folders.

COMAND uses these names accordingly for the display. Folders which contain data other

than MP3 or WMA tracks are not displayed by COMAND.

If MP3 or WMA files are stored in the root directory itself, the root directory will also be treated as a folder. COMAND will then show the name of the root directory as the folder name.

You must observe the following when assigning track names:

- track names must have at least 1 character.
- track names must have the extension "mp3" or "wma".
- there must be a full stop between the track name and the extension.

Example of a correct track name:
"Track 1.mp3".

i COMAND does not support ID3 tags.

Permissible formats

COMAND supports the following formats:

- Microsoft Windows Media Audio V2, V7, V8 and V9 (WMA)

Permissible bit and sampling rates

COMAND supports **MP3** files of the following types:

- fixed and variable bit rates from 32 kbit/s to 320 kbit/s
- sampling rates of 8 kHz to 48 kHz

COMAND supports **WMA** files of the following types:

- fixed bit rates from 5 kbit/s to 384 kbit/s
- sampling rates of 8 kHz to 48 kHz

COMAND does **not** support **WMA** files of the following types:

- DRM (Digital Rights Management) encrypted files

i Only use tracks with a bit rate of at least 128 kbit/s and a sampling rate of at least 44.1 kHz. Lower rates can cause a noticeable deterioration in quality. This is especially the case if you have activated a surround sound function.

Notes on copyright

MP3 or WMA tracks that you create or play back are generally subject to copyright protection in accordance with the applicable international and national regulations.

In many countries, reproductions, even for private use, are not permitted without the prior consent of the copyright holder.

Make sure that you know about the applicable copyright regulations and that you comply with these.

If you own these rights yourself, e.g. for your own compositions and recordings, or if the copyright holder has granted you permission, these restrictions do not apply.

Notes on CDs/DVDs

Discs with copy protection are not compatible with the audio CD standard and therefore may not be able to be played by COMAND.

There may be playback problems when playing copied discs. There is a wide range of data carriers, disc-writing software and writers available. This variety means that there is no guarantee that the system will be able to play discs that you have copied yourself.

There may be playback problems if you play CDs that you have copied yourself with a storage capacity of more than 700 MB. CDs of this type do not conform to the currently applicable standards.

i On many DVD audio discs, the last track does not contain any music and COMAND then switches to the next disc. This is normal system behavior and does not mean that there is a malfunction.

! Do not affix stickers or labels to the discs. They could peel off and damage the drive. The drive is designed to hold discs which comply with the EN 60908 standard. Therefore, you can only use discs with a maximum thickness of 1.3 mm.

If you insert thicker discs, e.g. those that contain data on both sides (DVD on one side and audio data on the other), they cannot be ejected and can damage the drive.

Do not use discs with a diameter of 8 cm, even with an adapter. Only use round discs with a diameter of 12 cm.

i COMAND is able to play back audio CDs in multichannel audio format.





MUSIC REGISTER

General notes

You can store music files in MP3 or WMA format in the MUSIC REGISTER. The memory has a capacity of approximately 7 GB.

! Retain the original music files in a secure location. An error in COMAND might result in the loss of the music files stored in the MUSIC REGISTER. Mercedes-Benz is not liable for any loss of data.

Switching to MUSIC REGISTER

- ▶ Select **Audio** in the main function bar by sliding  and turning  the COMAND controller and press  to confirm. If MUSIC REGISTER was the last mode selected, it is now switched on. If another audio source is switched on, you can now switch on the MUSIC REGISTER in the audio menu.
- ▶ Select **Music Register** and press  to confirm.



Example display: MUSIC REGISTER

- ① Type of data carrier: MUSIC REGISTER
- ② Track number
- ③ Track name
- ④ Track time
- ⑤ Graphic time and track display
- ⑥ Current playback settings (no symbol for "Normal track sequence")
- ⑦ Sound settings
- ⑧ Media selection
- ⑨ Current folder
- ⑩ Search functions
- ⑪ Data carrier position in the media list
- ⑫ To call up the MUSIC REGISTER menu

Copying music data to the MUSIC REGISTER

Introduction

You can copy music files from discs in the DVD changer, the single DVD drive, the memory card or the COMAND USB, as long as they are in MP3 and/or WMA formats.

i While copying, several functions will not be available. If this is the case, you will see a message to this effect.

1. Selecting a data medium

- ▶ Select **Audio** by sliding $\uparrow \odot$ and turning $\{\odot\}$ the COMAND controller and press \odot to confirm.
The audio menu appears.

- ▶ Select **Music Register** and press \odot to confirm.
- ▶ Select **Copy Music Files** and press \odot to confirm.



- ① Data medium selected
- ▶ **To select a disc:** slide $\uparrow \odot \downarrow$ or turn $\{\odot\}$ and press \odot to confirm.
The data medium is loaded.

2. Selecting music files

- ▶ Select **All Music Files**.
This function copies all music files on the selected data carrier. The symbol in front of **All Music Files** is filled in.
- ▶ Select **Continue**.
The copying menu appears.

Folders can also be selected individually.

- ▶ **To select individual folders:** select the corresponding folder by sliding $\uparrow \odot \downarrow$ or turning $\{\odot\}$ and press \odot to confirm.
A tick in front of the entry highlights the selection.

3. Starting the copying process

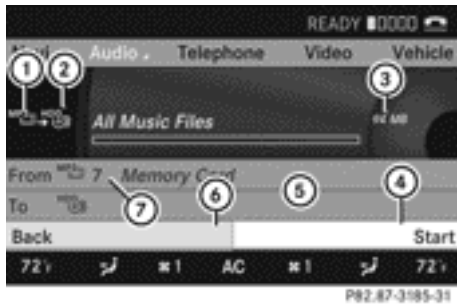

- ① To copy from a memory card
- ② To copy to the MUSIC REGISTER
- ③ Memory requirement, see "Calling up memory space info" (> page 220)
- ④ To start the copying process
- ⑤ Name of the data carrier from which data is being copied and storage location
- ⑥ To cancel copying of music files
- ⑦ Data carrier position in the media list

- ▶ Select **Start** and press to confirm. Copying begins. The progress bar indicates the status of the copying procedure.
- ▶ **To exit without copying files:** select **Back** and press to confirm.

! Under no circumstances should you remove the memory card while you are copying data from it. This will generate unusable data in the MUSIC REGISTER.



- ① Progress bar

i It may take some time for the copying process to be completed, depending on the

amount of data. The time required may vary depending on the data source. If there is not enough memory space, you will see a message to this effect.

- ▶ **To cancel copying:** select **Cancel**. Music files are stored in the MUSIC REGISTER up until the point of cancellation.

Deleting all music files

This function deletes all music files from the MUSIC REGISTER.

! The deletion procedure may take several minutes. In order to prevent malfunctions, do not use COMAND during this period.

- ▶ Select **Music Register** by sliding and turning the COMAND controller and press to confirm.

- ▶ Select **Delete All Music Files** and press to confirm.

A query appears. **No** is highlighted.

If you select **Yes**, all music files are deleted. You see the **Please wait...** message. Then, you see the **Deletion successful** message.

If you select **No**, the process will be aborted.

Calling up memory space info

- ▶ Select **Music Register** by sliding and turning the COMAND controller and press to confirm.

- ▶ Select **Memory Information** and press to confirm.

The following is displayed:

- storage capacity
- available memory
- occupied memory
- content (folders, tracks)

Folder functions

Introduction

You can view the content of the MUSIC REGISTER, change folder or track names and delete individual folders or tracks.

Calling up a folder

- ▶ Select **Search** by sliding $\odot \downarrow$ and turning $\{\odot\}$ the COMAND controller and press \odot to confirm.
- ▶ Select **Folder** and press \odot to confirm.
You see the contents of the current folder.
- ▶ **To switch to the superordinate folder:** select the \uparrow icon and press \odot to confirm.
The display changes to the next folder up.

Changing the folder/track name



- ① Folder selection symbol
 - ② Icon for music file
 - ③ Current folder
- ▶ Select **Music Register** by sliding $\odot \downarrow$ and turning $\{\odot\}$ the COMAND controller and press \odot to confirm.
 - ▶ Select **Rename/Delete Files** by sliding $\odot \rightarrow$ the COMAND controller and press \odot to confirm.
 - ▶ Select a folder/track by turning $\{\odot\}$.
 - ▶ Select **Options** by sliding $\odot \rightarrow$ and press \odot to confirm.
 - ▶ Select **Edit** and press \odot to confirm.

- ▶ Enter a name for the folder/track.
- ▶ **To save the changes:** select **ok** and press \odot to confirm.

Deleting folders/tracks

- ▶ Select **Rename/Delete Files** by sliding $\odot \downarrow$ and turning $\{\odot\}$ the COMAND controller and press \odot to confirm.
- ▶ Select the folder/track by turning $\{\odot\}$.
- ▶ Select **Options** by sliding $\odot \rightarrow$ and press \odot to confirm.
- ▶ Select **Delete** and press \odot to confirm.
A query appears. **No** is highlighted.
If you select **Yes**, the folders/tracks are deleted. You see the **Please wait...** message. Then, you see the **Deletion Successful** message.
If you select **No**, the process will be aborted.

Playback options

The following options are available:

- **Normal Track Sequence**
The tracks are played in the normal order (e.g. track 1, 2, 3, etc.).
- **Medium Mix**
All the tracks on the medium are played in random order.
- **Track List Mix** (MP3 mode only)
All the tracks that are listed in the current track list are played in random order.
- ▶ **To select options:** switch on the MUSIC REGISTER (\triangleright page 218).
- ▶ Select **Music Register** by sliding $\odot \downarrow$ and turning $\{\odot\}$ the COMAND controller and press \odot to confirm.
The options list appears. The \bullet dot indicates the option selected.
- ▶ Select an option and press \odot to confirm.
The option is switched on. All options except **Normal Track Sequence** will be indicated by a corresponding icon in the display/selection window.

i The **Normal Track Sequence** option is automatically selected when you change the disc you are currently listening to or when you select a different medium. If an option is selected, it remains selected after COMAND is switched on or off.

Media Interface mode

Connection options

Overview

You will find the connection sockets in the glove box.

Device-specific adapter cables are required to connect external devices to the Media Interface. These cables are included in the Media Interface scope of delivery.

i Store individual parts in a safe place.
Only use genuine Mercedes-Benz connection cables.

You can connect the following data carriers to COMAND via the Media Interface:

- iPod®
- USB devices (USB sticks, USB hard drives, MP3 players)

i iPod® is a registered trademark of Apple Inc., Cupertino, California, USA.

Supported iPod® variants

The following are examples of supported iPod® variants:

- iPod® nano
- iPod® classic
- iPod® touch
- iPhone®

Supported USB devices

The following USB devices are supported:

- USB sticks (flash memory)
- USB hard drives requiring a startup/permanent current of a maximum of

800 mA (it may be necessary to connect a separate power supply)

- certain MP3 players

i The Media Interface supports USB storage media of "USB Device Subclass 6". Information concerning USB Device Subclass 6 is available from the equipment manufacturer.

For details and a list of supported devices, visit <http://www.mbusa-mobile.com>. Or call the Mercedes-Benz Customer Assistance Center at 1-800-FOR-MERcedes(1-800-367-6372) (for the USA) or Customer Relations at 1-800-387-0100 (for Canada).

Connecting an external device

i Do not leave external devices in the vehicle as extreme temperatures (e.g. direct sunlight or extremely low outside temperatures) could cause them to malfunction (see the operating instructions for the respective device). Mercedes-Benz USA, LLC accepts no liability for damage to external devices.

Never connect more than one device at a time. You will otherwise not be able to operate the external device.

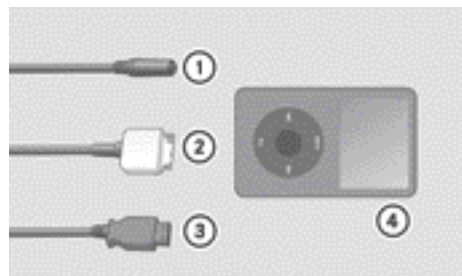

P82 60-6736-31

- ① 4-pin jack for 1/8 inch jack plug, e.g. for MP3 player (audio and video)
- ② iPod® plug
- ③ USB socket
- ④ Example of device, iPod®

- ▶ Connect the external device with suitable socket ①, ② or ③.
COMAND activates the device automatically for sockets ② and ③.
COMAND does not activate the device automatically for socket ①.



If you remove a device from sockets ② and ③, the **No device connected** message appears.

- ❗ A connected iPod® or MP3 player should not be simultaneously operated via the Media Interface and the remote control (e.g. Bluetooth® remote control), as this may produce unpredictable results.
- ❗ Connecting a fully discharged iPod® or MP3 player can result in an extended initialization period.

Error messages appear while the device is being activated if:

- COMAND does not support the device connected.
- two devices are connected.
- the connected device consumes too much power.
- the Media Interface connection is faulty.
- ❗ Consult an authorized Mercedes-Benz Center if required.

Switching to Media Interface mode

General notes

In extreme cases, starting up individual functions can take up to several minutes – this depends on the external device and its content (e.g. video podcasts).

Only use the original software to save files on iPods or MP3 players. Otherwise, some or all functions may not be available.

Option 1

- ▶ Connect an external device (▷ page 222). COMAND activates the device. Following this, the basic display appears if there are any playable files on the data carrier.

or

- ▶ Select **Audio** in the main function bar by sliding $\uparrow \odot$ and turning $\left\{ \odot \right\}$ the COMAND controller and press \odot to confirm.
If you had previously selected Media Interface mode, this will now be activated.
If another audio source is switched on, you can now switch to Media Interface mode in the audio menu.
- ▶ Select **Audio** by sliding $\uparrow \odot$ and turning $\left\{ \odot \right\}$ the COMAND controller and press \odot to confirm.
The audio menu appears.
- ▶ Select **Media Interface** and press \odot to confirm.

Option 2

- ▶ Select **Audio** by sliding $\uparrow \odot$ and turning $\left\{ \odot \right\}$ the COMAND controller and press \odot to confirm.
The audio menu appears.
- ▶ Select **Media Interface** and press \odot to confirm.

Option 3

- ▶ In the media list, (▷ page 212) turn $\left\{ \odot \right\}$ the COMAND controller to select the entry

under the corresponding position and press  to confirm.

COMAND activates the connected device. You will see a message to this effect. The basic display then appears.

If no device is connected, you will see the [Media Interface](#) entry instead of a device name.

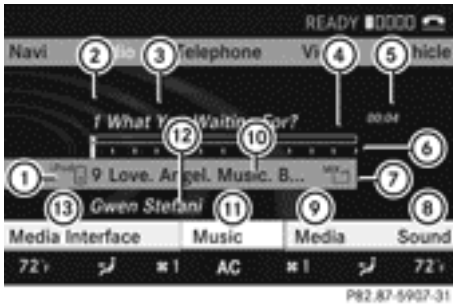

Example display: iPod mode

- ① Data medium type
- ② Track number
- ③ Track name
- ④ Graphic time display
- ⑤ Track time
- ⑥ Graphic track display
- ⑦ Current playback settings (no symbol for "Normal track sequence")
- ⑧ Sound settings
- ⑨ Media list
- ⑩ Album name (if available)
- ⑪ Categories, playlists and/or folders
- ⑫ Artist (if available)
- ⑬ Playback options

Type of device ① connected is indicated by the corresponding symbol for iPod, MP3 player or USB mass storage device.

- i** If the device connected does not contain any playable tracks, a message appears to this effect.

Selecting music files





Note

COMAND displays the data stored on the iPod®, MP3 player or USB mass storage device according to the filing structure used in the respective medium.



Selecting by skipping to a track

- ▶ **To skip forwards or back to a track:** turn  the COMAND controller when the display/selection window is active.

The skip forward function skips to the next track. The skip back function skips to the beginning of the current track if the track has been playing for more than eight seconds. If the track has been playing for less than eight seconds, it skips to the start of the previous track. If you have selected a playback option other than [Normal Track Sequence](#), the track sequence is random.

- ▶ **On the multifunction steering wheel:** switch on Media Interface mode (▷ page 222).
- ▶ On the multifunction steering wheel, press the  or  button to select the [Audio](#) menu.
- ▶ On the multifunction steering wheel, press  or  to select a track.

Selecting using the number keypad

- ▶ **To make an entry:** press the  button. An input menu appears. The number of characters available for input depends on the number of tracks that can currently be selected.
- ▶ **To enter a track number:** press a number key, e.g. . The digit is entered in the first position in the input line.

- i** COMAND will ignore and not display an invalid digit.

- ▶ Enter more numbers if desired. The selected track is played.

Fast forward/rewind

▶ While the display/selection window is active, slide and hold the COMAND controller until the desired position has been reached.

i On an iPod®, fast rewind only functions within the current track.

Selecting a category/playlist/folder

iPod® and certain MP3 players

For an iPod® or MP3 player, you can select tracks using categories or folders.

Depending on the device connected, the following categories may be available, for example:

- **Current tracklist**
- **Playlists** (e.g. **All**)
- **Artists**
- **Albums**
- **Tracks**
- **Podcasts**
- **Genres**
- **Composers**
- **Audiobooks**

i Some playback categories contain the entry **All**. If this entry has been selected, the entire content of the category selected will be played.

USB devices

For USB mass storage devices, you can select both folders as well as any existing playlists. COMAND can also display the album name and artist (metadata) during playback, if this information has been entered into the system.

Playlists are indicated in the display by a special icon. When you open the playlist, the corresponding tracks are displayed and playback begins once a track is selected. You can now select **Category Mix** instead of **Random Folder** as a playback option.

For USB mass storage devices, you can choose to display the metadata contained in the tags of the encoded music data, or to display the file and directory names during playback.

▶ **To display the album and artist name:** select **Media Interface** in the basic display by sliding and turning the COMAND controller and press to confirm.

▶ Select **Display Metadata** and press to confirm.

Selecting a category and opening a folder

▶ Press the COMAND controller when the display/selection window is active.

▶ Select **Folder** by sliding and turning the COMAND controller and press to confirm.

You will see the available categories or the folder content (e.g. other folders). The display's status bar shows the selected category or the folder name.

i The **Music** menu item is not available until the device has been activated.

▶ Select the category/folder by turning the COMAND controller and press to confirm.

You will see the content of the selected category or selected folder.

i If the data needs to be read from the connected device, the **Please wait...** message appears.

▶ If necessary, repeat this step until the tracks in the desired folder/album appear.



▶ Select the track by turning the COMAND controller and press to confirm.

The track is played.

▶ **To select one folder higher:** select the icon and confirm with .

i The icon is always shown at the top of the respective folder.



Playing back the contents of a category or folder

- ▶ Select the category or folder by turning  the COMAND controller.
- ▶ Press  the COMAND controller for longer than two seconds.
The content of the category or folder selected is played in accordance with the playback option (▶ page 226) selected.

Alphabetical track selection

iPod® and MP3 players

This function is available for alphabetically sorted categories and folders. This function is not available for albums or playlists, for example.

- ▶ Select a category, e.g. **Artists**, by turning  the COMAND controller and press  to confirm.
The available artists are displayed.
- ▶ Press the corresponding number key once or several times to select the first letter of the artist's name (e.g. for an artist beginning with the letter "C", press number key  three times).
The available letters are listed at the lower edge of the display.
After a message, the first entry in the list which matches the letter entered is highlighted.
- i** If no corresponding entry exists, the last entry corresponding to a previous letter is highlighted instead.
- i** For iPods® and MP3 players, the quality of the search results is highly dependent on the version and language variant of the software (e.g. iTunes® version) used to populate the device.





USB mass storage device

This function is available for alphabetically sorted directories. This function is not available for albums or playlists, for example.

- ▶ In a directory, press the corresponding number key once or several times to select the first letter of the artist's name (e.g. for an artist beginning with the letter "C", press number key  three times).
The available letters are listed at the lower edge of the display.
If the directory only contains folders, COMAND searches for folders. After a message, the first entry which matches the letter entered is shown at the top of the list.
If no entry matches the entered letter, the first item in the list is the last entry to correspond to a selection.

Selecting an active partition (USB mass storage devices only)

You can select this function for USB mass storage devices when the storage device is partitioned. Up to four partitions (primary or logical; FAT format) are supported.

- i** The Windows formatting program supports FAT partitioning up to 32 GB as standard.
- ▶ Select **Media Interface** in the basic display by sliding  and turning  the COMAND controller and press  to confirm.
- ▶ Select **Select Active Partition** and press  to confirm.

Playback options

The following options are available:

- **Normal Track Sequence**
Normal track sequence: you hear the tracks in their normal order (e.g. numerical or alphabetical).
- **Random Tracks**
All the tracks on the medium are played in random order.
- **Category Mix** or **Random Folder** (for USB devices if **Folder** has been selected)

The tracks in the currently active category or folder, including any subfolders, are played in random order.

- i** For USB devices, the random playlists offer a maximum of 300 tracks chosen at random.
- ▶ **To select a playback option:** select **Media Interface** in the basic display by sliding $\odot \updownarrow$ and turning $\left\{ \odot \right\}$ the COMAND controller and press \odot to confirm. The options list appears. The **•** dot indicates the option selected.
- ▶ Select an option and press \odot to confirm.

Separate USB connection

In addition to the USB connection on the Media Interface, there is another USB connection in the glove box. This connection can also be used to play audio files.

Electrical consumption at this connection must not exceed a continuous current of 500 mA. If the electrical consumption is higher, use a separate source to provide power for the USB device (e.g. 12 V power supply).



- ▶ **To select music from the USB port as the audio source:** select **Audio** by sliding $\updownarrow \odot$ and turning $\left\{ \odot \right\}$ the COMAND controller and press \odot to confirm. The audio menu appears.
- ▶ Select **USB** and press \odot to confirm.

Notes on USB devices

Data formats

The following data formats are supported:

- MP3: CBR, VBR (up to 320 kbit/s)
- WMA: CBR, VBR (up to 320 kbit/s)

Notes on USB devices

- In order to keep the initialization time to a minimum, store only music data on a USB device.
- Approximately 10,000 tracks are supported. Multiple partitions should be used for larger numbers of tracks.
- Do not use USB extension leads or adapters. They can impair functionality.
- A background search of the USB device is performed and any playlists found are shown in a separate category in addition to the folders. Initialization of larger USB mass storage devices containing a large number of files may take several minutes.

- i** DRM (Digital Rights Management) protected files are not supported by the Media Interface.

Audio AUX mode

Notes on audio AUX mode

You can connect an external audio source (AUX) to COMAND. The socket for this is located in the glove box.

If COMAND is equipped with a Media Interface, external audio sources are connected using the corresponding cable set. An AUX socket is not provided.

- i** You can find more information on the Internet at <http://www.mercedes-benz.com/connect> and in the "Media Interface mode" section (▶ page 222).

Activating audio AUX mode

When you connect an external audio source, audio AUX is not selected automatically.

- ▶ Select **Audio** in the main function bar by sliding $\uparrow \odot$ and turning $\left[\odot \right]$ the COMAND controller and press \odot to confirm.
- ▶ Select **AUX** using $\left[\odot \right]$ and press \odot to confirm.

The audio AUX menu appears. The medium in the external audio source is played, if the source is connected and playback selected.



Please see the respective operating instructions for how to operate the external audio source.

You will find details on volume (▷ page 127) and sound (▷ page 128) settings in the "At a glance" section.

WARNING

External audio sources may have different volumes, which can mean that system messages such as traffic announcements and navigation system announcements are much louder. If necessary, please deactivate the system messages or adjust their volume manually.

Increasing the volume

In some cases, the volume of the AUX device may be quieter or louder, or the usual maximum possible volume cannot be reached. On some devices, it is possible to adjust the volume separately. In this case,

start at a medium volume and increase it gradually. This enables you to determine whether the system is able to play tones at high volume without distorting them.

Video

General information

Automatic picture shutoff

If the vehicle is traveling faster than approximately 3 mph (5 km/h) and video DVD mode is activated, the picture is deactivated automatically.

The video picture is only shown if the selector lever is in the **P** position.

When the selector lever is moved from the **P** position, the **In order not to distract the driver, the picture is faded out while the vehicle is in motion.** message appears.

As soon as the vehicle speed falls below approximately 3 mph (5 km/h), the picture is reactivated.











Basic settings

Picture settings

Adjusting the brightness, contrast or color

- ▶ Press \odot the COMAND controller to show the menu.
- ▶ Select **Video** by sliding $\odot \downarrow$ and turning $\left[\odot \right]$ the COMAND controller and press \odot to confirm.
- ▶ Select **DVD-V** and press \odot to confirm.
- ▶ Select **Brightness, Contrast** or **Color** by turning $\left[\odot \right]$ the COMAND controller and press \odot to confirm.

Changing the picture format

- ▶ Press  the COMAND controller to show the menu.
- ▶ Select **Video** by sliding  and turning  the COMAND controller and press  to confirm.
- ▶ Select **Video DVD** and press  to confirm.
- ▶ Select **DVD-V** and press  to confirm. The DVD-V menu appears. The  dot in front of a menu item indicates the current setting.
- ▶ Select **Auto, 16:9 optimized, 4:3 or Widescreen** and press  to confirm.
- ▶ Select a setting by turning  the COMAND controller and press  to confirm.

Video DVD mode

Safety notes

WARNING

COMAND is classified as a Class 1 laser product. You must not open the casing. If you open the casing, or if the casing is faulty or damaged, there is a risk of exposure to invisible laser radiation. This may damage your eyes, or those of others.

COMAND does not contain any parts that can be serviced by the user. For safety reasons, all maintenance work must be carried out by qualified aftersales technicians.

WARNING

Only when the vehicle is stationary should you:

- load a disc
- eject a disc

There is a risk of being distracted from the road and traffic conditions if this is done while the vehicle is in motion.

Notes about discs

There may be playback problems when playing copied discs. There are a large variety of discs, DVD authoring software, writing software and writers available. This variety means that there is no guarantee that the system will be able to play discs that you have copied yourself.

 Do not affix stickers or labels to the discs, as they could peel off and damage COMAND. Stickers can cause the disc to bend, which can result in read errors and disc recognition problems.

 COMAND is designed to accommodate discs which comply with the EN 60908 standard. You can therefore only use discs with a maximum thickness of 1.3 mm.

If you insert thicker discs, e.g. those that contain data on both sides (DVD on one side and audio data on the other), they cannot be ejected and can damage COMAND.

Use round discs with a diameter of 12 cm. Do not use discs with a diameter of 8 cm, even with an adapter.

DVD playback conditions

If video DVDs do not conform to the NTSC or PAL TV standards, they may create picture, sound or other problems during playback.

COMAND can play back video DVDs produced according to the following standards:

- region code 1 or region code 0 (no region code)

 If you insert a video DVD with a different region code, you will see a message to this effect.

- PAL or NTSC standard

You will generally find the relevant details either on the DVD itself or on the DVD case.

 COMAND is set to region code 1 at the factory. This setting can be changed at an

authorized Mercedes-Benz Center. This will allow you to play video DVDs with a different region code, provided that they are produced in accordance with the PAL or NTSC standard. The region code can be changed up to five times.

Function restrictions

Depending on the DVD, it is possible that certain functions or actions will be temporarily blocked or may not function at all. As soon as you try to activate these functions or actions, you will see the  symbol in the display.

Inserting and removing DVDs



- ▶ Proceed as described in the "Inserting and ejecting CDs and DVDs" section ([▷ page 209](#)).

Activating video DVD mode





Option 1

- ▶ Insert a video DVD.
COMAND loads the medium inserted and starts to play it.

Option 2

- ▶ Select **Video** in the main function bar by sliding  and turning  the COMAND controller and press  to confirm.
Video DVD mode is switched on.

Hiding/showing the navigation menu

- ▶ **To show:** turn  or slide  the COMAND controller.
-  This function is not available while the DVD's own menu ([▷ page 232](#)) is being displayed.
- ▶ **To hide:** slide  the COMAND controller.

or

- ▶ Wait for approximately eight seconds.



Navigation menu displayed



- ① Data medium type
- ② Current track
- ③ Current scene
- ④ Track time
- ⑤ To show the menu

Showing/hiding the menu

This function is not available while the DVD's own menu ([▷ page 232](#)) is being displayed.

- ▶ **To show:** press  the COMAND controller.

or

- ▶ Select **Menu** while the navigation menu is shown and press  to confirm.
- ▶ **To hide:** slide  the COMAND controller and confirm **Full Screen** by pressing .

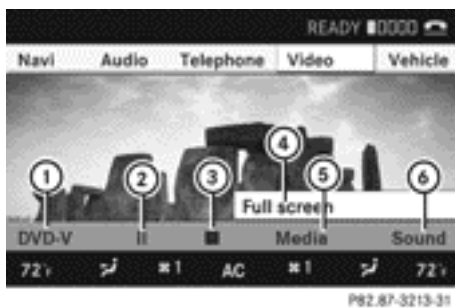

Menu shown

- ① Video DVD options
- ② Pause function
- ③ Stop function
- ④ Full-screen function

- ⑤ Media selection
- ⑥ Sound settings

Fast forward/rewind

- ▶ Slide $\leftarrow \odot \rightarrow$ and hold the COMAND controller until the desired position has been reached.
You see the navigation menu.

Selecting a video DVD

- ▶ Press \odot the COMAND controller to show the menu.
- ▶ Select **Media** by sliding $\odot \downarrow$ and turning $\left\{ \odot \right\}$ the COMAND controller and press \odot to confirm.
The media list appears. The \bullet dot indicates the current medium being played. Video DVDs are indicated by the DVD-V icon.

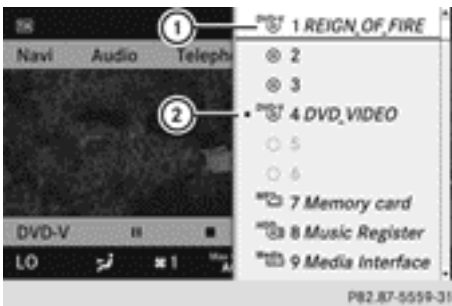

- ① DVD-V symbol for a video DVD
- ② Video DVD currently playing
- ▶ Select **DVD-V** by turning $\left\{ \odot \right\}$ the COMAND controller and press \odot to confirm.
COMAND loads the video DVD and starts playback.
- i** If you select a CD, an audio DVD or an MP3 medium, you switch to the respective audio mode. You can find further information about the media list on (▷ page 212).

Stop function

- ▶ Press \odot the COMAND controller to show the menu.
- ▶ **To interrupt playback:** select \blacksquare by turning $\left\{ \odot \right\}$ the COMAND controller and press \odot to confirm.
The II display changes to \blacktriangleright . The video image is hidden.
- ▶ **To continue playback:** select \blacktriangleright and press \odot to confirm.
Playback continues from the point where it was interrupted.
- ▶ **To stop playback:** while playback is interrupted, select \blacksquare again and press \odot to confirm.
or
▶ During playback, confirm \blacksquare by pressing \odot twice in quick succession.
Selection is at \blacktriangleright .
- ▶ **To restart playback:** confirm \blacktriangleright by pressing \odot .
Playback restarts from the beginning.

Pause function

- ▶ Press \odot the COMAND controller to show the menu.
- ▶ **To pause:** select II by turning $\left\{ \odot \right\}$ the COMAND controller and press \odot to confirm.
The II display changes to \blacktriangleright .
- ▶ **To continue playback:** select \blacktriangleright and press \odot to confirm.
The menu is hidden.

Selecting a scene/chapter

If the film is divided into scenes or chapters, you can select them directly while the film is running, or skip forwards step-by-step. Some DVDs do not permit this at certain points (e.g. during the opening credits).

It may also be possible to select the scene/ chapter from within the menu stored on the DVD.

- ▶ **To skip forwards or back:** turn $\left[\odot \right]$ or slide $\leftarrow \odot \rightarrow$ the COMAND controller. The control menu (\triangleright page 230) appears for approximately eight seconds.

- ▶ **On the multifunction steering wheel:** switch on video DVD mode in COMAND (\triangleright page 230).
- ▶ Use the $\left[\blacktriangleleft \right]$ or $\left[\blacktriangleright \right]$ button to select the **Audio** menu.
- ▶ Press $\left[\blacktriangleup \right]$ or $\left[\blacktriangledown \right]$ to select a scene/ chapter. If you press and hold $\left[\blacktriangleup \right]$ or $\left[\blacktriangledown \right]$ for an extended period, rapid scroll begins.

Selecting a film/title

This function is only available if the DVD is divided into several films/tracks. If the DVD contains several films, these can be selected directly. A film can be selected either when the DVD is being played back or when it is stopped.

The film can also be selected from the menu on the DVD itself.

- ▶ Press \odot the COMAND controller to show the menu.
- ▶ Select **DVD-V** by turning $\left[\odot \right]$ the COMAND controller and press \odot to confirm.
- ▶ Select **DVD Functions** and press \odot to confirm. A menu appears.

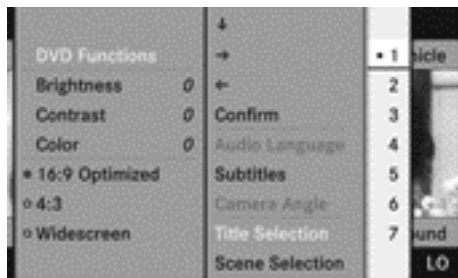

P82.87-5614-31

- ▶ Select **Title Selection** by turning $\left[\odot \right]$ the COMAND controller and press \odot to confirm.
- ▶ Select a film/title and press \odot to confirm.

DVD menu

Calling up the DVD menu

The DVD menu is the menu stored on the DVD itself. It is structured in various ways according to the individual DVD and permits certain actions and settings.

In the case of multi-language DVDs, for example, you can set the language in the DVD menu.

- ▶ Press \odot the COMAND controller to show the menu.
- ▶ Select **DVD-V** in the menu by turning $\left[\odot \right]$ the COMAND controller and press \odot to confirm.
- ▶ Select **DVD Functions** and press \odot to confirm.
- ▶ Select **Menu** and press \odot to confirm. The DVD menu appears.

Selecting menu items in the DVD menu

- ▶ Select a menu item by sliding $\uparrow \odot \downarrow$ or turning $\leftarrow \odot \rightarrow$ the COMAND controller and press \odot to confirm. The menu appears.

i Menu items that cannot be selected are grayed out.

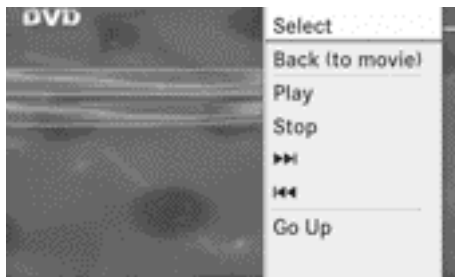



P82.87-2182-31

- ▶ **To reconfirm your selection:** confirm **Select** by pressing \odot .





COMAND executes the action.

Make a selection from the further options, if necessary.

COMAND then switches back to the DVD menu.

- i** Depending on the DVD, it is possible that the **Back (to the movie)**, **Play, Stop**, ,  or **Go up** menu item may not be operative or operative only at certain points of the DVD. To indicate this, the  symbol is shown in the display.

Stopping a film or skipping to the beginning or end of a scene

- ▶ Select any menu item from the DVD menu. The menu appears.
- ▶ **To stop the film:** select the **Stop** menu item and press  to confirm.
- ▶ **To skip to the end of a scene:** select the  menu item and press  to confirm.
- ▶ **To skip to the beginning of a scene:** select the  menu item and press  to confirm.



Moving up one level in the DVD menu

- ▶ Press the  back button.

or

- ▶ Select the corresponding menu item in the DVD menu and press  the COMAND controller to confirm.

or

- ▶ Select any menu item in the DVD menu and press  the COMAND controller to confirm.
- ▶ Select **Go up** and press  to confirm.

Back to the film











- ▶ Press the  back button repeatedly until you see the movie.

or

- ▶ Select the corresponding menu item from the DVD menu.
- ▶ Select the **Back (to the movie)** menu item in the menu and press  to confirm.



Setting the language and audio format







This function is not available on all DVDs. If it is available, you can set the DVD menu language, the audio language or the audio format. The number of settings is determined by the DVD content. It is possible that the settings may also be accessed in the DVD menu (▶ page 232).

- ▶ Press  the COMAND controller to show the menu.
- ▶ Select **DVD-V** in the menu by turning  the COMAND controller and press  to confirm.
- ▶ Select **DVD Functions** and press  to confirm.
- ▶ Select **Audio Language** and press  to confirm.
In both cases, a menu appears after a few seconds. The  dot in front of an entry indicates the currently selected language.
- ▶ Select a setting by turning  the COMAND controller and press  to confirm.
- ▶ **To exit the menu:** slide    the COMAND controller.

Subtitles and camera angle





These functions are not available on all DVDs. The number of subtitle languages and camera angles available depends on the content of the DVD. It is possible that the settings may also be accessed in the DVD menu (▶ page 232).

- ▶ Press  the COMAND controller to show the menu.
- ▶ Select **DVD-V** in the menu by turning  the COMAND controller and press  to confirm.

- ▶ Select **DVD Functions** and press  to confirm.
- ▶ Select **Subtitles** or **Camera angle** and press  to confirm.
In both cases, a menu appears. The  dot in front of an entry indicates the current setting.
- ▶ Select a setting by turning  the COMAND controller and press  to confirm.
- ▶ **To exit the menu:** slide  the COMAND controller.

Interactive content

DVDs can contain interactive content (e.g. a video game). In a video game, for example, you may be able to influence events by selecting and triggering actions. The type and number of actions depend on the DVD.

- ▶ Select an action by sliding  or  the COMAND controller and press  to execute it.
A menu appears and the first entry, **Select**, is highlighted.
- ▶ Press  the COMAND controller.





AUX video mode

AUX jacks

An external video source (video AUX) can be connected to COMAND via the media interface (▷ page 222) using the AUX jacks in the glove box.



-  In vehicles with a rear view camera, the video AUX jack cannot be used for external video sources.

Switching to video AUX mode

- ▶ Select **Video** in the main function bar by sliding  and turning  the COMAND controller and press  to confirm.
If video AUX mode was the last mode selected, it will now be active.
If another video source is switched on, you can now switch to video AUX mode in the video menu.
- ▶ Select **Video** and press  to confirm.
- ▶ Select **AUX** and press  to confirm.
The video AUX menu appears. You will hear and see the content of the external video source if it is connected and switched to playback.

For details on how to operate the external video source, see the respective device's operating instructions.

Showing/hiding the menu

- ▶ **To show:** press  the COMAND controller.
- ▶ **To hide:** slide  the COMAND controller and confirm **Full screen** by pressing .

Volume and sound settings

You will find details on volume (▷ page 127) and sound (▷ page 128) settings in the "At a glance" section.

WARNING

External video sources may have different volumes, which can mean that system messages such as traffic announcements and navigation system announcements are much louder. If necessary, please deactivate the system messages or adjust their volume manually.

-  In some cases, the volume of the AUX device may be quieter or louder, or the usual maximum possible volume cannot be reached. On some devices, it is possible to adjust the volume separately. In this case, start at a medium volume and increase it

gradually. This enables you to determine whether the system is able to play the music at high volume without distorting it.

Vehicle
Vehicle functions

General information

In this menu, you can set the following vehicle functions:

- ECO
- multicontour seat settings
- rear window blind
- EASY-ENTRY/EXIT feature
- exterior lighting delayed switch-off
- interior lighting delayed switch-off
- ambient lighting
- automatic folding mirror function
- locator lighting
- automatic locking feature
- trunk lid opening height restriction

You can open the "Vehicle" menu in one of two ways.

Opening the "Vehicle" menu from the main area in the center of the display

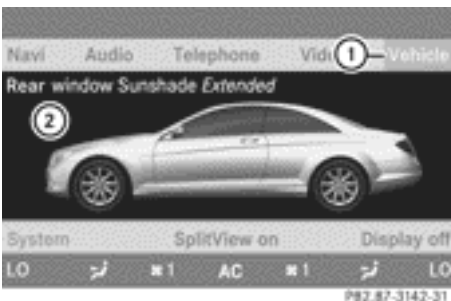

- ① "Vehicle" menu item
 - ② Main area
- ▶ Select **Vehicle** in the main function bar by sliding ←→ and turning **⌂** the

COMAND controller and press **⌂** to confirm.
 Main area ② is active.

- ▶ Select the individual vehicle functions by sliding ←→ or turning **⌂** the COMAND controller and press **⌂** to confirm.

Opening from the "Vehicle" menu

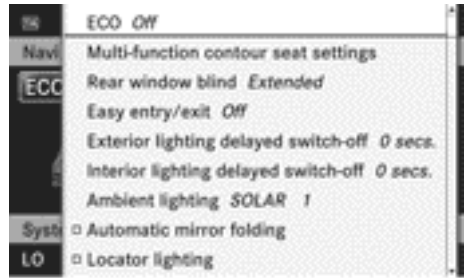

- ▶ Select **Vehicle** in the main function bar by sliding ←→ and turning **⌂** the COMAND controller and press **⌂** to confirm.
 The "Vehicle" submenu opens.
- ▶ Select the individual vehicle functions in the menu by sliding ←→ or turning **⌂** the COMAND controller and press **⌂** to confirm.

In the next section, it is the first procedure that is always described.





Switching the ECO function on/off

i Hybrid vehicles: the ECO start/stop function cannot be switched off.

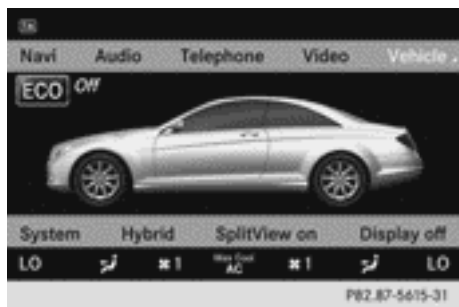
The ECO start/stop function switches the engine off automatically if the vehicle is stopped under certain conditions. When pulling away again, the engine starts automatically (▷ page 276). You can switch the ECO start/stop function on and off using COMAND.

If you switch the ECO start/stop function off using COMAND, the function is switched on again automatically. This is the case if you switch the ignition off and on again.





- ▶ **To switch the ECO start/stop function on/off:** select **Vehicle** in the main function bar by sliding ←→ and turning  the COMAND controller and press  to confirm. The main area is active.
- ▶ Select the **ECO function** by sliding ←→ or turning  the COMAND controller and press  to confirm. The ECO start/stop function is switched on and off alternately.

Extending/retracting the rear window blind

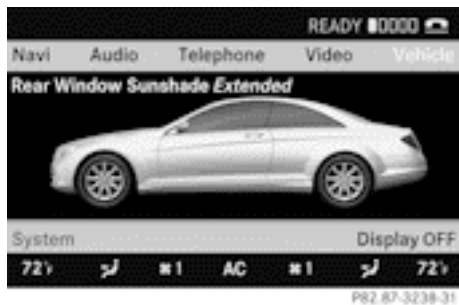

- ! Make sure that the rear window blind can move freely. Otherwise, the blind or other objects could be damaged.
- i The rear window blind is deactivated at temperatures below -20 °C.



- ▶ **To extend/retract the rear window blind:** select **Vehicle** in the main function bar by sliding ←→ and turning  the

COMAND controller and press  to confirm.





The main area is active.

- ▶ Select the **Rear Window Sunshade function** by sliding ←→ or turning  the COMAND controller and press  to confirm.

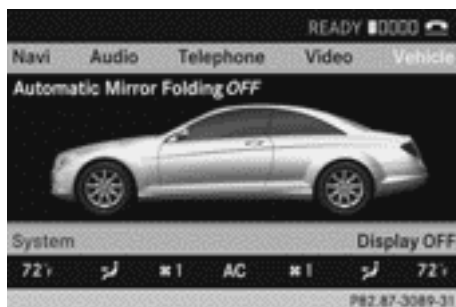
Activating/deactivating the automatic folding mirror function

In the **Automatic Mirror Folding** menu, you can set the exterior mirrors so that they automatically fold in when the vehicle is locked.



- ▶ **To activate/deactivate automatic mirror folding:** select **Vehicle** in the main function bar by sliding ←→ and turning  the COMAND controller and press  to confirm. The main area is active.
- ▶ Select the **Automatic Mirror Folding function** by sliding ←→ or turning  the COMAND controller and press  to confirm.

Setting the EASY-ENTRY/EXIT feature

WARNING

Make sure that nobody can become trapped when you activate the EASY-ENTRY/EXIT feature.

If there is a risk of entrapment by the steering column, move the steering wheel adjustment

lever or press the position button of the memory function.

If there is a risk of entrapment by the seat, you can also cancel the adjustment procedure by moving the switch for seat adjustment. The steering column and driver's seat stop moving immediately.

Never leave children unsupervised in the vehicle. They could open the driver's door and thereby unintentionally activate the EASY-ENTRY/EXIT feature and become trapped.

You can make a setting in COMAND so that the steering wheel swings upwards and/or the driver's seat moves backwards before you get into the vehicle. You can make the following settings:

- **Off**: the function is switched off.
- **Steering Column**: the steering wheel swings upwards.
- **Steering Column and Seat**: the steering wheel swings upwards and the driver's seat moves backwards.

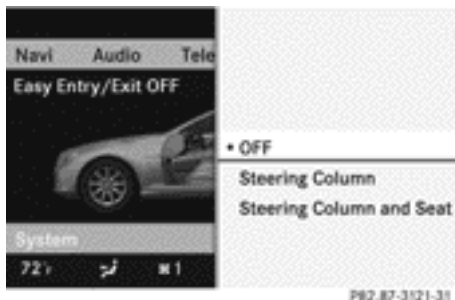

- ▶ **To set the EASY-ENTRY/EXIT feature:** select **Vehicle** in the main function bar by sliding ←⊙→ and turning Ⓜ the

COMAND controller and press ⊙ to confirm.

The main area is active.

- ▶ Select the **Easy Entry/Exit Feature menu** by sliding ←⊙→ or turning Ⓜ the COMAND controller. The EASY-ENTRY/EXIT feature menu appears. The current setting is indicated by a • dot.
- ▶ Select **Setting** by sliding ↑⊙↓ or turning Ⓜ the COMAND controller. The selected setting is indicated by a • dot.

Setting the interior/exterior lighting delayed switch-off time

Interior lighting: you can set whether and for how long you wish the interior lighting to remain on in the dark after you have removed the SmartKey from the ignition lock.

Exterior light: you can set whether and for how long you want the exterior lighting to remain on in the dark after the doors have been closed. The exterior lighting automatically switches off after the switch-off delay has elapsed.

You may select from the following settings:

- 0 seconds: delayed switch-off is deactivated.
- 15, 30, 45, 60 seconds: delayed switch-off is activated.

- ⓘ You can reactivate this function by opening a door within one minute. If none of the doors are opened after the key is removed from the ignition lock or if a door is not closed after it has been opened, the exterior lights switch off after 60 seconds.



P82.87-3123-31

- ▶ **To set the interior/exterior lighting delayed switch-off time:** select **Vehicle** in the main function bar by sliding ←⊙→ and turning Ⓚ the COMAND controller and press ⊙ to confirm. The main area is active.
- ▶ Select the **Interior Lighting Delayed Shut-off/Exterior Lighting Delayed Shut-off menu** by sliding ←⊙→ or turning Ⓚ the COMAND controller. The interior/exterior lighting delayed switch-off menu appears. The current setting is indicated by a • dot.
- ▶ Select **Setting** by sliding ↑⊙↓ or turning Ⓚ the COMAND controller. The selected setting is indicated by a • dot.

Setting the ambient lighting

You can make the following settings:

- **SOLAR** (yellow interior lighting)
- **NEUTRAL** (white interior lighting)
- **POLAR** (blue interior lighting)
- **Brightness** of the interior lighting on a scale of 0 (off) to 5 (bright)



P82.87-3126-31

- ▶ **To set the ambient lighting:** select **Vehicle** in the main function bar by sliding ←⊙→ and turning Ⓚ the COMAND controller and press ⊙ to confirm. The main area is active.
- ▶ Select the **Ambient Lighting menu** by sliding ←⊙→ or turning Ⓚ the COMAND controller. The ambient lighting menu appears. The current setting is indicated by a • dot.
- ▶ Select **Setting** by sliding ↑⊙↓ or turning Ⓚ the COMAND controller. The selected setting is indicated by a • dot.

Switching locator lighting on/off

If you switch on the locator lighting, the following come on in the dark after you have unlocked the vehicle using the remote control:

- the parking lamps
- the tail lamps
- the license plate lamp
- the front fog lamps
- the entry lamps in the exterior mirror

The locator lighting switches off again when you open the driver's door. If you do not open the driver's door, the locator lighting switches off automatically after 40 seconds.



- ▶ **To switch the locator lighting on/off:** select **Vehicle** in the main function bar by sliding ←→ and turning the COMAND controller and press to confirm. The main area is active.
- ▶ Select the **Locator Lighting** function by sliding ←→ or turning the COMAND controller and press to confirm.

Switching the automatic locking feature on/off

You can use this function to activate or deactivate the automatic central locking feature. If the automatic locking feature is activated, your vehicle will lock centrally from a speed of approximately 15 km/h.

Further information about the automatic locking feature is available in the "Automatic locking feature" section .

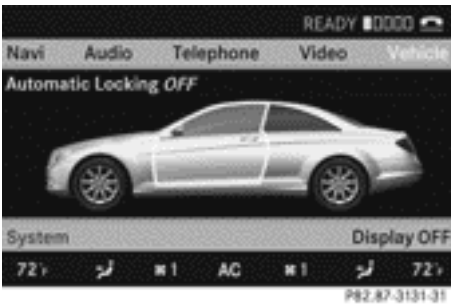

- ▶ **To switch the automatic locking feature on/off:** select **Vehicle** in the main function bar by sliding ←→ and

turning the COMAND controller and press to confirm. The main area is active.

- ▶ Select the **Automatic Locking** function by sliding ←→ or turning the COMAND controller and press to confirm.

Activating/deactivating the trunk lid opening height restriction



- ▶ **To activate/deactivate the trunk lid opening height restriction:** select **Vehicle** in the main function bar by sliding ←→ and turning the COMAND controller and press to confirm. The main area is active.
- ▶ Select the **Trunk Opening-height Restriction** function by sliding ←→ or turning the COMAND controller and press to confirm.

Automatic climate control

Introduction to automatic climate control

You can operate automatic climate control using COMAND or the buttons on the upper section of the center console (▶ page 263). Several special automatic climate control functions can only be adjusted using COMAND.

You can access the automatic climate control menu via the air-conditioning function bar.

To do so, make certain that the SmartKey is in position **2** in the ignition lock.

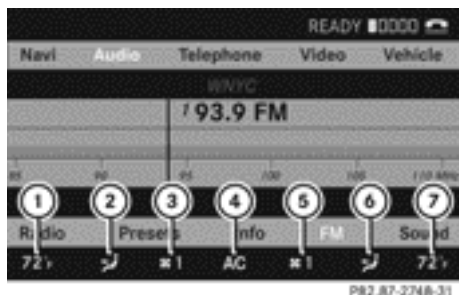

Air-conditioning function bar

- ① To set the temperature, left
- ② To set the air distribution, left
- ③ To set the airflow, left
- ④ Climate control main menu (▷ page 241)
- ⑤ To set the airflow, right
- ⑥ To set the air distribution, right
- ⑦ To set the temperature, right

Setting the temperature

You can set the temperature separately for the driver's and front-passenger side.

- ▶ Select left temperature display ① or right temperature display ⑦ in the air-conditioning function bar by turning $\left[\odot \right]$ the COMAND controller and press $\left[\odot \right]$ to confirm.



- ▶ **To adjust the temperature:** slide $\uparrow \odot \downarrow$ or turn $\left[\odot \right]$ the COMAND controller.

- ▶ **To confirm the selection:** press $\left[\odot \right]$ the COMAND controller.

Setting the air distribution

You can set the air distribution separately for the driver's and front-passenger side.

- ▶ Select left air distribution ② or right air distribution ⑥ by turning $\left[\odot \right]$ the COMAND controller and press $\left[\odot \right]$ to confirm.





- Directs air through the defroster vents
- Directs air through the center and side air vents
- Directs air through the footwell vents
- Directs air through the center, side and footwell vents
- Directs air through the defroster and footwell vents
- Directs air through the defroster, center, side and footwell vents
- Directs air through the defroster, center and side air vents
- Controls air distribution automatically

- ▶ **To adjust the air distribution:** turn $\left[\odot \right]$ the COMAND controller.





- ▶ **To confirm the selection:** press $\left[\odot \right]$ the COMAND controller.

Setting the airflow

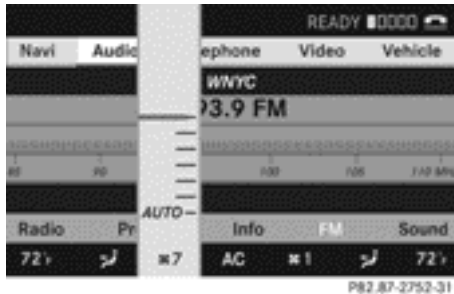
You can set the airflow separately for the driver's and front-passenger side.



- ▶ Select left airflow (3) or right airflow (5) by turning  the COMAND controller and press  to confirm.



- ▶ **To adjust the airflow:** slide   or turn  the COMAND controller.
- ▶ **To confirm the selection:** press  the COMAND controller.

Climate control main menu

COMAND allows you to set additional functions which cannot be selected using the control panel in the center console. Call up these functions using the climate control main menu.

- ▶ **To open the climate control main menu:** select the **AC** climate control symbol in the air-conditioning function bar by turning  the COMAND controller and press  to confirm. The climate control menu opens.

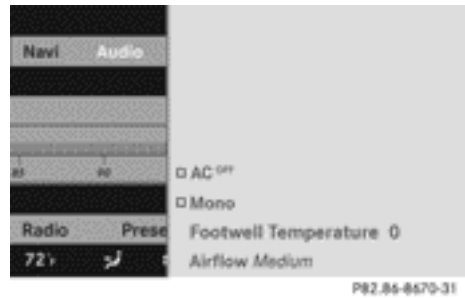

Climate control main menu

You can:

- switch cooling with dehumidification on or off ()
- control climate control centrally (**Mono**)
- adjust the **Footwell Temperature**
- set the **Airflow** for the air vents

Switching cooling with air dehumidification on/off

Cooling is operational when the engine is running, and cools according to the selected interior temperature for the vehicle. Cooling also dehumidifies the air inside the vehicle and, thereby, prevents the windows from fogging up.





WARNING

If you switch off cooling with dehumidification, the vehicle will not be cooled and the air not dehumidified in warm weather conditions. The windows can mist up faster. This could result in your no longer being able to observe the traffic conditions properly and you may cause an accident.

-  Condensation may collect on the underside of the vehicle when the cooler is operating.
- ▶ Select the climate control main menu in the air-conditioning function bar by turning

☺ the COMAND controller and press  to confirm.

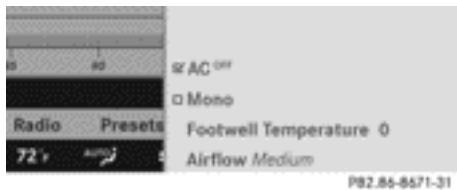

The climate control menu opens.

- ▶ **To switch on:** select  and press .
 - ▶ **To switch off:** select  and press .
- A tick appears.



Controlling climate control centrally

You can use the **Mono** function to set all the air-conditioning zones in the vehicle to the same settings. If the **Mono** function is switched on and you adjust climate control on the driver's side, these changes will also be made in all the air-conditioning zones.

- ▶ Select the climate control main menu in the air-conditioning function bar by turning  the COMAND controller and press  to confirm.
The climate control menu opens.
 - ▶ Select **Mono** and press .
- A tick appears when the function is selected.

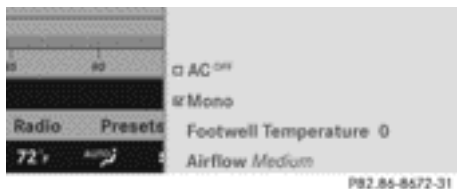

The **Mono** function is automatically switched off if you:



- change settings for automatic climate control on the front-passenger side using COMAND
- press one of the rocker switches to operate automatic climate control on the front-passenger side

Adjusting the footwell temperature





You can use the **Footwell Temperature** function to set the temperature difference between the footwell and the rest of the vehicle interior.

 This setting is quite effective in automatic mode, especially at low outside temperatures.

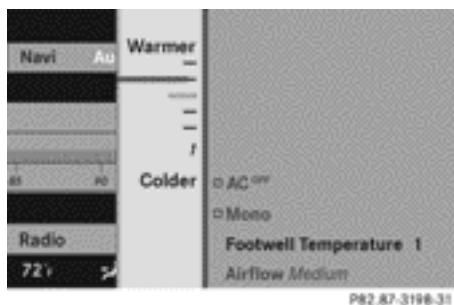
The greater the value you set, the higher the temperature in the footwell.

- ▶ Select the climate control main menu in the air-conditioning function bar by turning  the COMAND controller and press .
 - ▶ Select **Footwell Temperature** and press .
- A scale appears.



- ▶ **To change the temperature difference:** slide   or turn .
- ▶ **To confirm your selection:** press .

Setting the blower settings for the air vents



This function allows you to determine the way the air is blown through the air vents in automatic mode.

You can select:



- **Focused** (high blower setting)
- **Medium** (standard setting)
- **Diffuse** (low blower setting)

i This setting is quite effective in automatic mode, especially at high outside temperatures.

If the vehicle has become very warm and the automatic air conditioning is cooling the interior, the blower settings are briefly canceled.

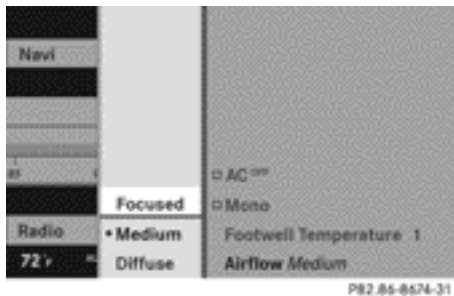
- ▶ Select the climate control main menu in the air-conditioning function bar by turning  the COMAND controller and press  to confirm. The climate control menu opens.
- ▶ Select **Airflow** and press . A menu appears. The current setting is indicated by a • dot.



- ▶ **To change the airflow:** slide  or turn .
- ▶ **To confirm your selection:** press .



Seats

Lumbar supports

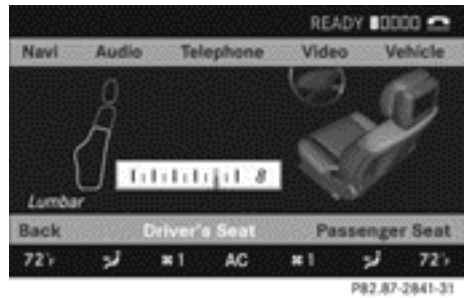

The lumbar support in the backrest of the driver's and front-passenger seats can be adjusted to provide optimum support for your back.

- ▶ **To select the seat:** press the  function button. The main area of the COMAND display is active. A scale appears.



- ▶ **To move to the lower menu bar:** select by sliding  the COMAND controller and press .

i When you press the  function button, the previously adjusted seat is active.

- ▶ **To adjust the lumbar support:** select by sliding  or turning  the COMAND controller and press .

Multicontour seat

i Information about the components and operating principles of COMAND can be found on (▶ page 112).

The contour of the driver's seat and front-passenger seat backrests can be individually adjusted to provide optimum support for your back. This is achieved by controlling the pressure in the air chambers in the multicontour seat.

The adjustments are made using the COMAND display.

i When you adjust the multicontour seat, you may hear the air being pumped in or released.



You can adjust the following air cushions:

- seat side bolsters
- seat backrest side bolsters
- backrest curvature in the lumbar region
- backrest curvature in the upper back region

- ▶ Make sure that the SmartKey is in position **2** in the ignition lock.
- ▶ Press the  function button.

Selecting the seat

You must first select the seat for which you wish to make adjustments.

- ▶ Press the  function button. The main area is active.
- ▶ **To move to the lower menu bar:** select by sliding $\uparrow\odot\downarrow$ the COMAND controller and press  to confirm.

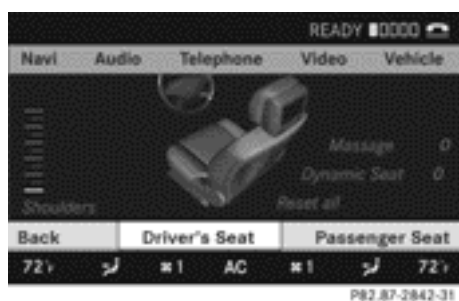

- ▶ **To select a seat:** select by sliding $\leftarrow\odot\rightarrow$ or turning $\left\{\odot\right\}$ the COMAND controller and press  to confirm.

Exiting a menu

There are several ways of exiting the menu for the multicontour seat:

- ▶ Press the  function button again.
- or
- ▶ Press any function button.
- or
- ▶ Select another main function from the basic menu.

Display values

Two values are displayed on the setting scale if you adjust the multicontour seat:

- red: this is the desired value which you specify when making the setting.
- white: this is the current value. It is changed gradually until it reaches the desired value.

Adjusting the seat side bolsters

This function allows you to adjust the air cushions in the seat side bolsters.

- ▶ Select the seat (\triangleright page 244).
- ▶ Select **Seat Sides** by sliding $\leftarrow\odot\rightarrow$ or turning $\left\{\odot\right\}$ the COMAND controller and press  to confirm. A scale appears.

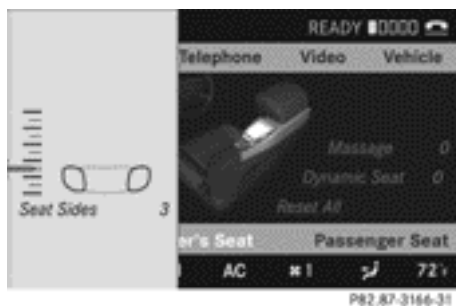



- ▶ Select **Setting** by sliding $\uparrow\odot\downarrow$ or turning $\left\{\odot\right\}$ the COMAND controller and press  to confirm.

Adjusting the seat backrest side bolsters

This function allows you to adjust the air cushions in the seat backrest side bolsters.

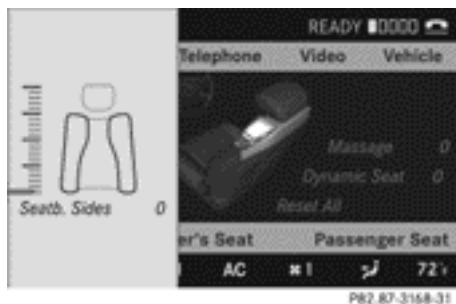
- ▶ Select the seat (\triangleright page 244).
- ▶ Select **Seatb. Sides** by sliding $\leftarrow\odot\rightarrow$ or turning $\left\{\odot\right\}$ the COMAND controller and press  to confirm. A scale appears.



- ▶ Select **Setting** by sliding $\uparrow\odot\downarrow$ or turning $\left\{\odot\right\}$ the COMAND controller and press  to confirm.

Adjusting the backrest curvature in the lumbar region

This function allows you to adjust the air cushions in the lumbar region of the backrest.

- ▶ Select the seat (▷ page 244).
- ▶ Select **Lumbar** by sliding ←⊙→ or turning ⌚ the COMAND controller and press ⊗ to confirm.

A crosshair appears. You can make two settings:

- **Vertical:** to move the point of greatest lumbar support up or down
- **Horizontal:** to adjust the amount of support

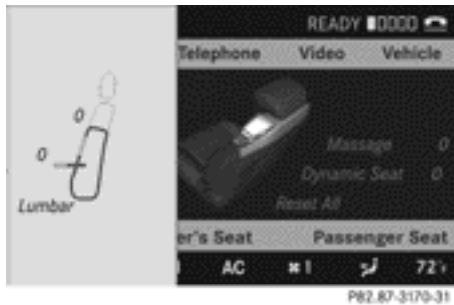

- ▶ Select **Setting** by sliding ↑⊙↓ or turning ⌚ the COMAND controller and press ⊗ to confirm.

Adjusting the backrest curvature in the upper back region

This function allows you to adjust the air cushions in the upper back region of the backrest.

- ▶ Select the seat (▷ page 244).
 - ▶ Select **Shoulders** by sliding ←⊙→ or turning ⌚ the COMAND controller and press ⊗ to confirm.
- A scale appears.

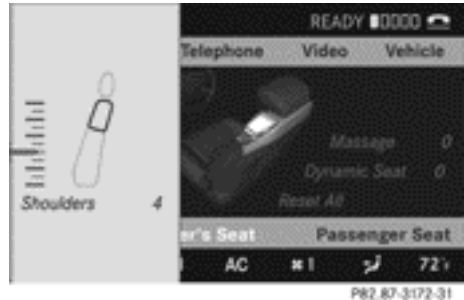

- ▶ Select **Setting** by sliding ↑⊙↓ or turning ⌚ the COMAND controller and press ⊗ to confirm.

Resetting adjustments

You can reset the seat settings to the factory settings.

- ▶ Select the seat (▷ page 244).
- ▶ Select **Reset All** by sliding ←⊙→ or turning ⌚ the COMAND controller and press ⊗ to confirm.

Active multicontour seat

The dynamic function of the active multicontour seat automatically adapts the side bolsters of the backrest to your current driving style.

- ▶ Select the seat (▷ page 244).
- ▶ Select **Dynamic Seat** by sliding ←⊙→ or turning ⌚ the COMAND controller and press ⊗ to confirm.
- ▶ **To confirm your selection:** press ⊗.

A scale appears.

You can select:

- **0:** Off
- **1:** Level 1
- **2:** Level 2



- ▶ Select **Setting** by sliding $\uparrow \odot \downarrow$ or turning $\left\{ \odot \right\}$ the COMAND controller and press \odot to confirm.

Massage function (PULSE)

The massage function helps you to prevent muscle tension on long journeys.

- ▶ Select the seat (▷ page 244).
- ▶ Select **Message** by sliding $\leftarrow \odot \rightarrow$ or turning $\left\{ \odot \right\}$ the COMAND controller and press \odot to confirm.

A list appears.

You can select different types of massage function:

- 0: OFF
- 1: Slow and Gentle
- 2: Slow and Vigorous
- 3: Fast and Gentle
- 4: Fast and Vigorous

- ▶ **To confirm your selection:** press \odot .



- ▶ Select **Setting** by sliding $\uparrow \odot \downarrow$ or turning $\left\{ \odot \right\}$ the COMAND controller and press \odot to confirm.

The massage function runs for approximately 6 to 20 minutes, depending on the setting.

Uploading/downloading data

With this function, you can transfer COMAND data from one system (vehicle) to another system (vehicle). You can use either a USB stick or an SD card as temporary storage.

You can only transfer the complete transferable data record.

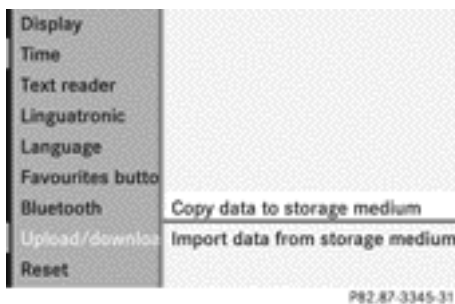

The following data is included in the complete transferable data record:

- navigation destination memory and last destination
- address book entries
- audio station/video channel presets
- system settings







Copying data to a storage medium

- ▶ Insert an SD card into the SD card slot or
 - ▶ Insert a USB stick into the socket on the side in the glove box.
 - ▶ Select **Vehicle** in the main function bar by turning $\left\{ \odot \right\}$ the COMAND controller and press \odot to confirm.
- The "Vehicle" menu appears.
- ▶ Select **System** and press \odot to confirm.

- ▶ Select **Upload/Download Data** and press  to confirm.
- ▶ Select **Copy Data to Storage Medium** and press  to confirm.
- ▶ Select the storage medium to which the data should be copied.
- ▶ Select **Start Copying**.
COMAND checks whether the storage medium has enough storage capacity. If there is enough storage capacity, the data is copied to the storage medium.
- ▶ If there is not enough storage capacity, remove the storage medium. Make more storage space available on the storage medium. Then, try to copy the COMAND data to the storage medium again.
- ▶ Remove the storage medium.

Transferring data to another system (vehicle)

- ▶ Insert/connect the storage medium (SD card or USB stick) with the saved data into/to the relevant interface.
- ▶ Select **Vehicle** in the main function bar by turning  the COMAND controller and press  to confirm.
The "Vehicle" menu appears.
- ▶ Select **System** and press  to confirm.
- ▶ Select **Upload/Download Data** and press  to confirm.
- ▶ Select **Import Data from Storage Medium** and press  to confirm.
- ▶ Select **Start Data Import**.
A prompt appears, asking whether the COMAND data should be overwritten.
- ▶ Press **Yes** to confirm that the data saved in COMAND should be overwritten.
COMAND imports the data and restarts the system.

or

- ▶ Press **No** to cancel the import process.

Useful information	250
Exterior lighting	250
Interior lighting	255
Replacing bulbs	256
Windshield wipers	257

Useful information

- i** This Operator's Manual describes all models and all standard and optional equipment of your vehicle available at the time of publication of the Operator's Manual. Country-specific differences are possible. Please note that your vehicle may not be equipped with all features described. This also applies to safety-related systems and functions.
- i** Please read the information on qualified specialist workshops (▷ page 29).

Exterior lighting

Important safety notes

For reasons of safety, Mercedes-Benz recommends that you drive with the lights switched on even during the daytime. In some countries, operation of the headlamps varies due to legal requirements and self-imposed obligations.

Notes on driving abroad

To convert to symmetrical low beam when driving abroad: switch the headlamps to symmetrical low beam in countries in which traffic drives on the opposite side of the road from the country where the vehicle is registered. This prevents glare to oncoming traffic. Symmetrical lights do not illuminate as large an area of the edge of the road.

Have the headlamps converted at a qualified specialist workshop as close to the border as possible before driving in these countries.

To convert to asymmetrical low beam after returning: have the headlamps converted back to asymmetrical low beam at a qualified specialist workshop as soon as possible after crossing the border and returning to the original country.

Light switch

Operation

Depending on the date of manufacture of your vehicle, the **A** or **AUTO** symbol for the automatic headlamp mode/daytime running lamps is located on the light switch.

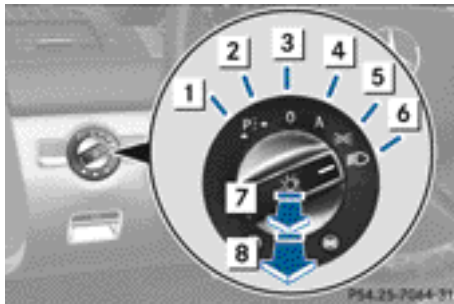

- 1** Left-hand standing lamps
- 2** Right-hand standing lamps
- 3** **0** Lights off/daytime running lamps
- 4** **A** Automatic headlamp mode/daytime running lamps
- 5** Parking lamps, license plate and instrument cluster lighting
- 6** Low-beam/high-beam headlamps
- 7** Front fog lamps
- 8** Rear fog lamp

The turn signals, high-beam headlamps and the high-beam flasher are operated using the combination switch (▷ page 252).

! Switch off the parking lamps and standing lamps when you leave the vehicle. This prevents the battery from discharging.



The exterior lighting (except the parking/standing lamps) switches off automatically if you:

- remove the SmartKey from the ignition lock
- open the driver's door with the SmartKey in position **0**

If you hear a warning tone when you leave the vehicle, the lights may still be switched on.

- ▶ Turn the light switch to **0** or **A**.
or
- ▶ If the rear fog lamp is switched on: press the light switch in to the stop.

Low-beam headlamps

- ▶ **To switch on the low-beam headlamps:** turn the SmartKey in the ignition lock to position **2** or start the engine.
- ▶ Turn the light switch to .
The  indicator lamp on the light switch lights up.
- ▶ **To switch off the low-beam headlamps:** turn the light switch to **0**.

Daytime running lamps

Daytime running lamps in Canada

The daytime running lamps function is required by law in Canada. It cannot therefore be deactivated.

- ▶ Turn the light switch to **0** or **A**.
With the engine running: depending on the ambient light, the daytime running lamps or the low-beam headlamps are switched on.
When the low-beam headlamps are switched on, the  indicator lamp on the light switch lights up.

When the engine is running and the vehicle is stationary or if the electronic parking brake is applied: if you move the selector lever from a drive position to **P**, the daytime running lamps/low-beam headlamps go out after three minutes.

When the engine is running, the vehicle is stationary and in high ambient light brightness: if you turn the light switch to , you turn on the daytime running lamps and parking lamps.



If the engine is running and you turn the light switch to , the manual settings take precedence over the daytime running lamps.

Daytime running lamps in the USA

In the USA, the daytime running lamps are deactivated upon delivery from the factory.

- ▶ **To activate the daytime running lamps:** activate the daytime running lamps function in the on-board computer (▷ page 349).

- ▶ Turn the light switch to **0** or **A**.
With the engine running: depending on the ambient light, the daytime running lamps or the low-beam headlamps are switched on.
When the low-beam headlamps are switched on, the  indicator lamp on the light switch lights up.

If the engine is running and you turn the light switch to  or , the manual settings take precedence over the daytime running lamps.

Automatic headlamp mode

- ▶ **To switch on automatic headlamp mode:** turn the light switch to **A**.
SmartKey in position **1** in the ignition lock: the parking lamps are switched on or off automatically depending on the brightness of the ambient light.
With the engine running: depending on the brightness of the ambient light, the daytime running lamps¹⁰ or the parking lamps and low-beam headlamps are switched on or off automatically.
When the low-beam headlamps are switched on, the  indicator lamp on the light switch lights up.



WARNING

If the light switch is set to **A**, the low-beam headlamps will not come on automatically if it is foggy. This could endanger you and others. Therefore, turn the light switch to  in fog.

¹⁰ Only if daytime running lamps have been activated via the on-board computer.

The automatic headlamp feature is only an aid. The driver is responsible for the vehicle's lighting at all times.

WARNING





When it is dark or foggy, turn the light switch quickly from  to . Otherwise, the headlamps could switch off temporarily and you could cause an accident.





Front fog lamps

WARNING







If you suspect that driving conditions will be foggy, turn the light switch to  before you start your journey. Your vehicle may otherwise not be visible and you could endanger yourself and others.

WARNING

In low ambient lighting or foggy conditions, only switch from position  to  with the vehicle at a standstill in a safe location. Switching from  to  will briefly switch off the headlamps. Doing so while driving in low ambient lighting conditions may result in an accident.

- ▶ **To switch on the front fog lamps:** turn the SmartKey in the ignition lock to position **2** or start the engine.
- ▶ Turn the light switch to  or . If the light switch is set to , you cannot switch on the fog lamps.
- ▶ Pull the light switch out to the first detent. The green  indicator lamp on the light switch lights up.
- ▶ **To switch off the front fog lamps:** press the light switch in as far as it will go. The green  indicator lamp on the light switch goes out.

Rear fog lamp

- ▶ **To switch on the rear fog lamp:** turn the SmartKey in the ignition lock to position **2** or start the engine.
- ▶ Turn the light switch to  or . If the light switch is set to , you cannot switch on the rear fog lamp.
- ▶ Turn the light switch to . If the light switch is set to , you cannot switch on the rear fog lamp.
- ▶ Pull the light switch out to the second detent. The yellow  indicator lamp on the light switch lights up.
- ▶ **To switch off the rear fog lamp:** press the light switch in as far as it will go. The yellow  indicator lamp on the light switch goes out.

Headlamp cleaning system

If the "Wipe with washer fluid" function is operated five times (▷ page 257) while the lights are on and the engine is running, the headlamps are cleaned automatically. When you switch off the ignition, the automatic headlamp cleaning system is reset and counting is resumed from 0.

Combination switch

Turn signal

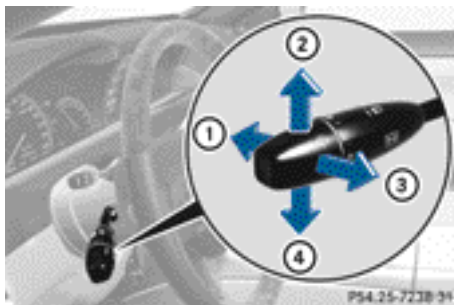



- ① High-beam headlamps
- ② Right turn signal

- ③ High-beam flasher
- ④ Left turn signal

- ▶ **To indicate briefly:** press the combination switch briefly to the pressure point in the direction of arrow ② or ④.
The corresponding turn signal flashes three times.
- ▶ **To indicate:** press the combination switch beyond the pressure point in the direction of arrow ② or ④.

High-beam headlamps

- ▶ **To switch on the high-beam headlamps:** turn the SmartKey in the ignition lock to position **2** or start the engine.
- ▶ Turn the light switch to .
- ▶ Press the combination switch beyond the pressure point in the direction of arrow ①.
The  indicator lamp in the instrument cluster lights up.
- ▶ **To switch off the high-beam headlamps:** move the combination switch back to its normal position.
The  indicator lamp in the instrument cluster goes out.

High-beam flasher

- ▶ **To switch on:** turn the SmartKey in the ignition lock to position **1** or **2** or start the engine.
- ▶ Pull the combination switch in the direction of arrow ③.

Hazard warning lamps



The hazard warning lamps automatically switch on if:

- an air bag is deployed.
- the vehicle is slowed down rapidly from a speed of over 45 mph (70 km/h) and comes to a halt.

- ▶ **To switch on the hazard warning lamps:** press button ①.
All turn signals flash. If you now switch on a turn signal using the combination switch, only the turn signal lamp on the corresponding side of the vehicle will flash.
- ▶ **To switch off the hazard warning lamps:** press button ①.

If the vehicle returns to a speed of over 6 mph (10 km/h) after a full application of the brakes, the hazard warning lamps are deactivated automatically.

- ❗ The hazard warning lamps still operate if the ignition is switched off.

Cornering light function



The cornering light function improves the illumination of the road over a wide angle in the direction you are turning, enabling better visibility in tight bends, for example. The cornering light function can only be activated when the low-beam headlamps are switched on.

Active:

- if you are driving at speeds below 25 mph (40 km/h) and switch on the turn signals or turn the steering wheel
- if you are driving at speeds between 25 mph (40 km/h) and 45 mph (70 km/h) and turn the steering wheel

Not active: if you are driving at speeds above 25 mph (40 km/h) or switch off the turn signals or turn the steering wheel to the straight-ahead position.

The cornering light function may remain lit for a short time, but is automatically switched off after no more than three minutes.

Adaptive Highbeam Assist

You can use this function to set the headlamps to change between low beam and high beam automatically. The system recognizes vehicles with their lights on, either approaching from the opposite direction or traveling in front of your vehicle, and consequently switches the headlamps from high beam to low beam.

The system automatically adapts the low-beam headlamp range depending on the distance to the other vehicle. Once the system no longer detects any other vehicles, it reactivates the high-beam headlamps.

The system's optical sensor is located behind the windshield near the overhead control panel.

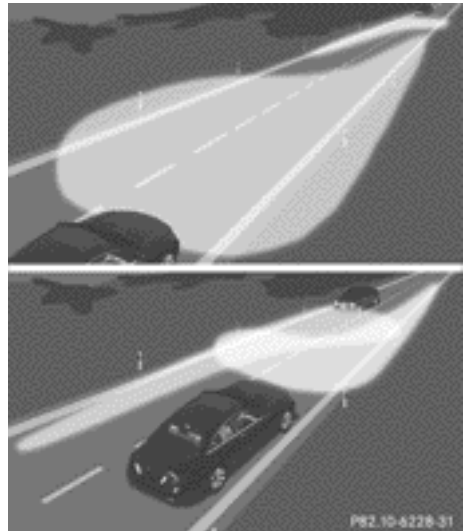

- ▶ **To activate:** activate the Adaptive Highbeam Assist function using the on-board computer (▷ page 350).
- ▶ Turn the light switch to **A**.
- ▶ Press the combination switch beyond the pressure point in the direction of arrow ① (▷ page 252).

If it is dark and the light sensor activates the low-beam headlamps, the  indicator lamp in the instrument cluster lights up.



If you drive at speeds above approximately 28 mph (45 km/h):

the headlamp range is set automatically depending on the distance between the vehicle and other road users.

If you are driving at speeds above approximately 35 mph (55 km/h) and no other road users have been detected:

the high-beam headlamps are switched on automatically. The  indicator lamp in the instrument cluster also lights up.

If you drive at speeds below approximately 30 mph (45 km/h) or if other road users are identified or if the roads are sufficiently illuminated:

the high-beam headlamps are switched off automatically. The  indicator lamp in the instrument cluster goes out. The  indicator lamp in the instrument cluster stays on.

- ▶ **To deactivate:** move the combination switch back to its normal position. The  indicator lamp in the instrument cluster goes out.

WARNING

The Adaptive Highbeam Assist is only an aid intended to support you while driving. The driver is and remains responsible for proper vehicle lighting in accordance with the prevailing light, sight and traffic conditions. The system may be impaired or unavailable when

- visibility is poor, e.g. due to snow, rain, fog, or heavy spray
- the optical sensor area of the windshield is dirty, fogged up, or covered by a sticker for example

The system cannot recognize the following road users:

- Road users without a lighting system of their own, e.g. pedestrians
- Road users with dim lighting of their own, e.g. cyclists
- Road users whose lighting is obstructed, e.g. road users behind a guardrail
- In some seldom cases, even road users with a lighting system of their own may be recognized too late or not at all.

The automatic high-beam headlamps will then not be deactivated or it will be activated in spite of preceding or oncoming road users.

This could endanger you and/or others and cause an accident. Always pay close attention to the traffic situation and switch off the high beam manually if necessary.

Headlamps fogged up on the inside

The headlamps may fog up on the inside if there is high atmospheric humidity.

- ▶ Drive with the headlamps switched on. The level of moisture diminishes, depending on the length of the journey and the weather conditions (humidity and temperature).

If the level of moisture does not diminish:



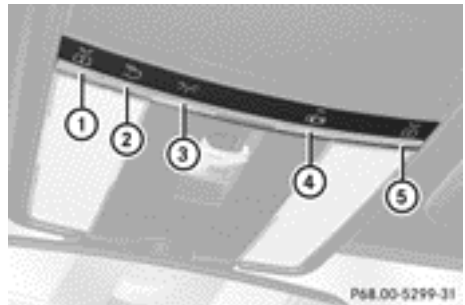

- ▶ Have the headlamps checked at a qualified specialist workshop.

Interior lighting

Overview of interior lighting



Overhead control panel

- ①  Switches the left-hand reading lamp on/off
- ②  Switches the rear interior lighting on/off
- ③  Switches the front interior lighting on/off
- ④  Switches the automatic interior lighting control on/off
- ⑤  Switches the right-hand reading lamp on/off

Interior lighting control

Important notes

In order to prevent the vehicle's battery from discharging, the interior lighting functions are automatically deactivated after some time except for when the SmartKey is in position 2 in the ignition lock.

Automatic interior lighting control



- ▶ **To switch on/off:** press the  button. The OFF indicator lamp shows whether the automatic interior lighting control is deactivated (indicator lamp on) or activated (indicator lamp off).

The interior lighting automatically switches on if you:

- unlock the vehicle
- open a door
- remove the SmartKey from the ignition lock

The interior light is activated for a short while when the SmartKey is removed from the ignition lock. You can activate this delayed switch-off using COMAND (▷ page 237).

Manual interior lighting control

- ▶ **To switch the front interior lighting on/off:** press the  button.
- ▶ **To switch the rear interior lighting on/off:** press the  button.
- ▶ **To switch the reading lamps on/off:** press the  button.

Replacing bulbs

Important safety notes

Xenon bulbs

DANGER

Xenon bulbs carry a high voltage. You could get an electric shock and be seriously or even fatally injured if you touch the electric

contacts on Xenon bulbs. Therefore, never remove the cover from Xenon bulbs.

Do not change the Xenon bulbs yourself, but have them replaced at a qualified workshop.

If your vehicle is equipped with Xenon bulbs, you can recognize this by the following: the cone of light from the Xenon bulbs moves from the top to the bottom and back again when you start the engine. For this to be observed, the lights must be switched on before starting the engine.

Bulbs and lamps are an important aspect of vehicle safety. You must therefore make sure that these function correctly at all times. Have the headlamp setting checked regularly.

Other bulbs

There are bulbs other than the Xenon bulbs that you cannot replace. Replace only the bulbs listed (▷ page 257). Have the bulbs that you cannot replace yourself changed at a qualified specialist workshop.

If you require assistance changing bulbs, consult a qualified specialist workshop.

Do not touch the glass tube of new bulbs with your bare hands. Even minor contamination can burn into the glass surface and reduce the service life of the bulbs. Always use a lint-free cloth or only touch the base of the bulb when installing.

Only use bulbs of the correct type.

If the new bulb still does not light up, consult a qualified specialist workshop.

Bulbs and lamps are an important aspect of vehicle safety. You must therefore make sure that these function correctly at all times. Have the headlamp setting checked regularly.

WARNING

Bulbs and lamps can become very hot. For this reason, allow them to cool down before changing them. Otherwise, you could burn yourself when you touch them.

Keep bulbs out of the reach of children. Otherwise, they could, for example, damage the bulbs and injure themselves.

Never use a bulb which has been dropped. Such a bulb may explode and injure you.

Halogen bulbs are pressurized and could explode when you change them, especially if they are very hot. You should therefore wear eye protection and gloves when you are changing them.

Overview: changing bulbs/bulb types

You can change the following bulbs. The bulb type can be found in the legend.



Bi-Xenon headlamps

- ① High-beam spot lamp: H11 55 W
- Infrared light (Night View Assist Plus): H11 55 W

Changing the front bulbs

High-beam spot lamp/infrared light (Night View Assist Plus)

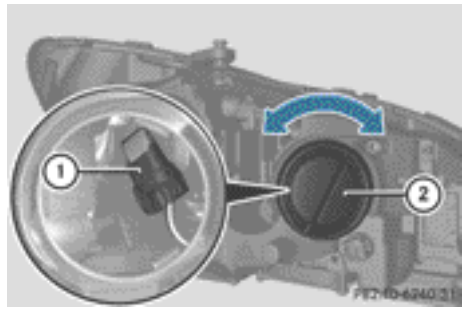

- ▶ Switch off the lights.
- ▶ Open the hood.
- ▶ Turn housing cover ② counter-clockwise and pull it out.
- ▶ Turn bulb holder ① counter-clockwise and pull it out.
- ▶ Take the bulb out of bulb holder ①.
- ▶ Insert the new bulb into bulb holder ①.
- ▶ Insert bulb holder ①.
- ▶ Turn bulb holder ① clockwise.
- ▶ Align housing cover ② and turn it clockwise until it engages.

Windshield wipers

Switching the windshield wipers on/off

WARNING

Wiper blades are components that are subject to wear and tear. Replace the wiper blades twice a year, preferably in the spring and fall. Otherwise the windshield will not be wiped properly. As a result, you may not be able to observe surrounding traffic conditions and could cause an accident.

- ❗ Do not operate the windshield wipers when the windshield is dry, as this could damage the wiper blades. Moreover, dust

that has collected on the windshield can scratch the glass if wiping takes place when the windshield is dry.

- ❗ If the windshield wipers leave smears on the windshield after the vehicle has been washed in an automatic car wash, wax or other residues may be the reason for this. Clean the windshield using washer fluid after washing the vehicle in an automatic car wash.

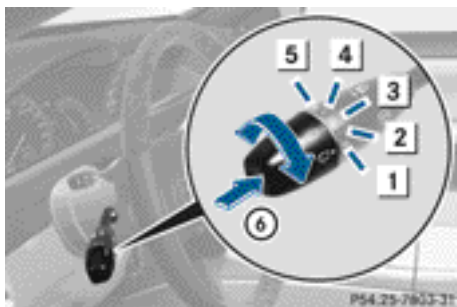

Combination switch

- 1 **0** Windshield wipers off
- 2 **...** Intermittent wipe, low¹¹
- 3 **....** Intermittent wipe, high¹²
- 4 **—** Continuous wipe, slow
- 5 **==** Continuous wipe, fast
- 6 Single wipe / To wipe the windshield using washer fluid

- ▶ Switch on the ignition.
- ▶ Turn the combination switch to the corresponding position.

- ❗ Intermittent wiping with rain sensor: due to optical influences and the windshield becoming dirty in dry weather conditions, the windshield wipers may be activated inadvertently. This could then damage the windshield wiper blades or scratch the windshield.

For this reason, you should always switch off the windshield wipers in dry weather.

In the **...** or **....** position, the appropriate wiping frequency is set automatically according to the intensity of the rain. In the **....** position, the rain sensor is more sensitive than in the **...** position, causing the windshield wipers to wipe more frequently.

Replacing the wiper blades

Important safety notes

WARNING

For safety reasons, switch off the windshield wipers and remove the SmartKey from the ignition lock before changing the wiper blades (vehicles with KEYLESS-GO: make sure that the on-board electronics are in state **0**). Otherwise, the wiper motor could be switched on suddenly and cause injury.

- ❗ Never open the hood if a windshield wiper arm has been folded away from the windshield.

Never fold a windshield wiper arm without a wiper blade back onto the windshield.

Hold the windshield wiper arm firmly when you change the wiper blade. If you release the windshield wiper arm without a wiper blade and it falls onto the windshield, the windshield may be damaged by the force of the impact.

Mercedes-Benz recommends that you have the wiper blades replaced by a qualified specialist workshop, e.g. at an authorized Mercedes-Benz Center.

- ❗ Always position the windshield wiper arms vertically before folding them away from the windshield. By doing so, you will avoid damage to the hood.
- ❗ To avoid damaging the wiper blades, make sure that you touch only the wiper arm of the wiper.

¹¹ Rain sensor set to low sensitivity.

¹² Rain sensor set to high sensitivity.

Changing the windshield wiper blades

Moving the wiper blades to a vertical position

Vehicles without KEYLESS-GO

- ▶ Turn the SmartKey to position **1** or **2** in the ignition lock.
- ▶ Set the windshield wipers to position .
- ▶ When the wiper arms have reached a vertical position, turn the SmartKey to position **0** and remove it from the ignition lock.

Vehicles with KEYLESS-GO

- ▶ Switch off the engine.
- ▶ Remove your foot from the brake pedal.
- ▶ Set the windshield wipers to position .
- ▶ Press the Start/Stop button repeatedly until the windshield wipers start.
- ▶ When the wiper arms have reached a vertical position, press the Start/Stop button.

Removing the wiper blades

- ▶ Fold the wiper arm away from the windshield until it engages.
- ▶ Set the wiper blade at right angles to the wiper arm.

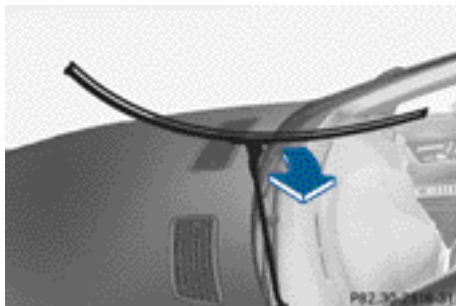

- ▶ Remove the wiper blade from the retaining pin on the wiper arm in the direction of the arrow.

Installing the wiper blades

- ▶ Push the new wiper blade onto the retaining pin on the wiper arm in the opposite direction to the arrow.
Make sure that the wiper blade slides fully onto the retaining pin on the wiper arm.
- ▶ Turn the wiper blade parallel to the wiper arm.
- ▶ Fold the wiper arm back onto the windshield.

Problems with the windshield wipers

The windshield wipers are obstructed

Leaves or snow, for example, may be obstructing the windshield wiper movement. The wiper motor has been deactivated.

- ▶ For safety reasons, you should remove the SmartKey from the ignition lock.

or

- ▶ Switch off the engine using the Start/Stop button and open the driver's door.
- ▶ Remove the cause of the obstruction.
- ▶ Switch the windshield wipers back on.

The windshield wipers are inoperative

The windshield wiper drive is malfunctioning.

- ▶ Select another wiper speed on the combination switch.
- ▶ Have the windshield wipers checked at a qualified specialist workshop.

The spray nozzles are misaligned

The windshield washer fluid from the spray nozzles no longer hits the center of the windshield. The spray nozzles are misaligned.

- ▶ Have the spray nozzles adjusted at a qualified specialist workshop.

Useful information	262
Overview of climate control systems	262
Operating the climate control systems	263
Setting the air vents	268

Useful information

- i** This Operator's Manual describes all models and all standard and optional equipment of your vehicle available at the time of publication of the Operator's Manual. Country-specific differences are possible. Please note that your vehicle may not be equipped with all features described. This also applies to safety-related systems and functions.
- i** Please read the information on qualified specialist workshops (▷ page 29).

Overview of climate control systems

Important safety notes

 **WARNING**

Severe conditions (e.g. strong air pollution) may require replacement of the filter before its scheduled replacement interval. A clogged filter will reduce the air volume to the interior and the windows could fog up, impairing visibility and endangering you and others. Have a blocked filter replaced at a Mercedes-Benz Center as soon as possible.

 **WARNING**

Follow the recommended settings for heating and cooling given on the following pages. Otherwise, the windows could fog up, impairing visibility and endangering you and others.

Automatic climate control controls the temperature and the humidity in the vehicle interior and filters undesirable substances from the air.

Automatic climate control is only operational when the engine is running¹³. Optimum operation is only achieved if you drive with the side windows and sliding sunroof closed.

You can also set some automatic climate control functions via COMAND (▷ page 239).

- i** Ventilate the vehicle for a brief period during warm weather, e.g. using the convenience opening feature (▷ page 89). This will speed up the cooling process and the desired vehicle interior temperature will be reached more quickly.
- i** The integrated filter can filter out most particles of dust, and completely filters out pollen. A clogged filter reduces the amount of air supplied to the vehicle interior. For this reason, you should always observe the interval for replacing the filter, which is specified in the Maintenance Booklet. As it depends on environmental conditions, e.g. heavy air pollution, the interval may be shorter than stated in the Maintenance Booklet.

- i** It is possible that the blower may be activated automatically 40 minutes after the SmartKey is removed. The vehicle is then ventilated for 30 minutes to dry the air-conditioning system.

¹³ The residual heat function can only be activated/deactivated if the ignition is switched off.

Automatic climate control panel

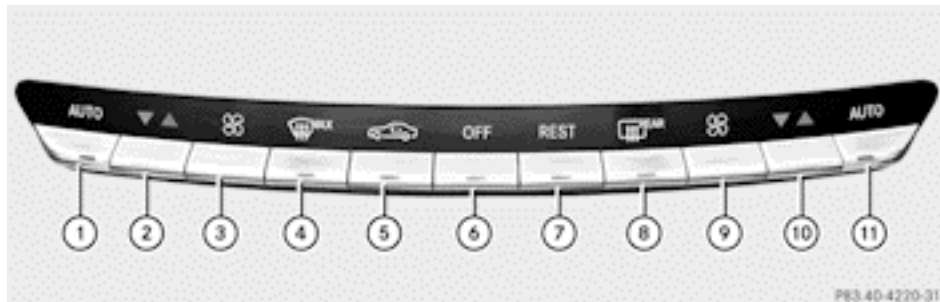

PE3.40-4220-31

- ① Sets climate control to automatic mode, left (▷ page 264)
- ② Sets the temperature, left (▷ page 265)
- ③ Sets the airflow, left (▷ page 265)
- ④ Defrosts the windshield (▷ page 265)
- ⑤ Activates/deactivates air-recirculation mode (▷ page 267)
- ⑥ Switches climate control on /off (▷ page 263)
- ⑦ Switches the residual heat function on/off (▷ page 267)
- ⑧ Switches the rear window defroster on/off (▷ page 266)
- ⑨ Sets the airflow, right (▷ page 265)
- ⑩ Sets the temperature, right (▷ page 265)
- ⑪ Sets climate control to automatic mode, right (▷ page 264)

Notes on using climate control

Below, you can find a number of notes and recommendations to help you use climate control optimally.

- Activate climate control using the **AUTO** rocker switch. The indicator lamp in the **AUTO** rocker switch lights up.
- Set the temperature to 72 °F (22 °C).
- Only use the "defrosting" function briefly until the windshield is clear again.
- Only use "air-recirculation" mode briefly, e.g. if there are unpleasant outside odors or when in a tunnel. The windows could otherwise fog up as in air-recirculation mode no fresh air is drawn into the vehicle.
- Use the residual heat function if you want to heat or ventilate the vehicle interior when the ignition is switched off. The "residual heat" function can only be

activated or deactivated with the ignition switched off.

Operating the climate control systems

Switching climate control on/off

Important information

⚠ WARNING

When the climate control system is deactivated, the outside air supply and circulation are also deactivated. Only choose this setting for a short time. Otherwise the windows could fog up, impairing visibility and endangering you and others.

- ❗ Switch on climate control primarily using the **AUTO** rocker switch (▷ page 264).

Activating/deactivating

- ▶ Turn the SmartKey to position **2** in the ignition lock.
- ▶ **To activate:** press the **OFF** rocker switch up or down.
The indicator lamp in the rocker switch goes out. The previously selected settings come into effect again.
- ▶ **To deactivate:** press the **OFF** rocker switch up or down.
The indicator lamp in the rocker switch lights up.

Activating/deactivating cooling with air dehumidification

Important information

The cooling with air dehumidification function is only available when the engine is running. The air inside the vehicle is cooled and dehumidified according to the temperature selected.

WARNING

If you switch off the cooling function, the vehicle will not be cooled when weather conditions are warm. The windows can fog up more quickly. Window fogging may impair visibility and endanger you and others.

Condensation may drip from the underside of the vehicle when it is in cooling mode. This is normal and not a sign that there is a malfunction.

You can activate or deactivate the cooling with air dehumidification function via COMAND (> page 241).

-  The cooling with air dehumidification function uses refrigerant R134a. This coolant does not contain chlorofluorocarbons, and therefore does not damage the ozone layer.

Problems with the cooling with air dehumidification function

If you can no longer switch on the cooling with air dehumidification function via COMAND, the cooling with air dehumidification function is switched off due to a malfunction.

- ▶ Consult a qualified specialist workshop.

Setting climate control to automatic

WARNING

If you switch off the cooling function, the vehicle will not be cooled when weather conditions are warm. The windows can fog up more quickly. Window fogging may impair visibility and endanger you and others.

In automatic mode, the set temperature is maintained automatically at a constant level. The system automatically regulates the temperature of the dispensed air, the airflow and the air distribution.

Automatic mode will achieve optimal operation if cooling with air dehumidification is also activated. If desired, cooling with air dehumidification can be deactivated.

- ▶ Turn the SmartKey to position **2** in the ignition lock.
- ▶ Set the desired temperature.
- ▶ **To switch on:** press the **AUTO** rocker switch up or down.
The indicator lamp in the **AUTO** rocker switch lights up.
- ▶ **To deactivate:** press the  rocker switch up or down.
The indicator lamp in the **AUTO** rocker switch goes out.

or

- ▶ Set the air distribution using COMAND (> page 240).
The indicator lamp in the **AUTO** rocker switch goes out.

Setting the temperature

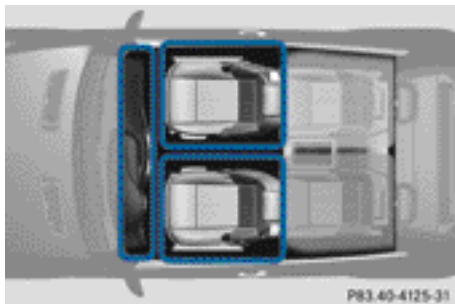

Climate control climate zones

You can select different temperature settings for the driver's and front-passenger sides as well as for the footwells.

► Turn the SmartKey to position **2** in the ignition lock.

► **To increase/reduce:** press the rocker switch up or down.

Only change the temperature setting in small increments. Start at 72 °F (22 °C).

i You can also use COMAND to set the temperature (► page 240).

i The footwell temperature can be set via COMAND (► page 242).

Setting the air distribution

Air distribution settings

The air distribution can be set individually for the driver's and front-passenger sides.

- Directs air through the defroster vents
- Directs air through the center and side air vents
- Directs the airflow through the footwell air vents
- Directs air through the center, side and footwell vents
- Directs air through the defroster and footwell vents

Directs air through the defroster, center, side and footwell vents

Directs air through the defroster, center and side air vents

Sets the air distribution to automatic

The air distribution can be set using COMAND (► page 240).

Setting the airflow

You can select different airflow settings for the driver's and front-passenger sides.

► Turn the SmartKey to position **2** in the ignition lock.

► **To increase/reduce:** press the rocker switch up or down.

You can also use COMAND to set the airflow (► page 241).

Defrosting the windshield

You can use this function to defrost the windshield or to defrost the inside of the windshield and the side windows.

i You should only select the defrosting function until the windshield is clear again.

► Turn the SmartKey to position **2** in the ignition lock.



► **To switch on:** press the rocker switch up or down.

The indicator lamp in the rocker switch lights up.

The climate control system switches to the following functions:

- cooling with air dehumidification on
- high airflow¹⁴
- high temperature¹⁴
- air distribution to the windshield and front side windows
- air-recirculation mode off

¹⁴ Depending on the outside temperature.

- ▶ **To deactivate:** press the  rocker switch up or down.
The indicator lamp in the  rocker switch goes out. The previously selected settings come into effect again. The cooling with air dehumidification function remains on. Air-recirculation mode remains deactivated.

or

- ▶ Press the  rocker switch up or down.

or

- ▶ Press the  rocker switch up or down.

MAX COOL maximum cooling

The MAX COOL function is only available in vehicles for the USA.

MAX COOL is only operational when the engine is running.

The MAX COOL function is activated automatically:

- if climate control is set to automatic (**AUTO**) on both sides
- if additional cooling is used

The display shows **MAX COOL**.

This is the quickest way to cool the vehicle interior when the sliding sunroof and the side windows are closed.

Defrosting the windows

Windows fogged up on the inside

- ▶ Activate the cooling with air dehumidification function via COMAND (> page 241).
- ▶ Activate automatic mode **AUTO**.
- ▶ If the windows continue to fog up, activate the defrosting function (> page 265).

- i** You should only select this setting until the windshield is clear again.

Windows fogged up on the outside

- ▶ Switch on the windshield wipers.
- ▶ Activate automatic climate control.
- i** You should only select this setting until the windshield is clear again.

Rear window defroster



Activating/deactivating

WARNING

Any accumulation of snow and ice should be removed from the rear window before driving. Visibility could otherwise be impaired, endangering you and others.

The rear window defroster has a high current draw. You should therefore switch it off as soon as the window is clear. Otherwise, the rear window defroster switches off automatically after several minutes.

If the battery voltage is too low, the rear window defroster may switch off.

- ▶ Turn the SmartKey to position **2** in the ignition lock.
- ▶ Press the  rocker switch up or down.
The indicator lamp in the  rocker switch lights up or goes out.

Problems with the rear window defroster

The rear window defroster has deactivated prematurely or cannot be activated.





- ▶ Switch off any consumers that are not required, e.g. reading lamps or interior lighting.
When the battery is sufficiently charged, the rear window defroster is activated again automatically.

Activating/deactivating air-recirculation mode

You can deactivate the flow of fresh air if unpleasant odors are entering the vehicle from outside. The air already inside the vehicle will then be recirculated.

WARNING

Fogged windows impair visibility, endangering you and others. If the windows begin to fog on the inside, switching off the air recirculation mode immediately should clear interior window fogging. If interior window fogging persists, make sure the air conditioning is activated, or press the  button.

- ▶ Turn the SmartKey to position **2** in the ignition lock.
- ▶ **To activate:** press the  rocker switch up or down.
The indicator lamp in the  rocker switch lights up.
- ▶ **To deactivate:** press the  rocker switch up or down.
The indicator lamp in the  rocker switch goes out.

i Air-recirculation mode is activated automatically at high outside temperatures. The indicator lamp in the  rocker switch is not lit when automatic air-recirculation mode is activated.





Outside air is added after about 30 minutes.

i Air-recirculation mode deactivates automatically:

- after approximately five minutes at outside temperatures below approximately 41 °F (5 °C)
- after approximately five minutes if cooling with air dehumidification is deactivated
- after approximately 30 minutes at outside temperatures above approximately 41 °F (5 °C)

Activating/deactivating the residual heat function

It is possible to make use of the residual heat of the engine to continue heating the stationary vehicle for up to 30 minutes after the engine has been switched off. The heating time depends on the temperature that has been set.

- ▶ **To activate:** press the  rocker switch up or down.
The indicator lamp in the  rocker switch lights up.
 - ▶ **To deactivate:** press the  rocker switch up or down.
The indicator lamp in the  rocker switch goes out.
- i** The blower will run at a low speed regardless of the airflow setting.
- i** If you activate the residual heat function at high temperatures, only the ventilation will be activated. The blower runs at medium speed.
- i** Residual heat is deactivated automatically:
- after about 30 minutes
 - when the ignition is switched on
 - if the battery voltage drops
 - if the coolant temperature is too low

Setting the air vents

Important safety notes

WARNING

When operating the climate control, the air that enters the passenger compartment through the air vents can be very hot or very cold (depending on the set temperature). This could cause burns or frostbite to unprotected skin in the immediate area of the air vents.

Always keep sufficient distance between unprotected parts of the body and the air vents. If necessary, use the air distribution adjustment to direct the air to air vents in the vehicle interior that are not in the immediate area of unprotected skin.

In order to ensure the direct flow of fresh air through the air vents into the vehicle interior, please observe the following notes:

- keep the air intake grille on the hood free of blockages, such as ice, snow or leaves
 - never cover the air vents or air intake grille in the vehicle interior.
- i** For virtually draft-free ventilation, adjust the sliders of the air vents to the center position.

Setting the center air vents

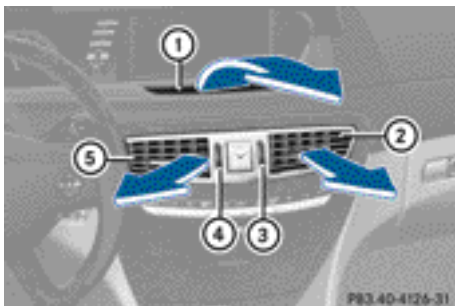

- ① Fixed center air vent
- ② Center air vent, right
- ③ Center vent thumbwheel, right

- ④ Center vent thumbwheel, left
- ⑤ Center air vent, left

► **To open/close:** turn thumbwheels ③ and ④ up or down.

Setting the side air vents

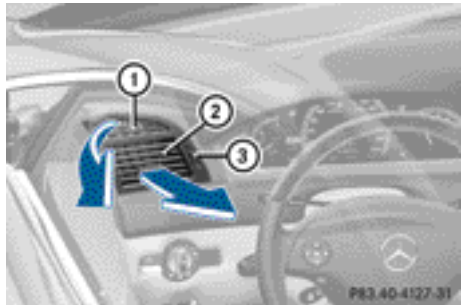

► **To open/close:** turn thumbwheel ③ up or down.

- i** Side window defroster vent ① is never completely shut, even if side air vent ② is shut.

Setting the air vents in the stowage compartment

When automatic climate control is activated the stowage compartment can be ventilated, for instance to cool its contents. The level of airflow depends on the airflow and air distribution settings. The temperature of the air is approximately the same as that of the air flowing from the center air vents.

- !** Close the stowage compartment air vent when heating mode is activated and activate "cooling with air dehumidification" if the outside temperature is high. Otherwise, temperature-sensitive items stored in the stowage compartment could be damaged.

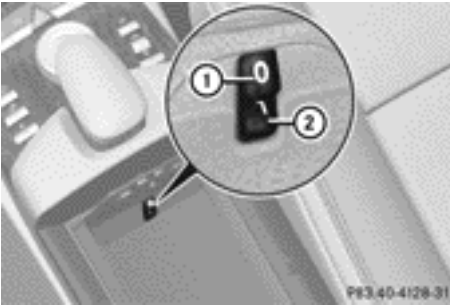

- **To switch the ventilation on/off:** push rocker switch down ② or up ①.

Setting the glove box air vent

When automatic climate control is activated, the glove box can be ventilated, for instance to cool its contents. The level of airflow depends on the airflow and air distribution settings.

- ! Close the air vent when heating the vehicle.

At high outside temperatures, open the air vent and activate the "cooling with air dehumidification" function. Otherwise, temperature-sensitive items stored in the glove box could be damaged.

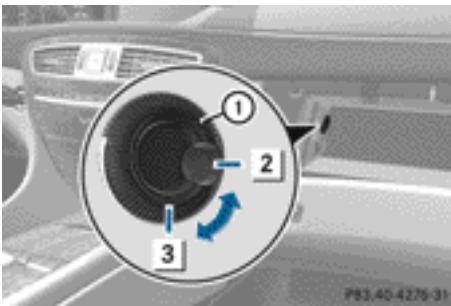

- **To open:** turn thumbwheel ① counter-clockwise from position ③ to position ②.
- **To close:** turn thumbwheel ① clockwise from position ② to position ③.

Setting the rear-compartment air vents

Setting the center vents in the rear compartment

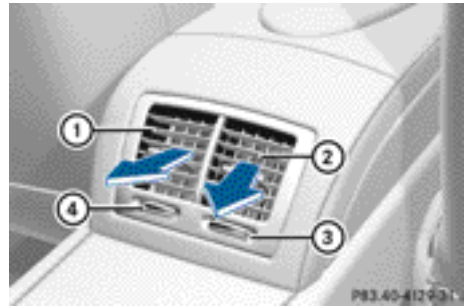

- ① Rear-compartment air vent, left
- ② Rear-compartment air vent, right
- ③ Rear-compartment air vent thumbwheel, right
- ④ Rear-compartment air vent thumbwheel, left

- **To open/close:** turn thumbwheel ③ or ④ to the right or left.

- i Close the rear-compartment air vents when heating mode is activated, as no warm air flows through the rear-compartment air vents in the basic heating setting.

Useful information	272
Notes on breaking-in a new vehicle	272
Driving	272
Automatic transmission	279
Refueling	286
Parking	289
Driving tips	292
Driving systems	296

Useful information

- i** This Operator's Manual describes all models and all standard and optional equipment of your vehicle available at the time of publication of the Operator's Manual. Country-specific differences are possible. Please note that your vehicle may not be equipped with all features described. This also applies to safety-related systems and functions.
- i** Please read the information on qualified specialist workshops (▷ page 29).

Notes on breaking-in a new vehicle

The first 1,000 miles (1,500 km)

The more you look after the engine when it is new, the more satisfied you will be with its performance in the future.

- You should therefore drive at varying vehicle and engine speeds for the first 1,000 miles (1,500 km).
- Avoid heavy loads, e.g. driving at full throttle, during this period.
- Change gear in good time, before the tachometer needle is $\frac{2}{3}$ of the way to the red area of the tachometer.
- Do not manually shift to a lower gear to brake the vehicle.
- If possible, do not depress the accelerator pedal past the point of resistance (kickdown).
- Only select shift ranges **3**, **2** or **1** when driving slowly, e.g. in mountainous terrain.
- If possible, for the first 1,000 miles (1,500 km), drive in drive program **E** (in AMG vehicles in drive program **C**).

After 1,000 miles (1,500 km), you can increase the engine speed gradually and bring the vehicle up to full speed.

Additional breaking-in notes for AMG vehicles:

- do not drive faster than 85 mph (140 km/h) for the first 1,000 miles (1,500 km).
 - only allow the engine to reach a maximum engine speed of 4,500 rpm briefly.
 - change gear in good time.
- i** You should also observe these breaking-in notes if the engine or parts of the drive train on your vehicle have been replaced.
 - i** Always observe the respective speed limits.

Driving

Important safety notes

WARNING

Make sure absolutely no objects are obstructing the pedals' range of movement. Keep the driver's footwell clear of all obstacles. If there are any floor mats or carpets in the footwell, make sure the pedals still have sufficient clearance.

During sudden driving or braking maneuvers the objects could get caught between the pedals. You could then no longer brake or accelerate. This could lead to accidents and injury.

WARNING

On slippery road surfaces, never downshift in order to obtain braking action. This could result in drive wheel slip and reduced vehicle control. Your vehicle's ABS will not prevent this type of loss of control.

WARNING

It is dangerous to shift the automatic transmission out of parking position **P** or neutral position **N** if the engine speed is higher than idle speed. If your foot is not firmly on the brake pedal, the vehicle could accelerate quickly forward or in reverse. You

could lose control of the vehicle and hit someone or something. Only shift into gear when the engine is idling normally and when your right foot is firmly on the brake pedal.

! Warm up the engine quickly. Do not use the engine's full performance until it has reached operating temperature.

Only shift the automatic transmission to the desired drive position when the vehicle is stationary.

Where possible, avoid spinning the drive wheels when pulling away on slippery roads. You could otherwise damage the drive train.

! CL 63 AMG: at low engine oil temperatures below 68 °F (+20 °C), the maximum engine speed is restricted in order to protect the engine. To protect the engine and maintain smooth engine operation, avoid driving at full throttle when the engine is cold.

Key positions

SmartKey

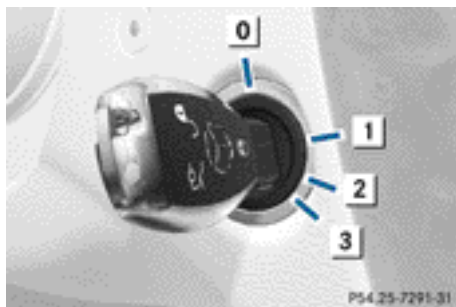

- 0 To remove the SmartKey
 - 1 Power supply for some consumers, such as the windshield wipers
 - 2 Ignition (power supply for all consumers) and drive position
 - 3 To start the engine
- i** The SmartKey can be turned in the ignition lock even if it is not the correct

SmartKey for the vehicle. The ignition is not switched on. The engine cannot be started.

KEYLESS-GO

General information

Vehicles with KEYLESS-GO are equipped with a SmartKey featuring an integrated KEYLESS-GO function and a detachable Start/Stop button.

The Start/Stop button must be inserted into the ignition lock and the SmartKey must be in the vehicle.

Pressing the Start/Stop button several times in succession corresponds to the different SmartKey positions in the ignition lock. This is only the case if you are not depressing the brake pedal.

If you depress the brake pedal and press the Start/Stop button, the engine starts immediately.

The Start/Stop button can be removed from the ignition lock. Then, you can insert the SmartKey into the ignition lock.

i You do not have to remove the Start/Stop button from the ignition lock when you leave the vehicle. However, you should always take the SmartKey with you when leaving the vehicle. The vehicle can be started with the Start/Stop button and the electrical equipment can be operated while the SmartKey is in the vehicle.

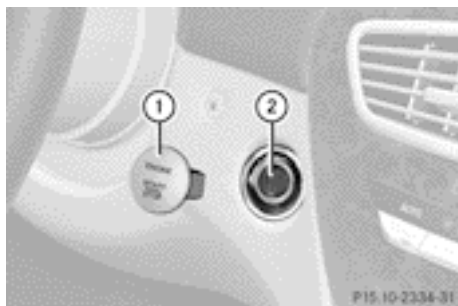

- 1 Start/Stop button
- 2 Ignition lock

- ▶ Insert Start/Stop button ① into ignition lock ②.

- i** When you insert Start/Stop button ① into ignition lock ②, the system requires a detection time of approximately two seconds before you can use Start/Stop button ①.

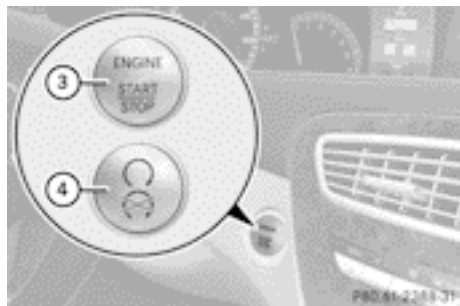

Start/Stop button

③ USA only

④ Canada only

- ▶ Position **0**: if Start/Stop button ① has not yet been pressed, this corresponds to the SmartKey being removed from the ignition.

- ▶ Position **1**: press Start/Stop button ①. You can now activate the windshield wipers, for example.

- i** If you then open the driver's door when in this position, the power supply is deactivated.

- ▶ Position **2** (ignition): press Start/Stop button ① twice.

- i** If you press Start/Stop button ① once when in this position and the driver's door is open, the power supply is deactivated again.

As soon as the ignition is switched on, all the indicator lamps in the instrument cluster light up. If an indicator lamp does not go out after the engine is started or if it lights up while the vehicle is in motion, see (▷ page 390).

Starting the engine

Important safety notes

⚠ WARNING

Inhalation of exhaust gas is hazardous to your health. All exhaust gas contains carbon monoxide (CO), and inhaling it can cause unconsciousness and possible death.

Do not run the engine in confined areas (such as a garage) which are not properly ventilated. If you think that exhaust gas fumes are entering the vehicle while driving, have the cause determined and corrected immediately. If you must drive under these conditions, drive only with at least one window fully open at all times.

- !** Do not depress the accelerator pedal when starting the engine.

General notes

- i** The catalytic converter is preheated for up to 30 seconds after a cold start. The sound of the engine may change during this time.

Automatic transmission

- ▶ Shift the transmission to position **P**. The transmission position display in the multifunction display shows **P**.

- i** You can also start the engine when the transmission is in position **N**.

Starting procedure with the SmartKey

- i** To start the engine using the SmartKey instead of KEYLESS-GO, pull the Start/Stop button out of the ignition lock.
- ▶ Turn the SmartKey to position **3** in the ignition lock (▷ page 273) and release it as soon as the engine is running.



Using KEYLESS-GO to start the engine

WARNING

As long as the SmartKey is in your vehicle, the vehicle can be started. Therefore, never leave children unattended in the vehicle, as they could otherwise accidentally start the engine. When leaving the vehicle, always take the SmartKey with you and lock the vehicle. Do not leave children unattended in the vehicle, or with access to an unlocked vehicle. A child's unsupervised access to a vehicle could result in an accident and/or serious personal injury.

- i** The Start/Stop button can be used to start the vehicle manually without inserting the SmartKey into the ignition lock. The Start/Stop button must be inserted into the ignition lock and the SmartKey must be in the vehicle. This mode for starting the engine operates independently of the ECO start/stop automatic engine start function.
- ▶ Depress the brake pedal and keep it depressed.
- ▶ Press Start/Stop button (▷ page 273) once.
The engine starts.

you depress the brake pedal. Only then is the parking lock released. If you do not depress the brake pedal, you can move the DIRECT SELECT lever but the parking lock remains engaged.

- ▶ Depress the brake pedal and keep it depressed.
- ▶ Shift the transmission to position **D** or **R**.
- ▶ Release the brake pedal.
- ▶ Carefully depress the accelerator pedal. The electric parking brake (▷ page 290) is automatically released.
The red  (USA only) or  (Canada only) indicator lamp in the instrument cluster goes out.

- i** The vehicle locks centrally once you have pulled away. The locking knobs in the doors drop down.

You can open the doors from the inside at any time.

You can also deactivate the automatic locking feature (▷ page 239).

- i** Upshifts take place at higher engine speeds after a cold start. This helps the catalytic converter to reach its operating temperature more quickly.

Pulling away

Automatic transmission

WARNING

It is dangerous to shift the automatic transmission out of parking position **P** or neutral position **N** if the engine speed is higher than idle speed. If your foot is not firmly on the brake pedal, the vehicle could accelerate quickly forward or in reverse. You could lose control of the vehicle and hit someone or something. Only shift into gear when the engine is idling normally and when your right foot is firmly on the brake pedal.

- i** It is only possible to shift the transmission from position **P** to the desired position if

Hill start assist

Hill start assist helps you when pulling away forwards or in reverse on an uphill gradient. It holds the vehicle for a short time after you have removed your foot from the brake pedal. This gives you enough time to move your foot from the brake pedal to the accelerator pedal and to depress it before the vehicle begins to roll.

WARNING

Never leave the vehicle when it is held by hill start assist. After approximately one second, hill start assist will no longer brake your vehicle and it could roll away.

- ▶ Take your foot off the brake pedal.
- i** Once you have taken your foot off the brake pedal, the vehicle is held for around one second.
- ▶ Pull away.

Hill start assist will not function if:

- you are pulling away on a level road or on a downhill gradient.
- the transmission is in position **N**.
- the electric parking brake is applied.
- ESP® is malfunctioning.

ECO start/stop function

General notes

The ECO start/stop function is only available for the CL 63 AMG.

The ECO start/stop function is only available in drive program **C**.

The ECO start/stop function switches the engine off automatically when the vehicle stops moving.

The engine starts automatically when the driver wants to pull away again. The ECO start/stop function thereby helps you to reduce the fuel consumption and emissions of your vehicle.

The ECO start/stop function is activated each time the engine is switched on. If all conditions for automatic engine switch-off are fulfilled (▷ page 276), the green **ECO** symbol is shown in the multifunction display and the **Stop/Start active** message appears. If not all the conditions are fulfilled, the **ECO** symbol is shown in yellow and the **Stop/Start inactive** message is shown. If the ECO start/stop function is deactivated (▷ page 277), the **ECO** symbol is not shown.

⚠ WARNING

If the engine is switched off and the ECO symbol is shown in green in the multifunction display, the engine has been switched off automatically. All of the vehicle's systems

remain active. If you open the door, unfasten your seat belt or remove your foot from the brake pedal, the engine will automatically start. The vehicle may begin moving. You could suffer serious or even fatal injury or cause an accident resulting in injury or death. Never leave the vehicle while the ECO symbol in the multifunction display is shown in green or yellow. Always secure the vehicle against rolling away before leaving it.

- !** Always switch the ignition off and take the key with you when leaving the vehicle.

Automatic engine switch-off

The ECO start/stop function switches the engine off automatically if the vehicle is braked to a standstill and the brake remains depressed with the transmission in position **D** or **N**.

- i** You can still activate the HOLD function when the vehicle is stationary, even if the engine has been switched off automatically. It is then not necessary to continue applying the brakes during the automatic stop phase. When you depress the accelerator pedal, the engine starts automatically and the braking effect of the HOLD function is deactivated. Depress the accelerator pedal carefully, as the engine must be started first.

The engine is only switched off if:

- the outside temperature is within the range which is suitable for the system.
- the engine is at normal operating temperature.
- the set temperature for the vehicle interior has been reached.
- the battery is sufficiently charged.
- the system detects that the windshield is not fogged up when the air-conditioning system is switched on.
- the hood is closed.

- no engine-relevant diagnostics are active.
- the driver's door is closed and the seat belt is fastened.

Automatic engine start

The engine is started automatically if you:

- release the brake pedal when HOLD is not activated and the transmission is in position **D** or **N**
- shift the transmission to position **R**
- depress the accelerator pedal
- switch off the ECO start/stop function or switch to drive program **S** or **M**
- unfasten your seat belt or open the driver's door

The engine is also started automatically if:

- the vehicle starts to roll.
- the brake system requires this.
- the system detects moisture on the windshield when the air-conditioning system is switched on.
- the temperature in the vehicle interior deviates from the set range.
- the charge level of the battery is too low.

Deactivating/activating the ECO start/stop function

General notes

You can deactivate and activate the ECO start/stop function using COMAND (▷ page 235).

- i** You can also use the programmable button (▷ page 113) to activate and deactivate the ECO start/stop function if you have assigned this function to the button.

Deactivating

- ▶ Deactivate the ECO start/stop function using COMAND (▷ page 235). The **[ECO]** symbol goes out and the **Stop/Start deactivated** message is shown in the multifunction display.

- i** If drive program **S** or **M** has been selected, the ECO start/stop function is always deactivated.

Activating

- ▶ Activate the ECO start/stop function using COMAND (▷ page 235). The **[ECO]** symbol and the **Stop/Start active** message are shown in multifunction display. If not all conditions for automatic engine switch-off (▷ page 276) are fulfilled, the **Stop/Start inactive** message appears.
- i** If you activate the ECO Start/Stop function in drive programs **S** or **M**, drive program **C** is selected automatically.

Problems with the engine	
Problem	Possible causes/consequences and ► Solutions
The engine does not start. The starter motor can be heard.	<ul style="list-style-type: none"> • There is a malfunction in the engine electronics. • There is a malfunction in the fuel supply. <p>► Before attempting to start the engine again, turn the SmartKey in the ignition back to position 0 or press the Start/Stop button repeatedly until all indicator lamps in the instrument cluster go out.</p> <p>► Try to start the engine again (▷ page 274). Avoid excessively long and frequent attempts to start the engine as these will drain the battery.</p> <p>If the engine does not start after several attempts:</p> <p>► Consult a qualified specialist workshop.</p>
The engine does not start. You cannot hear the starter motor.	<p>The on-board voltage is too low because the battery is too weak or discharged.</p> <p>► Jump-start the vehicle (▷ page 445).</p> <p>If the engine does not start despite attempts to jump-start it:</p> <p>► Consult a qualified specialist workshop.</p> <p>The starter motor was exposed to a thermal load that was too high.</p> <p>► Allow the starter motor to cool down for approximately two minutes.</p> <p>► Try to start the engine again.</p> <p>If the engine still does not start:</p> <p>► Consult a qualified specialist workshop.</p>
The engine is not running smoothly and is misfiring.	<p>There is a malfunction in the engine electronics or in a mechanical component of the engine management system.</p> <p>► Only depress the accelerator pedal slightly. Otherwise, non-combusted fuel may get into the catalytic converter and damage it.</p> <p>► Have the cause rectified immediately at a qualified specialist workshop.</p>
The coolant temperature gauge shows a value above 248 °F (120 °C).	<p>The coolant level is too low. The coolant is too hot and the engine is no longer being cooled sufficiently.</p> <p>► Stop as soon as possible and allow the engine and the coolant to cool down.</p> <p>► Check the coolant level (▷ page 424). Observe the warning notes as you do so and add coolant if necessary.</p>

Automatic transmission

Important safety notes

WARNING

It is dangerous to shift the automatic transmission out of parking position **P** or neutral position **N** if the engine speed is higher than idle speed. If your foot is not firmly on the brake pedal, the vehicle could accelerate quickly forward or in reverse. You could lose control of the vehicle and hit someone or something. Only shift into gear when the engine is idling normally and when your right foot is firmly on the brake pedal.

WARNING

Keep in mind that turning off the engine alone only will shift the automatic transmission into neutral position **N** automatically.

Always shift the automatic transmission into park position **P** before turning off the engine. Otherwise the vehicle could roll away which could result in an accident and/or serious personal injury.

DIRECT SELECT lever

Overview of transmission positions

The DIRECT SELECT lever is on the right of the steering column.

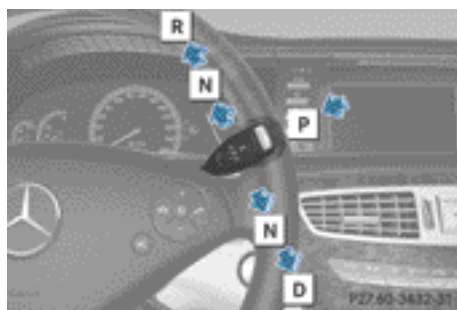

- P Park position with parking lock
- R Reverse gear
- N Neutral
- D Drive

-  The DIRECT SELECT lever always returns to its original position. The current transmission position **P**, **R**, **N** or **D** appears in the transmission position display (> page 280) in the multifunction display.

Engaging park position P

- ▶ Push the DIRECT SELECT lever in the direction of arrow **P**.

-  The automatic transmission shifts into park position **P** automatically:

- if you open the driver's door while the vehicle is stationary in transmission position **D** or **R**
- if you open the door while traveling at very low speeds in transmission position **D** or **R**

-  If the engine speed is too high or the vehicle is moving, do not shift the automatic transmission directly from **D** to **R**, from **R** to **D** or directly to **P**. The automatic transmission could otherwise be damaged.

Engaging reverse gear R

-  Only shift the automatic transmission to **R** when the vehicle is stationary.

-  The ECO start/stop function is not available when reverse gear is engaged. Further information on the ECO start/stop function (> page 276).

- ▶ When the vehicle is stationary, depress the brake pedal.
- ▶ Push the DIRECT SELECT lever up past the first point of resistance.

Neutral N with ECO start/stop function activated

The ECO start/stop function switches the engine off automatically if:

- the vehicle is braked until stationary while in neutral **N** and
- you continue to apply the brakes.

Further information on the ECO start/stop function (▷ page 276).

Shifting to neutral N

- ▶ When the vehicle is stationary, depress the brake pedal.
- ▶ Push the DIRECT SELECT lever up or down to the first point of resistance.

If the engine has been switched off, the automatic transmission automatically switches to **N**.

Remaining in neutral N

If the automatic transmission is to remain in neutral **N**, e.g. for washing the vehicle in car washes with a towing device, please observe the following instructions:

WARNING

When leaving the SmartKey in the starter switch, do not leave children unattended in the vehicle. It is possible for children to switch on the ignition which could result in unsupervised use of vehicle equipment. Unsupervised use of vehicle equipment could result in an accident and/or serious personal injury.

Using the SmartKey:

- make sure that the ignition is switched on.
- when the vehicle is stationary, depress the brake pedal and keep it depressed.
- shift to neutral **N**.
- release the brake pedal.
- if the electric parking brake is engaged, release it.
- switch off the ignition and leave the SmartKey in the ignition lock.

Using KEYLESS-GO:

- make sure that the ignition is switched on.
- when the vehicle is stationary, depress the brake pedal and keep it depressed.
- engage park position **P**.
- release the brake pedal.
- remove the Start/Stop button from the ignition lock.
- insert the SmartKey into the ignition lock.
- switch on the ignition.
- depress the brake pedal and keep it depressed.
- shift to neutral **N**.
- release the brake pedal.
- if the electric parking brake is engaged, release it.
- switch off the ignition and leave the SmartKey in the ignition lock.

Drive position D with ECO start/stop function activated

The ECO start/stop function switches the engine off automatically if:

- the vehicle is braked until stationary while in transmission position **D** and
- you continue to apply the brakes.

Further information on the ECO start/stop function (▷ page 276).

Engaging drive position D

- ▶ When the vehicle is stationary, depress the brake pedal.
- ▶ Push the DIRECT SELECT lever down past the first point of resistance.

Transmission position display

The current transmission position is shown in the multifunction display.

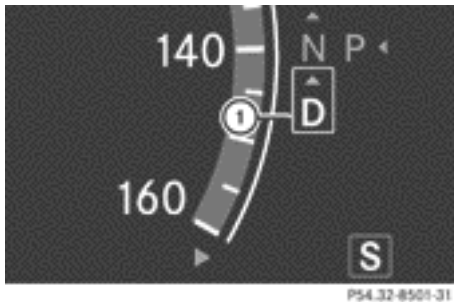

① Transmission position

- ① The arrows in the transmission position display show how and into which transmission positions you can change using the DIRECT SELECT lever.
- ❗ If the transmission position display in the multifunction display is not working, you should pull away carefully to check whether the desired transmission position is engaged. Ideally, you should select transmission position **D** and drive program **E** (drive program **C** on AMG vehicles) or **S**. Do not restrict the shift range.

Transmission positions

P Park position

Do not shift the transmission into position **P** unless the vehicle is stationary. The parking lock should not be used as a brake when parking. In addition to engaging the parking lock, you must always apply the electric parking brake to secure the vehicle.

If the vehicle electronics are malfunctioning, the transmission may be locked in position **P**. Have the vehicle electronics checked immediately at a qualified specialist workshop.

R Reverse gear

Only shift the transmission to **R** when the vehicle is stationary.

N Neutral

Do not shift the transmission to **N** while driving. The transmission could otherwise be damaged.

No power is transmitted from the engine to the drive wheels.

Releasing the brakes will allow you to move the vehicle freely, e.g. to push it or tow it.

If ESP[®] is deactivated or faulty: only shift the transmission to position **N** if the vehicle is in danger of skidding, e.g. on icy roads.

❗ Rolling in neutral **N** can damage the drive train.

D Drive

The automatic transmission changes gear automatically. All forward gears are available.

Changing gear

The automatic transmission shifts to the individual gears automatically when it is in transmission position **D**. This automatic gearshifting behavior is determined by:

- a shift range restriction, if selected
- the selected drive program
E/S or, for AMG vehicles,
C/S/M (▷ page 282)
- the position of the accelerator pedal
- the road speed

Driving tips

Kickdown

Use kickdown for maximum acceleration.

- ▶ **All vehicles (except AMG vehicles):**
depress the accelerator pedal beyond the point of resistance.
The transmission shifts to a lower gear depending on the engine speed.

Rocking the vehicle free

Rocking the vehicle free by shifting back and forth between transmission positions **D** and **R** can help to free a vehicle that has become stuck in mud or snow. The engine management system of the vehicle limits shifting back and forth between transmission positions **D** and **R** to a maximum speed of 5 mph (9 km/h). To shift back and forth between transmission positions **D** and **R**, move the selector lever up and down beyond the pressure point.

Working on the vehicle

WARNING

When working on the vehicle, engage the electronic parking brake and shift the automatic transmission into park position **P**. Otherwise the vehicle could roll away which

could result in an accident and/or serious personal injury.

Program selector button

General information

The program selector button influences:

- the drive program
- the AIRMATIC (▷ page 309) or ABC (▷ page 310) suspension settings
- the engine management

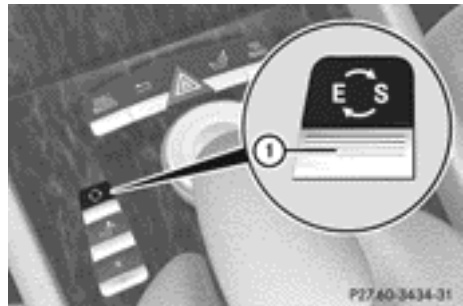

Program selector button

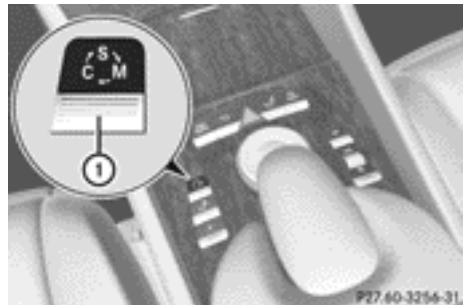

Program selector button on AMG vehicles

In AMG vehicles, drive program **E** is called drive program **C**.

E Economy	Comfortable, economical driving
C Controlled Efficiency	
S Sport	Sporty driving style
M Manual	Manual gear shifting

i For further information on the automatic drive program, see (▷ page 283).

AMG vehicles: only change from automatic drive program **C** or **S** to manual drive program **M** when the vehicle is stationary.

▶ Press program selector button ① repeatedly until the letter for the desired gearshift program appears in the multifunction display.

i When the engine is started, the automatic transmission always switches to automatic drive program **E** (drive program **C** in AMG vehicles).

Steering wheel paddle shifters

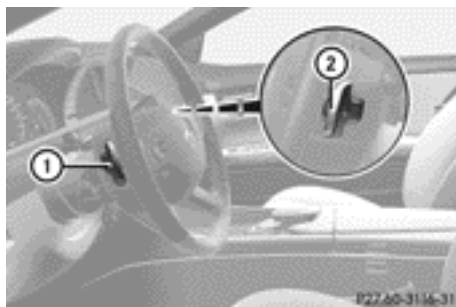

- ① Left-hand steering wheel paddle shifter
- ② Right-hand steering wheel paddle shifter

You can restrict or derestrict the shift range by using the steering wheel paddle shifters. You can change gear yourself by using the steering wheel paddle shifters in the manual drive program.

Automatic drive program

Drive program **E** (drive program **C** on AMG vehicles) is characterized by the following:

- the vehicle pulling away more gently in forward and reverse gears, unless the accelerator pedal is depressed fully
- increased sensitivity. This improves driving stability on slippery road surfaces, for example
- the automatic transmission shifting up sooner. This results in the vehicle being driven at lower engine speeds and the wheels being less likely to spin

Drive program **S** is characterized by the following:

- sporty engine settings
- the vehicle pulling away in first gear
- the automatic transmission shifting up later
- the fuel consumption possibly being higher as a result of the later automatic transmission shift points

Shift ranges

Introduction

When the automatic transmission is in position **D**, it is possible to restrict or derestrict the shift range (▷ page 283).

The shift range selected is shown in the multifunction display. The automatic transmission shifts only as far as the selected gear.

Shift range

- | | |
|----------|--|
| 3 | You can use the engine's braking effect. |
|----------|--|

2

To use the braking effect of the engine on downhill gradients and for driving:

- on steep mountain roads
- in mountainous terrain
- in arduous conditions

1

To use the braking effect of the engine on extremely steep downhill gradients and on long downhill stretches

Restricting the shift range

- ▶ Pull the left-hand steering wheel paddle shifter.
The automatic transmission shifts down one gear and restricts the shift range to the relevant gear.

- i** If the engine exceeds the maximum engine speed when shifting down, the automatic transmission protects against engine damage by not shifting down.
- i** If the maximum engine speed for the shift range is reached and you continue to accelerate, the automatic transmission shifts up in order to prevent the engine from overrevving, even if the shift range is restricted.

Derestricting the shift range

- ▶ Pull the right-hand steering wheel paddle shifter.
The shift range is derestricted.

Clearing the shift range restriction

- ▶ Pull and hold the right-hand steering wheel paddle shifter until **D** is shown again in the multifunction display.
The automatic transmission shifts from the current shift range directly to **D**.

Selecting the ideal shift range

- ▶ Pull the left-hand steering wheel paddle shifter and hold it in position.
The automatic transmission shifts to the gear which allows optimum acceleration and deceleration. To do this, the automatic transmission shifts down one or more gears.

Manual drive program

Switching on the manual drive program

The manual drive program is only available for AMG vehicles.

Manual drive program **M** is different from drive program **S** with regard to spontaneity, responsiveness and smoothness of gear changes.

Manual drive program **M** can be selected using the program selector button. In manual drive program **M**, you can change gear using the steering wheel paddle shifters if the transmission is in position **D**. The gear currently selected and engaged is shown in the multifunction display.

- ▶ Press the program selector button (▷ page 282) repeatedly until **M** appears in the multifunction display.

Upshifting

! In manual drive program **M**, the automatic transmission does not shift up automatically even when the engine limiting speed for the current gear is reached. When the engine limiting speed is reached, the fuel supply is cut to prevent the engine from overrevving. Always make sure that the engine speed does not reach the red area of the tachometer. There is otherwise a risk of engine damage.

- ▶ Pull the right-hand steering wheel paddle shifter (▷ page 283).
The automatic transmission shifts up to the next gear.

Before the engine speed reaches the red area, an upshift indicator appears in the multifunction display.

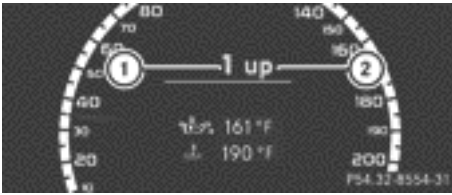

- ① Gear indicator
- ② Upshift indicator

Downshifting

► Pull the left-hand steering wheel paddle shifter (▷ page 283).
The automatic transmission shifts down to the next gear.

- i** If you brake the vehicle or stop without shifting down, the automatic transmission will shift down to a gear that will allow the vehicle to accelerate or pull away again.
- i** For maximum acceleration, pull the left-hand steering wheel paddle shifter until the transmission selects the optimum gear for the current speed.

Kickdown

- i** Kickdown is not possible in manual drive program **M**.

Switching off the manual drive program

► Press the program selector button (▷ page 282) repeatedly until **C** or **S** appears in the multifunction display.

Problems with the transmission

Problem	Possible causes/consequences and ► Solutions
The transmission has problems shifting gear.	The transmission is losing oil. ► Have the transmission checked at a qualified specialist workshop immediately.
The acceleration ability is deteriorating. The transmission no longer changes gear.	The transmission is in emergency mode. It is only possible to shift into second gear and reverse gear. ► Stop the vehicle. ► Shift the transmission to position P . ► Switch off the engine. ► Wait at least 10seconds before restarting the engine. ► Shift the transmission to position D or R . If D is selected, the transmission shifts into second gear; if R is selected, the transmission shifts into reverse gear. ► Have the transmission checked at a qualified specialist workshop immediately.

Transfer case

This section is only valid for vehicles with 4-wheel drive (4MATIC). Power is always transmitted to both axles.

❗ Performance tests may only be carried out on a 2-axle dynamometer. The brake system or transfer case could otherwise be damaged. Contact a qualified specialist workshop for a performance test.

❗ To prevent ESP® from intervening, the ignition must be switched off (SmartKey or the Start/Stop button in position **0** or **1**) if:

- the electric parking brake is being tested on a brake dynamometer.
- the vehicle is being towed with only one axle raised (not permitted for vehicles with 4MATIC).

The brake system could otherwise be damaged.

❗ Vehicles with 4MATIC must not be towed with either the front or the rear axle raised, as doing so will damage the transmission.

Refueling

Important safety notes

⚠ WARNING

Gasoline is highly flammable and poisonous. It burns violently and can cause serious personal injury.

Never allow sparks, flames or smoking materials near gasoline.

Turn off the engine before refueling.

Whenever you are around gasoline, avoid inhaling fumes and any skin or clothing contact.

Direct skin contact with fuels and the inhalation of fuel vapors are damaging to your health.

⚠ WARNING

Overfilling of the fuel tank may create pressure in the system which could cause a gas discharge. This could cause the gasoline to spray back out when removing the fuel pump nozzle, which could cause personal injury.

! Do not use diesel to refuel vehicles with a gasoline engine. Even small amounts of the wrong fuel result in damage to the fuel system and engine.

! Do not switch on the ignition if you accidentally refuel with the wrong fuel. Otherwise, the fuel will enter the fuel lines. Notify a qualified specialist workshop and have the fuel tank and fuel lines drained completely.

! Overfilling the fuel tank could damage the fuel system.

! Take care not to spill any fuel on painted surfaces. You could otherwise damage the paintwork.

! Use a filter when refueling from a fuel can. Otherwise, the fuel lines and/or injection system could be blocked by particles from the fuel can.

Further information on fuel and on fuel grades can be found in the "Fuel" section (▷ page 484).

Refueling

Fuel filler flap

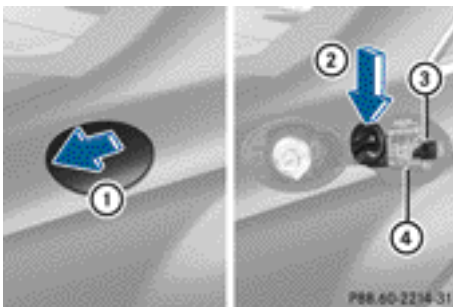

- ① To open the fuel filler flap
- ② To insert the fuel filler cap
- ③ Tire pressure table
- ④ Fuel type

The fuel filler flap is unlocked or locked automatically when you open or close the

vehicle with the SmartKey or with KEYLESS-GO.

The position of the fuel filler cap  is displayed in the instrument cluster. The arrow next to the filling pump indicates the side of the vehicle.

Opening

- ▶ Switch off the engine.
- ▶ Remove the SmartKey from the ignition lock.
- ▶ KEYLESS-GO: open the driver's door. This corresponds to SmartKey position **0**: "SmartKey removed". The driver's door can be closed again.
- ▶ Press the fuel filler flap in the direction of arrow ①. The fuel filler flap opens slightly.
- ▶ Open the fuel filler flap fully.
- ▶ Turn the fuel filler flap counter-clockwise and remove it.
- ▶ Insert the fuel filler cap into the holder bracket on the inside of filler flap ②.
- ▶ Completely insert the filler neck of the fuel pump nozzle into the tank and refuel.
- ▶ Only fill the tank until the pump nozzle switches off.

i Do not add any more fuel after the pump stops filling for the first time. Otherwise, fuel may leak out.

Closing

- ▶ Replace the cap on the filler neck and turn clockwise until it engages audibly.
- ▶ Close the fuel filler flap.

i If you drive with the fuel filler cap open, the reserve fuel warning lamp flashes. In addition, the  Check Engine warning lamp may light up. A message appears in the multifunction display (▷ page 374).

For further information on warning and indicator lamps in the instrument cluster, see (▷ page 396).

- i** Close the fuel filler flap before locking the vehicle. Otherwise, the locking pin of the central locking prevents the fuel filler flap from closing.

Problems with fuel and the fuel tank	
Problem	Possible causes/consequences and ► Solutions
Fuel is leaking from the vehicle.	<p> Risk of explosion or fire</p> <p>The fuel line or the fuel tank is faulty.</p> <ul style="list-style-type: none"> ► Turn the SmartKey to position 0 in the ignition lock and remove it immediately (▷ page 273). ► Do not restart the engine under any circumstances. ► Consult a qualified specialist workshop.
The fuel filler flap cannot be opened.	<p>The fuel filler flap is not unlocked.</p> <p>or</p> <p>The SmartKey battery is discharged.</p> <ul style="list-style-type: none"> ► Unlock the vehicle . <p>or</p> <ul style="list-style-type: none"> ► Unlock the vehicle using the mechanical key (▷ page 77).
	<p>The fuel filler flap is unlocked, but the opening mechanism is jammed.</p> <ul style="list-style-type: none"> ► Consult a qualified specialist workshop.

Parking

Important safety notes

WARNING

Do not park this vehicle in areas where combustible materials can come into contact with the hot exhaust system. Combustible materials, such as grass, hay or leaves could be ignited by the hot exhaust system and cause a vehicle fire. Do not park the vehicle on dry grassland or harvested grain fields.

Unintended vehicle movement can cause serious personal injury or damage to the vehicle or the vehicle drivetrain. To reduce such risks, always do the following before turning off the engine and leaving the vehicle:

- keep your right foot on the brake pedal.
- engage the electric parking brake.
- shift the automatic transmission into park position **P**.
- slowly release the brake pedal.

- when parked on an incline, always turn the front wheels towards the road curb.
- turn the SmartKey in the ignition lock to position **0** and remove the SmartKey from the ignition lock, or press the KEYLESS-GO Start/Stop button.
- take the SmartKey with you and lock the vehicle when leaving.

Switching off the engine

Important safety notes

WARNING

Do not turn off the engine before the vehicle has come to a complete stop. With the engine not running, there is no power assistance for the brake and steering systems. In this case, it is important to keep in mind that a considerably higher degree of effort is necessary to brake and steer the vehicle.

⚠ WARNING

Keep in mind that turning off the engine alone only will shift the automatic transmission into neutral position **N** automatically.

Always shift the automatic transmission into park position **P** before turning off the engine.

Otherwise the vehicle could roll away which could result in an accident and/or serious personal injury.

- ❗ If you cannot turn off the engine as described here, see "Engine emergency stop" (▷ page 451).

Vehicles with automatic transmission

- ▶ Apply the electric parking brake.
- ▶ Shift the transmission to position **P**.

Using the SmartKey

- ▶ Turn the SmartKey to position **0** in the ignition lock and remove it. The immobilizer is activated.
- ❗ If you turn off the engine with the SmartKey and then remove it from the ignition lock or open a front door, the automatic transmission shifts to **P** automatically.

Using KEYLESS-GO

- ▶ Press the Start/Stop button (▷ page 273). The engine stops and all the indicator lamps in the instrument cluster go out.
- ❗ When the driver's door is closed, this corresponds to SmartKey position **1**. When the driver's door is open, it corresponds to SmartKey position **0** or "SmartKey removed".
- ❗ If you use the Start/Stop button to switch off the engine, the automatic transmission shifts to **N** automatically. If you then open the driver's or front-passenger door, the automatic transmission shifts to **P**.
- ❗ In an emergency, the engine can be turned off while the vehicle is in motion by

pressing and holding the Start/Stop button for 3 seconds. This function operates independently from the ECO start/stop automatic engine switch-off function.

Electric parking brake**General notes****⚠ WARNING**

When leaving the vehicle, always remove the SmartKey from the starter switch, take it with you, and lock the vehicle. Do not leave children unattended in the vehicle, or with access to an unlocked vehicle. Children could release the parking brake and/or shift the automatic transmission out of park position **P**, either of which could result in an accident and/or serious personal injury.

**Applying/releasing manually**

- ▶ **To engage:** push handle ①. When the electric parking brake is engaged, the **PARK** (USA only) or **(P)** (Canada only) red indicator lamp lights up in the instrument cluster.
- ❗ The electric parking brake can also be applied when the SmartKey is removed.
- ▶ **To release:** switch on the ignition.
- ▶ Pull handle ①. The red **PARK** (USA only) or **(P)** (Canada only) indicator lamp in the instrument cluster goes out.

- i** The electric parking brake can only be released:
 - if the SmartKey is in position **1** in the ignition lock or
 - if the ignition was switched on using the Start/Stop button.

Engaging the electric parking brake automatically

If the HOLD function or DISTRONIC PLUS brake the vehicle until it is stationary, the electric parking brake is automatically applied. Additionally, at least one of the following conditions must be fulfilled:

- the engine is switched off.
- the driver's door is open and the seat belt is not fastened.
- the hood is released.
- the trunk lid is opened while the automatic transmission is in position **R**.
- the vehicle is stationary for a lengthy period.

The red **PARK** (USA only) or **(P)** (Canada only) indicator lamp in the instrument cluster lights up.

- i** In addition to the electric parking brake, **P** may also be engaged automatically.

Releasing the electric parking brake automatically

The electric parking brake is released automatically when the following conditions are simultaneously fulfilled:

- the engine is running.
- the automatic transmission is in position **D** or **R**.
- the hood is closed.
- your seat belt is fastened.
- you accelerate.

If the automatic transmission is in position **R**, the trunk lid must be closed.

If your seat belt is not fastened, the following conditions must be fulfilled to automatically release the electric parking brake:

- the driver's door is closed.
- you have shifted out of **P** or you have previously driven faster than 3 km/h.
- you have shifted out of **P** or you have previously driven faster than 2 mph (3 km/h).

Emergency braking

The vehicle can also be braked during an emergency by using the electric parking brake.

- ▶ While driving, push handle **1** of the electric parking brake (▷ page 290).

- i** The vehicle is braked as long as you keep the handle of the electric parking brake pressed. The longer the electric parking brake handle is depressed, the greater the braking force.

During braking:

- a warning tone sounds.
- the **Please Release Parking Brake** message appears
- the red **PARK** (USA only) or **(P)** (Canada only) indicator lamp in the instrument cluster appears.

When the vehicle has been braked to a standstill, the electric parking brake is engaged.

Parking the vehicle for a long period

If you leave the vehicle parked for longer than four weeks, the battery may be damaged by exhaustive discharging.

- ▶ Connecting a trickle charger.
- i** You can obtain information about trickle chargers from a qualified specialist workshop.

If you leave the vehicle parked for longer than six weeks, the vehicle may suffer damage as a result of lack of use.

- ▶ Visit a qualified specialist workshop and seek advice.

Driving tips

General driving tips

Important safety notes

WARNING

Always remember that you must concentrate primarily on driving the vehicle. The driver's concentration must always be directed primarily at road traffic. For your own safety and that of others, we recommend that you stop the vehicle at a safe place and in accordance with the traffic conditions before making or accepting a phone call.

Comply with all legal requirements if you use the telephone while driving. Use the hands-free system and only use the telephone when road, weather and traffic conditions permit. In some jurisdictions, it is forbidden for drivers to use mobile phones while driving.

Only operate COMAND (Cockpit Management and Data System) in compliance with all legal requirements and when the road, weather and traffic conditions permit. You may otherwise not be able to observe the traffic conditions, endangering yourself and others.

Remember that your vehicle covers a distance of 44 ft (approximately 14 m) a second when it is traveling at only 30 mph (approximately 50 km/h).

Drive sensibly – save fuel

Observe the following tips to save fuel:

- ▶ The tires should always be inflated to the recommended tire pressure.
- ▶ Remove unnecessary loads.
- ▶ Remove roof racks when they are not needed.

- ▶ Warm up the engine at low engine speeds.
- ▶ Avoid frequent acceleration or braking.
- ▶ Have all maintenance work carried out as indicated by the service intervals in the Maintenance Booklet or by the service interval display.

Fuel consumption also increases when driving in cold weather, in stop-and-go traffic and in mountainous terrain.

Drinking and driving

WARNING

Drinking and driving and/or taking drugs and driving are very dangerous combinations. Even a small amount of alcohol or drugs can affect your reflexes, perceptions and judgment.

The possibility of a serious or even fatal accident are greatly increased when you drink or take drugs and drive.

Do not drink or take drugs and drive or allow anyone to drive who has been drinking or taking drugs.

Pedals

WARNING

Make sure absolutely no objects are obstructing the pedals' range of movement. Keep the driver's footwell clear of all obstacles. If there are any floor mats or carpets in the footwell, make sure that the pedals still have sufficient clearance.

During sudden driving or braking maneuvers, the objects could get caught between the pedals. You could then no longer brake or accelerate. This could lead to accidents and injury.

Rolling with the engine switched off

WARNING

There is no power assistance for the steering and the brake when the engine is not running.

Steering and braking requires significantly more effort and you could lose control of the vehicle and cause an accident as a result.

Do not turn off the engine while the vehicle is in motion.

Exhaust check

WARNING

Inhalation of exhaust gas is hazardous to your health. All exhaust gas contains carbon monoxide (CO), and inhaling it can cause unconsciousness and possible death.

Do not run the engine in confined areas (such as a garage) which are not properly ventilated. If you think that exhaust gas fumes are entering the vehicle while driving, have the cause determined and corrected immediately. If you must drive under these conditions, drive only with at least one window fully open at all times.

Certain engine systems are designed to keep the level of poisonous components in exhaust fumes within legal limits.

These systems only work at peak efficiency if they are serviced exactly in accordance with the manufacturer's specifications. For this reason, all work on the engine should only be carried out by qualified and authorized Mercedes-Benz technicians.

The engine settings must not be changed under any circumstances. Furthermore, all specific service work must be carried out at regular intervals and in accordance with the Mercedes-Benz service requirements. Details can be found in the Maintenance Booklet.

Braking

Important safety notes

WARNING

On slippery road surfaces, never downshift in order to obtain braking action. This could result in drive wheel slip and reduced vehicle

control. Your vehicle's ABS will not prevent this type of loss of control.

WARNING

Make sure that you do not endanger other road users when you apply the brakes.

Downhill gradients

! On long and steep gradients, you must reduce the load on the brakes by shifting early to a lower gear. This allows you to take advantage of the engine braking effect and helps avoid overheating and excessive wear of the brakes.

When you take advantage of the engine braking effect, a drive wheel may not turn for some time, e.g. on a slippery road surface. This could cause damage to the drive train. This type of damage is not covered by the Mercedes-Benz warranty.

Heavy and light loads

WARNING

Depressing the brake pedal constantly results in excessive and premature wear to the brake pads.

It may also cause the brakes to overheat, seriously impairing their effectiveness. It may then not be possible to stop the vehicle in sufficient time to avoid an accident.

If the brakes have been subjected to a heavy load, do not stop the vehicle immediately, but drive on for a short while. This allows the airflow to cool the brakes more quickly.

Wet roads

WARNING

After driving in heavy rain for some time without applying the brakes or through water deep enough to wet brake components, the first braking action may be somewhat reduced. You have to depress the brake pedal

more firmly. Maintain a safe distance from vehicles in front.

After driving on a wet road or having the vehicle washed, brake firmly while paying attention to the traffic conditions. This will warm up the brake discs, thereby drying them more quickly and protecting them against corrosion.

Limited braking performance on salt-treated roads

WARNING

The layer of salt on the brake discs and the brake pads/linings may cause a delay in the braking effect, resulting in a significantly longer braking distance, which could lead to an accident.

To avoid this danger, you should:

- occasionally brake carefully, without putting other road users at risk, when you are driving on salted roads. This helps to remove any salt that may have started to build up on the brake discs and the brake pads/linings.
- maintain a greater distance to the vehicle ahead and drive with particular care.
- carefully apply the brakes at the end of a trip and immediately after commencing a new trip, so that salt residues are removed from the brake discs.

Servicing the brakes

 If the red brake warning lamp lights up in the instrument cluster and you hear a warning tone while the engine is running, the brake fluid level may be too low. Observe additional warning messages in the multifunction display.

The brake fluid level may be too low due to brake pad wear or leaking brake lines.

Have the brake system checked immediately. This work should be carried out at a qualified specialist workshop.

All checks and maintenance work on the brake system must be carried out at a qualified specialist workshop. Consult a qualified specialist workshop to arrange this. Have brake pads installed and brake fluid replaced at a qualified specialist workshop.

WARNING

If brake pads or brake fluid other than those recommended are used, the braking properties of the vehicle can be degraded to an extent that safe braking is substantially impaired. This could result in an accident.

 **Vehicles with 4MATIC:** function or performance tests may only be carried out on a 2-axle dynamometer. If you are planning to have the vehicle tested on such a dynamometer, contact an authorized Mercedes-Benz Center to obtain further information first. Otherwise, you could damage the drive train or the brake system.

 **Vehicles with 4MATIC:** as the ESP[®] system operates automatically, the engine and the ignition must be switched off (SmartKey in position **0** or **1** in the ignition lock or Start/Stop button in position **0** or **1**) when the electric parking brake is being tested on a brake dynamometer.

Braking maneuvers triggered automatically by ESP[®] may seriously damage the brake system.

 **Vehicles with 4MATIC:** as the ESP[®] system operates automatically, the engine and the ignition system must be switched off (SmartKey in position **0** or **1** in the ignition lock or Start/Stop button in position **0** or **1**) when:

- testing the electric parking brake on a brake dynamometer.
- you intend to have the vehicle towed with one of the axles raised.

Braking maneuvers triggered automatically by ESP[®] may seriously damage the brake system.

If the brake system has only been subject to moderate loads, you should test the functionality of your brakes at regular intervals. To do so, press firmly on the brake pedal when driving at a high speed. This improves the grip of the brake pads.

WARNING

Make sure that you do not endanger other road users when you apply the brakes.

You can find a description of Brake Assist (BAS) on (▷ page 65) or of BAS PLUS on (▷ page 66).

High-performance brake system for AMG vehicles

The high-performance brake system is installed only on the CL 63 AMG and CL 65 AMG.

WARNING

New vehicle brake pads and discs, and replacement brake pads and discs may take several hundred miles of driving until they provide optimum braking efficiency. Until that time, you may need to use increased brake pedal pressure while braking. Please be aware of this and adjust your driving and braking accordingly during this break-in period.

Excessive high-demand braking will cause correspondingly high brake wear. Please be attentive to the brake warning lamp in the instrument cluster and brake condition messages in the multifunction display. Especially for high performance driving, it is important to maintain and have the brake system checked regularly.

The high-performance brake system is designed for heavy loads. This may lead to noise when braking. This will depend on:

- speed
- braking force
- environmental conditions, such as temperature and humidity

The wear of individual components of the brake system, such as the brake pads/linings or brake discs, depends on the individual driving style and operating conditions.

For this reason, it is impossible to state a mileage that will be valid under all circumstances. An aggressive driving style will lead to high wear. You can obtain further information about this from your authorized Mercedes-Benz Center.

Driving on wet roads

Hydroplaning

If water has accumulated to a certain depth on the road surface, there is a danger of hydroplaning occurring, even if:

- you drive at low speeds.
- the tires have adequate tread depth.

For this reason, in the event of heavy rain or in conditions in which hydroplaning can occur, you must drive in the following manner:

- lower your speed.
- avoid ruts.
- brake carefully.

Driving on flooded roads

 Do not drive through flooded areas. Check the depth of any water before driving through it. Drive slowly through standing water. Otherwise, water may enter the vehicle interior or the engine compartment. This can damage the electronic components in the engine or the automatic transmission. Water can also be drawn in by the engine's air suction nozzles and this can cause engine damage.

Winter driving

Important safety notes

WARNING

If the vehicle becomes trapped in snow, ensure that snow is kept away from the exhaust pipe and from around the vehicle as long as the engine is running. Otherwise, poisonous carbon monoxide (CO) may enter the vehicle, resulting in loss of consciousness and even death.

To assure sufficient fresh air ventilation, open a window slightly on the side of the vehicle not facing the wind.

Have your vehicle winterproofed at a qualified specialist workshop at the onset of winter. Observe the notes in the "Winter operation" section (▷ page 456).

Driving with summer tires

Observe the notes in the "Winter operation" section (▷ page 456).

Slippery road surfaces

WARNING

The outside temperature indicator is not designed to serve as an ice-warning device and is therefore unsuitable for that purpose. Indicated temperatures just above the freezing point do not guarantee that the road surface is free of ice. The road may still be icy, especially in wooded areas or on bridges.

WARNING

On slippery road surfaces, never downshift in order to obtain braking action. This could result in drive wheel slip and reduced vehicle control. Your vehicle's ABS will not prevent this type of loss of control.

Drive particularly carefully on slippery road surfaces. Avoid sudden acceleration, steering and braking maneuvers. Do not use the cruise control or DISTRONIC PLUS.

If the vehicle threatens to skid or cannot be stopped when moving at low speed:

► Shift the transmission to position N.

 For more information on driving with snow chains, see (▷ page 457).

WARNING

Make sure that you do not endanger other road users when you apply the brakes.

Driving systems

Cruise control

Important safety notes

Cruise control maintains a constant road speed for you. It brakes automatically in order to avoid exceeding the set speed. On long and steep downhill gradients, especially if the vehicle is laden, you must select shift range **1**, **2** or **3** in good time. By doing so, you will make use of the braking effect of the engine, which relieves the load on the brake system and prevents the brakes from overheating and wearing too quickly.

Use cruise control only if road and traffic conditions make it appropriate to maintain a steady speed for a prolonged period. You can store any road speed above 20 mph (30 km/h).

WARNING

The cruise control is a convenience system designed to assist the driver during vehicle operation. The driver is and must always remain responsible for the vehicle's speed and for safe brake operation.

Only use the cruise control if the road, traffic, and weather conditions make it advisable to travel at a constant speed.

- The use of the cruise control can be dangerous on winding roads or in heavy

traffic because conditions do not allow safe driving at a constant speed.

- The use of the cruise control can be dangerous on slippery roads. Rapid changes in tire traction can result in wheel spin and loss of control.
- Deactivate the cruise control when driving in fog.

The "Resume" function should only be operated if the driver is fully aware of the previously set speed and wishes to resume this particular preset speed.

Cruise control lever

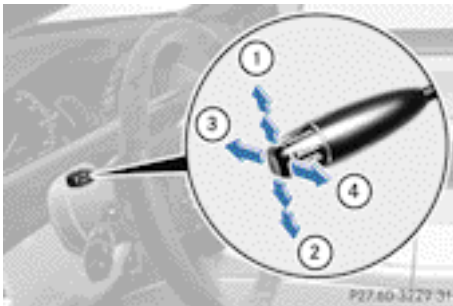

- ① To activate or increase speed
- ② To activate or reduce speed
- ③ To deactivate cruise control
- ④ To activate at the current speed/last stored speed

When you activate cruise control, the stored speed is shown in the multifunction display for five seconds. A triangle is also shown in the speedometer. The speedometer dial lights up between the set speed and the maximum speed.

Storing and maintaining the current speed

You can store the current speed if you are driving faster than 20 mph (30 km/h).

- ▶ Accelerate the vehicle to the desired speed.
- ▶ Briefly press the cruise control lever up ① or down ②.
- ▶ Remove your foot from the accelerator pedal.
Cruise control is activated. The vehicle automatically maintains the stored speed.

- ① Cruise control may be unable to maintain the stored speed on uphill gradients. The stored speed is resumed when the gradient evens out. Cruise control maintains the stored speed on downhill gradients by automatically applying the brakes.

Storing the current speed or calling up the last stored speed

WARNING

The set speed stored in memory should only be set again if prevailing road conditions and legal speed limits permit. Possible acceleration or deceleration differences arising from returning to the preset speed could cause an accident and/or serious injury to you and others.

- ▶ Briefly pull the cruise control lever towards you ④.
- ▶ Remove your foot from the accelerator pedal.
The first time cruise control is activated, it stores the current speed or regulates the speed of the vehicle to the previously stored speed.

Setting a speed

WARNING

Keep in mind that it may take a brief moment until the vehicle has made the necessary adjustments.

Increase or decrease the set vehicle speed to a value that the prevailing road conditions and legal speed limits permit. Otherwise, sudden and unexpected acceleration or deceleration

of the vehicle could cause an accident and/or serious injury to you and others.

► Press the cruise control lever up ① for a higher speed or down ② for a lower speed.

► **To adjust the speed in 1 mph increments (1 km/h increments):** briefly press the cruise control lever up ① or down ② to the pressure point.

The last speed stored is increased or decreased every time the cruise control lever is pushed up ① or down ②.

► **To adjust the speed in 5 mph increments (10 km/h increments):** briefly press the cruise control lever up ① or down ② beyond the pressure point.

The last speed stored is increased or decreased every time the cruise control lever is pushed up ① or down ②.

i Cruise control is not deactivated if you depress the accelerator pedal. For example, if you accelerate briefly to overtake, cruise control adjusts the vehicle's speed to the last speed stored after you have finished overtaking.

Deactivating cruise control

There are several ways to deactivate cruise control:

► Briefly press the cruise control lever forwards ③.

or

► Brake.

Cruise control is automatically deactivated if:

- you engage the electric parking brake.
- you are driving at less than 20 mph (30 km/h)
- ESP® intervenes or you deactivate ESP®.
- you shift the transmission to position **N** while driving.

If cruise control is deactivated, you will hear a warning tone. You will see the **Cruise**

Control Off message in the multifunction display for approximately five seconds.

i When you switch off the engine, the last speed stored is cleared.

DISTRONIC PLUS

Important safety notes

DISTRONIC PLUS regulates the speed and automatically helps you maintain the distance to the vehicle detected in front. DISTRONIC PLUS brakes automatically so that the set speed is not exceeded.

On long and steep downhill gradients, especially if the vehicle is laden, you must select shift range **1**, **2** or **3** in good time. By doing so, you will make use of the braking effect of the engine. This relieves the load on the brake system and prevents the brakes from overheating and wearing too quickly.

If DISTRONIC PLUS detects a slower-moving vehicle in front, your vehicle is braked in order to maintain the preset distance to the vehicle in front.

WARNING

The DISTRONIC PLUS requires familiarity with its operational characteristics. We strongly recommend that you review the following information carefully before operating the system.

WARNING

When DISTRONIC brakes, the brake pedal is pulled back (i.e. operated automatically). The area around the pedal must not be blocked by obstacles:

- do not place any objects in the footwell.
- ensure that floor mats and carpets are fixed securely. In particular, do not place several floor mats on top of one another.
- do not place your foot under the brake pedal, as it could become trapped.

Non-compliance could lead you to cause an accident in which you and/or others could be seriously injured.

WARNING

The DISTRONIC PLUS is a convenience system. Its speed adjustment reduction capability is intended to make cruise control more effective and usable when traffic speeds vary. It is not however, intended to, nor does it, replace the need for extreme care.

The responsibility for the vehicle's speed, distance to the preceding vehicle and, most importantly, brake operation to ensure a safe stopping distance, always remains with the driver.

The DISTRONIC PLUS cannot take street and traffic conditions into account.

Complex driving situations are not always fully recognized by the DISTRONIC PLUS. This could result in wrong or missing distance warnings.

For DISTRONIC PLUS to assist you, the radar sensor system must be operational.

If there is no vehicle in front, DISTRONIC PLUS operates in the same way as cruise control in the speed range between 20 mph (Canada: 30 km/h) and 120 mph (Canada: 200 km/h). If a vehicle is driving in front of you, it operates in the speed range between 0 mph (0 km/h) and 120 mph (Canada: 200 km/h).

Do not use DISTRONIC PLUS while driving on roads with steep gradients.

As DISTRONIC PLUS transmits radar waves, it can resemble the radar detectors of the responsible authorities. You can refer to the relevant chapter in the Operator's Manual if questions are asked about this.

USA only:

This device has been approved by the FCC as a "Vehicular Radar System". The radar sensor is intended for use in an automotive radar system only. Removing, tampering with, or altering the device will void any

warranties, and is not permitted by the FCC. Do not tamper with, alter, or use in any non-approved way.

Any unauthorized modification to this device could void the user's authority to operate the equipment.

Canada only: This device complies with RSS-210 of Industry Canada. Operation is subject to the following two conditions:

1. This device may not cause harmful interference, and
 2. this device must accept any interference received, including interference that may cause undesired operation of the device.
- Removal, tampering, or altering of the device will void any warranties, and is not permitted. Do not tamper with, alter, or use in any non-approved way.

Any unauthorized modification to this device could void the user's authority to operate the equipment.

WARNING

DISTRONIC PLUS distance is not a substitute for the active intervention of the driver. It does not detect pedestrians or stationary objects, nor can it detect, recognize or predict the road's course or the movements of vehicles in front. DISTRONIC PLUS can only brake the vehicle using 40% of the vehicle's maximum available brake force.

DISTRONIC PLUS may not detect narrow vehicles driving in front, e.g. motorcycles, or vehicles driving in the lane beyond the lane next to your vehicle, especially if the vehicles are not driving on the middle of their lane.

The driver must always pay careful attention to the road, weather and traffic conditions. The driver must drive, steer and brake in a manner which will allow him to always have control of the vehicle.

Sources of high-frequency radio waves, such as toll stations, speed-measuring radar, etc., can cause DISTRONIC PLUS to fail temporarily.

⚠ WARNING

The DISTRONIC PLUS cannot take road and traffic conditions into account. Only use the DISTRONIC PLUS if the road, weather and traffic conditions make it advisable to travel at a constant speed.

⚠ WARNING

Use of the DISTRONIC PLUS can be dangerous on slippery roads. Rapid changes in tire traction can result in wheel spin and loss of control.

The DISTRONIC PLUS does not function in adverse sight and distance conditions. Do not use the DISTRONIC PLUS during conditions of fog, heavy rain, snow or sleet.

⚠ WARNING

The DISTRONIC PLUS cannot take weather conditions into account. Switch off the DISTRONIC PLUS or do not switch it on if:

- roads are slippery or covered with snow or ice. The wheels could lose traction while braking or accelerating, and the vehicle could skid.
- the DISTRONIC PLUS system sensor covers are dirty or visibility is diminished due to snow, rain or fog, for example. The distance control system functionality could be impaired.

Always pay attention to surrounding traffic conditions even while the DISTRONIC PLUS is switched on. Otherwise, you may not be able to recognize dangerous situations until it is too late. This could cause an accident in which you and/or others could be injured.

⚠ WARNING

The "Resume" function should only be operated if the driver is fully aware of the previously set speed and wishes to resume this particular preset speed.

⚠ WARNING

Your undivided attention to street and traffic conditions is necessary at all times whether DISTRONIC PLUS is active or not.

The use of DISTRONIC PLUS can be dangerous on winding roads or in heavy traffic because conditions do not allow safe driving at a constant speed.

DISTRONIC PLUS does not react to stationary objects on the road (for example, a vehicle stopped in traffic or an abandoned vehicle). DISTRONIC PLUS likewise does not react to oncoming vehicles.

Deactivate DISTRONIC PLUS:

- when changing to the right lane, if the vehicles in the left lane are driving slower
- when driving into a filter lane or an expressway exit
- in complex driving situations, for example in construction sites on an expressway

In these situations DISTRONIC PLUS will maintain the set speed if it is not deactivated.

DISTRONIC PLUS is intended only for maintaining a set speed and a set distance from the objects moving in front of the vehicle.

⚠ WARNING

An intermittent warning sounds and the distance warning lamp  in the instrument cluster is illuminated if the DISTRONIC PLUS system calculates that the distance to the vehicle ahead and your vehicle's current speed indicate that the DISTRONIC PLUS will not be capable of slowing the vehicle sufficiently to maintain the preset following distance, which creates a danger of a collision.

Immediately brake the vehicle to increase your distance to the preceding vehicle. The warning sound is intended as a final caution in which you should intercede with your own braking inputs to avoid a potentially dangerous situation. Do not wait for the operation of the warning signal to intercede

with your own braking. This will result in potentially dangerous emergency braking which will not always result in an impact being avoided.

Tailgating increases the risk of an accident.

WARNING

DISTRONIC PLUS brakes your vehicle with a maximum deceleration of 13 ft/s² (4 m/s²). This corresponds to approximately 40% of your vehicle's maximum braking force.

To avoid a collision, you must apply the brakes yourself. DISTRONIC PLUS brakes the vehicle just enough to restore the preset speed or the preset distance to the vehicle in front.

WARNING

If you do not receive visual or acoustic warning signals during a critical traffic situation, DISTRONIC PLUS has either not recognized the collision risk, has been deactivated or is malfunctioning.

Remember, whether or not DISTRONIC PLUS is operating, it is ultimately always the drivers responsibility to apply the brakes in order to control the vehicle and avoid a collision.

Cruise control lever

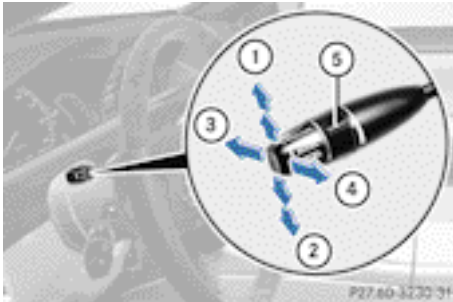

- ① To store the current speed or a higher speed
- ② To store the current speed or a lower speed
- ③ To deactivate DISTRONIC PLUS

- ④ Storing the current speed or calling up the last stored speed
- ⑤ Setting the specified minimum distance

Switching on DISTRONIC PLUS, storing and maintaining the current speed

Important safety notes

WARNING

The vehicle can be braked when DISTRONIC PLUS is activated. For this reason, deactivate DISTRONIC PLUS if the vehicle is to be set in motion by other means (e.g. in a car wash or by towing).

In order to activate DISTRONIC PLUS, the following conditions must be fulfilled:

- the engine must be started. It may take up to two minutes after pulling away before DISTRONIC PLUS is operational.
- the electric parking brake must be released.
- ESP® must be active, but not intervening.
- the transmission must be in position **D**.
- the hood must be closed.
- the driver's door must be closed when you shift from **P** to **D** or your seat belt must be fastened.
- the front-passenger door must be closed.
- the vehicle must not skid.

Activating while driving

When driving at speeds below 20 mph (30 km/h), you can only activate DISTRONIC PLUS if the vehicle in front has been detected and is shown in the multifunction display. If the vehicle in front is no longer detected and displayed, DISTRONIC PLUS switches off and a tone sounds.

- ▶ Briefly pull the cruise control lever towards you ④, or press it up ① or down ②. DISTRONIC PLUS is selected.
- ▶ Press the cruise control lever repeatedly up ① or down ② until the desired speed is set.
- ▶ Remove your foot from the accelerator pedal.
Your vehicle adapts its speed to that of the vehicle in front, but only up to the desired stored speed.
- ❗ If you do not fully release the accelerator pedal, the **DISTRONIC PLUS Override** message appears in the multifunction display. The set distance to a slower-moving vehicle in front will then not be maintained. You will be driving at the speed you determine by the position of the accelerator pedal.

Activating when driving towards a stationary vehicle

If the vehicle in front of you is stationary, you can only activate DISTRONIC PLUS once your vehicle is stationary as well.

- ▶ Briefly pull the cruise control lever towards you ④, or press it up ① or down ②. DISTRONIC PLUS is selected.
- ❗ DISTRONIC PLUS can only be activated at under 20 mph (30km/h) if a vehicle in front has been detected. Therefore, the DISTRONIC PLUS distance display in the instrument cluster should be activated (▷ page 347).
- ▶ Press the cruise control lever repeatedly up ① or down ② until the desired speed is set.
- ❗ You can use the cruise control lever to set the stored speed and the control on the cruise control lever to set the specified minimum distance (▷ page 304).

Pulling away

- ▶ **If the vehicle in front pulls away:** remove your foot from the brake pedal.
 - ▶ Briefly pull the cruise control lever towards you ④.
- or
- ▶ Accelerate briefly.
Your vehicle pulls away and adapts its speed to that of the vehicle in front.

Driving

If there is no vehicle in front, DISTRONIC PLUS operates in the same way as cruise control.

If DISTRONIC PLUS detects that the vehicle in front has slowed down, it brakes your vehicle. In this way, the distance you have selected is maintained.

If DISTRONIC PLUS detects that the vehicle in front is driving faster, it accelerates your vehicle, but only up to the speed you have stored.

WARNING

If you depress the brake, DISTRONIC PLUS is deactivated unless your vehicle is stationary. DISTRONIC PLUS then no longer brakes your vehicle. In such cases, control the distance from vehicles travelling in front with the brake alone. You could otherwise cause an accident and thereby injure yourself and others. The driver remains fully responsible for the vehicle's distance from other vehicles, the speed being driven and for braking in good time.

Changing lanes

If you change to the passing lane, DISTRONIC PLUS supports you when:

- you are driving faster than 40mph (60 km/h).
- DISTRONIC PLUS is maintaining the distance to a vehicle in front.
- you switch on the appropriate turn signal.
- DISTRONIC PLUS does not detect a danger of collision.

If these conditions are fulfilled, your vehicle is accelerated. Acceleration will be interrupted if changing lanes takes too long or if the distance between your vehicle and the vehicle in front becomes too small.

- i** When changing lanes, DISTRONIC PLUS monitors the left lane on left-hand drive vehicles and the right lane on right-hand drive vehicles.

WARNING

DISTRONIC PLUS and Active Blind Spot Assist are only aids designed to assist driving.

They do not relieve you of the responsibility of paying attention. The driver remains fully responsible for the vehicle's distance from other vehicles, the vehicle's speed and for braking in good time. Always pay attention to traffic conditions and your surroundings. Otherwise, you may fail to recognize dangers in time, cause an accident and injure yourself and others.

Stopping

WARNING

Never get out of the vehicle when DISTRONIC PLUS is activated.

DISTRONIC PLUS must also never be operated, activated or deactivated by a passenger or from outside the vehicle.

DISTRONIC PLUS does not replace the electric parking brake and must not be used for parking.

The DISTRONIC PLUS braking effect is canceled and the vehicle can start moving if:

- DISTRONIC PLUS is deactivated using the cruise control lever.
- you accelerate.
- there is a malfunction in the system or an interruption in the power supply, e.g. battery failure.
- the electrical system in the engine compartment, the battery or the fuses are tampered with.
- the battery is disconnected.

If you wish to leave the vehicle or park it, deactivate DISTRONIC PLUS and secure the vehicle against rolling away.

If DISTRONIC PLUS detects that the vehicle in front is stopping, it brakes your vehicle until it is stationary.

Once your vehicle is stationary, it remains stationary and you do not need to depress the brake.

- i** After a time, the electric parking brake secures the vehicle and relieves the service brake.
- i** Depending on the specified minimum distance, your vehicle will come to a standstill at a sufficient distance behind the vehicle in front. The specified minimum distance is set using the control on the cruise control lever.

Setting a speed

WARNING

Keep in mind that it may take a brief moment until the vehicle has made the necessary adjustments.

Increase or decrease the set vehicle speed to a value that the prevailing road conditions and legal speed limits permit. Otherwise, sudden and unexpected acceleration or deceleration of the vehicle could cause an accident and/or serious injury to you and others.

- ▶ Press the cruise control lever up **①** for a higher speed or down **②** for a lower speed.
- ▶ **To adjust the speed in 1 mph increments (1 km/h increments):** briefly press the cruise control lever up **①** or down **②** to the pressure point. The last speed stored is increased or decreased every time the cruise control lever is pushed up **①** or down **②**.
- ▶ **To adjust the speed in 5 mph increments (10 km/h increments):** briefly press the cruise control lever

up ① or down ② beyond the pressure point.

The last speed stored is increased or decreased every time the cruise control lever is pushed up ① or down ②.

- ❗ **DISTRONIC PLUS** is not deactivated if you depress the accelerator pedal. If you accelerate to overtake, **DISTRONIC PLUS** adjusts the vehicle's speed to the last speed stored after you have finished overtaking.

Storing the current speed or calling up a stored speed

WARNING

The set speed stored in memory should only be set again if prevailing road conditions and legal speed limits permit. Possible acceleration or deceleration differences arising from returning to the preset speed could cause an accident and/or serious injury to you and others.

- ▶ Briefly pull the cruise control lever towards you ④.
- ▶ Remove your foot from the accelerator pedal. **DISTRONIC PLUS** is activated. The first time it is activated, the current speed is stored. Otherwise, it sets the vehicle cruise speed to the previously stored value.

Setting the specified minimum distance

You can set the specified minimum distance for **DISTRONIC PLUS** by varying the time span between one and two seconds. With this function, you can set the minimum distance that **DISTRONIC PLUS** keeps to the vehicle in front, dependent on vehicle speed. You can see this distance in the multifunction display (▷ page 305).

WARNING

It is up to the driver to exercise discretion to select the appropriate setting given road

conditions, traffic, driver's preferred driving style and applicable laws and driving recommendations for safe following distance.

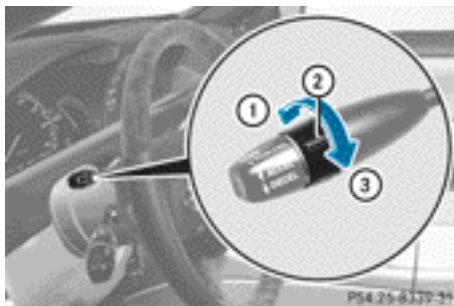

- ▶ **To increase:** turn control ② in direction ③. **DISTRONIC PLUS** then maintains a greater distance between your vehicle and the vehicle in front.
- ▶ **To decrease:** turn control ② in direction ①. **DISTRONIC PLUS** then maintains a shorter distance between your vehicle and the vehicle in front.
- ❗ Make sure that you maintain a sufficiently safe distance from the vehicle in front. Adjust the distance to the vehicle in front if necessary.

DISTRONIC PLUS displays in the speedometer



When you switch on **DISTRONIC PLUS**, triangle ① shows the stored speed.

- i** For design reasons, the speed displayed in the speedometer may differ slightly from the speed set for DISTRONIC PLUS.

If DISTRONIC PLUS detects a vehicle in front, the speedometer dial lights up between speed of the vehicle in front ① and stored speed ②.

DISTRONIC PLUS displays in the multifunction display

General notes

You can select the distance display in the Assistance menu (▷ page 347) of the on-board computer.

Display when DISTRONIC PLUS is deactivated

- ▶ Select the **Distance Display** function using the on-board computer (▷ page 347).

When DISTRONIC PLUS is deactivated, you will see the following in the multifunction display:

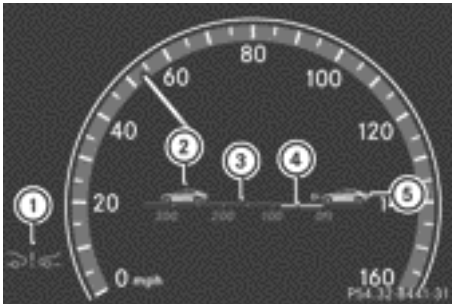

- ① Symbol for activated PRE-SAFE® Brake
- ② Vehicle in front, if detected
- ③ Distance indicator, current distance to the vehicle in front
- ④ Specified minimum distance to the vehicle in front; adjustable
- ⑤ Own vehicle

Display when DISTRONIC PLUS is activated

- ▶ Select the **Distance display** function using the on-board computer (▷ page 347).

You will see the stored speed for about five seconds when you activate DISTRONIC PLUS. After this time, you will see the following in the multifunction display while DISTRONIC PLUS is activated:



- ① DISTRONIC PLUS activated
- ② Own vehicle
- ③ Specified minimum distance to the vehicle in front; adjustable
- ④ Vehicle in front, if detected

Deactivating DISTRONIC PLUS

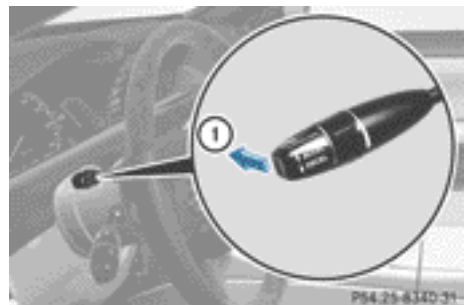

There are several ways to deactivate DISTRONIC PLUS:

- ▶ Briefly press the cruise control lever forwards ①.

or

- ▶ Brake, unless the vehicle is stationary.

When you deactivate DISTRONIC PLUS, the **DISTRONIC PLUS Off** message is shown in the multifunction display for approximately five seconds.

- The last speed stored remains stored until you switch off the engine.

DISTRONIC PLUS is automatically deactivated if:

- you engage the electric parking brake or if the vehicle is automatically secured with the electric parking brake
- you are driving slower than 15 mph (25 km/h) and there is no vehicle in front, or if the vehicle in front is no longer detected
- ESP® intervenes or you deactivate ESP®
- the transmission is in the **P**, **R** or **N** position
- you pull the cruise control lever towards you in order to pull away and the front-passenger door is open
- the vehicle has skidded

If DISTRONIC PLUS is deactivated, you will hear a warning tone. The **DISTRONIC PLUS Off** message is shown in the multifunction display for approximately five seconds.

WARNING

DISTRONIC PLUS is deactivated and releases the brakes if the vehicle is slowed down to a speed below 20 mph (30km/h) by the system, provided that DISTRONIC PLUS does not detect a vehicle directly in front. At this point, the driver must apply the brakes in order to slow down further and bring the vehicle to a standstill.

Tips for driving with DISTRONIC PLUS

Important safety notes

The following contains descriptions of certain road and traffic conditions in which you must be particularly attentive. In such situations, brake if necessary. DISTRONIC PLUS is then deactivated.

WARNING

The DISTRONIC PLUS works to maintain the speed selected by the driver unless a moving obstacle proceeding directly ahead of it in the same travel direction is detected (e.g. following another vehicle ahead of you at your set distance).

This means that:

- Your vehicle can pass another vehicle after you have changed lanes.
- While in a sharp turn or if the preceding vehicle is in a sharp turn, the DISTRONIC PLUS could lose sight of the preceding vehicle. Your vehicle could then accelerate to the previously selected speed.

The DISTRONIC PLUS regulates only the distance between your vehicle and those directly ahead of it. It may not register stationary objects in the road, e.g.:

- a stopped vehicle in a traffic jam
- a disabled vehicle
- an oncoming vehicle

The driver must always be alert, observe all traffic and intercede as required by means of steering or braking the vehicle.

WARNING

The DISTRONIC PLUS should not be used in snowy or icy road conditions.

Cornering, going into and coming out of a bend

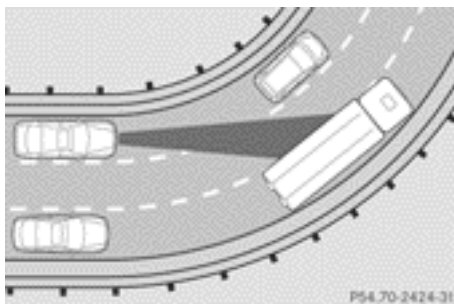

The ability of DISTRONIC PLUS to detect vehicles when cornering is limited. Your vehicle may brake unexpectedly or late.

Vehicles traveling on a different line

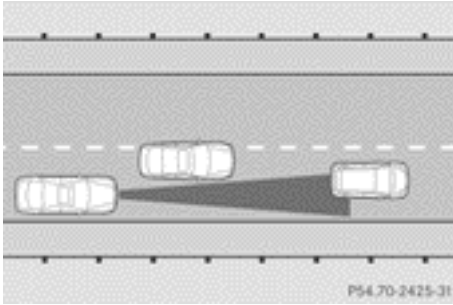

DISTRONIC PLUS may not detect vehicles traveling on a different line. The distance to the vehicle in front will be too short.

Other vehicles changing lane

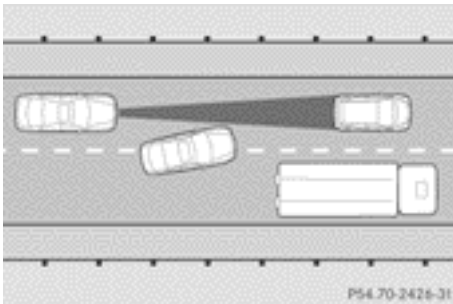

DISTRONIC PLUS has not detected the vehicle cutting in yet. The distance to this vehicle will be too short.

Narrow vehicles

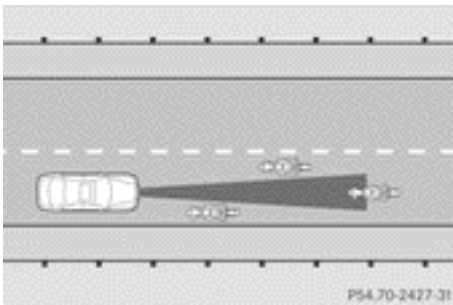

DISTRONIC PLUS has not yet detected the vehicle in front on the edge of the road, because of its narrow width. The distance to the vehicle in front will be too short.

Obstructions and stationary vehicles

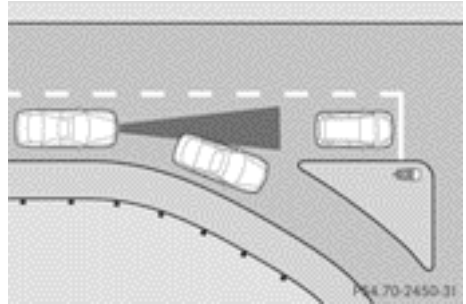

DISTRONIC PLUS does not brake for obstacles or stationary vehicles. If, for example, the detected vehicle turns a corner and reveals an obstacle or stationary vehicle, DISTRONIC PLUS will not brake for these.

Crossing vehicles

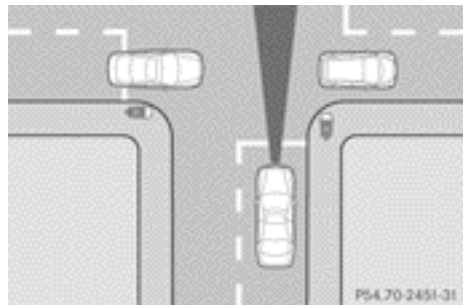

DISTRONIC PLUS may mistakenly detect vehicles that are crossing your lane. Activating DISTRONIC PLUS at traffic lights with crossing traffic, for example, could cause your vehicle to pull away unintentionally.

HOLD function

General notes

The HOLD function can assist the driver in the following situations:

- when pulling away, especially on steep slopes
- when maneuvering on steep slopes
- when waiting in traffic

The vehicle is kept stationary without the driver having to depress the brake pedal.

The braking effect is canceled and the HOLD function deactivated when you depress the accelerator pedal to pull away.

Activation conditions

You can activate the HOLD function if:

- the vehicle is stationary.
- the driver's door is closed or your seat belt is fastened.
- the electric parking brake is released.
- the hood is closed.
- the transmission is in position **R**, **N** or **D**.
The trunk lid must be closed in position **R**.
- DISTRONIC PLUS is deactivated.

Activating the HOLD function

- ▶ Make sure that the activation conditions are met.
- ▶ Depress the brake pedal.
- ▶ Quickly depress the brake pedal further until **HOLD** appears in the instrument cluster.

The HOLD function is activated. You can release the brake pedal.

- i** If depressing the brake pedal the first time does not activate the HOLD function, wait briefly and then try again.

WARNING

The vehicle's brakes are applied when the HOLD function is activated. For this reason, deactivate the HOLD function if the vehicle is

to be set in motion by other means (e.g. in a car wash or by towing).

Deactivating the HOLD function

The HOLD function is deactivated automatically if:

- you accelerate and the transmission is in position **D** or **R**.
- you shift the transmission to position **P**.
- you apply the brakes again with a certain amount of pressure until **HOLD** disappears from the instrument cluster.
- you secure the vehicle using the electric parking brake.
- you activate DISTRONIC PLUS.

- i** After a time, the electric parking brake secures the vehicle and relieves the service brake.

WARNING

Never get out of the vehicle when the HOLD function is activated.

The HOLD function must never be operated or deactivated by a passenger or from outside the vehicle.

The HOLD function does not replace the electric parking brake and must not be used for parking.

The braking effect of the HOLD function is canceled and the vehicle could roll away if:

- the HOLD function is deactivated by depressing the accelerator pedal or the brake pedal.
- there is a malfunction in the system or an interruption in the power supply, e.g. battery failure.
- the electrical system in the engine compartment, the battery or the fuses are tampered with.
- the battery is disconnected.

If you leave the vehicle or park it, deactivate the HOLD function and secure the vehicle against rolling away.

AIRMATIC

Vehicle level

Important safety notes

Your vehicle regulates its height automatically. All-round level control ensures the best possible suspension and constant ground clearance, even with a laden vehicle. When you drive fast, the vehicle is lowered automatically to improve driving safety and to reduce fuel consumption.

The following vehicle levels are possible:

- Normal
- raised: the vehicle is raised by about 1.20 in (30 mm) when compared with the normal level
- lowered: the vehicle is lowered by about 0.40 in (10 mm) when compared with the normal level

The "Normal" and "Raised" vehicle levels can be set manually.

The "Lowered" vehicle level is set automatically at speeds over 60 mph (100 km/h).

Setting the vehicle level

Select the "Normal" setting for normal road surfaces and "Raised" for driving with snow chains or on particularly poor road surfaces. Your selection remains stored even if you remove the SmartKey from the ignition lock.

WARNING

To help avoid personal injury, keep hands and feet away from wheel housing area, and stay away from under the vehicle when lowering the vehicle chassis.

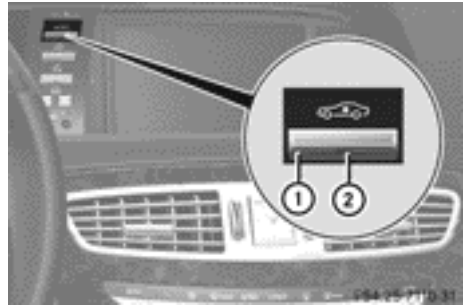

Setting raised level

- ▶ Start the engine.

If indicator lamp ② is not lit:

- ▶ Press button ①. Indicator lamp ② lights up. The vehicle height is adjusted to raised level. The **Vehicle Rising** message appears in the display.

The "Raised level" setting is canceled if you:

- drive at speeds above 75 mph (120 km/h)
- drive for about three minutes at speeds above 50 mph (80 km/h).

The "Raised level" remains active when you are not driving within these speed ranges.

Setting the normal level

- ▶ Start the engine.

If indicator lamp ② is lit:

- ▶ Press button ①. Indicator lamp ② goes out. The vehicle is adjusted to normal level.

Suspension tuning

General notes

The Adaptive Damping System (ADS) automatically controls the calibration of the dampers and springs.

The damping is tuned individually to each wheel and depends on:

- your driving style, e.g. sporty
- the road surface condition, e.g. bumps
- your individual selection, i.e. sports or comfort

Your selection remains stored even if you remove the SmartKey from the ignition lock.



Sports tuning

The firmer suspension tuning in Sport mode ensures even better contact with the road. Select this mode when employing a sporty driving style, e.g. on winding country roads.

► **If indicator lamp ② is not lit:** press button ①.

Indicator lamp ② lights up. Sports suspension tuning is selected.

The **AIRMATIC SPORT** message appears in the multifunction display.

Comfort tuning

In Comfort mode, the driving characteristics of your vehicle are more comfortable.

Therefore, select this mode if you favor a more comfortable driving style. Select comfort mode also when driving fast on straight roads, e.g. on straight stretches of freeway.

► **If indicator lamp ② is lit:** press button ①.

Indicator lamp ② goes out. Comfort tuning is selected.

The **AIRMATIC COMFORT** message appears in the multifunction display.

Active Body Control (ABC)

Vehicle level

Your vehicle automatically adjusts its ride height to improve driving safety and reduce fuel consumption.

Depending on the vehicle height that has been set, the vehicle automatically adjusts its height dependent on the current speed. As speed increases, the vehicle is lowered by up to 0.4 in (10 mm). As the speed is reduced, the vehicle is raised up to the set vehicle height.

WARNING

The vehicle is lowered when the engine is switched off. Therefore, make sure that nobody is in the vicinity of the wheel housing or under the vehicle when you switch off the engine. Otherwise, limbs could become trapped.

 The vehicle is lowered when the engine is switched off. When parking, position your vehicle so that it does not make contact with the curb as the vehicle is lowered. Your vehicle could otherwise be damaged.

 For AMG vehicles: when the engine is switched off, the vehicle is lowered by approx. 0.2 in (5 mm).

Setting the vehicle level

Select the "Normal" setting for normal road surfaces and "Raised" for driving with snow chains or on particularly poor road surfaces.

WARNING

To help avoid personal injury, keep hands and feet away from wheel housing area, and stay away from under the vehicle when lowering the vehicle chassis.

Your selection remains stored even if you remove the SmartKey from the ignition lock.

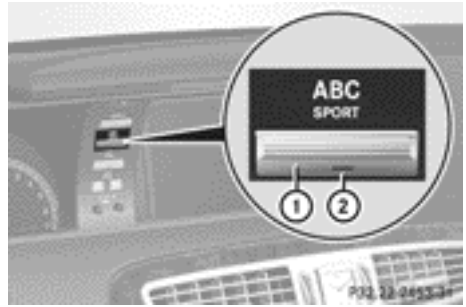
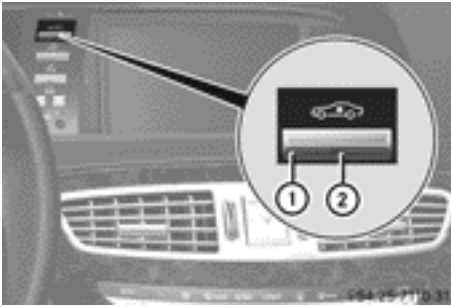

Setting raised level

- ▶ Start the engine.

If indicator lamp ② is not lit:

- ▶ Press button ①.
Indicator lamp ② lights up. The vehicle height is adjusted to raised level.

Setting the normal level

- ▶ Start the engine.

If indicator lamp ② is lit:

- ▶ Press button ①.
Indicator lamp ② goes out. The vehicle is adjusted to normal level.

Suspension tuning

The electronically controlled ABC suspension system works continuously. This improves driving safety and comfort.

The ABC suspension system is tuned individually to each wheel and depends on:

- your driving style, e.g. sporty
- the road surface condition, e.g. bumps
- your individual selection, i.e. sports or comfort
- the vehicle load

Your selection remains stored even if you remove the SmartKey from the ignition lock.

Sports tuning

The firmer suspension tuning in Sport mode ensures even better contact with the road. Select this mode when employing a sporty driving style, e.g. on winding country roads.

- ▶ **If indicator lamp ② is not lit:** press button ①.

Indicator lamp ② lights up. You have selected the suspension for a sporty driving style.

The **ABC Active Body Control SPORT** message appears in the multifunction display.

Comfort tuning

In Comfort mode, the driving characteristics of your vehicle are more comfortable. Therefore, select this mode if you favor a more comfortable driving style.

- ▶ **If indicator lamp ② is lit:** press button ①.

Indicator lamp ② goes out. You have selected the suspension for a comfortable driving style.

The **ABC Active Body Control COMFORT** message appears in the multifunction display.

4MATIC (permanent four-wheel drive)

4MATIC ensures that all four wheels are permanently driven. Together with ESP®, it improves the traction of your vehicle

whenever a drive wheel spins due to insufficient grip.

WARNING

If a drive wheel is spinning due to insufficient traction:

- While driving off, apply as little throttle as possible.
- While driving, ease up on the accelerator pedal.
- Adapt your speed and driving style to the prevailing road conditions.

Failure to observe these guidelines could cause the vehicle to skid.

4MATIC cannot prevent accidents resulting from excessive speed.

! Never tow the vehicle with one axle raised. This may damage the transfer case. Damage of this sort is not covered by the Mercedes-Benz Limited Warranty. All wheels must remain either on the ground or be fully raised. Observe the instructions for towing the vehicle with all wheels in full contact with the ground.

i In wintry driving conditions, the maximum effect of 4MATIC can only be achieved if you use winter tires (M+S tires), with snow chains if necessary.

PARKTRONIC

Important safety notes

WARNING

The PARKTRONIC is a supplemental system. It is not intended to, nor does it replace, the need for extreme care. The responsibility during parking and other critical maneuvers always remains with the driver.

WARNING

Make sure no persons or animals are in or near the area in which you are parking/maneuvering. Otherwise, they could be injured.

PARKTRONIC is an electronic parking aid with ultrasonic sensors. It indicates visually and audibly the distance between your vehicle and an object.

PARKTRONIC is activated automatically when you:

- switch on the ignition
- shift the transmission to position **D**, **R** or **N**
- release the electric parking brake

PARKTRONIC is deactivated at speeds above 11 mph (18km/h). It is reactivated at lower speeds.

PARKTRONIC monitors the area around your vehicle using six sensors in the front and four sensors in the rear.

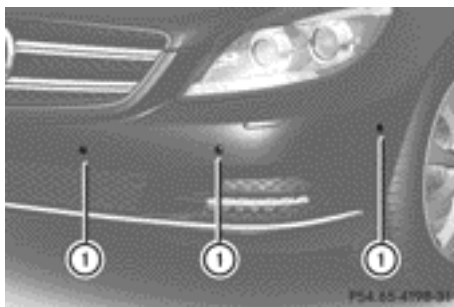

① Example: sensors in the front bumper, left-hand side

Range of the sensors

General notes

The sensors must be free of dirt, ice and slush. Otherwise, they may not function correctly. Clean the sensors regularly, taking care not to scratch or damage them (> page 431).

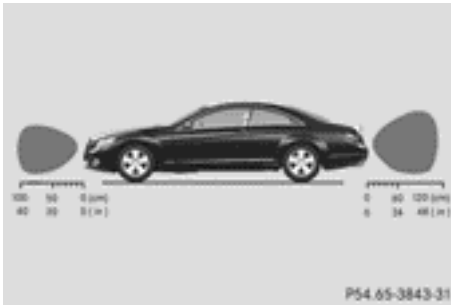

Side view

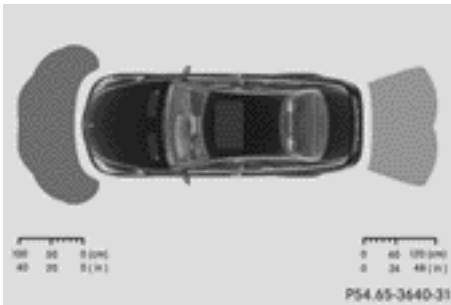

Top view

Front sensors

Center	approximately 40in (approximately 100cm)
Corners	approximately 24in (approximately 60cm)

Rear sensors

Center	approximately 48in (approximately 120cm)
Corners	approximately 32in (approximately 80cm)

! When parking, pay particular attention to objects above or below the sensors, such as flower pots or trailer drawbars. PARKTRONIC does not detect such objects when they are in the immediate vicinity of the vehicle. You could damage the vehicle or the objects.

The sensors may not detect snow and other objects that absorb ultrasonic waves.

Ultrasonic sources such as an automatic car wash, the compressed-air brakes on a truck or a pneumatic drill could cause PARKTRONIC to malfunction.

PARKTRONIC may not function correctly on uneven terrain.

Minimum distance

Center	approximately 8in (approximately 20cm)
Corners	approximately 8in (approximately 20cm)

If there is an obstacle within this range, the relevant warning displays light up and a warning tone sounds. If the distance falls below the minimum, the distance may no longer be shown.

Warning displays

The warning displays show the distance between the sensors and the obstacle. The warning display for the front area is in the instrument cluster. The warning display for the rear area is located on the headliner in the rear compartment.

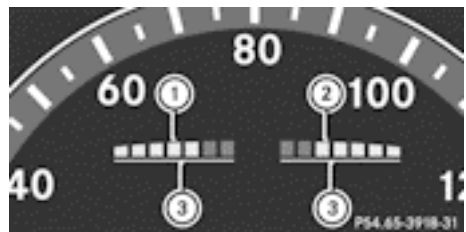

Warning display for the front area

- ① Segments on the left-hand side of the vehicle
- ② Segments on the right-hand side of the vehicle
- ③ Segments showing operational readiness

The warning display for each side of the vehicle is divided into five yellow and two red segments. PARKTRONIC is operational if

yellow segments showing operational readiness ③ light up.

The selected transmission position determines which warning display is active when the engine is running.

Transmission position	Warning display
D	Front area activated
R	Rear and front areas activated
N	If the electric parking brake is engaged: no areas are activated If the electric parking brake is released: rear and front areas are activated
P	No areas activated

One or more segments light up as the vehicle approaches an obstacle, depending on the vehicle's distance from the obstacle.

When the first red segment lights up, you hear an intermittent warning for about two seconds. From the second red segment, you hear a continuous warning. This indicates that you have now reached the minimum distance.

Deactivating/activating PARKTRONIC



- ① To deactivate/activate PARKTRONIC
- ② Indicator lamp

If indicator lamp ② lights up, PARKTRONIC is deactivated.

- ① PARKTRONIC is automatically activated when you turn the SmartKey to position 2 in the ignition lock.

Problems with PARKTRONIC

Problem	Possible causes/consequences and ► Solutions
<p>Only the red segments in the PARKTRONIC warning displays are lit. You also hear a warning tone for approximately two seconds.</p> <p>PARKTRONIC is deactivated after approximately 20 seconds, and the indicator lamp in the PARKTRONIC button lights up.</p>	<p>PARKTRONIC has malfunctioned and has switched off.</p> <p>► If problems persist, have PARKTRONIC checked at a qualified specialist workshop.</p>
<p>Only the red segments in the PARKTRONIC warning displays are lit. PARKTRONIC is deactivated after approximately 20 seconds.</p>	<p>The PARKTRONIC sensors are dirty or there is interference.</p> <p>► Clean the PARKTRONIC sensors (▷ page 431).</p> <p>► Switch the ignition back on.</p>
	<p>The problem may be caused by an external source of radio or ultrasound waves.</p> <p>► See if PARKTRONIC functions in a different location.</p>

Parking Guidance

Important safety notes

Parking Guidance is an electronic parking aid with ultrasound. Ultrasound is used to measure the road on both sides of the vehicle. A suitable parking space is indicated by the parking symbol. You receive steering instructions when parking. You may also use PARKTRONIC (▷ page 312).

WARNING

Parking Guidance is merely an aid and may display parking spaces that are not suitable for parking, for example:

- no-parking areas
- parking spaces with unsuitable surfaces (road surface)

- driveways
- entrances and exits

Parking Guidance detects and measures potential parking spaces while driving past. Changes to the parking space after this point are not taken into account, for example if the vehicle in front of or behind the parking space changes position or objects in the parking space are moved.

Even when using Parking Guidance, you are still responsible for driving carefully. If you rely on Parking Guidance alone, you could cause an accident and injure yourself and others.

Safety always remains your responsibility and you must continue paying careful attention to your immediate surroundings when parking and maneuvering.

⚠ WARNING

Objects located above the height range of Parking Guidance will not be detected when the parking space is measured. These objects are not taken into account when the parking procedure is calculated, e.g. overhanging loads, tail sections or loading ramps of goods vehicles. Under some circumstances, Parking Guidance might therefore issue steering instructions too soon. This may lead to a collision. For this reason, you should avoid using Parking Guidance in such situations.

⚠ WARNING

Make sure that no persons or animals are in the maneuvering range. Otherwise, they could be injured.

- !** Pay particular attention to low objects or objects with flat surfaces, such as trailer drawbars, posts, cross beams and curbs. These types of objects cannot be detected by Parking Guidance and may damage the vehicle.

When PARKTRONIC is deactivated, Parking Guidance is also unavailable.

Use Parking Guidance for parking spaces:

- that are parallel to the direction of travel
- that are on straight roads, not bends
- that are on the same level as the road, i.e. not on the pavement, for example. Parking Guidance may not detect flat curbs

Parking tips:

- on narrow roads, drive past the parking space as close as possible.
- parking spaces that are littered, overgrown or partially occupied by trailer drawbars might be identified incorrectly or not at all.
- snowfall or heavy rain may lead to a parking space being measured inaccurately.
- pay attention to the PARKTRONIC (▷ page 313) warning messages during the parking procedure.

- when transporting a load which protrudes from your vehicle, you must not use Parking Guidance.
- never use Parking Guidance with snow chains or an emergency spare wheel mounted.
- make sure that the tire pressures are always correct. This has a direct effect on the steering instructions.
- the way your vehicle is positioned in the parking space after parking is dependent on various factors. These include the position and shape of the vehicles parked in front and behind it and the conditions of the location. In some cases, Parking Guidance may guide you too far or not far enough into a parking space. In some cases, it may also lead you across or onto the curb. If necessary, cancel the parking procedure with Parking Guidance.

- !** If unavoidable, you should drive over obstacles such as curbs slowly and not at a sharp angle. Otherwise, you may damage the wheels or tires.

Detecting parking spaces



- ① Detected parking space on the left
- ② Parking symbol
- ③ Detected parking space on the right

Parking Guidance is automatically activated when you drive forwards. The system is operational at speeds of up to approximately 22 mph (35 km/h). While in operation, the system independently locates and measures parking spaces on both sides of the vehicle. At speeds below 19 mph (30km/h), you see white parking symbol ② in the instrument cluster as a status indicator. Parking

Guidance only shows parking spaces on the passenger side in the default setting. Parking spaces on the driver's side are displayed as soon as the turn signal on the driver's side is activated. To park on the driver's side, you must leave the driver's side turn signal switched on until you have engaged reverse gear. If a parking space is detected, parking symbol ② changes to blue. Additionally, an arrow pointing to the right ③ or left ① is shown.

Parking Guidance will only detect parking spaces:

- that are closed in at the back
- that are parallel to the direction of travel
- that are at least 5 ft (1.5 m) wide
- that are at least 4.3 ft (1.3 m) longer than your vehicle.

A parking space is displayed while you are driving past it, and until you are approximately 50 ft (15 m) away from it.

Parking

The following instructions refer to parking in a space on the front-passenger side. To park in a space on the driver's side, mirror the instructions.

WARNING

The Parking Guidance is only an aid and may not detect all obstacles. The Parking Guidance does not relieve you of the responsibility to pay attention. You are always responsible for safety and must continue to pay attention to your immediate surroundings when parking and maneuvering. Otherwise, you could endanger yourself and others.

- ▶ Stop the vehicle when the blue parking space symbol shows the desired parking space in the instrument cluster.
- ▶ Engage reverse gear. The multifunction display shows the message: **Check surroundings Confirm with OK.**
- ▶ Press **OK** on the multifunction steering wheel to confirm. The display in the instrument cluster switches to Parking Guidance.

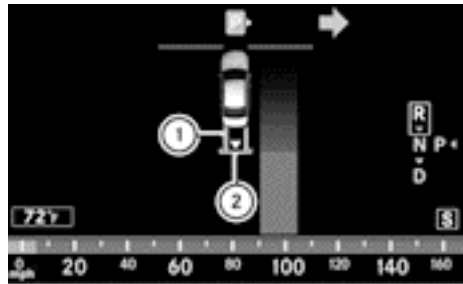

- ① Green lane
- ② White bracket marking the target position
- ▶ Depending on the distance, you may have to reverse along the lane towards the parking space. This is indicated by green lane ①. Continue backing up until you hear a tone. Stop; the parking position has been reached and is marked by white bracket ② with an arrow for the target position.

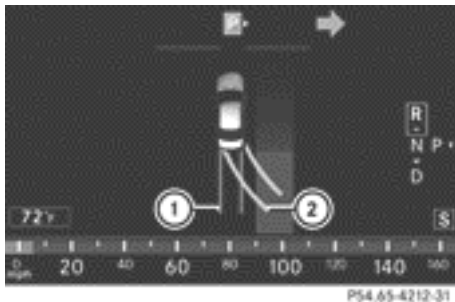

Steering tips

- ① Red lane indicating the route the vehicle will take with the steering wheel in its current position
- ② Yellow lane indicating the route the vehicle will take when you have turned the steering wheel in the required direction

- ▶ Turn the steering wheel while the vehicle is stationary until red lane ① and yellow lane ② overlap.

Lane ② is then marked in green and you hear a tone. If the parking space is inside the area displayed, the end of the green lane is marked with a white bracket and an arrow showing the target position.

Backing up into a parking space

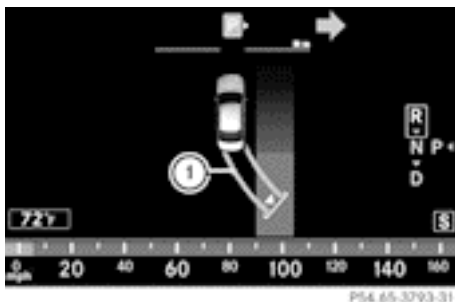

- ① Lane turns green when the steering wheel is turned in the correct direction
- ▶ Keep the steering wheel in that position and reverse carefully.
 - ▶ Stop as soon as you hear a tone. The vehicle has reached the position in which you need to countersteer.

Countersteering

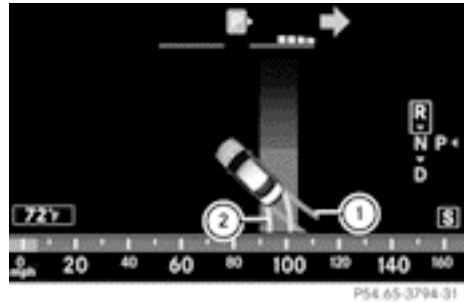

- ① Red lane indicating the route the vehicle will take with the steering wheel in its current position
- ② Yellow lane indicating the route the vehicle will take when you have turned the steering wheel in the required direction

- ▶ Turn the steering wheel while the vehicle is stationary until red lane ① and yellow lane ② overlap.

Lane ② is then marked in green and you hear a tone. A white arrow and white bracket are shown to indicate the target position.

Driving to the final position

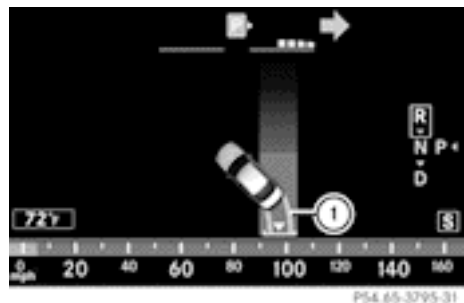

- ① Lane turns green when the steering wheel is turned in the correct direction
- ▶ Keep the steering wheel turned in that direction and reverse carefully until you have reached the final position. The **Parking Guidance finished** message appears in the multifunction display and a tone sounds.

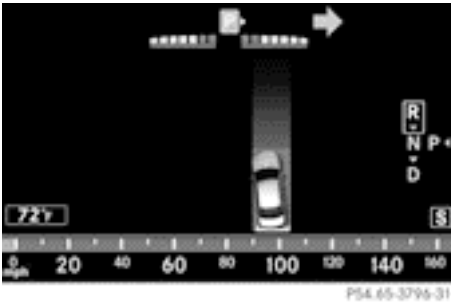

Final position

Depending on the size of the parking space, you may now be in an angled position in the parking space. If possible, Parking Guidance will guide you as far back as possible towards the rear limit of the parking space.

- ▶ Maneuver to the final position if necessary.
- ▶ Always observe the warning messages displayed by PARKTRONIC (▷ page 313).

Canceling Parking Guidance

- ▶ Press the PARKTRONIC button on the dashboard (▷ page 314).
Parking Guidance is canceled immediately and PARKTRONIC is deactivated.

Parking Guidance is canceled automatically if it is no longer possible to guide you into the parking space, or if a malfunction occurs.

The parking space symbol goes out and a warning tone sounds. The **Parking Guidance Canceled** message appears in the multifunction display.

Rear view camera

Important safety notes

The rear view camera is an optical parking aid. It shows the area behind your vehicle in the COMAND display.

WARNING

Make sure that no persons or animals are in the maneuvering range. Otherwise, they could be injured.

The rear view camera is located in the handle strip of the trunk lid.

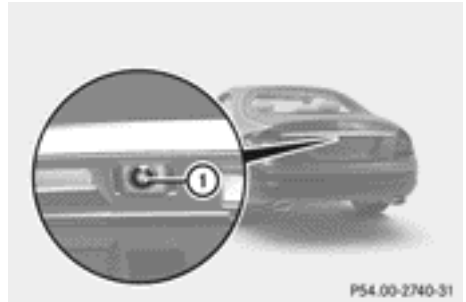

- ① Rear view camera

View through the camera

The area behind the vehicle is displayed as a mirror image, as in the rear view mirror.

WARNING

The rear view camera is only an aid and may display obstacles

- from a distorted perspective
- inaccurately
- may not display obstacles at all

The rear view camera does not relieve you of the responsibility to be cautious. Take care and pay careful attention. The rear view camera may not show objects which are

- very close to the rear bumper
- under the rear bumper
- above the trunk handle

You are responsible for safety at all times and must continue to pay attention to the immediate surroundings when parking and maneuvering. This includes the area behind, in front of, and beside the vehicle. Otherwise you could endanger yourself and/or others.

WARNING

The rear view camera will not function or will not fully function if:

- the trunk lid is open
- it is raining or snowing strongly or if it is foggy
- it is night or if you are parking/maneuvering your vehicle in a very dark area
- a very bright white light is affecting the camera
- the immediate vicinity is illuminated with fluorescent light (the display of the COMAND system can flicker)
- temperature changes abruptly, for example if you drive out of the cold into a heated garage (condensation on the lens)
- the camera lens is dirty or covered
- the rear of your vehicle is damaged

In this case, have the position and the setting of the camera checked at a specialist workshop. Mercedes-Benz recommends that you consult a Mercedes-Benz Center for this purpose.

Do not use the rear view camera in these situations. You could otherwise injure yourself and other people and/or cause damage - including damage to your vehicle - while parking/maneuvering.

Activating the rear view camera

- ▶ Make sure that the SmartKey is in position **2** in the ignition lock.
- ▶ Engage reverse gear.
The area behind the vehicle is shown in the COMAND display with guide lines.

Guide lines in the COMAND display

WARNING

Use of rear view camera can be dangerous if you are color-blind or have impaired color vision.

Only use rear view camera if you can see and distinguish all colored guidelines shown by rear view camera on the COMAND system display.

WARNING

Please note that objects that do not touch the ground may appear to be further away than they actually are, for example:

- the bumper of a vehicle parked behind you
- the trailer drawbar
- the ball coupling of a trailer tow hitch
- the rear end of a truck
- a slanted post

In such cases, you should not use the guide lines to judge the distance. You may misjudge the distance, which increases the risk of impacting the objects.

Even if the object you approach is directly on the ground, do not approach the object any closer than the red guide line.

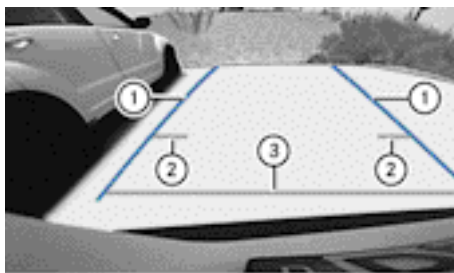

PS4 65-4407 31

Example: information in the COMAND display
Guide lines **②** and **③** show the approximate distance to the rear area. Yellow guide line **②** indicates a distance of approximately 3 ft (1 m) and red guide line **③** indicates a distance of approximately 10 in (0.25 m). The distances only apply to objects that are at ground level. Blue guide lines **①** depict the width required for the vehicle. They are used to align the vehicle with the edge of the road, e.g. the curb.

ATTENTION ASSIST

Important safety notes

ATTENTION ASSIST helps you during long, monotonous journeys such as on freeways and interstate highways. It is active in the range between 50 mph (80 km/h) and 112 mph (180 km/h).

If ATTENTION ASSIST detects typical indicators of fatigue or increasing lapses in concentration on the part of the driver, it suggests you take a break.

WARNING

ATTENTION ASSIST is only an aid and may detect your tiredness or lapses in concentration too late or not at all. It is not a substitute for a well-rested and attentive driver.

Fatigue may cause you to recognize hazardous situations too late, misjudge a situation or react more slowly. For this reason, make sure you feel rested before you begin driving and during your journey. Make sure that you take regular breaks in time, particularly on long journeys. Otherwise, you may fail to recognize dangers in time, cause an accident and injure yourself and others.

ATTENTION ASSIST assesses your level of fatigue or lapses in concentration by taking the following criteria into account:

- your personal driving style, e.g. steering characteristics
- driving conditions, e.g. time, driving time

The functionality of ATTENTION ASSIST is restricted and warnings may be delayed or not occur at all:

- if the road condition is poor, e.g. if the surface is uneven or if there are potholes
- if there is a strong side wind
- if you have adopted a sporty driving style with high cornering speeds or high rates of acceleration

- if you are predominantly driving slower than 50 mph (80 km/h) or faster than 112 mph (180 km/h)
- if you are currently using COMAND or making a telephone call with it
- if the time has been set incorrectly
- in active driving situations, such as when you change lanes or change your speed

Warning and display messages in the multifunction display

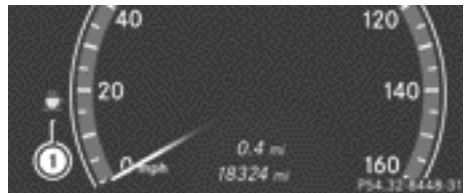

- ▶ Activate ATTENTION ASSIST using the on-board computer (▶ page 348). Symbol  appears in the multifunction display.

If ATTENTION ASSIST is active, you will be warned no sooner than 20 minutes after your journey has begun. You will then hear an intermittent warning tone twice, and the **Attention Assist: Drowsiness Detected** message appears in the multifunction display.

- ▶ If necessary, take a break.
- ▶ Press to confirm the message.

On long journeys, take regular breaks in good time to allow yourself to rest properly. If you do not take a break, you will be warned again after 15 minutes at the earliest. The precondition for this is that ATTENTION ASSIST still detects typical indicators of fatigue or increasing lapses in concentration.

ATTENTION ASSIST is reset when you continue your journey and starts assessing your tiredness again if:

- you switch off the engine.
- you take off your seat belt and open the driver's door, e.g. for a change of drivers or to take a break.

Night View Assist Plus with spotlight function

Important safety notes

In addition to the illumination provided by the normal headlamps, Night View Assist Plus uses infrared light to illuminate the road. The Night View Assist Plus camera picks up the infrared light and shows a black-and-white image in the multifunction display. The image shown in the multifunction display corresponds to a road lit up by high-beam headlamps. This enables you to see the road's course and any obstacles in good time. If pedestrian recognition is activated, pedestrians recognized by the system are highlighted in the Night View Assist Plus display.

The spotlight function also illuminates individual detected pedestrians with a spotlight that flashes four times in quick succession. After this targeted illumination, the headlamps return to the original driving position again.

WARNING

Night View Assist Plus is only an aid designed to assist driving. It is not a substitute for attentive driving. Do not rely solely on the Night View Assist Plus display. Continue to look through the windshield. You are responsible for safety and must drive in accordance with traffic conditions. You could otherwise put yourself and others in danger.

The system may be impaired or unavailable if:

- there is poor visibility, e.g. due to snow, rain, fog or heavy spray.
- the windshield is dirty, fogged up or covered, for instance by a sticker, in the vicinity of the camera.
- you are driving on bends, uphill gradients or downhill gradients.

Light from the headlamps of oncoming vehicles does not affect the Night View Assist Plus display in the multifunction display. This is also the case if you cannot switch on the high-beam headlamps due to oncoming traffic.

WARNING

The Night View Assist Plus cannot record objects immediately in front of or next to the vehicle. When maneuvering, continue to look through the windshield. Make sure no persons or animals are in the area in which you are maneuvering. You could otherwise injure them.

- ① Infrared light is not visible to the human eye and therefore does not glare. Night View Assist Plus can therefore remain switched on even if there is oncoming traffic.

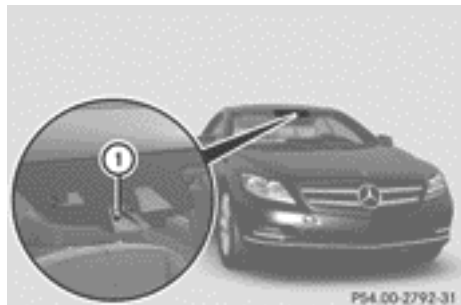

① Night View Assist Plus camera

Pedestrian recognition

WARNING

Pedestrian recognition may be impaired or inoperative if:

- pedestrians are partially or entirely obscured by objects, e.g. parked vehicles.
- the silhouette of the pedestrian in the Night View Assist Plus display is incomplete or interrupted, e.g. by powerful light reflections.
- pedestrians do not contrast with the surroundings.
- pedestrians are not standing upright, for example, if they are sitting, crouching or lying down.

i Animals are not recognized by pedestrian recognition.

Night View Assist Plus is able to recognize pedestrians by typical characteristics, e.g. a silhouette in the shape of a person.

Pedestrian recognition is then switched on automatically if:

- Night View Assist Plus is activated.
- you are driving faster than 6 mph (10 km/h).
- the surroundings are dark, e.g. when driving outside built-up areas without street lighting.

If pedestrian recognition is active, the symbol for active pedestrian recognition (▷ page 325) appears in the multifunction display. If a pedestrian is now recognized, they are framed and thereby highlighted. If the pedestrian recognition system has brought a pedestrian to your attention, look through the windshield to evaluate the situation. The actual distance to objects and pedestrians cannot be gauged accurately by looking at a screen.

It may be the case that objects are highlighted as well as pedestrians.

Spotlight function

Pedestrian recognition with spotlight function is activated automatically if:

- Night View Assist Plus with spotlight function is activated.
- you are driving faster than 28 mph (45 km/h).
- the surroundings are dark, e.g. when driving outside built-up areas without street lighting.

Only one person or object can be illuminated by the spotlight at any one time.

The spotlight function will not function if:

- pedestrians or objects cannot be recognized due to fast cornering.
- pedestrians or objects are on the driver's side of the vehicle.

Conversely, if you switch to symmetrical low beams (▷ page 250), pedestrians or objects located on the passenger side of the vehicle will not be detected.

It may be the case that pedestrians and other objects are inadvertently illuminated.

Activating/deactivating Night View Assist Plus with spotlight function

You can only activate Night View Assist Plus with spotlight function if:

- the SmartKey is in position **2** in the ignition lock.
- it is dark.
- the "Adaptive Highbeam Assist" function is activated via the on-board computer (▷ page 350).
- the light switch is in position **A**.
- the combination switch is pushed forward beyond the point of resistance.
- reverse gear has not been engaged.

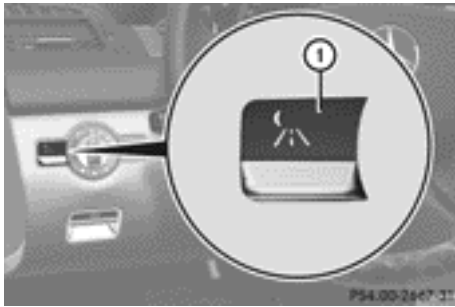

► **To activate:** activate Adaptive Highbeam Assist (► page 254).

► Press button ①.

The Night View Assist Plus with spotlight function display appears in the multifunction display.

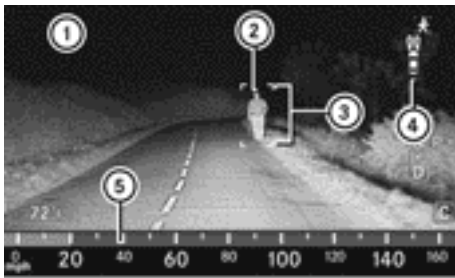

Example: display for a slow-moving vehicle

- ① Night View Assist Plus display
- ② Pedestrian recognized
- ③ Framing
- ④ Example: symbol for active spotlight function
- ⑤ Speed display

The active spotlight function symbol ④ changes according to the vehicle's speed and surroundings.

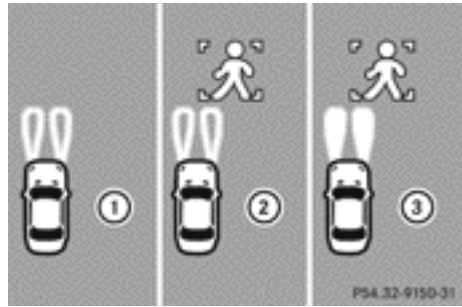

Symbols for the active spotlight function

- ① Symbol for stationary vehicle and when driving on well-lit roads
- ② Symbol at speeds above approximately 6 mph (10 km/h)
- ③ Symbol at speeds above approximately 28 mph (45 km/h)

You can find out more about adjusting the brightness of the multifunction display in the "COMAND" section (► page 118).

i The spotlight function only switches on when you are driving at speeds of at least 28 mph (45 km/h). Therefore, when the vehicle is stationary or moving slowly, you cannot check whether Night View Assist Plus with spotlight function is operating.

When you activate Night View Assist Plus with spotlight function, speed display ⑤ in the multifunction display changes. Speed display ⑤ is shown as a bar at the bottom edge of the multifunction display. This line is no longer available for basic menus. You have to deactivate Night View Assist Plus with spotlight function in order to change a setting using the buttons on the multifunction steering wheel.

► **To deactivate the spotlight function briefly:** move the combination switch back to its normal position.

The spotlight function and Adaptive Highbeam Assist are deactivated.

If you push the combination switch forward beyond the point of resistance again, both systems are reactivated.

- ▶ **To deactivate:** press button ① again.
- ▶ Deactivate Adaptive Highbeam Assist (▷ page 254).

i If you do not wish to use the spotlight function, you first need to deactivate Night View Assist Plus and then activate it again without the spotlight function (▷ page 325).

Activating/deactivating Night View Assist Plus without spotlight function

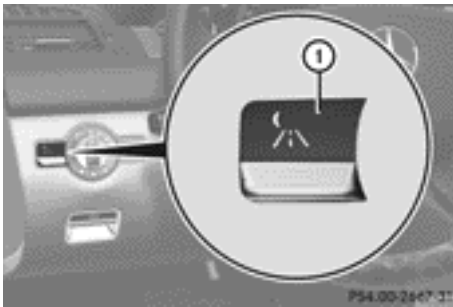

You can only activate Night View Assist Plus without spotlight function if:

- the SmartKey is in position **2** in the ignition lock.
- it is dark.
- the light switch is in the **A** or  position.
- reverse gear has not been engaged.

▶ **To activate:** press and hold button ① until the active spotlight function symbol goes out in the Night View Assist Plus display in the multifunction display.
If you drive faster than approximately 6 mph (10 km/h), the symbol for active pedestrian recognition without spotlight function appears instead.

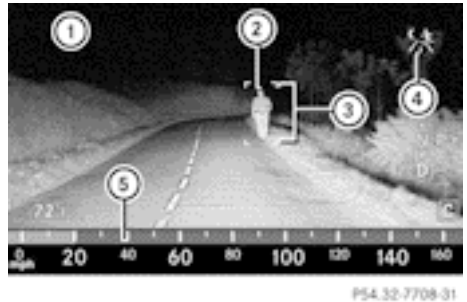

- ① Night View Assist Plus display
- ② Pedestrian recognized
- ③ Framing
- ④ Symbol for active pedestrian recognition without spotlight function
- ⑤ Speed display

You can find out more about adjusting the brightness of the multifunction display in the "COMAND" section (▷ page 118).

i The infrared lamps switch on automatically from a speed of about 6 mph (10 km/h). This means that you do not have the full visual range while the vehicle is stationary and cannot check whether Night View Assist Plus is working.

When you activate Night View Assist Plus, speed display ⑤ in the multifunction display changes. Speed display ⑤ is shown as a bar at the bottom edge of the multifunction display. This line is no longer available for basic menus. You have to deactivate Night View Assist Plus if you want to change a setting using the buttons on the multifunction steering wheel.

▶ **To deactivate:** press button ① again.

i If you want to use the spotlight function as well, you first need to deactivate Night View Assist Plus and then reactivate it with the spotlight function (▷ page 323).

Fogged up or dirty windshield

If the windshield in front of the camera is fogged up or dirty on the inside or outside, the Night View Assist Plus display is affected.

WARNING

Always remember that you must concentrate primarily on driving the vehicle. A driver's attention to the road must always be his/her primary focus when driving. For your safety and the safety of others: stop the vehicle before attempting to clean fogged up windows or the windshield area in front of the Night View Assist Plus camera.

Please remember that when your vehicle is traveling at a speed of only 30 mph (approximately 50 km/h) it covers a distance of 44 ft (approximately 14 m) per second.

- ▶ **To defrost:** check the automatic air conditioning settings (▷ page 266) and fold down the camera cover (▷ page 432).
- ▶ **To defrost the inside of the windshield:** fold down the camera cover (▷ page 432) and clean the windshield (▷ page 430).

Problems with Night View Assist Plus

Problem	Possible causes/consequences and ► Solutions
The picture quality of Night View Assist Plus has deteriorated.	The windshield wipers are smearing the windshield. ► Replace the wiper blades (▷ page 258).
	The windshield is smeared after the vehicle has been cleaned in a car wash. ► Clean the windshield (▷ page 430).
	There is windshield chip damage in the camera's field of vision. ► Replace the windshield.
	The windshield is fogged up on the inside. ► Defrost the windshield (▷ page 266).
	The windshield is iced up. ► De-ice the windshield (▷ page 265).
	There is dirt on the inside of the windshield. ► Clean the inside of the windshield (▷ page 430).

Active Driving Assistance package

General notes

The Active Driving Assistance package consists of DISTRONIC PLUS (▷ page 298), Active Blind Spot Assist (▷ page 327) and Active Lane Keeping Assist (▷ page 330).

Active Blind Spot Assist

Important safety notes

Active Blind Spot Assist uses a radar sensor system to monitor the side areas of your vehicle which are behind the driver. A warning display in the exterior mirrors draws your attention to vehicles detected in the monitored area. If you then switch on the corresponding turn signal to change lanes, you will also receive a visual and audible collision warning. If a risk of lateral collision is detected, corrective braking may help you avoid a collision. To support the course-correcting brake application, Active Blind

Spot Assist also uses the forward-facing radar sensor system. Active Blind Spot Assist supports you from a speed of approximately 20 mph (30 km/h).

WARNING

Active Blind Spot Assist is only an aid, and may detect vehicles/obstacles incorrectly or not at all.

The system may be impaired or may not function if:

- there is poor visibility, e.g. due to snow, rain, fog or spray.
- the rear and/or front sensors are dirty.

Active Blind Spot Assist may not detect narrow vehicles, such as motorcycles or bicycles, or may only detect them too late. It cannot detect vehicles that are overtaken at a small distance and then enter the blind spot area.

Active Blind Spot Assist cannot detect road and traffic conditions. It is not a substitute for

attentive driving. You are responsible for the vehicle's speed, braking in good time, and steering correctly. Always adapt your driving style to suit the prevailing road and weather conditions. Always pay attention to traffic conditions and your surroundings. Otherwise, you may fail to recognize dangers in time, cause an accident and injure yourself and others.

i USA only:

This device has been approved by the FCC as a "Vehicular Radar System". The radar sensor is intended for use in an automotive radar system only. Removing, tampering with, or altering the device will void any warranties, and is not permitted by the FCC. Do not tamper with, alter, or use in any non-approved way.

Any unauthorized modification to this device could void the user's authority to operate the equipment.

For Active Blind Spot Assist to assist you when driving, the radar sensor system must be operational.

Monitoring area

Active Blind Spot Assist monitors the area up to 10 ft (3 m) behind your vehicle and directly next to your vehicle, as shown in the diagram. For this purpose, Active Blind Spot Assist uses radar sensors in the rear bumper.

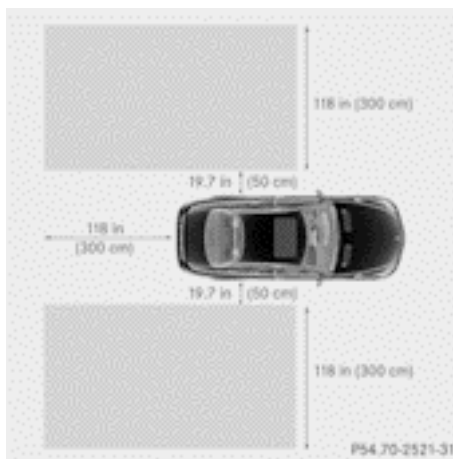

! WARNING

Active Blind Spot Assist monitors certain areas in the immediate vicinity of your vehicle. Vehicles that approach and drive past at high speeds are not detected. No visual nor audible warnings are emitted and the system does not brake the vehicle to correct your course.

If the lanes are very wide, it may not be possible to monitor the complete width of the neighboring lane. For this reason, vehicles in the next lane may not be detected, especially if they are driving in a staggered formation. This may be the case if vehicles are driving at that edge of their lane which is furthest away from your vehicle.

Always pay attention to traffic conditions and your surroundings. Otherwise, you may fail to recognize dangers in time, cause an accident and injure yourself and others.

If the lanes are narrow, vehicles driving in the lane beyond the lane next to your vehicle may be indicated, especially if the vehicles are not driving in the middle of their lane. This may be the case if there are vehicles driving at the inner edge of their lanes.

Due to the nature of the system:

- warnings may be issued in error when driving close to crash barriers or similar solid lane borders.
- the warning is canceled when driving for an extended period next to long vehicles, such as trucks.

Two Active Blind Spot Assist radar sensors are integrated into the front and rear bumpers respectively. An additional radar sensor is located behind the cover in the radiator grill. Make sure that the sensors and areas around them are free of dirt, ice or slush. The rear sensors must not be covered, for example by cycle racks or overhanging cargo. Following a severe impact or in the event of damage to the bumpers, have the function of the sensors checked at a qualified specialist workshop. Blind Spot Assist may otherwise not work properly.

Indicator and warning display

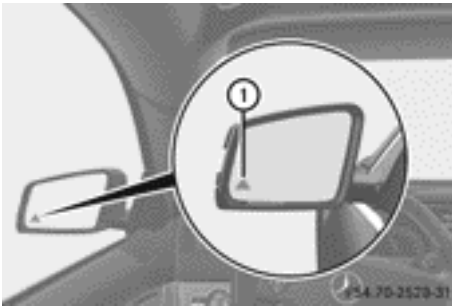

① Yellow indicator lamp/red warning lamp

When Active Blind Spot Assist is activated, indicator lamp ① in the exterior mirrors lights up yellow at speeds of up to 20 mph (30 km/h). At speeds above 20 mph (30 km/h), the indicator lamp goes out and Active Blind Spot Assist is operational.

If a vehicle is detected within the blind spot monitoring range at speeds above 20 mph (30 km/h), warning lamp ① on the corresponding side lights up red. This warning is always emitted when a vehicle enters the blind spot monitoring range from behind or

from the side. When you overtake a vehicle, the warning only occurs if the difference in speed is less than 7 mph (12 km/h).

The yellow indicator lamp goes out if reverse gear is engaged. In this event, Active Blind Spot Assist is no longer active.

The brightness of the indicator/warning lamps is adjusted automatically according to the ambient light.

WARNING

Active Blind Spot Assist is not active at speeds below 20 mph (30km/h). The indicator lamps in the exterior mirrors are yellow. Vehicles in the monitoring range are then not indicated.

Always pay attention to traffic conditions and your surroundings. Otherwise, you may fail to recognize dangers in time, cause an accident and injure yourself and others.

Visual and acoustic collision warning

If a vehicle is detected in the side monitoring range and you switch on the respective turn signals, you will receive a collision warning. You will hear a double warning tone and red warning lamp ① flashes. If the turn signal remains on, detected vehicles are indicated by the flashing of red warning lamp ①. There are no further warning tones.

Course-correcting brake application

If Active Blind Spot Assist detects a risk of a lateral collision in the monitoring range, a course-correcting brake application is carried out. This is meant to assist you in avoiding a collision.

The course-correcting brake application is available in the speed range between 20 mph (30 km/h) and 120 mph (200 km/h). If a course-correcting brake application occurs, red warning lamp ① flashes in the exterior mirror and the following is shown in the multifunction display, for example:



⚠ WARNING

Active Blind Spot Assist is only an aid designed to assist driving. It is not a substitute for attentive driving. In some cases, the course-correcting brake application is not sufficient to avoid a collision. In such a case, you must steer, brake or accelerate.

In very rare cases, the system may erroneously detect a danger of collision in the area of crash barriers or similar lane borders and apply the brakes. Active Blind Spot Assist does not detect all traffic situations and road users. Always make sure that there is sufficient distance on the side for other traffic or obstacles. An inappropriate brake application may be interrupted at any time if you steer slightly in the opposite direction or accelerate.

You are responsible for driving at appropriate speeds, braking in good time, and steering correctly. Always adapt your driving style to suit the prevailing road and weather conditions. Always pay attention to traffic conditions and your surroundings. Otherwise, you may fail to recognize dangers in time, cause an accident and injure yourself and others.

Either a very slight course-correcting brake application, or none at all, may occur if:

- there are vehicles or obstacles, e.g. crash barriers, located on both sides of your vehicle.
- a vehicle approaches you too closely at the side.
- you have adopted a sporty driving style with high cornering speeds.
- you clearly brake or accelerate.

- a driving safety system intervenes, e.g. ESP® or PRE-SAFE® Brake.
- ESP® is switched off.
- a loss of tire pressure or a defective tire is detected.

Switching on Active Blind Spot Assist

- ▶ Make sure that Active Blind Spot Assist is activated in the on-board computer (▷ page 348)
- ▶ Turn the SmartKey to position **2** in the ignition lock. Warning lamps ① in the exterior mirrors light up red for approximately 1.5 seconds and then turn yellow.

Active Lane Keeping Assist

Important safety notes

Active Lane Keeping Assist monitors the area in front of your vehicle by means of a camera behind the top of the windshield. Active Lane Keeping Assist detects lane markings on the road and warns you before you leave your lane unintentionally. If you do not react to the warning, a lane-correcting application of the brakes can bring the vehicle back into the original lane.

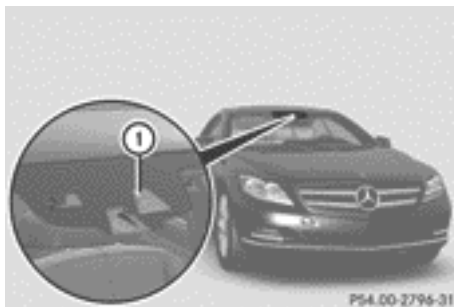

① Active Lane Keeping Assist camera

If you have selected the **Display Unit Speed-/Odometer** (▷ page 350) function in the on-board computer and select **km** as the unit of measurement, Active Lane Keeping Assist is active from speeds of 60 km/h. If

the mph display unit is selected, the assistance range begins at 40 mph.

WARNING

Active Lane Keeping Assist does not keep your vehicle in its lane. It is only an aid and may detect the lane markings on the road incorrectly or not at all.

The system may be impaired or may not function if:

- several or no lane markings for a single lane are present.
- there is poor visibility, e.g. due to insufficient illumination of the road, or due to snow, rain, fog or spray.
- there is glare, e.g. from oncoming traffic, the sun, or reflection from other vehicles.
- the windshield is dirty, fogged up or covered, for instance by a sticker, in the vicinity of the camera.
- the lane markings are worn away, dark or covered up, e.g. by dirt or snow.
- the distance to the vehicle in front is too small and the lane markings thus cannot be detected.
- the lane markings on the road are unclear, e.g. near roadworks.
- the lane markings change quickly, e.g. lanes branch off, cross one another or merge.
- the road is narrow and winding.

Active Lane Keeping Assist cannot detect road and traffic conditions. It is not a substitute for attentive driving. You are responsible for the vehicle's speed, braking in good time, and steering correctly. Always adapt your driving style to suit the prevailing road and weather conditions. Always pay attention to traffic conditions and your surroundings. Otherwise, you may fail to recognize dangers in time, cause an accident and injure yourself and others.

Warning vibration in the steering wheel

A warning may be given if a front wheel passes over a lane marking. It will warn you by means of intermittent vibration in the steering wheel for up to 1.5 seconds.

In order that you are warned only when necessary and in good time if you cross the lane marking, the system recognizes certain conditions and warns you accordingly.

The warning vibration occurs earlier if:

- you approach the outer lane marking on a bend.
- the road has very wide lanes, e.g. a freeway.
- the system recognizes solid lane markings.

The warning vibration occurs later if:

- the road has narrow lanes.
- you cut the corner on a bend.

No warning vibration occurs if:

- you clearly and actively steer, brake or accelerate.
- you cut the corner on a sharp bend.
- a driving safety system intervenes, e.g. ABS, BAS or ESP®.
- you switch on the turn signals. In this event, the warnings are suppressed for a certain period of time.

Lane-correcting brake application

If you leave your lane under certain circumstances the vehicle will brake briefly on one side. This is meant to assist you in bringing the vehicle back to the original lane. This function is available in the range between 40 mph and 120 mph (60 km/h and 200 km/h).

A lane-correcting brake application can only be made after driving over a solid, recognizable lane marking. Before this, a warning must be given by means of intermittent vibration in the steering wheel. In addition, a lane with lane markings on both sides must be recognized. The brake

application also slightly reduces vehicle speed.

If a lane-correcting brake application occurs, the following, for example, appears in the multifunction display:



- i** A further lane-correcting brake application can only occur after your vehicle has returned to the original lane.

⚠ WARNING

Active Lane Keeping Assist does not keep your vehicle in its lane. It is only an aid designed to assist driving. It is not a substitute for attentive driving. In some cases, the lane-correcting brake application is not sufficient to bring your vehicle back to the original lane. In such cases, you must steer the vehicle yourself to ensure that it does not leave the lane.

Active Lane Keeping Assist does not detect road and traffic conditions. Always make sure that there is sufficient distance to the side for other traffic or obstacles. In rare cases, unclear markings or particular structures on the roadway can be recognized as solid lane markings. An inappropriate brake application, e.g. after intentionally driving over a solid lane marking, may be interrupted at any time by steering slightly in the opposite direction.

Active Lane Keeping Assist cannot take weather conditions into account.

You are responsible for the driving at appropriate speeds, braking in good time, and steering correctly. Always adapt your driving style to suit the prevailing road and weather conditions. Always pay attention to traffic conditions and your surroundings. Otherwise, you may fail to recognize dangers in time,

cause an accident and injure yourself and others.

No lane-correcting brake application occurs if:

- you clearly and actively steer, brake or accelerate.
- you cut the corner on a sharp bend.
- you switch on the turn signals.
- a driving safety system intervenes, e.g. ESP®, PRE-SAFE® Brake or Active Blind Spot Assist.
- you have adopted a sporty driving style with high cornering speeds or high rates of acceleration.
- ESP® is switched off.
- the transmission is not in position **D**.
- a loss of tire pressure or a defective tire has been detected and displayed.

Active Lane Keeping Assist does not detect traffic situations or road users. An inappropriate brake application may be interrupted at any time if you:

- steer slightly in the opposite direction.
- use a turn signal.
- clearly brake or accelerate.

A lane-correcting brake application is interrupted automatically if:

- a driving safety system intervenes, e.g. ESP®, PRE-SAFE® Brake or Active Blind Spot Assist.
- lane markings can no longer be recognized.

Switching on Active Lane Keeping Assist

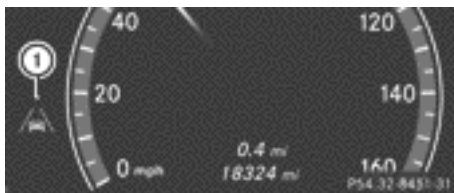

- ▶ Switch on Active Lane Keeping Assist using the on-board computer (▷ page 349). Symbol ① appears in the instrument cluster.

If your speed exceeds 40 mph (60 km/h) and lane markings are detected, symbol ① is highlighted in green. Active Lane Keeping Assist is ready for use.

Useful information	336
Important safety notes	336
Displays and operation	336
Menus and submenus	339
Display messages	352
Warning and indicator lamps in the instrument cluster	389

Useful information

- i** This Operator's Manual describes all models and all standard and optional equipment of your vehicle available at the time of publication of the Operator's Manual. Country-specific differences are possible. Please note that your vehicle may not be equipped with all features described. This also applies to safety-related systems and functions.
- i** Please read the information on qualified specialist workshops (▷ page 29).

Important safety notes

You will find an illustration of the instrument cluster in the "At a glance" section (▷ page 35).

WARNING

The driver's concentration must always be directed primarily at road traffic.

For your safety and the safety of others, selecting features through the multifunction steering wheel should only be done by the driver when traffic and road conditions permit it to be done safely.

Bear in mind that at a speed of only 30 mph (approximately 50 km/h), the vehicle covers a distance of 44 feet (approximately 14 m) per second.

WARNING

No messages will be displayed if either the instrument cluster or the multifunction display is inoperative.

As a result, you will not be able to see information about your driving conditions, such as

- speed
- outside temperature
- warning/indicator lamps

- malfunction/warning messages
- failure of any systems

Driving characteristics may be impaired.

If you must continue to drive, do so with added caution. Contact an authorized Mercedes-Benz Center as soon as possible.

WARNING

Malfunction and warning messages are only indicated for certain systems and are intentionally not very detailed. The malfunction and warning messages are simply a reminder with respect to the operation of certain systems. They do not replace the owner's and/or driver's responsibility to maintain the vehicle's operating safety. Have all required maintenance and safety checks performed on the vehicle. Bring the vehicle to an authorized Mercedes-Benz Center to address the malfunction and warning messages.

Displays and operation

Coolant temperature display

WARNING

Driving when your engine is overheated can cause some fluids which may have leaked into the engine compartment to catch fire. You could be seriously burned.

Steam from an overheated engine can cause serious burns which can occur just by opening the engine hood. Stay away from the engine if you see or hear steam coming from it.

Stop the vehicle in a safe location away from other traffic. Turn off the engine, get out of the vehicle and do not stand near the vehicle until the engine has cooled down.

The coolant temperature gauge is in the instrument cluster on the left-hand side.

Under normal operating conditions and with the specified coolant level, the coolant temperature may rise to 248 °F (120 °C).

! A display message is shown if the coolant temperature is too high.

If the coolant temperature is over 248 °F (120 °C), do not continue driving. The engine will otherwise be damaged.

Tachometer

The red band in the tachometer indicates the engine's overrevving range.

! Do not drive in the overrevving range, as this could damage the engine.

The fuel supply is interrupted to protect the engine when the red band is reached.

Outside temperature display

The outside temperature display is in the multifunction display (▷ page 338).

WARNING

The outside temperature indicator is not designed to serve as an ice-warning device and is therefore unsuitable for that purpose.

Indicated temperatures just above the freezing point do not guarantee that the road surface is free of ice. The road may still be icy, especially in wooded areas or on bridges.







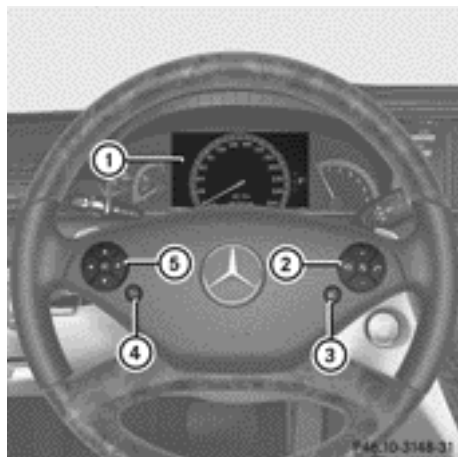

Changes in the outside temperature are displayed after a short delay.

Operating the on-board computer

The on-board computer is activated as soon as you turn the SmartKey to position **2** in the ignition lock.

You can control the multifunction display and the settings in the on-board computer using the buttons on the multifunction steering wheel.



①	Multifunction display
②	 Rejects or ends a call Exits phone book/redial memory  Makes or accepts a call Switches to the redial memory   Adjusts the volume or operates the RACETIMER in AMG vehicles  Mute
③	 Switches on the Voice Control System; see the separate operating instructions
④	 Press briefly: Back Switches off the Voice Control System; see the separate operating instructions Hides display messages or calls up the last Trip menu function used
	 Press and hold: Calls up the standard display in the Trip menu

⑤



Selects a menu

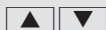

Press briefly:

Selects a function or scrolls through lists

In the **Audio** menu: selects a stored station, an audio track or a video scene

In the **Telephone** menu: switches to the phone book and selects a name or a telephone number



Press and hold:

In the **Audio** menu: selects a station from the alphabetical list of stations, starts station search or starts rapid scrolling through an audio/video disc

In the **Telephone** menu: starts rapid scrolling through the phone book

OK

Confirms selections and display messages

In the **Telephone** menu: switches to the phone book and starts dialing

In the **Audio** menu: stops the station search function at the desired station



- ① Menu bar
- ② Description field

Multifunction display

Values and settings as well as display messages are shown in the multifunction display.

Menus and submenus

Menu overview

The number of menus shown depends on the optional equipment in the vehicle.

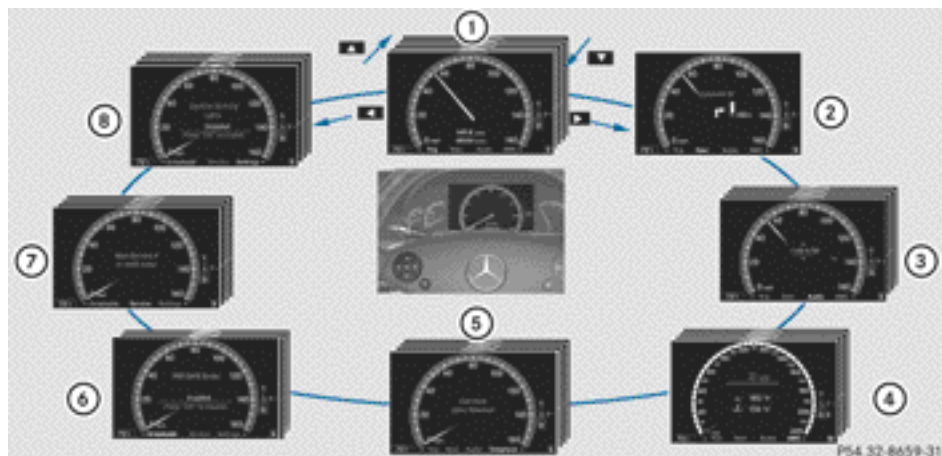



P54 32-8659-31

	Function
①	Trip menu (▷ page 340)
②	Navi menu (navigation instructions) (▷ page 341)
③	Audio menu (▷ page 342)
④	AMG menu in AMG vehicles (▷ page 343)
⑤	Telephone menu (▷ page 346)
⑥	DriveAssist menu (▷ page 347)
⑦	Service menu (▷ page 349) <ul style="list-style-type: none"> • calling up display messages (▷ page 352) • checking the tire pressure electronically (▷ page 461) • calling up a service due date (▷ page 426) • oil level check (▷ page 421)
⑧	Settings menu (▷ page 349)

Trip menu

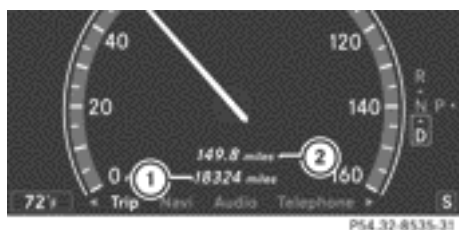



Standard display



- ▶ Press and hold the  button on the steering wheel until the **Trip** menu with odometer ① and trip odometer ② is shown.

Trip computer "From Start" or "From Reset"

The values in the **From Start** submenu are calculated from the start of a journey, while the values in the **From Reset** submenu are calculated from the last time the submenu was reset (▷ page 341).

- ▶ Press the  or  button on the steering wheel to select the **Trip** menu.
- ▶ Press the  or  button to select **After start** or **After reset**.

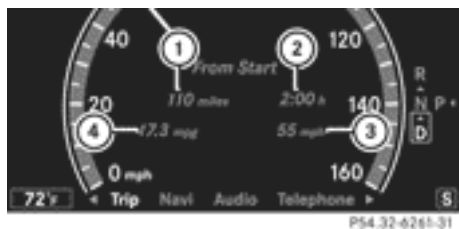

Example: trip computer "From start"





- ① Distance
- ② Time
- ③ Average speed
- ④ Average fuel consumption

The **From Start** trip computer is reset automatically when:

- the ignition has been switched off for more than four hours.
- 999 hours have been exceeded.
- 9999 miles have been exceeded.

When 9,999 hours or 99,999 miles have been exceeded, the trip computer is automatically reset **From Reset**.

Displaying the range and current fuel consumption



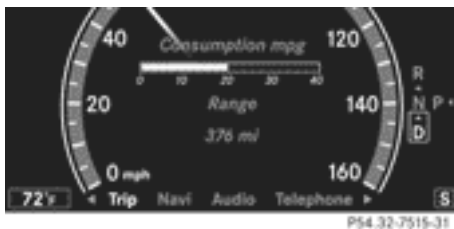

- ▶ Press the  or  button on the steering wheel to select the **Trip** menu.
- ▶ Press the  or  button to select **Range**.

You can see the current fuel consumption (except for AMG vehicles) and the approximate range.



The approximate range that can be covered depends on the fuel level and your current driving style. If there is only a small amount of fuel left in the fuel tank, the display shows a vehicle being refueled  instead of the range.

Digital speedometer

- ▶ Press the  or  button on the steering wheel to select the **Trip** menu.
- ▶ Press  or  to select the digital speedometer.



① Digital speedometer

Resetting values

You can reset the values of the following functions:

- trip odometer
- trip computer "From start"
- trip computer "From reset"
- ▶ Press the ◀ or ▶ button on the steering wheel to select the **Trip** menu.
- ▶ Press the ▲ or ▼ button to select the function that you wish to reset.
- ▶ Press **OK**.



Resetting the trip odometer (example)

- ▶ Press ▼ to select **Yes** and press **OK** to confirm.

Navi menu

Displaying navigation instructions

In the **Navi** menu, the multifunction display shows navigation instructions. Further information (▷ page 138).

- ▶ Activate COMAND (▷ page 126).
- ▶ Press the ◀ or ▶ button on the steering wheel to select the **Navi** menu.

Route guidance not active



- ① Direction of travel
- ② Current street

Route guidance active

No change of direction announced



- ① Distance to the destination
- ② Symbol "follow the road's course"
- ③ Distance to the next change of direction
- ④ Current street

Change of direction announced without a lane recommendation



- ① Road into which the change of direction leads
- ② Symbol for change of direction
- ③ Distance to change of direction and visual distance display

When a change of direction has been announced, you will see visual distance

display ③ next to the symbol for the change of direction ②. This decreases in size as you approach the announced change of direction.

Change of direction announced with a lane recommendation

Lane recommendations are only displayed if the relevant data is available on the digital map.



- ① Road into which the change of direction leads
- ② Symbol for change of direction
- ③ Distance to change of direction and visual distance display
- ④ Lane recommendation

On multiple-lane roads, COMAND can provide lane recommendation ④ for the next change of direction. During the change of direction, additional lanes may be displayed.



- ① Uninterrupted lane
- ② New lane during a change of direction
- ③ Lane recommended for the change of direction

Other status indicators of the navigation system

- : you have reached the destination or an intermediate destination.
- **New route...**: COMAND is calculating the new route.
- **Direction of Dest. Off map** or **Direction of Dest. Off mapped road**: the vehicle position is outside the area of the digital map (off-map position).
- **Direction of Dest. No Route**: no route could be calculated to the selected destination.

Audio menu

Selecting a radio station







- ① SIRIUS XM satellite radio functions like a normal radio.

For more information on satellite radio operation, see the separate operating instructions.

- ▶ Switch on COMAND and select Radio (▷ page 199).
- ▶ Press the or button on the steering wheel to select the **Audio** menu.





- ① Memory slot (only if the station is stored)
- ② Station
- ③ Waveband

- ▶ **To select a stored station:** briefly press the  or  button.
- ▶ **To select a station from the station list:** press and briefly hold the  or  button.
- ▶ **To select a station using station search¹⁵:** press and briefly hold the  or  button.
- ▶ Press  to stop the station search function at the desired station.





Operating an audio player or audio media



Audio data from various audio devices or media can be played, depending on the equipment installed in the vehicle.

- ▶ Switch on COMAND and select audio device or audio medium (▷ page 209).
- ▶ Press the  or  button on the steering wheel to select the **Audio** menu.



CD player display (example)



- ① Current title
- ② Medium (disc number only for DVD changer)
- ▶ **To select the next/previous track:** briefly press the  or  button.
- ▶ **To select a track from the track list (rapid scrolling):** press and hold the  or  button until the desired track has been reached.

If you press and hold the  or  button, the rapid scrolling speed is increased. Not all audio drives or data carriers support this function.





¹⁵ Only if no station list is received.

If track information is stored on the audio device or medium, the multifunction display will show the number and name of the track. The current track does not appear in audio AUX mode (**A**uxiliary audio mode: external audio source connected).

Video DVD operation



- ▶ Switch on COMAND and select video DVD (▷ page 229).
- ▶ Press the  or  button on the steering wheel to select the **Audio** menu.



- ① Current scene
- ② Medium (disc number only for DVD changer)
- ▶ **To select the next or previous scene:** briefly press the  or  button.
- ▶ **To select a scene from the scene list (rapid scrolling):** press and hold the  or  button until the desired scene has been reached.

AMG menu in AMG vehicles

AMG displays

- ▶ Press the  or  button on the steering wheel to select the **AMG** menu.

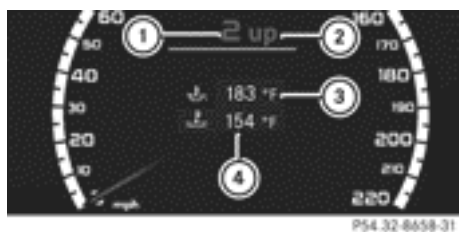

- ① Gear indicator
- ② Upshift indicator
- ③ Engine oil temperature
- ④ Coolant temperature

Upshift indicator **up** ② indicates that the engine has reached the overrevving range when in the manual gearshift program.

Upshift indicator **up** ② fades out other messages until you have shifted up.

When the engine oil temperature is below 80 °C, the oil temperature is shown in blue. Avoid driving at full engine output during this time.

i CL 63 AMG: the status of the ECO start/stop function (▷ page 276) is also shown.



RACETIMER



Displaying and starting RACETIMER

WARNING

The RACETIMER feature is only for use on roads and in conditions where high speed driving is permitted. Racing on public roads is prohibited under all circumstances. The driver is and must always remain responsible for following posted speed limits.

You can use the RACETIMER to store lap times.

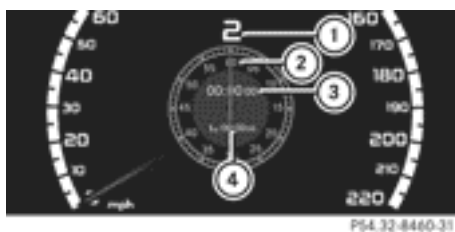

With RACETIMER, you cannot use the  and  buttons on the steering wheel to adjust the volume.

- ▶ Press the  or  button on the steering wheel to select the **AMG** menu.
- ▶ Press the  button repeatedly until the RACETIMER is shown.



- ① Gear indicator
- ② Seconds indicator
- ③ RACETIMER
- ④ Lap



You can start the RACETIMER when the engine is running or if the SmartKey is in position **2** in the ignition lock.

- ▶ **To start:** press the  button to start the RACETIMER.
- ▶ **To display the intermediate time:** press the  button to show the intermediate time.
The intermediate time is displayed for five seconds.
- ▶ **To stop:** press the  button to stop the RACETIMER.

The RACETIMER interrupts timing when you stop the vehicle and turn the SmartKey to position **1** in the ignition lock. When you turn the SmartKey to position **2** or **3** and then press the  button, timing is continued.

Storing the lap time and starting a new lap

It is possible to store a maximum of sixteen laps.

- ▶ Press the  button on the steering wheel to show the intermediate time during timing.
The intermediate time is displayed for five seconds.
- ▶ Press the  button again within five seconds.
The displayed intermediate time is stored as a lap time.

Timing starts for a new lap. The new lap is timed from when the intermediate time is called up.

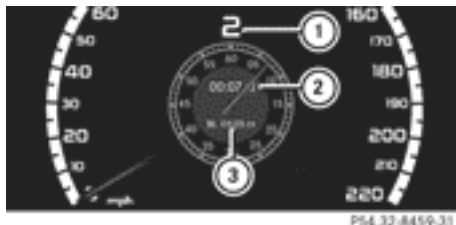

- ① Gear indicator
- ② RACETIMER
- ③ Fastest lap time (best lap)

Resetting the current lap

- ▶ Press the button on the steering wheel to stop the RACETIMER.
- ▶ Press the button to reset the lap time to "0".

Deleting all laps

You cannot delete individual stored laps.

- ▶ Press the button on the steering wheel to stop the RACETIMER.
- ▶ Press and hold the button for a minimum of three seconds.
- ▶ Press the button to start the RACETIMER.
All laps are deleted.

or

- ▶ Press the button on the steering wheel to stop the RACETIMER.
- ▶ Press the button.
Reset Race Timer appears in the multifunction display.



- ▶ Press the button to select **Yes** and press the button to confirm.
All laps are deleted.

Overall statistics

This function is shown if you have stored at least one lap and stopped the RACETIMER.

- ▶ Press or on the steering wheel to select the **AMG** menu.
- ▶ Press the button repeatedly until the overall evaluation is shown.

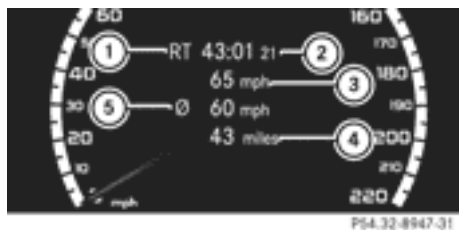



- ① RACETIMER overall evaluation
- ② Total time driven
- ③ Top speed
- ④ Distance covered
- ⑤ Average speed

Lap statistics

This function is only available if you have stored at least two laps and have stopped the RACETIMER.

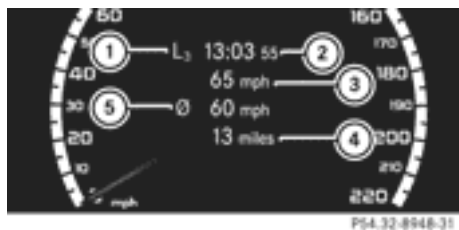
- ▶ Press the or button on the steering wheel to select the **AMG** menu.
- ▶ Press the button repeatedly until the lap evaluation is shown.
Each lap is shown in a separate submenu.
The fastest lap is indicated by flashing symbol ①.



- ① Lap
 - ② Lap time
 - ③ Top speed during lap
 - ④ Lap length
 - ⑤ Average lap speed
- ▶ Press the  or  button to select a different lap evaluation.

Telephone menu



Introduction

You can establish a Bluetooth® connection to COMAND (▷ page 183).

WARNING

The driver's attention to the road must always be his/her primary focus when driving. For your safety and the safety of others, we recommend that you pull over to a safe location and stop before placing or taking a telephone call. If you choose to use the telephone while driving, please use the hands-free device and only use the telephone when road, weather and traffic conditions permit.

Some jurisdictions prohibit the driver from using a mobile phone while driving a vehicle. Bear in mind that at a speed of just 30 mph (approximately 50 km/h), your vehicle covers a distance of 44 feet (approximately 14 m) every second.

- ▶ Switch on the mobile phone and COMAND (▷ page 126).
- ▶ Press the  or  button on the steering wheel to select the **Telephone** menu.

You will see one of the following display messages in the multifunction display:

- **Telephone ready** or the name of the network provider: the mobile phone has found a network and is ready to receive.
- **No Service**: no network is available, or the mobile phone is searching for a network.

Accepting a call

If someone calls you when you are in the **Telephone** menu, a display message appears in the multifunction display, for example:



- ▶ Press the  button on the steering wheel to accept an incoming call.

If you are not in the **Telephone** menu, you can still accept a call.

Rejecting or ending a call

- ▶ Press the  button on the steering wheel.

If you are not in the **Telephone** menu, you can still reject or end a call.

Dialing a number from the phone book











You can use the mobile phone to enter new telephone numbers into the phone book (see COMAND) (▷ page 191). If your mobile phone is able to receive calls, you can search for and dial a number from the phone book.

When you establish a Bluetooth® connection to COMAND, COMAND reads in the phone book of the mobile phone. This can take some time.







While the on-board computer reads in the SIM card:

- you can dial a telephone number from the redial list (**Calls Dialed** list).
- you can dial a telephone number from the telephone book stored in COMAND.
- the multifunction display shows the **Reading data...** display message below the phone book entries.



When the multifunction display shows the **Updating data...** display message, COMAND has finished importing data. The multifunction display then shows all the phone book entries in COMAND and the mobile phone.

- ▶ Press the  or  button on the steering wheel to select the **Telephone** menu.
- ▶ Press the ,  or  button to call up the phone book.
- ▶ Press the  or  button to select the desired name.
To scroll rapidly, press and hold the  or  button for longer than one second. After skipping eight entries, the rapid scroll speeds up.
Rapid scrolling stops when you release the button or reach the end of the list.
- ▶ **If only one telephone number is stored for a name:** press the  or  button to start dialing.

or









- ▶ **If there is more than one number for a particular name:** press the  or  button to display the numbers.
- ▶ Press the  or  button to select the number you want to dial.
- ▶ Press the  or  button to start dialing.

or



- ▶ **If you do not want to make a call:** press the  or  button.

Redialing

The on-board computer saves the last names or numbers dialed in the redial memory (**Calls Dialed** list).

- ▶ Press the  or  button on the steering wheel to select the **Telephone** menu.
- ▶ Press the  button to switch to the redial memory.
- ▶ Press the  or  button to select the desired name or number.
To scroll rapidly, press and hold the  or  button for longer than one second.
- ▶ Press the  or  button to start dialing.





or

- ▶ **If you do not want to make a call:** press the  or  button.

Assistance menu

Showing the distance display

This function is only available with DISTRONIC PLUS.

- ▶ Press the  or  button on the steering wheel to select the **DriveAssist** menu.
 - ▶ Press the  or  button to select **Distance Display**.
 - ▶ Press .
- The DISTRONIC PLUS distance display (▷ page 305) appears in the multifunction display.

Deactivating/activating ESP®







WARNING

Under no circumstances should you deactivate ESP® when the  ESP® warning lamp in the instrument cluster flashes. Proceed as follows:

- when driving off, apply as little throttle as possible.
- while driving, ease up on the accelerator pedal.
- adapt your speed to suit the prevailing road and weather conditions.



Failure to observe these guidelines could cause the vehicle to skid. ESP® cannot prevent accidents resulting from excessive speed.

For further information about ESP®, see (▷ page 67).

- ▶ Start the engine.
- ▶ Press  or  on the steering wheel to select the **Assistance** menu.
- ▶ Press the  or  button to select **ESP**.
- ▶ Press the  button.
- ▶ **To deactivate:** press  again.
The  warning lamp in the instrument cluster comes on.



WARNING

When the  ESP® OFF warning lamp is lit, ESP® is deactivated.

If the  ESP® warning lamp and the  ESP® OFF warning lamp remain lit, ESP® is not available due to a malfunction.







When ESP® is deactivated or not operational, vehicle stability in standard driving maneuvers is reduced.

Adapt your speed and driving to the prevailing road conditions and to the non-operating status of the ESP®.

- ▶ **To activate:** press  again.
The  warning lamp in the instrument cluster goes out.







Activating/deactivating PRE-SAFE® Brake

PRE-SAFE® Brake is only available in vehicles with DISTRONIC PLUS.

- ▶ Press the  or  button on the steering wheel to select the **DriveAssist** menu.
- ▶ Press  or  to select **PRE-SAFE Brake**.
- ▶ Press .
The current selection is displayed.
- ▶ **To activate/deactivate:** press  again.

When PRE-SAFE® Brake (▷ page 68) is activated, the multifunction display shows the  symbol as long as the HOLD function is not activated (▷ page 308).







Activating/deactivating ATTENTION ASSIST

- ▶ Press the  or  button on the steering wheel to select the **DriveAssist** menu.
- ▶ Press the  or  button to select **Attention Assist**.
- ▶ Press .
The current selection is displayed.
- ▶ **To activate/deactivate:** press  again.

When ATTENTION ASSIST (▷ page 321) is activated, the  symbol appears in the multifunction display when the ignition is on.







Activating/deactivating Active Blind Spot Assist

You can use the **Blind Spot Assist** function to activate or deactivate Active Blind Spot Assist (▷ page 327).

- ▶ Press the  or  button on the steering wheel to select the **DriveAssist** menu.
- ▶ Press  or  to select **Blind Spot Assist**.
- ▶ Press the  button.
The current selection is displayed.
- ▶ **To activate/deactivate:** press the  button again.

Activating/deactivating Active Lane Keeping Assist

You can use the **Lane Keeping Assist** function to activate or deactivate Active Lane Keeping Assist (▷ page 330).

- ▶ Press the  or  button on the steering wheel to select the **DriveAssist** menu.
- ▶ Press  or  to select **Lane Keeping Assist**.
- ▶ Press the  button.
The current selection is displayed.
- ▶ **To activate/deactivate:** press the  button again.

When Active Lane Keeping Assist is activated, the  symbol appears in the multifunction display when the ignition is on.

Maintenance menu

In the **Service** menu, you have the following options:

- calling up display messages (▷ page 352)
- checking the tire pressure electronically (▷ page 461)
- calling up a service due date (▷ page 426)
- checking the oil level (▷ page 421)

Settings menu



Introduction

The **Settings** menu can be used for:

- Switching the daytime running lamps on/off
- switching Adaptive Highbeam Assist on/off
- showing or hiding the additional speedometer
- selecting the units for speed and distance
- activating/deactivating the radar sensor system



Switching the daytime running lamps on/off

This function is not available in Canada.







If you have activated the **Daytime running lights** function and the light switch is in the  or  position, the daytime running lamps are automatically switched on when the engine is running.

Depending on the ambient light, the following will additionally light up:







- parking lamps
- tail lamps
- license plate lamp
- side marker lamps

If you turn the light switch to a different position, the corresponding lights are switched on. If you switch off the daytime running lamps at night, make sure that the light switch is set to  or .

The factory setting is **On**.

- ▶ Press the  or  button on the steering wheel to select the **Settings** menu.
- ▶ Press the  or  button to select **daytime running lamps**.
- ▶ Press the  button to confirm.
- ▶ **To activate/deactivate:** press  button again.

Switching Adaptive Highbeam Assist on/off







- ▶ Press the  or  button on the steering wheel to select the [Settings](#) menu.
- ▶ Press the  or  button to select [Adapt. High-beam Asst..](#)
- ▶ Press the  button to confirm.
- ▶ **To activate/deactivate:** press  again.

Switching the additional speedometer on/off

An additional digital speedometer can be shown in the multifunction display.

Vehicles with a kilometer speedometer: the digital speedometer has mph units.

Vehicles with a miles speedometer: the digital speedometer has km/h units.

- ▶ Press the  or  button on the steering wheel to select the [Settings](#) menu.
- ▶ Press  or  to select [Add. Speedometer.](#)
- ▶ Press the  button to confirm.
- ▶ Press the  button to save the setting.







Selecting the unit of measurement for distance

The [Display Unit Speed-/Odometer:](#) function allows you to choose whether certain displays appear in kilometers or miles.

The selected unit of measurement for distance applies to:







- analog speedometers
- digital speedometers in the [Trip](#) menu
- odometer and the trip odometer
- Trip computer
- navigation instructions in the [Navi](#) menu
- DISTRONIC PLUS
- ASSYST PLUS service interval display

The digital speedometer shows alternative speed units (▷ page 350).

- ▶ Press the  or  button on the steering wheel to select the [Settings](#) menu.
- ▶ Press  or  to select [Units.](#)
- ▶ Press  to confirm.
- ▶ Press the  button to save the setting. The unit switches [km/h](#) and [mph](#).





Activating/deactivating the acoustic locking verification signal

If you activate the [Acoustic Lock Feedb.](#) function, an audible signal sounds depending on the vehicle's date of manufacture:

- when locking
or
- once when unlocking and three times when locking
- ▶ Press the  or  button on the steering wheel to select the [Settings](#) menu.
- ▶ Press the  or  button to select [Acoustic Lock Feedb.](#)
- ▶ Press the  button to confirm.
- ▶ **To activate/deactivate:** press  again.

Activating/deactivating the radar sensor system

The following systems are switched off when the radar sensor system is deactivated:

- DISTRONIC PLUS (▷ page 298)
- BAS PLUS (▷ page 66)
- PRE-SAFE® Brake (▷ page 68)
- Active Blind Spot Assist (▷ page 327)
- ▶ Press the  or  button on the steering wheel to select the [Settings](#) menu.
- ▶ Press  or  to select [Radar Sensors.](#)

- ▶ Press to confirm.
- ▶ **To activate/deactivate:** press the button again.

Display messages

General notes

WARNING

All categories of messages contain important information which should be taken note of and, where a malfunction is indicated, addressed as soon as possible at an authorized Mercedes-Benz Center.

Failure to repair the condition noted may cause damage not covered by the Mercedes-Benz Limited Warranty, or result in property damage or personal injury.

Display messages appear in the multifunction display.

Display messages with graphic displays may be shown in simplified form in the Operator's Manual and may differ from the messages shown in the multifunction display.



Please respond in accordance with the display messages and follow the additional notes in this Operator's Manual.

Certain display messages are accompanied by an audible warning tone or a continuous tone.

When you stop and park the vehicle, please observe the notes on the HOLD function (▷ page 308) and parking (▷ page 289).

Hiding display messages

You can hide some display messages with a low priority.

- ▶ Press the  or  button on the steering wheel to hide the display message. The display message is cleared.







Display messages with a low priority are shown in either yellow or white.

Display messages with a high priority are shown in red.

You cannot hide display messages of the highest priority. The multifunction display shows these messages continuously until the causes for the messages have been remedied.

Message memory

The on-board computer saves certain display messages. You can call up the display messages in the **message memory**.

- ▶ Press the  or  button on the steering wheel and select the **Service** menu. If there are display messages, the multifunction display shows, for example, **2 messages**.
- ▶ Press the  or  button to select the entry, e.g. **2 messages**.
- ▶ Confirm with .
- ▶ Press the  or  button to scroll through the display messages.

When the ignition is switched off, all display messages are deleted, apart from some high-priority display messages. Once the causes of the high-priority display messages have been rectified, the corresponding display messages are also deleted.

Safety systems

Display messages





Currently
Unavailable See
Operator's Manual

Possible causes/consequences and ► Solutions

ABS (Anti-lock Braking System), ESP® (Electronic Stability Program), BAS (Brake Assist), PRE-SAFE®, the HOLD function and hill start assist are temporarily unavailable.

BAS PLUS and PRE-SAFE® Brake may also have failed.

In addition, the ,  and  warning lamps light up in the instrument cluster.

ATTENTION ASSIST is deactivated.

For example, the on-board voltage may be insufficient.

 **WARNING**

The brake system continues to function normally, but without the functions listed above. The wheels could therefore lock if you brake hard, for example.

The steerability and braking characteristics may be severely affected. The braking distance in an emergency braking situation can increase.

If ESP® is not operational, ESP® is unable to stabilize the vehicle.

There is an increased risk of skidding and an accident.

► Carefully drive a suitable distance, making slight steering movements at a speed above 12 mph (20 km/h).



If the display message disappears, the functions mentioned above are available again.

If the display message continues to be displayed:

- Drive on carefully.
- Visit a qualified specialist workshop.

ABS, ESP®, BAS, PRE-SAFE®, the HOLD function and hill start assist are temporarily unavailable.

BAS PLUS and PRE-SAFE® Brake may also have failed.







In addition, the ,  and  warning lamps light up in the instrument cluster.





ATTENTION ASSIST is deactivated.







For example, the on-board voltage may be insufficient.











 **WARNING**











The brake system continues to function normally, but without the functions listed above. The wheels could therefore lock if you brake hard, for example.











Display messages	Possible causes/consequences and ► Solutions
	<p>The steerability and braking characteristics may be severely affected. The braking distance in an emergency braking situation can increase.</p> <p>If ESP® is not operational, ESP® is unable to stabilize the vehicle. There is an increased risk of skidding and an accident.</p> <p>► Drive on carefully. If the display message disappears, the functions mentioned above are available again.</p> <p>If the display message continues to be displayed:</p> <p>► Drive on carefully. ► Visit a qualified specialist workshop.</p>
  <p>Inoperative See Operator's Manual</p>	<p>ABS, ESP®, BAS, PRE-SAFE®, the HOLD function and hill start assist are unavailable due to a malfunction.</p> <p>BAS PLUS and PRE-SAFE® Brake may also have failed.</p> <p>The  (USA only)/ (Canada only), ,  and  warning lamps in the instrument cluster also light up. ATTENTION ASSIST is deactivated.</p> <p>▲ WARNING</p> <p>The brake system continues to function normally, but without the functions listed above. The wheels could therefore lock if you brake hard, for example.</p> <p>The steerability and braking characteristics may be severely affected. The braking distance in an emergency braking situation can increase.</p> <p>If ESP® is not operational, ESP® is unable to stabilize the vehicle. There is an increased risk of skidding and an accident.</p> <p>► Drive on carefully. ► Visit a qualified specialist workshop immediately.</p>















Display messages	Possible causes/consequences and ► Solutions
 <p>Currently Unavailable See Operator's Manual</p>	<p>ESP®, BAS, PRE-SAFE®, the HOLD function and hill start assist are temporarily unavailable.</p> <p>BAS PLUS and PRE-SAFE® Brake may also have failed.</p> <p>In addition, the  and  warning lamps light up in the instrument cluster.</p> <p>The self-diagnosis function might not be complete, for example. ATTENTION ASSIST is deactivated.</p> <p>⚠ WARNING</p> <p>The brake system continues to function normally, but without the functions listed above.</p> <p>The braking distance in an emergency braking situation can thus increase.</p> <p>If ESP® is not operational, ESP® is unable to stabilize the vehicle. There is an increased risk of skidding and an accident.</p> <ul style="list-style-type: none"> ► Carefully drive a suitable distance, making slight steering movements at a speed above 12 mph (20 km/h). If the display message disappears, the functions mentioned above are available again. <p>If the display message continues to be displayed:</p> <ul style="list-style-type: none"> ► Drive on carefully. ► Visit a qualified specialist workshop. <p>⚠ WARNING</p> <p>If the display message is shown and the  warning lamp flashes at the same time, the Electronic Traction System is deactivated. Otherwise, the brakes on the drive wheels could overheat.</p> <ul style="list-style-type: none"> ► Let the brakes cool down until the display message disappears and the  warning lamp goes out. The Electronic Traction System is activated again.





Display messages	Possible causes/consequences and ► Solutions
 <p data-bbox="87 228 300 284">Inoperative See Operator's Manual</p>	<p data-bbox="342 177 1003 233">ESP®, BAS, PRE-SAFE®, the HOLD function and hill start assist are unavailable due to a malfunction.</p> <p data-bbox="342 244 897 268">BAS PLUS and PRE-SAFE® Brake may also have failed.</p> <p data-bbox="342 279 960 335">In addition, the  and  warning lamps light up in the instrument cluster.</p> <p data-bbox="342 346 992 402">The self-diagnosis function might not be complete, for example. ATTENTION ASSIST is deactivated.</p> <p data-bbox="353 426 505 450">▲ WARNING</p> <p data-bbox="342 467 1003 523">The brake system continues to function normally, but without the functions listed above.</p> <p data-bbox="342 534 1003 590">The braking distance in an emergency braking situation can thus increase.</p> <p data-bbox="342 601 1003 657">If ESP® is not operational, ESP® is unable to stabilize the vehicle. There is an increased risk of skidding and an accident.</p> <ul data-bbox="342 675 736 730" style="list-style-type: none"> ► Drive on carefully. ► Visit a qualified specialist workshop.
 <p data-bbox="87 807 316 831">System Inoperative</p>	<p data-bbox="353 762 505 786">▲ WARNING</p> <p data-bbox="342 804 1003 860">ESP®, BAS, PRE-SAFE®, the HOLD function and hill start assist are unavailable due to a malfunction. BAS PLUS and PRE-SAFE® Brake may also have failed. In addition, the  and  warning lamps light up in the instrument cluster.</p> <p data-bbox="342 932 695 956">ATTENTION ASSIST is deactivated.</p> <ul data-bbox="342 973 736 1029" style="list-style-type: none"> ► Drive on carefully. ► Visit a qualified specialist workshop.

Display messages	Possible causes/consequences and ► Solutions
   <p data-bbox="115 276 329 331">Inoperative See Operator's Manual</p>	<p data-bbox="370 177 1032 264">EBD (electronic brake force distribution), ABS, ESP®, BAS, PRE-SAFE®, the HOLD function and hill start assist are unavailable due to a malfunction.</p> <p data-bbox="370 276 927 300">BAS PLUS and PRE-SAFE® Brake may also have failed.</p> <p data-bbox="370 311 1016 367">In addition, the ,  and  warning lamps light up in the instrument cluster and a warning tone sounds.</p> <p data-bbox="370 378 725 402">ATTENTION ASSIST is deactivated.</p> <p data-bbox="381 421 535 448">⚠ WARNING</p> <p data-bbox="370 464 1032 552">The brake system continues to function normally, but without the functions listed above. The front and rear wheels could therefore lock if you brake hard, for example.</p> <p data-bbox="370 560 1032 647">The steerability and braking characteristics may be severely affected. The braking distance in an emergency braking situation can increase.</p> <p data-bbox="370 655 1032 711">If ESP® is not operational, ESP® is unable to stabilize the vehicle. There is an increased risk of skidding and an accident.</p> <ul data-bbox="370 727 897 783" style="list-style-type: none"> ► Drive on carefully. ► Visit a qualified specialist workshop immediately.
 <p data-bbox="115 869 306 925">Check Brake Pad Wear</p>	<p data-bbox="370 818 919 842">The brake pads/linings have reached their wear limit.</p> <ul data-bbox="370 858 768 882" style="list-style-type: none"> ► Visit a qualified specialist workshop.
<p data-bbox="115 954 340 1066">PARK (USA only)  (Canada only)</p> <p data-bbox="115 1074 295 1129">Please Release Parking Brake</p>	<p data-bbox="370 946 990 1002">The red PARK (USA only)/  (Canada only) indicator lamp flashes and a warning tone sounds.</p> <p data-bbox="370 1010 930 1034">You are driving with the electric parking brake applied.</p> <ul data-bbox="370 1050 751 1145" style="list-style-type: none"> ► Release the electric parking brake. or ► Pull away carefully (► page 290). <p data-bbox="370 1177 990 1233">The red PARK (USA only)/  (Canada only) indicator lamp flashes and a warning tone sounds.</p> <p data-bbox="370 1241 997 1297">You are making an emergency stop using the electric parking brake (► page 290).</p> <ul data-bbox="370 1313 1012 1369" style="list-style-type: none"> ► After the emergency stop: release the electric parking brake lever.



Display messages	Possible causes/consequences and ► Solutions
	<p>The red  (USA only)/ (Canada only) indicator lamp lights up. The yellow  (USA only)/ (Canada only) warning lamp lights up and a warning tone sounds.</p> <p>The electric parking brake is malfunctioning and the braking effect is restricted.</p> <p>While the vehicle is in motion:</p> <ul style="list-style-type: none"> ► Release the electric parking brake handle. <p>While the vehicle is stationary:</p> <ul style="list-style-type: none"> ► Switch off the ignition and turn it back on. ► Release the electric parking brake. <p>If the display message continues to be displayed:</p> <ul style="list-style-type: none"> ► Shift the transmission to P. ► Use the folding wheel chock (► page 438) from the vehicle tool kit to secure the vehicle against rolling away. ► Consult a qualified specialist workshop.
<p> (USA only)  (Canada only)</p> <p>Parking Brake See Operator's Manual</p>	<p>The yellow  (USA only)/ (Canada only) warning lamp lights up. Additionally, the red  (USA only)/ (Canada only) indicator lamp may light up.</p> <p>The electric parking brake is malfunctioning.</p> <p>To release:</p> <ul style="list-style-type: none"> ► Pull the electric parking brake handle. <p>or</p> <ul style="list-style-type: none"> ► Pull away carefully. ► Visit a qualified specialist workshop. <p>To apply:</p> <ul style="list-style-type: none"> ► Switch the ignition off. ► Pull the electric parking brake lever for at least ten seconds, until the display message disappears. <p>If the display message continues to be displayed:</p> <ul style="list-style-type: none"> ► Shift the transmission to P. ► Use the folding wheel chock (► page 438) from the vehicle tool kit to secure the vehicle against rolling away. ► Consult a qualified specialist workshop.









Display messages	Possible causes/consequences and ► Solutions
	<p>The red  (USA only)/ (Canada only) indicator lamp lights up.</p> <p>The power supply for the electric parking brake was interrupted.</p> <ul style="list-style-type: none"> ► Pull the electric parking brake handle. <p>or</p> <ul style="list-style-type: none"> ► Pull away carefully. <p>or</p> <ul style="list-style-type: none"> ► Pull the electric parking brake handle until the display message disappears.
	<p>The red  (USA only)/ (Canada only) indicator lamp lights up. The yellow  (USA only)/ (Canada only) warning lamp lights up.</p> <p>The electric parking brake is malfunctioning.</p> <ul style="list-style-type: none"> ► Switch off the ignition and turn it back on. ► Engage or release the electric parking brake. <p>or</p> <ul style="list-style-type: none"> ► Pull away carefully. ► Visit a qualified specialist workshop.
	<p>The yellow  (USA only)/ (Canada only) warning lamp lights up. The red  (USA only)/ (Canada only) indicator lamp flashes for approximately ten seconds after the electric parking brake has been applied or released. It then goes out or remains lit.</p> <p>The electric parking brake is malfunctioning, e.g. because of overvoltage or undervoltage.</p> <ul style="list-style-type: none"> ► Pull away carefully. ► Visit a qualified specialist workshop. <p>If there is overvoltage or undervoltage:</p> <ul style="list-style-type: none"> ► Remove the cause for the overvoltage or undervoltage, e.g. by charging the battery or restarting the engine. ► Switch the ignition off and on, and then engage or release the electric parking brake. <p>If this does not release the electric parking brake:</p> <ul style="list-style-type: none"> ► Do not drive on. ► Consult a qualified specialist workshop.

Display messages	Possible causes/consequences and ► Solutions
	<p>The yellow  (USA only)/  (Canada only) warning lamp lights up. The red  (USA only)/  (Canada only) indicator lamp flashes for approximately ten seconds after the electric parking brake has been applied or released. It then goes out or remains lit.</p> <p>The electric parking brake has overheated.</p> <ul style="list-style-type: none"> ► Allow the vehicle to cool down. Do not engage or release the electric parking brake during this time. ► Use the folding wheel chock (▷ page 438) from the vehicle tool kit to secure the vehicle against rolling away. ► When the vehicle has cooled down: switch the ignition off and on again, then engage or release the electric parking brake.
<p> (USA only)  (Canada only)</p> <p>Parking Brake Inoperative</p>	<p>The yellow  (USA only)/  (Canada only) warning lamp lights up. The red  (USA only)/  (Canada only) indicator lamp flashes for approximately ten seconds after the electric parking brake has been applied or released. It then goes out or remains lit.</p> <p>The electric parking brake is malfunctioning.</p> <ul style="list-style-type: none"> ► Switch the ignition off and on, and then engage the electric parking brake. <p>If it is not possible to engage the electric parking brake:</p> <ul style="list-style-type: none"> ► Shift the transmission to P. ► Use the folding wheel chock (▷ page 438) from the vehicle tool kit to secure the vehicle against rolling away. ► Consult a qualified specialist workshop.
<p> (USA only)  (Canada only)</p> <p>Turn On the Ignition to Release the Parking Brake</p>	<p>The red  (USA only)/  (Canada only) indicator lamp lights up.</p> <p>You attempted to release the electric parking brake while the ignition was switched off.</p> <ul style="list-style-type: none"> ► SmartKey: turn the SmartKey to position 1 in the ignition lock. ► KEYLESS-GO: switch on the ignition.

Display messages	Possible causes/consequences and ► Solutions
<p>BRAKE (USA only)  (Canada only)</p> <p>Service See Operator's Manual</p>	<p>There is a malfunction in the system. The brake system continues to operate normally.</p> <ul style="list-style-type: none"> ► Drive on carefully. ► Visit a qualified specialist workshop.
<p>BRAKE (USA only)  (Canada only)</p> <p>Check Brake Fluid Level</p>	<p>There is not enough brake fluid in the brake fluid reservoir. Additionally, the red BRAKE (USA only) /  (Canada only) warning lamp lights up in the instrument cluster and a warning tone sounds.</p> <p> WARNING</p> <p>The braking effect may be impaired. There is a risk of an accident.</p> <ul style="list-style-type: none"> ► Pull over and stop the vehicle safely as soon as possible, paying attention to road and traffic conditions. Do not continue driving under any circumstances. ► Secure the vehicle against rolling away (► page 289). ► Consult a qualified specialist workshop. ► Do not add brake fluid. This does not correct the malfunction.

Display messages	Possible causes/consequences and ► Solutions
<p> SOS</p> <p>Tele Aid Inoperative</p>	<p>USA only: one or more of the main functions in the mbrace system are malfunctioning.</p> <p>Canada only: one or more of the main functions of the TELEAID system are malfunctioning.</p> <ul style="list-style-type: none"> ► USA only: have the mbrace system checked at a qualified specialist workshop. ► Canada only: have the TELEAID system checked at a qualified specialist workshop.
<p>PRE-SAFE</p> <p>Inoperative See Operator's Manual</p>	<p>Important functions of PRE-SAFE® have failed. All other occupant safety systems, e.g. air bags, remain available.</p> <ul style="list-style-type: none"> ► Visit a qualified specialist workshop immediately.

Display messages	Possible causes/consequences and ► Solutions
<p>PRE-SAFE Function Currently Limited See Operator's Manual</p>	<p>PRE-SAFE® Brake is temporarily inoperative. Possible causes are:</p> <ul style="list-style-type: none"> • the DISTRONIC PLUS cover in the radiator trim is dirty • function is impaired due to heavy rain or snow. • the sensors in the bumpers are dirty. • the radar sensor system is temporarily inoperative, e.g. due to electromagnetic radiation emitted by nearby TV or radio stations or other sources of electromagnetic radiation. • the system is outside the operating temperature range. • the on-board voltage is too low. <p>If the display message does not disappear:</p> <ul style="list-style-type: none"> ► Pull over and stop the vehicle safely as soon as possible, paying attention to road and traffic conditions. ► Secure the vehicle against rolling away (▷ page 289). ► Clean the DISTRONIC PLUS cover in the radiator trim (▷ page 431). ► Clean the bumpers (▷ page 431). ► Restart the engine. <p>If the system detects that the sensors are fully operational, the display message disappears.</p> <p>PRE-SAFE® Brake is operational again.</p>
<p>PRE-SAFE Function Limited See Operator's Manual</p>	<p>PRE-SAFE® Brake is defective. BAS PLUS or the distance warning signal may also have failed.</p> <ul style="list-style-type: none"> ► Visit a qualified specialist workshop.
<p> SRS Malfunction Service Required</p>	<p>There is a malfunction in the SRS (Supplemental Restraint System). The  warning lamp also lights up in the instrument cluster.</p> <p>⚠ WARNING</p> <p>The air bags or Emergency Tensioning Devices may either be triggered unintentionally or, in the event of an accident, may not be triggered.</p> <p>There is an increased risk of injury.</p> <ul style="list-style-type: none"> ► Visit a qualified specialist workshop.

Display messages	Possible causes/consequences and ► Solutions
 <p>Front Left SRS Malfunction Service Required or Front Right SRS Malfunction Service Required</p>	<p>SRS has malfunctioned at the front on the left or right. The  warning lamp also lights up in the instrument cluster.</p> <p> WARNING</p> <p>The air bags or Emergency Tensioning Devices may either be triggered unintentionally or, in the event of an accident, may not be triggered.</p> <p>There is an increased risk of injury.</p> <p>► Visit a qualified specialist workshop.</p>
 <p>Rear Left SRS Malfunction Service Required or Rear Right SRS Malfunction Service Required</p>	<p>SRS has malfunctioned at the rear on the left or right. The  warning lamp also lights up in the instrument cluster.</p> <p> WARNING</p> <p>The air bags or Emergency Tensioning Devices may either be triggered unintentionally or, in the event of an accident, may not be triggered.</p> <p>There is an increased risk of injury.</p> <p>► Visit a qualified specialist workshop.</p>
 <p>Left Side Curtain Airbag Malfunction Service Required or Right Side Curtain Airbag Malfunction Service Required</p>	<p>There is a malfunction in the left-hand or right-hand window curtain air bag.</p> <p>The  warning lamp also lights up in the instrument cluster.</p> <p> WARNING</p> <p>The left or right window curtain air bag may either be triggered unintentionally or, in the event of an accident, may not be triggered.</p> <p>There is an increased risk of injury.</p> <p>► Visit a qualified specialist workshop.</p>

Display messages	Possible causes/consequences and ► Solutions
<p>Front Passenger Airbag Disabled See Operator's Manual</p>	<p>The front-passenger air bag is disabled during the journey, even though:</p> <ul style="list-style-type: none"> • an adult or • a person larger than a certain size is occupying the front-passenger seat <p>If additional forces are applied to the seat, the system may interpret the occupant's weight as lower than it actually is.</p> <ul style="list-style-type: none"> ► Pull over and stop the vehicle safely as soon as possible, paying attention to road and traffic conditions. ► Apply the parking brake. ► Switch the ignition off. ► Have the occupant get out of the vehicle. ► Keep the seat unoccupied, close the front-passenger door and switch on the ignition. <p>Observe the PASSENGER AIR BAG OFF indicator lamp (► page 50) and the multifunction display and check the following: Seat unoccupied and ignition switched on:</p> <ul style="list-style-type: none"> • the PASSENGER AIR BAG OFF indicator lamp must light up and remain lit. If the indicator lamp is on, OCS (► page 50) has deactivated the front-passenger air bag. • The Front Passenger Airbag Enabled See Oper. Manual or Front Passenger Airbag Disabled See Oper. Manual display messages must not appear in the multifunction display. <ul style="list-style-type: none"> ► Wait for a period of at least 60 seconds until the necessary system checks have been completed. ► Make sure that the display messages do not appear in the multifunction display. <p>If these conditions are fulfilled, the front-passenger seat can be occupied again. Whether the PASSENGER AIR BAG OFF indicator lamp remains lit or goes out depends on how OCS classifies the occupant.</p> <p>If the conditions are not fulfilled, the system is not operating correctly.</p> <ul style="list-style-type: none"> ► Visit a qualified specialist workshop immediately.

 **WARNING**

If the  **PASS AIR BAG OFF** indicator lamp remains lit with an adult occupant on the front-passenger seat even after performing the above corrective steps, do not have any passenger use the front-passenger seat until the system has been repaired.

Display messages	Possible causes/consequences and ► Solutions
<p>Front Passenger Airbag Enabled See Operator's Manual</p>	<p>The front-passenger air bag is enabled during the journey, even though:</p> <ul style="list-style-type: none"> • a child, a small adult or an object weighing less than the system's weight threshold is located on the front-passenger seat or • the front-passenger seat is unoccupied <p>The system may detect objects or forces applying additional weight on the seat.</p> <ul style="list-style-type: none"> ► Pull over and stop the vehicle safely as soon as possible, paying attention to road and traffic conditions. ► Apply the parking brake. ► Switch the ignition off. ► Open the front-passenger door. ► Remove the child and the child restraint system from the front-passenger seat. ► If necessary, secure the child in a child restraint system on a suitable rear seat. ► Make sure that there are no objects on the seat adding to the weight. The system may otherwise detect the additional weight and interpret the seat occupant's weight as greater than it actually is. ► Keep the seat unoccupied, close the front-passenger door and switch on the ignition. <p>Observe the PASSENGER AIR BAG OFF indicator lamp (▷ page 50) and the multifunction display and check the following: Seat unoccupied and ignition switched on:</p> <ul style="list-style-type: none"> • the PASSENGER AIR BAG OFF indicator lamp must light up and remain lit. If the indicator lamp is on, OCS (▷ page 50) has deactivated the front-passenger air bag. • The Front Passenger Airbag Enabled See Operator's Manual or Front Passenger Airbag Disabled See Operator's Manual display messages must not appear in the multifunction display. <ul style="list-style-type: none"> ► Wait for a period of at least 60 seconds until the necessary system checks have been completed. ► Make sure that the display messages do not appear in the multifunction display. <p>If these conditions are fulfilled, the front-passenger seat can be occupied again. Whether the PASSENGER AIR BAG OFF indicator</p>

Display messages	Possible causes/consequences and ► Solutions
	<p>lamp remains lit or goes out depends on how OCS classifies the occupant.</p> <p>If the conditions are not fulfilled, the system is not operating correctly.</p> <p>► Visit a qualified specialist workshop immediately.</p>



WARNING



If the  PASS AIR BAG OFF indicator lamp remains off even after performing the above corrective steps, do not have any children twelve years old and under and other small individuals use the front-passenger seat until the system has been repaired.

Lights





Display messages about LEDs:

This display message will only appear if all LEDs have failed.



Display messages	Possible causes/consequences and ► Solutions
 Check Left Cornering Light or Check Right Cornering Light	<p>The left or right-hand cornering light is defective.</p> <p>► Check whether you are permitted to change the bulb yourself (> page 256).</p> <p>or</p> <p>► Visit a qualified specialist workshop.</p>
 Check Left Low Beam or Check Right Low Beam	<p>The left or right-hand low-beam headlamp is defective.</p> <p>► Check whether you are permitted to change the bulb yourself (> page 256).</p> <p>or</p> <p>► Visit a qualified specialist workshop.</p>
 Check Rear Left Turn Signal or Check Rear Right Turn Signal	<p>The rear left-hand or rear right-hand turn signal is defective.</p> <p>► Check whether you are permitted to change the bulb yourself (> page 256).</p> <p>or</p> <p>► Visit a qualified specialist workshop.</p>



Display messages	Possible causes/consequences and ► Solutions
 <p>Check Front Left Turn Signal or Check Front Right Turn Signal</p>	<p>The front left-hand or front right-hand turn signal is defective.</p> <ul style="list-style-type: none"> ► Check whether you are permitted to change the bulb yourself (▷ page 256). <p>or</p> <ul style="list-style-type: none"> ► Visit a qualified specialist workshop.
 <p>Check Left Mirror Turn Signal or Check Right Mirror Turn Signal</p>	<p>The turn signal in the left-hand or right-hand exterior mirror is defective.</p> <ul style="list-style-type: none"> ► Check whether you are permitted to change the bulb yourself (▷ page 256). <p>or</p> <ul style="list-style-type: none"> ► Visit a qualified specialist workshop.
 <p>Check Center Brake Lamp</p>	<p>The high-mounted brake lamp is faulty.</p> <ul style="list-style-type: none"> ► Check whether you are permitted to change the bulb yourself (▷ page 256). <p>or</p> <ul style="list-style-type: none"> ► Visit a qualified specialist workshop.
 <p>Check Left Tail and Brake Lamp or Check Right Tail and Brake Lamp</p>	<p>The left or right-hand tail lamp/brake lamp is defective.</p> <ul style="list-style-type: none"> ► Check whether you are permitted to change the bulb yourself (▷ page 256). <p>or</p> <ul style="list-style-type: none"> ► Visit a qualified specialist workshop.
 <p>Check Left High Beam or Check Right High Beam</p>	<p>The left or right-hand high beam is defective.</p> <ul style="list-style-type: none"> ► Check whether you are permitted to change the bulb yourself (▷ page 256). <p>or</p> <ul style="list-style-type: none"> ► Visit a qualified specialist workshop.
 <p>Check Left License Plate Lamp or Check Right License Plate Lamp</p>	<p>The left or right-hand license plate lamp is defective.</p> <ul style="list-style-type: none"> ► Check whether you are permitted to change the bulb yourself (▷ page 256). <p>or</p> <ul style="list-style-type: none"> ► Visit a qualified specialist workshop.







Display messages	Possible causes/consequences and ► Solutions
 <p>Check Left Fog Lamp or Check Right Fog Lamp</p>	<p>The left-hand or right-hand front fog lamp is defective.</p> <ul style="list-style-type: none"> ► Check whether you are permitted to change the bulb yourself (▷ page 256). <p>or</p> <ul style="list-style-type: none"> ► Visit a qualified specialist workshop.
 <p>Check Rear Left Fog Lamp or Check Rear Right Fog Lamp</p>	<p>The left-hand or right-hand rear fog lamp is defective.</p> <ul style="list-style-type: none"> ► Check whether you are permitted to change the bulb yourself (▷ page 256). <p>or</p> <ul style="list-style-type: none"> ► Visit a qualified specialist workshop.
 <p>Check Front Left Parking Lamp or Check Front Right Parking Lamp</p>	<p>The front left or front right parking or standing lamp is defective.</p> <ul style="list-style-type: none"> ► Check whether you are permitted to change the bulb yourself (▷ page 256). <p>or</p> <ul style="list-style-type: none"> ► Visit a qualified specialist workshop.
 <p>Check Left Reverse Lamp or Check Right Reverse Lamp</p>	<p>The left or right-hand backup lamp is defective.</p> <ul style="list-style-type: none"> ► Check whether you are permitted to change the bulb yourself (▷ page 256). <p>or</p> <ul style="list-style-type: none"> ► Visit a qualified specialist workshop.
 <p>Check Front Left Sidemarker Lamp or Check Front Right Sidemarker Lamp</p>	<p>The left or right front side marker lamp is defective.</p> <ul style="list-style-type: none"> ► Check whether you are permitted to change the bulb yourself (▷ page 256). <p>or</p> <ul style="list-style-type: none"> ► Visit a qualified specialist workshop.
 <p>Check Rear Left Sidemarker Lamp or Check Rear Right Sidemarker Lamp</p>	<p>The rear left or right side marker lamp is defective.</p> <ul style="list-style-type: none"> ► Check whether you are permitted to change the bulb yourself (▷ page 256). <p>or</p> <ul style="list-style-type: none"> ► Visit a qualified specialist workshop.









Display messages	Possible causes/consequences and ► Solutions
 <p>Check Left Daytime Running Light or Check Right Daytime Running Light</p>	<p>The left or right-hand daytime running lamp is defective.</p> <ul style="list-style-type: none"> ► Check whether you are permitted to change the bulb yourself (▷ page 256). <p>or</p> <ul style="list-style-type: none"> ► Visit a qualified specialist workshop.
 <p>Active Headlamps Inoperative</p>	<p>The active light function is defective.</p> <ul style="list-style-type: none"> ► Visit a qualified specialist workshop.
 <p>Malfunction See Oper. Manual</p>	<p>The exterior lighting is defective.</p> <ul style="list-style-type: none"> ► Visit a qualified specialist workshop.
 <p>AUTO Lamp Function Inoperative</p>	<p>The light sensor is defective.</p> <ul style="list-style-type: none"> ► Visit a qualified specialist workshop. <p>USA only:</p> <ul style="list-style-type: none"> ► Switch off the daytime running lamps in the on-board computer (▷ page 349). ► Switch the lights on and off using the light switch.
 <p>Please Switch Off Lights</p>	<p>The lights are still switched on when you leave the vehicle. A warning tone also sounds.</p> <ul style="list-style-type: none"> ► Turn the light switch to <input type="checkbox"/> O or <input type="checkbox"/> A. <p>or</p> <ul style="list-style-type: none"> ► If the rear fog lamp is switched on: press the light switch in to the stop.
<p>Adaptive High-beam Assist Inoperative</p>	<p>Adaptive Highbeam Assist is faulty.</p> <ul style="list-style-type: none"> ► Visit a qualified specialist workshop.





Engine	
Display messages	Possible causes/consequences and ► Solutions
 Check Coolant Level See Oper. Manual	<p>The coolant level is too low.</p> <p>! Avoid making long journeys with too little coolant in the engine cooling system. The engine will otherwise be damaged.</p> <ul style="list-style-type: none">► Add coolant, observing the warning notes before doing so (► page 424).► If coolant needs to be added more often than usual, have the engine coolant system checked at a qualified specialist workshop.

Display messages	Possible causes/consequences and ► Solutions
	<p>The fan motor is faulty.</p> <ul style="list-style-type: none"> ► At coolant temperatures under 248 °F (120 °C), drive to the next qualified specialist workshop. ► Avoid subjecting the engine to heavy loads, e.g. driving in mountainous terrain, and stop-and-go traffic.
 <p>Coolant Low Stop Vehicle Turn Engine Off</p>	<p>The coolant is too hot. A warning tone also sounds.</p> <p> WARNING</p> <p>Do not drive when your engine is overheated. This can cause some fluids which may have leaked into the engine compartment to catch fire. Steam from the overheated engine can also cause serious burns which can occur just by opening the hood. There is a risk of injury.</p> <ul style="list-style-type: none"> ► Pull over and stop the vehicle safely and switch off the engine, paying attention to road and traffic conditions. ► Secure the vehicle against rolling away (▷ page 289). ► Leave the vehicle and keep a safe distance from the vehicle until the engine has cooled down. ► Make sure that the air supply to the engine radiator is not blocked, e.g. by snow, slush or ice. ► Do not start the engine again until the display message goes out and the coolant temperature is under 248 °F (120 °C). Otherwise, the engine could be damaged. ► Pay attention to the coolant temperature display. ► If the temperature increases again, visit a qualified specialist workshop immediately. <p>Under normal operating conditions and with the specified coolant level, the coolant temperature may rise to 248 °F (120 °C).</p>

Display messages	Possible causes/consequences and ► Solutions
	<p>The battery is not being charged.</p> <p>Possible causes are:</p> <ul style="list-style-type: none"> • a defective alternator • a torn poly-V-belt • a malfunction in the electronics <p>► Pull over and stop the vehicle safely and switch off the engine, paying attention to road and traffic conditions.</p> <p>► Open the hood.</p> <p>► Check whether the poly-V-belt is torn.</p> <p>If the poly-V-belt is torn:</p> <p>! Do not continue driving. The engine could otherwise overheat.</p> <p>► Consult a qualified specialist workshop.</p> <p>If the poly-V-belt is not damaged:</p> <p>► Visit a qualified specialist workshop.</p>
 <p>Check Engine Oil at Next Refueling</p>	<p>Vehicles with an oil dipstick: the oil level has dropped to the minimum level.</p> <p>► Check the oil level when next refueling, at the latest (▷ page 421).</p> <p>► If necessary, add engine oil (▷ page 423).</p> <p>► Have the engine checked at a qualified specialist workshop if engine oil needs to be added more often than usual.</p> <p>! Avoid long journeys with too little engine oil. The engine will otherwise be damaged.</p> <p>Information on approved engine oils can be obtained from any qualified specialist workshop or on the Internet at http://www.mbusa.com (USA only).</p>
 <p>Check Engine Oil Level (Add 1 quart) (USA only) Check Engine Oil Level (Add 1 Liter) (Canada only)</p>	<p>Vehicles without an oil dipstick: the engine oil level is too low.</p> <p>► Check the oil level when next refueling, at the latest (▷ page 421).</p> <p>► If necessary, add engine oil (▷ page 423).</p> <p>► Have the engine checked at a qualified specialist workshop if engine oil needs to be added more often than usual.</p> <p>! Avoid long journeys with too little engine oil. The engine will otherwise be damaged.</p> <p>Information on approved engine oils can be obtained from any qualified specialist workshop or on the Internet at http://www.mbusa.com (USA only).</p>



Display messages	Possible causes/consequences and ► Solutions
 <p>Engine Oil Level Low Stop Vehicle Turn Engine Off</p>	<p>Vehicles without an oil dipstick: the engine oil level is too low. There is a risk of engine damage.</p> <ul style="list-style-type: none"> ► Pull over and stop the vehicle safely and switch off the engine, paying attention to road and traffic conditions. ► Apply the parking brake. ► Add engine oil (► page 423) and check the oil level (► page 421).
 <p>Engine Oil Level Too High</p>	<p>Vehicles without an oil dipstick: you have added too much engine oil. There is a risk of damage to the engine or to the catalytic converter.</p> <ul style="list-style-type: none"> ► Have the excess oil siphoned off at a qualified specialist workshop. Observe the legal requirements.
 <p>Engine Oil Level Cannot measure eng. oil level</p>	<p>Vehicles without an oil dipstick: the measuring system is defective.</p> <ul style="list-style-type: none"> ► Visit a qualified specialist workshop.
 <p>Reserve fuel level</p>	<p>The fuel level has dropped into the reserve range.</p> <ul style="list-style-type: none"> ► Refuel at the nearest gas station.
	<p>There is only a very small amount of fuel in the fuel tank.</p> <ul style="list-style-type: none"> ► Refuel at the nearest gas station without fail.
 <p>Fuel filler cap open</p>	<p>The fuel system pressure is too low. The fuel filler cap is not closed correctly or the fuel system is leaking.</p> <ul style="list-style-type: none"> ► Check that the fuel filler cap is correctly closed. <p>If the fuel filler cap is not correctly closed:</p> <ul style="list-style-type: none"> ► Close the fuel filler cap. <p>If the fuel filler cap is correctly closed:</p> <ul style="list-style-type: none"> ► Visit a qualified specialist workshop.

Driving systems	
Display messages	Possible causes/consequences and ► Solutions
 <p>Attention Assist: Drowsiness Detected</p>	<p>Based on specific criteria, ATTENTION ASSIST has determined that the driver is tired or paying less attention. A warning tone also sounds.</p> <ul style="list-style-type: none"> ► If necessary, take a break. <p>During long journeys, take regular breaks in good time so you get enough rest.</p>
 <p>Attention Assist Inoperative</p>	<p>ATTENTION ASSIST has failed.</p> <ul style="list-style-type: none"> ► Visit a qualified specialist workshop.
 <p>Night View Assist Inoperative</p>	<p>Night View Assist Plus is defective.</p> <ul style="list-style-type: none"> ► Visit a qualified specialist workshop.
 <p>Night View Assist Currently Unavailable</p>	<p>The temperature of the camera is too high.</p> <ul style="list-style-type: none"> ► Wait until you see the Night View Assist Available Again display message. <p>You can also:</p> <ul style="list-style-type: none"> ► Fold the camera cover down (► page 432). ► Adjust the air distribution of the automatic air conditioning upwards.
 <p>Night View Assist Lights Must Be Set To AUTO or ON</p>	<p>A condition for activating Night View Assist Plus has not been fulfilled.</p> <ul style="list-style-type: none"> ► Turn the light switch to A or .
 <p>Night View Assist Not In Reverse Gear</p>	<p>A condition for activating Night View Assist Plus has not been fulfilled.</p> <ul style="list-style-type: none"> ► Shift the transmission to P, N or D.
 <p>Night View Assist Lights ON or AUTO, Not in R Gear</p>	<p>A condition for activating Night View Assist Plus has not been fulfilled.</p> <ul style="list-style-type: none"> ► Turn the light switch to A or . ► Shift the transmission to P, N or D.

Display messages	Possible causes/consequences and ► Solutions
 <p>Night View Assist Only When It Is Dark</p>	<p>You have attempted to activate Night View Assist Plus in the daytime.</p> <p>Night View Assist Plus can only be activated when it is dark.</p>
 <p>Vehicle Rising</p>	<p>Your vehicle is adjusting to the level you have selected.</p>
 <p>Vehicle Rising Please Wait Briefly</p>	<p>The vehicle level is too low when the vehicle is stationary. A warning tone also sounds.</p> <ul style="list-style-type: none"> ► Do not pull away. The vehicle level is set when the display message disappears.
 <p>STOP Car Too Low</p>	<p>You have pulled away while the vehicle level is still too low. AIRMATIC sets the vehicle to the selected level after a short period.</p> <ul style="list-style-type: none"> ► Pull over and stop the vehicle safely as soon as possible, paying attention to road and traffic conditions. ► Secure the vehicle against rolling away (▷ page 289). ► Wait until the display message disappears before pulling away. <p>AIRMATIC is defective. A warning tone also sounds.</p> <ul style="list-style-type: none"> ► Do not drive at speeds above 50 mph (80 km/h). ► Make only slight steering movements. Otherwise, the front fender or the tires could be damaged if the steering movement is too large. ► Listen for scraping sounds. ► Pull over and stop the vehicle safely, paying attention to road and traffic conditions, and select a higher vehicle level. Depending on the malfunction, it may be possible to raise the vehicle. ► Visit a qualified specialist workshop.
 <p>Malfunction</p>	<p>The AIRMATIC function is restricted. The vehicle's handling characteristics may be affected.</p> <ul style="list-style-type: none"> ► Do not drive at speeds above 50 mph (80 km/h). ► Visit a qualified specialist workshop.

Display messages	Possible causes/consequences and ► Solutions
<p>ABC Malfunction Stop Vehicle</p>	<p>The ABC (Active Body Control) vehicle level is too low.</p> <ul style="list-style-type: none"> ► Pull over and stop the vehicle safely as soon as possible, paying attention to road and traffic conditions. After a few seconds, the vehicle level is adjusted and the display message disappears. <p>The vehicle is leaking oil. The display message is shown continuously.</p> <ul style="list-style-type: none"> ► Pull over and stop the vehicle safely as soon as possible, paying attention to road and traffic conditions. Do not continue driving under any circumstances. ► Notify a qualified specialist workshop or breakdown service. <p>The display message is shown continuously. ABC is malfunctioning.</p> <ul style="list-style-type: none"> ► Do not drive at speeds above 50 mph (80 km/h). ► Make only slight steering movements. Otherwise, the front fender or the tires could be damaged if the steering movement is too large. ► Listen for scraping sounds. ► Visit a qualified specialist workshop.
<p>ABC Vehicle Rising Please Wait Briefly</p>	<p>The ABC vehicle level is too low when the vehicle is stationary.</p> <ul style="list-style-type: none"> ► Do not pull away. The vehicle level is set when the display message disappears.
<p>ABC Malfunction</p>	<p>The ABC function is restricted. The vehicle's handling characteristics may be affected.</p> <ul style="list-style-type: none"> ► Do not drive at speeds above 50 mph (80 km/h). ► Visit a qualified specialist workshop.
<p>HOLD Off</p>	<p>The HOLD function is deactivated. The vehicle is skidding. A warning tone also sounds.</p> <ul style="list-style-type: none"> ► Reactivate the HOLD function later (► page 308). <p>The HOLD function is deactivated. When the brake pedal is firmly depressed, an activation condition is not fulfilled. A warning tone also sounds.</p> <ul style="list-style-type: none"> ► Check the activation conditions for the HOLD function (► page 308).

Display messages	Possible causes/consequences and ► Solutions
Radar Sensors Deactivated See Oper. Manual	The radar sensor system is deactivated. ► Switch on the radar sensor system (▷ page 350).
Active Lane Keeping Assist Currently Unavailable See Oper. Manual	Active Lane Keeping Assist is deactivated and temporarily inoperative. Possible causes are: <ul style="list-style-type: none"> • the windshield in the camera's field of vision is dirty. • visibility is impaired due to heavy rain, snow or fog. • there are no lane markings for a longer period. • the lane markings are worn, dark or covered, e.g. by dirt or snow. If the display message does not disappear: <ul style="list-style-type: none"> ► Pull over and stop the vehicle safely as soon as possible, paying attention to road and traffic conditions. ► Secure the vehicle against rolling away (▷ page 289). ► Clean the windshield. If the system detects that the camera is fully operational, the display message disappears. Active Lane Keeping Assist is operational again.
Active Lane Keeping Assist Inoperative	Active Lane Keeping Assist is defective. ► Visit a qualified specialist workshop.

Display messages	Possible causes/consequences and ► Solutions
<p>Active Blind Spot Assist Currently Unavailable See Operator's Manual</p>	<p>Active Blind Spot Assist is temporarily inoperative. Possible causes are:</p> <ul style="list-style-type: none"> • the sensors are dirty. • function is impaired due to heavy rain or snow. • the radar sensor system is outside the operating temperature range. • the radar sensor system is temporarily inoperative, e.g. due to electromagnetic radiation emitted by nearby TV or radio stations or other sources of electromagnetic radiation. <p>The yellow  indicator lamps also light up in the exterior mirrors.</p> <p>If the display message does not disappear: If the display message does not disappear:</p> <ul style="list-style-type: none"> ► Pull over and stop the vehicle safely as soon as possible, paying attention to road and traffic conditions. ► Secure the vehicle against rolling away (▷ page 289). ► Clean the sensors (▷ page 431). ► Restart the engine. <p>If the system detects that the sensors are fully operational, the display message disappears.</p> <p>Active Blind Spot Assist is operational again.</p>
<p>Active Blind Spot Assist Inoperative</p>	<p>Active Blind Spot Assist is defective.</p> <p>The yellow  indicator lamps also light up in the exterior mirrors.</p> <ul style="list-style-type: none"> ► Visit a qualified specialist workshop.
<p>Parking Guidance Inoperative</p>	<p>Parking Guidance is malfunctioning (▷ page 315).</p> <ul style="list-style-type: none"> ► Restart the engine. <p>If the display message continues to be displayed:</p> <ul style="list-style-type: none"> ► Visit a qualified specialist workshop.



Display messages	Possible causes/consequences and ► Solutions
Parking Guidance Canceled	<p>Parking Guidance is deactivated. Possible causes are:</p> <ul style="list-style-type: none"> • the vehicle is skidding. • the sensors are dirty. • a malfunction has occurred. <p>► Reactivate Parking Guidance later (▷ page 315).</p> <p>If the parking space symbol does not appear in the multifunction display at speeds below 19 mph (30 km/h):</p> <ul style="list-style-type: none"> ► Clean the sensors (▷ page 431). ► Restart the engine. <p>If the parking space symbol still does not appear in the multifunction display at speeds below 19 mph (30 km/h):</p> <ul style="list-style-type: none"> ► Visit a qualified specialist workshop. <p>Parking Guidance has been deactivated because you are no longer following the recommended path.</p> <ul style="list-style-type: none"> ► Park again and, while doing so, observe the display messages in the multifunction display.
Parking Guidance Finished	<p>The vehicle is parked. A warning tone also sounds.</p> <p>The display message disappears automatically.</p>
DISTRONIC PLUS Off	<p>DISTRONIC PLUS has been deactivated (▷ page 298). If it was deactivated automatically, a warning tone also sounds.</p>
DISTRONIC PLUS Available Again	<p>DISTRONIC PLUS is operational again after having been temporarily unavailable. You can now reactivate DISTRONIC PLUS (▷ page 298).</p>



Display messages	Possible causes/consequences and ► Solutions
<p>DISTRONIC PLUS Currently Unavailable See Operator's Manual</p>	<p>DISTRONIC is deactivated and temporarily inoperative. Possible causes are:</p> <ul style="list-style-type: none"> • the DISTRONIC PLUS cover in the radiator trim is dirty • function is impaired due to heavy rain or snow. • the sensors in the bumpers are dirty. • the radar sensor system is temporarily inoperative, e.g. due to electromagnetic radiation emitted by nearby TV or radio stations or other sources of electromagnetic radiation. • the system is outside the operating temperature range. • the on-board voltage is too low. <p>A warning tone also sounds.</p> <p>If the display message does not disappear:</p> <ul style="list-style-type: none"> ► Pull over and stop the vehicle safely as soon as possible, paying attention to road and traffic conditions. ► Secure the vehicle against rolling away (▷ page 289). ► Clean the DISTRONIC PLUS cover in the radiator trim (▷ page 431). ► Clean the bumpers (▷ page 431). ► Restart the engine. <p>If the system detects that the sensors are fully operational, the display message disappears.</p> <p>DISTRONIC is operational again.</p>
<p>DISTRONIC PLUS Inoperative</p>	<p>DISTRONIC PLUS is defective. BAS PLUS (Brake Assist PLUS) and PRE-SAFE® Brake may be inoperative as well.</p> <p>A warning tone also sounds.</p> <ul style="list-style-type: none"> ► Visit a qualified specialist workshop.
<p>DISTRONIC PLUS Override</p>	<p>You have depressed the accelerator pedal. DISTRONIC PLUS is no longer controlling the speed of the vehicle.</p> <ul style="list-style-type: none"> ► Remove your foot from the accelerator pedal.
<p>DISTRONIC PLUS --- mph</p>	<p>An activation condition for DISTRONIC PLUS is not fulfilled.</p> <ul style="list-style-type: none"> ► Check the activation conditions for DISTRONIC PLUS (▷ page 298).



Display messages	Possible causes/consequences and ► Solutions
Cruise Control Inoperative	Cruise control is defective. A warning tone also sounds. ► Visit a qualified specialist workshop.
Cruise Control --- mph	A condition for activating cruise control has not been fulfilled. You have tried to store a speed below 20 mph (30 km/h), for example. ► If conditions permit, drive faster than 20 mph (30 km/h) and store the speed. ► Check the activation conditions for cruise control (> page 296).

Tires



Display messages	Possible causes/consequences and ► Solutions
tire pressures displayed after driving a few minutes	The tire pressure monitor is measuring the tire pressure. ► Drive on. The tire pressures appear in the multifunction display after you have been driving for a few minutes.
tire press. monitor inoperative	The tire pressure monitor is faulty. ► Visit a qualified specialist workshop.
tire press. monitor inoperative No wheel sensors	The wheels mounted do not have a suitable tire pressure sensor. The tire pressure monitor is deactivated. ► Mount wheels with suitable tire pressure sensors. The tire pressure monitor is activated automatically after driving for a few minutes.





Display messages	Possible causes/consequences and ► Solutions
<p>Check tire(s)</p>	<p>The tire pressure in one or more tires has dropped significantly. The wheel position is displayed in the multifunction display. A warning tone also sounds.</p> <p> WARNING</p> <p>With tire pressures which are too low, there is a risk of the following hazards:</p> <ul style="list-style-type: none"> • they may burst, especially as the load and vehicle speed increase. • they may wear excessively and/or unevenly, which may greatly impair tire traction. • the driving characteristics, as well as steering and braking, may be greatly impaired. <p>There is a risk of an accident.</p> <ul style="list-style-type: none"> ► Stop the vehicle without making any sudden steering or braking maneuvers. Pay attention to the traffic conditions as you do so. ► Secure the vehicle against rolling away (▷ page 289). ► If there is a flat tire, inspect the tires (▷ page 437). ► Check the tire pressure (▷ page 461). ► If necessary, correct the tire pressure.
<p>Caution, tire defect</p>	<p>The tire pressure in one or more tires has dropped suddenly. The wheel position is shown in the multifunction display.</p> <p> WARNING</p> <p>If you drive with a flat tire, there is a risk of the following hazards:</p> <ul style="list-style-type: none"> • A flat tire affects the ability to steer or brake the vehicle. • You could lose control of the vehicle. • Continued driving with a flat tire will cause excessive heat build-up and possibly a fire. <p>There is a risk of an accident.</p> <ul style="list-style-type: none"> ► Stop the vehicle without making any sudden steering or braking maneuvers. Pay attention to the traffic conditions as you do so. ► Secure the vehicle against rolling away (▷ page 289). ► If there is a flat tire, inspect the tires (▷ page 437).
<p>Please correct tire pressure(s)</p>	<p>The tire pressure is too low in at least one of the tires, or the tire pressure difference between the wheels is too great.</p> <ul style="list-style-type: none"> ► Check the tire pressures at the next opportunity. If necessary, correct the tire pressure (▷ page 461). ► Restart the tire pressure monitor (▷ page 464).





Display messages	Possible causes/consequences and ► Solutions
Wheel sensor(s) missing	<p>There is no signal from the tire pressure sensor of one or several wheels. The pressure of the affected tire is not displayed in the multifunction display.</p> <p>► Have the faulty tire pressure sensor replaced at a qualified specialist workshop.</p>
tire press. monitor currently unavailable	<p>Due to a source of radio interference, no signals can be received from the wheel sensors. The tire pressure monitor is temporarily malfunctioning.</p> <p>► Drive on. The tire pressure monitor restarts automatically as soon as the problem has been solved.</p>
 <p>tire pressure Caution, tire defect</p>	<p>The tire pressure in one or more tires has dropped suddenly. A warning tone also sounds.</p> <p> WARNING</p> <p>If you drive with a flat tire, there is a risk of the following hazards:</p> <ul style="list-style-type: none"> • A flat tire affects the ability to steer or brake the vehicle. • You could lose control of the vehicle. • Continued driving with a flat tire will cause excessive heat build-up and possibly a fire. There is a risk of an accident. <p>► Stop the vehicle without making any sudden steering or braking maneuvers. Pay attention to the traffic conditions as you do so.</p> <p>► Secure the vehicle against rolling away (▷ page 289).</p> <p>► If there is a flat tire, inspect the tires (▷ page 437).</p>







Display messages	Possible causes/consequences and ► Solutions
 <p>tire pressure Check tire(s)</p>	<p>The tire pressure in one or more tires has dropped significantly.</p> <p> WARNING</p> <p>With tire pressures which are too low, there is a risk of the following hazards:</p> <ul style="list-style-type: none"> • they may burst, especially as the load and vehicle speed increase. • they may wear excessively and/or unevenly, which may greatly impair tire traction. • the driving characteristics, as well as steering and braking, may be greatly impaired. <p>There is a risk of an accident.</p> <ul style="list-style-type: none"> ► Stop the vehicle without making any sudden steering or braking maneuvers. Pay attention to the traffic conditions as you do so. ► Secure the vehicle against rolling away (▷ page 289). ► If there is a flat tire, inspect the tires (▷ page 437). ► Check the tire pressure (▷ page 461). ► If necessary, correct the tire pressure.
 <p>Please correct tire pressure(s)</p>	<p>The tire pressure is too low in at least one of the tires, or the tire pressure difference between the wheels is too great.</p> <ul style="list-style-type: none"> ► Check the tire pressures at the next opportunity. If necessary, correct the tire pressure (▷ page 461).

Vehicle	
Display messages	Possible causes/consequences and ► Solutions
Shift to P or N to Start Engine	<p>You have attempted to start the engine with the transmission in position R or D.</p> <ul style="list-style-type: none"> ► Shift the transmission to position P or N.
Auxiliary Battery Malfunction (White display message)	<p>The auxiliary battery for the automatic transmission is no longer being charged.</p> <ul style="list-style-type: none"> ► Visit a qualified specialist workshop.

Display messages	Possible causes/consequences and ► Solutions
Auxiliary Battery Malfunction (Red display message)	The auxiliary battery for the automatic transmission is discharged. If there is a malfunction in the vehicle's electrical system, you may not be able to change the transmission position. <ul style="list-style-type: none"> ► Pull over and stop the vehicle safely as soon as possible, paying attention to road and traffic conditions. Do not continue driving under any circumstances. ► Consult a qualified specialist workshop.
Apply Brake to Shift from 'P'	You have attempted to move the transmission selector lever to position D , R or N without depressing the brake pedal. <ul style="list-style-type: none"> ► Depress the brake pedal.
Door Open Vehicle Not in Park	The driver's door is open and the transmission is in position R , N or D . <ul style="list-style-type: none"> ► Shift the transmission to position P. ► Secure the vehicle against rolling away (▷ page 289).
Service Required Do Not Shift Gears	You cannot change the transmission position due to a malfunction. A warning tone also sounds. If transmission position D is selected: <ul style="list-style-type: none"> ► Drive to a qualified specialist workshop without shifting the transmission from position D. If transmission position R , N or P is selected: <ul style="list-style-type: none"> ► Notify a qualified specialist workshop or breakdown service.
Only Shift to Position 'P' When Vehicle Is Stationary	The vehicle is moving. <ul style="list-style-type: none"> ► Pull over and stop the vehicle safely as soon as possible, paying attention to road and traffic conditions. ► Shift the transmission to position P.
	The trunk lid is open. <ul style="list-style-type: none"> ► Close the trunk lid.
	The hood is open. <p>⚠ WARNING</p> The open hood may block your view when the vehicle is in motion. There is a risk of an accident. <ul style="list-style-type: none"> ► Pull over and stop the vehicle safely as soon as possible, paying attention to road and traffic conditions. ► Apply the electric parking brake. ► Close the hood.





Display messages	Possible causes/consequences and ► Solutions
	At least one door is open. ► Close all the doors.
 Lock Seat Backrest Front Left or Lock Seat Backrest Front Right	The driver's or front passenger's seat backrest is not engaged. The seat belt will have no effect. ► Push the backrest back until it engages.
 Power Steering Malfunction See Operator's Manual	The power steering is malfunctioning. ⚠ WARNING You will need to use more force to steer. There is a risk of an accident. ► Check whether you are able to apply the extra force required. ► If you are able to steer safely: carefully drive on to a qualified specialist workshop. ► If you are unable to steer safely: do not drive on. Contact the nearest qualified specialist workshop.
 Check Washer Fluid	The washer fluid level in the washer fluid reservoir has dropped below the minimum. ► Add washer fluid (> page 425).

SmartKey	
Display messages	Possible causes/consequences and ► Solutions
 Key Does Not Belong to Vehicle	You have put the wrong SmartKey in the ignition lock. ► Use the correct SmartKey.
 Take Your Key From Ignition	The SmartKey is in the ignition lock. ► Remove the SmartKey.
 Obtain a New Key	The SmartKey needs to be replaced. ► Visit a qualified specialist workshop.
 Replace Key Battery	The batteries of the KEYLESS-GO key are discharged. ► Change the batteries .



Display messages	Possible causes/consequences and ► Solutions
 <p>Don't Forget Your Key</p>	<p>This display message is displayed for a maximum of 60 seconds and is simply a reminder.</p> <p>You have opened the driver's door with the engine switched off. The KEYLESS-GO key is not in the ignition lock.</p> <ul style="list-style-type: none"> ► Remember to take the KEYLESS-GO key with you when you leave the vehicle.
 <p>Key Not Detected (red display message)</p>	<p>The KEYLESS-GO key is not in the vehicle. A warning tone also sounds.</p> <p>If the engine is switched off, you can no longer lock the vehicle centrally or start the engine.</p> <ul style="list-style-type: none"> ► Pull over and stop the vehicle safely as soon as possible, paying attention to road and traffic conditions. ► Secure the vehicle against rolling away (▷ page 289). ► Locate the KEYLESS-GO key. <p>The KEYLESS-GO key is not detected while the engine is running because there is interference from a strong source of radio waves. A warning tone also sounds.</p> <ul style="list-style-type: none"> ► Pull over and stop the vehicle safely as soon as possible, paying attention to road and traffic conditions. ► Secure the vehicle against rolling away (▷ page 289). ► Operate the vehicle with the SmartKey in the ignition lock.
 <p>Key Not Detected (white display message)</p>	<p>The KEYLESS-GO key cannot be detected at present.</p> <ul style="list-style-type: none"> ► Change the location of the SmartKey with the KEYLESS-GO functions in the vehicle. <p>If the KEYLESS-GO key is still not detected:</p> <ul style="list-style-type: none"> ► Operate the vehicle with the SmartKey in the ignition lock.
 <p>Key Detected In Vehicle</p>	<p>The KEYLESS-GO key has been detected inside the vehicle during locking.</p> <ul style="list-style-type: none"> ► Remove the KEYLESS-GO key from the vehicle.
 <p>Remove 'Start' Button and Insert Key</p>	<p>KEYLESS-GO is temporarily malfunctioning or is defective.</p> <ul style="list-style-type: none"> ► Insert the SmartKey into the ignition lock and turn it to the desired position. ► Visit a qualified specialist workshop.
 <p>Close Doors to Lock Vehicle</p>	<p>At least one door is open. A warning tone also sounds.</p> <ul style="list-style-type: none"> ► Close all doors and lock the vehicle again.





Warning and indicator lamps in the instrument cluster



Seat belts









Problem	Possible causes/consequences and ► Solutions
 <p>After starting the engine, the red seat belt warning lamp lights up for six seconds.</p>	<p>The seat belt warning lamp reminds the driver and front passenger to fasten their seat belts.</p> <ul style="list-style-type: none"> ► Fasten your seat belt (▷ page 55).
 <p>After starting the engine, the red seat belt warning lamp lights up. In addition, a warning tone sounds for up to six seconds.</p>	<p>The driver's seat belt is not fastened.</p> <ul style="list-style-type: none"> ► Fasten your seat belt (▷ page 55). The warning tone ceases.
 <p>The red seat belt warning lamp lights up after the engine starts, as soon as the driver's or the front-passenger door is closed.</p>	<p>The driver or front passenger has not fastened their seat belt.</p> <ul style="list-style-type: none"> ► Fasten your seat belt (▷ page 55). The warning lamp goes out. <p>There are objects on the front-passenger seat.</p> <ul style="list-style-type: none"> ► Remove the objects from the front-passenger seat and stow them in a secure place. The warning lamp goes out.
 <p>The red seat belt warning lamp flashes and an intermittent audible warning sounds.</p>	<p>The driver or front passenger has not fastened their seat belt. In addition, you are driving faster than 15 mph (25 km/h) or you have briefly driven faster than 15 mph (25 km/h).</p> <ul style="list-style-type: none"> ► Fasten your seat belt (▷ page 55). The warning lamp goes out and the intermittent warning tone ceases. <p>There are objects on the front-passenger seat. In addition, you are driving faster than 15 mph (25 km/h) or you have briefly driven faster than 15 mph (25 km/h).</p> <ul style="list-style-type: none"> ► Remove the objects from the front-passenger seat and stow them in a secure place. The warning lamp goes out and the intermittent warning tone ceases.





Safety systems





Problem	Possible causes/consequences and ► Solutions
<p> (USA only)</p> <p> (Canada only)</p> <p>The red brake system warning lamp comes on while the engine is running. A warning tone also sounds.</p>	<p>There is not enough brake fluid in the brake fluid reservoir.</p> <p> WARNING</p> <p>The braking effect may be impaired.</p> <p>There is a risk of an accident.</p> <ul style="list-style-type: none"> ► Pull over and stop the vehicle safely as soon as possible, paying attention to road and traffic conditions. Do not continue driving under any circumstances. ► Apply the electric parking brake. ► Consult a qualified specialist workshop immediately. ► Observe the additional display messages in the multifunction display. <p>Do not add brake fluid. This does not correct the malfunction.</p>

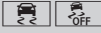

Problem	Possible causes/consequences and ► Solutions
 <p>The yellow ABS warning lamp is lit while the engine is running.</p>	<p>ABS (Anti-lock Brake System) is deactivated due to a malfunction. BAS (Brake Assist), BAS PLUS, ESP® (Electronic Stability Program), PRE-SAFE®, PRE-SAFE® Brake, the HOLD function and hill start assist are therefore also deactivated, for example. ATTENTION ASSIST is deactivated.</p> <p> WARNING</p> <p>The brake system continues to function normally, but without the functions listed above. The wheels could therefore lock if you brake hard, for example.</p> <p>The steerability and braking characteristics may be severely affected. The braking distance in an emergency braking situation can increase.</p> <p>If ESP® is not operational, ESP® is unable to stabilize the vehicle. There is an increased risk of skidding and an accident.</p> <ul style="list-style-type: none"> ► Observe the additional display messages in the multifunction display. ► Drive on carefully. ► Visit a qualified specialist workshop.
 <p>The yellow ABS warning lamp is lit while the engine is running.</p>	<p>ABS is temporarily unavailable. BAS, BAS PLUS, ESP®, EBD (electronic brake force distribution), PRE-SAFE®, PRE-SAFE® Brake, the HOLD function, hill start assist are therefore also deactivated, for example.</p> <p>Self-diagnosis is not yet complete or the on-board voltage may be insufficient, for example.</p> <p>ATTENTION ASSIST is deactivated.</p> <p> WARNING</p> <p>The brake system continues to function normally, but without the functions listed above. The front and rear wheels could therefore lock if you brake hard, for example.</p> <p>The steerability and braking characteristics may be severely affected. The braking distance in an emergency braking situation can increase.</p> <p>If ESP® is not operational, ESP® is unable to stabilize the vehicle. There is an increased risk of skidding and an accident.</p> <ul style="list-style-type: none"> ► Carefully drive a short distance on a suitable stretch of road, making slight steering movements at a speed above 12 mph (20 km/h). <p>The functions mentioned above are available again when the warning lamp goes out.</p>

Problem	Possible causes/consequences and ► Solutions
	<p>If the warning lamp is still on:</p> <ul style="list-style-type: none"> ► Observe the additional display messages in the multifunction display. ► Drive on carefully. ► Visit a qualified specialist workshop.
 <p>The yellow ABS warning lamp is lit while the engine is running. A warning tone also sounds.</p>	<p>EBD is malfunctioning. Therefore, ABS, BAS, BAS PLUS, ESP®, PRE-SAFE®, PRE-SAFE® Brake, the HOLD function and hill start assist are also unavailable, for example. ATTENTION ASSIST is deactivated.</p> <p> WARNING</p> <p>The brake system continues to function normally, but without the functions listed above. The front and rear wheels could therefore lock if you brake hard, for example.</p> <p>The steerability and braking characteristics may be severely affected. The braking distance in an emergency braking situation can increase.</p> <p>If ESP® is not operational, ESP® is unable to stabilize the vehicle. There is an increased risk of skidding and an accident.</p> <ul style="list-style-type: none"> ► Observe the additional display messages in the multifunction display. ► Drive on carefully. ► Visit a qualified specialist workshop.





Problem	Possible causes/consequences and ► Solutions
<p>  (USA only)  (Canada only)    </p> <p>The red brake warning lamp, the yellow ESP[®] and ESP[®] OFF warning lamps and the yellow ABS warning lamp are lit while the engine is running.</p>	<p>ABS and ESP[®] are malfunctioning. Therefore, BAS, BAS PLUS, EBD, PRE-SAFE[®], PRE-SAFE[®] Brake, the HOLD function and hill start assist, for example, are not available either. ATTENTION ASSIST is deactivated.</p> <p> WARNING</p> <p>The brake system continues to function normally, but without the functions listed above. The front and rear wheels could therefore lock if you brake hard, for example.</p> <p>The steerability and braking characteristics may be severely affected. The braking distance in an emergency braking situation can increase.</p> <p>If ESP[®] is not operational, ESP[®] is unable to stabilize the vehicle. There is an increased risk of skidding and an accident.</p> <ul style="list-style-type: none"> ► Observe the additional display messages in the multifunction display. ► Drive on carefully. ► Visit a qualified specialist workshop.
<p>  </p> <p>The yellow ESP[®] warning lamp flashes while the vehicle is in motion.</p>	<p>ESP[®] or traction control has intervened because there is a risk of skidding or at least one wheel has started to spin. Cruise control or DISTRONIC PLUS is deactivated.</p> <ul style="list-style-type: none"> ► When pulling away, only depress the accelerator pedal as far as necessary. ► Ease off the accelerator pedal while the vehicle is in motion. ► Adapt your driving style to suit the road and weather conditions. ► Do not deactivate ESP[®]. <p>For exceptions, see: (► page 67).</p>
<p>  </p> <p>The yellow ESP[®] OFF warning lamp is lit while the engine is running.</p>	<p>ESP[®] is deactivated.</p> <p> WARNING</p> <p>If ESP[®] is switched off, ESP[®] is unable to stabilize the vehicle. There is an increased risk of skidding and an accident.</p> <ul style="list-style-type: none"> ► Reactivate ESP[®]. <p>For exceptions, see: (► page 67).</p> <ul style="list-style-type: none"> ► Adapt your driving style to suit the road and weather conditions. <p>If ESP[®] cannot be activated:</p> <ul style="list-style-type: none"> ► Drive on carefully. ► Have ESP[®] checked at a qualified specialist workshop.

Problem	Possible causes/consequences and ► Solutions
 <p>The yellow ESP[®] and ESP[®] OFF warning lamps are lit while the engine is running.</p>	<p>ESP[®], BAS, BAS PLUS, PRE-SAFE[®], PRE-SAFE[®] Brake, the HOLD function and hill start assist are not available due to a malfunction. ATTENTION ASSIST is deactivated.</p> <p> WARNING</p> <p>The brake system continues to function normally, but without the functions listed above.</p> <p>The braking distance in an emergency braking situation can thus increase.</p> <p>If ESP[®] is not operational, ESP[®] is unable to stabilize the vehicle. There is an increased risk of skidding and an accident.</p> <ul style="list-style-type: none"> ► Observe the additional display messages in the multifunction display. ► Drive on carefully. ► Visit a qualified specialist workshop.
 <p>The yellow ESP[®] and ESP[®] OFF warning lamps are lit while the engine is running.</p>	<p>ESP[®], BAS, PRE-SAFE[®], the HOLD function and hill start assist are temporarily unavailable.</p> <p>BAS PLUS and PRE-SAFE[®] Brake may also have failed. ATTENTION ASSIST is deactivated.</p> <p>Self-diagnosis is not yet complete.</p> <p> WARNING</p> <p>The brake system continues to function normally, but without the functions listed above.</p> <p>The braking distance in an emergency braking situation can thus increase.</p> <p>If ESP[®] is not operational, ESP[®] is unable to stabilize the vehicle. There is an increased risk of skidding and an accident.</p> <ul style="list-style-type: none"> ► Carefully drive a short distance on a suitable stretch of road, making slight steering movements at a speed above 12 mph (20 km/h). The functions mentioned above are available again when the warning lamp goes out. <p>If the warning lamp is still on:</p> <ul style="list-style-type: none"> ► Observe the additional display messages in the multifunction display. ► Drive on carefully. ► Visit a qualified specialist workshop.

Problem	Possible causes/consequences and ► Solutions
<p> (USA only)</p> <p> (Canada only)</p> <p>The red indicator lamp for the electric parking brake flashes and/or the yellow warning lamp for the electric parking brake lights up.</p>	<p>The electric parking brake is temporarily malfunctioning or defective.</p> <p>► Observe the additional display messages in the multifunction display.</p>
<p></p> <p>The red SRS warning lamp is lit while the engine is running.</p>	<p>There is a malfunction in the SRS (Supplemental Restraint System).</p> <p> WARNING</p> <p>The air bags or Emergency Tensioning Devices may either be triggered unintentionally or, in the event of an accident, may not be triggered.</p> <p>There is an increased risk of injury.</p> <p>► Drive on carefully.</p> <p>► Have SRS checked at a qualified specialist workshop immediately.</p> <p>For further information about SRS, see (► page 44).</p>

Engine	
Problem	Possible causes/consequences and ► Solutions
 <p>The yellow Check Engine warning lamp lights up while the engine is running.</p>	<p>There may be a malfunction, for example:</p> <ul style="list-style-type: none"> • in the engine management • in the fuel injection system • in the exhaust system • in the ignition system • in the fuel system <p>The emission limit values may be exceeded and the engine may be running in emergency mode.</p> <p>► Have the vehicle checked as soon as possible at a qualified specialist workshop.</p> <p>i In some states, you must immediately visit a qualified specialist workshop as soon as the yellow Check Engine warning lamp lights up. This is due to the legal requirements in effect in these states. If in doubt, check whether such legal regulations apply in the state in which you are currently driving.</p>
<p>The yellow reserve fuel warning lamp flashes while the vehicle is in motion.</p> <p>In addition, the  Check Engine warning lamp may light up.</p>	<p>The fuel system pressure is too low. The fuel filler cap is not closed correctly or the fuel system is leaking.</p> <p>► Observe the additional display messages in the multifunction display.</p> <p>► Check that the fuel filler cap is correctly closed.</p> <p>► If the fuel filler cap is not correctly closed: close the fuel filler cap.</p> <p>► If the fuel filler cap is closed: visit a qualified specialist workshop.</p>
<p>The yellow reserve fuel warning lamp lights up while the engine is running.</p>	<p>The fuel level has dropped into the reserve range.</p> <p>► Refuel at the nearest gas station.</p>

Driving systems	
Problem	Possible causes/consequences and ► Solutions
 <p>The red distance warning lamp lights up while the vehicle is in motion. A warning tone also sounds.</p>	<p>You are approaching a vehicle or a stationary obstacle in your line of travel at too high a speed.</p> <ul style="list-style-type: none">► Be prepared to brake immediately.► Pay careful attention to the traffic situation. You may have to brake or take evasive action. <p>More information about DISTRONIC PLUS (► page 298) and PRE-SAFE® Brake (► page 68).</p>

Tires	
Problem	Possible causes/consequences and ► Solutions
 USA only: The yellow tire pressure monitor warning lamp (pressure loss/malfunction) is lit. Canada only: The yellow tire pressure monitor warning lamp (pressure loss) is lit.	<p>The tire pressure monitor has detected a loss of pressure in at least one of the tires.</p> <p> WARNING</p> <p>With tire pressures which are too low, there is a risk of the following hazards:</p> <ul style="list-style-type: none"> • they may burst, especially as the load and vehicle speed increase. • they may wear excessively and/or unevenly, which may greatly impair tire traction. • the driving characteristics, as well as steering and braking, may be greatly impaired. <p>There is a risk of an accident.</p> <ul style="list-style-type: none"> ► Stop the vehicle without making any sudden steering or braking maneuvers. Pay attention to the traffic conditions as you do so. ► Observe the additional display messages in the multifunction display. ► Check the tire pressure. If necessary, correct the tire pressure (► page 461). ► If necessary, change the wheel (► page 477).
 USA only: The yellow tire pressure monitor warning lamp (pressure loss/malfunction) flashes for approximately one minute and then remains lit.	<p>The tire pressure monitor is faulty.</p> <p> WARNING</p> <p>The system is possibly unable to recognize or register low tire pressure.</p> <p>There is a risk of an accident.</p> <ul style="list-style-type: none"> ► Observe the additional display messages in the multifunction display. ► Visit a qualified specialist workshop.

Useful information	400
Loading guidelines	400
Stowage areas	400
Features	403

Useful information

- i** This Operator's Manual describes all models and all standard and optional equipment of your vehicle available at the time of publication of the Operator's Manual. Country-specific differences are possible. Please note that your vehicle may not be equipped with all features described. This also applies to safety-related systems and functions.
- i** Please read the information on qualified specialist workshops (▷ page 29).

Loading guidelines

WARNING

Always fasten items being carried as securely as possible. Use cargo tie-down rings and fastening materials appropriate for the weight and size of the load.

In an accident, during hard braking or sudden maneuvers, loose items will be thrown around inside the vehicle. This can cause injury to vehicle occupants unless the items are securely fastened in the vehicle.

To help avoid personal injury during a collision or sudden maneuver, exercise care when transporting cargo. Do not pile luggage or cargo higher than the seat backrests.

The trunk is the preferred place to carry objects.

Never drive a vehicle with the trunk open. Deadly carbon monoxide (CO) gases may enter vehicle interior resulting in unconsciousness and death.

The handling characteristics of a laden vehicle are dependent on the distribution of the load within the vehicle. For this reason, you should observe the following notes when transporting a load:

- when transporting a load, never exceed the maximum permissible gross vehicle weight or the gross axle weight rating of the

vehicle (including occupants). The values are specified on the vehicle identification plate on the driver's door frame.

- position heavy loads as far forwards as possible and as low down in the trunk as possible.
- the load must not protrude above the upper edge of the seat backrests.
- always place the load against the rear seat backrests.
- always place the load behind unoccupied seats if possible.
- secure the load with sufficiently strong and wear-resistant tie-downs. Pad sharp edges for protection.

Stowage areas

Stowage space

Important safety notes

WARNING

To help avoid personal injury during a collision or sudden maneuver, exercise care when storing objects in the vehicle. Put luggage or cargo in the trunk if possible.

Do not pile luggage or cargo higher than the seat backrests.

Keep compartment lids closed. This will help to prevent stored objects from being thrown about and injuring vehicle occupants during

- braking
- vehicle maneuvers
- an accident

Stowage compartments in the front

Glove box

- i** Depending on the vehicle's equipment, you will find the following installed in the glove box: an audio and video AUX jack, a USB socket or Media Interface, a universal interface for portable audio equipment, e.g. for an iPod or USB device, and a bracket for

a remote control (see the COMAND section in this Operator's Manual).

- i** The glove box can be ventilated (▷ page 269).

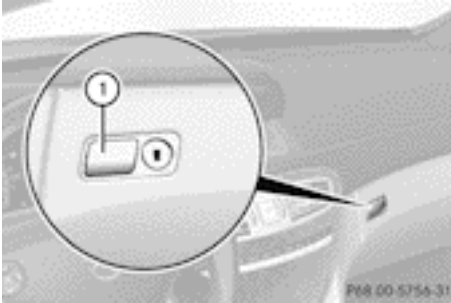

- ▶ **To open:** press button ①.
- ▶ **To close:** fold the glove box flap upwards until it engages.

The glove box can only be locked and unlocked using the mechanical key.

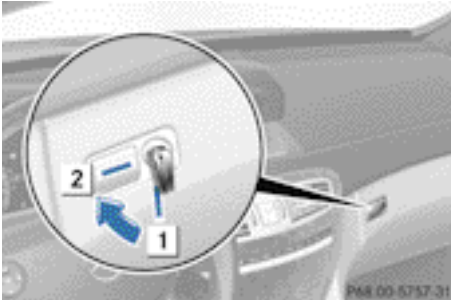



- ① Glove box unlocked
- ② Glove box locked

Eyeglasses compartment



- ▶ **To open:** press marking ①.

Stowage compartment under the armrest

- i** The  Roadside Assistance call button (▷ page 409) and the  MB Info call button (▷ page 410) are located in the stowage compartment under the armrest.

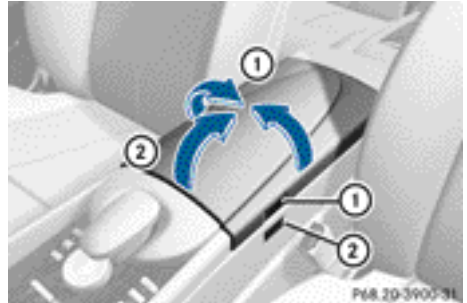

- ▶ **To open the stowage compartment:** press button ① and fold the armrest in the direction of arrow ① to the left or right.
- ▶ **To open the stowage compartment:** press button ② and fold up the armrest in the direction of arrow ②.

Stowage space in the rear

Stowage compartment in the rear seat armrest

- !** Do not sit or lean your bodyweight on the armrests when they are folded out as you could damage them.
- !** Close the cover of the stowage compartment before folding the rear seat armrest back into the seat backrest.



- ▶ **To open:** fold down the seat armrest.
- ▶ Pull handle ① and fold the armrests upwards.

Stowage box between the rear seats



- ▶ **To open:** pull handle ① backwards in the direction of the arrow.

Stowage box in the rear seat backrest

- ⚠ Do not sit or lean your bodyweight on the armrests when they are folded out as you could damage them.

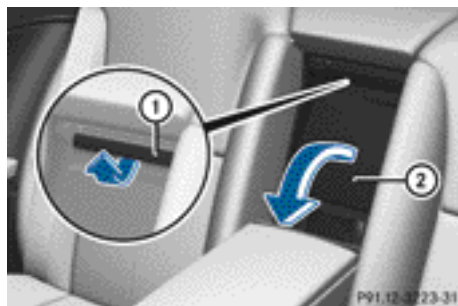

- ▶ **To open:** fold down the rear seat armrest.
- ▶ Pull handle ① and fold down cover ②.

Storage pockets

⚠ WARNING

Storage bags are intended for storing light-weight items only.

Heavy objects, objects with sharp edges or fragile objects may not be transported in the storage bag. In an accident, during hard braking, or sudden maneuvers, they could be

thrown around inside the vehicle and cause injury to vehicle occupants.

Storage bags cannot protect transported goods in the event of an accident.

Storage bags are located in the rear compartment on the driver's and front-passenger seat backrests.

Parcel nets

⚠ WARNING

Parcel nets are intended for storing light-weight items only, such as road maps, mail, etc.

Heavy objects, objects with sharp edges, or fragile objects may not be transported in the parcel nets. In an accident, during hard braking, or sudden maneuvers, they could be thrown around inside the vehicle and cause injury to vehicle occupants.

Parcel nets cannot protect transported goods in the event of an accident.

Parcel nets are located in the front-passenger footwell and on the right-hand side of the trunk.

Securing cargo

Cargo tie-down rings

Observe the following notes on securing loads:

- secure the load using the cargo tie down rings.
- do not use elastic straps or nets to secure a load, as these are only intended as an anti-slip protection for light loads.
- do not route tie downs across sharp edges or corners.
- pad sharp edges for protection.

There are four cargo tie down rings in the trunk.

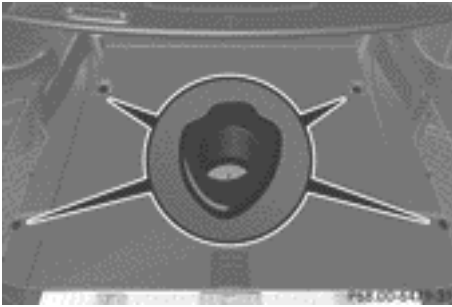

Bag hook

- !** The bag hook can bear a maximum load of 6.6lbs (3kg) and should not be used to secure a load.



- Pull bag hook (2) down by tab (1).

Stowage well under the trunk floor

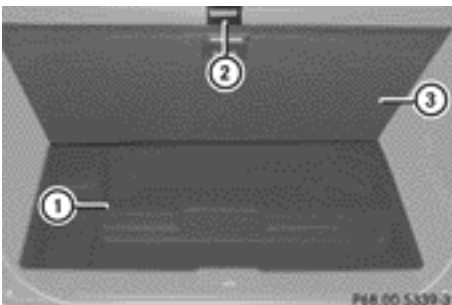

- ① Stowage well
- ② Hook
- ③ Trunk floor cover

- Attach trunk floor cover (3) to the upper edge of the trunk with hooks (2).

Features

Cup holder

Important safety notes

WARNING

In order to help prevent spilling liquids on vehicle occupants and/or vehicle equipment, only use containers that fit into the cup holder. Use lids on open containers and do not fill containers to a height where the contents, especially hot liquids, could spill during braking, vehicle maneuvers, or in an accident. Liquids spilled on vehicle occupants may cause serious personal injury. Liquids spilled on vehicle equipment may cause damage not covered by the Mercedes-Benz Limited Warranty.

When not in use, keep the cup holder closed. An open cup holder may cause injury to you or others when contacted during braking, vehicle maneuvers, or in an accident.

Keep in mind that objects placed in the cup holder may come loose during braking, vehicle maneuvers, or in an accident and be thrown around in the vehicle interior. Objects thrown around in the vehicle interior may cause an accident and/or serious personal injury.

Cup holder in the front-compartment center console

You can remove the cup holder to clean it. Clean with clear, lukewarm water only.

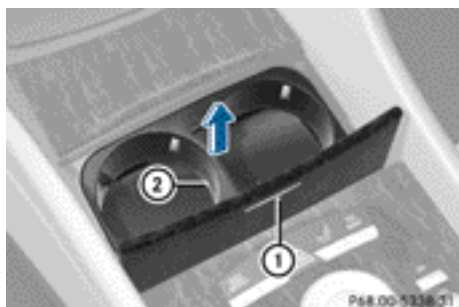

- ▶ **To open:** press marking ①.
- ▶ **To remove:** pull the cup holder upwards in the direction of the arrow by silver handle ②.
- ▶ **To insert:** press down until it engages. Observe the installation position indicated by "Front".

Cup holder in the rear seat armrest

- ❗ Do not sit on or support your body weight on the rear seat armrest when it is folded down, as you could otherwise damage it.
- ❗ Close the cup holder before folding the rear seat armrest up. Otherwise, the cup holder could be damaged.

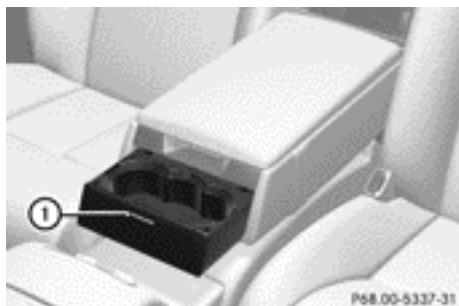

- ▶ Fold down the rear seat armrest.
- ▶ **To open:** press the front of cup holder ①. Cup holder ① extends automatically.
- ▶ **To close:** slide the cup holder back until it engages.

Sun visors

Overview of sun visors

⚠ WARNING

Do not use the vanity mirror while driving. Keep the vanity mirrors in the sun visors closed while the vehicle is in motion. Reflected glare can endanger you and others.

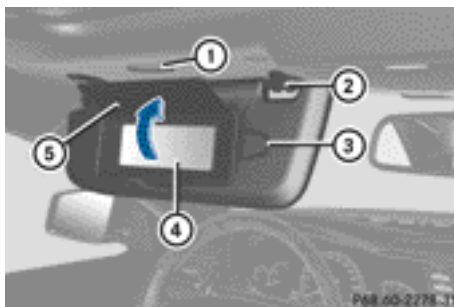

- ① Mirror light
- ② Bracket
- ③ Retaining clip, e.g. for a car park ticket
- ④ Vanity mirror
- ⑤ Mirror cover

Vanity mirror in the sun visor

Mirror light ① only functions if the sun visor is clipped into retainer ② and mirror cover ⑤ has been folded up.

Glare from the side

- ▶ Fold down the sun visor.
- ▶ Pull the sun visor out of retainer ②.
- ▶ Swing the sun visor to the side.

Rear window roller sunblind

Important safety notes

⚠ WARNING

When leaving the vehicle, always remove the SmartKey from the ignition lock. Always take the SmartKey with you and lock the vehicle. Do not leave children unattended in the vehicle, even if they are secured in a child restraint system, or with access to an unlocked vehicle. A child's unsupervised access to a vehicle could result in an accident and/or serious personal injury. The children could:

- injure themselves on parts of the vehicle
- be seriously or fatally injured through excessive exposure to extreme heat or cold
- injure themselves or cause an accident with vehicle equipment that can be operated even if the SmartKey is removed from the ignition lock or removed from the vehicle, such as seat adjustment, steering wheel adjustment, or the memory function

If children open a door, they could injure other persons or get out of the vehicle and injure themselves or be injured by following traffic.

Do not expose the child restraint system to direct sunlight. The child restraint system's metal parts, for example, could become very hot, and the child could be burned on these parts.

⚠ WARNING

When adjusting a roller sunblind, the roller blind moves up or down. You might become trapped in the process.

In the event of danger, briefly press the button for the roller sunblind to change the roller blind's direction of movement.

Extending/retracting the roller sunblind

- ❗ Make sure that the roller sunblind can move freely. Otherwise, the roller sunblind or other objects could be damaged.

At temperatures below -4 °F (-20 °C), the roller sunblind is deactivated.

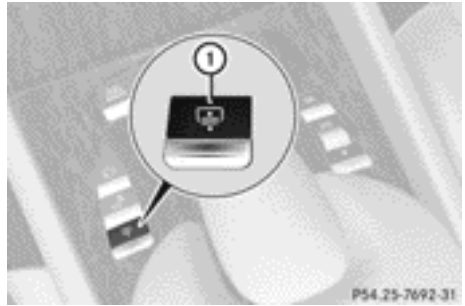

- ▶ Turn the SmartKey to position **2** in the ignition lock.
- ▶ **To extend or retract:** briefly press button ①. The roller sunblind fully extends or fully retracts.
- ▶ **To stop:** briefly press button ① again. The roller sunblind stops briefly and moves back into the out-of-use position.

Ashtray

Ashtray in the front-compartment center console

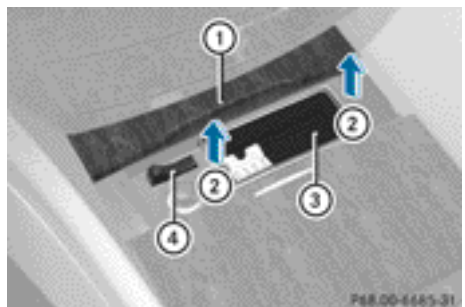

- ▶ **To open:** slide cover ① forwards until it engages.
- ▶ **To remove the insert:** push sliding knob ④ in the housing of the ashtray to the left. Ashtray insert ③ slides out slightly.
- ▶ Lift insert ③ up ② and out.

- ▶ **To re-install the insert:** press insert ③ into the holder until it engages.
- ▶ **To close:** press cover ① briefly at the front. The cover moves back.

Cigarette lighter

WARNING

When leaving the vehicle, always remove the SmartKey from the ignition lock. Always take the SmartKey with you and lock the vehicle. Do not leave children unattended in the vehicle, even if they are secured in a child restraint system, or with access to an unlocked vehicle. A child's unsupervised access to a vehicle could result in an accident and/or serious personal injury. The children could:

- injure themselves on parts of the vehicle
- be seriously or fatally injured through excessive exposure to extreme heat or cold
- injure themselves or cause an accident with vehicle equipment that can be operated even if the SmartKey is removed from the ignition lock or removed from the vehicle, such as seat adjustment, steering wheel adjustment, or the memory function

If children open a door, they could injure other persons or get out of the vehicle and injure themselves or be injured by following traffic.

Do not expose the child restraint system to direct sunlight. The child restraint system's metal parts, for example, could become very hot, and the child could be burned on these parts.

WARNING

Never touch the heating element or sides of the lighter; they are extremely hot. Hold the knob only.

Make sure any children traveling with you do not injure themselves or start a fire with the hot cigarette lighter.



- ▶ Turn the SmartKey to position **2** in the ignition lock.
- ▶ **To open:** slide cover ① forwards until it engages.
- ▶ Press in cigarette lighter ②. Cigarette lighter ② will pop out automatically when the heating element is red-hot.
- ▶ **To close:** press cover ① briefly at the front. The cover moves back.

12 V sockets

Points to observe before use

The sockets can be used for accessories with a maximum draw of 180 W (15 A).

Accessories include such items as lamps or chargers for mobile phones.

If you use the sockets for long periods when the engine is switched off, the battery may discharge.

- ▶ Turn the SmartKey to position **1** in the ignition lock.

 An emergency cut-out ensures that the on-board voltage does not drop too low. If the on-board voltage is too low, the power to the sockets is automatically cut. This ensures that there is sufficient power to start the engine.

Socket in the glove box

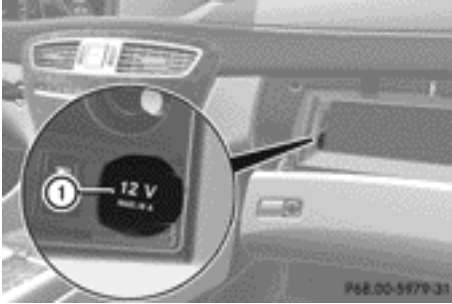

- ▶ Open the glove box (▷ page 400).
- ▶ Lift up the cover of socket ①.

Socket in the trunk

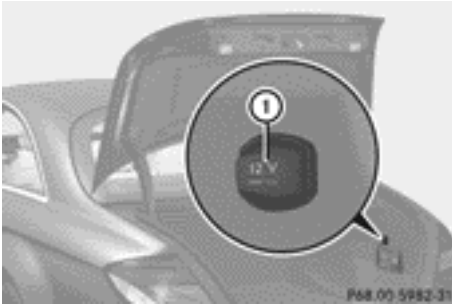

- ▶ Lift up the cover of socket ①.

mbrace

Important safety notes

- ! You must have a license agreement to activate the mbrace service. Ensure that your system is activated and ready for use, and press the  MB Info call button to register. If one of these steps is not carried out, it may not be possible to activate the system.

If you have questions about the activation, contact one of the following telephone hotlines:

- **USA:** Mercedes-Benz Customer Assistance Center at 1-800-FOR-MERCEdes (1-800-367-6372) or 1-888-990-9007
- **Canada:** Customer Service at 1-888-923-8367

Shortly after successfully registering with the mbrace service, a user ID and password will be sent to you by mail. You can use this password to log in to the mbrace section under "Owners Online" at <http://www.mbusa.com>¹⁶.

The mbrace system is available if:

- it has been activated and is operational
 - the corresponding mobile phone network is available for transmitting data to the Customer Center
 - a service subscription is available
 - the starter battery is sufficiently charged
- ! Determining the location of the vehicle on a map is only possible if:
- GPS reception is available.
 - the vehicle position can be forwarded to the Customer Assistance Center



The mbrace system

The mbrace system provides different services, e.g.:

- automatic and manual emergency call
- Roadside Assistance call
- MB Info call

¹⁶ USA only.

To adjust the volume during an mbrace call, proceed as follows:

▶ Press the  or  button on the multifunction steering wheel.

or





▶ Use the  volume controller of COMAND (▶ page 113).

You can find further information and a description of all available features under "Owners Online" at <http://www.mbusa.com>¹⁷.

System self-test

After you have switched on the ignition, the system carries out a self-diagnosis.

A malfunction in the system has been detected if one of the following occurs:

- the indicator lamp in the SOS button does not come on during the system self-test.
- the indicator lamp in the  Roadside Assistance button does not light up during self-diagnosis of the system.
- the indicator lamp in the  MB-Info call button does not light up during self-diagnosis of the system.
- the indicator lamp in one or more of the following buttons continues to light up red after the system self-diagnosis:
 - SOS button
 - the  Roadside Assistance call button
 - the  MB Info call button
- the **Tele Aid Inoperative** or **Tele Aid Not Activated** message appears in the multifunction display after the system self-diagnosis.



If a malfunction is indicated as outlined above, the system may not operate as expected. In the event of an emergency, assistance must be summoned by other means.

Have the system checked at the nearest authorized Mercedes-Benz Center or contact the following service hotlines:

- **USA:** Mercedes-Benz Customer Assistance Center at 1-800-FOR-MERCEdes (1-800-367-6372) or 1-888-990-9007
- **Canada:** Customer Service at 1-888-923-8367

Emergency call

Important safety notes

 You must have a license agreement to activate the mbrace service. Ensure that your system is activated and ready for use, and press the  MB Info call button to register. If one of these steps is not carried out, it may not be possible to activate the system.

If you have questions about the activation, contact one of the following telephone hotlines:

- **USA:** Mercedes-Benz Customer Assistance Center at 1-800-FOR-MERCEdes (1-800-367-6372) or 1-888-990-9007
- **Canada:** Customer Service at 1-888-923-8367

An emergency call is dialed automatically if an air bag or Emergency Tensioning Device is triggered.

 You cannot end an automatically triggered emergency call yourself.

An emergency call can also be initiated manually.

As soon as the emergency call has been initiated, the indicator lamp in the SOS button flashes. The **Connecting Call** message appears on the multifunction display.

Emergency Call Activated is shown in the COMAND display. The audio system is muted.

¹⁷ USA only.

Once the connection has been made, the **Call Connected** message appears in the multifunction display.

The **Emergency Call Activated** message is shown in the COMAND display.

All important information on the emergency call is transmitted, for example:

- current location of the vehicle (as determined by the GPS system)
- vehicle identification number
- information on the type of emergency

i If the **Emergency Call Activated** message is shown in the COMAND display, you cannot use other functions of COMAND.

Shortly after the emergency call has been initiated, a voice connection is automatically established between the Mercedes-Benz Customer Assistance Center and the vehicle occupants. If the vehicle occupants respond, the Mercedes-Benz Customer Assistance Center attempts to get more information on the emergency.

i If there is no response from the vehicle occupants, an ambulance is immediately sent to the vehicle.

⚠ WARNING

If the indicator lamp in the SOS button is flashing continuously and there was no voice connection to the Response Center established, then the mbrace system could not initiate an emergency call (e.g. the relevant cellular phone network is not available).

The message **Call Failed** appears in the multifunction display for approximately 10 seconds.

Should this occur, assistance must be summoned by other means.

i During an emergency call, the Bluetooth® connection on the phone is canceled automatically. After making the

emergency call, the connection is automatically re-established.

Making an emergency call

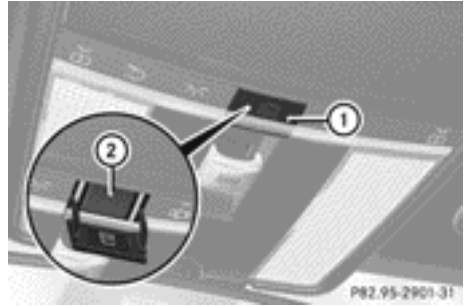

- ▶ **To initiate an emergency call manually:** press cover ① briefly to open.
- ▶ Press SOS button ② briefly. The indicator lamp in SOS button ② flashes until the emergency call is concluded.
- ▶ Wait for a voice connection to the Mercedes-Benz Customer Assistance Center.
- ▶ After the emergency call, close cover ①.

⚠ WARNING

If you feel at any way in jeopardy when in the vehicle (e.g. smoke or fire in the vehicle, vehicle in a dangerous road location), please do not wait for voice contact after you have pressed the SOS button. Carefully leave the vehicle and move to a safe location. The Response Center will automatically contact local emergency officials with the vehicle's approximate location if they receive an automatic SOS signal and cannot make voice contact with the vehicle occupants.

Roadside Assistance button

- ▶ Open the stowage compartment under the armrest (▷ page 401).

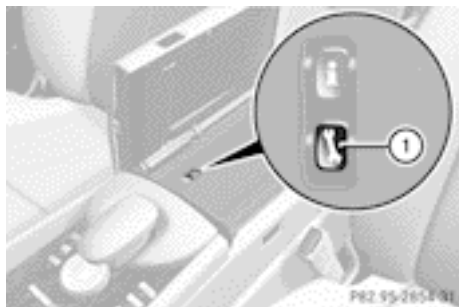

- ▶ Press and hold Roadside Assistance button ① for more than two seconds. This initiates a call to the Mercedes-Benz Customer Assistance Center. The indicator lamp in Roadside Assistance button ① flashes while the call is active. The **Connecting Call** message appears in the multifunction display and the COMAND display. The audio output is muted.

If a connection can be established, the **Call Connected** message appears in the multifunction display and in the COMAND display.

If a cellular phone network is available and there is sufficient GPS reception, the mbrace system transmits data to the Mercedes-Benz Customer Assistance Center, for example:

- current location of the vehicle
- vehicle identification number

- ❗ The multifunction display and COMAND display show that an mbrace call is active. You can change to the navigation menu by pressing the  button during the call, for example.

Voice output is not available.

A voice connection is established between the Mercedes-Benz Customer Assistance Center and the vehicle occupants.

- ▶ Describe the type of assistance needed.

The Mercedes-Benz Customer Assistance Center either sends a qualified Mercedes-Benz technician or organizes for your vehicle to be transported to the nearest authorized Mercedes-Benz Center. You may be charged

for services such as repair work and/or towing. Further details are available in your mbrace manual.

- ❗ The mbrace system failed to initiate a Roadside Assistance call if:
 - the indicator lamp in Roadside Assistance button ① is flashing continuously.
 - no voice connection to the Mercedes-Benz Customer Assistance Center was established.

This may be because the corresponding mobile phone network is not available.

The **Call Failed** message appears in the multifunction display.

The COMAND display shows the **Call could not be connected!** message. Press  to confirm the message.

- ▶ **To end a call:** press the  button on the multifunction steering wheel.

or

- ▶ Press the corresponding button for ending a phone call on the COMAND telephone keypad.

MB Info call button

- ▶ Open the stowage compartment under the armrest (▷ page 401).

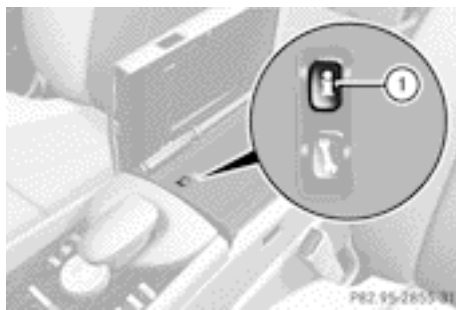

- ▶ Press and hold MB Info call button ① for more than two seconds. This initiates a call to the Mercedes-Benz Customer Assistance Center. The indicator lamp in MB Info call button ① flashes while

the connection is being established. The **Connecting Call** message appears in the multifunction display. The COMAND display shows the **Information Call Activated** message. The audio output is muted.

If a connection can be established, the **Call Connected** message appears in the multifunction display.

The COMAND display shows the **Information Call Activated** message.

If a cellular phone network is available and there is sufficient GPS reception, the mbrace system transmits data to the Mercedes-Benz Customer Assistance Center, for example:

- current location of the vehicle
- vehicle identification number

i The COMAND display shows that an mbrace call is active. You can change to the navigation menu by pressing the  button during the call, for example.

Voice output is not available.

A voice connection is established between the Mercedes-Benz Customer Assistance Center and the vehicle occupants. You can obtain information on how to operate your vehicle's systems, on the location of the nearest authorized Mercedes-Benz Center, and on further products and services offered by Mercedes-Benz USA.

Further details on the mbrace system can be found under <http://www.mbusa.com>¹⁸. Log in under "Owners Online".

i The mbrace system failed to initiate an MB Info call if:

- the indicator lamp in MB Info call button  is flashing continuously.
- no voice connection to the Mercedes-Benz Customer Assistance Center was established.

This may be because the corresponding mobile phone network is not available.

The **Call Failed** message appears in the multifunction display.

The COMAND display shows the **Call could not be connected!** message. Press  to confirm the message.

► **To end a call:** press the  button on the multifunction steering wheel.

or

► Press the corresponding button for ending a phone call on the COMAND telephone keypad.

Call priority

When service calls are active, e.g. Roadside Assistance or MB Info calls, an emergency call can still be initiated. In this case, an emergency call will take priority and override all other active calls.

The indicator lamp of the respective button flashes until the call is ended. An emergency call can only be terminated by the Mercedes-Benz Customer Assistance Center. All other calls can be ended by pressing the  button on the multifunction steering wheel or the corresponding button for ending a telephone call on the COMAND telephone keypad.

Downloading destinations in COMAND

i The components and operating principles of COMAND can be found on (> page 112).

i You can only use the Destination Download function if the vehicle is equipped with a navigation system.

Destination Download gives you access to a database with over 15 million points of interest (POIs)/important destinations that can be downloaded onto the navigation system of your vehicle. If you know the destination, you can download the address or obtain the location of points of interest

¹⁸ USA only.

(POIs)/important destinations in the surrounding area.

You are prompted to confirm route guidance to the address entered.

- ▶ Slide and turn the COMAND controller to select **Yes** and confirm by pressing .

The system calculates the route and subsequently starts the route guidance with the address entered.

- i** If you select **No**, the address can be stored in the address book.
- i** The Destination Download function is available if the corresponding mobile phone network is available and data transfer is possible.

Route Assistance

This service is part of the mbrace PLUS Package and cannot be purchased separately.

- i** You can also use the Route Assistance function if your vehicle is not equipped with a navigation system.

Within the framework of this service, you receive a professional and reliable form of navigation support without having to leave your vehicle.

The customer service representative determines a suitable driving route based on your current vehicle position and the desired destination and guides you live through the current sections of the route.

Search & Send

Points to observe before use

- i** To use "Search & Send", your vehicle must be equipped with mbrace and a navigation system. You must also have an mbrace service subscription.

"Search & Send" is a destination entry service. A destination address which is found on Google Maps® can be transferred via

mbrace directly to your vehicle's navigation system.

Specifying and sending the destination address

- ▶ Go to the website <http://www.maps.google.com> and enter a destination address into the entry field.
- ▶ **To send the destination address to the E-Mail address of your mbrace account:** click on the corresponding button.

- i** Example:

If you select 'Send to vehicle' and then 'Mercedes-Benz', the destination address will be sent to your vehicle.

- ▶ When the "Send" dialog window appears: In the relevant field, enter the e-mail address which you specified when activating your mbrace account.
- ▶ Click "Send".

- i** Information on specific commands such as "Address entry" or "Sending" can be found on the website.

Calling up destination addresses

- ▶ Press the MB Info call button to load the destination address to your vehicle's navigation system. A display message appears, asking whether navigation should be started.
- ▶ Select **Yes** by sliding and turning the COMAND controller and press to confirm. The system calculates the route and subsequently starts the route guidance with the address entered.

- i** If you select **No**, the address can be stored in the address book.
- i** If you have sent more than one destination address, you have to make an info call to load each individual address.
- i** Destination addresses are loaded in the same order as the order in which they were

sent. If you own multiple Mercedes-Benz vehicles with mbrace and activated mbrace accounts:

Each destination address sent can be accessed by every vehicle which is connected with the relevant e-mail address.

Vehicle remote opening

You can use the vehicle remote opening if you have unintentionally locked your vehicle and a replacement SmartKey is not available. The vehicle can be opened by the Mercedes-Benz Customer Assistance Center.

The vehicle can be opened remotely up to four days after the ignition was last switched off.

► Contact the following service hotlines:

- **USA:** Mercedes-Benz Customer Assistance Center at 1-800-FOR-MERCEdes (1-800-367-6372) or 1-888-990-9007
- **Canada:** Customer Service at 1-888-923-8367

You will be asked for your password.

► Return to your vehicle at the time agreed upon with the Mercedes-Benz Customer Assistance Center.

► Pull on the trunk lid handle for at least 20 seconds until the indicator lamp in the SOS button (> page 408) flashes. The **Connecting Call** message appears in the multifunction display.

USA only: alternatively, the vehicle can be opened via:

- the Internet, under the "Owners Online" section
- the telephone application (e.g. iPhone®)

i Vehicle remote opening is only possible if the corresponding mobile phone network is accessible.

The SOS button flashes and the **Connecting Call** message appears in the multifunction display to confirm that the

command for vehicle remote unlocking has been received.

If the trunk lid handle is pulled for longer than 20 seconds before authorization has been received, you must wait for 15 minutes. Only then can you pull the trunk lid handle once again.

Vehicle remote closing

The remote closing feature can be used when you have forgotten to lock the vehicle and you are no longer nearby. The vehicle can then be locked by the Mercedes-Benz Customer Assistance Center.

The vehicle can be locked remotely up to four days after the ignition was last switched off.

► Contact the following service hotlines:

- **USA:** Mercedes-Benz Customer Assistance Center at 1-800-FOR-MERCEdes (1-800-367-6372) or 1-888-990-9007
- **Canada:** Customer Service at 1-888-923-8367

You will be asked for your PIN.

The next time you are in your vehicle and switch on the ignition, the **Tele Aid Doors Locked Remotely** message appears in the multifunction display.

USA only: alternatively, the vehicle can be locked via:

- the Internet, under the "Owners Online" section
- the telephone application (e.g. iPhone®)

i The vehicle remote closing feature is available when the relevant mobile phone network is available and data connection is possible.

Automatic vehicle data retrieval for the service due date

Your vehicle comes with a function which improves the servicing of the vehicle considerably. Shortly before the service due date, mbrace sends important vehicle

maintenance information to the Mercedes-Benz Customer Assistance Center. The Mercedes-Benz Customer Assistance Center then informs your authorized Mercedes-Benz Service Center of the work required. This happens automatically and does not require any action from the driver. This function allows the Mercedes-Benz Center to improve appointment planning significantly and ensures that your vehicle receives the best service possible.

- i** The "Automatic retrieval of vehicle data for the service due date" function is only available if the relevant mobile phone network is available and a data connection is possible.

Stolen vehicle recovery service

If your vehicle has been stolen:

- ▶ Notify the police.
The police will issue a numbered incident report.
- ▶ This number will be forwarded to the Mercedes-Benz Customer Assistance Center together with your PIN.
The Mercedes-Benz Customer Assistance Center then attempts to locate the mbrace system. The Mercedes-Benz Customer Assistance Center contacts you and the local law enforcement agency if the vehicle is located. However, only the law enforcement agency is informed of the location of the vehicle.
- i** If the anti-theft alarm system is active for longer than 30 seconds, mbrace automatically informs the Mercedes-Benz Customer Assistance Center.

Garage door opener

Important safety notes

WARNING

When you operate or program the garage door with the integrated garage door opener,

persons in the range of movement of the garage door can become trapped or struck by the garage door. There is a risk of injury.

When using the integrated garage door opener, always make sure that nobody is within the range of movement of the garage door.

WARNING

Combustion engines emit poisonous exhaust gases such as carbon monoxide. Inhaling these exhaust gases leads to poisoning. There is a risk of fatal injury. Therefore never leave the engine running in enclosed spaces without sufficient ventilation.

The HomeLink® garage door opener integrated in the rear-view mirror allows you to operate up to three different door and gate systems.

Use the integrated garage door opener only on garage doors that:

- have safety stop and reverse features and
- meet current U.S. federal safety standards

When programming a garage door opener, park the vehicle outside the garage.

- i** Certain garage door drives are incompatible with the integrated garage door opener. If you have difficulty programming the integrated garage door opener, contact an authorized Mercedes-Benz Center.

Alternatively, you can call the following telephone assistance services:

- **USA:** Mercedes-Benz Customer Assistance Center at 1-800-FOR-MERCedes
- **Canada:** Customer Service at 1-800-387-0100
- HomeLink® hotline 1-800-355-3515 (free of charge)

More information on HomeLink® and/or compatible products is also available online at <http://www.homelink.com>.

- i** Notes on the declaration of conformity .
USA: FCC ID: CB2HMIHL4
Canada: IC: 279B-HMIHL4

Programming the integrated garage door opener on the rear-view mirror

Programming buttons

Observe the "Important safety notes" (▷ page 414).

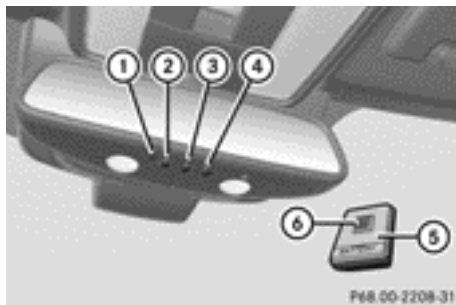

Integrated garage door opener in the rear-view mirror

Garage door remote control (5) is not part of the integrated garage door opener.

- ▶ The first time before programming, clear the integrated garage door opener memory (▷ page 417).
- ▶ Turn the SmartKey to position **2** in the ignition lock.
- ▶ Press and hold one of buttons (2) to (4) on the integrated garage door opener. After a short time, indicator lamp (1) lights up yellow.
- i** Indicator lamp (1) lights up yellow as soon as button (2), (3) or (4) is programmed for the first time. If the selected button has already been programmed, indicator lamp (1) will only light up yellow after ten seconds have elapsed.
- ▶ Release button (2), (3) or (4). Indicator lamp (1) flashes yellow.
- ▶ Point garage door remote control (5) towards buttons (2) to (4) on the rear-view

mirror at a distance of 2 to 8 inches (5 to 20 cm).

- i** The required distance between remote control (5) and the integrated garage door opener depends on the garage door drive system. Several attempts might be necessary. You should test every position for at least 25 seconds before trying another position.
- ▶ Press and hold button (6) on remote control (5) until indicator lamp (1) lights up green. If indicator lamp (1) lights up green or flashes, then programming has been successful.
- ▶ Release button (6) on remote control (5) for the garage door drive system.
- ▶ If indicator lamp (1) lights up red: repeat the programming procedure for the corresponding button on the rear-view mirror. When doing so, vary the distance between remote control (5) and the rear-view mirror.

- i** If the indicator lamp flashes green after successful programming, the garage door system is using a rolling code. After programming, you must synchronize the garage door opener integrated in the rear-view mirror with the receiver of the garage door system.

Synchronizing the rolling code

Observe the "Important safety notes" (▷ page 414).

Your vehicle must be within reach of the garage door or exterior gate drive. Make sure that neither your vehicle nor any persons/ objects are present within the sweep of the door or gate.

- ▶ Turn the SmartKey to position **2** in the ignition lock.
- ▶ Press the program button of the door or gate drive (see the door or gate drive operating instructions, e.g. under "programming of additional remote controls").

- i** Usually, you now have 30seconds to initiate the next step.
- ▶ Press previously programmed button ②, ③ or ④ of the integrated garage door opener until the door closes. The rolling code synchronization is then complete.

Notes on programming the remote control

Canadian radio frequency laws require a "break" (or interruption) of the transmission signals after broadcasting for a few seconds. Therefore, these signals may not last long enough for the integrated garage door opener. The signal is not recognized during programming. Comparable with Canadian law, some U.S. garage door openers also feature a "break".

Proceed as follows:

- if you live in Canada
- if you have difficulties programming the garage door opener (regardless of where you live) when using the programming steps
- ▶ Press and hold one of buttons ② to ④ on the integrated garage door opener. After a short time, indicator lamp ① lights up yellow.
- ▶ Release the button. Indicator lamp ① flashes yellow.
- ▶ Press button ⑥ of garage door remote control ⑤ for two seconds, then release it for two seconds.
- ▶ Press button ⑥ again for two seconds.
- ▶ Repeat this sequence on button ⑥ of remote control ⑤ until indicator lamp ① lights up green. If indicator lamp ① turns red, repeat the process.
- ▶ Continue with the other programming steps (see above).

Problems when programming

If you are experiencing problems programming the integrated garage door opener on the rear-view mirror, take note of the following instructions:

- Check the transmitter frequency of garage door drive remote control ⑤. This can usually be found on the back of the remote control.

The integrated garage door opener is compatible with devices that have units which operate in the frequency range of 280to 433MHz.

- Replace the batteries in garage door remote control ⑤. This increases the likelihood that garage door remote control ⑤ will transmit a strong and precise signal to the integrated garage door opener in the rear-view mirror.
- When programming, hold remote control ⑤ at varying distances and angles from the button that you are programming. Try various angles at a distance between 2and 12 inches (5to 30 cm) or at the same angle but at varying distances.
- If another remote control for the same garage door drive is available, repeat the same programming steps with this remote control. Before performing these steps, make sure that new batteries have been installed in garage door drive remote control ⑤.
- Note that some remote controls only transmit for a limited amount of time (the indicator lamp on the remote control goes out). Press button ⑥ on remote control ⑤ again before transmission ends.
- Align the antenna cable of the garage door opener unit. This can improve signal reception/transmission.

Opening/closing the garage door

After it has been programmed, the integrated garage door opener performs the function of the garage door system remote control.

Please also read the operating instructions for the garage door system.

- ▶ Turn the SmartKey to position **2** in the ignition lock.
- ▶ Press button ②, ③ or ④ which you have programmed to operate the garage door. Garage door system with a fixed code: indicator lamp ① lights up green.

Garage door system with a rolling code: indicator lamp ① flashes green.

- ① The transmitter will transmit a signal as long as the button is pressed. The transmission is halted after a maximum of ten seconds and indicator lamp ① lights up yellow. Press button ②, ③ or ④ again if necessary.

Clearing the memory of the integrated garage door opener on the rear-view mirror

- ▶ Turn the SmartKey to position **2** in the ignition lock.
- ▶ Press buttons ② and ④. The indicator lamp lights up yellow.
- ▶ Press and hold buttons ② and ④ until the indicator lamp turns green.
- ① Make sure that you clear the memory of the integrated garage door opener before selling the vehicle.

Floormat on the driver's side

⚠ WARNING

Whenever you are using a floormat, make sure there is enough clearance and that the floormat is securely fastened.

The floormat should always be securely fastened using the fastening equipment.

Before driving off, check that the floormat is securely in place and adjust it if necessary. A loose floormat could slip and hinder proper functioning of the pedals.

Do not place several floormats on top of each other as this may impair pedal movement.

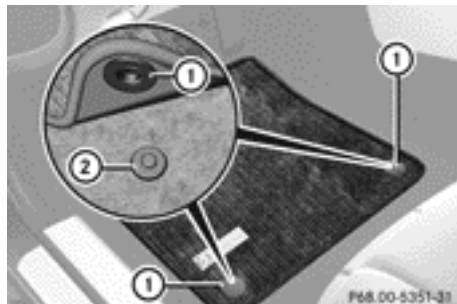

- ▶ Slide the seat backwards.
- ▶ **To install:** place the floormat in the footwell.
- ▶ Press studs ① onto retainers ②.
- ▶ **To remove:** pull the floormat off retainers ②.
- ▶ Remove the floormat.

Infrared reflective windshield

The infrared reflecting glass prevents the vehicle interior from becoming too hot. It also blocks radio waves up into the gigahertz range.

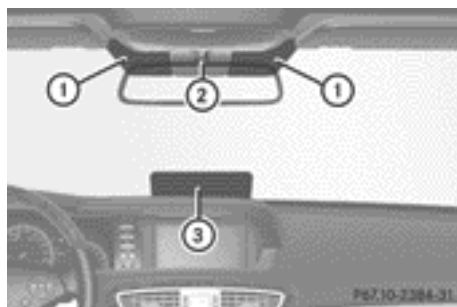

Vehicles without Night View Assist

- ① Areas permeable to radio waves (to the left and right of the rain sensor cover)
- ② Rain sensor cover
- ③ Areas permeable to radio waves

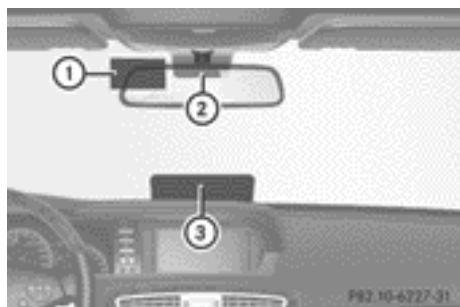

Vehicles with Night View Assist

- ① Areas permeable to radio waves (to the left of the rain sensor cover)
- ② Rain sensor cover
- ③ Areas permeable to radio waves

In order to operate radio-controlled equipment, e.g. toll recording systems, areas ① and ③ on the windshield are permeable to radio waves. In these areas, you can install radio-controlled systems.

These areas can best be seen from outside the vehicle by observing the light reflected off the windshield.

Useful information	420
Engine compartment	420
Maintenance	426
Care	427

Useful information

- i** This Operator's Manual describes all models and all standard and optional equipment of your vehicle available at the time of publication of the Operator's Manual. Country-specific differences are possible. Please note that your vehicle may not be equipped with all features described. This also applies to safety-related systems and functions.
- i** Please read the information on qualified specialist workshops (▷ page 29).

Engine compartment

Hood

Opening the hood

⚠ WARNING

Do not pull the release lever while the vehicle is in motion. Otherwise, the hood could be forced open by passing air flow.

This could cause the hood to come loose and injure you and/or others.

⚠ WARNING

Do not open the hood when the engine is overheated. You could be seriously injured. Observe the coolant temperature gauge to determine whether the engine may be overheated. If you see flames or smoke coming from the engine compartment, move away from the vehicle. Wait until the engine has cooled. If necessary, call the fire department.

⚠ WARNING

There is a risk of injury if the hood is open, even if the engine is not running.

Some engine components can become very hot.

To avoid the risk of burns, only touch those components described in the Operator's Manual and observe the relevant safety notes.

⚠ WARNING

To avoid injury, stay clear of moving parts when the hood is open and the engine is running.

The radiator fan may continue to run for approximately 30seconds or may even restart after the engine has been switched off. For this reason, you must not reach into the fan rotation area.

⚠ WARNING

The engine is equipped with a transistorized ignition system. Because of the high voltage, it is dangerous to touch any components (ignition coils, spark plug sockets, diagnostic socket) of the ignition system:

- with the engine running
- while starting the engine
- when the ignition is switched on and the engine is turned manually

- ▶ Make sure that the windshield wipers are switched off.

⚠ WARNING

The windshield wipers and wiper linkage could be set in motion.

When the hood is open, you or others could be injured by the wiper linkage.

Make sure that the windshield wipers are switched off. Remove the SmartKey or make sure that no ignition position has been selected with KEYLESS-GO. All indicator lamps must be off in the instrument panel.



- ▶ Pull release lever ① for the hood.
The hood is released.

! Make sure that the windshield wipers are not folded away from the windshield. You could otherwise damage the windshield wipers or the hood.

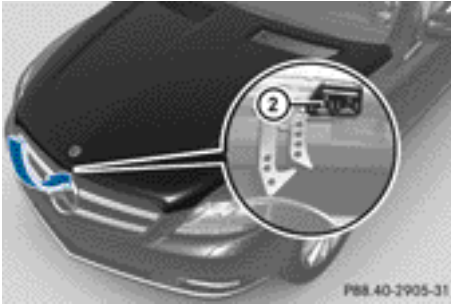

- ▶ Reach into the gap, pull hood catch handle ② up and lift the hood.
Once you have lifted the hood about 15 inches (40cm), it is automatically opened the rest of the way and held open by the gas-filled struts.

Closing the hood

WARNING

When closing the hood, use extreme caution not to catch hands or fingers. Be careful that you do not close the hood on anyone.

Make sure the hood is securely engaged before driving off. Do not continue driving if the hood can no longer engage after an accident, for example. The hood could otherwise come loose while the vehicle is in motion and injure you and/or others.

- ▶ Lower the hood and let it fall from a height of approximately 8 inches (20cm).
- ▶ Check that the hood has engaged properly. If the hood can be raised slightly, it is not properly engaged. Open it again and close it with a little more force.

Engine oil

Notes on the oil level

Depending on the driving style, the vehicle consumes up to 0.9 US qts (0.8 l) of oil over a distance of 600 miles (1,000 km). The oil consumption may be higher than this when the vehicle is new or if you frequently drive at high engine speeds.

On vehicles with a 12-cylinder engine, the oil level can be checked using the on-board computer. On all other models, the oil dipstick must be used to check the engine oil level.

Depending on the engine, the oil dipstick may be in a different location.

When checking the oil level:

- park the vehicle on a level surface.
- the engine should be switched off for approximately five minutes if the engine is at normal operating temperature.
- if the engine is not at normal operating temperature, e.g. if the engine was only started briefly: wait about 30 minutes before carrying out the measurement.

Checking the oil level using the oil dipstick

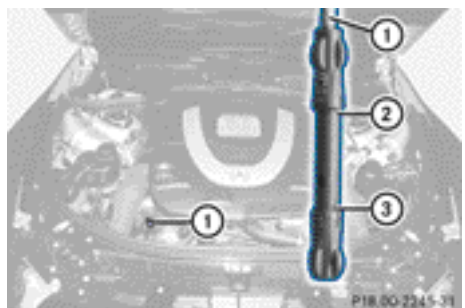







- ▶ Pull oil dipstick ① out of the dipstick guide tube.
- ▶ Wipe off oil dipstick ①.

- ▶ Slowly slide oil dipstick ① into the guide tube to the stop, and take it out again. If the level is between MIN mark ③ and MAX mark ②, the oil level is correct.
- ▶ If the oil level has dropped to MIN mark ③ or below, add 1.1 US qt (1.0 liter) of engine oil.

Checking the oil level using the on-board computer

Measurement

- ▶ Make sure that the SmartKey is in position 2 in the ignition lock.
- ▶ Press the  or  button to select the **Service** menu.
- ▶ Press the  or  button to select **Engine Oil Level**.
- ▶ Press the  button.
The multifunction display shows the following message: **Measuring Engine Oil Level Accurate Only When Vehicle Is Level**

- i** If you wish to cancel the measurement, press the  button on the multifunction steering wheel.

Display messages

The measurement takes a few seconds. You will see one of the following messages in the multifunction display:

Problem	Possible causes/consequences and ► Solutions
Engine Oil Level OK	The oil level is correct.
Add 1.0 l Engine Oil At Next Refueling.	The oil level is too low. ► add 1.0 l of engine oil.
Add 1.5 l Engine Oil At Next Refueling.	The oil level is too low. ► add 1.5 l of engine oil.
Add 2.0 l Engine Oil At Next Refueling.	The oil level is too low. ► add 2.0 l of engine oil.
Engine Oil Level Reduce Oil Level	The engine oil level is too high. ► Have excess engine oil siphoned off.
For Engine Oil Level Ignition Must be On	The ignition is switched off. ► Turn the SmartKey to position 2 in the ignition lock.
Need More Time to Check Engine Oil Level	The required waiting period was not observed. ► If the engine is at normal operating temperature: repeat the measurement after about five minutes. If the engine is not at normal operating temperature (e.g. if the engine was only started briefly): repeat the measurement after about 30 minutes.
Engine Oil Level Not When Engine On	The engine is running; oil level measurement is not possible. ► Switch off the engine. ► If the engine is at normal operating temperature: wait about five minutes before carrying out the measurement. If the engine is not at normal operating temperature, e.g. if the engine was only started briefly: wait approximately 30 minutes before carrying out the measurement.

Adding engine oil

WARNING

If engine oil comes into contact with hot engine parts, it may ignite and you could burn yourself. Do not spill any engine oil on hot engine parts.

Environmental note

When adding oil, take care not to spill any. If oil enters the soil or waterways, it is harmful to the environment.

 Only use engine oils and oil filters that have been approved for vehicles with a

service system. You can obtain a list of the engine oils and oil filters tested and approved in accordance with the Mercedes-Benz Specifications for Service Products at any Mercedes-Benz Service center.

Damage to the engine or exhaust system is caused by the following:

- using engine oils and oil filters that have not been specifically approved for the service system
- replacing engine oil and oil filters after the interval for replacement specified by the service system has been exceeded
- using engine oil additives.

! Do not add too much oil. adding too much engine oil can result in damage to the engine or to the catalytic converter. Have excess engine oil siphoned off.



Example: engine oil cap

- ▶ Turn cap ① counter-clockwise and remove it.
- ▶ Add engine oil.
Vehicles with oil level measurement function in the on-board computer: observe the information in the on-board computer when doing so. Vehicles with an oil dipstick: if the oil level is at or below the MIN mark on the dipstick, add 1.1 US qt (1.0 liters) of engine oil.

- ▶ Replace cap ① on the filler neck and turn clockwise.
Ensure that the cap locks into place securely.
- ▶ Check the oil level again with the oil dipstick (▷ page 421) or the on-board computer (▷ page 422).

Further information on engine oil (▷ page 486).

Checking and adding other service products

Checking coolant level

! WARNING

In order to avoid any potentially serious burns:

- use extreme caution when opening the hood if there are any signs of steam or coolant leaking from the cooling system, or if the coolant temperature display indicates that the coolant is overheated.
- do not remove the pressure cap on the coolant reservoir if the coolant temperature is above 158 °F (70 °C). Allow the engine to cool down before removing the cap. The coolant reservoir contains hot fluid and is under pressure.
- using a rag, slowly turn the cap approximately $1/2$ turn to relieve excess pressure. If opened immediately, scalding hot fluid and steam will be blown out under pressure.
- do not spill antifreeze on hot engine parts. Antifreeze contains ethylene glycol which may burn if it comes into contact with hot engine parts.

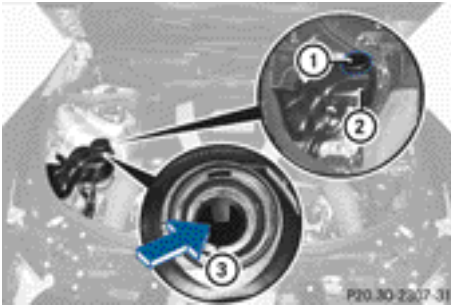

- ▶ Park the vehicle on a level surface.
Only check the coolant level when the vehicle is on a level surface and the engine has cooled down.
- ▶ Turn the SmartKey to position **2** in the ignition lock (▷ page 273).
On vehicles with KEYLESS-GO, press the Start/Stop button twice (▷ page 273).
- ▶ Check the coolant temperature display in the instrument cluster.
The coolant temperature must be below 158 °F (70 °C).
- ▶ Turn the SmartKey to position **0** (▷ page 273) in the ignition lock.
- ▶ Slowly turn cap ① half a turn counter-clockwise to allow excess pressure to escape.
- ▶ Turn cap ① further counter-clockwise and remove it.
If the coolant is at the level of marker bar ③ in the filler neck when cold, there is enough coolant in coolant expansion tank ②.
- ▶ If the coolant level is approximately 0.6 in (1.5 cm) above marker bar ③ in the filler neck when warm, there is enough coolant in coolant expansion tank ②.
- ▶ If necessary, add coolant that has been tested and approved by Mercedes-Benz.
- ▶ Replace cap ① and turn it clockwise as far as it will go.

For further information on coolant, see (▷ page 487).

Adding washer fluid to the windshield washer system/headlamp cleaning system

WARNING

Washer solvent/antifreeze is highly flammable. Do not spill washer solvent/antifreeze on hot engine parts, because it may ignite and burn. You could be seriously burned.

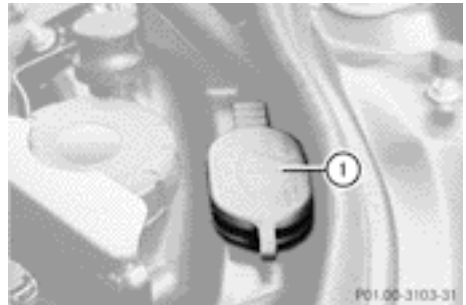

- ▶ **To open:** pull cap ① upwards by the tab.
- ▶ Add the premixed washer fluid.
- ▶ **To close:** press cap ① onto the filler neck until it engages.

The washer fluid reservoir is used for both the windshield washer system and the headlamp cleaning system.

Further information on windshield washer fluid/antifreeze (▷ page 488).

Brake fluid level

- ❗ If the brake fluid level in the brake fluid reservoir has fallen to the MIN mark or below, check the brake system immediately for leaks. Also check the thickness of the brake linings. Visit a qualified specialist workshop immediately.
Do not add brake fluid. This does not correct the malfunction.

Only check the brake fluid level when the vehicle is stationary and on a level surface.

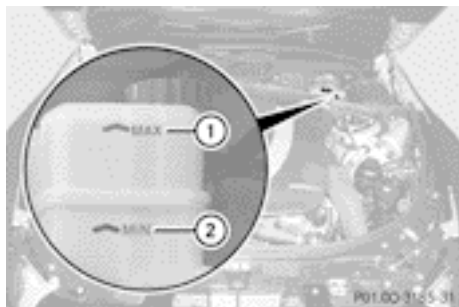

If the brake fluid level is between MIN marking ② and MAX marking ① on the brake fluid reservoir, it is correct.

Maintenance

Service interval display

Displaying service messages

- ▶ Switch on the ignition.
- ▶ Press or on the steering wheel to select the **Service** menu.
- ▶ Press or to select the **ASSYST PLUS** submenu and press to confirm. The service due date appears in the multifunction display.

Hiding a service message

- ▶ Press the or button on the steering wheel.

Service messages

Information on the type of service and service intervals (see separate Maintenance Booklet).

You can obtain further information from an authorized Mercedes-Benz Center or at <http://www.mbusa.com> (USA only).

The service interval message informs you of the next service due date.

The multifunction display shows a service message for several seconds, e.g.:

Next service A Due in .. Days

Service A Due

Service A Exceeded By .. Days

The letter indicates how much time the workshop will require to carry out the service work. The letters displayed range from **A** for a short service duration to **H** for a long service duration.

The service interval display does not take into account any periods of time during which the battery is disconnected.

Maintaining the time-dependent service schedule:

- ▶ Note down the service due date displayed in the multifunction display before disconnecting the battery.

or

- ▶ Subtract the battery disconnection periods from the service date shown on the display after reconnecting the battery.

- i** The service interval display does not provide any information regarding the engine's oil level. Observe the notes on the engine oil level (▷ page 421).

Information about Service

Resetting the service interval display

A qualified specialist workshop, e.g. an authorized Mercedes-Benz Center, will reset the service interval display after the necessary service work has been carried out.

Further information, on maintenance for example, can be obtained at an authorized Mercedes-Benz Center or directly from Mercedes-Benz.

- !** If the service interval display has been reset unintentionally, have the setting corrected at a Mercedes-Benz Center. Have service work carried out as described in the Maintenance Booklet. This may otherwise lead to increased wear and damage to the major assemblies or the vehicle.

Driving abroad

An extensive Mercedes-Benz Service network is also available in other countries. You can obtain further information from any authorized Mercedes-Benz Center.

Care

Notes on care

Regular care of your vehicle is a condition for retaining the quality in the long term.

Use care products and cleaning agents recommended and approved by Mercedes-Benz.

WARNING

Many cleaning products can be hazardous. Some are poisonous, others are flammable. Always follow the instructions on the particular container. Always open your vehicle's doors or windows when cleaning the inside.

Never use fluids or solvents that are not designed for cleaning your vehicle.

Always lock away cleaning products and keep them out of reach of children.

 For cleaning your vehicle, do not use any of the following:

- dry, rough or hard cloths
- abrasive cleaning agents
- solvents
- cleaning agents containing solvents

Do not scrub.

Do not touch the surfaces or protective films with hard objects, e.g. a ring or ice scraper. You could otherwise scratch or damage the surfaces and protective film.

Environmental note

Dispose of empty packaging and cleaning cloths in an environmentally responsible manner.

 Do not park the vehicle for an extended period straight after cleaning it, particularly after having cleaned the wheels with wheel cleaner. Wheel cleaners could cause increased corrosion of the brake discs and brake pads/linings. For this reason, you should drive for a few minutes after cleaning. Braking heats the brake discs and the brake pads/linings, thus drying them. The vehicle can then be parked.

Exterior care

Automatic car wash

WARNING

Braking efficiency is reduced after washing the vehicle. This could cause an accident. For this reason, you must drive particularly carefully after washing the vehicle until the brakes have dried.

You can wash the vehicle in an automatic car wash from the very start.

 It is preferable to use car washes with adjustable¹⁹ high-pressure precleaning. In car washes that use high water pressures, there is a risk that a small amount of water may leak into the vehicle.

 Never clean your vehicle in a Touchless Automatic Car Wash as these use special cleaning agents. These cleaning agents can damage the paintwork or plastic parts.

If the vehicle is very dirty, pre-wash it before cleaning it in an automatic car wash.

 In car washes with a towing mechanism, make sure that the automatic transmission is in transmission position **N**, otherwise the vehicle could be damaged.

- Vehicles with a SmartKey:

Do not remove the SmartKey from the ignition lock. Do not open the driver's door or front-passenger door when the engine is switched off. Otherwise, the

¹⁹ Corresponds to the specification for the Cabriolet program.

automatic transmission selects park position **P** automatically and locks the wheels. You can prevent this by shifting the automatic transmission to **N** beforehand.

- Vehicles with KEYLESS-GO:
Do not open the driver's door or front-passenger door when the engine is switched off. Otherwise, the automatic transmission selects park position **P** automatically and locks the wheels.

Observe the following to make sure that the automatic transmission stays in position **N**:

- ▶ Make sure the vehicle is stationary and the ignition is switched off.
- ▶ Turn the key to position **2** (▷ page 273) in the ignition lock.
Use the SmartKey instead of the Start/Stop button on vehicles with KEYLESS-GO.
- ▶ Depress and hold the brake pedal.
- ▶ Shift the automatic transmission to position **N**.
- ▶ Release the brake pedal.
- ▶ Release the electric parking brake.
- ▶ Switch off the ignition and leave the SmartKey in the ignition lock.

! Make sure that:

- the side windows and the sliding sunroof are fully closed.
- the ventilation/heating is switched off (the OFF button has been pressed).
- the windshield wiper switch is in position **0**.

Otherwise, the vehicle might be damaged.

After using an automatic car wash, wipe off wax from the windshield and the wiper blades. This will prevent smears and reduce wiping noises caused by residue on the windshield.

Washing by hand

In some countries, washing by hand is only allowed at specially equipped washing bays.

Observe the legal requirements in all countries concerned.

- ▶ Do not use hot water and do not wash the vehicle in direct sunlight.
- ▶ Use a soft sponge to clean.
- ▶ Use a mild cleaning agent, such as a car shampoo approved by Mercedes-Benz.
- ▶ Thoroughly hose down the vehicle with a gentle jet of water.
- ▶ Do not point the water jet directly towards the air inlet.
- ▶ Use plenty of water and rinse out the sponge frequently.
- ▶ Rinse the vehicle with clean water and dry thoroughly with a chamois.
- ▶ Do not let the cleaning agent dry on the paintwork.

When using the vehicle in winter, remove all traces of road salt deposits carefully and as soon as possible.

Power washers

⚠ WARNING

Do not use power washers with circular-jet nozzles (dirt grinders) to clean your vehicle, in particular the tires. You could otherwise damage the tires and cause an accident.

- ▶ **!** Always maintain a distance of at least 11.8 in (30 cm) between the vehicle and the power washer nozzle. Information about the correct distance is available from the equipment manufacturer.

Move the power washer nozzle around when cleaning your vehicle.

Do not aim directly at any of the following:

- tires
- door gaps, roof gaps, joints, etc.
- electrical components
- battery
- connectors
- lights
- seals

- trim
- ventilation slots

Damaged seals or electrical components can lead to leaks or failures.

Cleaning the wheels

! Do not use acidic wheel cleaning products to remove brake dust. This could damage wheel bolts and brake components.

! Do not park the vehicle for an extended period straight after cleaning it, particularly after having cleaned the wheels with wheel cleaner. Wheel cleaners could cause increased corrosion of the brake discs and brake pads/linings. For this reason, you should drive for a few minutes after cleaning. Braking heats the brake discs and the brake pads/linings, thus drying them. The vehicle can then be parked.

Cleaning the paintwork

Scratches, corrosive deposits, areas affected by corrosion and damage caused by inadequate care cannot always be completely repaired. In such cases, visit a qualified specialist workshop.

- ▶ Remove dirt immediately, where possible, while avoiding rubbing too hard.
- ▶ Soak insect remains with insect remover and rinse off the treated areas afterwards.
- ▶ Soak bird droppings with water and rinse off the treated areas afterwards.
- ▶ Remove coolant, brake fluid, tree resin, oils, fuels and greases by rubbing gently with a cloth soaked in petroleum ether or lighter fluid.
- ▶ Use tar remover to remove tar stains.
- ▶ Use silicone remover to remove wax.

! Do not affix:

- stickers
- films
- magnetic plates or similar items

to painted surfaces. You could otherwise damage the paintwork.

If water no longer forms "beads" on the paint surface, use the paint care products recommended and approved by Mercedes-Benz. This is the case approximately every three to five months, depending on the climate conditions and the care product used. If the dirt has penetrated the paint surface or if the paintwork has become dull, then the paintwork should be cleaned. For cleaning, please use the paint cleaner recommended and approved by Mercedes Benz.

Do not use these care products in the sun or on the hood while the hood is hot.

- ▶ Use a suitable touch-up stick, e.g. MB Touch-Up Stick, to repair slight damage to the paintwork quickly and provisionally.

Matte finish care

If your vehicle has a clear matte finish, observe the following instructions in order to avoid damage to the paintwork due to incorrect care.

These notes also apply to light alloy wheels with a clear matte finish.

! Never polish the vehicle or the light alloy wheels. Polishing causes the finish to shine.

! The following may cause the paint to become shiny and thus reduce the matte effect:

- Vigorous rubbing with unsuitable materials.
- Frequent use of car washes.
- Washing the vehicle in direct sunlight.

! Never use paint cleaner, buffing or polishing products, or gloss preserver, e.g. wax. These products are only suitable for high-gloss surfaces. Their use on vehicles with matte finish leads to considerable surface damage (shiny, spotted areas).

Always have paintwork repairs carried out at a qualified specialist workshop.

- !** Do not use wash programs with a hot wax treatment under any circumstances.
- i** The vehicle should preferably be washed by hand using a soft sponge, car shampoo and plenty of water.
- i** Use only insect remover and car shampoo from the range of recommended and approved Mercedes-Benz care products.

Cleaning the windows

WARNING

Before cleaning the windshield or wiper blades, switch off the windshield wipers and remove the SmartKey from the ignition lock. On vehicles with KEYLESS-GO, press the Start/Stop button repeatedly until all indicator lamps in the instrument cluster have gone out. The windshield wipers could otherwise move and injure you.

- !** Only fold the windshield wipers away from the windshield when vertical. Otherwise, you will damage the hood.
- ▶ Clean the inside and outside of the windows with a damp cloth and a cleaning agent that is recommended and approved by Mercedes-Benz.
- !** Do not use dry cloths, abrasive products, solvents or cleaning agents containing solvents to clean the inside of the windows. Do not touch the insides of the windows with hard objects, e.g. an ice scraper or ring. There is otherwise a risk of damaging the windows.
- !** Clean the water drainage channels of the windshield and the rear window at regular intervals. Deposits such as leaves, petals and pollen may under certain circumstances prevent water from draining away. This can lead to corrosion damage and damage to electronic components.

Cleaning wiper blades

WARNING

Before cleaning the windshield or wiper blades, switch off the windshield wipers and remove the SmartKey from the ignition lock. On vehicles with KEYLESS-GO, press the Start/Stop button repeatedly until all indicator lamps in the instrument cluster have gone out. The windshield wipers could otherwise move and injure you.

- !** Only fold the windshield wipers away from the windshield when vertical. Otherwise, you will damage the hood.
- !** Do not pull the wiper blade. Otherwise, the wiper blade could be damaged.
- !** Do not clean wiper blades too often and do not rub them too hard. Otherwise, the graphite coating could be damaged. This could cause wiper noise.
- ▶ Fold the wiper arms away from the windshield.
- ▶ Carefully clean the wiper blades with a damp cloth.
- ▶ Fold the windshield wipers back again before switching on the ignition.
- !** Hold the wiper arm securely when folding back. The windshield could be damaged if the wiper arm smacks against it suddenly.

Cleaning the exterior lighting

- !** Only use cleaning agents or cleaning cloths which are suitable for plastic light lenses. Unsuitable cleaning agents or cleaning cloths could scratch or damage the plastic light lenses.
- ▶ Clean the plastic lenses of the exterior lighting using a wet sponge and a mild cleaning agent, e.g. Mercedes-Benz car shampoo. Or clean the exterior lighting with cleaning cloths.

Cleaning the mirror turn signals

- ❗ Only use cleaning agents or cleaning cloths that are suitable for plastic lenses. Unsuitable cleaning agents or cleaning cloths could scratch or damage the plastic lenses of the mirror turn signals.
- ▶ Clean the plastic lenses of the mirror turn signals using a wet sponge and a mild cleaning agent, e.g. Mercedes-Benz car shampoo. Cleaning cloths may be used as well.

Cleaning the sensors

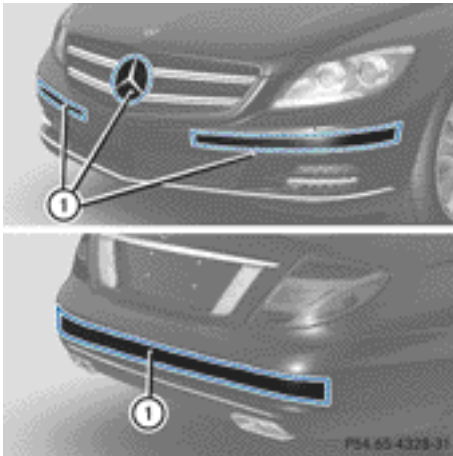

- ▶ Clean sensors ① of the driving systems with water, car shampoo and a soft cloth.
- ❗ If you clean the sensors with a power washer, make sure that you keep a distance of at least 11.8 in (30 cm) between the vehicle and the power washer nozzle. Information about the correct distance is available from the equipment manufacturer.

Cleaning the rear view camera

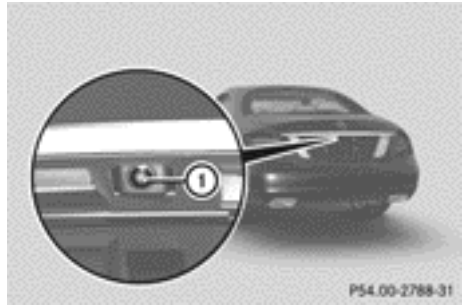

- ▶ Use clear water and a soft cloth to clean camera lens ①.
- ❗ Do not clean the camera lens and the area around the rear view camera with a power washer.

Cleaning the exhaust pipes

Impurities combined with the effects of road grit and corrosive environmental factors may cause flash rust to form on the surface. You can restore the original shine of the exhaust tail pipe by cleaning it regularly, especially in winter and after washing.

- ❗ Do not clean the exhaust tail pipes with alkaline-based cleaning agents, such as wheel cleaner.
- ▶ Clean the exhaust tail pipes with a chrome care product tested and approved by Mercedes-Benz.

Interior care

Cleaning the display

- ▶ Before cleaning the display, make sure that it is switched off and has cooled down.
- ▶ Clean the display surface using a commercially-available microfiber cloth and TFT/LCD display cleaner.
- ▶ Dry the display surface using a dry microfiber cloth.

! For cleaning, do not use any of the following:

- alcohol-based thinner or gasoline
- abrasive cleaning agents
- commercially-available household cleaning agents

These may damage the display surface. Do not put pressure on the display surface when cleaning. This could lead to irreparable damage to the display.

Cleaning Night View Assist Plus

! Never clean the camera lens. When cleaning the field of vision of the driving systems, make sure that you do not spray glass cleaner on the camera lens. If the camera lens is dirty, visit a qualified specialist workshop.

! WARNING

Always remember that your primary responsibility is to drive the vehicle. The driver must always concentrate on the road. For your safety and the safety of others, stop the vehicle before trying to clean fogged-up windows or to clean the window in front of the Night View Assist Plus camera.

Bear in mind that at a speed of only 30 mph (approximately 50 km/h), the vehicle covers a distance of 44 feet (approximately 14 m) per second.

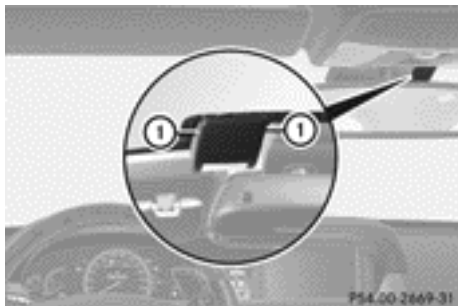

► Fold down the camera cover by recess ①.

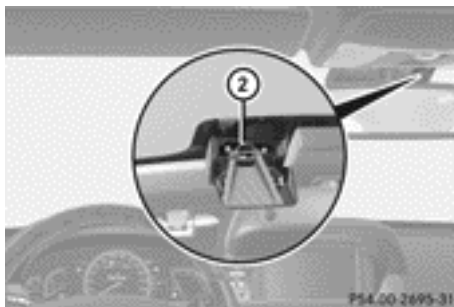

► Use a soft cloth to clean the windshield in front of camera ②.

Cleaning the plastic trim

! WARNING

When cleaning the steering wheel boss and dashboard, do not use cockpit sprays or cleaning agents containing solvents. Cleaning agents containing solvents cause the surface to become porous, and as a result, plastic parts may break away and be thrown around the interior when an air bag is deployed, which may result in severe injuries.

! Do not affix the following to plastic surfaces:

- stickers
- films
- scented oil bottles or similar items

You can otherwise damage the plastic.

! Do not allow cosmetics, insect repellent or sunscreen to come into contact with the plastic trim. This maintains the high-quality look of the surfaces.

► Wipe the plastic trim with a damp, lint-free cloth, e.g. a microfiber cloth.

► **Heavy soiling:** use car care and cleaning products recommended and approved by Mercedes-Benz.

The surface may change color temporarily. Wait until the surface is dry again.

Cleaning the steering wheel and gear or selector lever

- ▶ Thoroughly wipe with a damp cloth or use leather care agents that have been recommended and approved by Mercedes-Benz.

Cleaning genuine wood and trim elements

- ▶ Wipe the wooden trim and trim pieces with a damp, lint-free cloth, e.g. a microfiber cloth.
- ▶ **Heavy soiling:** use car care and cleaning products recommended and approved by Mercedes-Benz.

! Do not use solvent-based cleaning agents such as tar remover, wheel cleaners, polishes or waxes. There is otherwise a risk of damaging the surface.

! Do not use chrome polish on trim pieces. The trim pieces have a chrome look but are mostly made of anodized aluminum and can lose their shine if chrome polish is used. Use a damp, lint-free cloth instead when cleaning the trim pieces.

If the chrome-plated trim pieces are very dirty, you can use a chrome polish. If you are unsure as to whether the trim pieces are chrome-plated or not, consult an authorized Mercedes-Benz Center.

Cleaning the seat covers

! Do not use microfiber cloths to clean genuine leather, artificial leather or Alcantara® covers. If used often, these can damage the cover.

- !** Observe the following when cleaning:
 - clean genuine leather covers carefully with a damp cloth and then wipe the covers down with a dry cloth. Make sure that the leather does not become soaked. It may otherwise become rough and cracked. Only use leather care

agents that have been tested and approved by Mercedes-Benz. You can obtain these from a qualified specialist workshop.

- clean artificial leather covers with a cloth moistened with a solution containing 1% detergent (e.g. dish washing liquid).
- clean cloth covers with a microfiber cloth moistened with a solution containing 1% detergent (e.g. dish washing liquid). Rub carefully and always wipe entire seat sections to avoid leaving visible lines. Leave the seat to dry afterwards. Cleaning results depend on the type of dirt and how long it has been there.
- clean Alcantara® covers with a damp cloth. Make sure that you wipe entire seat sections to avoid leaving visible lines.

i Note that regular care is essential to ensure that the appearance and comfort of the covers is retained over time.

Cleaning the seat belts

- ▶ Use clean, lukewarm water and soap solution.

! Do not clean the seat belts using chemical cleaning agents. Do not dry the seat belts by heating at temperatures above 176 °F (80 °C) or in direct sunlight.

⚠ WARNING

Do not bleach or dye seat belts as this may severely weaken them. In a crash, they may not be able to provide adequate protection.

Cleaning the headliner and carpets

- ▶ **Headliner:** use a soft brush or a cleaning agent recommended and approved by Mercedes-Benz to remove heavy soiling.
- ▶ **Carpets:** use the carpet and textile cleaning agents recommended and approved by Mercedes-Benz.

Useful information	436
Where will I find...?	436
Flat tire	437
Battery	442
Jump-starting	445
Towing and tow-starting	446
Fuses	449

Useful information

- i** This Operator's Manual describes all models and all standard and optional equipment of your vehicle available at the time of publication of the Operator's Manual. Country-specific differences are possible. Please note that your vehicle may not be equipped with all features described. This also applies to safety-related systems and functions.
- i** Please read the information on qualified specialist workshops (▷ page 29).

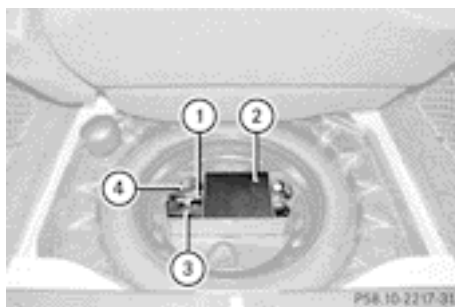

- ① Folding wheel chock
- ② Vehicle tool kit tray cover
- ③ Vehicle tool kit
- ④ Jack

Where will I find...?

First-aid kit

- ▶ Open the trunk lid.

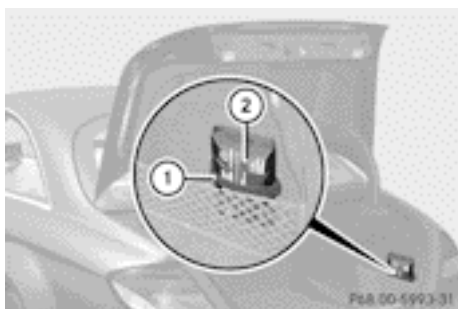

- ▶ Remove tensioning strap ①.
 - ▶ Remove first-aid kit ② from the parcel net.
- i** Check the expiration date on the first-aid kit at least once a year. Replace the contents if necessary, and replace missing items.

Vehicle tool kit

The vehicle tool kit can be found in the stowage well under the trunk floor.

- ▶ Lift the trunk floor upwards (▷ page 403).

"Minispare" emergency spare wheel

The "Minispare" emergency spare wheel can be found in the stowage well under the trunk floor.

- ▶ Lift the trunk floor up (▷ page 403).

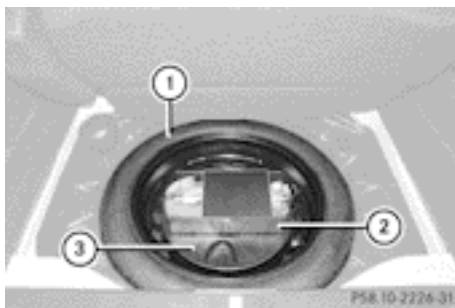

- ▶ Turn stowage tray ③ counterclockwise and remove together with vehicle tool kit tray ②.
- ▶ Remove "Minispare" emergency spare wheel ①.

For further information on changing a wheel and installing the spare wheel, see (▷ page 437).

Flat tire

Preparing the vehicle

- i** Vehicle preparation is not necessary on vehicles with MOExtended tires.
- ▶ Stop the vehicle on solid, non-slippery and level ground, as far away as possible from traffic.
- ▶ Switch on the hazard warning lamps.
- ▶ Apply the electric parking brake manually (▷ page 290).
- ▶ Bring the front wheels into the straight-ahead position.
- ▶ Move the DIRECT SELECT lever to position **P**.
- ▶ Switch off the engine.
- ▶ **Vehicles without KEYLESS-GO:** remove the SmartKey from the ignition lock.
- ▶ **Vehicles with KEYLESS-GO:** open the driver's door.
The on-board electronics have status **0**, which is the same as the SmartKey having been removed.
- ▶ **Vehicles with KEYLESS-GO:** remove the Start/Stop button from the ignition lock (▷ page 273).
- ▶ All occupants must get out of the vehicle. Make sure that they are not endangered as they do so.
- ▶ Make sure that no one is near the danger area while a wheel is being changed. Anyone who is not directly assisting in the wheel change should, for example, stand behind the barrier.
- ▶ Get out of the vehicle. Pay attention to traffic conditions when doing so.
- ▶ Close the driver's door.

Changing a wheel and mounting the spare wheel

Preparing the vehicle

When using a different size spare wheel or emergency spare wheel, do not exceed the maximum road speed of 50 mph (80 km/h)

WARNING

The wheel or tire size as well as the tire type of the spare wheel or emergency spare wheel and the wheel to be replaced may differ. Mounting an emergency spare wheel may severely impair the driving characteristics. There is a risk of an accident.

To avoid hazardous situations:

- adapt your driving style accordingly and drive carefully.
- never mount more than one spare wheel or emergency spare wheel that differs in size.
- only use a spare wheel or emergency spare wheel of a different size briefly.
- do not switch ESP[®] off.
- have a spare wheel or emergency spare wheel of a different size replaced at the nearest qualified specialist workshop. Observe that the wheel and tire dimensions as well as the tire type must be correct.

- i** Vehicles without a spare wheel or emergency spare wheel are not equipped with a tire-change tool kit at the factory. For more information on which tools are required to perform a wheel change on your vehicle, e.g. wheel chock, lug wrench or alignment bolt, consult an authorized Mercedes-Benz Center.
- ▶ Prepare the vehicle as described (▷ page 437).
- ▶ Remove the following items (depending on the vehicle's equipment) from the stowage well under the trunk floor:
 - emergency spare wheel
 - vehicle tool kit

- folding wheel chock
 - jack
- Secure the vehicle to prevent it from rolling away.

Securing the vehicle to prevent it from rolling away

If your vehicle is equipped with a wheel chock, it can be found in the vehicle tool kit (► page 436).

The folding wheel chock is an additional securing measure to prevent the vehicle from rolling away, for example when changing a wheel.

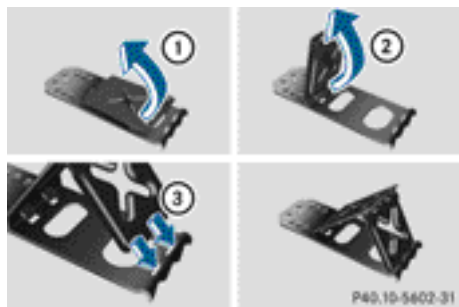

- Fold both plates upwards ①.
- Fold out lower plate ②.
- Guide the lugs on the lower plate fully into the openings in base plate ③.

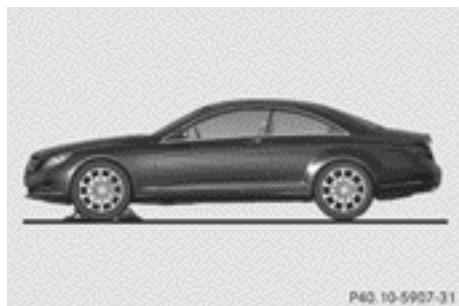

Securing the vehicle on level ground

- **On level ground:** place chocks or other suitable items under the front and rear of

the wheel that is diagonally opposite the wheel you wish to change.

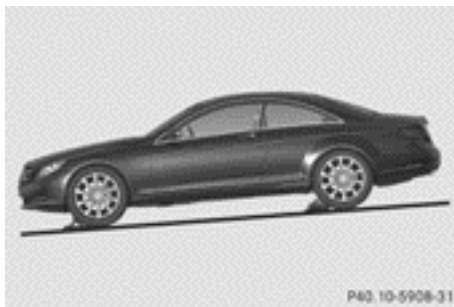

Securing the vehicle on slight downhill gradients

- **On downhill gradients:** place chocks or other suitable items in front of the wheels of the front and rear axle.

Raising the vehicle

WARNING

If you do not position the jack correctly at the appropriate jacking point of the vehicle, the jack could tip over with the vehicle raised. There is a risk of injury.

Only position the jack at the appropriate jacking point of the vehicle. The base of the jack must be positioned vertically, directly under the jacking point of the vehicle.

The following must be observed when raising the vehicle:

- to raise the vehicle, only use the vehicle-specific jack that has been tested and approved by Mercedes-Benz. If used incorrectly, the jack could tip over with the vehicle raised.
- the jack is designed only to raise and hold the vehicle for a short time while a wheel is being changed. It is not suited for performing maintenance work under the vehicle.
- avoid changing the wheel on uphill and downhill slopes.
- before raising the vehicle, secure it from rolling away by applying the parking brake

and inserting wheel chocks. Never disengage the parking brake while the vehicle is raised.

- the jack must be placed on a firm, flat and non-slip surface. On a loose surface, a large, load-bearing underlay must be used. On a slippery surface, a non-slip underlay must be used, e.g. rubber mats.
- do not use wooden blocks or similar objects as a jack underlay. Otherwise, the jack will not be able to achieve its load-bearing capacity due to the restricted height.
- The maximum clearance between the underside of the tire and the ground must be 1.2 in (3 cm).
- never place your hands and feet under the raised vehicle.
- never lie under the raised vehicle.
- never start the engine when the vehicle is raised.
- never open or close a door or the trunk lid when the vehicle is raised.
- make sure that no persons are present in the vehicle when the vehicle is raised.

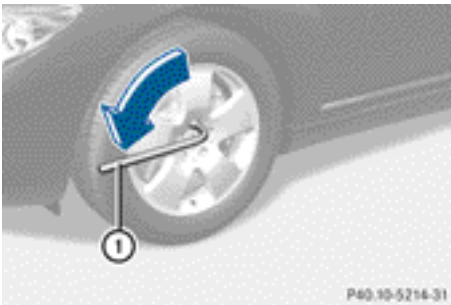

- ▶ Using lug wrench (1), loosen the bolts on the wheel you wish to change by about one full turn. Do not unscrew the bolts completely.

The jacking points are located just behind the wheel housings of the front wheels and just in front of the wheel housings of the rear wheels (arrows).

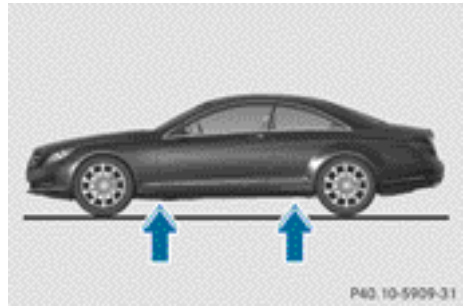

- ! The jack is designed exclusively for jacking up the vehicle at the jacking points. Otherwise, your vehicle could be damaged.

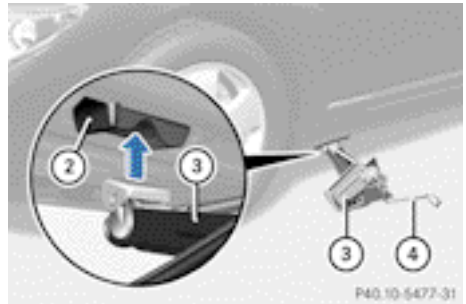

- ▶ Position jack (3) at jacking point (2).

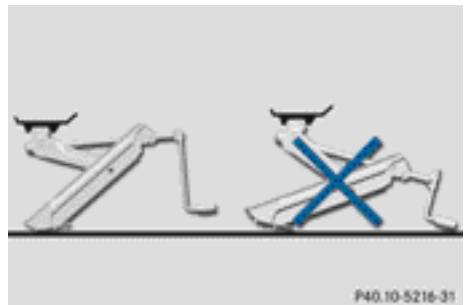

- ▶ Make sure that the base of the jack is positioned directly under the jacking point.
- ▶ Turn crank (4) clockwise until jack (3) sits completely on jacking point (2) and the base of the jack lies evenly on the ground.
- ▶ Turn handle (4) until the tire is 1.2 in (3 cm) from the ground at most.

Removing a wheel

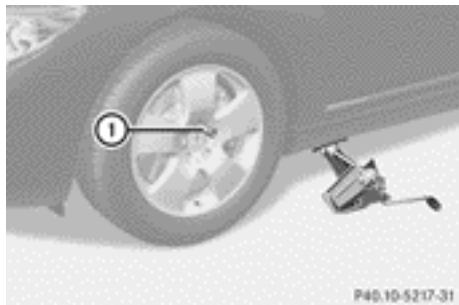

- ▶ Unscrew the uppermost wheel bolt completely.
 - ▶ Screw alignment bolt ① into the thread instead of the wheel bolt.
 - ▶ Unscrew the remaining wheel bolts fully.
- !** Do not place wheel bolts in sand or on a dirty surface. The bolt and wheel hub threads could otherwise be damaged when you screw them in.
- ▶ Remove the wheel.

Mounting a new wheel

WARNING

Oiled or greased wheel bolts or damaged wheel bolts/hub threads can cause the wheel bolts to come loose. As a result, you could lose a wheel while driving. There is a risk of accident.

Never oil or grease wheel bolts. In the event of damage to the threads, contact a qualified specialist workshop immediately. Have the damaged wheel bolts or hub threads replaced/renewed. Do not continue driving.

WARNING

If you tighten the wheel bolts or wheel nuts when the vehicle is raised, the jack could tip over. There is a risk of injury.

Only tighten the wheel bolts or wheel nuts when the vehicle is on the ground.

Always pay attention to the instructions and safety notices in "Changing a wheel" (▷ page 477).

Only use wheel bolts that have been designed for the wheel and the vehicle. For safety reasons, Mercedes-Benz recommends that you only use wheel bolts which have been approved for Mercedes-Benz vehicles and the respective wheel.

Be sure to use the original-length wheel bolts when refitting the original wheel after it has been repaired.

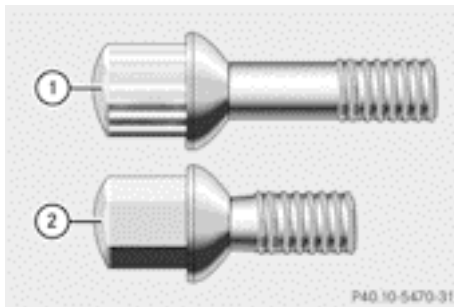

Wheel bolts for:

- ① All alloy wheels
- ② "Minispare" emergency spare wheel

! Always use wheel bolts ② to mount the "Minispare" emergency spare wheel. Using other wheel bolts to mount the "Minispare" emergency spare wheel could damage the brake system.

- ▶ Clean the wheel and wheel hub contact surfaces.

! To prevent damage to the paintwork, hold the wheel securely against the wheel hub while screwing in the first wheel bolt.

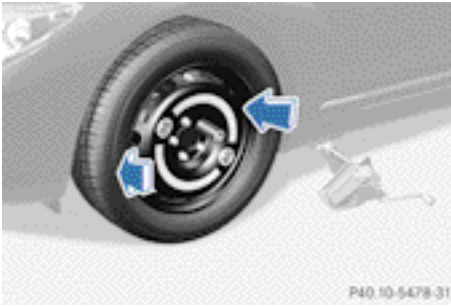

- ▶ Slide the emergency spare wheel onto the alignment bolt and push it on.
- ▶ Tighten the wheel bolts until they are finger-tight.
- ▶ Unscrew the alignment bolt.
- ▶ Tighten the last wheel bolt until it is finger-tight.

Lowering the vehicle

WARNING

Tire pressure that is too high or too low can lead to a blowout of the mounted emergency spare wheel/spare wheel, particularly when driving with a heavy load and increasing speed. There is a risk of accident.

Check the tire pressure of the emergency spare wheel or spare wheel and adjust it. When doing so, observe the specified tire pressure.

- ▶ Turn the crank of the jack counter-clockwise until the vehicle is once again standing firmly on the ground.
- ▶ Place the jack to one side.

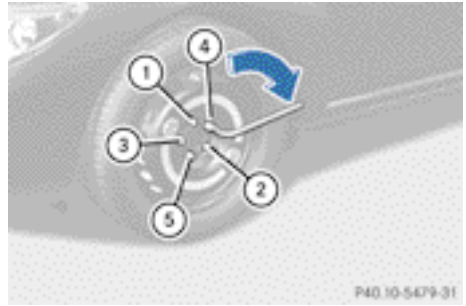

WARNING

The wheels could work loose if the wheel nuts and bolts are not tightened to the specified tightening torque. There is a risk of accident. Have the tightening torque immediately checked at a qualified specialist workshop after a wheel is changed.

- ▶ Tighten the wheel bolts evenly in a crosswise pattern in the sequence indicated (① to ⑤). The tightening torque must be **110 lb-ft (150 Nm)**.
 - ▶ Turn the jack back to its initial position and store it together with the rest of the tire-change tool kit in the stowage well under the trunk floor.
- i** When you are driving with the emergency spare wheel mounted, the tire pressure monitoring system cannot function reliably. Only restart the tire pressure monitoring system when the defective wheel has been replaced with a new wheel. All wheels mounted must be equipped with functioning sensors. The defective wheel should no longer be in the vehicle.

MOExtended tires (tires with run-flat properties)

With MOExtended tires (tires with run flat characteristics), you can continue to drive your vehicle even if there is a total loss of pressure in one or more tires.

MOExtended tires may only be used in conjunction with the activated tire pressure loss warning system or with the activated tire pressure monitoring system.

The driving distance in partially laden condition is approximately 50 miles (80 km), and approximately 18 miles (30 km) when fully loaded.

In addition to the vehicle load, the driving distance possible depends upon:

- speed
- road condition
- outside temperature

The driving distance possible in run-flat mode may be reduced by extreme driving conditions/maneuvers, or it can be increased through a moderate style of driving.

The maximum permissible distance which can be driven in run-flat mode is counted from the moment the tire pressure loss warning appears in the multifunction display.

Do not exceed a vehicle speed of 50 mph (80 km/h).

WARNING

When driving in emergency mode, the driving characteristics deteriorate, e.g. when cornering, accelerating quickly and when braking. There is a risk of an accident.

Do not exceed the stated maximum speed. Avoid abrupt steering and driving maneuvers, and driving over obstacles (curbs, potholes, off-road). This applies in particular to a laden vehicle.

Stop driving in emergency mode if:

- you hear banging noises.
- the vehicle starts to shake.
- you see smoke and smell rubber.
- ESP® is intervening constantly.
- there are tears in the sidewalls of the tire.

After driving in emergency mode, have the wheel rims checked at a qualified specialist workshop with regard to their further use. The defective tire must be replaced in every case.

- i** When replacing one or all tires, make sure that you only use tires marked MOExtended. Also ensure that they are of the specified size for the vehicle.

Battery

Important safety notes

Special tools and expert knowledge are required when working on the battery, e.g. removal and installing. You should therefore have all work involving the battery carried out at a qualified specialist workshop.

WARNING

Work carried out incorrectly on the battery can, for example, lead to a short circuit and damage your vehicle's electronic system. This can disrupt driving safety systems such as ABS (anti-lock braking system) or ESP® (Electronic Stability Program).

- If ABS malfunctions, the wheels can lock during braking. This limits the steerability of the vehicle when braking and the braking distance may increase. There is a risk of accident.
- If ESP® malfunctions, the vehicle will not be stabilized if it starts to skid or a wheel starts to spin. There is a risk of accident.

You should therefore have all work involving the battery carried out at a qualified specialist workshop.

WARNING

Comply with safety precautions and take protective measures when handling batteries.



Risk of explosion



Fire, open flames and smoking are prohibited when handling the battery. Avoid creating sparks.



Battery acid is caustic. Avoid contact with the skin, eyes or clothing.

Wear suitable protective clothing, in particular gloves, an apron and a face mask.

Immediately rinse acid splashes off with clean water. Consult a doctor if necessary.

Wear eye protection.



Keep children away.



Observe this Operator's Manual.



WARNING

Failure to follow these instructions can result in severe injury or death.

Never lean over batteries while connecting. You might get injured.

Battery fluid contains sulfuric acid. Do not allow this fluid to come in contact with eyes, skin or clothing. In case it does, immediately flush affected area with water and seek medical help if necessary.

A battery will also produce hydrogen gas, which is flammable and explosive. Keep flames or sparks away from battery, avoid improper connection of jumper cables, smoking etc.

WARNING

Do not place any metal objects on the battery as this could result in a short circuit.

Use leak-proof batteries only to avoid the risk of acid burns in the event of an accident.

Take care that you do not become statically charged, e.g. by wearing synthetic clothing or

rubbing against textiles. For this reason, you also should not pull or push the battery over carpets or other synthetic materials.

Never touch the battery first. First, touch the outside body of the vehicle in order to release any possible electrostatic charges.

Do not rub the battery with rags or cloths. The battery could explode if touched due to electrostatic charge or due to spark formation.

Environmental note



Batteries contain dangerous substances. It is against the law to dispose of them with the household rubbish. They must be collected separately and recycled to protect the environment.



Dispose of batteries in an environmentally friendly manner. Take discharged batteries to a qualified specialist workshop or a special collection point for used batteries.

! Have the battery checked regularly at a qualified specialist workshop. Observe the service intervals in the Maintenance Booklet or contact a qualified specialist workshop for more information.

! You should have all work involving the battery carried out at a qualified specialist workshop. In the exceptional case that it is necessary for you to disconnect the battery yourself, make sure that:

- you switch off the engine and remove the SmartKey. On vehicles with KEYLESS-GO, ensure that the ignition is switched off. Check that all the indicator lamps in the instrument cluster are off. Otherwise, electronic components, such as the alternator, may be damaged.
- you first remove the negative terminal clamp and then the positive terminal

clamp. Never swap the terminal clamps. Otherwise, the vehicle's electronic system may be damaged.

- the transmission is locked in position **P** after disconnecting the battery. The vehicle is secured against rolling away. You can then no longer move the vehicle.

The battery and the cover of the positive terminal clamp must be installed securely during operation.

In order for the battery to achieve the maximum possible service life, it must always be sufficiently charged.

Like other batteries, the vehicle battery may discharge over time if you do not use the vehicle. In this case, have the battery disconnected at a qualified specialist workshop. You can also charge the battery with a charger recommended by Mercedes-Benz. Contact a qualified specialist workshop for further information.

Have the battery charge level checked more frequently if you use the vehicle mainly for short trips or if you leave it standing idle for a lengthy period. Consult a qualified specialist workshop if you wish to leave your vehicle parked for a long period of time.

- ❶ Remove the SmartKey if you park the vehicle and do not require any electrical consumers. The vehicle will then use very little energy, thus conserving battery power.

Charging the battery

WARNING

Never charge a battery still installed in the vehicle unless a battery charger unit approved by Mercedes-Benz is being used. Gases may escape during charging and cause explosions that may result in paint damage, corrosion or personal injury.

A battery charger unit specially adapted for Mercedes-Benz vehicles and tested and approved by Mercedes-Benz is available as an

accessory. It permits the charging of the battery in its installed position. Contact an authorized Mercedes-Benz Center for further information and availability.

Charge the battery in accordance with the separate instructions for the battery charger.

WARNING

There is a risk of acid burns during the charging process due to the gases which escape from the battery. Do not lean over the battery during the charging process.

WARNING

Battery acid is caustic. Avoid contact with the skin, eyes or clothing.

- ❶ Only charge the installed battery with a battery charger which has been tested and approved by Mercedes-Benz. These battery chargers allow the battery to be charged while still installed in the vehicle.

- ❷ Only use battery chargers with a maximum charging voltage of 14.8 V.

- ❸ Only charge the battery using the jump-starting connection point.

The jump-starting connection point is in the engine compartment (▷ page 445).

- ▶ Open the hood (▷ page 420).
- ▶ Connect the battery charger to the positive terminal and ground point in the same order as when connecting the donor battery in the jump-starting procedure (▷ page 445).
- ▶ Read the battery charger's operating instructions before charging the battery.

Jump-starting

WARNING

Failure to follow these directions will cause damage to the electronic components, and can lead to a battery explosion and severe injury or death.

Never lean over batteries while connecting or jump starting. You might get injured.

Battery fluid contains sulfuric acid. Do not allow this fluid to come in contact with eyes, skin or clothing. In case it does, immediately flush affected area with water, and seek medical help if necessary.

A battery will also produce hydrogen gas, which is flammable and explosive. Keep flames or sparks away from battery, avoid improper connection of jumper cables, smoking, etc.

Attempting to jump start a frozen battery can result in it exploding, causing personal injury.

Read all instructions before proceeding.

WARNING

Non-combusted fuel can collect in the exhaust system and ignite. There is a risk of fire. Avoid repeated and lengthy starting attempts.

- !** Avoid repeated and lengthy starting attempts. Otherwise, the catalytic converter could be damaged by the non-combusted fuel.

Do not use a rapid charging device to start the vehicle. If your vehicle's battery is discharged, the engine can be jump-started from another vehicle or from a second battery using jumper cables. Observe the following points:

- The battery is not accessible in all vehicles. If the other vehicle's battery is not accessible, jump-start the vehicle using a second battery or a jump-starting device.
- You may only jump-start the vehicle when the engine and catalytic converter are cold.
- Do not start the engine if the battery is frozen. Let the battery thaw first.
- jump-starting may only be performed from batteries with a nominal voltage of 12 V.
- Only use jumper cables which have a sufficient cross-section and insulated terminal clamps.
- If the battery is fully discharged, leave the battery that is being used to jump-start connected for a few minutes before attempting to start. This charges the empty battery a little.
- Make sure that the two vehicles do not touch.

Make sure that:

- the jumper cables are not damaged.
- bare parts of the terminal clamp do not come into contact with other metal parts while the jumper cables are connected to the battery.
- the jumper cables cannot come into contact with parts such as the V-belt pulley or the fan. These parts move when the engine is started and while it is running.
- ▶ Secure the vehicle by applying the electric parking brake.
- ▶ Shift the transmission to position **P**.
- ▶ Switch off all electrical consumers (e.g. radio, blower, etc.).
- ▶ Open the hood (▷ page 420).

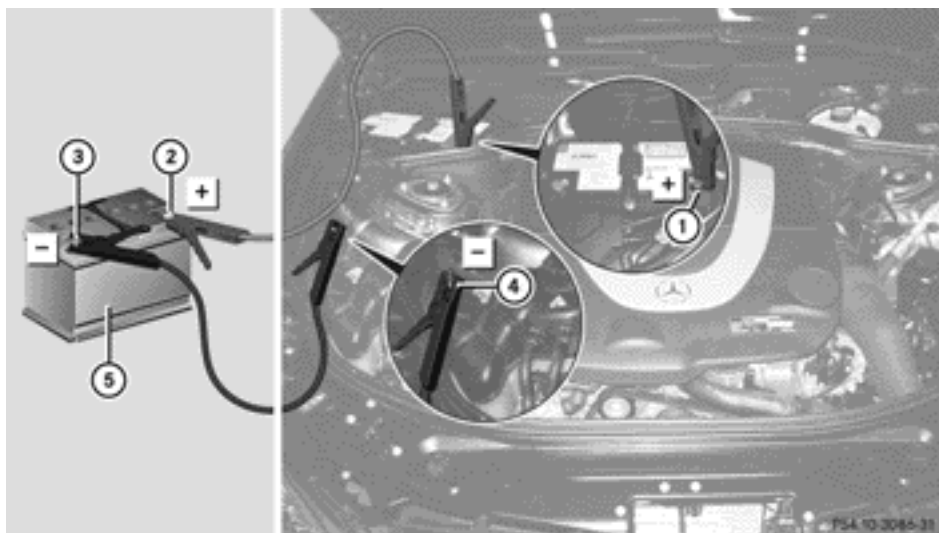

Position number ⑤ identifies the charged battery of the other vehicle or an equivalent jump-starting device.

- ▶ Remove the cover from positive terminal ①.
- ▶ Connect positive terminal ① on your vehicle to positive terminal ② of donor battery ⑤ using the jumper cable, beginning with your own battery.
- ▶ Start the engine of the donor vehicle and run it at idling speed.
- ▶ Connect negative terminal ③ of donor battery ⑤ to ground point ④ of your vehicle using the jumper cable, connecting the jumper cable to donor battery ⑤ first.
- ▶ Start the engine.
- ▶ Before disconnecting the jumper cables, let the engine run for several minutes.
- ▶ First remove the jumper cables from ground point ④ and negative terminal ③, then from positive terminal ① and positive terminal ②, each time disconnecting from the battery on your own vehicle first.
- ▶ Have the battery checked at a qualified specialist workshop.

i Jump-starting is not considered to be a normal operating condition.

i Jumper cables and further information regarding jump starting can be obtained at any qualified specialist workshop.

Towing and tow-starting

Important safety notes

WARNING

If you tow the vehicle, you must use a rigid towing bar if:

- the engine is not running.
- there is a brake system malfunction.
- there is a malfunction in the power supply or the vehicle's electrical system.

The power assistance for the steering and the brake force booster do not work when the

engine is not running. You will need more force to steer and brake, you may have to depress the brake pedal with maximum force. Before towing away, make sure that the steering can be moved and is not locked. If you tow or tow-start another vehicle, its weight must not exceed the maximum permissible gross vehicle weight of your vehicle.

It is better to have the vehicle transported than to have it towed.

! The vehicle can be towed a maximum of 30 miles (50km). The towing speed of 30 mph (50 km/h) must not be exceeded. If the vehicle has to be towed more than 30 miles (50km), the entire vehicle must be raised and transported.

! Make sure that the electric parking brake is released. If the electric parking brake is faulty, visit a qualified specialist workshop.

! Only secure the tow rope or tow bar at the towing eyes. Otherwise, the vehicle could be damaged.

! Do not use the towing eye for recovery, as this could damage the vehicle. If in doubt, recover the vehicle with a crane.

! When towing, pull away slowly and smoothly. If the tractive power is too high, the vehicles could be damaged.

! Do not tow with sling-type equipment. This could damage the vehicle.

! When towing vehicles with KEYLESS-GO, use the key instead of the Start/Stop button. Otherwise, the automatic transmission may shift to position **P** when the driver's or front-passenger door are opened, which could lead to damage to the transmission.

The automatic transmission must be in position **N** when the vehicle is being towed.

The battery must be connected and charged. Otherwise, you:

- cannot turn the SmartKey to position **2** in the ignition lock
 - cannot shift the automatic transmission to position **N**
- i** Switch off the automatic locking feature (▷ page 239) You could otherwise be locked out when pushing or towing the vehicle.

Installing/removing the towing eye

Installing the towing eye

- Remove the towing eye from the vehicle tool kit (▷ page 436).

⚠ WARNING

The exhaust tail pipe may be hot. You could burn yourself if you touch the tail pipe. Be particularly careful when removing the rear cover.

The mountings for the removable towing eyes are located in the bumpers. They are at the front and at the rear, under the covers.

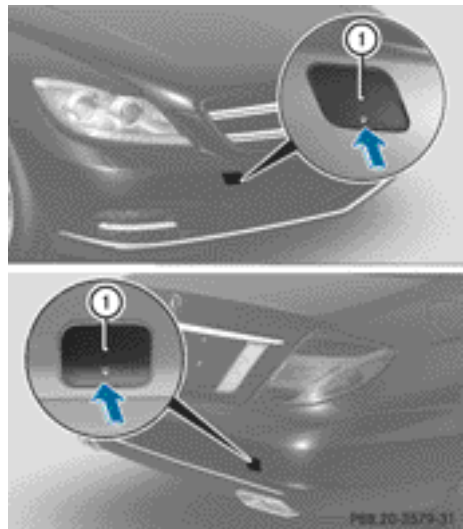

- ▶ Press the mark on cover ① inwards in the direction of the arrow.
- ▶ Take cover ① off the opening.
- ▶ Screw the towing eye in clockwise to the stop and tighten it.

Removing the towing eye

- ▶ Loosen the towing eye and unscrew it.
- ▶ Attach cover ① to the bumper and press until it engages.
- ▶ Place the towing eye in the vehicle tool kit.

Towing the vehicle with the rear axle raised

Only possible on vehicles without 4MATIC.

When towing your vehicle with the rear axle raised, it is important that you observe the safety instructions (▷ page 446).

- ❗ The ignition must be switched off if you are towing the vehicle with the rear axle raised. Intervention by ESP® could otherwise damage the brake system.
- ▶ Switch on the hazard warning lamps (▷ page 253).
- ▶ Turn the SmartKey to position **0** in the ignition lock and remove the SmartKey from the ignition lock.
- ▶ When leaving the vehicle, take the SmartKey or the KEYLESS-GO key with you.

Towing a vehicle with both axles on the ground

When having your vehicle towed, observe the important safety notes (▷ page 446).

WARNING

The power assistance for the steering and the brake force booster do not work when the engine is not running. You will then need much more effort to brake and steer the

vehicle. Adapt your style of driving accordingly.

The automatic transmission automatically shifts to position **P** when you open the driver's or front-passenger door or when you remove the SmartKey from the ignition lock. In order to ensure that the automatic transmission stays in position **N** when towing the vehicle, you must observe the following points:

- ▶ Make sure that the vehicle is stationary and the SmartKey in the ignition lock is in position **0**.
- ▶ Turn the SmartKey to position **2** in the ignition lock.

On vehicles with KEYLESS-GO, use the key instead of the Start/Stop button (▷ page 273).

- ▶ Depress and hold the brake pedal.
- ▶ Shift the automatic transmission to position **N**.
- ▶ Release the brake pedal.
- ▶ Release the electric parking brake.
- ▶ Switch on the hazard warning lamps (▷ page 253).
- ▶ Leave the SmartKey in position **2** in the ignition lock.

i When towing with the hazard warning lamps switched on, use the combination switch as usual to signal a change of direction. In this case, only the turn signals for the desired direction flash. When the combination switch is reset, the hazard warning lamps start flashing again.

Transporting the vehicle

The towing eye can be used to pull the vehicle onto a trailer or transporter for transporting purposes.

- ▶ Turn the SmartKey to position **2** in the ignition lock.
- ▶ Shift the automatic transmission to position **N**.

As soon as the vehicle is loaded:

- ▶ Prevent the vehicle from rolling away by applying the electric parking brake.
 - ▶ Shift the automatic transmission to position **P**.
 - ▶ Turn the SmartKey to position **0** in the ignition lock and remove the SmartKey from the ignition lock.
 - ▶ Secure the vehicle.
- !** Only lash the vehicle down by the wheels or wheel rims, not by parts of the vehicle such as axle or steering components. Otherwise, the vehicle could be damaged.

Notes on 4MATIC vehicles

- !** Vehicles with 4MATIC must not be towed with either the front or the rear axle raised, as doing so will damage the transmission.

If the vehicle has transmission damage or damage to the front or rear axle, have it transported on a transporter or trailer.

In the event of damage to the electrical system

If the battery is defective, the automatic transmission will be locked in position **P**. To shift the automatic transmission to position **N**, you must provide power to the vehicle's electrical system in the same way as when jump-starting (▷ page 445).

Have the vehicle transported on a transporter or trailer.

Tow-starting (emergency engine starting)

- !** Vehicles with automatic transmission must not be started by tow-starting. This could otherwise damage the transmission.

For further information on "Jump-starting" see (▷ page 445).

Fuses**Important safety notes****⚠ WARNING**

Only use fuses that have been approved for Mercedes-Benz vehicles and that have the correct fuse rating for the systems concerned. Do not attempt to repair or bridge faulty fuses. Using fuses that have not been approved or attempting to repair or bridge faulty fuses could cause the fuse to be overloaded and result in a fire. Have the cause traced and rectified at a qualified specialist workshop.

The fuses in your vehicle serve to close down faulty circuits. If a fuse blows, all the components on the circuit and their functions stop operating.

Blown fuses must be replaced with fuses of the same rating, which you can recognize by the color and value. The fuse ratings are listed in the fuse allocation chart.

If a newly inserted fuse also blows, have the cause traced and rectified at a qualified specialist workshop, e.g. an authorized Mercedes-Benz Center.

- !** Only use fuses that have been approved for Mercedes-Benz vehicles and which have the correct fuse rating for the system concerned. Otherwise, components or systems could be damaged.

Before changing a fuse

- ▶ Secure the vehicle against rolling away (▷ page 289).
- ▶ Switch off all electrical consumers.
- ▶ Remove the SmartKey from the ignition lock.

The fuses are located in various fuse boxes:

- Fuse box on the right and left-hand sides of the dashboard
- Fuse box in the rear

- Fuse box in the engine compartment on the left-hand side of the vehicle, when viewed in the direction of travel
- Fuse box in the engine compartment on the right-hand side of the vehicle, when viewed in the direction of travel

The fuse allocation chart is in the vehicle document wallet.

Dashboard fuse box

There is a fuse box located on both the driver's side and the front-passenger side.

! Do not use a pointed object such as a screwdriver to open the cover in the dashboard. You could damage the dashboard or the cover.



Driver's side illustrated

- ▶ **To open:** pull cover ① outwards in the direction of the arrow and remove it.
- ▶ **To close:** clip in cover ① on the front of the dashboard.
- ▶ Fold cover ① inwards until it engages.

Fuse box in the rear

The fuse box is behind the armrest in the rear.

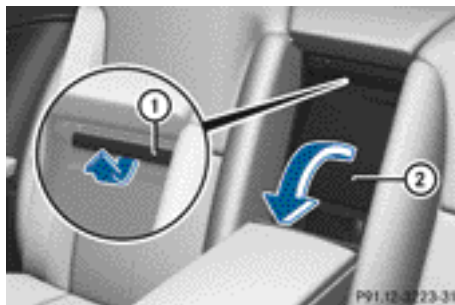

- ▶ **To open:** fold down the armrest.
- ▶ Pull handle ① on the trim behind the rear seat armrest up in the direction of the arrow.
- ▶ Fold down trim ②.

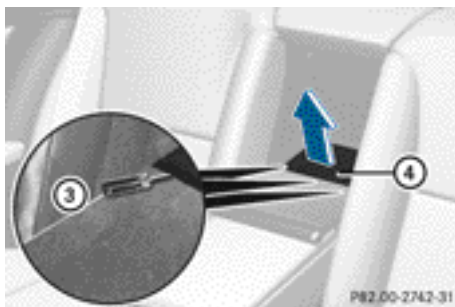

- ▶ Loosen cover ④ with a suitable object ③.
- ▶ Remove cover ④ upwards in the direction of the arrow.

! The cover must be seated properly, otherwise moisture or dirt could impair the function of the fuses.

Fuse box in the engine compartment

Fuse box on the left in the direction of travel

- ▶ Open the hood (▷ page 420).

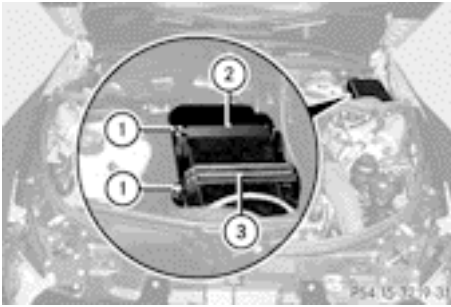

- ▶ Remove any existing moisture from the fuse box using a dry cloth.
- ▶ AMG vehicles: remove the control unit above the fuse box.
- ▶ **To open:** undo screws ① with an Allen key.
- ▶ Remove bracket ③.
- ▶ Remove cover ②.
- ▶ **To close:** check whether the rubber seal is lying correctly in cover ②.
- ▶ Put cover ② back in position.
- ▶ Replace bracket ③.
- ▶ Tighten screws ① using an Allen key.

! The cover must be seated properly, otherwise moisture or dirt could impair the function of the fuses.

- ▶ Close the hood (▷ page 421).

Fuse box on the right in the direction of travel

- ▶ Open the hood (▷ page 420).

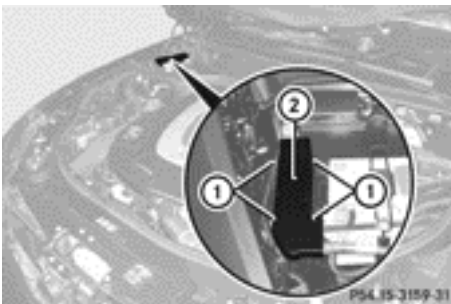

- ▶ Remove any existing moisture from the fuse box using a dry cloth.
 - ▶ **To open:** open clamps ②.
 - ▶ Remove cover ② upwards.
 - ▶ **To close:** check whether the rubber seal is lying correctly in cover ②.
 - ▶ Put cover ② back in position.
 - ▶ Fold down cover ① and close clamps ②.
- !** The cover must be seated properly, otherwise moisture or dirt could impair the function of the fuses.
- ▶ Close the hood (▷ page 421).

Engine emergency off

If the engine cannot be switched off as described, observe the following procedure:

- ▶ Take the fuse allocation chart out of the vehicle document wallet.
- ▶ Search for "Emergency engine shutdown" in the fuse allocation chart.
- ▶ Remove the fuses listed under "Emergency engine shutdown".

Useful information	454
Important safety notes	454
Operation	454
Winter operation	456
Tire pressure	458
Loading the vehicle	464
Maximum load rating	468
Uniform Tire Quality Grading Standards	469
Tire labeling	470
Definition of terms for tires and loading	474
Changing a wheel	477
Wheel and tire combinations	477

Useful information

- i** This Operator's Manual describes all models and all standard and optional equipment of your vehicle available at the time of publication of the Operator's Manual. Country-specific differences are possible. Please note that your vehicle may not be equipped with all features described. This also applies to safety-related systems and functions.
- i** Please read the information on qualified specialist workshops (▷ page 29).

Important safety notes

WARNING

If wheels and tires of the wrong size are used, the wheel brakes or suspension components may be damaged. There is a risk of accident. Always replace wheels and tires with those that fulfill the specifications of the original part (designation, manufacturer, model).

WARNING

A flat tire severely impairs the driving, steering and braking characteristics of the vehicle. There is a risk of accident.

Tires without run-flat characteristics:

- do not drive with a flat tire.
- immediately replace the flat tire with your emergency spare wheel or spare wheel, or consult a qualified specialist workshop.

Tires with run-flat characteristics:

- pay attention to the information and warning notices on MOExtended tires (tires with run-flat characteristics).

Accessories that are not approved for your vehicle by Mercedes-Benz or are not being used correctly can impair the operating safety.

Before purchasing and using non-approved accessories, visit a qualified specialist workshop and inquire about:

- suitability
- legal stipulations
- factory recommendations

Information on the dimensions and types of wheels and tires for your vehicle can be found in the "Wheel/tire combinations" section (▷ page 477).

Information on air pressure for the tires on your vehicle can be found:

- on the vehicle's Tire and Loading Information placard on the B-pillar
- on the tire pressure label on the fuel filler flap
- in the "Tire pressure" section

Pay special attention to the country-specific requirements for tire approval. These requirements can stipulate a specific tire type for your vehicle. Furthermore, the use of certain tire types in certain regions and areas of operation can be highly beneficial. You can find further information regarding tires at specialist tire retailers, at qualified specialist workshops or at any authorized Mercedes-Benz Center.

- i** Further information on wheels and tires can be obtained at any qualified specialist workshop.

Operation

Information on driving

- If the vehicle is heavily loaded, check the tire pressures and correct them if necessary.
- While driving, pay attention to vibrations, noises and unusual handling characteristics, e.g. pulling to one side. This may indicate that the wheels or tires are damaged. If you suspect that a tire is defective, reduce your speed immediately. Stop the vehicle as soon as possible to

check the wheels and tires for damage. Hidden tire damage could also be causing the unusual handling characteristics. If you find no signs of damage, have the tires and wheels checked at a qualified specialist workshop.

- When parking your vehicle, make sure that the tires do not get deformed by the curb or other obstacles. If it is necessary to drive over curbs, speed humps or similar elevations, try to do so slowly and at an obtuse angle. Otherwise, the tires, particularly the sidewalls, may be damaged.

Regular checking of wheels and tires

WARNING

Damaged tires can cause tire inflation pressure loss. As a result, you could lose control of your vehicle. There is a risk of accident.

Check the tires regularly for signs of damage and replace any damaged tires immediately.

Regularly check the wheels and tires of your vehicle for damage at least once a month, as well as after driving off-road or on rough roads. Damaged wheels can cause a loss of tire pressure. Pay particular attention to damage such as:

- cuts in the tires
- punctures
- tears in the tires
- bulges on tires
- deformation or severe corrosion on wheels

Regularly check the tire tread depth and the condition of the tread across the whole width of the tire (▷ page 455). If necessary, turn the front wheels to full lock in order to inspect the inner side of the tire surface.

All wheels must have a valve cap to protect the valve against dirt and moisture. Do not mount anything onto the valve other than the standard valve cap or other valve caps

approved by Mercedes-Benz for your vehicle. Do not use any other valve caps or systems, e.g. tire pressure monitoring systems.

Regularly check the pressure of all the tires particularly prior to long trips. Adjust the tire pressure as necessary (▷ page 458).

Observe the notes on the emergency spare wheel (▷ page 437).

The service life of tires depends on the following factors amongst other things:

- Driving style
- Tire pressure
- Distance covered

Important safety notes on the tire tread

WARNING

Insufficient tire tread will reduce tire traction. The tire is no longer able to dissipate water. This means that on wet road surfaces, the risk of hydroplaning increases, in particular where speed is not adapted to suit the driving conditions. There is a risk of accident.

If the tire pressure is too high or too low, tires may exhibit different levels of wear at different locations on the tire tread. Thus, you should regularly check the tread depth and the condition of the tread across the entire width of all tires.

Minimum tire tread depth for:

- Summer tires: $\frac{1}{8}$ in (3 mm)
- M+S tires: $\frac{1}{6}$ in (4 mm)

For safety reasons, replace the tires before the legally prescribed limit for the minimum tire tread depth is reached.

Treadwear indicators (TWI) are required by law. Six indicators are positioned on the tire tread. They are visible once the tread depth is approximately $\frac{1}{16}$ in (1.6 mm). If this is the case, the tire is so worn that it must be replaced.

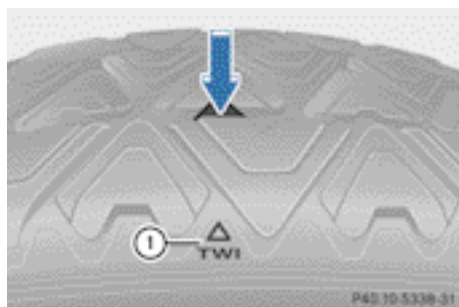

Bar indicator ① for tread wear is integrated into the tire tread.

Selecting, mounting and replacing tires

- Only mount tires and wheels of the same type and make.
Exception: it is permissible to install a different type or make in the event of a flat tire. Observe the "MOExtended tires (tires with run-flat characteristics)" section (> page 441).
- Only mount tires of the correct size onto the wheels.
- Break in new tires at moderate speeds for the first 60 miles (100 km). They only reach their full performance after this distance.
- Do not drive with tires which have too little tread depth, as this significantly reduces the traction on wet roads (hydroplaning).
- Replace the tires after six years at the latest, regardless of wear. This also applies to the spare wheel/emergency spare wheel.

The service life of tires depends on the following factors amongst other things:

- Driving style
- Tire pressure
- Distance covered

MOExtended tires (tires with run-flat properties)

MOExtended tires (tires with run-flat properties) allow you to continue driving your vehicle even if one or more tires are entirely deflated.

MOExtended tires may be used only in conjunction with the activated tire pressure loss warning system or the activated tire pressure monitor and only on wheels specifically tested by Mercedes-Benz.

Notes on driving with MOExtended tires in the event of a flat tire can be found in the "Breakdown assistance" section (> page 441).

Winter operation

Points to remember

Have your vehicle winterproofed at a qualified specialist workshop at the onset of winter. Observe the notes in the "Changing a wheel" section (> page 477).

Driving with summer tires

At temperatures below 45 °F (+7 °C), the elasticity of summer tires and therefore also the traction and braking capability are reduced considerably. Mount M+S tires on your vehicle. Using summer tires at very cold temperatures could cause cracks to form, thereby damaging the tires permanently. Mercedes-Benz cannot accept responsibility for this type of damage.

M+S tires

At temperatures below 45 °F (+7 °C), use winter tires or all-season tires. Both types of tire are identified by the M+S marking. Only winter tires bearing the  snowflake symbol in addition to the M+S marking provide the best possible grip in wintry road

conditions. Only these tires will allow driving safety systems such as ABS and ESP® to function optimally in winter. These tires have been developed specifically for driving in snow.

Use M+S tires of the same make and tread on all wheels to maintain safe handling characteristics.

WARNING

M+S tires with a tire tread depth of less than $\frac{1}{8}$ in (4 mm) are not suitable for use in winter and do not provide sufficient traction. There is a risk of an accident.

M+S tires with a tread depth of less than $\frac{1}{8}$ in (4 mm) must be replaced immediately.

Always observe the maximum permissible speed specified for the M+S tires you have mounted.

When you have mounted M+S tires:

- ▶ Check the tire pressures (▷ page 461).
- ▶ Restart the tire pressure monitor (▷ page 461).

After mounting a spare wheel or an emergency spare wheel, do not drive faster than 50 mph (80 km/h).

WARNING

The wheel or tire size as well as the tire type of the spare wheel or emergency spare wheel and the wheel to be replaced may differ. Mounting an emergency spare wheel may severely impair the driving characteristics. There is a risk of an accident.

To avoid hazardous situations:

- adapt your driving style accordingly and drive carefully.
- never mount more than one spare wheel or emergency spare wheel that differs in size.
- only use a spare wheel or emergency spare wheel of a different size briefly.
- do not switch ESP® off.
- have a spare wheel or emergency spare wheel of a different size replaced at the

nearest qualified specialist workshop. Observe that the wheel and tire dimensions as well as the tire type must be correct.

Snow chains

For safety reasons, Mercedes-Benz recommends that you only use snow chains that have been specially approved for your vehicle by Mercedes-Benz, or are of a corresponding standard of quality.

! You must drive at raised vehicle level if snow chains have been mounted. The vehicle could otherwise be damaged.

! On some tire sizes there is not enough space for snow chains. To avoid damage to the vehicle or tires, observe the "Wheel and tire combinations" section under "Tires and wheels".

If you intend to mount snow chains, please bear the following points in mind:

- Snow chains may not be mounted on all wheel/tire combinations. Permissible wheel-tire combinations (▷ page 477).
- Mount snow chains only in pairs and only on the rear wheels. Observe the manufacturer's mounting instructions.
- Only use snow chains when driving on roads completely covered by snow. Remove the snow chains as soon as possible when you come to a road that is not snow-covered.
- Local regulations may restrict the use of snow chains. Observe the appropriate regulations if you wish to mount snow chains.
- Do not exceed the maximum permissible speed of 30 mph (50 km/h).
- Snow chains may not be mounted on the emergency spare wheel.

! If snow chains are mounted on the front wheels, the snow chains could grind against the bodywork or components of the

chassis. This could result in damage to the vehicle or the tires.

! **Vehicles with steel wheels:** if you wish to mount snow chains on steel wheels, make sure that you remove the respective wheels' hubcaps first. The hubcaps may otherwise be damaged.

i You may wish to deactivate ESP® (▷ page 67) when pulling away with snow chains mounted. This way you can allow the wheels to spin in a controlled manner, achieving an increased driving force (cutting action).

Tire pressure

Tire pressure specifications

! WARNING

Tires with tire pressures that are too low or too high are associated with the following hazards:

- they can burst, in particular if the vehicle is heavily laden or when driven at high speeds.
- the tires can wear excessively and/or unevenly, which can severely impair tire traction.
- the driving, steering and braking characteristics may be severely impaired.

There is a risk of accident.

Follow recommended tire inflation pressures and check the pressure of all the tires including the spare wheel:

- monthly, at least
- if the load changes
- before beginning a long journey
- under different operating conditions, e.g. off-road driving

If necessary, correct the tire pressure.

The recommended tire pressures for the tires mounted at the factory can be found on the labels described here.

Option 1) **Tire and Loading Information placard** on the B-pillar on the driver's side of the vehicle (▷ page 464).

The Tire and Loading Information placard contains the recommended tire pressures for cold tires on a fully loaded vehicle and for the maximum permissible vehicle speed.

i The specifications given on the following Tire and Loading Information placard are examples. Tire pressure specifications are vehicle-specific and may deviate from the data shown here. The tire pressures applicable to your vehicle can be found on the Tire and Loading Information placard on your vehicle.

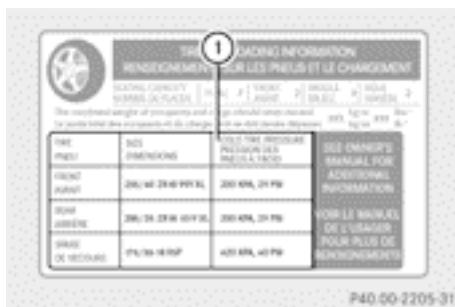

① Recommended tire pressures

Option 2) **Tire pressure table** on the inside of the fuel filler flap.

The tire pressure table contains the recommended pressures for cold tires for various operating conditions, i.e. differing load and speed conditions.

i Specifications shown in the examples of tire pressure tables are for illustration purposes only. Tire pressure specifications are vehicle-specific and may deviate from the data shown here. Tire pressure specifications applicable to your vehicle are located in your vehicle's tire pressure table.

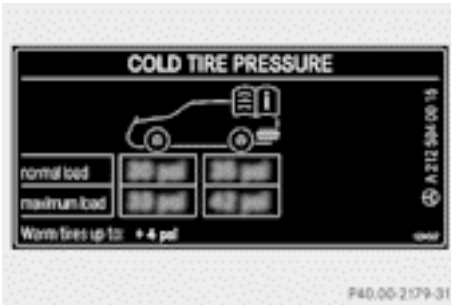

Example: tire pressure table for all tires permitted for this vehicle by the factory

If a tire size precedes a tire pressure, the tire pressure information following is only valid for that tire size. The load conditions "partially laden" and "fully laden" are defined in the table for different numbers of occupants and amounts of luggage. The actual number of seats may differ.

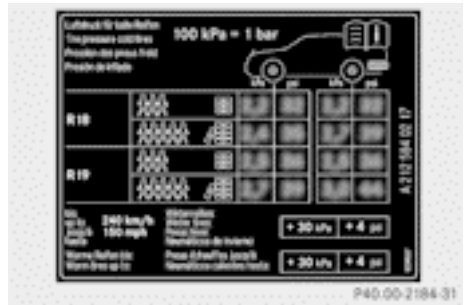

If the tire pressures have been set to the lower values for lighter loads and/or lower road speeds, the pressures should be reset to the higher values:

- if you want to drive with an increased load and/or
- if you want to drive at higher road speeds.

i The tire pressures for increased loads and/or higher road speeds, shown in the tire pressure table, may have a negative effect on driving comfort.

Option 3) The **tire pressure for the emergency/collapsible spare wheel** (depending on vehicle equipment) can be found:

- printed in yellow on the rim of the emergency/collapsible spare wheel
- in the "Wheel and tire combinations" section (▷ page 477) in this Operator's Manual
- on the Tire and Loading Information placard on the B-pillar on the driver's side.

If the tire pressure is not set correctly, this can lead to an excessive build up of heat and a sudden loss of pressure.

For more information, contact a qualified specialist workshop.

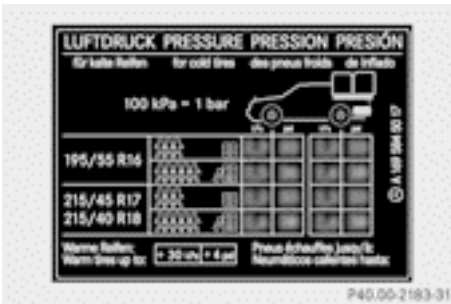

Example: tire pressure table with tire dimensions

Some tire pressure tables show only the rim diameters instead of the full tire size, e.g.

R18. The rim diameter is part of the tire size and can be found on the tire sidewall (▷ page 471).

Important notes on tire pressure

⚠ WARNING
If the tire pressure drops repeatedly, the wheel, valve or tire may be damaged. Tire

pressure that is too low may result in a tire blow-out. There is a risk of an accident.

- Check the tire for foreign objects.
- Check whether the wheel is losing air or the valve is leaking.

If you are unable to rectify the damage, contact a qualified specialist workshop.

WARNING

If you fit unsuitable accessories onto tire valves, the tire valves may be overloaded and malfunction, which can cause tire pressure loss. Due to their design, retrofitted tire pressure monitors keep the tire valve open. This can also result in tire pressure loss. There is a risk of an accident.

Only screw the standard valve cap or other valve caps approved by Mercedes-Benz for your vehicle onto the tire valve.

To test tire pressure, use a suitable tire pressure gauge. The outer appearance of a tire does not permit any reliable conclusion about the tire pressure. On vehicles equipped with the electronic tire pressure monitoring system, the tire pressure can be checked using the on-board computer.

The tire temperature and pressure increase when the vehicle is in motion. This is dependent on the driving speed and the load. Therefore, you should only correct tire pressures when the tires are cold.

The tires are cold:

- if the vehicle has been parked without direct sunlight on the tires for at least three hours and
- if the vehicle has not been driven further than 1 mile (1.6 km)

The tire temperature changes depending on the outside temperature, the vehicle speed and the tire load. If the tire temperature changes by 18 °F (10 °C), the tire pressure changes by approximately 10 kPa (0.1 bar/ 1.5 psi). Take this into account when checking the pressure of warm tires and only correct the tire pressure if it is too low for the

current operating conditions. If you check the tire pressure when the tires are warm, the resulting value will be higher than if the tires were cold. This is normal. Do not reduce the tire pressure to the value specified for cold tires. The tire pressure would otherwise be too low.

Observe the recommended tire pressures for cold tires:

- on the Tire and Loading Information placard on the B-pillar on the driver's side
- in the tire pressure table on the inside of the fuel filler flap
- printed in yellow on the rim of the emergency/collapsible spare wheel (depending on vehicle equipment)

Underinflated or overinflated tires

Underinflation

WARNING

Tires with pressure that is too low can overheat and burst as a consequence. In addition, they also suffer from excessive and/ or irregular wear, which can severely impair the braking properties and the driving characteristics. There is a risk of an accident. Avoid tire pressures that are too low in all the tires, including the spare wheel.

Underinflated tires may:

- wear quickly and unevenly
- have an adverse effect on fuel consumption
- overheat, leading to tire defects
- have an adverse effect on handling characteristics

Overinflation

WARNING

Tires with excessively high pressure can burst because they are damaged more easily by road debris, potholes etc. In addition, they also suffer from irregular wear, which can

severely impair the braking properties and the driving characteristics. There is a risk of an accident.

Avoid tire pressures that are too high in all the tires, including the spare wheel.

Overinflated tires may:

- have an adverse effect on handling characteristics
- wear quickly and unevenly
- be more susceptible to damage
- have an adverse effect on ride comfort
- increase the braking distance

Maximum tire pressures

Never exceed the maximum permissible tire inflation pressure. Always observe the recommended tire pressure for your vehicle when adjusting the tire pressure (▷ page 458).

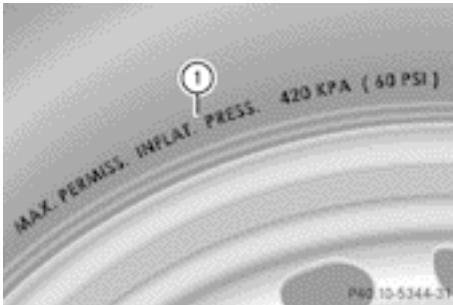

① Example: maximum permissible tire pressure

i The actual values for tires are vehicle-specific and may deviate from the values in the illustration.

Checking the tire pressures

Important safety notes

Observe the "Tire pressure information" section (▷ page 458).

Information on air pressure for the tires on your vehicle can be found:

- on the vehicle's Tire and Loading Information placard on the B-pillar
- on the tire pressure label on the fuel filler flap
- in the "Tire pressure information" section

Checking tire pressures manually

To determine and set the correct tire pressure, proceed as follows:

- ▶ Remove the valve cap of the tire that is to be checked.
- ▶ Press the tire pressure gauge securely onto the valve.
- ▶ Read the tire pressure and compare it with the recommended value on the Tire and Loading Information placard on the B-pillar on the driver's side of your vehicle.
- ▶ If necessary, increase the tire pressure to the recommended value (▷ page 458).
- ▶ If the tire pressure is too high, release air by pressing down the metal pin in the valve using the tip of a pen, for example. Then check the tire pressure again using the tire pressure gauge.
- ▶ Screw the valve cap onto the valve.
- ▶ Repeat these steps for the other tires.

Tire Pressure Monitor

General notes

If a tire pressure monitor is installed, the vehicle's wheels have sensors that monitor the tire pressures in all four tires. The tire pressure monitor warns you if the pressure drops in one or more of the tires. The tire pressure monitor only functions if the correct sensors are installed to all wheels.

Information on tire pressures is displayed in the multifunction display. After a few minutes of driving, the current tire pressure of each tire is shown in the **Serv** menu of the

multifunction display. For further information on displaying this message, refer to the "Checking the tire pressure electronically" section (▷ page 463).

Important safety notes

WARNING

Each tire, including the spare (if provided), should be checked at least once a month when cold and inflated to the pressure recommended by the vehicle manufacturer on the Tire and Loading Information placard on the driver's door B-pillar or the tire pressure label on the inside of the fuel filler flap. If your vehicle has tires of a different size than the size indicated on the Tire and Loading Information placard or the tire pressure label, you should determine the proper tire pressure for those tires.

As an added safety feature, your vehicle has been equipped with a tire pressure monitoring system (TPMS) that illuminates a low tire pressure telltale when one or more of your tires are significantly underinflated.

Accordingly, when the low tire pressure telltale illuminates, you should stop and check your tires as soon as possible, and inflate them to the proper pressure. Driving on a significantly underinflated tire causes the tire to overheat and can lead to tire failure.

Underinflation also reduces fuel efficiency and tire tread life, and may affect the vehicle's handling and stopping ability.

Please note that the TPMS is not a substitute for proper tire maintenance, and it is the driver's responsibility to maintain correct tire pressure, even if underinflation has not reached the level to trigger illumination of the TPMS low tire pressure telltale.

USA only:

Your vehicle has also been equipped with a TPMS malfunction indicator to indicate if the system is not operating properly. The TPMS malfunction indicator is combined with the low tire pressure telltale. When the system detects a malfunction, the warning lamp will

flash for approximately a minute and then remain continuously illuminated. This sequence will be repeated every time the vehicle is started as long as the malfunction exists.

When the malfunction indicator is illuminated, the system may not be able to detect or signal low tire pressure as intended. TPMS malfunctions may occur for a variety of reasons, including the installation of incompatible replacement or alternate tires or wheels on the vehicle that prevent the TPMS from functioning properly. Always check the TPMS malfunction telltale after replacing one or more tires or wheels on your vehicle to ensure that the replacement or alternate tires and wheels allow the TPMS to continue to function properly.

It is the driver's responsibility to set the tire pressure to that recommended for cold tires which is suitable for the operating situation (▷ page 458). Note that the correct tire pressure for the current operating situation must first be taught-in to the tire pressure monitor. If there is a substantial loss of pressure, the warning threshold for the warning message is aligned to the reference values taught-in. Restart the tire pressure monitor after adjusting the pressure of the cold tires (▷ page 464). The current pressures are saved as new reference values. As a result, a warning message will appear if the tire pressure drops significantly.

The tire pressure monitor does not warn you of an incorrectly set tire pressure. Observe the notes on the recommended tire pressure (▷ page 458).

The tire pressure monitor is not able to warn you of a sudden loss of pressure, e.g. if the tire is penetrated by a foreign object. In the event of a sudden loss of pressure, bring the vehicle to a halt by braking carefully. Avoid abrupt steering maneuvers.

The tire pressure monitor has a yellow warning lamp in the instrument cluster for indicating pressure loss/malfunctions (USA) or pressure loss (Canada). Whether the warning lamp flashes or lights up indicates whether a tire pressure is too low or the tire pressure monitor is malfunctioning:

- if the warning lamp is lit continuously, the tire pressure on one or more tires is significantly too low. The tire pressure monitor is not malfunctioning.
- USA only: if the warning lamp flashes for around a minute and then remains lit constantly, the tire pressure monitor is malfunctioning.





i USA only:

If the tire pressure monitor is malfunctioning, it may take more than ten minutes for the tire pressure warning lamp to inform you of the malfunction by flashing for approximately one minute and then remaining lit.

When the malfunction has been rectified, the tire pressure warning lamp goes out after a few minutes of driving.

- i** The tire pressure values indicated by the on-board computer may differ from those measured at a gas station with a pressure gauge. The tire pressures shown by the on-board computer refer to those measured at sea level. At high altitudes, the tire pressure values indicated by a pressure gauge are higher than those shown by the on-board computer. In this case, do not reduce the tire pressures.
- i** The operation of the tire pressure monitor can be affected by interference from radio transmitting equipment (e.g. radio headphones, two-way radios) that may be being operated in or near the vehicle.

Checking the tire pressure electronically

- ▶ Make sure that the SmartKey is in position **2** in the ignition lock (▷ page 273).
- ▶ Press the  or  button on the steering wheel to select the **Service** menu.
- ▶ Press the  or  button to select **Tire Pressure**.
- ▶ Press the  button.

The current tire pressure of each tire is shown in the multifunction display.

If the vehicle has been parked for longer than 20 minutes, the **Tire pressure displayed after driving a few minutes** message appears.

After a teach-in process, the tire pressure monitor automatically detects new wheels or new sensors. As long as a clear allocation of the tire pressure value to the individual wheels is not possible, the **Tire Pressure Monitor Active** display message is shown instead of the tire pressure display. The tire pressures are already being monitored.

- i** If a spare wheel/emergency spare wheel is mounted, the system may continue to show the tire pressure of the wheel that has been removed for a few minutes. If this occurs, note that the value displayed for the position where the spare tire is mounted is not the same as the spare wheel/emergency spare wheel's current tire pressure.

Tire pressure monitor warning messages

If the tire pressure monitor detects a significant pressure loss on one or more tires, a warning message is shown in the multifunction display. A warning tone also sounds and the tire pressure warning lamp lights up in the instrument cluster.

Each tire that is affected by a significant loss of pressure is highlighted with a color.

If the **Tire Pressure(s) Please Correct** message appears in the multifunction display:

- ▶ Check the tire pressure on all four wheels and correct it if necessary.

i If the wheel positions on the vehicle are rotated, the tire pressures may be displayed for the wrong positions for a short time. This is rectified after a few minutes of driving, and the tire pressures are displayed for the correct positions.

Restarting the tire pressure monitor







When you restart the tire pressure monitor, all existing warning messages are deleted and the warning lamps go out. The monitor uses the currently set tire pressures as the reference values for monitoring.

The tire pressure monitor must be restarted when you set the tire pressure to a new value (as a result of changed drive or load characteristics, for example). The tire pressure monitor then monitors the new tire pressure values.

i Canada only: in most cases, the tire pressure monitor recognizes the new reference values automatically. However, you can also define reference values manually as described here.

Restart the tire pressure monitor after you have set the tire pressure to the value recommended for the desired driving situation (▷ page 458). Only correct tire pressures on cold tires. Comply with the recommended tire pressures on the Tire and Loading Information placard the B-pillar on the driver's side. Additional tire pressure values for driving at high speeds or with heavy loads can be found in the tire pressure table on the inside of the fuel filler flap.

- ▶ Make sure that the tire pressure is correct on all four wheels.
- ▶ Make sure that the SmartKey is in position **2** in the ignition lock.

- ▶ Press the  or  button on the steering wheel to select the **Service** menu.
- ▶ Press the  or  button to select **Tire Pressure**.
- ▶ Press the  button.
The multifunction display shows the current tire pressure of the individual tires or the **Tire pressure displayed after driving a few minutes** message.
- ▶ Press the  button.
The **Use Current Pressures as New Reference Values** message appears in the multifunction display.

If you wish to confirm the restart:

- ▶ Press the  button.
The **Tire Pressure Monitor Restarted** message appears in the multifunction display.

After driving for a few minutes, the system checks whether the current tire pressures are within the specified range. The new tire pressures are then accepted as reference values and monitored.

If you wish to cancel the restart:

- ▶ Press the  button.
The tire pressure values stored at the last restart will continue to be monitored.

Loading the vehicle

Instruction labels for tires and loads

WARNING

Overloaded tires can overheat, causing a blowout. Overloaded tires can also impair the steering and driving characteristics and lead to brake failure. There is a risk of accident.

Observe the load rating of the tires. The load rating must be at least half of the GAWR of your vehicle. Never overload the tires by exceeding the maximum load.

Two instruction labels on your vehicle show the maximum possible load.

- (1) The Tire and Loading Information placard is on the B-pillar on the driver's side. The Tire and Loading Information placard shows the maximum permissible number of occupants and the maximum permissible vehicle load. It also contains details of the tire sizes and corresponding pressures for tires installed at the factory.
- (2) The vehicle identification plate is on the B-pillar on the driver's side. The vehicle identification plate informs you of the gross vehicle weight rating. It is made up of the vehicle weight, all vehicle occupants, the fuel and the cargo. You can also find information about the maximum gross axle weight rating on the front and rear axle.

The maximum gross axle weight rating is the maximum weight that can be carried by one axle (front or rear axle). Never exceed the maximum load or the maximum gross axle weight rating for the front or rear axle.

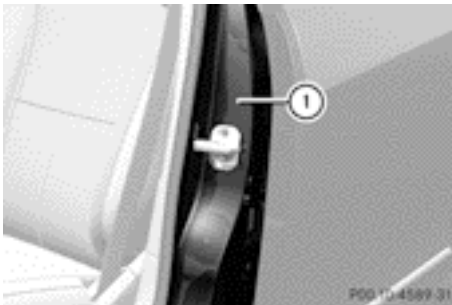

① B-pillar, driver's side

Maximum permissible load

① The specifications shown on the Tire and Loading Information placard in the illustration are examples. The maximum permissible load is vehicle-specific and may deviate from the data shown here. The

maximum permissible load that applies for your vehicle can be found on your vehicle's Tire and Loading Information placard.

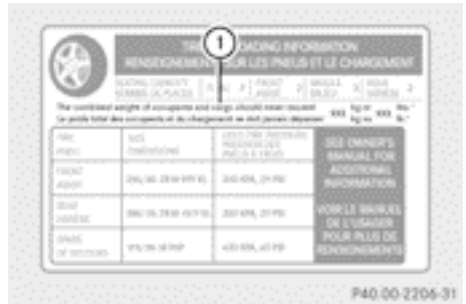

► Specification for maximum permissible load ① is listed on the Tire and Loading Information placard: "The gross weight of occupants and luggage must not exceed XXX kg or XXX lbs."

The gross weight of all vehicle occupants, load, luggage and trailer load/noseweight (if applicable) must not exceed the specified value.

Number of seats

① The specifications shown on the Tire and Loading Information placard in the illustration are examples. The number of seats is vehicle-specific and can differ from the details shown. The number of seats in your vehicle can be found on the Tire and Loading Information placard.

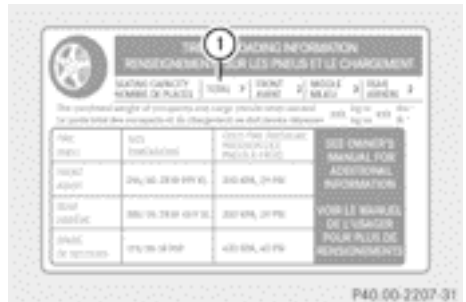

Maximum number of seats ① determines the maximum number of occupants allowed to

travel in the vehicle. This information can be found on the Tire and Loading Information placard.

Determining the correct load limit

Step-by-step instructions

The following steps have been developed as required of all manufacturers under Title 49, Code of U.S. Federal Regulations, Part 575 pursuant to the "National Traffic and Motor Vehicle Safety Act of 1966".

- ▶ **Step 1:** Locate the statement "The combined weight of occupants and cargo should never exceed XXX kg or XXX lbs." on your vehicle's Tire and Loading Information placard.
- ▶ **Step 2:** Determine the combined weight of the driver and passengers that will be riding in your vehicle.
- ▶ **Step 3:** Subtract the combined weight of the driver and passengers from XXX kilograms or XXX lbs.
- ▶ **Step 4:** The resulting figure equals the available amount of cargo and luggage load capacity. For example, if the "XXX" amount equals 1400 lbs and there will be five 150 lbs passengers in your vehicle, the amount of available cargo and luggage load capacity is 650 lbs (1 400 - 750 (5 x 150) = 650 lbs).
- ▶ **Step 5:** Determine the combined weight of luggage and cargo being loaded on the vehicle. That weight may not safely exceed the available cargo and luggage load capacity calculated in step 4.
- ▶ **Step 6 (if applicable):** If your vehicle will be towing a trailer, load from your trailer will be transferred to your vehicle. Consult this manual to determine how this reduces the available cargo and luggage load capacity of your vehicle (▶ page 468).

Example: steps 1 to 3

The following table shows examples on how to calculate total and cargo load capacities with varying seating configurations and number and size of occupants. The following examples use a load limit of 1 500 lbs (680 kg). **This is for illustration purposes only.** Make sure you are using the actual load limit for your vehicle stated on your vehicle's Tire and Loading Information placard (▷ page 465).

		Example 1	Example 2	Example 3
Step 1	Combined maximum weight of occupants and cargo (data from the Tire and Loading Information placard)	1500 lbs (680 kg)	1500 lbs (680 kg)	1500 lbs (680 kg)

		Example 1	Example 2	Example 3
Step 2	Number of people in the vehicle (driver and occupants)	5	3	1
	Distribution of the occupants	Front: 2 Rear: 3	Front: 1 Rear: 2	Front: 1
	Weight of the occupants	Occupant 1: 150 lbs (68 kg) Occupant 2: 180 lbs (82 kg) Occupant 3: 160 lbs (73 kg) Occupant 4: 140 lbs (63 kg) Occupant 5: 120 lbs (54 kg)	Occupant 1: 200 lbs (91 kg) Occupant 2: 190 lbs (86 kg) Occupant 3: 150 lbs (68 kg)	Occupant 1: 150 lbs (68 kg)
	Gross weight of all occupants	750 lbs (340 kg)	540 lbs (245 kg)	150 lbs (68 kg)

		Example 1	Example 2	Example 3
Step 3	Permissible load and trailer load/ noseweight (maximum permissible load rating from the Tire and Loading Information placard minus the gross weight of all occupants)	1500 lbs (680 kg) - 750 lbs (340 kg) = 750 lbs (340 kg)	1500 lbs (680 kg) - 540 lbs (245 kg) = 960 lbs (435 kg)	1500 lbs (680 kg) - 150 lbs (68 kg) = 1350 lbs (612 kg)

The higher the weight of all the occupants, the smaller the maximum load for luggage. Further information can be found under "Towing a trailer" (> page 468).

Vehicle identification plate

Even if you have calculated the total load carefully, you should still make sure that the gross vehicle weight rating and the gross axle weight rating are not exceeded. Details can be found on the vehicle identification plate on the B-pillar on the driver's side of the vehicle (> page 464).

Permissible gross vehicle weight: the gross weight of the vehicle, all passengers, load and trailer load/noseweight (if applicable) must not exceed the permissible gross vehicle weight.

Gross axle weight rating: the maximum permissible weight that can be carried by one axle (front or rear axle).

To ensure that your vehicle does not exceed the maximum permissible values (gross vehicle weight and maximum gross axle weight rating), have your loaded vehicle (including driver, occupants, cargo, and full trailer load if applicable) weighed on a suitable vehicle weighbridge.

Trailer load/noseweight

The trailer load/noseweight affects the gross weight of the vehicle. If a trailer is attached,

the trailer load/noseweight is included in the load along with occupants and luggage. The trailer load/noseweight is usually approximately 10% of the gross weight of the trailer and its load.

Your Mercedes-Benz has been designed primarily to carry passengers and their luggage. Mercedes-Benz does not recommend towing a trailer with your vehicle.

Maximum load rating

Do not overload the tires by exceeding the specified load limit. The maximum permissible load can be found on the vehicle's Tire and Loading Information placard on the B-pillar on the driver's side (> page 464).

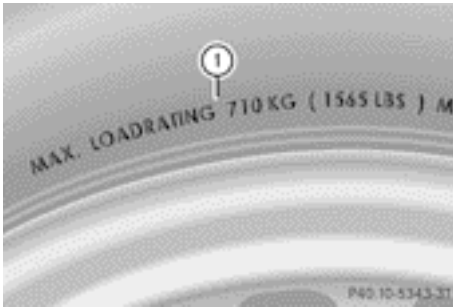

i The actual values for tires are vehicle-specific and may deviate from the values in the illustration.

Maximum tire load ① is the maximum permissible weight for which the tire is approved.

Uniform Tire Quality Grading Standards

Overview of Tire Quality Grading Standards

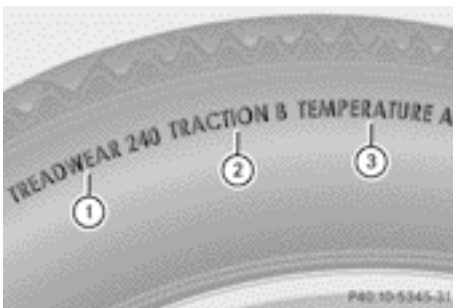

Uniform Tire Quality Grading Standards are U.S. government specifications. Their purpose is to provide drivers with uniform reliable information on tire performance data. Tire manufacturers have to grade tires using three performance factors: tread wear ①, tire traction ②, and heat resistance ③. All tires sold in North America are provided with the corresponding quality class mark on the sidewall of the tire, even though these regulations do not apply to Canada.

i The actual values for tires are vehicle-specific and may deviate from the values in the illustration.

Where applicable, the tire grading information can be found on the tire sidewall between the tread shoulder and maximum tire width.

For example:

Tread wear	Traction	Temperature
200	AA	A

All passenger car tires must conform to the statutory safety requirements in addition to these grades.

Tread wear

The tread wear grade is a comparative rating based on the wear rate of the tire when tested under controlled conditions on a specified U.S. government course. For example, a tire graded 150 would wear one and one-half times as well on the government course as a tire graded 100.

The relative performance of tires depends upon the actual conditions of their use, however, and may depart significantly from the norm, due to variations in driving habits, service practices and differences in road characteristics and climate conditions.

Traction

⚠ WARNING

The traction grade assigned to this tire is based on straight-ahead braking traction tests, and does not include acceleration, cornering, hydroplaning, or peak traction characteristics.

The traction grades, from highest to lowest, are AA, A, B, and C. Those grades represent the tire's ability to stop on a wet surface as measured under controlled conditions on

specified government test surfaces of asphalt and concrete. A tire marked C may have poor traction performance.

The safe speed on a wet, snow covered or icy road is always lower than on dry road surfaces.

You should pay special attention to road conditions when temperatures are around the freezing point.

Mercedes-Benz recommends a minimum tread depth of $\frac{1}{8}$ in (4 mm) for all four winter tires (▷ page 456) to maintain normal driving characteristics in winter. Winter tires can reduce the braking distance on snow-covered surfaces in comparison with summer tires. Stopping distance, however, is still considerably greater than when the road is not covered with ice or snow. Take appropriate care when driving.

! Avoid wheelspin. This can lead to damage to the drive train.

represent higher levels of performance on the laboratory test wheel than the minimum required by law.

Tire labeling

Overview of tire labeling

The following markings are on the tire in addition to the tire name (sales designation) and the manufacturer's name:

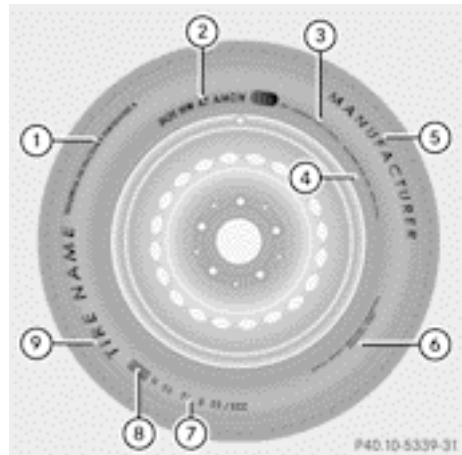

- ① Uniform tire Quality Grading Standard (▷ page 474)
 - ② DOT, Tire Identification Number (▷ page 473)
 - ③ Maximum tire load (▷ page 468)
 - ④ Maximum tire pressure (▷ page 46 1)
 - ⑤ Manufacturer
 - ⑥ Tire material (▷ page 474)
 - ⑦ Tire size designation, load-bearing capacity and speed rating (▷ page 471)
 - ⑧ Load index (▷ page 473)
 - ⑨ Tire name
- i** Tire data is vehicle-specific and may deviate from the data in the example.

Temperature

⚠ WARNING

The temperature grade for this tire is established for a tire that is properly inflated and not overloaded. Excessive speed, underinflation, or excessive loading, either separately or in combination, can cause excessive heat build-up and possible tire failure.

The temperature grades are A (the highest), B, and C. These represent the tire's resistance to the generation of heat and its ability to dissipate heat when tested under controlled conditions on a specified indoor laboratory test wheel. Sustained high temperature can cause the material of the tire to degenerate and reduce tire life, and excessive temperature can lead to sudden tire failure. The grade C corresponds to a level of performance which all passenger car tires must meet under the Federal Motor Vehicle Safety Standard No. 109. Grades B and A

Tire size designation, load-bearing capacity and speed rating

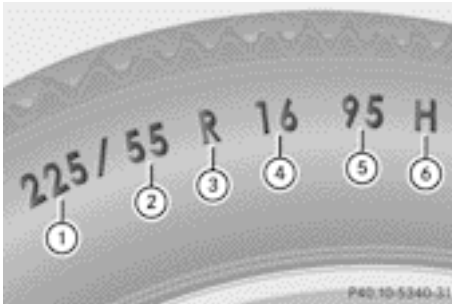

- ① Tire width
 - ② Nominal aspect ratio in %
 - ③ Tire code
 - ④ Rim diameter
 - ⑤ Load bearing index
 - ⑥ Speed rating
- i** Tire data is vehicle-specific and may deviate from the data in the example.

General: depending on the manufacturer's standards, the size imprinted in the tire wall may not contain any letters or may contain one letter that precedes the size description. If there is no letter preceding the size description (as shown above): these are passenger vehicle tires according to European manufacturing standards. If "P" precedes the size description: these are passenger vehicle tires according to U.S. manufacturing standards.

If "LT" precedes the size description: these are light truck tires according to U.S. manufacturing standards.

If "T" precedes the size description: these are compact emergency spare wheels at high tire pressure, to be used only temporarily in an emergency.

Tire width: tire width ① shows the nominal tire width in millimeters.

Height-width ratio: aspect ratio ② is the size ratio between the tire height and tire width and is shown in percent. The aspect

ratio is calculated by dividing the tire width by the tire height.

Tire code: tire code ③ specifies the tire type. "R" represents radial tires; "D" represents diagonal tires; "B" represents diagonal radial tires.

Optionally, tires with a maximum speed of over 149mph (240km/h) may have "ZR" in the size description, depending on the manufacturer (e.g. 245/40 ZR 18).

Rim diameter: rim diameter ④ is the diameter of the bead seat, not the diameter of the rim flange. The rim diameter is specified in inches (in).

Load-bearing index: load-bearing index ⑤ is a numerical code that specifies the maximum load-bearing capacity of a tire.

Do not overload the tires by exceeding the specified load limit. The maximum permissible load can be found on the vehicle's Tire and Loading Information placard on the B-pillar on the driver's side (▷ page 464).

Example:

A load-bearing index of 91 indicates a maximum load of 1,356lb (615kg) that can be carried by the tires. For further information on the maximum tire load in kilograms and pounds, see (▷ page 468).

For further information on the load-bearing index, see Load index (▷ page 473).

Speed rating: speed rating ⑥ specifies the approved maximum speed of the tire.

WARNING

Exceeding the stated tire load-bearing capacity and the approved maximum speed could lead to tire damage or the tire bursting. There is a risk of accident.

Therefore, only use tire types and sizes approved for your vehicle model. Observe the tire load rating and speed rating required for your vehicle.

Regardless of the speed rating, always observe the speed limits. Drive carefully and

adapt your driving style to the traffic conditions.

Summer tires	
Index	Speed rating
Q	up to 100mph (160 km/h)
R	up to 106mph (170 km/h)
S	up to 112mph (180 km/h)
T	up to 118mph (190 km/h)
H	up to 130mph (210 km/h)
V	up to 149mph (240 km/h)
W	up to 168mph (270 km/h)
Y	up to 186mph (300 km/h)
ZR...Y	up to 186mph (300 km/h)
ZR...(..Y)	over 186mph (300 km/h)
ZR	over 149mph (240 km/h)

- Optionally, tires with a maximum speed of over 149 mph (240km/h) may have "ZR" in the size description, depending on the manufacturer (e.g. 245/40 ZR 18).

The service specification is made up of load-bearing index (5) and speed rating (6).

- If the size description of your tire includes "ZR" and there are no service specifications, ask the tire manufacturer in order to find out the maximum speed.

If a service specification is available, the maximum speed is limited according to the speed rating in the service specification. Example: 245/40 ZR 18 97 Y. In this example, "97 Y" is the service specification. The letter "Y" represents the speed rating and the maximum speed of the tire is limited to 186 mph (300km/h).

- The size description for all tires with maximum speeds of over 186mph

(300km/h) must include "ZR", **and** the service specification must be given in brackets. Example: 275/40 ZR 18 (99 Y). The speed rating "Y" indicates that the maximum speed of the tire is over 186mph (300km/h). Ask the tire manufacturer about the maximum speed.

All-weather tires and winter tires

Index	Speed rating
Q M+S ²⁰	up to 100mph (160 km/h)
T M+S ²⁰	up to 118mph (190 km/h)
H M+S ²⁰	up to 130mph (210 km/h)
V M+S ²⁰	up to 149mph (240 km/h)

- i** Not all tires with the M+S marking provide the driving characteristics of winter tires. In addition to the M+S marking, winter tires also have the  snowflake symbol on the tire wall. Tires with this marking fulfill the requirements of the Rubber Manufacturers Association (RMA) and the Rubber Association of Canada (RAC) regarding snow traction, and were specially developed for driving on snow.

An electronic speed limiter prevents your vehicle from exceeding the following speeds:

- 130 mph (210 km/h):
 - all vehicles (except AMG vehicles)
- 155 mph (250 km/h):
 - CL 63 AMG
 - CL 65 AMG
- 186 mph (300 km/h):
 - CL 63 AMG (Performance Package)
 - CL 63 AMG with increased top speed
 - CL 65 AMG with increased top speed

The speed rating of tires mounted at the factory may be higher than the maximum speed that the electronic speed limiter permits.

²⁰ Or M+S  for winter tires.

Make sure that your tires have the required speed rating for your vehicle as specified in the "Tires" section (▷ page 477), e.g. if you buy new tires.

Further information about reading tire data can be obtained from any qualified specialist workshop.

Load index



i Tire data is vehicle-specific and may deviate from the data in the example.

In addition to the load bearing index, load index **①** may be imprinted after the letters that identify speed rating **⑥** (▷ page 471) on the sidewall of the tire.

- If no specification is given: no text (as in the example above), represents a standard load (SL) tire
- XL or Extra Load: represents a reinforced tire
- Light load: represents a light load tire
- C, D, E: represents a load range that depends on the maximum load that the tire can carry at a certain pressure

DOT, Tire Identification Number (TIN)

U.S. tire regulations prescribe that every manufacturer of new tires or retreader has to imprint a TIN in or on the sidewall of each tire produced.

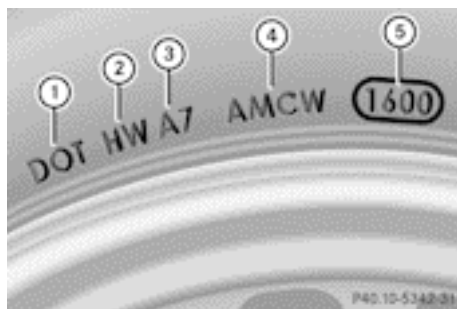

The TIN is a unique identification number. The TIN enables the tire manufacturers to inform purchasers of recalls and other safety-relevant matters. It makes it possible for the purchaser to easily identify the affected tires. The TIN is made up of manufacturer identification code **②**, tire size **③**, tire type code **④** and manufacturing date **⑤**.

i Tire data is vehicle-specific and may deviate from the data in the example.

DOT (Department of Transportation): tire symbol **①** indicates that the tire complies with the requirements of the U.S. Department of Transportation.

Manufacturer identification code: manufacturer identification code **②** provides details on the tire manufacturer. New tires have a code with two symbols. Retreaded tires have a code with four symbols.

Further information about retreaded tires (▷ page 454).

Tire size: identifier **③** describes the tire size.

Tire type code: tire type code **④** can be used by the manufacturer as a code to describe specific characteristics of the tire.

Date of manufacture: date of manufacture **⑤** provides information about the age of a tire. The first and second positions represent the week of manufacture, starting with "01" for the first calendar week. Positions three and four represent the year of manufacture. For example, a tire that is marked with "3208", was manufactured in week 32 in 2008.

Tire characteristics

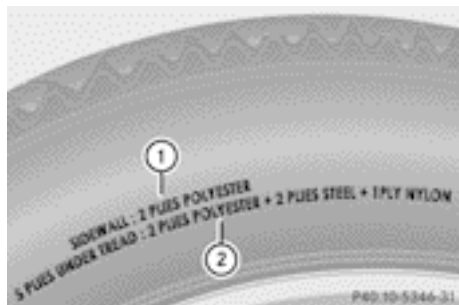

- i** Tire data is vehicle-specific and may deviate from the data in the example.

This information describes the tire cord and the number of layers in sidewall ① and under the tread ②.

Definition of terms for tires and loading

Tire ply composition and material used

Describes the number of plies or the number of layers of rubber-coated fabric in the tire tread and sidewall. These are made of steel, nylon, polyester and other materials.

Bar

Metric unit for tire pressure. 14.5038 pounds per square inch (psi) and 100 kilopascals (kPa) are the equivalent of 1 bar.

DOT (Department of Transportation)

DOT marked tires fulfill the requirements of the United States Department of Transportation.

Normal occupant weight

The number of occupants the vehicle is designed to seat, multiplied by 68 kilograms (150 lb).

Uniform Tire Quality Grading Standards

A uniform standard to grade the quality of tires with regards to tread quality, tire traction and temperature characteristics. Ratings are determined by tire manufacturers using U.S. government testing procedures. The ratings are molded into the sidewall of the tire.

Recommended tire pressure

The recommended tire pressure applies to the tires mounted at the factory.

The Tire and Loading Information placard contains the recommended tire pressures for cold tires on a fully loaded vehicle and for the maximum permissible vehicle speed.

The tire pressure table contains the recommended pressures for cold tires for various operating conditions, i.e. differing load and speed conditions.

Increased vehicle weight due to optional equipment

This is the combined weight of all standard and optional equipment available for the vehicle, regardless of whether it is actually installed on the vehicle or not.

Rim

This is the part of the wheel on which the tire is mounted.

GAWR (Gross Axle Weight Rating)

The GAWR is the maximum permissible axle load. The actual load on an axle must never exceed the gross axle weight rating. The gross axle weight rating can be found on the vehicle identification plate on the B-pillar on the driver's side.

Speed rating

The speed rating is part of the tire identification. It specifies the speed range for which the tire is approved.

GVW (Gross Vehicle Weight)

The gross vehicle weight includes the weight of the vehicle including fuel, tools, the spare wheel, accessories installed, occupants, luggage and the drawbar noseweight, if applicable. The gross vehicle weight must not exceed the gross vehicle weight rating GVWR as specified on the vehicle identification plate on the B-pillar on the driver's side.

GVWR (Gross Vehicle Weight Rating)

The GVWR is the maximum permissible gross weight of a fully loaded vehicle (the weight of the vehicle including all accessories, occupants, fuel, luggage and the drawbar noseweight, if applicable). The gross vehicle weight rating is specified on the vehicle identification plate on the B-pillar on the driver's side.

Maximum loaded vehicle weight

The maximum weight is the sum of the curb weight of the vehicle, the weight of the accessories, the total load limit and the weight of the optional equipment installed at the factory.

Kilopascal (kPa)

Metric unit for tire pressure. 6.9 kPa corresponds to 1 psi. Another unit for tire pressure is bar. There are 100 kilopascals (kPa) to 1 bar.

Load index

In addition to the load-bearing index, the load index may also be imprinted on the sidewall of the tire. This specifies the load-bearing capacity more precisely.

Curb weight

The weight of a vehicle with standard equipment including the maximum capacity of fuel, oil and coolant. It also includes the air-conditioning system and optional equipment if these are installed in the vehicle, but does not include passengers or luggage.

Maximum load rating

The maximum load rating in kilograms or pounds is the maximum weight for which a tire is approved.

Maximum permissible tire pressure

Maximum permissible tire pressure for one tire.

Maximum load on one tire

Maximum load on one tire. This is calculated by dividing the maximum axle load of one axle by two.

PSI (pounds per square inch)

A standard unit of measure for tire pressure.

Aspect ratio

Relationship between tire height and tire width in percent.

Tire pressure

This is pressure inside the tire applying an outward force to each square inch of the tire's surface. The tire pressure is specified in pounds per square inch (psi), in kilopascal (kPa) or in bar. The tire pressure should only be corrected when the tires are cold.

Tire pressure of cold tires

The tires are cold:

- if the vehicle has been parked without direct sunlight on the tires for at least three hours and
- if the vehicle has not been driven more than 1 mile (1.6 km).

Tread

The part of the tire that comes into contact with the road.

Bead

The tire bead ensures that the tire sits securely on the wheel. There are several steel wires in the bead to prevent the tire from coming loose from the wheel rim.

Sidewall

The part of the tire between the tread and the bead.

Weight of optional extras

The combined weight of those optional extras that weigh more than the replaced standard part and more than 2.3 kg (5 lb). These

optional extras, such as high-performance brakes, level control, a roof rack or a high-performance battery, are not included in the curb weight and the weight of the accessories.

TIN (Tire Identification Number)

This is a unique identifier which can be used by a tire manufacturer to identify tires, for example for a product recall, and thus identify the purchasers. The TIN is made up of the manufacturer's identification code, tire size, tire type code and the manufacturing date.

Load bearing index

The load bearing index (also load index) is a code that contains the maximum load bearing capacity of a tire.

Traction

Traction is the result of friction between the tires and the road surface.

Treadwear indicators

Narrow bars (tread wear bars) that are distributed over the tire tread. If the tire tread is level with the bars, the wear limit of $\frac{1}{16}$ in (1.6 mm) has been reached.

Occupant distribution

The distribution of occupants in a vehicle at their designated seating positions.

Total load limit

Rated cargo and luggage load plus 68 kilograms (150 lb), multiplied by the vehicle's designated seating capacity.

Changing a wheel

Flat tire

The "Breakdown assistance" section (▷ page 437) contains information and notes on how to deal with a flat tire. It also provides instructions on changing a wheel or mounting the spare wheel/emergency spare wheel.

Rotating the wheels

WARNING

Interchanging the front and rear wheels may severely impair the driving characteristics if the wheels or tires have different dimensions. The wheel brakes or suspension components may also be damaged. There is a risk of accident.

Rotate front and rear wheels only if the wheels and tires are of the same dimensions.

Always pay attention to the instructions and safety notices in the section on "Changing a wheel and mounting the spare wheel" (▷ page 437).

The wear patterns on the front and rear tires differ, depending on the operating conditions. Rotate the wheels before a clear wear pattern has formed on the tires. Front tires typically wear more on the shoulders and the rear tires in the center.

If your vehicle's tire configuration allows, you can rotate the wheels according to the intervals in the tire manufacturer's warranty book in your vehicle documents. If no warranty book is available, the tires should be rotated every 3,000 to 6,000 miles (5,000 to 10,000 km), or earlier if tire wear requires. Do not change the direction of wheel rotation.

Clean the contact surfaces of the wheel and the brake disc thoroughly every time a wheel is rotated. Check the tire pressures.

Information on changing tires and mounting the spare wheel (▷ page 437).

 On vehicles equipped with a tire pressure monitor, electronic components are located in the wheel.

Tire-mounting tools should not be used near the valve. This could damage the electronic components.

Only have tires changed at a qualified specialist workshop.

Direction of rotation

Tires with a specified direction of rotation have additional benefits, e.g. if there is a risk of hydroplaning. You will only gain these benefits if the correct direction of rotation is maintained.

An arrow on the sidewall of the tire indicates its correct direction of rotation.

You may mount a spare wheel/emergency spare wheel against the direction of rotation. Observe the time restriction on use as well as the speed limit specified on the spare wheel/emergency spare wheel

Storing wheels

Store wheels that are not being used in a cool, dry and preferably dark place. Protect the tires from oil, grease, gasoline and diesel.

Cleaning the wheels

WARNING

Do not use power washers with circular-jet nozzles (dirt grinders) to clean your vehicle, in particular the tires. You could otherwise damage the tires and cause an accident.

Wheel and tire combinations

Points to remember

 For safety reasons, Mercedes-Benz recommends that you only use tires and wheels which have been approved by

Mercedes-Benz specifically for your vehicle.

These tires have been specially adapted for use with the control systems, such as ABS or ESP®, and are marked as follows:

- MO = Mercedes-Benz Original
- MOE = Mercedes-Benz Original Extended (tires featuring run-flat characteristics)
- MO1 = Mercedes-Benz Original (only certain AMG tires)

Mercedes-Benz Original Extended tires may only be used on wheels that have been specifically approved by Mercedes-Benz.

Only use tires, wheels or accessories tested and approved by Mercedes-Benz. Certain characteristics, e.g. handling, vehicle noise emissions or fuel consumption, may otherwise be adversely affected. In addition, when driving with a load, tire dimension variations could cause the tires to come into contact with the bodywork and axle components. This could result in damage to the tires or the vehicle.

Mercedes-Benz accepts no liability for damage resulting from the use of tires, wheels or accessories other than those tested and approved.

Information on tires, wheels and approved combinations can be obtained from any qualified specialist workshop.

- i** The recommended pressures for various operating conditions can be found:
- on the Tire and Loading Information placard with the recommended tire pressures on the B-pillar on the driver's side
 - in the tire pressure table on the inside of the fuel filler flap

Observe the notes on recommended tire pressures under various operating conditions (> page 458).

Check tire pressures regularly, and only when the tires are cold. Comply with the maintenance recommendations of the tire

manufacturer in the vehicle document wallet.

- i** Notes on the vehicle equipment – always equip the vehicle with:
- tires of the same size on a given axle (left/right)
 - the same type of tires at a given time (summer tires, winter tires, MOExtended tires)

- i** On the following pages, you can find information on approved wheel rims and tire sizes for equipping your vehicle with winter tires. Winter tires are not available at the factory as standard equipment or optional extras.

If you would like to equip your vehicle with approved winter tires, you may also, in certain circumstances, require rims of the appropriate size. The size of the approved winter tires may deviate from that of the standard tires. This is dependent on the model and the equipment installed at the factory.

The tires and wheel rims, as well as further information, can be obtained at a qualified specialist workshop.

- i** Overview of abbreviations used in the following tire tables:

- BA: both axles
- FA: front axle
- RA: rear axle

In the following table, the wheel/tire combinations are assigned to the vehicle models through variants, e.g. V1, V2 etc.:

V1	CL 550 4MATIC
V2	CL 600
V3	CL 63 AMG
V4	CL 65 AMG





- i** Not all wheel and tire combinations are available at the factory for all countries.

Tires						
	Summer tires	Alloy wheels	V1	V2	V3	V4
BA	255/45 R18 99 Y MOExtended ²¹	8.5 J x 18 H2 Wheel offset: 1.69 in (43 mm)	●	–	–	–
FA	255/45 R18 99 Y MOExtended ²¹	8.5 J x 18 H2 Wheel offset: 1.69 in (43 mm)	–	●	–	–
RA	275/45 R18 103 Y MOExtended ^{21, 22}	9.5 J x 18 H2 Wheel offset: 1.69 in (43 mm)	–	–	–	–
BA	255/40 R19 100 Y XL	8.5 J x 19 H2 Wheel offset: 1.69 in (43 mm)	●	–	–	–
FA	255/40 R19 100 Y XL	8.5 J x 19 H2 Wheel offset: 1.69 in (43 mm)	–	●	–	–
RA	275/40 R19 101 Y ²²	9.5 J x 19 H2 Wheel offset: 1.69 in (43 mm)	–	–	–	–
FA	255/40 ZR 19 XL	8.5 J x 19 H2 Wheel offset: 1.69 in (43 mm)	–	–	●	●
RA	275/40 ZR 19 XL ²²	9.5 J x 19 H2 Wheel offset: 1.69 in (43 mm)	–	–	–	–
BA	255/35 ZR 20 XL ²²	8.5 J x 20 H2 Wheel offset: 1.69 in (43 mm)	●	–	–	–
FA	255/35 ZR 20 XL	8.5 J x 20 H2 Wheel offset: 1.69 in (43 mm)	–	●	●	●
RA	275/35 ZR 20 XL ²²	9.5 J x 20 H2 Wheel offset: 1.69 in (43 mm)	–	–	–	–
	All-weather tires	Alloy wheels	V1	V2	V3	V4
BA	255/45 R18 99 H M+S	8.5 J x 18 H2 Wheel offset: 1.69 in (43 mm)	●	●	–	–
FA	255/45 R18 99 H M+S	8.5 J x 18 H2 Wheel offset: 1.69 in (43 mm)	–	●	–	–
RA	275/45 R18 103 H M+S ²²	9.5 J x 18 H2 Wheel offset: 1.69 in (43 mm)	–	–	–	–

²¹ MOExtended tires (tires with run-flat characteristics) only in combination with an activated tire pressure monitor.

²² Use of snow chains is not permitted. Observe the notes in the "Snow chains" section.

	All-weather tires	Alloy wheels	V1	V2	V3	V4
BA	255/40 R19 100 V XL M+S	8.5 J x 19 H2 Wheel offset: 1.69 in (43 mm)	•	•	–	–
FA	255/40 R19 100 V XL M+S	8.5 J x 19 H2 Wheel offset: 1.69 in (43 mm)	–	•	–	–
RA	275/40 R19 101 V M+S ²²	9.5 J x 19 H2 Wheel offset: 1.69 in (43 mm)				

	Winter tires	Alloy wheels	V1	V2	V3	V4
BA	255/45 R18 99 V M+S 	8.5 J x 18 H2 Wheel offset: 1.69 in (43 mm)	•	•	–	–
BA	255/40 R19 100 V XL M+S 	8.5 J x 19 H2 Wheel offset: 1.69 in (43 mm)	•	•	•	•
FA	255/40 R19 100 V XL M+S 	8.5 J x 19 H2 Wheel offset: 1.69 in (43 mm)	–	–	•	•
RA	275/40 R19 105 V XL M+S  ²²	9.5 J x 19 H2 Wheel offset: 1.69 in (43 mm)				

"Minispare" emergency spare wheel²²

Tires	Wheels	V1	V2	V3	V4
T 155/70 R19 113 M Tire pressure: 420 kPa (4.2 bar/ 61 psi)	4.5 B x 19 H2 Wheel offset: 1.38 in (35 mm)	•	•	•	•

 The specified tire pressure is printed in yellow on the emergency spare wheel.

²² Use of snow chains is not permitted. Observe the notes in the "Snow chains" section.

Useful information	482
Notes on technical data	482
Warranty	482
Identification plates	482
Service products and filling capacities	484
Vehicle data	490

Useful information

- i** This Operator's Manual describes all models and all standard and optional equipment of your vehicle available at the time of publication of the Operator's Manual. Country-specific differences are possible. Please note that your vehicle may not be equipped with all features described. This also applies to safety-related systems and functions.
- i** Please read the information on qualified specialist workshops (▷ page 29).

Notes on technical data

- i** The data stated here specifically refers to a vehicle with standard equipment. Consult a Mercedes-Benz Center for the data for all vehicle variants and trim levels.

Warranty

The Service and Warranty Information booklet contains detailed information about the warranties covering your vehicle. Your authorized Mercedes-Benz Center will exchange or repair any defective parts originally installed in the vehicle in accordance with the terms of the following warranties:

- New Vehicle Limited Warranty
- Emission System Warranty
- Emission Performance Warranty
- California, Connecticut, Maine, Massachusetts, New York, Pennsylvania, Rhode Island and Vermont Emission Control Systems Warranty
- State Warranty Enforcement Laws (Lemon Laws)

Replacement parts and accessories are covered by the Mercedes-Benz Parts and Accessories warranties. You can obtain

information about this from any authorized Mercedes-Benz Center.

- i** Should you lose your Service and Warranty Information booklet, have an authorized Mercedes-Benz Center arrange for a replacement. It will be mailed to you.

Identification plates

Vehicle identification plate with vehicle identification number (VIN) and paint code number

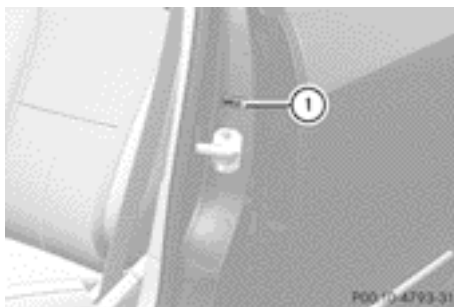

- Open the driver's door. You will see vehicle identification plate ①.

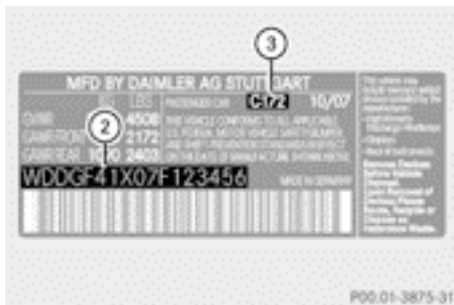

Example: vehicle identification plate (USA only)

- ② VIN
- ③ Paint code



Example: vehicle identification plate (Canada only)

- ② VIN
- ③ Paint code

i The data shown on the identification plate is example data. This data is different for every vehicle and can deviate from the data shown here. You can find the data applicable to your vehicle on the vehicle's identification plate.

Vehicle identification number (VIN)

The vehicle identification number (VIN) can be found in the following locations:

- on the vehicle identification plate (▷ page 482)
- at the lower edge of the windshield (▷ page 483)

In addition to being stamped on the vehicle identification plate, the vehicle identification number (VIN) is also stamped onto the vehicle body. It is under the trim behind the rear seat armrest.

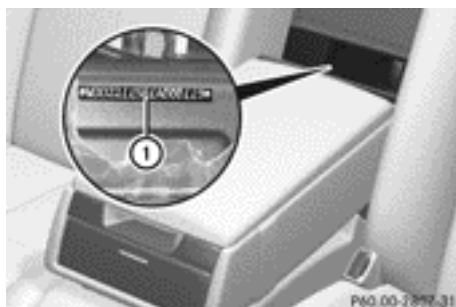

- ▶ Fold down the rear seat armrest.
- ▶ Open the trim.
You will see vehicle identification number (VIN) ①.

Engine number

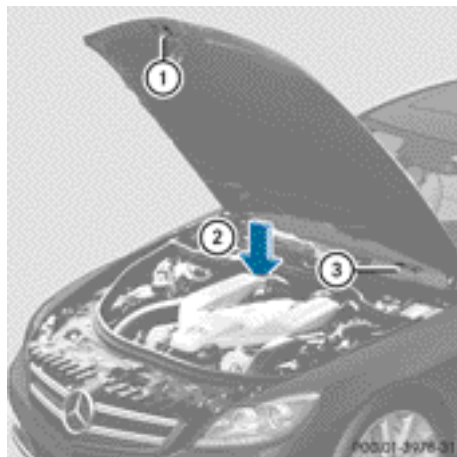

(AMG vehicles)

- ① Emission control information plate, including the certification of both federal and Californian emissions standards
- ② Engine number (stamped into the crankcase)
- ③ VIN (on the lower edge of the windshield)

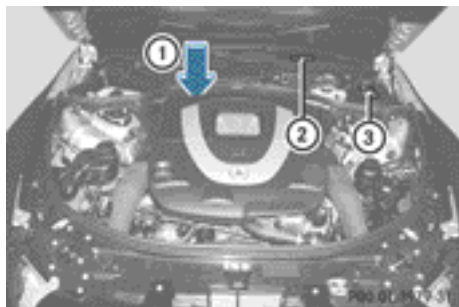

- ① Engine number (stamped into the crankcase)
- ② VIN (on the lower edge of the windshield)
- ③ Emission control information plate, including the certification of both federal and Californian emissions standards

Service products and filling capacities

Important safety notes

WARNING

Comply with all valid regulations with respect to handling, storing and disposing of service fluids. Otherwise, you could endanger persons or the environment.

Keep service fluids out of the reach of children.

For health reasons, you should prevent service fluids from coming into direct contact with your skin or clothing.

If a service fluid is swallowed, contact a physician immediately.

Environmental note

Dispose of service products in an environmentally responsible manner.

Service products include the following:

- fuels
- lubricants (e.g. engine oil, transmission oil)
- coolant
- brake fluid

- windshield washer fluid
- climate control system refrigerant

Components and service products must be matched. You should therefore only use products that have been tested and approved by Mercedes-Benz.

Information on tested and approved products can be obtained at an authorized Mercedes-Benz Center or on the Internet at <http://bevo.mercedes-benz.com>.

You can recognize service products approved by Mercedes-Benz by the following inscription on the containers:

- MB approval (e.g. MB approval 229.51)
- MB Approval (e.g. MB Approval 229.51)

Other designations or recommendations indicate a level of quality or a specification in accordance with an MB Sheet number (e.g. MB 229.5). They have not necessarily been approved by Mercedes-Benz.

Fuel

Important safety notes

WARNING

Fuel is highly flammable. If you handle fuel incorrectly, there is a risk of fire and explosion.

You must avoid fire, open flames, creating sparks and smoking. Switch off the engine and, if applicable, the auxiliary heating before refueling.

WARNING

Fuel is poisonous and hazardous to health. There is a risk of injury.

You must make sure that fuel does not come into contact with your skin, eyes or clothing and that it is not swallowed. Do not inhale fuel vapors. Keep fuel away from children.

If you or others come into contact with fuel, observe the following:

- Wash away fuel from skin immediately using soap and water.
- If fuel comes into contact with your eyes, immediately rinse them thoroughly with clean water. Seek medical assistance without delay.
- If fuel is swallowed, seek medical assistance without delay. Do not induce vomiting.
- Immediately change out of clothing which has come into contact with fuel.

Tank capacity

Model	Total capacity
CL 550 4MATIC	21.9 US gal (83.0 l)
CL 600 AMG vehicles	23.8 US gal (90.0 l)

Model	Of which reserve
AMG vehicles	Approx. 3.7 US gal (14.0 l)
All other models	Approx. 2.9 US gal (11.0 l)

Gasoline

Fuel grade

! Do not use diesel to refuel vehicles with a gasoline engine. Do not switch on the ignition if you accidentally refuel with the wrong fuel. Otherwise, the fuel will enter the fuel system. Even small amounts of the wrong fuel could result in damage to the fuel system and the engine. Notify a

qualified specialist workshop and have the fuel tank and fuel lines drained completely.

- !** Only refuel using unleaded gasoline with a minimum octane rating of 91.
- !** Only use the fuel recommended. Operating the vehicle with other fuels can lead to engine failure.
- !** Do not use the following:
 - E85 (gasoline with 85% ethanol)
 - E100 (100% ethanol)
 - M15 (gasoline with 15% methanol)
 - M30 (gasoline with 30% methanol)
 - M85 (gasoline with 85% methanol)
 - M100 (100% methanol)
 - Gasoline with metalliferous additives
 - Diesel

Do not mix such fuels with the fuel recommended for your vehicle. Do not use additives. This can otherwise lead to engine damage. This does not include cleaning additives for the removal and prevention of residue build-up. Gasoline may only be mixed with cleaning additives recommended by Mercedes-Benz; see "Additives". You can obtain further information from any authorized Mercedes-Benz Center.

- !** To ensure the longevity and full performance of the engine, only premium-grade unleaded gasoline must be used. If standard premium-grade unleaded gasoline is unavailable and unleaded gasoline of a lower grade is used for refueling, observe the following precautions:

- only fill the fuel tank to half full with regular unleaded gasoline and fill the rest with premium-grade unleaded gasoline as soon as possible.
- do not drive at the maximum speed.

- avoid sudden acceleration and engine speeds above 3000 rpm.
- never refuel using fuel with an octane number lower than 87. Otherwise, engine failure could occur.

Using mixtures of methanol and ethanol is not permitted. E10 fuel or E15 fuel (unleaded gasoline with 10% or 15% ethanol) can be used.

You will usually find information about the fuel grade on the pump. If you cannot find the label on the pump, ask the staff for assistance.

i For further information, consult a qualified specialist workshop or on the Internet at <http://www.mbusa.com> (USA only).

Information on refueling (▷ page 287).

Additives

L Operating the engine with fuel additives added later can lead to engine failure. Do not mix fuel additives with fuel. This does not include additives for the removal and prevention of residue buildup. Gasoline must only be mixed with additives recommended by Mercedes-Benz. Comply with the instructions for use on the product label. More information about recommended additives can be obtained from any authorized Mercedes-Benz Center.

Mercedes-Benz recommends that you use fuel brands that have the additives.

The quality of the fuel available in some countries may not be sufficient. Residue could build up as a result. In such cases, and in consultation with an authorized Mercedes-Benz Center, the gasoline may be mixed with the cleaning additive recommended by Mercedes-Benz (part no. A000989254512). You must observe the notes and mixing ratios specified on the container.

Engine oil

Points to remember

L Never use engine oil or an oil filter of a specification other than is necessary to fulfill the prescribed service intervals. Do not change the engine oil or oil filter in order to achieve longer replacement intervals than those prescribed. You could otherwise cause engine damage or damage to the exhaust gas aftertreatment.

Follow the instructions in the service interval display regarding the oil change. Otherwise, you may damage the engine and the exhaust gas aftertreatment.

The engine oils are matched to the performance of Mercedes-Benz engines and service intervals. You should therefore only use engine oils and oil filters that are approved for vehicles with maintenance systems.

For a list of approved engine oils and oil filters, consult an authorized Mercedes-Benz Center. Or visit the website <http://bevo.mercedes-benz.com>.

The table shows which engine oils have been approved for your vehicle.

Model	Engine model	MB Approval
CL 550 4MATIC	278	229.5
CL 600	275	
CL 63 AMG ²³	157	
CL 65 AMG ²³	275	

i MB approval is indicated on the oil containers.

Filling capacities

The following values refer to an oil change including the oil filter.

²³ Only SAE 0W-40/SAE 5W-40 engine oils may be used.

Model	Capacity
CL 550 4MATIC	9.0 US qt (8.5 l)
CL 63 AMG	10.0 US qt (9.5 l) ²⁴
CL 600	9.5 US qt (9.0 l)
CL 65 AMG	

Additives

! Do not use any additives in the engine oil. This could damage the engine.

Engine oil viscosity

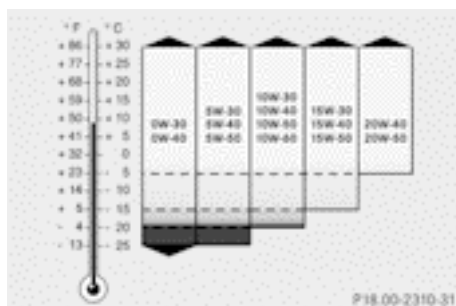

Viscosity describes the flow characteristics of a fluid. If an engine oil has a high viscosity, this means that it is thick; a low viscosity means that it is thin.

Select an engine oil with an SAE classification (viscosity) suitable for the prevailing outside temperatures. The table shows you which SAE classifications are to be used. The low-temperature characteristics of engine oils can deteriorate significantly, e.g. as a result of aging, soot and fuel deposits. It is therefore strongly recommended that you carry out regular oil changes using an approved engine oil with the appropriate SAE classification.

Brake fluid

⚠ WARNING

Over a period of time, the brake fluid absorbs moisture from the air; this lowers its boiling point.

If the boiling point of the brake fluid is too low, vapor pockets may form in the brake system when the brakes are applied hard (e.g. when driving downhill). This would impair braking efficiency.

You should have the brake fluid renewed at regular intervals. The brake fluid change intervals can be found in the Maintenance Booklet.

Only use brake fluid approved by Mercedes-Benz. Information about approved brake fluid can be obtained at any qualified specialist workshop or on the Internet at <http://bevo.mercedes-benz.com>.

Coolant

Important safety notes

⚠ WARNING

Antifreeze is highly flammable. Fire, open flames and smoking are prohibited when handling antifreeze.

If antifreeze comes into contact with hot engine parts, it may ignite and you could burn yourself. Do not spill any antifreeze on hot engine parts.

! Only add coolant that has been premixed with the desired antifreeze protection. You could otherwise damage the engine. Further information on coolants can be found in the Mercedes-Benz Specifications for Service Products, MB Specifications for Service Products 310.1, e.g. on the Internet at <http://bevo.mercedes-benz.com>. Or contact a qualified specialist workshop.

²⁴ Including external oil cooler.

! Always use a suitable coolant mixture, even in countries where high temperatures prevail.

Otherwise, the engine cooling system is not sufficiently protected from corrosion and overheating.

The coolant is a mixture of water and antifreeze/corrosion inhibitor. It performs the following tasks:

- corrosion protection
- antifreeze protection
- raising the boiling point

If the coolant has antifreeze protection down to -35 °F (-37 °C), the boiling point of the coolant during operation is approximately 266 °F (130 °C).

The antifreeze/corrosion inhibitor concentration in the engine cooling system should:

- be at least 50%. This will protect the engine cooling system against freezing down to approximately -35 °F (-37 °C).
- not exceed 55% (antifreeze protection down to -49 °F [-45 °C]). Otherwise, heat will not be dissipated as effectively.

If the vehicle has lost coolant, add equal amounts of water and antifreeze/corrosion inhibitor. Mercedes-Benz recommends an antifreeze/corrosion inhibitor concentrate in accordance with MB Specifications for Service Products 310.1.

The coolant is checked with every maintenance interval at a qualified specialist workshop.

i When the vehicle is first delivered, it is filled with a coolant mixture that ensures adequate antifreeze and corrosion protection.

Capacity

Model	Capacity
CL 550 4MATIC	Approx. 14.5 US qt (13.7 l)
CL 600	Approx. 15.3 US qt (14.5 l)
CL 63 AMG	Approx. 12.2 US qt (11.5 l)
CL 65 AMG	Approx. 14.7 US qt (13.9 l)

i Use MB 325.0 or MB 326.0 corrosion inhibitor/antifreeze.

Washer fluid

WARNING

Washer solvent/antifreeze is highly flammable. Do not spill washer solvent/antifreeze on hot engine parts, because it may ignite and burn. You could be seriously burned.

! Only use washer fluid that is suitable for plastic lamp lenses, e.g. MB SummerFit or MB WinterFit. Unsuitable washer fluid could damage the plastic lenses of the headlamps.

! Do not add distilled or de-ionized water to the washer fluid container. Otherwise, the level sensor may be damaged.

! Only MB SummerFit and MB WinterFit washer fluid should be mixed together. The spray nozzles may otherwise become blocked.

At temperatures above freezing:

- ▶ Fill the washer fluid reservoir with a mixture of water and windshield washer fluid, e.g. MB SummerFit.
- ▶ Add 1 part MB SummerFit to 100 parts water.

At temperatures below freezing:

- ▶ Fill the washer fluid reservoir with a mixture of water and windshield washer fluid, e.g. MB WinterFit. Adapt the mixing ratio to the outside temperature.
- ▶ Down to 14 °F (-10 °C): mix 1 part MB WinterFit to 2 parts water.
- ▶ Down to -4 °F (-20 °C): mix 1 part MB WinterFit to 1 part water.
- ▶ Down to -20.2 °F (-29 °C): mix 2 parts MB WinterFit to 1 part water.

- i** Add windshield washer fluid, e.g. MB SummerFit or MB WinterFit, to the washer fluid all year round.

Climate control system refrigerant

Important safety notes

The climate control system of your vehicle is filled with refrigerant R-134a.

The instruction label regarding the refrigerant type used can be found on the radiator cross member.

- !** Only the refrigerant R-134a and the PAG oil approved by Mercedes-Benz may be used. The approved PAG oil may not be mixed with any other PAG oil that is not approved for R-134a refrigerant. Otherwise, the climate control system may be damaged.

Service work, such as topping-up refrigerant or replacing components, may only be carried out by a qualified specialist workshop. All applicable regulations must be adhered to, SAE standard J639 included.

Always have work on the climate control system carried out at a qualified specialist workshop.

Refrigerant instruction label



Example: refrigerant instruction label

- ① Warning symbol
- ② Refrigerant filling capacity
- ③ Applicable SAE standards
- ④ PAG oil part number
- ⑤ Type of refrigerant

Warning symbols ① indicate:

- possible dangers
- having service work carried out at a qualified specialist workshop

Filling capacities

Missing values were not available at time of going to print.

All models	Capacity
Refrigerant	
PAG oil	

Vehicle data

Please note that for the specified vehicle data:

- the heights specified may vary as a result of:
 - tires
 - load
 - condition of the suspension
 - optional equipment
- the vehicle length specified includes the front license plate adapter.

All models (except for AMG vehicles)

Vehicle length	200.6 in (5095 mm)
Vehicle width including exterior mirrors	83.9 in (2130 mm)
Vehicle height	55.9 in (1419 mm)
Wheelbase	116.3 in (2955 mm)
Turning radius	38.2 ft (11.63 m)
Maximum trunk load	220 lb (100 kg)

AMG vehicles

Vehicle length	201.0 in (5106 mm)
Vehicle width including exterior mirrors	83.9 in (2130 mm)
Wheelbase	116.3 in (2955 mm)
Turning radius	38.1 ft (11.60 m)
Maximum trunk load	220 lb (100 kg)

Model

Vehicle height

CL 63 AMG	56.1 in (1425 mm)
CL 65 AMG	56.2 in (1428 mm)

Publication details

Internet

Further information about Mercedes-Benz vehicles and about Daimler AG can be found on the following websites:

<http://www.mbusa.com> (USA only)

<http://www.mercedes-benz.ca> (Canada only)

Editorial office

Not to be reprinted, translated or otherwise reproduced, in whole or in part, without the written permission of Daimler AG.

As at 04.10.2012

Nur für internen Gebrauch / For internal use only



2165842382

Order no. 6515 2384 13 Part no. 216 584 23 82 Edition A 2014

Nur für internen Gebrauch / For internal use only