

B R A

V A D A



1993

OWNER'S MANUAL

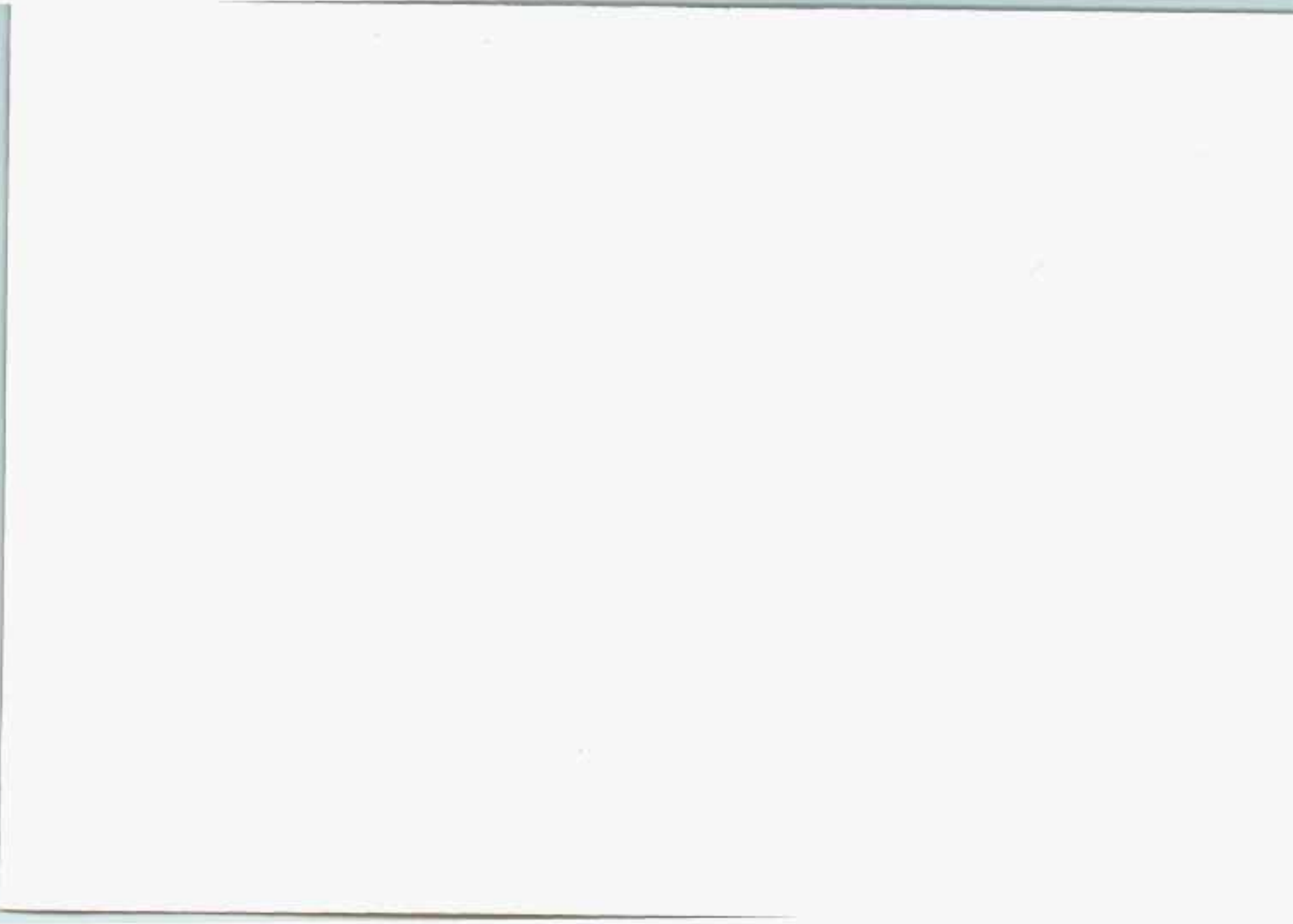



Table of Contents

	<i>The Power of Intelligent Engineering</i>	3
	<i>How to Use this Manual</i>	6
Part 1	<i>Seats & Safety Belts</i>	11
2	<i>Features & Controls</i>	39
3	<i>Comfort Controls & Audio Systems</i>	101
4	<i>Your Driving and the Road</i>	117
5	<i>Problems on the Road</i>	175
6	<i>Service & Appearance Care</i>	201
7	<i>Maintenance Schedule</i>	259
8	<i>Customer Assistance Information</i> <i>Includes "Reporting Safety Defects" on page 286</i>	281
9	<i>Index</i>	295
	<i>Service Station Information</i>	Last Page

Important Notes About this Manual

Please keep this manual in your Oldsmobile, so it will be there if you ever need it when you're on the road. If you sell the vehicle, please leave this manual in it so the new owner can use it.

This manual includes the latest information at the time it was printed. We reserve the right to make changes in the product after that time without further notice.

About Driving Your Bravada

As with other vehicles of this type, failure to operate this vehicle correctly may result in loss of control or an accident. Be sure to read the "on-pavement" and "off-road" driving guidelines in this manual. (See the *Index* under *Driving Guidelines* and *Off-Road Driving*.)

Published by
Oldsmobile Division
General Motors
Corporation
920 Townsend Street
Lansing, Michigan 48921

The words *Oldsmobile* and *Bravada* and the Oldsmobile rocket emblem are registered trademarks of General Motors Corporation.

The word *Delco* is a registered trademark of General Motors Corporation.

The Power of Intelligent Engineering

Engineering with a purpose. It's at the heart of every Oldsmobile. Your new Oldsmobile continues a 96-year tradition of engineering excellence.

That tradition was born in Lansing, Michigan, on August 21, 1897, when Ransom E. Olds began building a horseless carriage "in as nearly a perfect manner as possible." Soon, Oldsmobiles rolled off the nation's first assembly line.

Innovation and refinement have always set Oldsmobiles apart. In 1939, Oldsmobile introduced the celebrated Hydra-Matic transmission, a four-speed forerunner of today's advanced systems. In 1948, the high-spirited Rocket V8 engine set standards for performance.



A Step Ahead

In 1966, Toronado made front-wheel-drive news, including Motor Trend's "Car of the Year." Still breaking new ground, the 1974 "Toro" became the first car equipped with a production "air bag."

Recent Oldsmobile engineering has created exciting advancements like the responsive Quad 4 engine. Versions of the 4-cylinder, 16-valve Quad 4 propelled Oldsmobiles on roads and racetracks to new standards of economy and performance.

Today, the all-wheel-drive security of SmartTrak in the Oldsmobile Bravada continues that proud tradition of meaningful technology.

1965

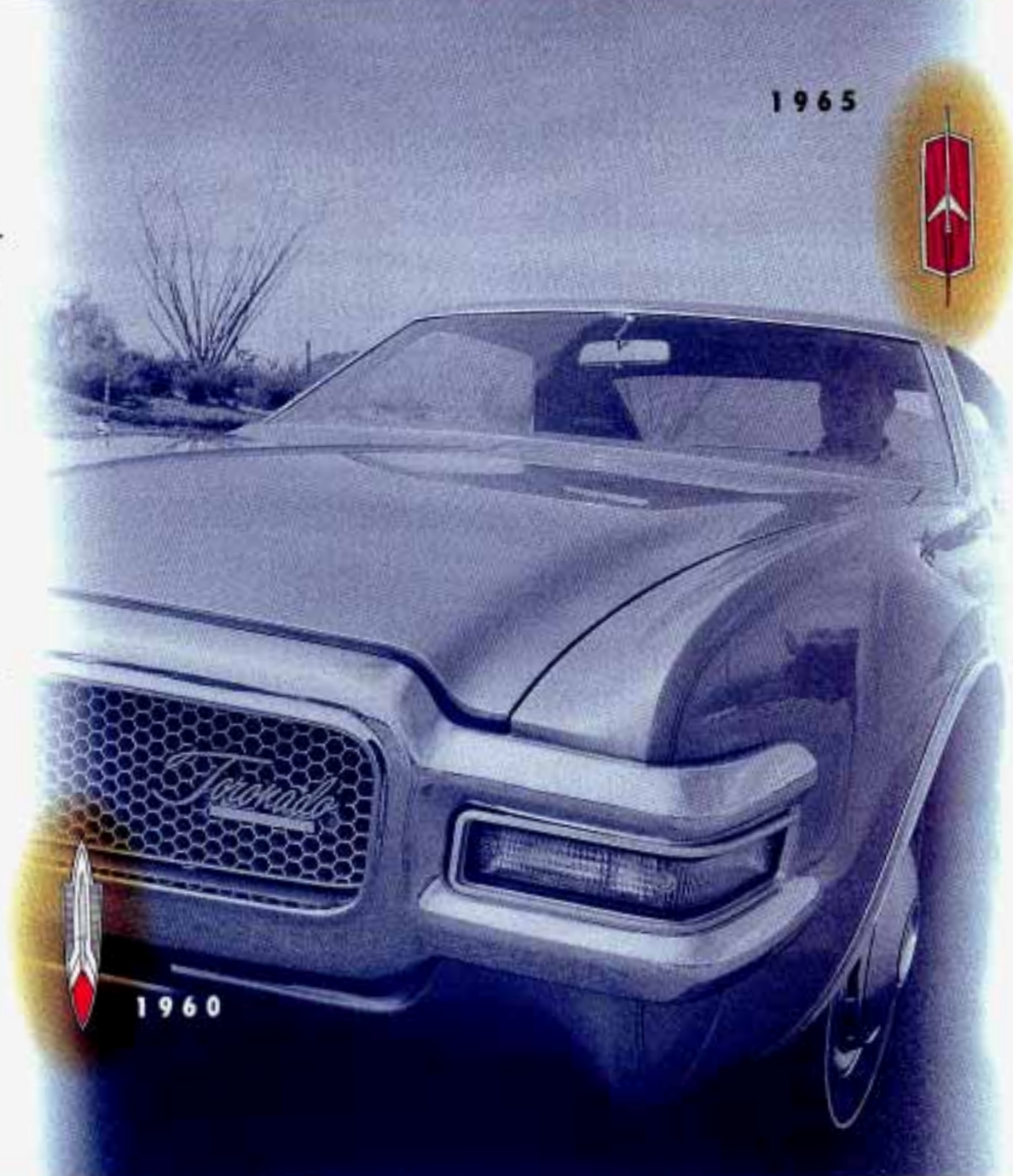

1960





The Security of Owner Satisfaction

The quality we built into your new Oldsmobile gives us the confidence to back it with the Oldsmobile Edge—the most comprehensive owner satisfaction program in the industry. The Edge gives you 24-hour roadside assistance, Bumper-to-Bumper Plus Warranty protection, even free transportation while your vehicle is in for warranty service. With the Oldsmobile Edge, we've pledged to make your ownership experience a great one.



J. D. Rock
General Manager

How to Use this Manual

MANY PEOPLE READ THEIR OWNER'S manual from beginning to end when they first receive their new vehicle. This will help you learn about the features and controls for your vehicle. In this manual, you'll find that pictures and words work together to explain things quickly.

There are nine tabs to help you find each of the parts of this manual. Each part begins with a brief list of contents, so you can usually tell at a glance if that part contains the information you want.

Part 1: Seats & Safety Belts

This part tells you how to use your seats and safety belts properly.

Part 2: Features & Controls

This part explains how to start and operate your Oldsmobile.

Part 3: Comfort Controls & Audio Systems

This part tells you how to adjust the ventilation and comfort controls and how to operate your audio system.



Part 4: Your Driving and the Road

Here you'll find helpful information and tips about the road and how to drive under different conditions.

Part 5: Problems on the Road

This part tells you what to do if you have a problem while driving, such as a flat tire or engine overheating.

Part 6: Service & Appearance Care

Here the manual tells you how to keep your Oldsmobile running properly and looking good.

Part 7: Maintenance Schedule

This part tells you when to perform vehicle maintenance and what fluids and lubricants to use.

Part 8: Customer Assistance Information

This part tells you how to contact Oldsmobile for assistance and how to get service publications. It also gives you information on *Reporting Safety Defects*.

Part 9: Index

Here's an alphabetical listing of almost every subject in this manual. You can use it to quickly find something you want to read.

Service Station Information:

This is a quick reference of service information. You can find it on the last page of this manual.



How to Use this Manual

Safety Warnings and Symbols

You will find a number of safety cautions in this book. We use yellow and the word CAUTION to tell you about things that could hurt you if you were to ignore the warning.

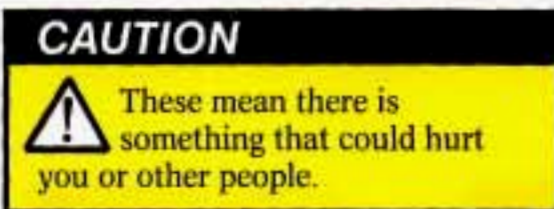

In the yellow caution area, we tell you what the hazard is. Then we tell you what to do to help avoid or reduce the hazard. Please read these cautions. If you don't, you or others could be hurt.

You will also find a red circle with a slash through it in this book. This safety symbol means:

Don't
Don't do this
Don't let this happen



Vehicle Damage Warnings

Also, in this book you will find these blue notices:

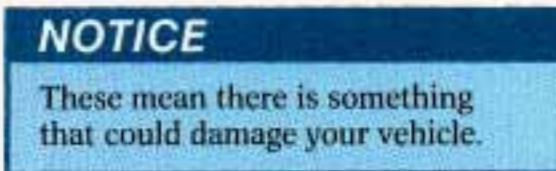

In the blue notice area, we tell you about something that can damage your vehicle. Many times, this damage would not be covered by your warranty, and it could be costly. But the notice will tell you what to do to help avoid the damage.

When you read other manuals, you might see CAUTION and NOTICE warnings in different colors or in different words. In this manual, we've used the familiar words and colors that Oldsmobile has used for years.

You'll also see warning labels on your vehicle. They use the same colors, and the words CAUTION or NOTICE.

Vehicle Symbols

These are some of the symbols you will find on your vehicle. For example, these symbols are used on an original battery:

Caution Possible Injury



Protect Eyes by Shielding



Caustic Battery Acid Could Cause Burns



Avoid Sparks or Flames



Spark or Flame Could Explode Battery



These symbols are important for you and your passengers whenever your vehicle is driven:

Fasten Safety Belts



Door Lock/Unlock



These symbols have to do with your lights:

Master Lighting Switch



Turn Signal Direction

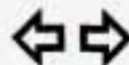

Hazard Warning Flashers



Headlight High Beam



Parking Lights

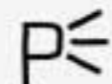

Fog Lights



How to Use this Manual

Vehicle Symbols (CONT.)

These symbols are on some of your controls:

Windshield Wiper



Windshield Washer



Windshield Defroster



Rear Window Defogger



Rear Window Wiper



Rear Window Washer/Wiper



Ventilating Fan



Power Window



These symbols are used on warning and indicator lights:

Engine Coolant Temperature



Battery Charging System



Fuel



Engine Oil Pressure



Brake



Anti-Lock Brakes



Here are some other symbols you may see:

Fuse



Tailgate Window

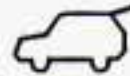

Lighter



Horn



Speaker



Hood Release





Part 1

Seats & Safety Belts

Here you'll find information about the seats in your Oldsmobile and how to use your safety belts properly. You can also learn about some things you should not do with safety belts.

Seats and Seat Controls	12
Folding Rear Seat	14
Safety Belts	14
How to Wear Safety Belts Properly	19
Driver Position	19
Safety Belt Use During Pregnancy	23
Right Front Passenger Position	23
Rear Seat Passengers	23
Children	27
Smaller Children and Babies	27
Child Restraints	28
Larger Children	35
Safety Belt Extender	37
Replacing Safety Belts After a Crash	37

Seats & Safety Belts

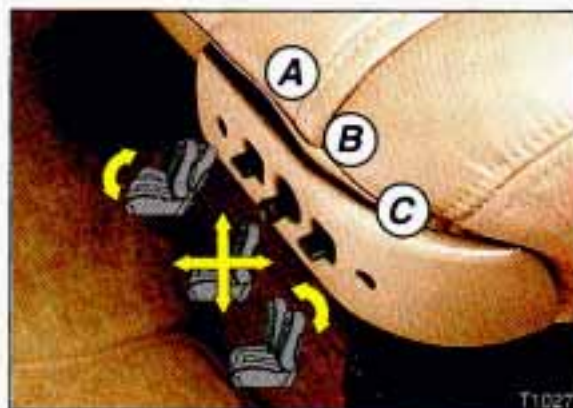

■ Seats and Seat Controls

This section tells you about the seats—how to adjust them—and also about reclining seatbacks and the folding rear seat.

Power Seat

To adjust the driver's power seat:

Front Control (A): Raise the front of the seat by holding the switch up. Lower the front of the seat by holding the switch down.

Center Control (B): Move the seat forward or back by holding the control right or left.

Move the seat higher by holding the control up. Lower the seat by holding the control down.

Rear Control (C): Raise the rear of the seat by holding the switch up. Lower the rear of the seat by holding the switch down.

Lumbar Control

This switch is located on the right front of the driver's seat and the left front of the passenger's seat.

To adjust lower back support on the driver's seat:

Press the switch left to increase support. Press the switch right to decrease support.

To adjust lower back support on the passenger's seat:

Press the switch right to increase support. Press the switch left to decrease support.



Manual Front Seat

Move the control lever under the front of the passenger's seat to unlock it. Slide the seat to where you want it. Then release the lever and try to move the seat with your body, to make sure the seat is locked into place.



Reclining Front Seatbacks

To adjust the seatback, lift the lever on the outside of your seat. Move the seatback where you want it, then release the lever.

But don't have a seatback reclined if your vehicle is moving.

Pull up on the lever and the seatback will go to its original upright position.



CAUTION

 Sitting in a reclined position when your vehicle is in motion can be dangerous. Even if you buckle up, your safety belts can't do their job when you're reclined like this.

The shoulder belt can't do its job because it won't be against your body. Instead, it will be in front of you. In a crash you could go into it, receiving neck or other injuries.

The lap belt can't do its job either. In a crash the belt could go up over your abdomen. The belt forces would be there, not at your pelvic

(Continued)

Seats & Safety Belts



Reclining Front Seatbacks (CONT.)

CAUTION



(Continued)

bones. This could cause serious internal injuries.

For proper protection when the vehicle is in motion, have the seatback upright. Then sit well back in the seat and wear your safety belt properly.

Folding Rear Seat

You can fold the rear seatback down for more cargo space. The latch is in the upper center of the rear of the seatback.

To lower the seatback, push it forward as you pull up on the latch.

To raise it, lift the seatback and push it back until it locks in the upright position.

Test to see that it is locked in place by pushing and pulling the seatback.

■ Safety Belts: *They're For Everyone*

This part of the manual tells you how to use safety belts properly. It also tells you some things you should not do with safety belts.



CAUTION

 Don't let anyone ride where they can't wear a safety belt properly. If you are in a crash and you're not wearing a safety belt, your injuries can be **much** worse. You can hit things inside the vehicle or be ejected from it. You can be seriously injured or killed. In the same crash, you might not be if you are buckled up. Always fasten your safety belt, and check that your passengers' belts are fastened properly too.

This figure lights up when you turn the key to **Run** or **Start** when your safety belt isn't buckled, and you'll hear a chime, too. It's the reminder to buckle up. In many states and Canadian provinces, the law says to wear safety belts. Here's why: **They work.**



You never know if you'll be in a crash. If you do have a crash, you don't know if it will be a bad one.

A few crashes are very mild. In them, you won't get hurt even if you're not buckled up. And some crashes can be so serious, like being hit by a train, that even buckled up a person wouldn't survive. But most crashes are in between. In many of them, people who buckle up can survive and sometimes walk away. Without belts they could be badly hurt or killed.

After 25 years of safety belts in vehicles, the facts are clear. In most crashes buckling up does matter . . . a lot!

Seats & Safety Belts

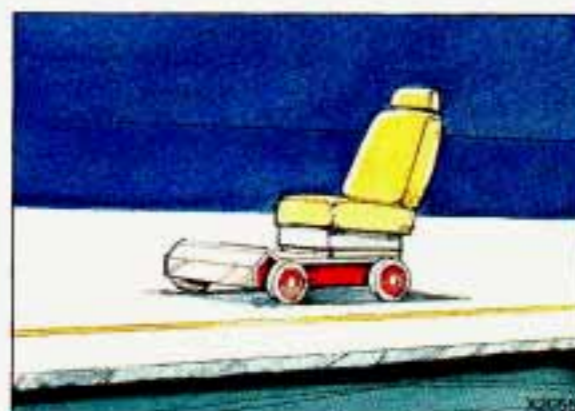
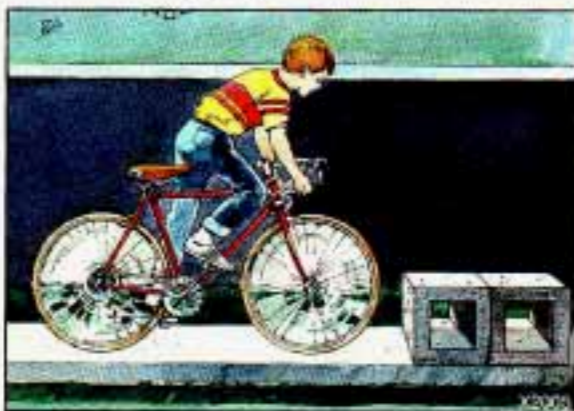

Why Safety Belts Work

When you ride in or on anything, you go as fast as it goes.

1. For example, if the bike is going 10 mph (16 km/h), so is the child.

2. When the bike hits the block, it stops. But the child keeps going!

3. Take the simplest "car." Suppose it's just a seat on wheels.

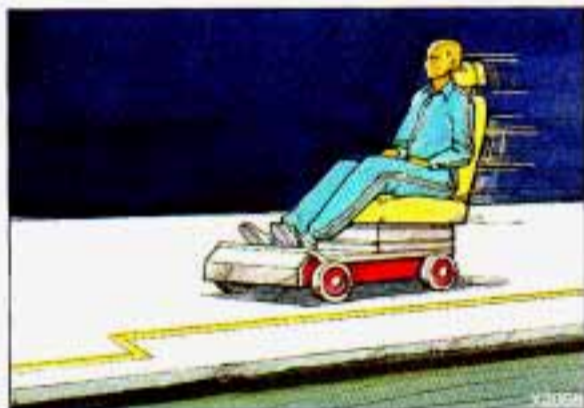

4. Put someone on it.

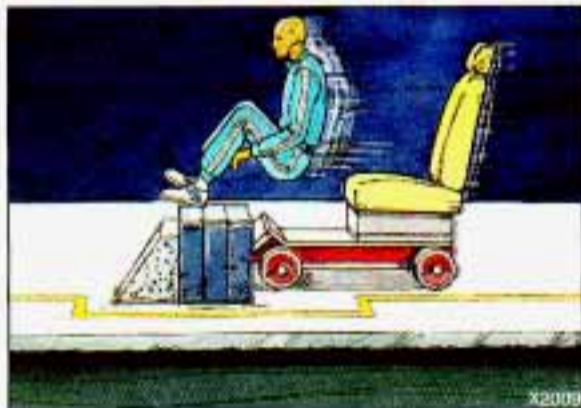

5. Get it up to speed. Then stop the "car." The rider doesn't stop.



6. The person keeps going until stopped by something. In a real vehicle, it could be the windshield...



7. or the instrument panel...



8. or the safety belts!

With safety belts, you slow down as the vehicle does. You get more time to stop. You stop over more distance, and your strongest bones take the forces. That's why safety belts make such good sense.

Seats & Safety Belts

Here Are Questions Many People Ask About Safety Belts—and the Answers

Q: Won't I be trapped in the vehicle after an accident if I'm wearing a safety belt?

A: You **could** be—whether you're wearing a safety belt or not. But you can easily unbuckle a safety belt, even if you're upside down. And your chance of being conscious during and after an accident, so you **can** unbuckle and get out, is **much** greater if you are belted.

Q: Why don't they just put in air bags so people won't have to wear safety belts?

A: "Air bags," or Supplemental Inflatable Restraint systems, are in some vehicles today and will be in more of them in the future. But they are supplemental systems only—so they work **with** safety belts, not instead of them. Every "air bag" system ever offered for sale has required the use of safety belts. Even if you're in a vehicle that has "air bags," you still have to buckle up to get the most protection. That's true not only in frontal collisions, but especially in side and other collisions.

Q: If I'm a good driver, and I never drive far from home, why should I wear safety belts?

A: You may be an excellent driver, but if you're in an accident—even one that isn't your fault—you and your passengers can be hurt. Being a good driver doesn't protect you from things beyond your control, such as bad drivers.

Most accidents occur within 25 miles (40 km) of home. And the greatest number of serious injuries and deaths occur at speeds of less than 40 mph (65 km/h).

Safety belts are for everyone.



Safety Belt Reminder Light

When the key is turned to **Run** or **Start**, a light will come on for about eight seconds to remind people to fasten their safety belts. Unless the driver's safety belt is buckled, a buzzer will also sound.

■ ***How to Wear Safety Belts Properly—Adults***

This section is only for people of adult size.

CAUTION

 There are special things to know about safety belts and children. And there are different rules for babies and smaller children. If a child will be riding in your Oldsmobile, see the *Index* under *Children and Safety Belts*. Follow those rules for everyone's protection.

First, you'll want to know which restraint systems your vehicle has. We'll start with the driver position.

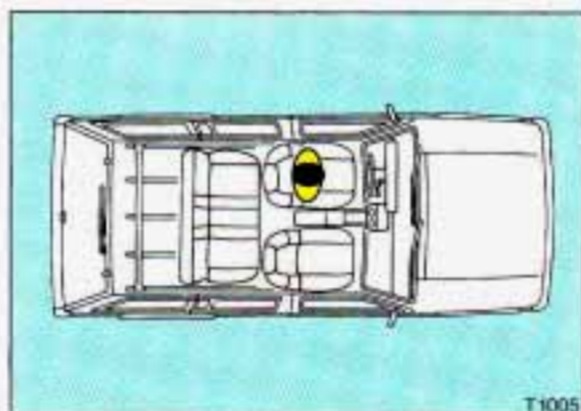

Driver Position

This section describes the driver's restraint system.

Seats & Safety Belts



Lap-Shoulder Belt

The driver has a lap-shoulder belt. Here's how to wear it properly.

1. Close and lock the door.
2. Adjust the seat (to see how, see the *Index* under *Seat Controls*) so you can sit up straight.



3. Pick up the latch plate and pull the belt across you. Don't let it get twisted.
4. Push the latch plate into the buckle until it clicks.

If the belt isn't long enough, see the *Index* under *Safety Belt Extender*.

Make sure the release button on the buckle faces upward or outward so you would be able to unbuckle it quickly if you ever had to.



The lap part of the belt should be worn low and snug on the hips, just touching the thighs. In a crash, this applies force to the strong pelvic bones. And you'd be less likely to slide under the lap belt. If you slid under it, the belt would apply force at your abdomen. This could cause serious or even fatal injuries. The shoulder belt should go over the shoulder and across the chest. These parts of the body are best able to take belt restraining forces.

The safety belt locks if there's a sudden stop or a crash.



Q: What's wrong with this?

A: The shoulder belt is too loose. It won't give nearly as much protection this way.

CAUTION



You can be seriously hurt if your shoulder belt is too loose. In a crash you would move forward too much, which could increase injury. The shoulder belt should fit against your body.



Q: What's wrong with this?

A: The belt is buckled in the wrong place.

CAUTION



You can be seriously injured if your belt is buckled in the wrong place like this. In a crash, the belt would go up over your abdomen. The belt forces would be there, not at the pelvic bones. This could cause serious internal injuries. Always buckle your belt into the buckle nearest you.

Seats & Safety Belts



Lap-Shoulder Belt (CONT.)

Q: What's wrong with this?

A: The shoulder belt is worn under the arm. It should be worn over the shoulder at all times.

CAUTION

 You can be seriously injured if you wear the shoulder belt under your arm. In a crash, your body would move too far forward, which would increase the chance of head and neck injury. Also, the belt would apply too much force to the ribs, which aren't as strong as shoulder bones. You could also severely injure internal organs like your liver or spleen.

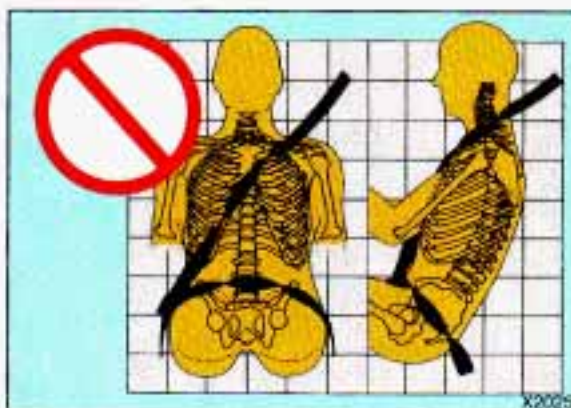

Q: What's wrong with this?

A: The belt is twisted across the body.

CAUTION

 You can be seriously injured by a twisted belt. In a crash, you wouldn't have the full width of the belt to spread impact forces. If a belt is twisted, make it straight so it can work properly, or ask your dealer to fix it.



To unlatch the belt, just push the button on the buckle. The belt should go back out of the way.

Before you close the door, be sure the belt is out of the way. If you slam the door on it, you can damage both the belt and your vehicle.



Safety Belt Use During Pregnancy

Safety belts work for everyone, including pregnant women. Like all occupants, they are more likely to be seriously injured if they don't wear safety belts.

A pregnant woman should wear a lap-shoulder belt, and the lap portion should be worn as low as possible throughout the pregnancy.

The best way to protect the fetus is to protect the mother. When a safety belt is worn properly, it's more likely that the fetus won't be hurt in a crash. For pregnant women, as for anyone, the key to making safety belts effective is wearing them properly.

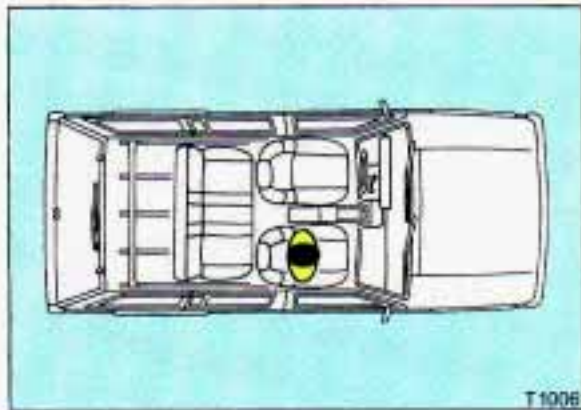

Right Front Passenger Position

The right front passenger's safety belt works the same way as the driver's safety belt. See the *Index* under *Driver Position*.

When the lap portion of the belt is pulled out all the way, it will lock. If it does, let it go back all the way and start again.

Rear Seat Passengers

It's very important for rear seat passengers to buckle up! Accident statistics show that unbelted people in the rear seat are hurt more often in crashes than those who are wearing safety belts.

Rear passengers who aren't safety belted can be thrown out of the vehicle in a crash. And they can strike others in the vehicle who are wearing safety belts.

Seats & Safety Belts

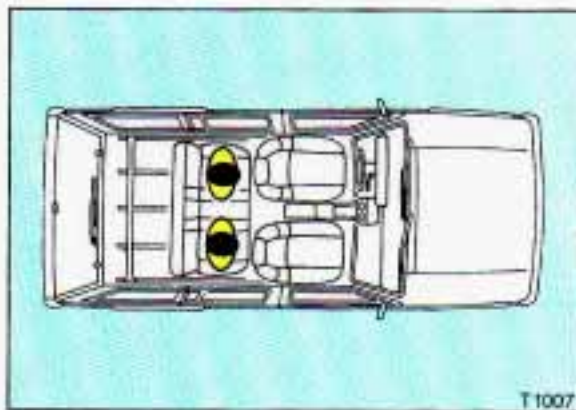

Rear Seat Outside Passenger Positions

The positions next to the windows have lap-shoulder belts.



Here's How to Wear One Properly:

1. Pick up the latch plate and pull the belt across you. Don't let it get twisted.
2. Push the latch plate into the buckle until it clicks.

When the shoulder belt is pulled out all the way, it will lock. If it does, let it go back all the way and start again.



If the belt is not long enough, see the *Index* under *Safety Belt Extender*.

Make sure the release button on the buckle faces upward or outward so you would be able to unbuckle it quickly if you ever had to.

To make the lap part tight, pull down on the buckle end of the belt as you pull up on the shoulder part.



The lap part of the belt should be worn low and snug on the hips, just touching the thighs. In a crash, this applies force to the strong pelvic bones. And you'd be less likely to slide under the lap belt. If you slid under it, the belt would apply force at your abdomen. This could cause serious or even fatal injuries. The shoulder belt should go over the shoulder and across the chest. These parts of the body are best able to take belt restraining forces.

The safety belt locks if there's a sudden stop or a crash.

CAUTION



You can be seriously hurt if your shoulder belt is too loose. In a crash you would move forward too much, which could increase injury. The shoulder belt should fit against your body.



To unclatch the belt, just push the button on the buckle.

Seats & Safety Belts

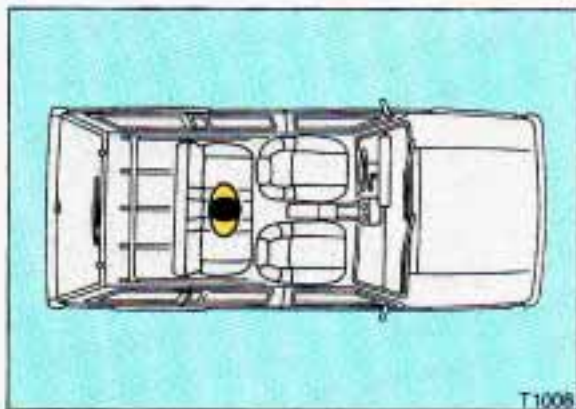

Center Passenger Position

If your vehicle has a rear bench seat, someone can sit in the center position.



When you sit in a center seating position, you have a lap safety belt, which has no retractor. To make the belt longer, tilt the latch plate and pull it along the belt.



To make the belt shorter, pull its free end as shown until the belt is snug. Buckle, position and release it the same way as the lap part of a lap-shoulder belt. If the belt isn't long enough, see the *Index* under *Safety Belt Extender*. Make sure the release button on the buckle faces upward or outward so you would be able to unbuckle it quickly if you ever had to.



■ Children

Everyone in a vehicle needs protection! That includes infants and all children smaller than adult size. In fact, the law in every state and Canadian province says children up to some age must be restrained while in a vehicle.

Smaller Children and Babies

CAUTION

 Smaller children and babies should always be restrained in a child or infant restraint. The instructions for the restraint will say whether it is the right type and size for your child. A very young child's hip bones are so small that a regular belt might not stay low on the hips, as it should. Instead, the belt will likely be over the child's abdomen. In a crash the belt would apply force right on the child's abdomen, which could cause serious or fatal injuries. So, be sure that any child small enough for one is always properly restrained in a child or infant restraint.



CAUTION

 Never hold a baby in your arms while riding in a vehicle. A baby doesn't weigh much—until a crash. During a crash a baby will become so heavy you can't hold it. For example, in a crash at only 25 mph (40 km/h), a 12-pound (5.5 kg) baby will suddenly become a 240-pound (110 kg) force on your arms. The baby would be almost impossible to hold.

(Continued)

Seats & Safety Belts



Smaller Children and Babies (CONT.)

CAUTION



(Continued)

Secure the baby in an infant restraint.

Child Restraints

Be sure to follow the instructions for the restraint. You may find these instructions on the restraint itself or in a booklet, or both. These restraints use the belt system in your vehicle, but the child also has to be secured within the restraint to help reduce the chance of personal injury. The instructions that come with the infant or child restraint will show you how to do that.

Where to Put the Restraint

Accident statistics show that children are safer if they are restrained in the rear rather than the front seat. We at General Motors therefore recommend that you put your child restraint in the rear seat unless the child is an infant and you're the only adult in the vehicle. In that case, you might want to secure the restraint in the front seat where you can keep an eye on the baby.

Wherever you install it, be sure to secure the child restraint properly.

CAUTION



An unsecured child restraint can move around in a collision or sudden stop and injure people in the vehicle. Be sure to properly secure any child restraint in your vehicle—even when no child is in it.

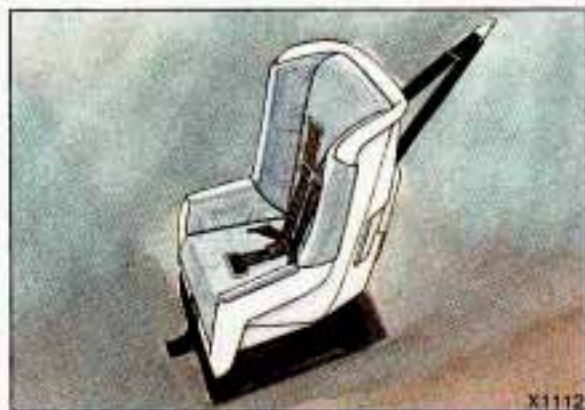

Top Strap

If your child restraint has a top strap, it should be anchored. If you need to have an anchor installed, you can ask your Oldsmobile dealer to put it in for you. If you want to install an anchor yourself, your dealer can tell you how to do it.

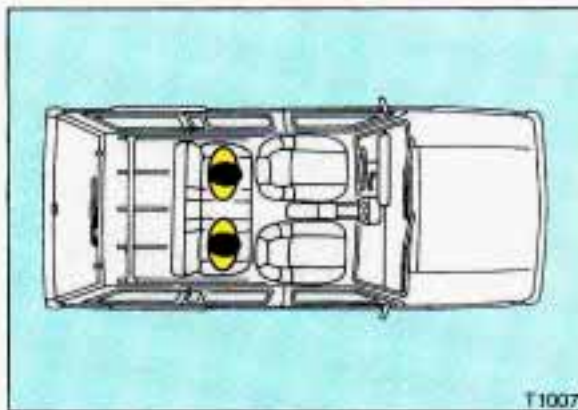

Securing a Child Restraint in a Rear Outside Position

You'll be using the lap-shoulder belt. See the earlier section about the top strap if the child restraint has one.

1. Put the restraint on the seat. Follow the instructions for the child restraint.
2. Secure the child in the child restraint as the instructions say.
3. Pull out the vehicle's safety belt and run the lap part through or around the restraint. The child restraint instructions will show you how. See if the shoulder belt would go in front of the child's face or neck. If so, put it behind the child restraint.

Seats & Safety Belts



Securing a Child Restraint in a Rear Outside Position (CONT.)

4. Buckle the belt. Make sure the release button faces upward or outward, so you'll be able to unbuckle it quickly if you ever need to.



5. Pull the rest of the shoulder belt all the way out of the retractor to set the lock.



6. To tighten the belt, feed the shoulder belt into the retractor while you push down on the child restraint.



7. Push and pull the child restraint in different directions to be sure it is secure.

To remove the child restraint, just unbuckle the vehicle's safety belt and let it go back all the way. The safety belt will move freely again and be ready to work for an adult or larger child passenger.

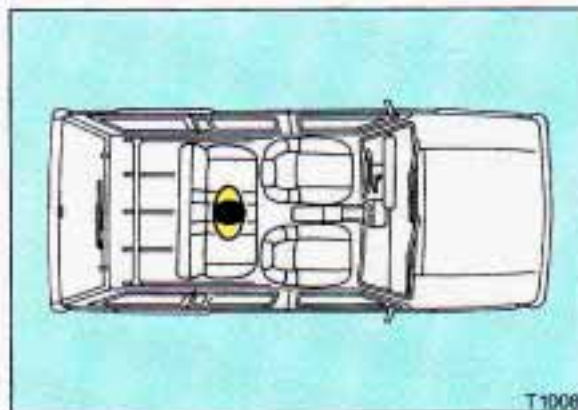

Securing a Child Restraint in a Center Seat Position

When you secure a child restraint in a center seating position, you'll be using the lap belt. But don't use the rear center seat, unless the base of the child restraint is small enough to let you reach the buckle and latch plate easily.

See the *Index* under *Top Strap* if the child restraint has one.

Seats & Safety Belts



Securing a Child Restraint in a Center Seat Position (CONT.)

1. Make the belt as long as possible by tilting the latch plate and pulling it along the belt.
2. Put the restraint on the seat. Follow the instructions for the child restraint.
3. Secure the child in the child restraint as the instructions say.



4. Run the vehicle's safety belt through or around the restraint. The child restraint instructions will show you how.
5. Buckle the belt. Make sure the release button faces upward or outward, so you'll be able to unbuckle it quickly if you ever need to.
6. To tighten the belt, pull its free end while you push down on the child restraint.
7. Push and pull the child restraint in different directions to be sure it is secure. If the child restraint isn't secure, turn the latch plate over and buckle it again. Then see if it is secure. If it isn't, secure the restraint in a different place in the vehicle and contact the child restraint maker for their advice.

To remove the child restraint, just unbuckle the vehicle's safety belt. It will be ready to work for an adult or larger child passenger.

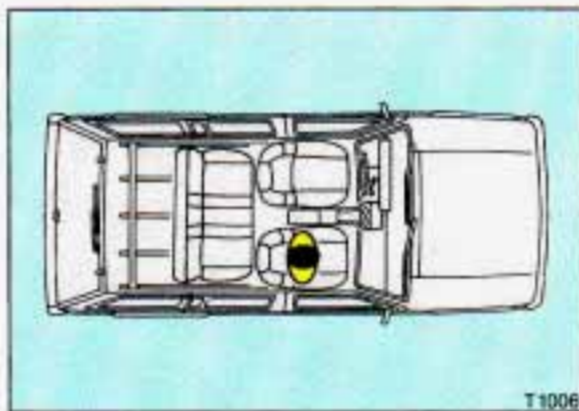

Securing a Child Restraint in the Right Front Seat

You'll be using the lap-shoulder belt. See the *Index* under *Top Strap* if the child restraint has one.

1. Put the restraint on the seat. Follow the instructions for the child restraint.
2. Secure the child in the child restraint as the instructions say.



3. Pull out the vehicle's safety belt and run the lap part through or around the restraint. The child restraint instructions will show you how.
See if the shoulder belt would go in front of the child's face or neck. If so, put it behind the child restraint.
4. Buckle the belt. Make sure the release button faces upward or outward, so you'll be able to unbuckle it quickly if you ever need to.

Seats & Safety Belts



Securing a Child Restraint in the Right Front Seat (CONT.)

5. Pull the rest of the lap belt all the way out of the retractor to set the lock.



6. To tighten the belt, feed the lap belt back into the retractor while you push down on the child restraint.



7. Push and pull the child restraint in different directions to be sure it is secure.
8. Adjust the bucket seat forward until the lap portion of the safety belt holds the restraint firmly. But don't move it any more than needed to tighten the lap belt.



To remove the child restraint, just unbuckle the vehicle's safety belt and let it go back all the way. The safety belt will move freely again and be ready to work for an adult or larger child passenger.

Larger Children

Children who have outgrown child restraints should wear the vehicle's safety belts. If you have the choice, a child should sit next to a window so the child can wear a lap-shoulder belt and get the additional restraint a shoulder belt can provide.

- Children who aren't buckled up can be thrown out in a crash.



- Children who aren't buckled up can strike other people who are.

Seats & Safety Belts



Larger Children (CONT.)

CAUTION



Never do this.

Here two children are wearing the same belt. The belt can't properly spread the impact forces. In a crash, the two children can be crushed together and seriously injured. A belt must be used by only one person at a time.

Q: What if a child is wearing a lap-shoulder belt, but the child is so small that the shoulder belt is very close to the child's face or neck?

A: Move the child toward the center of the vehicle, but be sure that the shoulder belt still is on the child's shoulder, so that in a crash the child's upper body would have the restraint that belts provide.

If the child is so small that the shoulder belt is still very close to the child's face or neck, you might want to place the child in a seat that has a lap belt, if your vehicle has one.



CAUTION



Never do this.

Here a child is sitting in a seat that has a lap-shoulder belt, but the shoulder part is behind the child. If the child wears the belt in this way, in a crash the child might slide under the belt. The belt's force would then be applied right on the child's abdomen. That could cause serious or fatal injuries.

Wherever the child sits, the lap portion of the belt should be worn low and snug on the hips, and just touching the child's thighs. This applies belt force to the child's pelvic bones in a crash.

Safety Belt Extender

If the vehicle's safety belt will fasten around you, you should use it.

But if a safety belt isn't long enough to fasten, your dealer will order you an extender. It's free. When you go in to order it, take the heaviest coat you will wear, so the extender will be long enough for you. The extender will be just for you, and just for the seat in your vehicle that you choose. Don't let someone else use it, and use it only for the seat it is made to fit. To wear it, just attach it to the regular safety belt.

Checking Your Restraint Systems

Now and then, make sure all your belts, buckles, latch plates, retractors, anchorages and reminder systems are working properly. Look for any loose parts or damage. If you see anything that might keep a restraint system from doing its job, have it repaired.



Replacing Safety Belts After a Crash

If you've had a crash, do you need new belts?

After a very minor collision, nothing may be necessary. But if the belts were stretched, as they would be if worn during a more severe crash, then you need new belts.

If you ever see a label on a right front safety belt that says to replace the belt, be sure to do so. Then it will be there to help protect you in an accident. You would see this label on the belt near the door opening.

If belts are cut or damaged, replace them. Collision damage also may mean you will have to have safety belt parts,

Seats & Safety Belts

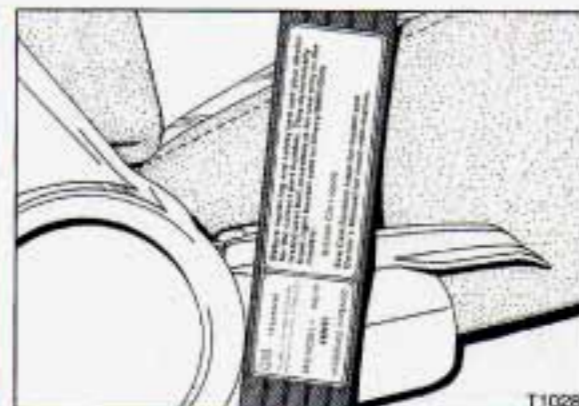

Replacing Safety Belts After a Crash (CONT.)

like the retractor, replaced or anchorage locations repaired—even if the belt wasn't being used at the time of the collision.

Q: What's wrong with this?

A: The belt is torn.

CAUTION

 Torn or frayed belts may not protect you in a crash. They can rip apart under impact forces. If a belt is torn or frayed, get a new one right away.

Before replacing any safety belt, see your dealer for the correct part number. You'll need the model year and model number for your vehicle. The model year is on your title and registration. And you can find the model number on the Certification/Tire label of your vehicle.

The model number on the replacement belt must be listed on the safety belt you want to replace.



Here you can learn about the many standard and optional features on your Oldsmobile, and information on starting, shifting and braking. Also explained are the instrument panel and the warning systems that tell you if everything is working properly—and what to do if you have a problem.

Part 2

Features & Controls

Keys	40
Locks	41
Remote Lock Control	42
Tailgate	45
Ignition	49
Starting Your Engine	50
Shifting the Transmission	53
Parking Brake	56
Shifting into Park	57
Horn	60
Tilt Steering Wheel	61
Windows	61
Turn Signal and Lane Change Indicator	62
Cruise Control	63
Headlights	67
Fog Lights	68
Windshield Wipers	69
Windshield Washer	70
Rear Window Wiper and Washer	71
Overhead Console	72
Sun Visors	77
Mirrors	77
Storage Compartments	79
Ashtrays and Lighter	81
Luggage Carrier	82
Instrument Panel	84
Gages	91
Warning Lights	97

Features & Controls



Keys

CAUTION

 Leaving young children in a vehicle with the ignition key is dangerous for many reasons. A child or others could be badly injured or even killed. They could operate power windows or other controls or even make the vehicle move. Don't leave the keys in a vehicle with young children.



The ignition keys are for the ignition only.



The door keys are for the doors and all other locks.

When a new Oldsmobile is delivered, the dealer removes the plugs from the keys and gives them to the first owner.

Each plug has a code on it that tells your dealer or a qualified locksmith how to make extra keys. Keep the plugs in a safe place. If you lose your keys, you'll be able to have new ones made easily using these plugs.

NOTICE

Your Oldsmobile has a number of new features that can help prevent theft. But you can have a lot of trouble getting into your vehicle if you ever lock your keys inside. You may even have to damage your vehicle to get in. So be sure you have extra keys.

Door Locks

CAUTION

 Unlocked doors can be dangerous.

Passengers—especially children—can easily open the doors and fall out. When a door is locked, the inside handle won't open it.

Outsiders can easily enter through an unlocked door when you slow down or stop your vehicle.

This may not be so obvious: You increase the chance of being thrown out of the vehicle in a crash if the doors aren't locked. Wear safety belts properly, lock your doors, and you will be far better off whenever you drive your vehicle.



There are several ways to lock and unlock your vehicle.

From the Outside:

Use your door key or Remote Lock Control.

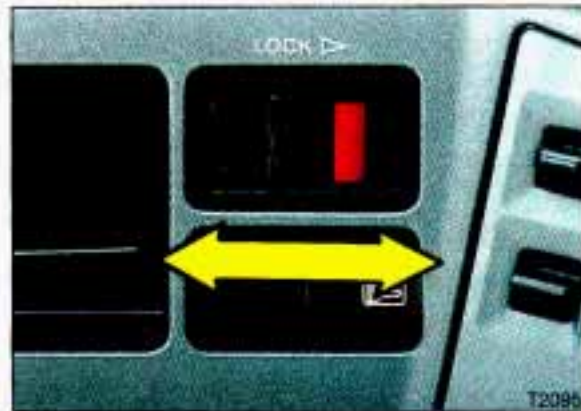

From the Inside:

To lock the door, push the manual locking lever forward. To unlock the door, push the lever back.

The rear doors have only a manual door lock lever.

Features & Controls



Power Door Locks

You can lock or unlock all doors at the same time from either front door. Push the switch forward to lock the doors. Push it rearward to unlock them. This switch does not keep you from locking or unlocking a door with the key.

The switch on each rear door works only that door's lock. It won't lock (or unlock) all of the doors—that's a safety feature.

Leaving Your Vehicle

If you are leaving the vehicle, open your door and set the locks from the inside. Then get out and close the door.



Remote Lock Control

You can lock and unlock your doors, or unlock your tailgate glass, from about 30 feet (9 m) using the key chain transmitter supplied with your vehicle.

Operation

When you press **UNLOCK**, the driver's door will unlock automatically. If you press **UNLOCK** again within five seconds, all doors will unlock. All doors will lock when **DOOR** is pressed.

The tailgate glass will unlock when  is pressed, but only when the transmission is in **P** (Park).

Matching Transmitters to Your Vehicle

Each key chain transmitter is coded to prevent another transmitter from unlocking your vehicle. If a transmitter is lost or stolen, a replacement can be purchased through your dealer.

Remember to bring the remaining transmitter with you when you go to your dealer. When the dealer matches the replacement transmitter to your vehicle, the remaining transmitter must also be matched. Once the new transmitter is coded, the lost transmitter will not unlock your vehicle.

You can match a transmitter to as many different vehicles as you own, provided they are equipped with **exactly the same model system**. (General Motors offers several different models of these systems on their vehicles.) Each vehicle can have only two transmitters matched to it.

Your Remote Lock Control operates on a radio frequency subject to Federal Communications Commission (FCC) Rules.

This device complies with Part 15 of the FCC Rules. Operation is subject to the following two conditions: (1) This device may not cause harmful interference, and (2) This device must accept any interference received, including interference that may cause undesired operation.

Should interference to this system occur, try this:

- Check to determine if battery replacement is necessary. See the instructions on battery replacement.
- Check the distance. You may be too far from the vehicle. This product has a maximum range.
- Check the location. Other vehicles or objects may be blocking the signal.
- See your Oldsmobile dealer or a qualified technician for service.

Changes or modifications to this system by other than an authorized service facility could void authorization to use this equipment.

Battery Replacement

Under normal use, the batteries in your key chain transmitter should last about two years.

You can tell the batteries are weak if the transmitter won't work at the normal range in any location. If you have to get close to your vehicle before the transmitter works, it's probably time to change the batteries.

Features & Controls

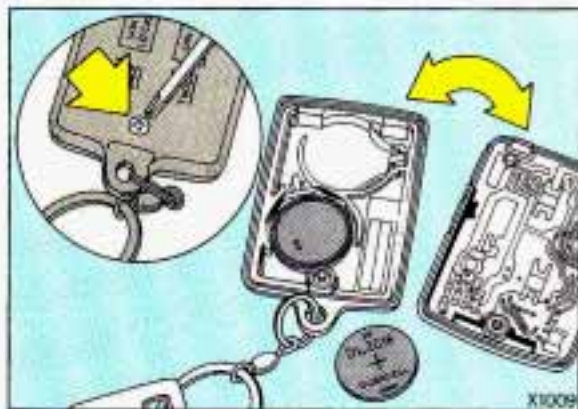

Battery Replacement (CONT.)

To Replace Batteries in the Remote Lock Control:

1. If your transmitter has a screw, remove it from the back cover. If it doesn't have a screw, pop the cover off by inserting a dime (or something similar) in the slot between the covers and twisting.
2. Lift the front cover off, bottom half first.
3. Remove and replace the batteries (2016).
4. Reassemble the transmitter.
5. Check the transmitter operation.

Theft

Vehicle theft is big business, especially in some cities. Although your Oldsmobile has a number of theft deterrent features, we know that nothing we put on it can make it impossible to steal. However, there are ways you can help.

Key in the Ignition:

If you walk away from your vehicle with the keys inside, it's an easy target for joy riders or professional thieves—so don't do it. When you park your Oldsmobile and open the driver's door, you'll hear a tone reminding you to remove your key from the ignition and take it with you. Always do this. Your steering wheel will be locked, and so will your ignition and transmission. And remember to lock your doors.

Parking at Night:

Park in a lighted spot, close all windows and lock your vehicle. Remember to keep your valuables out of sight. Put them in a storage area, or take them with you.

Parking Lots:

If you park in a lot where someone will be watching your vehicle, it's best to lock it up and take your keys. But what if you have to leave your ignition key? What if you have to leave something valuable in your vehicle?

- Put your valuables in a storage area, like your glove box.
- Lock the glove box.
- Lock all doors except the driver's.
- Then take the door key with you.



Tailgate Lock

From the outside, use the round key to open the tailgate. With the key in the lock, turn the lock handle to the left to unlock the window.

Raise the window, then turn the lock handle to the right to unlock the tailgate.



Power Tailgate Window Release

From inside the vehicle, press the **REAR WINDOW** button, located to the left of the radio, to unlock the tailgate window.

Your shift lever must be in **P** (Park) or **N** (Neutral).

CAUTION



It can be dangerous to drive with the tailgate window open. Carbon monoxide (CO) gas can come into your vehicle. You can't see or smell CO. It can cause unconsciousness and even death. If you must drive with the tailgate window open:

- Make sure all other windows are shut.
- Turn the fan on your heating or cooling system to its highest speed with the setting on **VENT** or **BI-LEV A/C**. That will force outside air into your vehicle. See the *Index* under *Comfort Controls*.
- If you have air vents on or under the instrument panel, open them all the way.

Features & Controls



Tailgate-Mounted Spare Tire Carrier (OPTION)

You must move the carrier arm out of the way to open the tailgate window.



Here's How to Move the Arm:

1. Squeeze the release handle to free the carrier arm.
2. Swing the carrier arm away from the tailgate. You may need to give it a slight tug.

To latch the carrier arm, swing it hard toward the tailgate. The latch has two catches, so push hard on the carrier arm to make sure it has locked in place. It shouldn't move. If it is not securely latched the carrier may rattle.



Glove Box

Use the door key to lock and unlock the glove box. To open, pinch the latch release.

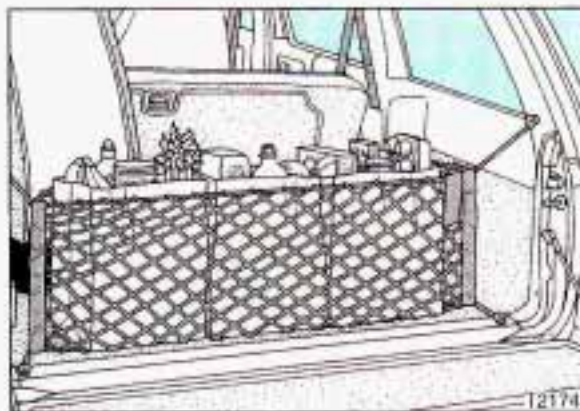

Convenience Net

A convenience net may be provided for the rear of your vehicle to help keep small loads, like grocery bags, from falling over during sharp turns or quick stops and starts. The net is not designed to retain these items during off-road use or an accident, and is not for larger, heavier loads. Store such things on the load floor as far forward as you can.

Install the convenience net at the rear of your vehicle, just inside the tailgate. Attach the upper loops to the posts on either side of the tailgate opening (the label should be in the upper righthand corner). Attach the lower loops to the hooks on the floor.

The side of the convenience net closest to the front of the vehicle has a loop that

Features & Controls

Convenience Net (CONT.)

you can use as a handle. Pull the handle away from you to load items into the net.

When not in use, we recommend that you take down the convenience net to extend its life and retain its elasticity.

New Vehicle "Break-In"

NOTICE

Your modern Oldsmobile doesn't need an elaborate "break-in." But it will perform better in the long run if you follow these guidelines:

- Keep your speed at 55 mph (88 km/h) or less for the first 500 miles (804 km).
- Don't drive at any one speed—fast or slow—for the first 500 miles (804 km). Don't make full-throttle starts.
- Avoid making hard stops for the first 200 miles (322 km) or so. During this time your new brake linings aren't yet broken in. Hard stops with new linings can mean premature wear and earlier replacement. Follow this "breaking-in" guideline every time you get new brake linings.

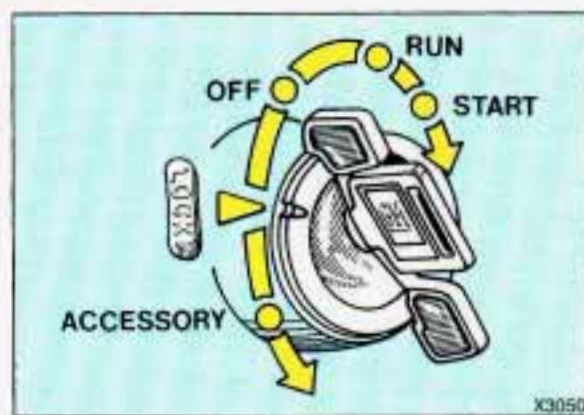

Ignition Switch

With the ignition key in the ignition switch, you can turn the switch to five positions:

Accessory: An “on” position in which you can operate your electrical power accessories. Press in the ignition switch as you turn the top of it toward you.

Lock: The only position in which you can remove the key. This locks your steering wheel, ignition and transmission.

Off: Unlocks the steering wheel, ignition, and transmission, but does not send electrical power to any accessories. Use this position if your vehicle must be pushed or towed, but never try to push-start your vehicle. A warning chime will sound if you open the driver’s door when the ignition is off and the key is in the ignition.

Run: An “on” position to which the switch returns after you start your engine and release the switch. The switch stays in the **Run** position when the engine is running. But even when the engine is not running, you can use **Run** to operate your electrical power accessories, and to display some instrument panel warning lights.

Start: Starts the engine. When the engine starts, release the key. The ignition switch will return to **Run** for normal driving.

Note that even if the engine is not running, the positions **Accessory** and **Run** are “on” positions that allow you to operate your electrical accessories, such as the radio.

NOTICE

If your key seems stuck in **Lock** and you can’t turn it, be sure it is all the way in. If it is, then turn the steering wheel left and right while you turn the key hard. But turn the key only with your hand. Using a tool to force it could break the key or the ignition switch. If none of this works, then your vehicle needs service.

Features & Controls

Starting Your Engine

Move your shift lever to **P** (Park) or **N** (Neutral). Your engine won't start in any other position—that's a safety feature. To restart when you're already moving, use **N** (Neutral) only.

NOTICE

Don't try to shift to **P** (Park) if your Oldsmobile is moving. If you do, you could damage the transmission. Shift to **P** (Park) only when your vehicle is stopped.

1. Don't push the accelerator pedal before starting your engine. In some other vehicles you might need to do this, but because of your vehicle's computer systems, you don't.
2. Turn your ignition key to **Start**. When the engine starts, let go of the key. The idle speed will go down as your engine gets warm.

NOTICE

Holding your key in **Start** for longer than 15 seconds at a time will cause your battery to be drained much sooner. And the excessive heat can damage your starter motor.

3. If it doesn't start right away, hold your key in **Start**. If it doesn't start in three seconds, push the accelerator pedal about one-quarter of the way down for 12 more seconds, or until it starts.

4. If your engine still won't start (or starts but then stops), it could be flooded with too much gasoline. Try this:

Wait 15 seconds to let the starter motor cool down. Then push your accelerator pedal all the way to the floor. Hold it there. Then, hold the key in **Start** for no more than 10 seconds. This clears the extra gasoline from the engine. If the engine still doesn't start, wait another 15 seconds and do it all again. When the engine starts, let go of the key and the accelerator pedal.

NOTICE

Your engine is designed to work with the electronics in your vehicle. If you add electrical parts or accessories, you could change the way the fuel injection system operates. Before adding electrical equipment, check with your dealer. If you don't, your engine might not perform properly.

If you ever have to have your vehicle towed, see the part of this manual that tells how to do it without damaging your vehicle. See the *Index* under *Towing Your Bravada*.

Driving Through Deep Standing Water

NOTICE

If you drive too quickly through deep puddles or standing water, water can come in through your engine's air intake and badly damage your engine. If you can't avoid deep puddles or standing water, drive through them very slowly.

Features & Controls



Engine Block Heater (OPTION)

In very cold weather, 0°F (-18°C) or colder, the engine block heater can help. You'll get easier starting and better fuel economy during engine warm-up.

To Use the Block Heater:

1. Turn off the engine.
2. Open the hood and unwrap the electrical cord.
3. Plug it into a normal, grounded 110-volt outlet.

CAUTION



Plugging the cord into an ungrounded outlet could cause an electrical shock. Also, the wrong kind of extension cord could overheat and cause a fire. You could be seriously injured. Plug the cord into a properly grounded three-prong 110-volt outlet. If the cord won't reach, use a heavy-duty three-prong extension cord rated for at least 15 amps.

NOTICE

After you've used the block heater, be sure to store the cord as it was before, to keep it away from moving engine parts. If you don't, it could be damaged.

How long should you keep the block heater plugged in? The answer depends on the weather, the kind of oil you have, and some other things. Instead of trying to list everything here, we ask that you contact an Oldsmobile dealer in the area where you'll be parking your vehicle. The dealer can give you the best advice for that particular area.



■ *Shifting the Automatic Transmission*

There are several different positions for your shift lever.

Park	P
Reverse	R
Neutral	N
Overdrive	D
Drive	D
Second	2
First	1



Park

P (Park): This locks your rear wheels. It's the best position to use when you start your engine because your vehicle can't move easily.

CAUTION



It is dangerous to get out of your vehicle if the shift lever is not fully in **P** (Park) with the parking brake firmly set. Your vehicle can roll.

Don't leave your vehicle when the engine is running unless you have to. If you have left the engine running, the vehicle can move suddenly. You or others could be injured. To be sure your vehicle won't move, when you're on fairly level ground, always set your parking brake and move the shift lever to **P** (Park). See the *Index* under *Shifting Into P (Park)*. If you are parking on a hill, or if you're pulling a trailer, also see the *Index* under *Parking on Hills* or *Towing a Trailer*.

Features & Controls



Reverse

R (Reverse): Use this gear to back up.

NOTICE

Shifting to **R** (Reverse) while your vehicle is moving forward could damage your transmission. Shift to **R** only after your vehicle is stopped.

To rock your vehicle back and forth to get out of snow, ice or sand without damaging your transmission, see the *Index* under *If You're Stuck: In Sand, Mud, Ice or Snow*.



Neutral

N (Neutral): In this position, your engine doesn't connect with the wheels. To restart when you're already moving, use **N** (Neutral) only.

CAUTION



Shifting out of **P** (Park) or **N** (Neutral) while your engine is "racing" (running at high speed) is dangerous. Unless your foot is firmly on the brake pedal, your vehicle could move very rapidly. You could lose control and hit people or objects. Don't shift out of **P** (Park) or **N** (Neutral) while your engine is racing.

NOTICE

Damage to your transmission caused by shifting out of **P** (Park) or **N** (Neutral) with the engine racing isn't covered by your warranty.



Forward Gears

D (Automatic Overdrive): This position is for normal driving. If you need more power for passing, and you're:

- Going less than about 35 mph (56 km/h), push your accelerator pedal about halfway down.
- Going about 35 mph (56 km/h) or more, push the accelerator all the way down.

You'll shift down to the next gear and have more power.

D (Third Gear): This is like **D**, but you never go into Overdrive. Here are some times you might choose **D** instead of **D**:

- When driving on hilly, winding roads.
- When towing a trailer, so there is less shifting between gears.
- When going down a steep hill.

2 (Second Gear): This position gives you more power but lower fuel economy. You can use **2** on hills. It can help control your speed as you go down steep mountain roads, but then you would also want to use your brakes off and on.

Features & Controls

Forward Gears (CONT.)

1 (First Gear): This position gives you even more power (but lower fuel economy) than **2**. You can use it on very steep hills, or in deep snow or mud. If the selector lever is put in **1**, the transmission won't shift into first gear until the vehicle is going slowly enough.

NOTICE

If your rear wheels can't rotate, don't try to drive. This might happen if you were stuck in very deep sand or mud or were up against a solid object. You could damage your transmission or transfer case or both.

Also, if you stop when going uphill, don't hold your vehicle there with only the accelerator pedal. This could overheat and damage the transmission. Use your brakes or shift into **P** (Park) to hold your vehicle in position on a hill.



Parking Brake

To Set the Parking Brake:

Hold the regular brake pedal down with your right foot. Push down the parking brake pedal with your left foot. If the ignition is on, the brake system warning light will come on.



To Release the Parking Brake:

Hold the regular brake pedal down. Pull the **BRAKE RELEASE** lever.

NOTICE

Driving with the parking brake on can cause your rear brakes to overheat. You may have to replace them, and you could also damage other parts of your vehicle.

If You Are on a Hill:

See the *Index* under *Parking on Hills*. That section shows how to turn your front wheels.

If You Are Towing a Trailer and Are Parking on a Hill:

See the *Index* under *Towing a Trailer*. That section shows what to do first to keep the trailer from moving.

Shifting Into P (Park)

CAUTION



It is dangerous to get out of your vehicle if the shift lever is not fully in **P** (Park) with the parking brake firmly set. Your vehicle can roll. If you have left the engine running, the vehicle can move suddenly. You or others could be injured. To be sure your vehicle won't move, when you're on fairly level ground, use the steps that follow. If you are parking on a hill, or if you're pulling a trailer, also see the *Index* under *Parking on Hills* or *Towing a Trailer*.

1. Hold the brake pedal down with your right foot and set the parking brake.

Features & Controls



Shifting into P (Park) (CONT.)

2. Move the shift lever into the **P** (Park) position like this:
 - Pull the lever toward you.



- Move the lever up as far as it will go.
3. Move the ignition key to **Lock**.
 4. Remove the key and take it with you. If you can walk away from your vehicle with the ignition key in your hand, your vehicle is in **P** (Park).

Leaving Your Vehicle with the Engine Running

CAUTION

 It is dangerous to leave your vehicle with the engine running. Your vehicle could move suddenly if the shift lever is not fully in **P** (Park) with the parking brake firmly set. And, if you leave the vehicle with the engine running, it could overheat and even catch fire. You or others could be injured. Don't leave your vehicle with the engine running unless you have to.

If you have to leave your vehicle with the engine running, be sure your vehicle is in **P** (Park) and your parking brake is firmly set before you leave it. After you've moved the shift lever into the **P** (Park) position, hold the regular brake pedal down. Then, see if you can move the shift lever away from **P** (Park) without first pulling it toward you.

If you can, it means that the shift lever wasn't fully locked into **P** (Park).



Parking Over Things That Burn

CAUTION

 Things that can burn could touch hot exhaust parts under your vehicle and ignite. Don't park over papers, leaves, dry grass or other things that can burn.

Engine Exhaust

CAUTION

 Engine exhaust can kill. It contains the gas carbon monoxide (CO), which you can't see or smell. It can cause unconsciousness and death.

You might have exhaust coming in if:

- Your exhaust system sounds strange or different.
- Your vehicle gets rusty underneath.
- Your vehicle was damaged in a collision.
- Your vehicle was damaged when driving over high points on the road or over road debris.
- Repairs weren't done correctly.
- Your vehicle or exhaust system had been modified improperly.

If you **ever** suspect exhaust is coming into your vehicle:

- Drive it only with all the windows down to blow out any CO; and
- Have it fixed **immediately**.

Features & Controls

Running Your Engine While You're Parked

It's better not to park with the engine running. But if you ever have to, here are some things to know.

CAUTION



Idling the engine with the air system control **OFF** could allow dangerous exhaust into your vehicle (see the earlier CAUTION under *Engine Exhaust*).

Also, idling in a closed-in place can let deadly carbon monoxide (CO) into your vehicle even if the fan switch is at the highest setting. One place this can happen is a garage. Exhaust—with CO—can come in easily. **Never** park in a garage with the engine running.

Another closed-in place can be a blizzard. (See the *Index* under *Blizzard*.)

It can be dangerous to get out of your vehicle if the shift lever is not fully in **P** (Park) with the parking brake firmly set. Your vehicle can roll. Don't leave your vehicle when the engine is running unless you have to. If you've left the engine running, the vehicle can move suddenly. You or others could be injured. To be sure your vehicle won't move, even when you're on fairly level ground, always set your parking brake and move the shift lever to **P** (Park).

If you are parking on a hill, or if you're pulling a trailer, also see the *Index* under *Parking on Hills* or *Towing a Trailer*.

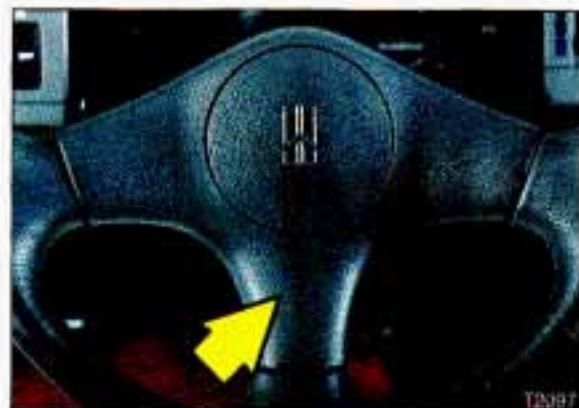

Horn

You can sound the horn by pressing the horn symbol on your steering wheel.

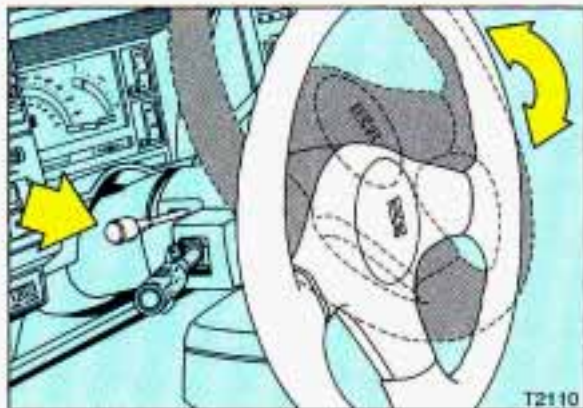

T2110

Tilt Steering Wheel

A tilt steering wheel allows you to adjust the steering wheel before you drive. You can also raise it to the highest level to give your legs more room when you exit and enter the vehicle.

To tilt the wheel, hold the steering wheel and pull the lever. Move the steering wheel to a comfortable level, then release the lever to lock the wheel in place.



T2084

Power Windows

Switches on the driver's door control each of the windows when the ignition is on. In addition, each passenger door has a control switch for its own window.

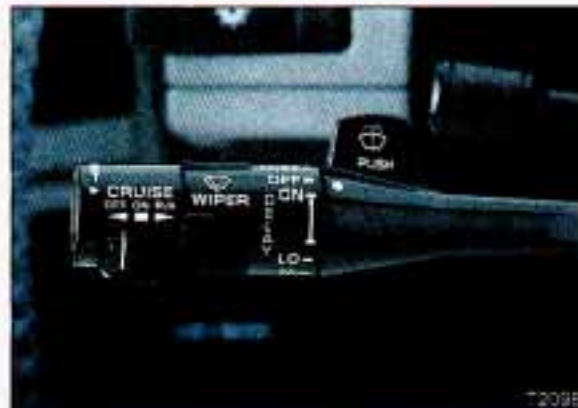

T2098

■ *Turn Signal/Headlight Beam Lever*

The lever on the left side of the steering column includes your:

- Turn Signal and Lane Change Indicator
- Cruise Control
- Headlight High-Low Beam
- Windshield Wipers
- Windshield Washer

The High-Low Beam feature is discussed under *Headlights*. See the *Index* under *Headlights*.

Features & Controls

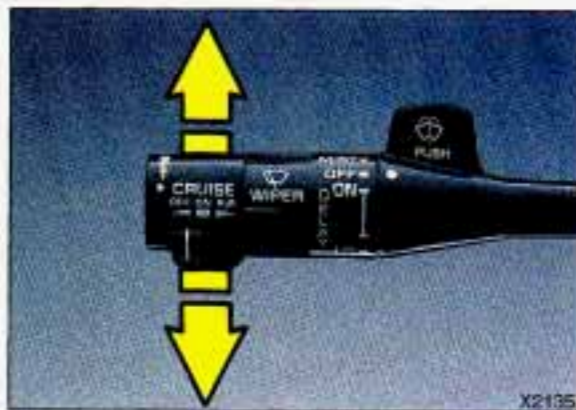

Turn Signal and Lane Change Indicator

The turn signal has two upward (for Right) and two downward (for Left) positions. These positions allow you to signal a turn or a lane change.

To signal a turn, move the lever all the way up or down. When the turn is finished, the lever will return automatically.

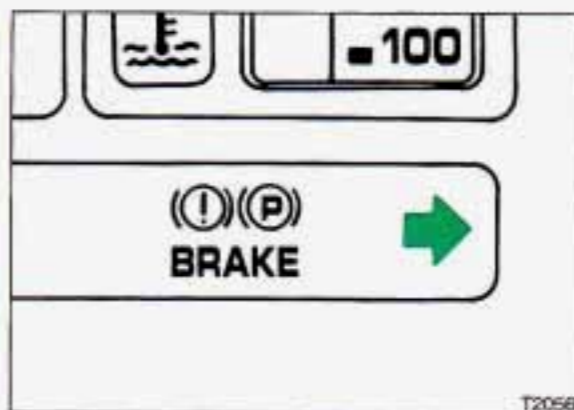

A green arrow on the instrument panel will flash in the direction of the turn or lane change.

To signal a lane change, just raise or lower the lever until the green arrow starts to flash. Hold it there until you complete your lane change. The lever will return by itself when you release it.

As you signal a turn or a lane change, if the arrows don't flash but just stay on, a signal bulb may be burned out and other drivers won't see your turn signal. (If your vehicle has the digital instrument cluster, the turn signal arrows will flash at a faster rate if a signal bulb is burned out.)

If a bulb is burned out, replace it to help avoid an accident.

If the green arrows don't go on at all when you signal a turn, check the fuse (see the *Index* under *Fuses & Circuit Breakers*) and for burned-out bulbs.

If you have a trailer towing option with added wiring for the trailer lights, a different turn signal flasher is used. With this flasher installed, the signal indicator will flash even if a turn signal bulb is burned out. Check the front and rear turn signal lights regularly to make sure they are working.

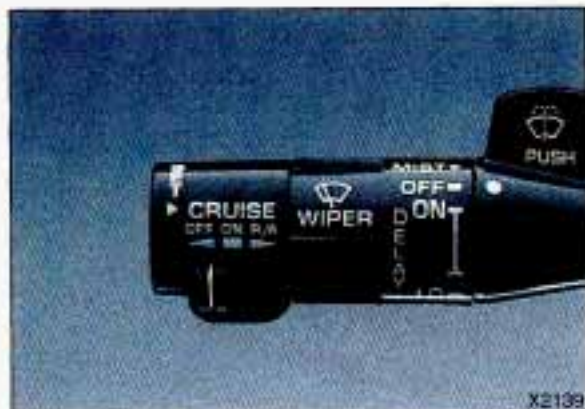

■ Cruise Control

With cruise control, you can maintain a speed of about 25 mph (40 km/h) or more without keeping your foot on the accelerator. This can really help on long trips.

Cruise control does not work at speeds below about 25 mph (40 km/h).

When you apply your brakes, the cruise control shuts off.

CAUTION



- Cruise control can be dangerous where you can't drive safely at a steady speed. So, don't use your cruise control on winding roads or in heavy traffic.
- Cruise control can be dangerous on slippery roads. On such roads, fast changes in tire traction can cause needless wheel spinning, and you could lose control. Don't use cruise control on slippery roads.

To Set Cruise Control

1. Move the cruise control switch to **ON**.

CAUTION



If you leave your cruise control switch **ON** when you're not using cruise, you might hit a button and go into cruise when you don't want to. You could be startled and even lose control. Keep the cruise control switch **OFF** until you want to use it.

2. Get up to the speed you want.

Features & Controls

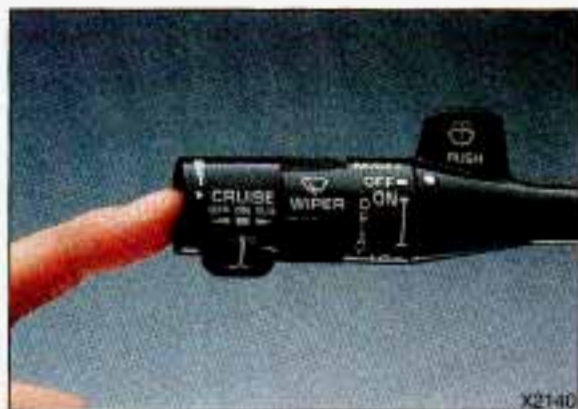

To Set Cruise Control (CONT.)

3. Push in the SET button at the end of the lever and release it.
4. Take your foot off the accelerator pedal.



To Resume a Set Speed

Suppose you set your cruise control at a desired speed and then you apply the brake. This, of course, shuts off the cruise control. But you don't need to reset it. Once you're going about 25 mph (40 km/h) or more, you can move the cruise control switch from ON to R/A (which stands for Resume/Accelerate) for about half a second.

You'll go right back up to your chosen speed and stay there.

CAUTION



If you hold the switch at R/A longer than half a second, the vehicle will keep going faster until you release the switch or apply the brake. You could be startled and even lose control. So unless you want to go faster, don't hold the switch at R/A.

To Increase Speed While Using Cruise Control

There are two ways to go to a higher speed. Here's the first:

1. Use the accelerator pedal to get to the higher speed.
2. Push the button at the end of the lever, then release the button and the accelerator pedal. You'll now cruise at the higher speed.

Here's the second way to go to a higher speed:

- Move the cruise switch from **ON** to **R/A**. Hold it there until you get up to the speed you want, and then release the switch.
- To increase your speed in very small amounts, move the switch to **R/A** for less than half a second and then release it. Each time you do this, your vehicle will go about 1 mph (1.6 km/h) faster.

To Reduce Speed While Using Cruise Control

There are two ways to reduce your speed while using cruise control:

- Push in the button at the end of the lever until you reach the lower speed you want, then release it.
- To slow down in very small amounts, push the button for less than half a second. Each time you do this, you'll go 1 mph (1.6 km/h) slower.

Features & Controls

Passing Another Vehicle While Using Cruise Control

Use the accelerator pedal to increase your speed. When you take your foot off the pedal, your vehicle will slow down to the cruise control speed you set earlier.

Using Cruise Control on Hills

How well your cruise control will work on hills depends upon your speed, load, and the steepness of the hills. When going up steep hills, you may have to step on the accelerator pedal to maintain your speed. When going downhill, you may have to brake or shift to a lower gear to keep your speed down. Of course, applying the brake takes you out of cruise control. Many drivers find this to be too much trouble and don't use cruise control on steep hills.

To Get Out of Cruise Control

There are two ways to turn off the cruise control:

- Step lightly on the brake pedal; OR
- Move the cruise switch to **OFF**.

To Erase Cruise Speed Memory

When you turn off the cruise control or the ignition, your cruise control set speed memory is erased.



Headlights

Push the switch marked **P** to turn on:

- Parking Lights
- Side Marker Lights
- Taillights
- Instrument Panel Lights



Push the  switch to turn on the headlights, together with:

- Parking Lights
- Side Marker Lights
- Taillights
- Instrument Panel Lights

Pull the switch or press **OFF** to turn off the lights.

Operation of Lights

Although your vehicle's lighting system (headlamps, parking lamps, fog lamps, side marker lamps and tail lamps) meets all applicable federal lighting requirements, certain states and provinces may apply their own lighting regulations that may require special attention before you operate these lamps. For example, some jurisdictions may require that you operate your lower beam lamps with fog lamps at all times, or that headlamps be turned on whenever you must use your windshield wipers. In addition, most jurisdictions prohibit driving solely with parking lamps, especially at dawn or dusk. It is recommended that you check with your own state or provincial highway authority for applicable lighting regulations.

Lights On Reminder

If you open the door while leaving the lights on, you will hear a warning tone.

Features & Controls



Headlight High-Low Beam

To change the headlights from low beam to high or high to low, pull the turn signal lever all the way toward you. Then release it.

When the high beams are on, a blue light on the instrument panel also will be on.



Instrument Panel Intensity Control

Turn the dial above the headlight switch to the left to dim your instrument panel lights. This will also silence your Lights On Reminder.

Turn the dial to the right to make your instrument panel lights brighter. If you turn the dial all the way to the right until it clicks, your interior lights will come on.



Fog Lights

Use your fog lights for better vision in foggy or misty conditions. Your parking lights or low beam headlights must be on for them to come on.

The fog light switch is on the instrument panel under the headlight switch. Press the right side of the switch to turn the fog lights on, and the left side of the switch to turn them off. An indicator light will glow in the right side of the switch when they are on.

Remember, fog lights alone will not give off as much light as your headlights. Never use your fog lights in the dark without turning on your headlights.

The fog lights will go off whenever your high beam headlights come on. When the high beams go off, the fog lights will come on again.

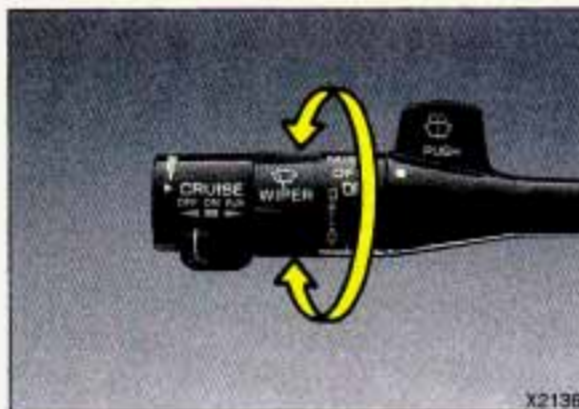

Windshield Wipers

You control the windshield wipers by turning the band marked **WIPER**.

For a single wiping cycle, turn the band to **MIST**. Hold it there until the wipers start, then let go. The wipers will stop after one cycle. If you want more cycles, hold the band on **MIST** longer.

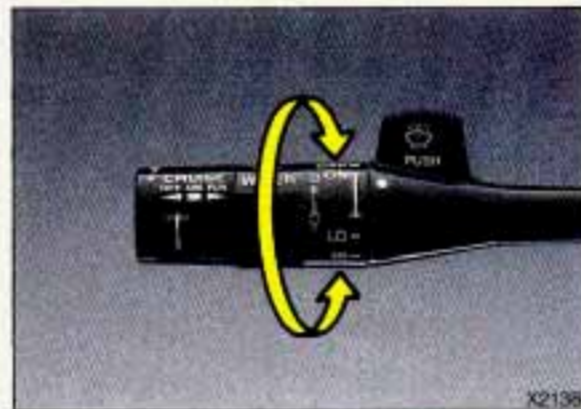

You can set the wiper speed for a long or short delay between wipes. This can be very useful in light rain or snow. Turn the band to choose the delay time. The closer to **LO**, the shorter the delay.

For steady wiping at low speed, turn the band away from you to the **LO** position. For high speed wiping, turn the band further, to **HI**. To stop the wipers, move the band to **OFF**.

Features & Controls

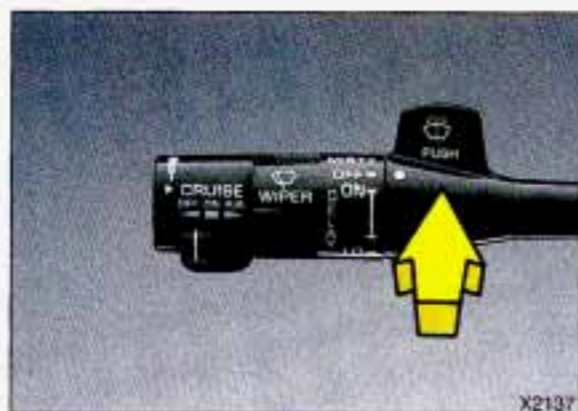

Windshield Wipers (CONT.)

CAUTION

 Damaged wiper blades may prevent you from seeing well enough to drive safely. To avoid damage, be sure to clear ice and snow from the wiper blades before using them. If they're frozen to the windshield, carefully loosen or thaw them. If your blades do become damaged, get new blades or blade inserts.

Heavy snow or ice can overload your wipers. A circuit breaker will stop them until the motor cools. Clear away snow or ice to prevent an overload.

Windshield Washer

At the top of the turn signal/headlight beam lever there's a paddle with the word **PUSH** on it. To spray washer fluid on the windshield, push the paddle.

The wipers will clear the window and then either stop or return to your preset speed.

See the *Index* under *Windshield Washer Fluid*.

CAUTION

-  Driving without washer fluid can be dangerous. A bad mud splash can block your vision. You could hit another vehicle or go off the road. Check your washer fluid level often.
- In freezing weather, don't use your washer until the windshield is warmed. Otherwise the washer fluid can form ice on the windshield, blocking your vision.

NOTICE

- When using concentrated washer fluid, follow the manufacturer's instructions for adding water.
- Don't mix water with ready-to-use washer fluid. Water can cause the solution to freeze and damage your washer fluid tank and other parts of the washer system. Also, water doesn't clean as well as washer fluid.
- Fill your washer fluid tank only $\frac{3}{4}$ full when it's very cold. This allows for expansion, which could damage the tank if it is completely full.
- Don't use radiator antifreeze in your windshield washer. It can damage your washer system and paint.



Rear Window Wiper and Washer

The switch to control the rear window wiper and washer is on the left side of the instrument panel.

To Turn the Wiper On:

Press the top of the switch to the first position.

To Wash the Window:

Press the top of the switch in all the way and hold it there. The wiper will continue to work after you release the switch.

To Turn the Wiper Off:

Press the bottom of the switch.

The rear window washer uses the same fluid reservoir as the windshield washer. However, the rear window washer will run out of fluid before the windshield washer, because fluid will not flow easily to the rear of the vehicle when it reaches a low level. If you can wash your windshield but not your rear window, check your fluid level.

CAUTION



Driving without washer fluid can be dangerous. A bad mud splash can block your vision. You could hit another vehicle or go off the road. Check your washer fluid level often.

Features & Controls

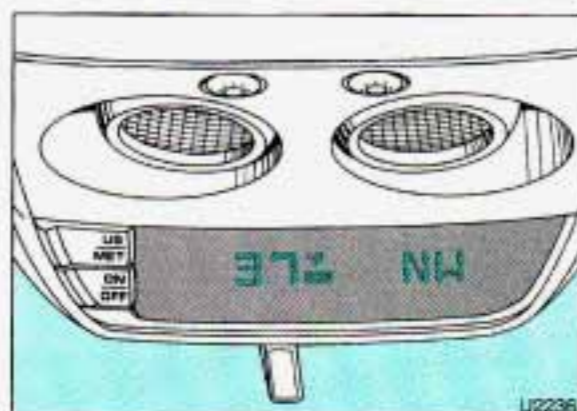

■ *Overhead Console*

The front overhead console has reading lights, a center dome light, a compass and outside temperature display, and storage compartments—including one for your garage door opener and one for sunglasses.

Temperature and Compass Display

The outside air temperature and the compass are displayed at the front of the overhead console. The control switches are located to the left of the display.

Turn the display on or off by pressing the **ON/OFF** switch. Display the temperature in either degrees Fahrenheit (English) or Celsius (metric) by pressing the **US/MET** switch.

Before you turn on the ignition and move the vehicle, the temperature indicated will be the last outside temperature recorded with the ignition on.

If the outside temperature is 37°F (3°C) or lower when you turn on the ignition, **ICE** will appear on the display. It's a caution to the driver that road conditions may be icy, and that appropriate precautions should be taken.

Compass Calibration:

The compass is self-calibrating, so it does not need to be manually set. However, when your Bravada is new, the compass may function erratically. If it does, **CAL** (Calibration) will appear on the display. To correct the problem, drive in a complete 360° circle three times, and the compass will function normally.



Compass Variance:

Variance is the difference between magnetic north and geographic north. In some areas the difference between the two can be great enough to cause false compass readings. If this happens, follow these instructions to set the variance for your particular location:

1. Locate your location on the zone map. Note your zone number.

2. Press and hold both the **ON/OFF** and the **US/MET** switches. The display will go off.
3. After 5 seconds, **VAR CAL** will appear on the display. When it does, release both buttons.
4. Press **US/MET** until your zone number appears on the display.
5. Press **ON/OFF** to enter your zone number. Your variance is now set.

Features & Controls



Garage Door Opener Compartment

You can store your garage door opener in the front compartment of your overhead console, and operate it from this position. To install your garage door opener, follow these instructions:

1. Open the compartment by pressing the compartment latch forward. Remove the piece of self-sticking Velcro®

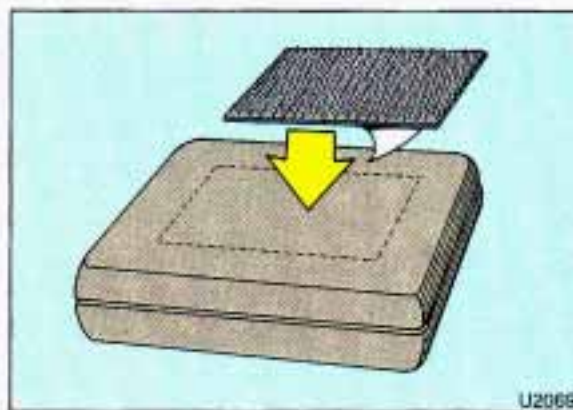

2. Then peel the protective backing from the Velcro® and press it firmly to the back of your garage door opener.

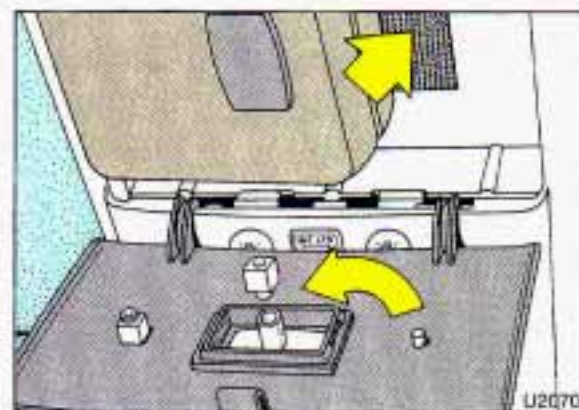

3. To make sure the button on your garage door opener is centered above the button on the compartment door, use the white intersecting lines inside the compartment as a guide. Center the control button of your garage door opener over the point where the lines intersect, and press the opener firmly into place. Make sure the button is facing down.
4. Once the opener is installed, the button on the compartment door must be adjusted so that it will contact the control button on your garage door opener. Use the pegs located inside the compartment door.



5. Add one peg at a time until your garage door opener operates when you press the button with the compartment door closed.



Overhead Storage Compartment

To open the rear storage compartment in the overhead console, press the release button.



Sunglasses Storage Compartment

To open the sunglasses storage compartment in the overhead console, press the release button. Then pull the compartment down to the full open position, as shown.

Features & Controls



Console Reading Lights

To turn either reading light on or off, press the switch next to it. To adjust the aim of the lights, simply pivot the lamps in their sockets.



Center Dome Light

Located in the center of your vehicle, this light has no switch of its own. It will go on each time you open the doors. You can also turn it on by turning the Instrument Panel Intensity Control to the right until it clicks.

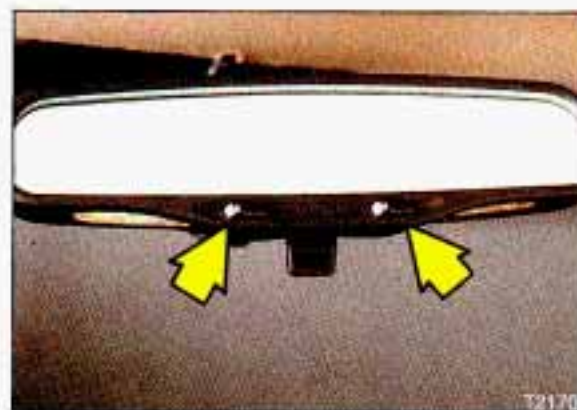

Front Reading Lights

These lights are part of the rearview mirror, and may be operated in two ways:

- With the ignition on, turn each light on and off with its switch.
- With the ignition off, open any door. These lights will come on for about 15 seconds, then turn off.

If you turn on the ignition during this delay, the lights will turn off immediately.

To avoid draining your vehicle's battery power, be sure to turn off all interior lights when leaving your vehicle. But remember that the mirror reading lights will still come on for about 15 seconds, then turn off.

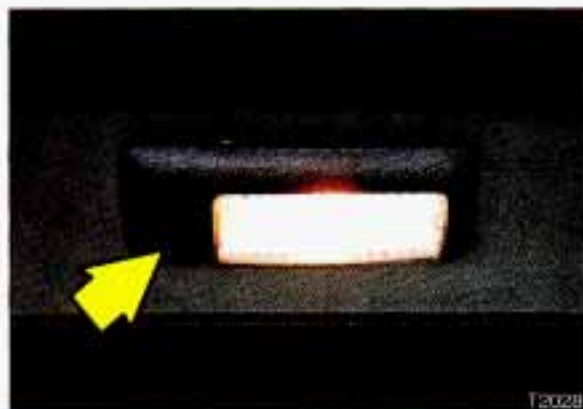

Rear Dome Light

The rear dome light will come on with the center dome light each time you open the doors. It also has a switch. Be sure to turn it off when you are finished using it.



Sun Visors

To block out glare, you can swing down the visors. You can also remove them from the center mount and swing them to the side, while the auxiliary sunshade remains to block glare from the front.

To extend the visor at the sides, pull out the sunshade.

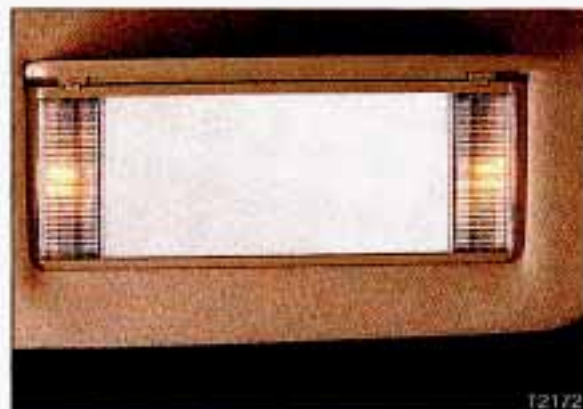

Lighted Visor Vanity Mirrors

Open the cover to expose the vanity mirror.

The lights come on when you open the cover. These can even be used for reading.

Features & Controls



Inside Day/Night Rearview Mirror

To reduce glare from lights behind you, pull the lever toward you to the night position.

For information on this mirror's reading lights, see the *Index* under *Front Reading Lights*.



Power Remote Control Mirrors

Use the control on the instrument panel to adjust both outside rearview mirrors. Turn the control to the left to select the driver's side rearview mirror, or to the right to select the passenger's side rearview mirror. Then use the control to adjust each mirror so that you can just see the side of your vehicle when you are sitting in a comfortable driving position.



Convex Outside Mirror

Your right side mirror is convex. A convex mirror's surface is curved so you can see more from the driver's seat.

CAUTION

 If you aren't used to a convex mirror, you can hit another vehicle. A convex mirror can make things (like other vehicles) look farther away than they really are. If you cut too sharply into the right lane, you could hit a vehicle on your right. Check your inside mirror or glance over your shoulder before changing lanes.



Accessory Power Outlets

The two power outlets on the center console can be used to plug in electrical equipment such as a cellular telephone, CB radio, etc. Follow the proper installation instructions that are included with any electrical equipment you install.

NOTICE

When using the accessory power outlets:

- Maximum load of all electrical equipment should not exceed 8 amps.
- Be sure to turn off any electrical equipment when not in use. Leaving electrical equipment on for extended periods can drain your battery.



Storage Compartments

The center console has a cup holder and three storage compartments.

To open the cup holder, lightly press on the edge.

Push the cup holder back in until it clicks when it's not in use.

Features & Controls

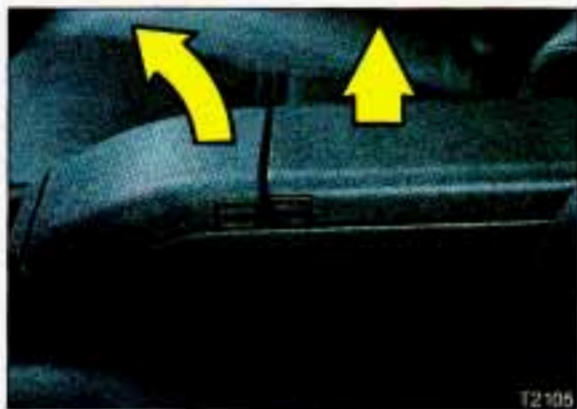

Storage Compartments (CONT.)

There are also two storage compartments with latching lids. Press the latch and lift the cover to open these.

The smaller compartment has a molded rack for cassette tapes and compact discs. The larger one has a removable tray.



There are two cup holders inside the glove box door.



You will find a storage compartment on each of the front doors. The driver's door pocket contains a coin holder.

A narrow storage shelf runs along the bottom of the instrument panel. It's handy for items such as gloves or small books.

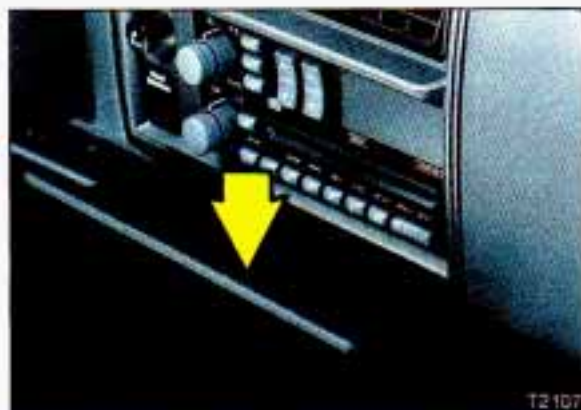

Ashtrays and Lighter

The front ashtray is located below the radio. To use the ashtray, pull it toward you.

To remove the ashtray for cleaning, press down on the front edge of the ashtray and pull the entire ashtray out of the instrument panel.



To use the lighter, push it in all the way and let go. When it's ready, it will pop back by itself.

NOTICE

Don't hold a cigarette lighter in with your hand while it is heating. If you do, it won't be able to back away from the heating element when it's ready. That can make it overheat, damaging the lighter and the heating element.



The rear ashtrays are located in the rear doors. To remove them for cleaning, press down on the snuffer and pull them out.

NOTICE

Don't put papers and other things that burn into your ashtrays. If you do, cigarettes or other smoking materials could set them on fire, causing damage.

Features & Controls



Luggage Carrier

You can load things on top of your vehicle. The luggage carrier has slats and side rails attached to the roof, and crossrails which can be moved forward and rearward in the side rails to secure cargo.

NOTICE

Loading cargo that weighs more than 200 pounds (91 kg) on the luggage carrier may damage your vehicle. When you carry large things, never let them hang over the rear or the sides of your vehicle. Load your cargo so that it rests on the slats and does not scratch or damage the vehicle. Put the cargo against the side rails and fasten it securely to the luggage carrier. Put the main weight as far forward as you can.

Don't exceed the maximum vehicle capacity when loading your Oldsmobile. For more information on vehicle capacity and loading, see the *Index* under *Loading Your Vehicle*.

To prevent damage or loss of cargo as you're driving, check now and then to make sure the luggage carrier and cargo are still securely fastened.



To adjust the front crossrail, loosen the screws (there are two on each side) with the Torx® head wrench provided in the glove box. Slide the crossrail back. After repositioning, be sure to retighten the screws and return the wrench to its storage place.

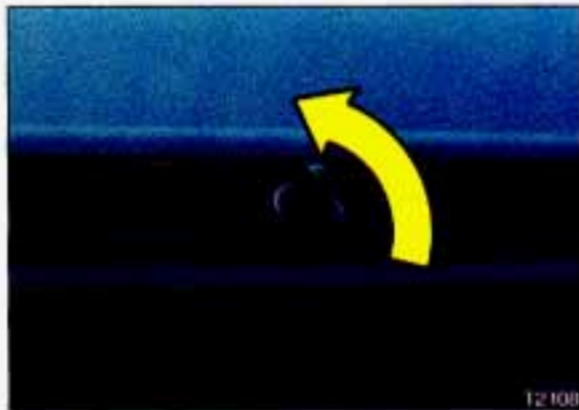

Use the tiedown loops to help secure large loads. To adjust them, turn them counterclockwise until they slide freely on the side rails. Tighten them in place by turning them clockwise.

Cargo Bed Liner

The removable cargo bed liner is washable. See the *Index* under *Cleaning Vinyl or Leather*.

Features & Controls

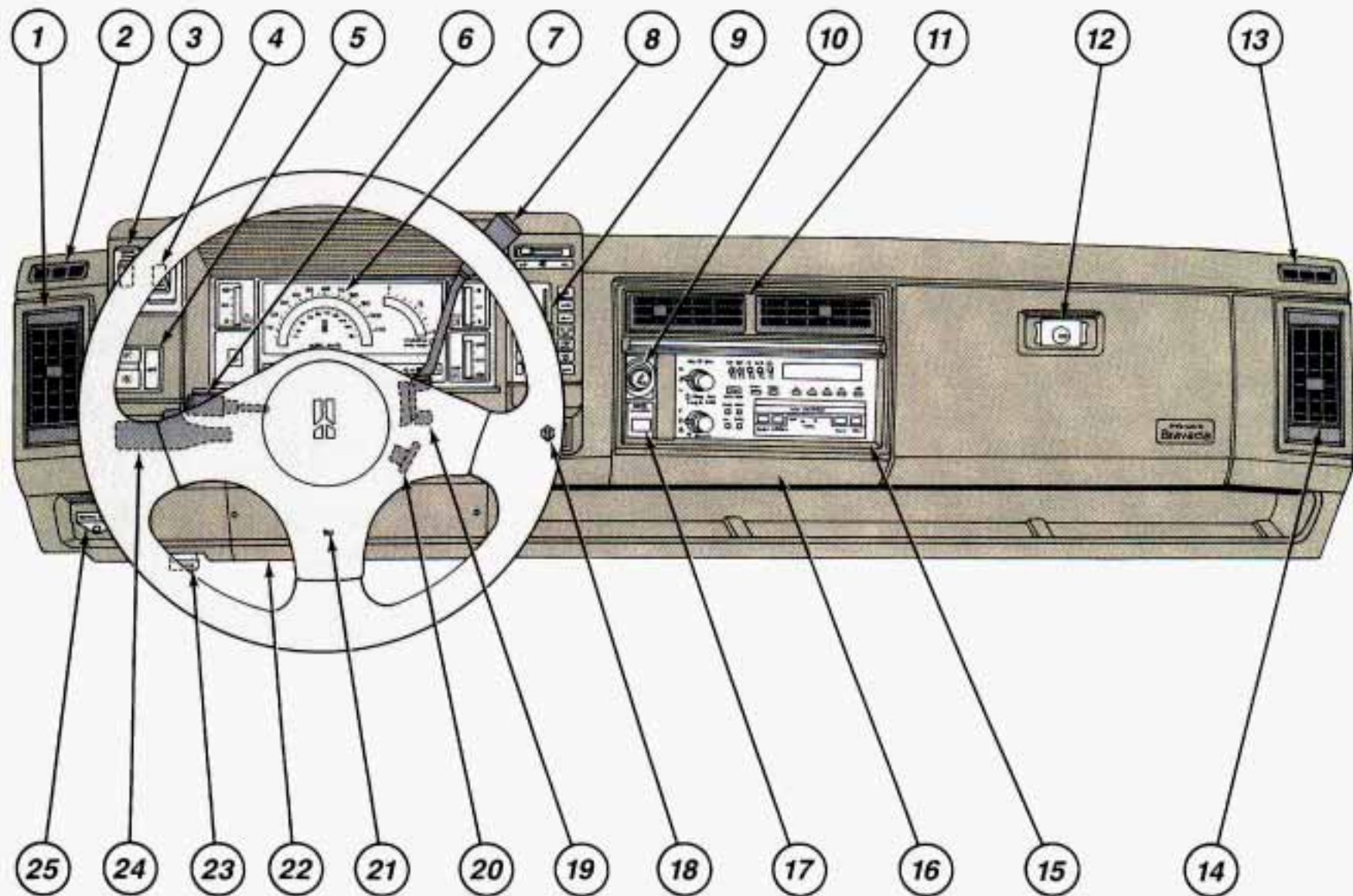

The Instrument Panel— Your Information System

Your instrument panel is designed to let you know at a glance how your vehicle is running. You'll know how fast you're going, how much fuel you're using, and many other things you'll need to drive safely and economically.

The main components of your instrument panel are:

1. Side Vents
2. Side Window Defogger
3. Rear Window Wiper/Washer
4. Rear Window Defogger
5. Light Controls
6. Tilt Steering Wheel Lever
7. Instrument Cluster
8. Gearshift Lever
9. Climate Controls
10. Lighter
11. Center Vents
12. Glove Box
13. Side Window Defogger
14. Side Vents
15. Audio System
16. Ashtray
17. Tailgate Window Release
18. Power Remote Control Mirrors
19. Ignition Switch
20. Hazard Warning Flashers Switch
21. Horn
22. Fuse Panel (under instrument panel)
23. Hood Release
24. Turn Signal/Headlight Beam Lever
25. Parking Brake Release

Features & Controls

■ Instrument Panel Clusters

You have one of these instrument panel clusters, which include indicator warning lights and gages that are explained on the following pages. Be sure to read about those that apply to the instrument panel cluster for your Oldsmobile.

STANDARD CLUSTER

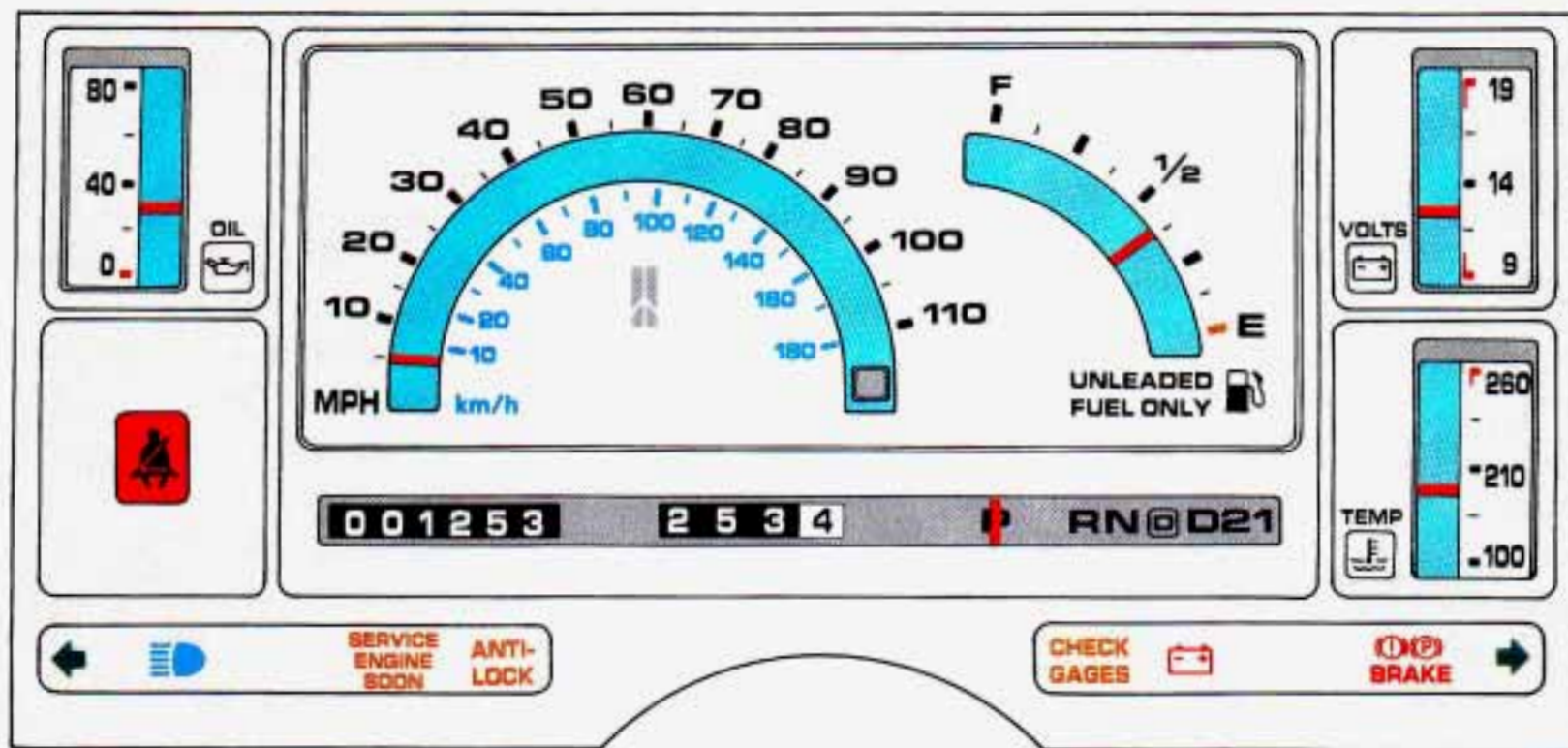

T2154

ELECTRONIC CLUSTER (OPTION)

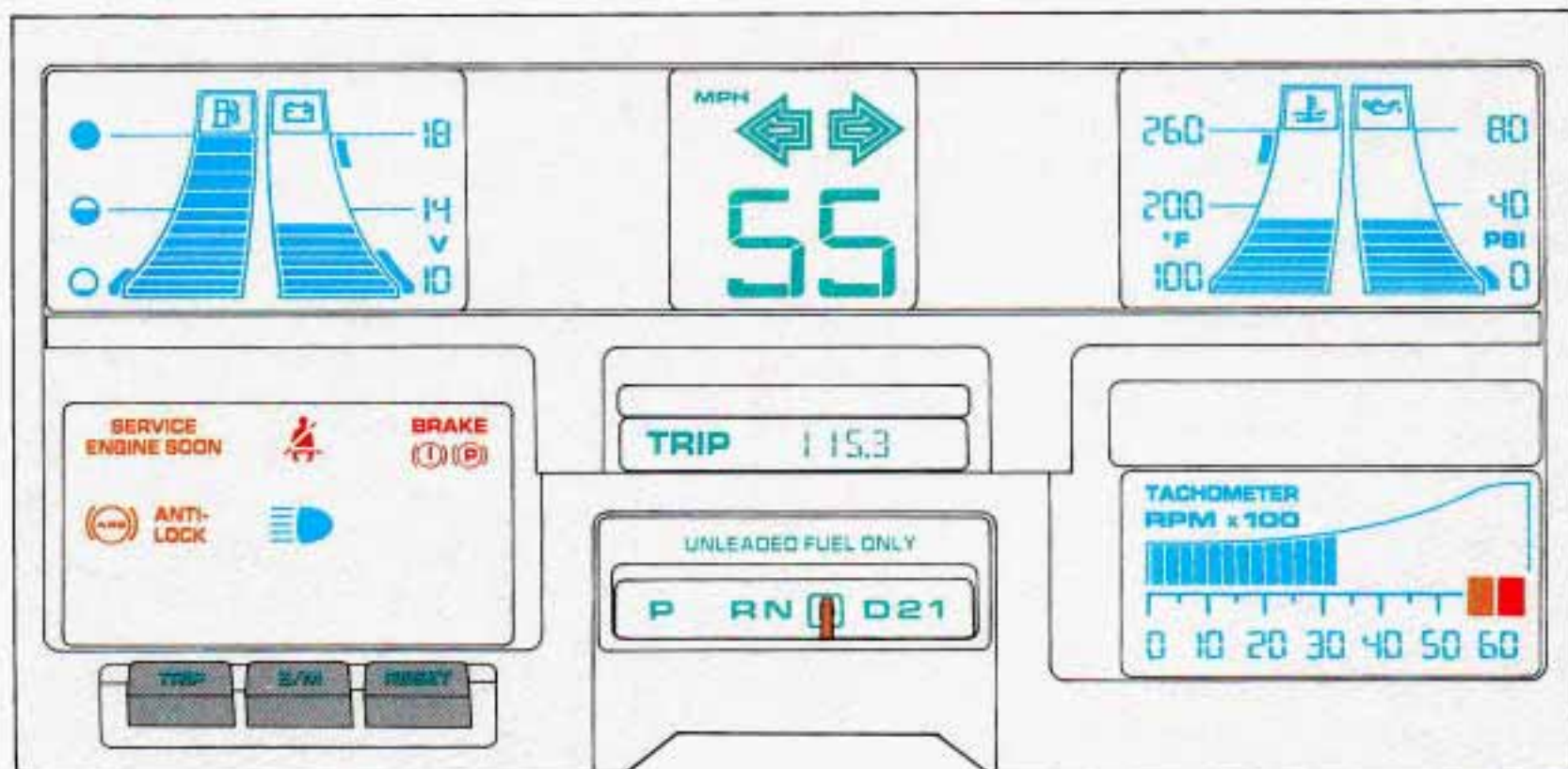

T2157

Features & Controls

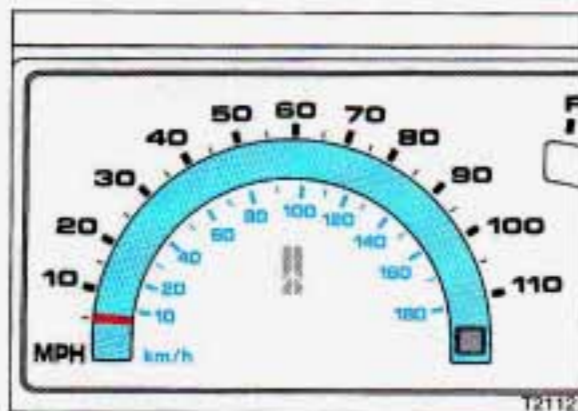

Speedometer (STANDARD CLUSTER)

Your speedometer lets you see your speed in both miles per hour (mph) and kilometers per hour (km/h).

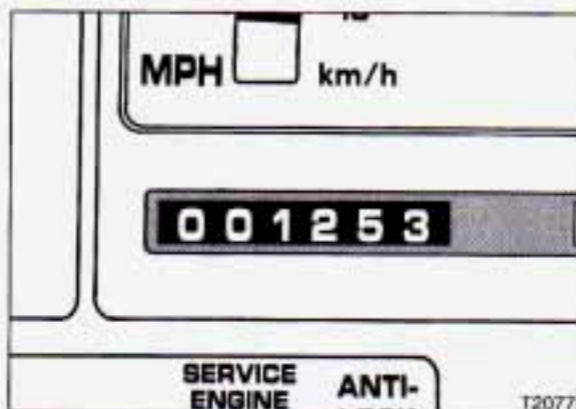

Odometer and Trip Odometer (STANDARD CLUSTER)

Your odometer shows how far your vehicle has been driven, in either miles (used in the U.S.) or kilometers (used in Canada). Your trip odometer tells how far you have driven since you last reset it. To set it to zero, press the reset button located in the right end of the speedometer.

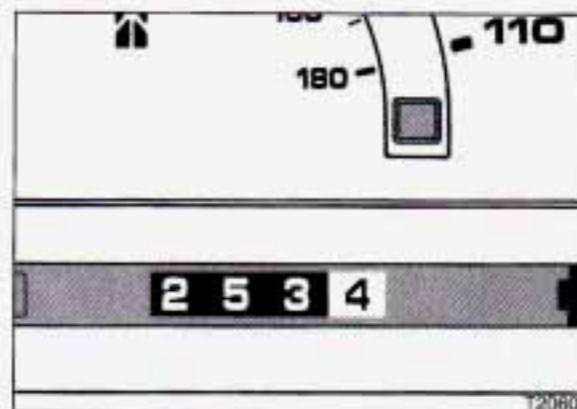

Your Oldsmobile has a tamper resistant odometer. If you see silver lines between the numbers, you'll know someone has probably tampered with it and the numbers may not be true.

You may wonder what happens if your vehicle needs a new odometer installed. If the new one can be set to the mileage total of the old odometer, then it must be. But if it can't, then it's set at zero and a label must be put on the driver's door to show the old mileage reading when the new odometer was installed.



Speedometer (ELECTRONIC CLUSTER)

Displays your speed in miles per hour (mph) or kilometers per hour (km/h). See *E/M Switch* later in this section.

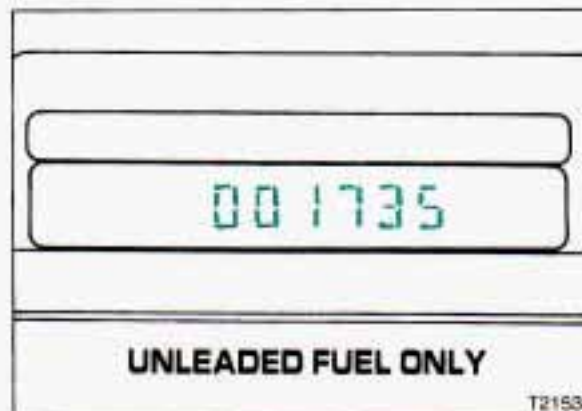

Odometer and Trip Odometer (ELECTRONIC CLUSTER)

The odometer shows how far your vehicle has been driven in either miles (used in the U.S.) or kilometers (used in Canada). Your trip odometer tells how far you have driven since you last reset it.

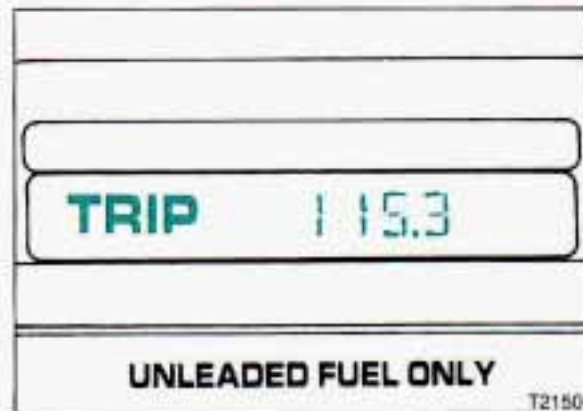

Trip mileage appears in place of the regular odometer reading when you press the **TRIP** switch down. To change back to the regular odometer, press the **TRIP** switch again.

Your Oldsmobile has a tamper resistant odometer. The odometer will read **ERROR** if someone has tampered with it.

You may wonder what happens if your vehicle needs a new odometer installed. If the new one can be set to the mileage total of the old odometer, then it must be. But if it can't, then it's set at zero and a label must be put on the driver's door to show the old mileage reading when the new odometer was installed.

Features & Controls



Odometer & Trip Odometer (CONT.)

To set the trip odometer to zero, press the **TRIP** switch to display the trip odometer. Then, press the **RESET** switch.



E/M Switch (ELECTRONIC CLUSTER)

To change your electronic display from English to metric units, or from metric to English, press this switch down. The gages affected are:

- Speedometer
- Odometer
- Trip Odometer
- Oil Pressure
- Engine Coolant Temperature

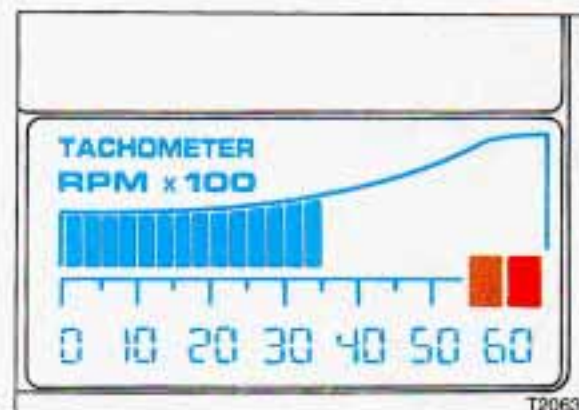

Tachometer (ELECTRONIC CLUSTER)

The tachometer displays the engine speed in revolutions per minute (rpm).

NOTICE

Do not operate the engine with the tachometer in the red area, or engine damage may occur.

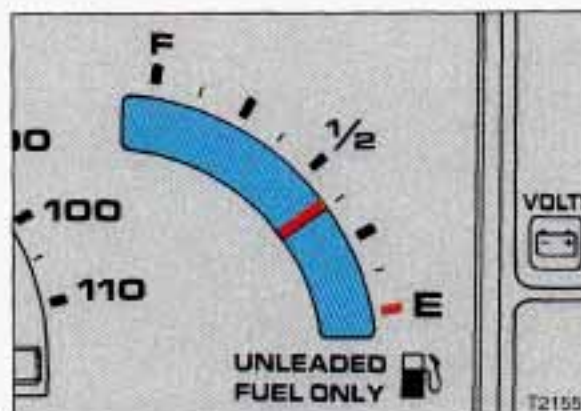

■ *Standard Cluster Gages*

This section explains the fuel, coolant temperature and oil pressure gages and the voltmeter for your cluster. Working together, the gages and the warning lights explained later in this part warn you when there may be or is a problem with one of your vehicle's functions. They can signal that something is wrong before it becomes serious enough to cause an expensive repair or replacement. Heeding your gages and warning lights could also save you or your passengers from injury.

Please follow the manual's advice. Waiting to do repairs can be costly—and even dangerous.

Fuel Gage (STANDARD CLUSTER)

Your fuel gage tells you about how much fuel you have left, when the ignition is on. When the indicator nears E (Empty), you will have a little fuel left but should get more soon.

Here are four things that some owners ask about. None of these show a problem with your fuel gage:

- At the gas station, the gas pump shuts off before the gage reads F (Full).

- It takes a little more or less fuel to fill up than the gage indicated. For example, the gage may have indicated the tank was half full, but it actually took a little more or less than half the tank's capacity to fill the tank.
- The gage moves a little when you turn a corner or speed up.
- The gage doesn't go back to E when you turn off the ignition.

For your fuel tank capacity, see *Service Station Information* on the last page of this manual.

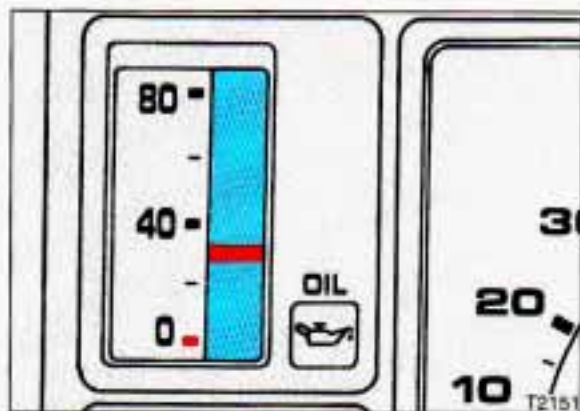

Oil Pressure Gage (STANDARD CLUSTER)

Your oil pressure gage shows the oil pressure in psi (pounds per square inch) when the engine is running. Oil pressure may vary with engine speed, outside temperature and oil viscosity.

Driving your vehicle with low oil pressure can cause extensive engine damage. Have your vehicle serviced immediately.

CAUTION



Don't keep driving if the oil pressure is low. If you do, your engine can become so hot that it catches fire. You or others could be burned. Check your oil as soon as possible and have your vehicle serviced.

NOTICE

Damage to your engine from neglected oil problems can be costly and is not covered by your warranty.

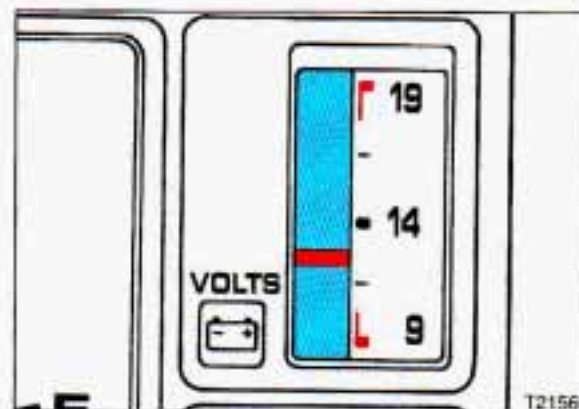

Voltmeter (STANDARD CLUSTER)

Your charging system gage will show the rate of charge when the engine is running. When the engine is not running but the ignition is on (in the **Run** position), the display measures the voltage output of your battery.

The reading will change as the rate of charge changes (with engine speed, etc.), but readings between the warning zones indicate the normal operating range. Readings in either warning zone indicate a possible problem with your charging system. Have your Oldsmobile serviced immediately.

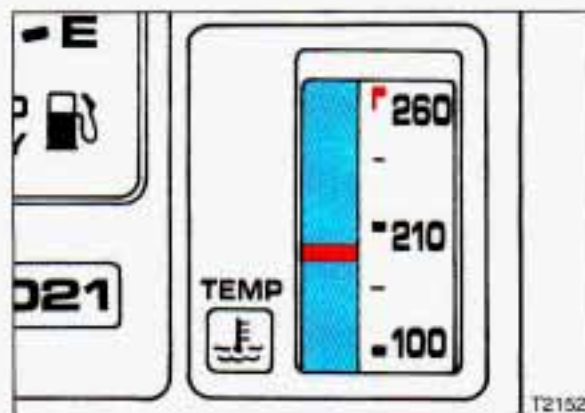

T2152

Engine Coolant Temperature Gage (STANDARD CLUSTER)

This gage shows the engine coolant temperature. If the gage pointer moves into the red area, your engine is too hot! It means that your engine coolant has overheated.

If you have been operating your vehicle under normal driving conditions, you should pull off the road, stop your vehicle and turn off the engine as soon as possible.

HOT COOLANT CAN BURN YOU BADLY!

In *Problems on the Road*, this manual shows what to do. See the *Index* under *Engine Overheating*.

■ **Electronic Cluster Gages**

This section explains the fuel, coolant temperature, and oil pressure gages and the voltmeter for your cluster. Working together, the gages and the warning lights explained later in this part warn you when there may be or is a problem with one of your vehicle's functions. They can signal that something is wrong before it becomes serious enough to cause an expensive repair or replacement. Heeding your gages and warning lights could also save you or your passengers from injury.

Please follow the manual's advice. Waiting to do repairs can be costly—and even dangerous.

Features & Controls

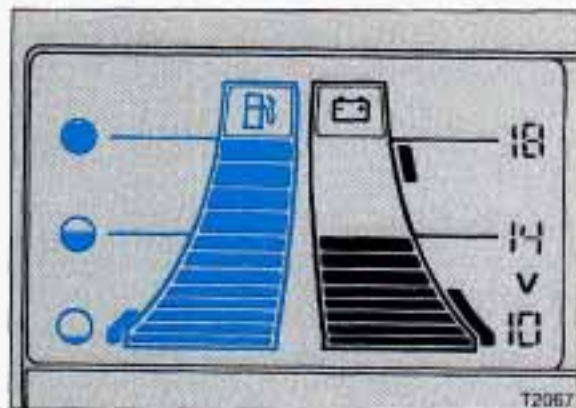

Fuel Gage (ELECTRONIC CLUSTER)

Your fuel gage bars light up when the ignition is on to show you about how much fuel you have left.

When the gage first indicates empty, you still have a little fuel left, but you should get more soon.

A box around the gas pump symbol will flash when your tank is $\frac{1}{8}$ full or less.

Here are five things that some owners ask about. None of these show a problem with your fuel gage:

- At the gas station, the gas pump shuts off before the gage reads full.
- The top bar does not go out until you have driven a long distance—about 30 miles (48 kilometers).

- It takes a little more or less fuel to fill up than the gage indicated. For example, the gage may have indicated the tank was half full, but it actually took a little more or less than half the tank's capacity to fill the tank.
- The gage moves a little when you turn a corner or speed up.
- The tank is not necessarily empty when the last bar goes out. There is a 1 to 1.5 gallon (4 to 5.6 L) fuel reserve.

For your fuel tank capacity, see *Service Station Information* on the last page of this manual.

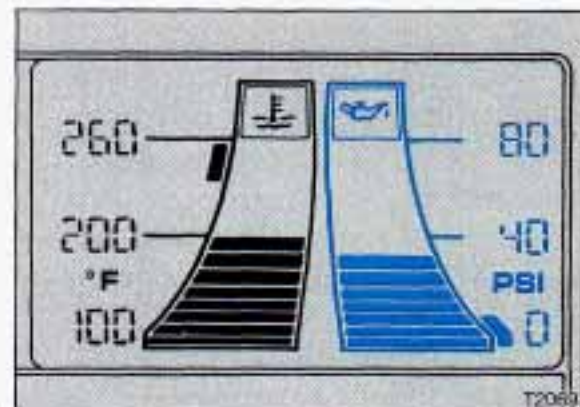

Oil Pressure Gage (ELECTRONIC CLUSTER)

Your oil pressure gage shows the oil pressure in psi (pounds per square inch) when the engine is running. Oil pressure may vary with engine speed, outside temperature and oil viscosity.

If you have a problem with your oil, the box around the oil pressure symbol may begin to flash after you start your engine, or when you are driving. This indicates that oil is not going through your engine quickly enough to keep it cool. The engine could be low on oil, or could have some other oil problem. Have it fixed right away.

The oil light could also flash on in three other situations:

- When the ignition is on (in the **Run** position) but the engine is not running, the light will flash as a test to show you it is working, but the light will go out when you turn the ignition to **Start**. If it doesn't come on with the ignition on, you may have a problem with the fuse. Have it fixed right away.
- Sometimes when the engine is idling at a stop, the light may flash on and off. This is normal.
- If you make a hard stop, the light may come on for a moment. This is normal.

CAUTION



Don't keep driving if the oil pressure is low. If you do, your engine can become so hot that it catches fire. You or others could be burned. Check your oil as soon as possible and have your vehicle serviced.

NOTICE

Damage to your engine from neglected oil problems can be costly and is not covered by your warranty.

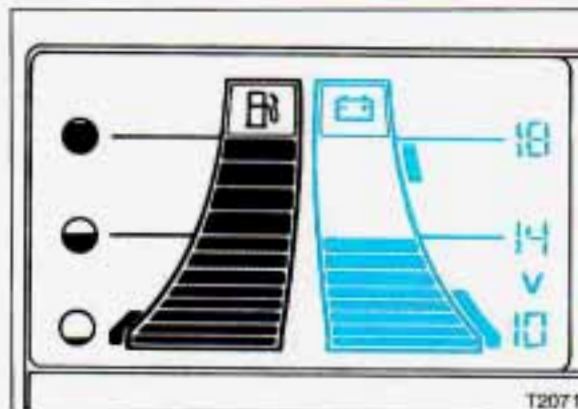

Voltmeter (ELECTRONIC CLUSTER)

Your charging system gage will show the rate of charge when the engine is running. When the engine is not running but the ignition is on (in the **Run** position), the display measures the voltage output of your battery, and will flash until you turn the ignition to **Start**.

The reading will change as the rate of charge changes (with engine speed, etc.), but readings between the warning zones indicate the normal operating range. Readings in either warning zone indicate a possible problem with your charging system. Have your Oldsmobile serviced immediately.

You also have a warning light. A box around the battery symbol will flash when the charging system needs service.

Features & Controls

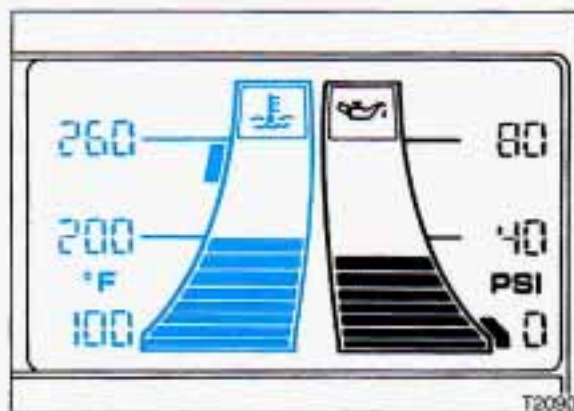

Voltmeter (CONT.)

If it comes on while you are driving, you may have a loose belt or other problem with the electrical charging system. Have it checked right away. Driving while this light is on could drain your battery.

If you must drive a short distance with the light on, be certain to turn off all your accessories, such as the radio and air conditioner.

Engine Coolant Temperature Gage (ELECTRONIC CLUSTER)

This gage has bars that show the engine coolant temperature.

A box around the temperature symbol will flash when your engine is too hot. It means that your engine coolant has overheated. If you have been operating your vehicle under normal driving conditions, you should pull off the road, stop your vehicle and turn off the engine as soon as possible.

HOT COOLANT CAN BURN YOU BADLY!

In *Problems on the Road*, this manual shows what to do. See the *Index* under *Engine Overheating*.

■ *Warning Lights*

This section describes the warning lights that may be on your vehicle. The pictures will help you locate them.

Warning lights can signal that something is wrong before it becomes serious enough to cause an expensive repair or replacement. Paying attention to your warning lights could also save you or others from injury.

Warning lights go on when there may be or is a problem with one of your vehicle's functions. As you will see in the details on the next few pages, some warning lights come on briefly when you turn the ignition key just to let you know they're working. If you are familiar with this section, you should not be alarmed when this happens.

When one of the warning lights comes on and stays on when you are driving, check the section that tells you what to do about it. Please follow the manual's advice. Waiting to do repairs can be costly—and even dangerous. So please get to know your warning lights. They're a big help.



Malfunction Indicator Lamp (Service Engine Soon Light)

A computer monitors operation of your fuel, ignition and emission control systems. This light should come on when the ignition is on, but the engine is not running, as a check to show you it is working. If it does not come on at all, have it fixed right away. If it stays on, or it comes on while you are driving, the computer is indicating that you have a problem. You should take your vehicle in for service soon.

NOTICE

If you keep driving your vehicle with this light on, after a while the emission controls won't work as well, your fuel economy won't be as good and your engine may not run as smoothly. This could lead to costly repairs not covered by your warranty.

Features & Controls

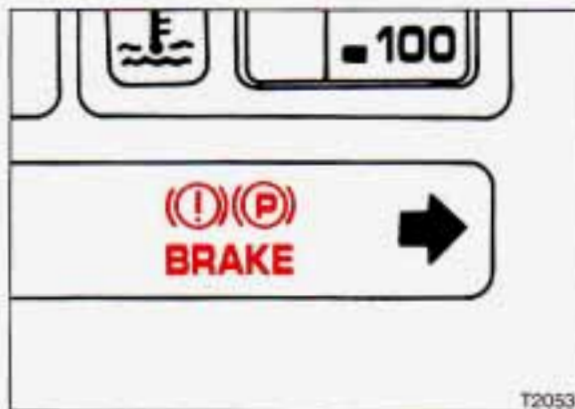

Brake System Warning Light

Your Oldsmobile's hydraulic brake system is divided into two parts. If one part isn't working, the other part can still work and stop you. For good braking, though, you need both parts working well. If the warning light goes on, there could be a brake problem. Have your brake system inspected right away.

This light should come on as you start the vehicle. If it doesn't come on then, have it fixed so it will be ready to warn you if there's a problem.

This light will also come on when you set your parking brake, and will stay on if your parking brake doesn't release fully. If it stays on after your parking brake is fully released, it means

you have a brake problem. If the light comes on while driving, pull off the road and stop carefully. You may notice that the pedal is harder to push. Or, the pedal may go closer to the floor. It may take longer to stop. If the light is still on, have the vehicle towed for service. (See the *Index* under *Towing Your Bravada*.)

CAUTION



Your brake system may not be working properly if the brake warning light is on. Driving with the brake warning light on can lead to an accident. If the light is still on after you've pulled off the road and stopped carefully, have the vehicle towed for service.



Anti-Lock Brake System Warning Light

With anti-lock, this light will go on when you start your engine and may stay on for five seconds or so. That's normal. If the light doesn't come on, have it fixed so it will be ready to warn you if there is a problem.

If the light stays on, or comes on when you're driving, your Oldsmobile needs service. Unless the regular brake system warning light is also on, you will still have brakes, but not anti-lock brakes. If the regular brake system warning light is also on, see *Brake System Warning Light* earlier in this section.

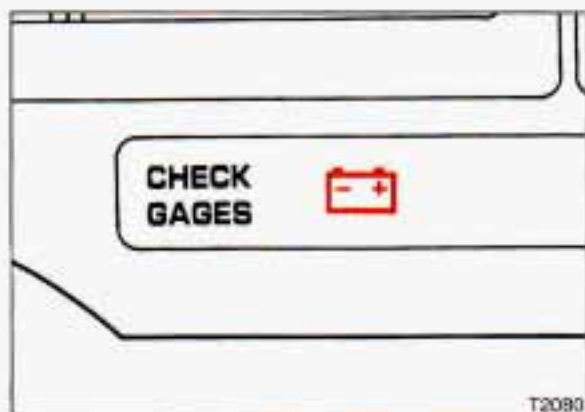

Battery Light (STANDARD CLUSTER)

The battery light will come on briefly when you turn on the ignition as a check to show you it is working. It should go out once the engine is running. If it stays on, or comes on while you are driving, you may have a loose belt or other problem with the electrical charging system. Have it checked right away. Driving while this light is on could drain your battery.

If you must drive a short distance with the light on, be certain to turn off all your accessories, such as the radio and air conditioner.

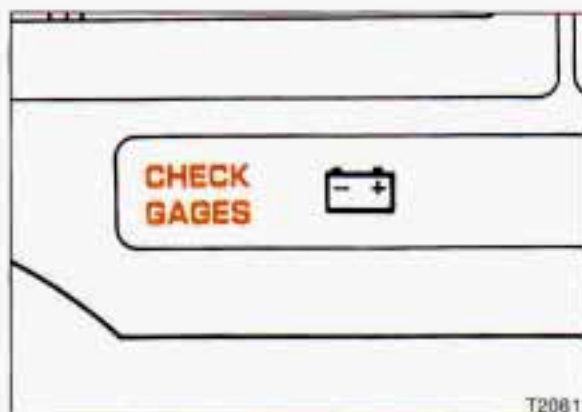

Check Gages Light (STANDARD CLUSTER)

This light will come on briefly when you are starting the engine. If the light comes on and stays on while you are driving, check your various gages to see if they are in the warning zones.

Notes



Part 3

Comfort Controls & Audio Systems

In this part you'll find out how to operate the comfort control systems and audio systems offered with your Oldsmobile. Be sure to read about the particular system supplied with your vehicle.

Climate Control System	102
Defogging and Defrosting	104
Rear Window Defogger	104
Setting the Clock	106
AM/FM Stereo with Cassette Player and Equalizer	107
AM/FM Stereo Radio with Compact Disc Player	110
Understanding Radio Reception	114
Care of Your Cassette Tape Player	114
Care of Your Compact Discs	115
Fixed Mast Antenna	115

Comfort Controls & Audio Systems



■ *Climate Control System*

Your vehicle's heater and air conditioner work best if you keep your windows closed. Your vehicle also has flow-through ventilation, described later in this section, to bring outside air into your vehicle.

Fan Lever: The lever at the top has four positions. Move it toward **HI** to increase the air flow. To decrease the air flow, move it toward **LO**.

Temperature Lever: Slide the lever on the left to control the temperature of the air flow into the vehicle. Move the lever up for warmer air, down for cooler air.

Function Lever: Slide the lever on the right to select the function desired. The air conditioner compressor will operate in all settings except **VENT** and **HTR** (Heater) when the outside temperature is above freezing. When the air conditioner compressor cycles on, you may sometimes notice slight changes in your vehicle's engine performance and power. This is normal, because the system is designed to keep the desired cooling level and help fuel economy.

There are three air conditioning settings: **MAX A/C**, **NORM A/C**, and **BI-LEV A/C**. On very hot days, your vehicle will cool down more quickly and economically in any of these settings if you open the windows long enough to let hot inside air escape. For all settings, adjust the temperature control lever and fan speed as desired.

MAX A/C: Select this setting to get maximum cooling or quick cool-down on very hot days. This setting recirculates much of the air inside your vehicle. It should not be used for long periods of time because the air may become too cold and dry.

Also slide the temperature control lever down to the coolest setting and adjust the fan speed as desired.

NORM A/C: Use this setting for normal cooling on hot days. This setting cools outside air and directs it through the instrument panel outlets.

BI-LEV A/C: Use on cool but sunny days. This setting brings in outside air, but directs it two ways—through the instrument panel outlets and the heater ducts at your feet. At times this temperature difference may be more apparent than others.

VENT: The vent setting brings in outside air through the instrument panel outlets and at your front side windows.

HTR: The heater setting brings in most heated air through the heater ducts, and some through the defroster vents.

If you have the optional engine block heater and use it during cold weather, 20°F (-8°C) or lower, your heating system will more quickly provide heat because the engine coolant is already warmed. See the *Index* under *Engine Block Heater*.

 **(Defrost):** This setting directs most of the warmed air to the windshield and side windows. Some will also go to the floor vents.

The air conditioner will also run in this setting to remove moisture from the air when the temperature is above 40°F (4°C). Adjust the temperature control as desired.

Comfort Controls & Audio Systems



Defogging and Defrosting

To rapidly defrost the windshield, slide the temperature control lever all the way up and select the  setting.

Adjust the fan to the highest speed.

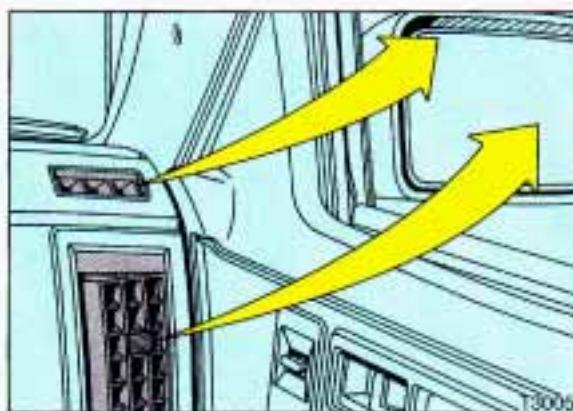

To rapidly defog the side windows, select the **BI-LEV A/C** setting and adjust the fan to the highest speed. Aim the side vents toward the side windows. For increased air flow to the side vents, close the center vents.



Rear Window Defogger

Press **ON** to warm the defogger grid on the rear window. The indicator light will glow while the rear window defogger is operating. The defogger will turn off automatically after about 10 minutes. If you turn it on again, the defogger will operate for about five minutes only. You can turn the defogger off by turning off the ignition or pressing **OFF**.

Do not attach a temporary vehicle license across the defogger grid on the rear window.

NOTICE

Don't use a razor blade or something else sharp on the inside of the rear window. If you do, you could cut or damage the warming grid, and the repairs wouldn't be covered by your warranty.

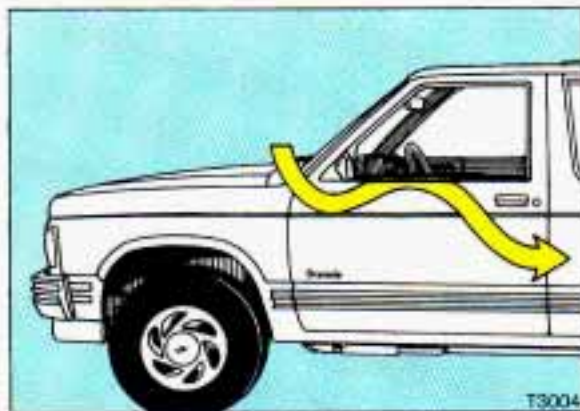

Flow-Through Ventilation System

Your vehicle's flow-through ventilation system supplies outside air into the vehicle when it is moving. Outside air will also enter the vehicle when the heater or the air conditioning fan is running.

Ventilation Tips

- Keep the hood and front air inlet free of ice, snow, or any other obstruction (such as leaves). The heater and defroster will work far better, reducing the chance of fogging the inside of your windows.
- When you enter a vehicle in cold weather, slide the function lever to **HTR** and turn the blower fan to **HI** for a few moments before driving off. This helps clear the intake ducts of snow and moisture, and reduces the chance of fogging the inside of your windows.
- Keep the air path under the front seats and console clear of objects. This helps air to circulate throughout your vehicle.

Comfort Controls & Audio Systems

■ Audio Systems

The following pages describe the audio systems available for your Oldsmobile, and how to get the best performance from them. Please read about the system in your vehicle.

CAUTION



Hearing damage from loud noise is almost undetectable until it is too late. Your hearing can adapt to higher volumes of sound. Sound that seems normal can be loud and harmful to your hearing. Take precautions by adjusting the volume control on your radio to a safe sound level before your hearing adapts to it.

To help avoid hearing loss or damage:

1. Adjust the volume control to the lowest setting.
2. Increase the volume slowly until you hear comfortably and clearly.

NOTICE

Before you add any sound equipment to your vehicle—like a tape player, CB radio, mobile telephone or two-way radio—be sure you can add what you want. If you can, it's very important to do it properly. Added sound equipment may interfere with the operation of your vehicle's engine, Delco® radio or other systems, and even damage them. And, your vehicle's systems may interfere with the operation of sound equipment that has been added improperly.

So, before adding sound equipment, check with your dealer and be sure to check federal rules covering mobile radio and telephone units.



Setting the Clock

Setting the clock is easy.

1. With the radio on or off and the ignition on, press **SET**. The **SET** indicator will appear on the digital screen for five seconds.
2. You must begin to set the clock to the correct hour and minute during those five seconds. Press **SCAN** to set the correct hour. Press **SEEK** to set the correct minute.



AM/FM Stereo with Cassette Player and Equalizer

The digital display indicates information on the time or radio station frequency, the AM or FM radio band, whether the station is in stereo, and many other radio functions.

PWR (Power): Press to turn the unit on and off when the ignition is on.

VOL-BAL (Volume-Balance): Turn the upper knob to the right to increase volume, or press it to change the side of a tape that's playing. Press the knob to display the time when the ignition is off, or to switch between time and radio station frequency while the radio is on.

The control ring behind the **VOL-BAL** knob adjusts the left/right speaker balance.

TUNE-FADE: This knob has two functions. Turn it to the left or right to tune in radio stations (the radio station frequency will be displayed on the digital screen). Press the knob to change between the AM and FM bands (the digital screen will momentarily display **AM** or **FM**, and if the radio is in stereo, **STEREO** will be displayed).

Your radio has an AMAX-certified receiver. It can produce quality AM stereo sound and receive C-Quam® stereo broadcasts. AMAX reduces noise without reducing the high frequencies you need for the best sound. You don't have to do anything to your Delco/GM radio because AMAX is automatic.

The control ring behind the **TUNE-FADE** knob adjusts the front/rear speaker balance.

Equalizer Controls: Boost the bass, emphasize a voice in a song, brighten the treble—your equalizer gives you freedom to adjust five separate frequencies of sound to your individual taste. Move a lever up to emphasize a frequency, move it down to de-emphasize. It's best to begin with the levers in the middle position, then adjust individual levers as you like.

LOUD: Press to increase the bass response. This is most helpful in producing a natural sound at low listening levels.

Comfort Controls & Audio Systems

AM/FM Stereo with Cassette Player and Equalizer (CONT.)

AUTO DNR (Dynamic Noise Reduction): This sound system automatically reduces background noises on AM, FM and cassette tapes.

AmSt: When you're tuned to an AM station that broadcasts in stereo, the **STEREO** light will come on. If the signal is weak, press **AmSt** to turn the feature off. You'll get better reception. Press **AmSt** again to turn the feature back on for strong signals.

SEEK: Each time you press **SEEK**, you will tune in the next station on the AM or FM radio band.

SCAN: Press to listen for a few seconds to the next station on the AM or FM band; the scan will continue every few seconds until you either press **SCAN** again or press the **VOL-BAL** knob to stop on a particular station.

To Preset Radio Stations:

The four pushbuttons can be used to preset up to 14 radio stations (seven AM and seven FM stations).

1. Turn the lower control knob (**TUNE**) to the station you want.
2. Press **SET**. The **SET** indicator will appear on the digital screen for five seconds.
3. While the **SET** indicator is displayed, press one of the four pushbuttons. The station is now preset. You can tune to it immediately by pressing the same button.
4. Repeat steps 1-3 for each of four AM and four FM stations.

Up to three additional stations on each band may be preset by "pairing" pushbuttons:

1. Tune in the desired station.
2. Press **SET**, and within five seconds press any two adjacent pushbuttons at the same time.
3. The station can be tuned in when the same two pushbuttons are pressed at the same time.



To Play a Cassette Tape:

Press **PWR (Power)** to turn the radio on. Then push a cassette into the cassette entry door (the tape side goes in first). Using tapes that are longer than 90 minutes (45 minutes on each side) is not recommended.

FWD (Fast Forward): Press to advance the tape rapidly; press again to play.

REV (Reverse): Press to reverse the tape rapidly; press again to play tape.

SEARCH: Push this switch to the right and the **FWD** and **REV** buttons will function as a "music search," stopping the tape at the next selection on the tape. (There must be at least a 3-second gap between selections on the tape.) The **ON** light will indicate the music search is selected.

Program: Press the **VOL-BAL** knob to change the side of tape being played. When the arrow pointing up is lighted, the selections listed on the top side of the tape are played. When the arrow pointing down is lighted, selections listed on the bottom side of the tape are played. The tape player automatically begins playing the other side when it reaches the end of the tape.

CrO₂: This button sets tape bias. When playing high bias chrome or metal tapes, press the button to turn the button light on. When playing standard tapes, press again to turn the light off.

EJECT: Press to have the cassette tape ejected (the radio will then play). The cassette tape will be ejected automatically when the radio is turned off.

Comfort Controls & Audio Systems



AM/FM Stereo Radio with Compact Disc Player

The digital display indicates information on the time or radio station frequency, the AM or FM radio band, whether the station is in stereo, and many other radio functions.

PWR (Power): Press to turn the unit on when the ignition is on. Press again to turn the unit off.

MUTE-VOL (Upper Knob): This control has three functions.

- Turn the knob to adjust volume up or down.
- Press the knob to silence the radio temporarily. Press again to restore original volume.
- Turn the ring behind the knob to adjust left-right speaker balance to your taste.

BAND-TUNE (Lower Knob): This control has three functions.

- Turn the knob to tune the radio.
- Press the knob to switch from the AM band to the FM band. Press again to switch from FM to AM.
- Turn the ring behind the knob to adjust the front-rear speaker balance (also called "fade") to your taste.

RCL (Recall): Press to switch the display from the time to radio station frequency. Press again to switch from the radio frequency to time.

BASS: Press the upper part to increase bass. Press the lower part to decrease bass.

TREB (Treble): Press the upper part to increase treble. Press the lower part to decrease treble.

SEEK: Press the left side to tune in the next station lower in frequency. Press the right side to tune in the next station higher in frequency.

SCAN: Press to listen for a few seconds to the next station on the AM or FM band; the scan will continue every few seconds until you press **SCAN** again at any time to stop on a particular station.

To Preset Radio Stations:

The five numbered pushbuttons are used to immediately select any of ten preset radio stations, five AM and five FM. Four of the pushbuttons are also used when you play a compact disc.

1. Tune the display to a station you want to preset.
2. Press **SET**. The **SET** indicator will appear on the digital screen for five seconds.
3. Press one of the numbered pushbuttons while the **SET** indicator is displayed.
The station is now preset. You can tune to it immediately by pressing the same numbered pushbutton.
4. Repeat these steps for up to five AM and five FM stations.

To Play a Compact Disc:

Your compact disc player is designed for full-size compact discs only. Do not use the mini-discs that are called singles. They won't eject.

1. Press **PWR** to turn the unit on.
2. Insert a disc partway into the slot, label side up. The player will pull it in. In a few seconds, the disc should play.

If the disc comes back out without playing:

- The disc may be upside down.
- The disc may be dirty, scratched or wet.
- The road may be too rough.
- There may be too much moisture in the air. Wait about one hour and try again.
- The player may be too hot. If so, **HOT** will appear on the display. When the compact disc player cools, it should play again. Press **RCL** to remove **HOT** from the display.

In addition to the normal tone and volume controls, you can use the following controls while the compact disc player is playing:

RCL (Recall): Press to see which track is playing. Its number will be displayed. Press again to see how long it has been playing.

The track number will also be displayed whenever you change the volume or a new track begins to play.

EJCT (Eject): Press to eject the disc. The radio will play.

ST-PL (Stop-Play): Press to stop the compact disc player and play the radio. Press again to stop the radio and play the compact disc. It will begin playing at the point where you stopped it.

Comfort Controls & Audio Systems

AM/FM Stereo Radio with Compact Disc Player (CONT.)

COMP (Compression): Press to make soft and loud passages more equal in volume. Press again to resume normal play.

RDM (Random): Press to play a disc's tracks in random order. Press again to play them in numbered sequence.

REV (Reverse): Press and hold to rapidly back up within a track. Release to play from that point.

FWD (Fast Forward): Press and hold to rapidly move forward within a track. Release to play from that point.

SCAN: Press to sample all tracks briefly, one at a time. Press again to continue the track that's playing.

PREV (Previous): Press to back up to the previous track. Pressing more than once backs up more than one track. Press and hold to scroll backward through the tracks.

NEXT: Press to move up to the next track. Pressing more than once moves up more than one track. Press and hold to scroll forward through the tracks.

CD Player Security System

Delco LOC II® is a security feature for the compact disc player. You can turn it on or not, as you prefer. If you turn it on, your player won't work if it's ever stolen.

When you turn on Delco LOC II®, you enter a secret code into the system to secure it. If your CD player loses battery power for any reason you must unlock the system with the secret code before the system will work again.

If you turn Delco LOC II® on and decide you don't want it on any longer, you can turn it off.

To Turn Delco LOC II® On:

1. Write down any 6-digit number and keep it in a safe place. This is your secret code.
2. Turn the ignition to the **Accessory** or **Run** position.
3. Make sure the radio is off.
4. Press and hold the **1** and **4** pushbuttons until _____ shows on the display. You now have 15 seconds for each of the following steps. If you take more than 15 seconds to complete any of them, you may need to start over.

5. Press **SET**. **000** will appear.
6. Press **SEEK** to the right and hold it until the second and third numbers of your secret code appear.
7. Press **SCAN** until the first number of your secret code appears.
8. Press **BAND-TUNE** and **000** will appear again.
9. Press **SEEK** to the right and hold it until the fifth and sixth numbers of your secret code appear.
10. Press **SCAN** until the fourth number of your secret code appears.
11. Press **BAND-TUNE**. **rEP** will appear for five seconds. Then **000** will appear.
12. Repeat steps 6-11. **SEC** will appear, indicating that the system is secure. If the display shows _____, the verification process was not successful. Repeat the entire sequence.

To Turn Delco LOC II® Off:

1. Turn the ignition to the **Accessory** or **Run** position.
2. Make sure the radio is off.
3. Press and hold the **1** and **4** pushbuttons until **SEC** shows on the display.
4. Press **SET**. The display will show **000**.
5. Press **SEEK** to the right and hold it until the second and third numbers of your secret code appear.
6. Press **SCAN** until the first number of your code appears.
7. Press **BAND-TUNE**. The display will show **000**.
8. Press **SEEK** to the right and hold it until the fifth and sixth numbers of your secret code appear.

9. Press **SCAN** until the fourth number of your code appears.
10. Press **BAND-TUNE**. If the display shows _____, the unit is no longer secured. If the display shows **SEC**, it is still secured (the numbers did not match either your secret code or the factory's back-up code).

To Unlock After a Power Loss: When battery power is lost and then resupplied to a secured unit, **LOC** will appear on the display. Follow these steps to unlock the unit:

1. Turn the ignition to the **Accessory** or **Run** position.
2. Make sure the radio is off.
3. Press **SET**. The display will show **000**.

4. Press **SEEK** to the right and hold it until the second and third numbers of your secret code appear.
5. Press **SCAN** until the first number of your code appears.
6. Press **BAND-TUNE**. The display will show **000**.
7. Press **SEEK** to the right and hold it until the fifth and sixth numbers of your secret code appear.
8. Press **SCAN** to make the fourth number of your code appear.
9. Press **BAND-TUNE**. If the display shows the time of day, the unit is no longer locked. If the display shows **LOC**, it is still secured (the numbers did not match either your secret code or the factory's back-up code).

Comfort Controls & Audio Systems

Understanding Radio Reception

FM Stereo

FM stereo will give you the best sound, but FM signals will reach only about 10 to 40 miles (16 to 65 km). Tall buildings or hills can interfere with FM signals, causing the sound to come and go.

AM

The range for most AM stations is greater than for FM, especially at night. The longer range, however, can cause stations to interfere with each other. AM can also pick up noise from things like storms and power lines. To lower this noise, try reducing the treble level.

AM Stereo

Your Delco® system may be able to receive C-Quam® stereo broadcasts. Many AM stations around the country use C-Quam® to produce stereo, though some do not. C-Quam® is a registered trademark of Motorola, Inc. If your Delco® system can get C-Quam® signals, your stereo indicator light will come on when you are receiving it.



Care of Your Cassette Tape Player

A tape player that is not cleaned regularly can cause reduced sound quality, ruined cassettes, or a damaged mechanism. Cassette tapes should be stored in their cases away from contaminants, direct sunlight, and extreme heat. If they aren't, they may not operate properly or cause failure of the tape player.

Your tape player should be cleaned regularly each month or after every 15 hours of use. If you notice a reduction in sound quality, try a known good cassette to see if the tape or the tape player is at fault. If this other cassette has no improvement in sound quality, clean the tape player.



Clean your tape player with a wiping-action, non-abrasive cleaning cassette, and follow the directions provided with it.

Cassettes are subject to wear and the sound quality may degrade over time. Always make sure that the cassette tape is in good condition before you have your tape player serviced.

Care of Your Compact Discs

Handle discs carefully. Store them in their original cases or other protective cases and away from direct sunlight and dust. If the surface of a disc is soiled, dampen a clean, soft cloth in a mild, neutral detergent solution and clean it, wiping from the center to the edge.

Be sure never to touch the signal surface when handling discs. Pick up discs by grasping the outer edges or the edge of the hole and the outer edge.

Fixed Mast Antenna

The fixed mast antenna can withstand most car washes without being damaged. If the mast should ever become slightly bent, you can straighten it out by hand. If the mast is badly bent, as it might be by vandals, you should replace it.

Check every once in a while to be sure the mast is still tightened to the fender.

Notes



Here you'll find information about driving on different kinds of roads and in varying weather conditions. We've also tried to include many other useful tips on driving.

Part 4

Your Driving and the Road

Road Signs	118
Defensive Driving	122
Drunken Driving	123
Control of a Vehicle	
What Is All-Wheel Drive?	126
Braking	126
Steering Tips	131
Steering in Emergencies	132
Passing	133
Driving Guidelines	136
Operating Your Bravada Off Paved Roads	137
Driving at Night	149
Driving in the Rain	152
City Driving	155
Freeway Driving	156
Driving a Long Distance	158
Hill and Mountain Roads	160
Parking on Hills	161
Winter Driving	163
Towing a Trailer	167

Your Driving and the Road

■ Road Signs

The road signs you see everywhere are coded by color and shape. It's a good idea to know these codes so that you can quickly grasp the basic meaning or intent of the sign even before you have a chance to read it.



STOP

DO NOT
ENTER

WRONG
WAY

Color of Road Signs

Red means **Stop**. It may also indicate that some movement is not allowed. Examples are **Do Not Enter** and **Wrong Way**.



Green is used to guide the driver. Green signs may indicate upcoming freeway exits or show the direction you should turn to reach a particular place.



RR ADVANCE
CROSSING

NARROW
BRIDGE

NO PASSING
ZONE

Yellow indicates a general warning. Slow down and be careful when you see a yellow sign. It may signal a railroad crossing ahead, a no passing zone, or some other potentially dangerous situation. Likewise, a yellow solid line painted on the road means **Don't Cross**.



HOSPITAL

INFORMATION

Blue signs with white letters show motorists' services.



LOW
SHOULDER

WORKERS
AHEAD

FLAGGER
AHEAD

X4027

Orange indicates road construction or maintenance. You'll want to slow down when you see an orange sign, as part of the road may be closed off or torn up. And there may be workers and maintenance vehicles around, too.



X3014

Shape of Road Signs

The shape of the sign will tell you something, too.

An **octagonal** (eight-sided) sign means **Stop**. It is always red with white letters.



X4028

A **diamond**-shaped sign is a warning of something ahead—for example, a curve, steep hill, soft shoulder, or a narrow bridge.



CANOEING

SWIMMING

X3013

Brown signs point out recreation areas or points of historic or cultural interest.



X3016

A **triangle**, pointed downward, indicates **Yield**. It assigns the right of way to traffic on certain approaches to an intersection.



X3017

A **triangular** sign also is used on two-lane roads to indicate a no passing zone. This sign will be on the left side of the roadway.

Your Driving and the Road

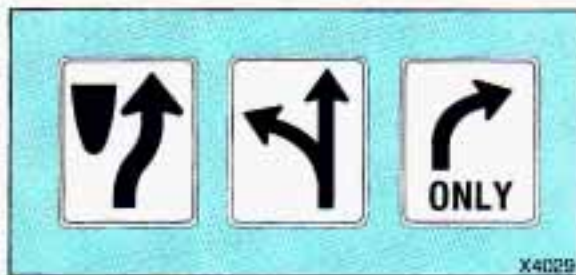

KEEP
RIGHT

LEFT OR
THROUGH

RIGHT TURN
ONLY

Shape of Road Signs (CONT.)

Rectangular (square or oblong) signs show speed limits, parking regulations, give directions, and such information as distances to cities.



X4030

Symbols on Road Signs

There are many international road signs in use today.



X4051

NO U
TURN

NO
PARKING

NO
BICYCLES

The basic message of many of these signs is in pictures or graphic symbols. A picture within a circle with a diagonal line across it shows what **not** to do.



X3021

Traffic Lights

We're all familiar with traffic lights or stop lights. Often green arrows are being used in the lights for improved traffic control. On some multilane roads, green arrows light up, indicating that traffic in one or more lanes can move or make a turn. Green arrows don't mean "go no matter what." You'll still need to proceed with caution, yielding the right of way to pedestrians and sometimes to other vehicles.

Some traffic lights also use red arrows to signify that you must stop before turning on red.

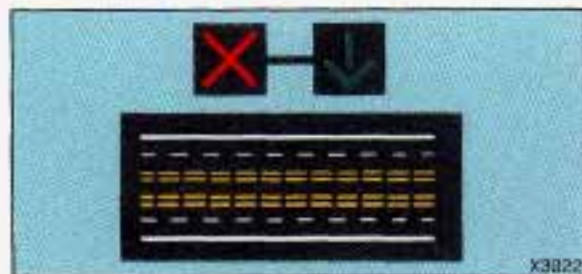

REVERSIBLE LANE ON MULTILANE ROADWAY

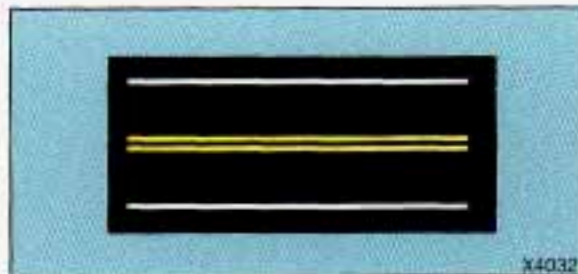

NO PASSING ZONE

Pavement Markings

Pavement markings add to traffic signs and signals. They give information to drivers without taking attention from the roadway. A solid yellow line on your side of the road or lane means **Don't Cross**.

Many city roads and expressways, and even bridges, use reversible-lane traffic control during rush hours. A red X light above a lane means no driving in that lane at that time. A green arrow means you may drive in that lane. Look for the signs posted to warn drivers what hours and days these systems are in effect.

Your Own Signals

Drivers signal to others, too. It's not only more polite, it's safer to let other drivers know what you are doing. And in some places the law requires driver signals.

Turn and Lane Change Signals:

Always signal when you plan to turn or change lanes.

If necessary, you can use hand signals out the window:

Left arm straight out for a left turn, down for slow or about-to-stop, and up for a right turn.

Slowing Down:

If time allows, tap the brake pedal once or twice in advance of slowing or stopping. This warns the driver behind you.

Disabled:

Your four-way flashers signal that your vehicle is disabled or is a hazard. See the *Index* under *Hazard Warning Flashers*.

Traffic Officer

The traffic police officer is also a source of important information. The officer's signals govern, no matter what the traffic lights or other signs say.

The next section discusses some of the road conditions you may encounter.

Your Driving and the Road

Defensive Driving

The best advice anyone can give about driving is: Drive defensively.

Please start with a very important safety device in your Oldsmobile: Buckle up. (See the *Index* under *Safety Belts*.)

Defensive driving really means “be ready for anything.” On city streets, rural roads, or freeways, it means “always expect the unexpected.”

Assume that pedestrians or other drivers are going to be careless and make mistakes. Anticipate what they might do. Be ready for their mistakes.

Expect children to dash out from behind parked cars, often followed by other children. Expect occupants in parked cars to open doors into traffic. Watch for movement in parked cars—someone may be about to open a door.

Expect other drivers to run stop signs when you are on a through street. Be ready to brake if necessary as you go through intersections. You may not have to use the brake, but if you do, you will be ready.

If you're driving through a shopping center parking lot where there are well-marked lanes, directional arrows, and designated parking areas, expect some drivers to ignore all these markings and dash straight toward one part of the lot.

Pedestrians can be careless. Watch for them. In general, you must give way to pedestrians even if you know you have the right of way.

Rear-end collisions are about the most preventable of accidents. Yet they are common. Allow enough following

distance. It's the best defensive driving maneuver, in both city and rural driving. You never know when the vehicle in front of you is going to brake or turn suddenly.

Here's a final bit of information about defensive driving. The most dangerous time for driving in the U.S. is very early on Sunday morning. In fact, GM Research studies show that the most and the least dangerous times for driving, every week, fall on the same day. That day is Sunday. The most dangerous time is Sunday from 3 a.m. to 4 a.m. The safest time is Sunday from 10 a.m. to 11 a.m. Driving the same distance on a Sunday at 3 a.m. isn't just a little more dangerous than it is at 10 a.m. It's about 134 times more dangerous!

That leads to the next section.

Drunken Driving

Death and injury associated with drinking and driving is a national tragedy. It's the number one contributor to the highway death toll, claiming thousands of victims every year. Alcohol takes away three things that anyone needs to drive a vehicle:

- Judgment
- Muscular Coordination
- Vision

Police records show that half of all motor vehicle-related deaths involve alcohol—a driver, a passenger or someone else, such as a pedestrian, had been drinking. In most cases, these deaths are the result of someone who was drinking and driving. Over 25,000 motor vehicle-related deaths occur each year because of alcohol, and thousands of people are injured.

Just how much alcohol is too much if a person plans to drive? Ideally, no one should drink alcohol and then drive. But if one does, then what's "too much"? It can be a lot less than many might think. Although it depends on each person and situation, here is some general information on the problem.

The Blood Alcohol Content (BAC) of someone who is drinking depends upon four things:

- How much alcohol is in the drink.
- The drinker's body weight.
- The amount of food that is consumed before and during drinking.
- The length of time it has taken the drinker to consume the alcohol.



According to the American Medical Association, a 180-pound (82 kg) person who drinks three 12-ounce (355 ml) bottles of beer in an hour will end up with a BAC of about 0.06 percent. The person would reach the same BAC by drinking three 4-ounce (120 ml) glasses of wine or three mixed drinks if each had 1½ ounces (45 ml) of a liquor like whiskey, gin or vodka.

It's the amount of alcohol that counts. For example, if the same person drank three double martinis (3 ounces or 90 ml of liquor each) within an hour, the person's BAC would be close to 0.12 percent. A person who consumes food just before or during drinking will have a slightly lower BAC level.

Your Driving and the Road

Drinking that Will Result in a BAC of .05% in the Time Shown

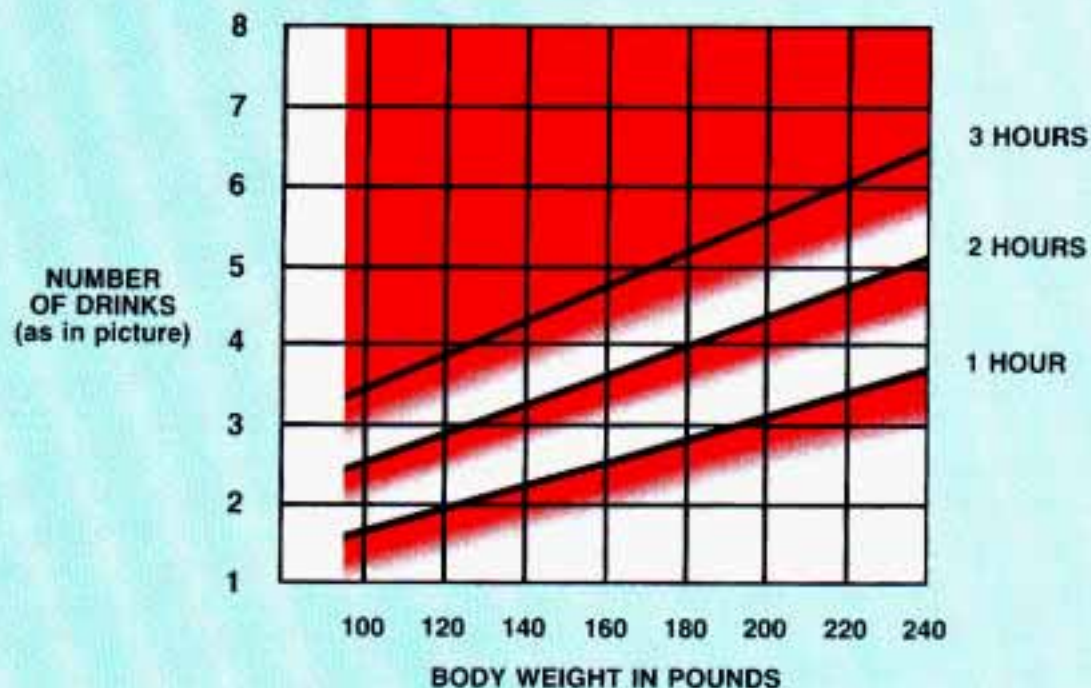

shows that the driving skills of many people are impaired at a BAC approaching 0.05 percent, and that the effects are worse at night. All drivers are impaired at BAC levels above 0.05 percent. Statistics show that the chance of being in an accident increases sharply for drivers who have a BAC of 0.05 percent or above. A driver with a BAC level of 0.06 percent (three beers in one hour for a 180-pound or 82 kg person) has doubled his or her chance of having an accident. At a BAC level of 0.10 percent, the chance of that driver having an accident is six times greater; at a level of 0.15 percent, the chances are twenty-five times greater! And, the body takes about an hour to rid itself of the alcohol in one drink. No amount of coffee or number of cold showers will speed that up.

Drunken Driving (CONT.)

The law in most U.S. states sets the legal limit at a BAC of 0.10 percent. In Canada the limit is 0.08 percent, and in some other countries it's lower than that. The BAC will be over 0.10 percent after three to six drinks (in one hour).

Of course, as we've seen, it depends on how much alcohol is in the drinks, and how quickly the person drinks them.

But it's very important to keep in mind that the ability to drive is affected well below a BAC of 0.10 percent. Research

“I’ll be careful” isn’t the right answer. What if there’s an emergency, a need to take sudden action, as when a child darts into the street? A person with a higher BAC might not be able to react quickly enough to avoid the collision. There’s something else about drinking and driving that many people don’t know. Medical research shows that alcohol in a person’s system can make crash injuries worse. That’s especially true for brain, spinal cord and heart injuries. That means that if anyone who has been drinking—driver or passenger—is in a crash, the chance of being killed or permanently disabled is higher than if that person had not been drinking. And we’ve already seen that

the chance of a crash itself is higher for drinking drivers.

CAUTION



Drinking and then driving is very dangerous. Your reflexes, perceptions, and judgment will be affected by even a small amount of alcohol. You could have a serious—or even fatal—accident if you drive after drinking. Please don’t drink and drive or ride with a driver who has been drinking. Ride home in a cab; or if you’re with a group, designate a driver who will not drink.



■ *Control of a Vehicle*

You have three systems that make your vehicle go where you want it to go. They are the brakes, the steering and the accelerator. All three systems have to do their work at the places where the tires meet the road.

Sometimes, as when you’re driving on snow or ice, it’s easy to ask more of those control systems than the tires and road can provide. That means you can lose control of your vehicle.

Your Driving and the Road

What Is All-Wheel Drive?

All the Wheels, All the Time

Bravada has a unique system called all-wheel drive (AWD). Simply stated, AWD supplies power from the engine to all four wheels, all the time. It works in all conditions—both on and off paved surfaces, no matter if the weather is fair or foul.

The heart of the AWD system is the transfer case. Here, engine power is divided by an interaxle differential. Under normal conditions, it sends 65 percent of the torque to the rear axle and the other 35 percent to the front axle.

But on a slippery surface, a viscous clutch in the transfer case adjusts the 65/35 proportion according to need,

sending more power to the axle with traction.

Another feature of the AWD system that helps Bravada keep its grip is the limited-slip rear axle. In conditions where one rear wheel loses traction but the other still has some—as when one wheel hits an icy patch or slips onto a muddy road shoulder—this design provides power to the wheel with traction. And AWD is simple. It's always there—working.

Braking

Braking action involves **perception time** and **reaction time**.

First, you have to decide to push on the brake pedal. That's **perception time**. Then you have to bring up your foot and do it. That's **reaction time**.

Average **reaction time** is about $\frac{3}{4}$ of a second. But that's only an average. It might be less with one driver and as long as two or three seconds or more with another. Age, physical condition, alertness, coordination, and eyesight all play a part. So do alcohol, drugs and frustration. But even in $\frac{3}{4}$ of a second, a vehicle moving at 60 mph (100 km/h) travels 66 feet (20 m). That could be a lot of distance in an emergency, so keeping enough space between your vehicle and others is important.

And, of course, actual stopping distances vary greatly with the surface of the road (whether it's pavement or gravel); the condition of the road (wet, dry, icy); tire tread; and the condition of your brakes.

Most drivers treat their brakes with care. Some, however, overwork the braking system with poor driving habits.

- Avoid needless heavy braking. Some people drive in spurts—heavy acceleration followed by heavy braking—rather than keeping pace with traffic. This is a mistake. Your brakes may not have time to cool between hard stops. Your brakes will wear out much faster if you do a lot of heavy braking.



- Don't "ride" the brakes by letting your left foot rest lightly on the brake pedal while driving.

CAUTION



"Riding" your brakes can cause them to overheat to the point that they won't work well. You might not be able to stop your vehicle in time to avoid an accident. If you "ride" your brakes, they will get so hot they will require a lot of pedal force to slow you down. Avoid "riding" the brakes.

NOTICE

"Riding" the brakes wears them out much faster. You would need costly brake replacement much sooner than normal, and it also reduces fuel economy.

If you keep pace with the traffic and allow realistic following distances, you will eliminate a lot of unnecessary braking. That means better braking and longer brake life.

- If your engine ever stops while you're driving, brake normally but don't pump your brakes. If you do, the pedal may get harder to push down. If your engine stops, you will still have some power brake assist. But you will use it when you brake. Once the power assist is used up, it may take longer to stop and the brake pedal will be harder to push.

Your Driving and the Road



Anti-Lock Brakes (ABS)

Your vehicle has an advanced electronic braking system that can help you keep it under control.

When you start your vehicle and begin to drive away, you may hear a momentary motor or clicking noise. This is the ABS system testing itself.



Here's how anti-lock works. Let's say the road is wet. You're driving safely. Suddenly an animal jumps out in front of you.

You slam on the brakes. Here's what happens with ABS.

A computer senses that wheels are slowing down. The computer separately works the brakes at each front wheel and at the rear wheels. The anti-lock system can change the brake pressure faster than any driver could. The computer is programmed to make the most of available tire and road conditions.



As you brake, your computer keeps receiving updates on wheel speed and controls braking pressure accordingly.

CAUTION

 Anti-lock doesn't change the time you need to get your foot up to the brake pedal. If you get too close to the vehicle in front of you, you won't have time to apply your brakes if that vehicle suddenly slows or stops. Always leave enough room up ahead to stop, even though you have anti-lock brakes.

To Use Four-Wheel Anti-Lock:

Don't pump the brakes. Just hold the brake pedal down and let anti-lock work for you. You may feel the brakes vibrate, or you may notice some noise, but this is normal.

Disc Brake Wear Indicators

Your Oldsmobile has front disc brakes and rear drum brakes. Disc brake pads have built-in wear indicators that make a high-pitched warning sound when the brake pads are worn and new pads are needed. The sound may come and go or be heard all the time your vehicle is moving (except when you are pushing on the brake pedal firmly).

CAUTION



The brake wear warning sound means that sooner or later your brakes won't work well. That could lead to an accident. When you hear the brake wear warning sound, have your vehicle serviced.

NOTICE

Continuing to drive with worn-out brake pads could result in costly brake repair.

Some driving conditions or climates may cause a brake squeal when the brakes are first applied or lightly applied. This does not mean something is wrong with your brakes.

Your Driving and the Road

Rear Drum Brakes

Your rear drum brakes don't have wear indicators, but if you ever hear a rear brake rubbing noise, have the rear brake linings inspected. Also, the rear brake drums should be removed and inspected each time the tires are removed for rotation or changing. When you have the front brakes replaced, have the rear brakes inspected, too.

Brake linings should always be replaced as complete axle sets.

Brake Pedal Travel

See your dealer if the brake pedal does not return to normal height, or if there is a rapid increase in pedal travel. This could be a sign of brake trouble.

Brake Adjustment

Every time you make a brake stop, your disc brakes adjust for wear.

If your brake pedal goes down farther than normal, your rear drum brakes may need adjustment. Adjust them by backing up and firmly applying the brakes a few times.

Braking In Emergencies

Use your anti-lock braking system when you need to. With anti-lock, you can steer and brake at the same time. In many emergencies, steering can help you more than even the very best braking.

Power Steering

If you lose power steering assist because the engine stops or the system fails to function, you can steer but it will take much more effort.

Steering Tips—Driving on Curves

It's important to take curves at a reasonable speed.

A lot of the "driver lost control" accidents mentioned on the news happen on curves. Here's why:

Experienced driver or beginner, each of us is subject to the same laws of physics when driving on curves. The traction of the tires against the road surface makes it possible for the vehicle to change its path when you turn the front wheels. If there's no traction, inertia will keep the vehicle going in the same direction. If you've ever tried to steer a vehicle on wet ice, you'll understand this.

The traction you can get in a curve depends on the condition of your tires and the road surface, the angle at which

the curve is banked, and your speed. While you're in a curve, speed is the one factor you can control.

Suppose you're steering through a sharp curve. Then you suddenly accelerate. Those two control systems—steering and acceleration—can overwhelm those places where the tires meet the road and make you lose control.

What should you do if this ever happens? Let up on the accelerator pedal, steer the vehicle the way you want it to go, and slow down.

Speed limit signs near curves warn that you should adjust your speed. Of course, the posted speeds are based on good weather and road conditions. Under less favorable conditions you'll want to go slower.

If you need to reduce your speed as you approach a curve, do it before you enter the curve, while your front wheels are straight ahead.

Try to adjust your speed so you can "drive" through the curve. Maintain a reasonable, steady speed. Wait to accelerate until you are out of the curve, and then accelerate gently into the straightaway.

When you drive into a curve at night, it's harder to see the road ahead of you because it bends away from the straight beams of your lights. This is one good reason to drive slower.

Your Driving and the Road



Steering in Emergencies

There are times when steering can be more effective than braking. For example, you come over a hill and find a truck stopped in your lane, or a car suddenly pulls out from nowhere, or a child darts out from between parked cars and stops right in front of you. You can avoid these problems by braking—if you can stop in time. But sometimes you can't; there isn't room. That's the time for evasive action—steering around the problem.

Your Oldsmobile can perform very well in emergencies like these. First apply your brakes. It is better to remove as much speed as you can from a possible collision. Then steer around the problem, to the left or right depending on the space available.

An emergency like this requires close attention and a quick decision. If you are holding the steering wheel at the recommended 9 and 3 o'clock positions, you can turn it a full 180 degrees very quickly without removing either hand. But you have to act fast, steer quickly, and just as quickly straighten the wheel once you have avoided the object. You must then be prepared to steer back to your original lane and then brake to a controlled stop.

Depending on your speed, this can be rather violent for an unprepared driver. This is one of the reasons driving experts recommend that you use your safety belts and keep both hands on the steering wheel.

The fact that such emergency situations are always possible is a good reason to practice defensive driving at all times.



Off-Road Recovery

You may find sometime that your right wheels have dropped off the edge of a road onto the shoulder while you're driving.

If the level of the shoulder is only slightly below the pavement, recovery should be fairly easy. Ease off the accelerator and then, if there is nothing in the way, steer so that your vehicle straddles the edge of the pavement. You can turn the steering wheel up to $\frac{1}{4}$ turn until the right front tire contacts the pavement edge. Then turn your steering wheel to go straight down the roadway.

If the shoulder appears to be about four inches (100 mm) or more below the pavement, this difference can cause problems. If there is not enough room to

pull entirely onto the shoulder and stop, then follow the same procedures. But if the right front tire scrubs against the side of the pavement, do **not** steer more sharply. With too much steering angle, the vehicle may jump back onto the road with so much steering input that it crosses over into the oncoming traffic before you can bring it back under control. Instead, ease off again on the accelerator and steering input, straddle the pavement once more, then try again.

Passing

The driver of a vehicle about to pass another on a two-lane highway waits for just the right moment, accelerates, moves around the vehicle ahead, then goes back into the right lane again. A simple maneuver?

Not necessarily! Passing another vehicle on a two-lane highway is a potentially dangerous move, since the passing vehicle occupies the same lane as oncoming traffic for several seconds. A miscalculation, an error in judgment, or a brief surrender to frustration or anger can suddenly put the passing driver face to face with the worst of all traffic accidents—the head-on collision.

So here are some tips for passing:

- “Drive ahead.” Look down the road, to the sides, and to crossroads for situations that might affect your passing patterns. If you have any doubt whatsoever about making a successful pass, wait for a better time.

Your Driving and the Road

Passing (CONT.)

- Watch for traffic signs, pavement markings, and lines. If you can see a sign up ahead that might indicate a turn or an intersection, delay your pass. A broken center line usually indicates it's all right to pass (providing the road ahead is clear). Never cross a solid line on your side of the lane or a double solid line, even if the road seems empty of approaching traffic.
- If you suspect that the driver of the vehicle you want to pass isn't aware of your presence, tap the horn a couple of times before passing.
- Do not get too close to the vehicle you want to pass while you're awaiting an opportunity. For one thing, following too closely reduces your area of vision, especially if you're following a larger vehicle. Also, you won't have adequate space if the vehicle ahead suddenly slows or stops. Keep back a reasonable distance.
- When it looks like a chance to pass is coming up, start to accelerate but stay in the right lane and don't get too close. Time your move so you will be increasing speed as the time comes to move into the other lane. If the way is clear to pass, you will have a "running start" that more than makes up for the distance you would lose by dropping back. And if something happens to cause you to cancel your pass, you need only slow down and drop back again and wait for another opportunity.
- If other cars are lined up to pass a slow vehicle, wait your turn. But take care that someone isn't trying to pass you as you pull out to pass the slow vehicle. Remember to glance over your shoulder and check the blind spot.
- Check your mirrors, glance over your shoulder, and start your left lane change signal before moving out of the right lane to pass. When you are far enough ahead of the passed vehicle to see its front in your inside mirror, activate your right lane change signal and move back into the right lane. (Remember that your right outside mirror is convex. The vehicle you just passed may seem to be farther away from you than it really is.)
- Try not to pass more than one vehicle at a time on two-lane roads. Reconsider before passing the next vehicle.
- Don't overtake a slowly moving vehicle too rapidly. Even though the brake lights are not flashing, it may be slowing down or starting to turn.
- If you're being passed, make it easy for the following driver to get ahead of you. Perhaps you can ease a little to the right.

Loss of Control

Let's review what driving experts say about what happens when the three control systems (brakes, steering and acceleration) don't have enough friction where the tires meet the road to do what the driver has asked.

In any emergency, don't give up. Keep trying to steer and constantly seek an escape route or area of less danger.

Skidding

In a skid, a driver can lose control of the vehicle. Defensive drivers avoid most skids by taking reasonable care suited to existing conditions, and by not "overdriving" those conditions. But skids are always possible.

The three types of skids correspond to your Oldsmobile's three control systems. In the braking skid your wheels aren't rolling. In the steering or cornering skid, too much speed or steering in a curve causes tires to slip and lose cornering force. And in the acceleration skid too much throttle causes the driving wheels to spin.

A cornering skid and an acceleration skid are best handled by easing your foot off the accelerator pedal. If your vehicle starts to slide (as when you turn a corner on a wet, snow- or ice-covered road), ease your foot off the accelerator

pedal as soon as you feel the vehicle start to slide. Quickly steer the way you want the vehicle to go. If you start steering quickly enough, your vehicle will straighten out. As it does, straighten the front wheels.

Of course, traction is reduced when water, snow, ice, gravel, or other material is on the road. For safety, you'll want to slow down and adjust your driving to these conditions. It is important to slow down on slippery surfaces because stopping distance will be longer and vehicle control more limited.

While driving on a surface with reduced traction, try your best to avoid sudden steering, acceleration, or braking (including engine braking by shifting to a lower gear). Any sudden change could

Your Driving and the Road

Skidding (CONT.)

cause the tires to slide. You may not realize the surface is slippery until your vehicle is skidding. Learn to recognize warning clues—such as enough water, ice or packed snow on the road to make a “mirrored surface”—and slow down when you have any doubt.

Remember: Any anti-lock braking system (ABS) helps avoid only the braking skid. Steer the way you want to go.

Driving Guidelines

This multipurpose passenger vehicle is defined as a utility vehicle in Consumer Information Regulations issued by the National Highway Traffic Safety Administration (NHTSA) of the United States Department of Transportation. Utility vehicles have higher ground clearance and a narrower track to make them capable of performing in a wide variety of off-road applications. Specific design characteristics give them a higher center of gravity than ordinary cars. An advantage of the higher ground clearance is a better view of the road, allowing you to anticipate problems. They are not designed for cornering at the same speeds as conventional two-

wheel drive vehicles any more than low-slung sports cars are designed to perform satisfactorily under off-road conditions. If at all possible, avoid sharp turns or abrupt maneuvers. As with other vehicles of this type, failure to operate this vehicle correctly may result in loss of control or vehicle rollover.



Operating Your Bravada Off Paved Roads

Many of the same design features that help make Bravada responsive on paved roads during poor weather conditions—features like the locking rear axle and all-wheel drive—help make it much better suited for off-road use than a conventional passenger car. Its higher ground clearance also helps Bravada step over some off-road obstacles. But Bravada doesn't have features like special underbody shielding and a transfer case low gear range, things that are usually thought necessary for extended or severe off-road service. This guide is for operating your Bravada off paved roads. Also, see the *Index* under *Anti-Lock Brakes*.

Off-road driving can be great fun. But it does have some definite hazards. The greatest of these is the terrain itself.

"Off-roading" means you've left the great North American road system behind. Traffic lanes aren't marked. Curves aren't banked. There are no road signs. Surfaces can be slippery, rough, uphill or downhill. In short, you've gone right back to nature.

Off-road driving involves some new skills. And that's why it's very important that you read this guide. You'll find many driving tips and suggestions. These will help make your off-road driving safer and more enjoyable.

Before You Go Off-Roading

There are some things to do before you go out. For example, be sure to have all necessary maintenance and service work done. Be sure you read all the information about your all-wheel drive vehicle in this manual. Is there enough fuel? Is the spare tire fully inflated? Are the fluid levels up where they should be? What are the local laws that apply to off-roading where you'll be driving? If you don't know, you should check with law enforcement people in the area. Will you be on someone's private land? If so, be sure to get the necessary permission.

Your Driving and the Road

Loading Your Vehicle for Off-Road Driving

There are some important things to remember about how to load your vehicle.

- The heaviest things should be on the load floor and forward of your rear axle. Put heavier items as far forward as you can.
- Be sure the load is secured properly, so driving on the off-road terrain doesn't toss things around.

CAUTION



- Cargo on the load floor piled higher than the seatbacks can be thrown forward during a sudden stop. You or your passengers could be injured. Keep cargo below the top of the seatbacks.
- Unsecured cargo on the load floor can be tossed about when driving over rough terrain. You or your passengers can be struck by flying objects. Secure the cargo properly.
- Heavy loads on the roof raise the vehicle's center of gravity, making it more likely to roll over. You can be seriously or fatally injured if the vehicle rolls over. Put heavy loads inside the cargo area, not on the roof. Keep cargo in the cargo area as far forward and low as possible.

You'll find other important information in this manual. See the *Index* under *Vehicle Loading*, *Luggage Carrier* and *Tires*.

Traveling to Remote Areas

It makes sense to plan your trip, especially when going to a remote area. Know the terrain and plan your route. You are much less likely to get bad surprises. Get accurate maps of trails and terrain. Try to learn of any blocked or closed roads.

It's also a good idea to travel with at least one other vehicle. If something happens to one of them, the other can help quickly.

Getting Familiar with Off-Road Driving

It's a good idea to practice in an area that's safe and close to home before you go into the wilderness. Off-road driving does require some new and different driving skills. Here's what we mean.

Tune your senses to different kinds of signals. Your eyes, for example, need to constantly sweep the terrain for unexpected obstacles. Your ears need to listen for unusual tire or engine sounds. With your arms, hands, feet, and body you'll need to respond to vibrations and vehicle bounce.

Controlling your vehicle is the key to successful off-road driving. One of the best ways to control your vehicle is to control your speed. Here are some things to keep in mind. At higher speeds:

- You approach things faster and you have less time to scan the terrain for obstacles.
- You have less time to react.
- You have more vehicle bounce when you drive over obstacles.
- You'll need more distance for braking, especially since you're on an unpaved surface.

Your Driving and the Road

Getting Familiar with Off-Road Driving (CONT.)

CAUTION



When you're driving off road, bouncing and quick changes in direction can easily throw you out of position. This could cause you to lose control and crash. So, whether you're driving on or off the road, you and your passengers should wear safety belts.

Scanning the Terrain

Off-road driving can take you over many different kinds of terrain. You need to be familiar with the terrain and its many different features. Here are some things to consider.

Surface Conditions

Off-roading can take you over hard-packed dirt, gravel, rocks, grass, sand, mud, snow or ice. Each of these surfaces affects the steering, acceleration, and braking of your vehicle in different ways. Depending upon the kind of surface you are on, you may experience slipping, sliding, wheel spinning, delayed acceleration, poor traction, and longer braking distances.

Surface Obstacles

Unseen or hidden obstacles can be hazardous. A rock, log, hole, rut, or bump can startle you if you're not prepared for them. Often these obstacles are hidden by grass, bushes, snow or even the rise and fall of the terrain itself. Here are some things to consider:

- Is the path ahead clear?
- Will the surface texture change abruptly up ahead?
- Does the travel take you uphill or downhill? (There's more discussion of these subjects later.)
- Will you have to stop suddenly or change direction quickly?

When you drive over obstacles or rough terrain, keep a firm grip on the steering

wheel. Ruts, troughs, or other surface features can jerk the wheel out of your hands if you're not prepared.

When you drive over bumps, rocks, or other obstacles, your wheels can leave the ground. If this happens, even with one or two wheels, you can't control the vehicle as well or at all.

Because you will be on an unpaved surface, it's especially important to avoid sudden acceleration, sudden turns, or sudden braking.

In a way, off-road driving requires a different kind of alertness from driving on paved roads and highways. There are no road signs, posted speed limits or signal lights. You have to use your own good judgment about what is safe and what isn't.

CAUTION



Drinking and driving can be very dangerous on any road. And this is certainly true for off-road driving. At the very time you need special alertness and driving skills, your reflexes, perceptions and judgment can be affected by even a small amount of alcohol. You could have a serious—or even fatal—accident if you drink and drive or ride with a driver who has been drinking. (See the *Index* under *Drunken Driving*.)

Your Driving and the Road

Driving on Off-Road Hills

Off-road driving often takes you up, down, or across a hill. Driving safely on hills requires good judgment and an understanding of what your vehicle can and can't do. There are some hills that simply can't be driven, no matter how well built the vehicle.

CAUTION



Many hills are simply too steep for any vehicle. If you drive up them, you will stall. If you drive down them, you can't control your speed. If you drive across them, you will roll over. You could be seriously injured or killed. If you have any doubt about the steepness, don't drive the hill.

Approaching a Hill

When you approach a hill, you need to decide if it's one of those hills that's just too steep to climb, descend, or cross. Steepness can be hard to judge. On a very small hill, for example, there may be a smooth, constant incline with only a small change in elevation where you can easily see all the way to the top. On a large hill, the incline may get steeper as you near the top, but you may not see this because the crest of the hill is hidden by bushes, grass, or shrubs.

Here are some other things to consider as you approach a hill:

- Is there a constant incline, or does the hill get sharply steeper in places?
- Is there good traction on the hillside, or will the surface cause tire slipping?

- Is there a straight path up or down the hill so you won't have to make turning maneuvers?
- Are there obstructions on the hill that can block your path (boulders, trees, logs or ruts)?
- What's beyond the hill? Is there a cliff, an embankment, a drop-off, a fence? Get out and walk the hill if you don't know. It's the smart way to find out.
- Is the hill simply too rough? Steep hills often have ruts, gullies, troughs and exposed rocks because they are more susceptible to the effects of erosion.

Driving Uphill

Once you decide you can safely drive up the hill, you need to take some special steps.

- Use a low gear and get a firm grip on the steering wheel.
- Get a smooth start up the hill and try to maintain your speed. Don't use more power than you need, because you don't want your wheels to start spinning or sliding.
- Try to drive straight up the hill if at all possible. If the path twists and turns, you might want to find another route.

CAUTION



Turning or driving across steep hills can be dangerous. You could lose traction, slide sideways, and possibly roll over. You could be seriously injured or killed. When driving up hills, always try to go straight up.

- Ease up on your speed as you approach the top of the hill.
- Attach a flag to the vehicle to make you more visible to approaching traffic on trails or hills.
- Sound the horn as you approach the top of the hill to let opposing traffic know you're there.
- Use your headlights even during the day. They make you more visible to oncoming traffic.

CAUTION



Driving to the top (crest) of a hill at full speed can cause an accident. There could be a drop-off, embankment, cliff, or even another vehicle. You could be seriously injured or killed. As you near the top of a hill, slow down and stay alert.

Q: What should I do if my vehicle stalls, or is about to stall, and I can't make it up the hill?

- A:** If this happens, there are some things you should do, and there are some things you must not do. First, here's what you **should** do:
- Push the brake pedal to stop the vehicle and keep it from rolling backwards. Also, apply the parking brake.
 - If your engine is still running, shift the transmission into **R** (Reverse), release the parking brake, and slowly back down the hill in **R** (Reverse).
 - If your engine has stopped running, you'll need to restart it. With the brake pedal depressed and the parking brake still applied, shift the transmission to **P** (Park) and restart the engine. Then,

Your Driving and the Road

Driving Uphill (CONT.)

shift to **R** (Reverse), release the parking brake, and slowly back down the hill in **R** (Reverse).

- As you are backing down the hill, put your left hand on the steering wheel at the 12 o'clock position. This way, you'll be able to tell if your wheels are straight or turned to the left or right as you back down.

Here are some things you **must not** do if you stall, or are about to stall, when going up a hill.

- Never attempt to prevent a stall by shifting into **N** (Neutral) to "rev-up" the engine and regain forward momentum. This won't work. Your vehicle will roll backwards very quickly and you could go out of control.

Instead, apply the regular brake to stop the vehicle. Then apply the parking brake. Shift into **R** (Reverse), release the parking brake, and slowly back down.

- Never attempt to turn around if you are about to stall when going up a hill. If the hill is steep enough to stall your vehicle, it's steep enough to cause you to roll over if you turn around. If you can't make it up the hill, you must back down the hill.

Q: Suppose, after stalling, I try to back down the hill and decide I just can't do it. What should I do?

A: Set the parking brake, put your transmission in **P** (Park), and turn off the engine. Leave the vehicle and go get some help. Exit on the uphill side and stay clear of the path the vehicle would take if it rolled downhill.

Driving Downhill

When off-roading takes you downhill, you'll want to consider a number of things:

- How steep is the downhill? Will I be able to maintain vehicle control?
- What's the surface like? Smooth? Rough? Slippery? Hard-packed dirt? Gravel?
- Are there hidden surface obstacles? Ruts? Logs? Boulders?
- What's at the bottom of the hill? Is there a hidden creek bank or even a river bottom with large rocks?

If you decide you can go down a hill safely, then try to keep your vehicle headed straight down, and use a low gear. This way, engine drag can help your brakes and they won't have to do all the work. Descend slowly, keeping your vehicle under control at all times.

CAUTION



Heavy braking when going down a hill can cause your brakes to overheat and fade. This could cause loss of control and a serious accident. Apply the brakes lightly when descending a hill and use a low gear to keep vehicle speed under control.

Q: Are there some things I should not do when driving down a hill?

A: Yes! These are important because if you ignore them you could lose control and have a serious accident.

- When driving downhill, avoid turns that take you across the incline of the hill. A hill that's not too steep to drive down may be too steep to drive across. You could roll over if you don't drive straight down.
- Never go downhill with the transmission in **N** (Neutral). This is called "free-wheeling." Your brakes will have to do all the work and could overheat and fade.

Your Driving and the Road

Driving Downhill (CONT.)

Q: Am I likely to stall when going downhill?

A: It's much more likely to happen going uphill. But if it happens going downhill, here's what to do.

- Stop your vehicle by applying the regular brakes. Apply the parking brake.
- Shift to **P** (Park) and, while still braking, restart the engine.
- Shift back to a low gear, release the parking brake, and drive straight down.
- If the engine won't start, get out and get help.

Driving Across an Incline

Sooner or later, an off-road trail will probably go across the incline of a hill. If this happens, you have to decide whether to try to drive across the incline. Here are some things to consider:

- A hill that can be driven straight up or down may be too steep to drive across. When you go straight up or down a hill, the length of the wheel base (the distance from the front wheels to the rear wheels) reduces the likelihood the vehicle will tumble end over end. But when you drive across an incline, the much more narrow track width (the distance between the left and right wheels) may not prevent the vehicle from tilting and rolling over. Also, driving across an incline puts more weight on the downhill wheels. This could cause a downhill slide or a rollover.

- Surface conditions can be a problem when you drive across a hill. Loose gravel, muddy spots, or even wet grass can cause your tires to slip sideways, downhill. If the vehicle slips sideways, it can hit something that will trip it (a rock, a rut, etc.) and roll over.
- Hidden obstacles can make the steepness of the incline even worse. If you drive across a rock with the uphill wheels, or if the downhill wheels drop into a rut or depression, your vehicle can tilt even more.

For reasons like these, you need to decide carefully whether to try to drive across an incline. Just because the trail goes across the incline doesn't mean you have to drive it. The last vehicle to try it might have rolled over.

CAUTION



Driving across an incline that's too steep will make your vehicle roll over. You could be seriously injured or killed. If you have any doubt about the steepness of the incline, don't drive across it. Find another route instead.

Q: What if I'm driving across an incline that's not too steep, but I hit some loose gravel and start to slide downhill. What should I do?

A: If you feel your vehicle starting to slide sideways, turn downhill. This should help straighten out the vehicle and prevent the side slipping. However, a much better way to prevent this is to get out and "walk the course" so you know what the surface is like before you drive it.



Stalling on an Incline

If your vehicle stalls when you're crossing an incline, be sure you (and your passengers) get out on the uphill side, even if the door there is harder to open. If you get out on the downhill side and the vehicle starts to roll over, you'll be right in its path.

If you have to walk down the slope, stay out of the path the vehicle will take if it does roll over.

CAUTION



Getting out on the downhill (low) side of a vehicle stopped across an incline is dangerous. If the vehicle rolls over, you could be crushed or killed. Always get out on the uphill (high) side of the vehicle and stay well clear of the rollover path.

Your Driving and the Road

Driving in Mud, Sand, Snow or Ice

When you drive in mud, snow or sand, your wheels won't get good traction. You can't accelerate as quickly, turning is more difficult, and you'll need longer braking distances.

It's best to use a low gear when you're in mud—the deeper the mud, the lower the gear. In really deep mud, the idea is to keep your vehicle moving so you don't get stuck.

When you drive on sand, you'll sense a change in wheel traction. But it will depend upon how loosely packed the sand is. On loosely packed sand (as on beaches or sand dunes) your tires will tend to sink into the sand. This has an effect on steering, accelerating, and braking. You may want to reduce the air pressure in your tires slightly when driving on sand. This will improve traction.

Hard packed snow and ice offer the worst tire traction. On these surfaces, it's very easy to lose control. On wet ice, for example, the traction is so poor that you will have difficulty accelerating. And if you do get moving, poor steering and difficult braking can cause you to slide out of control.

CAUTION



Driving on frozen lakes, ponds or rivers can be dangerous. Underwater springs, currents under the ice, or sudden thaws can weaken the ice. Your vehicle could fall through the ice and you and your passengers could drown. Drive your vehicle on safe surfaces only.

Driving In Water

Light rain causes no special off-road driving problems. But heavy rain can mean flash flooding, and flood waters demand extreme caution.

Find out how deep the water is before you drive through it. If it's deep enough to cover your wheel hubs, axles, or exhaust pipe, don't try it—you probably won't get through. Also, water that deep can damage your axle and other vehicle parts.

If the water isn't too deep, then drive through it slowly. At fast speeds, water splashes on your ignition system and your vehicle can stall. Stalling can also occur if you get your tailpipe under water. And, as long as your tailpipe is under water, you'll never be able to start your engine. When you go through water, remember that when your brakes get wet, it may take you longer to stop.

CAUTION



Driving through rushing water can be dangerous. Deep water can sweep your vehicle downstream and you and your passengers could drown. If it's only inches deep, it can still wash away the ground from under your tires, and you could lose traction and roll the vehicle over. Don't drive through rushing water.

After Off-Road Driving

Remove any brush or debris that has collected on the underbody, chassis or under the hood. These accumulations can be a fire hazard.

After operation in mud or sand, have the brake linings cleaned and checked. These substances can cause glazing and uneven braking. Check the body structure, steering, suspension, wheels, tires, and exhaust system for damage. Also, check the fuel lines and cooling system for any leakage.

Your vehicle will require more frequent service due to off-road use. Refer to the Maintenance Schedule for additional information.



Driving at Night

Night driving is more dangerous than day driving. One reason is that some drivers are likely to be impaired—by alcohol or drugs, with night vision problems, or by fatigue.

Here are some tips on night driving.

- Drive defensively. Remember, this is the most dangerous time.
- Don't drink and drive. (See the *Index* under *Drunken Driving* for more on this problem.)
- Adjust your inside rearview mirror to reduce the glare from headlights behind you.
- Since you can't see as well, you may need to slow down and keep more space between you and other vehicles.

Your Driving and the Road

Driving at Night (CONT.)

It's hard to tell how fast the vehicle ahead is going just by looking at its taillights.

- Slow down, especially on higher speed roads. Your headlights can light up only so much road ahead.
- In remote areas, watch for animals.
- If you're tired, pull off the road in a safe place and rest.

Night Vision

No one can see as well at night as in the daytime. But as we get older these differences increase. A 50-year-old driver may require at least twice as much light to see the same thing at night as a 20-year-old.

What you do in the daytime can also affect your night vision. For example, if you spend the day in bright sunshine you are wise to wear sunglasses. Your eyes will have less trouble adjusting to night.

But if you're driving, don't wear sunglasses at night. They may cut down on glare from headlights, but they also make a lot of things invisible that should remain visible—such as parked cars, obstacles, pedestrians, or even trains blocking railway crossings. You may want to put on your sunglasses after you have pulled into a brightly-lighted service or refreshment area. Eyes

shielded from that glare may adjust more quickly to darkness back on the road. But be sure to remove your sunglasses before you leave the service area.

You can be temporarily blinded by approaching lights. It can take a second or two, or even several seconds, for your eyes to readjust to the dark. When you are faced with severe glare (as from a driver who doesn't lower the high beams, or a vehicle with misaimed headlights), slow down a little. Avoid staring directly into the approaching lights. If there is a line of opposing traffic, make occasional glances over the line of headlights to make certain that one of the vehicles isn't starting to move into your lane. Once you are past the bright lights, give your eyes time to readjust before resuming speed.

High Beams

If the vehicle approaching you has its high beams on, signal by flicking yours to high and then back to low beam. This is the usual signal to lower the headlight beams. If the other driver still doesn't lower the beams, resist the temptation to put your high beams on. This only makes two half-blinded drivers.

On a freeway, use your high beams only in remote areas where you won't impair approaching drivers. In some places, like cities, using high beams is illegal.

When you follow another vehicle on a freeway or highway, use low beams. True, most vehicles now have day-night mirrors that enable the driver to reduce glare. But outside mirrors are not of this type and high beams from behind can bother the driver ahead.

A Few More Night Driving Suggestions

Keep your windshield and all the glass on your vehicle clean—inside and out. Glare at night is made much worse by dirt on the glass. Even the inside of the glass can build up a film caused by dust. Tobacco smoke also makes inside glass surfaces very filmy and can be a vision hazard if it's left there.

Dirty glass makes lights dazzle and flash more than clean glass would, making the pupils of your eyes contract repeatedly. You might even want to keep a cloth and some glass cleaner in your vehicle if you need to clean your glass frequently.

Remember that your headlights light up far less of a roadway when you are in a turn or curve.

Keep your eyes moving; that way, it's easier to pick out dimly lighted objects.

Just as your headlights should be checked regularly for proper aim, so should your eyes be examined regularly. Some drivers suffer from night blindness—the inability to see in dim light—and aren't even aware of it.

Your Driving and the Road



Driving in the Rain

Rain and wet roads can mean driving trouble. On a wet road you can't stop, accelerate or turn as well because your tire-to-road traction isn't as good as on dry roads. And, if your tires don't have much tread left, you'll get even less traction.

It's always wise to go slower and be cautious if rain starts to fall while you are driving. The surface may get wet suddenly when your reflexes are tuned for driving on dry pavement.

The heavier the rain, the harder it is to see. Even if your windshield wiper blades are in good shape, a heavy rain can make it harder to see road signs and traffic signals, pavement markings, the edge of the road, and even people

walking. Road spray can often be worse for vision than rain, especially if it comes from a dirty road.

So it is wise to keep your wiping equipment in good shape and keep your windshield washer tank filled. Replace your windshield wiper inserts when they show signs of streaking or missing areas on the windshield, or when strips of rubber start to separate from the inserts.



Driving too fast through large water puddles or even going through some car washes can cause problems, too. The water may affect your brakes. Try to avoid puddles. But if you can't, try to slow down before you hit them.

CAUTION



Wet brakes can cause accidents. They won't work well in a quick stop and may cause pulling to one side. You could lose control of the vehicle.

After driving through a large puddle of water or a car wash, apply your brake pedal lightly until your brakes work normally.

Hydroplaning

Hydroplaning is dangerous. So much water can build up under your tires that they can actually ride on the water. This can happen if the road is wet enough and you're going fast enough. When your vehicle is hydroplaning, it has little or no contact with the road.

You might not be aware of hydroplaning. You could drive along for some time without realizing your tires aren't in constant contact with the road. You could find out the hard way: when you have to slow, turn, move out to pass—or if you get hit by a gust of wind. You could suddenly find yourself out of control.

Hydroplaning doesn't happen often. But it can if your tires haven't much tread or if the pressure in one or more is low. It can happen if a lot of water is standing on the road. If you can see reflections from trees, telephone poles, or other vehicles, and raindrops "dimple" the water's surface, there could be hydroplaning.

Hydroplaning usually happens at higher speeds. There just isn't a hard and fast rule about hydroplaning. The best advice is to slow down when it is raining, and be careful.

Some Other Rainy Weather Tips

- Turn on your headlights—not just your parking lights—to help make you more visible to others.
- Look for hard-to-see vehicles coming from behind. You may want to use your headlights even in daytime if it's raining hard.
- Besides slowing down, allow some extra following distance. And be especially careful when you pass another vehicle. Allow yourself more clear room ahead, and be prepared to have your view restricted by road spray. If the road spray is so heavy you are actually blinded, drop back. Don't pass until conditions improve. Going more slowly is better than having an accident.
- Use your defogger if it helps.
- Have good tires with proper tread depth. (See the *Index* under *Tires*.)

Your Driving and the Road



Driving in Fog, Mist and Haze

Fog can occur with high humidity or heavy frost. It can be so mild that you can see through it for several hundred feet (meters). Or it might be so thick that you can see only a few feet (meters) ahead. It may come suddenly to an otherwise clear road. And it can be a major hazard.

When you drive into a fog patch, your visibility will be reduced quickly. The biggest dangers are striking the vehicle ahead or being struck by the one behind. Try to “read” the fog density down the road. If the vehicle ahead starts to become less clear or, at night, if the taillights are harder to see, the fog is probably thickening. Slow down to give traffic behind you a chance to slow down.

Everybody then has a better chance to avoid hitting the vehicle ahead.

A patch of dense fog may extend only for a few feet (meters) or for miles (kilometers); you can't really tell while you're in it. You can only treat the situation with extreme care.

One common fog condition—sometimes called mist or ground fog—can happen in weather that seems perfect, especially at night or in the early morning in valley or low, marshy areas. You can be suddenly enveloped in thick, wet haze that may even coat your windshield. You can often spot these fog patches or mist layers with your headlights. But sometimes they can be waiting for you as you come over a hill or dip into a shallow valley. Start your windshield wipers and washer to help clear accumulated road dirt. Slow down carefully.

Tips on Driving in Fog

If you get caught in fog, turn your headlights on low beam, even in daytime. You'll see—and be seen—better. Use your fog lights.

Don't use your high beams. The light will bounce off the water droplets that make up fog and reflect back at you.

Use your defogger. In high humidity, even a light build-up of moisture on the inside of the glass will cut down on your already limited visibility. Run your windshield wipers and washer occasionally. Moisture can build up on the outside glass, and what seems to be fog may actually be moisture on the outside of your windshield.

Treat dense fog as an emergency. Try to find a place to pull off the road. Of course you want to respect another's property, but you might need to put



something between you and moving vehicles—space, trees, telephone poles, a private driveway, anything that removes you from other traffic.

If visibility is near zero and you must stop but are unsure whether you are away from the road, turn your lights on, start your hazard warning flashers, and sound your horn at intervals or when you hear approaching traffic.

Pass other vehicles in fog only if you can see far enough ahead to pass safely. Even then, be prepared to delay your pass if you suspect the fog is worse up ahead. If other vehicles try to pass you, make it easy for them.

City Driving

One of the biggest problems with city streets is the amount of traffic on them. You'll want to watch out for what the other drivers are doing and pay attention to traffic signals.

Here are ways to increase your safety in city driving:

- Know the best way to get to where you are going. Try not to drive around trying to pick out a familiar street or landmark. Get a city map and plan your trip into an unknown part of the city just as you would for a cross-country trip.
- Try to use the freeways that rim and crisscross most large cities. You'll save time and energy. (See the next section, *Freeway Driving*.)

- Treat a green light as a warning signal. A traffic light is there because the corner is busy enough to need it. When a light turns green, and just before you start to move, check both ways for vehicles that have not cleared the intersection or may be running the red light.
- Obey all posted speed limits. But remember that they are for ideal road, weather and visibility conditions. You may need to drive below the posted limit in bad weather or when visibility is especially poor.
- Pull to the right (with care) and stop clear of intersections when you see or hear emergency vehicles.

Your Driving and the Road



Freeway Driving

Mile for mile, freeways (also called thruways, parkways, expressways, turnpikes, or superhighways) are the safest of all roads. But they have their own special rules.

The most important advice on freeway driving is: Keep up with traffic and keep to the right. Drive at the same speed most of the other drivers are driving. Too-fast or too-slow driving breaks a smooth traffic flow. Treat the left lane on a freeway as a passing lane.

Entering the Freeway

At the entrance there is usually a ramp that leads to the freeway. If you have a clear view of the freeway as you drive along the entrance ramp, you should begin to check traffic. Try to determine where you expect to blend with the flow. If traffic is light, you may have no problem. But if it is heavy, find a gap as you move along the entering lane and time your approach. Try to merge into the gap at close to the prevailing speed. Switch on your turn signal, check your rearview mirrors as you move along, and glance over your shoulder as often as necessary. Try to blend smoothly with the traffic flow.

Driving on the Freeway

Once you are on the freeway, adjust your speed to the posted limit or to the prevailing rate if it's slower. Stay in the right lane unless you want to pass. If you are on a two-lane freeway, treat the right lane as the slow lane and the left lane as the passing lane.

If you are on a three-lane freeway, treat the right lane as the slower-speed through lane, the middle lane as the higher-speed through lane, and the left lane as the passing lane.

Before changing lanes, check your rearview mirrors. Then use your turn signal. Just before you leave the lane, glance quickly over your shoulder to make sure there isn't another vehicle in your "blind" spot.

If you are moving from an outside to a center lane on a freeway having more than two lanes, make sure another vehicle isn't about to move into the same spot. Look at the vehicles two lanes over and watch for telltale signs: turn signals flashing, an increase in speed, or moving toward the edge of the lane. Be prepared to delay your move.

Once you are moving on the freeway, make certain you allow a reasonable following distance. Expect to move slightly slower at night.

Leaving the Freeway

When you want to leave the freeway, move to the proper lane well in advance. Dashing across lanes at the last minute is dangerous. If you miss your exit do not, under any circumstances, stop and back up. Drive on to the next exit.

At each exit point is a deceleration lane. Ideally it should be long enough for you to enter it at freeway speed (after signaling, of course) and then do your braking before moving onto the exit ramp. Unfortunately, not all deceleration lanes are long enough—some are too short for all the braking. Decide when to start braking. If you must brake on the through lane, and if there is traffic close behind you, you can allow a little

extra time and flash your brake lights (in addition to your turn signal) as extra warning that you are about to slow down and exit.

The exit ramp can be curved, sometimes quite sharply. The exit speed is usually posted. Reduce your speed according to your speedometer, not to your sense of motion. After driving for any distance at higher speeds, you may tend to think you are going slower than you actually are. For example, 40 mph (65 km/h) might seem like only 20 mph (30 km/h). Obviously, this could lead to serious trouble on a ramp designed for 20 mph (30 km/h)!

Your Driving and the Road

Driving a Long Distance

Although most long trips today are made on freeways, there are still many made on regular highways.

Long-distance driving on freeways and regular highways is the same in some ways. The trip has to be planned and the vehicle prepared, you drive at higher-than-city speeds, and there are longer turns behind the wheel. You'll enjoy your trip more if you and your vehicle are in good shape. Here are some tips for a successful long trip.

Before Leaving on a Long Trip

Make sure you're ready. Try to be well rested. If you must start when you're not fresh—such as after a day's work—don't plan to make too many miles that first part of the journey. Wear comfortable clothing and shoes you can easily drive in.

Is your vehicle ready for a long trip? If you keep it serviced and maintained, it's ready to go. If it needs service, have it done before starting out. Of course, you'll find experienced and able service experts in Oldsmobile dealerships all across North America. They'll be ready and willing to help if you need it.

Here are some things you can check before a trip:

- **Windshield Washer Fluid:** Is the reservoir full? Are all windows clean inside and outside?
- **Wiper Blades:** Are they in good shape?
- **Fuel, Engine Oil, Other Fluids:** Have you checked all levels?
- **Lights:** Are they all working? Are the lenses clean?
- **Tires:** They are vitally important to a safe, trouble-free trip. Is the tread good enough for long-distance driving? Are the tires all inflated to the recommended pressure?
- **Weather Forecasts:** What's the weather outlook along your route? Should you delay your trip a short time to avoid a major storm system?
- **Maps:** Do you have up-to-date maps?

On the Road

Unless you are the only driver, it is good to share the driving task with others. Limit turns behind the wheel to about 100 miles (160 km) or two hours at a sitting. Then, either change drivers or stop for some refreshment like coffee, tea or soft drinks and some limbering up. But do stop and move around. Eat lightly along the way. Heavier meals tend to make some people sleepy.

On two-lane highways or undivided multilane highways that do not have controlled access, you'll want to watch for some situations not usually found on freeways. Examples are: stop signs and signals, shopping centers with direct access to the highway, no passing zones and school zones, vehicles turning left and right off the road, pedestrians, cyclists, parked vehicles, and even animals.

Highway Hypnosis

Is there actually such a condition as "highway hypnosis"? Or is it just plain falling asleep at the wheel? Call it highway hypnosis, lack of awareness, or whatever.

There is something about an easy stretch of road with the same scenery, along with the hum of the tires on the road, the drone of the engine, and the rush of the wind against the vehicle that can make you sleepy. Don't let it happen to you! If it does, your vehicle can leave the road in **less than a second**, and you could crash and be injured.

What can you do about highway hypnosis? First, be aware that it can happen.

Then here are some tips:

- Make sure your vehicle is well ventilated, with a comfortably cool interior.

- Keep your eyes moving. Scan the road ahead and to the sides. Check your rearview mirrors frequently and your instruments from time to time. This can help you avoid a fixed stare.
- Wear good sunglasses in bright light. Glare can cause drowsiness. But don't wear sunglasses at night. They will drastically reduce your overall vision at the very time you need all the seeing power you have.
- If you get sleepy, pull off the road into a rest, service, or parking area and take a nap, get some exercise, or both. For safety, treat drowsiness on the highway as an emergency.

As in any driving situation, keep pace with traffic and allow adequate following distances.

Your Driving and the Road

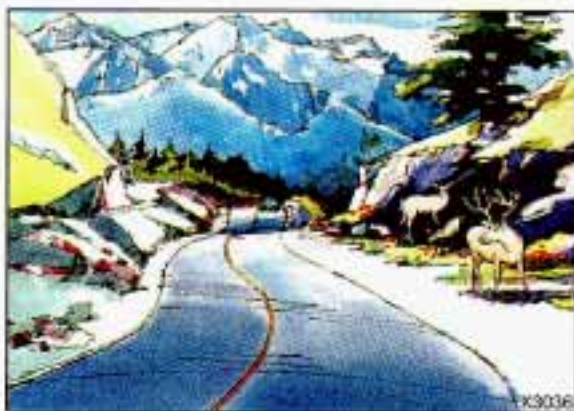

Hill and Mountain Roads

Driving on steep hills or mountains is different from driving in flat or rolling terrain. If you drive regularly in steep country, or if you're planning to visit there, here are some tips that can make your trips safer and more enjoyable. (See the *Index* under *Off-Road Driving* for information about driving off-road.)

- Keep your vehicle in good shape. Check all fluid levels and also the brakes, tires, cooling system and transmission. These parts can work hard on mountain roads.

- Know how to go down hills. The most important thing to know is this: let your engine do some of the slowing down. Don't make your brakes do it all. Shift to a lower gear when you go down a steep or long hill. That way, you will slow down without excessive use of your brakes.

CAUTION

- ⚠ If you don't shift down, your brakes could get so hot that they wouldn't work well. You would then have poor braking or even none going down a hill. You could crash. Shift down to let your engine assist your brakes on a steep downhill slope.

CAUTION

- ⚠ Coasting downhill in N (Neutral) or with the ignition off is dangerous. Your brakes will have to do all the work of slowing down. They could get so hot that they wouldn't work well. You could crash. Always have your engine running and your vehicle in gear when you go downhill.

- Know how to go uphill. You may want to shift down to a lower gear. The lower gears help cool your engine and transmission, and you can climb the hill better.

- Stay in your own lane when driving on two-lane roads in hills or mountains. Don't swing wide or cut across the center of the road. Drive at speeds that let you stay in your own lane. That way, you won't be surprised by a vehicle coming toward you in the same lane.



T4008

- It takes longer to pass another vehicle when you're going uphill. You'll want to leave extra room to pass. If a vehicle is passing you and doesn't have enough room, slow down to make it easier for the other vehicle to get by.
- As you go over the top of a hill, be alert. There could be something in your lane, like a stalled car or an accident.
- You may see highway signs on mountains that warn of special problems. Examples are long grades, passing or no passing zones, a falling rocks area, or winding roads. Be alert to these and take appropriate action.
- Winter driving can present special problems. See the *Index* under *Winter Driving*.

Parking on Hills

Hills and mountains mean spectacular scenery. But please be careful where you stop if you decide to look at the view or take pictures. Look for pull-offs or parking areas provided for scenic viewing.

Another part of this manual tells how to use your parking brake (see the *Index* under *Parking Brake*). But on a mountain or steep hill, you can do one more thing. You can turn your front wheels to keep your vehicle from rolling downhill or out into traffic.

Here's how:



T4009

Parking Downhill

Turn your wheels to the right.

You don't have to jam your tires against the curb, if there is a curb. A gentle contact is all you need.

Your Driving and the Road



Parking on Hills (CONT.)

Parking Uphill

If there is a curb, turn your wheels to the left if the curb is at the right side of your vehicle.



If you're going uphill on a one-way street and you're parking on the left side, your wheels should point to the right.



If there is no curb when you're parking uphill, turn the wheels to the right.
If there is no curb when you're parking uphill on the left side of a one-way street, your wheels should be turned to the left.

Torque Lock

If you are parking on a hill and you don't shift your transmission into **P** (Park) properly, the weight of the vehicle may put too much force on the parking pawl in the transmission. You may find it difficult to pull the shift lever out of **P** (Park). This is called "torque lock." To prevent torque lock, always be sure to shift into **P** (Park) properly before you leave the driver's seat. To find out how, see the *Index* under *Shifting Into P (Park)*.

When you are ready to drive, move the shift lever out of **P** (Park) **before** you release the parking brake.

If "torque lock" does occur, you may need to have another vehicle push yours a little uphill to take some of the pressure from the transmission, so you can pull the shift lever out of **P** (Park).



Winter Driving

Here are some tips for winter driving:

- Have your Oldsmobile in good shape for winter. Be sure your engine coolant mix is correct.
- Snow tires can help in loose snow, but they may give you less traction on ice than regular tires. If you do not expect to be driving in deep snow, but may have to travel over ice, you may not want to switch to snow tires at all.
- You may want to put winter emergency supplies in your vehicle. Include an ice scraper, a small brush or broom, a supply of windshield washer fluid, a rag, some winter outer clothing, a small shovel, a flashlight, a red cloth, and a couple of reflective warning triangles. And, if you will be driving under severe conditions, include a small bag of sand, a piece of old carpet or a couple of burlap bags to help provide traction. Be sure you properly secure these items in your vehicle.

Your Driving and the Road



Driving on Snow or Ice

Most of the time, those places where your tires meet the road probably have good traction.

However, if there is snow or ice between your tires and the road, you can have a very slippery situation. You'll have a lot less traction or "grip" and will need to be very careful.

What's the worst time for this? "Wet ice." Very cold snow or ice can be slick and hard to drive on. But wet ice can be even more trouble because it may offer the least traction of all. You can get wet ice when it's about freezing (32°F, 0°C) and freezing rain begins to fall. Try to avoid driving on wet ice until salt and sand crews can get there.

Whatever the condition—smooth ice, packed, blowing or loose snow—drive with caution. Accelerate gently. Try not to break the fragile traction. If you accelerate too fast, the drive wheels will spin and polish the surface under the tires even more.

Your anti-lock brakes improve your ability to make a hard stop on a slippery road. Even though you have the anti-lock braking system, you'll want to begin stopping sooner than you would on dry pavement. See the *Index* under *Anti-Lock Brakes*.

- Allow greater following distance on any slippery road.
- Watch for slippery spots. The road might be fine until you hit a spot that's covered with ice. On an otherwise clear road, ice patches may appear in shaded areas where the sun can't reach: around clumps of trees, behind buildings, or under bridges. Sometimes the surface of a curve or an overpass may remain icy when the surrounding roads are clear. If you see a patch of ice ahead of you, brake before you are on it. Try not to brake while you're actually on the ice, and avoid sudden steering maneuvers.



If You're Caught in a Blizzard

If you are stopped by heavy snow, you could be in a serious situation. You should probably stay with your vehicle unless you know for sure that you are near help and you can hike through the snow. Here are some things to do to summon help and keep yourself and your passengers safe:

- Turn on your hazard flashers.
- Tie a red cloth to your vehicle to alert police that you've been stopped by the snow.

- Put on extra clothing or wrap a blanket around you. If you have no blankets or extra clothing, make body insulators from newspapers, burlap bags, rags, floor mats—anything you can wrap around yourself or tuck under your clothing to keep warm.
- You can run the engine to keep warm, but be careful.



CAUTION



Snow can trap exhaust gases under your vehicle. This can cause deadly CO (carbon monoxide) gas to get inside. CO could overcome you and kill you. You can't see it or smell it, so you might not know it was in your vehicle. Clear away snow from around the base of your vehicle, especially any that is blocking your exhaust pipe. And check around again from time to time to be sure snow doesn't collect there.

Open a window just a little on the side of the vehicle that's away from the wind. This will help keep CO out.

Your Driving and the Road

If You're Caught in a Blizzard ***(CONT.)***

Run your engine only as long as you must. This saves fuel. When you run the engine, make it go a little faster than just idle. That is, push the accelerator slightly. This uses less fuel for the heat that you get and it keeps the battery charged. You will need a well-charged battery to restart the vehicle and possibly for signaling later on with your headlights. Let the heater run for a while.

Then, shut the engine off and close the window almost all the way to preserve the heat. Start the engine again and repeat this only when you feel really uncomfortable from the cold. But do it as little as possible. Preserve the fuel as long as you can.

To help keep warm, you can get out of the vehicle and do some fairly vigorous exercises every half-hour or so until help comes.

If You're Stuck in Deep Snow

This manual explains how to get the vehicle out of deep snow without damaging it. See the *Index* under *Rocking Your Vehicle*.

Towing a Trailer

CAUTION



If you don't use the correct equipment and drive properly, you can lose control when you pull a trailer. For example, if the trailer is too heavy, the brakes may not work well—or even at all. You and your passengers could be seriously injured. Pull a trailer only if you have followed all the steps in this section.

NOTICE

Pulling a trailer improperly can damage your vehicle and result in costly repairs not covered by your warranty. To pull a trailer correctly, follow the advice in this section.

Every Bravada is ready for some trailer towing. If it was built with trailering options, as many are, it's ready for heavier trailers. But trailering is different than just driving your vehicle by itself. Trailering means changes in handling, durability, and fuel economy. Successful, safe trailering takes correct equipment, and it has to be used properly.

That's the reason for this section. In it are many time-tested, important trailering tips and safety rules. Many of these are important for your safety and that of your passengers. So please read this section carefully before you pull a trailer.

- There are many different laws having to do with trailering. Make sure your rig will be legal, not only where you live but also where you'll be driving. A good source for this information can be state or provincial police.
- Consider using a sway control if your trailer will weigh 2,000 pounds (900 kg) or less. You should always use a sway control if your trailer will

Your Driving and the Road

Towing a Trailer (CONT.)

weigh more than 2,000 pounds (900 kg). You can ask a hitch dealer about sway controls.

- Don't tow a trailer at all during the first 500 miles (804 km) your new vehicle is driven. Your engine, axle or other parts could be damaged.
- Then, during the first 500 miles (804 km) that you tow a trailer, don't drive over 50 mph (80 km/h) and don't make starts at full throttle. This helps your engine and other parts of your vehicle wear in at the heavier loads.
- Three important considerations have to do with weight:

Weight of the Trailer

How heavy can a trailer safely be? It should never weigh more than 5,250 pounds (2 380 kg). But even that can be too heavy. It depends on how you plan to use your rig. For example, speed, altitude, road grades, outside temperature and how much your vehicle is used to pull a trailer are all important. And, it can also depend on any special equipment that you have on your vehicle. You can ask your dealer for our trailering information or advice, or you can write us at:

Oldsmobile Customer Assistance
Network
P.O. Box 30095
Lansing, MI 48909

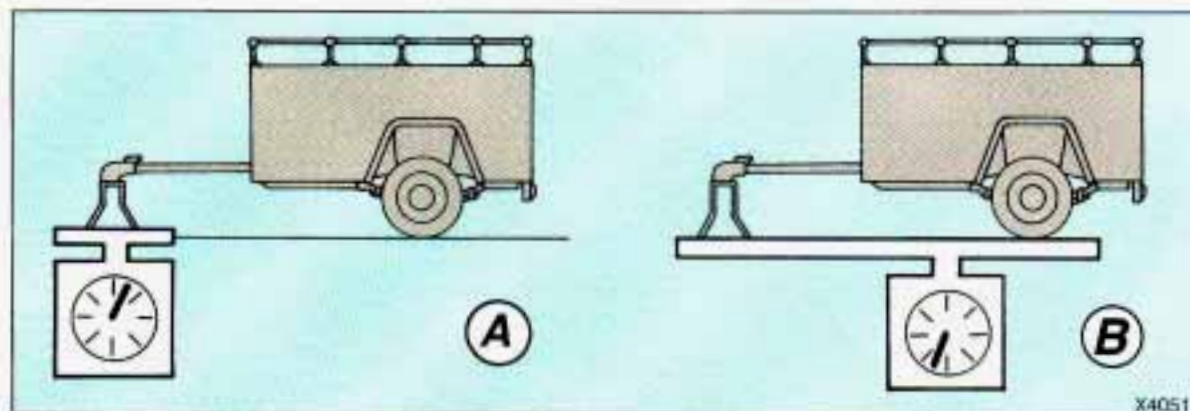

Weight of the Trailer Tongue

The tongue load (A) of any trailer is an important weight to measure because it affects the gross weight of your vehicle. The gross vehicle weight (GVW) includes the curb weight of the vehicle, any cargo you may carry in it, and the people who will be riding in the vehicle. When you tow a trailer, you must add the tongue load to the GVW because your vehicle will be carrying that weight, too. See the *Index* under *Loading Your Vehicle* for more information about your vehicle's maximum load capacity.

If you're using a "dead-weight" hitch, the trailer tongue (A) should weigh 10% of the total loaded trailer weight (B). If you have a "weight-distributing" hitch, the trailer tongue (A) should weigh 12% of the total loaded trailer weight (B).

After you've loaded your trailer, weigh the trailer and then the tongue, separately, to see if the weights are proper. If they aren't, you may be able to get them right simply by moving some items around in the trailer.

Total Weight on Your Vehicle's Tires

Be sure your vehicle's tires are inflated to the limit for cold tires. You'll find these numbers on the Certification label at the rear edge of the driver's door. See the *Index* under *Tire Loading*. Then be sure you don't go over the GVW limit for your vehicle.

Your Driving and the Road

Towing a Trailer (CONT.)

Hitches

It's important to have the correct hitch equipment. Crosswinds, large trucks going by, and rough roads are a few reasons why you'll need the right hitch. Here are some rules to follow:

- If you'll be pulling a trailer that, when loaded, will weigh more than 2,000 pounds (900 kg), be sure to use a properly mounted "weight-distributing" hitch and sway control of the proper size. This equipment is very important for proper vehicle loading and good handling when you're driving.

- Will you have to make any holes in the body of your vehicle when you install a trailer hitch? If you do, then be sure to seal the holes later when you remove the hitch. If you don't seal them, deadly carbon monoxide (CO) from your exhaust can get into your vehicle. (See the *Index* under *Carbon Monoxide in Exhaust*.) Dirt and water can, too.
- The bumpers on your vehicle are not intended for hitches. Do not attach rental hitches or other bumper-type hitches to them. Use only a frame-mounted hitch that does not attach to the bumper.

Safety Chains

You should always attach chains between your vehicle and your trailer. Cross the safety chains under the tongue of the trailer so that the tongue will not drop to the road if it becomes separated from the hitch. Instructions about safety chains may be provided by the hitch manufacturer or by the trailer manufacturer. Follow the manufacturer's recommendation for attaching safety chains. Always leave just enough slack so you can turn with your rig. And, never allow safety chains to drag on the ground.

Trailer Brakes

If your trailer weighs more than 1,000 pounds (450 kg) loaded, then it needs its own brakes—and they must be adequate.

Be sure to read and follow the instructions for the trailer brakes so you'll be able to install, adjust and maintain them properly.

Don't tap into your vehicle's brake system if the trailer's brake system will use more than 0.02 cubic inch (0.3 cc) of fluid from your vehicle's master cylinder. If it does, both braking systems won't work well. You could even lose your brakes.

- Will the trailer brake parts take 3,000 psi (20 650 kPa) of pressure? If not, the trailer brake system must not be used with your vehicle.
- If everything checks out this far, then make the brake fluid tap at the port on the master cylinder that sends fluid to the rear brakes. But don't use copper tubing for this. If you do, it will bend and finally break off. Use steel brake tubing.

Driving with a Trailer

Towing a trailer requires a certain amount of experience. Before setting out for the open road, you'll want to get to know your rig. Acquaint yourself with the feel of handling and braking with the added weight of the trailer. And always keep in mind that the vehicle you are driving is now a good deal longer and not nearly so responsive as your vehicle is by itself.

Before you start, check the trailer hitch and platform, safety chains, electrical connector, lights, tires and mirror adjustment. If the trailer has electric brakes, start your vehicle and trailer moving and then apply the trailer brake controller by hand to be sure the brakes are working. This lets you check your electrical connection at the same time.

CAUTION



If you have a rear-most window open and you pull a trailer with your vehicle, carbon monoxide (CO) could come into your vehicle. You can't see or smell CO. It can cause unconsciousness or death (see the *Index* under *Engine Exhaust*). To maximize your safety when towing a trailer:

- Have your exhaust system inspected for leaks, and make necessary repairs before starting on your trip.
- Keep the rear-most windows closed.
- If exhaust does come into your vehicle through a window in the rear or another opening, drive with your front, main heating or cooling system **on** and with the fan on any speed. This will bring fresh, outside air into your vehicle. Do not use **MAX A/C** because it only recirculates the air inside your vehicle. See the *Index* under *Comfort Controls*.

Your Driving and the Road

Driving with a Trailer (CONT.)

During your trip, check occasionally to be sure that the load is secure, and that the lights and any trailer brakes are still working.

Following Distance

Stay at least twice as far behind the vehicle ahead as you would when driving your vehicle without a trailer. This can help you avoid situations that require heavy braking and sudden turns.

Passing

You'll need more passing distance up ahead when you're towing a trailer. And, because you're a good deal longer, you'll need to go much farther beyond the passed vehicle before you can return to your lane.

Backing Up

Hold the bottom of the steering wheel with one hand. Then, to move the trailer to the left, just move that hand to the left. To move the trailer to the right, move your hand to the right. Always back up slowly and, if possible, have someone guide you.

Making Turns

When you're turning with a trailer, make wider turns than normal. Do this so your trailer won't strike soft shoulders, curbs, road signs, trees, or other objects. Avoid jerky or sudden maneuvers. Signal well in advance.

Turn Signals When Towing a Trailer

When you tow a trailer, your vehicle has to have a different turn signal flasher and extra wiring. The green arrows on your instrument panel will flash whenever you signal a turn or lane change. Properly hooked up, the trailer lights will also flash, telling other drivers you're about to turn, change lanes or stop.

When towing a trailer, the green arrows on your instrument panel will flash for turns even if the bulbs on the trailer are burned out. Thus, you may think drivers behind you are seeing your signal when they are not. It's important to check occasionally to be sure the trailer bulbs are still working.

Driving On Grades

Reduce speed and shift to a lower gear **before** you start down a long or steep downgrade. If you don't shift down, you might have to use your brakes so much that they would get hot and no longer work well.

On a long uphill grade, shift down and reduce your speed to around 45 mph (70 km/h) to reduce the possibility of engine and transmission overheating.

If your trailer weighs more than 3,000 pounds (1 350 kg), it's better not to use Overdrive. Just drive in **D** (Drive) instead of **D** (Overdrive) (or, as you need to, a lower gear). This will help your transmission.

Parking on Hills

You really should not park your vehicle, with a trailer attached, on a hill. If something goes wrong, your rig could start to move. People can be injured, and both your vehicle and the trailer can be damaged.

But if you ever have to park your rig on a hill, here's how to do it:

1. Apply your regular brakes, but don't shift into **P** (Park) yet.
2. Have someone place chocks under the trailer wheels.
3. When the wheel chocks are in place, release the regular brakes until the chocks absorb the load.
4. Reapply the regular brakes. Then apply your parking brake and then shift to **P** (Park).
5. Release the regular brakes.

When You Are Ready to Leave After Parking on a Hill

1. Apply your regular brakes and hold the pedal down while you:
 - Start your engine;
 - Shift into a gear; and
 - Release the parking brake.
2. Let up on the brake pedal.
3. Drive slowly until the trailer is clear of the chocks.
4. Stop and have someone pick up and store the chocks.

Your Driving and the Road

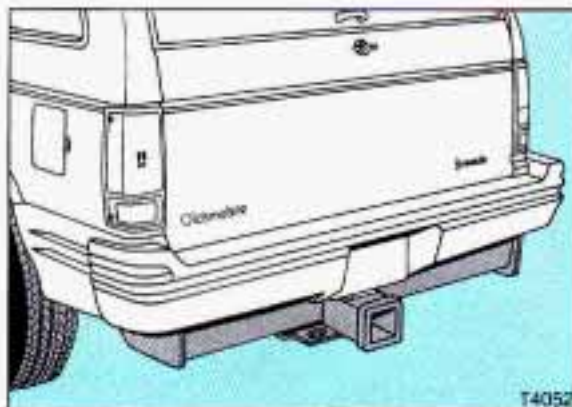

Maintenance When Trailer Towing

Your vehicle will need service more often when you're pulling a trailer. See the Maintenance Schedule for more on this. Things that are especially important in trailer operation are automatic transmission fluid (don't overfill), transfer case fluid, engine oil, axle lubricant, belts, cooling system, and brake adjustment. Each of these is covered in this manual, and the *Index* will help you find them quickly. If you're trailering, it's a good idea to review these sections before you start your trip.

Check periodically to see that all hitch nuts and bolts are tight.

Trailer Wiring Harness (OPTION)

Your Bravada is equipped with a 7-wire trailer harness with a 30-amp battery feed wire. It's stored under the vehicle along the rear frame crossmember.

Since connectors for trailers vary, no connector is provided. You will need to obtain one for the trailer you want to pull. Have it wired to the harness by a qualified service technician.

When wiring the harness to a connector, disconnect the battery before removing the tape from the wire.

The wire applications are:

- White—Ground
- Dark green—Right turn signal
- Yellow—Left turn signal
- Brown—Rear lamps
- Light green—Back-up lamps
- Red—Battery charging
- Blue—Trailer brakes, auxiliary

In use, tape or tie the harness to your vehicle's frame rail. Leave enough slack so the wiring doesn't bend or break, but not so much that it drags on the ground.

When it's not in use, fold the harness neatly and wrap or tie it. Store in the original place along the frame crossmember.



X5077

Here you'll find out what to do about some problems that can occur on the road.

Part 5

Problems on the Road

Hazard Warning Flashers	176
Jump Starting	177
Towing Your Bravada	181
Engine Overheating	184
If a Tire Goes Flat	190
Changing a Flat Tire	191
If You're Stuck: In Sand, Mud, Ice or Snow	199

Problems on the Road



Hazard Warning Flashers

Your hazard warning flashers let you warn others. They also let police know you have a problem. Your front and rear turn signal lights will flash on and off. But they won't flash if you're braking.



Press the button in to make your front and rear turn signal lights flash on and off.

Your hazard warning flashers work no matter what position your key is in, and even if the key isn't in.



To turn off the flashers, pull out on the collar.

When the hazard warning flashers are on, your turn signals won't work.

Other Warning Devices

If you carry reflective triangles, you can set one up at the side of the road about 300 feet (100 m) behind your vehicle.

Jump Starting

If your battery has run down, you may want to use another vehicle and some jumper cables to start your Oldsmobile. But please follow the steps below to do it safely.

CAUTION



Batteries can hurt you. They can be dangerous because:

- They contain **acid** that can burn you.
- They contain **gas** that can explode or ignite.
- They contain enough **electricity** to burn you.

If you don't follow these steps exactly, some or all of these things can hurt you.

NOTICE

Ignoring these steps could result in costly damage to your vehicle that wouldn't be covered by your warranty.

Trying to start your Oldsmobile by pushing or pulling it won't work, and it could damage your vehicle.

To Jump Start Your Oldsmobile:

1. Check the other vehicle. It must have a 12-volt battery with a negative ground system.

NOTICE

If the other system isn't a 12-volt system with a negative ground, both vehicles can be damaged.

Problems on the Road

Jump Starting (CONT.)

2. Get the vehicles close enough so the jumper cables can reach, but be sure the vehicles aren't touching each other. If they are, it could cause a ground connection you don't want. You wouldn't be able to start your Oldsmobile, and the bad grounding could damage the electrical systems.

CAUTION



You could be injured if the vehicles roll. Set the parking brake firmly on each vehicle. Put an automatic transmission in **P** (Park) or a manual transmission in **N** (Neutral).

3. Turn off the ignition on both vehicles. Turn off all lights that aren't needed, and radios. This will avoid sparks and help save both batteries. And it could save your radio!

NOTICE

If you leave your radio on, it could be badly damaged. The repairs wouldn't be covered by your warranty.

4. Open the hoods and locate the batteries.
Find the positive (+) and negative (-) terminals on each battery.

CAUTION

 Using a match near a battery can cause battery gas to explode. People have been hurt doing this, and some have been blinded. Use a flashlight if you need more light.

Be sure the battery has enough water. You don't need to add water to the Delco Freedom[®] battery installed in every new GM vehicle. But if a battery has filler caps, be sure the right amount of fluid is there. If it is low, add water to take care of that first. If you don't, explosive gas could be present.

Battery fluid contains acid that can burn you. Don't get it on you. If you accidentally get it in your eyes or on your skin, flush the place with water and get medical help immediately.

5. Check that the jumper cables don't have loose or missing insulation. If they do, you could get a shock. The vehicles could be damaged, too.

Before you connect the cables, here are some things you should know. Positive (+) will go to positive (+) and negative (-) will go to negative (-) or a metal engine part. Don't connect (+) to (-) or you'll get a short that would damage the battery and maybe other parts, too.

CAUTION

 Fans or other moving engine parts can injure you badly. Keep your hands away from moving parts once the engines are running.

Problems on the Road

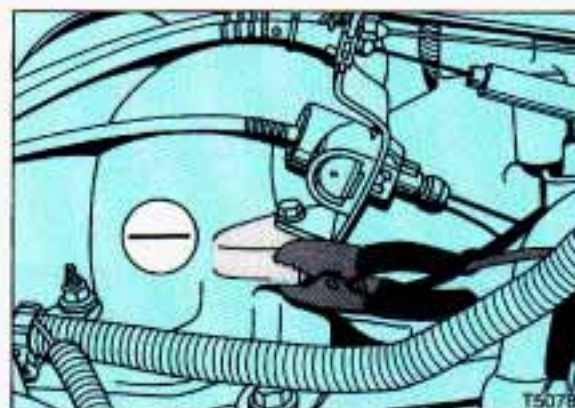
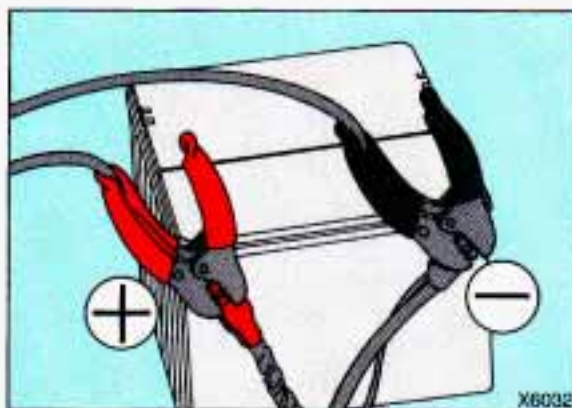

Jump Starting (CONT.)

6. Connect the red positive (+) cable to the positive (+) terminal of the vehicle with the dead battery. Use a remote positive (+) terminal if the vehicle has one.

7. Don't let the other end touch metal. Connect it to the positive (+) terminal of the good battery. Use a remote positive (+) terminal if the vehicle has one.

8. Now connect the black negative (-) cable to the good battery's negative (-) terminal.

Don't let the other end touch anything until the next step. The other end of the negative cable **doesn't** go to the dead battery. It goes to a heavy unpainted metal part on the engine of the vehicle with the dead battery.

9. Attach the cable at least 18 inches (45 cm) away from the dead battery, but not near engine parts that move. The electrical connection is just as good there, but the chance of sparks getting back to the battery is much less.

10. Now start the vehicle with the good battery and run the engine for a while.

11. Try to start the vehicle with the dead battery. If it won't start after a few tries, it probably needs service.

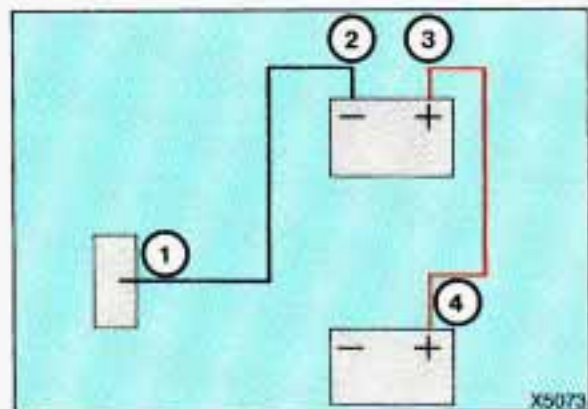

X5073

12. Remove the cables in reverse order to prevent electrical shorting. Take care that they don't touch each other or any other metal.

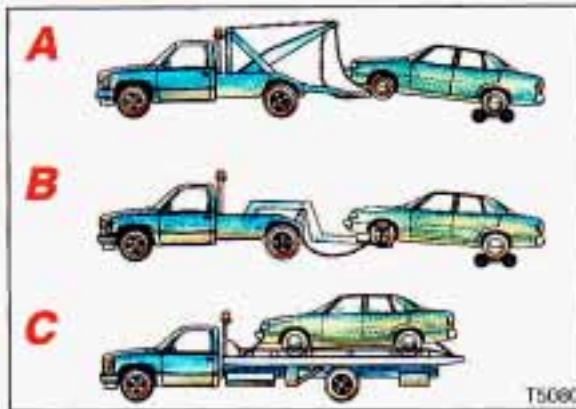

T5060

Towing Your Bravada

Try to have a GM dealer or a professional towing service tow your vehicle. The usual towing equipment is:

- (A) Sling-type tow truck
- (B) Wheel-lift tow truck
- (C) Car carrier

If your vehicle has been changed or modified since it was factory-new by adding aftermarket items like aero skirting or special tires and wheels, these instructions may not be correct.

Before you do anything, turn on the hazard warning flashers.

NOTICE

Dollies must be used on ground wheels or vehicle damage will occur.

Problems on the Road

Towing Your Bravada (CONT.)

When you call, tell the towing service:

- That your vehicle has all-wheel drive and cannot be towed with any wheels in contact with the ground. Your vehicle requires dollies with sling-type or wheel lift equipment, or a car carrier.
- The make, model, and year of your vehicle.
- Whether you can still move the shift lever.
- If there was an accident, what was damaged.

When the towing service arrives, let the tow operator know that this manual contains towing instructions. The operator may want to see them.

CAUTION



To help avoid injury to you or others:

- Never let passengers ride in a vehicle that is being towed.
- Never tow faster than safe or posted speeds.
- Never tow with damaged parts not fully secured.
- Never get under your vehicle after it has been lifted.
- Always use separate safety chains on each side when towing a vehicle.

When your vehicle is being towed, have the ignition key off. The steering wheel should be clamped in a straight-ahead position, with a clamping device designed for towing service. Do not use the vehicle's steering column lock for this. The transmission should be in **P** (Park), and the parking brake released.

Don't have your Bravada towed with the wheels in contact with the ground. If your vehicle is being towed with sling-type or wheel-lift equipment, either the front or rear wheels must be supported on a dolly.

If towing your Bravada with a car carrier, block supports may be required to prevent damage to the vehicle.

CAUTION



A vehicle can fall from a car carrier if it isn't properly secured. This can cause a collision, serious personal injury and vehicle damage. The vehicle should be tightly secured with chains or steel cables before it is transported.

Don't use substitutes (ropes, leather straps, canvas webbing, etc.) that can be cut by sharp edges underneath the towed vehicle.

Problems on the Road



Engine Overheating

You will find a coolant temperature gage and the warning light about a hot engine on your Oldsmobile's instrument panel.

NOTICE

If your engine catches fire because you keep driving with no coolant, your vehicle can be badly damaged. The costly repairs would not be covered by your warranty.

If Steam is Coming from Your Engine:

CAUTION

 Steam from an overheated engine can burn you badly, even if you just open the hood. Stay away from the engine if you see or hear steam coming from it. Just turn it off and get everyone away from the vehicle until it cools down. Wait until there is no sign of steam or coolant before opening the hood.

If you keep driving when your engine is overheated, the liquids in it can catch fire. You or others could be badly burned. Stop your engine if it overheats, and get out of the vehicle until the engine is cool.

If No Steam is Coming from Your Engine:

If you get the overheat warning but see or hear no steam, the problem may not be too serious. Sometimes the engine can get a little too hot when you:

- Climb a long hill on a hot day.
- Stop after high speed driving.
- Idle for long periods in traffic.
- Tow a trailer.

If you get the overheat warning with no sign of steam, try this for a minute or so:

1. Turn off your air conditioner.
2. Turn on your heater to full hot at the highest fan speed and open the window as necessary.
3. If you're in a traffic jam, shift to **N** (Neutral).

If you no longer have the overheat warning, you can drive. Just to be safe, drive slower for about ten minutes. If the warning doesn't come back on, you can drive normally.

If the warning continues, pull over, stop, and park your vehicle right away.

If there's still no sign of steam, push the accelerator until the engine speed is about twice as fast as normal idle speed. Bring the engine speed back to normal idle speed after two or three minutes. Now see if the warning stops.

But then, if you still have the warning, **TURN OFF THE ENGINE AND GET EVERYONE OUT OF THE VEHICLE** until it cools down. You may decide not to lift the hood but to get service help right away.

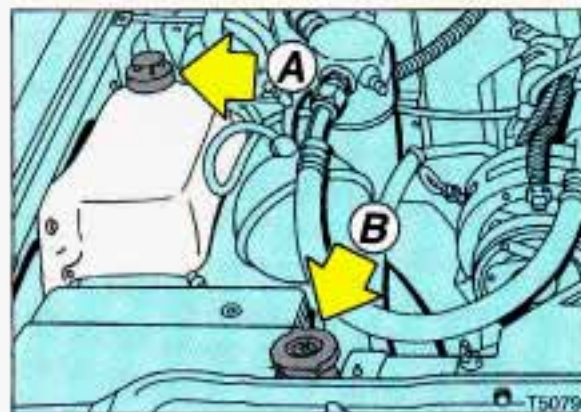

Cooling System

When you decide it's safe to lift the hood, here's what you'll see:

- (A) Coolant recovery tank
- (B) Radiator pressure cap

If the coolant inside the coolant recovery tank is boiling, don't do anything else until it cools down.

Problems on the Road

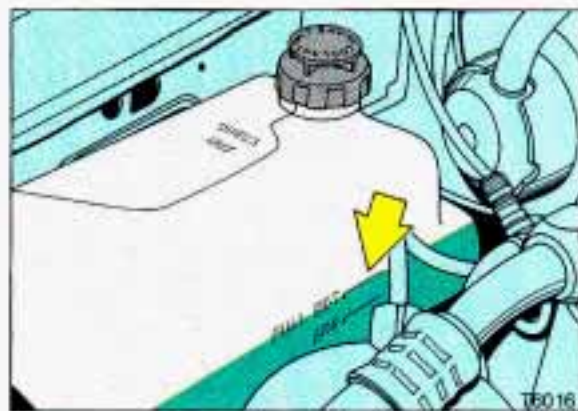

Engine Overheating (CONT.)

The coolant level should be at or above the **FULL HOT** mark. If it isn't, you may have a leak in the radiator hoses, heater hoses, radiator, water pump or somewhere else in the cooling system.

CAUTION

 Heater and radiator hoses, and other engine parts, can be very hot. Don't touch them. If you do, you can be burned.

Don't run the engine if there is a leak. If you run the engine, it could lose all coolant. That could cause an engine fire, and you could be burned. Get any leak fixed before you drive the vehicle.

NOTICE

Engine damage from running your engine without coolant isn't covered by your warranty.

If there seems to be no leak, start the engine again to see if the fan runs when the engine does. If it doesn't, your vehicle needs service. Turn off the engine.

How to Add Coolant to the Coolant Recovery Tank:

If you haven't found a problem yet, but the coolant level isn't at or above **FULL HOT**, add a 50/50 mixture of **clean water** (preferably distilled) and a proper antifreeze at the coolant recovery tank. See the *Index* under *Engine Coolant* for more information about the proper coolant mix.

CAUTION

 Adding only plain water to your cooling system can be dangerous. Plain water, or some other liquid like alcohol, can boil before the proper coolant mix will. Your vehicle's coolant warning system is set for the proper coolant mix. With plain water or the wrong mix, your engine could get too hot but you wouldn't get the overheat warning. Your engine could catch fire and you or others could be burned. Use a 50/50 mix of **clean water** and a proper antifreeze.

NOTICE

In cold weather, water can freeze and crack the engine, radiator, heater core and other parts. Use the recommended coolant.

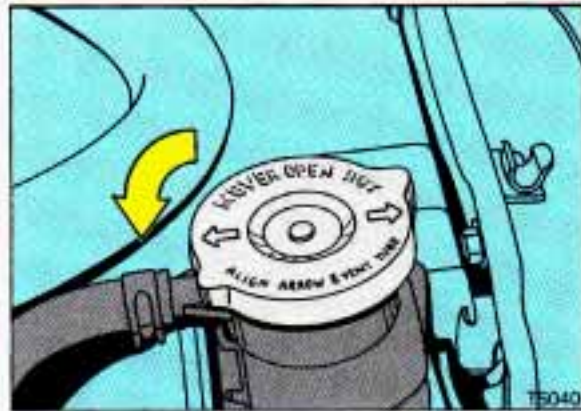

CAUTION

 You can be burned if you spill coolant on hot engine parts. Coolant contains ethylene glycol and it will burn if the engine parts are hot enough. Don't spill coolant on a hot engine.

When the coolant in the coolant recovery tank is at or above **FULL HOT**, start your vehicle. If the overheat warning continues, there's one more thing you can try. You can add the proper coolant mix directly to the radiator, but be sure the cooling system is cool before you do it.

CAUTION

 Steam and scalding liquids from a hot cooling system can blow out and burn you badly. They are under pressure, and if you turn the radiator pressure cap—even a little—they can come out at high speed. Never turn the cap when the cooling system, including the radiator pressure cap, is hot. Wait for the cooling system and radiator pressure cap to cool if you ever have to turn the pressure cap.

How to Add Coolant to the Radiator:

1. You can remove the radiator pressure cap when the cooling system, including the radiator pressure cap and upper radiator hose, is no longer hot. Turn the pressure cap slowly to the left until it first stops. (Don't press down while turning the pressure cap.)

If you hear a hiss, wait for that to stop. A hiss means there is still some pressure left.

Problems on the Road

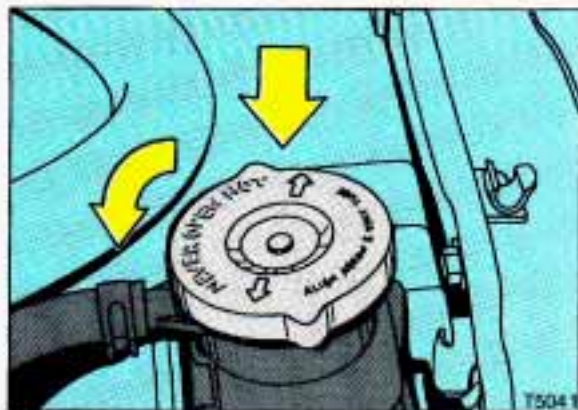

Engine Overheating (CONT.)

2. Then keep turning the pressure cap, but now push down as you turn it. Remove the pressure cap.



3. Fill the radiator with the proper mix, up to the base of the filler neck.



4. Then fill the coolant recovery tank to the **ADD** mark.

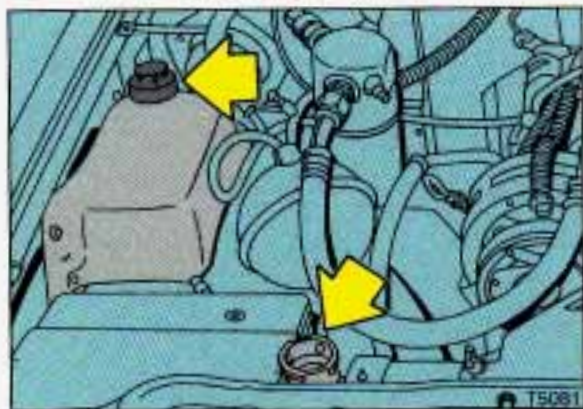

5. Put the cap back on the coolant recovery tank, but leave the radiator pressure cap off.



6. Start the engine and let it run until you can feel the upper radiator hose getting hot.
7. By this time, the coolant level inside the radiator filler neck may be lower. If the level is lower, add more of the proper mix through the filler neck until the level reaches the base of the filler neck.

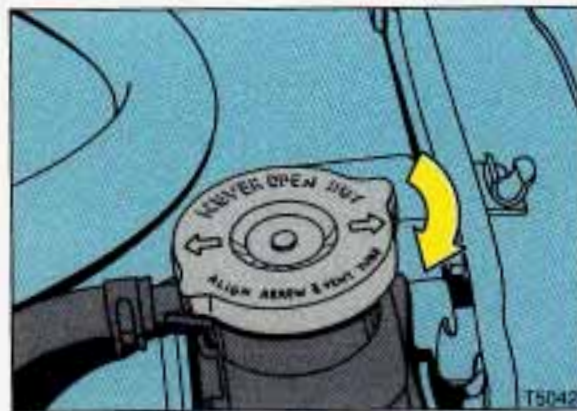

8. Then replace the pressure cap. Be sure the arrows on the pressure cap line up like this.

Problems on the Road

Engine Fan Noise

This vehicle has a clutched engine cooling fan. When the clutch is engaged, the fan spins faster to provide more air to cool the engine. In most everyday driving conditions the clutch is not engaged. This improves fuel economy and reduces fan noise. Under heavy vehicle loading, trailer towing and/or high outside temperatures, the fan speed increases when the clutch engages. So you may hear an increase in fan noise. This is normal and should not be mistaken as the transmission slipping or making extra shifts. It is merely the cooling system functioning properly.

The fan will slow down when additional cooling is not required and the clutch disengages. You may also hear this fan noise when you start the engine. It will go away as the fan clutch disengages.

■ *If a Tire Goes Flat*

It's unusual for a tire to "blow out" while you're driving, especially if you maintain your tires properly. If air goes out of a tire, it's much more likely to leak out slowly. But if you should ever have a "blowout," here are a few tips about what to expect and what to do:

If a front tire fails, the flat tire will create a drag that pulls the vehicle toward that side. Take your foot off the accelerator pedal and grip the steering wheel firmly. Steer to maintain lane position, then gently brake to a stop well out of the traffic lane.

A rear blowout, particularly on a curve, acts much like a skid and may require the same correction you'd use in a skid. In any rear blowout, remove your foot from the accelerator pedal. Get the vehicle under control by steering the way you want the vehicle to go. It may be very bumpy and noisy, but you can still steer. Gently brake to a stop, well off the road if possible.

If your tire goes flat, the next section shows how to use your jacking equipment to change a flat tire safely.



Changing a Flat Tire

If a tire goes flat, avoid further tire and wheel damage by driving slowly to a level place. Turn on your hazard warning flashers.

CAUTION



Changing a tire can cause an injury. The vehicle can slip off the jack and roll over you or other people. You and they could be badly injured. Find a level place to change your tire. To help prevent the vehicle from moving:

1. Set the parking brake firmly.
2. Put the shift lever in **P** (Park).
3. Turn off the engine.

To be even more certain the vehicle won't move, you can put chocks at the front and rear of the tire farthest away from the one being changed. That would be the tire on the other side of the vehicle, at the opposite end.

The following steps will tell you how to use the jack and change a tire.

Problems on the Road

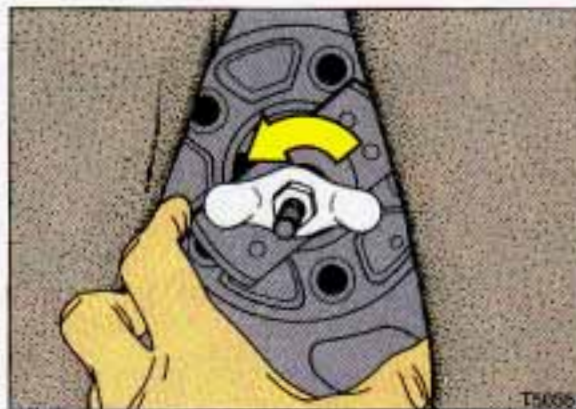
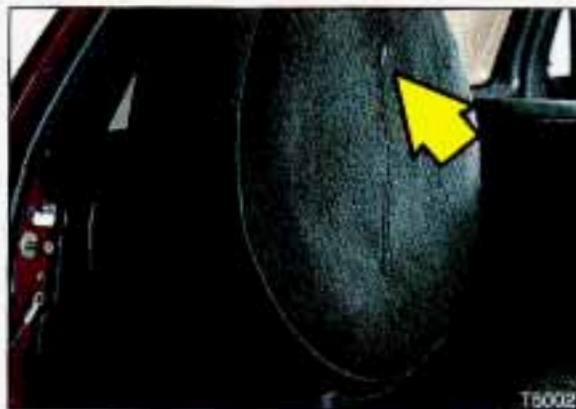

Changing a Flat Tire (CONT.)

If You Have an Inside-Mounted Spare Tire:

1. Unzip the cover.

2. Reach inside, and unscrew the wing nut at the center of the wheel. Remove it and the hold-down plate just behind the wing nut.

Lift the tire off the mounting shoe and remove the cover. Also remove the bolt hooked to the ring inside the jack storage compartment.

3. Open the jack storage compartment by lifting the latch and removing the cover.



4. Unscrew the wing nut and remove the jack and wheel wrench.



If You Have a Tailgate-Mounted Spare Tire:

1. Open the jack storage compartment by lifting the latch and removing the cover.



2. Unscrew the wing nut and remove the jack and wheel wrench.

Problems on the Road



Changing a Flat Tire (CONT.)

3. Outside the vehicle, make sure the spare tire carrier arm is fully latched to the tailgate. Unzip the tire cover and push it back.

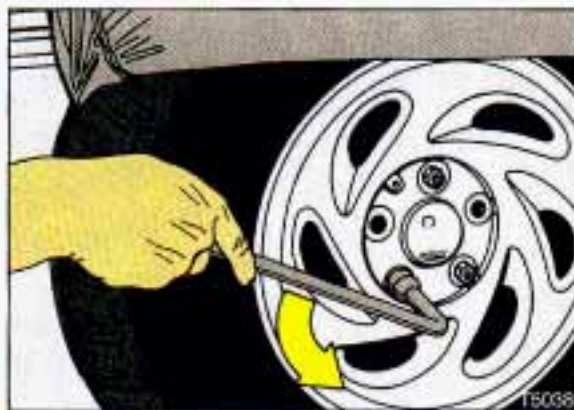

4. Use the wheel wrench to remove the wheel nuts that secure the tire to the carrier. Then lift the tire off the mounting bracket.

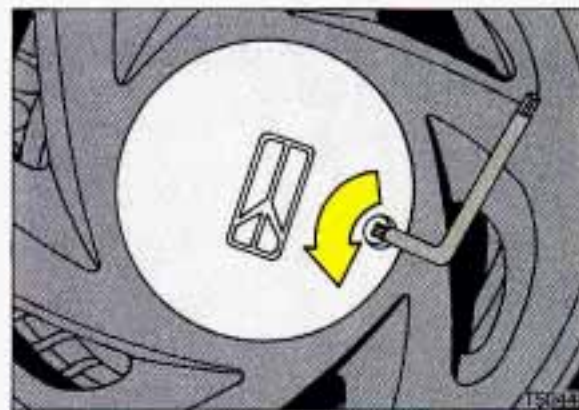

For Both Mounting Systems:

5. Put the spare tire near the flat one.
6. Using the Torx® head wrench supplied with the vehicle and stored in the glove box, remove the wheel nut cover.

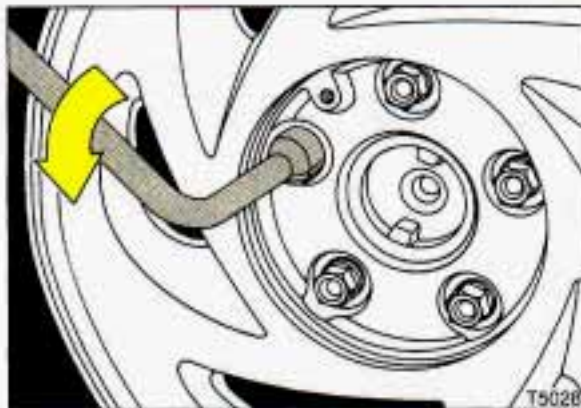

7. Using the wheel wrench, loosen all the wheel nuts. Don't remove them yet.

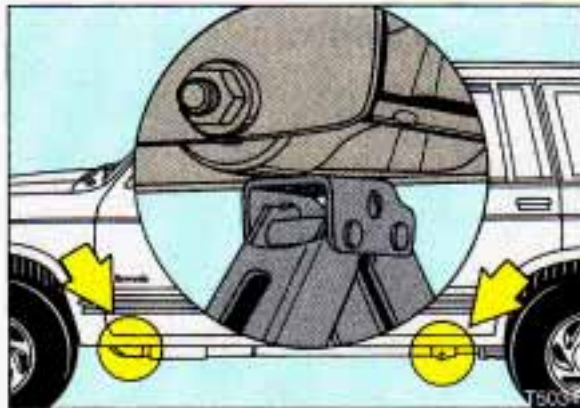

8. Rotate the jack handle clockwise to raise the jack head a little.
9. There is a hole in the vehicle's frame for the head of the jack to fit into, near the wheel to be removed. Position the jack there.

CAUTION



Getting under a vehicle when it is jacked up is dangerous. If the vehicle slips off the jack, you could be badly injured or killed. Never get under a vehicle when it is supported only by a jack.

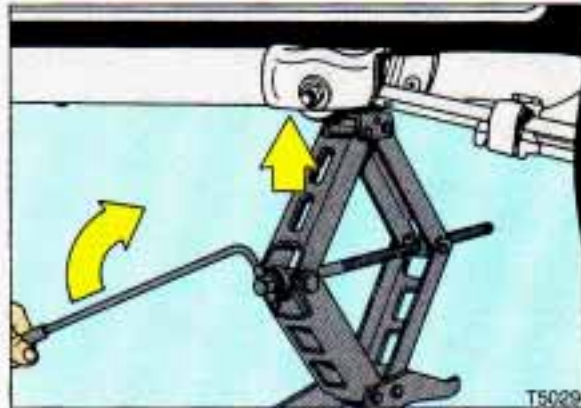

10. Raise the vehicle by rotating the jack handle clockwise. Raise the vehicle far enough off the ground so there is enough room for the spare tire to fit.

NOTICE

Raising your vehicle with the jack improperly positioned will damage the vehicle or may allow the vehicle to fall off the jack. Be sure to fit the jack lift head into the proper location before raising your vehicle.

11. Remove all wheel nuts and take off the flat tire.

Problems on the Road

Changing a Flat Tire (CONT.)

CAUTION

 Rust or dirt on the wheel, or on the parts to which it is fastened, can make the wheel nuts become loose after a time. The wheel could come off and cause an accident. When you change a wheel, remove any rust or dirt from the places where the wheel attaches to the vehicle. In an emergency, you can use a cloth or a paper towel to do this; but be sure to use a scraper or wire brush later, if you need to, to get all the rust or dirt off.

12. Remove any rust or dirt from the wheel bolts, mounting surfaces or spare wheel. Place the spare on the wheel mounting surface.

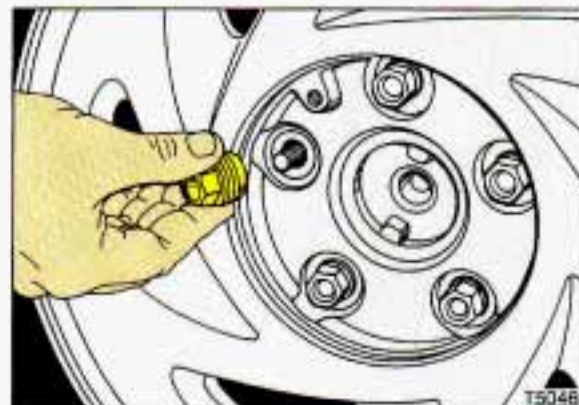

CAUTION

 Never use oil or grease on studs or nuts. If you do, the nuts might come loose. Your wheel could fall off, causing a serious accident.

13. Replace the wheel nuts with the rounded end of the nuts toward the wheel. Tighten each nut by hand until the wheel is held against the hub.

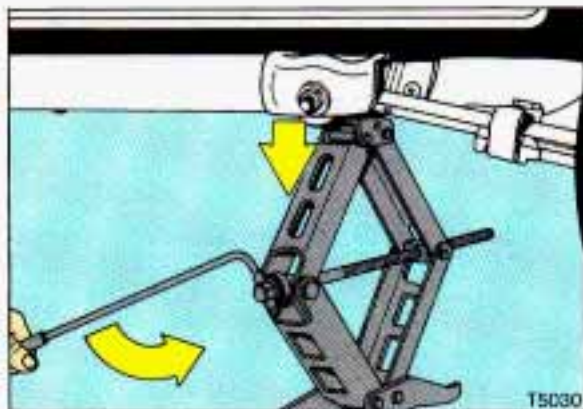

14. Lower the vehicle by rotating the wheel wrench counterclockwise. Lower the jack completely.

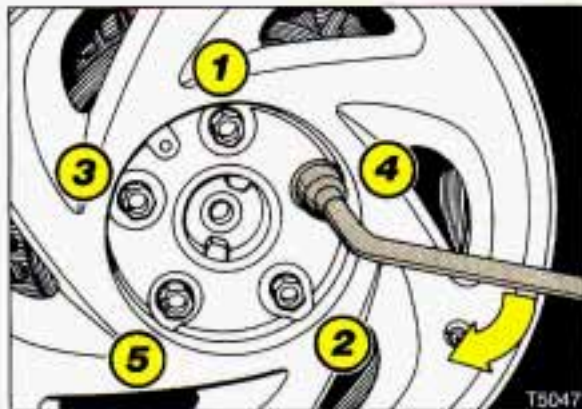

15. Tighten the wheel nuts firmly in a crisscross sequence as shown.

CAUTION



Incorrect wheel nuts or improperly tightened wheel nuts can cause the wheel to become loose and even come off. This could lead to an accident. Be sure to use the correct wheel nuts. If you have to replace them, be sure to get the right kind. Stop somewhere as soon as you can and have the nuts tightened with a torque wrench to 100 pound-feet (140 N•m).

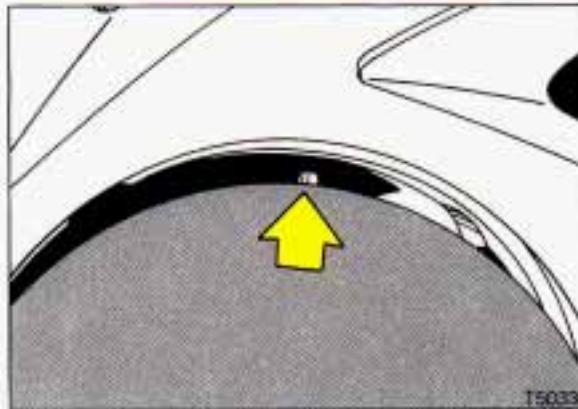

16. Replace the wheel nut cover on the spare wheel. Be sure to insert the pin on the wheel cover into the hole in the wheel. Screw the cover in place using the Torx® head wrench.
17. Lower the jack head completely by rotating the jack handle counterclockwise. If you have an inside-mounted spare tire, return the jack and wheel wrench to their storage compartment and secure them with the wing nut. Replace the jack storage compartment cover.

Problems on the Road

Changing a Flat Tire (CONT.)

18. Fasten the flat tire where the spare was stored. If you have a tailgate-mounted spare tire carrier, tighten firmly. Push and pull to make sure it is not loose. As soon as possible, tighten the nuts to 22-32 pound-feet (30-40 N•m) torque.

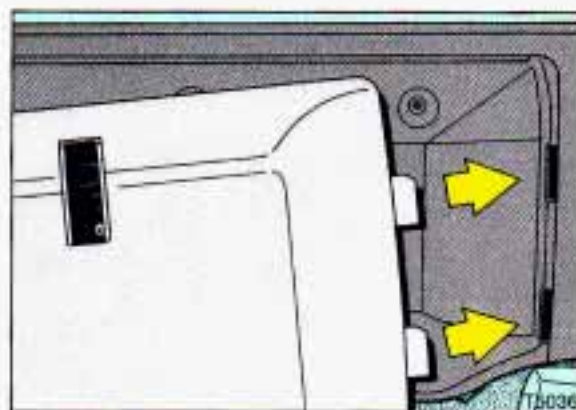

19. If you have a tailgate-mounted spare tire, return the jack and wheel wrench to their storage compartment and replace the jack storage compartment cover. Insert the cover tabs into the trim panel, align the cover and fasten the latch.

CAUTION

 Incorrect wheel nuts or improperly tightened wheel nuts can cause the wheel to become loose and even come off. This could lead to an accident. Be sure to use the correct wheel nuts. If you have to replace them, be sure to get the right kind. Stop somewhere as soon as you can and have the nuts tightened with a torque wrench to 100 pound-feet (140 N•m).

CAUTION

 Storing a jack, a tire or other equipment in the passenger compartment of the vehicle could cause injury. In a sudden stop or collision, loose equipment could strike someone. Store all these in the proper place.

If You're Stuck: In Sand, Mud, Ice or Snow

What you **don't** want to do when your vehicle is stuck is to spin your wheels. The method known as "rocking" can help you get out when you're stuck, but you must use caution.

CAUTION



If you let your tires spin at high speed, they can explode and you or others could be injured. And, the transmission and other parts of the vehicle can overheat. That could cause an engine compartment fire or other damage. When you're stuck, spin the wheels as little as possible. Don't spin the wheels above 35 mph (55 km/h) as shown on the speedometer.

NOTICE

Spinning your wheels can destroy parts of your vehicle as well as the tires. If you spin the wheels too fast while shifting your transmission back and forth, you can destroy your transmission.

Rocking Your Vehicle to Get It Out:

First, turn your steering wheel left and right. That will clear the area around your front wheels. Shift back and forth between **R** (Reverse) and a forward gear, spinning the wheels as little as possible. Release the accelerator pedal while you shift, and press lightly on the accelerator pedal when the transmission is in gear. If that doesn't get you out after a few tries, you may need to be towed out. If you do need to be towed out, see the *Index* under *Towing Your Bravada*.

Notes



Here you will find information about the care of your Oldsmobile. This part begins with service and fuel information, and then it shows how to check important fluid and lubricant levels. There is also technical information about your vehicle, and a section devoted to its appearance care.

Part 6

Service & Appearance Care

Service	202
Fuel	203
Hood Release	207
Engine Oil	210
Air Cleaner	214
Transmission Fluid	216
Engine Coolant	219
Power Steering Fluid	222
Windshield Washer Fluid	222
Brakes	223
Battery	225
Bulb Replacement	226
Windshield Wiper Blade Replacement	228
Loading Your Vehicle	228
Tires	233
Appearance Care	240
Vehicle Identification Number (VIN)	247
Add-On Electrical Equipment	248
Fuses & Circuit Breakers	249
Capacities & Specifications	252
Normal Maintenance Replacement Parts	253
Fluids & Lubricants	254
Replacement Bulbs	256

Service & Appearance Care



Service

Your Oldsmobile dealer knows your vehicle best and wants you to be happy with it. We hope you'll go to your dealer for all your service needs. You'll get genuine GM parts and GM-trained and supported service people.

We hope you'll want to keep your GM vehicle all GM. Genuine GM parts have one of these marks.

Doing Your Own Service Work

If you want to do some of your own service work, you'll want to get the proper Oldsmobile Service Manual. It tells you much more about how to service your Oldsmobile than this manual can. To order the proper service manual, see the *Index* under *Service Publications*.

You should keep a record with all parts receipts and list the mileage and the date of any service work you perform. See the *Index* under *Maintenance Record*.

CAUTION

 You can be injured if you try to do service work on a vehicle without knowing enough about it.

- Be sure you have sufficient knowledge, experience, and the proper replacement parts and tools before you attempt any vehicle maintenance task.
- Be sure to use the proper nuts, bolts and other fasteners. "English" and "metric" fasteners can be easily confused. If you use the wrong fasteners, parts can later break or fall off. You could be hurt.

NOTICE

If you try to do your own service work without knowing enough about it, your vehicle could be damaged.

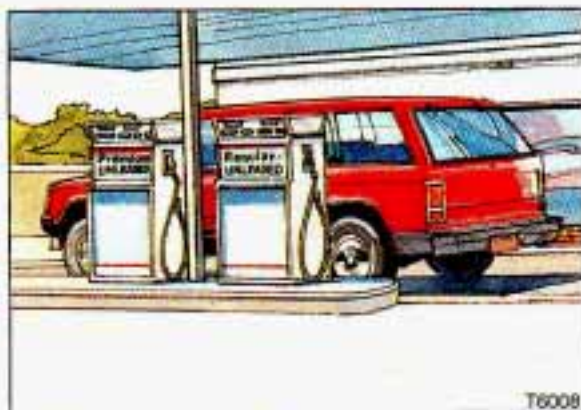

T6008

Fuel

Use regular unleaded gasoline rated at 87 octane or higher. With the 4.3L (Code W) engine, use premium unleaded gasoline at 91 octane or higher for high power performance, when towing a trailer or with a high payload requirement. But when operating with a light load as a normal condition, you may use middle grade or regular unleaded gasolines. The gasoline you use should meet specifications ASTM D4814 in the U.S. and CGSB 3.5-92 in

Canada. These fuels should have the proper additives, so you should not have to add anything to the fuel.

In the U.S. and Canada, it's easy to be sure you get the right kind of gasoline (unleaded). You'll see "UNLEADED" right on the pump. And only unleaded nozzles will fit into your vehicle's filler neck.

Be sure the posted octane is at least 91 for premium, 89 for middle grade and 87 for regular. If the octane is less than 87, you may get a heavy knocking noise when you drive.

If it's bad enough, it can damage your engine.

If you're using fuel rated at 91 octane or higher and you still hear heavy knocking, your engine needs service. But don't worry if you hear a little pinging noise when you're accelerating or driving up a hill. That's normal, and you don't have to buy a higher octane fuel to get rid of it. It's the heavy, constant knock that means you have a problem.

Fuel Capacity:

20 U.S. Gallons (76L). Use unleaded fuel only.

Service & Appearance Care

Fuel (CONT.)

What about gasoline with blending materials that contain oxygen, such as **MTBE** or **alcohol**?

- **MTBE** is “methyl tertiary-butyl ether.” Fuel that is no more than 15% MTBE is fine for your vehicle.
- **Ethanol** is ethyl or grain alcohol. Properly-blended fuel that is no more than 10% ethanol is fine for your vehicle.
- **Methanol** is methyl or wood alcohol.

NOTICE

Fuel that is more than 5% **methanol** is bad for your vehicle. Don't use it. It can corrode metal parts in your fuel system and also damage plastic and rubber parts. That damage wouldn't be covered under your warranty. And even at 5% or less, there must be “cosolvents” and corrosion preventers in this fuel to help avoid these problems.

Gasolines for Cleaner Air

Your use of gasoline with detergent additives will help prevent deposits from forming in your engine and fuel system. That helps keep your engine in tune and your emission control system working properly. It's good for your vehicle, and you'll be doing your part for cleaner air.

Many gasolines are now blended with materials called oxygenates. General Motors recommends that you use gasolines with these blending materials, such as MTBE and ethanol. By doing so, you can help clean the air, especially in those parts of the country that have high carbon monoxide levels.



In addition, some gasoline suppliers are now producing reformulated gasolines. These gasolines are specially designed to reduce vehicle emissions. General Motors recommends that you use reformulated gasoline. By doing so, you can help clean the air, especially in those parts of the country that have high ozone levels.

You should ask your service station operators if their gasolines contain detergents and oxygenates, and if they have been reformulated to reduce vehicle emissions.

Fuels in Foreign Countries

If you plan on driving in another country outside the U.S. or Canada, unleaded fuel may be hard to find.

Do not use leaded gasoline. If you use even one tankful, your emission controls won't work well or at all. With continuous use, spark plugs can get fouled, the exhaust system can corrode, and your engine oil can deteriorate quickly. Your vehicle's oxygen sensor will be damaged. All of that means costly repairs that wouldn't be covered by your warranty.

To check on fuel availability, ask an auto club, or contact a major oil company that does business in the country where you'll be driving.

You can also write us at the following address for advice. Just tell us where you're going and give your Vehicle Identification Number (VIN).

General Motors of Canada Ltd.
International Export Sales
P.O. Box 828
Oshawa, Ontario L1H 7N1, Canada

Service & Appearance Care



Filling Your Tank

The cap is behind a hinged door on the left side of your vehicle.

CAUTION

 Gasoline vapor is highly flammable. It burns violently, and that can cause very bad injuries. Don't smoke if you're near gasoline or refueling your vehicle. Keep sparks, flames, and smoking materials away from gasoline.

To take off the cap, turn it slowly to the left (counterclockwise).

CAUTION

 If you get gasoline on you and then something ignites it, you could be badly burned. Gasoline can spray out on you if you open the fuel filler cap too quickly. This spray can happen if your tank is nearly full, and is more likely in hot weather. Open the fuel filler cap slowly and wait for any "hiss" noise to stop. Then unscrew the cap all the way.

When you put the cap back on, turn it to the right until you hear a clicking noise.

NOTICE

If you need a new cap, be **sure** to get the right type. Your dealer can get one for you. If you get the wrong type, it may not fit or have proper venting, and your fuel tank and emissions system might be damaged.

■ *Checking Things Under the Hood*

The following sections tell you how to check fluids, lubricants and important parts under the hood.



Hood Release

To open the hood, first pull the **HOOD RELEASE** handle inside the vehicle.



Then go to the front of the vehicle and pull up on the underhood release.
Lift the hood.

Service & Appearance Care



Hood Release (CONT.)

The prop rod may be hot due to increased engine temperatures under the hood. Use the prop rod sleeve when handling the prop rod.

Press down on the prop rod to release it from its storage clip. Then put the end of the prop rod into the slot in the underside of the hood.

CAUTION



Things that burn can get on hot engine parts and start a fire. These include liquids like gasoline, oil, coolant, brake fluid, windshield washer and other fluids, and plastic or rubber. You or others could be burned. Be careful not to drop or spill things that will burn onto a hot engine.

Before closing the hood, be sure all the filler caps are on properly. Then lift the hood to relieve pressure on the prop rod. Remove the prop rod from the slot in the hood and return the prop to its retainer. Then just let the hood down and close it firmly.

Underhood Light

Your underhood light will come on whenever you open the hood.

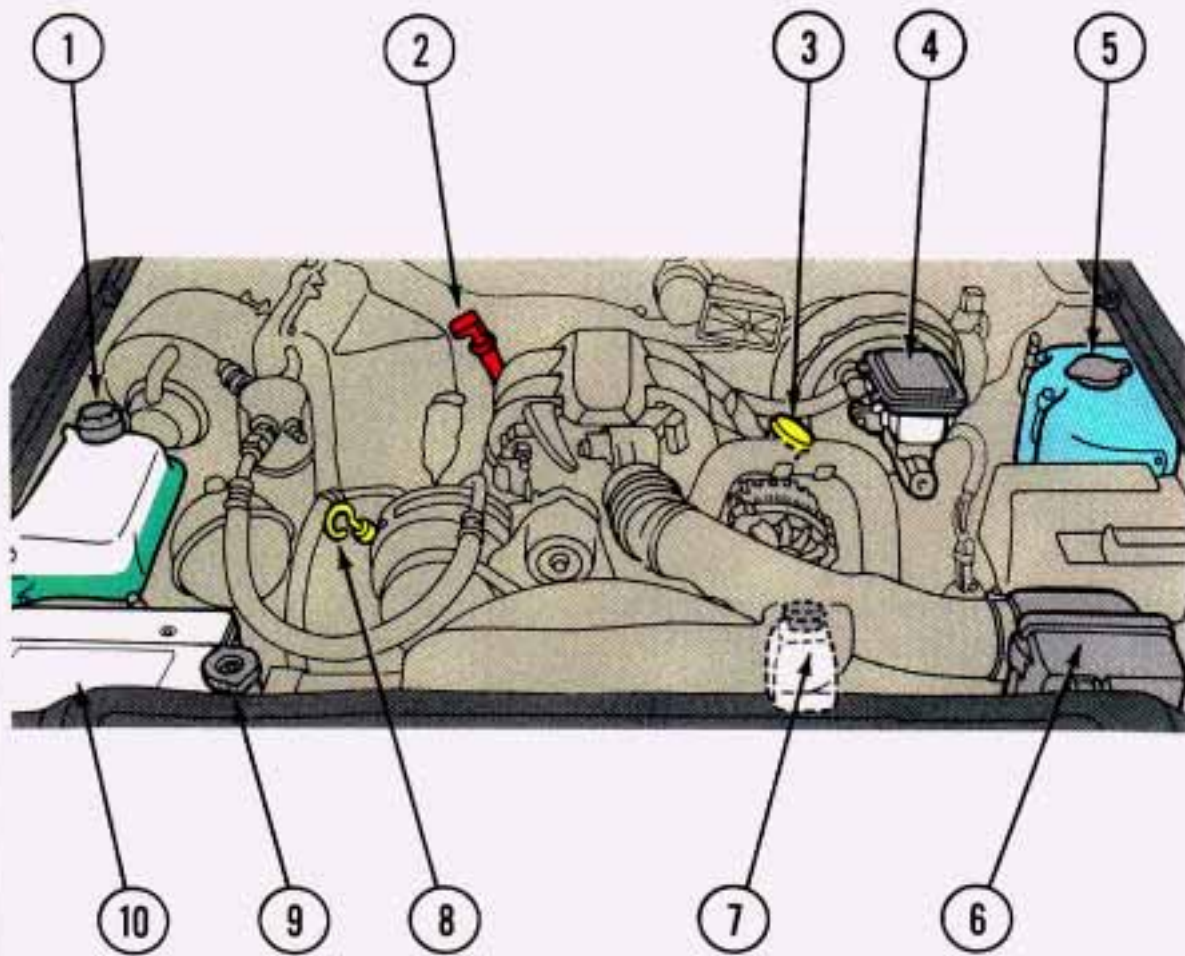

4.3L V6 Engine (CODE W)

When you open the hood, you'll see:

1. Engine Coolant Recovery Tank
2. Automatic Transmission Dipstick
3. Engine Oil Fill Cap
4. Brake Fluid Reservoir
5. Windshield Washer Fluid Reservoir
6. Air Cleaner
7. Power Steering Fluid Reservoir
8. Engine Oil Dipstick
9. Radiator Pressure Cap
10. Battery

T6087

Service & Appearance Care

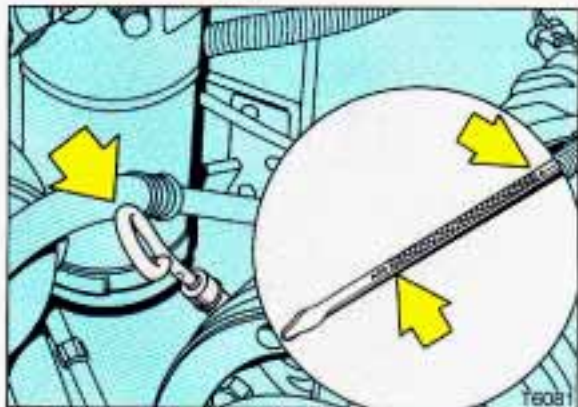

Engine Oil

It's a good idea to check your engine oil every time you get fuel. In order to get an accurate reading, the oil must be warm and the vehicle must be on level ground. Turn off the engine and give the oil a few minutes to drain back into the oil pan. If you don't, the oil dipstick might not show the actual level.

To Check Engine Oil:

Pull out the dipstick and clean it with a paper towel or cloth, then push it back in all the way. Remove it again, keeping the tip lower.

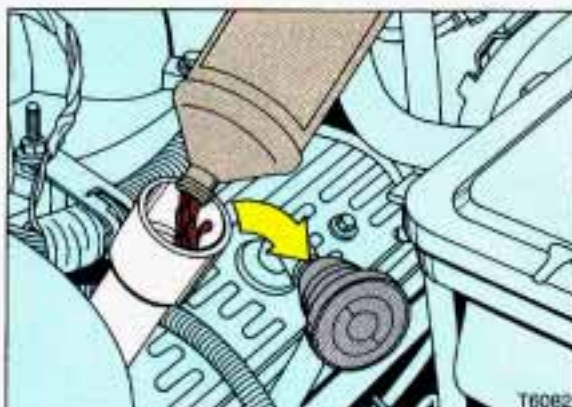

When to Add Oil:

If the oil is at or below the **ADD** line, then you'll need to add some oil. But you must use the right kind. This section explains what kind of oil to use. For crankcase capacity, see the *Index* under *Capacities and Specifications*.

NOTICE

Don't add too much oil. If your engine has so much oil that the oil level gets above the cross-hatched area that shows the proper operating range, your engine could be damaged.

Just fill it enough to put the level somewhere in the proper operating range. Push the dipstick all the way back in when you're through.



What Kind of Oil to Use

Look for Three Things:

- **SG**
 "SG" must be on the oil container, either by itself or combined with other quality designations, such as "SG/CC," "SG/CD," "SF, SG, CC," etc. These letters show American Petroleum Institute (API) levels of quality.

NOTICE

If you use oils that don't have the "SG" designation, you can cause engine damage not covered by your warranty.

Recommended SAE Viscosity Grade Engine Oils

For best fuel economy and cold starting, select the lowest SAE viscosity grade oil for the expected temperature range.

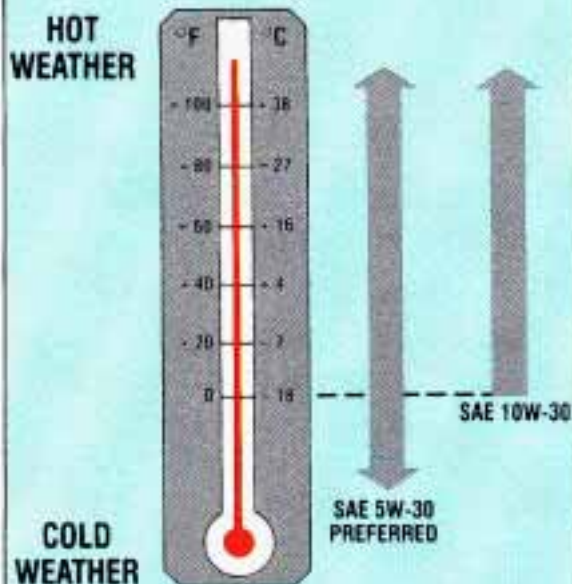

IF NEITHER SAE 5W-30 NOR SAE 10W-30 GRADE OILS ARE AVAILABLE, SAE 30 GRADE MAY BE USED AT TEMPERATURES ABOVE 40 DEGREES F (4 DEGREES C).

DO NOT USE SAE 10W-40, SAE 20W-50 OR ANY OTHER GRADE OIL NOT RECOMMENDED.

• SAE 5W-30

As shown in the viscosity chart, SAE 5W-30 is best for your vehicle. However, you can use SAE 10W-30 if it's going to be 0°F (-18°C) or above. These numbers on an oil container show its viscosity, or thickness. Do not use other viscosity oils such as SAE 10W-40 or SAE 20W-50.

• Energy Conserving II

Oils with these words on the container will help you save fuel.

This doughnut-shaped logo (symbol) is used on most oil containers to help you select the correct oil.

You should look for this on the oil container, and use **only** those oils that display the logo.

GM Goodwrench® Oil (in Canada, GM Engine Oil) meets all the requirements for your vehicle.

Service & Appearance Care

Engine Oil Additives

Don't add anything to your oil. Your Oldsmobile dealer is ready to advise if you think something should be added.

When to Change Engine Oil

See if any one of these is true for you:

- Most trips are less than 4 miles (6 km).
- It's below freezing outside and most trips are less than 10 miles (16 km).
- The engine is at low speed most of the time (as in door-to-door delivery, or in stop-and-go traffic).
- You tow a trailer often.
- Most trips are through dusty places.
- The vehicle is frequently operated off-road.

If any one of these is true for your vehicle, you need to change your **oil and filter** every 3,000 miles (5 000 km) or 3 months—whichever comes first.

If none of them is true, change the oil every 7,500 miles (12 500 km) or 12 months—whichever comes first. Change the filter at the first oil change and at every other oil change after that.

Engine Block Heater

An engine block heater can be a big help if you have to park outside in very cold weather, 0°F (-18°C) or colder. If your vehicle has this option, see the *Index* under *Engine Block Heater*.

What to Do with Used Oil

CAUTION



Used engine oil contains things that have caused skin cancer in laboratory animals. Don't let used oil stay on your skin for very long. Clean your skin and nails with soap and water, or a good hand cleaner. Wash or properly throw away clothing or rags containing used engine oil.

Used oil can be a real threat to the environment. If you change your own oil, be sure to drain all free-flowing oil from the filter before disposal. Don't ever dispose of oil by pouring it on the ground, into sewers, or into streams or bodies of water. Instead, recycle it by taking it to a place that collects used oil. If you have a problem properly disposing of your used oil, ask your dealer, a service station or a local recycling center for help.

Service & Appearance Care

Air Cleaner

Refer to the Maintenance Schedule to determine when to replace the air filter. See the *Index* under *Scheduled Maintenance Services*.

CAUTION



Operating the engine with the air cleaner off can cause you or others to be burned. The air cleaner not only cleans the air, it stops flame if the engine backfires. If it isn't there, and the engine backfires, you could be burned. Don't drive with it off, and be careful working on the engine with the air cleaner off.

NOTICE

If the air cleaner is off, a backfire can cause a damaging engine fire. And, dirt can easily get into your engine, which will damage it. Always have the air cleaner in place when you're driving.

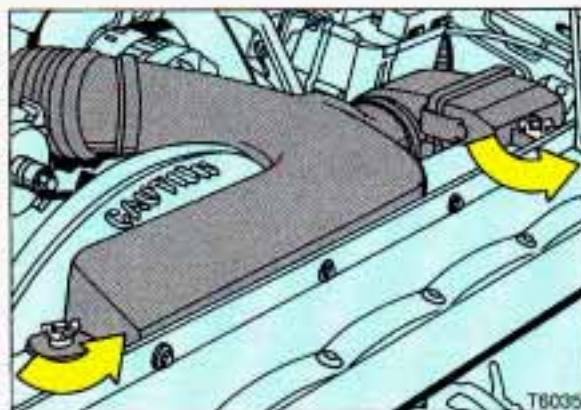

To Check or Replace the Air Cleaner Filter:

1. Loosen the two wing screws.
2. Lift the air cleaner filter housing.

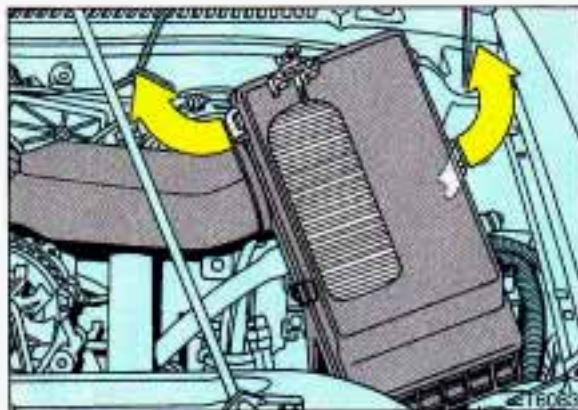

3. Unsnap the two clips on the housing cover and remove the cover.

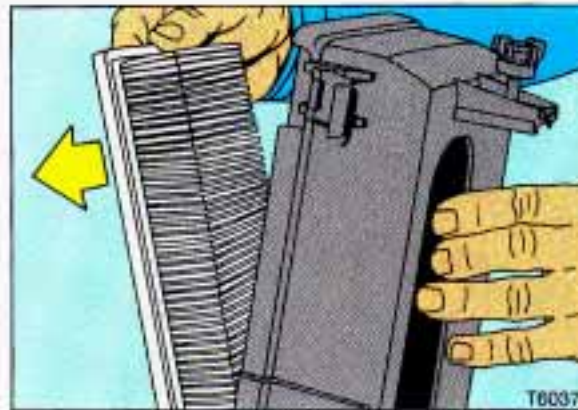

4. Remove the air cleaner filter from the housing.
5. Install a new air cleaner filter and reverse steps 1-3.

Service & Appearance Care

Automatic Transmission Fluid

When to Check and Change:

A good time to check your automatic transmission fluid level is when the engine oil is changed. Refer to the Maintenance Schedule to determine when to change your fluid. See the *Index* under *Scheduled Maintenance Services*.

How to Check:

Because this operation can be a little difficult, you may choose to have this done at an Oldsmobile dealership Service Department. If you do it yourself, be sure to follow all the instructions here, or you could get a false reading on the dipstick.

NOTICE

Too much or too little fluid can damage your transmission. Too much can mean that some of the fluid could come out and fall on hot engine parts, starting a fire. Be sure to get an accurate reading if you check your transmission fluid.

Wait at least 30 minutes before checking the transmission fluid level if you have been driving:

- When outside temperatures are above 90°F (32°C).
- At high speed for quite awhile.
- In heavy traffic—especially in hot weather.
- While pulling a trailer.

To get the right reading, the fluid should be at normal operating temperature, which is 180°F to 200°F (80°C to 93°C).

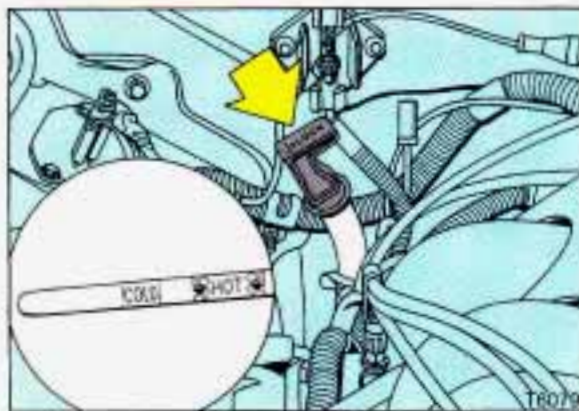

To Check Transmission Fluid Hot:

Get the vehicle warmed up by driving about 15 miles (24 km) when outside temperatures are above 50°F (10°C). If it's colder than 50°F (10°C), drive the vehicle in D (3rd gear) until the engine temperature gage moves and then remains steady for ten minutes. Then follow the hot check procedures.

To Check Transmission Fluid Cold:

A cold check is made after the vehicle has been sitting for eight hours or more with the engine off and is used only as a reference. Let the engine run at idle for five minutes if outside temperatures are 50°F (10°C) or more. If it's colder than 50°F (10°C), you may have to idle the engine longer. A hot check must follow when fluid is added during a cold check.

To Check the Fluid Hot or Cold:

- Park your vehicle on a level place.
- Place the shift lever in **P** (Park) with the parking brake applied.
- With your foot on the brake pedal, move the shift lever through each gear range, pausing for about three seconds in each range. Then, position the shift lever in **P** (Park).
- Let the engine run at idle for three minutes or more.

Then, Without Shutting Off the Engine, Follow These Steps:

1. Flip the handle up and then pull out the dipstick and wipe it with a clean rag or paper towel.

2. Push it back in all the way, wait three seconds and then pull it back out again.
3. Check both sides of the dipstick, and read the lower level. The fluid level must be in the **COLD** area for a cold check or in the **HOT** area or the cross-hatched area for a hot check.
4. If the fluid level is where it should be, push the dipstick back in all the way; then flip the handle down to lock the dipstick in place.

Service & Appearance Care

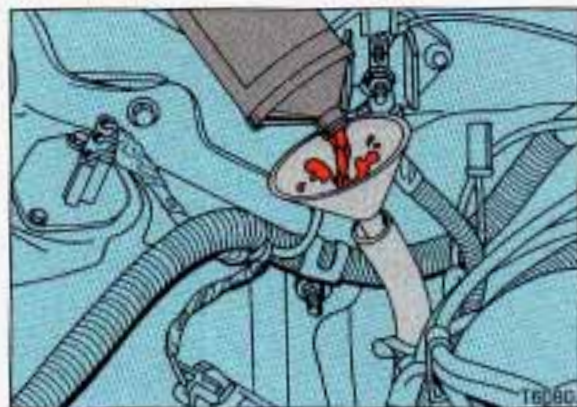

Automatic Transmission Fluid (CONT.)

How to Add Fluid:

Refer to the Maintenance Schedule to determine what kind of transmission fluid to use. See the *Index* under *Fluids & Lubricants*.

If the fluid level is low, add only enough of the proper fluid to bring the level up to the **COLD** area for a cold check or the **HOT** area for a hot check. It doesn't take much fluid, generally less than a pint. Don't overfill. We recommend you use only fluid labeled DEXRON®-III, because fluids with that label are made especially for your automatic transmission. Damage caused by fluid other than DEXRON®-III is not covered by your new vehicle warranty.

After adding fluid, recheck the fluid level as described earlier under *How to Check*.

When the correct fluid level is obtained, push the dipstick back in all the way.

Transfer Case

When to Check Lubricant:

Refer to the Maintenance Schedule to determine how often to check the lubricant. See the *Index* under *Periodic Maintenance Inspections*.

How to Check Lubricant:

If the level is below the bottom of the filler plug hole, you'll need to add some lubricant. Add enough lubricant to raise the level to the bottom of the filler plug hole.

What to Use:

Refer to the Maintenance Schedule to determine what kind of lubricant to use. See the *Index* under *Fluids & Lubricants*.

Front Axle

When to Check and Change Lubricant:

Refer to the Maintenance Schedule to determine how often to check the lubricant and when to change it. See the *Index* under *Scheduled Maintenance Services*.

How to Check Lubricant:

If the level is below the bottom of the filler plug hole, you'll need to add some lubricant. Add enough lubricant to raise the level to the bottom of the filler plug hole.

What to Use:

Refer to the Maintenance Schedule to determine what kind of lubricant to use. See the *Index* under *Fluids & Lubricants*.

Engine Coolant

The following explains your cooling system and how to add coolant when it is low. If you have a problem with engine overheating, see the *Index* under *Engine Overheating*.

The proper coolant for your Oldsmobile will:

- Give freezing protection down to -34°F (-37°C).
- Give boiling protection up to 258°F (125°C).
- Protect against rust and corrosion.
- Help keep the proper engine temperature.
- Let the warning lights and gages work as they should.

What to Use:

Use a mixture of one-half **clean water** (preferably distilled) and one-half antifreeze that meets GM Specification 6038-M, which won't damage aluminum parts.

Use GM Engine Coolant Supplement (sealer) with any complete coolant change. If you use these, you don't need to add anything else.

CAUTION



Adding only plain water to your cooling system can be dangerous. Plain water, or some other liquid like alcohol, can boil before the proper coolant mix will. Your vehicle's coolant warning system is set for the proper coolant mix. With plain water or the wrong mix, your engine could get too hot but you wouldn't get the overheat warning. Your engine could catch fire and you or others could be burned. Use a 50/50 mix of **clean water** and a proper antifreeze.

Service & Appearance Care

Engine Coolant (CONT.)

Some conditions, such as air trapped in the cooling system, can affect the coolant level in the radiator. Check the coolant level when the engine is cold and follow the steps under *Adding Coolant* for the proper way to add coolant.

Using the wrong fill procedure can cause a low coolant warning indication. If you have to add coolant more than four times a year, have your dealer check your cooling system.

NOTICE

If you use the proper coolant, you don't have to add extra inhibitors or additives which claim to improve the system. These can be harmful.

NOTICE

If you use an improper coolant mix, your engine could overheat and be badly damaged. The repair cost wouldn't be covered by your warranty. Too much water in the mix can freeze and crack the engine, radiator, heater core and other parts.

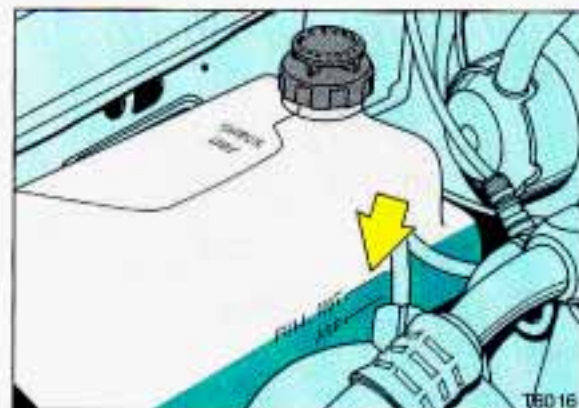

Adding Coolant

To Check Coolant:

When your engine is cold, the coolant level should be at **ADD** or a little higher. When your engine is warm, the level should be up to **FULL HOT**, or a little higher.

To Add Coolant:

If you need more coolant, add the proper mix **at the coolant recovery tank**.

CAUTION



Turning the radiator pressure cap when the engine and radiator are hot can allow steam and scalding liquids to blow out and burn you badly. With the coolant recovery tank, you will almost never have to add coolant at the radiator. Never turn the radiator pressure cap—even a little—when the engine and radiator are hot.

Add coolant mix at the recovery tank, but be careful not to spill it.

CAUTION



You can be burned if you spill coolant on hot engine parts. Coolant contains ethylene glycol, and it will burn if the engine parts are hot enough. Don't spill coolant on a hot engine.

Radiator Pressure Cap

NOTICE

Your radiator cap is a 15 psi (105 kPa) pressure-type cap and must be tightly installed to prevent coolant loss and possible engine damage from overheating. Be sure the arrows on the cap line up with the overflow tube on the radiator filler neck.

When you replace your radiator pressure cap, an AC® cap is recommended.

Thermostat

Engine coolant temperature is controlled by a thermostat in the engine coolant system. The thermostat stops the flow of coolant through the radiator until the coolant reaches a preset temperature.

When you replace your thermostat, an AC® thermostat is recommended.

Service & Appearance Care

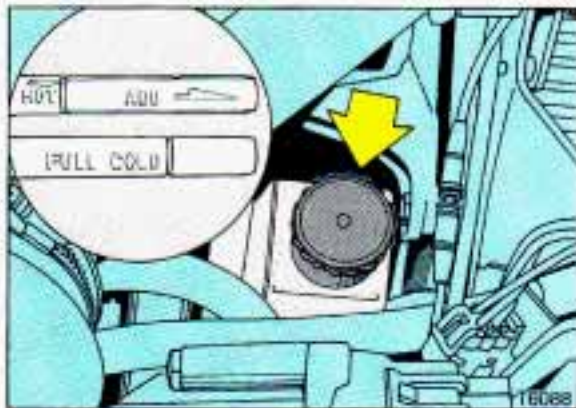

Power Steering Fluid

How To Check Power Steering Fluid:

Unscrew the cap and wipe the dipstick with a clean rag. Replace the cap and completely tighten it. Then remove the cap again and look at the fluid level on the dipstick.

- When the engine compartment is hot, the level should be at the **HOT** mark.
- When the engine compartment is cool, the level should be at the **FULL COLD** mark.

What to Add:

Refer to the Maintenance Schedule to determine what kind of fluid to use. See the *Index* under *Fluids & Lubricants*.

NOTICE

When adding power steering fluid or making a complete fluid change, always use the proper fluid. Failure to use the proper fluid can cause leaks and damage hoses and seals.

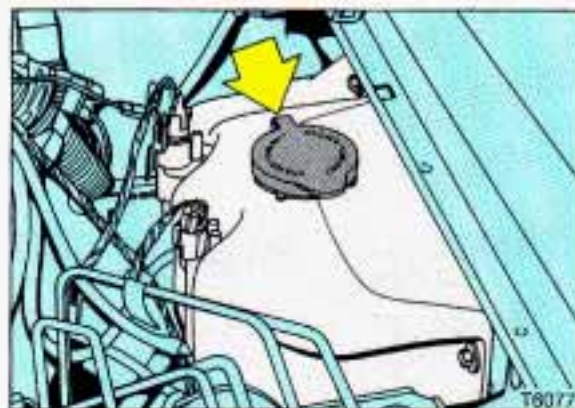

Windshield Washer Fluid

To Add:

Open the cap labeled **WASHER FLUID ONLY**. Add washer fluid until the bottle is full.

NOTICE

- When using concentrated washer fluid, follow the manufacturer's instructions for adding water.
- Don't mix water with ready-to-use washer fluid. Water can cause the solution to freeze and damage your washer fluid tank and other parts of the washer system. Also, water doesn't clean as well as washer fluid.
- Fill your washer fluid tank only $\frac{3}{4}$ full when it's very cold. This allows for expansion, which could damage the tank if it is completely full.
- Don't use radiator antifreeze in your windshield washer. It can damage your washer system and paint.

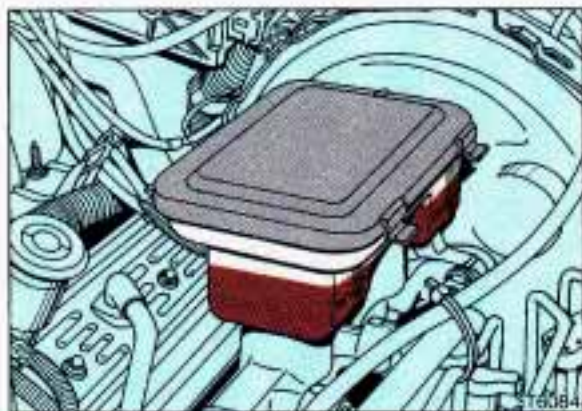

Brake Master Cylinder

Your brake master cylinder is here. It is filled with DOT-3 brake fluid.

There are only two reasons why the brake fluid level in your master cylinder might go down. The first is that the brake fluid goes down to an acceptable level during normal brake lining wear. When new linings are put in, the fluid level goes back up.

The other reason is that fluid is leaking out of the brake system. If it is, you should have your brake system fixed, since a leak means that sooner or later your brakes won't work well, or won't work at all.

So, it isn't a good idea to "top off" your brake fluid. Adding brake fluid won't correct a leak. If you add fluid when your linings are worn, then you'll have too much fluid when you get new brake linings. You should add (or remove) brake fluid, as necessary, only when work is done on the brake hydraulic system.

Service & Appearance Care

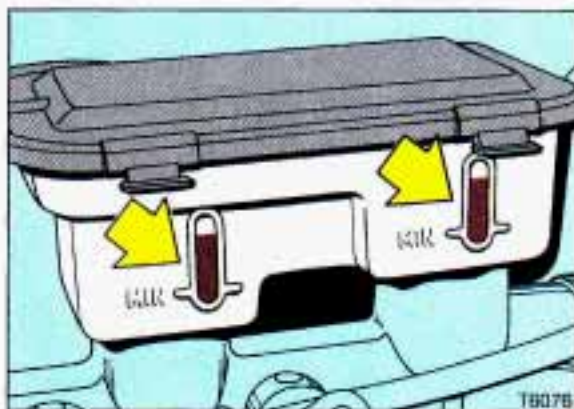

Brake Master Cylinder (CONT.)

CAUTION

 If you have too much brake fluid, it can spill on the engine. The fluid will burn if the engine is hot enough. You or others could be burned, and your vehicle could be damaged. Add brake fluid only when work is done on the brake hydraulic system.

Refer to the Maintenance Schedule to determine when to check your brake fluid. See the *Index* under *Periodic Maintenance Inspections*.

To Check Brake Fluid:

You can check the brake fluid without taking off the cap. Just look at the windows on the brake fluid reservoir. The fluid levels should be above **MIN**. If they aren't, have your brake system checked to see if there is a leak.

After work is done on the brake hydraulic system, make sure the levels are above **MIN** and below the top of each window.

What to Add:

When you do need brake fluid, use only DOT-3 brake fluid—such as Delco Supreme II® (GM Part No. 1052535). Use new brake fluid from a sealed container only.

NOTICE

- DOT-5 silicone brake fluid can damage your vehicle. Don't use it.
- Don't let someone put in the wrong kind of fluid. For example, just a few drops of mineral-based oil, such as engine oil, in your brake system can damage brake system parts so badly that they'll have to be replaced.
- Brake fluid can damage paint, so be careful not to spill brake fluid on your vehicle.

Replacing Brake System Parts

The braking system on a modern vehicle is complex. Its many parts have to be of top quality and work well together if the vehicle is to have really good braking. Vehicles we design and test have top-quality GM brake parts in them, as your Oldsmobile does when it is new. When you replace parts of your braking system—for example, when your brake linings wear down and you have to have new ones put in—be sure you get new genuine GM replacement parts. If you don't, your brakes may no longer work properly. For example, if someone puts in brake linings that are wrong for your vehicle, the balance between your front and rear brakes can change, for the worse. The braking performance you've come to expect can change in many other ways if someone puts in the wrong replacement brake parts.

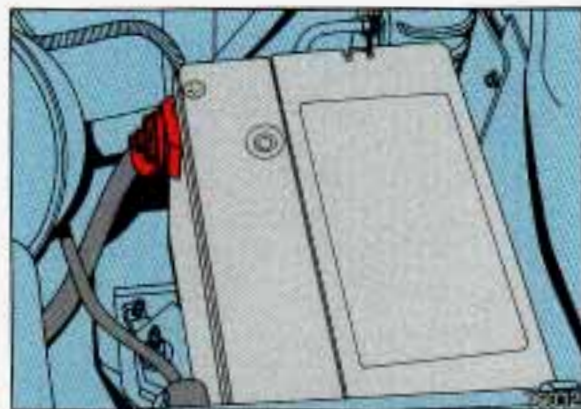

Battery

Every new Oldsmobile has a Delco Freedom® battery. You never have to add water to one of these. When it's time for a new battery, we recommend a Delco Freedom® battery. Get one that has the catalog number shown on the original battery's label.

Jump Starting

For jump starting instructions, see the *Index* under *Jump Starting*.

Vehicle Storage

If you're not going to drive your vehicle for 25 days or more, take off the black negative (–) cable from the battery. This will help keep your battery from running down.

CAUTION



Batteries have acid that can burn you and gas that can explode. You can be badly hurt if you aren't careful. See the *Index* under *Jump Starting* for tips on working around a battery without getting hurt.

Contact your dealer to learn how to prepare your vehicle for longer storage periods.

Service & Appearance Care

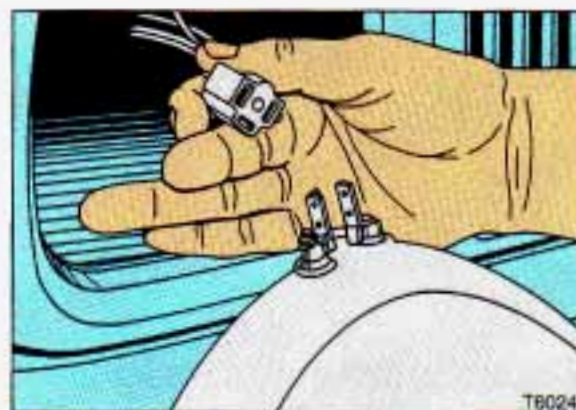
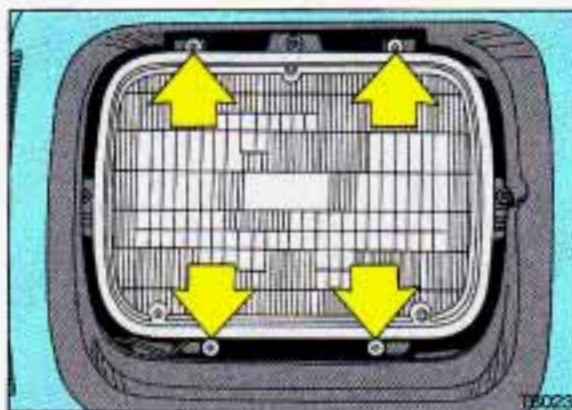

Halogen Bulbs

CAUTION

 Halogen bulbs have pressurized gas inside and can burst if you drop or scratch the bulb. You or others could be injured. Take special care when handling and disposing of halogen bulbs.

Headlight Bulb Replacement

For the type of bulb, see the *Index* under *Replacement Bulbs*.

1. Remove the four screws from the headlight retainer.
2. Pull the headlight out and remove the retainer.
3. Unplug the headlight.
4. Plug in the new bulb and put it in place.
5. Install the retainer to the headlight.
6. Install the screws.

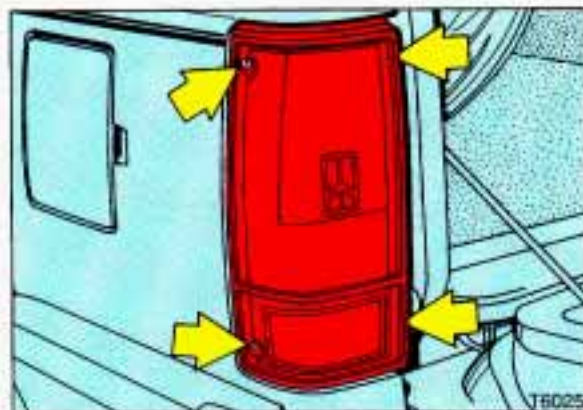

Taillight Bulb Replacement

For the type of bulb, see the *Index* under *Replacement Bulbs*.

1. Open the tailgate.
2. Remove the screws from the light assembly.
3. Pull the assembly away from the fender.

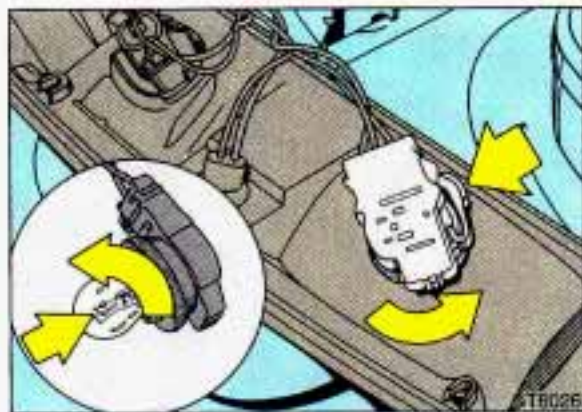

4. Turn the socket counterclockwise to remove it. If the socket has a tab, push the tab in while you turn the socket.
5. Turn the bulb counterclockwise to remove it.
6. Put the new bulb into the socket and turn the bulb clockwise.
7. Put the socket into the light assembly and turn the socket clockwise until it locks in place.
8. Install the light assembly and screws.
9. Close the tailgate.

Fog Light Bulb Replacement

Don't change your fog light bulbs unless you have the proper aiming equipment. See your Oldsmobile dealer if you have any further questions.

Service & Appearance Care

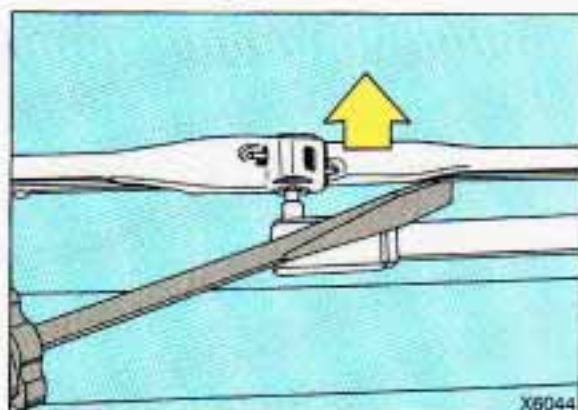

Windshield Wiper Blade Replacement

Replacement blades come in different types and are removed in different ways. Here's how to remove the type without a release clip:

1. Pull the windshield wiper arm away from the windshield.
2. With a screwdriver, pry the blade assembly off the wiper arm.
3. Push the new wiper blade securely on the wiper arm.



Loading Your Vehicle

The Certification/Tire label is found on the rear edge of the driver's door. The label shows the size of your original tires and the inflation pressures needed to obtain the gross weight capacity of your vehicle. This is called the GVWR (Gross Vehicle Weight Rating). The GVWR includes the weight of the vehicle, all occupants, fuel and cargo.

The Certification/Tire label also tells you the maximum weights for the front and rear axles, called Gross Axle Weight Rating (GAWR). To find out the

actual loads on your front and rear axles, you need to go to a weigh station and weigh your vehicle. Your dealer can help you with this. Be sure to spread out your load equally on both sides of the centerline.

Never exceed the GVWR for your vehicle, or the Gross Axle Weight Rating (GAWR) for either the front or rear axle. And, if you do have a heavy load, you should spread it out.

CAUTION



Do not load your vehicle any heavier than the GVWR or the maximum front and rear GAWRs. If you do, parts on your vehicle can break, or it can change the way your vehicle handles. These could cause you to lose control. Also, overloading can shorten the life of your vehicle.

Using heavier suspension components to get added durability might not change your weight ratings. Ask your dealer to help you load your vehicle the right way.

NOTICE

Your warranty does not cover parts or components that fail because of overloading.

If you put things inside your vehicle—like suitcases, tools, packages, or anything else—they will go as fast as the vehicle goes. If you have to stop or turn quickly, or if there is a crash, they'll keep going.

CAUTION



Things you put inside your vehicle can strike and injure people in a sudden stop or turn, or in a crash.

- Put things in the cargo area of your vehicle. Try to spread the weight evenly.
- Never stack heavier things, like suitcases, inside the vehicle so that some of them are above the tops of the seats.
- When you carry something inside the vehicle, secure it whenever you can.
- Don't leave a seat folded down unless you need to.

Service & Appearance Care

Payload

The Payload Capacity is shown on the Certification/Tire label. This is the maximum load capacity that your vehicle can carry. Be sure to include the weight of the people inside as part of your load. If you added any accessories or equipment after your vehicle left the factory, remember to subtract the weight of these things from the payload. Your dealer can help you with this.

Trailer Package

If your vehicle comes with the trailering package, there is also a load rating which includes the weight of the vehicle **and** the trailer it tows. This rating is called the Gross Combination Weight Rating (GCWR).

When you weigh your trailer, be sure to include the weight of everything you put in it. And, remember to figure the weight of the people inside as part of your load.

Your dealer can help you determine your GCWR.

Add-On Equipment

When you carry removable items, you may need to put a limit on how many people you carry inside your vehicle. Be sure to weigh your vehicle before you buy and install the new equipment.

NOTICE

Your warranty doesn't cover parts or components that fail because of overloading.

Single Belt Accessory Drive

Your vehicle uses a serpentine belt that is lighter, more durable and more fuel efficient than systems with several belts. The belt runs over or around the pulleys on the engine. A tensioner is used to keep the belt tight at all times. The tensioner also makes replacing the belt easier. If you need to replace the belt, be sure to get the correct replacement belt. Your dealership or parts supplier can help you with this. The Accessory Drive Belt Routing label on your vehicle will show you how to route the belt your vehicle uses.

Air Conditioning

Every now and then have your dealership check your air conditioning system to be sure it has not lost any cooling ability. If you think the system is not working properly, have your dealership check it out as soon as possible.

The air conditioning will not work when the temperature is below 40°F (4°C).

Accelerator Control System

Your Maintenance Schedule will tell you how often the accelerator linkage pivot points must be lubricated and what type of lubricant to use.

Accelerator cables and cruise control cables should not be lubricated. Any cables that are worn or are hard to pull should be replaced.

Service & Appearance Care

Hood Latches and Hood Hinge

Your Maintenance Schedule will tell you how to lubricate the hood latch and hood hinge assembly.

Lock Cylinders

To be sure your locks operate properly, they must be lubricated. Your Maintenance Schedule will tell you how often to lubricate them and what type of lubricant to use.

You should not use penetrating oils because they could wash out the factory installed lubricant and cause the lock to bind. De-icers which contain alcohol could also wash away the lubricant, so be sure to lubricate the lock after using a de-icer of this type.

Tailgate Mounted Spare Tire Carrier

The spare tire carrier must be lubricated to keep it operating smoothly. Your Maintenance Schedule will tell you what type of lubricant to use.

■ *Tires*

We don't make tires. Your new vehicle comes with high quality tires made by a leading tire manufacturer. These tires are warranted by the tire manufacturers and their warranties are delivered with every new Oldsmobile. If your spare tire is a different brand than your road tires, you will have a tire warranty folder from each of these manufacturers.

CAUTION



Poorly maintained and improperly used tires are dangerous.

- Overloading your tires can cause overheating as a result of too much friction. You could have an air-out and a serious accident. See the *Index* under *Loading Your Vehicle*.
- Underinflated tires pose the same danger as overloaded tires. The resulting accident could cause serious injury. Check all tires frequently to maintain the recommended pressure. Tire pressure should be checked when your tires are cold.
- Overinflated tires are more likely to be cut, punctured, or broken by sudden impact, such as when you hit a pothole. Keep tires at the recommended pressure.
- Worn, old tires can cause accidents. If your tread is badly worn, or if your tires have been damaged, replace them.
- Don't drive over 85 mph (135 km/h), even if it's legal, unless you have the correct high speed rated tires.

Service & Appearance Care

Inflation—Tire Pressure

The Certification/Tire label which is on the rear edge of the driver's door shows the correct inflation pressures for your tires, when they're cold. "Cold" means your vehicle has been sitting for at least three hours or driven no more than a mile.

NOTICE

Don't let anyone tell you that underinflation or overinflation is all right. It's not. If your tires don't have enough air (underinflation), you can get:

- Too much flexing
- Too much heat
- Tire overloading
- Bad wear
- Bad handling
- Bad fuel economy.

If your tires have too much air (overinflation), you can get:

- Unusual wear
- Bad handling
- Rough ride
- Needless damage from road hazards.

When to Check:

Check your tires once a month or more. Don't forget your spare tire.

How to Check:

Use a good quality pocket-type gage to check tire pressure. Simply looking at the tires will not tell you the pressure, especially if you have radial tires—which may look properly inflated even if they're underinflated.

If your tires have valve caps, be sure to put them back on. They help prevent leaks by keeping out dirt and moisture.

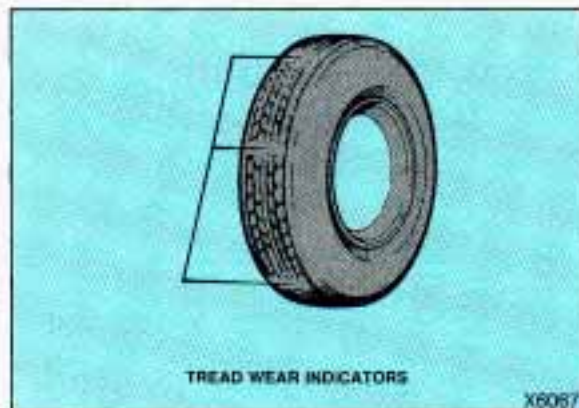
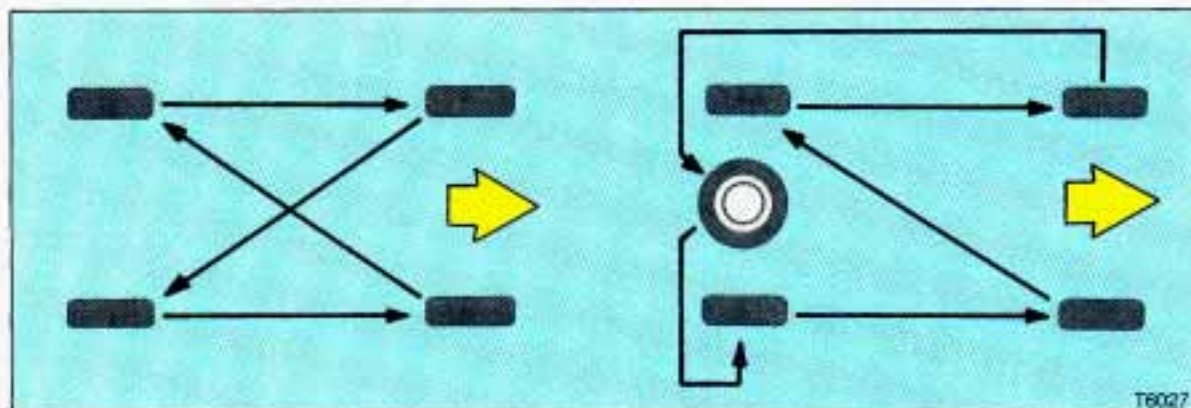

Tire Inspection and Rotation

To make your tires last longer, have them inspected and rotated at the mileages recommended in the Maintenance Schedule. See the *Index* under *Maintenance Schedule*. Use this rotation pattern. If your vehicle has front tires with different load ratings or tread designs (such as all season vs. on/off road) than the rear tires, don't rotate your tires front to rear.

After the tires have been rotated, adjust the front and rear inflation pressure as shown on the Certification/Tire label. Make certain that all wheel nuts are properly tightened. See the *Index* under *Wheel Nut Torque*.

CAUTION



Rust or dirt on a wheel, or on the parts to which it is fastened, can make wheel nuts become loose after a time. The wheel could come off and cause an accident. When you change a wheel, remove any rust or dirt from places where the wheel attaches to the vehicle. In an emergency, you can use a cloth or a paper towel to do this; but be sure to use a scraper or wire brush later, if you need to, to get all the rust or dirt off. See the *Index* under *Changing a Flat Tire*.

When It's Time for New Tires

One way to tell when it's time for new tires is to check the treadwear indicators, which will appear when your tires have only 2/32 inch (1.6 mm) or less of tread remaining.

You need a new tire if:

- You can see the indicators at three places around the tire.
- You can see cord or fabric showing through the tire's rubber.
- The tread or sidewall is cracked, cut or snagged deep enough to show cord or fabric.

Service & Appearance Care

When It's Time for New Tires *(CONT.)*

- The tire has a bump, bulge or split.
- The tire has a puncture, cut, or other damage that can't be repaired well because of the size or location of the damage.

Buying New Tires

To find out what kind and size of tires you need, look at the Certification/Tire label. The tires installed on your vehicle when it was new had a Tire Performance Criteria Specification (TPC Spec) number on each tire's sidewall. When you get new tires, get ones with that same TPC Spec number. That way, your vehicle will continue to have tires that are designed to give proper endurance, handling, speed rating, traction, ride and other things during normal service on your vehicle.

If your tires have an all-season tread design, the TPC number will be followed by a "MS" (for mud and snow).

If you ever replace your tires with those not having a TPC Spec number, make

sure they are the same size, load range, speed rating and construction type (bias, bias-belted or radial) as your original tires.

CAUTION



Mixing tires could cause you to lose control while driving. If you mix tires of different sizes or types (radial and bias-belted tires), the vehicle may not handle properly, and you could have a crash. Be sure to use the same size and type tires on all four wheels.

■ *Uniform Tire Quality Grading*

The following information relates to the system developed by the United States National Highway Traffic Safety Administration which grades tires by treadwear, traction and temperature performance. (This applies only to vehicles sold in the United States.)

Treadwear

The treadwear grade is a comparative rating based on the wear rate of the tire when tested under controlled conditions on a specified government test course. For example, a tire graded 150 would wear one and a half (1½) times as well on the government course as a tire graded 100. The relative performance of tires depends upon the actual conditions

of their use, however, and may depart significantly from the norm due to variations in driving habits, service practices and differences in road characteristics and climate.

Traction—A, B, C

The traction grades, from highest to lowest are: A, B, and C. They represent the tire's ability to stop on wet pavement as measured under controlled conditions on specified government test surfaces of asphalt and concrete. A tire marked C may have poor traction performance.

Warning: The traction grade assigned to this tire is based on braking (straight-ahead) traction tests and does not include cornering (turning) traction.

Temperature—A, B, C

The temperature grades are A (the highest), B, and C, representing the tire's resistance to the generation of heat and its ability to dissipate heat when tested under controlled conditions on a specified indoor laboratory test wheel. Sustained high temperature can cause the material of the tire to degenerate and reduce tire life, and excessive temperature can lead to sudden tire failure. The grade C corresponds to a level of performance which all passenger car tires must meet under the Federal Motor Vehicle Safety Standard No. 109. Grades B and A represent higher levels of performance on the laboratory test wheel than the minimum required by law.

Service & Appearance Care

Temperature—A, B, C (CONT.)

Warning: The temperature grade for this tire is established for a tire that is properly inflated and not overloaded. Excessive speed, underinflation, or excessive loading, either separately or in combination, can cause heat buildup and possible tire failure.

Those grades are molded on the sidewalls of passenger car tires.

While the tires available as standard or optional equipment on General Motors vehicles may vary with respect to these grades, all such tires meet General Motors performance standards and have been approved for use on General Motors vehicles. All passenger type (P Metric) tires must conform to Federal safety requirements in addition to these grades.

Wheel Alignment and Tire Balance

The wheels on your vehicle were aligned and balanced carefully at the factory to give you the longest tire life and best overall performance.

In most cases, you will not need to have your wheels aligned again. However, if you notice unusual tire wear or your vehicle pulling one way or the other, the alignment may need to be reset. If you notice your vehicle vibrating when driving on a smooth road, your wheels may need to be rebalanced.

Wheel Replacement

Replace any wheel that is bent, cracked or badly rusted. If wheel nuts keep coming loose, the wheel, wheel bolts, and wheel nuts should be replaced. If the wheel leaks air out, replace it (except some aluminum wheels, which can sometimes be repaired). See your Oldsmobile dealer if any of these conditions exist.

Your dealer will know the kind of wheel you need.

Each new wheel should have the same load carrying capacity, diameter, width, offset, and be mounted the same way as the one it replaces.

If you need to replace any of your wheels, wheel bolts, or wheel nuts, replace them only with **new GM**

original equipment parts. This way, you will be sure you have the right wheel, wheel bolts, and wheel nuts for your Oldsmobile model.

CAUTION

 Using the wrong replacement wheels, wheel bolts, or wheel nuts on your vehicle can be dangerous. It could affect the braking and handling of your vehicle, make your tires lose air and make you lose control. You could have a collision in which you or others could be injured. Always use the correct wheel, wheel bolts, and wheel nuts for replacement.

NOTICE

The wrong wheel can also cause problems with bearing life, brake cooling, speedometer/odometer calibration, headlight aim, bumper height, vehicle ground clearance, and tire clearance to the body and chassis.

Used Replacement Wheels

CAUTION

 Putting a used wheel on your vehicle is dangerous. You can't know how it's been used or how many miles it's been driven. It could fail suddenly and cause an accident. If you have to replace a wheel, use a **new** GM original equipment wheel.

Tire Chains

NOTICE

Don't use tire chains; they can damage your vehicle.

Service & Appearance Care



■ Appearance Care

CAUTION

 Cleaning products can be hazardous. Some are toxic. Others can burst into flame if you strike a match or get them on a hot part of the vehicle. Some are dangerous if you breathe their fumes in a closed space. When you use anything in a container to clean your Oldsmobile, be sure to follow the instructions. And always open your doors or windows when you're cleaning the inside. **Never** use these to clean your vehicle:

- Gasoline
- Benzene
- Naphtha
- Carbon Tetrachloride
- Acetone
- Paint Thinner
- Turpentine
- Lacquer Thinner
- Nail Polish Remover

They can all be hazardous—some more than others—and they can all damage your vehicle, too.

NOTICE

Don't use any of these unless this manual says you can. In many uses, they will damage your vehicle:

- Laundry Soap
- Bleach
- Reducing Agents

Cleaning the Inside of Your Oldsmobile

Use a vacuum cleaner often to get rid of dust and loose dirt. Wipe vinyl with a clean, damp cloth.

Your Oldsmobile dealer has two GM cleaners—a solvent-type spot lifter and a foam-type powdered cleaner. They will clean normal spots and stains very well.

Here are some cleaning tips:

- Always read the instructions on the cleaner label.
- Clean up stains as soon as you can—before they set.
- Use a clean cloth or sponge, and change to a clean area often. A soft brush may be used if stains are stubborn.

- Use solvent-type cleaners in a well-ventilated area only. If you use them, don't saturate the stained area.
- If a ring forms after spot cleaning, clean the entire area immediately or it will set.

Using Foam-Type Cleaner on Fabric

- Vacuum and brush the area to remove any loose dirt.
- Always clean a whole trim panel or section. Mask surrounding trim along stitch or welt lines.
- Mix Multi-Purpose Powdered Cleaner following the directions on the container label.
- Use suds only and apply with a clean sponge.

- Don't saturate the material.
- Don't rub it roughly.
- As soon as you've cleaned the section, use a sponge to remove the suds.
- Rinse the section with a clean, wet sponge.
- Wipe off what's left with a slightly damp paper towel or cloth.
- Then dry it immediately with an air hose, a hair dryer or a heat lamp.

NOTICE

Be careful with a hair dryer or heat lamp. You could scorch the fabric.

- Wipe with a clean cloth.

Service & Appearance Care

Using Solvent-Type Cleaner on Fabric

First, see if you have to use solvent-type cleaner at all. Some spots and stains will clean off better with just water and mild soap.

If you need to use it, then:

- Gently scrape excess soil from the trim material with a clean, dull knife or scraper. Use very little cleaner, light pressure and clean cloths (preferably cheesecloth). Cleaning should start at the outside of the stain, "feathering" toward the center. Keep changing to a clean section of the cloth.
- When you clean a stain from fabric, immediately dry the area with an air hose, hair dryer, or heat lamp to help prevent a cleaning ring. (See previous NOTICE.)

Special Cleaning Problems

Greasy or Oily Stains:

Like grease, oil, butter, margarine, shoe polish, coffee with cream, chewing gum, cosmetic creams, vegetable oils, wax crayon, tar and asphalt.

- Carefully scrape off excess stain.
- Then follow the solvent-type instructions above.
- Shoe polish, wax crayon, tar and asphalt will stain if left on a vehicle seat fabric. They should be removed as soon as possible. Be careful, because the cleaner will dissolve them and may cause them to bleed.

Non-Greasy Stains:

Like catsup, coffee (black), egg, fruit, fruit juice, milk, soft drinks, wine, vomit, urine and blood.

- Carefully scrape off excess stain, then sponge the soiled area with cool water.
- If a stain remains, follow the foam-type instructions above.
- If an odor lingers after cleaning vomit or urine, treat the area with a water/baking soda solution: 1 teaspoon (5 ml) of baking soda to 1 cup (250 ml) of lukewarm water.
- Finally, if needed, clean lightly with solvent-type cleaner.

Combination Stains:

Like candy, ice cream, mayonnaise, chili sauce and unknown stains.

- Carefully scrape off excess stain, then clean with cool water and allow to dry.
- If a stain remains, clean it with solvent-type cleaner.

Cleaning Vinyl or Leather

Just use warm water and a clean cloth.

- Rub with a clean, damp cloth to remove dirt. You may have to do it more than once.
- Things like tar, asphalt and shoe polish will stain if you don't get them off quickly. Use a clean cloth and solvent-type vinyl/leather cleaner.

Cleaning the Top of the Instrument Panel

Use only mild soap and water to clean the top surfaces of the instrument panel. Sprays containing silicones or waxes may cause annoying reflections in the windshield and even make it difficult to see through the windshield under certain conditions.

Care of Safety Belts

Keep belts clean and dry.

CAUTION



Do not bleach or dye safety belts. If you do, it may severely weaken them. In a crash they might not be able to provide adequate protection. Clean safety belts only with mild soap and lukewarm water.

Service & Appearance Care

Glass

Glass should be cleaned often. GM Glass Cleaner (GM Part No. 1050427) or a liquid household glass cleaner will remove normal tobacco smoke and dust films.

Don't use abrasive cleaners on glass, because they may cause scratches. Avoid placing decals on the inside rear window, since they may have to be scraped off later.

If abrasive cleaners are used on the inside of the rear window, an electric defogger element may be damaged. Any temporary license should not be attached across the defogger grid.

Cleaning the Outside of the Windshield and Wiper Blades

If the windshield is not clear after using the windshield washer, or if the wiper blade chatters when running, wax or other material may be on the blade or windshield.

Clean the outside of the windshield with GM Windshield Cleaner, Bon-Ami Powder® (GM Part No. 1050011). The windshield is clean if beads do not form when you rinse it with water.

Clean the blade by wiping vigorously with a cloth soaked in full strength windshield washer solvent. Then rinse the blade with water.

Wiper blades should be checked on a regular basis and replaced when worn.

Cleaning the Outside of Your Oldsmobile

The paint finish on your vehicle provides beauty, depth of color, gloss retention and durability.

Washing Your Vehicle

The best way to preserve your vehicle's finish is to keep it clean by washing it often with lukewarm or cold water.

Don't wash your vehicle in the direct rays of the sun. Don't use strong soaps or chemical detergents. Use liquid hand, dish or car washing (non-detergent) soaps. Don't use cleaning agents that contain acid or abrasives. All cleaning agents should be flushed promptly and not allowed to dry on the surface, or they could stain. Dry the finish with a soft, clean chamois or a 100% cotton towel to avoid surface scratches and water spotting.

High pressure vehicle washes may cause water to enter your vehicle.

Finish Care

Occasional waxing or mild polishing of your Oldsmobile may be necessary to remove residue from the paint finish. You can get GM approved cleaning products from your dealer.

Aluminum Wheels

Don't use chrome polish on your aluminum wheels. Use wax after you clean them. Also, don't use abrasive cleaners or cleaning brushes on them—you could damage the protective coating.

NOTICE

If you have aluminum wheels, don't use an automatic vehicle wash that has hard silicon carbide cleaning brushes. These brushes can take off the protective coating.

White Sidewall Tires

Your Oldsmobile dealer has a GM White Sidewall Tire Cleaner. You can use a stiff brush with it.

Weatherstrips

These are places where glass or metal meets rubber. Silicone grease there will make them last longer, seal better, and not squeak. Apply silicone grease with a clean cloth at least every six months.

Service & Appearance Care

Sheet Metal Damage

If your vehicle is damaged and requires sheet metal repair or replacement, make sure the body repair shop applies anti-corrosion material to the parts repaired or replaced to restore corrosion protection.

Foreign Material

Calcium chloride and other salts, ice melting agents, road oil and tar, tree sap, bird droppings, chemicals from industrial chimneys, and other foreign matter can damage your vehicle's finish if they remain on painted surfaces. Use cleaners that are marked safe for painted surfaces for these stains.

Finish Damage

Any stone chips, fractures or deep scratches in the finish should be repaired right away. Bare metal will corrode quickly and may develop into a major repair expense.

Minor chips and scratches can be repaired with touch-up materials available from your dealer or other service outlets. Larger areas of finish damage can be corrected in your dealer's body and paint shop.

Underbody Maintenance

Chemicals used for ice and snow removal and dust control can collect on the underbody. If these are not removed, accelerated corrosion (rust) can occur on the underbody parts such as fuel lines, frame, floor pan, and exhaust system even though they have corrosion protection.

At least every spring, flush these materials from the underbody with plain water. Clean any areas where mud and other debris can collect. Dirt packed in closed areas of the frame should be loosened before being flushed. Your dealer or an underbody vehicle washing system can do this for you.

Chemical Paint Spotting

Some weather and atmospheric conditions can create a chemical fallout. Airborne pollutants can fall upon and attack painted surfaces on your vehicle. This damage can take two forms: blotchy, ringlet-shaped discolorations, and small irregular dark spots etched into the paint surface.

Although no defect in the paint job causes this, Oldsmobile will repair, at no charge to the owner, the surfaces of new vehicles damaged by this fallout condition within 12 months or 12,000 miles (20 000 km) of purchase, whichever comes first.

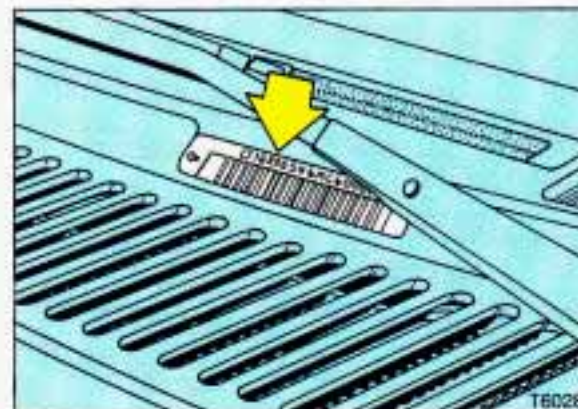

Vehicle Identification Number (VIN)

This is the legal identifier for your Oldsmobile. It appears on a plate in the front corner of the instrument panel, on the driver's side. You can see it if you look through the windshield from outside your vehicle. The VIN also appears on the Vehicle Certification and Service Parts labels and the certificates of title and registration.

Service & Appearance Care



Engine Identification

The eighth character in your VIN is the engine code for your GM engine. This code will help you identify your engine, specifications, and replacement parts in this section.

Service Parts Identification Label

You'll find this label inside the glove box. It's very helpful if you ever need to order parts. On this label is:

- Your VIN.
- Its model designation.
- Paint information.
- A list of all production options and special equipment.

Be sure that this label is not removed from the vehicle.

Add-On Electrical Equipment

NOTICE

Don't add anything electrical to your Oldsmobile unless you check with your dealer first. Some electrical equipment can damage your vehicle and the damage wouldn't be covered by your warranty. Some of it can just keep other things from working as they should.

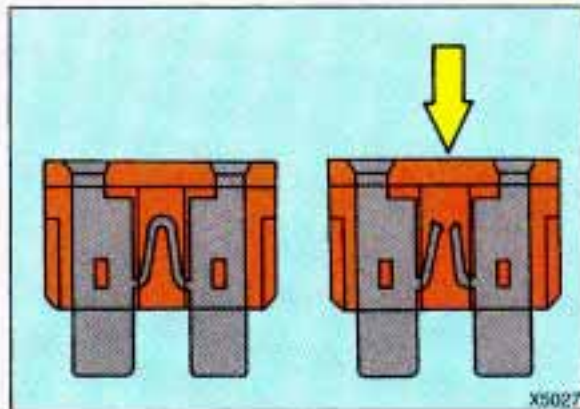

Fuses & Circuit Breakers

The fuse block is under the instrument panel on the driver's side. It is covered by an access panel.

The wiring circuits in your vehicle are protected from short circuits by a combination of fuses, circuit breakers, and fusible thermal links in the wiring itself. This greatly reduces the chance of fires caused by electrical problems.

To Remove the Access Panel:

1. Remove the screw.
2. Pull down and out on the access panel.

Look at the silver-colored band inside the fuse. If the band is broken or melted, replace the fuse. Be sure you replace a bad fuse with a new one of the correct size.

To Install the Access Panel:

1. Put the access panel tab into the slot below the fuse block.
2. Install the screw.

Service & Appearance Care

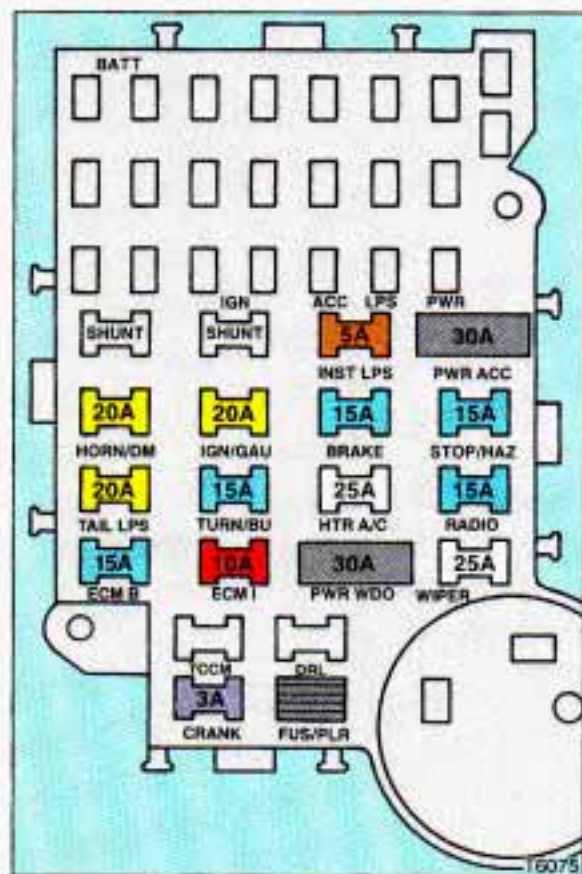

Fuse Usage

Position	Rating (AMP.)	Circuitry
INST LPS	5	Instrument Panel Lights, Headlight Warning Buzzer, Heater Light, Ashtray Light, Radio Illumination Light, Rear Wiper Switch Light
PWR ACC	30	Power Door Locks, Rear Defogger, Console Accessory Receptacles, CD Player
HORN/DM	20	Horn, Dome Lights, Glove Box Light, Clock, Lighter, Lighted Vanity Mirror, Outside Rearview Mirror, Courtesy Lights
IGN/GAU	20	Indicator Lights and Gages, Rear Defogger Relay, Cruise Control, Rear Defogger Switch, Seat Belt Timer
BRAKE	15	Four Wheel Anti-lock Brake Module, Digital Ratio Adapter Module (Speedometer)
STOP/HAZ	15	Stop Lights, Hazard Warning Lights, Chime Module
TAIL LPS	20	Light Switch, Tail/Park Lights, Electronic Cluster, License Light
TURN/BU	15	Turn Signals & Back-up Lights
HTR A/C	25	Heating and Air Conditioning
RADIO	15	Radio, Inside Rearview Mirror Map Lights, Rear Wiper, Rear Washer, Compass
ECM B	15	Electronic Control Module, Fuel Pump
ECM I	10	Electronic Control Module
PWR WDO	30	Power Windows
WIPER	25	Windshield Wipers and Washer
CRANK	3	Electronic Control Module
TRAILER*	30	Trailer Wiring Harness
UNDERHOOD*	4	Underhood Light
CD PLAYER	10	CD Player (attached to fuse block)

* In-line fuse.

Headlight Wiring

The headlight wiring is protected by a circuit breaker in the light switch. An electrical overload will cause the lights to go on and off, or in some cases to remain off. If this happens, have your headlight system checked right away.

Trailer Wiring Harness

The seven-wire trailer wiring harness is protected by an in-line fuse in the battery feed wire. This fuse is near the junction block. See the *Index* under *Trailer Wiring Harness*.

Windshield Wipers

The windshield wiper motor is protected by a circuit breaker and a fuse. If the motor overheats due to heavy snow, etc., the wiper will stop until the motor cools. If the overload is caused by some electrical problem, have it fixed.

Power Windows and Other Power Accessories

Circuit breakers in the fuse panel protect the power windows and other power accessories. When the current load is too heavy, the circuit breaker opens and closes, protecting the circuit until the problem is fixed or goes away.

Before you wire any other electrical accessories into your fuse block, please check with your Oldsmobile dealer.

Service & Appearance Care

Capacities & Specifications

Automatic Transmission

Pan Removal and Replacement	5 quarts	4.75 L
After Complete Overhaul	10.5 quarts	10.0 L

Cooling System 11.8 quarts 11.1 L

Refrigerant, Air Conditioning See refrigerant charge label under hood.

Not all air conditioning refrigerants are the same. If the air conditioning system in your vehicle needs refrigerant, be sure the proper refrigerant is used. If you're not sure, ask your Oldsmobile dealer.

Engine Crankcase

Without filter	4 quarts	3.75 L
With filter	4.5 quarts	4.3 L

Fuel Tank 20 gallons 76 L

Tire Pressures, Sizes See Certification/Tire label on driver's door.

Wheel Nut Torque 100 pound-feet (140 N·m)

NOTE: All capacities are approximate. When adding, be sure to fill to the appropriate level on the dipstick, or as recommended in this manual.

Engine Specifications

4.3L V6 Engine

VIN Engine Code	W
Type	V6
Displacement	4.3 Liters
Compression Ratio	9.1:1
Firing Order	1-6-5-4-3-2
Thermostat Temperature Specification	195° F (91° C)

Normal Maintenance Replacement Parts

Air Cleaner Element	AC Type All63C
Engine Oil Filter	AC Type PF-51
Fuel Filter	GF481
PCV Valve	AC Type CV-892C
Spark Plugs	AC Type CR43TS Gap: 0.045 inch (1.14 mm)

Service & Appearance Care

Fluids & Lubricants

ITEM	APPLICATION	GM PART NUMBER	SIZE
Antifreeze Coolant (Ethylene Glycol Base)	Year-round antifreeze for coolant mixtures	1052103	1 gal. (3.8 L)
Chassis Lubricant (Grease Gun Insert)	General chassis lube, etc.	12346003 or 1052497	14 oz. (397 g)
Delco Supreme 11 [®] Brake Fluid	Brake System	1052535	16 oz. (0.5 L)
DEXRON [®] -IIE Automatic Transmission Fluid	Automatic Transmission, Transfer Case	1051855 12345006	32 oz. (1.0 L) 1 gal. (3.8 L)
Engine Oil	Engine lubrication	See the <i>Index</i> under <i>Engine Oil</i> .	
Gear Lubricant 80W-90	Limited Slip Differential, Front Differential	1052271	
GM Engine Oil Supplement (E.O.S.)	See your dealer for advice	1052367	16 oz. (0.5 L)

ITEM	APPLICATION	GM PART NUMBER	SIZE
Engine Oil	Hood, tailgate and door hinges		
Windshield Washer Solvent	Windshield washer fluid		
Power Steering Fluid	Power Steering System.....	1050017	32 oz. (1.0 L)
		1052884	16 oz. (0.5 L)
Silicone Grease	Weatherstrips.....	12345579	1 oz. (28 g)
Spray-A-Squeak Silicone Lubricant	General purpose silicone lubricant,	1052276 (aerosol)	4.5 oz. (127 g)
	weatherstrips	1052277	12 oz. (0.35 L)

Service & Appearance Care

Replacement Bulbs

OUTSIDE LIGHTS	BULB
Back-up Lights	1156
Front Parking/Turn Signal Lights	2057
License Plate Light	67
Halogen Headlights	H6054
Front Sidemarket Lights	194
Stop/Tail/Turn Signal Lights	2057
Underhood	93
Fog	11513798H3

INSIDE LIGHTS	BULB
Courtesy Light	1003
Reading Lights	
Front	562
Dome Lights	
Center	561
Rear	561
Glove Box Light	1003
Indicator Lights	174
Turn Signal Indicators	174
Ashtray Light	161
Heater Light	194
Windshield Wiper Switch Light	194
Cargo Light	28
Instrument Cluster Illumination	168 194

Notes

IMPORTANT

KEEP ENGINE OIL
AT THE PROPER
LEVEL AND CHANGE AS
RECOMMENDED

This part covers the maintenance required for your Oldsmobile. Your vehicle needs these services to retain its safety, dependability and emission control performance.



Have you purchased the
GM Protection Plan?
The Plan supplements your
new vehicle warranties.
See your Oldsmobile dealer for details.

Part 7 Maintenance Schedule

Section

Introduction

A Word About Maintenance	260
Your Vehicle and the Environment	260
How This Part is Organized	261
A. Scheduled Maintenance Services	
Using Your Maintenance Schedules	262
Selecting the Right Schedule	262
Schedule I	264
Schedule II	266
Explanation of Scheduled Maintenance Services	268
B. Owner Checks & Services	
At Each Fuel Fill	271
At Least Once a Month	271
At Least Once a Year	272
C. Periodic Maintenance Inspections	274
D. Recommended Fluids & Lubricants	275
E. Maintenance Record	278

Maintenance Schedule

Introduction

A Word About Maintenance

We at General Motors want to help you keep your vehicle in good working condition. But we don't know exactly how you'll drive it. You may drive very short distances only a few times a week. Or you may drive long distances all the time in very hot, dusty weather. You may use your vehicle in making deliveries. Or you may drive it to work, to do errands or in many other ways.

Because of all the different ways people use their GM vehicles, maintenance needs vary. You may even need more frequent checks and replacements than you will find in the schedules in this part. So please read this part and note how you drive. If you have any questions on how to keep your vehicle in good condition, see your Oldsmobile dealer, the place many GM owners choose to have their maintenance work done. Your dealer can be relied upon to use proper parts and practices.

Your Vehicle and the Environment

Proper vehicle maintenance not only helps to keep your vehicle in good working condition, but also helps the environment. All recommended maintenance procedures are important. Improper vehicle maintenance or the removal of important components can significantly affect the quality of the air we breathe. Improper fluid levels or even the wrong tire inflation can increase the level of emissions from your vehicle. To help protect our environment, and to help keep your vehicle in good condition, please maintain your vehicle properly.

How This Part is Organized

The remainder of this part is divided into five sections:

Section A: Scheduled Maintenance Services shows what to have done and how often. Some of these services can be complex, so unless you are technically qualified and have the necessary equipment, you should let your dealer's service department or another qualified service center do these jobs.

CAUTION



Performing maintenance work on a vehicle can be dangerous. In trying to do some jobs, you can be seriously injured. Do your own maintenance work only if you have the required know-how and the proper tools and equipment for the job. If you have any doubt, have a qualified technician do the work.

If you are skilled enough to do some work on your vehicle, you will probably want to get the service information GM publishes. You will find a list of publications and how to get them in this manual. See the *Index* under *Service Publications*.

Section B: Owner Checks & Services tells you what should be checked whenever you stop for fuel. It also explains what you can easily do to help keep your vehicle in good condition.

Section C: Periodic Maintenance Inspections explains important inspections that your Oldsmobile dealer's service department or another qualified service center should perform.

Section D: Recommended Fluids & Lubricants lists some products GM recommends to help keep your vehicle properly maintained. These products, or their equivalents, should be used whether you do the work yourself or have it done.

Section E: Maintenance Record provides a place for you to record the maintenance performed on your vehicle. Whenever any maintenance is performed, be sure to write it down in this section. This will help you determine when your next maintenance should be done. In addition, it is a good idea to keep your maintenance receipts. They may be needed to qualify your vehicle for warranty repairs.

Maintenance Schedule

Section A: Scheduled Maintenance Services

Using Your Maintenance Schedules

This section tells you the maintenance services you should have done and when you should schedule them. Your Oldsmobile dealer knows your vehicle best and wants you to be happy with it. If you go to your dealer for your service needs, you'll know that GM-trained and supported service people will perform the work using genuine GM parts.

These Schedules are for vehicles that:

- carry passengers and cargo within recommended limits. You will find these limits on your vehicle's Certification/Tire label. See the *Index* under *Loading Your Vehicle*.
- are driven on reasonable road surfaces within legal driving limits.
- use the recommended unleaded fuel. See the *Index* under *Fuel*.

Selecting the Right Schedule

First you'll need to decide which of the two Schedules is right for your vehicle. Here is how to decide which schedule to follow:

Schedule I

Is any one of these true for your vehicle?

- Most trips are less than 4 miles (6 km).
- Most trips are less than 10 miles (16 km) when outside temperatures are below freezing.
- The engine is at low speed most of the time (as in door-to-door delivery, or in stop-and-go traffic).
- You operate your vehicle in dusty areas.
- You tow a trailer.

If any one (or more) of these is true for your driving, follow Schedule I.

Schedule II

Follow Schedule II **only** if none of the above conditions is true.

Maintenance Schedule

Section A: Scheduled Maintenance Services (Cont.)

Schedule I

Follow Schedule I if your vehicle is **MAINLY** driven under one or more of the following conditions:

- When most trips are less than 4 miles (6 km).
- When most trips are less than 10 miles (16 km) and outside temperatures remain below freezing.
- When most trips include extended idling and/or frequent low-speed operation, as in stop-and-go traffic.
- When towing a trailer.
- When operating in dusty areas.

Schedule I should also be followed if the vehicle is used for delivery service, police, taxi or other commercial applications.

*An Emission Control Service.

ITEM NO.	TO BE SERVICED <i>See Explanation of Scheduled Maintenance Services following Schedules I and II.</i>	WHEN TO PERFORM <i>Miles (kilometers) or Months (whichever occurs first).</i>
1	Engine Oil Change & Oil Filter Change*	Every 3,000 Miles (5 000 km) or 3 Months.
2	Chassis Lubrication	Every 3,000 Miles (5 000 km) or 12 Months.
3	Tire and Wheel Inspection & Rotation	At 6,000 Miles (10 000 km) and every 15,000 Miles (25 000 km) or as necessary.
4	Engine Accessory Drive Belt Inspection	Every 60,000 Miles (100 000 km).
5	Cooling System Service*	Every 30,000 Miles (50 000 km) or 24 Months.
6	Transmission Service	<i>See Explanation of Scheduled Maintenance Services following Schedules I and II.</i>
7	Spark Plug Replacement*	Every 30,000 Miles (50 000 km).
8	Spark Plug Wire Inspection*	Every 60,000 Miles (100 000 km).
9	Air Cleaner Filter Replacement*	Every 30,000 Miles (50 000 km).
10	Fuel Tank, Cap & Lines Inspection*	Every 60,000 Miles (100 000 km).
11	PCV System Inspection*	Every 60,000 Miles (100 000 km)
12	Fuel Filter Replacement*	Every 30,000 Miles (50 000 km)
13	Engine Timing Check*	Every 60,000 Miles (100 000 km)
14	Drive Axle Service	Every 3,000 Miles (5 000 km)
15	Brake Systems Inspection	<i>See Explanation of Scheduled Maintenance Services following Schedules I and II.</i>
16	Transfer Case Fluid Change	<i>See Explanation of Scheduled Maintenance Services following Schedules I and II.</i>

The services shown in this schedule for the first 60,000 miles (100 000 km) should be performed after the first 60,000 miles at the same intervals unless otherwise specified.

MILES (000)

3	6	9	12	15	18	21	24	27	30	33	36	39	42	45	48	51	54	57	60
---	---	---	----	----	----	----	----	----	----	----	----	----	----	----	----	----	----	----	----

KILOMETERS (000)

5	10	15	20	25	30	35	40	45	50	55	60	65	70	75	80	85	90	95	100
---	----	----	----	----	----	----	----	----	----	----	----	----	----	----	----	----	----	----	-----

•	•	•	•	•	•	•	•	•	•	•	•	•	•	•	•	•	•	•	•
---	---	---	---	---	---	---	---	---	---	---	---	---	---	---	---	---	---	---	---

•	•	•	•	•	•	•	•	•	•	•	•	•	•	•	•	•	•	•	•
---	---	---	---	---	---	---	---	---	---	---	---	---	---	---	---	---	---	---	---

	•					•					•					•			
--	---	--	--	--	--	---	--	--	--	--	---	--	--	--	--	---	--	--	--

																			•
--	--	--	--	--	--	--	--	--	--	--	--	--	--	--	--	--	--	--	---

									•										•
--	--	--	--	--	--	--	--	--	---	--	--	--	--	--	--	--	--	--	---

--	--	--	--	--	--	--	--	--	--	--	--	--	--	--	--	--	--	--	--

									•										•
--	--	--	--	--	--	--	--	--	---	--	--	--	--	--	--	--	--	--	---

																			•
--	--	--	--	--	--	--	--	--	--	--	--	--	--	--	--	--	--	--	---

									•										•
--	--	--	--	--	--	--	--	--	---	--	--	--	--	--	--	--	--	--	---

																			•
--	--	--	--	--	--	--	--	--	--	--	--	--	--	--	--	--	--	--	---

									•										•
--	--	--	--	--	--	--	--	--	---	--	--	--	--	--	--	--	--	--	---

																			•
--	--	--	--	--	--	--	--	--	--	--	--	--	--	--	--	--	--	--	---

									•										•
--	--	--	--	--	--	--	--	--	---	--	--	--	--	--	--	--	--	--	---

																			•
--	--	--	--	--	--	--	--	--	--	--	--	--	--	--	--	--	--	--	---

•	•	•	•	•	•	•	•	•	•	•	•	•	•	•	•	•	•	•	•
---	---	---	---	---	---	---	---	---	---	---	---	---	---	---	---	---	---	---	---

--	--	--	--	--	--	--	--	--	--	--	--	--	--	--	--	--	--	--	--

--	--	--	--	--	--	--	--	--	--	--	--	--	--	--	--	--	--	--	--

--	--	--	--	--	--	--	--	--	--	--	--	--	--	--	--	--	--	--	--

Maintenance Schedule

Section A: Scheduled Maintenance Services (Cont.)

Schedule II

Follow Schedule II ONLY if none of the driving conditions specified in Schedule I apply.

ITEM NO.	TO BE SERVICED <i>See Explanation of Scheduled Maintenance Services following Schedules I and II.</i>	WHEN TO PERFORM <i>Miles (kilometers) or Months (whichever occurs first).</i>
1	Engine Oil Change*	Every 7,500 Miles (12 500 km) or 12 Months.
	Oil Filter Change*	At first and every other oil change.
2	Chassis Lubrication	Every 7,500 Miles (12 500 km) or 12 Months.
3	Tire and Wheel Inspection & Rotation	At 7,500 Miles (12 500 km) and every 15,000 Miles (25 000 km) or as necessary.
4	Engine Accessory Drive Belt Inspection	Every 60,000 Miles (100 000 km).
5	Cooling System Service*	Every 30,000 Miles (50 000 km) or 24 Months.
6	Transmission Service	<i>See Explanation of Scheduled Maintenance Services following Schedules I and II.</i>
7	Spark Plug Replacement*	Every 30,000 Miles (50 000 km).
8	Spark Plug Wire Inspection*	Every 60,000 Miles (100 000 km).
9	Air Cleaner Filter Replacement*	Every 30,000 Miles (50 000 km).
10	Fuel Tank, Cap & Lines Inspection*	Every 60,000 Miles (100 000 km).
11	PCV System Inspection*	Every 60,000 Miles (100 000 km)
12	Fuel Filter Replacement*	Every 30,000 Miles (50 000 km)
13	Engine Timing Check*	Every 60,000 Miles (100 000 km)
14	Drive Axle Service	Every 7,500 Miles (12 500 km)
15	Brake System Inspection	<i>See Explanation of Scheduled Maintenance Services following Schedules I and II.</i>
16	Transfer Case Fluid Change	<i>See Explanation of Scheduled Maintenance Services following Schedules I and II.</i>

Maintenance Schedule

Section A: Scheduled Maintenance Services (Cont.)

Explanation of Scheduled Maintenance Services

Below are explanations of the services listed in Schedules I and II.

ITEM

NO. SERVICE

- 1 Engine Oil and Filter Change***—Always use SG Energy Conserving II Oils of proper viscosity. The “SG” designation may be shown alone or in combination with others, such as “SG/CC,” “SG/CD” or “SF, SG, CC,” etc. To determine the preferred viscosity for your vehicle’s engine (e.g., SAE 5W-30 or SAE 10W-30), see the *Index* under *Engine Oil*.
- 2 Chassis Lubrication**—Lubricate the transmission shift linkage, parking brake cable guides, underbody contact points and linkage. Lubricate the front suspension and steering linkage.

The proper fluids and lubricants to use are listed in Section D. Make sure whoever services your vehicle uses these. All parts should be replaced and all necessary repairs done before you or anyone else drives the vehicle.

ITEM

NO. SERVICE

- 3 Tire and Wheel Rotation and Inspection**—For proper wear and maximum tire life, rotate your tires following the instructions in this manual. See the *Index* under *Tires, Inspection & Rotation*. Check the tires for uneven wear or damage. If you see irregular or premature wear, check the wheel alignment. Check for damaged wheels also.
- 4 Engine Accessory Drive Belt Inspection**—Inspect the belt for cracks, fraying, wear and proper tension. Replace as needed.

* An Emission Control Service.

**ITEM
NO. SERVICE**

- 5 Cooling System Service***—Drain, flush and refill the system with new coolant. Keep coolant at the proper mixture as specified. See the *Index* under *Coolant*. This provides proper freeze protection, corrosion inhibitor level and engine operating temperature.
- Inspect hoses and replace if they are cracked, swollen or deteriorated. Tighten the screw-type hose clamps. Clean the outside of the radiator and air conditioning condenser. Wash the pressure cap and neck.
- To help ensure proper operation, we recommend a pressure test of both the cooling system and the pressure cap.
- 6 Transmission Service**
Change both the fluid and filter every 15,000 miles (25 000 km) if the vehicle is mainly driven under one or more of these conditions:
- In heavy city traffic where the outside temperature regularly reaches 90°F (32°C) or higher.
 - In hilly or mountainous terrain.
 - When doing frequent trailer towing.
 - Uses such as found in taxi, police car or delivery service.

**ITEM
NO. SERVICE**

- If you do not use your vehicle under any of these conditions, change both the fluid and filter every 100,000 miles (160 000 km).
- 7 Spark Plug Replacement***—Replace spark plugs with the proper type. See the *Index* under *Replacement Parts*.
- 8 Spark Plug Wire Inspection***—Inspect for burns, cracks or other damage. Check the boot fit at the coils and at the spark plugs. Replace wires as needed.
- 9 Air Cleaner Filter Replacement***—Replace every 30,000 miles (50 000 km) or more often under dusty conditions. Ask your dealer for the proper replacement intervals for your driving conditions.
- 10 Fuel Tank, Cap and Lines Inspection***—Inspect fuel tank, cap and lines (including fuel rails and injection assembly) for damage or leaks. Inspect fuel cap gasket for an even filler neck imprint or any damage. Replace parts as needed.
- 11 Positive Crankcase Ventilation (PCV) System Inspection***—Inspect the system for proper function. Replace any worn, plugged or collapsed hoses and seals. Replace valve only if necessary.

Maintenance Schedule

Section A: Scheduled Maintenance Services (Cont.)

ITEM

NO. SERVICE

- 12 Fuel Filter Replacement***—Replace the fuel filter every 30,000 miles (50 000 km) or sooner if clogged.
- 13 Engine Timing Check***—Adjust the timing to the underhood label specifications. Inspect the inside and outside of the distributor cap and rotor for cracks, carbon tracking and corrosion. Clean or replace as needed.
- 14 Drive Axle Service**—Check rear/front axle fluid level and add as needed. Check constant velocity joints and axle seals for leaking. **Locking Differential**—Drain fluid at first oil change and refill. Check fluid level and add as needed at subsequent oil changes. In dusty areas, or trailer towing applications, drain fluid at every 15,000 miles (25 000 km) and refill.
- More frequent lubrication may be required during heavy-duty or off-road use. A fluid loss in this system may indicate a problem. Have it inspected and repaired at once.

ITEM

NO. SERVICE

- 15 Brake System Inspection**—When the engine oil is changed, inspect the lines and hoses for proper hookup, binding, leaks, cracks, chafing, etc. Check the parking brake adjustment and the fluid level in the master cylinder. A low brake fluid level can indicate worn disc brake pads which may need to be serviced. A fluid loss in this system may indicate a problem. See the *Index* under *Brake System Warning Light*.
- When the wheels are removed for rotation, inspect disc brake pads for wear and rotors for surface condition. Also inspect drum brake linings for wear and cracks. Inspect other brake parts, including drums, wheel cylinders, calipers, parking brake, etc. at the same time.
- You may need to have your brakes inspected more often if your driving habits or conditions result in frequent braking.
- 16 Transfer Case Fluid Change**—In heavy or frequent trailer towing applications, drain fluid and refill every 30,000 miles (50 000 km).

*An Emission Control Service.

Section B: Owner Checks & Services

Listed below are owner checks and services which should be performed at the intervals specified to help ensure the safety, dependability and emission control performance of your vehicle.

Be sure any necessary repairs are completed at once. Whenever any fluids or lubricants are added to your vehicle, make sure they are the proper ones, as shown in Section D.

At Each Fuel Fill (It is important for you or a service station attendant to perform these underhood checks at each fuel fill.)

CHECK OR SERVICE	WHAT TO DO
Engine oil level	Check the engine oil level and add the proper oil if necessary. See the <i>Index</i> under <i>Engine Oil</i> for further details.
Engine coolant level	Check the engine coolant level in the coolant recovery tank and add the proper coolant mix if necessary. See the <i>Index</i> under <i>Coolant</i> for further details.
Windshield washer fluid level	Check the windshield washer fluid level in the windshield washer tank and add the proper fluid if necessary. See the <i>Index</i> under <i>Windshield Washer Fluid</i> for further details.

At Least Once a Month

CHECK OR SERVICE	WHAT TO DO
Tire Inflation	Check tire inflation. Make sure they are inflated to the pressures specified on the Certification/Tire label located on the rear edge of the driver's door. See the <i>Index</i> under <i>Tires</i> for further details.

Maintenance Schedule

Section B: Owner Checks & Services (Cont.)

At Least Once a Year

CHECK OR SERVICE	WHAT TO DO
Key Lock Cylinders	Lubricate the key lock cylinders with the lubricant specified in Section D.
Body Lubrication	Lubricate all body door hinges, including the tailgate. Also lubricate all hinges and latches including those for the hood, rear compartment, glove box door, console doors and any folding seat hardware. Section D tells you what to use.
Starter Switch	<p>CAUTION</p> <p> When you are doing this check, the vehicle could move suddenly. If it does, you or others could be injured. Follow the steps below.</p> <ol style="list-style-type: none">1. Before you start, be sure you have enough room around the vehicle.2. Firmly apply both the parking brake (see the <i>Index</i> under <i>Parking Brake</i> if necessary) and the regular brake. <p>NOTE: Do not use the accelerator pedal, and be ready to turn off the engine immediately if it starts.</p> <ol style="list-style-type: none">3. Try to start the engine in each gear. The starter should work only in P (Park) or N (Neutral). If the starter works in any other position, your vehicle needs service.
Steering Column Lock	<p>While parked, and with the parking brake set, try to turn the key to Lock in each shift lever position.</p> <ul style="list-style-type: none">• The key should turn to Lock only when the shift lever is in P (Park).• The key should come out only in Lock.

CHECK OR SERVICE	WHAT TO DO
Parking Brake and Automatic Transmission P (Park) Mechanism	<p>CAUTION</p> <p> When you are doing this check, your vehicle could move suddenly. You or others could be injured and property could be damaged. Make sure there is room in front of your vehicle in case it begins to roll. Be ready to apply the regular brake at once should the vehicle begin to move.</p> <p>Park on a fairly steep hill, with the vehicle facing downhill. Keeping your foot on the regular brake, set the parking brake.</p> <ul style="list-style-type: none"> • To check the parking brake: With the engine running and transmission in N (Neutral), slowly remove foot pressure from the regular brake pedal. Do this until the vehicle is held by the parking brake only. • To check the P (Park) mechanism's holding ability: Shift to P (Park). Then release all brakes.
Underbody Flushing	At least every spring, use plain water to flush any corrosive materials from the underbody. Take care to clean thoroughly any areas where mud and other debris can collect.
Drive Axle Service	Check rear/front axle fluid level and add as needed. Check constant velocity joints and axle seals for leaking.
Transfer Case	Check transfer case fluid level. Check vent hose at transfer case for kinks and proper installation. More frequent lubrication may be required on heavy-duty off-road use. A fluid loss may indicate a problem. Have it inspected and repaired at once.

Maintenance Schedule

Section C: Periodic Maintenance Inspections

Listed below are inspections and services which should be performed at least twice a year (for instance, each spring and fall). You should let your GM dealer's service department or other qualified service center do these jobs. Make sure any necessary repairs are completed at once.

INSPECTION OR SERVICE	WHAT SHOULD BE DONE
Steering, Suspension and Rear-Wheel-Drive Axle Boot and Seal Inspection	Inspect the front and rear suspension and steering system for damaged, loose or missing parts, signs of wear, or lack of lubrication. Inspect the power steering lines and hoses for proper hookup, binding, leaks, cracks, chafing, etc. Clean and then inspect the drive axle boot seals for damage, tears or leakage. Replace seals if necessary.
Exhaust System Inspection	Inspect the complete exhaust system. Inspect the body near the exhaust system. Look for broken, damaged, missing, or out-of-position parts as well as open seams, holes, loose connections, or other conditions which could cause a heat buildup in the floor pan or could let exhaust fumes into the vehicle. See the <i>Index</i> under <i>Engine Exhaust</i> .
Throttle Linkage Inspection	Inspect the throttle linkage for interference or binding, and for damaged or missing parts. Replace parts as needed.
Brake System Inspection	Inspect the complete system. Inspect brake lines and hoses for proper hook-up, binding, leaks, cracks, chafing, etc. Inspect disc brake pads for wear and rotors for surface condition. Also inspect drum brake linings for wear and cracks. Inspect other brake parts, including drums, wheel cylinders, calipers, parking brake, etc. Check parking brake adjustment. You may need to have your brakes inspected more often if your driving habits or conditions result in frequent braking. NOTE: A low brake fluid level can indicate worn disc brake pads which may need to be serviced. Also, if the brake system warning light stays on or comes on, something may be wrong with the brake system. See the <i>Index</i> under <i>Brake Systems Warning Light</i> . If your anti-lock brake system warning light stays on or comes on, something may be wrong with the anti-lock brake system. See the <i>Index</i> under <i>Anti-Lock Brake System Warning Light</i> .

Section D: Recommended Fluids & Lubricants

NOTE: Fluids and lubricants identified below by name, part number or specification may be obtained from your GM dealer.

USAGE	FLUID/LUBRICANT
Engine Oil	GM Goodwrench Motor Oil or equivalent for API service SG Energy Conserving II oils of the proper viscosity. The "SG" designation may be shown alone or in combination with others, such as "SG/CC," "SG/CD," or "SF, SG, CC," etc. To determine the preferred viscosity, see the <i>Index</i> under <i>Engine Oil</i> .
Engine Coolant	A 50/50 mixture of water (preferably distilled) and good quality ethylene glycol base antifreeze (GM Part No. 1052103 or equivalent) conforming to GM Specification 6038M.
Hydraulic Brake System	Delco Supreme II [®] Brake Fluid (GM Part No. 1052535) or equivalent DOT-3 Brake Fluid.
Parking Brake Guides	Chassis lubricant meeting requirements of NLGI Grade 2, Category LB or GC-LB (GM Part No. 12346003 or 1052497) or equivalent.
Power Steering System	GM Hydraulic Power Steering Fluid (GM Part No. 1052884) or equivalent.
Automatic Transmission	DEXRON [®] -III Automatic Transmission Fluid (GM Part No. 12345881) or equivalent.

Maintenance Schedule

Section D: Recommended Fluids & Lubricants (Cont.)

USAGE	FLUID/LUBRICANT
Locking Differential	SAE 80W-90 Gear Lubricant (GM Part No. 1052271).
Key Lock Cylinders	Lubricate with Multi-Purpose Lubricant (GM Part No. 12345120), synthetic SAE 5W-30 engine oil, or silicone lubricant (GM Part No. 1052276 or 1052277).
Automatic Transmission Shift Linkage	Engine oil.
Transfer Case	DEXRON [®] -III Automatic Transmission Fluid (GM Part No. 12345881).
Chassis Lubrication	Chassis lubricant meeting requirements of NLGI Grade 2, Category LB or GC-LB (or GM Part No. 12346003 or 1052497) or equivalent.
Windshield Washer Solvent	GM Optikleen [®] Washer Solvent (GM Part No. 1051515 or equivalent).

USAGE	FLUID/LUBRICANT
Hood Latch Assembly a. Pivots and Spring Anchor b. Release Pawl	a. Engine oil. b. Chassis lubricant meeting requirements of NLGI Grade 2, Category LB or GC-LB (GM Part No. 12346003 or 1052497) or equivalent.
Hood, door and tailgate hinges, rear folding seat, fuel door hinge, rear compartment lid hinges	Engine oil or Lubriplate Lubricant (GM Part No. 1050109).
Weatherstrips	Dielectric Silicone Grease (GM Part No. 12345579) or equivalent.
Tailgate Mounted Spare Tire Carrier (if equipped)	Multi-purpose lubricant meeting requirements of GM Part No. 12345120.

See the *Index* under *Replacement Parts* for recommended replacement filters, valves and spark plugs.

Maintenance Schedule

Section E: Maintenance Record

After the scheduled services are performed, record the date, odometer reading and who performed the service in the columns indicated. When completing the Maintenance Performed column, insert the numbers from the Schedule

I or Schedule II maintenance charts which correspond to the maintenance performed. Also, you should retain all maintenance receipts. Your owner information portfolio is a convenient place to store them.

<i>DATE</i>	<i>ODOMETER READING</i>	<i>SERVICED BY</i>	<i>MAINTENANCE PERFORMED</i>



Part 8

Customer Assistance Information

Here you will find out how to contact Oldsmobile if you need assistance. This part also tells you how to obtain service publications and how to report any safety defects.

Customer Satisfaction Procedure	282
Customer Assistance for the Hearing or Speech Impaired	283
BBB Mediation/Arbitration Program	284
Reporting Safety Defects	286
Oldsmobile Roadside Assistance Program	287
Service Publications	288

Customer Assistance Information



Customer Satisfaction Procedure

Your satisfaction and goodwill are important to your dealer and Oldsmobile. Normally, any problems with the sales transaction or the operation of your vehicle will be resolved by your dealer's Sales or Service Departments. Sometimes, however, despite the best intentions of all concerned, misunderstandings can occur. If your concern has not been resolved to your satisfaction, the following steps should be taken:

STEP ONE: Discuss your problem with a member of dealership management. Complaints can often be quickly resolved at that level. If the matter has already been reviewed with the Sales, Service or Parts Manager, contact the owner of the dealership or the General Manager.

STEP TWO: If after contacting a member of dealership management, it appears your problem cannot be resolved by the dealership without further help, contact the Oldsmobile Customer Assistance Network by calling 1-800-442-6537.

In Canada, contact GM of Canada Customer Assistance Center in Oshawa by calling 1-800-263-3777 (English) or 1-800-263-7854 (French).

In Mexico, call 254-17-86. In Puerto Rico or U.S. Virgin Islands, call 1-809-763-1315. In all other overseas locations, contact GM International Export Sales in Canada by calling 1-416-644-4112.

For prompt assistance, please have the following information available to give the Customer Assistance Representative:

- Your name, address, telephone number
- Vehicle Identification Number (This is available from the vehicle registration or title, or the plate attached to the left top of the instrument panel and visible through the windshield.)
- Dealership name and location
- Vehicle delivery date and present mileage
- Nature of problem

In order to give your inquiry prompt attention, please call the toll-free number listed above. However, if you wish to write Oldsmobile, write to:

United States

Customer Assistance Representative
Oldsmobile Central Office
920 Townsend St.
P. O. Box 30095
Lansing, MI 48909

Canada

Customer Assistance Center
General Motors of Canada Limited
Oshawa, Ontario L1H 8P7

A listing of all Oldsmobile Zone Offices and offices outside the U.S. which can assist you can also be found in the warranty booklet.

When contacting Oldsmobile, please remember that your problem will likely be resolved in the dealership, using the dealership's facilities, equipment and personnel. That is why we suggest you follow Step One first if you have a problem.

Customer Assistance For the Hearing or Speech Impaired

To assist owners who have hearing difficulties, Oldsmobile has installed special TDD (Telecommunication Devices for the Deaf) equipment in its Customer Assistance Network offices. Any hearing or speech impaired customer who has access to a TDD or a conventional teletypewriter (TTY) can communicate with Oldsmobile by dialing: 1-800-TDD-OLDS.

(TDD users in Canada can dial 1-800-263-3830.)

Customer Assistance Information

GM Participation In Better Business Bureau Mediation/Arbitration Program*

Our experience has shown that the Customer Satisfaction Procedure described earlier in this section has been very successful in achieving customer satisfaction. However, if you have not been substantially satisfied, Oldsmobile wants you to be aware of GM's voluntary participation in a no-charge mediation/arbitration program called BBB AUTO LINE. This program is administered by the Council of Better Business Bureaus through local Better Business Bureaus. The program can resolve individual disputes involving vehicle repairs and the interpretation of your New Vehicle Limited Warranty.

We prefer that you not resort to BBB AUTO LINE until after a final decision is made under the Customer Satisfaction Procedure. However, you may file a claim at any time by contacting your local Better Business Bureau (BBB) at the following toll-free number: 1-800-955-5100. For further information about filing a claim, you may also write to:

BBB AUTO LINE
Council of Better Business Bureaus
4200 Wilson Boulevard
Suite 800
Arlington, VA 22203

In order to file a claim, you will have to provide your name and address, the vehicle identification number (VIN) of your vehicle, and a statement of the nature of your complaint. BBB staff may try to help resolve your dispute through mediation. If mediation is not successful, or if you do not wish to participate in mediation, eligible customers may present their case to an impartial third-party arbitrator at an informal hearing. The arbitrator will render a decision in your case, which you may accept or reject. If you accept a valid arbitrator decision, GM will be bound by that decision. The entire dispute settlement process should ordinarily take about 40 days from the time you file your complaint to the time a

decision is rendered (or 47 days if you did not first contact your dealer or Oldsmobile).

We encourage you to use this program before or instead of resorting to the courts. We believe it offers advantages over courts in most jurisdictions because it is fast, free of charge, and informal (lawyers are not usually present, although you may retain one at your expense if you choose). Arbitrators make decisions based on the principles of fairness and equity, and are not required to duplicate the functions of courts by strictly applying state or federal law. If you wish to go to court, however, we do not require that you first file a claim with BBB AUTO LINE** unless state law provides otherwise.

Whatever your preference may be, remember that if you are unhappy with the results of BBB AUTO LINE, you can still go to court because an arbitrator's decision is binding on GM but not on you, unless you accept it.

Eligibility is limited by vehicle age/mileage and other factors. For further information concerning the program, call the BBB at 1-800-955-5100. You may also call the Oldsmobile Customer Assistance Network.

** This program may not be available in all states, depending on state law. Canadian owners refer to your warranty booklet.*

General Motors reserves the right to change eligibility limitations and/or to discontinue its participation in this program.

*** Some states may require that you file a claim with BBB AUTO LINE before resorting to state-operated procedures (including court).*

Customer Assistance Information

Reporting Safety Defects to the United States Government

If you believe that your vehicle has a defect which could cause a crash or could cause injury or death, you should immediately inform the National Highway Traffic Safety Administration (NHTSA), in addition to notifying General Motors.

If NHTSA receives similar complaints, it may open an investigation, and if it finds that a safety defect exists in a group of vehicles, it may order a recall and remedy campaign. However, NHTSA cannot become involved in individual problems between you, your dealer, or General Motors.

To contact NHTSA, you may either call the Auto Safety Hotline toll-free at 1-800-424-9393 (or 366-0123 in the Washington, D.C. area) or write to:

NHTSA
U.S. Department of Transportation
Washington, D.C. 20590

You can also obtain other information about motor vehicle safety from the Hotline.

Reporting Safety Defects to the Canadian Government

If you live in Canada, and you believe that your vehicle has a safety defect, you should immediately notify Transport Canada, in addition to notifying General Motors of Canada Ltd. You may write to:

Transport Canada
Box 8880
Ottawa, Ontario K1G 3J2

Reporting Safety Defects to General Motors

In addition to notifying NHTSA (or Transport Canada) in a situation like this, we certainly hope you'll notify us. Please call us at **1-800-442-6537**, or write:

Oldsmobile Customer
Assistance Network
P.O. Box 30095
Lansing, Michigan 48909

In Canada, please call us at 1-800-263-3777 (English) or 1-800-263-7854 (French). Or, write:

General Motors of Canada Limited
Customer Assistance Center
1908 Colonel Sam Drive
Oshawa, Ontario L1H 8P7



■ **Oldsmobile Roadside Assistance Program Features & Benefits**

The Oldsmobile Roadside Assistance program means help is just a toll-free call away—24 hours a day, 365 days a year.

Courteous and capable Customer Assistance Advisors are on-call to provide you with prompt assistance.

24-Hour Oldsmobile Roadside Assistance Number

1-800-535-OLDS (6537) is the one number to call for assistance in the United States. Trained Customer Assistance Advisors, on-call to render assistance to Oldsmobile drivers, can dispatch roadside assistance and towing service, locate the nearest Oldsmobile dealership, take your request for an Oldsmobile computerized trip routing or simply answer any questions the Oldsmobile driver may have about the coverage provided by your Oldsmobile Roadside Assistance Program. The Oldsmobile Roadside Assistance number is fully staffed and operational 24 hours a day, 365 days a year.

Who Is Covered?

Oldsmobile Roadside Assistance covers all 1993 Oldsmobile vehicles.*

Coverage is for the Oldsmobile vehicle, *regardless of the driver*, and is concurrent with the Bumper-to-Bumper Plus warranty period.

Oldsmobile reserves the right to limit services or reimbursement to an owner or driver when in Oldsmobile's judgement the claims become excessive in frequency or type of occurrence.

** Vehicles sold outside the United States do not have roadside assistance features and benefits.*

Customer Assistance Information

■ *Service Publications*

Information on how to obtain Product Service Publications, Subscriptions and Indexes as described below is applicable only in the fifty U.S. states (and the District of Columbia) and only for cars and light trucks with GVWR less than 10,000 pounds (4 536 kg).

In Canada, information pertaining to Product Service Bulletins and Indexes can be obtained by writing to:

General Motors of Canada Limited
Service Publications Department
1908 Colonel Sam Drive
Oshawa, Ontario L1H 8P7

Oldsmobile regularly sends its dealers useful service bulletins about Oldsmobile products. Oldsmobile monitors product performance in the field. We then prepare bulletins for servicing our products better. Now, you can get these bulletins too.

Bulletins cover various subjects. Some pertain to the proper use and care of your vehicle. Some describe costly repairs. Others describe inexpensive repairs which, if done on time with the latest parts, may avoid future costly repairs. Some bulletins tell a technician how to repair a new or unexpected condition. Others describe a quicker way to fix your vehicle. They can help a technician service your vehicle better.

Most bulletins apply to conditions affecting a small number of cars or trucks. Your Oldsmobile dealer or a qualified technician may have to determine if a specific bulletin applies to your vehicle.

You can subscribe to all Oldsmobile bulletins. This way you'll get them as they come out. You can wait a while and get an index to the bulletins. You can also get individual bulletins. However, you'll need the index to identify them.

Subscriptions

You can subscribe to all Oldsmobile Product Service Publications (PSP's). This will include bulletins for all vehicles sold by Oldsmobile and will not be limited to PSP's applicable to any particular model. When you buy a subscription, you will receive the PSP's in periodic mailings, shortly after they come out. A subscription costs \$100.00 U.S. and includes a special binder, and it entitles you to all PSP's published by Oldsmobile during the model year.* You can purchase a subscription by sending a check or money order to Lansing Lithographers, P.O. Box 23188, Lansing, Michigan 48909, along with the order form located in the following text.

You may get additional subscription ordering forms by calling the toll-free number shown in the following text.

**Prices subject to change.*

Individual PSP's

If you don't want to buy all the PSP's issued by Oldsmobile for all models in the model year, you can buy individual PSP's, such as those which may pertain to a particular model. To do this, you will first need to see our index of PSP's. It provides a variety of information. Here's what you'll find in the index and how you can get one:

What You'll Find in the Index

- A list of all PSP's published by Oldsmobile in a model year (1989 or later). PSP's covering all models of Oldsmobile vehicles are listed in the same index.
- Ordering information so you can buy the specific PSP's you may want.
- Price information for the PSP's you may want to buy.

Customer Assistance Information

How You Can Get an Index

Indexes are published periodically. Most of the PSP's which could potentially apply to the most recent Oldsmobile models will be listed in the most recent publication for that model year. This means you may want to wait until the end of the model year before ordering an index, if you are interested in buying PSP's pertaining to a current model year car or truck.

Some PSP's pertaining to a particular model year vehicle may be published in later years, and these would be listed in the later year's index. When you order an index for a model year that is not over yet, we'll send you the most recently published issue. Check the ordering form for indexes for earlier model years.

Cut out the ordering form, fill it out, and mail it in. We will then see to it that an index is mailed to you. There is no charge for indexes for the 1989-1993 model years.

Toll-Free Telephone Number

If you want an additional ordering form for an index or a subscription, just call toll-free and we'll be happy to send you one. Automated recording equipment will take your name and mailing address. The number to call is 1-800-551-4123.

Copies at Participating Dealers

Copies of indexes and individual PSP's are at your participating Oldsmobile dealer. You can ask to see them.

A Very Important Reminder

These PSP's are meant for technicians. They are not meant for the "do-it-yourselfer." Technicians have the equipment, tools, safety instructions, and know-how to do a job quickly and safely.

Oldsmobile Service Publications

You can get these by using the following order form. They include: Product Service Publications, Service Manuals and Owner Publications.

If the order form is missing, you can write:

Lansing Lithographers
P.O. Box 23188
Lansing, Michigan 48909

Publication Order Form

Oldsmobile Division service publications are intended for use by professional, qualified technicians. Attempting repairs or service without the appropriate training, tools, and equipment could cause injury to you or others and damage to your vehicle that may cause it not to operate properly.

Product Service Publications Indexes

(Mailed at no charge)

MODEL YEAR	QUANTITY
1993 Model Year	
1992 Model Year	
1991 Model Year	
1990 Model Year	
1989 Model Year	

Individual Product Service Publications

PSP NUMBER*	SERVICE GUILD MONTH/YEAR**	QUANTITY	EACH	SUBTOTAL
		1	\$4.00	\$4.00
			2.00	
			2.00	
			2.00	
			2.00	
			2.00	
			2.00	
			2.00	
First item per order is \$4; each additional item is \$2			SUBTOTAL	

* Orders cannot be filled without appropriate numbers. These numbers are in the PSP Index.

** No additional charge for other items from the same Service Guild issue.

Publication Order Form

Subscription Service	QUANTITY	PRICE *	SUBTOTAL
1993 Model Year with Binder		\$100.00	
1992 Model Year with Binder		100.00	
1991 Model Year with Binder		100.00	
1990 Model Year with Binder		100.00	
1989 Model Year with Binder		100.00	
Subtotal Subscription Service			
Subtotal Service Publications (From Front)			
Total Order			

* Price subject to change.

Mail Order Form and check or money order (in U.S. funds) payable to:

**Lansing Lithographers
P. O. Box 23188
Lansing, Michigan 48909**

Allow about 4 weeks for handling and mailing.

NAME (Type or Print)

STREET ADDRESS

CITY, STATE, ZIP CODE

1993 Service Manuals Order Form

Service Manuals	QUANTITY	PRICE*	SUBTOTAL
Eighty Eight/Ninety Eight		\$40.00	
Achieva		43.00	
Cutlass Ciera & Cutlass Cruiser		41.00	
Cutlass Supreme		50.00	
Silhouette		41.00	
Bravada		38.00	
Total Order			

(Includes Shipping & Handling, US order only. Foreign orders must remit U.S. funds and add \$10 for each Service Manual to cover postage and handling.)

Check here for free order form for past-model Service Manuals

* Price subject to change without prior notice.

Mail Order Form and check or money order (in U.S. funds) payable to:

Lansing Lithographers
P. O. Box 23188
Lansing, Michigan 48909

Allow about 4 weeks for handling and mailing.

NAME (Type or Print)

STREET ADDRESS

CITY, STATE, ZIP CODE

Index

- A**BS Warning Light 98
Accelerator Control System 231
Accessory Belt Drive 231
Accessory Power Outlets 79
Adding
 Automatic Transmission
 Fluid 218, 252, 254
 Brake Fluid 224, 254
 Electrical Equipment 51, 248
 Engine Coolant 219, 252, 254
 Engine Oil 210, 252, 254
 Power Steering Fluid 222, 255
 Windshield Washer
 Fluid 222
Add-On Equipment 230
Air Cleaner 214, 253
Air Conditioner 102, 231
Alcohol, Driving Under the Influence
 of 123
Alcohol in Gasoline 204
All-Wheel Drive 126
Aluminum Wheels
 Cleaning 245
Antenna 115
Antifreeze 219, 252, 254
Anti-Lock Brakes (ABS)
 Caution 128
 Using ABS 128
 Warning Light 98
Appearance Care 240
Ashtrays and Lighter 81
Audio Systems 106
 AM/FM Stereo Radio with
 Cassette Player & Equalizer ... 107
 AM/FM Stereo Radio with
 Compact Disc Player 110
 Care of Compact Discs 115
 Care of Cassette Player 114
 Radio Reception, For the Best 114
 Setting the Clock 106
Automatic Transmission
 Adding Fluid 218
 Checking Fluid 216
 Shifting 53
Battery 225
 Jump Starting 177
 Light 95, 99
Blizzard 165
Block Heater, Engine 52, 213
Blowout, Tire 190
Brake
 Adjustment 130
 Fluid 223, 254
 Master Cylinder 223
 Parking 56
 Rear Drum 130
 Replacing Brake System Parts ... 225
 Warning Light 98
 Wear Indicators 129
Brake System Warning Light 98
Brakes, Anti-Lock 128
Braking 126
Braking in Emergencies 130
Braking Technique 127
Break-In, New Vehicle 48
Buckling Up (see *Safety Belts*)
Bulb Replacement
 Fog Light 227
 Headlight 226
 Taillight 227
Bulbs, Replacement 256

Index

- C**
Capacities and Specifications 252
Carbon Monoxide in Exhaust 59
Cargo Bed Liner 83
Cassette Tape Player
 (see *Audio Systems*)
CD Player (see *Audio Systems*)
Center Passenger Position
 (see *Safety Belts*)
Chains, Tire 239
Changing a Flat Tire 191
Checking
 Brake Fluid 224
 Engine Coolant 220
 Engine Oil 210
 Power Steering Fluid 222
 Safety Belt Systems 37
 Transmission Fluid 216
Checking Things Under the Hood 207
Child Restraints 28
Children and Safety Belts 27
Cigarette Lighter 81
Circuit Breakers & Fuses 249
City Driving 155
Cleaner, Air 214, 253
Cleaning
 Aluminum Wheels 245
 Antenna 115
 Cassette Player 114
 Fabric 241
 Glass 244
 Inside of Your Vehicle 241
 Outside of Your Vehicle 244
 Safety Belts 243
 Special Problems 242
 Underbody Maintenance 247
 Vinyl or Leather 243
 Warnings 240, 241, 243, 245
 Weatherstrips 245
 White Sidewall Tires 245
 Windshield 244
Clock, Setting the 106
Clusters, Instrument Panel 86
Coin Holder 80
Comfort Controls 101
 Air Conditioner 102, 231
 Heater 102
 Ventilation 105
Compass 72
Console Storage 72, 79
Control of a Vehicle 125
Convenience Net 47
Convex Outside Mirror 78
Coolant 219
 Checking & Adding 187, 220
 Proper Mixture to Use 186, 219
 Safety Warnings
 About 219, 220
 Temperature Gage 93, 96
Cruise Control 63
Cup Holder 79
Curves, Driving on 131
Customer Assistance Information 281
D
Dead Battery: What to Do 177
Defensive Driving 122
Defogger, Rear Window 104
Defrosting 104
Dome Lights 76
Door Locks 41
Driver Position 19
Driving 117
 At Night 149
 City 155
 Controlling a Skid 135
 Defensively 122
 Drunken 123
 Freeway 156

Guidelines	136
Hill and Mountain	160
In a Foreign Country	205
In Fog, Mist and Haze	154
In the Rain	152
Long Distance	158
Loss of Control	135
Off-Road	137
On Curves	131
Passing	133
Through Deep Standing Water	51
Winter Driving	163
With a Trailer	171
Drunken Driving	123

E lectric Outside Mirror Control	78
Electrical Equipment, Adding	51, 248
Electronic Cluster	93
Emergencies, Braking in	130
Emergencies on the Road	175
Emergencies, Steering in	132
Emergency Starting	177
Emergency Towing	181
Engine Block Heater	52, 213
Engine Coolant	219

Engine Coolant Temperature	
Gage	93, 96
Engine Exhaust	59
Engine Identification	203, 248
Engine Oil	210
Additives	212
Capacity	252
Checking & Adding	210
Disposing of Used Oil	213
Energy Conserving	211
Pressure Gage	92, 94
When to Change	212
Engine Overheating	184
Engine Specifications	253
Engine, Starting	50
Ethanol in Gasoline	204
Exhaust	
Dangerous Gas in	59
Parking with the Engine Running	60
Expectant Mothers, Use of	
Safety Belts	23
Expressway Driving	156
Extender, Safety Belt	37
Exterior Appearance	
(see <i>Appearance Care</i>)	

F abric Cleaning	
(see <i>Appearance Care</i>)	
Fan Warnings	179
Filling the Fuel Tank	206
Filter	
Air Cleaner	214, 253
Fuel	253
Oil	212, 253
Flashers, Hazard Warning	176
Flat Tire	190
Flooded Engine	51
Fluid	
Brake	224, 254
Capacities	252
Power Steering	222, 255
Transmission	216, 252, 254
Windshield Washer	222, 255
Fluids & Lubricants	254
Fog, Driving in	154
Fog Lights	68
Folding Rear Seat	14
Foreign Countries, Fuels In	205
Freeway Driving	156
Front Reading Lights	76
Fuel	203
Alcohol in Fuel	204
Capacity	203, 252

Index

Exhaust Warnings	59
Filling Your Tank	206
Fuels with Alcohol	204
Gage	91
In Foreign Countries	205
Requirements	203
Fuse Panel	250
Fuses & Circuit Breakers	249

Gages

Coolant Temperature	93, 96
Fuel	91, 94
Oil Pressure	92, 94
Voltmeter	92, 95
Gasoline	203
Gasoline Tank, Filling Your	206
Gas Station Information	304
Gear Positions (see <i>Shifting the Transmission</i>)	
Gearshift Lever (see <i>Shifting the Transmission</i>)	
Glove Box	47
Graphic Equalizer (see <i>Audio Systems</i>)	

H alogen Bulbs	226
Harness, Trailer Wiring	174, 251
Hazard Warning Flashers	176
Headlight & Taillight, Removing and Replacing	226
Headlights	67
High-Low Beam Changer	68
Instrument Panel Intensity Control	68
"On" Reminder	67
Replacement Bulb	256
Wiring	251
Heater (see <i>Comfort Controls</i>)	
Heater, Engine Block	52, 213
High Beams	68, 151
Highway Hypnosis	159
Hill and Mountain Roads	160
Hills, Parking on	161
Hood Release	207
Safety Warning	208
Warning, Overheated Engine	184
Horn	60
Hot Engine, Safety Warnings	184, 185, 186, 187
Hydroplaning	153

I dentification Number, Vehicle	205, 247
Idling Your Engine	60
If You're Stuck: In Sand, Mud, Ice or Snow	199
Ignition Key	40
Positions	49
Indicator Lights (see <i>Warning Lights</i>)	
Infant Restraint (see <i>Child Restraints</i>)	
Inflation, Tires	233
Inside Rearview Mirror	76
Instrument Panel	84
Instrument Panel Clusters	86
Instrument Panel Warning Lights	97
Intensity Control	68

J ack, Tire	191
Jump Starting	177

K eys	40
--------------	----

L ane Change Indicator	62	Low Battery	177	Odometer and Trip Odometer	88, 89
Lap-Shoulder Belt	20	Low Oil Pressure Warning	92, 94	Off-Road Driving	139
Front	20, 23	Luggage Carrier	82	Oil, Engine	210
Rear	23	Lumbar Controls	13	Capacity	252
Use by Children	27	M aintenance Record	278	Disposing of Used Oil	213
Lighter	81	Maintenance Schedule	259	Pressure Gage	92, 94
Lights		Malfunction Indicator Lamp	97	Quality	211
Center Dome	76	Manual Front Seat	12	Thickness	211
Fog	68	Methanol in Gasoline	204	When to Change	212
Headlights	67	Mileage Indicator		Operating Off-Road	139
Interior	68	(see <i>Odometer</i>)		Operation of Lights	67
Reading	76	Mirrors		Outside Rearview Mirrors	78
Rear Dome	77	Convex Outside	78	Outside Temperature Display	72
Removing & Replacing		Inside Manual Day/Night	78	Overhead Console	72
Bulbs	226	Power Remote Control	78	Overheated Engine	
Replacement Bulbs	256	Visor Vanity	77	Warnings	184, 185, 186, 187
Taillights	227	Mountain Driving	160	Overheated Engine Coolant	
Turn Signal	61	N ew Vehicle "Break-In"	48	Warning	186, 187, 221
Underhood	208	Night Driving	149	P ark, Shifting Into	57
Warning	97	O ctane Requirements		Parking	
Loading Your Vehicle	138, 228	(see <i>Fuel Requirements</i>)		On Hills	161
Lock, Tailgate	45, 232			Over Things That Burn	59
Locks, Door	41, 232			With the Engine Running	58, 60
Locks, Power	42			Parking Brake	56
Long Distance Driving	158				

Index

Parking on Hills	161
Passenger Belts (see <i>Safety Belts</i>)	
Passing	133
Payload	230
Periodic Maintenance Inspections	274
Polishing and Waxing (see <i>Appearance Care</i>)	
Power Door Locks	42
Power Driver Seat	12
Power Mirrors	78
Power Outlets, Accessory	79
Power Steering	130
Power Steering Fluid	222, 255
Power Windows	61, 251
Pregnancy, Use of Safety Belts During	23
Problems on the Road	175
Publications (see <i>Service Publications</i>)	
R adiator Overheating (see <i>Overheated Engine</i>)	
Radiator Pressure Cap	185, 187, 221
Radio (see <i>Audio Systems</i>)	
Rain, Driving in the	152
Reading Lights	76

Rear Seat, Folding	14
Rear Window Defogger	104
Rear Window Wiper and Washer	71
Rearview Mirror	78
Reclining Front Seatbacks	13
Remote Lock Control	42
Replacement Bulbs	256
Replacement Fuses	250
Replacement Parts	253
Replacing Bulbs	226
Replacing Safety Belts	37
Replacing Tires	236
Replacing Wheels	238
Restraints, Child	28
Road Signs	118
Color	118
Shape	119
Symbols	120
Traffic Lights	120
Your Own Signals	121
Roads, Hill and Mountain	160
Rocking Your Vehicle	199
Rotation, Tire	235

S afety Belts	14
Adults	19
Center Passenger Position	26
Checking	37
Children	27
Child Restraints	28
Child Restraints, How to Install	29
Child Restraints, Where to Put	28
Cleaning	243
Driver Position	19
Extender	37
How to Wear	19
Lap-Shoulder Belt	20
Larger Children	35
Passenger Belts	23
Pregnancy, Use During	23
Questions & Answers	18, 21, 38
Rear Safety Belts	23
Reminder Light	19
Replacement	37
Right Front, Adult Passenger	23
Smaller Children and Babies	27
Top Strap	29
Torn	38
Twisted	22

Why You Should Wear	
Safety Belts	14
Scheduled Maintenance Services	262
Seat Adjustment	12
Seat Belts (see <i>Safety Belts</i>)	
Seat Controls	12
Lumbar Controls	12
Manual Front Seat	13
Power Front Seat	12
Rear Seat, Folding	14
Reclining Seatback	13
Service Engine Soon Light	97
Service Information	202
Service Parts Identification Label	248
Service Publications	288
Service Publications Order	
Form	291
Service Station Information	304
Setting the Clock	106
Setting the Trip Odometer	88, 89
Shifting Into Park	57
Shifting the Automatic Transmission	53
Signaling Turns	61, 121
Signs, Road	118
Skidding	135

Snowstorm, If You're	
Caught in a	165
Sockets, Accessory Power	79
Sound Equipment, Adding	106
Sound System (see <i>Audio System</i>)	
Spare Tire	192, 234
Inside-Mounted	192
Tailgate-Mounted	193, 232
Spare Tire Carrier	46, 232
Spark Plugs	253
Specifications and Capacities	252
Speed Control (see <i>Cruise Control</i>)	
Speedometer	88, 89
Stains, Removing	242
Starting Your Engine	50
Starting Your Vehicle if the Battery	
is "Dead" (see <i>Jump Starting</i>)	
Steering	
In Emergencies	132
Off-Road Recovery	133
Tips	131
Steering Wheel, Tilt	61
Stereo Sound System	
(see <i>Audio System</i>)	
Storage	
Console	79

Cup Holder	79
Door Compartment/	
Coin Holder	80
Garage Door Opener	74
Glove Box	47
Luggage Carrier	82
Overhead	75
Sunglasses	75
Storing Your Vehicle	225
Stuck, If You Are	199
Sun Visors	77

T achometer	90
Tailgate	45
Tape Player (see <i>Audio Systems</i>)	
Technical Facts & Specifications	
Bulbs	256
Electrical Equipment, Add-On	248
Fluid Capacities & Types	252, 254
Fuses & Circuit Breakers	249
Service Parts Identification	
Label	248
Vehicle Identification Number	
(VIN)	205, 247

Temperature Warning	93, 96
Theft	44
Thermostat	221
Tilt Steering Wheel	61
Time, Setting the	106
Tires	233
Blow Out	190
Buying New	236
Chains	239
Flat, Changing	191
Inflation	234
Inspection & Rotation	235
Loading	233
Pressure	234
Quality Grading	237
Spare	192, 233
Wear Indicators	235
Wheel Alignment & Tire Balance	238
Wheel Nut Torque	198, 252
Wheel Replacement	238
When to Replace Wheels	238
Winter Driving	148
Top Strap	29
Torque Lock	163
Towing a Trailer	167

Towing Your Bravada	181
Traffic Lights	120
Trailer Towing	167, 230
Trailer Wiring Harness	174, 251
Trailering Package	230
Transmission, Automatic (see <i>Automatic Transmission</i>)	
Trip Odometer	88, 89
Turn Signal and Lane Change Indicator	62
Turn Signal/Headlight Beam Lever	61
Cruise Control	63
Headlight High-Low Beam Changer	68
Turn & Lane Change Indicator	62
Turn Signal Indicator	62
Windshield Washer	70
Windshield Wipers	69

U nderhood Light	208
Unleaded Gasoline	203
Upholstery Care	241
Urban Driving	155

V ehicle Identification Number (VIN)	205, 247
Vehicle Loading	138, 228
Vehicle Storage	225
Ventilation	105
VIN	205, 247
Visor Vanity Mirror	77
Voltmeter	92, 95

W arning Flashers, Hazard	176
Warning Lights	
Anti-Lock Brake System	98
Battery	95, 99
Brake	98
Check Gages	99
Coolant Temperature	96
Oil Pressure	94
Malfunction Indicator Lamp (Service Engine Soon)	97
Washer, Windshield	70
Weight (GVWR)	228
Wheel Alignment & Tire Balance	238
Wheel Nut Torque	198, 252

Wheel Replacement	236
Window, Tailgate	45
Windows, Power	61
Windshield Washer	70
Fluid	70, 222, 255
Windshield Wiper	
Replacement	228
Windshield Wipers	69, 251
Winter Driving	163
If Your Vehicle is Stuck in	
Deep Snow	166
If You're Caught in a	
Blizzard	165
Wiper/Washer, Rear Window	71
Wiring Harness, Trailer	174, 251
Wrecker Towing	181

Service Station Information

