

# OLD SMOBILE



1994 SILHOUETTE  
OWNER'S MANUAL







## Table of Contents

	<i>The Heritage of Oldsmobile . . . . .</i>	<i>3</i>
	<i>How to Use this Manual . . . . .</i>	<i>6</i>
<b>Part 1</b>	<i>Seats &amp; Restraint Systems . . . . .</i>	<i>11</i>
<b>2</b>	<i>Features &amp; Controls . . . . .</i>	<i>43</i>
<b>3</b>	<i>Comfort Controls &amp; Audio Systems . . . . .</i>	<i>109</i>
<b>4</b>	<i>Your Driving and the Road . . . . .</i>	<i>131</i>
<b>5</b>	<i>Problems on the Road . . . . .</i>	<i>157</i>
<b>6</b>	<i>Service &amp; Appearance Care . . . . .</i>	<i>181</i>
<b>7</b>	<i>Maintenance Schedule . . . . .</i>	<i>231</i>
<b>8</b>	<i>Customer Assistance Information . . . . .</i>	<i>249</i>
	<i>Includes "Reporting Safety Defects" on page 252</i>	
<b>9</b>	<i>Index . . . . .</i>	<i>263</i>
	<i>Service Station Information . . . . .</i>	<i>Last Page</i>

## **Important Notes About this Manual**

Please keep this manual in your Oldsmobile, so it will be there if you ever need it when you're on the road. If you sell the vehicle, please leave this manual in it so the new owner can use it.

This manual includes the latest information at the time it was printed. We reserve the right to make changes in the product after that time without further notice.

Published by  
**Oldsmobile Division**  
General Motors Corporation  
920 Townsend Street  
Lansing, Michigan 48921

The word *Oldsmobile* and the Oldsmobile rocket emblem are registered trademarks of General Motors Corporation.

The word *Delco* is a registered trademark of General Motors Corporation.



## The Heritage of Oldsmobile

Engineering with a purpose. It's at the heart of every Oldsmobile. Your new Oldsmobile continues a 97-year tradition of engineering excellence.

That tradition was born in Lansing, Michigan, on August 21, 1897, whenansom E. Olds began building a horseless carriage "in as nearly a perfect manner as possible." Soon, Oldsmobiles rolled off the nation's first assembly line.

Innovation and refinement have always set Oldsmobiles apart. In 1939, Oldsmobile introduced the celebrated Hydra-Matic transmission, a four-speed forerunner of today's advanced systems. In 1948, the high-spirited Rocket V8 engine set standards for performance.



1941

1931

## A Step Ahead

In 1966, Toronado made front-wheel-drive news, including Motor Trend's "Car of the Year." Still breaking new ground, the 1974 "Toro" became the first car equipped with a production "air bag."

Recent Oldsmobile engineering has created exciting advancements like the responsive Quad 4 engine. Versions of the 4-cylinder, 16-valve Quad 4 propelled Oldsmobiles on roads and racetracks to new standards of economy and performance.

Today, the all-wheel-drive security of SmartTrak in the Oldsmobile Bravada continues that proud tradition of meaningful technology.

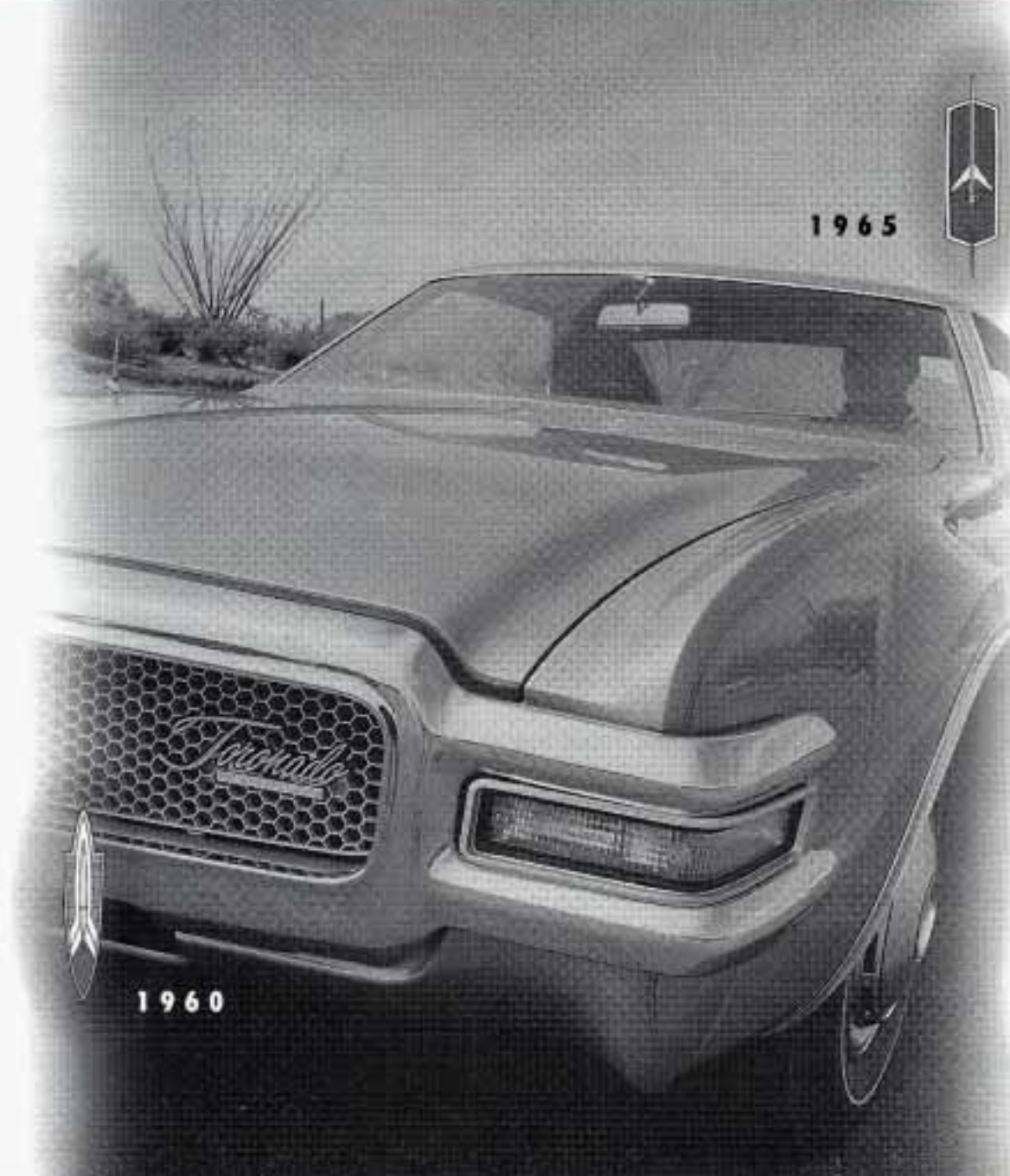





## The Security of Owner Satisfaction

---

The quality we built into your new Oldsmobile gives us the confidence to back it with the Oldsmobile Edge—the

most comprehensive owner satisfaction program in the industry. The Edge gives you 24-hour roadside assistance,

Bumper-to-Bumper Warranty

protection, even free transportation while your vehicle is in for warranty service. With the Oldsmobile Edge, we've pledged to make your ownership experience a great one.



J. D. Rock

General Manager

## How to Use this Manual

MANY PEOPLE READ THEIR OWNER'S manual from beginning to end when they first receive their new vehicle. This will help you learn about the features and controls for your vehicle. In this manual, you'll find that pictures and words work together to explain things quickly.

There are nine parts with thumb-tabbed pages in this manual. Each part begins with a brief list of contents, so you can usually tell at a glance if that part contains the information you want.

You can bend the manual slightly to reveal the tabs that help you find a part.

### **Part 1: Seats & Restraint Systems**

This part tells you how to use your seats and safety belts properly.

### **Part 2: Features & Controls**

This part explains how to start and operate your Oldsmobile.

### **Part 3: Comfort Controls & Audio Systems**

This part tells you how to adjust the ventilation and comfort controls and how to operate your audio system.

### **Part 4: Your Driving and the Road**

Here you'll find helpful information and tips about the road and how to drive under different conditions.

### **Part 5: Problems on the Road**

This part tells you what to do if you have a problem while driving, such as a flat tire or engine overheating.

**Part 6: Service & Appearance Care**

Here the manual tells you how to keep your Oldsmobile running properly and looking good.

**Part 7: Maintenance Schedule**

This part tells you when to perform vehicle maintenance and what fluids and lubricants to use.

**Part 8: Customer Assistance Information**

This part includes important information about reporting safety defects and gives you details about the "Roadside Assistance" program. You will also find customer satisfaction phone numbers (including customer satisfaction numbers for the hearing and speech impaired) as well as the mediation/arbitration procedure. We've also included ordering information for service publications in this part.

**Part 9: Index**

Here's an alphabetical listing of almost every subject in this manual. You can use it to quickly find something you want to read.

**Service Station Information:**

This is a quick reference of service information. You can find it on the last page of this manual.

## How to Use this Manual

### ***Safety Warnings and Symbols***

You will find a number of safety cautions in this book. We use a box with gray background and the word CAUTION to tell you about things that could hurt you if you were to ignore the warning.

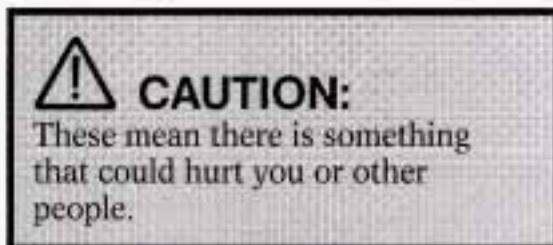

In the gray caution area, we tell you what the hazard is. Then we tell you what to do to help avoid or reduce the hazard. Please read these cautions. If you don't, you or others could be hurt.

You will also find a circle with a slash through it in this book. This safety symbol means:

*Don't*  
*Don't do this*  
*Don't let this happen*



### ***Vehicle Damage Warnings***

Also, in this book you will find these notices:

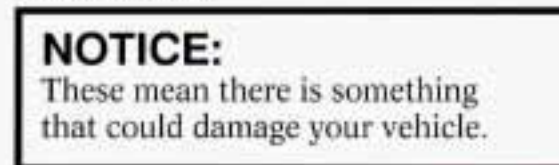

In the notice area, we tell you about something that can damage your vehicle. Many times, this damage would not be covered by your warranty, and it could be costly. But the notice will tell you what to do to help avoid the damage.

When you read other manuals, you might see CAUTION and NOTICE warnings in different colors or in different words.

You'll also see warning labels on your vehicle. They use yellow for cautions, blue for notices and the words CAUTION or NOTICE.



## Vehicle Symbols

These are some of the symbols you will find on your vehicle. For example, these symbols are used on an original battery:

<i>Caution Possible Injury</i>	
<i>Protect Eyes by Shielding</i>	
<i>Caustic Battery Acid Could Cause Burns</i>	
<i>Avoid Sparks or Flames</i>	
<i>Spark or Flame Could Explode Battery</i>	

These symbols are important for you and your passengers whenever your vehicle is driven:

<i>Fasten Safety Belts</i>	
<i>Air Bag(s)</i>	
<i>Door Lock/Unlock</i>	
<i>Liftgate Ajar</i>	
<i>Sliding Door Ajar</i>	

These symbols have to do with your lights:

<i>Master Lighting Switch</i>	
<i>Turn Signal Direction</i>	
<i>Hazard Warning Flashers</i>	
<i>Headlight High Beam</i>	
<i>Parking Lights</i>	
<i>Fog Lights</i>	
<i>Reading Lights</i>	

## How to Use this Manual

These symbols are on some of your controls:

*Windshield Wipers*



*Windshield Washer*



*Windshield Defroster*



*Rear Window Defogger*

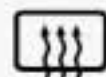

*Rear Window Wiper*



*Rear Window Washer*



*Ventilating Fan*



*Power Window*



These symbols are used on warning and indicator lights:

*Engine Coolant Temperature*



*Battery Charging System*



*Fuel*



*Engine Oil Pressure*



*Brake*



*Anti-Lock Brakes*



Here are some other symbols you may see:

*Fuse*



*Lighter*



*Horn*



*Speaker*



*Hood Release*





**Here you'll find information about the seats in your Oldsmobile and how to use your safety belts properly. You can also learn about some things you should not do with safety belts.**

## *Part 1*

### *Seats & Restraint Systems*

Seats and Seat Controls.....	12
Removing and Replacing Rear Seats.....	15
Safety Belts.....	18
How to Wear Safety Belts Properly.....	22
Driver Position.....	22
Supplemental Restraint System (Air Bag).....	26
Safety Belt Use During Pregnancy.....	30
Right Front Passenger Position.....	30
Rear Seat Passengers.....	30
Children.....	34
Smaller Children and Babies.....	34
Child Restraints.....	35
Larger Children.....	39
Safety Belt Extender.....	41
Replacing Safety Belts After a Crash.....	41

# Seats & Restraint Systems

## ■ *Seats and Seat Controls*

This section tells you about the seats—how to adjust them, take them out, put them back in, and fold them up and down.

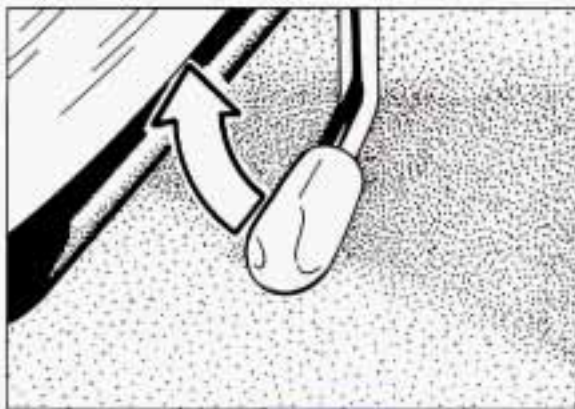

### **Manual Front Seats**

Pull up the lever on the front of the seat to unlock it. Slide the seat to where you want it. Then release the lever and try to move the seat with your body, to make sure the seat is locked into place.



### **Four-Way Manual Seat**

The driver's seat can be adjusted four ways.

Use the lever on the front of the seat to adjust the seat forward or back (see *Manual Front Seats* earlier in this section).

To raise the driver's seat, pull up the lever on the side of the seat. To lower the seat, push the lever down.



**⚠ CAUTION:**

You can lose control of the vehicle if you try to adjust a manual driver's seat while the vehicle is moving. The sudden movement could startle and confuse you, or make you push a pedal when you don't want to. Adjust the driver's seat only when the vehicle is not moving.

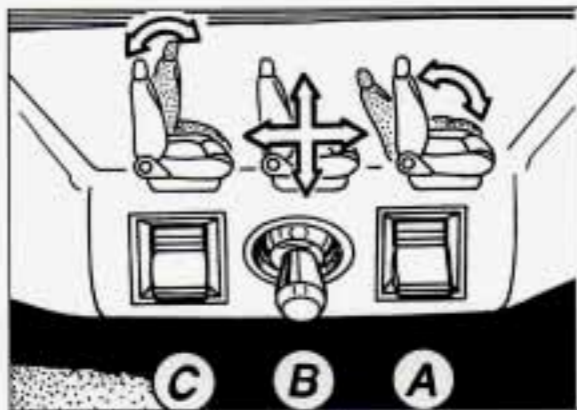

**Six-Way Power Seat (OPTION)**

To adjust the driver's six-way power seat:

**Front Control (A):** Raise the front of the seat by holding the switch up. Hold the switch down to lower the front of the seat.

**Center Control (B):** Move the seat forward or back by holding the control to the front or back. Raise or lower the seat by holding the control up or down.

**Rear Control (C):** Raise the rear of the seat by holding the switch up. Hold the switch down to lower the rear of the seat.



**Reclining Front Seatbacks**

To adjust the seatback, rotate this knob. But don't have a seatback reclined if your vehicle is moving.

# Seats & Restraint Systems



## **CAUTION:**

Sitting in a reclined position when your vehicle is in motion can be dangerous. Even if you buckle up, your safety belts can't do their job when you're reclined like this. The shoulder belt can't do its job because it won't be against your body. Instead, it will be in front of you. In a crash you could go into it, receiving neck or other injuries.

The lap belt can't do its job either. In a crash the belt could go up over your abdomen. The belt forces

**CAUTION (Continued)**

## **CAUTION (Continued)**

would be there, not at your pelvic bones. This could cause serious internal injuries.

For proper protection when the vehicle is in motion, have the seatback upright. Then sit well back in the seat and wear your safety belt properly.



## **Head Restraints**

Slide the head restraint up or down so that the top of the restraint is closest to the top of your ears.

This position reduces the chance of a neck injury in a crash.





### **Removable Rear Bucket Seats**

There are three types of rear bucket seats: **RIGHT ONLY**, **CENTER OR LEFT**, and **LEFT ONLY**. **RIGHT ONLY** and **LEFT ONLY** seats may be equipped with the built-in child restraint option.

The rear bucket seats can be removed to provide extra storage. Each seat that has the built-in child restraint option fits in only one location in your vehicle, but seats that don't have the built-in child restraint can be moved to different floor locations. The back of each seat has a diagram (similar to the one above) that shows where the seat must be located in your vehicle.

**RIGHT ONLY** seats that don't have the built-in child restraint fit only in the right locations. **LEFT ONLY** seats that don't have the built-in child restraint fit only in the left locations. The **CENTER OR LEFT** seat fits in the center location and in either left location.

**RIGHT ONLY** seats that have the built-in child restraint option fit only in the rear set of floor pins in the right location of the second row. **LEFT ONLY** seats that have the built-in child restraint option fit only in the rear set of floor pins in the left location of the second row.

To install third row seats, the second row seats must be tilted forward or removed. Don't put the seats in the wrong locations.



### **Entry to Third Row Bucket Seats**

The **RIGHT ONLY** seats have a lower lever to tilt the seat forward. To get into third row seats, push back the lower lever on the **RIGHT ONLY** seat nearest the sliding door and tilt the seat forward. Then pull the seat back and check that it locks into place.

# Seats & Restraint Systems

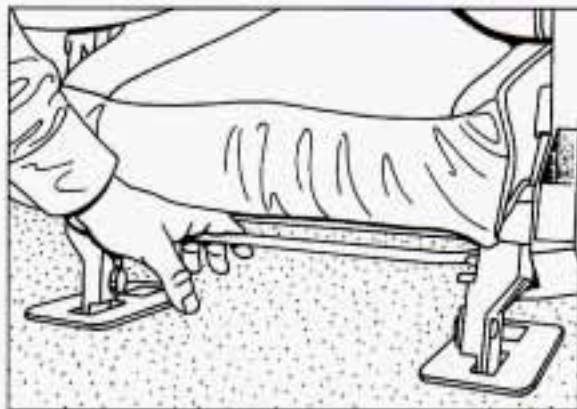

To get out of the third row seats, push down on the rear release bar under the seat ahead of you to tilt the seat forward.

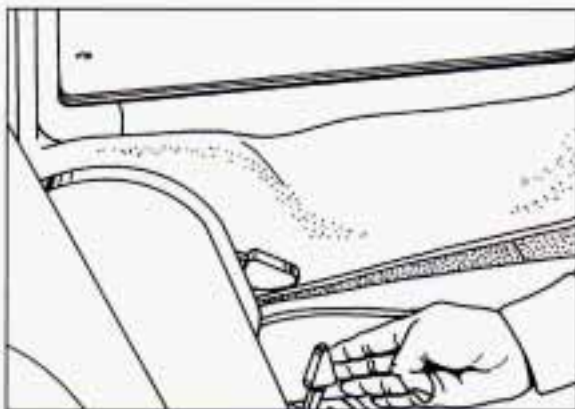

## **Removing Rear Bucket Seats** **Removing the RIGHT ONLY Seats:**

1. Lift the upper lever to fold the seatback forward.
2. Push the lower lever back so the entire seat and seatback tilt forward.

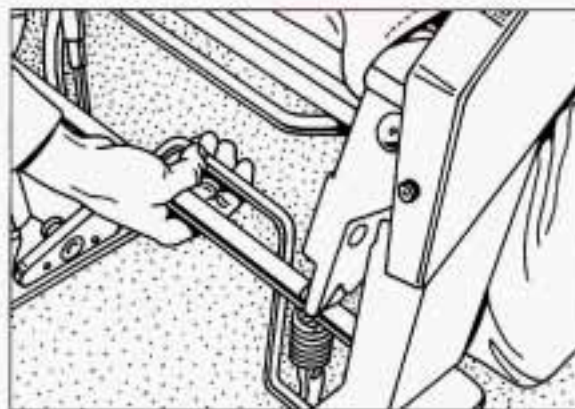

3. Then, from behind the seat, squeeze the front release bar toward the crossbar. The seat will release from the floor pins.

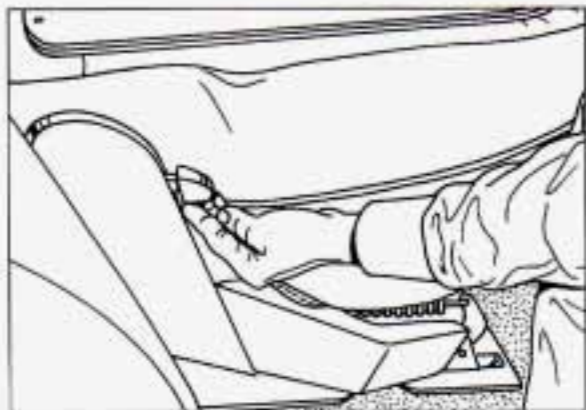

### Removing LEFT ONLY and CENTER OR LEFT Seats:

1. Lift the upper lever to fold the seatback forward.

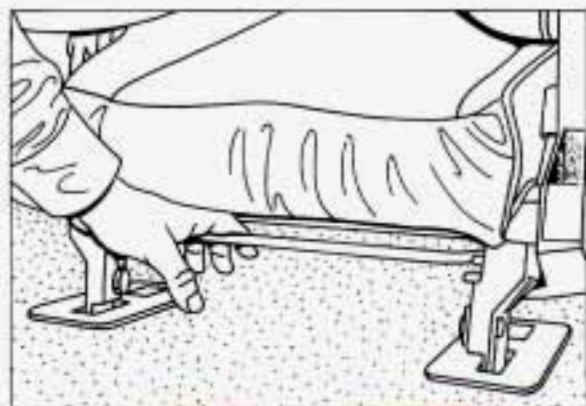

2. Push down on the rear release bar. The entire seat will tilt forward.

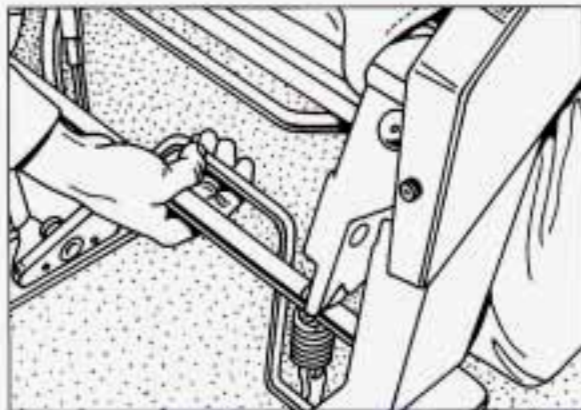

3. Then, from behind the seat, squeeze the front release bar toward the crossbar. The seat will release from the floor pins.

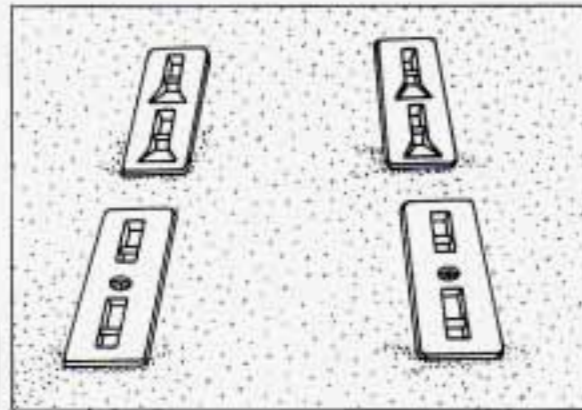

### Adjusting Rear Seats

Each rear seat location has two sets of floor pins. Seats equipped with the built-in child restraint option must be secured in the rear set of floor pins. Seats that don't have the built-in child restraint can be secured in either set of floor pins. Move the position of these seats up or back to provide a little more room behind or in front of a seat.



# Seats & Restraint Systems

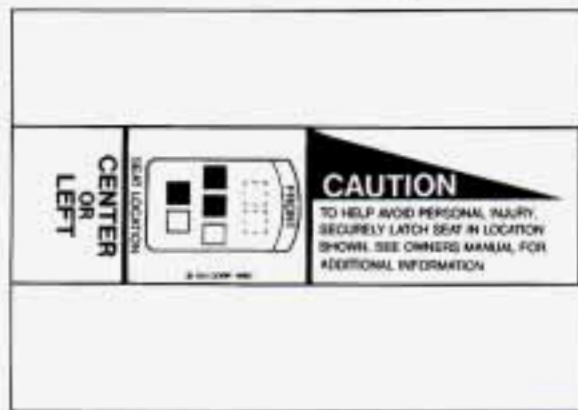

## Replacing Rear Bucket Seats

Follow the diagram on the back of the seats to replace the seats in their proper location.

See *Removable Rear Bucket Seats* earlier in this part.

Don't try to place the seats in backward, because they won't latch that way.

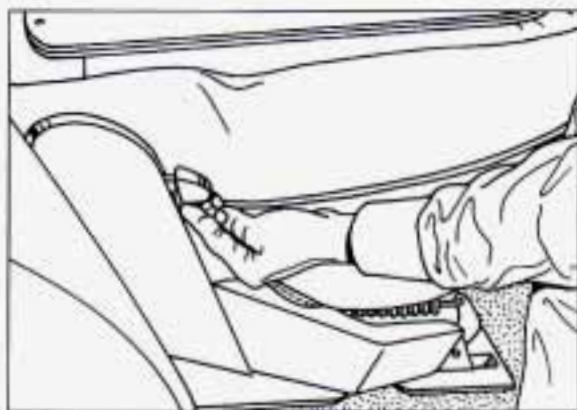

1. With the entire seat tilted forward, place the front hooks of the seat latch onto the front floor pins.
2. Firmly press the rear hooks onto the rear floor pins. The seat should lock into position.
3. Lift the upper lever and pull up on the seatback until it locks upright.
4. Push and pull on the seat to check that it is locked.
5. Check to see that you have put the seats into the proper location, according to the label on each seat. If not, the seats may not latch properly, and your passengers may not have the proper safety belt.

## ■ Safety Belts: They're For Everyone

This part of the manual tells you how to use safety belts properly. It also tells you some things you should not do with safety belts.

And it explains the Supplemental Restraint System, or "air bag" system.



### CAUTION:

Don't let anyone ride where they can't wear a safety belt properly. If you are in a crash and you're not wearing a safety belt, your injuries can be **much** worse. You can hit things inside the vehicle or be ejected from it. You can be seriously injured or killed. In the same crash, you might not be if you are buckled up. Always fasten your safety belt, and check that your passengers' belts are fastened properly too.



This figure lights up as a reminder to buckle up. (See *Safety Belt Reminder Light* in the *Index*.)

In many states and Canadian provinces, the law says to wear safety belts. Here's why: **They work.**



You never know if you'll be in a crash. If you do have a crash, you don't know if it will be a bad one.

A few crashes are mild, and some crashes can be so serious that even buckled up a person wouldn't survive. But most crashes are in between. In many of them, people who buckle up can survive and sometimes walk away. Without belts they could have been badly hurt or killed.

After more than 25 years of safety belts in vehicles, the facts are clear. In most crashes buckling up does matter... a lot!



### **Why Safety Belts Work**

When you ride in or on anything, you go as fast as it goes.

1. For example, if the bike is going 10 mph (16 km/h), so is the child.

# Seats & Restraint Systems

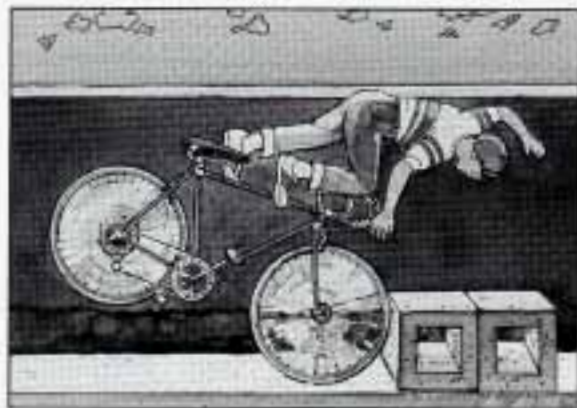

2. When the bike hits the block, it stops. But the child keeps going!

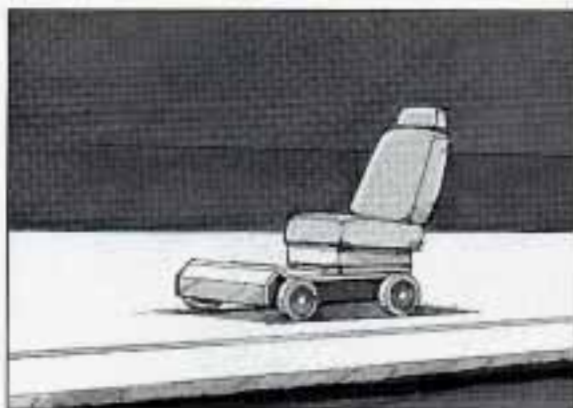

3. Take the simplest vehicle. Suppose it's just a seat on wheels.



4. Put someone on it.

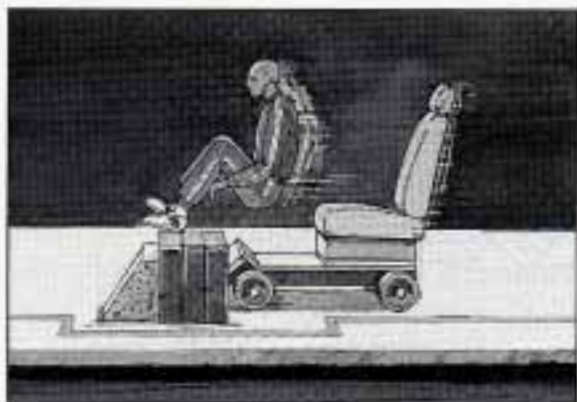

5. Get it up to speed. Then stop the vehicle. The rider doesn't stop.



6. The person keeps going until stopped by something.

In a real vehicle, it could be the windshield...



7. or the instrument panel...





8. or the safety belts!

With safety belts, you slow down as the vehicle does. You get more time to stop. You stop over more distance, and your strongest bones take the forces. That's why safety belts make such good sense.

## ■ *Here Are Questions Many People Ask About Safety Belts — and the Answers*

**Q: Won't I be trapped in the vehicle after an accident if I'm wearing a safety belt?**

**A:** You **could** be — whether you're wearing a safety belt or not. But you can easily unbuckle a safety belt, even if you're upside down. And your chance of being conscious during and after an accident, so you **can** unbuckle and get out, is **much** greater if you are belted.

**Q: Why don't they just put in air bags so people won't have to wear safety belts?**

**A:** Air bags, or Supplemental Restraint Systems, are in some vehicles today and will be in more of them in the future. But they are supplemental systems only — so they work **with** safety belts, not instead of them. Every air bag system ever offered for sale has required the use of safety

belts. Even if you're in a vehicle that has air bags, you still have to buckle up to get the most protection. That's true not only in frontal collisions, but especially in side and other collisions.

**Q: If I'm a good driver, and I never drive far from home, why should I wear safety belts?**

**A:** You may be an excellent driver, but if you're in an accident — even one that isn't your fault — you and your passengers can be hurt. Being a good driver doesn't protect you from things beyond your control, such as bad drivers. Most accidents occur within 25 miles (40 km) of home. And the greatest number of serious injuries and deaths occur at speeds of less than 40 mph (65 km/h).

Safety belts are for everyone.

# Seats & Restraint Systems

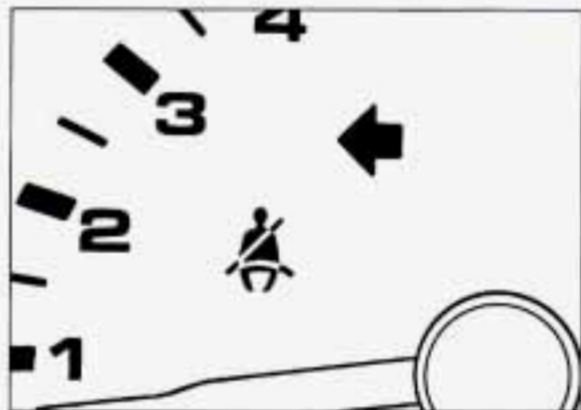

## **Safety Belt Reminder Light**

When the key is turned to **Run** or **Start**, a chime will come on for about eight seconds to remind people to fasten their safety belts, unless the driver's safety belt is already buckled. The safety belt light will also come on and stay on until the driver's belt is buckled.

## ■ **How To Wear Safety Belts Properly**

### **Adults**

This section is only for people of adult size.

Be aware that there are special things to know about safety belts and children. And there are different rules for smaller children and babies. If a child will be riding in your Oldsmobile, see the section after this one, called *Children*. Follow those rules for everyone's protection.

First, you'll want to know which restraint systems your vehicle has. We'll start with the driver position.

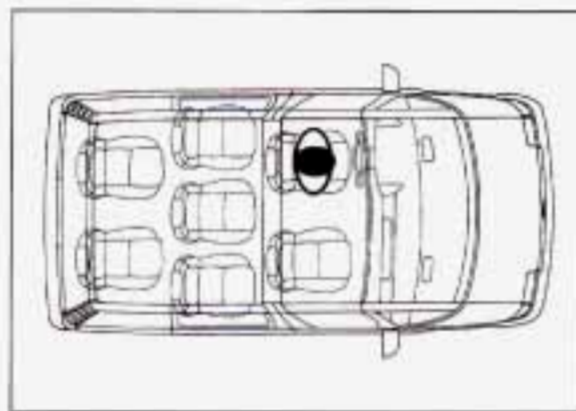

## ■ **Driver Position**

This section describes the driver's restraint system.



### **Lap-Shoulder Belt**

The driver has a lap-shoulder belt. Here's how to wear it properly.

1. Close and lock the door.
2. Adjust the seat (to see how, see *Seats* in the *Index*) so you can sit up straight.



3. Pick up the latch plate and pull the belt across you. Don't let it get twisted.
4. Push the latch plate into the buckle until it clicks.



If the belt stops before it reaches the buckle, tilt the latch plate and keep pulling until you can buckle the belt.

Pull up on the latch plate to make sure it is secure.

If the belt isn't long enough, see *Safety Belt Extender* at the end of this section.

Make sure the release button on the buckle is positioned so you would be able to unbuckle the safety belt quickly if you ever had to.



# Seats & Restraint Systems



5. To make the lap part tight, pull down on the buckle end of the belt as you pull up on the shoulder belt.

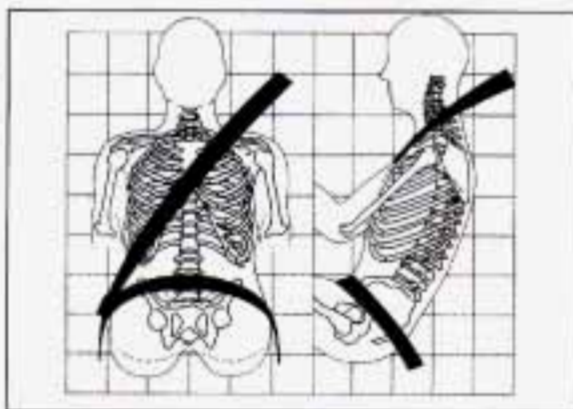

The lap part of the belt should be worn low and snug on the hips, just touching the thighs. In a crash, this applies force to the strong pelvic bones. And you'd be less likely to slide under the lap belt. If you slid under it, the belt would apply force at your abdomen. This could cause serious or even fatal injuries. The shoulder belt should go over the shoulder and across the chest. These parts of the body are best able to take belt restraining forces.

The safety belt locks if there's a sudden stop or a crash.

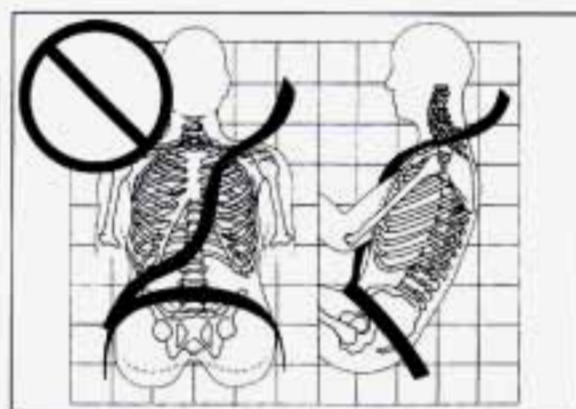

**Q: What's wrong with this?**

**A:** The shoulder belt is too loose. It won't give nearly as much protection this way.



## **CAUTION:**

You can be seriously hurt if your shoulder belt is too loose. In a crash you would move forward too much, which could increase injury. The shoulder belt should fit against your body.



**Q: What's wrong with this?**

**A:** The belt is buckled in the wrong place.

 **CAUTION:**

You can be seriously injured if your belt is buckled in the wrong place like this. In a crash, the belt would go up over your abdomen. The belt forces would be there, not at the pelvic bones. This could cause serious internal injuries. Always buckle your belt into the buckle nearest you.

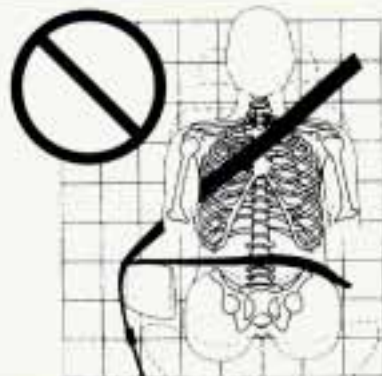

**Q: What's wrong with this?**

**A:** The belt is over an armrest.

 **CAUTION:**

You can be seriously injured if your belt goes over an armrest like this. The belt would be much too high. In a crash, you can slide under the belt. The belt force would then be applied at the abdomen, not at the pelvic bones, and that could cause serious or fatal injuries. Be sure the belt goes under the armrests.

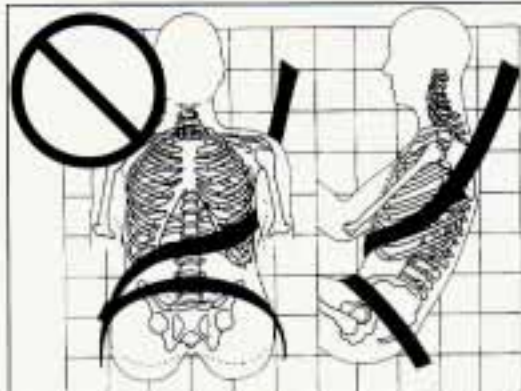

**Q: What's wrong with this?**

**A:** The shoulder belt is worn under the arm. It should be worn over the shoulder at all times.

 **CAUTION:**

You can be seriously injured if you wear the shoulder belt under your arm. In a crash, your body would move too far forward, which would increase the chance of head and neck injury. Also, the belt would apply too much force to the ribs, which aren't as strong as shoulder bones. You could also severely injure internal organs like your liver or spleen.



# Seats & Restraint Systems

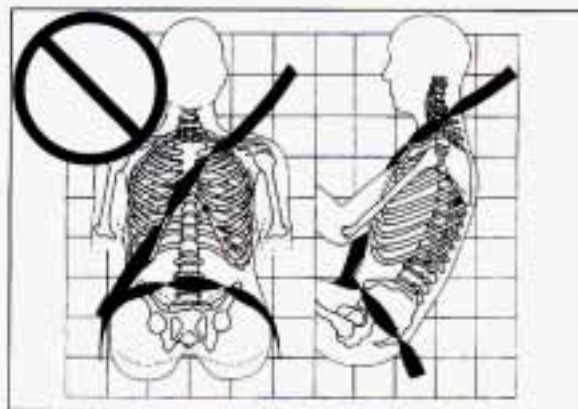

**Q: What's wrong with this?**

**A:** The belt is twisted across the body.



## **CAUTION:**

You can be seriously injured by a twisted belt. In a crash, you wouldn't have the full width of the belt to spread impact forces. If a belt is twisted, make it straight so it can work properly, or ask your dealer to fix it.



To unlatch the belt, just push the button on the buckle. The belt should go back out of the way.

Before you close the door, be sure the belt is out of the way. If you slam the door on it, you can damage both the belt and your vehicle.

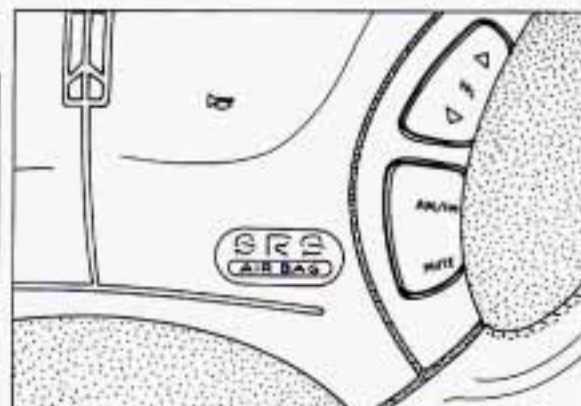

## ■ **Supplemental Restraint System (SRS)**

This section explains the driver's Supplemental Restraint System (SRS), commonly referred to as an air bag. Here are the most important things to know:



 **CAUTION:**

Even with an air bag, if you're not wearing a safety belt and you're in a crash, your injuries may be much worse. Air bags are not designed to inflate in rollovers or in rear, side or low-speed frontal crashes. You need to wear your safety belt to reduce the chance of hitting things inside the vehicle or being ejected from it. Always wear your safety belt, even with an air bag.

 **CAUTION:**

Air bags inflate with great force, faster than the blink of an eye. If you're too close to an inflating air bag, it could seriously injure you. Safety belts help keep you in position for an air bag inflation in a crash. Always wear your safety belt, even with an air bag, and sit as far back as you can while still maintaining control of your vehicle.

 **CAUTION:**

When an air bag inflates, there is dust in the air. This dust could cause breathing problems for people with a history of asthma or other breathing trouble. To avoid this, everyone in the vehicle should get out as soon as it is safe to do so. If you have breathing problems but can't get out of the vehicle after an air bag inflates, then get fresh air by opening a window or door.

 **CAUTION:**

Don't put anything on, or attach anything to, the driver air bag. Also, don't put anything (such as pets or objects) between the driver and the driver air bag. If something is between an occupant and an air bag, it could affect the performance of the air bag, or, worse, it could cause injury.



### *Air Bag Readiness Light*

There is an air bag readiness light on the instrument panel, which shows **AIR BAG**. The system checks for electrical malfunctions, and the light tells you if there is a problem.

You will see this light flash for a few seconds when you turn your ignition to **Run** or **Start**. Then the light should go out, which means the system is ready.

Remember, if the air bag readiness light doesn't come on when you start your vehicle, or stays on, or comes on when you are driving, your air bag system may not work properly. Have your vehicle serviced right away.

# Seats & Restraint Systems



## **How The Air Bag System Works**

### **Where is the air bag?**

The driver's air bag is in the middle of the steering wheel.

### **When is an air bag expected to inflate?**

The air bag is designed to inflate in moderate to severe frontal or near-frontal crashes. The air bag will only inflate if the velocity of the impact is above the designed threshold level.

When impacting straight into a wall that does not move or deform, the threshold level for most GM vehicles is between 9 and 15 mph (14 and 23 km/h).

However, this velocity threshold depends on the vehicle design and may be several miles-per-hour faster or

slower. In addition, this threshold velocity will be considerably higher if the vehicle strikes an object such as a parked car which will move and deform on impact. The air bag is also not designed to inflate in rollovers, side impacts, or rear impacts where the inflation would provide no occupant protection benefit.

In any particular crash, the determination of whether the air bag should have inflated cannot be based solely on the level of damage on the vehicle(s). Inflation is determined by the angle of the impact and the vehicle's deceleration, of which vehicle damage is only one indication. Repair cost is not a good indicator of whether an air bag should have deployed.

### **What makes an air bag inflate?**

In a frontal impact of sufficient severity, the air bag sensing system detects that the vehicle is suddenly stopping as a result of a crash. The sensing system triggers a chemical reaction of the sodium azide sealed in the inflator. The reaction produces nitrogen gas, which inflates the cloth bag. The inflator, cloth bag, and related hardware are all part of

the air bag inflator module packed inside the steering wheel.

### **How does an air bag restrain?**

In moderate to severe frontal or near-frontal collisions, even belted occupants can contact the steering wheel. The air bag supplements the protection provided by safety belts. Air bags distribute the force of the impact more evenly over the occupant's upper body, stopping the occupant more gradually. But air bags would not provide protection in many types of collisions, including rollovers and rear and side impacts, primarily because an occupant's motion is not toward the air bag. Air bags should never be regarded as anything more than a supplement to safety belt protection in moderate to severe frontal and near-frontal collisions.

### **What will you see after an air bag inflation?**

After the air bag has inflated, it will then quickly deflate. This occurs so quickly that some people may not even realize that the air bag inflated. Some components of the air bag module in



the steering wheel hub may be hot for a short time, but the portion of the bag that comes into contact with you will not be hot to the touch. There will be small amounts of smoke and dust coming from vents in the deflated air bag. The air bag will **not** impede the driver's vision or ability to steer the vehicle, nor will it hinder the occupants from exiting the vehicle.

- The air bag is designed to inflate only once. After it inflates, you'll need some new parts for your air bag system. If you don't get them, the air bag system won't be there to help protect you in another crash. A new system will include the air bag module and possibly other parts. The service manual has information about the need to replace other parts.
- Your vehicle is equipped with a diagnostic module, which records information about the air bag system if the air bag deploys during a crash. The module records information about the readiness of the system, which sensors activated the deployment, and whether the driver's safety belt was in use.

- Let only qualified technicians work on your air bag system. Improper service can mean that your air bag system won't work properly. See your dealer for service.

### **NOTICE:**

If you damage the cover for the driver's air bag, it may not work properly. You may have to replace the air bag on the steering wheel. Do not open or break the air bag cover.

### **Is the smoke from an air bag inflation harmful?**

The particles emitted during air bag inflation are not harmful to most people. Some people with respiratory ailments may experience difficulty breathing if they stay in the vehicle with the windows closed after air bag inflation. So, if your air bag inflates, you and any passengers should exit the vehicle if and when it is safe to do so. If you or your passengers can't get out of the vehicle, try to get fresh air by opening a window, turning on the fan, or opening a door.

## ***Servicing Your Oldsmobile with the Air Bag System***

The air bag affects how your Oldsmobile should be serviced. There are parts of the air bag system in several places around your vehicle. You don't want the system to inflate while someone is working on your vehicle. Your Oldsmobile dealer and the 1994 Silhouette Service Manual have information about servicing your vehicle and the air bag system. The air bag system does not need regular maintenance.



### **CAUTION:**

For up to 2 minutes after the ignition key is turned off and the battery is disconnected, an air bag can still inflate during improper service. You can be injured if you are close to an air bag when it inflates. Avoid wires wrapped with yellow tape, or yellow connectors. They are probably part of the air bag system. Be sure to follow proper service procedures, and make sure the person performing work for you is qualified to do so.

# Seats & Restraint Systems



## ■ *Safety Belt Use During Pregnancy*

Safety belts work for everyone, including pregnant women. Like all occupants, they are more likely to be seriously injured if they don't wear safety belts.

A pregnant woman should wear a lap-shoulder belt, and the lap portion should be worn as low as possible throughout the pregnancy.

The best way to protect the fetus is to protect the mother. When a safety belt is worn properly, it's more likely that the fetus won't be hurt in a crash. For pregnant women, as for anyone, the key to making safety belts effective is wearing them properly.

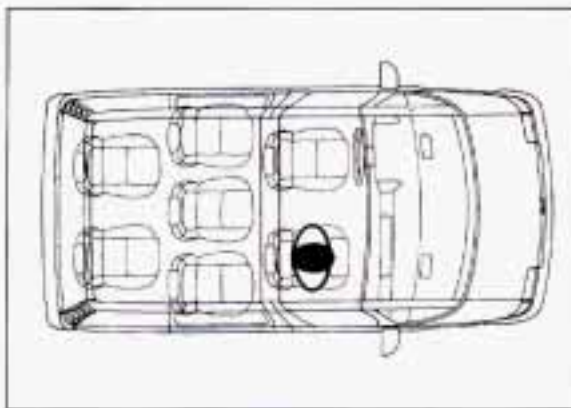

## ■ *Right Front Passenger Position*

The right front passenger's safety belt works the same way as the driver's safety belt. See *Driver Position*, earlier in this part.

## ■ *Rear Seat Passengers*

It's very important for rear seat passengers to buckle up! Accident statistics show that unbelted people in the rear seat are hurt more often in crashes than those who are wearing safety belts.

Rear passengers who aren't safety belted can be thrown out of the vehicle in a crash. And they can strike others in the vehicle who are wearing safety belts.

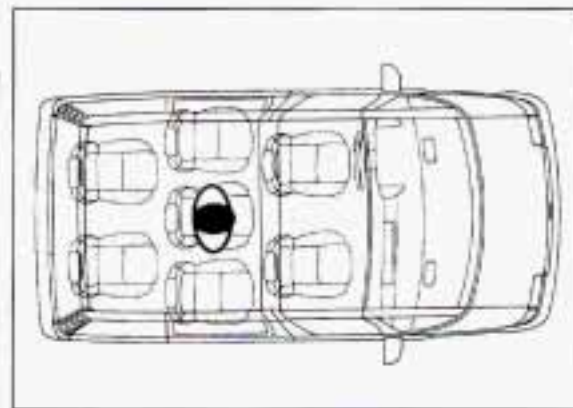

## Center Passenger Position Lap Belt

Someone can sit in the center position bucket seat.

When you sit in the center position bucket seat, you have a lap safety belt which has a retractor.





1. Pick up the latch plate and, in a single motion, pull the belt across you. Don't let it get twisted.
2. Push the latch plate into the buckle until it clicks. If the belt stops before it reaches the buckle, let it go back all the way and start again. Pull up on the latch plate to make sure it is secure.
3. Feed the lap belt into the retractor to tighten it.



4. Position and release it the same way as the lap part of a lap-shoulder belt. If the belt isn't long enough, see *Safety Belt Extender* at the end of this section. Make sure the release button on the buckle is positioned so you would be able to unbuckle the safety belt quickly if you ever had to.

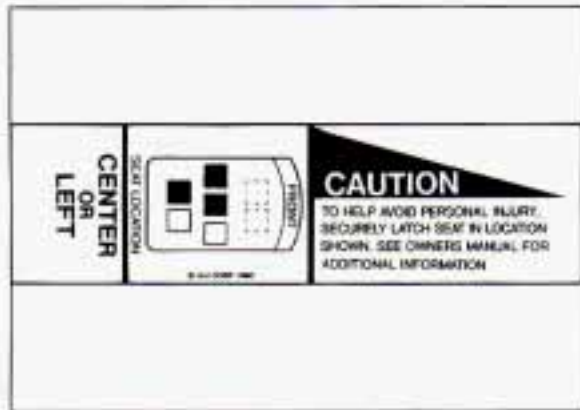

The center position bucket seat is a **CENTER OR LEFT** type seat. Because it is the only bucket seat with a lap belt, and has a buckle on only one side, there are certain places a **CENTER OR LEFT** type bucket seat should, and should not, be used. See *Seats* in the *Index*. If the **CENTER OR LEFT** bucket seat is used on the left side of the vehicle, the person sitting there should use the lap-shoulder belt. It works the same way as the driver's safety belt. See *Driver Position* in the *Index*.

# Seats & Restraint Systems

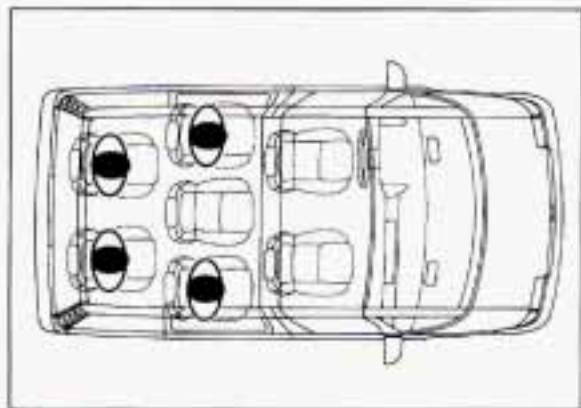

## **Rear Seat Outside Passenger Positions**

### **Lap-Shoulder Belt**

The positions next to the windows have lap-shoulder belts. Here's how to wear one properly.



1. Pick up the latch plate and pull the belt across you. Don't let it get twisted.
2. Push the latch plate into the buckle until it clicks.



If the belt stops before it reaches the buckle, tilt the latch plate and keep pulling until you can buckle it.

Pull up on the latch plate to make sure it is secure.

If the belt is not long enough, see *Safety Belt Extender* at the end of this section. Make sure the release button on the buckle is positioned so you would be able to unbuckle the safety belt quickly if you ever had to.



3. To make the lap part tight, pull down on the buckle end of the belt as you pull up on the shoulder part.

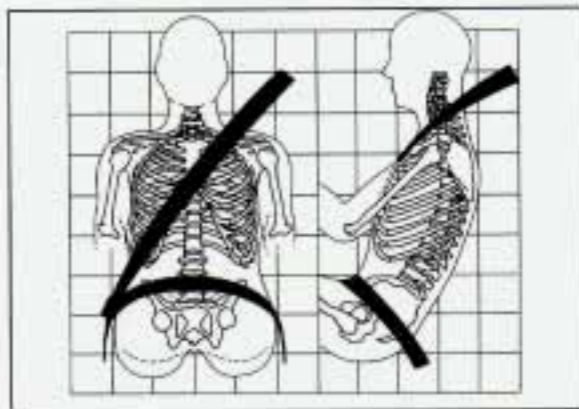

The lap part of the belt should be worn low and snug on the hips, just touching the thighs. In a crash, this applies force to the strong pelvic bones. And you'd be less likely to slide under the lap belt. If you slid under it, the belt would apply force at your abdomen. This could cause serious or even fatal injuries. The shoulder belt should go over the shoulder and across the chest. These parts of the body are best able to take belt restraining forces.

The safety belt locks if there's a sudden stop or a crash.



#### **CAUTION:**

You can be seriously hurt if your shoulder belt is too loose. In a crash you would move forward too much, which could increase injury. The shoulder belt should fit against your body.



# Seats & Restraint Systems



To unlatch the belt, just push the button on the buckle.



## ■ Children

Everyone in a vehicle needs protection! That includes infants and all children smaller than adult size. In fact, the law in every state in the United States and in every Canadian province says children up to some age must be restrained while in a vehicle.

## Smaller Children and Babies



### CAUTION:

Smaller children and babies should always be restrained in a child or infant restraint. The instructions for the restraint will say whether it is the right type and size for your child. A very young child's hip bones are so small that a regular belt might not stay low on the hips, as it should. Instead, the belt will likely be over the child's abdomen. In a crash the belt would apply force right on the child's abdomen, which could cause serious or fatal injuries. So, be sure that any child small enough for one is always properly restrained in a child or infant restraint.





**⚠ CAUTION:**

Never hold a baby in your arms while riding in a vehicle. A baby doesn't weigh much — until a crash. During a crash a baby will become so heavy you can't hold it. For example, in a crash at only 25 mph (40 km/h), a 12-pound (5.5 kg) baby will suddenly become a 240-pound (110 kg) force on your arms. The baby would be almost impossible to hold.

**CAUTION (Continued)**



**CAUTION (Continued)**

Secure the baby in an infant restraint.

■ ***Built-In Child Restraint***

**(OPTION)**

If you have a rear bucket seat with the optional built-in child restraint, see the Owner's Manual Supplement that came with your vehicle for information on use and appearance care. To find out where a seat that has the built-in child restraint must be located in your vehicle, see *Removable Rear Bucket Seats* in the *Index*.

■ ***Child Restraints***

Be sure to follow the instructions for the restraint. You may find these instructions on the restraint itself or in a booklet, or both. These restraints use the belt system in your vehicle, but the child also has to be secured within the restraint to help reduce the chance of personal injury. The instructions that come with the infant or child restraint will show you how to do that.

# Seats & Restraint Systems

## Where to Put the Restraint

Accident statistics show that children are safer if they are restrained in the rear rather than the front seat. We at General Motors therefore recommend that you put your child restraint in the rear seat unless the child is an infant and you're the only adult in the vehicle. In that case, you might want to secure the restraint in the front seat where you can keep an eye on the baby.

Wherever you install it, be sure to secure the child restraint properly.

Keep in mind that an unsecured child restraint can move around in a collision or sudden stop and injure people in the vehicle. Be sure to properly secure any child restraint in your vehicle — even when no child is in it.



## Top Strap

If your child restraint has a top strap, it should be anchored.



Anchor brackets for the second row outside positions are located just above the place where the third row lap-shoulder belts meet the floor. There's a vinyl sleeve there; to get to the bracket, push this vinyl sleeve aside slightly. Anchor the top strap to the bracket.

If you need to have an anchor bracket installed for any additional passenger seat position, you can ask your Oldsmobile dealer to put it in for you. If you want to install an anchor bracket yourself, your dealer can tell you how to do it.

Once you have the top strap anchored, you'll be ready to secure the child restraint itself.



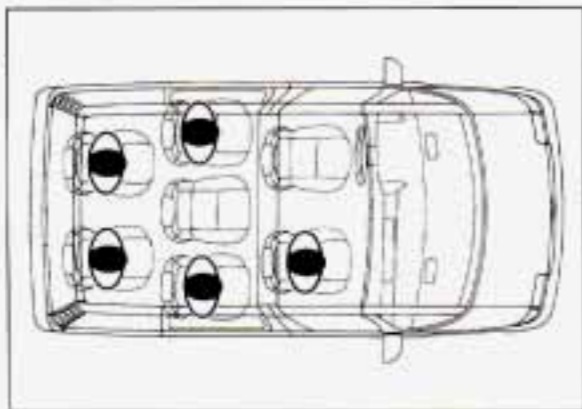

### **Securing a Child Restraint in an Outside Position**

You'll be using the lap-shoulder belt. See the earlier section about the top strap if the child restraint has one.

1. Put the restraint on the seat. Follow the instructions for the child restraint.
2. Secure the child in the child restraint as the instructions say.
3. Pick up the latch plate, and run the lap and shoulder portions of the vehicle's safety belt through or around the restraint. The child restraint instructions will show you how. Tilt the latch plate to adjust the belt if needed. If the shoulder belt goes in front of the child's face or neck, put it behind the child restraint.



4. Buckle the belt. Make sure the release button is positioned so you would be able to unbuckle the safety belt quickly if you ever had to.



5. To tighten the belt, pull up on the shoulder belt while you push down on the child restraint.



6. Push and pull the child restraint in different directions to be sure it is secure.

To remove the child restraint, just unbuckle the vehicle's safety belt and let it go back all the way. The safety belt will move freely again and be ready to work for an adult or larger child passenger.



# Seats & Restraint Systems

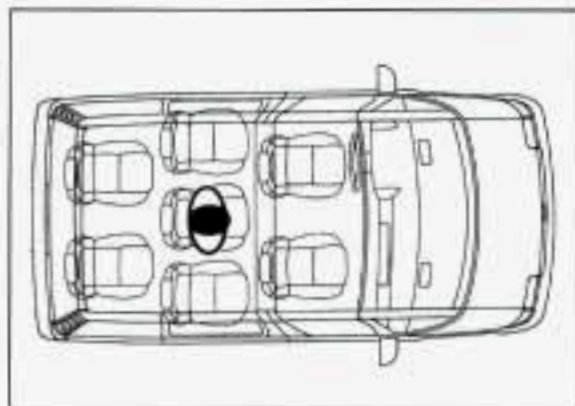

## **Securing a Child Restraint in the Center Seat Position**

You'll be using the lap belt. See the earlier section about the top strap if the child restraint has one.

1. Put the restraint on the seat. Follow the instructions for the child restraint.
2. Secure the child in the child restraint as the instructions say.



3. Pull the lap belt all the way out without stopping.
4. While holding it out, run the belt through or around the child restraint. The child restraint instructions will show you how.



5. Buckle the belt. Make sure the release button is positioned so you would be able to unbuckle the safety belt quickly if you ever had to.



6. To tighten the belt, feed it back into the retractor while you push down on the child restraint.



7. Push and pull the child restraint in different directions to be sure it is secure.

To remove the child restraint, just unbuckle the vehicle's safety belt and let it go back all the way. The safety belt will move freely again and be ready to work for an adult or larger child passenger.



### **Larger Children**

Children who have outgrown child restraints should wear the vehicle's safety belts.

If you have the choice, a child should sit next to a window so the child can wear a lap-shoulder belt and get the additional restraint a shoulder belt can provide.

Accident statistics show that children are safer if they are restrained in the rear seat. But they need to use the safety belts properly.

- Children who aren't buckled up can be thrown out in a crash.

# Seats & Restraint Systems

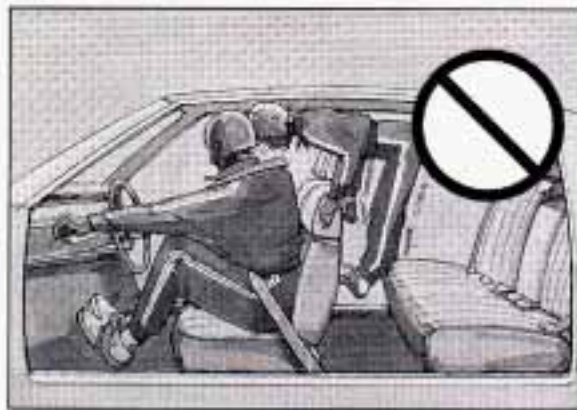

- Children who aren't buckled up can strike other people who are.



## CAUTION:

Never do this. Here two children are wearing the same belt. The belt can't properly spread the impact forces. In a crash, the two children can be crushed together and seriously injured. A belt must be used by only one person at a time.

**Q:** What if a child is wearing a lap-shoulder belt, but the child is so small that the shoulder belt is very close to the child's face or neck?

**A:** Move the child toward the center of the vehicle, but be sure that the shoulder belt still is on the child's

shoulder, so that in a crash the child's upper body would have the restraint that belts provide. If the child is so small that the shoulder belt is still very close to the child's face or neck, you might want to place the child in a seat that has a lap belt, if your vehicle has one.





### CAUTION:

Never do this. Here a child is sitting in a seat that has a lap-shoulder belt, but the shoulder part is behind the child. If the child wears the belt in this way, in a crash the child might slide under the belt. The belt's force would then be applied right on the child's abdomen. That could cause serious or fatal injuries.

Wherever the child sits, the lap portion of the belt should be worn low and snug on the hips, just touching the child's thighs. This applies belt force to the child's pelvic bones in a crash.

### ■ *Safety Belt Extender*

If the vehicle's safety belt will fasten around you, you should use it.

But if a safety belt isn't long enough to fasten, your dealer will order you an extender. It's free. When you go in to order it, take the heaviest coat you will wear, so the extender will be long enough for you. The extender will be just for you, and just for the seat in your vehicle that you choose. Don't let someone else use it, and use it only for the seat it is made to fit. To wear it, just attach it to the regular safety belt.

### ■ *Checking Your Restraint Systems*

Now and then, make sure all your belts, buckles, latch plates, retractors, anchorages and reminder systems are working properly. Look for any loose parts or damage. If you see anything that might keep a restraint system from doing its job, have it repaired.

### ■ *Replacing Safety Belts After a Crash*

If you've had a crash, do you need new belts?

After a very minor collision, nothing may be necessary. But if the belts were stretched, as they would be if worn during a more severe crash, then you need new belts.

If belts are cut or damaged, replace them. Collision damage also may mean you will need to have safety belt or seat parts repaired or replaced. New parts and repairs may be necessary even if the belt wasn't being used at the time of the collision.

# Seats & Restraint Systems

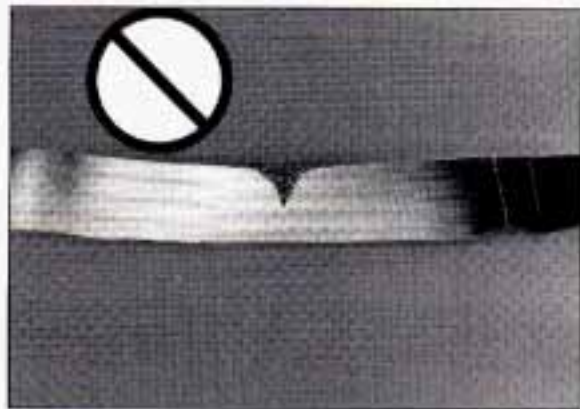

**Q: What's wrong with this?**

**A:** The belt is torn.

Torn or frayed belts may not protect you in a crash. They can rip apart under impact forces. If a belt is torn or frayed, get a new one right away.

Before replacing any safety belt, see your dealer for the correct part number. You'll need the model year and model number for your vehicle. The model year is on your title and registration. And you can find the model number on the Certification/Tire label of your vehicle. See *Certification/Tire Label* in the *Index*.

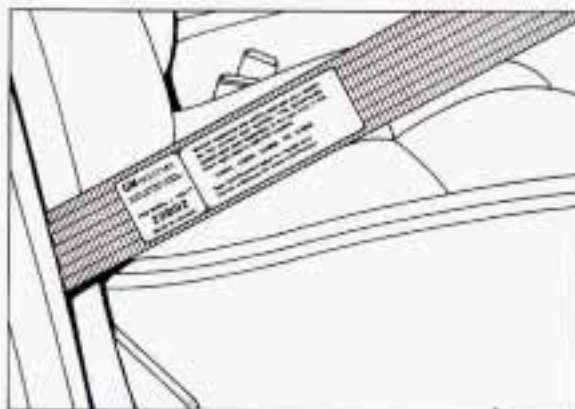

The model number on the replacement belt must be listed on the safety belt you want to replace. Pull the shoulder belt all the way out to see this label.

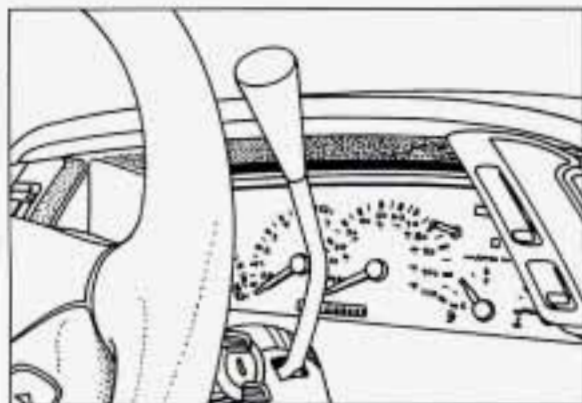

Here you can learn about the many standard and optional features on your Oldsmobile, and information on starting, shifting and braking. Also explained are the instrument panel and the warning systems that tell you if everything is working properly — and what to do if you have a problem.

## Part 2

### Features & Controls

Keys .....	44
Front Doors .....	45
Locks.....	45
Remote Lock Control.....	48
Sliding Door .....	51
Liftgate.....	56
Ignition .....	58
Starting Your Engine .....	58
Engine Coolant Heater.....	61
Shifting the Transaxle.....	62
Parking Brake.....	65
Shifting into Park.....	66
Horn.....	69
Tilt Steering Wheel.....	69
Windows .....	69
Turn Signal and Lane Change Indicator .....	71
Cruise Control .....	72
Headlights.....	74
Interior Lights .....	76
Windshield Wipers .....	77
Windshield Washer .....	78
Mirrors.....	86
Glove Box and Storage Compartments.....	88
Luggage Carrier.....	92
Instrument Panel.....	96
Warning Lights, Gages and Indicators.....	100



# Features & Controls



## ■ Keys



### CAUTION:

Leaving young children in a vehicle with the ignition key is dangerous for many reasons. A child or others could be badly injured or even killed. They could operate power windows or other controls or even make the vehicle move. Don't leave the keys in a vehicle with young children.

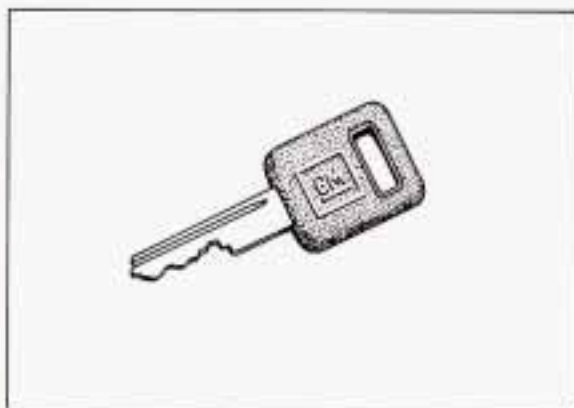

The ignition keys are for the ignition only.



The door keys are for the doors and all other locks.

When a new vehicle is delivered, the dealer removes the plugs from the keys and gives them to the first owner.

Each plug has a code on it that tells your dealer or a qualified locksmith how to make extra keys. Keep the plugs in a safe place. If you lose your keys, you'll be able to have new ones made easily using these plugs.

### NOTICE:

Your Oldsmobile has a number of new features that can help prevent theft. But you can have a lot of trouble getting into your vehicle if you ever lock your keys inside. You may even have to damage your vehicle to get in. So be sure you have extra keys.



### ■ *Front Doors*

 **CAUTION:**

Pay attention when you open or close these doors from the outside. Stay clear of the upper rear corner to avoid hitting your head.

### ■ *Door Locks*

 **CAUTION:**

Unlocked doors can be dangerous. Passengers — especially children — can easily open the doors and fall out. When a door is locked, the inside handle won't open it.

Outsiders can easily enter through an unlocked door when you slow down or stop your vehicle.

This may not be so obvious: You increase the chance of being thrown out of the vehicle in a crash if the doors aren't locked. Wear safety belts properly, lock your doors, and you will be far better off whenever you drive your vehicle.



There are several ways to lock and unlock your vehicle.

#### **From the Outside:**

Use your door key or remote lock control transmitter, if your vehicle has this option.

## Features & Controls

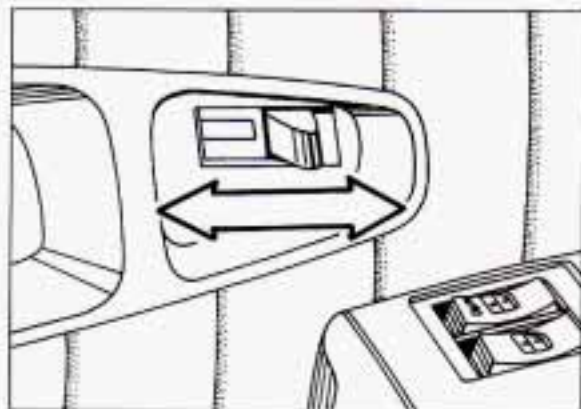

### From the Inside:

To lock the door, slide the locking lever rearward.

To unlock the door, slide the locking lever forward.

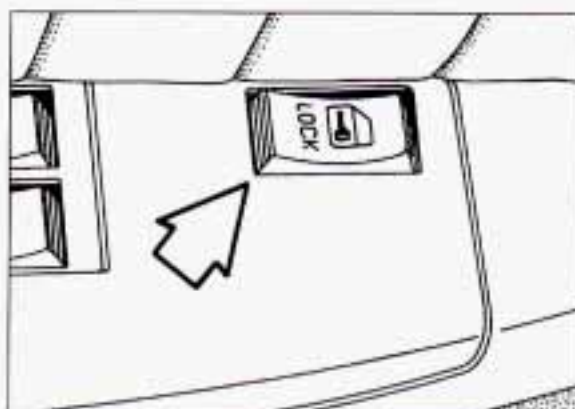

### Power Door Locks (OPTION)

From the outside of either front door, the door key unlocks all doors and the liftgate. From the inside, press the front of the power door lock switch on either front door.

You can lock all doors and the liftgate from inside by pressing the rear of the power lock switch on either front door.

If you have the optional remote lock control system, your vehicle has a special security feature. If the driver's door is open and your key is in the ignition in the **Off** position, you won't be able to set the door locks with the power door lock switch or the remote transmitter. This feature is designed to help keep you from locking your keys in your vehicle.

If the sliding door is open when you press the power door locks switch, it will lock automatically within five seconds after you close it.

If you have the optional remote lock control system, this feature will be replaced by a different lock delay system. See *Remote Lock Control* later in this section.

With power locks, when the doors are locked, the inside as well as the outside door latch release cannot open the doors. This safety feature prevents a door from being accidentally opened from the inside by moving the handle.

To override this safety feature, slide the locking lever to the unlock position on the door you want to open.

When the liftgate has been unlocked with the power door locks, you won't need the key to open it. Simply turn the lock clockwise until the latch releases. This is also true if you use the optional remote lock control transmitter. See *Remote Lock Control* later in this section.

To lock the liftgate, use either the power door lock switch or the optional



remote lock control transmitter, or lock it manually by turning the lock counterclockwise.

### **Automatic Door Locks (OPTION)**

With this feature you can unlock all of the doors from the outside by holding the key in the unlock position for one second. To unlock only the driver's or passenger's door, turn the key to the unlock position and release.

From the inside, when the ignition is on and the driver's door is closed, all doors will lock each time you move the shift lever out of **P** (Park). If the passenger door or the liftgate are open when you move the shift lever out of **P** (Park), they will lock when closed.

If the sliding door is open when you move the shift lever out of **P** (Park), a lock delay feature allows the sliding door to lock five seconds after it is closed. All other doors will lock again, too.

With the automatic door locks feature, you can still lock or unlock the doors at any time, either manually or with the power door lock switches.

### **Overriding Lock Delay**

To override the lock delay feature, press the front of the power door locks switch (the unlock position) while the shift lever is in **P** (Park).

If you have the remote lock control system, there are three additional ways you can disable the lock delay feature (see *Remote Lock Control* later in this section):

- Press the unlock symbol on your remote transmitter.
- Return the shift lever to **P** (Park), or
- Turn the ignition off.

### **Customizing Your Automatic Door Locks Feature**

With the remote lock control system you can customize your automatic door locks feature to suit your individual needs. (See *Remote Lock Control* later in this section.)

With the doors closed and the ignition on, press and hold the driver's power door lock switch in the lock position for ten seconds. The doors will lock, then unlock, indicating that you have ten seconds in which to program one of four custom modes.

- To program the automatic door locks system to unlock only the driver's door when the shift lever is returned to **P** (Park), press the unlock symbol on your remote transmitter once. The driver's door will unlock, indicating that this mode has been successfully programmed.
- To program the automatic door locks system to unlock all doors when the shift lever is returned to **P** (Park), press the unlock symbol on your remote transmitter once (the driver's door will unlock), then press the unlock symbol again. All doors will unlock, indicating that this mode has been successfully programmed.
- To program the automatic door locks system to leave all doors locked when the shift lever is returned to **P** (Park), press the lock symbol on your remote transmitter once. All doors will lock, indicating that this mode has been successfully programmed.
- To disengage the automatic door locks system, press the lock symbol on your remote transmitter once (all doors will lock). Then press the lock symbol again. All doors will lock

# Features & Controls

again, indicating that this mode has been successfully programmed.

You can reprogram the automatic door locks system at any time. If you do not program the automatic door locks system, all doors will remain locked when the shift lever is returned to **P** (Park).

If you have more than one remote transmitter for your vehicle, your automatic door locks system will operate as programmed with any of them. There is no need to program each one individually.

## Leaving Your Vehicle

If you are leaving the vehicle, open your door and set the locks from inside. Then get out and close the door.

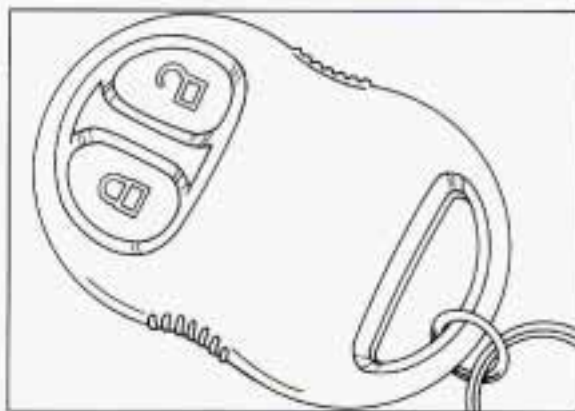

## ■ Remote Lock Control (OPTION)

If your Oldsmobile has this option, you can lock and unlock your doors and liftgate from up to 30 feet (9 m) away using the key chain transmitter supplied with your vehicle.

Your remote lock control operates on a radio frequency subject to Federal Communications Commission (FCC) Rules.



This device complies with Part 15 of the FCC Rules. Operation is subject to the following two conditions: (1) This device may not cause harmful interference, and (2) This device must accept any interference received, including interference that may cause undesired operation.

Should interference to this system occur, try this:

- Check to determine if battery replacement is necessary. See the instructions on battery replacement.
- Check the distance. You may be too far from your vehicle. This product has a maximum range.
- Check the location. Other vehicles or objects may be blocking the signal.
- See your Oldsmobile dealer or a qualified technician for service.

Changes or modifications to this system by other than an authorized service facility could void authorization to use this equipment.

## Operation

The driver's door will unlock and the interior lights will go on when  is pressed (see *Illuminated Entry System* later in this section). If pressed again within five seconds, all doors and the liftgate will unlock. All doors and the liftgate will lock when  is pressed.

If the driver's door is open and your key is in the ignition in the **Off** position,



you won't be able to set the door lock with the power door lock switch or the remote transmitter. This security feature is designed to help keep you from locking your keys in your vehicle.

### Lock Delay

The lock delay feature can be operated using either the remote key chain transmitter or the power door locks switch (see *Power Door Locks* earlier in this section).

For the lock delay feature to work, the ignition and the interior lights control to the left of the instrument panel cluster must be off.

If any door is open when you press  or the rear of either power door lock switch, a chime will sound three times. This indicates that all doors and the liftgate will lock about five seconds after the last door has been closed.



To override the lock delay feature, press the lock symbol or the rear of either power door lock switch again, and the doors and liftgate will lock immediately.

To cancel the lock delay feature, press the unlock symbol or the front of either power door lock switch.



### Remote Operation of Power Sliding Door

If you have the optional power sliding door (see *Power Sliding Door* later in this section), your remote transmitter will have a third button labeled . Press it to open or close the sliding door.

If the sliding door is locked, first press  twice to unlock all doors, then press  to open the sliding door.

You can operate the power sliding door with the remote transmitter only when the power sliding door enable switch on the overhead console is in the **ON** position.

### Matching Transmitter(s) To Your Vehicle

Each key chain transmitter is coded to prevent another transmitter from unlocking your vehicle. If a transmitter is lost or stolen, a replacement can be purchased through your dealer. Remember to bring the remaining transmitters with you when you go to your dealer. When the dealer matches the replacement transmitter to your vehicle, the remaining transmitters must also be matched. Once the new transmitter is coded, the lost transmitter will not unlock your vehicle.

You can match a transmitter to as many different vehicles as you own, provided they are equipped with **exactly the same model system**. (General Motors offers several different models of these systems on their vehicles.) Each vehicle can have up to four transmitters matched to it.

See your dealer to match transmitters to another vehicle.



# Features & Controls

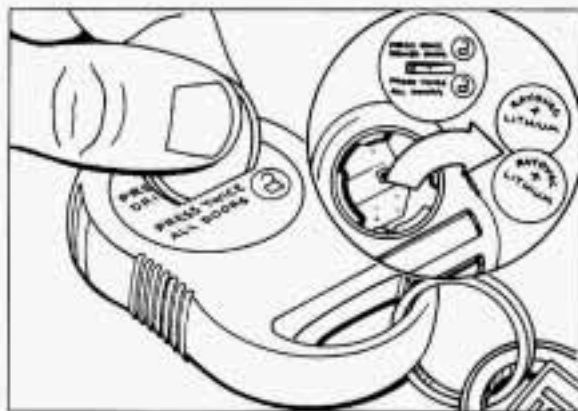

## Battery Replacement

Under normal use, the batteries in your key chain transmitter should last about two years.

You can tell the batteries are weak if the transmitter won't work at the normal range in any location. If you have to get close to your vehicle before the transmitter works, it's probably time to change the batteries.

### To Replace Batteries in the Remote Lock Control:

1. Insert a coin into the slot in the back of the transmitter, and turn counterclockwise to open the cover.
2. Remove the cover.
3. Remove and replace the two 3-volt batteries (DL 2016).

4. Reassemble the transmitter.
5. Check the transmitter operation.

## ■ *Illuminated Entry System* (OPTION)

This option comes with the optional remote lock control system.

When you open the driver's door, by itself or in combination with any passenger door or the liftgate, the interior lights will come on and then gradually dim to off 10 seconds after the last door is closed. (If the driver's door has not been opened, the interior lights will immediately dim to off.)

When you press  on your remote transmitter, the lights inside your vehicle will go on, then gradually dim to off after about 40 seconds, unless a door or the liftgate is opened.

When you turn on the ignition, the interior lights will immediately dim to off.

## ■ *Theft*

Vehicle theft is big business, especially in some cities. Although your Oldsmobile has a number of theft deterrent features, we know that nothing we put on it can make it impossible to steal. However, there are ways you can help.

## Key in the Ignition

If you walk away from your vehicle with the keys inside, it's an easy target for joy riders or professional thieves — so don't do it.

When you park your Oldsmobile and open the driver's door, you'll hear a chime reminding you to remove your key from the ignition and take it with you. Always do this. Your steering wheel will be locked, and so will your ignition and transaxle. And remember to lock the doors.

## **Parking at Night**

Park in a lighted spot, close all windows and lock your vehicle. Remember to keep your valuables out of sight. Put them in a storage area, or take them with you.

## **Parking Lots**

If you park in a lot where someone will be watching your vehicle, it's best to lock it up and take your keys. But what if you have to leave your ignition key? What if you have to leave something valuable in your vehicle?

- Put your valuables in a storage area, like your glove box or locking storage bin.
- Lock the storage bin.
- Lock all the doors except the driver's.
- Then take the door key with you.

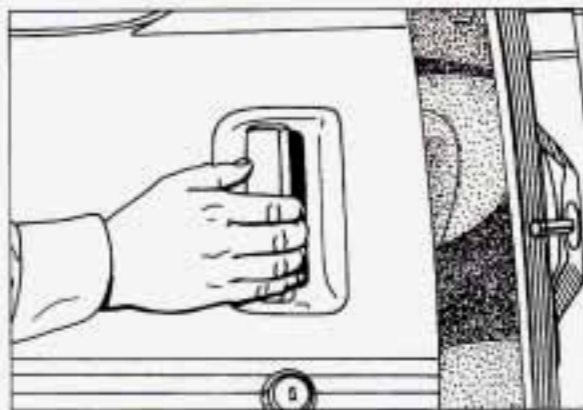

## ■ **Sliding Door**

To open the sliding door from outside the vehicle, pull the front of the latch release out and then toward the rear. If you slide the door all the way back, it will latch in the open position.

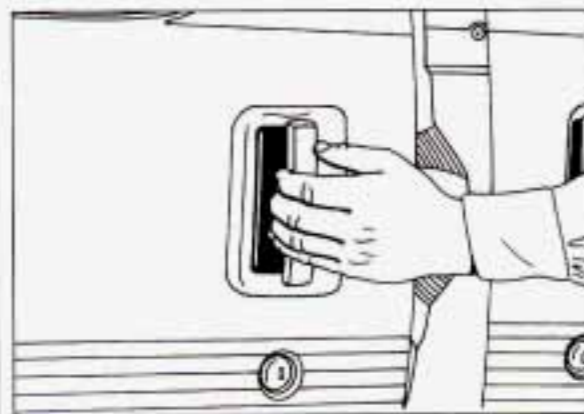

To move the door forward, you must first pull the inside or outside latch release out and then forward or the door will remain latched in the open position.

## Features & Controls

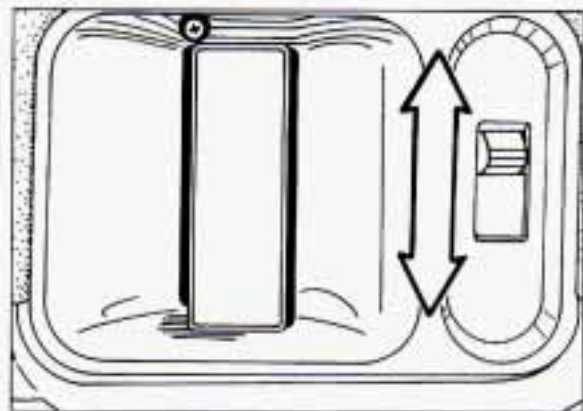

### Sliding Door Lock

From inside the vehicle, lock the sliding door by sliding the manual locking lever down. Unlock by sliding the lever up.

If you have the optional power door locks, the sliding door lock has a delay feature. See the *Index* under *Power Door Locks* or *Automatic Door Locks*.

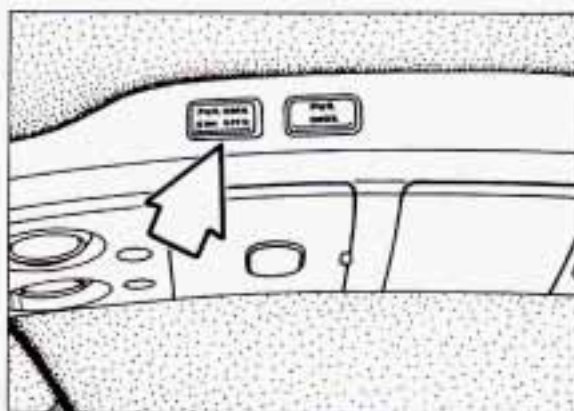

### Power Sliding Door (OPTION)

With this option, you can open and close the sliding door with switches inside your vehicle. If you have the optional remote lock control system, you can also operate the sliding door with your remote transmitter. See the *Index* under *Remote Lock Control*.

To operate the power sliding door, the power sliding door enable switch must be in the **ON** position. This switch is the forward-most of two power door switches located on the side of the overhead console. (If you have the standard compact overhead console, this switch is located between the reading lights.) To disable the power sliding door feature, slide the switch to **OFF**.

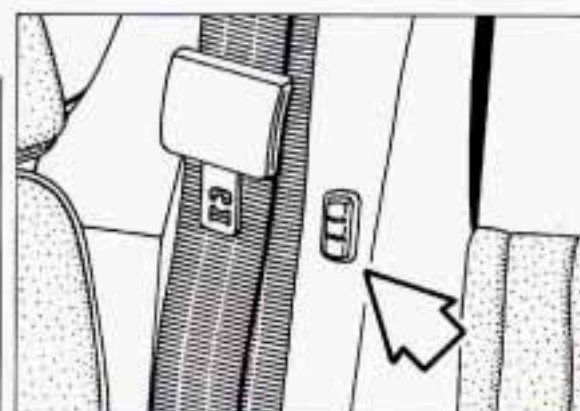

To open or close the sliding door, press and release one of two **PWR DOOR** (Power Door) switches. There is one mounted on the wall, just in front of the sliding door; the other is the rear-most



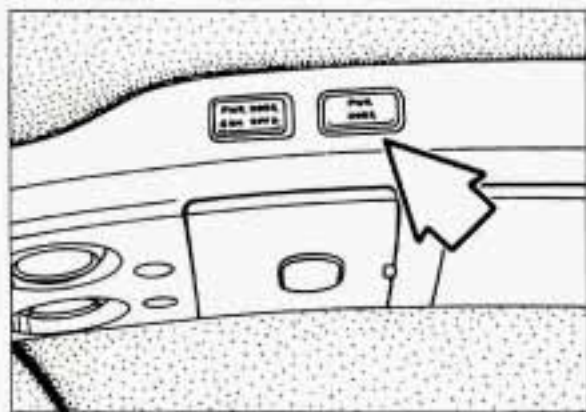

switch on the side of the overhead console. (If you have the standard compact overhead console, this switch is located between the reading lights.)

The sliding door must be unlocked for the power sliding door to operate. The ignition does not have to be on, and the key does not have to be in the ignition. To prevent accidental operation of the sliding door, disable the power sliding door by placing the power sliding door enable switch in the **OFF** position.



### CAUTION:

Leaving young children or pets unattended in your vehicle can be dangerous. They could operate the power sliding door. A child or others could be injured. Do not leave children unattended in your vehicle.

The power sliding door will only open if the transaxle is in **P** (Park). The transaxle does not have to be in **P** (Park) to close the door. If the enable switch is **ON** and the power sliding door is open or in the process of closing when you shift out of **P** (Park), a buzzer will sound and the light on your instrument panel will flash (see the *Index* under *Sliding Door Ajar Warning Light*). This is a warning that the sliding door is not completely closed.

## Features & Controls



If anything obstructs the sliding door while it is closing, the door will automatically reverse to the open position, provided it meets sufficient resistance. Resistance must be as strong as the force of the closing door, or stronger. The force of the closing door increases significantly as the door approaches the latch position.



### CAUTION:

If you shift the transaxle out of **P** (Park) and accelerate before the power sliding door latches closed, the door may reverse to the open position. A child or others could fall out of the vehicle and be injured. Always make sure the power sliding door is closed and latched before you drive away.



### CAUTION:

You or others could be injured if caught in the path of the sliding door. Make sure the door path is clear before closing the door.

Objects caught in the path of the sliding door may be damaged. Make sure the door path is clear before closing the door.

To manually open the power sliding door when the sliding door enable switch is in the **ON** position, pull the

inside or outside latch release and let go; the door will open fully and remain latched in the open position.

To manually open the power sliding door when the enable switch is in the **OFF** position, pull the inside or outside latch release and slide the door all the way back to the latch position.



### CAUTION:

If your vehicle is facing downward on a steep grade (20% or more), the door may not stay open and could slam shut, possibly injuring someone. To make sure the door does not slam shut, turn the enable switch **ON**. Then if the door closes, it will close under the control of the power door system.

To manually close the power sliding door when the sliding door enable switch is in the **ON** position, pull the inside or outside latch release or the edge of the door. Move the door about four inches toward the closed position

and release. The door will close completely and latch for you.

To manually close the power sliding door when the enable switch is in the **OFF** position, pull the inside or outside latch release and slide the door all the way forward to the latch position.

### Sliding Door Security Lock

Your Oldsmobile is equipped with a sliding door security lock that helps prevent passengers from opening the sliding door from the inside.

If you have the optional power sliding door, you can override the security lock by pressing the **PWR DOOR** (Power Door) switch when the power sliding door enable switch is in the **ON** position. See *Power Sliding Door* earlier in this section.

The security lock lever is located on the inside of the sliding door, near the rear edge of the door. To access the lever, open the sliding door. Use the security lock label on the rear edge of the door as a guide. Reach your hand around the inside rear corner of the sliding door to access the lever.



#### To Use the Security Lock:

1. Move the security lock lever all the way up.
2. Close the door.

#### With Optional Power Sliding Door

3. Slide the power sliding door enable switch on the overhead console to the **OFF** position.

The sliding door cannot be opened using the inside handle when the security lock feature is in use.

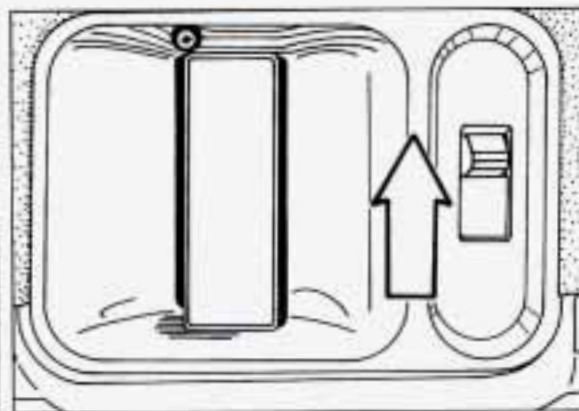

#### If You Want to Open the Sliding Door When the Security Lock is On:

1. Unlock the sliding door from the inside.



# Features & Controls

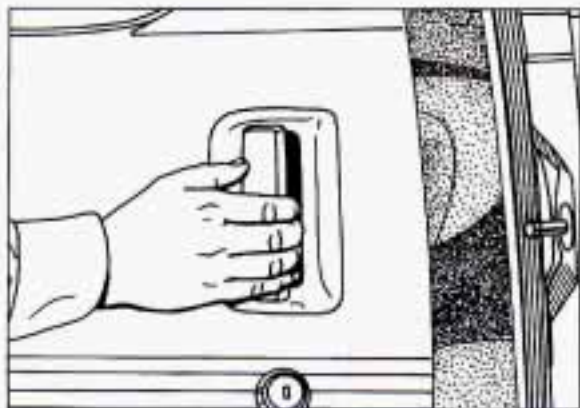

2. Then open the door from the outside.

### With Optional Power Sliding Door

- Slide the power sliding door enable switch to the **ON** position.
- Press either **PWR DOOR** (Power Door) switch.

You should let adults and older children know how the security lock works, and how to cancel the lock. If you don't, adults or older children who ride in the rear won't be able to open the sliding door from the inside when the security lock feature is in use.



### To Cancel the Sliding Door Lock:

- Unlock the sliding door from the inside and open the door.
- Move the security lock lever all the way down.

The sliding door lock will now work normally.

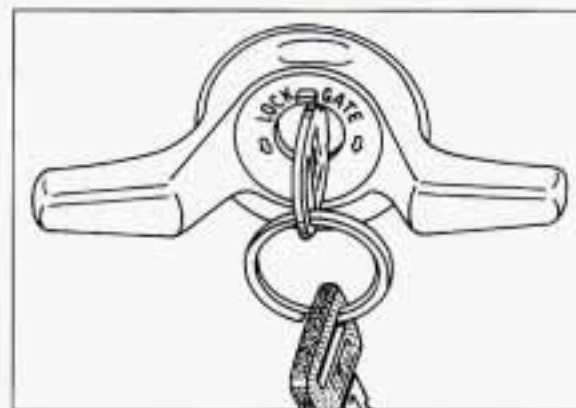

### Liftgate Lock

To unlock, insert the door key and turn the lock clockwise. The liftgate will automatically lock when you close it.

If you have the optional power door locks or the remote lock control system, the liftgate will lock and unlock differently. See the *Index* under *Power Door Locks* or *Remote Lock Control*.

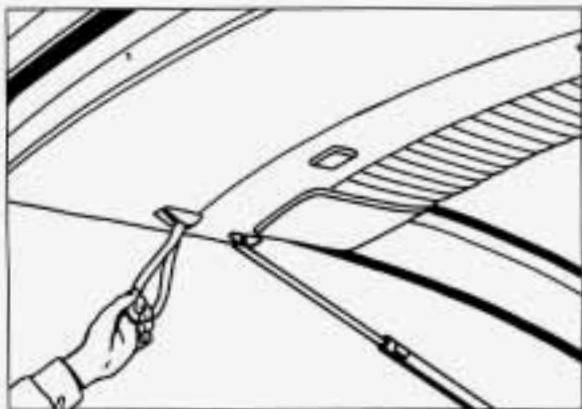

### Raising the Liftgate

Open the liftgate using the handle above the license plate. Then, step back and the liftgate will rise by itself. Lights in the liftgate will come on, illuminating the rear cargo area (see the *Index* under *Rear Interior Lights*).

#### NOTICE:

Be sure there are no overhead obstructions, such as a garage door, before you open the liftgate. You could slam the liftgate into something and break the glass.

To close the liftgate, pull down on the strap, then firmly shut the liftgate. Don't drive with the liftgate open, even slightly (see the *Index* under *Exhaust*).

A light on your instrument panel will warn you if the liftgate is not completely closed (see the *Index* under *Warning Lights, Liftgate Ajar*).



#### CAUTION:

It can be dangerous to drive with the liftgate open because carbon monoxide (CO) gas can come into your vehicle. You can't see or smell CO. It can cause unconsciousness and even death. If you must drive with the liftgate open or if electrical wiring or other cable connections must pass through the seal between the body and the liftgate:

- Make sure all windows are shut.
- Turn the fan on your heating or cooling system to its highest speed with the setting on **BI-LEV** (Bi-Level) or **UPPER**. That will force outside air into your vehicle. See *Comfort Controls* in the *Index*.
- If you have air vents on or under the instrument panel, open them all the way.

See *Engine Exhaust* in the *Index*.

## ■ New Vehicle "Break-In"

#### NOTICE:

Your modern Oldsmobile doesn't need an elaborate "break-in." But it will perform better in the long run if you follow these guidelines:

- Don't drive at any one speed — fast or slow — for the first 500 miles (804 km). Don't make full-throttle starts.
- Avoid making hard stops for the first 200 miles (322 km) or so. During this time your new brake linings aren't yet broken in. Hard stops with new linings can mean premature wear and earlier replacement. Follow this "breaking-in" guideline every time you get new brake linings.



# Features & Controls

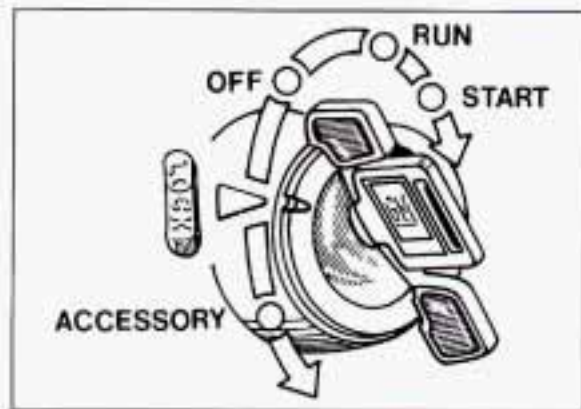

## ■ Ignition Switch

With the ignition key in the ignition switch, you can turn the switch to five positions:

**Accessory:** An “on” position in which you can operate your electrical power accessories. Press in the ignition switch as you turn the top of it toward you.

**Lock:** The only position in which you can remove the key. This locks your steering wheel, ignition and transaxle.

**Off:** Unlocks the steering wheel, ignition, and transaxle, but does not send electrical power to any accessories. Use this position if your vehicle must be pushed or towed, but never try to push-start your vehicle. A warning chime will sound if you open the driver’s door

when the ignition is off and the key is in the ignition.

**Run:** An “on” position to which the switch returns after you start your engine and release the switch. The switch stays in the **Run** position when the engine is running. But even when the engine is not running, you can use **Run** to operate your electrical power accessories, and to display some instrument panel warning lights.

**Start:** Starts the engine. When the engine starts, release the key. The ignition switch will return to **Run** for normal driving.

Note that even if the engine is not running, the positions **Accessory** and **Run** are “on” positions that allow you to operate your electrical accessories, such as the radio.

## NOTICE:

If your key seems stuck in **Lock** and you can’t turn it, be sure it is all the way in. If it is, then turn the steering wheel left and right while you turn the key hard. But turn the key only with your hand. Using a tool to force it could break the key or the ignition switch. If none of this works, then your vehicle needs service.

## ■ Starting Your Engine

Engines start differently. The 8th digit of your Vehicle Identification Number (VIN) shows the code letter or number for your engine. You will find the VIN at the top left of your instrument panel. (See *Vehicle Identification Number* in the *Index*.) Follow the proper steps to start the engine.

Move your shift lever to **P** (Park) or **N** (Neutral). Your engine won’t start in any other position — that’s a safety feature. To restart when you’re already moving, use **N** (Neutral) only.



**NOTICE:**

Don't try to shift to **P** (Park) if your Oldsmobile is moving. If you do, you could damage the transaxle. Shift to **P** (Park) only when your vehicle is stopped.

**NOTICE:**

Holding your key in **Start** for longer than 15 seconds at a time will cause your battery to be drained much sooner. And the excessive heat can damage your starter motor.

**NOTICE:**

Your engine is designed to work with the electronics in your vehicle. If you add electrical parts or accessories, you could change the way the fuel injection system operates. Before adding electrical equipment, check with your dealer. If you don't, your engine might not perform properly. If you ever have to have your vehicle towed, see the part of this manual that tells how to do it without damaging your vehicle. See *Towing Your Vehicle* in the *Index*.

**To start your 3100 V6 engine (Code D):**

1. Without pushing the accelerator pedal, turn your ignition key to **Start**. When the engine starts, let go of the key. The idle speed will go down as your engine gets warm.

2. If it doesn't start right away, hold your key in **Start**. If it doesn't start in three seconds (or starts but then stops), push the accelerator pedal about one-quarter of the way down for 12 more seconds, or until it starts.
3. If your engine still won't start (or starts but then stops), it could be flooded with too much gasoline. Try this: Wait 15 seconds to let the starter motor cool down. Then push your accelerator pedal all the way to the floor. Hold it there. Then hold the key in **Start**. This clears the extra gasoline from the engine. When the engine starts, let go of the key and the accelerator pedal. If the engine still doesn't start, wait another 15 seconds and do Step 2 again.

**To start your 3800 V6 engine (Code L):**

1. Without pushing the accelerator pedal, turn your ignition key to **Start**. When the engine starts, let go of the key. The idle speed will go down as your engine gets warm.

### NOTICE:

Holding your key in **Start** for longer than 15 seconds at a time will cause your battery to be drained much sooner. And the excessive heat can damage your starter motor.

2. If it doesn't start right away, hold your key in **Start** for about three to five seconds at a time until your engine starts. Wait about 15 seconds between each try to help avoid draining your battery.
3. If your engine still won't start (or starts but then stops), it could be flooded with too much gasoline. Try pushing your accelerator pedal all the way to the floor and holding it there as you hold the key in **Start** for about three seconds. If the vehicle starts briefly but then stops again, do the same thing, but this time keep the pedal down for five or six seconds. This clears the extra gasoline from the engine. After waiting about 15 seconds, repeat the normal starting procedure.

### NOTICE:

Your engine is designed to work with the electronics in your vehicle. If you add electrical parts or accessories, you could change the way the fuel injection system operates. Before adding electrical equipment, check with your dealer. If you don't, your engine might not perform properly. If you ever have to have your vehicle towed, see the part of this manual that tells how to do it without damaging your vehicle. See *Towing Your Vehicle* in the *Index*.

## ■ Driving Through Deep Standing Water

### NOTICE:

If you drive too quickly through deep puddles or standing water, water can come in through your engine's air intake and badly damage your engine. If you can't avoid deep puddles or standing water, drive through them very slowly.

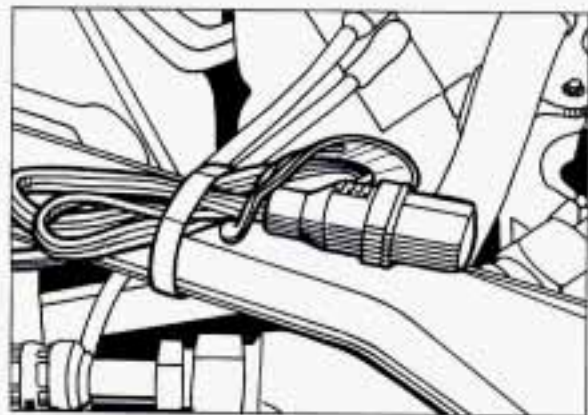

■ **Engine Coolant Heater**  
**(Engine Block Heater)**  
**(OPTION)**

In very cold weather, 0°F (-18°C) or colder, the engine coolant heater can help. You'll get easier starting and better fuel economy during engine warm-up. Usually, the coolant heater should be plugged in a minimum of four hours prior to starting your vehicle.

**To use the coolant heater:**

1. Turn off the engine.
2. Open the hood and unwrap the electrical cord.
3. Plug it into a normal, grounded 110-volt outlet.



**CAUTION:**

Plugging the cord into an ungrounded outlet could cause an electrical shock. Also, the wrong kind of extension cord could overheat and cause a fire. You could be seriously injured. Plug the cord into a properly grounded three-prong 110-volt outlet. If the cord won't reach, use a heavy-duty three-prong extension cord rated for at least 15 amps.

**NOTICE:**

After you've used the coolant heater, be sure to store the cord as it was before to keep it away from moving engine parts. If you don't, it could be damaged.

How long should you keep the coolant heater plugged in? The answer depends on the weather, the kind of oil you have, and some other things. Instead of trying to list everything here, we ask that you contact an Oldsmobile dealer in the area where you'll be parking your vehicle. The dealer can give you the best advice for that particular area.



# Features & Controls

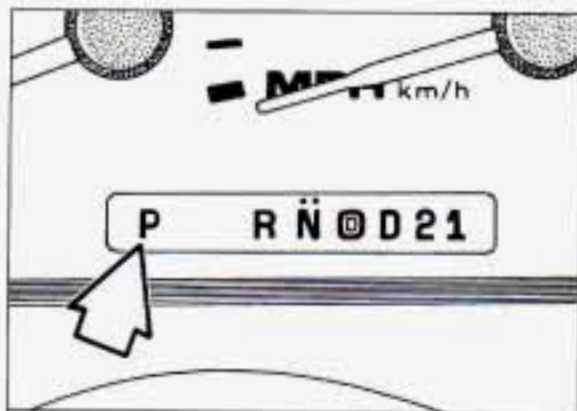
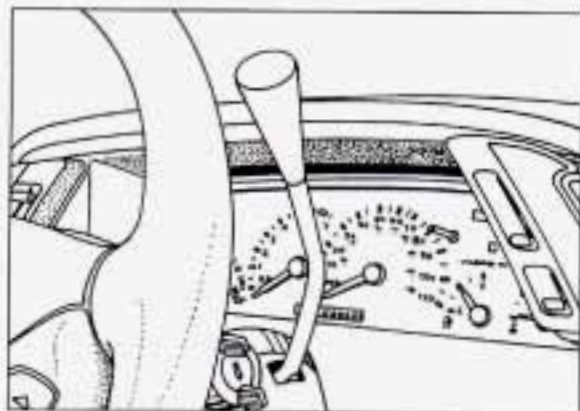

## ■ Automatic Transaxle

There are several different positions for your shift lever. In this manual, these are referred to by the commonly used symbols in the right column below:

Park	P
Reverse	R
Neutral	N
Overdrive	<b>D</b>
Drive	D
Second	2
First	1

## Park

**P (Park):** This locks your front wheels. It's the best position to use when you start your engine because your vehicle can't move easily.



## CAUTION:

It is dangerous to get out of your vehicle if the shift lever is not fully in **P** (Park) with the parking brake firmly set. Your vehicle can roll. Don't leave your vehicle when the engine is running unless you have to. If you have left the engine running, the vehicle can move suddenly. You or others could be injured. To be sure your vehicle won't move, even when you're on fairly level ground, always set your parking brake and move the shift lever to **P** (Park).

See *Shifting Into P (Park)* in the *Index*. If you're pulling a trailer, see *Towing a Trailer* in the *Index*.

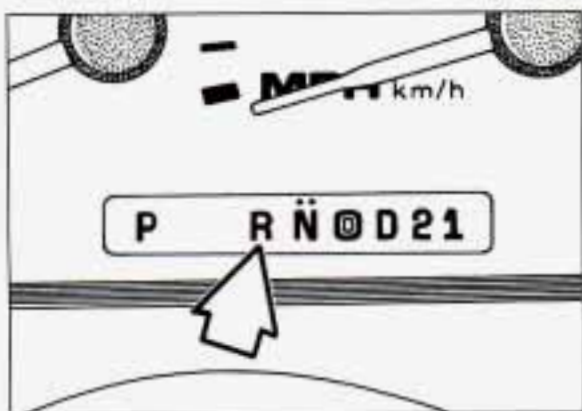

### Reverse

**R (Reverse):** Use this gear to back up.

#### NOTICE:

Shifting to **R** (Reverse) while your vehicle is moving forward could damage your transaxle. Shift to **R** only after your vehicle is stopped.

To rock your vehicle back and forth to get out of snow, ice or sand without damaging your transaxle, see the *Index* under *If You're Stuck: In Sand, Mud, Ice or Snow*.

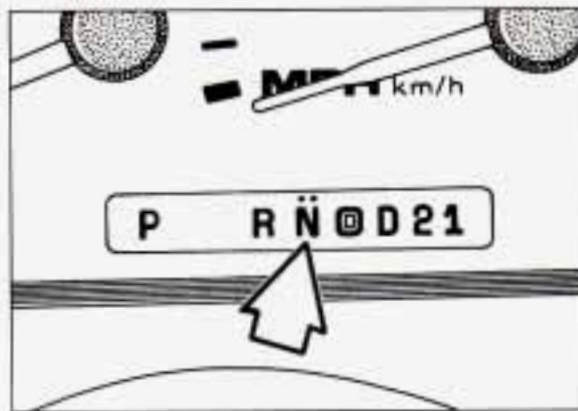

### Neutral

**N (Neutral):** In this position, your engine doesn't connect with the wheels. To restart when you're already moving, use **N** (Neutral) only. Also, use **N** when your vehicle is being towed.



#### CAUTION:

Shifting out of **P** (Park) or **N** (Neutral) while your engine is "racing" (running at high speed) is dangerous. Unless your foot is firmly on the brake pedal, your vehicle could move very rapidly. You could lose control and hit people or objects. Don't shift out of **P** (Park) or **N** (Neutral) while your engine is racing.

#### NOTICE:

Damage to your transaxle caused by shifting out of **P** (Park) or **N** (Neutral) with the engine racing isn't covered by your warranty.

# Features & Controls

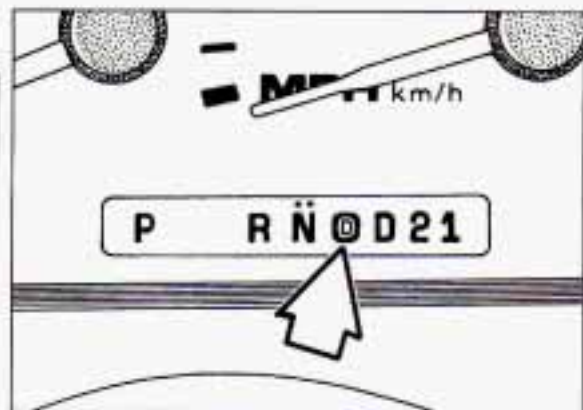

## Forward Gears

### **D** (Automatic Overdrive):

If your automatic transaxle has automatic overdrive, this position is for normal driving. If you need more power for passing, and you're:

- Going less than about 35 mph (56 km/h), push your accelerator pedal about halfway down.
- Going about 35 mph (56 km/h) or more, push the accelerator all the way down.

You'll shift down to the next gear and have more power.

## NOTICE:

This NOTICE applies only if you have the 3800 V6 engine and the automatic Overdrive transaxle. If your vehicle is so equipped, and if it seems to start up rather slowly, or if it seems not to shift gears as you go faster, something may be wrong with a transaxle system sensor. If you drive very far that way, your vehicle can be damaged. So, if this happens, have your vehicle serviced right away. Until then, you can use **2** (Second Gear) when you are driving less than 35 mph (56 km/h) and **D** (Overdrive) for higher speeds.

**D** (Third Gear): If your automatic transaxle does not have Overdrive, this position is for normal driving, at all speeds, in most street and highway situations.

If your automatic transaxle has Overdrive, **D** is like **D**, but you never go into Overdrive. Here are some times you might choose **D** instead of **D**:

- When driving on hilly, winding roads.
- When towing a trailer, so there is less shifting between gears.
- When going down a steep hill.

**2** (Second Gear): This position gives you more power but lower fuel economy. You can use **2** on hills. It can help control your speed as you go down steep mountain roads, but then you would also want to use your brakes off and on.

## NOTICE:

Don't drive in **2** (Second Gear) for more than 5 miles (8 km), or at speeds over 55 mph (88 km/h), or you can damage your transaxle. Use **D** (**D**) or **D** if your vehicle has Overdrive) as much as possible. Don't shift into **2** unless you are going slower than 65 mph (105 km/h), or you can damage your engine.

**1** (First Gear): This position gives you even more power (but lower fuel economy) than **2**. You can use it on very steep hills, or in deep snow or



mud. If the selector lever is put in **1**, the transaxle won't shift into first gear until the vehicle is going slowly enough.

### **NOTICE:**

If your front wheels can't rotate, don't try to drive. This might happen if you were stuck in very deep sand or mud or were up against a solid object. You could damage your transaxle. Also, if you stop when going uphill, don't hold your vehicle there with only the accelerator pedal. This could overheat and damage the transaxle. Use your brakes or shift into **P** (Park) to hold your vehicle in position on a hill.

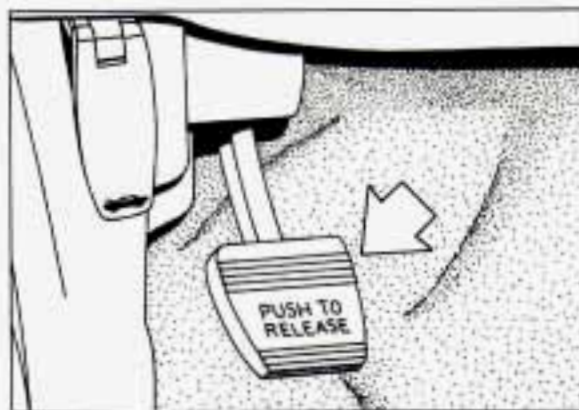

### **Parking Brake**

#### **To Set the Parking Brake:**

Hold the regular brake pedal down with your right foot. Push down the parking brake pedal with your left foot. If the ignition is on, the brake system warning light will come on. See the *Index* under *Brake System Warning Light*.

#### **To Release the Parking Brake:**

Hold the regular brake pedal down with your right foot while you push down on the parking brake pedal with your left foot. (To release the tension on the parking brake cable, you will need to apply about the same amount of pressure to the parking brake pedal as you did when you set the parking brake.) When you remove your foot

from the parking brake pedal, it will pop up to the release position.

### **NOTICE:**

Driving with the parking brake on can cause your rear brakes to overheat. You may have to replace them, and you could also damage other parts of your vehicle.

#### **If You are Towing a Trailer and are Parking on Any Hill:**

See the *Index* under *Towing a Trailer*. That section shows what to do first to keep the trailer from moving.

# Features & Controls

## ■ Shifting Into P (Park)



### CAUTION:

It can be dangerous to get out of your vehicle if the shift lever is not fully in **P** (Park) with the parking brake firmly set. Your vehicle can roll. If you have left the engine running, the vehicle can move suddenly. You or others could be injured. To be sure your vehicle won't move, even when you're on fairly level ground, use the steps that follow. If you're pulling a trailer, see *Towing a Trailer* in the *Index*.

1. Hold the brake pedal down with your right foot and set the parking brake.

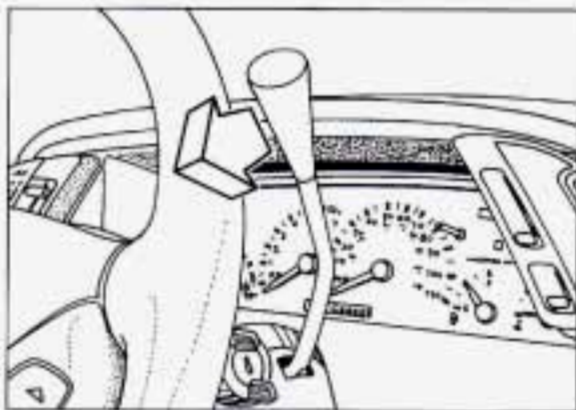

2. Move the shift lever into **P** (Park) position like this:

- Pull the lever toward you.

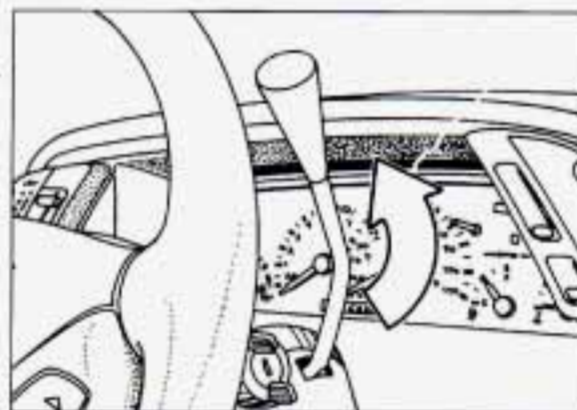

- Move the lever up as far as it will go.

3. Move the ignition key to **Lock**.
4. Remove the key and take it with you. If you can walk away from your vehicle with the ignition key in your hand, your vehicle is in **P** (Park).

## Leaving Your Vehicle With the Engine Running

### CAUTION:

It can be dangerous to leave your vehicle with the engine running. Your vehicle could move suddenly if the shift lever is not fully in **P** (Park) with the parking brake firmly set. And, if you leave the vehicle with the engine running, it could overheat and even catch fire. You or others could be injured. Don't leave your vehicle with the engine running unless you have to.

If you have to leave your vehicle with the engine running, be sure your vehicle is in **P** (Park) and your parking brake is firmly set before you leave it. After you've moved the shift lever into the **P** (Park) position, hold the regular brake pedal down. Then, see if you can move the shift lever away from **P** (Park) without first pulling it toward you.

If you can, it means that the shift lever wasn't fully locked into **P** (Park).

## Torque Lock

If you are parking on a hill and you don't shift your transaxle into **P** (Park) properly, the weight of the vehicle may put too much force on the parking pawl in the transaxle. You may find it difficult to pull the shift lever out of **P** (Park). This is called "torque lock." To prevent torque lock, set the parking brake and then shift into **P** (Park) properly before you leave the driver's seat. To find out how, see *Shifting Into P (Park)* in the *Index*.

When you are ready to drive, move the shift lever out of **P** (Park) BEFORE you release the parking brake.

If "torque lock" does occur, you may need to have another vehicle push yours a little uphill to take some of the pressure from the transaxle, so you can pull the shift lever out of **P** (Park).



## ■ Parking Over Things That Burn

### CAUTION:

Things that can burn could touch hot exhaust parts under your vehicle and ignite. Don't park over papers, leaves, dry grass or other things that can burn.



# Features & Controls

## ■ Engine Exhaust



### CAUTION:

Engine exhaust can kill. It contains the gas carbon monoxide (CO), which you can't see or smell. It can cause unconsciousness and death. You might have exhaust coming in if:

- Your exhaust system sounds strange or different.
- Your vehicle gets rusty underneath.
- Your vehicle was damaged in a collision.
- Your vehicle was damaged when driving over high points on the road or over road debris.
- Repairs weren't done correctly.
- Your vehicle or exhaust system had been modified improperly.

**CAUTION (Continued)**

### CAUTION (Continued)

If you ever suspect exhaust is coming into your vehicle:

- Drive it only with all the windows down to blow out any CO; and
- Have your vehicle fixed **immediately**.

## ■ Running Your Engine While You're Parked

It's better not to park with the engine running. But if you ever have to, here are some things to know.



### CAUTION:

Idling the engine with the air system control off could allow dangerous exhaust into your vehicle (see the earlier Caution under *Engine Exhaust*). Also, idling in a closed-in place can let deadly carbon monoxide (CO) into your vehicle even if the fan switch is at the highest setting. One place this can happen is a garage. Exhaust — with CO — can come in easily. NEVER park in a garage with the engine running.

Another closed-in place can be a blizzard. (See *Blizzard* in the *Index*.)

**⚠ CAUTION:**

It can be dangerous to get out of your vehicle if the shift lever is not fully in **P** (Park) with the parking brake firmly set. Your vehicle can roll. Don't leave your vehicle when the engine is running unless you have to. If you've left the engine running, the vehicle can move suddenly. You or others could be injured. To be sure your vehicle won't move, even when you're on fairly level ground, always set your parking brake and move the shift lever to **P** (Park).

Follow the proper steps to be sure your vehicle won't move. See *Shifting Into P (Park)* in the *Index*.

If you are parking on a hill and you're pulling a trailer, also see *Towing a Trailer* in the *Index*.

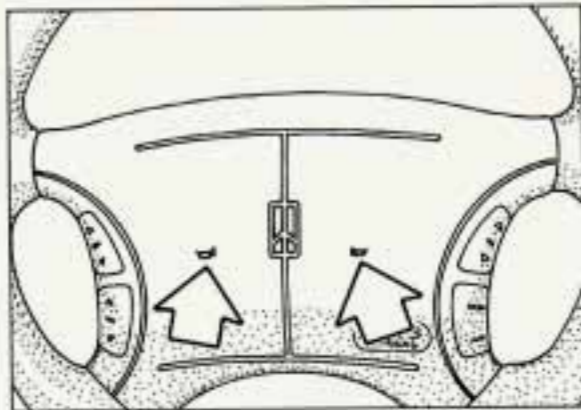

### **Horn**

You can sound the horn by pressing the horn symbols on your steering wheel.

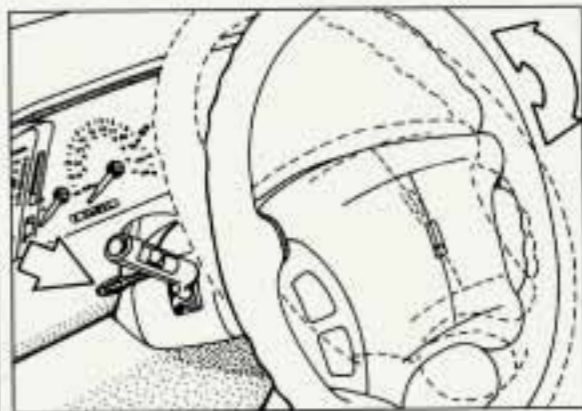

### **Tilt Steering Wheel**

A tilt steering wheel allows you to adjust the steering wheel before you drive. You can also raise it to the highest level to give your legs more room when you exit and enter the vehicle.

To tilt the wheel, hold the steering wheel and pull the lever. Move the steering wheel to a comfortable level, then release the lever to lock the wheel in place.

### **Manual Windows**

Use the manual crank to open and close the front windows.



## Features & Controls

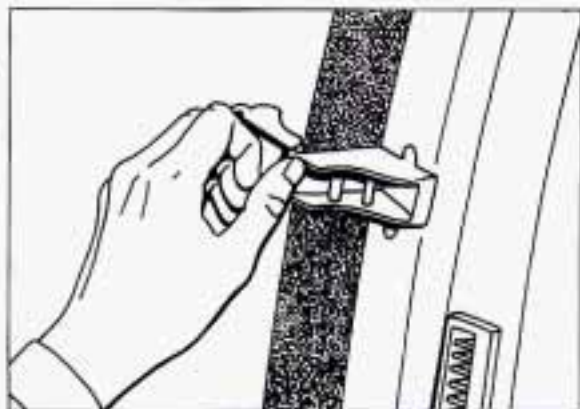

### Side Window Latches

The rear of the side windows swings open.

**To Open:** Pull the latch forward to release it, then swing the window outward and press the center of the latch to secure the window in the open position.

**To Close:** Pull the center of the latch forward and then close the latch.

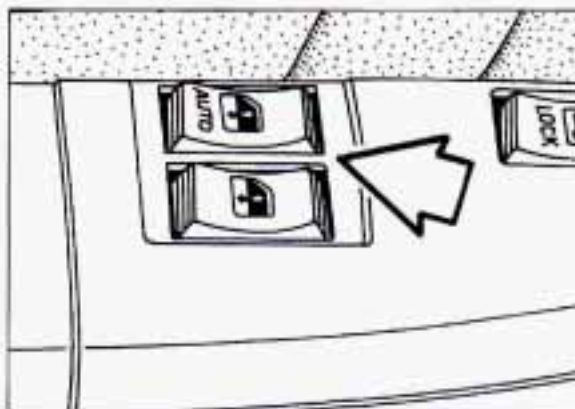

### Power Windows (OPTION)

With power windows, switches on the driver's door armrest control the front windows when the ignition is on. The left switch controls the driver's window. The right switch controls the passenger's window.

The driver's power window switch has two down positions. Hold the rear of the switch in the first position to lower the window normally.

To activate the auto down feature, fully press the rear of the switch, then release. The window will lower completely. To stop the window from lowering all the way, press the front of the switch.

To raise the window, press and hold the front of the switch.

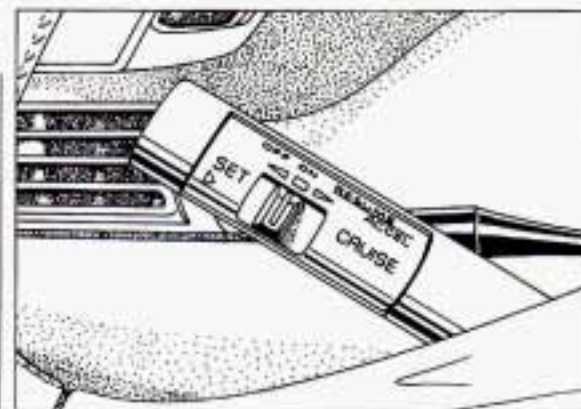

### ■ Turn Signal/Multifunction Lever

The lever on the left side of the steering column includes your:

- Turn Signal and Lane Change Indicator
- Headlight High-Low Beam Changer
- Cruise Control (Option)

The High-Low Beam feature is discussed under *Headlights*. See the *Index* under *Headlights*.



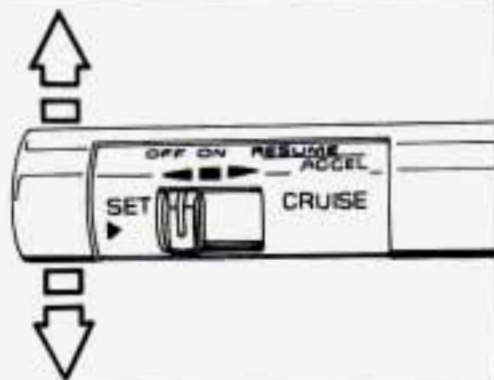

### Turn Signal and Lane Change Indicator

The turn signal has two upward (for Right) and two downward (for Left) positions. These positions allow you to signal a turn or a lane change.

To signal a turn, move the lever all the way up or down. When the turn is finished, the lever will return automatically.



A green arrow on the instrument panel will flash in the direction of the turn or lane change.

To signal a lane change, just raise or lower the lever until the green arrow starts to flash. Hold it there until you complete your lane change. The lever will return by itself when you release it.

As you signal a turn or a lane change, if the arrows don't flash but just stay on, a signal bulb may be burned out and other drivers won't see your turn signal.

If a bulb is burned out, replace it to help avoid an accident. If the green arrows don't go on at all when you signal a turn, check the fuse (see the *Index* under *Fuses & Circuit Breakers*) and for burned-out bulbs.

If you have a trailer towing option with added wiring for the trailer lights, a different turn signal flasher is used. With this flasher installed, the signal indicator will flash even if a turn signal bulb is burned out. Check the front and rear turn signal lights regularly to make sure they are working.

# Features & Controls

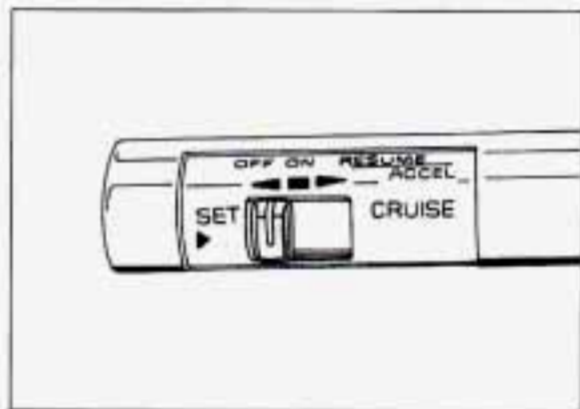

## ■ *Cruise Control* (OPTION)

With cruise control, you can maintain a speed of about 25 mph (40 km/h) or more without keeping your foot on the accelerator. This can really help on long trips.

Cruise control does not work at speeds below about 25 mph (40 km/h).

When you apply your brakes, the cruise control shuts off.



### **CAUTION:**

- Cruise Control can be dangerous where you can't drive safely at a steady speed. So, don't use your Cruise Control on winding roads or in heavy traffic.
- Cruise Control can be dangerous on slippery roads. On such roads, fast changes in tire traction can cause needless wheel spinning, and you could lose control. Don't use Cruise Control on slippery roads.

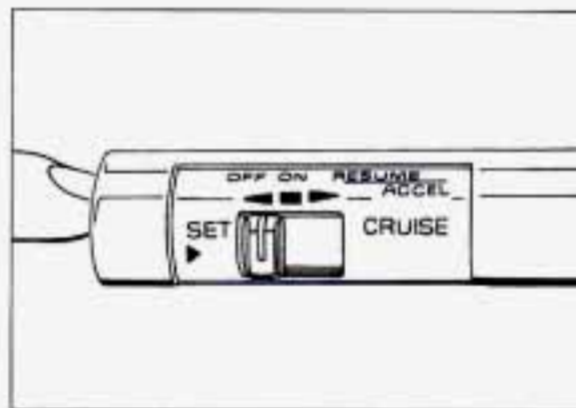

3. Push in the **SET** button at the end of the lever and release it.
4. Take your foot off the accelerator pedal.

## *To Set Cruise Control*

1. Move the cruise control switch to **ON**.



### **CAUTION:**

If you leave your Cruise Control switch on when you're not using Cruise, you might hit a button and go into Cruise when you don't want to. You could be startled and even lose control. Keep the Cruise Control switch **OFF** until you want to use it.

2. Get up to the speed you want.

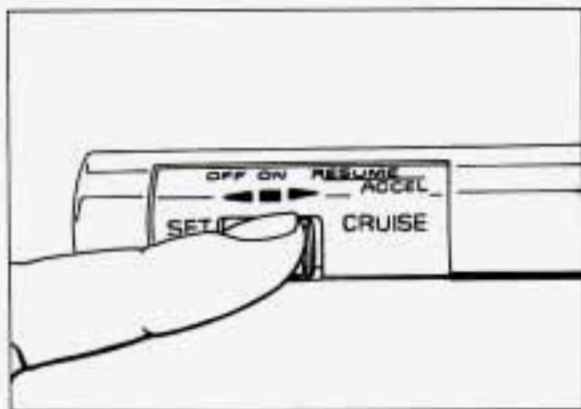

### To Resume a Set Speed

Suppose you set your cruise control at a desired speed and then you apply the brake. This, of course, shuts off the cruise control. But you don't need to reset it. Once you're going about 25 mph (40 km/h) or more, you can move the cruise control switch from **ON** to **RESUME/ACCEL** (which stands for Resume/Accelerate) for about half a second.

You'll go right back up to your chosen speed and stay there.

If you have the 3800 V6 engine, cruise control memory will be erased when you place the transaxle in **P** (Park). If this is the case, you will not be able to

resume your set speed by moving the cruise control switch to **RESUME/ACCEL**.

Use the **SET** button to reset cruise (see *To Set Cruise Control* earlier in this section).

If you hold the switch at **RESUME/ACCEL** longer than half a second, the vehicle will keep going faster until you release the switch or apply the brake. You could be startled and even lose control. So unless you want to go faster, don't hold the switch at **RESUME/ACCEL**.

### To Increase Speed While Using Cruise Control

There are two ways to go to a higher speed. Here's the first:

1. Use the accelerator pedal to get to the higher speed.
2. Push the button at the end of the lever, then release the button and the accelerator pedal. You'll now cruise at the higher speed.

Here's the second way to go to a higher speed:

- Move the cruise switch from **ON** to **RESUME/ACCEL**. Hold it there until you get up to the speed you want, and then release the switch.
- To increase your speed in very small amounts, move the switch to **RESUME/ACCEL** for less than half a second and then release it. Each time you do this, your vehicle will go about 1 mph (1.6 km/h) faster.

If you have the 3800 V6 engine, the accelerate feature will only work after you have set the initial cruise control speed by pushing the **SET** button. If you have the 3100 V6 engine, the accelerate feature will work whether or not you have set an initial cruise control speed.

### To Reduce Speed While Using Cruise Control

- Push in the button at the end of the lever until you reach the lower speed you want, then release it.



# Features & Controls

- To slow down in very small amounts, push the button for less than half a second. Each time you do this, you'll go 1 mph (1.6 km/h) slower.

## Passing Another Vehicle While Using Cruise Control

Use the accelerator pedal to increase your speed. When you take your foot off the pedal, your vehicle will slow down to the cruise control speed you set earlier.

## Using Cruise Control on Hills

How well your cruise control will work on hills depends upon your speed, load, and the steepness of the hills. When going up steep hills, you may have to step on the accelerator pedal to maintain your speed. When going downhill, you may have to brake or shift to a lower gear to keep your speed down. Of course, applying the brake takes you out of cruise control. Many drivers find this to be too much trouble and don't use cruise control on steep hills.

## To Get Out of Cruise Control

There are two ways to turn off the cruise control:

- Step lightly on the brake pedal; OR
- Move the cruise switch to **OFF**.

If your vehicle has the optional traction control system (**TCS**), the cruise control will shut off when **TCS** is actively controlling wheel spin. See the *Index* under *Traction Control System*.

## To Erase Cruise Speed Memory

When you turn off the cruise control or the ignition, your cruise control set speed memory is erased. If you have the 3800 V6 engine, cruise control memory will also be erased when you place the transaxle in **P** (Park).

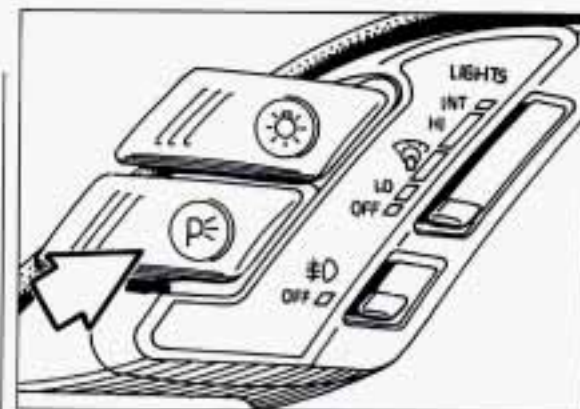



## ■ Headlights

Push the  $\text{P}$  switch to turn on:

- Parking Lights
- Side Marker Lights
- Taillights
- Instrument Panel Lights

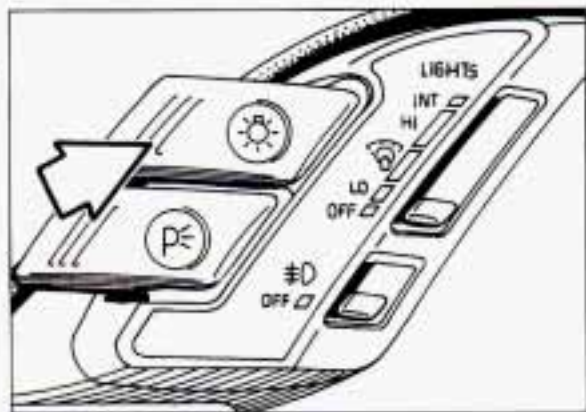
Pull the switch to turn off the lights.



Push the  switch to turn on the headlights, together with:

- Parking Lights
- Side Marker Lights
- Taillights
- Instrument Panel Lights

Pull the switch to turn off the lights.

### **Operation of Lights**

Although your vehicle's lighting system (headlights, parking lights, fog lamps, side marker lights and taillights) meets all applicable federal lighting requirements, certain states and provinces may apply their own lighting regulations that may require special attention before you operate these lights.

For example, some jurisdictions may require that you operate your fog lamps only when your lower beam headlights are also on, or that headlights be turned on whenever you must use your windshield wipers. In addition, most jurisdictions prohibit driving solely with parking lights, especially at dawn or dusk. It is recommended that you check with your own state or provincial highway authority for applicable lighting regulations.

### **Lights On Reminder**

If you turn the ignition key to the **Off** or **Lock** position while leaving the lights on, you will hear a warning chime.

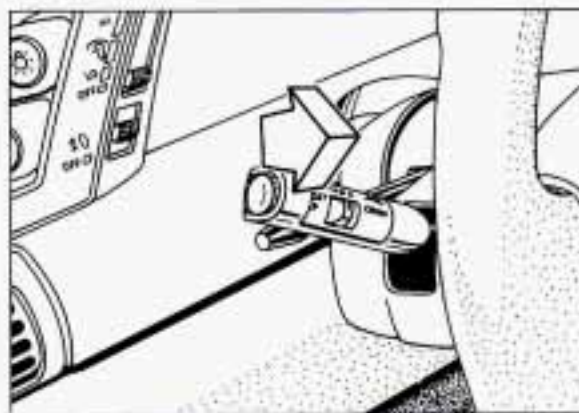

### **Headlight High-Low Beam Changer**

To change the headlights from high to low beam, or low to high, simply pull the turn signal lever all the way toward you. Then release it.

When the high beams are on, a blue light on the instrument cluster also will be on.

# Features & Controls

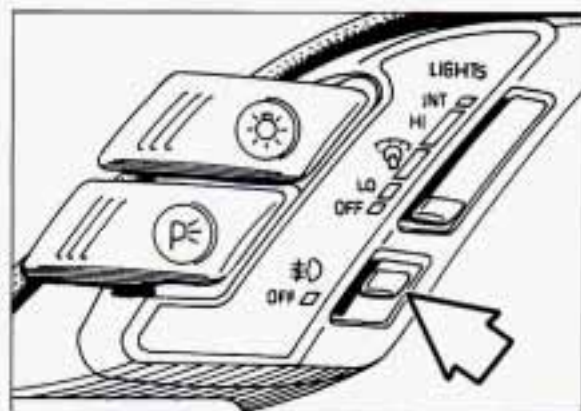

## Fog Lights

Slide the lower control up to turn on the fog lights, down to turn them off. An amber indicator light next to the control will glow when the fog lights are on.

Your headlights must be on for your fog lights to go on.

Although your fog lights will go off when your high beams are on, high beams are not recommended for driving in fog.

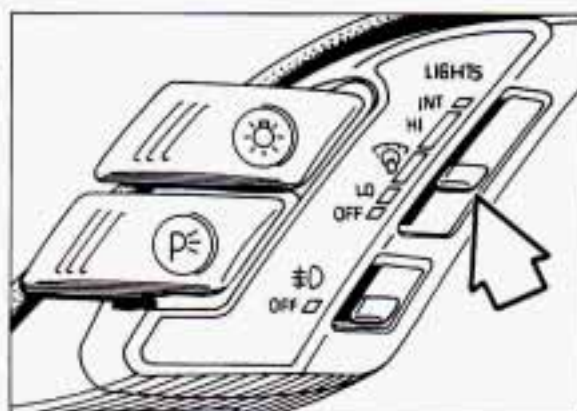

## Instrument Panel Intensity Control

Slide the upper control up to increase the brightness of the instrument panel lights, down to decrease the brightness. Slide the control all the way down to turn them off.

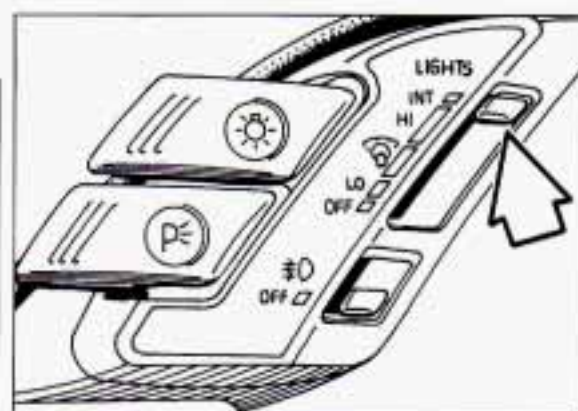

## Interior Lights Control

Slide the upper control all the way up to turn on the interior lights.



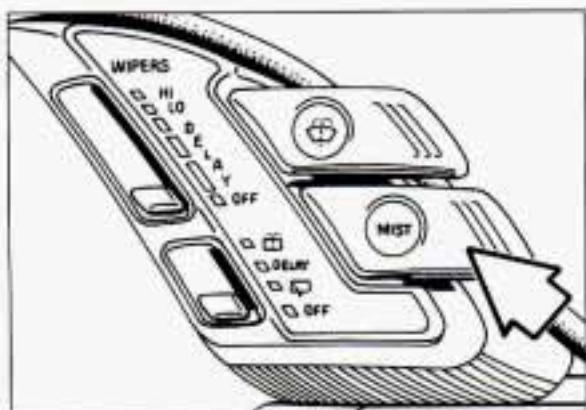

### **Windshield Wipers**

The windshield wiper and washer controls are located to the right of the instrument cluster.

**For a Single Wiper Cycle:** Press the switch marked **MIST** and release. For more cycles, press and hold the switch.

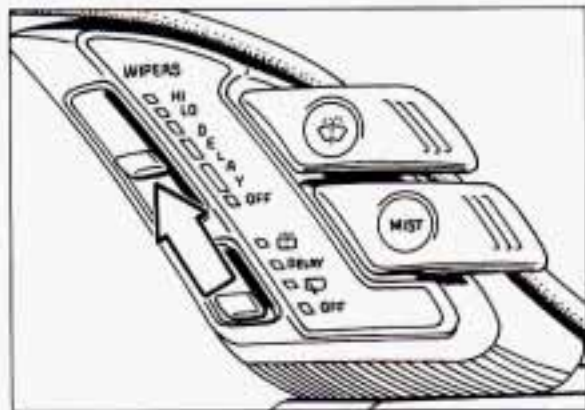

**For Pulse Delay Wiper Cycles:** The pulse delay cycle system allows you to set the wiper speed as slow as 20 seconds between cycles, or faster. Pulse delay cycles are very useful in light rain or snow. Slide the upper control to the **DELAY** area. The lower the position, the slower the cycle; the higher the position, the faster the cycle.

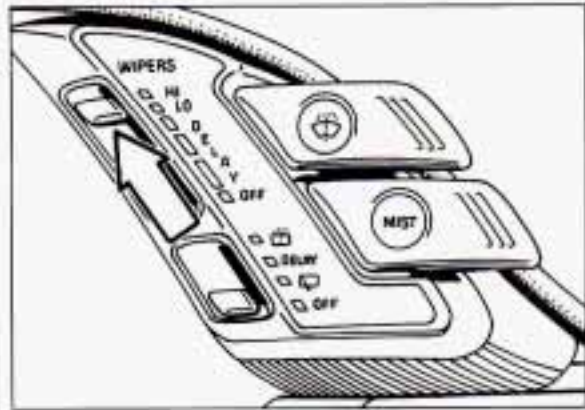

**For Steady Wiper Cycles:** Slide the upper control either to the **LO** or **HI** position, depending on the wiper speed you want.

## Features & Controls

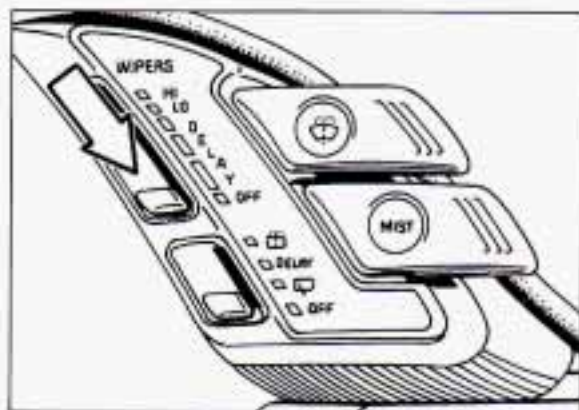

**To Turn the Wipers Off:** Slide the upper control to the **OFF** position.

Remember that damaged wiper blades may prevent you from seeing well enough to drive safely. To avoid damage, be sure to clear ice and snow from the wiper blades before using them. If they're frozen to the windshield, carefully loosen or thaw them. If your blades do become damaged, get new blades or blade inserts.

Heavy snow or ice can overload your wipers. A circuit breaker will stop them until the motor cools. Clear away snow or ice to prevent an overload.

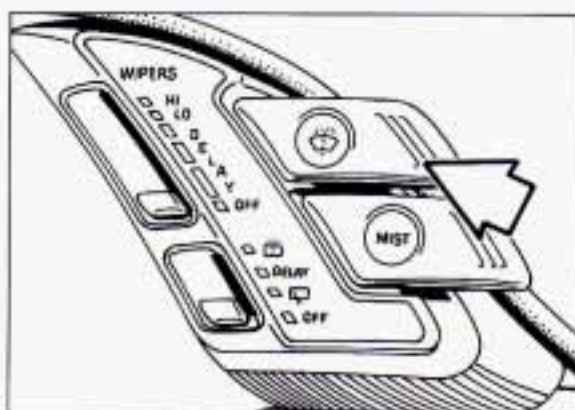

### **Windshield Washer**

To wash your windshield, press and hold the windshield washer switch. The washers and wipers will operate. When you release the switch, the washers will stop, and the wipers will continue to operate for two cycles, unless your wipers had already been on. In that case, the wipers will resume the wiper speed you had selected earlier.

Driving without washer fluid can be dangerous. A bad mud splash can block your vision. You could hit another vehicle or go off the road. Check your washer fluid level often.



### **CAUTION:**

In freezing weather, don't use your washer until the windshield is warmed. Otherwise the washer fluid can form ice on the windshield, blocking your vision.

## NOTICE:

- When using concentrated washer fluid, follow the manufacturer's instructions for adding water. Don't mix water with ready-to-use washer fluid. Water can cause the solution to freeze and damage your washer fluid tank and other parts of the washer system. Also, water doesn't clean as well as washer fluid.
- Fill your washer fluid tank only 3/4 full when it's very cold. This allows for expansion, which could damage the tank if it is completely full.
- Don't use radiator antifreeze in your windshield washer. It can damage your paint.

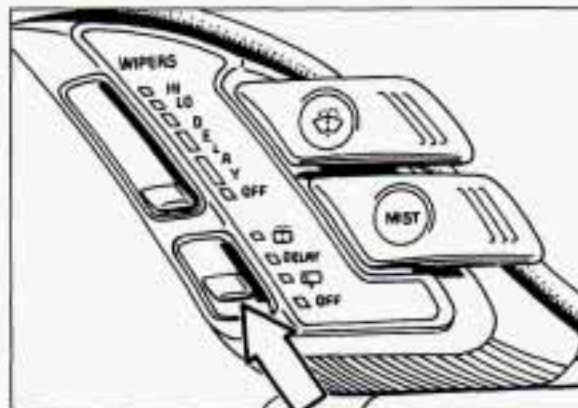

### **Rear Window Wiper and Washer**

**To Use Your Rear Wiper:** Slide the lower control to .

**For a Delayed Wiper Cycle:** Slide the lower control to **DELY**.

**To Wash the Rear Window:** Slide the lower control to  and hold it. The washer and wiper will operate only as long as the control is held in that position. Then the wiper will return to **DELY**.

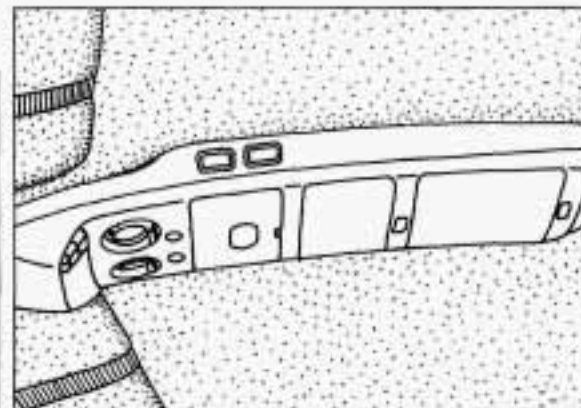

### **Overhead Console**

The optional front overhead console has reading lights, two switches for the optional power sliding door, storage compartments, including one for your garage door opener and one for sunglasses, a compass and an outside temperature display. The features of the optional overhead console are explained on the following pages.



## Features & Controls

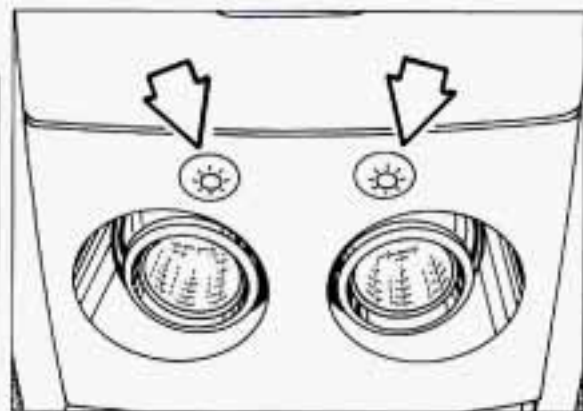

### Reading Lights

To turn on or off either reading light, press the switch next to it. To adjust the aim of the lights, pivot the lamps in their sockets.

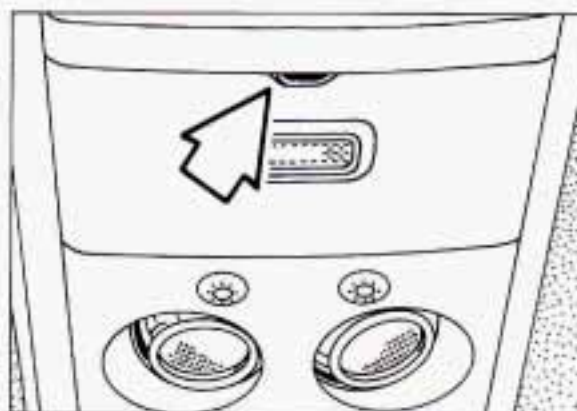

### Garage Door Opener Compartment

You can store your garage door opener in the front compartment of your overhead console, and operate it from this position. To install your garage door opener, follow these instructions:

1. Open the compartment by pressing the latch forward. Remove the piece of self-sticking Velcro®.

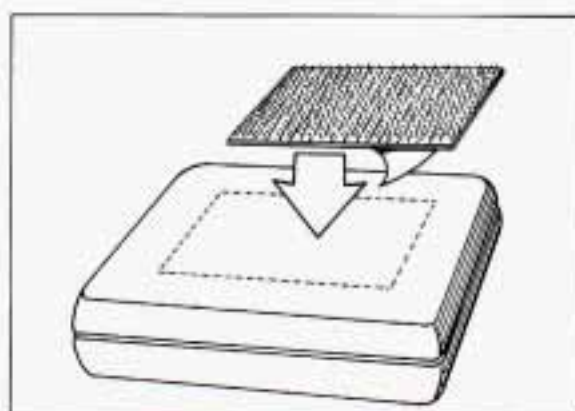

2. Peel the protective backing from the Velcro® and press it firmly to the back of your garage door opener.

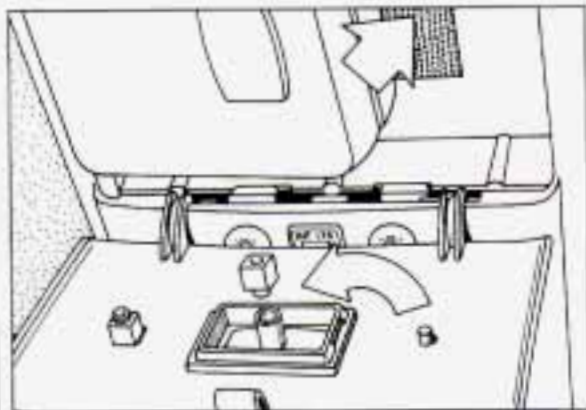

3. To make sure the button on your garage door opener is centered above the button on the compartment door, use the intersecting lines on the Velcro<sup>®</sup> inside the compartment as a guide. Center the control button of your garage door opener over the point where the lines intersect, and press the opener firmly into place. Make sure the button is facing down.
4. Once the opener is installed, use the pegs inside the compartment door to make sure the button on the compartment door will contact the control button on your garage door opener when pressed.

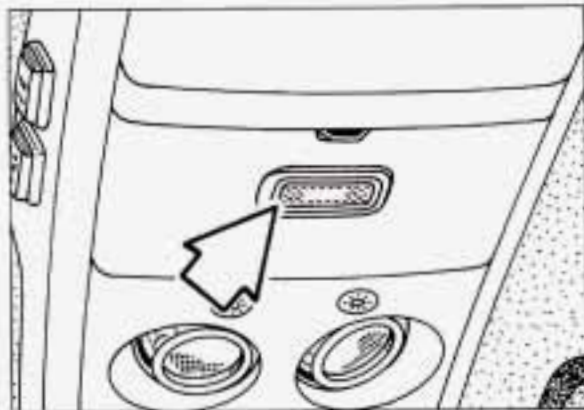

5. Add one peg at a time until your garage door opener operates with the compartment door closed when you press the button.

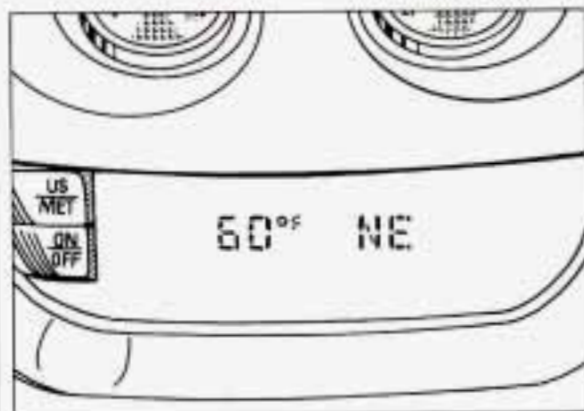

### **Temperature and Compass Display**

The outside air temperature and the compass are displayed at the front of the overhead console. The control switches are located to the left of the display.

Turn the display on or off by pressing the **ON/OFF** switch. Display the temperature in either degrees Fahrenheit (English) or Celsius (metric) by pressing the **US/MET** switch.

# Features & Controls

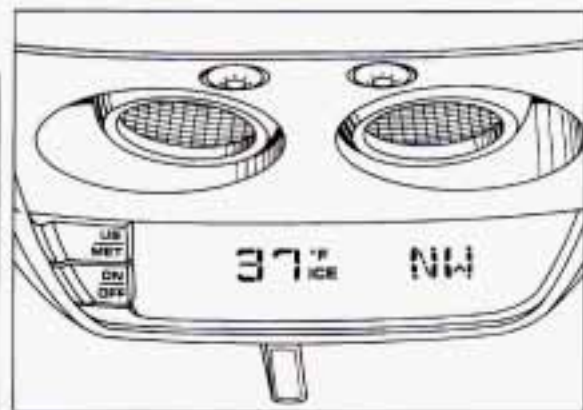

If the outside temperature is 37° F (3° C) or lower when you turn on the ignition, **ICE** will appear briefly on the display. It's there to caution the driver that road conditions may be icy and that appropriate precautions should be taken.

## Compass Calibration:

The compass is self-calibrating, so it does not need to be manually set. However, when your Silhouette is new, the compass may function erratically. If it does, **CAL** (Calibration) will appear on the display. To correct the problem, drive in a complete 360° circle three times, and the compass will function normally.

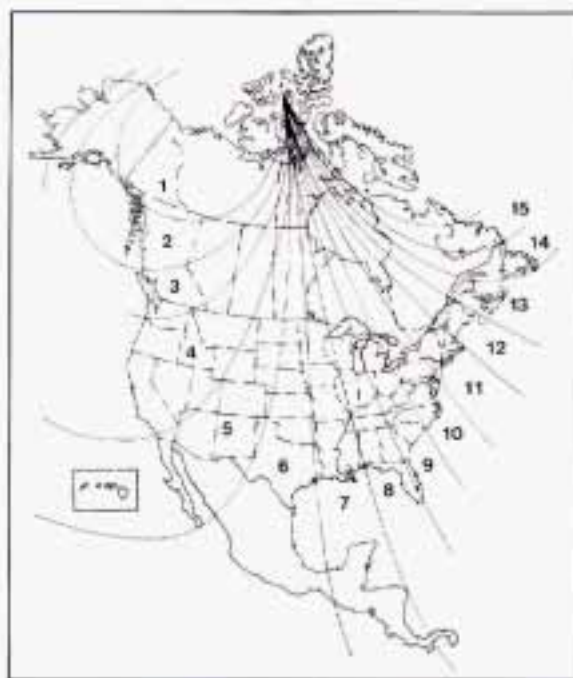

## Compass Variance:

Variance is the difference between magnetic north and geographic north. In some areas the difference between the two can be great enough to cause false compass readings. If this happens, follow these instructions to set the variance for your particular location:

1. Locate your location on the zone map. Note your zone number.
2. Press and hold both the **ON/OFF** and the **US/MET** switches. The display will go off.
3. After 5 seconds, **VAR CAL** will appear on the display. When it does, release both buttons.
4. Press **US/MET** until your zone number appears on the display.
5. Press **ON/OFF** to enter your zone number. Your variance is now set.



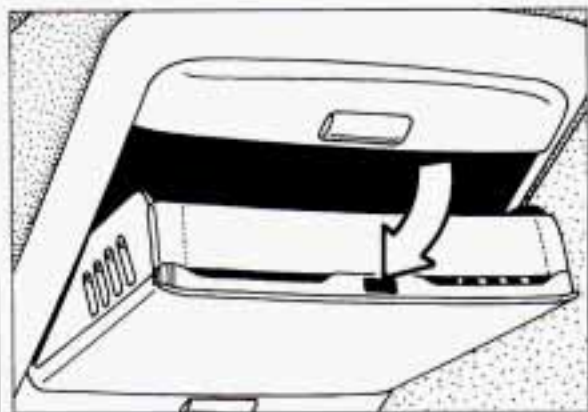

### **Storage Compartment**

To open the rear storage compartment in the overhead console, press the release button.

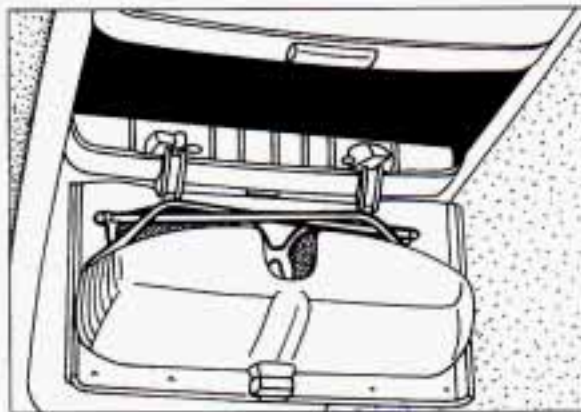

### **Sunglasses Storage Compartment**

To open the sunglasses storage compartment in the overhead console, press the release button. Then pull the compartment down to the full open position, as shown.

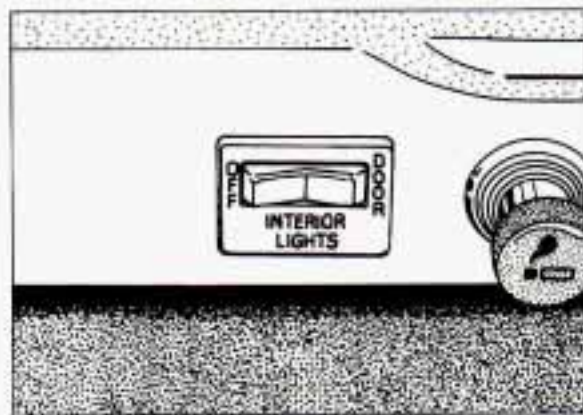

### **Interior Lights Override Switch**

This switch is located to the left of the cigarette lighter in the center instrument panel console. It has two positions, **DOOR** (on) and **OFF**, and overrides all interior lights except the reading lights.

The interior lights go on each time you open the doors. You can turn off these lights so that the doors may be left open without running down the battery by turning the interior lights override switch to **OFF**.

# Features & Controls

## Center Dome Light

Located in the center of your vehicle, this light has no switch of its own. It will go on each time you open the doors, unless you turn the interior lights override switch in the center instrument panel console to **OFF**.

If you have the optional rear climate control, you will not have a center dome light.

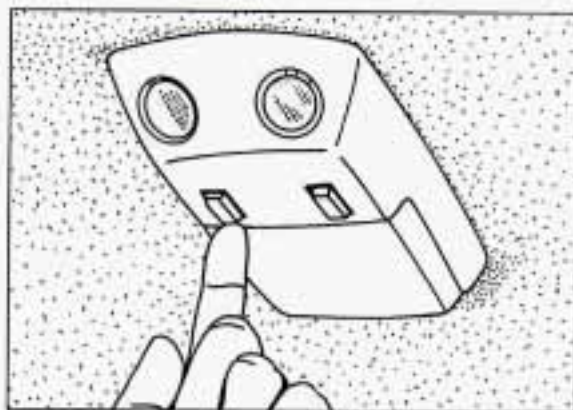

## Rear Interior Lights

The rear dome light also has two reading lights.

The dome light will go on each time you open the doors, unless you turn the interior lights override switch in the center instrument panel console to **OFF**.

To turn on either reading light, press the switch next to it.

There are also two lights in the liftgate to light the rear cargo area. These will come on each time you open the liftgate, unless the interior lights override switch is in the **OFF** position.

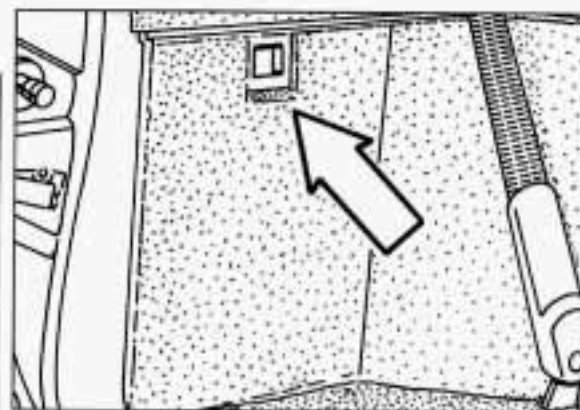

## Accessory Power Outlet

The power outlet is located in the rear compartment on the driver's side. To open, slide the latch down and remove the cover.

The power outlet can be used to plug in electrical equipment such as a cellular telephone, CB radio, etc. Follow the proper installation instructions that are included with any electrical equipment you install.

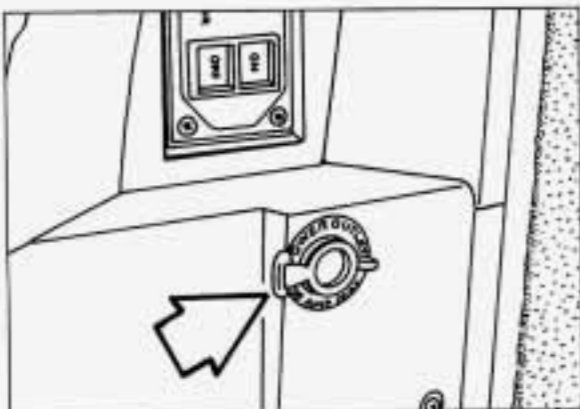

When not in use, always cover the outlet with the protective cap.

### **NOTICE:**

When using the accessory power outlet:

- Maximum load of any electrical equipment should not exceed 20 amps.
- Be sure to turn off any electrical equipment when not in use. Leaving electrical equipment on for extended periods can drain your battery.

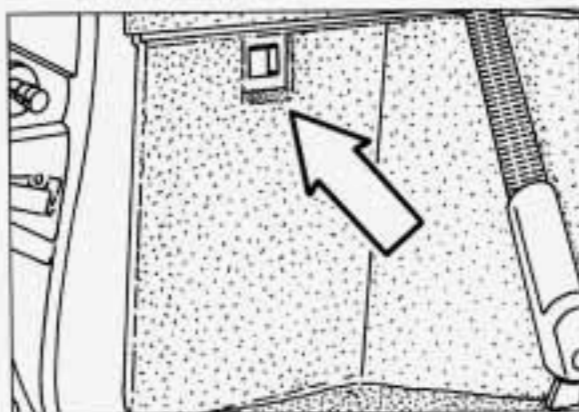

### ■ *Air Inflator System* (OPTION)

Your vehicle may be equipped with an air inflator. With it, you can inflate things like air mattresses and basketballs, and you can also use it to bring your tires up to the proper pressure.

The air inflator is located in the rear compartment on the driver's side. To open, slide the latch down and remove the cover.

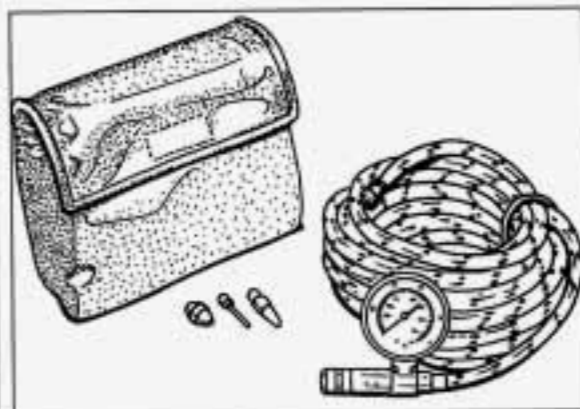

The air inflator kit is stored in a pouch in the glove box. It includes a 20-foot (6 m) hose with an air pressure gage, nozzle adapters and instructions.



### **CAUTION:**

Inflating something too much can make it explode, and you or others could be injured. Be sure to read the inflator instructions, and inflate any object only to its recommended pressure.



## Features & Controls

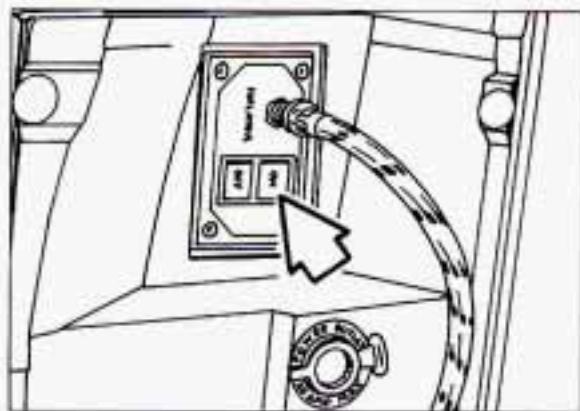

To use your air inflator system, attach the appropriate nozzle adapter, if required, to the end of the hose that has the pressure gage. Then attach that end of the hose to the object you wish to inflate. Attach the other end of the hose to the outlet. Press the **ON** switch. The **ON** switch will work even with the ignition off.

Your air inflator will automatically shut off after about 10 minutes. To reset, press the **ON** switch again.

Don't run your air inflator for longer than 30 minutes at one time. If you do,

you may damage the system. After 30 minutes, wait at least 10 minutes before restarting the air inflator.

To turn off the inflator, press **OFF** and detach the hose, first from the inflated object, then from the outlet. Place the inflator kit tools in the pouch and store it in the glove box.

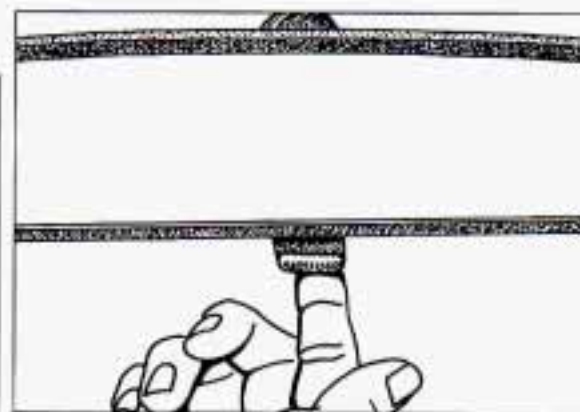

### ■ *Inside Day/Night Rearview Mirror*

To reduce glare from lights behind you, pull the lever toward you to the night position.

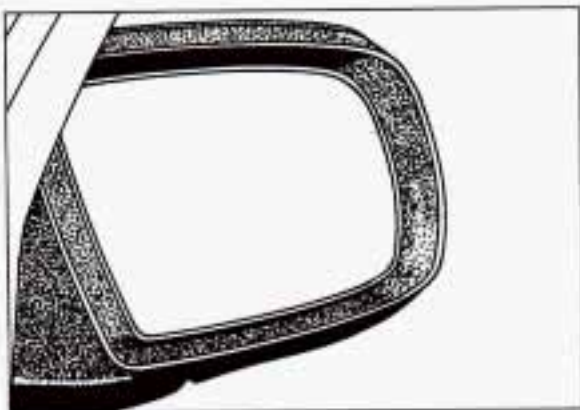

### ■ *Convex Outside Mirror*

Your right side mirror is convex.

A convex mirror's surface is curved so you can see more from the driver's seat.



#### **CAUTION:**

If you aren't used to a convex mirror, you can hit another vehicle. A convex mirror can make things (like other vehicles) look farther away than they really are. If you cut too sharply into the right lane, you could hit a vehicle on your right. Check your inside mirror or glance over your shoulder before changing lanes.

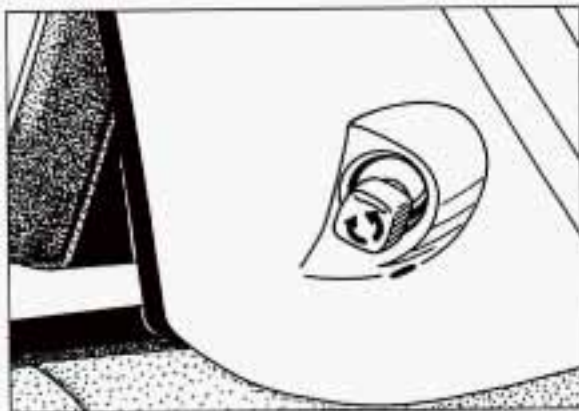

### ■ *Power Remote Control Mirrors*

The control on the driver's door controls both outside rearview mirrors. Turn the control to the left to select the driver side rearview mirror, or to the right to select the passenger side rearview mirror. Then use the control to adjust each mirror so that you can just see the side of your vehicle when you are sitting in a comfortable driving position.

Both outside mirrors can be folded forward or rearward. In the rearward position, they will fold flush with the vehicle. This feature is particularly useful in automatic car washes and when maneuvering your vehicle in narrow spaces.

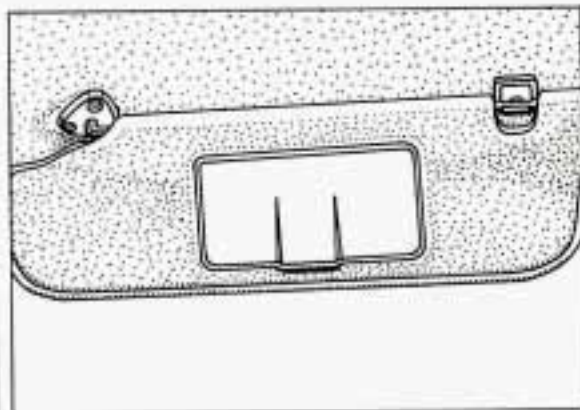

### ■ *Sun Visors*

To block out glare, you can swing down the visors. You can also remove them from the center mount and swing them to the side.

## Features & Controls

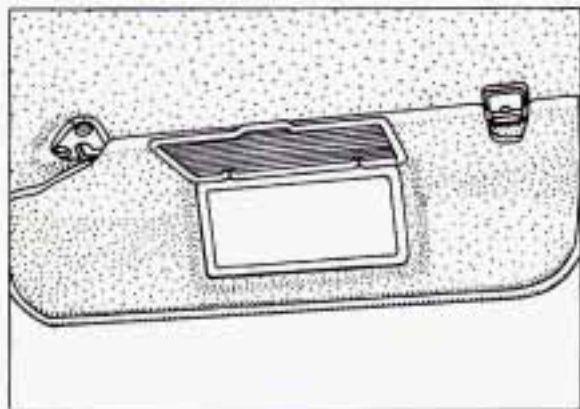

### Visor Vanity Mirrors

Lift the cover to expose the vanity mirror.

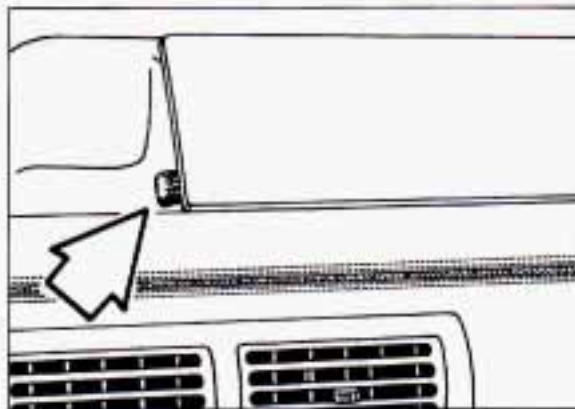

### Glove Box/Storage Compartment

Your vehicle has a storage compartment on top of the dash and a glove box below it.

To open the storage compartment, push in the latch release, then lift the lid.

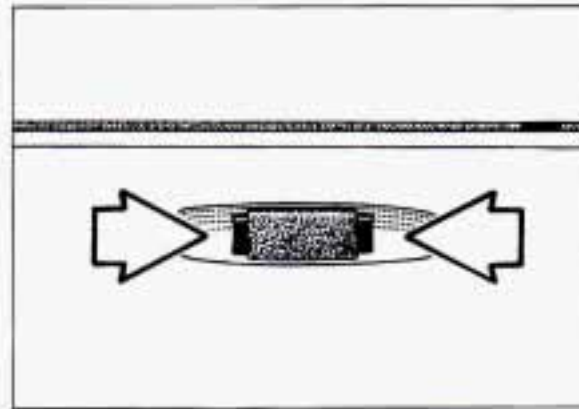

To open the glove box, pinch the latch release.

The fuse panel is located inside the glove box door. See the *Index* under *Fuses & Circuit Breakers*.



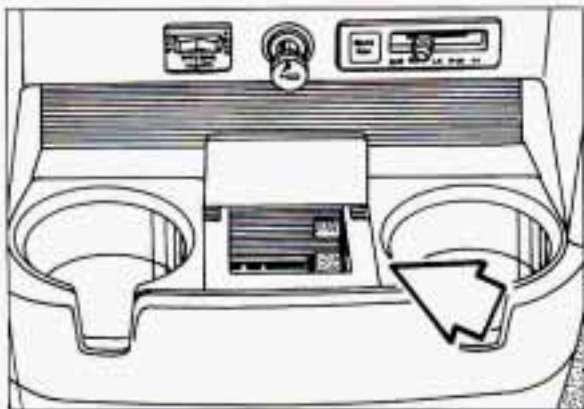

### **Cup Holders/Ashtray/Lighter**

Two cup holders, an ashtray and a lighter are located in the center instrument panel console.

The foam cup holder liners can be removed for cleaning. Should the liners ever become damaged, see your dealer for replacements.

To use the ashtray, lift the lid.

To remove the ashtray for cleaning, close the lid, then grasp the rear edge of the ashtray with your fingertips and pull up and out, in a rocking motion.

To use the lighter, push it in all the way and let go. When it's ready, it will pop back by itself.

#### **NOTICE:**

Don't hold a cigarette lighter in with your hand while it is heating. If you do, it won't be able to back away from the heating element when it's ready. That can make it overheat, damaging the lighter and the heating element.

#### **NOTICE:**

Don't put papers and other things that burn into your ashtrays. If you do, cigarettes or other smoking materials could set them on fire, causing damage.

## Features & Controls

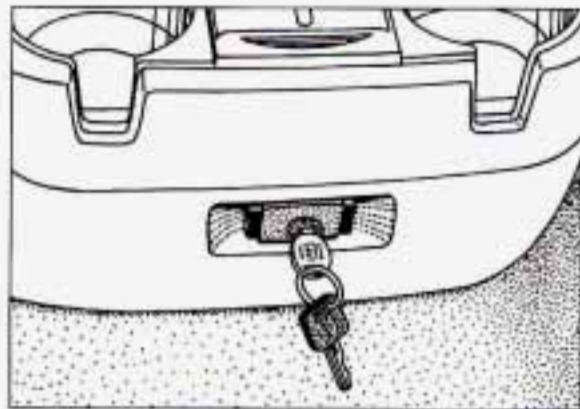

### **Locking Storage Bin**

At the base of the center instrument panel console is a storage bin. Use the door key to lock and unlock it. To open the bin, pinch the latch release.

To remove the bin for cleaning, open it part way, then pull out and slightly up.

To clean the inside of the bin, vacuum or wipe with a slightly damp cloth.

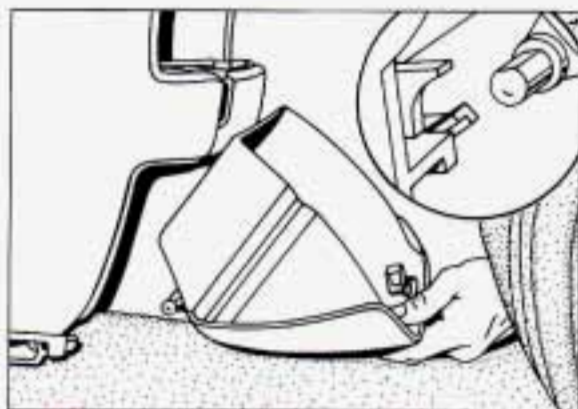

To replace the bin, set the hinge pins (one on each side of the bin, at the bottom) into the hinge guides (one at each side of the console opening, at the base), then close the bin. If the hinge pins are placed properly in the guides, the bin will close easily.

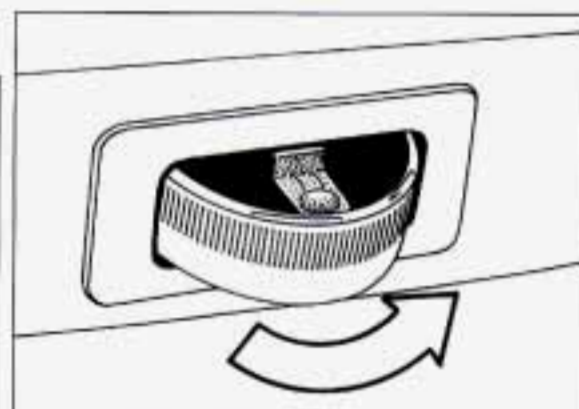

### **Side Ashtrays**

To open the ashtray, press one side and turn it open.

To remove the ashtray for cleaning, press the snuffer as you lift up the bottom of the ashtray.

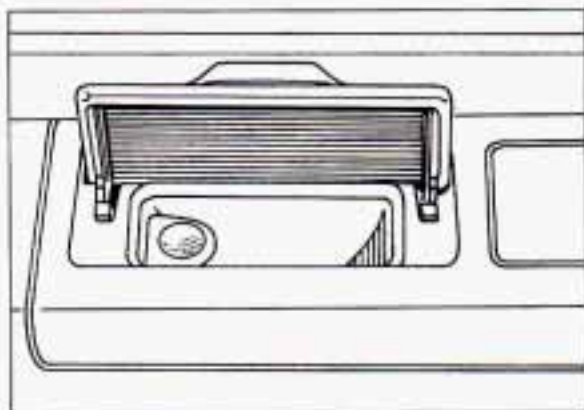

If you have the optional rear climate control, your side ashtray will have a flip-up cover.

To remove the ashtray for cleaning, pull up on the snuffer or the cover.

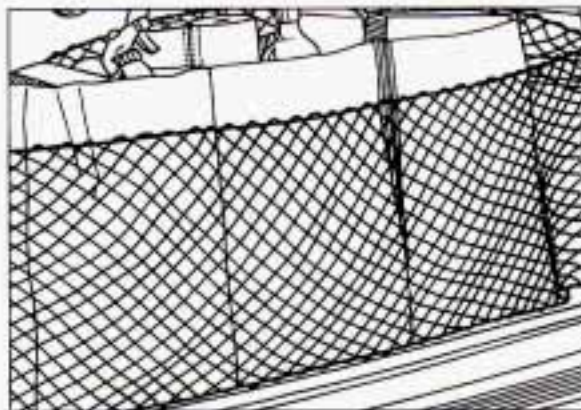

### **Convenience Net (OPTION)**

The optional convenience net is designed to help keep small loads, like grocery bags, from falling over during sharp turns or quick stops and starts.

Install the convenience net at the rear of your vehicle, just inside the liftgate. Attach the upper loops to the posts on either side of the liftgate opening (the label on the net should be in the upper righthand corner). Attach the lower loops to the hooks on the floor.

The side of the convenience net closest to the front of the vehicle is higher than the side closest to the liftgate. Once you've loaded items into the net, stretch the higher side of the net up and over the top of the load to hold it firmly in place.

The convenience net has a maximum capacity of 100 pounds (45 kg). It is not



## Features & Controls

designed to hold larger, heavier loads. Store such loads on the floor of your vehicle, as far forward as you can.

When not in use, we recommend that you take down the convenience net to extend its life and retain its elasticity, and to keep the rear exit clear. Store the net in the pouch behind either front seat.

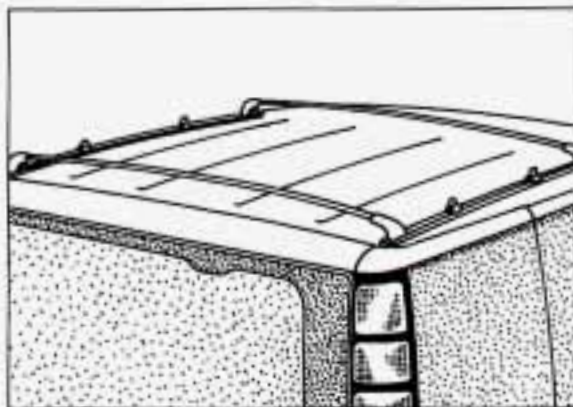

### **Luggage Carrier (OPTION)**

If you have the optional luggage carrier, you can load things on top of your vehicle. The luggage carrier has slats and side rails attached to the roof, sliding crossrails and places to use for tying things down. These let you load some things on top of your vehicle, so long as they are not wider or longer than the luggage carrier.

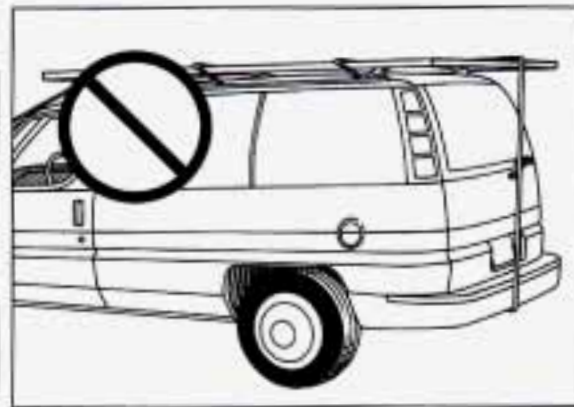

### **CAUTION:**

If you try to carry something on top of your vehicle that is longer or wider than the luggage carrier — like paneling, plywood, a mattress, and so forth — the wind can catch it as you drive along. This can cause you to lose control. What you are carrying could be violently torn off, and this could cause you or other drivers to have a collision, and of course damage your vehicle. You may be able to carry something like this inside. For example, a 4' by

**CAUTION (Continued)**

**CAUTION (Continued)**

8' sheet will fit inside your vehicle. But, never carry something longer or wider than your luggage carrier on top of your vehicle.

**NOTICE:**

Loading cargo that weighs more than 125 pounds (56 kg) on the luggage carrier may damage your vehicle. When you carry cargo on the luggage carrier of a proper size and weight, put it on the slats, as far forward as you can. Then slide the crossrail up against the rear of the load, to help keep it from moving. You can then tie it down.

Don't exceed the maximum vehicle capacity when loading your Oldsmobile. For more information on vehicle capacity and loading, see the *Index* under *Loading Your Vehicle*.

To prevent damage or loss of cargo as you're driving, check now and then to make sure the luggage carrier and cargo are still securely fastened.

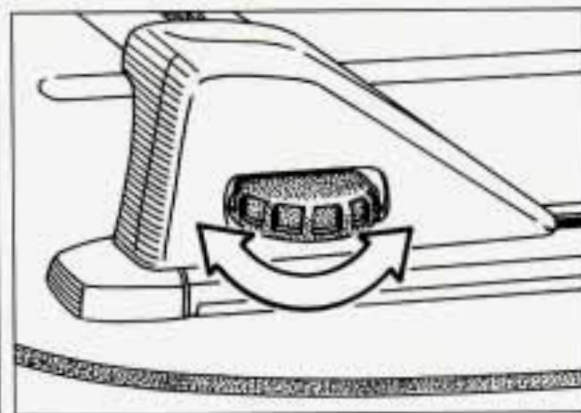

Your luggage carrier has release knobs set in the ends of each crossrail. Turn the release knobs counterclockwise, then slide the crossrails forward or back, as needed, to accommodate loads of varying size.

After repositioning the crossrails, be sure to tighten the release knobs by turning them clockwise, locking the crossrails in place.

## Features & Controls

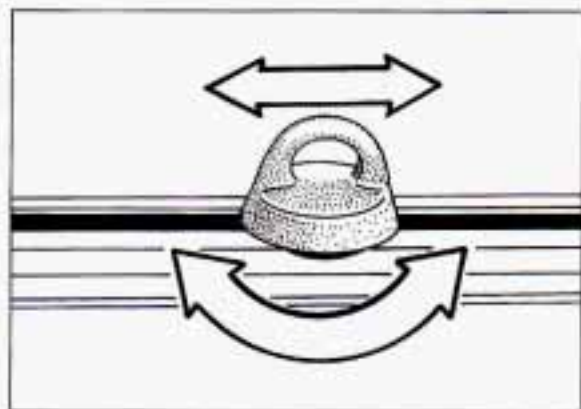

Use the adjustable tiedown loops in the side rails to help secure large loads. Reposition the tiedowns by turning them counterclockwise, then slide them along the side rail. Turn the tiedowns clockwise to tighten them in place.

Tiedowns may be removed and used in the adjustable tapped plates in the crossrails. You may also use these tapped plates to secure bicycle or ski racks.

### **Electronic Level Control (OPTION)**

With this option, the rear of the vehicle automatically adjusts to changes in load weight. (See the *Index* under *Loading Your Vehicle*.)

You may hear the compressor operating when you load or unload your vehicle, and periodically as the system self-adjusts. This is normal.

The compressor should operate for brief periods of time. If the sound continues for an extended period of time, your vehicle needs service. To keep your battery from being drained, you may want to pull the 20-amp ELC fuse in the fuse control panel until you can get your vehicle serviced (see the *Index* under *Fuses & Circuit Breakers*).



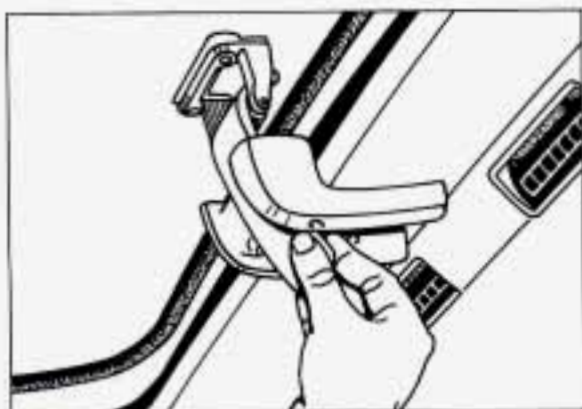

### **Sunroof (OPTION)**

This feature may not be available on your vehicle.

The sunroof has a glass panel that opens for ventilation.

#### **To Open the Sunroof:**

Pull down on the latch release handle and then push it forward and up until the glass panel locks into place.

#### **To Close the Sunroof:**

Pull the latch release handle forward and down, then push it back and up. Press firmly to lock the latch release handle into the closed position.

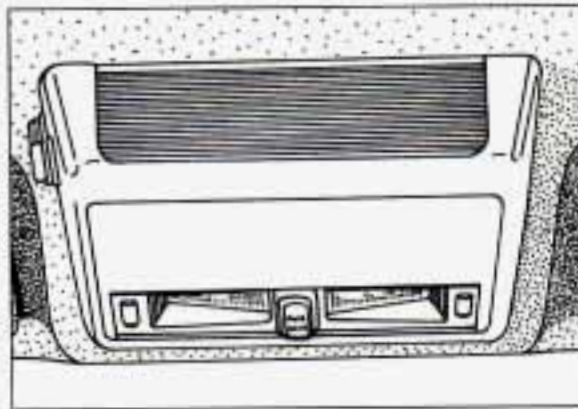

### **Compact Overhead Console**

The standard front overhead console includes two reading lights and a storage compartment.

To turn on or off either reading light, press the switch next to it.

If you have the optional power sliding door, your overhead console will also have two power sliding door switches. To operate these switches, see the *Index* under *Power Sliding Door*.

# Features & Controls

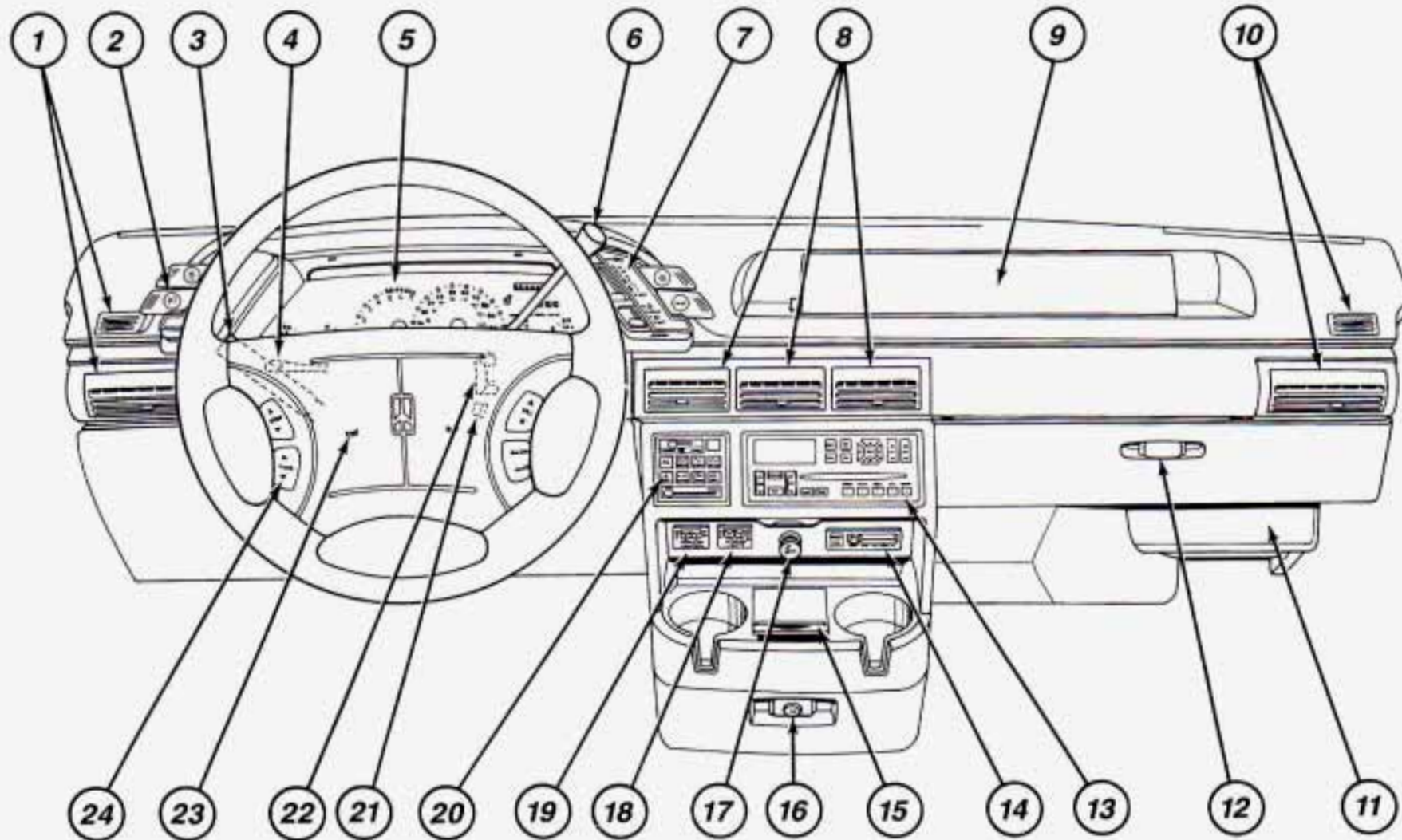

## ***The Instrument Panel—Your Information System***

Your instrument panel is designed to let you know at a glance how your vehicle is running. You'll know how fast you're going, how much fuel you're using, and many other things you'll need to drive safely and economically.

Refer to the accompanying diagram of your instrument panel to locate the components listed below.

1. Side Vents
2. Light Controls
3. Turn Signal/Multifunction Lever
4. Tilt Steering Wheel Lever
5. Instrument Cluster
6. Gearshift Lever
7. Wiper/Washer Controls
8. Center Vents
9. Storage Compartment
10. Side Vents
11. Circuit Breaker/Relay Panel
12. Glove Box/Fuse Panel
13. Audio System
14. Rear Fan Controls
15. Cup Holders/Ashtray
16. Locking Storage Bin
17. Lighter
18. Interior Lights Override Switch
19. Traction Control Switch
20. Climate Controls
21. Hazard Warning Flashers Switch
22. Ignition Switch
23. Horn
24. Steering Wheel Touch Controls (Option)



# Features & Controls

## ■ Instrument Panel Cluster

Your cluster includes indicator warning lights and gages that are explained on the following pages.

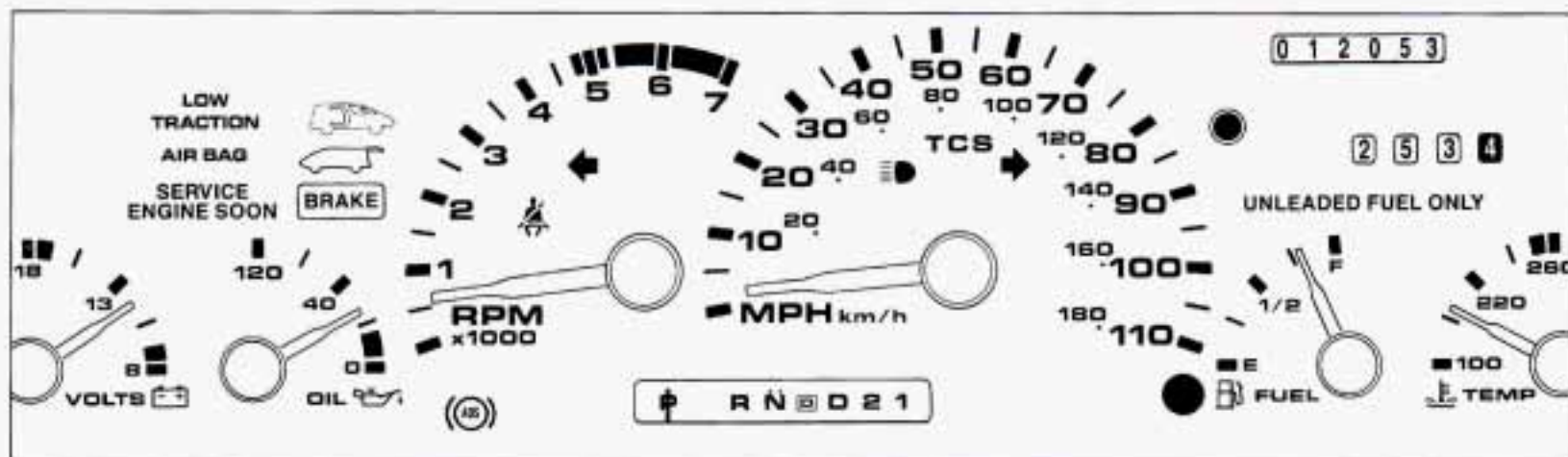

## Speedometer and Odometer

Your speedometer lets you see your speed in both miles per hour (mph) and kilometers per hour (km/h). Your odometer shows how far your vehicle has been driven, in either miles (used in the U.S.) or kilometers (used in Canada).

## Tamper Resistant Odometer

Your Oldsmobile has a tamper resistant odometer. If you see silver lines between the numbers, you'll know that someone has probably tried to turn it back, so the numbers may not be true.

You may wonder what happens if your vehicle needs a new odometer installed. If the new one can be set to the mileage total of the old odometer, then it must be. But if it can't, then it's set at zero and a label must be put on the driver's door to show the old mileage reading when the new odometer was installed.

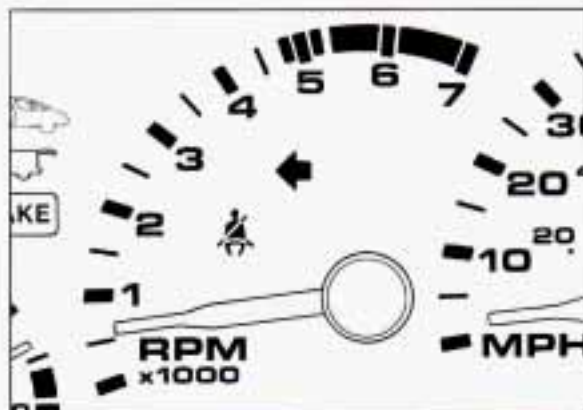

## Tachometer

The tachometer displays the engine speed in revolutions per minute (rpm).

### NOTICE:

Do not operate the engine with the tachometer in the red area, or engine damage may occur.

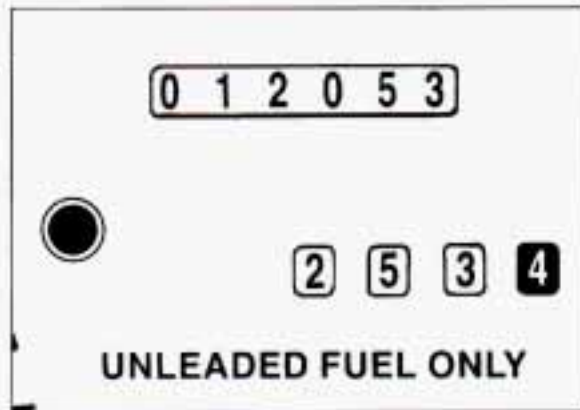

## Trip Odometer

The trip odometer can tell you how far your vehicle has been driven since you last set it to zero. To set it to zero, push the reset button located above the fuel gage.

# Features & Controls

## ■ *Warning Lights, Gages and Indicators*

This section describes the warning lights and gages that may be on your vehicle. The pictures will help you locate them.

Warning lights and gages can signal that something is wrong before it becomes serious enough to cause an expensive repair or replacement. Paying attention to your warning lights and gages could also save you or others from injury.

Warning lights go on when there may be or is a problem with one of your vehicle's functions. As you will see in the details on the next few pages, some warning lights come on briefly when you turn the ignition key just to let you know they're working. If you are familiar with this section, you should not be alarmed when this happens.

Gages can indicate when there may be or is a problem with one of your vehicle's functions. Often gages and warning lights work together to let you know when there's a problem with your vehicle.

When one of the warning lights comes on and stays on when you are driving, or when one of the gages shows there may be a problem, check the section that tells you what to do about it. Please follow the manual's advice. Waiting to do repairs can be costly — and even dangerous. So please get to know your warning lights and gages. They're a big help.

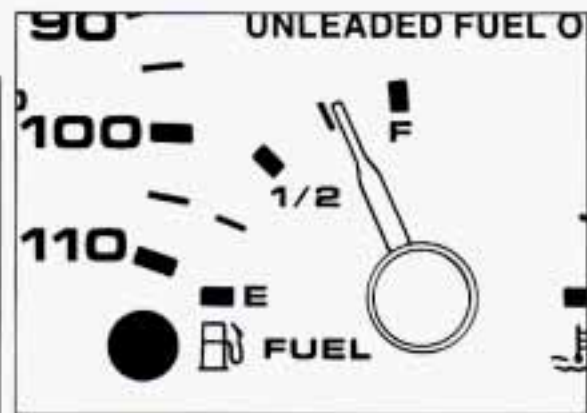

## *Fuel Gage*

Your fuel gage tells you about how much fuel you have left, when the ignition is on. When the gage first indicates **E** (Empty), you still have a little fuel left, but you should get more soon.

Here are four things that some owners ask about. None of these show a problem with your fuel gage:

- At the service station, the gas pump shuts off before the gage reads **F** (Full).
- It takes a little more or less fuel to fill up than the gage indicated. For example, the gage may have indicated the tank was half full, but it actually took a little more or less than half the tank's capacity to fill the tank.



- The gage moves a little when you turn a corner, brake or speed up.
- The gage doesn't go back to E when you turn off the ignition.

For your fuel tank capacity, see *Service Station Information* on the last page of this manual.

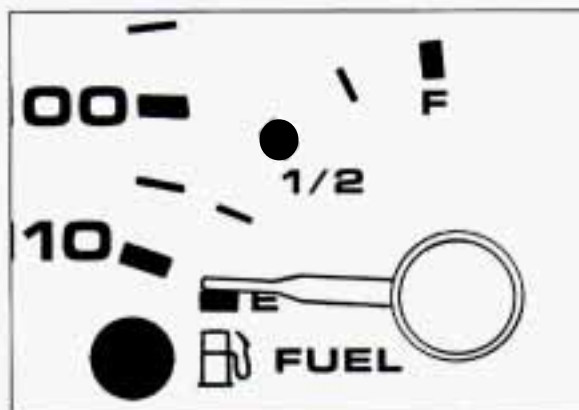

### **Low Fuel Warning Light**

When there is between 3 gallons (11 liters) and 0.5 gallon (1.8 liters) of fuel left in the tank, the warning light next to the fuel symbol will go on.

This light will also come on when you turn on the ignition, but the engine is not running, to show you it is working. If it doesn't come on as you start your vehicle, have it fixed right away.

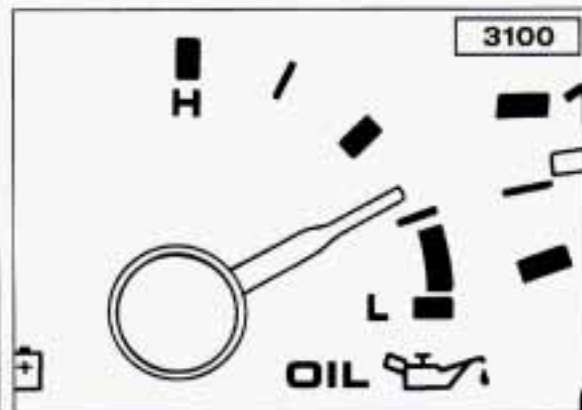

### **Oil Pressure Indicator**

**(3100 V6 ENGINE)**

Your vehicle is equipped with an oil pressure indicator rather than an oil pressure gage. Your oil pressure indicator lets you know when you may have a problem with your engine oil pressure.

When the engine is running, readings within the white graduation band indicate the normal operating range. Readings in or below the red area indicate that the engine's oil level may be dangerously low, or there may be another problem causing low oil pressure.

Driving your vehicle with low oil pressure can cause extensive engine damage. Have your vehicle serviced immediately.

# Features & Controls



## CAUTION:

Don't keep driving if the oil pressure is low. If you do, your engine can become so hot that it catches fire. You or others could be burned. Check your oil as soon as possible and have your vehicle serviced.

## NOTICE:

Damage to your engine from neglected oil problems can be costly and is not covered by your warranty.

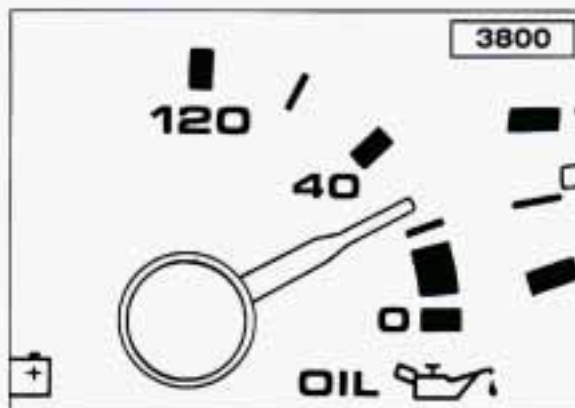

### **Oil Pressure Gage (3800 V6 ENGINE)**

Your oil pressure gage shows the oil pressure in psi (pounds per square inch) when the engine is running. Canadian vehicles indicate pressure in kPa (kilopascals). Oil pressure may vary with engine speed, outside temperature and oil viscosity. In fact, while the engine is warming up, the oil pressure will be higher than at the normal operating temperature. Readings above the red warning zone indicate the normal operating range.

If the gage reads in the red warning zone, your engine's oil level may be dangerously low or there may be another problem causing low oil pressure.

Driving your vehicle with low oil pressure can cause extensive engine damage. Have your vehicle serviced immediately.



## CAUTION:

Don't keep driving if the oil pressure is low. If you do, your engine can become so hot that it catches fire. You or others could be burned. Check your oil as soon as possible and have your vehicle serviced.

## NOTICE:

Damage to your engine from neglected oil problems can be costly and is not covered by your warranty.

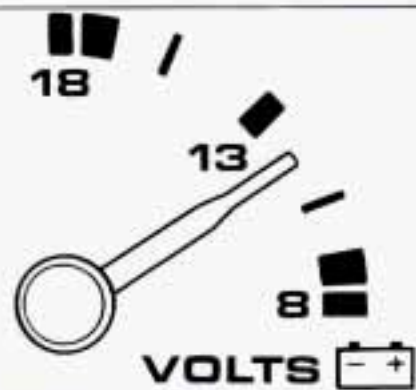

### Voltmeter

Your charging system gage will show the rate of charge when the engine is running.

The reading will change as the rate of charge changes (with the engine speed, etc.), but readings between the red warning zones indicate the normal operating range. Readings in either red zone indicate a possible problem with your charging system. Have your Oldsmobile serviced immediately.

When the engine is not running but the ignition is on (in the **Run** position), the display measures the voltage output of your battery.

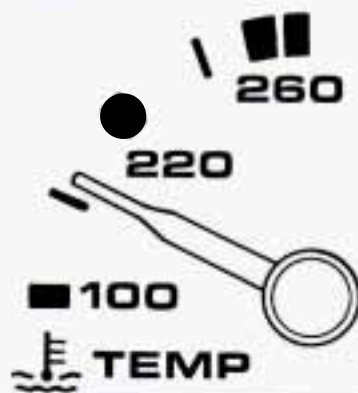

### Engine Coolant Temperature Gage

This gage shows the engine coolant temperature. If the gage pointer moves into the red area, your engine is too hot! It means that your engine coolant has overheated. If you have been operating your vehicle under normal driving conditions, you should pull off the road, stop your vehicle and turn off the engine as soon as possible.

**HOT COOLANT CAN BURN YOU BADLY!**

In *Problems on the Road*, this manual shows what to do. See the *Index* under *Engine Overheating*.



### Brake System Warning Light

Your Oldsmobile's hydraulic brake system is divided into two parts. If one part isn't working, the other part can still work and stop you. For good braking, though, you need both parts working well.

If the warning light comes on, there could be a brake problem. Have your brake system inspected right away.

This light should come on as you start the vehicle. If it doesn't come on then, have it fixed so it will be ready to warn you if there's a problem.

If the light comes on while you are driving, pull off the road and stop carefully. You may notice that the pedal is harder to push. Or, the pedal may go



## Features & Controls

closer to the floor. It may take longer to stop. If the light is still on, have the vehicle towed for service. (See *Towing Your Vehicle* in the *Index*.)



### CAUTION:

Your brake system may not be working properly if the brake system warning light is on. Driving with the brake system warning light on can lead to an accident. If the light is still on after you've pulled off the road and stopped carefully, have the vehicle towed for service.

The brake system warning light will also come on when you set your parking brake, and it will stay on if your parking brake doesn't release fully. If it stays on after your parking brake is fully released, it means you have a brake problem.

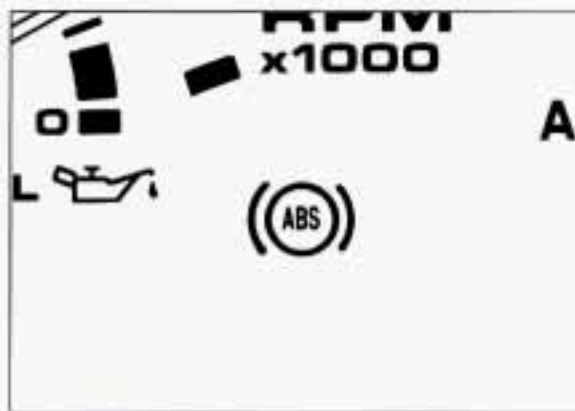

### Anti-Lock Brake System Warning Light

With anti-lock, this light will go on when you start your engine and it will stay on for three seconds. That's normal. If the light doesn't come on, have it fixed so it will be ready to warn you if there is a problem.

If the light flashes when you're driving, you don't have anti-lock brakes and there's a problem with your regular brakes. Pull off the road and stop carefully. You may notice that the pedal is harder to push. Or, the pedal may go closer to the floor. It may take longer to stop. Have the vehicle towed for service. (See *Towing Your Vehicle* in the *Index*.)



### CAUTION:

Your regular brake system may not be working properly if the anti-lock brake system warning light is flashing. Driving with the anti-lock brake system warning light flashing can lead to an accident. After you've pulled off the road and stopped carefully, have the vehicle towed for service.

If the anti-lock brake system warning light stays on longer than normal after you've started your engine, turn the ignition off. Or, if the light comes on and stays on when you're driving, stop as soon as possible and turn the ignition off. Then start the engine again to reset the system. If the light still stays on, or comes on again while you're driving, your Oldsmobile needs service. If the light is on but not flashing and the regular brake system warning light isn't on, you still have brakes, but you don't have anti-lock brakes.



**LOW  
TRACTION**

**AIR BAG**

**SERVICE  
ENGINE SOON**



### **Low Traction Light (OPTION)**

If your vehicle has the traction control system, there will be a **LOW TRACTION** light on the instrument panel. When your anti-lock system is adjusting brake pressure to help avoid a braking skid, or when your traction control system is limiting wheel spin, the **LOW TRACTION** light will come on. Slippery road conditions may exist if this light comes on, so adjust your driving accordingly. The light will come on and stay on for four seconds when your anti-lock system adjusts brake

pressure for less than four seconds or when your traction control system limits wheel spin for less than four seconds. Otherwise, the light will go out as soon as the anti-lock system stops adjusting brake pressure or the traction control system stops limiting wheel spin. The **LOW TRACTION** light also comes on briefly, as a bulb check, when the engine is started.

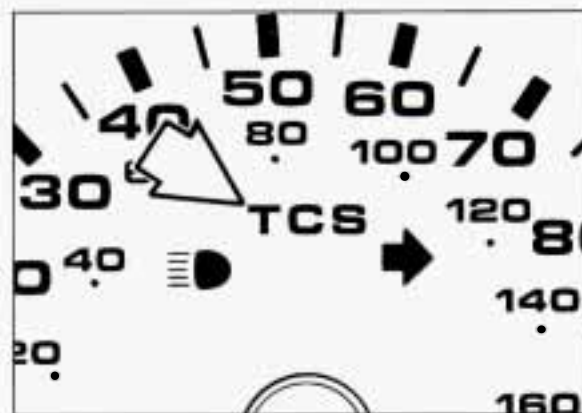

### **Traction Control System Warning Light (OPTION: 3800 V6 ENGINE)**

The **TCS** (Traction Control System) warning light may come on if your brakes overheat. When this warning light is on, the system will not limit wheel spin. Adjust your driving accordingly. This means that your traction control system has temporarily shut down to allow the brakes to cool. (The traction control system will not shut down while it is actively controlling wheel spin.) When the brakes have cooled down, the **TCS** warning light will go off.

If the **TCS** warning light comes on and stays on for an extended period of time, your vehicle needs service.

## Features & Controls



### CAUTION:

If you let your tires spin at high speed when the **TCS** warning light is on, your tires can explode and you or others could be injured. And, spinning your tires with this warning light on can cause the transaxle to overheat or can cause other problems. There could be an engine fire or other damage that you may not be able to see. This damage could cause an accident later. When you're stuck, spin the wheels as little as possible. Don't spin the wheels above 35 mph (55 km/h) as shown on the speedometer.

### NOTICE:

Spinning your wheels when the **TCS** warning light is on can destroy parts of your vehicle as well as the tires. If you spin your wheels too fast while shifting your transaxle back and forth, you can destroy your transaxle. When you're stuck, spin the wheels as little as possible.

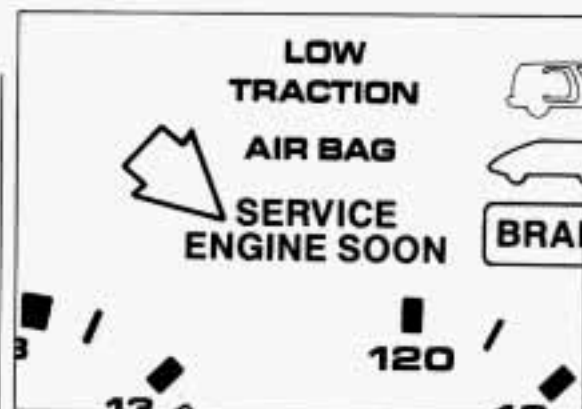

### Malfunction Indicator Lamp (Service Engine Soon Light)

A computer monitors operation of your fuel, ignition and emission controls systems. This light should come on when the ignition is on but the engine is not running, as a check to show you it is working. If it does not come on at all, have it fixed right away. If it stays on, or it comes on while you are driving, the computer is indicating that you have a problem. You should take your vehicle in for service soon.



## NOTICE:

If you keep driving your vehicle with this light on, after a while the emission controls won't work as well, your fuel economy won't be as good and your engine may not run as smoothly. This could lead to costly repairs not covered by your warranty.

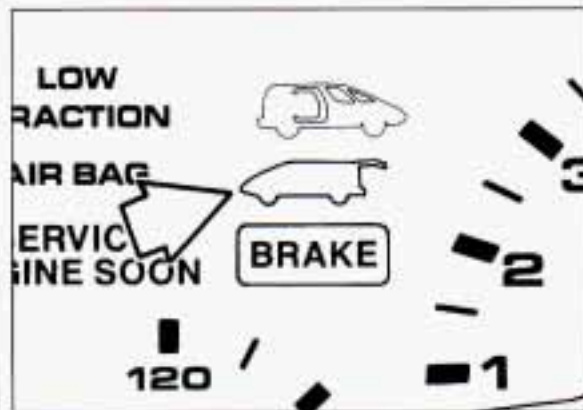

### *Liftgate Ajar Warning Light*

The liftgate ajar symbol on your instrument panel will come on if your liftgate is not completely closed.

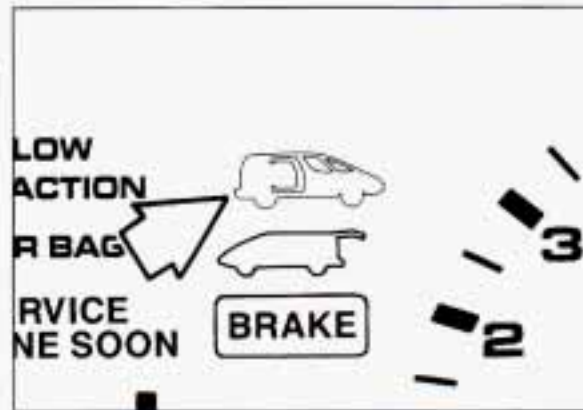

### *Power Sliding Door Warning Light*

With the optional power sliding door, the sliding door ajar symbol on your instrument panel will come on if your sliding door is not completely closed.

If you shift the transaxle out of **P** (Park) while the sliding door is open or in the process of closing, and the power sliding door enable switch is in the **ON** position, the  will flash and a buzzer will sound. This is a warning that the sliding door is not completely closed.

## Features & Controls



### CAUTION:

If you shift the transaxle out of **P** (Park) and accelerate before the power sliding door latches closed, the door may reverse to the open position. A child or others could fall out of the vehicle and be injured. Always make sure the power sliding door is closed and latched before you drive away.

If you manually slam the power sliding door shut when the ignition is on, the  may come on and stay on. To turn the light off, reopen and close the door using either power door switch, or manually open and close the door again more slowly.

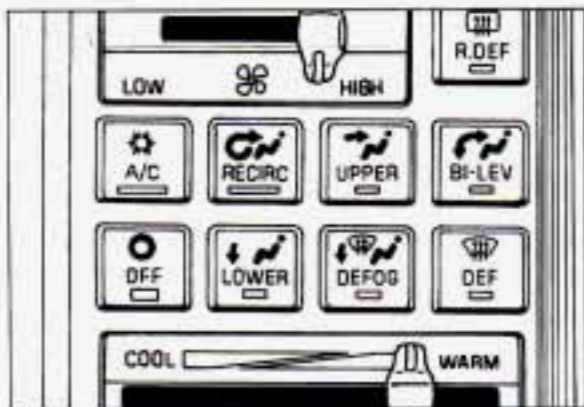

**In this part you'll find out how to operate the comfort control systems and audio systems offered with your Oldsmobile. Be sure to read about the particular system supplied with your vehicle.**

## *Part 3*

### *Comfort Controls & Audio Systems*

Climate Control System.....	110
Rear Climate Control .....	113
Defogging and Defrosting .....	115
Rear Window Defogger.....	115
Setting the Clock.....	117
AM/FM Stereo Radio .....	119
AM/FM Stereo with Cassette Player.....	120
AM/FM Stereo with Cassette Player with Dolby® .....	122
AM/FM Stereo with Compact Disc Player .....	124
Compact Disc Player Anti-Theft Feature.....	126
Steering Wheel Touch Controls.....	127
Understanding Radio Reception.....	128
Care of Your Cassette Tape Player.....	128
Care of Your Compact Discs .....	129
Integrated Roof Antenna .....	129



# Comfort Controls & Audio Systems

## Climate Control System Quick Reference Guide

Your Climate Control System has been designed to provide an expanded range of comfort options. Use this diagram as a quick reference guide for operating the controls.

For a complete explanation of this system, see *Climate Control System*.

FRONT FAN CONTROL LEVER

A/C (Air Conditioning)  
Press to turn the A/C on and off.

OFF  
Press to turn the system off.

FRONT TEMPERATURE CONTROL LEVER

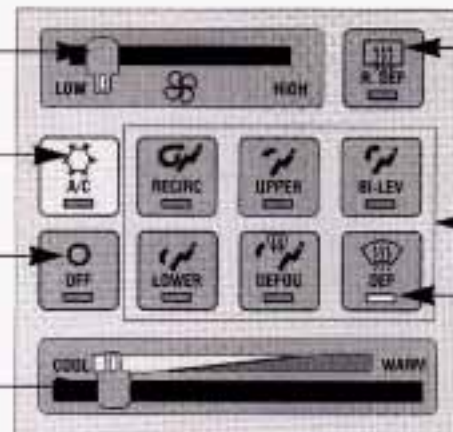

R. DEF (Rear Defog)  
Press to defog the rear window.

DIRECTIONAL CONTROLS

A lighted button lets you know that a selected control is on.

## SUGGESTED OPERATING MODES:

FOR HEAT, USE



FOR VENT (OUTSIDE AIR), USE

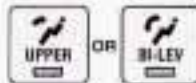

FOR MAX COOLING, USE



FOR OTHER A/C OPTIONS, USE

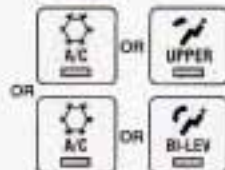

## REAR FAN

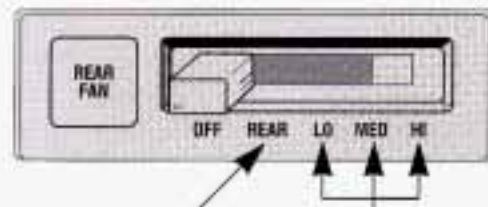

These positions allow the driver to adjust the rear fan speed.

This position transfers control of the rear fan to the second row passenger (for vehicles with the Rear Climate Control option only).

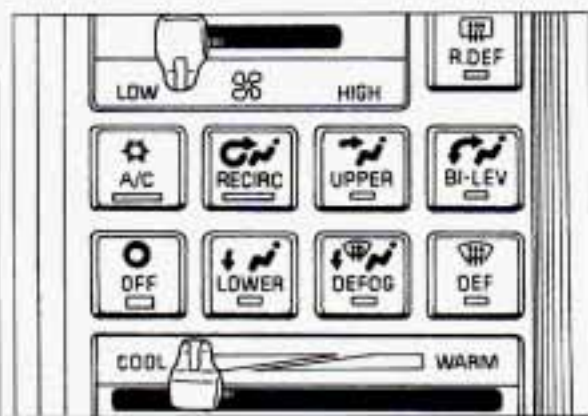

## ■ Climate Control System

Your vehicle's heater and air conditioner work best if you keep your windows closed. Your vehicle also has flow-through ventilation, described later in this section, to bring outside air into your vehicle.

If you have the optional engine coolant heater and use it during cold weather, 0°F (-18°C) or lower, your heating system will more quickly provide heat because the engine coolant is already warmed. See the *Index* under *Engine Coolant Heater*.

**OFF:** Press to turn the system off. Press any climate control setting to turn the system on.

: Slide the lever to the right to

increase fan speed, to the left to decrease fan speed.

**Temperature Control Lever:** Slide the lever to the right for warmer, heated air; slide it to the left for cooled air.

## Air Conditioner

When the temperature outside is above freezing, the air conditioner compressor will automatically condition the air when you press **RECIRC** (the **A/C** indicator light will glow), **DEFOG** or **DEF** (the **A/C** indicator light will not glow).

Press **A/C** (the **A/C** indicator light will glow) to condition the air when you press **UPPER**, **BI-LEV** or **LOWER**. To turn off the air conditioner compressor in these settings, press **A/C** again (the indicator light will go off).

Each time you turn on the ignition, the air conditioner will default to the setting you had selected before last turning off the ignition.

When the air conditioner compressor is on, you may sometimes notice slight changes in your vehicle's engine performance and power. This is normal,

because the system is designed to help fuel economy while it maintains the desired cooling level.

The air conditioner removes moisture from the air, so you may sometimes notice water dripping from under your vehicle when it is idling or after it has been turned off. This is normal.

On very hot days, your vehicle will cool down more quickly and economically if you open the windows long enough to let hot inside air escape. For all settings, adjust the temperature control lever and fan speed as desired.

## Directional Controls

**RECIRC (Recirculate):** Press to get maximum cooling or quick cool-down on very hot days. This setting recirculates much of the air inside your vehicle. It should not be used for long periods of time because the air may become too cold and dry.

Slide the temperature control lever down to the coolest setting and adjust the fan speed as desired.

**UPPER:** For normal cooling on hot days, press **A/C** along with **UPPER**.



## Comfort Controls & Audio Systems

This setting cools outside air and directs it through the instrument panel outlets. Adjust the temperature of the air with the temperature control lever.

**BI-LEV (Bi-Level):** This setting is designed for use on sunny days when the air is only moderately warm or cool. On days like these, the sun may adequately warm your upper body, but your lower body may not be warm enough.

The **BI-LEV** setting directs outside air into your vehicle in two ways. Cooler air is directed toward your upper body through the front instrument panel outlets, while warmed air is directed through the heater ducts at your feet. At times this temperature difference

may be more apparent than others. For best results, slide the temperature control lever to the middle position, and then adjust for comfort.

**LOWER:** This setting brings in most heated air through the heater ducts, and some through the defroster vents.

**DEFOG:** Because of your Silhouette's larger windshield area, this mode is particularly useful during cold or inclement weather. Press to direct warmed air to the windshield and through the heater ducts.

**DEF (Defrost):** Press to direct most warmed air to the windshield and side window vents.

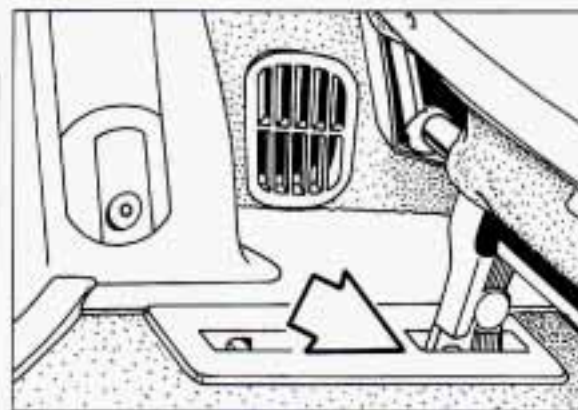

To maximize air flow to the rear of your vehicle, place the left second row bucket seat in the forward position (see the *Index* under *Adjusting Rear Seats*). This uncovers the rear air outlet.

Also keep the area around the base of the center instrument panel console and the area between and under the front seats free of objects that could obstruct air flow to the rear.



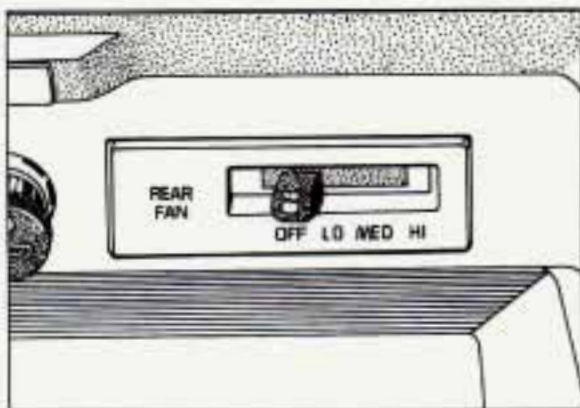

## Rear Fan

The control for the rear fan is located below the audio system. Select **LOWER**, **BI-LEV** or **DEFOG** to direct air flow to the rear air outlet and to the rear side windows.

Use the temperature control lever to adjust the temperature setting. Then, select the force of air you want, from **LO** to **HI**, by sliding the control to the desired setting.

To maintain a comfortable temperature in the rear area without making the front passengers uncomfortable, adjust the front fan speed first, then adjust the temperature setting.

To turn off the rear fan, slide the control to **OFF**.

## ■ Rear Climate Control (OPTION)

If you have this option, you will have a master control for the rear fan on the center instrument panel console, and a rear control next to the rear seat, on the driver side of the vehicle.

To maintain a comfortable temperature in the rear, use either rear fan control to adjust the force of air coming through the rear outlets. See *Rear Fan-Master Control* and *Rear Fan-Rear Control* later in this section. The temperature of heated or cooled air directed to the rear of the vehicle cannot be adjusted with the temperature control lever.

Select the desired climate control mode using the directional controls on the instrument panel (see *Directional Controls* earlier in this section). The mode you choose will regulate both the front and rear climate control systems.

Select **RECIRC**, **UPPER**, **BI-LEV** or **LOWER** when outside temperatures are warm or moderate.

In the **RECIRC** mode, or if you press **A/C** when the system is in the **UPPER** or **BI-LEV** modes, cooled air will be

directed to the rear of the vehicle through the overhead and third-row air conditioning outlets. If you select **A/C** in the **LOWER** mode, cooled air will be directed through the rear floor vent unless the temperature control lever is set more than 25 percent toward full **WARM**. Such settings will produce heated air. So, to receive cooled air through the rear floor vent, set the temperature control lever closer to full **COOL** (see *Rear Air Vents* later in this section).

If you do not select **A/C** in the **UPPER** or **BI-LEV** modes, air directed to the rear of the vehicle will be cabin temperature.

Select **LOWER**, **DEFOG** or **DEF** when outside temperatures are cool. In these modes, heated air will be directed to the rear of the vehicle through the rear side window vents and the rear floor heater vent.

# Comfort Controls & Audio Systems



## Rear Air Vents

To maximize air flow through the rear heater outlet, place the left second row bucket seat in the forward position (see the *Index* under *Adjusting Rear Seats*).

The vent forward of the rear heater outlet is the cold air return vent. Be sure to keep it free of obstructions.

Also keep the area around the base of the center instrument panel console and between and under the front seats free of objects that could obstruct air flow to the rear.

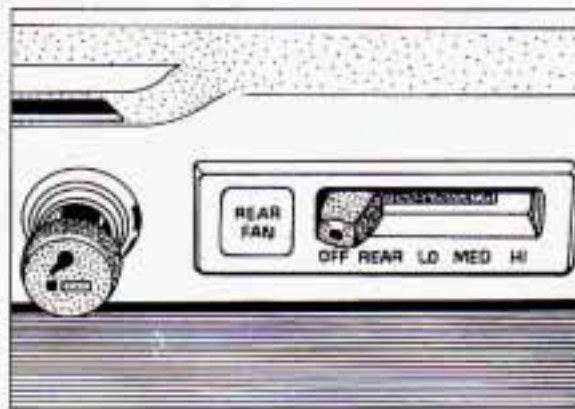

## Rear Fan—Master Control

The master control for the rear fan is located below the audio system.

To maintain a comfortable temperature in the rear area, select the force of air you want, from **LO** to **HI**, by sliding the control to the desired setting.

To transfer control of the rear fan to the rear control switch, slide the master control to **REAR**. The rear control switch will not operate when the master control is in any other position.

To turn off the rear fan, slide the master control to **OFF**.

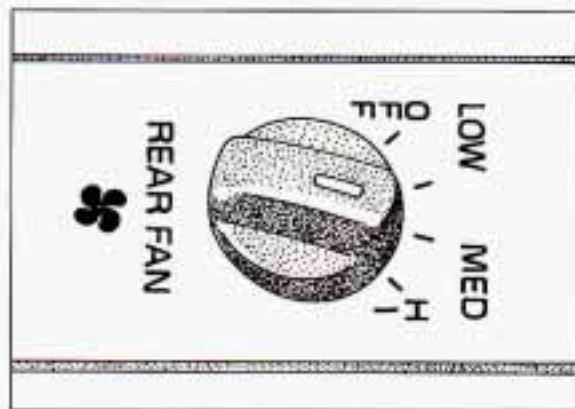

## Rear Fan—Rear Control

This feature allows passengers riding in the rear seats to control the flow of air to the rear area of the vehicle.

The rear control switch is located on the armrest next to the second row seat, left position. The rear fan master control on the instrument panel must be in the **REAR** position for the rear control switch to operate.

Select the force of air you want, from **LOW** to **HI**, by turning the switch to the desired setting. To turn the rear fan off, turn the switch to **OFF**. The rear fan can also be turned off at the master control.



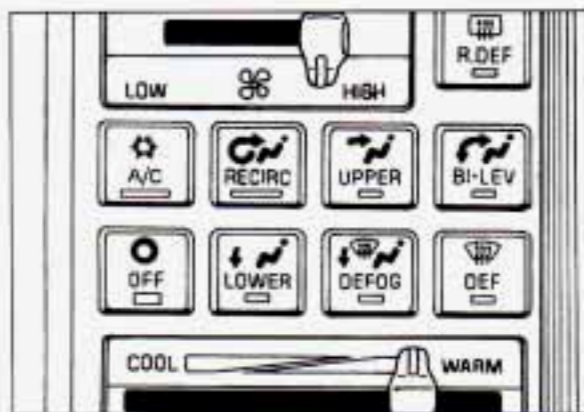

### Defogging and Defrosting

To rapidly defrost the windshield, slide the temperature control lever all the way to **WARM** and press **DEF**. Adjust the fan to the highest speed.

To keep the windshield clear and bring in heated air through the heater ducts, press **DEFOG**.

When the temperature outside is above freezing, the air conditioner compressor will run in these settings to help remove moisture from the air.

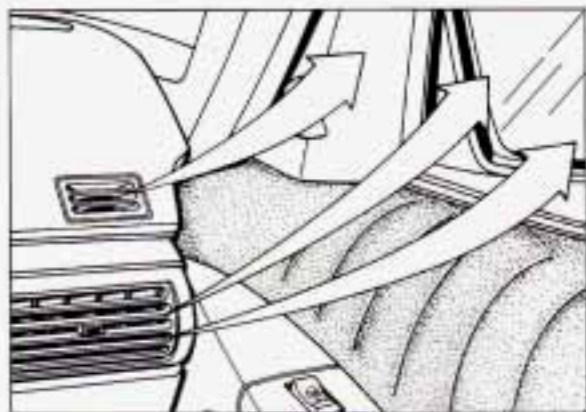

Your vehicle is equipped with side window defogger vents located on the top of the instrument panel. For additional side window defogging, press the **BI-LEV** button and adjust the fan to the highest speed. Aim the side vents on the instrument panel toward the side windows. For increased air flow to the side vents, close the center vents.

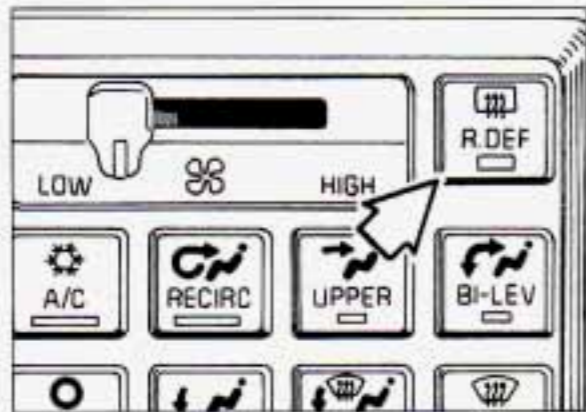

### Rear Window Defogger

Press **R. DEF** (Rear Defog) to warm the defogger grid on the rear window. The indicator light will glow while the rear window defogger is operating. The rear window defogger will turn off automatically after about 10 minutes. If you turn it on again, the defogger will operate for about five minutes only. You can also turn the defogger off by turning off the ignition or pressing the switch again.

Do not attach a temporary vehicle license across the defogger grid on the rear window.



# Comfort Controls & Audio Systems

## NOTICE:

Don't use a razor blade or something else sharp on the inside of the rear window. If you do, you could cut or damage the warming grid, and the repairs wouldn't be covered by your warranty.

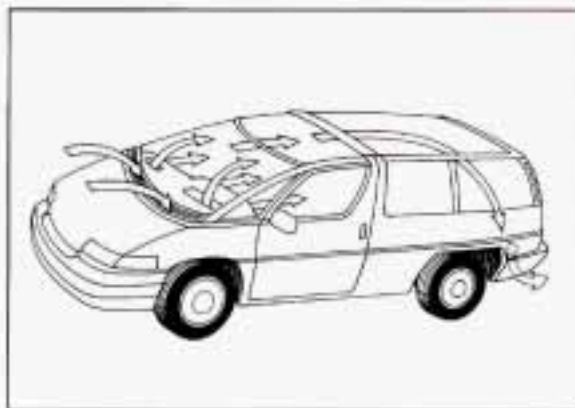

## Flow-Through Ventilation System

Your vehicle's flow-through ventilation system supplies outside air into the vehicle when it is moving. Outside air will also enter the vehicle when the heater or the air conditioning fan is running.

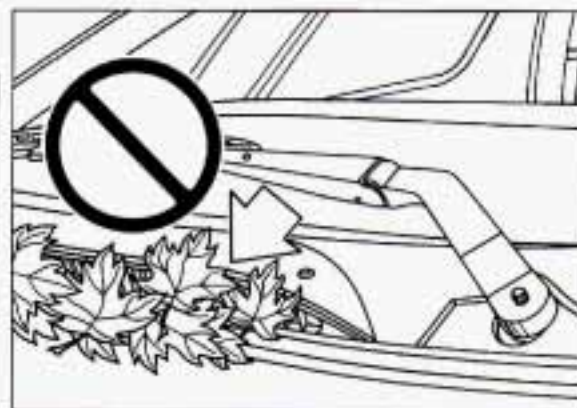

## Ventilation Tips:

- Keep the hood and front air inlet free of ice, snow, or any other obstruction (such as leaves). The heater and defroster will work far better, reducing the chance of fogging the inside of your windows.
- When you enter a vehicle in cold weather, turn the blower fan to **HIGH** for a few moments before driving off. This helps clear the intake ducts of snow and moisture, and reduces the chance of fogging the inside of your windows.
- Keep the area around the base of the center instrument panel console and the air path under the front seats clear of objects. This helps air to circulate throughout your vehicle.

## ■ *Audio Systems*

The following pages describe the audio systems available for your Oldsmobile, and how to get the best performance from them. Please read about the system in your vehicle.

Hearing damage from loud noise is almost undetectable until it is too late. Your hearing can adapt to higher volumes of sound. Sound that seems normal can be loud and harmful to your hearing. Take precautions by adjusting the volume control on your radio to a safe sound level before your hearing adapts to it.

To help avoid hearing loss or damage:

1. Adjust the volume control to the lowest setting.
2. Increase volume slowly until you hear comfortably and clearly.

### **NOTICE:**

Before you add any sound equipment to your vehicle — like a tape player, CB radio, mobile telephone or two-way radio — be sure you can add what you want. If you can, it's very important to do it properly. Added sound equipment may interfere with the operation of your vehicle's engine, Delco® radio or other systems, and even damage them. And, your vehicle's systems may interfere with the operation of sound equipment that has been added improperly. So, before adding sound equipment, check with your dealer and be sure to check Federal rules covering mobile radio and telephone units.

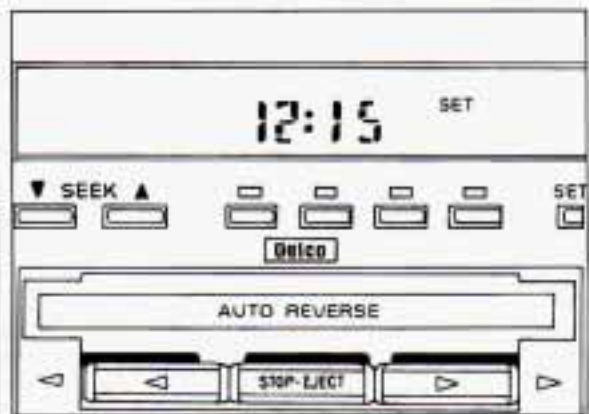

### **Setting the Clock**

For radios with ▼ **SEEK** ▲:

1. With the radio on or off, press **SET**. The **SET** indicator will appear on the digital display for five seconds. You must begin to set the clock to the correct hour and minute during those five seconds.
2. Press and hold ▼ **SEEK** until the correct hour appears on the display.
3. Press and hold **SEEK** ▲ until the correct minute appears on the display.

# Comfort Controls & Audio Systems

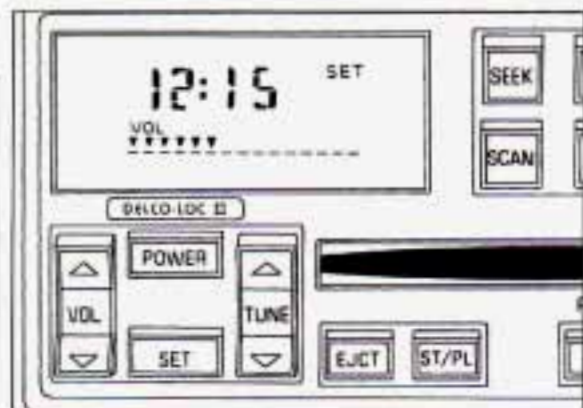

For radios with **SEEK** and **SCAN** buttons:

1. With the radio on or off, press **SET**. The **SET** indicator will appear on the digital display for five seconds. You must begin to set the clock to the correct hour and minute during those five seconds.
2. Press and hold **SEEK** until the correct hour appears on the display.
3. Press and hold **SCAN** until the correct minute appears on the display.

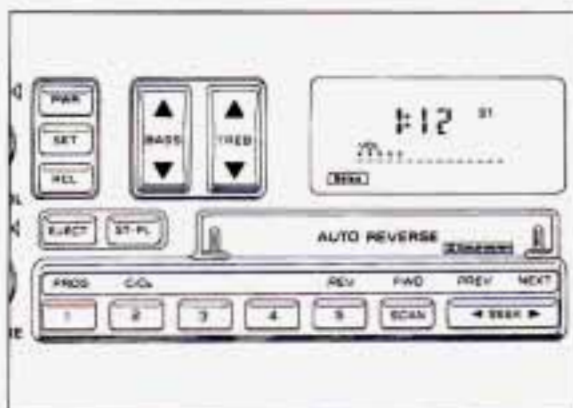

For radios with **< SEEK >** and **SCAN**:

1. With the radio on or off, press **SET**. The **SET** indicator will appear on the digital display for five seconds. You must begin to set the clock to the correct hour and minute during those five seconds.

2. Press and hold **SCAN** until the correct hour appears on the display.
3. Press and hold **< SEEK or SEEK >** until the correct minute appears on the display.



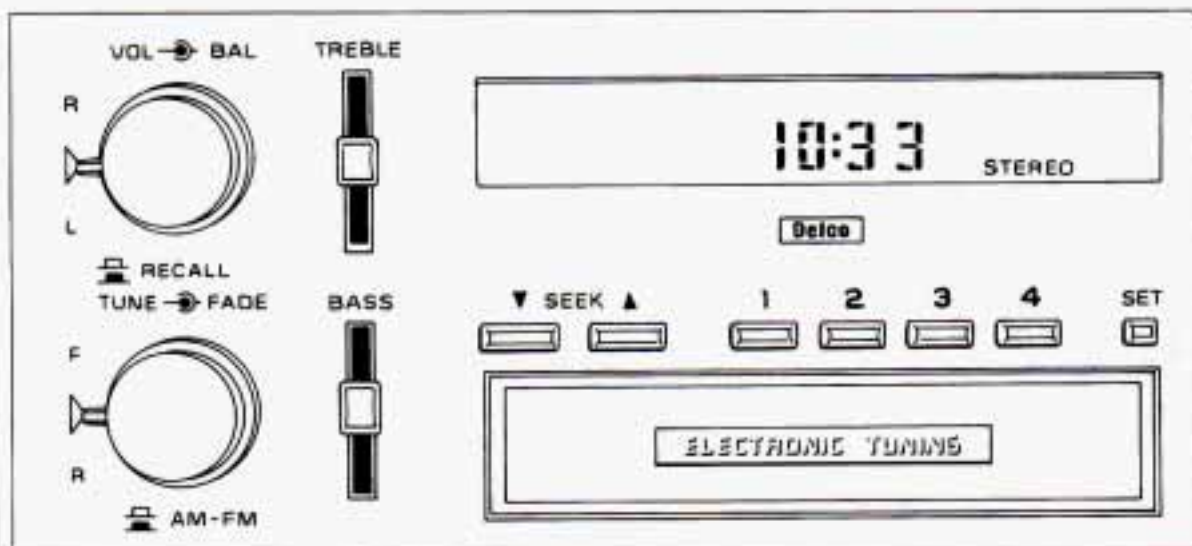

## AM/FM Stereo Radio

The digital display indicates information on time or radio station frequency, the AM or FM radio band, whether the station is in stereo, and other radio functions.

**Upper Knob (VOL):** This knob does four things:

- Turn it to turn the system on and off (your ignition must be on).
- Turn it to control the volume.
- When the radio is on, press it to recall the station frequency to the digital display screen.

- When the ignition is off, press it to display the clock.

**BAL (Balance):** The control ring behind the upper knob adjusts the left/right speaker balance.

**Lower Knob (TUNE):** This knob does two things:

- Turn it to tune in radio stations.
- Press it to change between the AM and FM bands (the digital screen will momentarily display AM or FM, and indicate if the station is in stereo).

**FADE:** The control ring behind the lower knob adjusts the front/rear speaker balance.

**▼SEEK▲:** Press to seek and stop on the next station higher or lower on the radio band.

You can also use the **SEEK** buttons to scan radio stations up or down the AM or FM bands.

To scan stations up the band, press and hold **SEEK▲**, then press **▼SEEK**, then release both buttons. The radio will go to the next station and pause there for a few seconds. It will continue to scan until you press either **SEEK** button.

To scan stations down the band, press and hold **▼SEEK**, then press **SEEK▲**, then release both buttons. The radio will go to the next station and pause there for a few seconds. It will continue to scan until you press either **SEEK** button.

**TREBLE:** Slide this lever up to increase treble, or down to decrease it. If a station is weak or noisy, reduce the treble.

**BASS:** Slide this lever up to increase bass, or down to decrease it.

# Comfort Controls & Audio Systems

## To Preset Radio Stations:

1. Tune in the desired station.
2. Press **SET**. The word **SET** will appear on the digital screen for five seconds.
3. While **SET** is displayed, press one of the four pushbuttons.
4. Repeat steps 1-3 for each of four AM and four FM stations.

Up to three additional stations on each band may be preset by "pairing" pushbuttons:

1. Tune in the desired station.
2. Press **SET**, and within five seconds press any two adjacent pushbuttons at the same time.
3. The station can be tuned in when the same two pushbuttons are pressed at the same time.

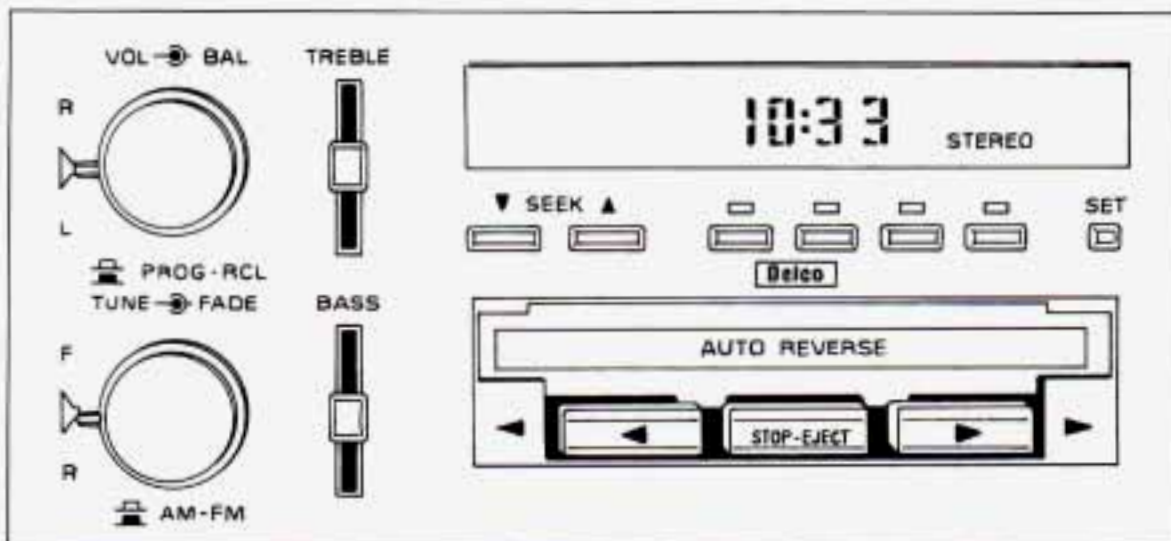

## AM/FM Stereo with Cassette Player

The digital display indicates information on time or radio station frequency, the AM or FM radio band, whether the station is in stereo, and other radio functions.

**Upper Knob (VOL):** This knob does five things:

- Turn it to turn the system on and off (your ignition must be on).
- Turn it to control the volume.
- When the radio is on, press it to recall the station frequency to the digital display screen.

- When the ignition is off, press it to display the clock.
- When a tape is playing, press it to hear the other side of the tape.

**BAL (Balance):** The control ring behind the upper knob adjusts the left/right speaker balance.

**Lower Knob (TUNE):** This knob does two things:

- Turn it to tune in radio stations.
- Press it to change between the AM and FM bands (the digital screen will momentarily display AM or FM, and indicate if the station is in stereo).

**FADE:** The control ring behind the lower knob adjusts the front/rear speaker balance.

**TREBLE:** Slide this lever up to increase treble, or down to decrease it. If a station is weak or noisy, reduce the treble.

**BASS:** Slide this lever up to increase bass, or down to decrease it.

**▼SEEK▲:** Press to seek and stop on the next station higher or lower on the radio band.

You can also use the **SEEK** buttons to scan radio stations up or down the AM or FM bands.

To scan stations up the band, press and hold **SEEK▲**, then press **▼SEEK**, then release both buttons. The radio will go to the next station and pause there for a few seconds. It will continue to scan until you press either **SEEK** button.

To scan stations down the band, press and hold **▼SEEK**, then press **SEEK▲**, then release both buttons. The radio will go to the next station and pause there for a few seconds. It will continue to scan until you press either **SEEK** button.

### To Preset Radio Stations:

1. Tune in the desired station.
2. Press **SET**. The word **SET** will appear on the digital screen for five seconds.
3. While **SET** is displayed, press one of the four pushbuttons.
4. Repeat steps 1-3 for each of four AM and four FM stations.

Up to three additional stations on each band may be preset by "pairing" pushbuttons:

1. Tune in the desired station.
2. Press **SET**, and within five seconds press any two adjacent pushbuttons at the same time.
3. The station can be tuned in when the same two pushbuttons are pressed at the same time.

### To Play a Cassette Tape:

With the power switch on, insert a tape into the cassette door. Do not use tapes that are longer than 45 minutes on each side.

When the right indicator arrow is lit, selections listed on the bottom side of

the cassette are playing. When the left arrow is lit, selections listed on the top side of the cassette are playing. To change sides of the tape while the cassette is playing, press the upper knob. When the end of a tape is reached, the other side will then play.

**Fast Forward:** Press the button with the arrow pointing in the same direction that the tape is playing. To stop fast forward, lightly press the **STOP-EJECT** button.

**Reverse:** Press the button with the arrow pointing in the opposite direction that the tape is playing. To stop reverse, lightly press the **STOP-EJECT** button.

**STOP-EJECT:** To stop playing a tape, fully press this button (the cassette will be partially ejected, and the radio will begin playing).



# Comfort Controls & Audio Systems

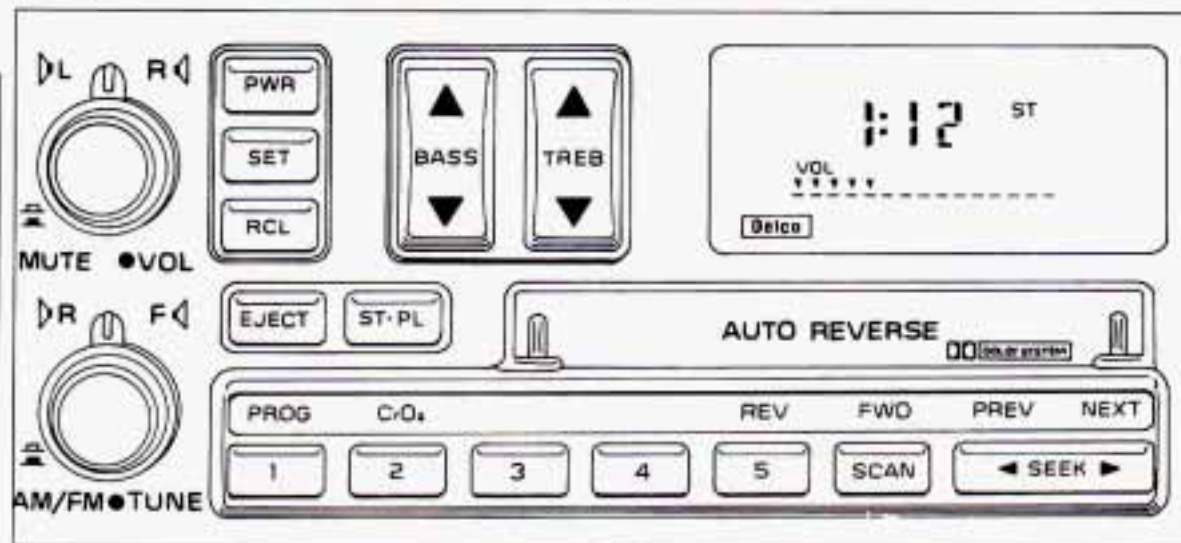

## AM/FM Stereo with Cassette Player with Dolby®

The digital display indicates information on time or radio station frequency, the AM or FM radio band, whether the station is in stereo, and other radio functions.

**PWR (Power):** Press to turn the unit on and off when the ignition is on.

**Upper Knob (VOL):** This knob does two things:

- Turn it slightly to the left or right to control the volume.
- Press it to mute the radio or tape player. Press again to listen.

**Balance:** Turn the control ring behind the upper knob slightly to the left or right to adjust the left/right speaker balance.

**Lower Knob (TUNE):** This knob does two things:

- Turn it slightly to the left or right to tune in radio stations. If you hold it to the left or right, it will tune rapidly. You can also turn it one stop at a time to fine-tune a specific frequency.
- Press it to change between the AM and FM bands. The band you select will appear momentarily on the digital display.

**Fade:** Turn the control ring behind the lower knob slightly to the left or right to adjust the front/rear speaker balance.

**SEEK:** Press to seek and stop on the next station higher or lower on the radio band.

**SCAN:** When you press **SCAN**, the radio will go to the next station and pause there for a few seconds. **SCAN** will display on the digital screen. Press **SCAN** again to stop on a station.

**RCL (Recall):** When the ignition is off, press to display the clock. When the radio is on, press to change between the clock and radio station frequency displayed on the digital screen.

**BASS:** Adjusts the bass level up or down. The bottom of the digital screen will display the level you have selected. For a normal listening level preset at the factory, press the center of the switch.

**TREB (Treble):** Adjusts the treble level up or down. The bottom of the digital screen will display the level you have selected. For a normal listening level preset at the factory, press the center of the switch.



The five pushbuttons under the cassette entry door can be used to preset up to 10 radio stations (five AM and five FM stations). The buttons have other uses when you are playing a tape (see *To Play a Cassette Tape* later in this section).

#### To Preset Radio Stations:

1. Tune in the digital display to the station you want.
2. Press **SET**. The **SET** indicator will appear on the digital screen for five seconds.
3. While the **SET** indicator is displayed, press one of the five pushbuttons.
4. Repeat steps 1-3 for each of five AM and five FM stations.

#### To Play a Cassette Tape:

Press **PWR** to turn the radio on. The radio will play until a cassette is pushed into the cassette entry door (the tape side goes in first). Do not use tapes that are longer than 90 minutes (45 minutes on each side).

This audio system has automatic  **DOLBY B NR**<sup>®</sup> to reduce background noise on Dolby encoded tapes. Dolby<sup>®</sup> Noise Reduction is manufactured under license from Dolby Laboratories Licensing Corporation. Dolby<sup>®</sup> and the  symbol are trademarks of Dolby Laboratories Licensing Corporation.

**PROG (Program):** Press to change the side of tape being played. When the end of a tape is reached, the other side will then play.

**CrO<sub>2</sub>:** This button sets tape bias. When playing high bias chrome or metal tapes, press the button to turn the CrO<sub>2</sub> display on. When playing standard tapes, press again to turn the display off.

**REV (Reverse):** Press to reverse the tape rapidly; lightly press again or lightly press **PROG** to play the tape. (The radio plays while a tape is rewinding.)

**FWD (Fast Forward):** Press to advance the tape rapidly; lightly press again or lightly press **PROG** to play a tape. (The radio plays while a tape is advancing.)

**PREV (Previous):** Press **PREV** to repeat a passage. The tape will back up and stop at the first four-second quiet spot in the tape, or when you press **PREV** again or **PROG**.

**NEXT:** Press to go to the next selection on the tape. The tape will stop at the first four-second quiet spot in the tape, or if you press **NEXT** again or **PROG**.

**ST-PL (Stop-Play):** Press to switch from the tape to the radio. Press again to resume playing the tape.

**EJECT:** Press to eject the cassette tape (the radio will then play). Tapes can be ejected when the ignition is off.



# Comfort Controls & Audio Systems

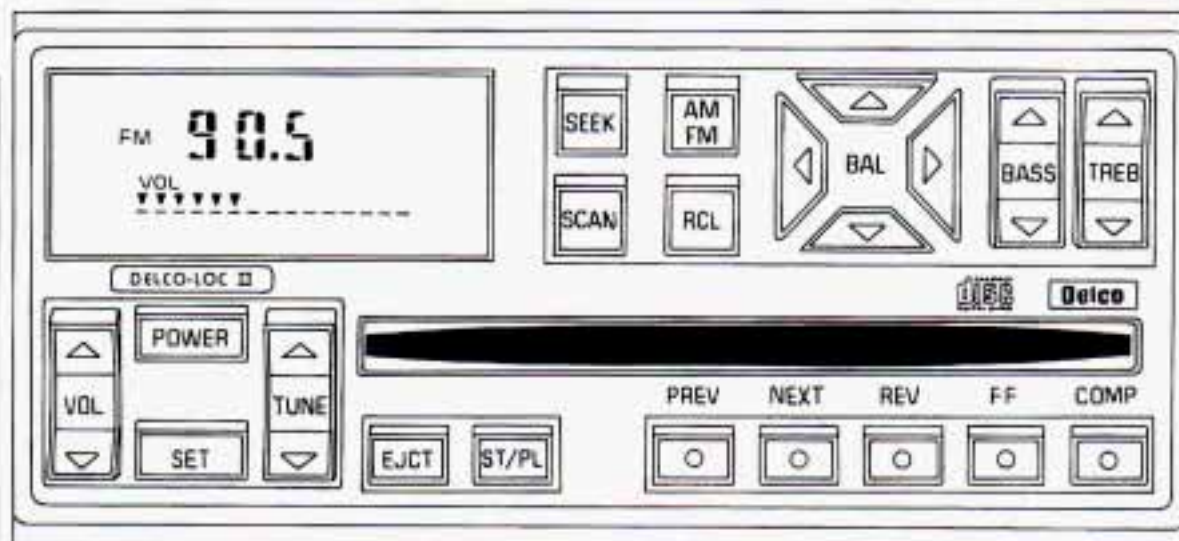

## AM/FM Stereo with Compact Disc Player

The digital display indicates information on time or radio station frequency, the AM or FM radio band, whether the station is in stereo, and other radio functions.

**POWER:** Turns the unit on and off when the ignition is on.

**VOL (Volume):** Adjusts the volume up or down, and the bottom of the digital screen displays the setting. For a normal listening level preset at the factory, press the center of the switch.

**TUNE:** Press the top of the switch to tune in radio stations higher on the AM or FM band. Press the bottom to tune in stations lower on the band.

**BASS:** Adjusts the bass level up or down. The bottom of the digital screen will display the level you have selected. For a normal listening level preset at the factory, press the center of the switch.

**TREB (Treble):** Adjusts the treble level up or down. The bottom of the digital screen will display the level you have selected. For a normal listening level preset at the factory, press the center of the switch.

**BAL (Balance):** Adjusts the left/right and front/rear speaker balance to your individual taste. When you change either adjustment, the bottom of the digital screen will display the point of balance you have selected. For the normal setting preset at the factory, press the left and right or front and rear buttons at the same time.

## Radio Controls

**AM/FM:** Press to select either the AM or FM radio band. The band you select will be displayed on the digital screen. The frequency of the station will be displayed, and if the station is in stereo, the **ST** (Stereo) indicator will also be displayed.

Your radio has AMAX. With an AMAX-certified receiver, your radio can produce quality AM sound comparable to FM stereo. AMAX reduces noise without reducing the high frequencies you need for the best sound. In addition to improved sound quality, AMAX includes more stations on the AM band. You don't have to do anything to your Delco/GM radio because AMAX is automatic.



**SEEK:** Press **SEEK** to tune in and stop on the next station on the AM or FM radio band.

**SCAN:** When you press **SCAN**, the radio will go to the next station and pause there for a few seconds. **SCAN** will display on the digital screen. Press **SCAN** again to stop on a station.

**RCL (Recall):** When the ignition is off, press to display the clock. When the radio is on, press to change between the clock and the radio station frequency displayed on the digital screen.

The five pushbuttons in the lower right corner can be used to preset up to ten radio stations (five AM and five FM stations). These buttons have other uses when you are playing a compact disc (see *Compact Disc Controls* later in this section).

#### **To Preset Radio Stations:**

1. Tune the digital display to the station you want.
2. Press **SET**. The **SET** indicator will appear on the digital screen for five seconds.
3. While the **SET** indicator is displayed, press one of the five pushbuttons.

4. Repeat steps 1-3 for each of five AM and five FM stations.

#### **Compact Disc Controls**

Many of the controls for the radio also have functions for the compact disc player, as explained here.

#### **To Play a Compact Disc:**

Don't use mini-discs that are called singles. They won't eject. Use only full-size compact discs.

1. Press **POWER** to turn the radio on.
2. Insert a disc part-way into the slot, with the label side up. The player will pull it in. In a few seconds, the disc should play.

If the disc comes back out:

- The disc may be upside down.
- The disc may be dirty, scratched or wet.
- There may be too much moisture in the air (wait about one hour and try again).
- The player may be too hot, or the road may be too rough for the disc to play. If the word **HOT** appears on the display, the player is too hot. Press

**RCL** to remove **HOT** from the display. As soon as things get back to normal, the disc should play.

While a disc is playing, the **CD** indicator is displayed on the digital screen, as is the clock.

**RCL (Recall):** Press once to see which track is playing. Press again within five seconds to see how long your selection has been playing. The track number also will be displayed when the volume is changed or a new track starts to play.

**PREV (Previous):** Press to play a track again. If you hold or keep pressing the **PREV** button, the disc will keep backing up to previous tracks.

**NEXT:** Press when you want to hear the next track before the track you are listening to has finished. If you hold or keep pressing the **NEXT** button, the disc will keep advancing to other tracks.

**REV (Reverse):** Press and hold to rapidly back up to a favorite passage. Release to resume playing.

**FF (Fast Forward):** Press and hold to rapidly advance the disc. Release to resume playing.

# Comfort Controls & Audio Systems

**COMP (Compression):** Press this button to make soft and loud passages more equal in volume. Press again to resume normal play.

## When Finished with the Compact Disc Player:

If you press **POWER** or turn off the ignition, the disc will stay in the player and start again when you turn on the ignition or power switch. The disc will begin playing at the point where it had been stopped.

**ST/PL (Stop/Play):** Press to stop the disc player; the radio will play. Press again to play the disc (the player will start playing the disc where it was stopped earlier).

**EJCT (Eject):** Press to eject the disc; the radio will play.

## CD Player Anti-Theft Feature

Delco LOC II<sup>®</sup> is a security feature for the compact disc player. It can be used or ignored. If ignored, the system plays normally. If it is used, your player won't be usable if it is ever stolen, because it

will go to **LOC** mode any time battery power is removed. Until an **unLOC** code is entered, it will not turn on.

The instructions below tell you how to enter a secret code into the system. If your vehicle loses battery power for any reason, you must unlock the system with the secret code before the radio will turn on.

## To Set the Anti-Theft System:

1. Write down any six-digit number and keep it in a safe place.
2. Turn the ignition to the **Accessory** or **Run** position.
3. Press the **POWER** button to turn the radio off.
4. Press the **PREV** and **FF** buttons together. Hold them down until “- - -” shows on the display (at least five seconds). You are ready to enter your secret code.

**NOTE:** If you allow more than 15 seconds to elapse between any steps, the radio automatically reverts to time and you must start the procedure over at step 4.

5. Press **SET** and **000** will appear on the display.
6. Press and hold **SEEK** until the first digit of your code appears.
7. Press and hold **SCAN** until the second and third digits of your code appear.
8. Press **AM/FM** and **000** will appear again. Now you are ready to enter the last three digits of your code.
9. Repeat steps 6 and 7 for the last three digits of your code.
10. Press **AM/FM** and **rEP** will appear.
11. Repeat steps 6 through 10. This time **SEC** will appear, indicating that the radio is secure. If “- - -” appears, the steps were not successful and you must repeat the entire procedure.

## To Unlock the System After a Power Loss:

When battery power is reapplied to a secured radio, the radio won't turn on and **LOC** will appear on the display. Enter your secret code as follows; pause no more than 15 seconds between steps.



1. Turn the ignition on. (Radio off.)
2. Press the **SET** button. The display will show **000**.
3. Enter the six digits of the code following steps 6-9 above. The display will show the numbers as entered.
4. Press the **AM/FM** button and the time appears, indicating that the disabling sequence was successful. If the display indicates **SEC**, the numbers did not match and the unit is still secured.

#### Disabling the Anti-Theft System:

1. Press **PREV** and **FF** together for five seconds with the ignition on and radio power off. The display will show **SEC**, indicating the unit is in the secure mode. (If "--" appears on the display, the anti-theft system has already been disabled.)
2. Press the **SET** button. The display will show **000**.
3. Enter the first three digits of the code following steps 6 and 7 of the preceding paragraphs. The display

will show the numbers as entered.

4. Press **AM/FM**. The radio will display **000**.
5. Repeat steps 6 and 7 to enter the second three digits of the code. The display will show the numbers as entered.
6. Press **AM/FM**. If "--" then the time appears, the disabling sequence was successful (the numbers matched the secret code) and the unit is in the **UNSECURED** mode. If the display shows **SEC**, the disabling sequence was unsuccessful (the numbers did not match) and the unit will remain in the **SECURED** mode.

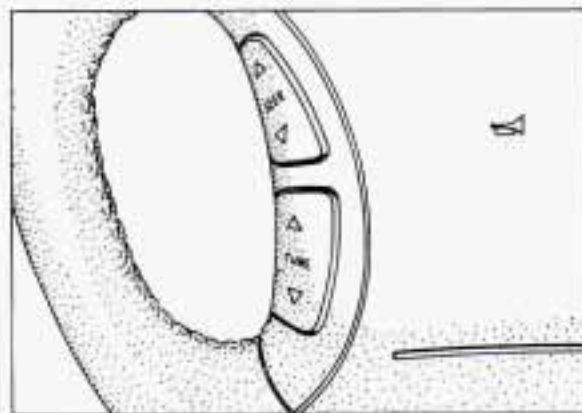

#### Steering Wheel Touch Controls (OPTION)

Some audio system functions can be operated with these controls.

**▲SEEK▼**: Press **▲** to seek and stop on the next station higher on the radio band; press **▼** to seek and stop on the next station lower on the radio band.

If you are listening to a cassette tape or compact disc, press **▲** to skip to the next selection; press **▼** to return to the previous selection.

**▲TUNE▼**: Press **▲** to tune in radio stations higher on the AM or FM band; press **▼** to tune in stations lower on the band.



# Comfort Controls & Audio Systems

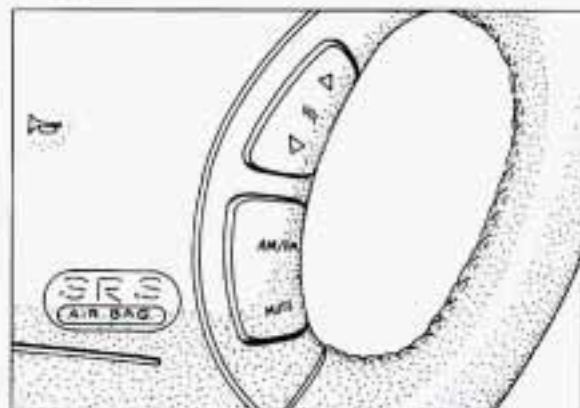

**▲VOL▼ (Volume):** Press ▲ to increase volume; press ▼ to decrease volume.

**AM/FM:** Press to change between the AM and FM radio bands.

**MUTE:** Whether you are listening to the radio, a cassette tape or a compact disc, this switch allows you to turn off the sound without turning off the power. Press again to restore the sound.

## Understanding Radio Reception

### FM Stereo

FM stereo will give you the best sound, but FM signals will reach only about 10 to 40 miles (16 to 65 km). Tall buildings or hills can interfere with FM signals, causing the sound to come and go.

### AM

The range for most AM stations is greater than for FM, especially at night. The longer range, however, can cause stations to interfere with each other. AM can also pick up noise from things like storms and power lines. To lower this noise, try reducing the treble level.

### AM Stereo

Your Delco® system may be able to receive C-Quam® stereo broadcasts. Many AM stations around the country use C-Quam® to produce stereo, though some do not. C-Quam® is a registered trademark of Motorola, Inc. If your Delco® system can get C-Quam® signals, your stereo indicator light will come on when you are receiving it.



## Care of Your Cassette Tape Player

A tape player that is not cleaned regularly is subject to reduced sound quality, ruining the cassette, or damaging the mechanism. Tape cassettes that are not properly stored in their plastic cases away from contaminants, direct sunlight, and extreme heat may not operate properly and could cause premature failure of the tape player.

Your tape player should be cleaned monthly or with every 15 hours of use, as regular maintenance. If you notice a reduction in sound quality, try a good cassette to see if the tape or the tape player is at fault. If the second cassette

results in no improvement in sound quality, try cleaning the tape player.

Proper tape player cleaning should be done with a **wiping action** nonabrasive cleaner cassette. To properly clean your tape player, you should follow the directions on the cleaning cassette.

Cassettes are subject to wear and the sound quality may degrade over time. Always verify that the cassette tape is in good condition before obtaining service on your tape player.



### **Care of Your Compact Discs**

Handle discs carefully. Store them in their original cases or other protective cases and away from direct sunlight and dust. If the surface of a disc is soiled, dampen a clean, soft cloth in a mild, neutral detergent solution and clean it, wiping from the center to the edge.

Be sure never to touch the signal surface when handling discs. Pick up discs by grasping the outer edges or the edge of the hole and the outer edge.

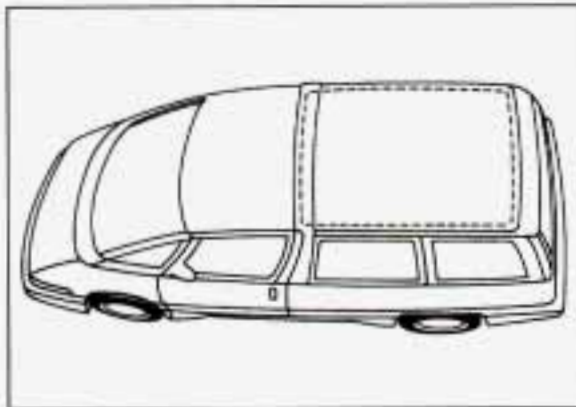

### **Integrated Roof Antenna**

Your state-of-the-art integrated roof antenna is not visible. It is located between the roof and headliner of your vehicle, covering the entire roof area from the rear edge of the front doors to the liftgate.

#### **NOTICE:**

Don't mount anything to your roof, such as an antenna or a luggage carrier, or to your headliner. If you puncture the roof or headliner, you could damage or destroy your integrated roof antenna. Have any work of this type done by your dealer.

## *Comfort Controls & Audio Systems*

If you want to add a mobile phone or two-way radio to your vehicle, there are special precautions you'll need to take because of your integrated roof antenna. See the *Index* under *Adding Sound Equipment*.





**Here you'll find information about driving on different kinds of roads and in varying weather conditions. We've also included many other useful tips on driving.**

## *Part 4*

### *Your Driving and the Road*

Defensive Driving.....	132
Drunken Driving.....	132
Control of a Vehicle	
Braking.....	134
Anti-Lock Brakes.....	135
Traction Control System.....	137
Steering Tips.....	138
Steering in Emergencies.....	139
Passing.....	140
Driving at Night.....	142
Driving in the Rain.....	143
City Driving.....	145
Freeway Driving.....	145
Hill and Mountain Roads.....	147
Winter Driving.....	148
Towing a Trailer.....	151

# Your Driving and the Road

## ■ *Defensive Driving*

The best advice anyone can give about driving is: Drive defensively.

Please start with a very important safety device in your Oldsmobile: Buckle up. (See *Safety Belts* in the *Index*.)

Defensive driving really means “be ready for anything.” On city streets, rural roads, or freeways, it means “always expect the unexpected.”

Assume that pedestrians or other drivers are going to be careless and make mistakes. Anticipate what they might do. Be ready for their mistakes.

Rear-end collisions are about the most preventable of accidents. Yet they are common. Allow enough following distance. It's the best defensive driving maneuver, in both city and rural driving. You never know when the vehicle in front of you is going to brake or turn suddenly.

## ■ *Drunken Driving*

Death and injury associated with drinking and driving is a national tragedy. It's the number one contributor to the highway death toll, claiming thousands of victims every year. Alcohol takes away three things that anyone needs to drive a vehicle:

- Judgment
- Muscular Coordination
- Vision

Police records show that almost half of all motor vehicle-related deaths involve alcohol — a driver, a passenger or someone else, such as a pedestrian, had been drinking. In most cases, these deaths are the result of someone who was drinking and driving. About 20,000 motor vehicle-related deaths occur each year because of alcohol, and thousands of people are injured.

Just how much alcohol is too much if a person plans to drive? Ideally, no one should drink alcohol and then drive. But if one does, then what's “too much”? It can be a lot less than many might think. Although it depends on

each person and situation, here is some general information on the problem.

The Blood Alcohol Content (BAC) of someone who is drinking depends upon four things:

- How much alcohol is in the drink.
- The drinker's body weight.
- The amount of food that is consumed before and during drinking.
- The length of time it has taken the drinker to consume the alcohol.



According to the American Medical Association, a 180-pound (82 kg) person who drinks three 12-ounce (355 ml) bottles of beer in an hour will end up with a BAC of about 0.06 percent. The person would reach the same BAC by drinking three 4-ounce (120 ml) glasses of wine or three mixed drinks if each had 1½ ounces (45 ml) of a liquor like whiskey, gin or vodka.

It's the amount of alcohol that counts. For example, if the same person drank three double martinis (3 ounces or 90 ml of liquor each) within an hour, the person's BAC would be close to 0.12 percent. A person who consumes food just before or during drinking will have a slightly lower BAC level.

### ***Drinking That Will Result in a BAC of .05% in the Time Shown***

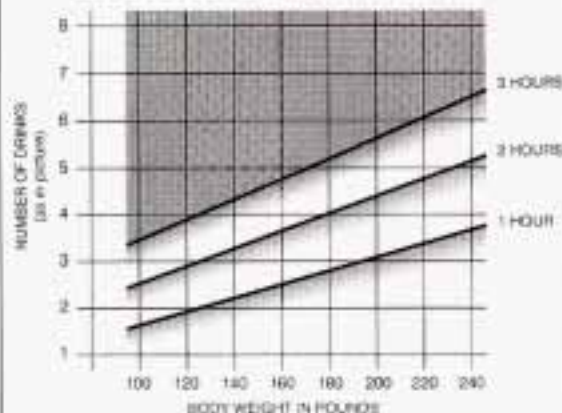

The law in most U.S. states sets the legal limit at a BAC of 0.10 percent. In Canada the limit is 0.08 percent, and in some other countries it's lower than that. The BAC will be over 0.10 percent after three to six drinks (in one hour). Of course, as we've seen, it depends on how much alcohol is in the drinks, and how quickly the person drinks them.

But it's very important to keep in mind that the ability to drive is affected well below a BAC of 0.10 percent. Research shows that the driving skills of many people are impaired at a BAC

approaching 0.05 percent, and that the effects are worse at night. All drivers are impaired at BAC levels above 0.05 percent. Statistics show that the chance of being in an accident increases sharply for drivers who have a BAC of 0.05 percent or above. A driver with a BAC level of 0.06 percent (three beers in one hour for a 180-pound or 82 kg person) has doubled his or her chance of having an accident. At a BAC level of 0.10 percent, the chance of that driver having an accident is six times greater; at a level of 0.15 percent, the chances are twenty-five times greater! And, the body takes about an hour to rid itself of the alcohol in one drink. No amount of coffee or number of cold showers will speed that up.

"I'll be careful" isn't the right answer. What if there's an emergency, a need to take sudden action, as when a child darts into the street? A person with a higher BAC might not be able to react quickly enough to avoid the collision. There's something else about drinking and driving that many people don't



know. Medical research shows that alcohol in a person's system can make crash injuries worse. That's especially true for brain, spinal cord and heart injuries. That means that if anyone who has been drinking — driver or passenger — is in a crash, the chance of being killed or permanently disabled is higher than if that person had not been drinking. And we've already seen that the chance of a crash itself is higher for drinking drivers.



### CAUTION:

Drinking and then driving is very dangerous. Your reflexes, perceptions, and judgment will be affected by even a small amount of alcohol. You could have a serious — or even fatal — accident if you drive after drinking. Please don't drink and drive or ride with a driver who has been drinking. Ride home in a cab, or if you're with a group, designate a driver who will not drink.



### ■ *Control of a Vehicle*

You have three systems that make your vehicle go where you want it to go. They are the brakes, the steering and the accelerator. All three systems have to do their work at the places where the tires meet the road.

Sometimes, as when you're driving on snow or ice, it's easy to ask more of those control systems than the tires and road can provide. That means you can lose control of your vehicle.

### ■ *Braking*

Braking action involves **perception time** and **reaction time**.

First, you have to decide to push on the

brake pedal. That's **perception time**. Then you have to bring up your foot and do it. That's **reaction time**.

Average **reaction time** is about  $\frac{1}{4}$  of a second. But that's only an average. It might be less with one driver and as long as two or three seconds or more with another. Age, physical condition, alertness, coordination, and eyesight all play a part. So do alcohol, drugs and frustration. But even in  $\frac{1}{4}$  of a second, a vehicle moving at 60 mph (100 km/h) travels 66 feet (20 m). That could be a lot of distance in an emergency, so keeping enough space between your vehicle and others is important.

And, of course, actual stopping distances vary greatly with the surface of the road (whether it's pavement or gravel); the condition of the road (wet, dry, icy); tire tread; and the condition of your brakes.

Avoid needless heavy braking. Some people drive in spurts — heavy acceleration followed by heavy braking — rather than keeping pace with traffic. This is a mistake. Your brakes may not have time to cool between hard stops. Your brakes will wear out much faster if

you do a lot of heavy braking. If you keep pace with the traffic and allow realistic following distances, you will eliminate a lot of unnecessary braking. That means better braking and longer brake life.

If your engine ever stops while you're driving, brake normally but don't pump your brakes. If you do, the pedal may get harder to push down. If your engine stops, you will still have some power brake assist. But you will use it when you brake. Once the power assist is used up, it may take longer to stop and the brake pedal will be harder to push.

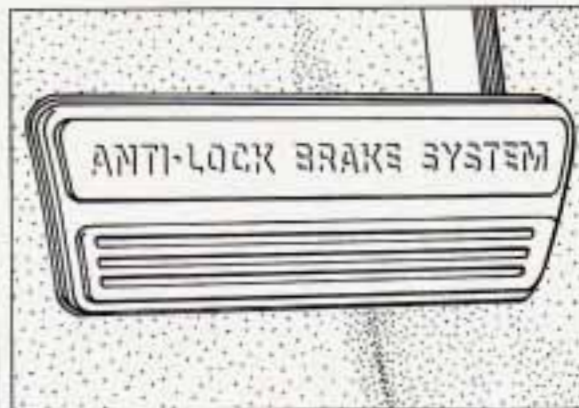

### ***Anti-Lock Brakes (ABS)***

Your Oldsmobile has an advanced electronic braking system that will help prevent skidding.



## Your Driving and the Road

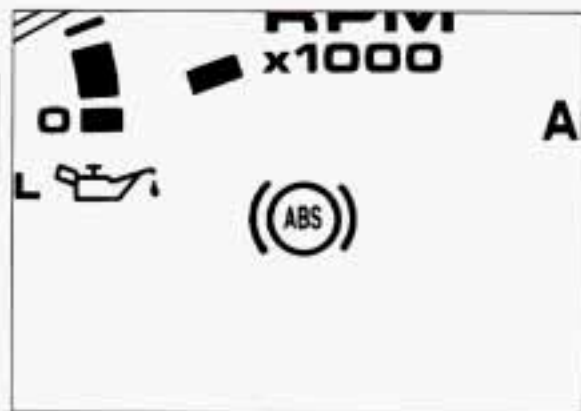

This light on the instrument panel will go on when you start your vehicle.

When you start your vehicle, or when you begin to drive away, you may hear a momentary motor or clicking noise. And you may even notice that your brake pedal moves a little while this is going on. This is the ABS system testing itself. (You may also hear a clicking noise if you leave the ignition in the **Run** position for about four seconds before starting the vehicle.) If there's a problem with the anti-lock brake system, the anti-lock brake system warning light will stay on or flash.

See *Anti-Lock Brake System Warning Light* in the *Index*.

Here's how anti-lock works. Let's say



the road is wet. You're driving safely. Suddenly an animal jumps out in front of you.

You slam on the brakes. Here's what happens with ABS.

A computer senses that wheels are slowing down. If one of the wheels is about to stop rolling, the computer will separately work the brakes at each front wheel and at the rear wheels.

The anti-lock system can change the brake pressure faster than any driver could. The computer is programmed to make the most of available tire and road conditions.



You can steer around the obstacle while braking hard.

As you brake, your computer keeps receiving updates on wheel speed and controls braking pressure accordingly.

Remember: Anti-lock doesn't change the time you need to get your foot up to the brake pedal. If you get too close to the vehicle in front of you, you won't have time to apply your brakes if that vehicle suddenly slows or stops. Always leave enough room ahead to stop, even though you have anti-lock brakes.

### To Use Anti-Lock

Don't pump the brakes. Just hold the brake pedal down and let anti-lock work for you. You may feel the system working, or you may notice some noise, but this is normal.



If your vehicle has the traction control system, the **LOW TRACTION** light will come on when your anti-lock system is adjusting brake pressure to help avoid a braking skid. See *Low Traction Light* in the *Index*.

### **Traction Control System** (OPTION: 3800 V6 ENGINE)

Your vehicle may have a traction control system that limits wheel spin. This is especially useful in slippery road conditions. The system operates only if it senses that one or both of the front wheels are spinning or beginning to lose traction.

When this happens, the system works the front brakes and reduces engine power (by shutting off fuel injectors and managing spark) to limit wheel spin.

The **LOW TRACTION** light will come on when your traction control system is limiting wheel spin. See *Low Traction Light* in the *Index*. You may feel the system working, or you may notice some noise, but this is normal.

If your vehicle is in cruise control when the traction control system begins to limit wheel spin, the cruise control will automatically disengage. When road conditions allow you to safely use it again, you may re-engage the cruise control. (See *Cruise Control* in the *Index*.)

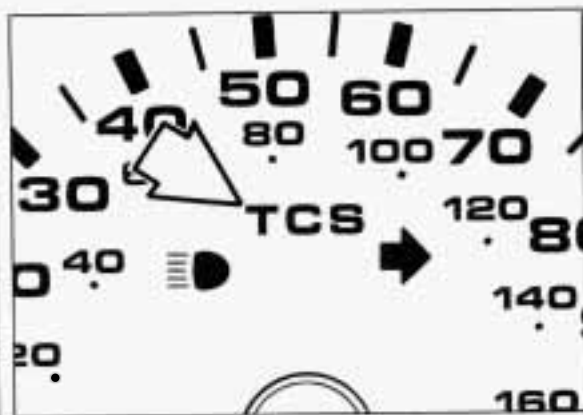

The TCS warning light will come on to let you know if there's a problem with your traction control system.

See *Traction Control System Warning Light* in the *Index*. When this warning light is on, the system will not limit wheel spin. Adjust your driving accordingly.

# Your Driving and the Road

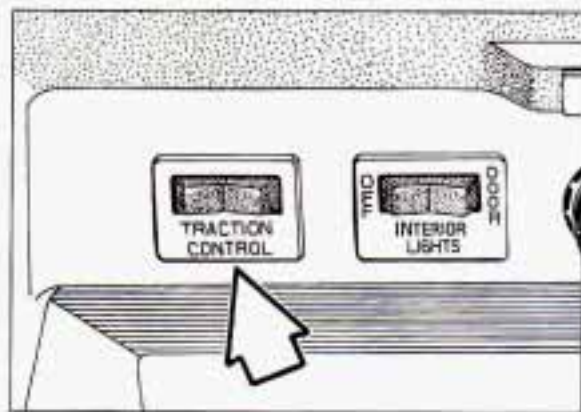

The traction control system automatically comes on whenever you start your vehicle.

To limit wheel spin, especially in slippery road conditions, you should always leave the system on. But you can turn the traction control system off if you ever need to. (You should turn the system off if your vehicle ever gets stuck in sand, mud, ice or snow. See *Rocking Your Vehicle* in the *Index*.)

To turn the system off, press the switch located on the center instrument panel console.

The light on the switch will go off. If the traction control system is limiting wheel spin when you press the switch, the system won't turn off right away. It will

wait until there's no longer a current need to limit wheel spin.

You can turn the system back on at any time by pressing the switch again. The light on the switch should come on.

## **Braking in Emergencies**

Use your anti-lock braking system when you need to. With anti-lock, you can steer and brake at the same time. In many emergencies, steering can help you more than even the very best braking.

## ■ **Steering**

### **Power Steering**

If you lose power steering assist because the engine stops or the system is not functioning, you can steer but it will take much more effort.

### **Steering Tips**

#### **Driving on Curves**

It's important to take curves at a reasonable speed.

A lot of the "driver lost control" accidents mentioned on the news happen on curves. Here's why:

Experienced driver or beginner, each of us is subject to the same laws of physics when driving on curves. The traction of the tires against the road surface makes it possible for the vehicle to change its path when you turn the front wheels. If there's no traction, inertia will keep the vehicle going in the same direction. If you've ever tried to steer a vehicle on wet ice, you'll understand this.

The traction you can get in a curve depends on the condition of your tires and the road surface, the angle at which the curve is banked, and your speed. While you're in a curve, speed is the one factor you can control.

Suppose you're steering through a sharp curve. Then you suddenly accelerate. Both control systems — steering and acceleration — have to do their work where the tires meet the road. Unless you have traction control and the system is on, adding the sudden acceleration can demand too much of those places. You can lose control.

What should you do if this ever happens? Ease up on the accelerator pedal, steer the vehicle the way you want it to go, and slow down.

Speed limit signs near curves warn that you should adjust your speed. Of course, the posted speeds are based on good weather and road conditions. Under less favorable conditions you'll want to go slower.

If you need to reduce your speed as you approach a curve, do it before you enter the curve, while your front wheels are straight ahead.

Try to adjust your speed so you can "drive" through the curve. Maintain a reasonable, steady speed. Wait to accelerate until you are out of the curve, and then accelerate gently into the straightaway.



### ***Steering in Emergencies***

There are times when steering can be more effective than braking. For example, you come over a hill and find a truck stopped in your lane, or a car suddenly pulls out from nowhere, or a child darts out from between parked cars and stops right in front of you. You can avoid these problems by braking — if you can stop in time. But sometimes you can't; there isn't room. That's the time for evasive action — steering around the problem.

Your Oldsmobile can perform very well in emergencies like these. First apply your brakes. It is better to remove as much speed as you can from a possible collision. Then steer around the

problem, to the left or right depending on the space available.

An emergency like this requires close attention and a quick decision. If you are holding the steering wheel at the recommended 9 and 3 o'clock positions, you can turn it a full 180 degrees very quickly without removing either hand. But you have to act fast, steer quickly, and just as quickly straighten the wheel once you have avoided the object.

The fact that such emergency situations are always possible is a good reason to practice defensive driving at all times and wear safety belts properly.



# Your Driving and the Road



## ■ Off-Road Recovery

You may find sometime that your right wheels have dropped off the edge of a road onto the shoulder while you're driving.

If the level of the shoulder is only slightly below the pavement, recovery should be fairly easy. Ease off the accelerator and then, if there is nothing in the way, steer so that your vehicle straddles the edge of the pavement. You can turn the steering wheel up to  $\frac{1}{4}$  turn until the right front tire contacts the pavement edge. Then turn your steering wheel to go straight down the roadway.

## ■ Passing

The driver of a vehicle about to pass another on a two-lane highway waits for just the right moment, accelerates, moves around the vehicle ahead, then goes back into the right lane again. A simple maneuver?

Not necessarily! Passing another vehicle on a two-lane highway is a potentially dangerous move, since the passing vehicle occupies the same lane as oncoming traffic for several seconds. A miscalculation, an error in judgment, or a brief surrender to frustration or anger can suddenly put the passing driver face to face with the worst of all traffic accidents — the head-on collision.

So here are some tips for passing:

- "Drive ahead." Look down the road, to the sides, and to crossroads for situations that might affect your passing patterns. If you have any doubt whatsoever about making a successful pass, wait for a better time.
- Watch for traffic signs, pavement markings, and lines. If you can see a sign up ahead that might indicate a turn or an intersection, delay your

pass. A broken center line usually indicates it's all right to pass (providing the road ahead is clear). Never cross a solid line on your side of the lane or a double solid line, even if the road seems empty of approaching traffic.

- Do not get too close to the vehicle you want to pass while you're awaiting an opportunity. For one thing, following too closely reduces your area of vision, especially if you're following a larger vehicle. Also, you won't have adequate space if the vehicle ahead suddenly slows or stops. Keep back a reasonable distance.
- When it looks like a chance to pass is coming up, start to accelerate but stay in the right lane and don't get too close. Time your move so you will be increasing speed as the time comes to move into the other lane. If the way is clear to pass, you will have a "running start" that more than makes up for the distance you would lose by dropping back. And if something happens to cause you to cancel your pass, you need only slow down and

drop back again and wait for another opportunity.

- If other cars are lined up to pass a slow vehicle, wait your turn. But take care that someone isn't trying to pass you as you pull out to pass the slow vehicle. Remember to glance over your shoulder and check the blind spot.
- Check your mirrors, glance over your shoulder, and start your left lane change signal before moving out of the right lane to pass. When you are far enough ahead of the passed vehicle to see its front in your inside mirror, activate your right lane change signal and move back into the right lane. (Remember that your right outside mirror is convex. The vehicle you just passed may seem to be farther away from you than it really is.)
- Try not to pass more than one vehicle at a time on two-lane roads. Reconsider before passing the next vehicle.
- Don't overtake a slowly moving vehicle too rapidly. Even though the

brake lights are not flashing, it may be slowing down or starting to turn.

- If you're being passed, make it easy for the following driver to get ahead of you. Perhaps you can ease a little to the right.

## ■ *Loss of Control*

Let's review what driving experts say about what happens when the three control systems (brakes, steering and acceleration) don't have enough friction where the tires meet the road to do what the driver has asked.

In any emergency, don't give up. Keep trying to steer and constantly seek an escape route or area of less danger.

### *Skidding*

In a skid, a driver can lose control of the vehicle. Defensive drivers avoid most skids by taking reasonable care suited to existing conditions, and by not "overdriving" those conditions. But skids are always possible.

The three types of skids correspond to your Oldsmobile's three control

systems. In the braking skid your wheels aren't rolling. In the steering or cornering skid, too much speed or steering in a curve causes tires to slip and lose cornering force. And in the acceleration skid too much throttle causes the driving wheels to spin.

A cornering skid is best handled by easing your foot off the accelerator pedal. If you have the traction control system, remember: It helps avoid only the acceleration skid. If you do not have traction control, or if the system is off, then an acceleration skid is also best handled by easing your foot off the accelerator pedal.

If your vehicle starts to slide, ease your foot off the accelerator pedal and quickly steer the way you want the vehicle to go. If you start steering quickly enough, your vehicle may straighten out. Always be ready for a second skid if it occurs.

Of course, traction is reduced when water, snow, ice, gravel, or other material is on the road. For safety, you'll want to slow down and adjust your driving to these conditions. It is important to slow down on slippery



# Your Driving and the Road

surfaces because stopping distance will be longer and vehicle control more limited.

While driving on a surface with reduced traction, try your best to avoid sudden steering, acceleration, or braking (including engine braking by shifting to a lower gear). Any sudden changes could cause the tires to slide. You may not realize the surface is slippery until your vehicle is skidding. Learn to recognize warning clues — such as enough water, ice or packed snow on the road to make a “mirrored surface” — and slow down when you have any doubt.

Remember: Any anti-lock braking system (ABS) helps avoid only the braking skid.



## ■ *Driving at Night*

Night driving is more dangerous than day driving. One reason is that some drivers are likely to be impaired — by alcohol or drugs, with night vision problems, or by fatigue.

Here are some tips on night driving.

- Drive defensively.
- Don't drink and drive.
- Adjust your inside rearview mirror to reduce the glare from headlights behind you.
- Since you can't see as well, you may need to slow down and keep more space between you and other vehicles.

- Slow down, especially on higher speed roads. Your headlights can light up only so much road ahead.
- In remote areas, watch for animals.
- If you're tired, pull off the road in a safe place and rest.

## *Night Vision*

No one can see as well at night as in the daytime. But as we get older these differences increase. A 50-year-old driver may require at least twice as much light to see the same thing at night as a 20-year-old.

What you do in the daytime can also affect your night vision. For example, if you spend the day in bright sunshine you are wise to wear sunglasses. Your eyes will have less trouble adjusting to night. But if you're driving, don't wear sunglasses at night. They may cut down on glare from headlights, but they also make a lot of things invisible.

You can be temporarily blinded by approaching lights. It can take a second or two, or even several seconds, for your eyes to readjust to the dark. When you are faced with severe glare (as from



a driver who doesn't lower the high beams, or a vehicle with misaimed headlights), slow down a little. Avoid staring directly into the approaching lights.

Keep your windshield and all the glass on your vehicle clean — inside and out. Glare at night is made much worse by dirt on the glass. Even the inside of the glass can build up a film caused by dust. Dirty glass makes lights dazzle and flash more than clean glass would, making the pupils of your eyes contract repeatedly.

Remember that your headlights light up far less of a roadway when you are in a turn or curve. Keep your eyes moving; that way, it's easier to pick out dimly lighted objects. Just as your headlights should be checked regularly for proper aim, so should your eyes be examined regularly. Some drivers suffer from night blindness — the inability to see in dim light — and aren't even aware of it.



### ■ *Driving in the Rain*

Rain and wet roads can mean driving trouble. On a wet road you can't stop, accelerate or turn as well because your tire-to-road traction isn't as good as on dry roads. And, if your tires don't have much tread left, you'll get even less traction. It's always wise to go slower and be cautious if rain starts to fall while you are driving. The surface may get wet suddenly when your reflexes are tuned for driving on dry pavement.

The heavier the rain, the harder it is to see. Even if your windshield wiper blades are in good shape, a heavy rain can make it harder to see road signs and traffic signals, pavement markings, the edge of the road, and even people walking.

It's wise to keep your wiping equipment in good shape and keep your windshield washer tank filled. Replace your windshield wiper inserts when they show signs of streaking or missing areas on the windshield, or when strips of rubber start to separate from the inserts.

## Your Driving and the Road



Driving too fast through large water puddles or even going through some car washes can cause problems, too. The water may affect your brakes. Try to avoid puddles. But if you can't, try to slow down before you hit them.



### **CAUTION:**

Wet brakes can cause accidents. They won't work well in a quick stop and may cause pulling to one side. You could lose control of the vehicle. After driving through a large puddle of water or a car wash, apply your brake pedal lightly until your brakes work normally.

### **Hydroplaning**

Hydroplaning is dangerous. So much water can build up under your tires that they can actually ride on the water. This can happen if the road is wet enough and you're going fast enough. When your vehicle is hydroplaning, it has little or no contact with the road.

Hydroplaning doesn't happen often. But it can if your tires haven't much tread or if the pressure in one or more is low. It can happen if a lot of water is standing on the road. If you can see reflections from trees, telephone poles, or other vehicles, and raindrops "dimple" the water's surface, there could be hydroplaning.

Hydroplaning usually happens at higher speeds. There just isn't a hard and fast rule about hydroplaning. The best advice is to slow down when it is raining.

### **Some Other Rainy Weather Tips**

- Turn on your low-beam headlights — not just your parking lights — to help make you more visible to others.
- Besides slowing down, allow some extra following distance. And be especially careful when you pass another vehicle. Allow yourself more clear room ahead, and be prepared to have your view restricted by road spray.
- Have good tires with proper tread depth. (See *Tires* in the *Index*.)





## ■ *City Driving*

One of the biggest problems with city streets is the amount of traffic on them. You'll want to watch out for what the other drivers are doing and pay attention to traffic signals.

Here are ways to increase your safety in city driving:

- Know the best way to get to where you are going. Get a city map and plan your trip into an unknown part of the city just as you would for a cross-country trip.
- Try to use the freeways that rim and crisscross most large cities. You'll save time and energy. (See the next section, *Freeway Driving*.)

- Treat a green light as a warning signal. A traffic light is there because the corner is busy enough to need it. When a light turns green, and just before you start to move, check both ways for vehicles that have not cleared the intersection or may be running the red light.



## ■ *Freeway Driving*

Mile for mile, freeways (also called thruways, parkways, expressways, turnpikes, or superhighways) are the safest of all roads. But they have their own special rules.

The most important advice on freeway driving is: Keep up with traffic and keep to the right. Drive at the same speed most of the other drivers are driving. Too-fast or too-slow driving breaks a smooth traffic flow. Treat the left lane on a freeway as a passing lane.

At the entrance there is usually a ramp that leads to the freeway. If you have a clear view of the freeway as you drive along the entrance ramp, you should begin to check traffic. Try to determine where you expect to blend with the



# Your Driving and the Road

flow. Try to merge into the gap at close to the prevailing speed. Switch on your turn signal, check your mirrors and glance over your shoulder as often as necessary. Try to blend smoothly with the traffic flow.

Once you are on the freeway, adjust your speed to the posted limit or to the prevailing rate if it's slower. Stay in the right lane unless you want to pass.

Before changing lanes, check your mirrors. Then use your turn signal.

Just before you leave the lane, glance quickly over your shoulder to make sure there isn't another vehicle in your "blind" spot.

Once you are moving on the freeway, make certain you allow a reasonable following distance. Expect to move slightly slower at night.

When you want to leave the freeway, move to the proper lane well in advance. If you miss your exit do not, under any circumstances, stop and back up. Drive on to the next exit.

The exit ramp can be curved, sometimes quite sharply.

The exit speed is usually posted.

Reduce your speed according to your speedometer, not to your sense of motion. After driving for any distance at higher speeds, you may tend to think you are going slower than you actually are.

## ■ *Before Leaving on a Long Trip*

Make sure you're ready. Try to be well rested. If you must start when you're not fresh — such as after a day's work — don't plan to make too many miles that first part of the journey. Wear comfortable clothing and shoes you can easily drive in.

Is your vehicle ready for a long trip? If you keep it serviced and maintained, it's ready to go. If it needs service, have it done before starting out. Of course, you'll find experienced and able service experts in Oldsmobile dealerships all across North America. They'll be ready and willing to help if you need it.

Here are some things you can check before a trip:

- **Windshield Washer Fluid:** Is the reservoir full? Are all windows clean inside and outside?
- **Wiper Blades:** Are they in good shape?
- **Fuel, Engine Oil, Other Fluids:** Have you checked all levels?
- **Lights:** Are they all working? Are the lenses clean?
- **Tires:** They are vitally important to a safe, trouble-free trip. Is the tread good enough for long-distance driving? Are the tires all inflated to the recommended pressure?
- **Weather Forecasts:** What's the weather outlook along your route? Should you delay your trip a short time to avoid a major storm system?
- **Maps:** Do you have up-to-date maps?

## ■ *Highway Hypnosis*

Is there actually such a condition as "highway hypnosis"? Or is it just plain falling asleep at the wheel? Call it highway hypnosis, lack of awareness, or whatever.

There is something about an easy stretch of road with the same scenery, along with the hum of the tires on the road, the drone of the engine, and the rush of the wind against the vehicle that can make you sleepy. Don't let it happen to you! If it does, your vehicle can leave the road in **less than a second**, and you could crash and be injured.

What can you do about highway hypnosis? First, be aware that it can happen.

Then here are some tips:

- Make sure your vehicle is well ventilated, with a comfortably cool interior.
- Keep your eyes moving. Scan the road ahead and to the sides. Check your mirrors and your instruments frequently.
- If you get sleepy, pull off the road into a rest, service, or parking area and take a nap, get some exercise, or both. For safety, treat drowsiness on the highway as an emergency.



### ■ *Hill and Mountain Roads*

Driving on steep hills or mountains is different from driving in flat or rolling terrain.

If you drive regularly in steep country, or if you're planning to visit there, here are some tips that can make your trips safer and more enjoyable.

- Keep your vehicle in good shape. Check all fluid levels and also the brakes, tires, cooling system and transaxle. These parts can work hard on mountain roads.
- Know how to go down hills. The most important thing to know is this: let your engine do some of the slowing down. Shift to a lower gear when you go down a steep or long hill.



#### **CAUTION:**

If you don't shift down, your brakes could get so hot that they wouldn't work well. You would then have poor braking or even none going down a hill. You could crash. Shift down to let your engine assist your brakes on a steep downhill slope.



#### **CAUTION:**

Coasting downhill in **N** (Neutral) or with the ignition off is dangerous. Your brakes will have to do all the work of slowing down. They could get so hot that they wouldn't work well. You could crash. Always have your engine running and your vehicle in gear when you go downhill.



# Your Driving and the Road

- Know how to go uphill. You may want to shift down to a lower gear. The lower gears help cool your engine and transaxle, and you can climb the hill better.
- Stay in your own lane when driving on two-lane roads in hills or mountains. Don't swing wide or cut across the center of the road. Drive at speeds that let you stay in your own lane.
- As you go over the top of a hill, be alert. There could be something in your lane, like a stalled car or an accident.
- You may see highway signs on mountains that warn of special problems. Examples are long grades, passing or no-passing zones, a falling rocks area, or winding roads. Be alert to these and take appropriate action.

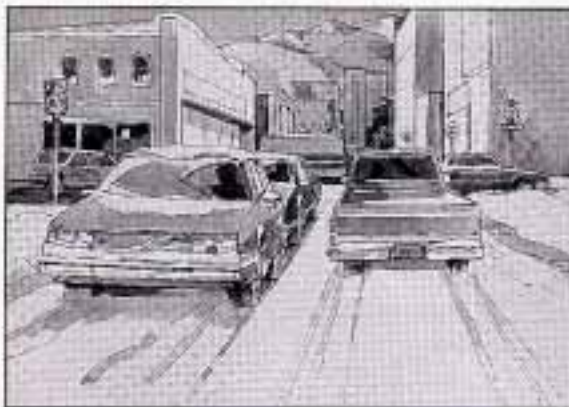

## ■ Winter Driving

Here are some tips for winter driving:

- Have your Oldsmobile in good shape for winter. Be sure your engine coolant mix is correct.
- You may want to put winter emergency supplies in your vehicle.

Include an ice scraper, a small brush or broom, a supply of windshield washer fluid, a rag, some winter outer clothing, a small shovel, a flashlight, a red cloth, and a couple of reflective warning triangles. And, if you will be driving under severe conditions, include a small bag of sand, a piece of old carpet or a couple of burlap bags to help provide traction. Be sure you properly secure these items in your vehicle.



## Driving on Snow or Ice

Most of the time, those places where your tires meet the road probably have good traction.

However, if there is snow or ice between your tires and the road, you can have a very slippery situation. You'll have a lot less traction or "grip" and will need to be very careful.

What's the worst time for this? "Wet ice." Very cold snow or ice can be slick and hard to drive on. But wet ice can be even more trouble because it may offer the least traction of all. You can get "wet ice" when it's about freezing (32°F; 0°C) and freezing rain begins to fall. Try to avoid driving on wet ice until salt and sand crews can get there.



Whatever the condition — smooth ice, packed, blowing or loose snow — drive with caution.

If you have the traction control system, keep the system on. It will improve your ability to accelerate when driving on a slippery road. Even though your vehicle has a traction control system, you'll want to slow down and adjust your driving to the road conditions. See *Traction Control System* in the *Index*.

If you don't have the traction control system, accelerate gently. Try not to break the fragile traction. If you accelerate too fast, the drive wheels will spin and polish the surface under the tires even more.

Your anti-lock brakes improve your ability to make a hard stop on a slippery road. Even though you have an anti-lock braking system, you'll want to begin stopping sooner than you would on dry pavement. See *Anti-Lock* in the *Index*.

- Allow greater following distance on any slippery road.
- Watch for slippery spots. The road might be fine until you hit a spot

that's covered with ice. On an otherwise clear road, ice patches may appear in shaded areas where the sun can't reach: around clumps of trees, behind buildings, or under bridges. Sometimes the surface of a curve or an overpass may remain icy when the surrounding roads are clear. If you see a patch of ice ahead of you, brake before you are on it. Try not to brake while you're actually on the ice, and avoid sudden steering maneuvers.



### ***If You're Caught in a Blizzard***

If you are stopped by heavy snow, you could be in a serious situation. You should probably stay with your vehicle unless you know for sure that you are near help and you can hike through the snow. Here are some things to do to summon help and keep yourself and your passengers safe: Turn on your hazard flashers. Tie a red cloth to your vehicle to alert police that you've been stopped by the snow. Put on extra clothing or wrap a blanket around you. If you have no blankets or extra clothing, make body insulators from

## Your Driving and the Road

newspapers, burlap bags, rags, floor mats — anything you can wrap around yourself or tuck under your clothing to keep warm.

You can run the engine to keep warm, but be careful.



### CAUTION:

Snow can trap exhaust gases under your vehicle. This can cause deadly CO (carbon monoxide) gas to get inside. CO could overcome you and kill you. You can't see it or smell it, so you might not know it is in your vehicle. Clear away snow from around the base of your vehicle, especially any that is blocking your exhaust pipe. And check around again from time to time to be sure snow doesn't collect there. Open a window just a little on the side of the vehicle that's away from the wind. This will help keep CO out.

Run your engine only as long as you must. This saves fuel. When you run the engine, make it go a little faster than just idle. That is, push the accelerator slightly. This uses less fuel for the heat that you get and it keeps the battery charged. You will need a well-charged battery to restart the vehicle, and possibly for signaling later on with your headlights. Let the heater run for awhile.

Then, shut the engine off and close the window almost all the way to preserve the heat. Start the engine again and repeat this only when you feel really uncomfortable from the cold. But do it as little as possible. Preserve the fuel as long as you can. To help keep warm, you can get out of the vehicle and do some fairly vigorous exercises every half hour or so until help comes.



## ■ Towing a Trailer



### CAUTION:

If you don't use the correct equipment and drive properly, you can lose control when you pull a trailer. For example, if the trailer is too heavy, the brakes may not work well — or even at all. You and your passengers could be seriously injured. Pull a trailer only if you have followed all the steps in this section. Ask your Oldsmobile dealer for advice and information about towing a trailer with your vehicle.

### NOTICE:

Pulling a trailer improperly can damage your vehicle and result in costly repairs not covered by your warranty. To pull a trailer correctly, follow the advice in this section, and see your Oldsmobile dealer for important information about towing a trailer with your vehicle.

Your vehicle can tow a trailer. To identify what the vehicle trailering capacity is for your vehicle, you should read the information in *Weight of the Trailer* that appears later in this section. But trailering is different than just driving your vehicle by itself. Trailering means changes in handling, durability, and fuel economy. Successful, safe trailering takes correct equipment, and it has to be used properly.

That's the reason for this section. In it are many time-tested, important trailering tips and safety rules. Many of these are important for your safety and that of your passengers. So please read this section carefully before you pull a

trailer.

Load-pulling components such as the engine, transaxle, wheel assemblies, and tires are forced to work harder against the drag of the added weight. The engine is required to operate at relatively higher speeds and under greater loads, generating extra heat. What's more, the trailer adds considerably to wind resistance, increasing the pulling requirements.

### If You Do Decide To Pull A Trailer

If you do, here are some important points.

- There are many different laws having to do with trailering. Make sure your rig will be legal, not only where you live but also where you'll be driving. A good source for this information can be state or provincial police.
- Consider using a sway control if your trailer will weigh 2,000 pounds (900 kg) or less. You should always use a sway control if your trailer will weigh more than 2,000 pounds (900 kg).

You can ask a hitch dealer about sway controls.



## *Your Driving and the Road*

- Don't tow a trailer at all during the first 500 miles (800 km) your new vehicle is driven. Your engine, axle or other parts could be damaged.
- Then, during the first 500 miles (800 km) that you tow a trailer, don't drive over 50 mph (80 km/h) and don't make starts at full throttle. This helps your engine and other parts of your vehicle wear in at the heavier loads.

Three important considerations have to do with weight:

### **Weight of the Trailer**

How heavy can a trailer safely be?

It should never weigh more than 1,400 pounds (630 kg) with up to six occupants or more than 2,000 pounds (900 kg) with up to two occupants unless you have the optional trailer-towing package. With the trailer-towing package (available only with the 3800 V6 engine), your vehicle can tow up to 2,400 pounds (1 090 kg) with up to six occupants or up to 3,000 pounds (1 360 kg) with up to two occupants. But even that can be too heavy.

It depends on how you plan to use your rig. For example, speed, altitude, road grades, outside temperature and how

much your vehicle is used to pull a trailer are all important. And, it can also depend on any special equipment that you have on your vehicle.

You can ask your dealer for our trailering information or advice, or you can write us at:

Oldsmobile Customer Assistance  
P.O. Box 30095  
Lansing, MI 48909

In Canada, write to:

General Motors of Canada Limited  
Customer Assistance Center  
1908 Colonel Sam Drive  
Oshawa, Ontario L1H 8P7

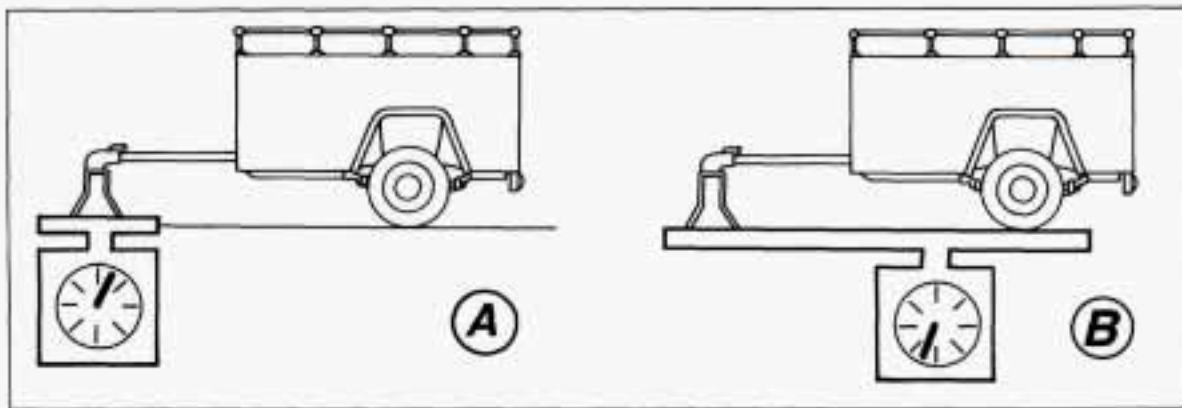

### Weight of the Trailer Tongue

The tongue load (A) of any trailer is an important weight to measure because it affects the total or gross weight of your vehicle. The gross vehicle weight (GVW) includes the curb weight of the vehicle, any cargo you may carry in it, and the people who will be riding in the vehicle. And if you will tow a trailer, you must add the tongue load to the GVW because your vehicle will be carrying that weight, too. See *Loading Your Vehicle* in the *Index* for more information about your vehicle's maximum load capacity.

If you're using a "dead-weight" hitch, the trailer tongue (A) should weigh 10% of the total loaded trailer weight (B). If you have a "weight-distributing"

hitch, the trailer tongue (A) should weigh 12% of the total loaded trailer weight (B).

After you've loaded your trailer, weigh the trailer and then the tongue, separately, to see if the weights are proper. If they aren't, you may be able to get them right simply by moving some items around in the trailer.

### Total Weight on Your Vehicle's Tires

Be sure your vehicle's tires are inflated to the limit for cold tires. You'll find these numbers on the Certification/Tire label at the rear edge of the driver's door or see *Tire Loading* in the *Index*. Then be sure you don't go over the GVW limit for your vehicle.

### Hitches

It's important to have the correct hitch equipment. Crosswinds, large trucks going by, and rough roads are a few reasons why you'll need the right hitch. Here are some rules to follow:

- If you'll be pulling a trailer that, when loaded, will weigh more than 2,000 pounds (900 kg), be sure to use a properly mounted, weight-distributing hitch and sway control of the proper size. This equipment is very important for proper vehicle loading and good handling when you're driving.
- Will you have to make any holes in the body of your vehicle when you install a trailer hitch? If you do, then be sure to seal the holes later when you remove the hitch. If you don't seal them, deadly carbon monoxide (CO) from your exhaust can get into your vehicle (see *Engine Exhaust* in the *Index*). Dirt and water can, too.
- The bumpers on your vehicle are not intended for hitches. Do not attach rental hitches or other bumper-type



# Your Driving and the Road

hitches to them. Use only a frame-mounted hitch that does not attach to the bumper.

## Safety Chains

You should always attach chains between your vehicle and your trailer. Cross the safety chains under the tongue of the trailer so that the tongue will not drop to the road if it becomes separated from the hitch. Instructions about safety chains may be provided by the hitch manufacturer or by the trailer manufacturer. Follow the manufacturer's recommendation for attaching safety chains. Always leave just enough slack so you can turn with your rig. And, never allow safety chains to drag on the ground.

## Trailer Brakes

If your trailer weighs more than 1,000 pounds (450 kg) loaded, then it needs its own brakes — and they must be adequate. Be sure to read and follow the instructions for the trailer brakes so you'll be able to install, adjust and maintain them properly.

Because you have anti-lock brakes, do not try to tap into your vehicle's brake system. If you do, both brake systems won't work well, or at all.

## Driving with a Trailer

Towing a trailer requires a certain amount of experience. Before setting out for the open road, you'll want to get to know your rig. Acquaint yourself with the feel of handling and braking with the added weight of the trailer. And always keep in mind that the vehicle you are driving is now a good deal longer and not nearly so responsive as your vehicle is by itself.

Before you start, check the trailer hitch and platform, safety chains, electrical connector, lights, tires and mirror adjustment. If the trailer has electric brakes, start your vehicle and trailer moving and then apply the trailer brake controller by hand to be sure the brakes are working. This lets you check your electrical connection at the same time.



## CAUTION:

If you have a rear-most window open and you pull a trailer with your vehicle, carbon monoxide (CO) could come into your vehicle. You can't see or smell CO. It can cause unconsciousness or death. (See *Engine Exhaust* in the *Index*.) To maximize your safety when towing a trailer:

- Have your exhaust system inspected for leaks, and make necessary repairs before starting on your trip.
- Keep the rear-most windows closed.
- If exhaust does come into your vehicle through a window in the rear or another opening, drive with your front, main heating or cooling system on and with the fan on any speed. This will bring fresh, outside air into your vehicle. Do not use **RECIRC** because it only recirculates the air inside your vehicle. (See *Comfort Controls* in the *Index*.)



During your trip, check occasionally to be sure that the load is secure, and that the lights and any trailer brakes are still working.

### **Following Distance**

Stay at least twice as far behind the vehicle ahead as you would when driving your vehicle without a trailer. This can help you avoid situations that require heavy braking and sudden turns.

### **Passing**

You'll need more passing distance up ahead when you're towing a trailer. And, because you're a good deal longer, you'll need to go much farther beyond the passed vehicle before you can return to your lane.

### **Backing Up**

Hold the bottom of the steering wheel with one hand. Then, to move the trailer to the left, just move that hand to the left. To move the trailer to the right, move your hand to the right. Always

back up slowly and, if possible, have someone guide you.

### **Making Turns**

When you're turning with a trailer, make wider turns than normal. Do this so your trailer won't strike soft shoulders, curbs, road signs, trees, or other objects. Avoid jerky or sudden maneuvers. Signal well in advance.

### **Turn Signals When Towing a Trailer**

When you tow a trailer, your vehicle has to have a different turn signal flasher and extra wiring. The green arrows on your instrument panel will flash whenever you signal a turn or lane change. Properly hooked up, the trailer lights will also flash, telling other drivers you're about to turn, change lanes or stop.

When towing a trailer, the green arrows on your instrument panel will flash for turns even if the bulbs on the trailer are burned out. Thus, you may think drivers behind you are seeing your

signal when they are not. It's important to check occasionally to be sure the trailer bulbs are still working.

### **Driving On Grades**

Reduce speed and shift to a lower gear **before** you start down a long or steep downgrade. If you don't shift down, you might have to use your brakes so much that they would get hot and no longer work well.

On a long uphill grade, shift down and reduce your speed to around 45 mph (70 km/h) to reduce the possibility of engine and transaxle overheating.

If you are towing a trailer that weighs more than 1,000 pounds (454 kg), and you have an automatic transaxle with Overdrive, you may prefer to drive in **D** instead of Overdrive (or, as you need to, a lower gear). This will minimize heat build-up and extend the life of your transaxle.

# Your Driving and the Road

## **Parking on Hills**

You really should not park your vehicle, with a trailer attached, on a hill. If something goes wrong, your rig could start to move. People can be injured, and both your vehicle and the trailer can be damaged.

But if you ever have to park your rig on a hill, here's how to do it:

1. Apply your regular brakes, but don't shift into **P** (Park) yet.
2. Have someone place chocks under the trailer wheels.
3. When the wheel chocks are in place, release the regular brakes until the chocks absorb the load.
4. Reapply the regular brakes. Then apply your parking brake, and then shift to **P** (Park).
5. Release the regular brakes.

## **When You Are Ready to Leave After Parking on a Hill**

1. Apply your regular brakes and hold the pedal down while you:

- Start your engine;
  - Shift into a gear; and
  - Release the parking brake.
2. Let up on the brake pedal.
  3. Drive slowly until the trailer is clear of the chocks.
  4. Stop and have someone pick up and store the chocks.

## **Maintenance When Trailer Towing**

Your vehicle will need service more often when you're pulling a trailer. See the Maintenance Schedule for more on this. Things that are especially

important in trailer operation are automatic transaxle fluid (don't overfill), engine oil, belts, cooling system, and brake adjustment. Each of these is covered in this manual, and the *Index* will help you find them quickly. If you're trailering, it's a good idea to review these sections before you start your trip.

Check periodically to see that all hitch nuts and bolts are tight.



Here you'll find what to do about some problems that can occur on the road.

## *Part 5*

### *Problems on the Road*

Hazard Warning Flashers .....	158
Jump Starting .....	158
Towing Your Vehicle .....	162
Engine Overheating.....	165
If a Tire Goes Flat .....	172
Changing a Flat Tire.....	172
Compact Spare Tire .....	178
If You're Stuck: In Sand, Mud, Ice or Snow .....	179



# Problems on the Road



## ■ Hazard Warning Flashers

Your hazard warning flashers let you warn others. They also let police know you have a problem. Your front and rear turn signal lights will flash on and off.

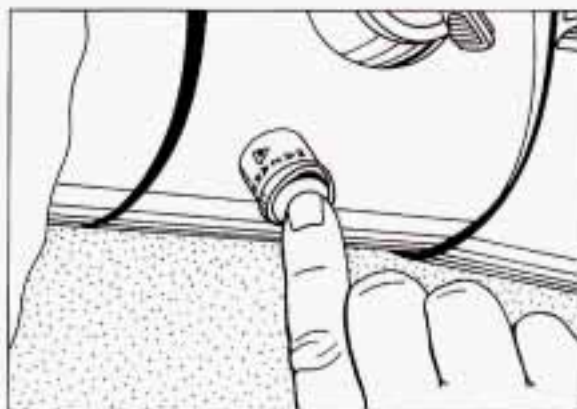

Your hazard warning flashers switch is on the steering column below the ignition switch. Press the button in to make your front and rear turn signal lights flash on and off.

Your hazard warning flashers work no matter what position your key is in, and even if the key isn't in.

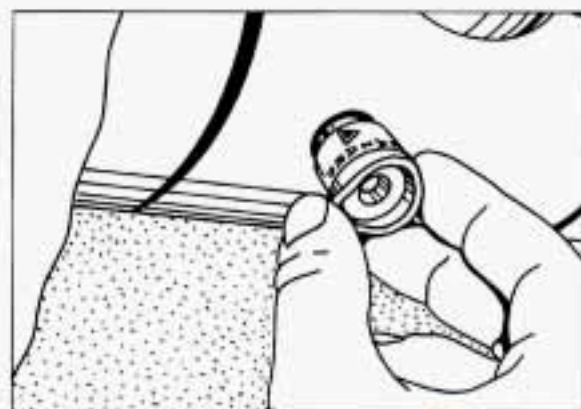

To turn off the flashers, pull out on the collar.

When the hazard warning flashers are on, your turn signals won't work.

## Other Warning Devices

If you carry reflective triangles, you can set one up at the side of the road about 300 feet (100 m) behind your vehicle.

## ■ Jump Starting

If your battery has run down, you may want to use another vehicle and some jumper cables to start your Oldsmobile. But please follow the steps below to do it safely.



### CAUTION:

Batteries can hurt you. They can be dangerous because:

- They contain **acid** that can burn you.
- They contain **gas** that can explode or ignite.
- They contain enough **electricity** to burn you.

If you don't follow these steps exactly, some or all of these things can hurt you.

### NOTICE:

Ignoring these steps could result in costly damage to your vehicle that wouldn't be covered by your warranty. Trying to start your Oldsmobile by pushing or pulling it won't work, and it could damage your vehicle.

### To Jump Start Your Oldsmobile:

1. Check the other vehicle. It must have a 12-volt battery with a negative ground system.

### NOTICE:

If the other system isn't a 12-volt system with a negative ground, both vehicles can be damaged.

2. Get the vehicles close enough so the jumper cables can reach, but be sure the vehicles aren't touching each other. If they are, it could cause a ground connection you don't want. You wouldn't be able to start your Oldsmobile, and the bad grounding could damage the electrical systems. You could be injured if the vehicles roll. Set the parking brake firmly on each vehicle. Put an automatic transaxle in **P** (Park) or a manual transaxle in **N** (Neutral).

3. Turn off the ignition on both vehicles. Turn off all lights that aren't needed, and radios. This will avoid sparks and help save both batteries. And it could save your radio!

### NOTICE:

If you leave your radio on, it could be badly damaged. The repairs wouldn't be covered by your warranty.

4. Open the hoods and locate the batteries.



### CAUTION:

An electric fan can start up even when the engine is not running and can injure you. Keep hands, clothing and tools away from any underhood electric fan.

Find the positive (+) and negative (-) terminals on each battery.

## Problems on the Road

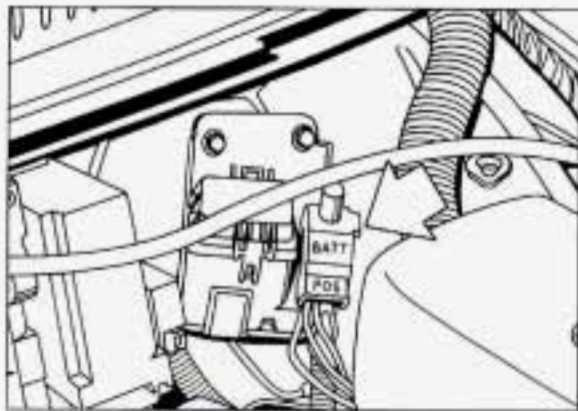

Your Oldsmobile has a remote positive (+) jump starting terminal. The terminal is in the red box on the same side of the engine compartment as your battery. You should always use the remote positive (+) terminal instead of the positive (+) terminal on your battery.

To open the remote positive (+) terminal box, pull the tab and open the cover.

### CAUTION:

Using a match near a battery can cause battery gas to explode. People have been hurt doing this, and some have been blinded. Use a flashlight if you need more light. You don't need to add water to the Delco Freedom<sup>®</sup> battery installed in every new GM vehicle. But if a battery has filler caps, be sure the right amount of fluid is there. If it is low, add water to take care of that first. If you don't, explosive gas could be present.

Battery fluid contains acid that can burn you. Don't get it on you. If you accidentally get it in your eyes or on your skin, flush the place with water and get medical help immediately.

5. Check that the jumper cables don't have loose or missing insulation. If they do, you could get a shock. The vehicles could be damaged, too. Before you connect the cables, here

are some things you should know. Positive (+) will go to positive (+) and negative (-) will go to negative (-) or a metal engine part. Don't connect (+) to (-) or you'll get a short that would damage the battery and maybe other parts, too.

### CAUTION:

Fans or other moving engine parts can injure you badly. Keep your hands away from moving parts once the engines are running.



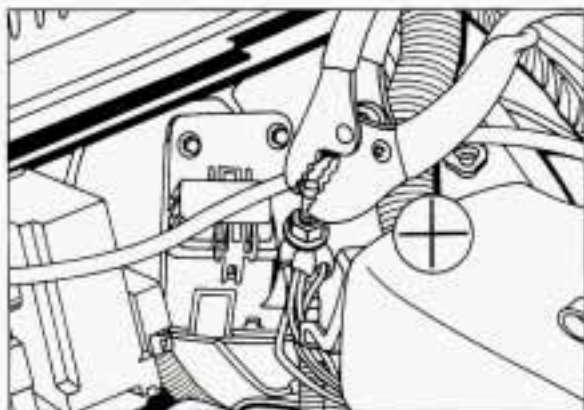

6. Connect the red positive (+) cable to the positive (+) terminal of the vehicle with the dead battery. Use a remote positive (+) terminal if the vehicle has one.

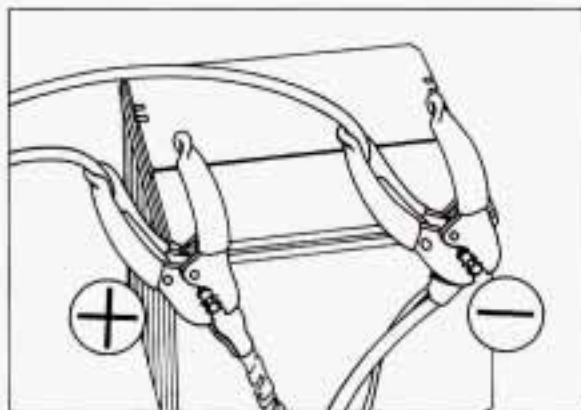

7. Don't let the other end touch metal. Connect it to the positive (+) terminal of the good battery. Use a remote positive (+) terminal if the vehicle has one.

8. Now connect the black negative (-) cable to the good battery's negative (-) terminal.

Don't let the other end touch anything until the next step. The other end of the negative cable **doesn't** go to the dead battery. It goes to a heavy unpainted metal part on the engine of the vehicle with the dead battery.

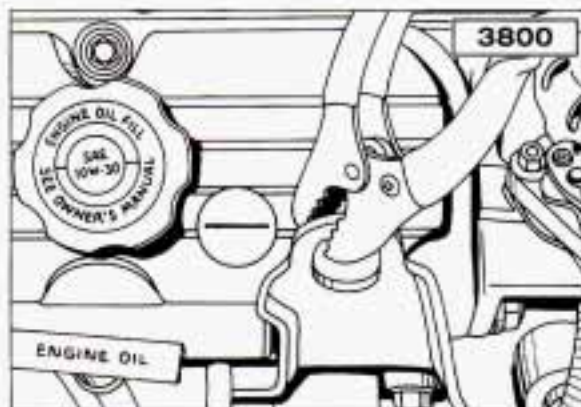
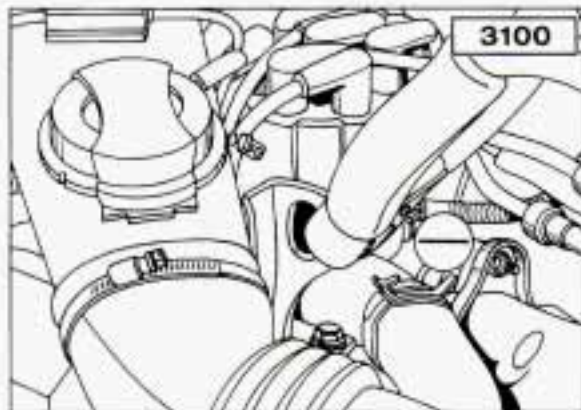

9. Attach the cable at least 18 inches (45 cm) away from the dead battery, but not near engine parts that move. The electrical connection is just as good there, but the chance of sparks getting back to the battery is much less.

## Problems on the Road

10. Now start the vehicle with the good battery and run the engine for a while.
11. Try to start the vehicle with the dead battery. If it won't start after a few tries, it probably needs service.

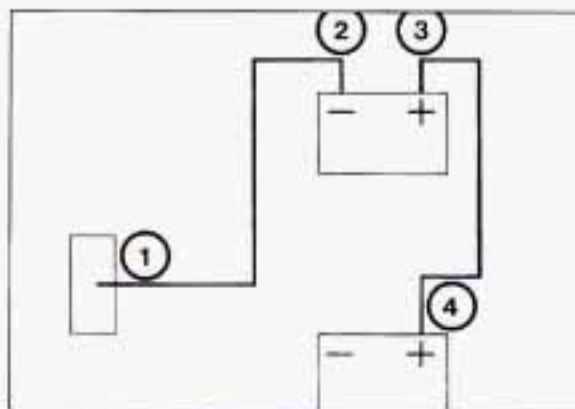

12. Remove the cables in reverse order to prevent electrical shorting. Take care that they don't touch each other or any other metal.

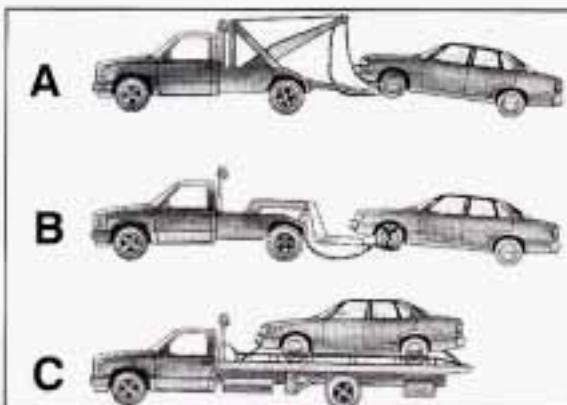

### Towing Your Vehicle

Try to have a GM dealer or a professional towing service tow your Oldsmobile. The usual towing equipment is:

- (A) Sling-type tow truck
- (B) Wheel-lift tow truck
- (C) Car carrier

If your vehicle has been changed or modified since it was factory-new by adding aftermarket items like fog lamps, aero skirting, or special tires and wheels, these instructions and illustrations may not be correct.

Before you do anything, turn on the hazard warning flashers.

When you call, tell the towing service:

- That your vehicle cannot be towed from the front with sling-type equipment.
- That your vehicle has front-wheel drive.
- The make, model, and year of your vehicle.
- Whether you can still move the shift lever.
- If there was an accident, what was damaged.

When the towing service arrives, let the tow operator know that this manual contains detailed towing instructions and illustrations. The operator may want to see them.



#### **CAUTION:**

To help avoid injury to you or others:

- Never let passengers ride in a vehicle that is being towed.
- Never tow faster than safe or posted speeds.
- Never tow with damaged parts not fully secured.
- Never get under your vehicle after it has been lifted by the tow truck.
- Always use separate safety chains on each side when towing a vehicle.
- Never use "J" hooks. Use T-hooks instead.

When your vehicle is being towed, have the ignition key off. The steering wheel

should be clamped in a straight-ahead position, with a clamping device designed for towing service. Do not use the vehicle's steering column lock for this. The transaxle should be in Neutral and the parking brake released.

Don't have your vehicle towed on the front wheels, unless you must. If the vehicle must be towed on the front wheels, don't go more than 35 mph (56 km/h) or farther than 50 miles (80 km) or your transaxle will be damaged. If these limits must be exceeded, then the front wheels have to be supported on a dolly.



#### **CAUTION:**

A vehicle can fall from a car carrier if it isn't adequately secured. This can cause a collision, serious personal injury and vehicle damage. The vehicle should be tightly secured with chains or steel cables before it is transported. Don't use substitutes (ropes, leather straps, canvas webbing, etc.) that can be cut by sharp edges underneath the towed vehicle. Always use T-hooks inserted in the T-hook slots. Never use J-hooks. They will damage drivetrain and suspension components.



# Problems on the Road

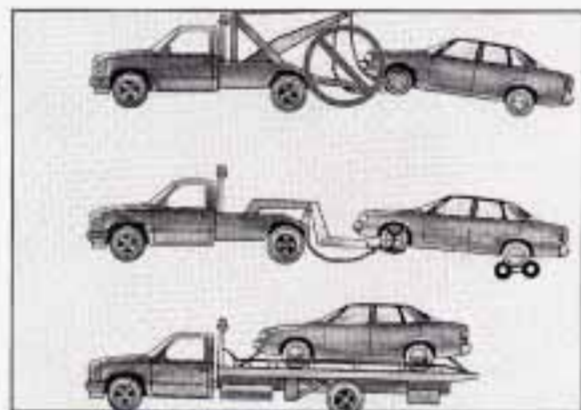

## Towing from the Front—Vehicle Hook-up

Before hooking up to a tow truck, be sure to read all the information on *Towing Your Vehicle* earlier in this section.

Do not tow with sling-type equipment or fascia damage will occur. Use wheel-lift or car carrier equipment. Additional ramping may be required for car carrier equipment. Use safety chains and wheel straps.

### NOTICE:

Towing a vehicle over rough surfaces could damage a vehicle. Damage can occur from vehicle to ground or vehicle to wheel-lift equipment. To help avoid damage, install a towing dolly and raise vehicle until adequate clearance is obtained between the ground and/or wheel-lift equipment.

Do not attach winch cables or J-hooks to suspension components when using car carrier equipment. Always use T-hooks inserted in the T-hook slots.

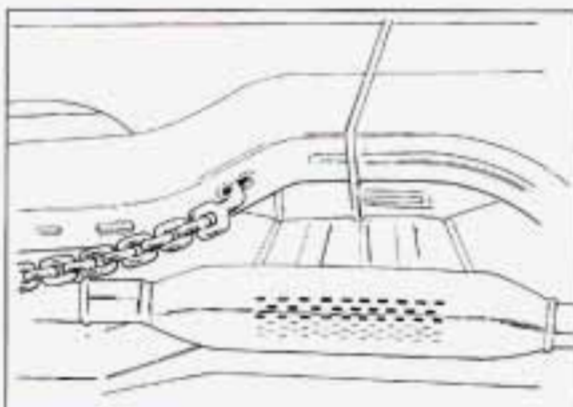

1. Attach T-hook chains on both sides in the slotted holes in the bottom of the frame rails, about 2 feet behind the front wheels.



2. Attach a separate safety chain around the outboard end of each control arm.

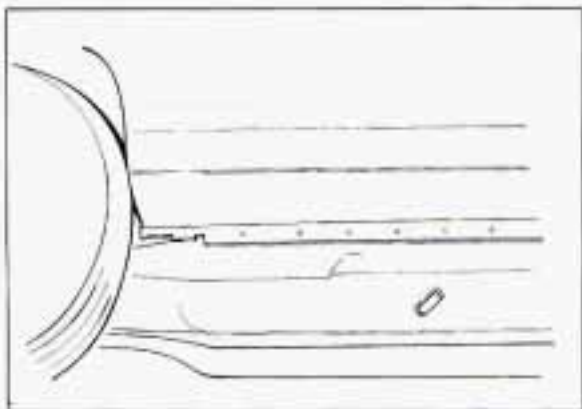

### **Towing from the Rear—Vehicle Hook-up**

Before hooking up to a tow truck, be sure to read all the information on *Towing Your Vehicle* earlier in this section.

1. Attach T-hook chains on both sides in the slotted holes in the frame rails just ahead of the rear wheels.

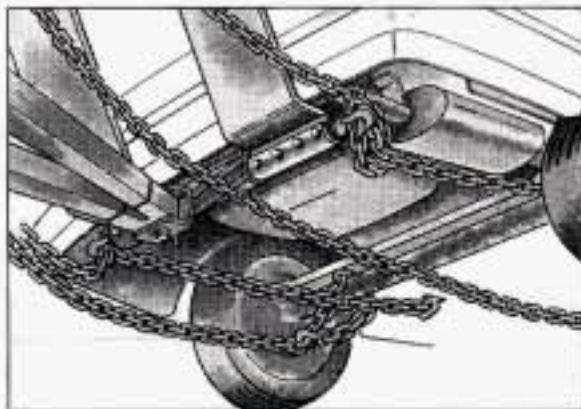

2. Position the lower sling crossbar directly under the rear bumper. No 4x4 wood beam is needed.

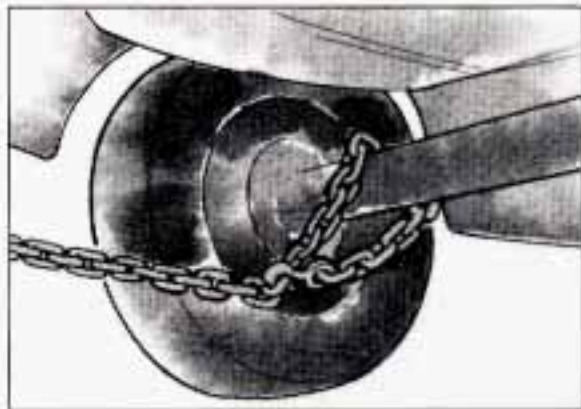

3. Attach a separate safety chain around the end of each axle inboard of the spring.
4. Be certain your vehicle is towed no faster than 35 mph (56 km/h) and no farther than 50 miles (80 km) to avoid damage to your transaxle.

### **■ Engine Overheating**

You will find a coolant temperature gage on your Oldsmobile's instrument panel. See the *Index* under *Coolant Temperature Gage*.

# Problems on the Road



## If Steam Is Coming From Your Engine



### CAUTION:

Steam from an overheated engine can burn you badly, even if you just open the hood. Stay away from the engine if you see or hear steam coming from it. Just turn it off and get everyone away from the vehicle until it cools down. Wait until there is no sign of steam or coolant before opening the hood. If you keep driving when your engine is overheated, the liquids in it can catch fire. You or others could be badly burned. Stop your engine if it overheats, and get out of the vehicle until the engine is cool.

### NOTICE:

If your engine catches fire because you keep driving with no coolant, your vehicle can be badly damaged. The costly repairs would not be covered by your warranty.

## If No Steam Is Coming From Your Engine

If you get the overheat warning but see or hear no steam, the problem may not be too serious. Sometimes the engine can get a little too hot when you:

- Climb a long hill on a hot day.
- Stop after high speed driving.
- Idle for long periods in traffic.
- Tow a trailer.

If you get the overheat warning with no sign of steam, try this for a minute or so:

1. Turn off your air conditioner.
2. Turn on your heater to full hot at the highest fan speed and open the window as necessary.
3. Try to keep your engine under load (in a drive gear where the engine runs slower).

If you no longer have the overheat warning, you can drive. Just to be safe, drive slower for about ten minutes. If the warning doesn't come back on, you can drive normally.

If the warning continues, pull over, stop, and park your vehicle right away.

If there's still no sign of steam, you can idle the engine for two or three minutes while you're parked, to see if the warning stops. But then, if you still have the warning, **TURN OFF THE ENGINE AND GET EVERYONE OUT OF THE VEHICLE** until it cools down.

You may decide not to lift the hood but to get service help right away.



## ■ Cooling System

When you decide it's safe to lift the hood, here's what you'll see:

- (A) Coolant recovery tank
- (B) Radiator pressure cap
- (C) Electric engine fan, or fans if you have the 3800 V6 engine.

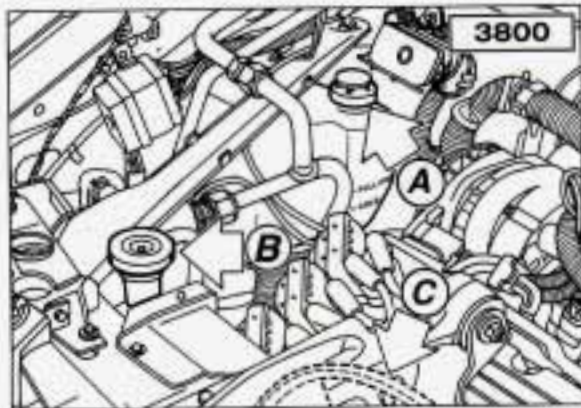
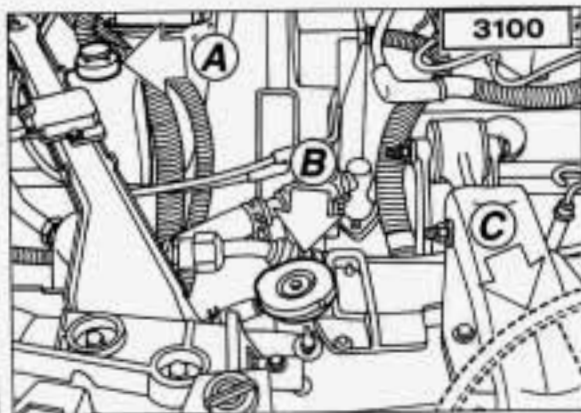

The coolant level should be at or above the **FULL HOT** mark. If it isn't, you may have a leak in the radiator hoses, heater hoses, radiator, water pump or somewhere else in the cooling system.



### CAUTION:

An electric fan under the hood can start up even when the engine is not running and can injure you. Keep hands, clothing and tools away from any underhood electric fan.



### CAUTION:

Heater and radiator hoses, and other engine parts, can be very hot. Don't touch them. If you do, you can be burned. Don't run the engine if there is a leak. If you run the engine, it could lose all coolant. That could cause an engine fire, and you could be burned. Get any leak fixed before you drive the vehicle.

If the coolant inside the coolant recovery tank is boiling, don't do anything else until it cools down.

## Problems on the Road

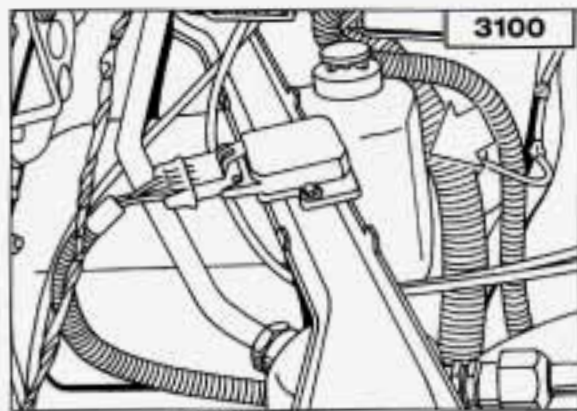

If there seems to be no leak, check to see if the electric engine fan is running. If the engine is overheating, the fan should be running. If it isn't, your vehicle needs service.

### How to Add Coolant to the Coolant Recovery Tank

If you haven't found a problem yet, but the coolant level isn't at or above the **FULL HOT** mark, add a 50/50 mixture of **clean water** (preferably distilled) and a proper antifreeze at the coolant recovery tank. (See *Engine Coolant* in the *Index* for more information about the proper coolant mix.)

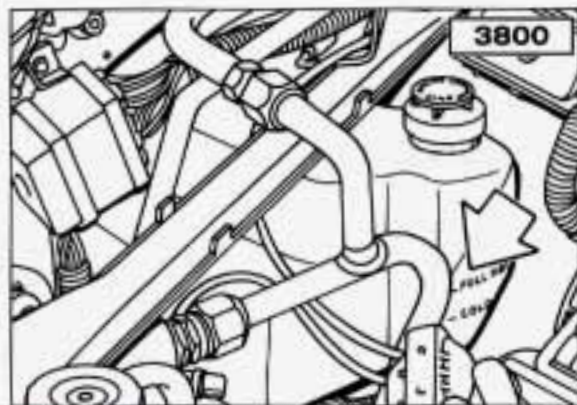

#### NOTICE:

Engine damage from running your engine without coolant isn't covered by your warranty.



#### CAUTION:

Adding only plain water to your cooling system can be dangerous. Plain water, or some other liquid like alcohol, can boil before the proper coolant mix will. Your vehicle's coolant warning system is set for the proper coolant mix. With plain water or the wrong mix, your engine could get too hot but you wouldn't get the overheat warning. Your engine could catch fire and you or others could be burned. Use a 50/50 mix of **clean water** and a proper antifreeze.

#### NOTICE:

In cold weather, water can freeze and crack the engine, radiator, heater core and other parts. Use the recommended coolant.



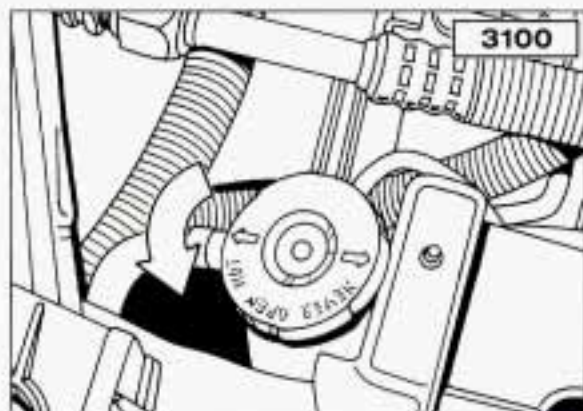
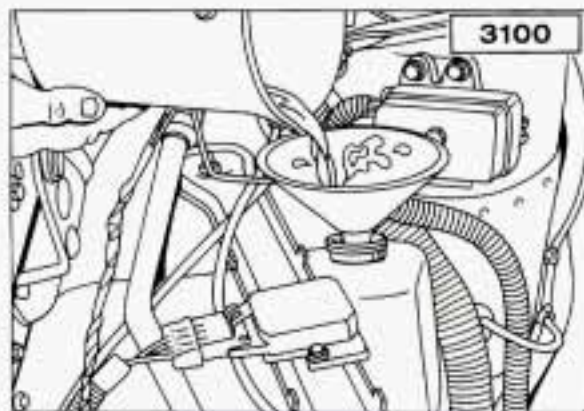

**⚠ CAUTION:**

You can be burned if you spill coolant on hot engine parts. Coolant contains ethylene glycol and it will burn if the engine parts are hot enough. Don't spill coolant on a hot engine.

When the coolant in the coolant recovery tank is at or above the **FULL HOT** mark, start your vehicle.

If the overheat warning continues, there's one more thing you can try. You can add the proper coolant mix directly to the radiator, but be sure the cooling system is cool before you do it.

**⚠ CAUTION:**

Steam and scalding liquids from a hot cooling system can blow out and burn you badly. They are under pressure, and if you turn the radiator pressure cap — even a little — they can come out at high speed. Never turn the cap when the cooling system, including the radiator pressure cap, is hot. Wait for the cooling system and radiator pressure cap to cool if you ever have to turn the pressure cap.

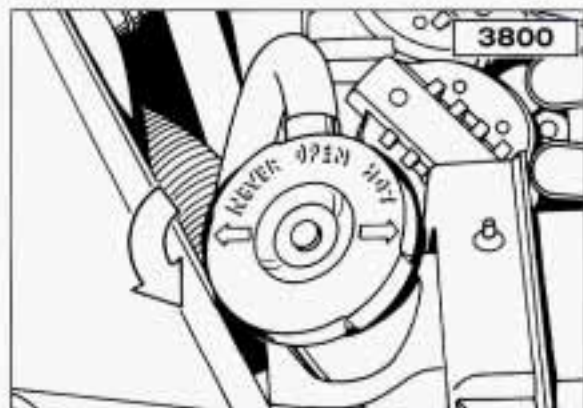

### **How to Add Coolant to the Radiator**

1. You can remove the radiator pressure cap when the cooling system, including the radiator pressure cap and upper radiator hose, is no longer hot. Turn the pressure cap slowly to the left until it first stops. (Don't press down while turning the pressure cap.)



## Problems on the Road

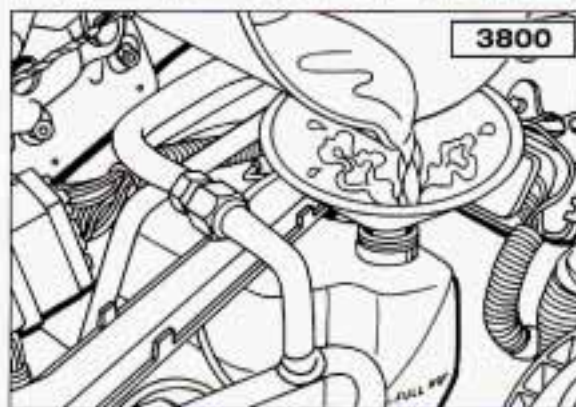
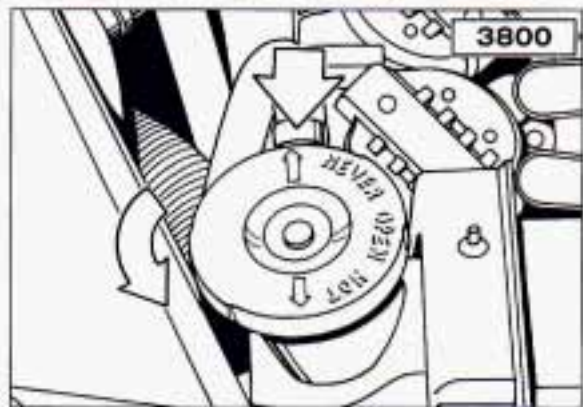
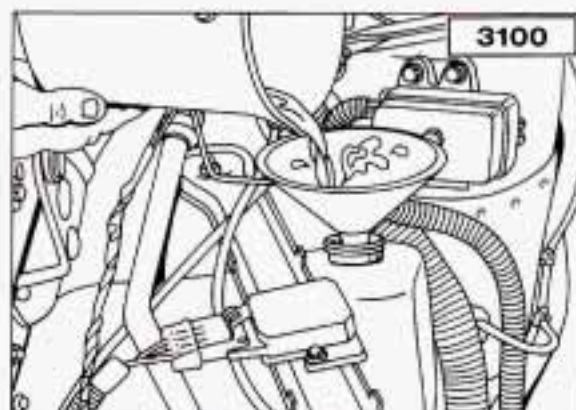
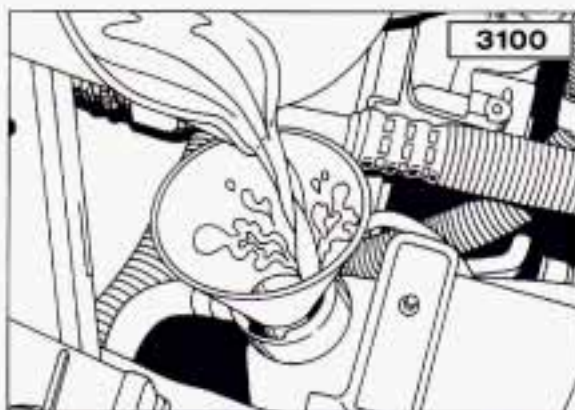
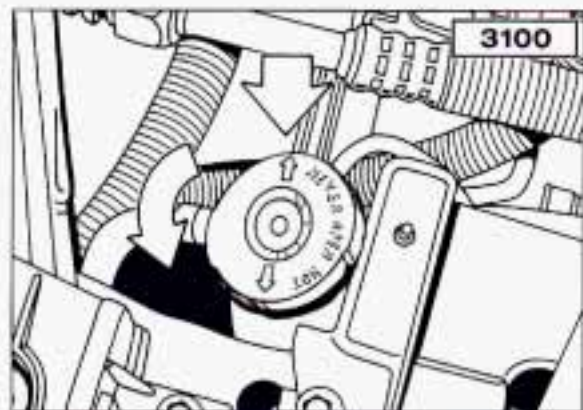

If you hear a hiss, wait for that to stop. A hiss means there is still some pressure left.

2. Then keep turning the pressure cap, but now push down as you turn it. Remove the pressure cap.

3. Fill the radiator with the proper mix, up to the base of the filler neck.

4. Then fill the coolant recovery tank to the **FULL HOT** mark.

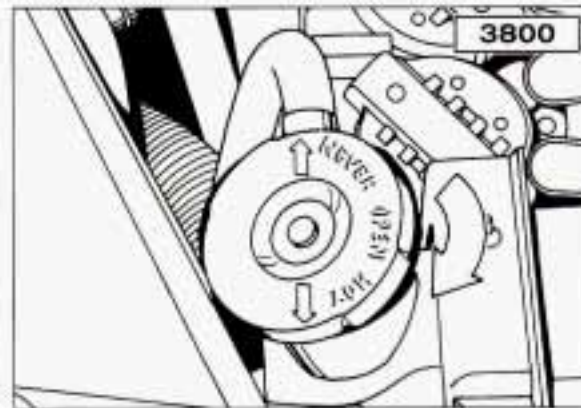
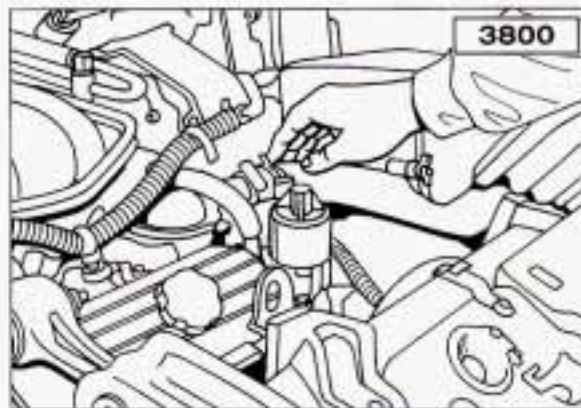
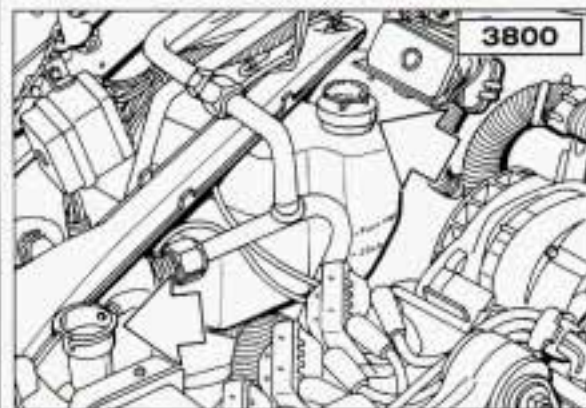
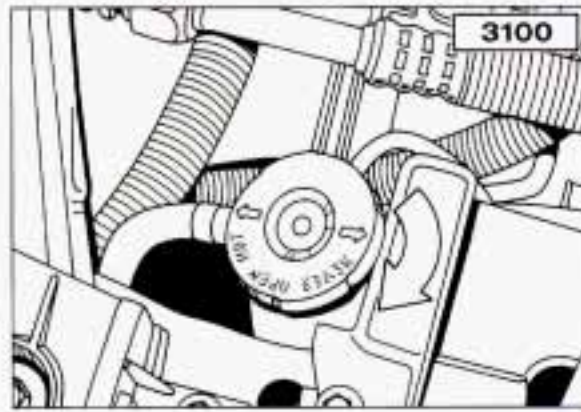
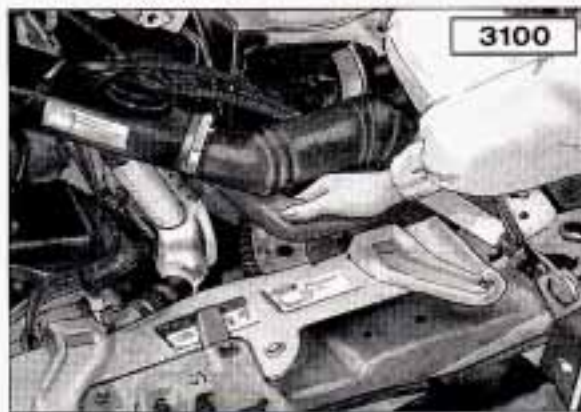
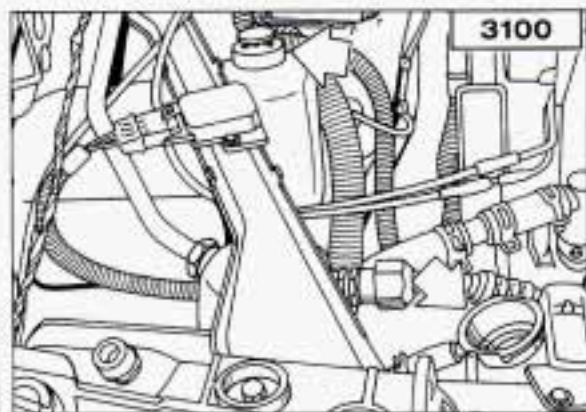

5. Put the cap back on the coolant recovery tank, but leave the radiator pressure cap off.

6. Start the engine and let it run until you can feel the upper radiator hose getting hot. Watch out for the engine fan(s).

7. By this time the coolant level inside the radiator filler neck may be lower. If the level is lower, add more of the proper mix through the filler neck until the level reaches the base of the filler neck.

8. Then replace the pressure cap. At any time during this procedure if coolant begins to flow out of the filler neck, reinstall the pressure cap. Be sure the arrows on the pressure cap line up like this.



# Problems on the Road

## ■ If a Tire Goes Flat

It's unusual for a tire to "blow out" while you're driving, especially if you maintain your tires properly. If air goes out of a tire, it's much more likely to leak out slowly. But if you should ever have a "blowout," here are a few tips about what to expect and what to do:

If a front tire fails, the flat tire will create a drag that pulls the vehicle toward that side. Take your foot off the accelerator pedal and grip the steering wheel firmly. Steer to maintain lane position, then gently brake to a stop well out of the traffic lane.

A rear blowout, particularly on a curve, acts much like a skid and may require the same correction you'd use in a skid. In any rear blowout, remove your foot from the accelerator pedal. Get the vehicle under control by steering the way you want the vehicle to go. It may be very bumpy and noisy, but you can still steer. Gently brake to a stop, well off the road if possible.

If a tire goes flat, the next section shows how to use your jacking equipment to change a flat tire safely.

## Air Inflator

Your vehicle may have an air inflator for use in bringing tires up to the proper pressure. To learn about it, see the *Index* under *Air Inflator System*.



### CAUTION:

Inflating something too much can make it explode, and you or others could be injured. Be sure to read the inflator instructions, and inflate any object only to its recommended pressure.

## ■ Changing a Flat Tire

If a tire goes flat, avoid further tire and wheel damage by driving slowly to a level place. Turn on your hazard warning flashers.



### CAUTION:

Changing a tire can cause an injury. The vehicle can slip off the jack and roll over you or other people. You and they could be badly injured. Find a level place to change your tire. To help prevent the vehicle from moving:

1. Set the parking brake firmly.
2. Put the shift lever in **P** (Park).
3. Turn off the engine.

To be even more certain the vehicle won't move, you can put chocks at the front and rear of the tire farthest away from the one being changed. That would be the tire on the other side of the vehicle, at the opposite end.



The following steps will tell you how to use the jack and change a tire.

The equipment you'll need is in the storage compartment at the rear of the vehicle.

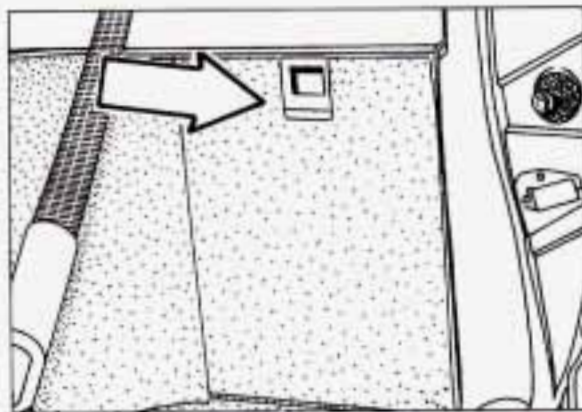

1. Open the jack storage compartment by sliding the latch down and removing the compartment cover.

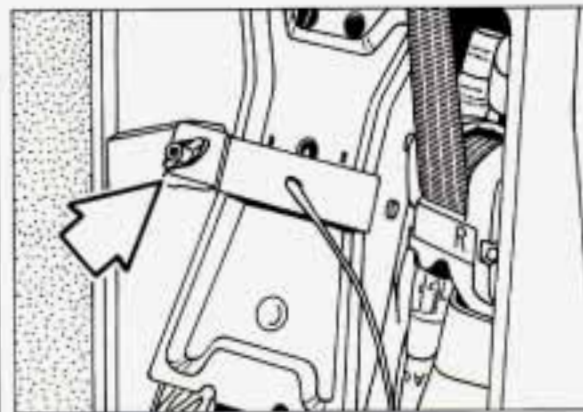

2. Remove the jack and jacking tools by loosening the wing nut and retainer bar.
3. Separate the plastic pouch from the jack and remove the jacking tools (folding wrench and shaft) from the pouch.

## Problems on the Road

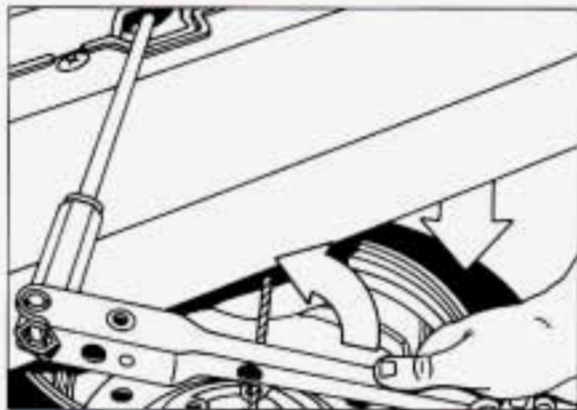

4. The compact spare tire is located under the vehicle, behind the rear bumper. Insert the narrow end of the shaft into the hole above the rear bumper. Then attach the folding wrench to the shaft.
5. Rotate the folding wrench counterclockwise to lower the compact spare tire until it can be pulled from under the vehicle.

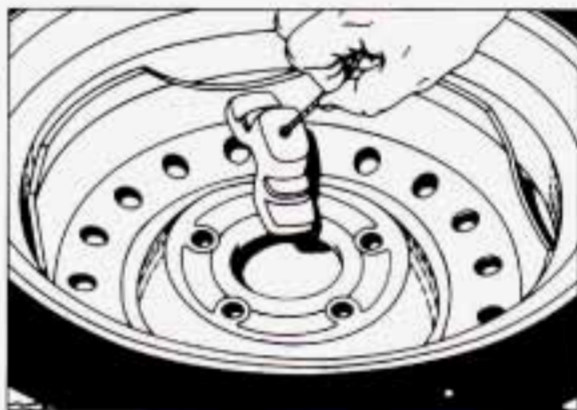

6. Slide the cable retainer through the center of the spare, then place the compact spare tire near the flat tire.

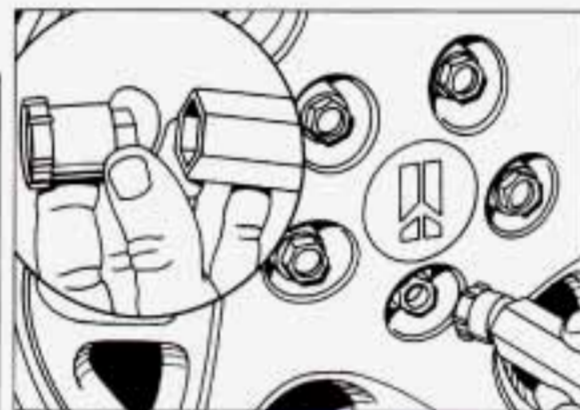

7. Each wheel nut is covered with a nylon cap. Use the folding wrench to remove the nylon caps from the wheel nuts before you loosen the nuts.

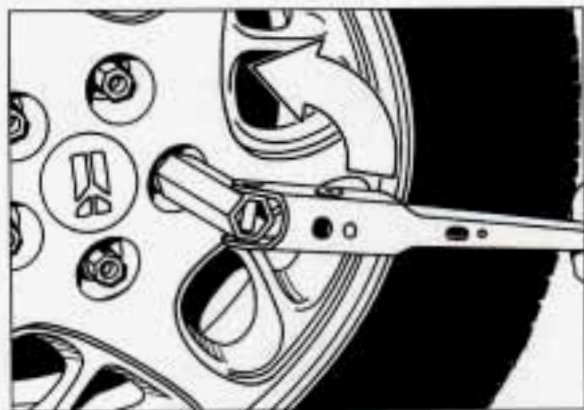

8. Loosen the wheel nuts—but do not remove them—using the folding wrench.



**CAUTION:**

Never use oil or grease on studs or nuts. If you do, the nuts might come loose. Your wheel could fall off, causing a serious accident.

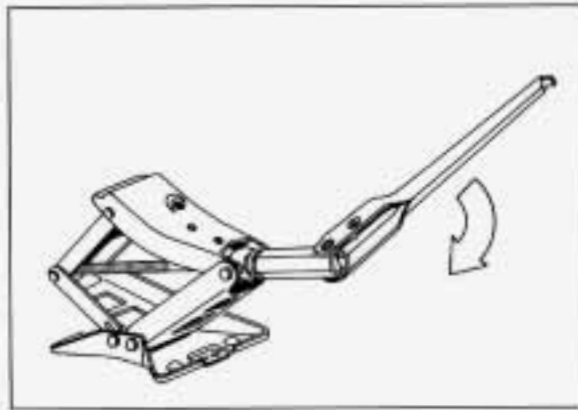

9. Attach the folding wrench to the jack, and rotate the wrench clockwise to raise the jack head a few inches.

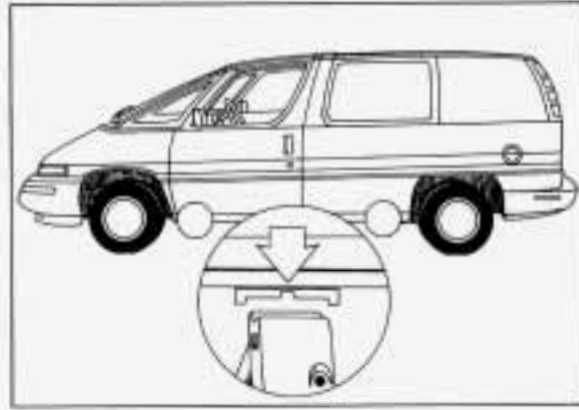

10. Near each wheel, there is a notch in the vehicle's frame. Position the jack and raise the jack head until it fits firmly into the notch in the vehicle's frame nearest the flat tire. Do not raise the vehicle yet. Put the compact spare tire near you.



**CAUTION:**

Getting under a vehicle when it is jacked up is dangerous. If the vehicle slips off the jack, you could be badly injured or killed. Never get under a vehicle when it is supported only by a jack.



## Problems on the Road

### NOTICE:

Raising your vehicle with the jack improperly positioned will damage the vehicle or may allow the vehicle to fall off the jack. Be sure to fit the jack lift head into the proper location before raising your vehicle.

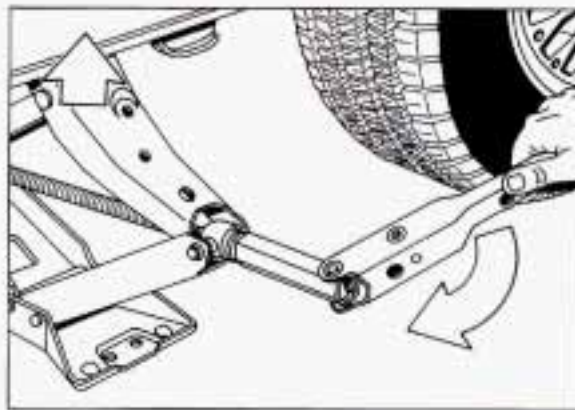

11. Raise the vehicle by rotating the folding wrench clockwise in the jack. Raise the vehicle far enough off the ground so there is enough room for the spare tire to fit.
12. Remove all the wheel nuts and take off the flat tire.



13. Remove any corrosion or dirt from the wheel bolts, mounting surfaces or spare wheel. Place the spare on the wheel mounting surface.



### CAUTION:

Rust or dirt on the wheel, or on the parts to which it is fastened, can make the wheel nuts become loose after a time. The wheel could come off and cause an accident. When you change a wheel, remove any rust or dirt from the places where the wheel attaches to the vehicle. In an emergency, you can use a cloth or a paper towel to do this; but be sure to use a scraper or wire brush later, if you need to, to get all the rust or dirt off.

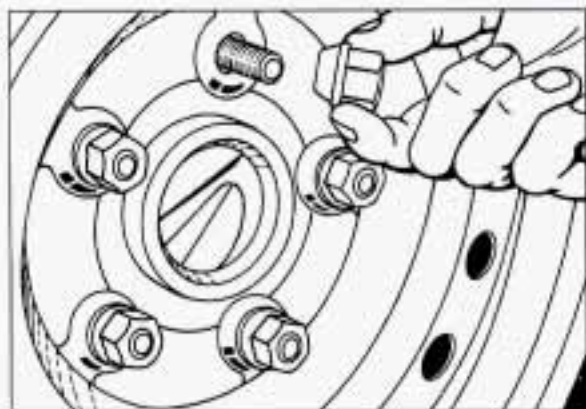

14. Replace the wheel nuts with the rounded end of the nuts toward the wheel. Tighten each nut by hand until the wheel is held against the hub.

 **CAUTION:**

Incorrect wheel nuts or improperly tightened wheel nuts can cause the wheel to become loose and even come off. This could lead to an accident. Be sure to use the correct wheel nuts. If you have to replace them, be sure to get the right kind. Stop somewhere as soon as you can and have the nuts tightened with a torque wrench to 100 pound-feet (140 N•m)

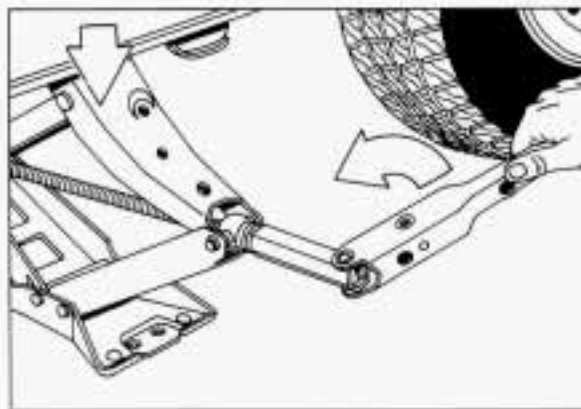

15. Lower the vehicle by attaching the folding wrench to the jack and rotating the wrench counterclockwise. Lower the jack completely.

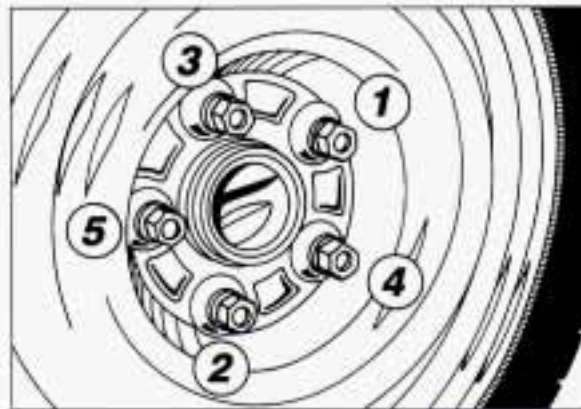

16. Tighten the wheel nuts firmly in a crisscross sequence as shown.

Stop somewhere as soon as you can and have the nuts tightened with a torque wrench. The torque setting should be 100 pound-feet (140 N•m).

## Problems on the Road

- 17.** Lay the flat tire near the rear of the vehicle with the valve stem down. Slide the cable retainer through the center of the wheel and raise the flat tire until you hear the hoist mechanism click twice. This means the wheel is firmly stored against the underside of the vehicle. When storing the spare tire, be certain to turn the spare so the valve stem is near the rear of the vehicle. This will help you to check and maintain tire pressure in the spare.

Push against the tire to be certain it is stored firmly.

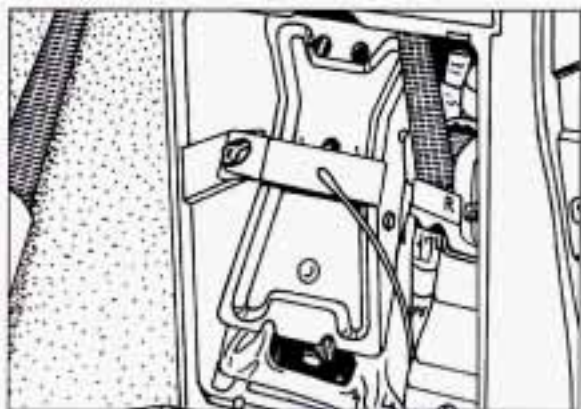

- 18.** Replace all jacking tools as they were stored in the storage compartment and replace the compartment cover. Be sure to also store the nylon nut caps.

When you replace the compact spare tire with a full-size tire, replace the nylon nut caps over the wheel nuts. Tighten them “hand tight” using the folding wrench (see step 7).



### CAUTION:

Storing a jack, a tire or other equipment in the passenger compartment of the vehicle could cause injury. In a sudden stop or collision, loose equipment could strike someone. Store all these in the proper place.

### ■ Compact Spare Tire

Although the compact spare was fully inflated when your vehicle was new, it can lose air after a time. Check the inflation pressure regularly. It should be 60 psi (420 kPa). After installing the compact spare on your vehicle, you should stop as soon as possible and make sure your spare tire is correctly inflated. The compact spare is made to perform well at posted speed limits for distances up to 3,000 miles (5 000 km). The compact spare is made to go up to 3,000 miles (5 000 km), so you can finish your trip and have your full-size tire repaired or replaced where you want. Of course, it's best to replace your spare with a full-size tire as soon as you can. Your spare will last longer and be in good shape in case you need it again.



**NOTICE:**

Don't take your compact spare through an automatic car wash with guide rails. The compact spare can get caught on the rails. That can damage the tire and wheel, and maybe other parts of your vehicle.

Don't use your compact spare on some other vehicle.

And don't mix your compact spare or wheel with other wheels or tires. They won't fit. Keep your spare and its wheel together.

**NOTICE:**

Tire chains won't fit your compact spare. Using them will damage your vehicle and destroy the chains too. Don't use tire chains on your compact spare.

**■ If You're Stuck: In Sand, Mud, Ice or Snow**

What you **don't** want to do when your vehicle is stuck is to spin your wheels. The method known as "rocking" can help you get out when you're stuck, but you must use caution.

**CAUTION:**

If you let your tires spin at high speed, they can explode and you or others could be injured. And, the transaxle or other parts of the vehicle can overheat. That could cause an engine compartment fire or other damage. When you're stuck, spin the wheels as little as possible. Don't spin the wheels above 35 mph (55 km/h) as shown on the speedometer.

**NOTICE:**

Spinning your wheels can destroy parts of your vehicle as well as the tires. If you spin the wheels too fast while shifting your transaxle back and forth, you can destroy your transaxle.

**Rocking Your Vehicle to Get it Out:**

First, turn your steering wheel left and right. That will clear the area around your front wheels. If you have the optional traction control system, you should turn it off. (See *Traction Control System* in the *Index*.) Then shift back and forth between **R** (Reverse) and a forward gear, spinning the wheels as little as possible. Release the accelerator pedal while you shift, and press lightly on the accelerator pedal when the transaxle is in gear. If that doesn't get you out after a few tries, you may need to be towed out. If you do need to be towed out, see *Towing Your Vehicle* in the *Index*.

# *Notes*



Here you will find information about the care of your Oldsmobile. This part begins with service and fuel information, and then it shows how to check important fluid and lubricant levels. There is also technical information about your vehicle, and a section devoted to its appearance care.

## Part 6

### *Service & Appearance Care*

Service .....	182
Fuel .....	183
Hood Release.....	186
Engine Oil.....	190
Air Cleaner .....	194
Transaxle Fluid.....	195
Engine Coolant .....	197
Power Steering Fluid.....	199
Windshield Washer Fluid.....	200
Brakes .....	201
Battery .....	203
Bulb Replacement .....	203
Windshield Wiper Blade Replacement .....	205
Loading Your Vehicle .....	206
Tires .....	207
Appearance Care.....	212
Vehicle Identification Number (VIN).....	218
Add-On Electrical Equipment .....	219
Fuses & Circuit Breakers.....	219
Capacities and Specifications .....	224
Normal Maintenance Replacement Parts.....	226
Fluids & Lubricants .....	227
Replacement Bulbs.....	228



# Service & Appearance Care



## ■ Service

Your Oldsmobile dealer knows your vehicle best and wants you to be happy with it. We hope you'll go to your dealer for all your service needs. You'll get genuine GM parts and GM-trained and supported service people.

We hope you'll want to keep your GM vehicle all GM. Genuine GM parts have one of these marks.

## Doing Your Own Service Work

If you want to do some of your own service work, you'll want to get the proper Oldsmobile Service Manual. It tells you much more about how to service your Oldsmobile than this manual can. To order the proper service manual, see *Service Publications* in the *Index*.

Your vehicle has an air bag system. Before attempting to do your own service work, see *Servicing Your Air Bag-Equipped Oldsmobile* in the *Index*.

You should keep a record with all parts receipts and list the mileage and the date of any service work you perform. See *Maintenance Record* in the *Index*.



## CAUTION:

You can be injured if you try to do service work on a vehicle without knowing enough about it.

- Be sure you have sufficient knowledge, experience, and the proper replacement parts and tools before you attempt any vehicle maintenance task.
- Be sure to use the proper nuts, bolts and other fasteners. "English" and "metric" fasteners can be easily confused. If you use the wrong fasteners, parts can later break or fall off. You could be hurt.

## NOTICE:

If you try to do your own service work without knowing enough about it, your vehicle could be damaged.

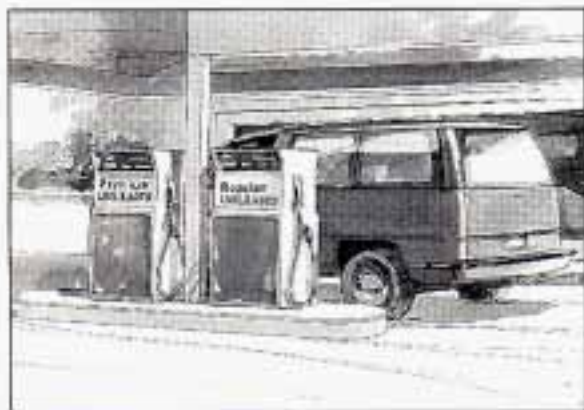

## ■ Fuel

Use regular unleaded gasoline rated at 87 octane or higher. It should meet specifications ASTM D4814 in the U.S. and CGSB 3.5-92 in Canada. These fuels should have the proper additives, so you should not have to add anything to the fuel.

In the U.S. and Canada, it's easy to be sure you get the right kind of gasoline (unleaded). You'll see "UNLEADED" right on the pump. And only unleaded nozzles will fit into your vehicle's filler neck.

Be sure the posted octane is at least 87. If the octane is less than 87, you may get a heavy knocking noise when you

drive. If it's bad enough, it can damage your engine.

If you're using fuel rated at 87 octane or higher and you still hear heavy knocking, your engine needs service. But don't worry if you hear a little pinging noise when you're accelerating or driving up a hill. That's normal, and you don't have to buy a higher octane fuel to get rid of pinging. It's the heavy, constant knock that means you have a problem.

What about gasoline with blending materials that contain oxygen (oxygenates), such as MTBE or alcohol?

**MTBE** is "methyl tertiary-butyl ether." Fuel that is no more than 15% MTBE is fine for your vehicle.

**Ethanol** is ethyl or grain alcohol. Properly-blended fuel that is no more than 10% **ethanol** is fine for your vehicle.

**Methanol** is methyl or wood alcohol.

## NOTICE:

Fuel that is more than 5% **methanol** is bad for your vehicle. Don't use it. It can corrode metal parts in your fuel system and also damage plastic and rubber parts. That damage wouldn't be covered under your warranty. And even at 5% or less, there must be "cosolvents" and corrosion preventers in this fuel to help avoid these problems.

## Gasolines for Cleaner Air

Your use of gasoline with deposit control additives will help prevent deposits from forming in your engine and fuel system. That helps keep your engine in tune and your emission control system working properly. It's good for your vehicle, and you'll be doing your part for cleaner air.

Many gasolines are now blended with oxygenates. General Motors recommends that you use gasolines with these blending materials, such as

## Service & Appearance Care

MTBE and ethanol. By doing so, you can help clean the air, especially in those parts of the country that have high carbon monoxide levels.

In addition, some gasoline suppliers are now producing reformulated gasolines. These gasolines are specially designed to reduce vehicle emissions. General Motors recommends that you use reformulated gasoline. By doing so, you can help clean the air, especially in those parts of the country that have high ozone levels.

You should ask your service station operators if their gasolines contain deposit control additives and oxygenates, and if they have been reformulated to reduce vehicle emissions.



### ■ *Fuels in Foreign Countries*

If you plan on driving in another country outside the U.S. or Canada, unleaded fuel may be hard to find. Do not use leaded gasoline. If you use even one tankful, your emission controls won't work well or at all. With continuous use, spark plugs can get fouled, the exhaust system can corrode, and your engine oil can deteriorate quickly. Your vehicle's oxygen sensor will be damaged. All of that means costly repairs that wouldn't be covered by your warranty.

To check on fuel availability, ask an auto club, or contact a major oil company that does business in the country where you'll be driving.

You can also write us at the following address for advice. Just tell us where you're going and give your Vehicle Identification Number (VIN).

General Motors Overseas  
Distribution Corporation  
North American Export Sales (NAES)  
1908 Colonel Sam Drive  
Oshawa, Ontario  
L1H 8P7



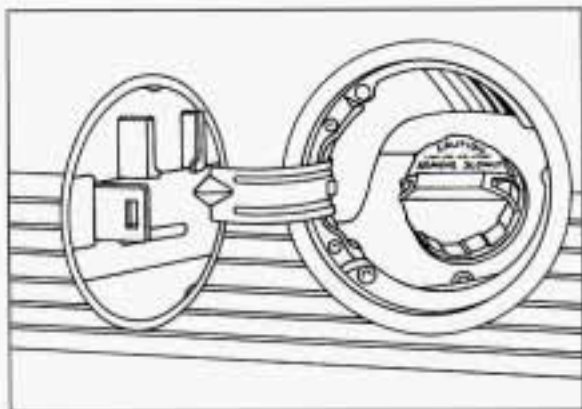

## ■ *Filling Your Tank*

**Fuel Capacity:** 20 U.S. Gallons (76 L).  
Use unleaded fuel only.

The cap is behind a hinged door on the left side of your vehicle.



### **CAUTION:**

Gasoline vapor is highly flammable. It burns violently, and that can cause very bad injuries. Don't smoke if you're near gasoline or refueling your vehicle. Keep sparks, flames, and smoking materials away from gasoline.

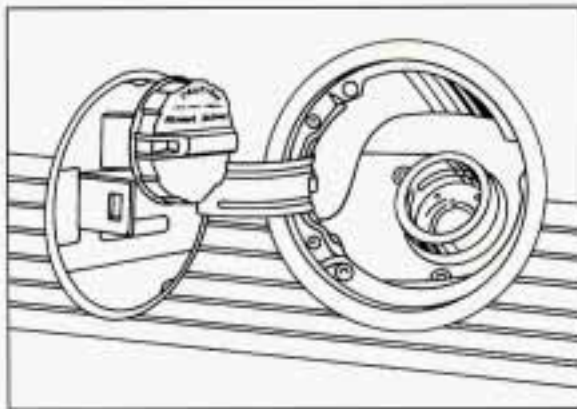

While refueling, hang the cap inside the fuel door.

To take off the cap, turn it slowly to the left (counterclockwise).



### **CAUTION:**

If you get gasoline on you and then something ignites it, you could be badly burned. Gasoline can spray out on you if you open the fuel filler cap too quickly. This spray can happen if your tank is nearly full, and is more likely in hot weather. Open the fuel filler cap slowly and wait for any "hiss" noise to stop. Then unscrew the cap all the way.

Be careful not to spill gasoline. Clean gasoline from painted surfaces as soon as possible. See *Cleaning the Outside of Your Oldsmobile* in the *Index*.

When you put the cap back on, turn it to the right until you hear a clicking noise.

### **NOTICE:**

If you need a new cap, be sure to get the right type. Your dealer can get one for you. If you get the wrong type, it may not fit or have proper venting, and your fuel tank and emissions system might be damaged.

# Service & Appearance Care

## ■ *Checking Things Under the Hood*

The following sections tell you how to check fluids, lubricants and important parts underhood.



### **Hood Release**

To open the hood, first pull the handle inside the vehicle.



Then go to the front of the vehicle and pull up on the hood release.

Lift the hood.

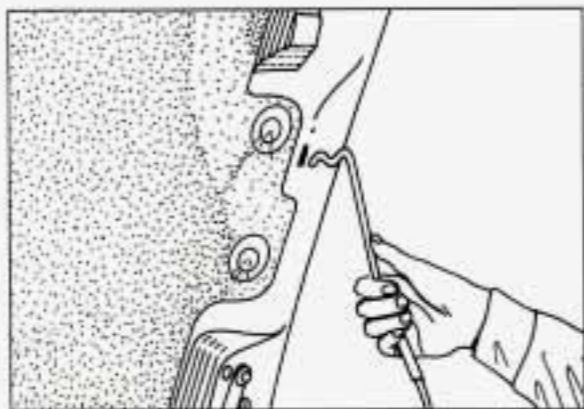

The hood prop rod may be hot due to increased engine temperatures under the hood, so be careful when handling it. Use your hood prop sleeve when handling the prop.

Pull forward on the hood prop to release it from its storage clip. Then put the end of the hood prop into the slot in the underside of the hood.

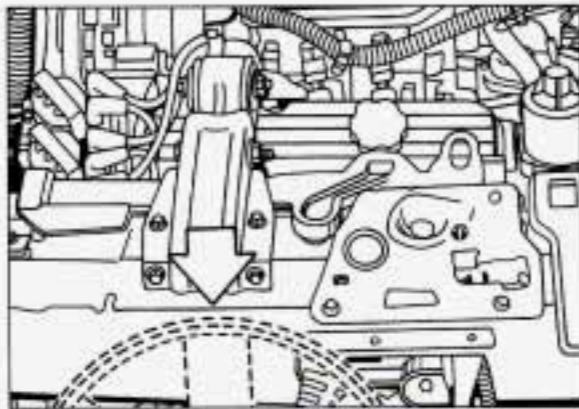

**!** CAUTION:

An electric fan under the hood can start up and injure you even when the engine is not running. Keep hands, clothing and tools away from any underhood electric fan.

**!** CAUTION:

Things that burn can get on hot engine parts and start a fire. These include liquids like gasoline, oil, coolant, brake fluid, windshield washer and other fluids, and plastic or rubber. You or others could be burned. Be careful not to drop or spill things that will burn onto a hot engine.

Before closing the hood, be sure all the filter caps are on properly. Then lift the hood to relieve pressure on the hood prop. Remove the hood prop from the slot in the hood and return the prop to its retainer. Then just let the hood down and close it firmly.



# Service & Appearance Care

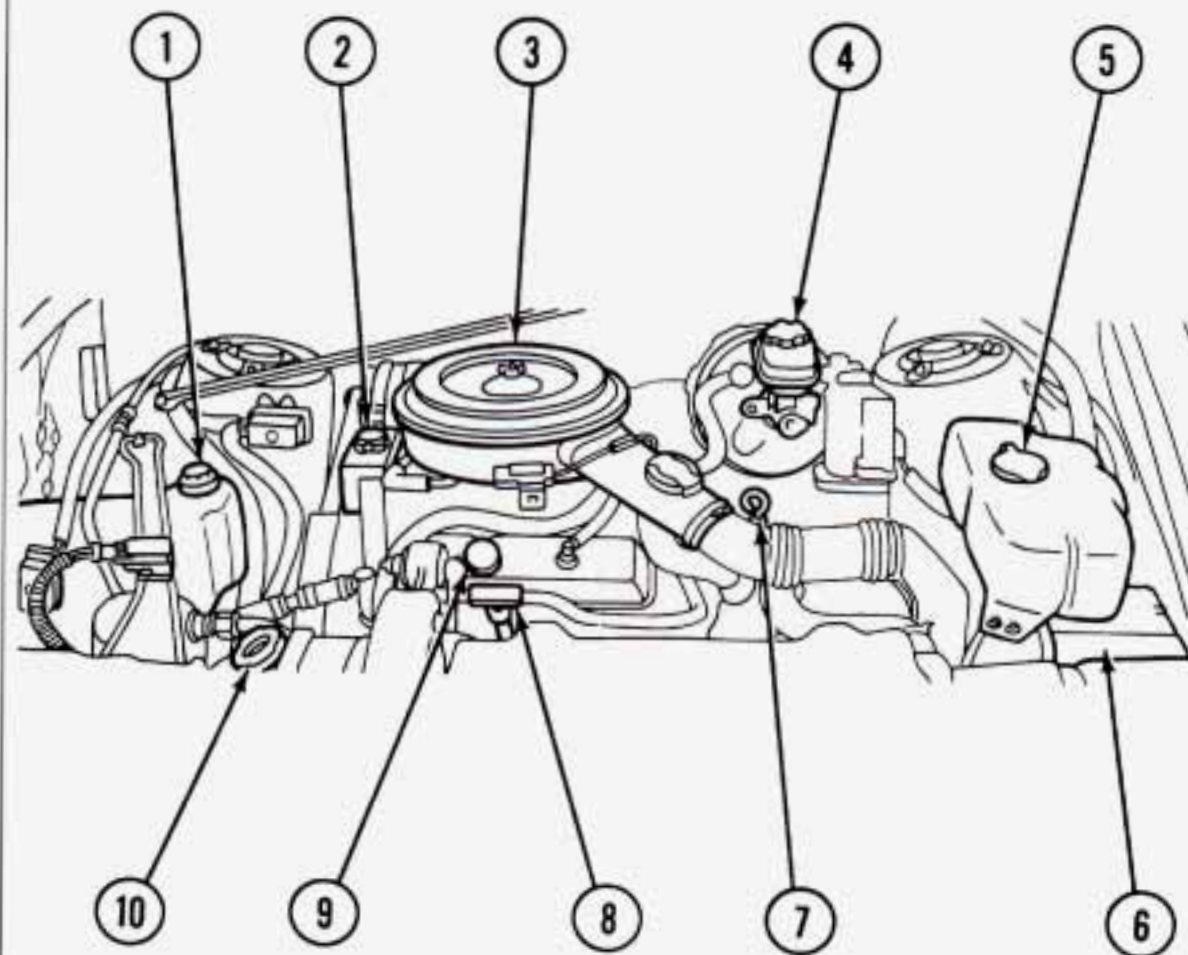

## 3100 V6 Engine

1. Engine Coolant Reservoir
2. Power Steering Fluid Reservoir
3. Air Cleaner
4. Brake Fluid Reservoir
5. Windshield Washer Fluid Reservoir
6. Battery
7. Automatic Transaxle Fluid Dipstick
8. Engine Oil Dipstick
9. Engine Oil Fill Cap
10. Radiator Cap

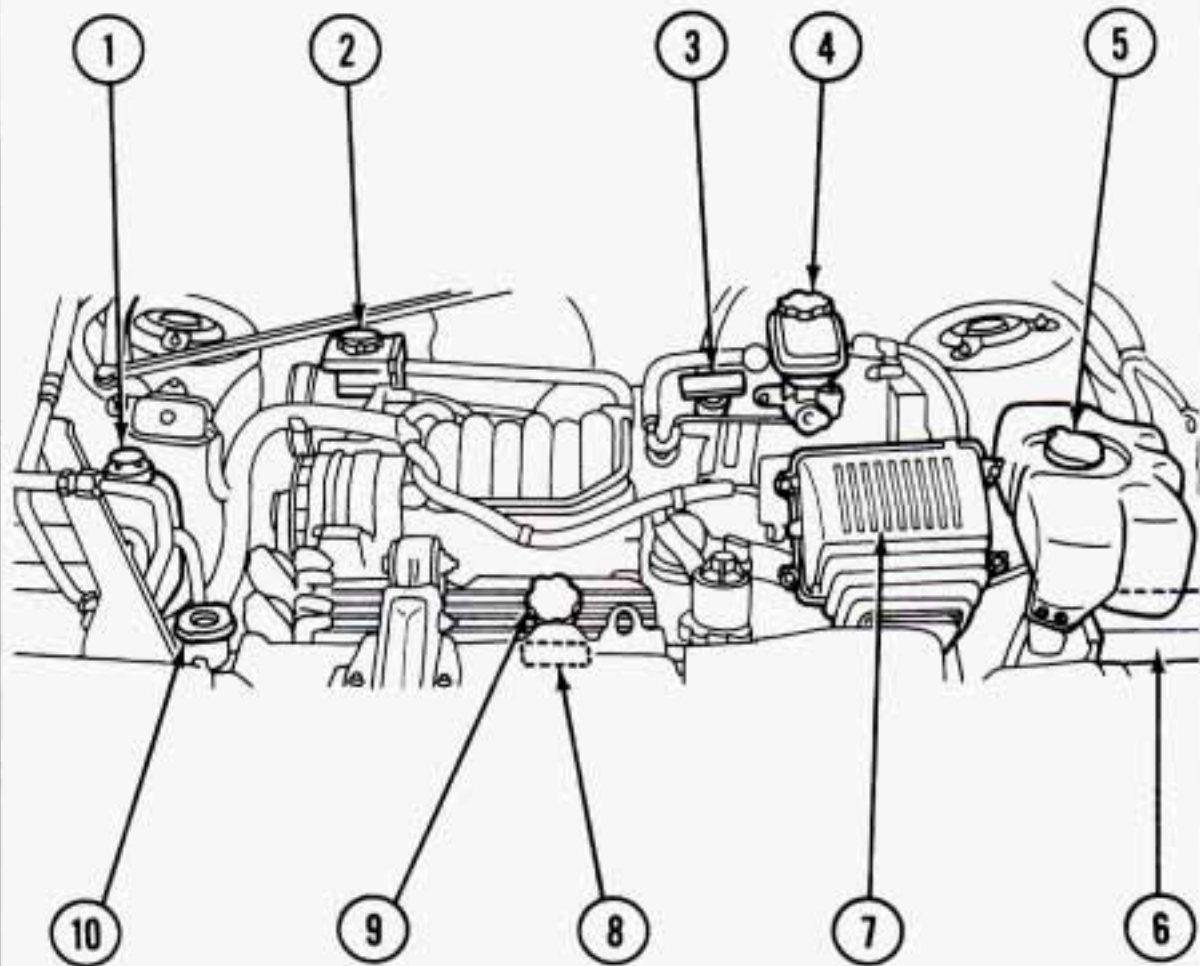

### **3800 V6 Engine**

1. Engine Coolant Reservoir
2. Power Steering Fluid Reservoir
3. Automatic Transaxle Fluid Dipstick
4. Brake Fluid Reservoir
5. Windshield Washer Fluid Reservoir
6. Battery
7. Air Cleaner
8. Engine Oil Dipstick
9. Engine Oil Fill Cap
10. Radiator Cap

# Service & Appearance Care

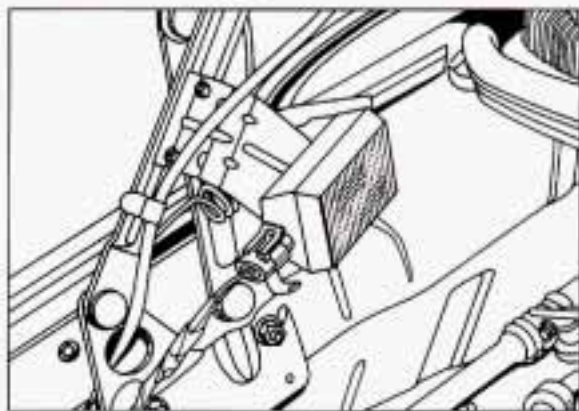

## Underhood Light

Your underhood light will go on when you open the hood.

## ■ Engine Oil

It's a good idea to check your engine oil every time you get fuel. In order to get an accurate reading, the oil must be warm and the vehicle must be on level ground.

Turn off the engine and give the oil a few minutes to drain back into the oil pan. If you don't, the oil dipstick might not show the actual level.

## To Check Engine Oil

Pull out the dipstick and clean it with a paper towel or cloth, then push it back in all the way. Remove it again, keeping the tip lower, and check the level.

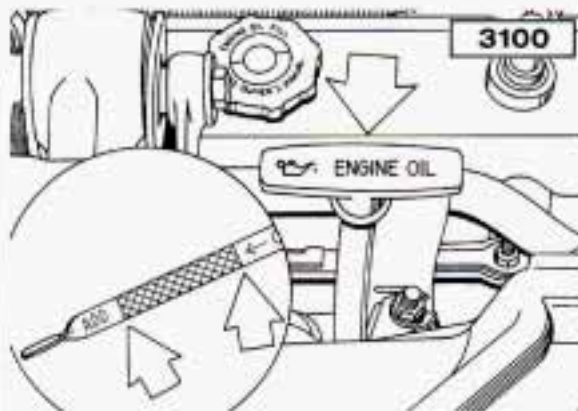

3100 V6: Checking Engine Oil

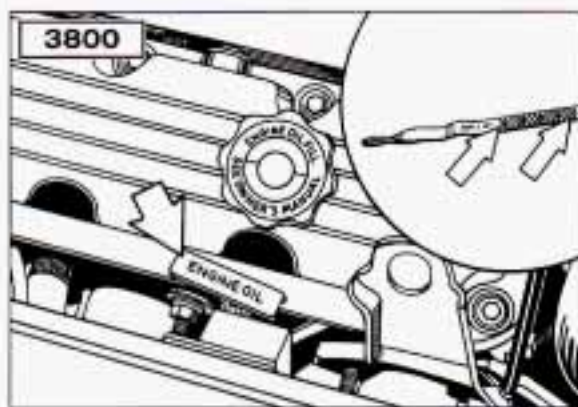

3800 V6: Checking Engine Oil



## When to Add Oil

If the oil is at or below the ADD mark, then you'll need to add some oil. But you must use the right kind. This section explains what kind of oil to use. For crankcase capacity, see *Capacities and Specifications* in the *Index*.

### NOTICE:

Don't add too much oil. If your engine has so much oil that the oil level gets above the cross-hatched area that shows the proper operating range, your engine could be damaged.

Just fill it enough to put the level somewhere in the proper operating range. Push the dipstick all the way back in when you're through.

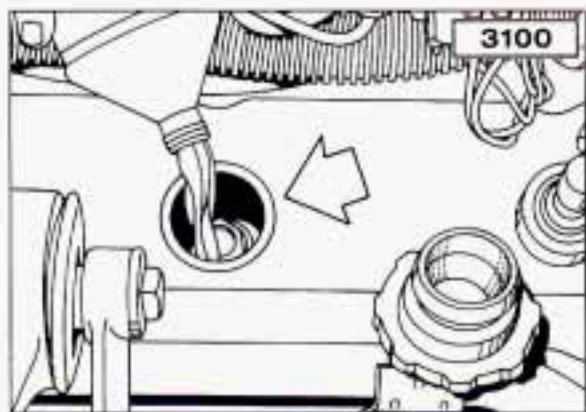

3100 V6: Adding Engine Oil

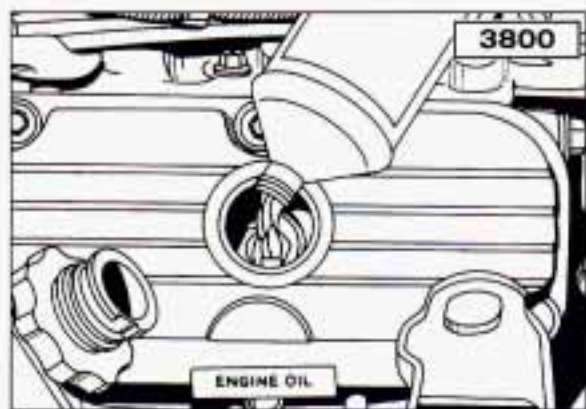

3800 V6: Adding Engine Oil



## What Kind of Oil to Use

Beginning midyear 1993, oils of the proper quality for your vehicle will be identified with this new "starburst" symbol. The "starburst" symbol indicates that the oil has been certified by the American Petroleum Institute (API), and is preferred for use in your gasoline engine.

You should look for this on the front of the oil container, and use only oils that display this new symbol.

You should also use the proper viscosity oil for your vehicle, as shown in the following charts.

# Service & Appearance Care

## RECOMMENDED SAE VISCOSITY GRADE ENGINE OILS

FOR BEST FUEL ECONOMY AND COLD STARTING,  
SELECT THE LOWEST SAE VISCOSITY GRADE OIL  
FOR THE EXPECTED TEMPERATURE RANGE.

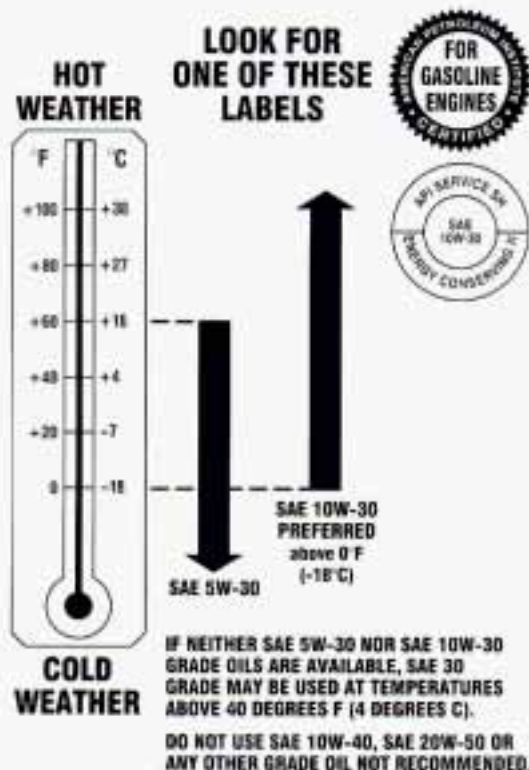

3800 V6: Oil Viscosity Chart

As shown in the chart, SAE 10W-30 is best for your vehicle. However, you can use SAE 5W-30 if it's going to be colder than 60°F (16°C) before your next oil change. When it's very cold, you should use SAE 5W-30. These numbers on an oil container show its viscosity, or thickness. Do not use other viscosity oils, such as SAE 10W-40 or SAE 20W-50.

## RECOMMENDED SAE VISCOSITY GRADE ENGINE OILS

FOR BEST FUEL ECONOMY AND COLD STARTING,  
SELECT THE LOWEST SAE VISCOSITY GRADE OIL  
FOR THE EXPECTED TEMPERATURE RANGE.

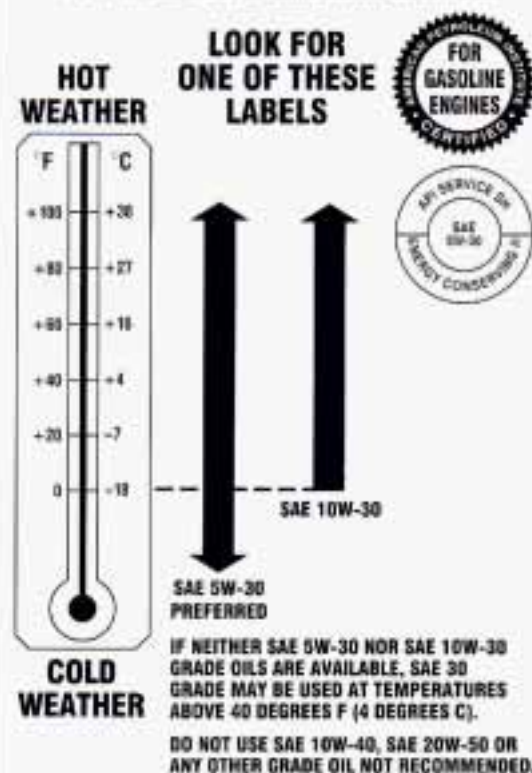

3100 V6: Oil Viscosity Chart



As shown in the chart, SAE 5W-30 is best for your vehicle. However, you can use SAE 10W-30 if it's going to be 0°F (-18°C) or above. These numbers on an oil container show its viscosity, or thickness. Do not use other viscosity oils, such as SAE 10W-40 or SAE 20W-50.

If you cannot find oils with the new "starburst" symbol on the front of the container, you should look for and use oils containing the following three things:

- **SH or SG**

"SH" or "SG" must be on the oil container, either by itself or combined with other quality designations, such as "SH/CD," "SH,SG,CD," "SG/CD," etc. These letters show American Petroleum Institute (API) levels of quality.

- **SAE 10W-30** (3800 engine)

- **SAE 5W-30** (3100 engine)

- **Energy Conserving II**

Oils with these words on the container will help you save fuel.

These three things are usually included in a doughnut shaped logo (symbol) on most containers. If you cannot find oils with the "starburst" symbol, you should look for oils with the doughnut shaped symbol, containing the three things noted above.



### NOTICE:

If you use oils that do not have either the "starburst" symbol or an API SH or SG designation, you can cause engine damage not covered by your warranty.

GM Goodwrench® oil (in Canada, GM Engine Oil) meets all the requirements for your vehicle.

### Engine Oil Additives

Don't add anything to your oil. Your Oldsmobile dealer is ready to advise if you think something should be added.

### When to Change Engine Oil

See if any one of these is true for you:

- Most trips are less than 4 miles (6 km).
- It's below freezing outside and most trips are less than 10 miles (16 km).
- The engine is at low speed most of the time (as in door-to-door delivery, or in stop-and-go traffic).
- You tow a trailer often.
- Most trips are through dusty places.

If any one of these is true for your vehicle, then you need to change your **oil and filter** every 3,000 miles (5 000 km) or 3 months — whichever comes first.

If none of them is true, change the oil every 7,500 miles (12 500 km) or 12 months — whichever comes first.

Change the filter at the first oil change and at every other oil change after that.

### Engine Coolant Heater (Engine Block Heater)

An engine coolant heater can be a big help if you have to park outside in very cold weather, 0°F (-18°C) or colder. If your vehicle has this option, see *Engine Coolant Heater* in the *Index*.



# Service & Appearance Care

## What to Do with Used Oil

Did you know that used engine oil contains certain elements that may be unhealthy for your skin and could even cause cancer? Don't let used oil stay on your skin for very long. Clean your skin and nails with soap and water, or a good hand cleaner. Wash or properly throw away clothing or rags containing used engine oil. (See the manufacturer's warnings about the use and disposal of oil products.)

Used oil can be a real threat to the environment. If you change your own oil, be sure to drain all free-flowing oil from the filter before disposal. Don't ever dispose of oil by putting it in the trash, pouring it on the ground, into sewers, or into streams or bodies of water. Instead, recycle it by taking it to a place that collects used oil. If you have a problem properly disposing of your used oil, ask your dealer, a service station or a local recycling center for help.

## ■ Air Cleaner

Refer to the Maintenance Schedule to determine when to replace the air filter. See *Scheduled Maintenance Services* in the *Index*.



### CAUTION:

Operating the engine with the air cleaner off can cause you or others to be burned. The air cleaner not only cleans the air, it stops flame if the engine backfires. If it isn't there, and the engine backfires, you could be burned. Don't drive with it off, and be careful working on the engine with the air cleaner off.

### NOTICE:

If the air cleaner is off, a backfire can cause a damaging engine fire. And, dirt can easily get into your engine, which will damage it. Always have the air cleaner in place when you're driving.

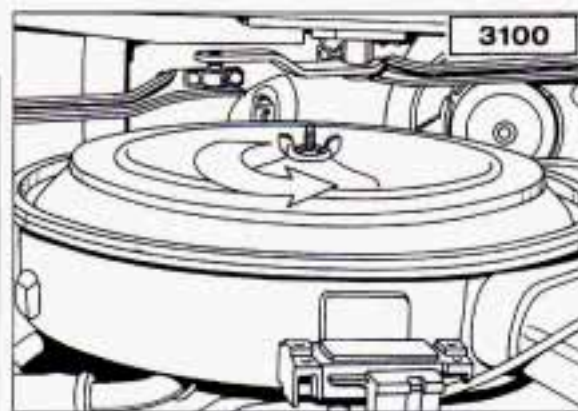

## 3100 V6: Checking Air Cleaner Filter To Check or Replace:

1. Remove the large wing nut and lift the cover.

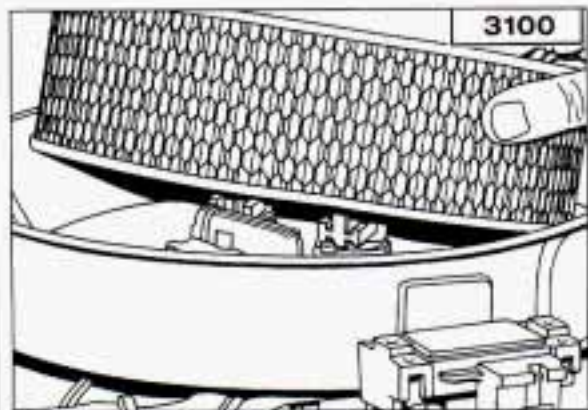

### 3100 V6: Replacing Air Cleaner Filter

2. Remove the air cleaner filter.
3. Be sure to install the air cleaner filter, replace the cover and tighten the wing nut securely.

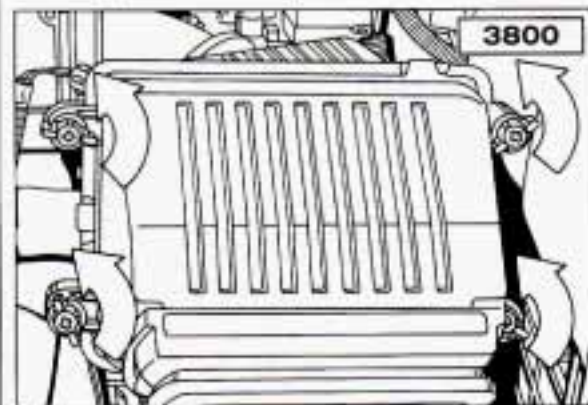

### 3800 V6: Checking Air Cleaner Filter To Check or Replace:

1. Loosen the four wing nuts.

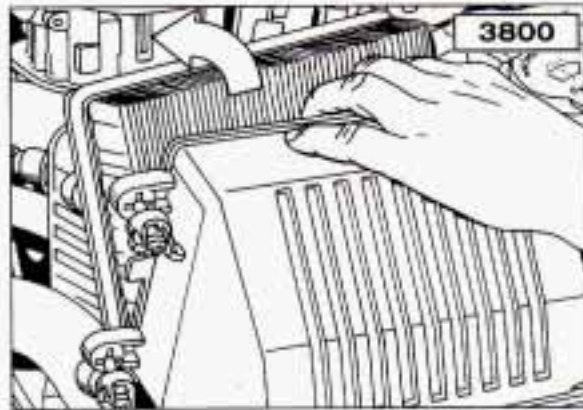

### 3800 V6: Replacing Air Cleaner Filter

2. Pull the top of the air cleaner toward the front of the vehicle and remove the air cleaner filter.
3. Be sure to install the air cleaner filter, replace the cover and tighten the wing nuts securely.

## ■ Automatic Transaxle Fluid When to Check and Change

A good time to check your automatic transaxle fluid level is when the engine oil is changed. Refer to the Maintenance Schedule to determine when to change your fluid. See *Scheduled Maintenance Services* in the *Index*.

## How to Check

Because this operation can be a little difficult, you may choose to have this done at an Oldsmobile dealership Service Department.

If you do it yourself, be sure to follow all the instructions here, or you could get a false reading on the dipstick.

## NOTICE:

Too much or too little fluid can damage your transaxle. Too much can mean that some of the fluid could come out and fall on hot engine parts or exhaust system, starting a fire. Be sure to get an accurate reading if you check your transaxle fluid.

Wait at least 30 minutes before checking the transaxle fluid level if you have been driving:

- When outside temperatures are above 90°F (32°C).
- At high speed for quite a while.
- In heavy traffic—especially in hot weather.
- While pulling a trailer.



# Service & Appearance Care

To get the right reading, the fluid should be at normal operating temperature, which is 180°F to 200°F (82°C to 93°C).

Get the vehicle warmed up by driving about 15 miles (24 km) when outside temperatures are above 50°F (10°C). If it's colder than 50°F (10°C), you may have to drive longer.

## To Check the Fluid Level

- Park your vehicle on a level place.
- With the parking brake applied, place the shift lever in **P** (Park).
- With your foot on the brake pedal, move the shift lever through each gear range, pausing for about three seconds in each range. Then, position the shift lever in **P** (Park).
- Let the engine run at idle for three to five minutes.

**Then, Without Shutting Off the Engine, Follow these Steps:**

1. Pull out the dipstick and wipe it with a clean rag or paper towel.
2. Push it back in all the way, wait three seconds and then pull it back out again.
3. Check both sides of the dipstick, and read the lower level. The fluid level must be in the cross-hatched area.
4. If the fluid level is in the acceptable range, push the dipstick back in all the way.

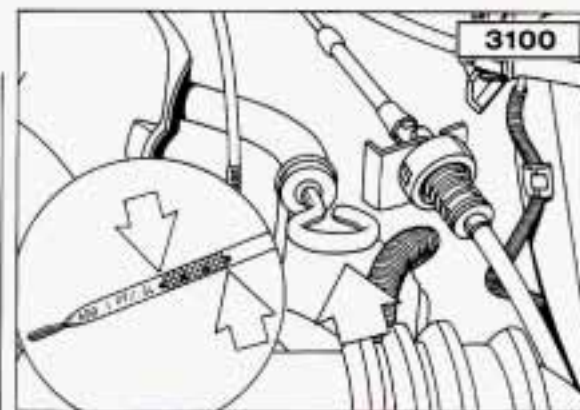

**3100 V6: Checking Automatic Transaxle Fluid**

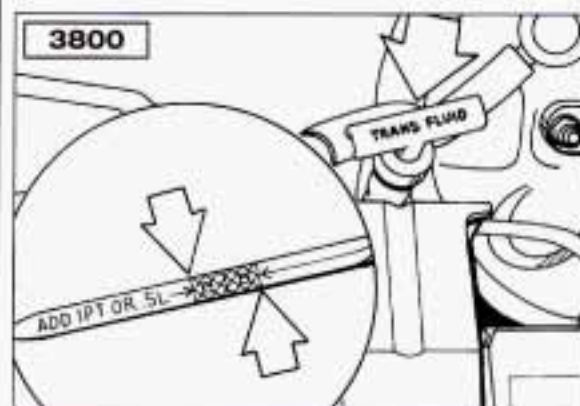

**3800 V6: Checking Automatic Transaxle Fluid**



## How to Add Fluid

Refer to the Maintenance Schedule to determine what kind of transaxle fluid to use. See *Recommended Fluids and Lubricants* in the *Index*.

If the fluid level is low, add only enough of the proper fluid to bring the level into the cross-hatched area on the dipstick.

1. Pull out the dipstick.
2. Using a long-neck funnel, add enough fluid at the dipstick hole to bring it to the proper level.

It doesn't take much fluid, generally less than a pint (0.5L). **Don't overfill.** We recommend you use only fluid labeled DEXRON<sup>®</sup>-III or DEXRON<sup>®</sup>-IIE, because fluids with that label are made especially for your automatic transaxle. Damage caused by fluid other than DEXRON<sup>®</sup>-III or DEXRON<sup>®</sup>-IIE is not covered by your new vehicle warranty.

- After adding fluid, recheck the fluid level as described under *How to Check*.
- When the correct fluid level is obtained, push the dipstick back in all the way.

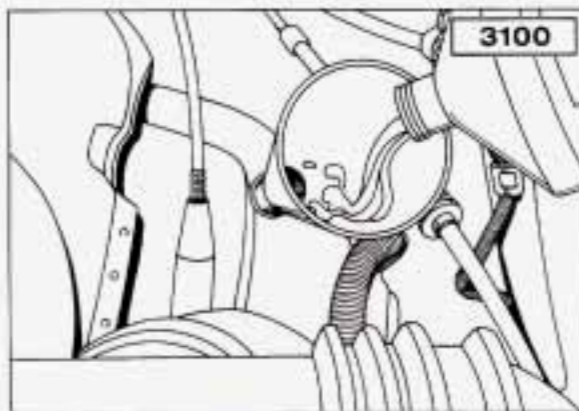

**3100 V6: Adding Automatic Transaxle Fluid**

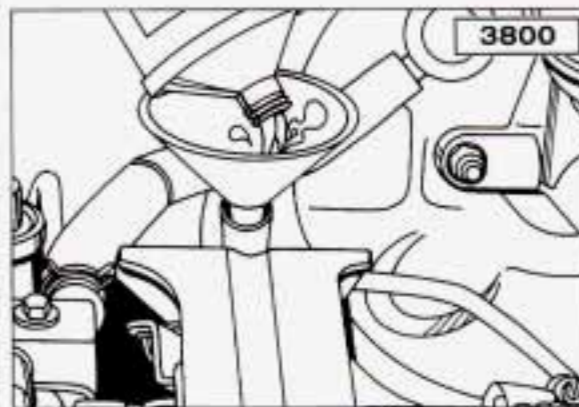

**3800 V6: Adding Automatic Transaxle Fluid**

## ■ Engine Coolant

The following explains your cooling system and how to add coolant when it is low. If you have a problem with engine overheating, see *Engine Overheating* in the *Index*.

The proper coolant for your Oldsmobile will:

- Give freezing protection down to -34°F (-37°C).
- Give boiling protection up to 262°F (128°C).
- Protect against rust and corrosion.
- Help keep the proper engine temperature.
- Let the warning lights work as they should.

### What to Use

Use a mixture of one-half **clean water** (preferably distilled) and one-half antifreeze that meets "GM Specification 1825-M," which won't damage aluminum parts. You can also use a recycled coolant conforming to GM Specification 1825-M with a complete coolant flush and refill. If you use this mixture, you don't need to add anything else.



## CAUTION:

Adding only plain water to your cooling system can be dangerous. Plain water, or some other liquid like alcohol, can boil before the proper coolant mix will. Your vehicle's coolant warning system is set for the proper coolant mix. With plain water or the wrong mix, your engine could get too hot but you wouldn't get the overheat warning. Your engine could catch fire and you or others could be burned. Use a 50/50 mix of clean water and a proper antifreeze.

## NOTICE:

If you use an improper coolant mix, your engine could overheat and be badly damaged. The repair cost wouldn't be covered by your warranty. Too much water in the mix can freeze and crack the engine, radiator, heater core and other parts.

## Adding Coolant

### To Check Coolant

When your engine is cold, the coolant level should be at **COLD**, or a little higher. When your engine is warm, the level should be up to **FULL HOT**, or a little higher.

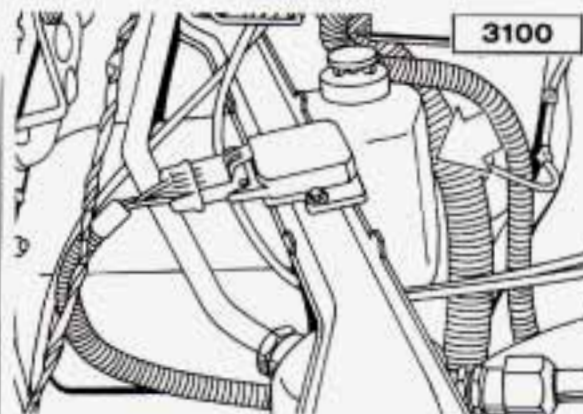

3100 V6: Checking Coolant

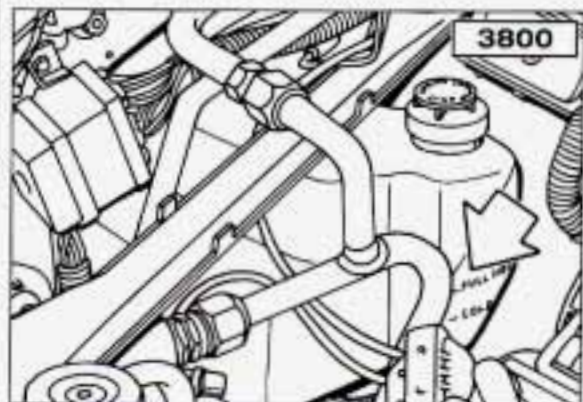

3800 V6: Checking Coolant



## To Add Coolant

If you need more coolant, add the proper mix **at the coolant recovery tank**.



### CAUTION:

Turning the radiator pressure cap when the engine and radiator are hot can allow steam and scalding liquids to blow out and burn you badly. With the coolant recovery tank, you will almost never have to add coolant at the radiator. Never turn the radiator pressure cap—even a little—when the engine and radiator are hot.

Add coolant mix at the recovery tank, but be careful not to spill it.



### CAUTION:

You can be burned if you spill coolant on hot engine parts. Coolant contains ethylene glycol, and it will burn if the engine parts are hot enough. Don't spill coolant on a hot engine.

## Radiator Pressure Cap

### NOTICE:

Your radiator cap is a 15 psi (105 kPa) pressure-type cap and must be tightly installed to prevent coolant loss and possible engine damage from overheating. Be sure the arrows on the cap line up with the overflow tube on the radiator filler neck.

When you replace your radiator pressure cap, an AC® cap is recommended.

## Thermostat

Engine coolant temperature is controlled by a thermostat in the engine coolant system. The thermostat stops the flow of coolant through the radiator until the coolant reaches a preset temperature.

When you replace your thermostat, an AC® thermostat is recommended.

## ■ Power Steering Fluid

### How To Check Power Steering Fluid

Unscrew the cap and wipe the dipstick with a clean rag. Replace the cap and completely tighten it. Then remove the cap again and look at the fluid level on the dipstick.

- When the engine compartment is hot, the level should be at the **H** (Hot) mark.
- When the engine compartment is cool, the level should be at the **C** (Cold) mark.



# Service & Appearance Care

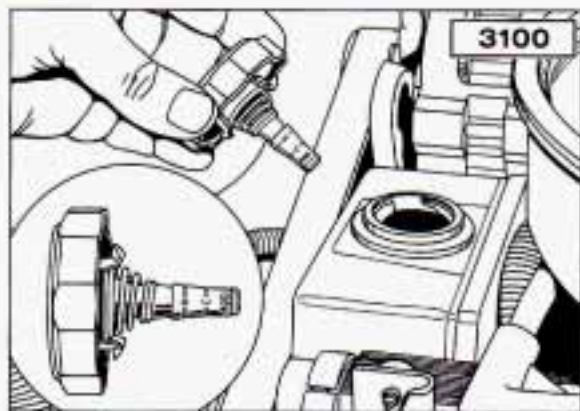

**3100 V6: Checking Power Steering Fluid**

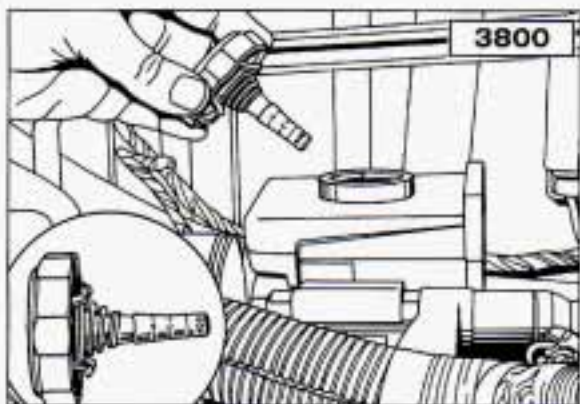

**3800 V6: Checking Power Steering Fluid**

## What to Add

Refer to the Maintenance Schedule to determine what kind of fluid to use. See *Recommended Fluids and Lubricants* in the *Index*.

### NOTICE:

When adding power steering fluid or making a complete fluid change, always use the proper fluid. Failure to use the proper fluid can cause leaks and damage hoses and seals.

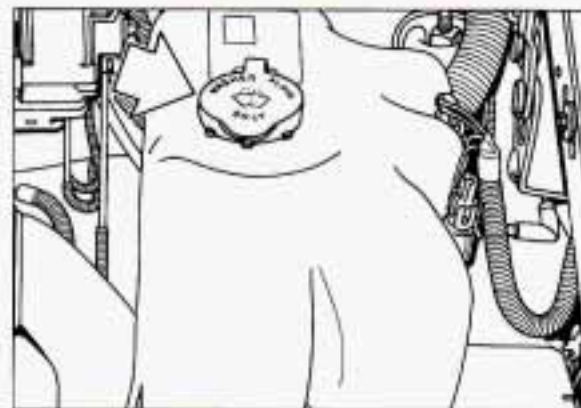

## ■ Windshield Washer Fluid

### To Add

Open the cap labeled **WASHER FLUID ONLY**. Add washer fluid until the bottle is full.

## NOTICE:

- When using concentrated washer fluid, follow the manufacturer's instructions for adding water.
- Don't mix water with ready-to-use washer fluid. Water can cause the solution to freeze and damage your washer fluid tank and other parts of the washer system. Also, water doesn't clean as well as washer fluid.
- Fill your washer fluid tank only  $\frac{3}{4}$  full when it's very cold. This allows for expansion, which could damage the tank if it is completely full.
- Don't use radiator antifreeze in your windshield washer. It can damage your washer system and paint.

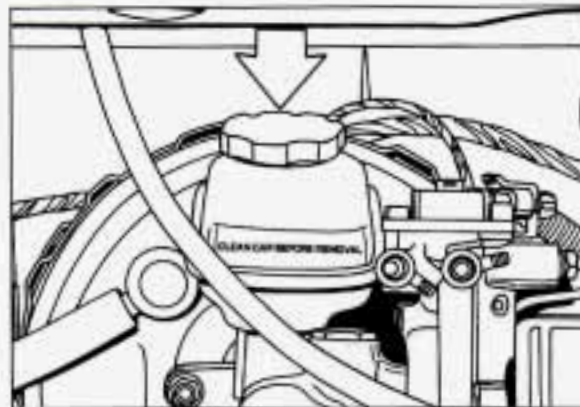

## ■ Brakes

### **Brake Master Cylinder**

Your brake master cylinder is here. It is filled with DOT-3 brake fluid.

There are only two reasons why the brake fluid level in your master cylinder might go down. The first is that the brake fluid goes down to an acceptable level during normal brake lining wear. When new linings are put in, the fluid level goes back up.

The other reason is that fluid is leaking out of the brake system. If it is, you should have your brake system fixed, since a leak means that sooner or later your brakes won't work well, or won't work at all. So, it isn't a good idea to "top off" your brake fluid. Adding brake

fluid won't correct a leak. If you add fluid when your linings are worn, then you'll have too much fluid when you get new brake linings. You should add (or remove) brake fluid, as necessary, only when work is done on the brake hydraulic system.



## CAUTION:

If you have too much brake fluid, it can spill on the engine. The fluid will burn if the engine is hot enough. You or others could be burned, and your vehicle could be damaged. Add brake fluid only when work is done on the brake hydraulic system.

When your brake fluid falls to a low level, your brake warning light will come on. See *Brake System Warning Light* in the *Index*.

### **What to Add**

When you do need brake fluid, use only DOT-3 brake fluid — such as Delco Supreme 11® (GM Part No.1052535). Use new brake fluid from a sealed



# Service & Appearance Care

container only, and always clean the brake fluid reservoir cap before removing it.

## NOTICE:

- DOT-5 silicone brake fluid can damage your vehicle. Don't use it.
- Don't let someone put in the wrong kind of fluid. For example, just a few drops of mineral-based oil, such as engine oil, in your brake system can damage brake system parts so badly that they'll have to be replaced.
- Brake fluid can damage paint, so be careful not to spill brake fluid on your vehicle. If you do, wash it off immediately. See *Appearance Care* in the *Index*.

## Brake Wear

Your Oldsmobile has front disc brakes and rear drum brakes.

Disc brake pads have built-in wear indicators that make a high-pitched warning sound when the brake pads are

worn and new pads are needed. The sound may come and go or be heard all the time your vehicle is moving (except when you are pushing on the brake pedal firmly).



## CAUTION:

The brake wear warning sound means that sooner or later your brakes won't work well. That could lead to an accident. When you hear the brake wear warning sound, have your vehicle serviced.

## NOTICE:

Continuing to drive with worn-out brake pads could result in costly brake repair.

Some driving conditions or climates may cause a brake squeal when the brakes are first applied or lightly applied. This does not mean something is wrong with your brakes.

Your rear drum brakes don't have wear indicators, but if you ever hear a rear brake rubbing noise, have the rear brake linings inspected. Also, the rear brake drums should be removed and inspected each time the tires are removed for rotation or changing. When you have the front brakes replaced, have the rear brakes inspected, too.

Brake linings should always be replaced as complete axle sets.

## Brake Pedal Travel

See your dealer if the brake pedal does not return to normal height, or if there is a rapid increase in pedal travel. This could be a sign of brake trouble.

## Brake Adjustment

Every time you apply the brakes moderately, with or without the vehicle moving, your brakes adjust for wear.



## Replacing Brake System Parts

The braking system on a modern vehicle is complex. Its many parts have to be of top quality and work well together if the vehicle is to have really good braking. Vehicles we design and test have top-quality GM brake parts in them, as your Oldsmobile does when it is new. When you replace parts of your braking system — for example, when your brake linings wear down and you have to have new ones put in — be sure you get new genuine GM replacement parts. If you don't, your brakes may no longer work properly. For example, if someone puts in brake linings that are wrong for your vehicle, the balance between your front and rear brakes can change, for the worse. The braking performance you've come to expect can change in many other ways if someone puts in the wrong replacement brake parts.

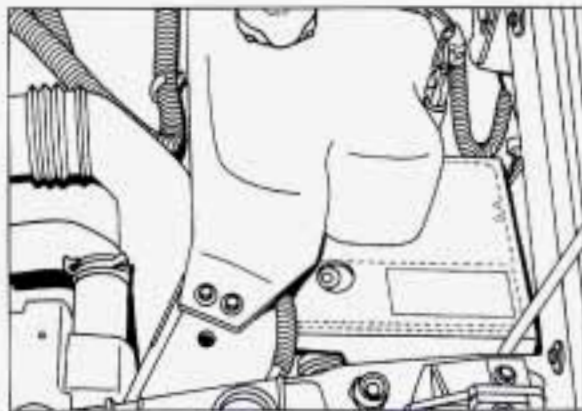

### ■ Battery

Every new Oldsmobile has a Delco Freedom<sup>®</sup> battery. You never have to add water to one of these. When it's time for a new battery, we recommend a Delco Freedom<sup>®</sup> battery. Get one that has the catalog number shown on the original battery's label.

### Vehicle Storage

If you're not going to drive your vehicle for 25 days or more, take off the black, negative (-) cable from the battery. This will help keep your battery from running down.



### CAUTION:

Batteries have acid that can burn you and gas that can explode. You can be badly hurt if you aren't careful. See *Jump Starting* in the *Index* for tips on working around a battery without getting hurt.

Contact your dealer to learn how to prepare your vehicle for longer storage periods.

### ■ Halogen Bulbs



### CAUTION:

Halogen bulbs have pressurized gas inside and can burst if you drop or scratch the bulb. You or others could be injured. Take special care when handling and disposing of halogen bulbs.

# Service & Appearance Care

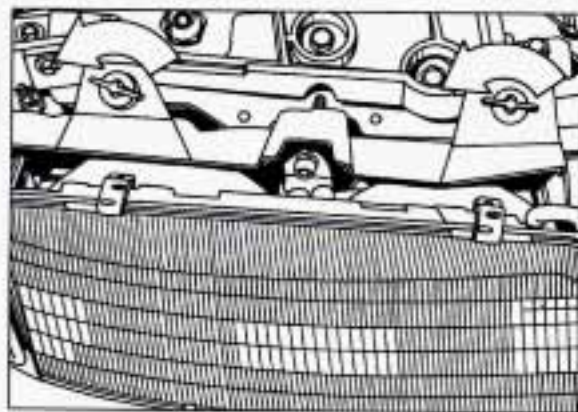

## Headlight Bulb Replacement

For the type of bulb, see the *Index* under *Replacement Bulbs*.



### CAUTION:

You can get hurt by halogen bulbs. They have pressurized gas inside and can burst if you:

- Touch or move the bulb when it's hot.
- Drop the bulb.
- Scratch the bulb.

1. Remove the two black knobs.
2. Tilt the bulb housing forward.

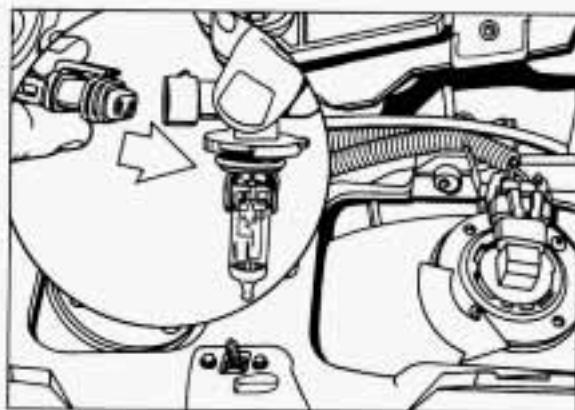

3. Twist the L-shaped bulb assembly counterclockwise  $\frac{1}{8}$  turn until the flanges align with the slots in the retainer ring.
4. Pull out the bulb assembly.
5. Disconnect the bulb wiring harness from the bulb assembly by lifting the plastic locking tab.
6. Snap a new bulb assembly onto the wiring harness.
7. Replace the bulb assembly by reversing step 3.
8. Replace the bulb housing and the two black knobs.

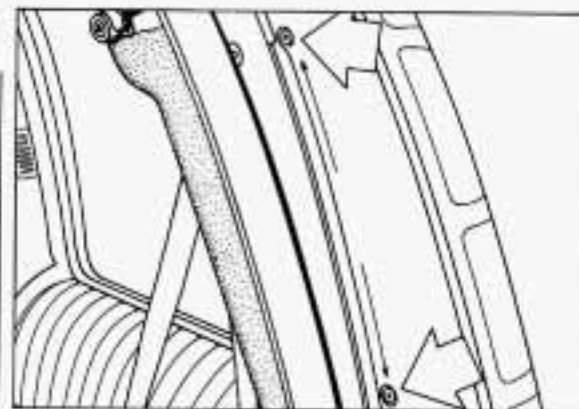

## Taillight Bulb Replacement

For the type of bulb, see the *Index* under *Replacement Bulbs*.

1. Open the rear side windows and liftgate.
2. Remove the two screws from the taillight housing.
3. Undo the spring clips under the weatherstrip at the rear of the side window.





4. Pull off the entire taillight housing.
5. Pinch the lever and twist the bulb assembly  $\frac{1}{2}$  turn counterclockwise to remove.
6. Remove the bulb by pressing in and turning  $\frac{1}{2}$  turn counterclockwise.
7. Line up the small retainer bumps on the replacement bulb so that the lower bump slides into the deepest slot in the housing. Press in and twist the bulb  $\frac{1}{2}$  turn clockwise. Reposition the bulb assembly in the taillight housing. Turn the assembly  $\frac{1}{2}$  turn clockwise to lock in place.
8. Replace the entire taillight housing and screws.

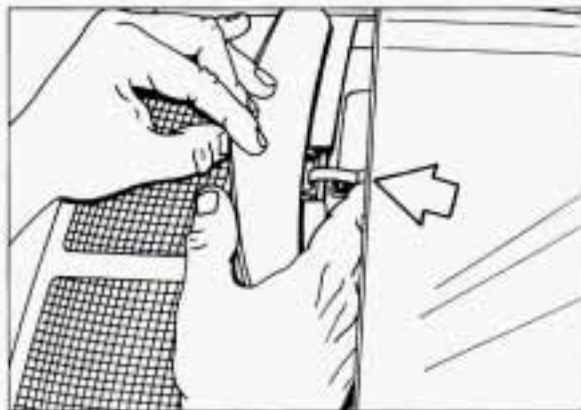

9. Attach the spring clips to the taillight housing and secure them.
10. Close the rear side windows and liftgate.
11. Test the bulbs by using your turn signals and taillights.

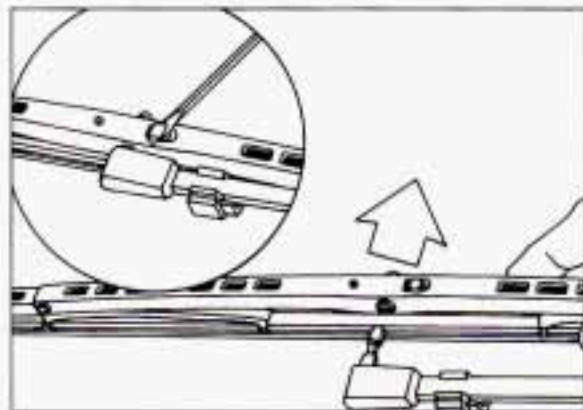

### **Windshield Wiper Blade Replacement**

Replacement blades for your vehicle are 24 inches in length. They come in different types and are removed in different ways. Here's how to remove the type with a release clip:

1. Pull the windshield wiper arm away from the windshield.
2. Lift the release clip with a screwdriver and pull the blade assembly off the wiper arm.
3. Push the new wiper blade securely on the wiper arm.



# Service & Appearance Care

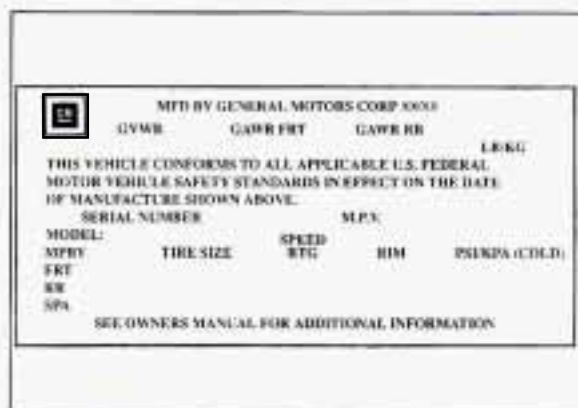

## Loading Your Vehicle

The Certification/Tire label is found on the rear edge of the driver's door.

The label shows the size of your original tires and the inflation pressures needed to obtain the gross weight capacity of your vehicle. This is called the GVWR (Gross Vehicle Weight Rating). The GVWR includes the weight of the vehicle, all occupants, fuel and cargo.

The Certification/Tire label also tells you the maximum weights for the front and rear axles, called Gross Axle Weight Rating (GAWR). To find out the actual loads on your front and rear axles, you need to go to a weigh station and weigh your vehicle. Your dealer can

help you with this. Be sure to spread out your load equally on both sides of the centerline.

Never exceed the GVWR for your vehicle, or the Gross Axle Weight Rating (GAWR) for either the front or rear axle.

And, if you do have a heavy load, you should spread it out.

## Electronic Level Control

On vehicles equipped with optional electronic level control, the rear of the vehicle is automatically kept level as you load or unload your vehicle. For more about this option see the *Index* under *Electronic Level Control*.



## CAUTION:

Do not load your vehicle any heavier than the GVWR or the maximum front and rear GAWRs. If you do, parts on your vehicle can break, or it can change the way your vehicle handles. These could cause you to lose control. Also, overloading can shorten the life of your vehicle.

Using heavier suspension components to get added durability might not change your weight ratings. Ask your dealer to help you load your vehicle the right way.

## NOTICE:

Your warranty does not cover parts or components that fail because of overloading.

If you put things inside your vehicle—like suitcases, tools, packages, or anything else—they will go as fast as the vehicle goes. If you have to stop or turn quickly, or if there is a crash, they'll keep going.



### CAUTION:

Things you put inside your vehicle can strike and injure people in a sudden stop or turn, or in a crash.

- Put things in the cargo area of your vehicle. Try to spread the weight evenly.
- Never stack heavier things, like suitcases, inside the vehicle so that some of them are above the tops of the seats.
- Don't leave an unsecured child restraint in your vehicle.
- When you carry something inside the vehicle, secure it whenever you can.
- Don't leave a seat folded down unless you need to.

### ■ Tires

We don't make tires. Your new vehicle comes with high quality tires made by a leading tire manufacturer. These tires are warranted by the tire manufacturers and their warranties are delivered with every new Oldsmobile. If your spare tire is a different brand than your road tires, you will have a tire warranty folder from each of these manufacturers.



### CAUTION:

Poorly maintained and improperly used tires are dangerous.

- Overloading your tires can cause overheating as a result of too much friction. You could have an air-out and a serious accident. See *Loading Your Vehicle* in the *Index*.
- Underinflated tires pose the same danger as overloaded tires. The resulting accident could cause serious injury. Check all tires frequently to maintain the recommended pressure. Tire pressure should be checked when your tires are cold.
- Overinflated tires are more likely to be cut, punctured, or broken by a sudden impact, such as when you hit a pothole. Keep tires at the recommended pressure.
- Worn, old tires can cause accidents. If your tread is badly worn, or if your tires have been damaged, replace them.

# Service & Appearance Care

## Inflation-Tire Pressure

The Certification/Tire label which is on the rear edge of the driver's door shows the correct inflation pressures for your tires, when they're cold. "Cold" means your vehicle has been sitting for at least three hours or driven no more than a mile.

### NOTICE:

Don't let anyone tell you that underinflation **or** overinflation is all right. It's not. If your tires don't have enough air (underinflation) you can get:

- Too much flexing
- Too much heat
- Tire overloading
- Bad wear
- Bad handling
- Bad fuel economy.

If your tires have too much air (overinflation), you can get:

- Unusual wear
- Bad handling
- Rough ride
- Needless damage from road hazards.

## When to Check

Check your tires once a month or more.

Don't forget your compact spare tire. It should be at 60 psi (420 kPa).

## How to Check

Use a good quality pocket-type gage to check tire pressure. Simply looking at the tires will not tell you the pressure, especially if you have radial tires — which may look properly inflated even if they're underinflated.

If your tires have valve caps, be sure to put them back on. They help prevent leaks by keeping out dirt and moisture.

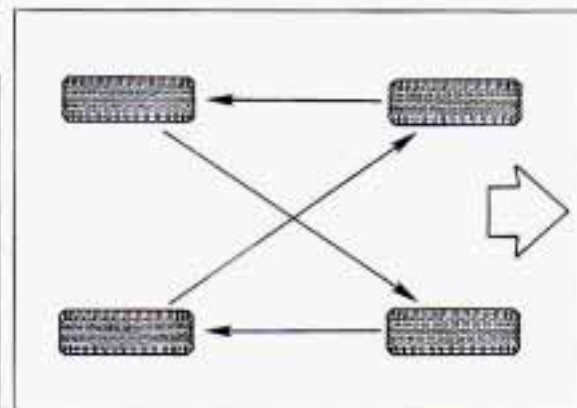

## Tire Inspection and Rotation

To make your tires last longer, have them inspected and rotated at the mileages recommended in the Maintenance Schedule. See *Scheduled Maintenance Services* in the *Index*.

Use this rotation pattern.

After the tires have been rotated, adjust the front and rear inflation pressure as shown on the Certification/Tire label. Make certain that all wheel nuts are properly tightened. See *Wheel Nut Torque* in the *Index*.





## CAUTION:

Rust or dirt on a wheel, or on the parts to which it is fastened, can make wheel nuts become loose after a time. The wheel could come off and cause an accident. When you change a wheel, remove any rust or dirt from places where the wheel attaches to the vehicle. In an emergency, you can use a cloth or a paper towel to do this; but be sure to use a scraper or wire brush later, if you need to, to get all the rust or dirt off. (See *Changing a Flat Tire* in the *Index*.)

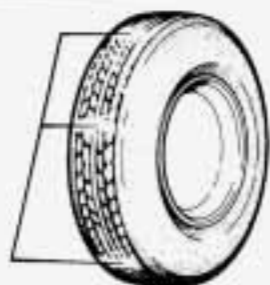

TREAD WEAR INDICATORS

### When It's Time for New Tires

One way to tell when it's time for new tires is to check the treadwear indicators, which will appear when your tires have only 2/32 inch (1.6 mm) or less of tread remaining.

You need a new tire if:

- You can see the indicators at three or more places around the tire.
- You can see cord or fabric showing through the tire's rubber.
- The tread or sidewall is cracked, cut or snagged deep enough to show cord or fabric.
- The tire has a bump, bulge or split.
- The tire has a puncture, cut, or other damage that can't be repaired well because of the size or location of the damage.

### Buying New Tires

To find out what kind and size of tires you need, look at the Certification/Tire label.

The tires installed on your vehicle when it was new had a Tire Performance Criteria Specification (TPC Spec) number on each tire's sidewall. When you get new tires, get ones with that same TPC Spec number. That way, your vehicle will continue to have tires that are designed to give proper endurance, handling, speed rating, traction, ride and other things during normal service on your vehicle. If your tires have an all-season tread design, the TPC number will be followed by a "MS" (for mud and snow).

If you ever replace your tires with those not having a TPC Spec number, make sure they are the same size, load range, speed rating and construction type (bias, bias-belted or radial) as your original tires.

# Service & Appearance Care



## CAUTION:

Mixing tires could cause you to lose control while driving. If you mix tires of different sizes or types (radial and bias-belted tires), the vehicle may not handle properly, and you could have a crash. Be sure to use the same size and type tires on all four wheels. It's all right to drive with your compact spare, though. It was developed for use on your vehicle.

### Uniform Tire Quality Grading

The following information relates to the system developed by the United States National Highway Traffic Safety Administration which grades tires by treadwear, traction and temperature performance. (This applies only to vehicles sold in the United States.)

#### Treadwear

The treadwear grade is a comparative rating based on the wear rate of the tire when tested under controlled

conditions on a specified government test course. For example, a tire graded 150 would wear one and a half (1 ½) times as well on the government course as a tire graded 100. The relative performance of tires depends upon the actual conditions of their use, however, and may depart significantly from the norm due to variations in driving habits, service practices and differences in road characteristics and climate.

#### Traction—A, B, C

The traction grades, from highest to lowest are: A, B, and C. They represent the tire's ability to stop on wet pavement as measured under controlled conditions on specified government test surfaces of asphalt and concrete. A tire marked C may have poor traction performance.

**Warning:** The traction grade assigned to this tire is based on braking (straight-ahead) traction tests and does not include cornering (turning) traction.

#### Temperature—A, B, C

The temperature grades are A (the highest), B, and C, representing the tire's resistance to the generation of

heat and its ability to dissipate heat when tested under controlled conditions on a specified indoor laboratory test wheel. Sustained high temperature can cause the material of the tire to degenerate and reduce tire life, and excessive temperature can lead to sudden tire failure. The grade C corresponds to a level of performance which all passenger car tires must meet under the Federal Motor Vehicle Safety Standard No. 109. Grades B and A represent higher levels of performance on the laboratory test wheel than the minimum required by law.

**Warning:** The temperature grade for this tire is established for a tire that is properly inflated and not overloaded. Excessive speed, underinflation, or excessive loading, either separately or in combination, can cause heat buildup and possible tire failure.

These grades are molded on the sidewalls of passenger car tires.

While the tires available as standard or optional equipment on General Motors vehicles may vary with respect to these grades, all such tires meet General Motors performance standards and



have been approved for use on General Motors vehicles. All passenger type (P Metric) tires must conform to Federal safety requirements in addition to these grades.

### **Wheel Alignment and Tire Balance**

The wheels on your vehicle were aligned and balanced carefully at the factory to give you the longest tire life and best overall performance.

In most cases, you will not need to have your wheels aligned again. However, if you notice unusual tire wear or your vehicle pulling one way or the other, the alignment may need to be reset. If you notice your vehicle vibrating when driving on a smooth road, your wheels may need to be rebalanced.

### **Wheel Replacement**

Replace any wheel that is bent, cracked or badly rusted. If wheel nuts keep coming loose, the wheel, wheel bolts, and wheel nuts should be replaced. If the wheel leaks air, replace it (except some aluminum wheels, which can sometimes be repaired). See your

Oldsmobile dealer if any of these conditions exist.

Your dealer will know the kind of wheel you need.

Each new wheel should have the same load carrying capacity, diameter, width, offset, and be mounted the same way as the one it replaces.

If you need to replace any of your wheels, wheel bolts, or wheel nuts, replace them only with new GM original equipment parts. This way, you will be sure to have the right wheel, wheel bolts, and wheel nuts for your Oldsmobile model.



#### **CAUTION:**

Using the wrong replacement wheels, wheel bolts, or wheel nuts on your vehicle can be dangerous. It could affect the braking and handling of your vehicle, make your tires lose air and make you lose control. You could have a collision in which you or others could be injured. Always use the correct wheel, wheel bolts, and wheel nuts for replacement.

#### **NOTICE:**

The wrong wheel can also cause problems with bearing life, brake cooling, speedometer/odometer calibration, headlight aim, bumper height, vehicle ground clearance, and tire or tire chain clearance to the body and chassis.

#### **Used Replacement Wheels**



#### **CAUTION:**

Putting a used wheel on your vehicle is dangerous. You can't know how it's been used or how many miles it's been driven. It could fail suddenly and cause an accident. If you have to replace a wheel use a **new** GM original equipment wheel.



# Service & Appearance Care

## Tire Chains

### NOTICE:

Use tire chains only where legal and only when you must. Use only SAE Class "S" type chains that are the proper size for your tires. Install them on the front tires and tighten them as tightly as possible with the ends securely fastened. Drive slowly and follow the chain manufacturer's instructions. If you can hear the chains contacting your vehicle, stop and retighten them. If the contact continues, slow down until it stops. Driving too fast with chains on will damage your vehicle.

## ■ Appearance Care

Remember, cleaning products can be hazardous. Some are toxic. Others can burst into flame if you strike a match or get them on a hot part of the vehicle. Some are dangerous if you breathe their fumes in a closed space. When you use anything from a container to clean your Oldsmobile, be sure to follow the manufacturer's warnings and

instructions. And always open your doors or windows when you're cleaning the inside.

**Never** use these to clean your vehicle:

- Gasoline
- Benzene
- Naphtha
- Carbon Tetrachloride
- Acetone
- Paint Thinner
- Turpentine
- Lacquer Thinner
- Nail Polish Remover

They can all be hazardous — some more than others — and they can all damage your vehicle, too.

### NOTICE:

Don't use any of these unless this manual says you can. In many uses, these will damage your vehicle:

- Laundry Soap
- Bleach
- Reducing Agents

## ■ Cleaning the Inside of Your Oldsmobile

Use a vacuum cleaner often to get rid of dust and loose dirt. Wipe vinyl or leather with a clean, damp cloth.

Your Oldsmobile dealer has two GM cleaners, a solvent-type spot lifter and a foam-type powdered cleaner. They will clean normal spots and stains very well. Do not use them on vinyl or leather.

Here are some cleaning tips:

- Always read the instructions on the cleaner label.
- Clean up stains as soon as you can — before they set.
- Use a clean cloth or sponge, and change to a clean area often. A soft brush may be used if stains are stubborn.
- Use solvent-type cleaners in a well-ventilated area only. If you use them, don't saturate the stained area.
- If a ring forms after spot cleaning, clean the entire area immediately or it will set.

### **Using Foam-Type Cleaner on Fabric**

- Vacuum and brush the area to remove any loose dirt.
- Always clean a whole trim panel or section. Mask surrounding trim along stitch or welt lines.
- Mix Multi-Purpose Powdered Cleaner following the directions on the container label.
- Use suds only and apply with a clean sponge.
- Don't saturate the material.
- Don't rub it roughly.
- As soon as you've cleaned the section, use a sponge to remove the suds.
- Rinse the section with a clean, wet sponge.
- Wipe off what's left with a slightly damp paper towel or cloth.
- Then dry it immediately with a blow dryer or a heat lamp.

#### **NOTICE:**

Be careful with a hair dryer or heat lamp. You could scorch the fabric.

- Wipe with a clean cloth.

### **Using Solvent-Type Cleaner on Fabric**

First, see if you have to use solvent-type cleaner at all. Some spots and stains will clean off better with just water and mild soap.

If you need to use a solvent:

- Gently scrape excess soil from the trim material with a clean, dull knife or scraper. Use very little cleaner, light pressure and clean cloths (preferably cheesecloth). Cleaning should start at the outside of the stain, "feathering" toward the center. Keep changing to a clean section of the cloth.
- When you clean a stain from fabric, immediately dry the area with an air hose, hair dryer, or heat lamp to help

prevent a cleaning ring. (See the previous NOTICE.)

### **Special Cleaning Problems**

#### **Greasy or Oily Stains**

Such as grease, oil, butter, margarine, shoe polish, coffee with cream, chewing gum, cosmetic creams, vegetable oils, wax crayon, tar and asphalt.

- Carefully scrape off excess stain.
- Follow the solvent-type instructions described earlier.
- Shoe polish, wax crayon, tar and asphalt will stain if left on a vehicle seat fabric. They should be removed as soon as possible. Be careful, because the cleaner will dissolve them and may cause them to spread.

#### **Non-Greasy Stains**

Such as catsup, coffee (black), egg, fruit, fruit juice, milk, soft drinks, wine, vomit, urine and blood.

- Carefully scrape off excess stain, then sponge the soiled area with cool water.



# Service & Appearance Care

- If a stain remains, follow the foam-type instructions described earlier.
- If an odor lingers after cleaning vomit or urine, treat the area with a water/baking soda solution: 1 teaspoon (5 ml) of baking soda to 1 cup (250 ml) of lukewarm water.
- If needed, clean lightly with solvent-type cleaner.

## Combination Stains

Such as candy, ice cream, mayonnaise, chili sauce and unknown stains.

- Carefully scrape off excess stain, then clean with cool water and allow to dry.
- If a stain remains, clean it with solvent-type cleaner.

## Cleaning Vinyl

Use warm water and a clean cloth.

- Rub with a clean, damp cloth to remove dirt. You may have to do it more than once.
- Things like tar, asphalt and shoe polish will stain if you don't get them

off quickly. Use a clean cloth and a solvent-type vinyl cleaner.

## Cleaning Leather

Use a soft cloth with lukewarm water and a mild soap or saddle soap.

- For stubborn stains, use a mild solution of 10% isopropyl alcohol (rubbing alcohol) and 90% water.
- **Never** use oils, varnishes, solvent-based or abrasive cleaners, furniture polish or shoe polish on leather.
- Soiled leather should be cleaned immediately. If dirt is allowed to work into finish, it can harm the leather.

## Cleaning the Top of the Instrument Panel

Use only mild soap and water to clean the top surfaces of the instrument panel. Sprays containing silicones or waxes may cause annoying reflections in the windshield and even make it difficult to see through the windshield under certain conditions.

Vacuum the carpeted area as needed, and clean as you would any other carpet.

## ■ Care of Safety Belts

Keep belts clean and dry.



### CAUTION:

Do not bleach or dye safety belts. If you do, it may severely weaken them. In a crash they might not be able to provide adequate protection. Clean safety belts only with mild soap and lukewarm water.



## ■ *Glass*

Glass should be cleaned often. GM Glass Cleaner (GM Part No. 1050427) or a liquid household glass cleaner will remove normal tobacco smoke and dust films.

Don't use abrasive cleaners on glass, because they may cause scratches. Avoid placing decals on the inside rear window, since they may have to be scraped off later. If abrasive cleaners are used on the inside of the rear window, an electric defogger element may be damaged. Any temporary license should not be attached across the defogger grid.

## ■ *Cleaning the Outside of the Windshield, Backglass and Wiper Blades*

If the windshield is not clear after using the windshield washer, or if the wiper blade chatters when running, wax or other material may be on the blade or windshield.

Clean the outside of the windshield with GM Windshield Cleaner, Bon-Ami Powder® (GM Part No. 1050011). The windshield is clean if beads do not form when you rinse it with water.

Clean the blade by wiping vigorously with a cloth soaked in full strength windshield washer solvent. Then rinse the blade with water.

Wiper blades should be checked on a regular basis and replaced when worn.

## ■ *Cleaning the Outside of Your Oldsmobile*

The paint finish on your vehicle provides beauty, depth of color, gloss retention and durability.

## *Washing Your Vehicle*

The best way to preserve your vehicle's finish is to keep it clean by washing it often with lukewarm or cold water.

Don't wash your vehicle in the direct rays of the sun. Don't use strong soaps or chemical detergents. Use liquid hand, dish or car washing (mild detergent) soaps. Don't use cleaning agents that contain acid or abrasives. All cleaning agents should be flushed promptly and not allowed to dry on the surface, or they could stain. Dry the finish with a soft, clean chamois or a 100% cotton towel to avoid surface scratches and water spotting.

High pressure vehicle washes may cause water to enter your vehicle.

# Service & Appearance Care

## Finish Care

Occasional waxing or mild polishing of your Oldsmobile may be necessary to remove residue from the paint finish. You can get GM approved cleaning products from your dealer.

Your Oldsmobile has a "basecoat/clearcoat" paint finish. The clearcoat gives more depth and gloss to the colored basecoat. Always use waxes and polishes that are non-abrasive and made for a basecoat/clearcoat paint finish.

### NOTICE:

Machine compounding or aggressive polishing on a basecoat/clearcoat paint finish may dull the finish or leave swirl marks.

## ■ Aluminum Wheels

Your aluminum wheels have a protective coating similar to the painted surface of your vehicle. Don't use strong soaps, chemicals, chrome polish, abrasive cleaners or abrasive cleaning brushes on them because you could damage this coating. After rinsing thoroughly, a wax may be applied.

### NOTICE:

Don't use an automatic vehicle wash that has hard silicon carbide cleaning brushes. These brushes can take off the protective coating.

## ■ Weatherstrips

Silicone grease on weatherstrips will make them last longer, seal better, and not stick or squeak. Apply silicone grease with a clean cloth at least every six months. During very cold, damp weather more frequent application may be required. (See *Recommended Fluids & Lubricants* in the *Index*.)

## ■ Foreign Material

Calcium chloride and other salts, ice melting agents, road oil and tar, tree sap, bird droppings, chemicals from industrial chimneys, and other foreign matter can damage your vehicle's finish if they remain on painted surfaces. Use cleaners that are marked safe for painted surfaces to remove foreign matter.

## ■ Finish Damage

Any stone chips, fractures or deep scratches in the finish should be repaired right away.

Minor chips and scratches can be repaired with touch-up materials available from your dealer or other service outlets. Larger areas of finish damage can be corrected in your dealer's body and paint shop.

### ■ *Underbody Maintenance*

Chemicals used for ice and snow removal and dust control can collect on the underbody. If these are not removed, accelerated corrosion (rust) can occur on the underbody parts such as fuel lines, frame, floor pan, and exhaust system even though they have corrosion protection.

At least every spring, flush these materials from the underbody with plain water. Clean any areas where mud and other debris can collect. Dirt packed in closed areas of the frame should be loosened before being flushed. Your dealer or an underbody vehicle washing system can do this for you.

### ■ *Collision Repair*

Your vehicle was built with composite SMC (Sheet Molding Compound) fiberglass body panels and molded RIM (Reaction Injection Molding) front fenders and bumper covers. These panels require different collision repair procedures than metal-paneled vehicles. See your Oldsmobile dealer for information on collision repair.

### ■ *Chemical Paint Spotting*

Some weather and atmospheric conditions can create a chemical fallout. Airborne pollutants can fall upon and attack painted surfaces on your vehicle. This damage can take two forms: blotchy, ringlet-shaped discolorations, and small irregular dark spots etched into the paint surface.

Although no defect in the paint job causes this, Oldsmobile will repair, at no charge to the owner, the surfaces of new vehicles damaged by this fallout condition within 12 months or 12,000 miles (20 000 km) of purchase, whichever comes first.



# Service & Appearance Care

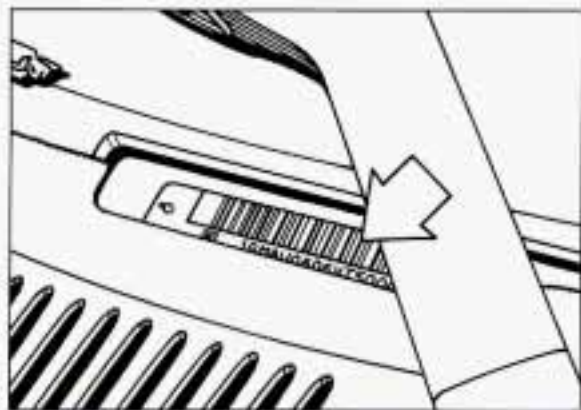

## ■ *Vehicle Identification Number (VIN)*

This is the legal identifier for your Oldsmobile. It appears on a plate in the front corner of the instrument panel, on the driver's side. You can see it if you look through the windshield from outside your vehicle. The VIN also appears on the Vehicle Certification and Service Parts labels and the certificates of title and registration.

## *Engine Identification*

The eighth character in your VIN is the engine code. This code will help you identify your engine, specifications, and replacement parts.

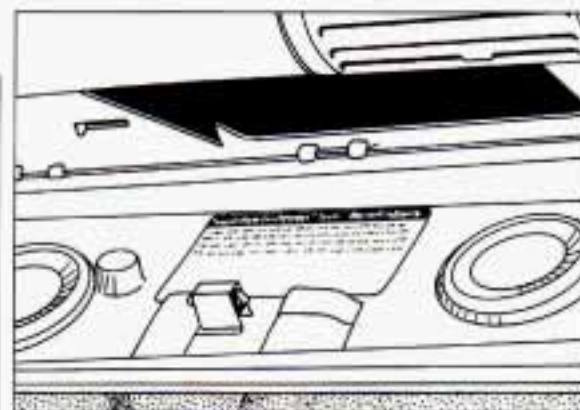

## ■ *Service Parts Identification Label*

You'll find this label inside the glove box door. It's very helpful if you ever need to order parts. On this label is:

- your VIN,
- the model designation,
- paint information, and
- a list of all production options and special equipment.

Be sure that this label is not removed from the vehicle.

## ■ *Add-On Electrical Equipment*

### **NOTICE:**

Don't add anything electrical to your Oldsmobile unless you check with your dealer first. Some electrical equipment can damage your vehicle and the damage wouldn't be covered by your warranty. Some add-on electrical equipment can keep other components from working as they should.

Your vehicle has an air bag system. Before attempting to add anything electrical to your Oldsmobile, see *Servicing Your Air Bag-Equipped Oldsmobile* in the *Index*.

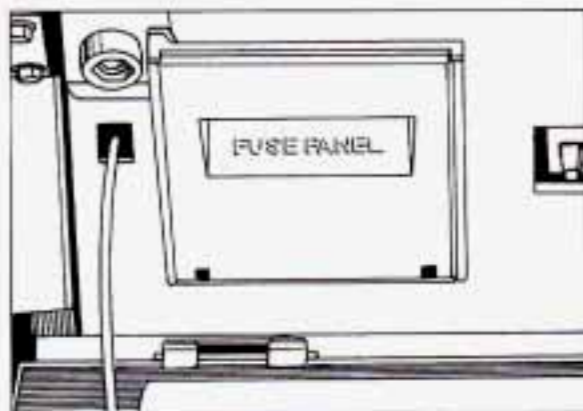

## ■ *Fuses & Circuit Breakers*

The wiring circuits in your vehicle are protected from short circuits by a combination of fuses and circuit breakers in the wiring itself. This greatly reduces the chance of damage caused by electrical problems.

To identify and check fuses, refer to the fuse panel, which is behind the glove box door, and the fuse usage chart later in this section.

To remove a fuse, grasp it firmly and pull.

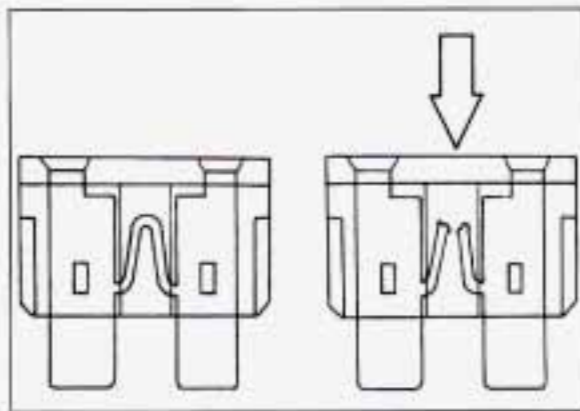

Look at the silver-colored band inside the fuse. If the band is broken or melted, replace the fuse. Be sure you replace a bad fuse with a new one of the correct size.

# Service & Appearance Care

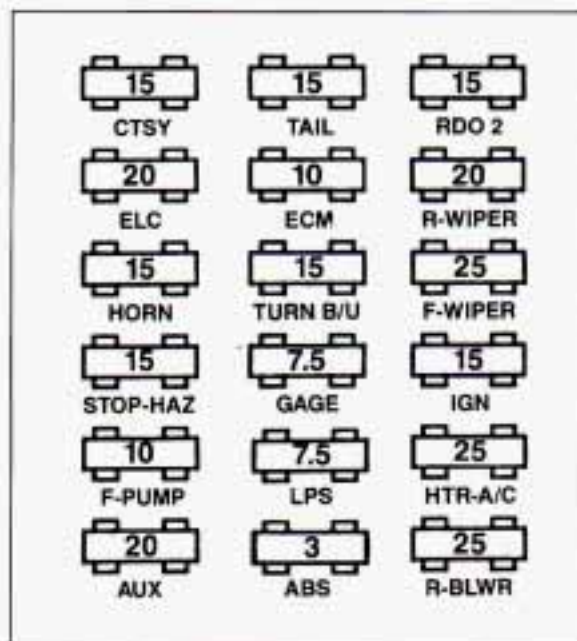

**Fuse Panel** (3100 V6 ENGINE)

Position	Rating (AMP.)	Circuitry
CTSY	15	Dome Lamps, Courtesy Lamps, Power Door Lock Switches, Glove Box Lamp, Power Mirrors, Power Sliding Delay Lock Module
ELC	20	Auto Level Control, Underhood Lamp
HORN	15	Horns, Horn Relay, Safety Belt Buzzer
STOP HAZ	15	Front/Rear Turn Lamps, Front Side Marker Lamps, Rear Stop Lamps, Instrument Cluster Turn Indicator Lamps, Cruise Brake Switch
F PUMP	10	Fuel Pump, Oil Pressure Sender/Fuel Pump Switch
AUX	20	Radio, Front Cigar Lighter, Accessory Power Outlet
TAIL	15	Front Park Lamps, Rear Tail Lamps, Front Side Marker Lamps, License Plate Lamp, Radio, Heat/Vent/AC Control Head, Power Sliding Door
ECM	10	Throttle Body Fuel Injection, Fuel Pump Relay, Elec. Vac. Reg. Valve, Elec. Control Module, Elec. Spark Control Module
TURN B/U	15	Front/Rear Turn Lamps, Front Side Marker Lamps, Cluster Turn Telltale, Back-Up Lamps, Fog Lamps
GAGE	7.5	Cluster, Anti-Lock Brake System Lamp Module, Elec. Level Control Sensor
LPS	7.5	Cluster, Radio, Wiper Switch, Headlamp Switch, Rear Blower Switch, Heat/Vent/AC Control Head, Door Switch Illumination, Front/Rear Ashtray Illumination Bulbs
ABS	3	Anti-Lock Brake System
RDO2	15	Radio
R/WIPER	20	Rear Wiper/Washer Motors; Overhead Console Compass
F/WIPER	25	Front Wiper/Washer Motor
IGN	15	A/C Compressor, A/C Solenoid Box, Compressor Relay, Temp. Door Motor, Low Blower Relay; Heat/Vent/AC Control Head; Cruise Module; Cooling Fan Relay; Rear Defogger Relay; Key Chime; Vehicle Speed Sensor Buffer and Generator Charge Discrete, Transaxle Converter Clutch Switch
HTR A/C	25	Front/Rear Blower Motors, High Blower Relay
R BLWR	25	Rear Blower, Rear Heat/Vent/AC



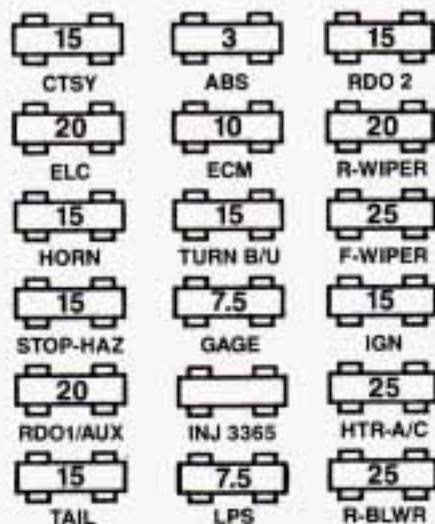

**Fuse Panel (3800 V6 ENGINE)**

Position	Rating (AMP.)	Circuitry
CTSY	15	Dome Lamps, Courtesy Lamps, Power Door Lock Switches, Glove Box Lamp, Power Mirrors, Power Sliding Delay Lock Module
ELC	20	Auto Level Control, Underhood Lamp
HORN	15	Horns, Horn Relay, Safety Belt Buzzer
STOP HAZ	15	Front/Rear Turn Lamps, Front Side Marker Lamps, Rear Stop Lamps, Instrument Cluster Turn Indicator Lamps
RDO1/AUX	20	Radio, Front Cigar Lighter, Accessory Power Outlet
TAIL	15	Front Park Lamps, Rear Tail Lamps, Front Side Marker Lamps, License Plate Lamp, Radio, Heat/Vent/AC Control Head, Power Sliding Door
ABS	3	Anti-Lock Brake/Traction Control System
ECM	10	Mass Air Flow Sensor, Electronic Control Module
TURN B/U	15	Front/Rear Turn Lamps, Front Side Marker Lamps, Cluster Turn Telltale, Back-Up Lamps, Fog Lamps
GAGE	7.5	Cluster, Anti-Lock Brake System Lamp Module, Elec. Level Control Sensor
LPS	7.5	Cluster, Radio, Wiper Switch, Headlamp Switch, Rear Blower Switch, Heat/Vent/AC Control Head, Door Switch Illumination, Front/Rear Ashtray Illumination Bulbs
RDO2	15	Radio
R/WIPER	20	Rear Wiper/Washer Motors; Overhead Console Compass
F/WIPER	25	Front Wiper/Washer Motor
IGN	15	A/C Solenoid Box, Temp. Door Motor, Low Blower Relay; Heat/Vent/AC Control Head; Cooling Fan Relay; Rear Defogger Relay; Key Chime; Transaxle Converter Clutch Solenoid and Generator Charge Discrete
HTR A/C	25	Front/Rear Blower Motors, High Blower Relay
R BLWR	25	Rear Blower, Rear Heat/Vent/AC

# Service & Appearance Care

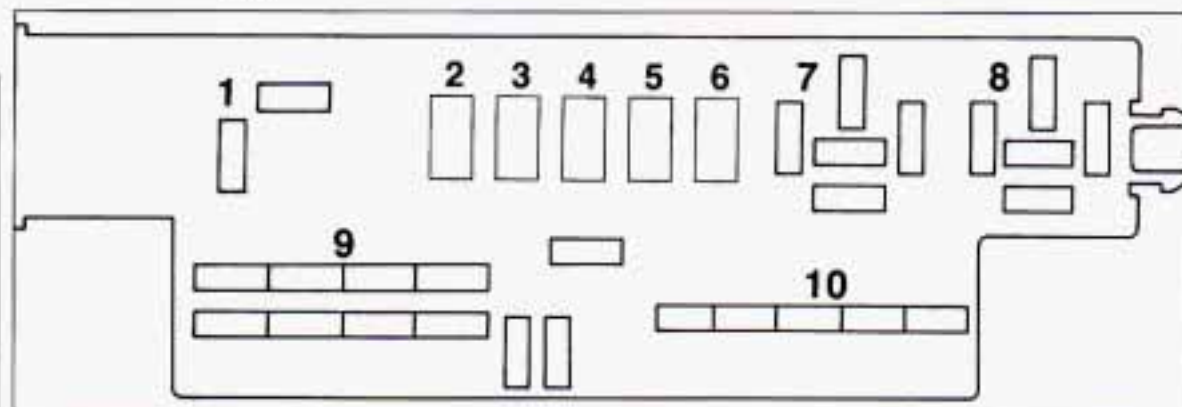

## Circuit Breaker/Relay Panel

Circuit breakers and relays are located in the circuit breaker/relay panel. This is located behind the panel under the glove box, near the passenger's door.

Position	Rating (AMP.)	Circuitry
1		Hazard Flasher
2	15	With 3800 V6 engine only: Canister Purge Solenoid, A/C Clutch Control Relay, Cruise Control
3		Not Used
4	30	Power Windows Circuit Breaker
5	30	Power Seat/Power Sliding Door Motor Circuit Breaker
6	30	Rear Defogger Circuit Breaker
7		Air Conditioning Blower Relay
8		Horn Relay
9		Chime Module
10		Defogger Timer Relay

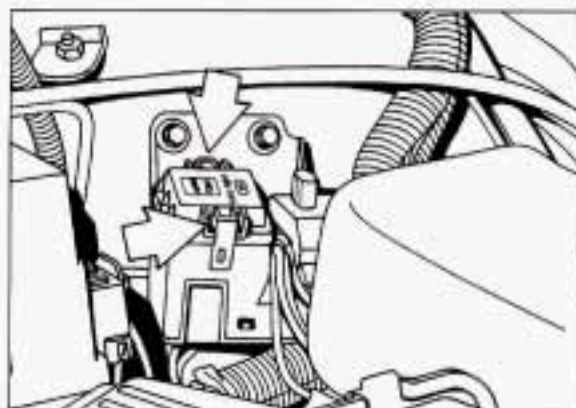

## Anti-Lock Brake System (ABS) Junction Block Fuse

You'll find this fuse under the hood in the ABS junction block, located next to the remote positive jump starting terminal.

To open the junction block, press in on both sides of the cover.

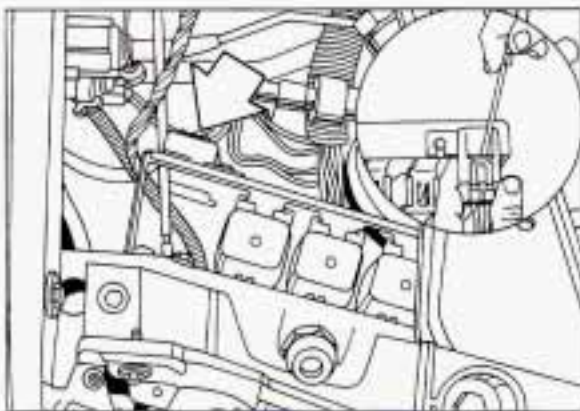

### **Injector 3365 Fuse**

**(3800 V6 ENGINE ONLY)**

This 20-amp fuse is located underhood, on a bracket just behind the passenger side headlight. It is mounted on the face of the bracket in the position closest to the passenger side of the vehicle. The fuse services the injectors, fuel pump, oil pressure sender and fuel pump switch.

To access the fuse, pry back the latch with a screwdriver, then pull down on the base of the unit. If you need to replace the fuse, be sure to use a 20-amp fuse.

Push the base of the unit firmly up into the cover until the latch snaps into the locked position.

### **Headlight Wiring**

The headlight wiring is protected by a circuit breaker in the light switch. An electrical overload will cause the lights to go on and off, or in some cases to remain off. If this happens, have your headlight system checked right away.

### **Windshield Wipers**

The windshield wiper motor is protected by a circuit breaker and a fuse. If the motor overheats due to heavy snow, etc., the wiper will stop until the motor cools. If the overload is caused by some electrical problem, have it fixed.

### **Power Windows and Other Power Options**

Circuit breakers in the circuit breaker/relay panel protect the power windows and other power accessories. When the current load is too heavy, the circuit breaker opens and closes, protecting the circuit until the problem is fixed.



# Service & Appearance Care

## Capacities and Specifications

**Engine Crankcase** (All Models) ..... 4 quarts      3.75 L

*When changing filter, up to 1/2 quart (1/2 liter) more oil may be needed.  
Use your dipstick to measure.*

**Automatic Transaxle** .....

*When draining or replacing torque converter, more fluid may be needed.*

### 3-Speed:

Pan Removal and Replacement..... 4 quarts      3.80 L

After Complete Overhaul ..... 7 quarts      6.60 L

### 4-Speed:

Pan Removal and Replacement..... 6 quarts      5.70 L

After Complete Overhaul ..... 8 quarts      7.60 L

## Cooling System

### 3100 V6 Engine:

With Air Conditioning..... 12.50 quarts      12.00 L

### 3800 V6 Engine:

With Air Conditioning..... 11.50 quarts      10.75 L

With Rear Climate Control ..... 13.00 quarts      12.25 L

**NOTE:** All capacities are approximate. When adding, be sure to fill to the appropriate level, as recommended in this manual.

**Refrigerant (R134A), Air Conditioning**

Front A/C only.....	2.25 pounds	1.02 kg
Front and Rear A/C.....	3.00 pounds	1.36 kg

*Not all air conditioning refrigerants are the same. If the air conditioning system in your vehicle needs refrigerant, be sure the proper refrigerant is used. If you're not sure, ask your Oldsmobile dealer. For additional information, see your "Warranty and Owner Assistance Information" booklet.*

<b>Fuel Tank</b> .....	20 gallons	76.00 L
------------------------	------------	---------

**Power Steering**

**3100 V6 Engine:**

Pump Only.....	1 pint	0.50 L
Complete System.....	1.25 pints	0.60 L

**3800 V6 Engine:**

Pump Only.....	1 pint	0.50 L
Complete System.....	1.50 pints	0.70 L

**Tire Pressures, Sizes** ..... See Certification/Tire label on driver's door.

**Wheel Nut Torque** ..... 100 pound-feet 140 N•m

**NOTE:** All capacities are approximate. When adding, be sure to fill to the appropriate level, as recommended in this manual.

# Service & Appearance Care

## Engine Specifications

	3100 V6 Engine	3800 V6 Engine
VIN Engine Code .....	D	L
Type .....	V6	V6
Displacement .....	3.1 Liters	3.8 Liters
Compression Ratio .....	8.5:1	9.0:1
Firing Order .....	1-2-3-4-5-6	1-6-5-4-3-2
Thermostat Temperature Specification .....	195°F (91°C)	195°F (91°C)

## Normal Maintenance Replacement Parts

Air Cleaner Element .....	AC Type A-773C	AC Type A-974C
Engine Oil Filter .....	AC Type PF-51	AC Type PF-47
PCV Valve .....	AC Type CV-789C	AC Type CV-892C
Spark Plugs .....	AC Type •R43TS	AC Type 41-600
	Gap: 0.045 inch (1.14 mm)	Gap: 0.060 inch (1.52 mm)
Remote Lock Control Batteries (2) .....	DL 2016	DL 2016



## Fluids & Lubricants

ITEM	APPLICATION	GM PART NUMBER	SIZE
Antifreeze Coolant ..... (Ethylene Glycol Base) .....	Year-round antifreeze for ..... coolant mixtures	1052753	1 gal. (3.8 L)
Chassis Lubricant ..... (Grease Gun Insert)	General chassis lube, etc. ....	12346003 or 1052497	14 oz. (397 g)
Delco Supreme 11 <sup>®</sup> Brake Fluid .....	Brake System .....	1052535	16 oz. (0.5 L)
Automatic Transmission Fluid .....	Automatic Transaxle		
DEXRON <sup>®</sup> -III .....	.....	12346143	32 oz. (1.0 L)
DEXRON <sup>®</sup> -IIE.....	.....	12345881	32 oz. (1.0 L)
Engine Oil .....	Engine lubrication .....	See <i>Engine Oil</i> in this section.	
GM Engine Oil Supplement ..... (E.O.S.)	See your dealer for advice .....	1052367	16 oz. (0.5 L)
Lubriplate (White Grease) .....	Sliding door tracks .....	1052349 (aerosol)	12 oz. (340.2 g)
Engine Oil .....	Hood, liftgate and door hinges .....		
Windshield Washer Solvent .....	Windshield washer fluid .....		
Power Steering Fluid ..... (Normal)	Power Steering System .....	1050017 1052884	32 oz. (1.0 L) 16 oz. (0.5 L)
Power Steering Fluid ..... (Cold Climate) (System must be drained and refilled.)	Power Steering System .....	12345867	32 oz. (1.0 L)
Silicone Grease .....	Weatherstrips .....	12345866	16 oz. (0.5 L)
Spray-A-Squeak Silicone ..... Lubricant	General purpose silicone lubricant .....	12345579	1 oz. (28 g)
		1052276 (aerosol) 1052277	4.5 oz. (127 g) 12 oz. (0.35 L)

# Service & Appearance Care

## Replacement Bulbs

OUTSIDE LIGHTS	BULB
Back-up Lights .....	3057
Center High-Mounted Stop Light .....	577
Front Parking/Turn Signal Lights .....	3357
License Plate Light .....	194
Halogen Headlights	
Outer .....	9006
Inner .....	9005
Fog Lights .....	HI-55W
Front Side Marker Lights .....	194NA
Stop/Tail/Turn Signal Lights	
Upper 2 Positions .....	194
Lower 2 Positions .....	2057
Underhood Light .....	561

<b>INSIDE LIGHTS</b>	<b>BULB</b>
Courtesy Lights	
Cargo Area .....	562
Sliding Door Stepwell .....	562
Front Floor .....	194
Reading Light(s)	
Front .....	562
Rear .....	906
Dome Light(s)	
Front .....	561
Rear .....	561
Glove Compartment Light .....	194
Indicator Lights .....	74
Turn Signal Indicators .....	74



# *Notes*

## IMPORTANT

KEEP ENGINE OIL  
AT THE PROPER  
LEVEL AND CHANGE AS  
RECOMMENDED

This part covers the maintenance required for your Oldsmobile. Your vehicle needs these services to retain its safety, dependability and emission control performance.



Have you purchased the  
GM Protection Plan?  
The Plan supplements your new  
vehicle warranties. See your  
Oldsmobile dealer for details.

# Part 7

## Maintenance Schedule

### Section

#### Introduction

A Word About Maintenance.....	232
Your Vehicle and the Environment.....	232
How This Part is Organized .....	232

#### A. Scheduled Maintenance Services

Using Your Maintenance Schedule.....	233
Selecting the Right Schedule .....	233
Schedule I.....	234
Schedule II.....	236
Explanation of Scheduled Maintenance Services .....	238

#### B. Owner Checks & Services

At Each Fuel Fill.....	240
At Least Once a Month.....	240
At Least Once a Year .....	241

#### C. Periodic Maintenance Inspections .....

#### D. Recommended Fluids & Lubricants.....

#### E. Maintenance Record .....

# Maintenance Schedule

## ■ Introduction

### A Word About Maintenance

We at General Motors want to help you keep your vehicle in good working condition. But we don't know exactly how you'll drive it. You may drive very short distances only a few times a week. Or you may drive long distances all the time in very hot, dusty weather. You may use your vehicle in making deliveries. Or you may drive it to work, to do errands or in many other ways.

Because of all the different ways people use their GM vehicles, maintenance needs vary. You may even need more frequent checks and replacements than you will find in the schedules in this part. So please read this part and note how you drive. If you have any questions on how to keep your vehicle in good condition, see your Oldsmobile dealer, the place many GM owners choose to have their maintenance work done. Your dealer can be relied upon to use proper parts and practices.

### Your Vehicle and the Environment

Proper vehicle maintenance not only helps to keep your vehicle in good working condition, but also helps the environment. All recommended maintenance procedures are important. Improper vehicle maintenance or the removal of important components can significantly affect the quality of the air we breathe. Improper fluid levels or even the wrong tire inflation can increase the level of emissions from your vehicle. To help protect our environment, and to help keep your vehicle in good condition, please maintain your vehicle properly.

### How This Part is Organized

The remainder of this part is divided into five sections:

Section A: Scheduled Maintenance Services shows what to have done and how often. Some of these services can be complex, so unless you are technically qualified and have the necessary equipment, you should let your dealer's service department or another qualified service center do these jobs.



### CAUTION:

Performing maintenance work on a vehicle can be dangerous. In trying to do some jobs, you can be seriously injured. Do your own maintenance work only if you have the required know-how and the proper tools and equipment for the job. If you have any doubt, have a qualified technician do the work.

If you are skilled enough to do some work on your vehicle, you will probably want to get the service information GM publishes. You will find a list of publications and how to get them in this manual. See *Service Publications* in the *Index*.

Section B: Owner Checks and Services tells you what should be checked whenever you stop for fuel. It also explains what you can easily do to help keep your vehicle in good condition.

Section C: Periodic Maintenance Inspections explains important



inspections that your Oldsmobile dealer's service department or another qualified service center should perform.

Section D: Recommended Fluids and Lubricants lists some products GM recommends to help keep your vehicle properly maintained. These products, or their equivalents, should be used whether you do the work yourself or have it done.

Section E: Maintenance Record provides a place for you to record the maintenance performed on your vehicle. Whenever any maintenance is performed, be sure to write it down in this section. This will help you determine when your next maintenance should be done. In addition, it is a good idea to keep your maintenance receipts. They may be needed to qualify your vehicle for warranty repairs.

## ■ *Section A: Scheduled Maintenance Services*

### **Using Your Maintenance Schedule**

This section tells you the maintenance services you should have done and when you should schedule them. Your Oldsmobile dealer knows your vehicle best and wants you to be happy with it. If you go to your dealer for your service needs, you'll know that GM-trained and supported service people will perform the work using genuine GM parts.

These schedules are for vehicles that:

- carry passengers and cargo within recommended limits. You will find these limits on your vehicle's Certification/Tire label. See *Loading Your Vehicle* in the *Index*.
- are driven on reasonable road surfaces within legal driving limits.
- use the recommended unleaded fuel. See *Fuel* in the *Index*.

## **Selecting the Right Schedule**

First you'll need to decide which of the two schedules is right for your vehicle. Here's how to decide which schedule to follow:

### **Schedule I**

Is any one of these true for your vehicle?

- Most trips are less than 4 miles (6 km).
- Most trips are less than 10 miles (16 km) when outside temperatures are below freezing.
- The engine is at low speed most of the time (as in door-to-door delivery, or in stop-and-go traffic).
- You operate your vehicle in dusty areas.
- You tow a trailer.

If any one (or more) of these is true for your driving, follow Schedule I.

### **Schedule II**

Follow Schedule II **only** if none of the above conditions is true.

# Maintenance Schedule

## Schedule I

Follow Schedule I if your vehicle is **MAINLY** driven under one or more of the following conditions:

- When most trips are less than 4 miles (6 km).
- When most trips are less than 10 miles (16 km) and outside temperatures remain below freezing.
- When most trips include extended idling and/or frequent low-speed operation, as in stop-and-go traffic.
- When towing a trailer.
- When operating in dusty areas.

**Schedule I should also be followed if the vehicle is used for delivery service, police, taxi or other commercial applications.**

\* = An Emission Control Service.

† = The U.S. Environmental Protection Agency or the California Air Resources Board has determined that the failure to perform this maintenance item will not nullify the emission warranty or limit recall liability prior to the completion of vehicle useful life. General Motors, however, urges that all recommended maintenance services be performed at the indicated intervals and the maintenance be recorded in "Section E: Maintenance Record."

ITEM NO.	TO BE SERVICED <i>See Explanation of Scheduled Maintenance Services following Schedules I and II.</i>	WHEN TO PERFORM <i>Miles (kilometers) or Months (whichever occurs first).</i>
1	Engine Oil Change & Oil Filter Change*	Every 3,000 Miles (5 000 km) or 3 Months.
2	Chassis Lubrication	Every 3,000 Miles (5 000 km) or 12 Months.
3	Tire and Wheel Rotation & Inspection	At 6,000 Miles (10 000km) and then every 15,000 Miles (25 000 km) or as necessary.
4	Engine Accessory Drive Inspection	Every 60,000 Miles (100 000 km) or 60 Months.
5	Cooling System Service*	Every 30,000 Miles (50 000 km) or 24 Months.
6	Transaxle Service	<i>See Explanation of Scheduled Maintenance Services following Schedules I and II.</i>
7	Spark Plug Replacement*	Every 30,000 Miles (50 000 km).
8	Spark Plug Wire Inspection†	Every 60,000 Miles (100 000 km) or 60 Months.
9	Exhaust Gas Recirculation (EGR) System Inspection*†	Every 60,000 Miles (100 000 km) or 60 Months.
10	Air Cleaner Filter Replacement*	<i>See Explanation of Scheduled Maintenance Services following Schedules I and II.</i>
11	Air Cleaner Inspection*†	Every 30,000 Miles (50 000 km).
12	Fuel Tank, Cap & Lines Inspection*†	Every 30,000 Miles (50 000 km) or 60 Months.
13	Engine Timing and Distributor Check (3100 Code D engine only)*†	Every 60,000 Miles (100 000 km).

The services shown in this schedule for the first 60,000 miles (100 000 km) should be performed after 60,000 miles at the same intervals.

**MILES (000)**

3	6	9	12	15	18	21	24	27	30	33	36	39	42	45	48	51	54	57	60
---	---	---	----	----	----	----	----	----	----	----	----	----	----	----	----	----	----	----	----

**KILOMETERS (000)**

5	10	15	20	25	30	35	40	45	50	55	60	65	70	75	80	85	90	95	100
---	----	----	----	----	----	----	----	----	----	----	----	----	----	----	----	----	----	----	-----

•	•	•	•	•	•	•	•	•	•	•	•	•	•	•	•	•	•	•	•
•	•	•	•	•	•	•	•	•	•	•	•	•	•	•	•	•	•	•	•
	•					•					•					•			
																			•
										•									•
																			•
																			•
																			•
																			•
																			•
																			•
																			•
																			•



# Maintenance Schedule

## Schedule II

Follow Schedule II ONLY if none of the driving conditions specified in Schedule I apply.

ITEM NO.	TO BE SERVICED <i>See Explanation of Scheduled Maintenance Services following Schedules I and II.</i>	WHEN TO PERFORM <i>Miles (kilometers) or Months (whichever occurs first).</i>
1	Engine Oil Change*	Every 7,500 Miles (12,500 km) or 12 Months.
	Oil Filter Change*	At first and every other oil change.
2	Chassis Lubrication	Every 7,500 Miles (12,500 km) or 12 Months.
3	Tire and Wheel Rotation & Inspection	At 7,500 Miles (12,500 km) and then every 15,000 Miles (25,000 km) or as necessary.
4	Engine Accessory Drive Inspection	Every 60,000 Miles (100,000 km) or 60 Months.
5	Cooling System Service*	Every 30,000 Miles (50,000 km) or 24 Months.
6	Transaxle Service	<i>See Explanation of Scheduled Maintenance Services following Schedules I and II.</i>
7	Spark Plug Replacement*	Every 30,000 Miles (50,000 km).
8	Spark Plug Wire Inspection*	Every 60,000 Miles (100,000 km) or 60 Months.
9	Exhaust Gas Recirculation (EGR) System Inspection*†	Every 60,000 Miles (100,000 km) or 60 Months.
10	Air Cleaner Filter Replacement*	<i>See Explanation of Scheduled Maintenance Services following Schedules I and II.</i>
11	Air Cleaner Inspection*†	Every 30,000 Miles (50,000 km).
12	Fuel Tank, Cap & Lines Inspection*†	Every 30,000 Miles (50,000 km) or 60 Months.
13	Engine Timing and Distributor Check (3100 Code D engine only)*†	Every 60,000 Miles (100,000 km) or 60 Months.

\* = An Emission Control Service.

† = The U.S. Environmental Protection Agency or the California Air Resources Board has determined that the failure to perform this maintenance item will not nullify the emission warranty or limit recall liability prior to the completion of vehicle useful life. General Motors, however, urges that all recommended maintenance services be performed at the indicated intervals and the maintenance be recorded in "Section E: Maintenance Record."

The services shown in this schedule for the first 60,000 miles (100 000 km) should be performed after the first 60,000 miles at the same intervals unless otherwise specified.

**MILES (000)**

5	7.5	10	15	20	22.5	25	30	35	37.5	40	45	50	52.5	55	60
---	-----	----	----	----	------	----	----	----	------	----	----	----	------	----	----

**KILOMETERS (000)**

8	12.5	16	25	32	37.5	40	50	56	62.5	64	75	83.5	87.5	92	100
---	------	----	----	----	------	----	----	----	------	----	----	------	------	----	-----

	•		•		•		•		•		•		•		•
	•				•				•				•		
	•		•		•		•		•		•		•		•
	•				•				•				•		
															•
								•							•
															•
															•
															•
															•
								•							•
								•							•
															•

# Maintenance Schedule

## Explanation of Scheduled Maintenance Services

Following are explanations of the services listed in Schedule I and Schedule II.

The proper fluids and lubricants to use are listed in Section D. Make sure whoever services your vehicle uses these. All parts should be replaced and all necessary repairs done before you or anyone else drives the vehicle.

## ITEM NO.

## SERVICE

- 1. Engine Oil and Filter Change**<sup>®</sup> — Always use SH or SG Energy Conserving II oils of proper viscosity. The "SH" or "SG" designation may be shown alone or in combination with others, such as "SH/CD," "SH, SG, CD," "SG/CD," etc. To determine the preferred viscosity for your vehicle's engine (e.g., SAE 5W-30 or SAE 10W-30), see *Engine Oil* in the *Index*.
- 2. Chassis Lubrication** — Lubricate suspension and steering linkage. Lubricate the transaxle shift linkage, and parking brake cable guides, underbody contact points and linkage.
- 3. Tire and Wheel Rotation and Inspection** — For proper wear and maximum tire life, rotate your tires following the instructions in this manual. See *Tires, Inspection & Rotation* in the *Index*. Check the tires for uneven wear or damage. If you see irregular or premature wear, check the wheel alignment. Check for damaged wheels also.

- 4. Engine Accessory Drive Inspection** — Inspect the drive belt for cracks, fraying, wear and proper tension. Replace as needed.
- 5. Cooling System Service**<sup>®</sup> — Drain, flush and refill the system with new or approved recycled coolant conforming to GM Specification 1825M. Keep coolant at the proper mixture as specified. See *Coolant* in the *Index*. This provides proper freeze and boil protection, corrosion inhibitor level and maintains proper engine operating temperature. Inspect hoses and replace if they are cracked, swollen or deteriorated. Tighten screw-type hose clamps. Clean the outside of the radiator and air conditioning condenser. Wash the pressure cap and neck.  
  
To help ensure proper operation, we recommend a pressure test of both the cooling system and the pressure cap.



**6. Transaxle Service** — Change both the fluid and filter every 15,000 miles (25 000 km) if the vehicle is mainly driven under one or more of these conditions:

- In heavy city traffic where the outside temperature regularly reaches 90°F (32°C) or higher.
- In hilly or mountainous terrain.
- When doing frequent trailer towing.
- Uses such as found in taxi, police car or delivery service.

If you do not use your vehicle under any of these conditions, change both the fluid and filter every 100,000 miles (166 000 km).

**7. Spark Plug Replacement\*** — Replace spark plugs with the proper type. See *Replacement Parts* in the *Index*.

**8. Spark Plug Wire Inspection\*** — Inspect for burns, cracks or other damage. Check the boot fit at the distributor or coils and at the spark plugs. Replace wires as needed.

**9. Exhaust Gas Recirculation (EGR) System Inspection\*†** — Conduct the EGR system service as described in the service manual. To purchase a service manual, see *Service Publications* in the *Index*.

**10. Air Cleaner Filter Replacement\*** — Replace every 30,000 miles (50 000 km) or more often under dusty conditions. Ask your dealer for the proper replacement intervals for your driving conditions.

**11. Air Cleaner Inspection\*†** — Inspect all hoses and ducts for proper hookup. Make sure the valve works properly.

**12. Fuel Tank, Cap and Lines Inspection\*†** — Inspect fuel tank, cap and lines for damage or leaks. Inspect fuel cap gasket for an even filler neck imprint or any damage. Replace parts as needed. Periodic replacement of the fuel filter is not required.

**13. Engine Timing and Distributor Check (3100 Code D engine only)\*†** — Adjust the timing to the underhood label specifications. Inspect the inside and outside of the distributor cap and rotor for cracks, carbon tracking and corrosion. Clean or replace as needed.

NOTE: To determine your engine's displacement and code, see *Engine Identification* in the *Index*.

\* = An Emission Control Service.

† = The U.S. Environmental Protection Agency or the California Air Resources Board has determined that the failure to perform this maintenance item will not nullify the emission warranty or limit recall liability prior to the completion of vehicle useful life. General Motors, however, urges that all recommended maintenance services be performed at the indicated intervals and the maintenance be recorded in "Section E: Maintenance Record."

# Maintenance Schedule

## ■ Section B: Owner Checks and Services

Listed below are owner checks and services which should be performed at the intervals specified to help ensure the safety, dependability and emission control performance of your vehicle.

Be sure any necessary repairs are completed at once. Whenever any fluids or lubricants are added to your vehicle, make sure they are the proper ones, as shown in Section D.

**At Each Fuel Fill** (It is important for you or a service station attendant to perform these underhood checks at each fuel fill.)

CHECK OR SERVICE	WHAT TO DO
Engine Oil Level	Check the engine oil level and add the proper oil if necessary. See <i>Engine Oil</i> in the <i>Index</i> for further details.
Engine Coolant Level	Check the engine coolant level and add the proper coolant mix if necessary. See <i>Coolant</i> in the <i>Index</i> for further details.
Windshield Washer Fluid Level	Check the windshield washer fluid level in the windshield washer tank and add the proper fluid if necessary. See <i>Windshield Washer Fluid</i> in the <i>Index</i> for further details.

**At Least Once a Month**

CHECK OR SERVICE	WHAT TO DO
Tire Inflation	Check tire inflation. Make sure they are inflated to the pressures specified on the Certification/Tire label located on the rear edge of the driver's door. See <i>Tires</i> in the <i>Index</i> for further details.
Cassette Deck	Clean cassette deck. Cleaning should be done every 15 hours of tape play. See <i>Audio Systems</i> in the <i>Index</i> for further details.

### At Least Once a Year

CHECK OR SERVICE	WHAT TO DO
Key Lock Cylinders	Lubricate the key lock cylinders with the lubricant specified in Section D.
Body Lubrication	Lubricate all body door hinges, including the liftgate. Also lubricate all hinges and latches, including those for the hood, sliding door track, rear compartment, glove box door, console door, and any folding seat hardware. Section D tells you what to use.
Starter Switch	<p><b>CAUTION: When you are doing this check, the vehicle could move suddenly. If it does, you or others could be injured. Follow the steps below.</b></p> <ol style="list-style-type: none"><li>1. Before you start, be sure you have enough room around the vehicle.</li><li>2. Firmly apply both the parking brake (<i>see Parking Brake in the Index if necessary</i>) and the regular brake.</li></ol> <p>NOTE: Do not use the accelerator pedal, and be ready to turn off the engine immediately if it starts.</p> <ol style="list-style-type: none"><li>3. Try to start the engine in each gear. The starter should work only in <b>P</b> (Park) or <b>N</b> (Neutral). If the starter works in any other position, your vehicle needs service.</li></ol>
Steering Column Lock	<p>While parked, and with the parking brake set, try to turn the key to <b>LOCK</b> in each shift lever position.</p> <ul style="list-style-type: none"><li>• The key should turn to <b>LOCK</b> only when the shift lever is in <b>P</b> (Park).</li><li>• The key should come out only in <b>LOCK</b>.</li></ul>



# Maintenance Schedule

## At Least Once a Year (CONT.)

CHECK	WHAT TO DO
Parking Brake and Automatic Transaxle <b>P</b> (Park) Mechanism Check	<p><b>CAUTION:</b> When you are doing this check, your vehicle could begin to move. You or others could be injured and property could be damaged. Make sure there is room in front of your vehicle in case it begins to roll. Be ready to apply the regular brake at once should the vehicle begin to move.</p> <p>Park on a fairly steep hill, with the vehicle facing downhill. Keeping your foot on the regular brake, set the parking brake.</p> <ul style="list-style-type: none"><li>• To check the parking brake: With the engine running and transaxle in <b>N</b> (Neutral), slowly remove foot pressure from the regular brake pedal. Do this until the vehicle is held by the parking brake only.</li><li>• To check the <b>P</b> (Park) mechanism's holding ability: Shift to <b>P</b> (Park). Then release all brakes.</li></ul>
Underbody Flushing	At least every spring, use plain water to flush any corrosive materials from the underbody. Take care to clean thoroughly any areas where mud and other debris can collect.

## ■ Section C: Periodic Maintenance Inspections

Listed below are inspections and services which should be performed at least twice a year (for instance, each spring and

fall). You should let your GM dealer's service department or other qualified service center do these jobs. Make sure any necessary repairs are completed at once.

INSPECTION OR SERVICE	WHAT SHOULD BE DONE
Restraint Systems	Now and then, make sure all your belts, buckles, latch plates, retractors, anchorages and reminder systems are working properly. Look for any loose parts or damage. If you see anything that might keep a restraint system from doing its job, have it repaired.
Steering, Suspension and Front-Wheel-Drive Axle Boot and Seal Inspection	Inspect the front and rear suspension and steering system for damaged, loose or missing parts, signs of wear, or lack of lubrication. Inspect the power steering lines and hoses for proper hookup, binding, leaks, cracks, chafing, etc. Clean and then inspect the drive axle boot seals for damage, tears or leakage. Replace seals if necessary.
Exhaust System Inspection	Inspect the complete exhaust system. Inspect the body near the exhaust system. Look for broken, damaged, missing or out-of-position parts as well as open seams, holes, loose connections, or other conditions which could cause a heat build-up in the floor pan or could let exhaust fumes into the vehicle. See <i>Engine Exhaust</i> in the <i>Index</i> .
Throttle Linkage Inspection	Inspect the throttle linkage for interference or binding, and for damaged or missing parts. Replace parts as needed.
Brake System Inspection	Inspect the complete system. Inspect brake lines and hoses for proper hook-up, binding, leaks, cracks, chafing, etc. Inspect disc brake pads for wear and rotors for surface condition. Also inspect drum brake linings for wear and cracks. Inspect other brake parts, including drums, wheel cylinders, calipers, parking brake, etc. Check parking brake adjustment. You may need to have your brakes inspected more often if your driving habits or conditions result in frequent braking. NOTE: A low brake fluid level can indicate worn disc brake pads which may need to be serviced. Also, if the brake system warning light stays on or comes on, something may be wrong with the brake system. See the <i>Index</i> under <i>Brake System Warning Light</i> . If your anti-lock brake system warning light stays on or comes on, something may be wrong with the anti-lock brake system. See the <i>Index</i> under <i>Anti-Lock Brake System Warning Light</i> .

# Maintenance Schedule

## ■ Section D: Recommended Fluids and Lubricants

NOTE: Fluids and lubricants identified below by name, part number or specification may be obtained from your GM dealer.

USAGE	FLUID/LUBRICANT
Engine Oil	API service SH or SG Energy Conserving II oils of the proper viscosity. The "SH" or "SG" designation may be shown alone or in combination with others, such as "SH/CD," "SH,SG,CD," "SG/CD," etc. To determine the preferred viscosity for your vehicle's engine, see <i>Engine Oil</i> in the <i>Index</i> .
Engine Coolant	50/50 mixture of water (preferably distilled) and good quality ethylene glycol base antifreeze (GM Part No. 1052753 or equivalent) conforming to GM Specification 1825M or approved recycled coolant conforming to GM Specification 1825M.
Hydraulic Brake System	Delco Supreme 11 <sup>®</sup> Brake Fluid (GM Part No. 1052535 or equivalent DOT-3 brake fluid).
Parking Brake Guides	Chassis lubricant (GM Part No. 1052497 or equivalent) or lubricant meeting requirements of NLGI Grade 2, Category LB or GC-LB.
Power Steering System	GM Hydraulic Power Steering Fluid (GM Part No. 1052884 or equivalent).
Automatic Transaxle	DEXRON <sup>®</sup> -III or DEXRON <sup>®</sup> -IIE Automatic Transmission Fluid.
Key Lock Cylinders	Lubricate with Multi-Purpose Lubricant (GM Part No. 12345120), synthetic SAE 5W-30 engine oil or silicone lubricant (GM Part No. 1052276 or 1052277).
Automatic Transaxle Shift Linkage	Engine oil.



USAGE	FLUID/LUBRICANT
Chassis Lubrication	Chassis lubricant (GM Part No. 1052497 or equivalent) or lubricant meeting requirements of NLGI Grade 2, Category LB or GC-LB.
Windshield Washer Solvent	GM Optikleen® Washer Solvent (GM Part No. 1051515) or equivalent.
Hood Latch Assembly a. Pivots and Spring Anchor b. Release Pawl	a. Engine oil. b. Chassis lubricant meeting requirements of NLGI Grade 2, Category LB (GM Part No. 1052497 or equivalent) or GC-LB.
Hood and Door Hinges, Rear Folding Seat, Fuel Door Hinge, Rear Compartment Lid Hinges	Engine oil or Lubriplate Lubricant (GM Part No. 1050109).
Sliding Door Track	Lubriplate Lubricant aerosol (GM Part No. 1052349) or equivalent white grease.
Weatherstrips	Dielectric Silicone Grease (GM Part No. 12345579 or equivalent).

# Maintenance Schedule

## ■ Section E: Maintenance Record

After the scheduled services are performed, record the date, odometer reading and who performed the service in the columns indicated. When completing the Maintenance

Performed column, insert the numbers from the Schedule I or Schedule II maintenance charts which correspond to the maintenance performed. Also, you should retain all maintenance receipts. Your owner information portfolio is a convenient place to store them.

<b>DATE</b>	<b>ODOMETER READING</b>	<b>SERVICED BY</b>	<b>MAINTENANCE PERFORMED</b>

<b>DATE</b>	<b>ODOMETER READING</b>	<b>SERVICED BY</b>	<b>MAINTENANCE PERFORMED</b>



# *Maintenance Schedule*

<i>DATE</i>	<i>ODOMETER READING</i>	<i>SERVICED BY</i>	<i>MAINTENANCE PERFORMED</i>



**Here you will find out how to contact Oldsmobile if you need assistance. This part also tells you how to obtain service publications and how to report any safety defects.**

## *Part 8*

### *Customer Assistance Information*

Customer Satisfaction Procedure.....	250
Customer Assistance for the Hearing or Speech Impaired .....	251
BBB Auto Line/Alternative Arbitration.....	251
Reporting Safety Defects .....	252
Oldsmobile Roadside Assistance Program.....	253
Service Publications.....	254

# Customer Assistance Information



## ■ Customer Satisfaction Procedure

Your satisfaction and goodwill are important to your dealer and Oldsmobile. Normally, any concern with the sales transaction or the operation of your vehicle will be resolved by your dealer's Sales or Service Departments. Sometimes, however, despite the best intentions of all concerned, misunderstandings can occur. If your concern has not been resolved to your satisfaction, the following steps should be taken:

**STEP ONE** — Discuss your concern with a member of dealership management. Complaints can often be quickly resolved at that level. If the

matter has already been reviewed with the Sales, Service, or Parts Manager, contact the owner of the dealership or the General Manager.

**STEP TWO** — If after contacting a member of dealership management, it appears your concern cannot be resolved by the dealership without further help, contact the Oldsmobile Customer Assistance Network by calling 1-800-442-6537. In Canada, contact GM of Canada Customer Assistance Center in Oshawa by calling 1-800-263-3777 (English) or 1-800-263-7854 (French).

In Mexico, call (525) 254-3777. In Puerto Rico or U.S. Virgin Islands, call 1-809-763-1315. In all other overseas locations, contact GM North American Export Sales in Canada by calling 1-416-644-4112.

For prompt assistance, please have the following information available to give the Customer Assistance Representative:

- Your name, address, telephone number

- Vehicle Identification Number (This is available from the vehicle registration or title, or the plate at the left top of the instrument panel and visible through the windshield.)
- Dealership name and location
- Vehicle delivery date and present mileage
- Nature of concern

We encourage you to call the toll free number listed previously in order to give your inquiry prompt attention. However, if you wish to write Oldsmobile, write to

### United States

Customer Assistance Representative  
Oldsmobile Central Office  
920 Townsend Street  
P.O. Box 30095  
Lansing, MI 48909

### Canada

General Motors of Canada Limited  
Customer Assistance Center  
1908 Colonel Sam Drive  
Oshawa, Ontario L1H 8P7



When contacting Oldsmobile, please remember that your concern will likely be resolved in the dealership, using the dealership's facilities, equipment and personnel. That is why we suggest you follow Step One first if you have a concern.

### ■ *Customer Assistance for the Hearing or Speech Impaired (TDD)*

To assist owners who have hearing difficulties, Oldsmobile has installed special TDD (Telecommunication Devices for the Deaf) equipment at its Customer Assistance Center. Any hearing or speech impaired customer who has access to a TDD or a conventional teletypewriter (TTY) can communicate with Oldsmobile by dialing: 1-800-TDD-OLDS. (TDD users in Canada can dial 1-800-263-3830.)

### ■ *GM Participation in BBB AUTO LINE- Alternative Resolution Program\**

Both Oldsmobile and your Oldsmobile dealer are committed to making sure you are completely satisfied with your new vehicle. If a situation arises where you feel your concern has not been adequately addressed, our experience has shown that the Customer Satisfaction Procedure described earlier in this section is very successful at resolving problems.

There may be instances where an impartial third-party can assist in arriving at a solution to a disagreement regarding vehicle repairs or interpretation of the New Vehicle Limited Warranty. To assist in resolving these disagreements Oldsmobile voluntarily participates in BBB AUTO LINE.

BBB AUTO LINE is an out-of-court program administered by the Better Business Bureau system to settle disputes between customers and automobile manufacturers. This

program is available free of charge to customers who currently own or lease a GM vehicle.

If you are not satisfied after following the Customer Satisfaction Procedure, you may contact the BBB using the toll-free telephone number, or write them at the following address:

BBB AUTO LINE  
Council of Better Business Bureaus  
4200 Wilson Boulevard  
Suite 800  
Arlington, VA 22203

Telephone: 1-800-955-5100

To file a claim, you will be asked to provide your name and address, your vehicle identification number (VIN), and a statement of the nature of your complaint. Eligibility is limited by vehicle age and mileage, and other factors.

We prefer you utilize the Customer Satisfaction Procedure before you resort to AUTO LINE, but you may contact the BBB at any time. The BBB will attempt to resolve the complaint serving as an intermediary between you and Oldsmobile. If this mediation is unsuccessful, an informal hearing will

## Customer Assistance Information

be scheduled where eligible customers may present their case to an impartial third-party arbitrator.

The arbitrator will make a decision which you may accept or reject. If you accept the decision, GM will be bound by that decision. The entire dispute resolution procedure should ordinarily take about forty days from the time you file a claim until a decision is made.

Some state laws may require you to use this program before filing a claim with a state-run arbitration program or in the courts. For further information, contact the BBB or the Oldsmobile Customer Assistance Center at 1-800-442-6537.

*\*This program may not be available in all states, depending on state law. Canadian owners refer to your Warranty and Owner Assistance information booklet. General Motors reserves the right to change eligibility limitations and/or to discontinue its participation in this program.*

### ■ **REPORTING SAFETY DEFECTS TO THE UNITED STATES GOVERNMENT**

If you believe that your vehicle has a defect which could cause a crash or could cause injury or death, you should immediately inform the National Highway Traffic Safety Administration (NHTSA), in addition to notifying General Motors.

If NHTSA receives similar complaints, it may open an investigation, and if it finds that a safety defect exists in a group of vehicles, it may order a recall and remedy campaign. However, NHTSA cannot become involved in individual problems between you, your dealer, or General Motors.

To contact NHTSA, you may either call the Auto Safety Hotline toll-free at 1-800-424-9393 (or 366-0123 in the Washington, D.C. area) or write to:

NHTSA  
U.S. Department of Transportation  
Washington, D.C. 20590

You can also obtain other information about motor vehicle safety from the Hotline.

### ■ **REPORTING SAFETY DEFECTS TO THE CANADIAN GOVERNMENT**

If you live in Canada, and you believe that your vehicle has a safety defect, you should immediately notify Transport Canada, in addition to notifying General Motors of Canada Limited. You may write to:

Transport Canada  
Box 8880  
Ottawa, Ontario K1G 3J2



## ■ **REPORTING SAFETY DEFECTS TO GENERAL MOTORS**

In addition to notifying NHTSA (or Transport Canada) in a situation like this, we certainly hope you'll notify us. Please call us at **1-800-442-6537**, or write:

Oldsmobile Customer Assistance  
Network  
P.O. Box 30095  
Lansing, Michigan 48909

In Canada, please call us at  
1-800-263-3777 (English) or  
1-800-263-7854 (French). Or, write:  
General Motors of Canada Limited  
Customer Assistance Center  
1908 Colonel Sam Drive  
Oshawa, Ontario L1H 8P7



## ■ **Oldsmobile Roadside Assistance Program Features & Benefits**

The Oldsmobile Roadside Assistance program means help is just a toll-free call away—24 hours a day, 365 days a year.

Courteous and capable Customer Assistance Advisors are on-call to provide you with prompt assistance.

### **24-Hour Oldsmobile Roadside Assistance Number**

1-800-442-OLDS (6537) is the one number to call for assistance in the

United States. Trained Customer Assistance Advisors, on-call to render assistance to Oldsmobile drivers, can dispatch roadside assistance and towing service, locate the nearest Oldsmobile dealership, take your request for an Oldsmobile computerized trip routing or simply answer any questions the Oldsmobile driver may have about the coverage provided by your Oldsmobile Roadside Assistance Program. The Oldsmobile Roadside Assistance number is fully staffed and operational 24 hours a day, 365 days a year.

### **Who Is Covered?**

Oldsmobile Roadside Assistance covers all 1994 Oldsmobile vehicles.

Coverage is for the Oldsmobile vehicle, *regardless of the driver*, and is concurrent with the Bumper-to-Bumper warranty period.

Oldsmobile reserves the right to limit services or reimbursement to an owner or driver when in Oldsmobile's judgement the claims become excessive in frequency or type of occurrence.



# Customer Assistance Information

## ■ *Service Publications*

Information on how to obtain Product Service Publications, Subscriptions and Indexes and Service Manuals as described below is applicable only in the fifty U.S. states (and the District of Columbia) and only for cars and light trucks with GVWR less than 10,000 pounds (4 536 kg).

In Canada, information pertaining to Product Service Bulletins and Indexes can be obtained by writing to:

General Motors of Canada Limited  
Service Publications Department  
1908 Colonel Sam Drive  
Oshawa, Ontario L1H 8P7

Oldsmobile regularly sends its dealers useful service bulletins about Oldsmobile products. Oldsmobile monitors product performance in the field. We then prepare bulletins for servicing our products better. Now, you can get these bulletins too.

Bulletins cover various subjects. Some pertain to the proper use and care of your vehicle. Some describe costly repairs. Others describe inexpensive

repairs which, if done on time with the latest parts, may avoid future costly repairs. Some bulletins tell a technician how to repair a new or unexpected condition. Others describe a quicker way to fix your vehicle. They can help a technician service your vehicle better.

Most bulletins apply to conditions affecting a small number of cars or trucks. Your Oldsmobile dealer or a qualified technician may have to determine if a specific bulletin applies to your vehicle.

You can subscribe to all Oldsmobile bulletins. This way you'll get them as they come out. You can wait a while and get an index to the bulletins. You can also get individual bulletins. However, you'll need the index to identify them.

## *Subscriptions*

You can subscribe to all Oldsmobile Product Service Publications (PSP's). This will include bulletins for all vehicles sold by Oldsmobile and will not be limited to PSP's applicable to any particular model. For subscription costs and ordering information call the toll free number shown in the following text.

### *What You'll Find in the Index*

- A list of all PSP's published by Oldsmobile in a model year (1990 or later). PSP's covering all models of Oldsmobile vehicles are listed in the same index.
- Price information for the PSP's you may want to buy.

### *How You Can Get an Index*

Indexes are published periodically. Most of the PSP's which could potentially apply to the most recent Oldsmobile models will be listed in the

most recent publication for that model year. This means you may want to wait until the end of the model year before ordering an index, if you are interested in buying PSP's pertaining to a current model year car or truck.

Some PSP's pertaining to a particular model year vehicle may be published in later years, and these would be listed in the later year's index. When you order an index for a model year that is not over yet, we'll send you the most recently published issue.

### ***Toll-Free Telephone Number***

If you want an ordering form for an index or a subscription, just call toll-free and we'll be happy to send you one. Automated recording equipment will take your name and mailing address. The number to call is 1-800-551-4123.

### ***Copies at Participating Dealers***

Copies of Indexes and PSP's are at your participating Oldsmobile dealer. You can ask to see them.

**A VERY IMPORTANT REMINDER:** These PSP's are meant for technicians. They are not meant for the "do-it-yourselfer." Technicians have the equipment, tools, safety instructions, and know-how to do a job quickly and safely.

### ***Oldsmobile Service Manuals***

For Service Manual costs and ordering information call 1-800-551-4123.

## *Product Service Publication Ordering Information*

Oldsmobile Division service publications are intended for use by professional, qualified technicians. Attempting repairs or service without the appropriate training, tools, and equipment could cause injury to you or others and damage to your vehicle that may cause it not to operate properly.

Available publications include Service Manuals, Product Service Publication indexes, quarterly and model year PSP's and binders. For 1994 Product Service Publication pricing information and orders call 1-800-551-4123.





## *Notes*





## *Notes*



# Notes

---



# Index

- A**ccessory Power Outlet..... 84  
Adding  
  Brake Fluid..... 201, 227  
  Electrical Equipment..... 60, 117, 219  
  Engine Coolant..... 167, 197, 224, 227  
  Engine Oil..... 190, 224  
  Power Steering Fluid..... 199, 225, 227  
  Sound Equipment..... 117  
  Transaxle Fluid..... 195, 224, 227  
  Windshield Washer Fluid..... 200, 227  
Adjusting Rear Seats..... 17  
Air Bag Readiness Light ..... 27  
Air Bags..... 26  
Air Cleaner..... 194, 226  
Air Conditioner..... 111  
Air Inflator System..... 85  
Alcohol, Driving Under the  
  Influence of..... 132  
Alcohol in Gasoline..... 183  
Aluminum Wheels..... 211, 216  
Antenna..... 129  
Antifreeze..... 197, 224, 227  
Anti-Lock..... 135  
Anti-Lock Brake System..... 135  
  Brake Master Cylinder..... 201  
  Junction Block Fuse..... 222  
  Warning Light..... 104  
Appearance Care..... 212  
Ashtrays and Lighter..... 89, 90  
Audio Systems..... 117  
  AM/FM Stereo Radio..... 119  
  Cassette Player..... 120, 122  
  AM/FM Stereo Radio with Compact  
  Disc Player..... 124  
  Care of Audio Systems..... 128  
  Radio Reception, For the Best..... 128  
  Setting the Clock..... 117  
  Steering Wheel Touch Controls.... 127  
Automatic Transaxle  
  Adding Fluid..... 197, 225, 227  
  Checking Fluid..... 195  
  Shifting..... 62  
**B**attery..... 203  
  Jump Starting..... 158  
Battery Warning Gage..... 103  
Blizzard..... 149  
"Blowout," Tire..... 172  
Brake  
  Adjustment..... 202  
  Anti-Lock Brakes..... 135  
  Anti-Lock Brake System Warning  
  Light..... 104  
  Junction Block Fuse..... 222  
  Fluid..... 201, 227  
  Master Cylinder..... 201  
  Parking..... 65  
  Pedal Travel..... 202  
  Rear Drums..... 202  
  Warning Light..... 103  
  Wear Indicators..... 202  
Brake System Warning Light..... 103  
Braking..... 134  
Braking in Emergencies..... 138  
Braking Technique..... 134  
"Break-In," New Vehicle..... 57, 152  
Bucket Seats, Removable Rear..... 15  
Buckling Up (see *Safety Belts*)  
Bulb Replacement  
  Headlight..... 203  
  Taillight..... 204  
Bulbs, Replacement..... 228  
**C**apacities & Specifications..... 224  
Carbon Monoxide in  
  Exhaust..... 57, 68, 150, 154  
Cassette Tape Player  
  (see *Audio Systems*)  
Center Passenger Position  
  (see *Safety Belts*)  
Chains, Safety..... 154  
Chains, Tire..... 179, 212  
Changing a Flat Tire..... 172  
Checking  
  Brake Fluid..... 201  
  Engine Coolant..... 197  
  Engine Oil..... 190  
  Power Steering Fluid..... 199  
  Safety Belt Systems..... 41

# Index

- |                                     |          |                                 |                    |  |            |
|-------------------------------------|----------|---------------------------------|--------------------|--|------------|
| Things Under the Hood .....         | 186      | Underbody Maintenance .....     | 217                | Curves, Driving on .....               | 138        |
| Transaxle Fluid .....               | 195      | Vinyl or Leather .....          | 214                | Customer Assistance Information ...    | 249        |
| Chemical Paint Spotting .....       | 217      | Warnings .....                  | 212                | <b>D</b> ead Battery: What to Do ..... | 158        |
| Child Restraints .....              | 35       | Weatherstrips .....             | 216                | Defensive Driving .....                | 132        |
| How to Install .....                | 35       | Windshield .....                | 215                | Defogger, Rear Window .....            | 115        |
| Where to Put .....                  | 36       | Climate Control System .....    | 111,113            | Defogging and Defrosting .....         | 115        |
| Children and Safety Belts .....     | 34, 39   | Clock, Setting the .....        | 117                | Delco LOC II® .....                    | 126        |
| Child Security Lock .....           | 55       | Cluster, Instrument Panel ..... | 98                 | Dome Lights .....                      | 84         |
| Cigarette Lighter .....             | 89       | Comfort Controls .....          | 111                | Door Locks .....                       | 45, 46, 52 |
| Circuit Breaker/Relay Panel .....   | 222      | Air Conditioner .....           | 111                | Door, Power Sliding .....              | 52, 107    |
| Circuit Breakers & Fuses .....      | 219      | Heater .....                    | 111                | Door, Sliding .....                    | 51         |
| City Driving .....                  | 145      | Rear .....                      | 113                | Driver Position .....                  | 22         |
| Cleaner, Air .....                  | 194, 226 | Ventilation .....               | 116                | Driving                                |            |
| Cleaning                            |          | Compact Disc Player             |                    | At Night .....                         | 142        |
| Aluminum Wheels .....               | 216      | (see <i>Audio Systems</i> )     |                    | City .....                             | 145        |
| Cassette Tape Player .....          | 128      | Compact Overhead Console .....  | 95                 | Controlling a Skid .....               | 141        |
| Compact Discs .....                 | 129      | Compact Spare Tire .....        | 178                | Defensively .....                      | 132        |
| Fabric .....                        | 213, 214 | Compass Display .....           | 81                 | Drunken .....                          | 132        |
| Finish Care .....                   | 216      | Console, Overhead .....         | 79                 | Freeway .....                          | 145        |
| Foreign Material .....              | 216      | Control of a Vehicle .....      | 134                | Hill and Mountain .....                | 147        |
| Glass .....                         | 215      | Convenience Net .....           | 91                 | In a Foreign Country .....             | 184        |
| Inside of Your Oldsmobile .....     | 212      | Convex Outside Mirror .....     | 87                 | In Rain .....                          | 143        |
| Leather and Vinyl .....             | 214      | Coolant .....                   | 197                | Long Distance .....                    | 146        |
| Outside of the Windshield and Wiper |          | Checking & Adding .....         | 198                | Loss of Control .....                  | 141        |
| Blades .....                        | 215      | Proper Mixture to Use .....     | 168,197            | On Curves .....                        | 138        |
| Outside of Your Oldsmobile .....    | 215      | Safety Warnings                 |                    | Passing .....                          | 140        |
| Safety Belts .....                  | 214      | About .....                     | 167, 168, 169, 198 | Through Deep Standing Water .....      | 60         |
| Special Problems .....              | 213      | Temperature Gage .....          | 103                | Winter Driving .....                   | 148        |
| Stains, Removing .....              | 213      | Cruise Control .....            | 72                 | With a Trailer .....                   | 151        |
| Top of the Instrument Panel .....   | 214      | Cup Holder/Ashtray, Front ..... | 89                 |  |            |



Drunken Driving.....	132	Exhaust		Fluids & Lubricants.....	227
<b>E</b> lectric Outside Mirror Control.....	87	Dangerous Gas		Fog Lights.....	76
Electrical Equipment,		in.....	57, 68, 150, 154	Freeway Driving.....	145
Adding.....	60, 117, 219	Parking with the Engine		Fuel.....	183
Electronic Level Control.....	94, 206	Running.....	67, 68	Alcohol in Fuel.....	183
Emergencies, Braking in.....	138	Expectant Mothers, Use of Safety		Capacity.....	185
Emergencies on the Road.....	157	Belts.....	30	Exhaust Warnings.....	57, 68, 150, 154
Emergencies, Steering in.....	139	Expressway Driving.....	145	Filling Your Tank.....	185
Emergency Starting.....	158	Extender, Safety Belt.....	41	Fuels with Alcohol.....	183
Emergency Towing.....	162	Exterior Appearance		Gage.....	100
Engine Coolant.....	197, 224, 227	(see <i>Appearance Care</i> )		In Foreign Countries.....	184
Engine Coolant Heater.....	61	<b>F</b> abric Cleaning		Low, Warning.....	101
Engine Coolant Temperature		(see <i>Appearance Care</i> )		Methanol in Fuel.....	183
Gage.....	103	Fan Warnings.....	159, 160, 167, 187	Requirements.....	183
Engine Exhaust.....	57, 68, 150, 154	Filling the Fuel Tank.....	185, 272	Fuse Panel and Usage.....	220, 221
Engine Identification.....	218	Filter		Fuses & Circuit Breakers.....	219
Engine Oil.....	190	Air Cleaner.....	194, 226	Anti-Lock Brakes Fuse.....	222
Additives.....	193	Oil.....	193, 226	Injector Fuse.....	223
Checking & Adding.....	190, 191	Finish Care.....	216	<b>G</b> ages	
Disposing of Used Oil.....	194	Flashers, Hazard Warning.....	158	Coolant Temperature.....	103
Energy Conserving.....	193	Flat Tire.....	172	Fuel.....	100
Pressure Gage.....	102	Flooded Engine.....	59	Oil Pressure.....	102
Pressure Indicator.....	101	Flow-Through Ventilation.....	116	Oil Pressure Indicator.....	101
Warning.....	193	Fluid		Tachometer.....	99
When to Change.....	193	Brake.....	200, 227	Voltmeter.....	103
Engine Overheating.....	165	Capacities.....	224	Garage Door Opener Compartment..	80
Engine Specifications.....	226	Power Steering.....	199, 225, 227	Gasoline.....	183
Engine, Starting.....	58	Transaxle.....	195, 224, 227	Gasoline Tank, Filling Your.....	185
Ethanol in Gasoline.....	183	Windshield Washer.....	200, 227	Gas Station Information.....	272



# Index

Gate Ajar Light .....	107
Gear Positions (see <i>Shifting the Transaxle</i> )	
Gearshift Lever (see <i>Shifting the Transaxle</i> )	
Glove Boxes/Storage Compartment .....	88
<b>H</b> alogen Bulbs .....	203
Hazard Warning Flashers .....	158
Headlight & Taillight, Removing and Replacing .....	203
Headlights .....	74
High-Low Beam Changer .....	75
Instrument Panel Intensity Control ..	76
"On" Reminder .....	75
Operation .....	75
Replacement Bulb .....	228
Wiring .....	223
Head Restraint .....	14
Heater (see <i>Comfort Controls</i> )	
High Beams .....	75
"Highway Hypnosis" .....	146
Hill and Mountain Roads .....	147
Hills, Parking on .....	156
Hood Release .....	186
Safety Warning .....	187
Warning, Overheated Engine .....	187, 198, 199
Horn .....	69

Hot Engine, Safety Warnings .....	166, 187, 198, 199
Hydroplaning .....	144
<b>I</b> dentification Number, Vehicle .....	218
Idling Your Engine .....	67, 68
If You're Stuck: In Sand, Mud, Ice or Snow .....	179
Ignition Key .....	44
Positions .....	58
Illuminated Entry System .....	50
Indicator Lights (see <i>Warning Lights</i> )	
Infant Restraint (see <i>Child Restraints</i> )	
Inflation, Tire .....	178, 208
Inflator, Air .....	85
Inside Rearview Mirror .....	86
Instrument Panel .....	97
Instrument Panel Cluster .....	98
Instrument Panel Intensity Control ..	76
Instrument Panel Warning Lights ...	100
Interior Lights .....	76, 79, 80
Override Switch .....	83
<b>J</b> ack, Tire .....	172
Jump Starting .....	158
<b>K</b> eyless Entry, Remote .....	48
Keys .....	44

<b>L</b> ane Change Indicator .....	71
Lap-Shoulder Belt .....	23
Front .....	23
Rear .....	32
Use by Children .....	34, 39
Level Control, Electronic .....	94, 206
Liftgate .....	56, 107
Lighter .....	89
Lights Dome .....	84
Fog .....	76
Headlights .....	74
Interior Lights Control .....	76
Interior Lights Override Switch .....	83
"On" Reminder .....	75
Reading .....	80, 83
Rear Interior Lights .....	84
Removing & Replacing Bulbs .....	204, 228
Replacement Bulbs .....	228
Taillights .....	204
Turn Signal .....	71
Underhood .....	190
Warning Lights .....	100
Lights On Reminder .....	75
Loading Your Vehicle .....	92, 206
Locks Manual .....	45, 52
Power .....	46

Remote Control .....	48
Sliding Door.....	52
Long Distance Driving.....	146
Low Battery.....	158
Low Fuel Warning.....	101
Low Oil Pressure Warning.....	102
Low Traction Light.....	105
Lubricants and Fluids.....	227
Luggage Carrier.....	92

<b>M</b> aintenance Record.....	246
Maintenance Schedule.....	234
Malfunction Indicator Lamp.....	106
Manual Front Seat.....	12
Manual Lap-Shoulder Safety Belt.....	23
Methanol in Gasoline.....	183
Mileage Indicator (see <i>Odometer &amp; Speedometer</i> )	

Mirrors	
Inside Manual Day/Night.....	86
Outside Convex.....	87
Power Remote Control.....	87
Visor Vanity.....	88
Mountain Driving.....	147

<b>N</b> ew Vehicle "Break-In" Requirements.....	57, 152
Night Driving.....	142
Night Vision.....	142

<b>O</b> ctane Requirements (see <i>Fuel Requirements</i> )	
Odometer & Speedometer.....	99
Oil, Engine.....	190
Pressure Gage.....	102
Pressure Indicator.....	101
Quality.....	191
Thickness.....	192
Used Oil.....	194
When to Change.....	193
Oil Warning.....	101
Outside Rearview Mirrors.....	87
Overhead Console.....	79, 95
Overheated Engine.....	165
Warnings.....	166, 187, 198, 199
Owner Checks & Services.....	240

<b>P</b> ark, Shifting Into.....	66
Parking	
Over Things That Burn.....	67
With the Engine Running.....	67, 68
Parking Brake.....	65
Passenger Belts (see <i>Safety Belts</i> )	
Passing.....	140
Payload.....	206
Periodic Maintenance Inspections..	243
Polishing and Waxing (see <i>Appearance Care</i> )	
Power (Anti-Lock) Brakes.....	135

Power Door Locks.....	46
Power Mirrors.....	87
Power Outlet, Accessory.....	84
Power Seat Controls.....	13
Power Sliding Door.....	52, 107
Power Steering.....	138
Power Steering Fluid.....	199, 225, 227
Power Windows.....	70, 223
Pregnancy, Use of Safety Belts	
During.....	30
Problems on the Road.....	157
Publications.....	254

<b>R</b> adiator Overheating (see <i>Overheated Engine</i> )	
Radiator Pressure Cap.....	199
Radio (see <i>Audio Systems</i> )	
Reading Lights.....	80
Rear Climate Control.....	113
Rear Interior Lights.....	84
Rear Seats.....	15
Adjusting.....	17
Removing.....	16
Replacing.....	18
Third Row Entry.....	15
Rear Window Defogger.....	115
Rear Window Wiper and Washer.....	79
Rearview Mirror.....	86
Reclining Seatbacks.....	13



# Index

Recommended Fluids and Lubricants .....	244
Reminder Light .....	75
Remote Lock Control.....	48
Removing Rear Bucket Seats.....	16
Replacement Bulbs .....	228, 229
Replacement Fuses.....	220
Replacement Parts .....	226
Replacing Brake System Parts.....	203
Replacing Bulbs.....	228, 229
Replacing Rear Bucket Seats .....	18
Replacing Safety Belts.....	41
Replacing Tires.....	209
Replacing Wheels .....	211
Replacing Windshield Wipers.....	205
Restraint, Head .....	14
Restraints, Child.....	35
Roadside Assistance.....	253
Roads, Hill and Mountain .....	147
Rocking Your Vehicle .....	179
Rotation, Tire .....	208

<b>S</b> afety Belts .....	18
Adults.....	22
Center Passenger Position .....	31
Checking .....	41
Children .....	34,39
Child Restraints .....	35
Cleaning .....	214
Driver Position .....	22

Extender.....	41
How to Wear.....	22
Lap-Shoulder Belt .....	23
Passenger Belts.....	30
Pregnancy, Use During .....	30
Questions & Answers ...	21, 24, 40, 42
Rear Safety Belts .....	30
Reminder Light.....	22
Replacement .....	41
Right Front, Adult Passenger.....	30
Smaller Children and Babies.....	34
Top Strap .....	36
Torn.....	42
Twisted.....	26
Why You Should Wear Safety Belts .....	18
Safety Belt Extender .....	41
Safety Belt Reminder Light.....	22
Safety Defects, Reporting .....	252
Scheduled Maintenance Services ...	233
Seat Adjustment.....	12, 17
Seat Belts (see <i>Safety Belts</i> )	
Seat Controls.....	12
Head Restraint.....	14
Manual Front Seat.....	12
Manual Reclining Seatback.....	13
Manual Seat, Four-Way .....	12
Power Seat, Six-Way .....	13
Rear Seats .....	15
Adjusting.....	17

Removing .....	15
Replacing .....	18
Third Row Entry .....	15
Reclining Seatback .....	13
“Service Engine Soon” Light.....	106
Service Information .....	182
Service Parts Identification Label ...	218
Service Publications.....	254
Service Station Information .....	272
Servicing Your Air Bag-Equipped Oldsmobile.....	29
Setting the Clock.....	117
Setting the Trip Odometer.....	99
Shifting Into P (Park) .....	66
Shifting the Automatic Transaxle ....	62
Signaling Turns .....	71, 155
Six-Way Power Seat.....	13
Skidding.....	141
Sliding Door .....	51
Sliding Door Ajar Warning Light ....	107
Snowstorm, If You’re Caught in a...	149
Sound Equipment, Adding .....	117
Sound Systems (see <i>Audio Systems</i> )	
Spare Tire, Compact .....	178
Specifications & Capacities .....	224
Speed Control (see <i>Cruise Control</i> )	
Speedometer & Odometer.....	99
Stains, Removing .....	213
Starting Your Engine .....	58



Starting Your Vehicle if the Battery is "Dead" (see <i>Jump Starting</i> )		
Steering		
In Emergencies .....	139	
Off-Road Recovery .....	140	
Power .....	138	
Tips .....	138	
Steering Wheel, Tilt.....	69	
Steering Wheel Touch Controls .....	127	
Stereo Sound Systems (see <i>Audio Systems</i> )		
Storing Your Vehicle.....	203	
Storage		
Compact Overhead Console .....	95	
Compartment.....	83	
Convenience Net .....	91	
Cup Holder .....	89	
Garage Door Opener.....	80	
Glove Boxes.....	88	
Locking Bin .....	90	
Luggage Carrier .....	92	
Overhead Console .....	79	
Rear Compartment .....	91	
Sunglasses.....	83	
Stuck, If You Are.....	179	
Sunroof.....	95	
Sun Visors .....	87	
Supplemental Restraint System (SRS) .....	26	
<b>T</b> achometer.....	99	
Taillights.....	204	
Tape Player (see <i>Audio Systems</i> )		
Technical Facts & Specifications		
Bulbs .....	228, 229	
Capacities & Specifications .....	224	
Circuit Breakers/Relays.....	222	
Electrical Equipment, Add-On .....	60, 117, 219	
Engine .....	226	
Fluids & Lubricants .....	227	
Fuses.....	219, 220, 221	
Replacement Parts.....	226	
Service Parts Identification Label.....	218	
Vehicle Identification Number (VIN).....	218	
Temperature Display.....	81	
Temperature Warning.....	103	
Theft.....	50	
Thermostat .....	199	
Tilt Steering Wheel.....	69	
Time, Setting the.....	117	
Tire Loading .....	206	
Tires .....	207	
"Blow Out" .....	172	
Buying New .....	209	
Chains .....	178, 212	
Flat, Changing .....	172	
Inflation .....	85, 172, 178, 208	
Inspection & Rotation.....	208	
Loading .....	206	
Pressure .....	208	
Quality Grading.....	210	
Spare, Compact .....	178	
Wear Indicators .....	209	
Wheel Alignment & Tire Balance.....	211	
Wheel Nut Torque.....	177, 225	
Wheel Replacement .....	211	
Top Strap.....	36	
Torque Lock .....	67	
Towing a Trailer .....	151	
Towing Your Vehicle .....	162	
Traction Control System.....	137	
Traction Control System Warning Light .....	105	
Trailer Towing.....	151	
Brakes .....	154	
Maintenance .....	156	
Parking on Hills.....	156	
Safety Chains.....	154	
Transaxle, Automatic (see <i>Automatic Transaxle</i> )		
Transmission, Automatic (see <i>Automatic Transaxle</i> )		
Trip Odometer.....	99	
Turn Signal Indicator.....	71	
Turn Signal/Multifunction Lever .....	70	

# Index

Cruise Control .....	72
Headlight High-Low Beam Changer .....	75
Turn and Lane Change Indicator .....	71
Turn Signal Indicator .....	71
<b>U</b> nderhood Light .....	190
Unleaded Gasoline .....	183
Upholstery Care .....	213, 214
Urban Driving .....	145
<b>V</b> ehicle Identification Number (VIN) .....	218
Vehicle Loading .....	92, 206
Vehicle Storage .....	203
Ventilation .....	116
VIN .....	218
Visor Vanity Mirror .....	88
Voltmeter .....	103

<b>W</b> arning Flashers, Hazard .....	158
Warning Lights	
Anti-Lock Brake System .....	104
Brake .....	103
Liftgate Ajar .....	57, 107
Low Fuel .....	101
Service Engine Soon .....	106
Sliding Door Ajar .....	53, 107
Warning, Used Oil .....	194
Washer, Windshield .....	78
Weatherstrips .....	216
Weight	
Gross Axle Weight Rating (GAWR) .....	206
Gross Vehicle Weight Rating (GVWR) .....	206
Wheel Alignment and Tire	
Balance .....	211
Wheel Nuts .....	174

Wheel Nut Torque .....	177, 225
Wheel Replacement .....	211
Windows .....	69
Windows, Power .....	70, 223
Windshield Washer .....	78
Fluid .....	200, 227
Windshield Wipers .....	77, 223
Blade Replacement .....	205
Cleaning the Outside of the Windshield and Wiper Blades .....	215
Pulse Delay .....	77
Rear .....	79
Winter Driving .....	148
If You're Caught in a Blizzard .....	149
If Your Vehicle is Stuck in Deep Snow .....	149, 179
Snow or Ice, Driving On .....	148
Wiper/Washer, Rear Window .....	79
Wrecker Towing .....	162





# Service Station Information

