

15-

THE **15**s

Front Wheel Drive

CITROËN

Types :

Light Fifteen (BL : 11 Légère)

Big Fifteen (B : 11 Normale)

SOCIÉTÉ ANONYME ANDRÉ CITROËN

117 à 167, Quai de Javel, Paris (15^e)

— 1953 —

GENUINE SPARE PARTS

When it becomes necessary to replace any parts of your car, always insist upon your repairer using genuine Citroën spare parts.

The spare parts which we supply are exactly the same as those which we fit on the production lines; they are of the same quality and materials.

You may consult the price list at any of our distributors, agents or branches. Make sure that any invoice bears a statement that the parts used are genuine.

ALPHABETICAL INDEX

	Pages		Pages
Advance, ignition	6, 8	Levels (oil, water)	5, 18
Air Filter	14	Lighting (car)	6
Ammeter	7	Lighting (instruments).....	7
Antifreeze	12	Lubrication	18, 19
Battery	12	Maintenance	12
Brakes	13	Manual Ignition Control....	6, 8
Capacities, tanks and sumps..	24	Oil dipstick	5
Carburettor	9	Petrol gauge	8
Comfort	15	Petrol filter	14
Draining (gearbox)	23	Petrol pump	8
Draining (engine)	18	Radiator	12
Driving	5	Radiator muff	16
Engine oil	18	Running-in	4
Filter (air)	14	S.A.F. Classification	18
Filter (petrol)	14	Seats	15
Frost precautions	12	Shockabsorbers	23
Gearbox (draining).....	23	Special checks	23
General information	24	Starter	6
Heater	16	Starting	6
Identification	24	Tool Kit	11
Important points	3	Tyres (pressures)	13
Instrument panel	7	Tyres (sizes)	24
Jack	10, 11	Ventilation	17
Level (battery)	12	Wheel (changing a).....	11
Level (gearbox)	23	Windscreen wiper	8

IMPORTANT POINTS

- The life of your car depends upon careful running-in and maintenance.
- Use lubricants of high quality.
- Grease all round every 1,000 miles; drain and refill engine oil every 2,500 miles.
- Check the engine oil level from time to time.
- At all times use oil viscosity S.A.E. 20 (see page 18).
- In winter, protect your car against frost.
- Check the acid-level of the battery frequently, especially in summer.
- Do not use the choke excessively.
- Never race the engine when it is cold.
- When you are driving, do not let your foot rest on the clutch pedal.

RUNNING-IN

1. For the first 300 miles do not exceed the following speeds

1st gear	15 m.p.h.
2nd gear	28 m.p.h.
Top gear.....	45 m.p.h.

Between 300 miles and 1,250 miles, gradually increase your speed.

After 1,250 miles your car is run-in.

2. When delivered the car contains the correct quantities of oil. Drain and refill the engine after 300 miles, again after 1,250 miles, and every 2,500 miles there after.

DRIVING

Before starting check the levels:

Oil.—Should come to the upper end of the cutout on the oil dipstick A (fig. 1), and should not be allowed to drop below the lower end of the cutout. Check the level when the engine is cold, and with the car on a horizontal surface.

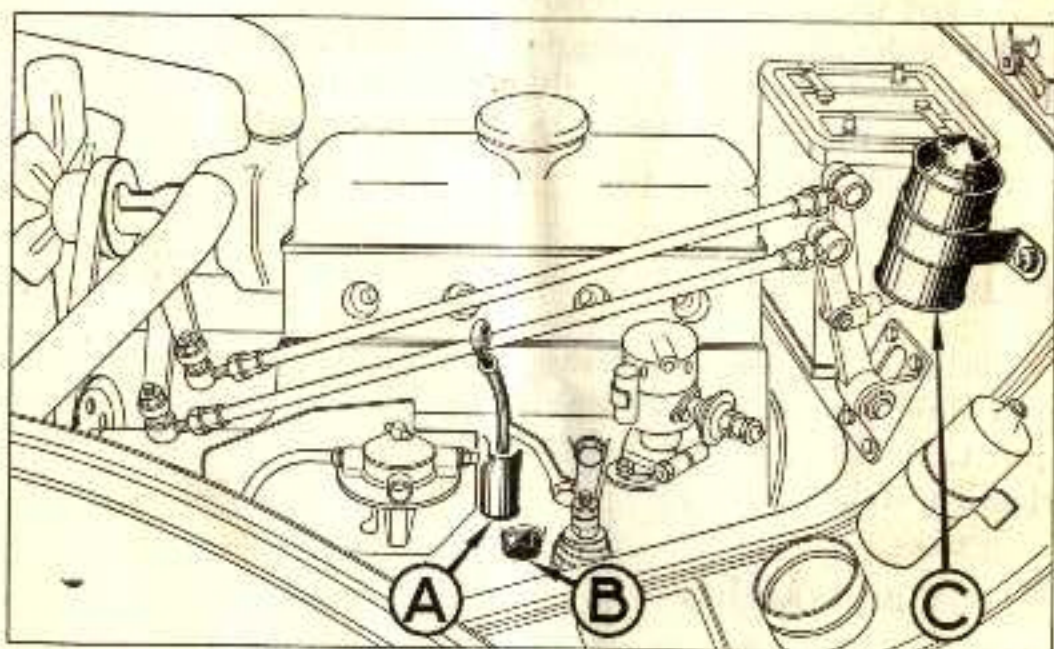

Fig. 1. — OIL DIPSTICK (A). — CRANKCASE DRAIN PLUG (B).
BRAKE FLUID RESERVOIR (C).

Water.—The water level should be within 1" of the upper edge of the radiator filler neck.

Starting

Declutch completely before starting the engine, and turn the Manual Ignition Control Knob (fig. 2) as far as it will go in the direction opposite to that shown by the arrow.

When the engine is cold: do not touch the accelerator. Pull the Choke Knob fully; pull the Starter Knob. If the engine does not fire, wait three or four seconds and pull the Starter Knob again. Never run the Starter Motor for more than 3 or 4 seconds at a time.

As soon as the engine starts, advance the ignition (see page 8), push back the choke control gradually as the engine warms up, and right in as soon as possible.

Do not use the choke excessively.

When the engine is warm: do not touch the Choke Control. Depress the accelerator pedal fully, pull the Starter Knob; as soon as the engine fires, release the accelerator pedal so as not to race the engine (1).

Changing Gear

Declutch completely; change gear gently, make sure each gear is fully engaged. Pause slightly when changing from one gear to another. When driving, do not rest your foot on the clutch pedal.

Horns and Lights

A single knob under the steering wheel, to the right of the steering column, controls the lights and horns (fig. 10).

(1) Incorrect procedure when starting, such as repeated movements of the accelerator pedal or excessive use of the choke, may flood the engine; in this case, proceed as for starting when the engine is warm or, alternatively, wait for 5 or 6 minutes and recommence.

The Stoplamp only operates when the brakes are applied and when the Ignition is switched on.

Instrument Panel (fig. 2)

Lighting.—When the ignition and driving lights are on, the instruments are illuminated; their lighting can be dimmed by turning the milled knob (fig. 2).

Speedometer Trip Reading.—To re-set to zero, push and turn the knob.

Ammeter.—When the car is being driven, the ammeter needle should be more or less to the left of the zero mark.

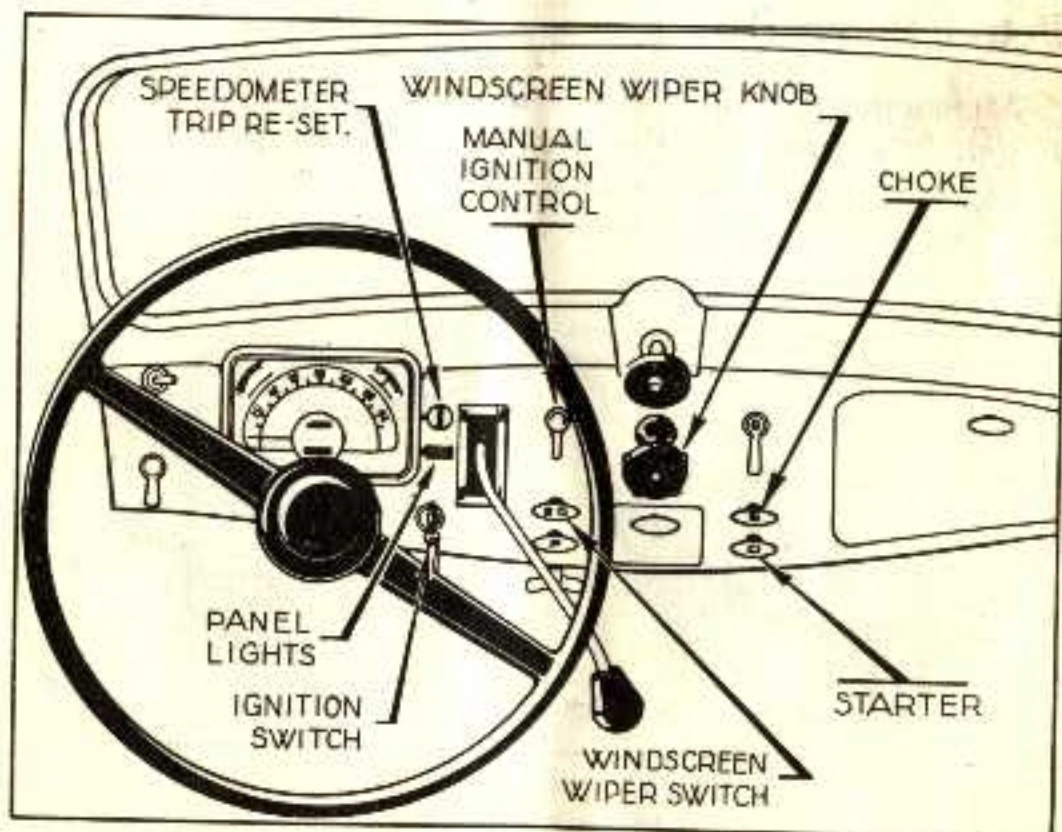

Fig. 2. — INSTRUMENT PANEL.

If, on the other hand, it goes over definitely to the right, have the wiring checked by a Citroen Agent as soon as possible.

Manual Ignition Control.—To obtain the best performance from your car, run with the manual ignition control knob in the position at which the engine just fails to “pink”. With insufficient advance the engine is sluggish and overheats; with excessive advance it pinks; in both cases it uses more petrol.

Petrol gauge.—Only operates when the ignition is switched on.

Windscreen Wiper.—If the windscreen is covered with snow, operate the wiper by hand a few times to clear the screen.

Petrol Pump (1)

After a petrol trouble, if you have to refill the tank, do not forget, before starting the engine, to fill the pump by operating the priming lever L a few times. Proceed the same way when the car has been idle fore some time.

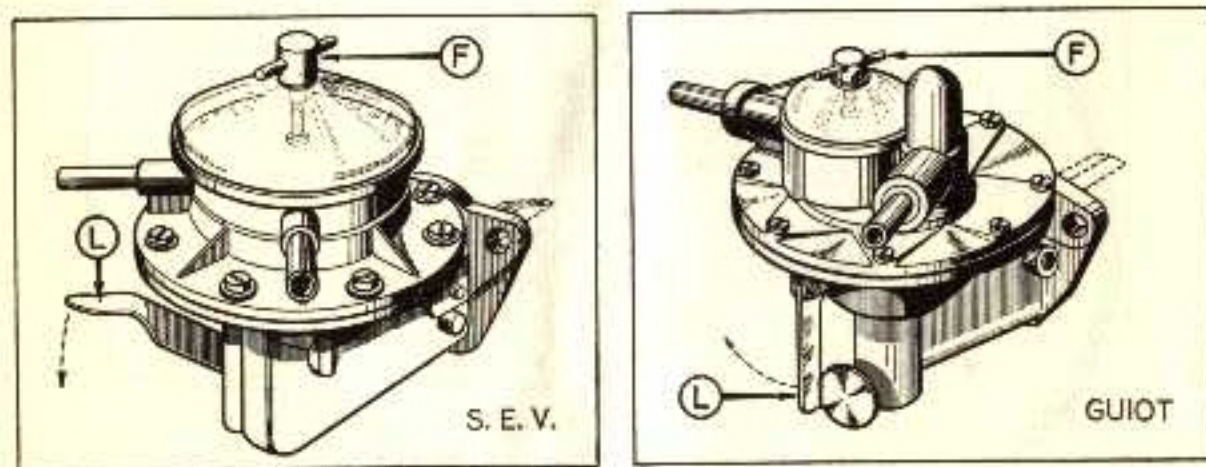
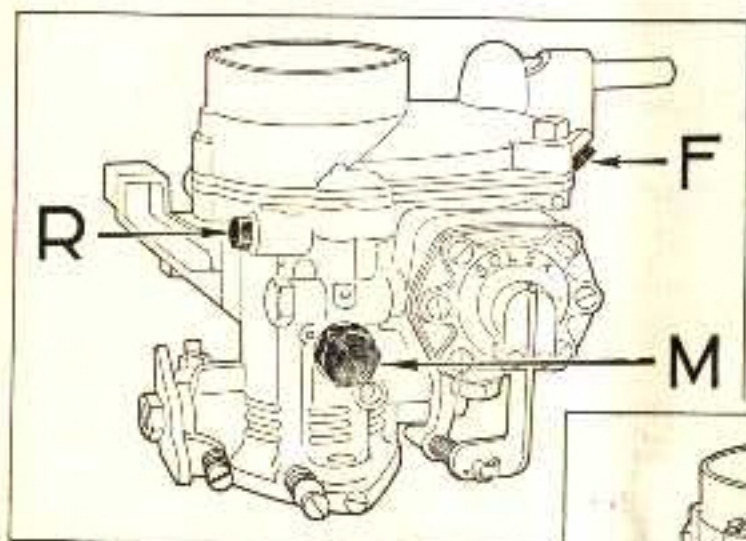

Fig. 3. — S.E.V. and GUIOT
PETROL PUMPS.

(1) Note. — We fit either S.E.V. or GUIOT pumps.

Carburettor (1)

Interfere with this as little as possible. In particular do not change the original settings.



SOLEX 32 PBIC

ZENITH 32 IN

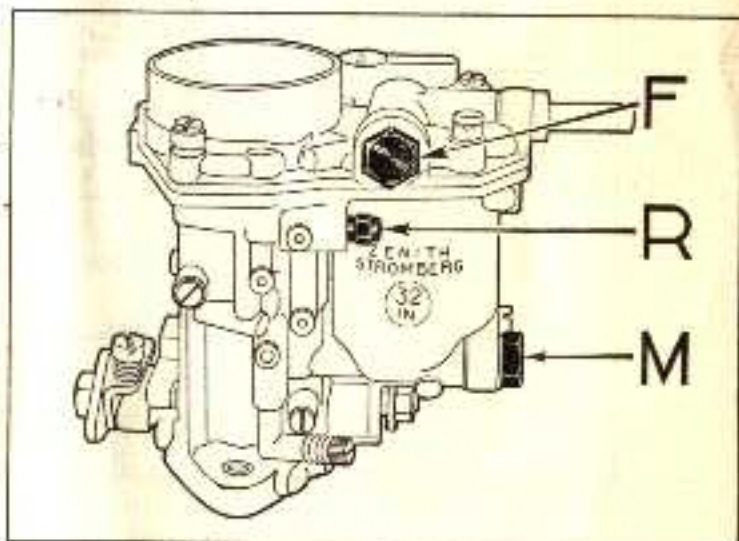

Fig. 4. — CARBURETTORS.

The two illustrations on p. 9 indicate the points which may need cleaning: Filter F; main jet M; slow running jet R (2) (fig. 4).

(1) Note. — We fit either SOLEX or ZENITH carburettors.

(2) Blow these jets clean; never use a needle or piece of wire.

Changing a wheel

Place your car on a level surface.

Do not put your jack just anywhere, but use the jacking pads provided:

—at the front, under the boss at the outer end of the lower link arm (fig. 5);

—at the back, under the rear axle arm jack pads C (fig. 6).

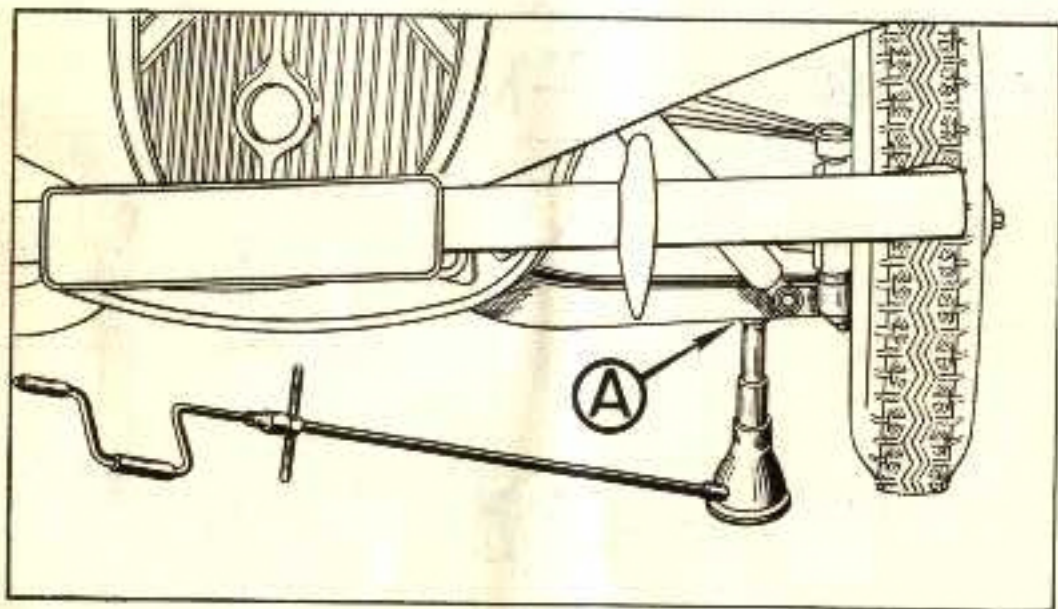

Fig. 5. — FRONT JACKING POSITION.

Never lift the car by the middle of the rear axle.

The toolkit includes a brace for the wheelnuts and embellisher fixing screw.

When refitting the wheels, tighten every alternate nut, gently at first, then tighten right down.

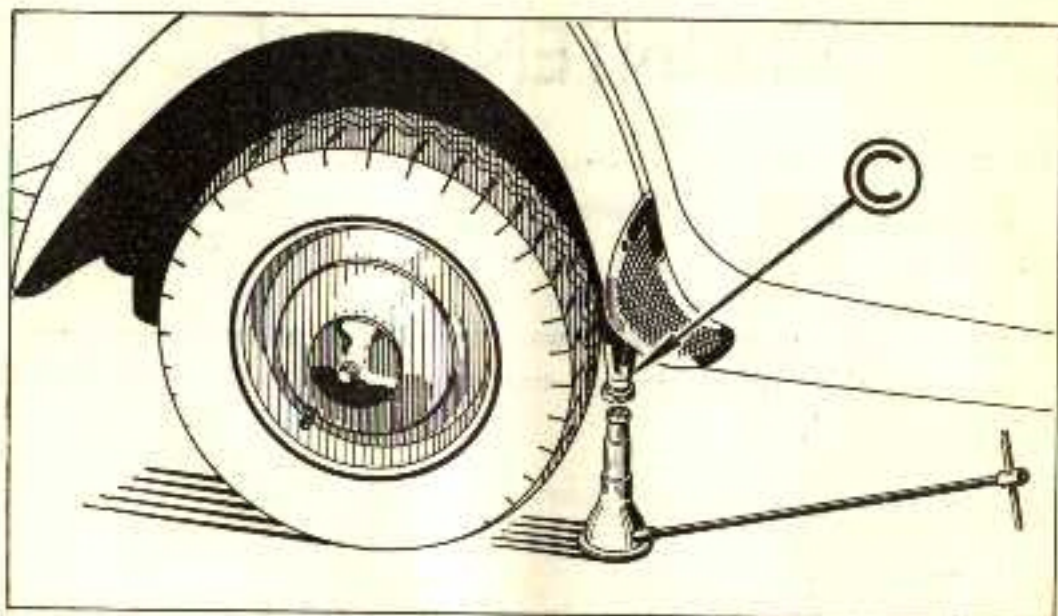

Fig. 6. — JACKING POSITION AT BACK.

Use of the jack.—Unscrew the head of the jack by hand until it will just go under the jacking pad A or C (fig. 5 or 6); rotate the jack handle until the car starts to lift, then use the wheelbrace; do not try to strain the jack when it is extended.

The Tool Kit delivered with your car comprises:

A bag containing an adjustable spanner, a pair of pliers, a screwdriver, radiator muff, ⁽¹⁾ jack and handle, starting handle, wheelbrace, plug spanner, a special spanner for the headlamp nuts and for the drainplugs of the petrol tank, crankcase, and gearbox.

(1) See page 16.

MAINTENANCE

Battery

Check the acid level frequently, especially in summer; it should be $3/8$ " above the plates in each cell. Top up with pure distilled water only.

The terminals may become sulphated; undo them, clean them, dip the felt washer in castor-oil, refit and smear them with castor-oil.

Frost Precautions

A.—Battery:

Cold diminishes a battery's capacity; if it freezes it bursts and becomes useless.

When fully charged, acid S.G.1.210, a battery will withstand a temperature of -20°F (52° of frost).

When half charged, acid S.G.1.160, it will withstand a temperature of $+5^{\circ}\text{F}$.

A flat battery, acid S.G. 1.075, will freeze and burst at $+13^{\circ}\text{F}$. Make sure your battery is always well charged.

B.—Radiator and crankcase:

Three and a half pints of antifreeze will save you the trouble of draining, and will protect your engine at a temperature as low as 5°F (27° of frost).

You can use:

1. Good quality, neutral, commercial antifreeze mixtures.
2. Alcohol: it evaporates and must be replaced.
3. Glycerine: does not evaporate. It must have no acid reaction; if you are in doubt as to acidity, add loz. of sodium carbonate (washing soda crystals) to the contents of the radiator.

4. Glycol: does not evaporate and is neutral.

When the cold weather is over, drain and flush out the cooling system; refill with clean water.

If you do not wish to use antifreeze, drain the radiator and crankcase every night during frosty weather. The drain plugs are shown at:

R (fig. 14, page 22) for the radiator;

B (fig. 1, page 5), for the crankcase.

Tyres

Among other things, tyre wear depends on correct pressures; the table below shows the pressures, measured with the tyres cold:

	FRONT	REAR	SPARE
Light 15	17 lbs/sq.in.	20 lbs/sq.in.	23 lbs/sq.in.
Big 15	18 1/2 —	21 1/2 —	24 1/2 —

The front and rear pressures are different; maintain this difference for the sake of good road-holding.

When you have occasion to use the spare wheel, bring it to the correct pressure.

Every 4,000 miles, change your wheels round diagonally to equalise tyre wear, adjust the pressures as required.

Brakes

Every month check the level of the special brake-fluid in its reservoir C (fig. 1); it should not fall below the "normal" mark. Never use any liquid other than the Special Brake Fluid.

If the brakes do not operate well, or if the pedal travel becomes excessive, consult a Citroen Agent immediately.

General maintenance

Your Citroen Agent will advise you as to the most suitable products for general maintenance. For example, use neither solvent nor abrasive material to clean the direction indicators, parking lamps or rear lamp; the surface-gloss would be destroyed.

Air filter

Instructions for cleaning are marked on the casing. To remove the Miofiltre element, undo screws A and B and remove the cover (fig. 7).

Every 4.000 miles wash the filter element in petrol and dry. Dip in light oil, allow to drain, then replace.

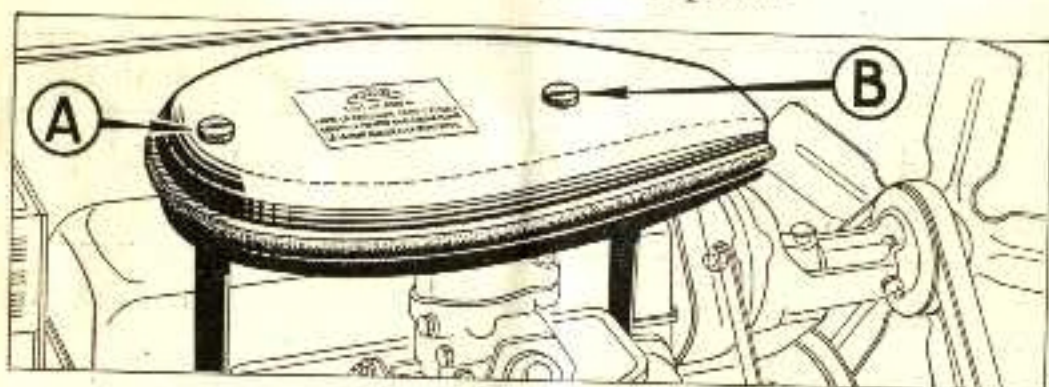

Fig. 7. — MIOFILTRE.

Petrol filters.

A. — In the Petrol Tank, a filter block is fitted to the lower end of the Outlet pipe. It is advisable to unscrew it and clean it from time to time. The frequency of cleaning this Filter depends on the cleanliness of the petrol used and the amount of dust on the roads one usually takes.

B. — At the point where petrol enters the carburettor, just below the union, is another filter, a cylinder of fine metallic gauze. After a long period a whitish deposit may form on it which will restrict the petrol supply. It is very easily cleaned.

COMFORT

Adjustment of Front Seats

When you are seated, pull lever L (fig. 8) upwards.

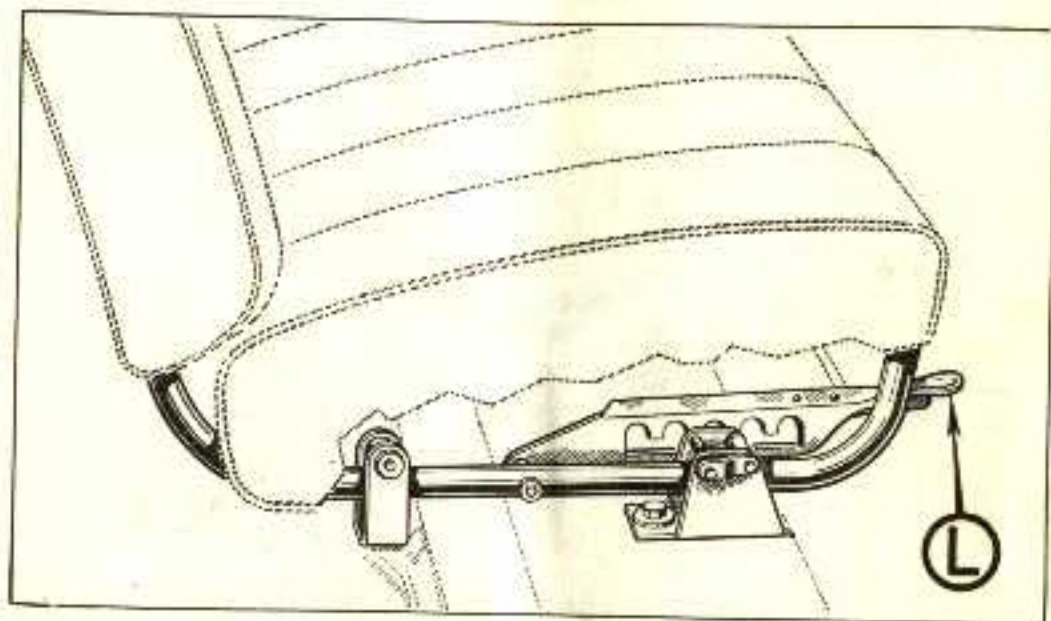

Fig. 8. — ADJUSTMENT OF FRONT SEATS.

Move the seat backwards or forwards by pushing or pulling with your feet; when you have found a comfortable position release the lever which will then lock the seat in place.

Loose Covers

A cloth which is too heavy or too tightly stretched will reduce considerably the comfort of the seating. Use rustless clips for attaching the loose covers.

Heater

By turning the Heater control knob (fig. 10) you can open or close the Heater valve.

In winter the car is delivered with its heater tube in position.

In summer the heater tube should be removed. To do this, remove nut A (fig. 9), loosen nut B, release the hose clip C; then the whole assembly may be removed; replace and tighten the nuts A and B.

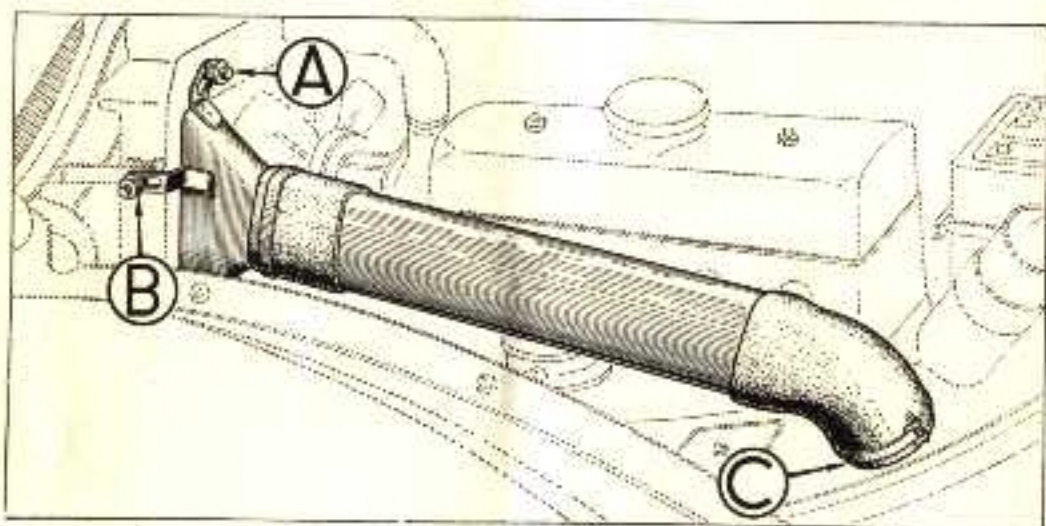

Fig. 9. — HEATER.

To refit the heater, reverse the operations mentioned above.

The heater is only effective if the lower part of the radiator is blanked off by the Radiator Muff which you will find in your toolkit. It is secured by elastic attachments which fit into hooks at the sides of the radiator.

Interior Lamp

Pulling the Knob (fig. 10) lights and extinguishes alternately the Interior Lamp.

Direction Indicators

An automatic time switch extinguishes them after about 10-12 seconds.

Ventilation

You can open:

- a. The windscreen, by turning the Knob shown in fig. 10.

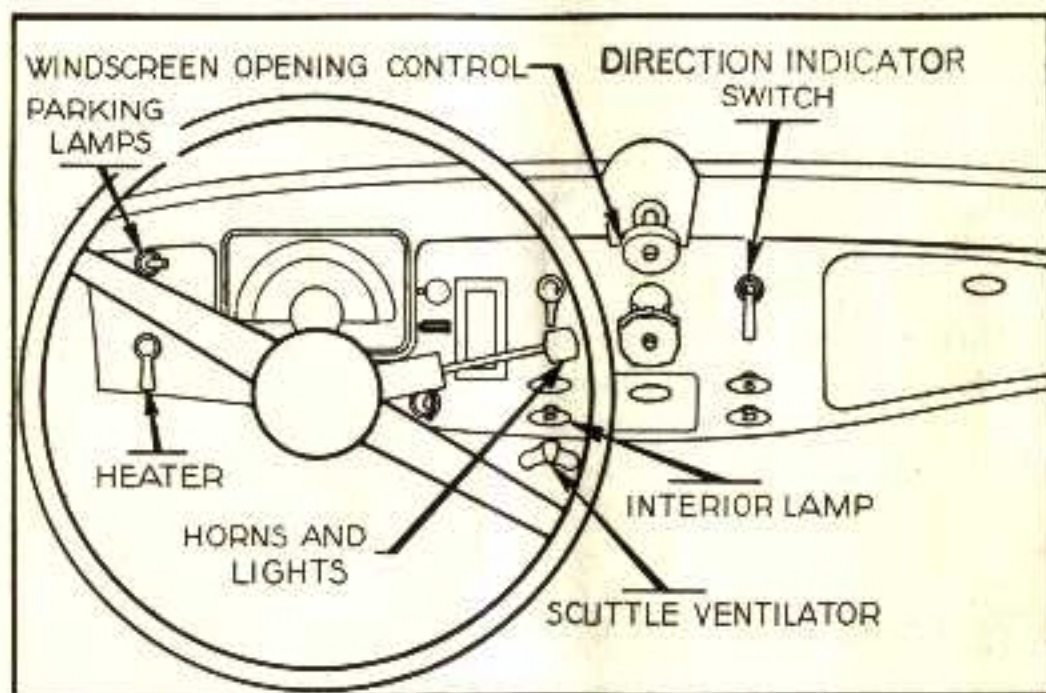

Fig. 10. — INSTRUMENT BOARD.

- b. The Scuttle Ventilator, by turning the Wing Nut.
- c. In very hot weather, the windscreen, the scuttle ventilator, and/or the door glasses (preferably at the front).

LUBRICATION

Choice of lubricants

Do not use just any oil, choose one of proven quality; do not mix makes and grades of oil. Your Citroen Agent will advise you as to the most suitable products.

S.A.E. classification

Instead of using letters, A, B, C, etc., or adjectives such as "thin", "light", or "heavy", to designate oils, there is a growing tendency among oil-suppliers to quote the international S.A.E. reference.

This reference concerns only one characteristic, namely viscosity, but does not imply any particular make or grade.

In observing our recommendations, the user will be sure of obtaining the lubricants best suited to his car.

Engine oil level and draining every 2,500 M

After a long journey check the engine oil level (fig. 1, page 5), top up if necessary with oil of the same make and grade as that which is already in the sump.

After 2,500 miles, drain the engine while it is hot. Remove the drain plug, let the oil run out and drain for 15 minutes, carefully replace and tighten the drain plug, refill with oil.

At all times use oil of viscosity S.A.E.20 for the engine.

GENERAL LUBRICATION

GREASE EVERY 1,000 MILES :
(use an adhesive grease).

The Front Suspension Ball Joints, 1 and 3 (fig. 11), 2 greasers on the R.H. side and 2 on the L.H. side.

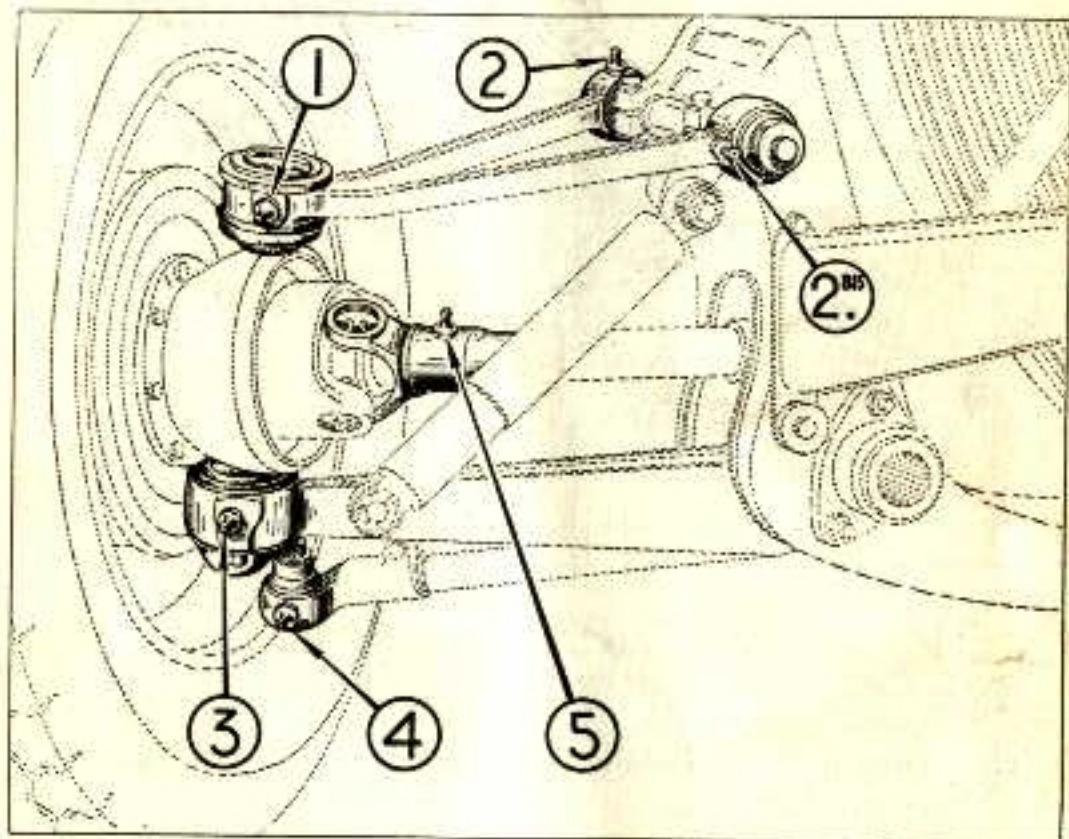

Fig. 11. — FRONT AXLE GREASERS.

The Track Rod Ball Joints, 4 (fig. 11). 1 greaser on the R.H. side, 1 on the L.H. side.

The Drive Shaft universal joints 5 (fig. 11), 1 greaser on the R.H. side, 1 on the L.H. side.

The Upper Link Arm Spindles, 2 and 2a (fig. 11), 2 greasers on the R.H. side, 2 on the L.H. side.

EVERY 1.000 MILES (continued)

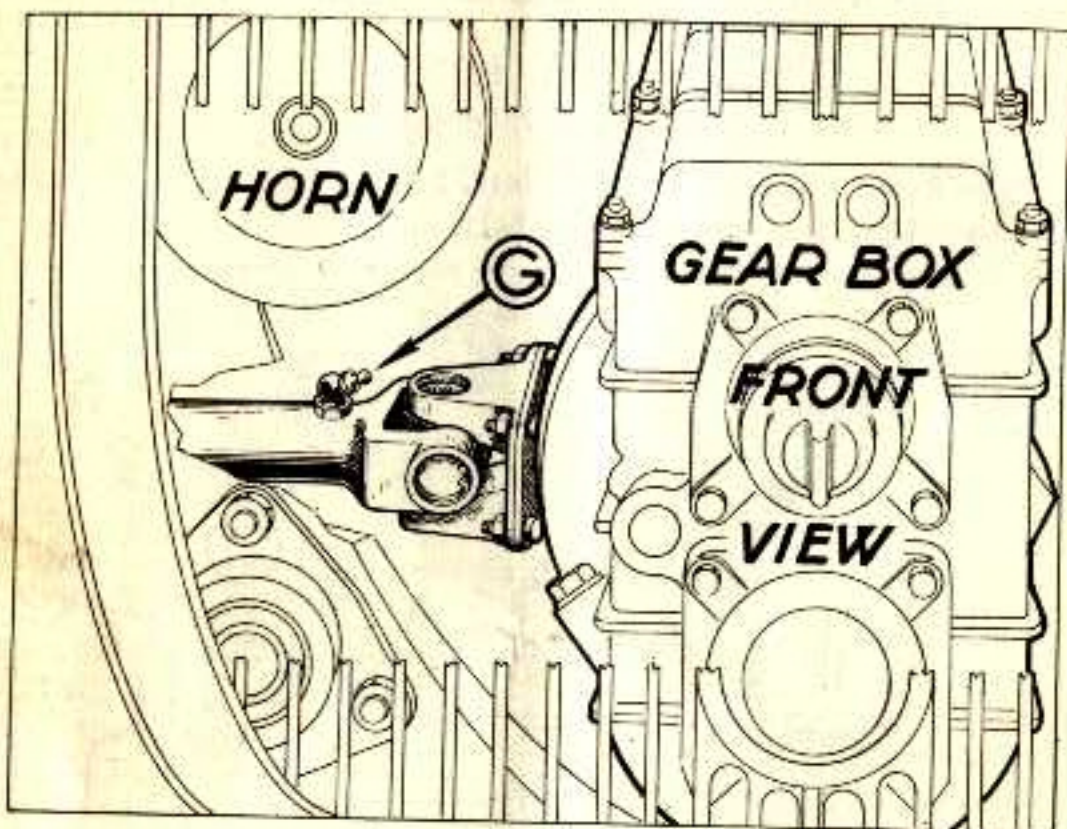

Fig. 12. — DRIVE SHAFT SPLINES (1).

The Drive Shaft Spindles, G (fig. 12), 1 greaser on the R.H. side, 1 on the L.H. side.

The Gear Selector Spindle, 1 (fig. 13).

The Fan Belt Drive Pulley Shaft, 3 (fig. 13).

The Fan Spindle Bearing at V (fig. 14).

(1) On the « Light 15 », this greaser points towards the wheel; to reach it under the wing, turn the wheel outwards to full lock. On the « Big 15 », the greaser is accessible from under the bonnet.

EVERY 1.000 MILES (continued)
with engine oil

The Clutch Thrust Race oiler at 2 (fig. 13).

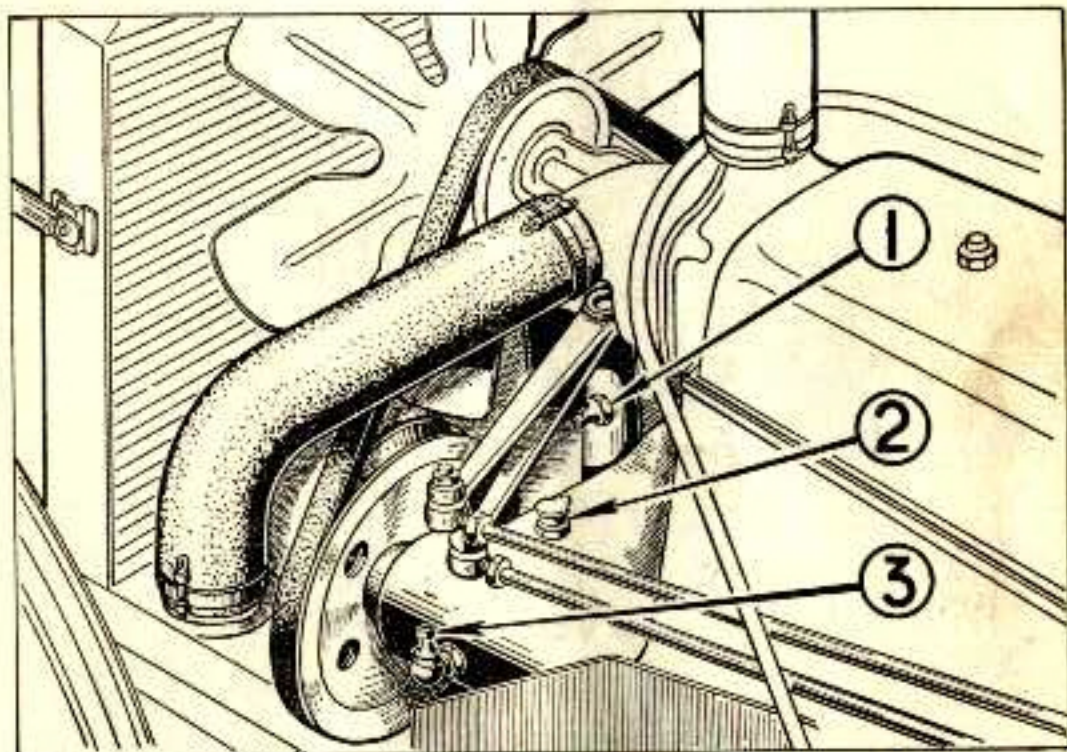

Fig. 13.

The Water Pump Spindle oiler at P (fig. 14).

The Gear Rod Ball Joints 1, 2, 3 and 4 (fig. 15).

Every 4,000 miles, 1 or 2 drops only in the oiler for the
Dynamo Spindle Bearing, D (fig. 14).

EVERY 1.000 MILES (the end)

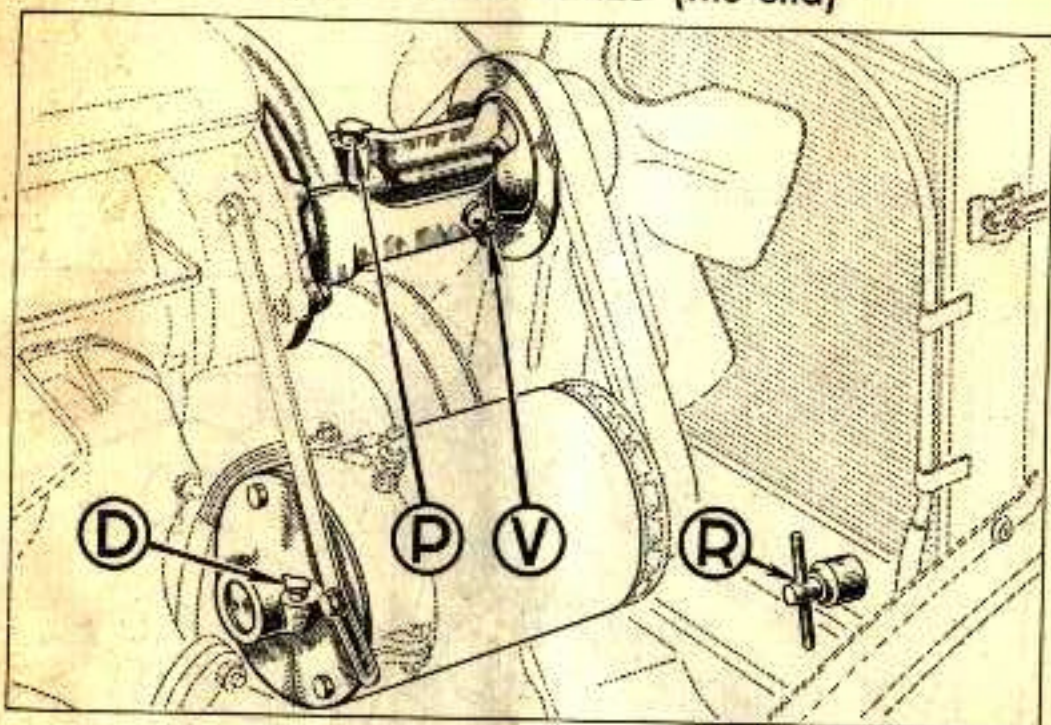

Fig. 14.

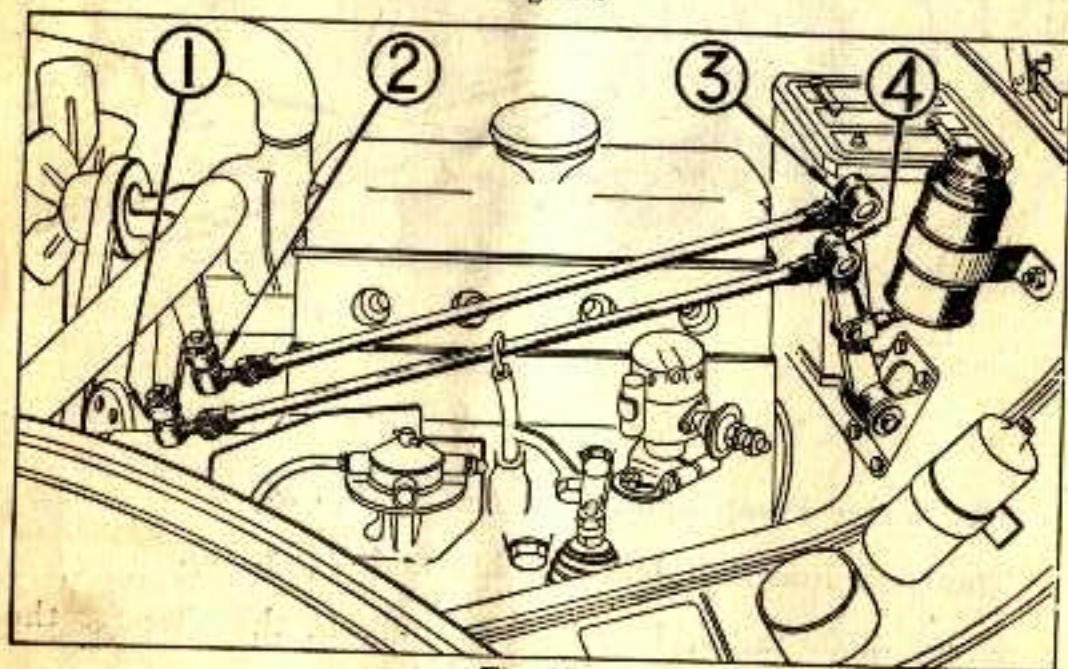

Fig. 15.

SPECIAL CHECKS

I. EVERY 4.000 MILES

Check the oil level in the gearbox; remove the Filler Plug R (fig. 16).

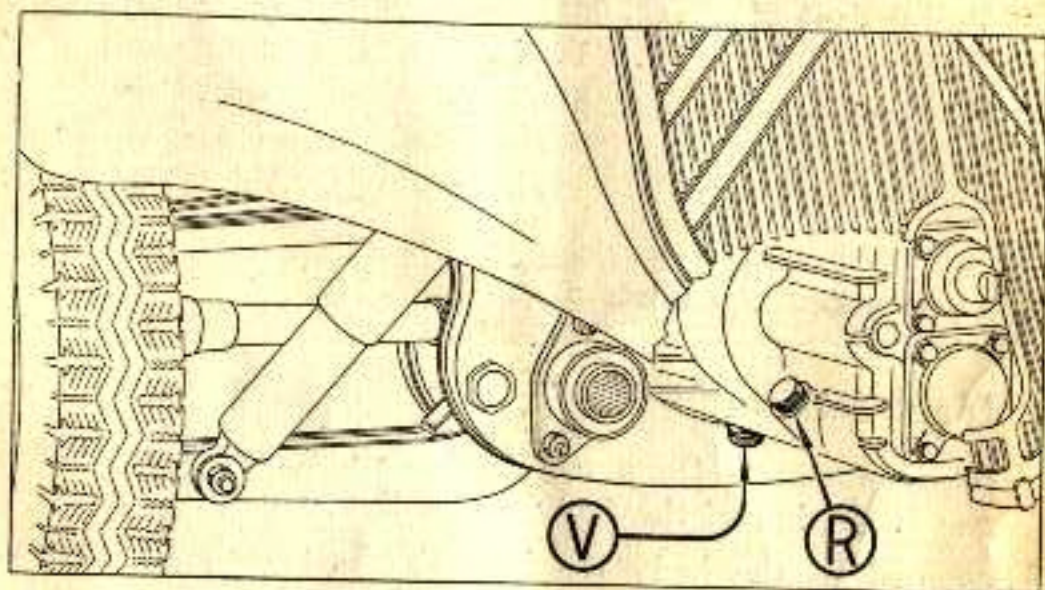

Fig. 16.

The oil should be level with the hole. Top up if necessary, using S.A.E.90 (Extreme Pressure) oil.

2. EVERY 12.000 MILES

Ask a Citroen Agent to :—

- a. — drain and refill the gearbox (Drain Plug V, fig. 16).
- b. — grease the steering, clutch cable, choke and starter cables, and speedometer cable.
- c. — check the Shock absorbers and their bushes.

GENERAL INFORMATION

1. Capacities

	Big 15	Light 15
Petrol Tank	11 gallons	11 gallons
Radiator	1 3/4 gallons	1 5/8 gallons
Gearbox	3 1/2 pints	3 1/2 pints
Sump.....	7 pints	7 pints
Hydraulic Brakes ...	1.4 pints	1.4 pints

2. Tyre sizes : « Pilote » 165×400

3. Identification

Chassis number.—On a rectangular aluminium plate fixed on the R.H. side of the body under the bonnet ;

Stamped on the body itself on the L.H. side under the bonnet.

Body Number.—On a small plate near the chassis number plate.

Engine Number.—On a rectangular aluminium plate on the R.H. side of the crankcase.

4. Overall dimensions

	Big 15	Light 15
Length	15'-3"	14'-7 1/4"
Width	5'-10 1/2"	5'-6 1/4"
Height (empty)	5'-0 3/4"	5'-0 3/4"

SUPPLEMENTARY INFORMATION

Our Spare Parts Dept., Citroen Cars Ltd., Slough, Bucks,
(England) can supply :

Spare Part Catalogue (in English) ;

Repair Manual (in English).

Our Spare Parts Dept., 23, rue Ernest-Cognacq, Levallois-
Perret (Seine), Paris (France), can supply :

Spare Part Catalogue (in French), *Catalogue P.D.* ;

Repair Manual (in French), *Dictionnaire de réparations* ;

Technical Handbook (in French), *Mémento technique*.