

2009 Pontiac Vibe Owner Manual

Seats and Restraints	1-1	Lighting	5-1	Jump Starting	9-71
Front Seats	1-2	Lighting	5-1	Towing	9-75
Rear Seats	1-7	Infotainment	6-1	Appearance Care	9-83
Safety Belts	1-8	Audio System(s)	6-1	Technical Data	10-1
Airbag System	1-21	Climate Controls	7-1	Vehicle Identification	10-1
Child Restraints	1-36	Climate Controls	7-1	Capacities and Specifications	10-2
Keys, Doors and Windows	2-1	Driving and Operating	8-1	Normal Maintenance Replacement Parts	10-4
Keys	2-2	Starting and Operating Your Vehicle	8-2	Service and Maintenance	11-1
Doors and Locks	2-6	Driving Your Vehicle	8-17	Service and Maintenance	11-1
Theft-Deterrent Systems	2-9	Fuel	8-36	Customer Information	12-1
Windows	2-12	Vehicle Service and Care	9-1	Customer Information	12-1
Mirrors	2-13	Service	9-2	Reporting Safety Defects	12-15
Sunroof	2-14	Owner Checks	9-5	Vehicle Data Recording and Privacy	12-17
Storage	3-1	Headlamp Aiming	9-30	Index	i-1
Storage	3-1	Bulb Replacement	9-31		
Instruments and Controls	4-1	Electrical System	9-35		
Instrument Panel Overview	4-2	Tires	9-41		
Warning Lights, Gages, and Indicators	4-11	Tire Changing	9-61		
OnStar® System	4-25				



GENERAL MOTORS, GM, the GM Emblem, PONTIAC, the PONTIAC Emblem and the name VIBE are registered trademarks of General Motors Corporation.

This manual includes the latest information at the time it was printed. GM reserves the right to make changes after that time without

further notice. For vehicles first sold in Canada, substitute the name "General Motors of Canada Limited" for Pontiac Division wherever it appears in this manual.

This manual describes features that may or may not be on your specific vehicle.

Read this manual from beginning to end to learn about the vehicle's features and controls. Pictures, symbols, and words work together to explain vehicle operation.

Keep this manual in the vehicle for quick reference.

Canadian Owners

A French language copy of this manual can be obtained from your dealer/retailer or from:

Helm, Incorporated
P.O. Box 07130
Detroit, MI 48207

1-800-551-4123
helminc.com

Propriétaires Canadiens

On peut obtenir un exemplaire de ce guide en français auprès de concessionnaire ou à l'adresse suivante:

Helm Incorporated
P.O. Box 07130
Detroit, MI 48207

1-800-551-4123
helminc.com

Index

To quickly locate information about the vehicle use the Index in the back of the manual. It is an alphabetical list of what is in the manual and the page number where it can be found.

Cautions and Notices



A circle with a slash through it is a safety symbol which means “Do Not,” “Do not do this” or “Do not let this happen.”

A box with the word CAUTION is used to tell about things that could hurt you or others if you were to ignore the warning.



These mean there is something that could hurt you or other people.

Cautions tell what the hazard is and what to do to avoid or reduce the hazard. Read these cautions.

A notice tells about something that can damage the vehicle.

Notice: These mean there is something that could damage your vehicle.

Many times, this damage would not be covered by the vehicle's warranty, and it could be costly. The notice tells what to do to help avoid the damage.

There are also warning labels on the vehicle which use the same words, CAUTION or Notice.

Seats and Restraints

Front Seats

Manual Seats	1-2
Seat Height Adjuster	1-2
Reclining Seatbacks	1-3
Passenger Folding Seatback	1-4
Head Restraints	1-6

Rear Seats

Rear Seat Operation	1-7
---------------------------	-----

Safety Belts

Safety Belts	1-8
How to Wear Safety Belts Properly	1-11
Lap-Shoulder Belt	1-16
Safety Belt Use During Pregnancy	1-19

Safety Belt Extender	1-19
Safety Belt Check	1-20
Care of Safety Belts	1-20
Replacing Safety Belt System Parts After a Crash	1-20

Airbag System

Airbag System	1-21
Where Are the Airbags?	1-23
When Should an Airbag Inflate?	1-24
What Makes an Airbag Inflate?	1-26
How Does an Airbag Restrain?	1-26
What Will You See After an Airbag Inflates?	1-26
Passenger Sensing System	1-28
Servicing Your Airbag-Equipped Vehicle	1-33

Adding Equipment to Your Airbag-Equipped Vehicle	1-34
Airbag System Check	1-35
Replacing Airbag System Parts After a Crash	1-35

Child Restraints

Older Children	1-36
Infants and Young Children	1-38
Child Restraint Systems	1-41
Where to Put the Restraint	1-43
Lower Anchors and Tethers for Children (LATCH)	1-44
Replacing LATCH System Parts After a Crash	1-49
Securing Child Restraints (Right Front Seat)	1-50
Securing Child Restraints (Rear Seats)	1-53

Front Seats

Manual Seats

CAUTION

You can lose control of the vehicle if you try to adjust a manual driver's seat while the vehicle is moving. The sudden movement could startle and confuse you, or make you push a pedal when you do not want to. Adjust the driver's seat only when the vehicle is not moving.

To move a manual seat forward or rearward:

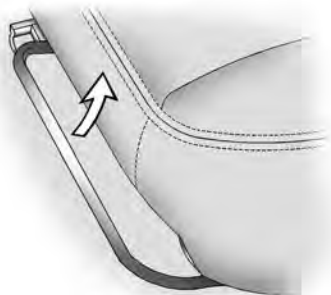

1. Lift the bar to unlock the seat.
2. Slide the seat to the desired position and release the bar.

Try to move the seat to be sure it is locked in place.

Seat Height Adjuster

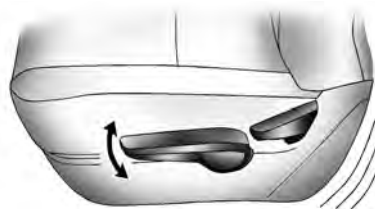

The driver seat height adjuster is located on the outboard side of the seat. To raise or lower the seat, pull up or push down on the lever repeatedly until the seat is at the desired height.

Reclining Seatbacks

CAUTION

You can lose control of the vehicle if you try to adjust a manual driver's seat while the vehicle is moving. The sudden movement could startle and confuse you, or make you push a pedal when you do not want to. Adjust the driver's seat only when the vehicle is not moving.

CAUTION

If the seatback is not locked, it could move forward in a sudden stop or crash. That could cause injury to the person sitting there. Always push and pull on the seatback to be sure it is locked.



CAUTION

Sitting in a reclined position when your vehicle is in motion can be dangerous. Even if you buckle up, your safety belts cannot do their job when you are reclined like this.

The shoulder belt cannot do its job because it will not be against your body. Instead, it will be in front of you. In a crash, you could go into it, receiving neck or other injuries.

The lap belt cannot do its job either. In a crash, the belt could go up over your abdomen. The belt forces would be there, not at your pelvic bones. This could cause serious internal injuries.

For proper protection when the vehicle is in motion, have the seatback upright. Then sit well back in the seat and wear your safety belt properly.

1-4 Seats and Restraints

On vehicles with manual reclining seatbacks the lever used to operate them is located on the outboard side of the seat.

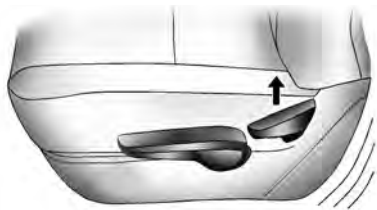

To recline the seatback:

1. Lift the recline lever.
2. Move the seatback to the desired position, then release the lever to lock the seatback in place.
3. Push and pull on the seatback to make sure it is locked.

To return the seatback to an upright position:

1. Lift the lever fully, without applying pressure to the seatback, and the seatback will return to the upright position.
2. Push and pull on the seatback to make sure it is locked.

Passenger Folding Seatback



If you fold the seatback forward to carry longer objects, such as skis, be sure any such cargo is not near an airbag. In a crash, an inflating airbag might force that object toward a person. This could cause severe injury or even death. Secure objects away from the area in which an airbag would inflate. For more information, see *Where Are the Airbags?* on page 1-23 and *Loading the Vehicle* on page 8-32.

CAUTION

Things you put on this seatback can strike and injure people in a sudden stop or turn, or in a crash. Remove or secure all items before driving.

On vehicles with this feature, the seatback folds down to allow for more cargo space. When the area is not being used for more cargo space or as a temporary table, put the seatback in the locked, upright position. Only adjust the seat when the vehicle is not moving.

To fold the seatback down:

1. Move the seat rearward.
2. Lower the head restraint to the lowest position and make sure the seatback is at the most upright position and locked.

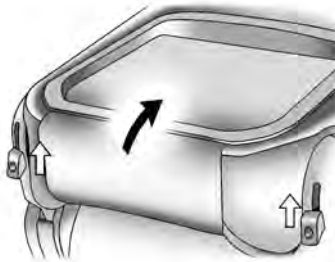

3. Pull up on one of the levers located on either side of the back of the passenger seatback.
4. Fold the seatback down.

To raise the seatback:

1. Pull up on one of the levers located on either side of the back of the passenger's seatback.
2. Pull the seatback up and push it back to lock it into place. Make sure the safety belt is not twisted or caught in the seatback.
3. Push and pull the top of the seatback to be sure it is locked into position.
4. Use the reclining front seatback lever to adjust the seatback to a comfortable position.

1-6 Seats and Restraints

Head Restraints

The front seats have adjustable head restraints. The rear seats have adjustable headrests in all seating positions.

CAUTION

With head restraints that are not installed and adjusted properly, there is a greater chance that occupants will suffer a neck/spinal injury in a crash. Do not drive until the head restraints for all occupants are installed and adjusted properly.



Adjust the head restraint so that the top of the restraint is at the same height as the top of the occupant's head. This position reduces the chance of a neck injury in a crash.

Pull the head restraint up to raise it.

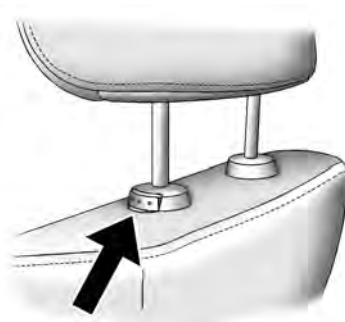

To lower the head restraint, press the button, located on the top of the seatback, and push the restraint down.

Push down on the head restraint after the button is released to make sure that it is locked in place.

The head restraints are not designed to be removed.

Always raise the rear center head rest at least one position when there is a passenger seated there.

Active Head Restraint System

The vehicle has an active head restraint system in the front seating positions. These automatically tilt forward to reduce the risk of neck injury if the vehicle is hit from behind.

Rear Seats

Rear Seat Operation

You can fold either side of the seatback down. The rear right side seatback can also be used as a temporary table while the vehicle is stopped.

CAUTION

A rear seatback folded forward, or any other object contacting or pressing the front seatback may affect the proper functioning of the passenger sensing system. See *Passenger Sensing System on page 1-28*.

To fold either seatback down:

1. Move the front seat forward and the seatback to the upright position.
2. Move the headrests all the way down.

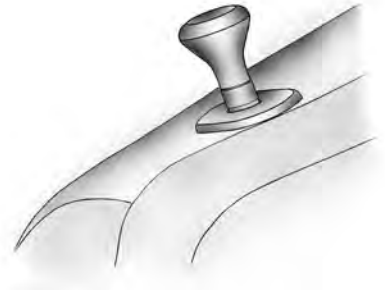

3. Pull up on the lock release knob, located on the top outboard side of the seatback.

Notice: Folding a rear seat with the safety belts still fastened may cause damage to the seat or the safety belts. Always unbuckle the safety belts and return them to their normal stowed position before folding a rear seat.

4. Fold the seatback down.

1-8 Seats and Restraints

To raise the seatback:

1. Pull the seatback up and push it back to lock it into place. The safety belts should not be twisted or caught in the seatback.

CAUTION

A safety belt that is improperly routed, not properly attached, or twisted will not provide the protection needed in a crash. The person wearing the belt could be seriously injured. After raising the rear seatback, always check to be sure that the safety belts are properly routed and attached, and are not twisted.

2. Push and pull the top of the seatback to check that it is locked into position.

CAUTION

If the seatback is not locked, it could move forward in a sudden stop or crash. That could cause injury to the person sitting there. Always push and pull on the seatback to be sure it is locked.

Safety Belts

This section of the manual describes how to use safety belts properly. It also describes some things not to do with safety belts.

CAUTION

Do not let anyone ride where a safety belt cannot be worn properly. In a crash, if you or your passenger(s) are not wearing safety belts, the injuries can be much worse. You can hit things inside the vehicle harder or be ejected from the vehicle. You and your passenger(s) can be seriously injured or killed. In the same crash, you might not be, if you are buckled up. Always fasten your safety belt, and check that your passenger(s) are restrained properly too.

⚠ CAUTION

It is extremely dangerous to ride in a cargo area, inside or outside of a vehicle. In a collision, people riding in these areas are more likely to be seriously injured or killed. Do not allow people to ride in any area of your vehicle that is not equipped with seats and safety belts. Be sure everyone in your vehicle is in a seat and using a safety belt properly.

This vehicle has indicators as a reminder to buckle the safety belts. See *Safety Belt Reminders on page 4-14* for additional information.

In most states and in all Canadian provinces, the law requires wearing safety belts. Here is why:

You never know if you will be in a crash. If you do have a crash, you do not know if it will be a serious one.

A few crashes are mild, and some crashes can be so serious that even buckled up, a person would not survive. But most crashes are in between. In many of them, people who buckle up can survive and sometimes walk away. Without safety belts they could have been badly hurt or killed.

After more than 40 years of safety belts in vehicles, the facts are clear. In most crashes buckling up does matter... a lot!

Why Safety Belts Work

When you ride in or on anything, you go as fast as it goes.

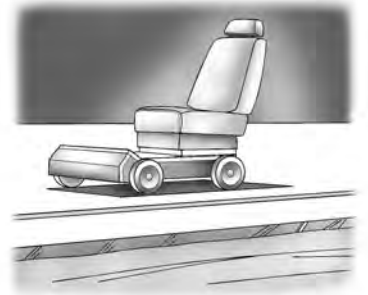

Take the simplest vehicle. Suppose it is just a seat on wheels.

1-10 Seats and Restraints



Put someone on it.



Get it up to speed. Then stop the vehicle. The rider does not stop.



The person keeps going until stopped by something. In a real vehicle, it could be the windshield...

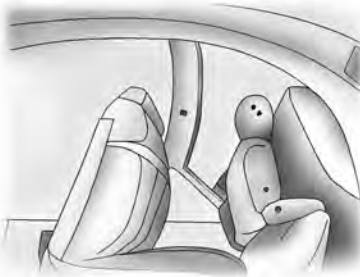

or the instrument panel...



or the safety belts!

With safety belts, you slow down as the vehicle does. You get more time to stop. You stop over more distance, and your strongest bones take the forces. That is why safety belts make such good sense.

Questions and Answers About Safety Belts

Q: Will I be trapped in the vehicle after a crash if I am wearing a safety belt?

A: You *could* be — whether you are wearing a safety belt or not. But your chance of being conscious during and after an accident, so you *can* unbuckle and get out, is *much* greater if you are belted. And you can unbuckle a safety belt, even if you are upside down.

Q: If my vehicle has airbags, why should I have to wear safety belts?

A: Airbags are supplemental systems only; so they work *with* safety belts — not instead of them. Whether or not an airbag is provided, all occupants still have to buckle up to get the most protection. That is true not only in frontal collisions, but especially in side and other collisions.

Q: If I am a good driver, and I never drive far from home, why should I wear safety belts?

A: You may be an excellent driver, but if you are in a crash — even one that is not your fault — you and your passenger(s) can be hurt. Being a good driver does not protect you from things beyond your control, such as bad drivers.

Most accidents occur within 25 miles (40 km) of home. And the greatest number of serious injuries and deaths occur at speeds of less than 40 mph (65 km/h).

Safety belts are for everyone.

How to Wear Safety Belts Properly

This section is only for people of adult size.

Be aware that there are special things to know about safety belts and children. And there are different rules for smaller children and infants. If a child will be riding in the vehicle, see *Older Children on page 1-36* or *Infants and Young Children on page 1-38*. Follow those rules for everyone's protection.

It is very important for all occupants to buckle up. Statistics show that unbelted people are hurt more often in crashes than those who are wearing safety belts.

Occupants who are not buckled up can be thrown out of the vehicle in a crash. And they can strike others in the vehicle who are wearing safety belts.

1-12 Seats and Restraints

First, before you or your passenger(s) wear a safety belt, there is important information you should know.

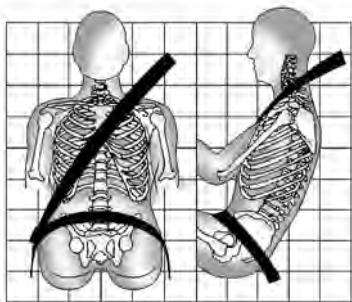

Sit up straight and always keep your feet on the floor in front of you. The lap part of the belt should be

worn low and snug on the hips, just touching the thighs. In a crash, this applies force to the strong pelvic bones and you would be less likely to slide under the lap belt. If you slid under it, the belt would apply force on your abdomen. This could cause serious or even fatal injuries. The shoulder belt should go over the shoulder and across the chest. These parts of the body are best able to take belt restraining forces.

The shoulder belt locks if there is a sudden stop or crash.

Q: What is wrong with this?

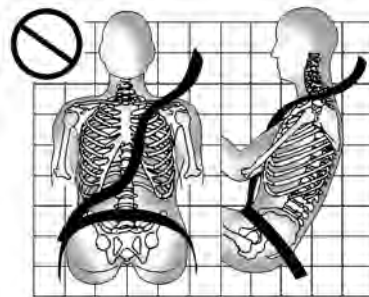

A: The shoulder belt is too loose. It will not give as much protection this way.

CAUTION

You can be seriously hurt if your shoulder belt is too loose. In a crash, you would move forward too much, which could increase injury. The shoulder belt should fit snugly against your body.

Q: What is wrong with this?

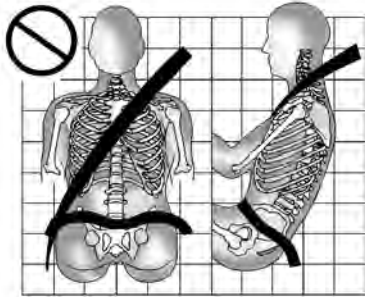

A: The lap belt is too loose. It will not give nearly as much protection this way.

⚠ CAUTION

You can be seriously hurt if your lap belt is too loose. In a crash, you could slide under the lap belt and apply force on your abdomen. This could cause serious or even fatal injuries. The lap belt should be worn low and snug on the hips, just touching the thighs.

Q: What is wrong with this?

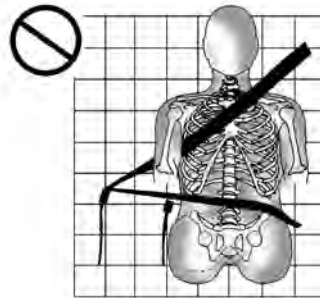

A: The belt is buckled in the wrong buckle.

⚠ CAUTION

You can be seriously injured if your belt is buckled in the wrong place like this. In a crash, the belt would go up over your abdomen. The belt forces would be there, not on the pelvic bones. This could cause serious internal injuries. Always buckle your belt into the buckle nearest you.

1-14 Seats and Restraints

Q: What is wrong with this?

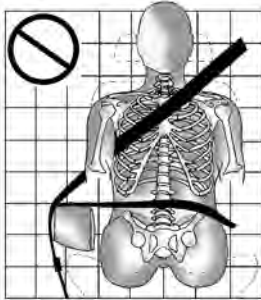

A: The belt is over an armrest.

CAUTION

You can be seriously injured if your belt goes over an armrest like this. The belt would be much too high. In a crash, you can slide under the belt. The belt force would then be applied on the abdomen, not on the pelvic bones, and that could cause serious or fatal injuries. Be sure the belt goes under the armrests.

Q: What is wrong with this?

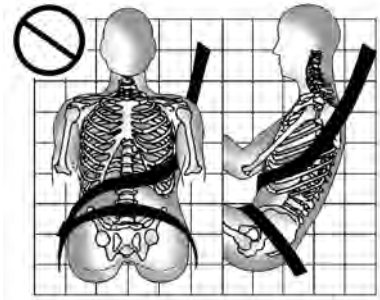

A: The shoulder belt is worn under the arm. It should be worn over the shoulder at all times.

⚠ CAUTION

You can be seriously injured if you wear the shoulder belt under your arm. In a crash, your body would move too far forward, which would increase the chance of head and neck injury. Also, the belt would apply too much force to the ribs, which are not as strong as shoulder bones. You could also severely injure internal organs like your liver or spleen. The shoulder belt should go over the shoulder and across the chest.

Q: What is wrong with this?

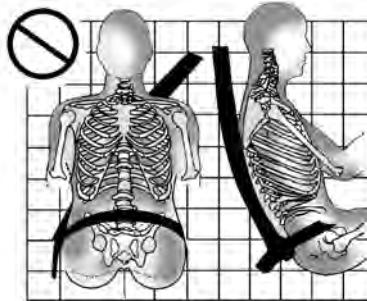

A: The belt is behind the body.

⚠ CAUTION

You can be seriously injured by not wearing the lap-shoulder belt properly. In a crash, you would not be restrained by the shoulder belt. Your body could move too far forward increasing the chance of head and neck injury. You might also slide under the lap belt. The belt force would then be applied right on the abdomen. That could cause serious or fatal injuries. The shoulder belt should go over the shoulder and across the chest.

Q: What is wrong with this?

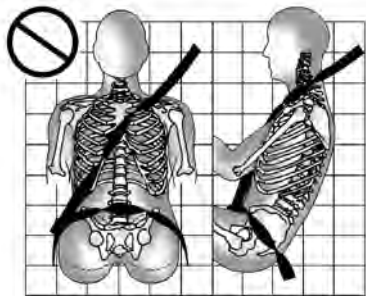

A: The belt is twisted across the body.

CAUTION

You can be seriously injured by a twisted belt. In a crash, you would not have the full width of the belt to spread impact forces. If a belt is twisted, make it straight so it can work properly, or ask your dealer/retailer to fix it.

Lap-Shoulder Belt

All seating positions in the vehicle have a lap-shoulder belt.

The following instructions explain how to wear a lap-shoulder belt properly.

1. Adjust the seat so you can sit up straight. To see how, see “Seats” in the Index.



2. Pick up the latch plate and pull the belt across you. Do not let it get twisted.

The lap-shoulder belt may lock if you pull the belt across you very quickly. If this happens, let the belt go back slightly to unlock it. Then pull the belt across you more slowly.

If the shoulder portion of a passenger belt is pulled out all the way, the child restraint locking feature may be engaged. If this happens, let the belt go back all the way and start again.



3. Push the latch plate into the buckle until it clicks.

If the latch plate will not go fully into the buckle, check if the correct buckle is being used.

Pull up on the latch plate to make sure it is secure. If the belt is not long enough, see *Safety Belt Extender on page 1-19*.

Position the release button on the buckle so that the safety belt could be quickly unbuckled if necessary.

4. If equipped with a shoulder belt height adjuster, move it to the height that is right for you. See “Shoulder Belt Height Adjustment” later in this section for instructions on use and important safety information.
5. To make the lap part tight, pull up on the shoulder belt.

It may be necessary to pull stitching on the safety belt through the latch plate to fully tighten the lap belt on smaller occupants.



To unlatch the belt, push the button on the buckle. The belt should return to its stowed position.

Before a door is closed, be sure the safety belt is out of the way. If a door is slammed against a safety belt, damage can occur to both the safety belt and the vehicle.

Shoulder Belt Height Adjuster

The vehicle has a shoulder belt height adjuster for the driver and right front passenger seating positions.

1-18 Seats and Restraints

Adjust the height so that the shoulder portion of the belt is centered on the shoulder. The belt should be away from the face and neck, but not falling off of the shoulder. Improper shoulder belt height adjustment could reduce the effectiveness of the safety belt in a crash.



Push down on the release button and move the height adjuster to the desired position. The adjuster can be moved up by pushing on the front of the height adjuster.

After the adjuster is set to the desired position, try to move it down without pushing the button to make sure it has locked into position.

Safety Belt Pretensioners

This vehicle has safety belt pretensioners for the front outboard occupants. Although the safety belt pretensioners cannot be seen, they are part of the safety belt assembly. They can help tighten the safety belts during the early stages of a moderate to severe frontal and near frontal crash if the threshold conditions for pretensioner activation are met. And, if the vehicle has side impact airbags, safety belt pretensioners can help tighten the safety belts in a side crash.

If the passenger sensing system detects that there is not a passenger in the right front passenger position, the safety belt pretensioner for that position will not activate. See *Passenger Sensing System on page 1-28*.

Pretensioners work only once. If the pretensioners activate in a crash, they will need to be replaced, and probably other new parts for your safety belt system. See *Replacing Safety Belt System Parts After a Crash on page 1-20*.

Safety Belt Use During Pregnancy

Safety belts work for everyone, including pregnant women. Like all occupants, they are more likely to be seriously injured if they do not wear safety belts.

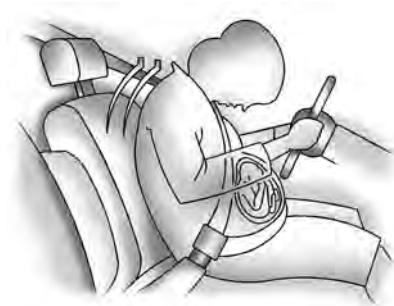

A pregnant woman should wear a lap-shoulder belt, and the lap portion should be worn as low as possible, below the rounding, throughout the pregnancy.

The best way to protect the fetus is to protect the mother. When a safety belt is worn properly, it is more likely that the fetus will not be hurt in a crash. For pregnant women, as for anyone, the key to making safety belts effective is wearing them properly.

Safety Belt Extender

If the vehicle's safety belt will fasten around you, you should use it.

But if a safety belt is not long enough, your dealer/retailer will order you an extender. When you go in to order it, take the heaviest coat you will wear, so the extender will be long enough for you. To help avoid personal injury, do not let someone else use it, and use it only for the seat it is made to fit. The extender has been designed for adults. Never use it for securing child seats. To wear it, just attach it to the regular safety belt. For more information, see the instruction sheet that comes with the extender.

When a safety belt extender is installed in the right front passenger safety belt, make sure the passenger airbag status indicator displays ON. See *Passenger Airbag Status Indicator* on page 4-15. If the indicator shows OFF, disconnect the extender's latch from the buckle then reconnect the safety belt. The passenger airbag status indicator light should be ON and then the safety belt extender can be reconnected. If the safety belt extender is used while the passenger airbag status indicator light is OFF, the right front passenger frontal and seat-mounted side impact airbags (if equipped) may not activate correctly.

Always disconnect the extender from the safety belt after you use it so that the airbag will work properly the next time someone uses that seat.

Safety Belt Check

Now and then, check the safety belt reminder light, safety belts, buckles, latch plates, retractors and anchorages are working properly. Look for any other loose or damaged safety belt system parts that might keep a safety belt system from doing its job. See your dealer/retailer to have it repaired. Torn or frayed safety belts may not protect you in a crash. They can rip apart under impact forces. If a belt is torn or frayed, get a new one right away.

Make sure the safety belt reminder light is working. See *Safety Belt Reminders on page 4-14* for more information.

Keep safety belts clean and dry. See *Care of Safety Belts on page 1-20*.

Care of Safety Belts

Keep belts clean and dry.

CAUTION

Do not bleach or dye safety belts. If you do, it may severely weaken them. In a crash, they might not be able to provide adequate protection. Clean safety belts only with mild soap and lukewarm water.

Replacing Safety Belt System Parts After a Crash

CAUTION

A crash can damage the safety belt system in the vehicle. A damaged safety belt system may not properly protect the person using it, resulting in serious injury or even death in a crash. To help make sure the safety belt systems are working properly after a crash, have them inspected and any necessary replacements made as soon as possible.

After a minor crash, replacement of safety belts may not be necessary. But the safety belt assemblies that were used during any crash may have been stressed or damaged. See your dealer/retailer to have the safety belt assemblies inspected or replaced.

New parts and repairs may be necessary even if the safety belt system was not being used at the time of the crash.

Have the safety belt pretensioners checked if the vehicle has been in a crash, or if the airbag readiness light stays on after you start the vehicle or while you are driving. See *Airbag Readiness Light* on page 4-14.

Airbag System

This vehicle has the following airbags:

- A frontal airbag for the driver.
- A frontal airbag for the right front passenger.

The vehicle may have the following airbags:

- A seat-mounted side impact airbag for the driver.
- A seat-mounted side impact airbag for the right front passenger.
- A roof-rail airbag for the driver and the passenger seated directly behind the driver.
- A roof-rail airbag for the right front passenger and the passenger seated directly behind the right front passenger.

All of the airbags in the vehicle will have the word AIRBAG embossed in the trim or on an attached label near the deployment opening.

For frontal airbags, the word AIRBAG will appear on the middle part of the steering wheel for the driver and on the instrument panel for the right front passenger.

With seat-mounted side impact airbags, the word AIRBAG will appear on the side of the seatback closest to the door.

With roof-rail airbags, the word AIRBAG will appear along the headliner or trim.

Airbags are designed to supplement the protection provided by safety belts. Even though today's airbags are also designed to help reduce the risk of injury from the force of an inflating bag, all airbags must inflate very quickly to do their job.

1-22 Seats and Restraints

Here are the most important things to know about the airbag system:

CAUTION

You can be severely injured or killed in a crash if you are not wearing your safety belt — even if you have airbags. Airbags are designed to work with safety belts, but do not replace them.

Also, airbags are not designed to deploy in every crash. In some crashes safety belts are your only restraint. See *When Should an Airbag Inflate?* on page 1-24.

Wearing your safety belt during a crash helps reduce your chance of hitting things inside the vehicle or being ejected from it. Airbags are “supplemental restraints” to the safety belts. Everyone in your vehicle should wear a safety belt properly — whether or not there is an airbag for that person.

CAUTION

Airbags inflate with great force, faster than the blink of an eye. Anyone who is up against, or very close to, any airbag when it inflates can be seriously injured or killed. Do not sit unnecessarily close to the airbag, as you would be if you were sitting on the edge of your seat or leaning forward. Safety belts help keep you in position before and during a crash. Always wear your safety belt, even with airbags. The driver should sit as far back as possible while still maintaining control of the vehicle.

Occupants should not lean on or sleep against the door or side windows in seating positions with seat-mounted side impact airbags and/or roof-rail airbags.

CAUTION

Children who are up against, or very close to, any airbag when it inflates can be seriously injured or killed. Airbags plus lap-shoulder belts offer protection for adults and older children, but not for young children and infants. Neither the vehicle’s safety belt system nor its airbag system is designed for them. Young children and infants need the protection that a child restraint system can provide. Always secure children properly in your vehicle. To read how, see *Older Children* on page 1-36 or *Infants and Young Children* on page 1-38.

There is an airbag readiness light on the instrument panel cluster, which shows the airbag symbol. The system checks the airbag electrical system for malfunctions. The light tells you if there is an electrical problem. See *Airbag Readiness Light* on page 4-14 for more information.

Where Are the Airbags?

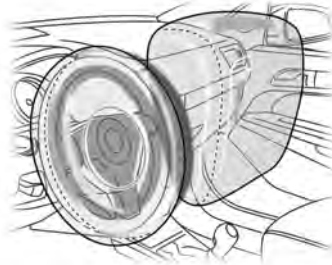

The driver frontal airbag is in the middle of the steering wheel.

The right front passenger frontal airbag is in the instrument panel on the passenger's side.



Driver Side shown, Passenger Side similar

If the vehicle has seat-mounted side impact airbags for the driver and right front passenger, they are in the side of the seatbacks closest to the door.

1-24 Seats and Restraints

If the vehicle has roof-rail airbags for the driver, right front passenger, and second row outboard passengers, they are in the ceiling above the side windows.

CAUTION

If something is between an occupant and an airbag, the airbag might not inflate properly or it might force the object into that person causing severe injury or even death. The path of an inflating airbag must be kept clear. Do not put anything between an occupant and an airbag, and do not attach or put anything on the steering wheel hub or on or near any other airbag covering.

(Continued)

CAUTION (Continued)

Do not use seat accessories that block the inflation path of a seat-mounted side impact airbag.

Never secure anything to the roof of a vehicle with roof-rail airbags by routing a rope or tie down through any door or window opening. If you do, the path of an inflating roof-rail airbag will be blocked.

When Should an Airbag Inflate?

Frontal airbags are designed to inflate in moderate to severe frontal or near-frontal crashes to help reduce the potential for severe injuries mainly to the driver or right front passenger head and chest. However, they are only designed to inflate if the impact exceeds a

predetermined deployment threshold. Deployment thresholds are used to predict how severe a crash is likely to be in time for the airbags to inflate and help restrain the occupants.

Whether the frontal airbags will or should deploy is not based on how fast the vehicle is traveling. It depends largely on what you hit, the direction of the impact, and how quickly your vehicle slows down.

Frontal airbags may inflate at different crash speeds. For example:

- If the vehicle hits a stationary object, the airbags could inflate at a different crash speed than if the vehicle hits a moving object.
- If the vehicle hits an object that deforms, the airbags could inflate at a different crash speed than if the vehicle hits an object that does not deform.

- If the vehicle hits a narrow object (like a pole), the airbags could inflate at a different crash speed than if the vehicle hits a wide object (like a wall).
- If the vehicle goes into an object at an angle, the airbags could inflate at a different crash speed than if the vehicle goes straight into the object.

Thresholds can also vary with specific vehicle design.

Frontal airbags are not intended to inflate during vehicle rollovers, rear impacts, or in many side impacts. Frontal airbags for the driver and right front passenger may also deploy if a serious impact occurs to the underside of the vehicle such as hitting a curb, falling into a deep hole, or landing hard.

In addition, the vehicle has dual-stage frontal airbags. Dual-stage airbags adjust the restraint according to crash severity.

The vehicle has electronic frontal sensors, which help the sensing system distinguish between a moderate frontal impact and a more severe frontal impact. For moderate frontal impacts, dual-stage airbags inflate at a level less than full deployment. For more severe frontal impacts, full deployment occurs.

The vehicle may have seat-mounted side impact and roof-rail airbags. See *Airbag System on page 1-21*. Seat-mounted side impact and roof-rail airbags are intended to inflate in moderate to severe side crashes. Seat-mounted side impact and roof-rail airbags will inflate if the crash severity is above the system's designed threshold level. Your vehicle has sensors which detect side impacts. These sensors signal the appropriate side impact airbag to inflate. The threshold level can vary with specific vehicle design.

Seat-mounted side impact and roof-rail airbags are not intended to inflate in frontal impacts, near-frontal impacts, rollovers, or rear impacts. A seat-mounted side impact airbag is intended to deploy on the side of the vehicle that is struck. A roof-rail airbag is intended to deploy on the side of the vehicle that is struck. It is possible that, in a crash involving the rear side of your vehicle, that only the roof-mounted airbag will deploy.

In any particular crash, no one can say whether an airbag should have inflated simply because of the damage to a vehicle or because of what the repair costs were. For frontal airbags, inflation is determined by what the vehicle hits, the angle of the impact, and how quickly the vehicle slows down. For seat-mounted side impact and roof-rail airbags, deployment is determined by the location and severity of the side impact.

What Makes an Airbag Inflate?

In a deployment event, the sensing system sends an electrical signal triggering a release of gas from the inflator. Gas from the inflator fills the airbag causing the bag to break out of the cover and deploy. The inflator, the airbag, and related hardware are all part of the airbag module.

Frontal airbag modules are located inside the steering wheel and instrument panel. For vehicles with seat-mounted side impact airbags, there are airbag modules in the side of the front seatbacks closest to the door. For vehicles with roof-rail airbags, there are airbag modules in the ceiling of the vehicle, near the side windows that have occupant seating positions.

How Does an Airbag Restrain?

In moderate to severe frontal or near frontal collisions, even belted occupants can contact the steering wheel or the instrument panel. In moderate to severe side collisions, even belted occupants can contact the inside of the vehicle.

Airbags supplement the protection provided by safety belts. Frontal airbags distribute the force of the impact more evenly over the occupant's upper body, stopping the occupant more gradually. Seat-mounted side impact and roof-rail airbags distribute the force of the impact more evenly over the occupant's upper body.

But airbags would not help in many types of collisions, primarily because the occupant's motion is not toward those airbags. See *When Should an Airbag Inflate?* on page 1-24 for more information.

Airbags should never be regarded as anything more than a supplement to safety belts.

What Will You See After an Airbag Inflates?

After the frontal airbags and seat-mounted side impact airbags inflate, they quickly deflate, so quickly that some people may not even realize an airbag inflated. Roof-rail airbags may still be at least partially inflated for some time after they deploy. Some components of the airbag module may be hot for several minutes. For location of the airbag modules, see *What Makes an Airbag Inflate?* on page 1-26.

The parts of the airbag that come into contact with you may be warm, but not too hot to touch. There may be some smoke and dust coming from the vents in the deflated airbags. Airbag inflation does not prevent the driver from seeing out of the windshield or being able to steer the vehicle, nor does it prevent people from leaving the vehicle.

 **CAUTION**

When an airbag inflates, there may be dust in the air. This dust could cause breathing problems for people with a history of asthma or other breathing trouble. To avoid this, everyone in the vehicle should get out as soon as it is safe to do so. If you have

(Continued)

CAUTION (Continued)

breathing problems but cannot get out of the vehicle after an airbag inflates, then get fresh air by opening a window or a door. If you experience breathing problems following an airbag deployment, you should seek medical attention.

The vehicle has a feature that may automatically unlock the doors, turn the interior lamps on, and turn the hazard warning flashers on when the airbags inflate. You can lock the doors, turn the interior lamps off, and turn the hazard warning flashers off by using the controls for those features.

In many crashes severe enough to inflate the airbag, windshields are broken by vehicle deformation.

Additional windshield breakage may also occur from the right front passenger airbag.

- Airbags are designed to inflate only once. After an airbag inflates, you will need some new parts for the airbag system. If you do not get them, the airbag system will not be there to help protect you in another crash. A new system will include airbag modules and possibly other parts. The service manual for your vehicle covers the need to replace other parts.
- The vehicle has a crash sensing and diagnostic module which records information after a crash. See *Vehicle Data Recording and Privacy on page 12-17* and *Event Data Recorders on page 12-17*.
- Let only qualified technicians work on the airbag systems. Improper service can mean that an airbag system will not work properly. See your dealer/retailer for service.

Passenger Sensing System

The vehicle has a passenger sensing system for the right front passenger position. The passenger airbag status indicator will be visible in the instrument panel when the vehicle is started.



The words ON and OFF will be visible during the system check. When the system check is complete, either the word ON or the word OFF will be visible depending on

whether the seat is occupied and/or the weight of the occupant. If the seat is unoccupied, the light will not be visible after the system check. See *Passenger Airbag Status Indicator* on page 4-15.

The passenger sensing system will turn off the right front passenger frontal airbag and seat-mounted side impact airbag under certain conditions. The driver airbags and the roof-rail airbags are not affected by the passenger sensing system.

The passenger sensing system will also turn off the right front passenger frontal airbag, seat-mounted side impact airbag (if equipped), and safety belt pretensioner if it detects that there is no occupant in that position.

The passenger sensing system works with sensors that are part of the right front passenger seat. The sensors are designed to detect

the presence of a properly-seated occupant and determine if the right front passenger frontal airbag and seat-mounted side impact airbag (if equipped) should be enabled (may inflate) or not.

According to accident statistics, children and infants are safer when properly restrained in a child restraint system or infant restraint system secured in a rear seating position.

We recommend that children be secured in a rear seat, including: an infant or a child riding in a rear-facing child restraint; a child riding in a forward-facing child seat; an older child riding in a booster seat; and children, who are large enough, using safety belts.

A label on the sun visor says, "Never put a rear-facing child seat in the front." This is because the risk to the rear-facing child is so great, if the airbag deploys.

 **CAUTION**

A child in a rear-facing child restraint can be seriously injured or killed if the right front passenger airbag inflates. This is because the back of the rear-facing child restraint would be very close to the inflating airbag. A child in a forward-facing child restraint can be seriously injured or killed if the right front passenger airbag inflates and the passenger seat is in a forward position.

Even if the passenger sensing system has turned off the right front passenger frontal airbag and seat-mounted side impact airbag (if equipped), no system is fail-safe. No one can guarantee

(Continued)

CAUTION (Continued)

that an airbag will not deploy under some unusual circumstance, even though the airbag(s) are off.

Secure rear-facing child restraints in a rear seat, even if the airbag(s) are off. If you secure a forward-facing child restraint in the right front seat, always move the front passenger seat as far back as it will go. It is better to secure the child restraint in a rear seat.

The passenger sensing system is designed to turn off the right front passenger frontal airbag and seat-mounted side impact airbag (if equipped) if:

- The right front passenger seat is unoccupied.
- The system determines that an infant is present in a rear-facing infant seat.

- The system determines that a small child is present in a child restraint.
- The system determines that a small child is present in a booster seat.
- A right front passenger takes his/her weight off of the seat for a period of time.
- The right front passenger seat is occupied by a smaller person, such as a child who has outgrown child restraints.
- Or, if there is a critical problem with the airbag system or the passenger sensing system.

1-30 Seats and Restraints

When the passenger sensing system has turned off the right front passenger frontal airbag and seat-mounted side impact airbag (if equipped), the off indicator will light and stay lit to remind you that the airbags are off. See *Passenger Airbag Status Indicator* on page 4-15.

The passenger sensing system is designed to turn on (may inflate) the right front passenger frontal airbag and seat-mounted side impact airbag (if equipped) anytime the system senses that a person of adult size is sitting properly in the right front passenger seat.

When the passenger sensing system has allowed the airbags and pretensioner to be enabled, the on indicator will light and stay lit to remind you that the airbags and pretensioner are active.

For some children who have outgrown child restraints and for very small adults, the passenger sensing system may or may not turn off the right front passenger frontal airbag and seat-mounted side impact airbag (if equipped), depending upon the person's seating posture and body build. Everyone in the vehicle who has outgrown child restraints should wear a safety belt properly — whether or not there is an airbag for that person.

If the airbag readiness light and the OFF light in the passenger airbag status indicator come on together, it may mean there is a malfunction in the passenger sensing system. Secure the child in the child restraint in a rear seat position in the vehicle and check with your dealer/retailer.

CAUTION

If the airbag readiness light in the instrument panel cluster ever comes on and stays on, it means that something may be wrong with the airbag system. If this ever happens, have the vehicle serviced promptly, because an adult-size person sitting in the right front passenger's seat may not have the protection of the airbag(s). See *Airbag Readiness Light* on page 4-14 for more on this, including important safety information.

If the On Indicator is Lit for a Child Restraint

If a child restraint has been installed and the on indicator is lit:

1. Turn the vehicle off.
2. Remove the child restraint from the vehicle.
3. Remove any additional items from the seat such as blankets, cushions, seat covers, seat heaters, or seat massagers.
4. Reinstall the child restraint with the ignition key in the ACC or LOCK position while following the directions provided by the child restraint manufacturer and refer to *Securing Child Restraints (Right Front Seat)* on page 1-50 or *Securing Child Restraints (Rear Seats)* on page 1-53.

5. If, after reinstalling the child restraint and restarting the vehicle, the on indicator is still lit, turn the vehicle off. Then slightly recline the vehicle seatback and adjust the seat cushion, if adjustable, to make sure that the vehicle seatback is not pushing the child restraint into the seat cushion.
6. Also make sure the child restraint is not trapped under the vehicle head restraint. If this happens, adjust the head restraint. See *Head Restraints* on page 1-6.

If the on indicator is still lit, secure the child in the child restraint in a rear seat position in the vehicle, and check with your dealer/retailer.

If the Off Indicator is Lit for an Adult-Size Occupant



If a person of adult-size is sitting in the right front passenger seat, but the off indicator is lit, it could be because that person is not sitting properly in the seat.

1-32 Seats and Restraints

If this happens, use the following steps to allow the system to detect that person and enable the right front passenger frontal airbag and seat-mounted side impact airbag (if equipped):

1. Turn the vehicle off.
2. Remove any additional material from the seat, such as blankets, cushions, seat covers, seat heaters, or seat massagers.
3. Place the seatback in the fully upright position.
4. Have the person sit upright in the seat, centered on the seat cushion, with legs comfortably extended.
5. Restart the vehicle and have the person remain in this position for two to three minutes after the on indicator is lit.

Additional Factors Affecting System Operation

Safety belts help keep the passenger in position on the seat during vehicle maneuvers and braking, which helps the passenger sensing system maintain the passenger airbag status. See “Safety Belts” and “Child Restraints” in the Index for additional information about the importance of proper restraint use.

A thick layer of additional material, such as a blanket or cushion, or aftermarket equipment such as seat covers, seat heaters, seat backpacks, and seat massagers can affect how well the passenger sensing system operates. We recommend that you not use seat covers or other aftermarket equipment except when approved by GM for your specific vehicle. See *Adding Equipment to Your Airbag-Equipped Vehicle on page 1-34* for more information about modifications that can affect how the system operates.

The passenger sensing system may suppress the airbag deployment when liquid soaks into the seat. If this happens, the off indicator in the passenger airbag status indicator and the airbag readiness light will be lit. Have your dealer/retailer check the system.

An object, person or child in the rear seat contacting or pressing the right front passenger seatback, or objects stowed under the right front passenger seat, may affect the proper functioning of the passenger sensing system.

When a safety belt extender is used in the right front passenger seat, make sure the passenger airbag status indicator shows ON. If the indicator shows OFF, disconnect the extender's latch from the buckle then reconnect the safety belt.

The passenger airbag status indicator light should be ON and then the safety belt extender can be reconnected. If the safety belt extender is used while the passenger airbag status indicator light is OFF, the right front passenger frontal and seat-mounted side impact airbags (if equipped) may not activate correctly.

 **CAUTION**

Stowing of articles under the passenger seat or between the passenger seat cushion and seatback may interfere with the proper operation of the passenger sensing system.

Servicing Your Airbag-Equipped Vehicle

Airbags affect how the vehicle should be serviced. There are parts of the airbag system in several places around the vehicle. Your dealer/retailer and the service manual have information about servicing the vehicle and the airbag system. To purchase a service manual, see *Service Publications Ordering Information on page 12-16*.

 **CAUTION**

For up to 10 seconds after the ignition is turned off and the battery is disconnected, an airbag can still inflate during improper service. You can be injured if you are close to an airbag when it inflates. Avoid yellow connectors. They are probably part of the airbag system. Be sure to follow proper service procedures, and make sure the person performing work for you is qualified to do so.

Adding Equipment to Your Airbag-Equipped Vehicle

Q: Is there anything I might add to or change about the vehicle that could keep the airbags from working properly?

A: Yes. If you add things that change the vehicle's frame, bumper system, height, front end or side sheet metal, they may keep the airbag system from working properly. Changing or moving any parts of the front seats, safety belts, the airbag sensing and diagnostic module, steering wheel, instrument panel, roof-rail airbag modules, ceiling headliner or pillar garnish trim, front sensors, or airbag wiring can affect the operation of the airbag system.

In addition, the vehicle has a passenger sensing system for the right front passenger position, which includes sensors that are part of the passenger's seat.

The passenger sensing system may not operate properly if the original seat trim is replaced with non-GM covers, upholstery or trim, or with GM covers, upholstery or trim designed for a different vehicle. Any object, such as an aftermarket seat heater or a comfort enhancing pad or device, installed under or on top of the seat fabric, could also interfere with the operation of the passenger sensing system.

This could either prevent proper deployment of the passenger airbag(s) or prevent the passenger sensing system from properly turning off the passenger airbag(s). See *Passenger Sensing System on page 1-28*.

If you have any questions, call Customer Assistance. The phone numbers and addresses for Customer Assistance are in Step Two of the Customer Satisfaction Procedure in this manual. See *Customer Satisfaction Procedure on page 12-1*.

Q: Because I have a disability, I have to get my vehicle modified. How can I find out whether this will affect my airbag system?

A: If you have questions, call Customer Assistance. The phone numbers and addresses for Customer Assistance are in Step Two of the Customer Satisfaction Procedure in this manual. See *Customer Satisfaction Procedure on page 12-1*.

In addition, your dealer/retailer and the service manual have information about the location of the airbag sensors, sensing and diagnostic module and airbag wiring.

Airbag System Check

The airbag system does not need regularly scheduled maintenance or replacement. Make sure the airbag readiness light is working. See *Airbag Readiness Light* on page 4-14 for more information.

Notice: If an airbag covering is damaged, opened, or broken, the airbag may not work properly. Do not open or break the airbag coverings. If there are any opened or broken airbag covers, have the airbag covering and/or airbag module replaced. For the location of the airbag modules, see *What Makes an Airbag Inflate?* on page 1-26. See your dealer/retailer for service.

Replacing Airbag System Parts After a Crash

CAUTION

A crash can damage the airbag systems in your vehicle. A damaged airbag system may not work properly and may not protect you and your passenger(s) in a crash, resulting in serious injury or even death. To help make sure your airbag systems are working properly after a crash, have them inspected and any necessary replacements made as soon as possible.

If an airbag inflates, you will need to replace airbag system parts. See your dealer/retailer for service.

If the airbag readiness light stays on after the vehicle is started or comes on when you are driving, the airbag system may not work properly. Have the vehicle serviced right away. See *Airbag Readiness Light* on page 4-14 for more information.

Child Restraints

Older Children



Older children who have outgrown booster seats should wear the vehicle's safety belts.

The manufacturer's instructions that come with the booster seat, state the weight and height limitations for that

booster. Use a booster seat with a lap-shoulder belt until the child passes the below fit test:

- Sit all the way back on the seat. Do the knees bend at the seat edge? If yes, continue. If no, return to the booster seat.
- Buckle the lap-shoulder belt. Does the shoulder belt rest on the shoulder? If yes, continue. If no, then return to the booster seat.
- Does the lap belt fit low and snug on the hips, touching the thighs? If yes, continue. If no, return to the booster seat.
- Can proper safety belt fit be maintained for the length of the trip? If yes, continue. If no, return to the booster seat.

Q: What is the proper way to wear safety belts?

A: An older child should wear a lap-shoulder belt and get the additional restraint a shoulder belt can provide. The shoulder belt should not cross the face or neck. The lap belt should fit snugly below the hips, just touching the top of the thighs. This applies belt force to the child's pelvic bones in a crash. It should never be worn over the abdomen, which could cause severe or even fatal internal injuries in a crash.

According to accident statistics, children and infants are safer when properly restrained in a child restraint system or infant restraint system secured in a rear seating position.

In a crash, children who are not buckled up can strike other people who are buckled up, or can be thrown out of the vehicle. Older children need to use safety belts properly.

⚠ CAUTION

Never do this.

Never allow two children to wear the same safety belt. The safety belt can not properly spread the impact forces. In a crash, the two children can be crushed together and seriously injured. A safety belt must be used by only one person at a time.



⚠ CAUTION

Never do this.

Never allow a child to wear the safety belt with the shoulder belt behind their back. A child can be seriously injured by not wearing the lap-shoulder belt properly. In a crash, the child would not be restrained by the shoulder belt.

(Continued)

CAUTION (Continued)

The child could move too far forward increasing the chance of head and neck injury. The child might also slide under the lap belt. The belt force would then be applied right on the abdomen. That could cause serious or fatal injuries. The shoulder belt should go over the shoulder and across the chest.



Infants and Young Children

Everyone in a vehicle needs protection! This includes infants and all other children. Neither the distance traveled nor the age and size of the traveler changes the need, for everyone, to use safety restraints. In fact, the law in every state in the United States and in every Canadian province says children up to some age must be restrained while in a vehicle.

CAUTION

Children can be seriously injured or strangled if a shoulder belt is wrapped around their neck and the safety belt continues to tighten. Never leave children unattended in a vehicle and never allow children to play with the safety belts.

Airbags plus lap-shoulder belts offer protection for adults and older children, but not for young children and infants. Neither the vehicle's safety belt system nor its airbag system is designed for them.

Every time infants and young children ride in vehicles, they should have the protection provided by appropriate child restraints. Every time infants and young children ride in vehicles, they should have the protection provided by appropriate child restraints.

Children who are not restrained properly can strike other people, or can be thrown out of the vehicle.

⚠ CAUTION

Never do this.

Never hold an infant or a child while riding in a vehicle. Due to crash forces, an infant or a child will become so heavy it is not possible to hold it during a crash. For example, in a crash at only 25 mph (40 km/h), a 12 lb (5.5 kg) infant will suddenly become a 240 lb (110 kg) force on a person's arms. An infant should be secured in an appropriate restraint.



⚠ CAUTION

Never do this.

Children who are up against, or very close to, any airbag when it inflates can be seriously injured or killed. Never put a rear-facing child restraint in the right front seat. Secure a rear-facing child

(Continued)

CAUTION (Continued)

restraint in a rear seat. It is also better to secure a forward-facing child restraint in a rear seat. If you must secure a forward-facing child restraint in the right front seat, always move the front passenger seat as far back as it will go.



1-40 Seats and Restraints

Q: What are the different types of add-on child restraints?

A: Add-on child restraints, which are purchased by the vehicle's owner, are available in four basic types. Selection of a particular restraint should take into consideration not only the child's weight, height, and age but also whether or not the restraint will be compatible with the motor vehicle in which it will be used.

For most basic types of child restraints, there are many different models available. When purchasing a child restraint, be sure it is designed to be used in a motor vehicle. If it is, the restraint will have a label saying that it meets federal motor vehicle safety standards.

The restraint manufacturer's instructions that come with the restraint state the weight and height limitations for a particular child restraint. In addition, there are many kinds of restraints available for children with special needs.

 **CAUTION**

To reduce the risk of neck and head injury during a crash, infants need complete support. This is because an infant's neck is not fully developed and its head weighs so much compared with the rest of its body. In a crash, an infant in a rear-facing child restraint settles into the restraint, so the crash forces can be distributed across the strongest part of an infant's body, the back and shoulders. Infants should always be secured in rear-facing child restraints.

 **CAUTION**

A young child's hip bones are still so small that the vehicle's regular safety belt may not remain low on the hip bones, as it should. Instead, it may settle up around the child's abdomen. In a crash, the belt would apply force on a body area that is unprotected by any bony structure. This alone could cause serious or fatal injuries. To reduce the risk of serious or fatal injuries during a crash, young children should always be secured in appropriate child restraints.

Child Restraint Systems



(A) Rear-Facing Infant Seat

A rear-facing infant seat (A) provides restraint with the seating surface against the back of the infant.

The harness system holds the infant in place and, in a crash, acts to keep the infant positioned in the restraint.



(B) Forward-Facing Child Seat

A forward-facing child seat (B) provides restraint for the child's body with the harness.

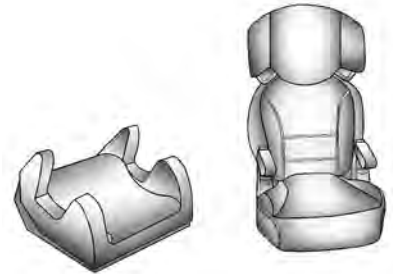

(C) Booster Seats

A booster seat (C) is a child restraint designed to improve the fit of the vehicle's safety belt system. A booster seat can also help a child to see out the window.

1-42 Seats and Restraints

Securing an Add-On Child Restraint in the Vehicle

 **CAUTION**

A child can be seriously injured or killed in a crash if the child restraint is not properly secured in the vehicle. Secure the child restraint properly in the vehicle using the vehicle's safety belt or LATCH system, following the instructions that came with that child restraint and the instructions in this manual.

To help reduce the chance of injury, the child restraint must be secured in the vehicle. Child restraint systems must be secured in vehicle seats by lap belts or the lap belt portion of a lap-shoulder belt, or by the LATCH system. See *Lower Anchors and Tethers for Children (LATCH)* on page 1-44 for more information. A child can be endangered in a crash if the child restraint is not properly secured in the vehicle.

When securing an add-on child restraint, refer to the instructions that come with the restraint which may be on the restraint itself or in a booklet, or both, and to this manual. The child restraint instructions are important, so if they are not available, obtain a replacement copy from the manufacturer.

Keep in mind that an unsecured child restraint can move around in a collision or sudden stop and injure people in the vehicle. Be sure to properly secure any child restraint in the vehicle — even when no child is in it.

Securing the Child Within the Child Restraint

 **CAUTION**

A child can be seriously injured or killed in a crash if the child is not properly secured in the child restraint. Secure the child properly following the instructions that came with that child restraint.

Where to Put the Restraint

According to accident statistics, children and infants are safer when properly restrained in a child restraint system or infant restraint system secured in a rear seating position.

We recommend that children and child restraints be secured in a rear seat, including: an infant or a child riding in a rear-facing child restraint; a child riding in a forward-facing child seat; an older child riding in a booster seat; and children, who are large enough, using safety belts.

A label on the sun visor says, "Never put a rear-facing child restraint in the front." This is because the risk to the rear-facing child is so great, if the airbag deploys.

CAUTION

A child in a rear-facing child restraint can be seriously injured or killed if the right front passenger airbag inflates. This is because the back of the rear-facing child restraint would be very close to the inflating airbag. A child in a forward-facing child restraint can be seriously injured or killed if the right front passenger airbag inflates and the passenger seat is in a forward position.

Even if the passenger sensing system has turned off the right front passenger frontal airbag, no system is fail-safe. No one can guarantee that an airbag will not deploy under some unusual circumstance, even though it is turned off.

(Continued)

CAUTION (Continued)

Secure rear-facing child restraints in a rear seat, even if the airbag is off. If you secure a forward-facing child restraint in the right front seat, always move the front passenger seat as far back as it will go. It is better to secure the child restraint in a rear seat.

See *Passenger Sensing System* on page 1-28 for additional information.

When securing a child restraint in a rear seating position, study the instructions that came with the child restraint to make sure it is compatible with this vehicle.

Wherever a child restraint is installed, be sure to secure the child restraint properly.

1-44 Seats and Restraints

Keep in mind that an unsecured child restraint can move around in a collision or sudden stop and injure people in the vehicle. Be sure to properly secure any child restraint in the vehicle — even when no child is in it.

Lower Anchors and Tethers for Children (LATCH)

The LATCH system holds a child restraint during driving or in a crash. This system is designed to make installation of a child restraint easier. The LATCH system uses anchors in the vehicle and attachments on the child restraint that are made for use with the LATCH system.

Make sure that a LATCH-compatible child restraint is properly installed using the anchors, or use the vehicle's safety belts to secure the restraint, following the instructions that came with that restraint, and also the instructions in this manual. When installing a child restraint with a top tether, you must also use either the lower anchors or the safety belts to properly secure the child restraint. A child restraint must never be installed using only the top tether and anchor.

In order to use the LATCH system in the vehicle, you need a child restraint has LATCH attachments. The child restraint manufacturer provides instructions on how to use the child restraint and its attachments. The following explains how to attach a child restraint with these attachments in the vehicle.

Not all vehicle seating positions or child restraints have lower anchors and attachments or top tether anchors and attachments.

Lower Anchors

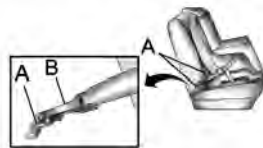

Lower anchors (A) are metal bars built into the vehicle. There are two lower anchors for each LATCH seating position that will accommodate a child restraint with lower attachments (B).

Top Tether Anchor

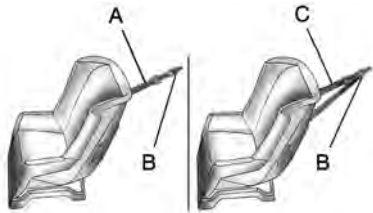

A top tether (A, C) anchors the top of the child restraint to the vehicle. A top tether anchor is built into the vehicle. The top tether attachment (B) on the child restraint connects to the top tether anchor in the vehicle in order to reduce the forward movement and rotation of the child restraint during driving or in a crash.

The child restraint may have a single tether (A) or a dual tether (C). Either will have a single attachment (B) to secure the top tether to the anchor.

Some child restraints with top tethers are designed for use with or without the top tether being attached. Others require the top tether always to be attached. In Canada, the law requires that forward-facing child restraints have a top tether, and that the tether be attached. Be sure to read and follow the instructions for the child restraint.

If the child restraint does not have a top tether, one can be obtained, in kit form, for many child restraints. Ask the child restraint manufacturer whether or not a kit is available.

Lower Anchor and Top Tether Anchor Locations

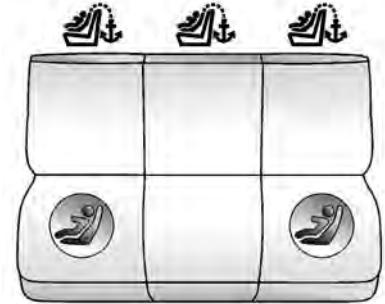

Rear Seat

 (Top Tether Anchor): Seating positions with top tether anchors.

 (Lower Anchor): Seating positions with two lower anchors.



To assist you in locating the lower anchors, each seating position with lower anchors has two labels, near the crease between the seatback and the seat cushion.



To assist you in locating the top tether anchors, the top tether anchor symbol is located on the cover.

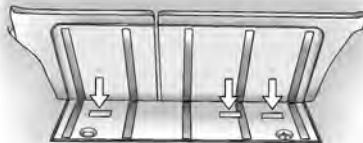

The top tether anchors are located on the floor of the rear cargo area. Open the cover to access the anchors. If the vehicle has a cargo mat, you may need to fold it back to access the top tether anchors. Be sure to use an anchor located on the same side of the vehicle as the seating position where the child restraint will be placed.

Do not secure a child restraint in a position without a top tether anchor if a national or local law requires that the top tether be attached, or if the instructions that come with the child restraint say that the top tether must be attached.

Accident statistics show that children are safer if they are restrained in the rear rather than the front seat. See *Where to Put the Restraint* on page 1-43 for additional information.

Securing a Child Restraint Designed for the LATCH System

CAUTION

If a LATCH-type child restraint is not attached to anchors, the child restraint will not be able to protect the child correctly. In a crash, the child could be seriously injured or killed. Install a LATCH-type child restraint properly using the anchors, or use the vehicle's safety belts to secure the restraint, following the instructions that came with the child restraint and the instructions in this manual.

 **CAUTION**

Do not attach more than one child restraint to a single anchor. Attaching more than one child restraint to a single anchor could cause the anchor or attachment to come loose or even break during a crash. A child or others could be injured. To reduce the risk of serious or fatal injuries during a crash, attach only one child restraint per anchor.

 **CAUTION**

Children can be seriously injured or strangled if a shoulder belt is wrapped around their neck and the safety belt continues to tighten. Buckle any unused safety belts behind the child restraint so children cannot reach them. Pull the shoulder belt all the way out of the retractor to set the lock, if your vehicle has one, after the child restraint has been installed.

Notice: Do not let the LATCH attachments rub against the vehicle's safety belts. This may damage these parts. If necessary, move buckled safety belts to avoid rubbing the LATCH attachments.

Do not fold the empty rear seat with a safety belt buckled. This could damage the safety belt or the seat. Unbuckle and return the safety belt to its stowed position.

1. Attach and tighten the lower attachments to the lower anchors. If the child restraint does not have lower attachments or the desired seating position does not have lower anchors, secure the child restraint with the top tether and the safety belts. Refer to the child restraint manufacturer instructions and the instructions in this manual.
 - 1.1. Find the lower anchors for the desired seating position.
 - 1.2. Put the child restraint on the seat.
 - 1.3. Attach and tighten the lower attachments on the child restraint to the lower anchors.

1-48 Seats and Restraints

2. If the child restraint manufacturer recommends that the top tether be attached, attach and tighten the top tether to the top tether anchor, if equipped. Refer to the child restraint instructions and the following steps:

- 2.1. Find the top tether anchor.
- 2.2. If the vehicle has a cargo mat, you may need to fold it back to access the top tether anchors.
- 2.3. Open the top tether anchor cover to expose the anchor.

2.4. Route, attach, and tighten the top tether according to the child restraint instructions and the following instructions:



If the position you are using does not have a headrest or head restraint and you are using a single tether, route the tether over the seatback.



If the position you are using does not have a headrest or head restraint and you are using a dual tether, route the tether over the seatback.



If the position you are using has an adjustable headrest or head restraint and you are using a dual tether, route the tether around the headrest or head restraint.



If the position you are using has an adjustable headrest or head restraint and you are using a single tether, raise the headrest or head restraint and route the tether under the headrest or head restraint and in between the headrest or head restraint posts.

3. Push and pull the child restraint in different directions to be sure it is secure.

Replacing LATCH System Parts After a Crash

CAUTION

A crash can damage the LATCH system in the vehicle. A damaged LATCH system may not properly secure the child restraint, resulting in serious injury or even death in a crash. To help make sure the LATCH system is working properly after a crash, see your dealer/retailer to have the system inspected and any necessary replacements made as soon as possible.

If the vehicle has the LATCH system and it was being used during a crash, new LATCH system parts may be needed.

1-50 Seats and Restraints

New parts and repairs may be necessary even if the LATCH system was not being used at the time of the crash.

Securing Child Restraints (Right Front Seat)

This vehicle has airbags. A rear seat is a safer place to secure a forward-facing child restraint. See *Where to Put the Restraint* on page 1-43.

In addition, your vehicle has a passenger sensing system which is designed to turn off the right front passenger frontal and seat-mounted side impact airbag under certain conditions. See *Passenger Sensing System* on page 1-28 and *Passenger Airbag Status Indicator* on page 4-15 for more information, including important safety information.

A label on the sun visor says, "Never put a rear-facing child seat in the front." This is because the risk to the rear-facing child is so great, if the airbag deploys.

CAUTION

A child in a rear-facing child restraint can be seriously injured or killed if the right front passenger airbag inflates. This is because the back of the rear-facing child restraint would be very close to the inflating airbag. A child in a forward-facing child restraint can be seriously injured or killed if the right front passenger airbag inflates and the passenger seat is in a forward position.

(Continued)

CAUTION (Continued)

Even if the passenger sensing system has turned off the right front passenger frontal airbag, no system is fail-safe. No one can guarantee that an airbag will not deploy under some unusual circumstance, even though it is turned off.

Secure rear-facing child restraints in a rear seat, even if the airbag is off. If you secure a forward-facing child restraint in the right front seat, always move the front passenger seat as far back as it will go. It is better to secure the child restraint in a rear seat.

See *Passenger Sensing System* on page 1-28 for additional information.

If the child restraint has the LATCH system, see *Lower Anchors and Tethers for Children (LATCH)* on page 1-44 for how to install the child restraint using LATCH. If a child restraint is secured in the seating position using a safety belt and it uses a top tether, see *Lower Anchors and Tethers for Children (LATCH)* on page 1-44 for top tether anchor locations.

Do not secure a child seat in a position without a top tether anchor if a national or local law requires that the top tether be anchored, or if the instructions that come with the child restraint say that the top strap must be anchored.

In Canada, the law requires that forward-facing child restraints have a top tether, and that the tether be attached.

You will be using the lap-shoulder belt to secure the child restraint in this position. Follow the instructions that came with the child restraint.

1. Move the seat as far back as it will go before securing the forward-facing child restraint.

When the passenger sensing system has turned off the right front passenger frontal and seat-mounted side impact airbag, the off indicator on the passenger airbag status indicator should light and stay lit when you start the vehicle. See *Passenger Airbag Status Indicator* on page 4-15.

2. Put the child restraint on the seat.
3. Pick up the latch plate, and run the lap and shoulder portions of the vehicle's safety belt through or around the restraint. The child restraint instructions will show you how.



4. Push the latch plate into the buckle until it clicks. Position the release button on the buckle so that the safety belt could be quickly unbuckled if necessary.

1-52 Seats and Restraints



5. Pull the rest of the shoulder belt all the way out of the retractor to set the lock.



6. To tighten the belt, push down on the child restraint, pull the shoulder portion of the belt to tighten the lap portion of the belt and feed the shoulder belt back into the retractor. When installing a forward-facing child restraint, it may be helpful to use your knee to push down on the child restraint as you tighten the belt.
7. Push and pull the child restraint in different directions to be sure it is secure.

If the airbags are off, the off indicator in the passenger airbag status indicator will come on and stay on when the vehicle is started.

If a child restraint has been installed and the on indicator is lit, see "If the On Indicator is Lit for a Child Restraint" under *Passenger Sensing System* on page 1-28 for more information.

To remove the child restraint, unbuckle the vehicle safety belt and let it return to the stowed position.

Securing Child Restraints (Rear Seats)

When securing a child restraint in a rear seating position, study the instructions that came with the child restraint to make sure it is compatible with this vehicle.

If the child restraint has the LATCH system, see *Lower Anchors and Tethers for Children (LATCH)* on page 1-44 for how to install the child restraint using LATCH. If a child restraint is secured in a seating position using a safety belt and it uses a top tether, see *Lower Anchors and Tethers for Children (LATCH)* on page 1-44 for top tether anchor locations.

Do not secure a child restraint in a position without a top tether anchor if a national or local law requires that the top tether be anchored, or if the instructions that come with the child restraint say that the top strap must be anchored.

In Canada, the law requires that forward-facing child restraints have a top tether, and that the tether be attached.

If the child restraint does not have the LATCH system, you will be using the safety belt to secure the child restraint in this position. Be sure to follow the instructions that came with the child restraint. Secure the child in the child restraint when and as the instructions say.

If more than one child restraint needs to be installed in the rear seat, be sure to read *Where to Put the Restraint* on page 1-43.

1. Put the child restraint on the seat.
2. Pick up the latch plate, and run the lap and shoulder portions of the vehicle's safety belt through or around the restraint. The child restraint instructions will show you how.

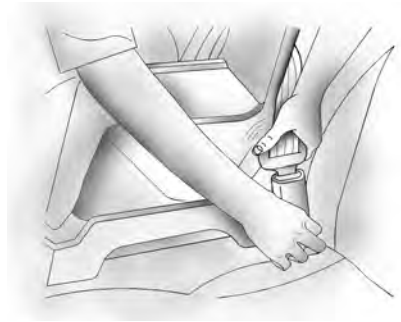

3. Push the latch plate into the buckle until it clicks. If the latch plate will not go fully into the buckle, check if the correct buckle is being used. Position the release button on the buckle so that the safety belt could be quickly unbuckled if necessary.

1-54 Seats and Restraints



4. Pull the rest of the shoulder belt all the way out of the retractor to set the lock.



5. To tighten the belt, push down on the child restraint, pull the shoulder portion of the belt to tighten the lap portion of the belt, and feed the shoulder belt back into the retractor. When installing a forward-facing child restraint, it may be helpful to use your knee to push down on the child restraint as you tighten the belt.

6. If the child restraint has a top tether, follow the child restraint manufacturer's instructions regarding the use of the top tether. See *Lower Anchors and Tethers for Children (LATCH)* on page 1-44 for more information.
7. Push and pull the child restraint in different directions to be sure it is secure.

To remove the child restraint, unbuckle the vehicle safety belt and let it return to the stowed position. If the top tether is attached to a top tether anchor, disconnect it.

Keys, Doors and Windows

Keys

Keys2-2
Remote Keyless Entry
(RKE) System2-3
Remote Keyless Entry
(RKE) System Operation2-4

Doors and Locks

Door Locks2-6
Power Door Locks2-7
Rear Door Security Locks2-7
Liftgate2-8

Theft-Deterrent Systems

Theft-Deterrent Systems2-9
Immobilizer2-9
Immobilizer Operation2-9
Content Theft-Deterrent2-10

Windows

Windows2-12
Power Windows2-12
Sun Visors2-13

Mirrors

Manual Rearview Mirror2-13
Outside Power Mirror(s)2-14

Sunroof

Sunroof2-14

2-2 Keys, Doors and Windows

Keys

CAUTION

Leaving children in a vehicle with the ignition key is dangerous for many reasons, children or others could be badly injured or even killed. They could operate the power windows or other controls or even make the vehicle move. The windows will function with the keys in the ignition and children could be seriously injured or killed if caught in the path of a closing window. Do not leave the keys in a vehicle with children.



The key is used for the ignition, doors, and all other locks.

The key number is on the tag attached to the key ring. Keep this tag and give it to your dealer/retailer if a new key needs to be made.

If the vehicle has an Immobilizer theft deterrent system, the key has a transponder in the key that matches a decoder in the vehicle. See *Immobilizer Operation* on page 2-9 for additional information.

Do not do any of the following to keys with a transponder:

- Cover the key.
- Hit the key hard against other objects.
- Expose it to high temperatures for a long time.
- Put the key in water.
- Use the key with electromagnetic materials.

Any new Immobilizer key must be programmed before it will start the vehicle. See your dealer/retailer. If you make your own duplicate key, you will not be able to cancel the system or start the vehicle.

In an emergency, contact Roadside Assistance. See *Roadside Assistance Program* on page 12-5 for more information.

Notice: If you ever lock your keys in the vehicle, you may have to damage the vehicle to get in. Be sure you have spare keys.

Remote Keyless Entry (RKE) System

If this vehicle has the Remote Keyless Entry (RKE) system, it operates on a radio frequency subject to Federal Communications Commission (FCC) Rules and with Industry Canada.

This device complies with Part 15 of the FCC Rules. Operation is subject to the following two conditions:

1. This device may not cause interference.
2. This device must accept any interference received, including interference that may cause undesired operation of the device.

This device complies with RSS-210 of Industry Canada. Operation is subject to the following two conditions:

1. This device may not cause interference.
2. This device must accept any interference received, including interference that may cause undesired operation of the device.

Changes or modifications to this system by other than an authorized service facility could void authorization to use this equipment.

If there is a decrease in the RKE operating range, try this:

- Check the distance. The transmitter may be too far from the vehicle. Stand closer during rainy or snowy weather.
- Check the location. Other vehicles or objects may be blocking the signal. Take a few steps to the left or right, hold the transmitter higher, and try again.
- Check the transmitter's battery. See "Battery Replacement" later in this section.
- If the transmitter is still not working correctly, see your dealer/retailer or a qualified technician for service.

2-4 Keys, Doors and Windows

Remote Keyless Entry (RKE) System Operation

The Remote Keyless Entry (RKE) transmitter functions work up to 30 feet (9 m) away from the vehicle.



🔒 (Lock): Press to lock all of the doors and liftgate.

The hazard warning flashers flash once to confirm that the doors have locked.

🔓 (Unlock): Press once to unlock the driver door. If **🔓** is pressed again within three seconds, all remaining doors unlock. The hazard warning flashers flash twice to confirm that the door has unlocked.

HOLD 🚨 (Panic): Press to arm the alarm. The lights flash and the horn sounds. The alarm turns off when the ignition is shifted to ON/RUN or HOLD **🚨** is pressed again. The ignition must be in LOCK/OFF or ACC/ACCESSORY for the alarm to work.

Programming Transmitters to the Vehicle

Only RKE transmitters programmed to this vehicle will work. If a transmitter is lost or stolen, a replacement can be purchased and programmed through your dealer/retailer. When the replacement transmitter is programmed to this vehicle, all remaining transmitters must also be reprogrammed. Any lost or stolen transmitters will no longer work once the new transmitter is programmed. Each vehicle can have up to four transmitters programmed to it.

Battery Replacement

The battery in the transmitter is weak and should be changed if it does not work at the normal range in any location.

Notice: When replacing the battery, do not touch any of the circuitry on the transmitter. Static from your body could damage the transmitter.

To replace the battery, use a flat, thin non-metal object or tape-wrapped metal object.

1. Separate the transmitter.



2. Remove the module.



3. Open the module cover.
4. Remove the old battery.

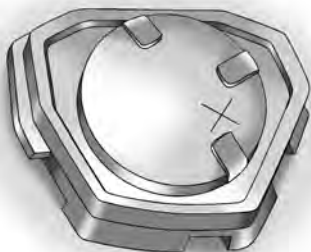

5. Insert the new battery, positive (+) side facing up. Replace with a CR2025 or equivalent battery.
6. Snap the module back together and replace it in the transmitter.
7. Snap the front and back of the transmitter together.

Doors and Locks

Door Locks

CAUTION

Unlocked doors can be dangerous.

- Passengers, especially children, can easily open the doors and fall out of a moving vehicle. When a door is locked, the handle will not open it. You increase the chance of being thrown out of the vehicle in a crash if the doors are not locked. So, wear safety belts properly and lock the doors whenever you drive.

(Continued)

CAUTION (Continued)

- Young children who get into unlocked vehicles may be unable to get out. A child can be overcome by extreme heat and can suffer permanent injuries or even death from heat stroke. Always lock your vehicle whenever you leave it.
- Outsiders can easily enter through an unlocked door when you slow down or stop your vehicle. Locking your doors can help prevent this from happening.

To lock and unlock your vehicle from the outside, use your key or the Remote Keyless Entry transmitter, if equipped. See *Remote Keyless Entry (RKE) System Operation* on page 2-4 for more information.

Open the driver door, on vehicles with power door locks, by turning the key in the lock toward the rear of the vehicle.

Turn the key back toward the center and toward the rear again, within three seconds, to unlock all of the doors. Use the key in the passenger door to also unlock all of the doors.

Lock a door by turning the key toward the front of the vehicle. If you have power door locks, all the doors will lock.

To manually lock or unlock the door from the inside, move the lever on the door forward or rearward. The driver and front passenger door open from the inside while locked.

With manual locks, the key must be used to lock and unlock the liftgate.

Power Door Locks

On vehicles with this feature, the power door lock switch is located on the armrest of the driver and front passenger door.

 : Press to lock all the doors.

 : Press to unlock all the doors.

Rear Door Security Locks

Rear door security locks prevent passengers from opening the rear doors from the inside.



Open the rear doors to access the security locks.

To set these locks, slide the lever down on each door and close it. The doors can only be opened from outside with the door unlocked. To return the doors to normal operation, slide the lever up.

Liftgate

CAUTION

It can be dangerous to drive with the liftgate open because carbon monoxide (CO) gas can come into your vehicle. You cannot see or smell CO. It can cause unconsciousness and even death. If you must drive with the liftgate open or if electrical wiring or other cable connections must pass through the seal between the body and the liftgate:

- Make sure all other windows are shut.
- Turn the fan on your heating or cooling system to its highest speed and select the

(Continued)

CAUTION (Continued)

control setting that will force outside air into your vehicle. See *Climate Control System* on page 7-1.

- If you have air outlets on or under the instrument panel, open them all the way. See *Engine Exhaust* on page 8-16.

Unlock and open the liftgate by inserting the key, turning it counterclockwise and raise it by hand.



Close the liftgate by using the handle to pull it down.

Lock the liftgate by inserting the key and turning it clockwise to the first position.

See *Remote Keyless Entry (RKE) System Operation* on page 2-4 for more information.

Theft-Deterrent Systems

Vehicle theft is big business, especially in some cities. This vehicle has theft-deterrent features, however, they do not make it impossible to steal.

Immobilizer

This device complies with Part 15 of the FCC Rules. Operation is subject to the following two conditions:

1. This device may not cause interference.
2. This device must accept any interference received, including interference that may cause undesired operation.

This device complies with RSS-210 of Industry Canada. Operation is subject to the following two conditions:

1. This device may not cause interference.
2. This device must accept any interference received, including interference that may cause undesired operation of the device.

Changes or modifications to this system by other than an authorized service facility could void authorization to use this equipment.

Immobilizer Operation

This vehicle has a passive theft-deterrent system.

You do not have to manually arm or disarm the system.

The system is automatically armed when the key is removed from the ignition.



The security light, located on the center of the instrument panel, comes on if there is a problem with arming or disarming the theft-deterrent system.

2-10 Keys, Doors and Windows

The security light flashes when the system is armed.

When the key is inserted in the ignition the transponder in the key head transmits an electronic code to the vehicle and automatically cancels the system. Only the correct key starts the vehicle.

If the engine does not start, there could be a problem with the theft-deterrent system. Turn the ignition off and try again.

If the engine still does not start, and the key appears to be undamaged, try another ignition key. Check the fuse. See *Fuses and Circuit Breakers* on page 9-36.

If the engine still does not start with the other key, the vehicle needs service. If the vehicle does start, the first key may be faulty. See your dealer/retailer who can service the theft-deterrent system and have a new key made.

If any of the following conditions occur, contact your dealer/retailer.

- The security light stays on.
- The security light does not start flashing when the key is removed from the ignition.
- The security light flashes inconsistently.

See your dealer/retailer to have a new key with a transponder made. Bring the key and key number with you.

In an emergency, contact Roadside Assistance Program. See *Roadside Assistance Program* on page 12-5.

Do not leave the key or device that disarms or deactivates the theft deterrent system in the vehicle.

Content Theft-Deterrent

This vehicle may have a theft-deterrent system that activates an alarm if attempts are made to damage or break into the vehicle. The alarm sounds and the lights flash.



The security light is located on the center of the instrument panel.

Arming the System

To arm the system:

1. Close all the doors and the liftgate.
2. Lock the doors and liftgate with the key or Remote Keyless Entry (RKE) transmitter.

The security light comes on solid.

The system automatically arms after 30 seconds. The security light flashes when the system is armed.

No one should be in the vehicle when the alarm system is armed because unlocking the vehicle from the inside activates the system.

To avoid setting off the alarm make sure all passengers are out of the vehicle and the windows are closed before arming the system.

Disarming the System

To disarm the alarm do one of the following:

- Unlock the doors with the key.
- Unlock the doors and liftgate with the RKE transmitter.
- Start the engine.

Testing the Alarm

To test the alarm:

1. Open all the windows.
2. Set the system as described in the previous procedure. The doors and liftgate should be locked with the key or RKE transmitter. Be sure to wait until the security light starts flashing.
3. Unlock the driver door from the inside. The system should activate the alarm.
4. Stop the alarm as described in the disarming procedure.
5. Repeat this operation for the other doors. Also, check that the system is activated when the battery terminal is disconnected and then reconnected.

If the system does not work properly, have it checked by your dealer/retailer.

How the System Alarm is Activated

The system activates the alarm if:

- A locked door or the liftgate is unlocked or opened without the RKE transmitter.
- A locked door is unlocked or opened without the key.
- The liftgate is unlocked or opened with the key.
- The battery is reconnected.
- The side windows are tapped or broken.

Do not leave the key or device that disarms or deactivates the theft deterrent system in the vehicle.

Windows

CAUTION

Leaving children, helpless adults, or pets in a vehicle with the windows closed is dangerous. They can be overcome by the extreme heat and suffer permanent injuries or even death from heat stroke. Never leave a child, a helpless adult, or a pet alone in a vehicle, especially with the windows closed in warm or hot weather.



Manual Windows

Turn the crank on the door to open and close a manual window.

Power Windows

CAUTION

Leaving children in a vehicle with the keys is dangerous for many reasons, children or others could be badly injured or even killed. They could operate the power windows or other controls or even make the vehicle move. The windows will function and they could be seriously injured or killed if caught in the path of a closing window. Do not leave keys in a vehicle with children. When there are children in the rear seat use the window lockout button to prevent unintentional operation of the windows.



On vehicles with this feature, the power windows only work when the ignition is turned to ON/RUN or in Retained Accessory Power (RAP). See *Retained Accessory Power (RAP)* on page 8-4.

Switches on the driver door control the driver and passenger windows. Each passenger door has a switch to control that window.

Press or pull the front of a switch to lower or raise a window.

AUTO (Express-Down): Press all the way down and release to lower the driver window automatically. Pull up at any time to stop the window from lowering.

 **(Lock-Out):** Press the lock-out button, located on the driver door, to disable the passenger power windows and again to enable them.

Only the driver window can be operated when the lock-out feature is used.

Sun Visors

Pull the visor toward you or move it to the side to help reduce glare.

To use the mirror, slide the attached cover.

Mirrors

Manual Rearview Mirror

Adjust the mirror to see clearly behind the vehicle. Hold the mirror in the center to move it up, down, and side to side. The day/night lever lets you adjust the mirror to avoid glare from headlamps behind your vehicle. Move the lever to the right for nighttime use and back to the center for daytime use.

Vehicles with OnStar[®] have three control buttons located at the bottom of the mirror. See *OnStar[®] System* on page 4-25 for more information.

Outside Power Mirror(s)



The controls are located to the left of the steering wheel on the instrument panel.

The vehicle must be in ON/RUN or ACC/ACCESSORY to adjust the mirrors.

1. Adjust either mirror by pushing the selector switch to the L (left) or R (right).
2. Use the arrows on the control pad to adjust the direction of the mirror.
3. Move the selector switch back to the center. This locks the mirrors in place.

Manually fold the mirrors inward to prevent damage when going through an automatic car wash. To fold, push the mirror toward the vehicle. Push the mirror outward, to return to its original position.

Sunroof

On vehicles with a sunroof, the controls are on the overhead console. The ignition must be in ON/RUN or Retained Accessory Power (RAP) for the sunroof to work.

TILT: Slide the sunshade back. Press to tilt the sunroof. Press again to stop movement at any time.

DOWN: Press to lower the sunroof.

SLIDE: Press to open the sunroof. It express opens and stops before the fully open position. Press again to fully open. Press the switch at any time to stop the sunroof from moving. If the sunshade is closed it opens with the sunroof.

CLOSE: Press to express close the sunroof. Press again to stop movement at any time.

The sunshade must be closed by hand.

Anti-Pinch Feature

If there is an obstruction when the sunroof is closing, it stops and partly opens again. Remove the obstruction and press the button again to close the sunroof.

Storage

Storage

Glove Box	3-1
Cupholders	3-1
Overhead Console	3-2
Center Console Storage	3-2
Luggage Carrier	3-2
Driver Storage	
Compartment	3-3
Floor Mats	3-3
Hooks	3-3
Cargo Cover	3-4
Cargo Tie Downs	3-6
Cargo Management	
System	3-6

Storage

Glove Box

Lift up on the glovebox lever to open it.

Cupholders

There are cupholders located in the console area between the front seats.



The cupholder size can be adjusted by changing the location of the provided insert.

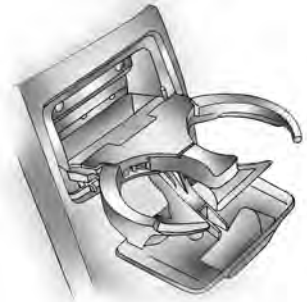

There are also cupholders that fold out from the back of the center console.

There are also molded bottle holders located in the front and rear doors.

3-2 Storage

Overhead Console

If your vehicle has an overhead console, push on the cover to open it.

Center Console Storage

To access the center console storage area, pull up on the lock release lever to raise the upper cover and access the tray storage. Pull up on the lower release lever to raise the tray and access more storage.

Luggage Carrier

CAUTION

If something is carried on top of the vehicle that is longer or wider than the luggage carrier — like paneling, plywood, or a mattress — the wind can catch it while the vehicle is being driven. This can cause a driver to lose control. The item being carried could be violently torn off, and this could cause a collision, and damage the vehicle. Items may be carried inside. Never carry something longer or wider than the luggage carrier on top of the vehicle.

Do not exceed the maximum vehicle capacity when loading your vehicle. For more information on vehicle capacity and loading, see *Loading the Vehicle* on page 8-32.



Notice: Loading cargo on the luggage carrier that weighs more than 132 lbs (60 kg) or hangs over the rear or sides of the vehicle may damage your vehicle. Load cargo so that it rests evenly between the crossrails, making sure to fasten it securely.

To prevent damage or loss of cargo as you are driving, check to make sure the luggage carrier and cargo are still securely fastened.

Loading cargo on the roof rack will make the center of the vehicle gravity higher. Avoid high speeds, sudden starts, sharp turns, sudden braking or abrupt maneuvers, otherwise it may result in loss of control or vehicle rollover due to failure to operate the vehicle correctly.

If driving for a long distance, on rough roads, or at high speeds, stop the vehicle now and then during the trip to make sure the cargo remains in its place.

Driver Storage Compartment

The driver storage compartment is located near the left side of the steering column on the bottom of the instrument panel. Pull up on the lever to open the cover.

Floor Mats

The driver side floor mat is held in place by two locator hooks.

The floor mat must be properly placed on the floor so that it does not block the movement of the accelerator pedal.

How to Remove and Replace the Floor Mat

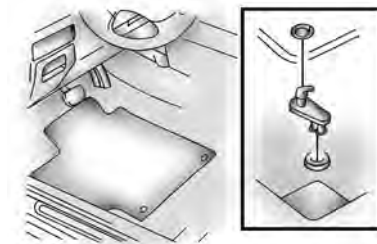

To remove the floor mat, pull up on the rear of the mat to disconnect it from the locator hooks.

To reinstall the floor mat, line up the openings in the floor mat over the locator hooks and push down into place.

Hooks

There are hooks for hanging items in the cabin, luggage compartment, and in the cargo management system, if the vehicle has one.

On the front passenger side, press the hook to open and use it. There is a weight limit of 44 lb (20 kg).

The luggage compartment hooks should only be used to hang items under 7 lb (3 kg).

For vehicles with a cargo management system, open the deck lid to hang items under 5 lb (2.3 kg).

3-4 Storage

Cargo Cover

For vehicles equipped with a cargo cover.

Using the cargo cover:

1. Remove the cargo cover from its storage location.
2. Unfold the cargo cover.

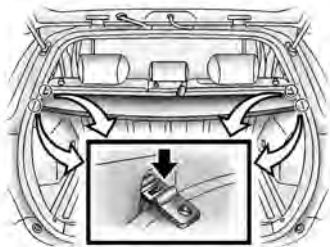

3. Attach the hooks to the indented slots on the sides of the rear cargo area.

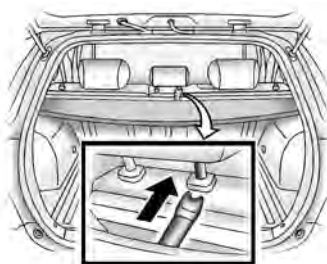

4. Attach the center hook to the center head restraint.

CAUTION

An improperly stored cargo cover could be thrown about the vehicle during a collision or sudden maneuver. Someone could be injured. If the cover is removed, always store it in the proper storage location. When it is replaced, always be sure that it is securely reattached.

Folding the Cargo Cover:

1. Hold the cargo cover with both hands.



2. Bend one side of the cover toward the body.



3. Twist the other side in the opposite direction.



4. Make a small circle, and then fold the cover inward.



5. Make sure the cover's three circles are side by side.
6. Return the cover to its storage bag.

3-6 Storage

Cargo Tie Downs

The cargo tie down straps and hooks are intended to be used to secure a flat tire or other items. The tie down hooks are located in the rear cargo area. The straps are under the rear floor panel.

To use, hook the end of the straps to the hooks in a criss-cross pattern. Pull on the straps at the buckle to tighten as needed.

Cargo Management System

A cargo management system, for vehicles that have it, can be used for organizing and separating items in the rear of the vehicle.

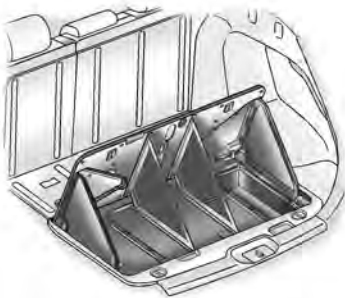

To use:

1. Open the cover.
2. Unfold the side panels out and lock them into place to hold up the cover.
3. Hook the nets into the cover slots on the lid to use as dividers.

There are also hooks on the inside cover to hold items.

Additional storage is available on both sides of the cargo management system. Turn the knobs to the UNLOCK position, and remove the deck boards to access the storage area.

Instruments and Controls

Instrument Panel Overview

- Instrument Panel Overview4-2
- Hazard Warning Flashers4-3
- Horn4-3
- Tilt Wheel4-4
- Turn Signal/Multifunction Lever4-4
- Cruise Control4-4
- Turn and Lane-Change Signals4-7
- Headlamp High/Low-Beam Changer4-7
- Flash-to-Pass4-7
- Windshield Wipers4-7
- Windshield Washer4-8
- Rear Window Wiper/Washer4-8
- Accessory Power Outlet(s)4-9

- Power Outlet 115 Volt Alternating Current4-10
- Ashtray(s)4-10

Warning Lights, Gages, and Indicators

- Warning Lights, Gages, and Indicators4-11
- Instrument Panel Cluster ...4-12
- Speedometer and Odometer4-13
- Trip Odometer(s)4-13
- Tachometer4-13
- Safety Belt Reminders4-14
- Airbag Readiness Light4-14
- Passenger Airbag Status Indicator4-15
- Service Airbag Notification System Message4-16
- Charging System Light4-16
- Brake System Warning Light4-17
- Antilock Brake System (ABS) Warning Light4-18
- Speed Sensitive Power Steering (SSPS) Warning Light4-18

- Low Tire Pressure Warning Light4-18
- Traction Control System (TCS) Warning Light4-19
- StabiliTrak[®] Indicator Light4-19
- Engine Coolant Temperature Gage4-19
- Malfunction Indicator Lamp4-20
- Security Light4-22
- Oil Pressure Light4-22
- Fog Lamp Light4-23
- Lights On Reminder4-23
- Taillamp Indicator Light4-23
- Cruise Control Light4-23
- Low Washer Fluid Warning Light4-23
- Service All-Wheel Drive Light4-24
- Highbeam On Light4-24
- Door Ajar Light4-24
- Fuel Gage4-24
- Low Fuel Warning Light4-25

OnStar[®] System

- OnStar[®] System4-25

4-2 Instruments and Controls

Instrument Panel Overview

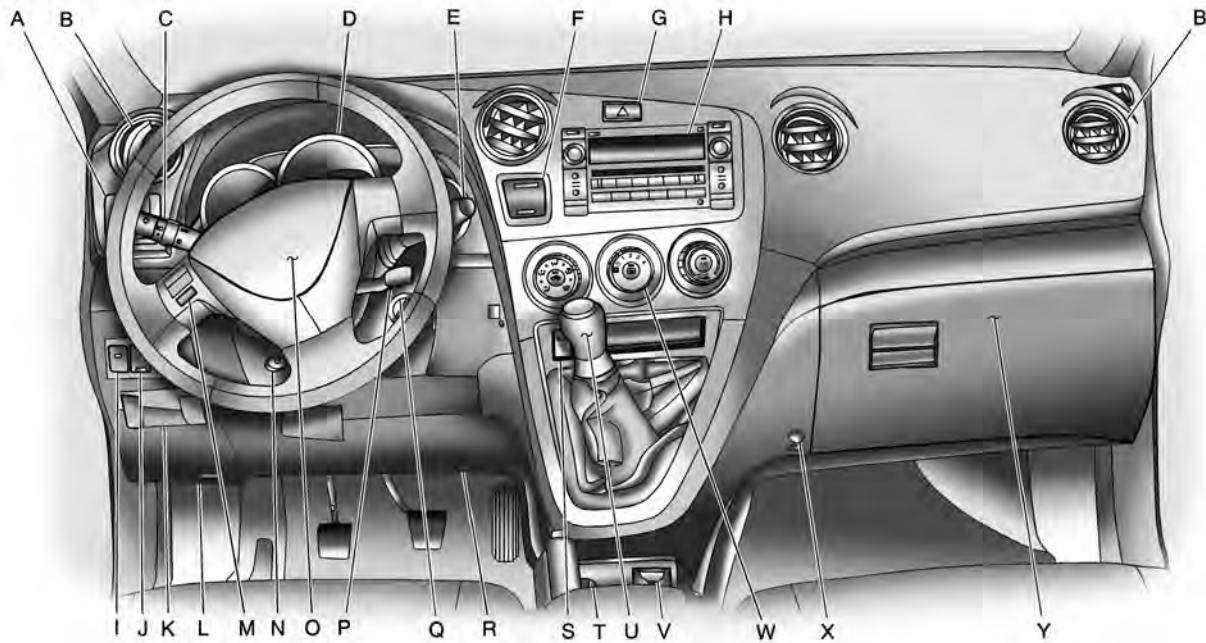

The main components of the instrument panel are the following:

- A. *Outside Power Mirror(s)* on page 2-14.
- B. *Outlet Adjustment* on page 7-3.
- C. *Turn Signal/Multifunction Lever* on page 4-4.
- D. *Instrument Panel Cluster* on page 4-12.
- E. *Windshield Wipers* on page 4-7.
- F. *Passenger Airbag Status Indicator. Passenger Sensing System* on page 1-28.
Security Light. See Content Theft-Deterrent on page 2-10.
- G. *Hazard Warning Flashers* on page 4-3.
- H. *Audio System(s)* on page 6-1.
- I. *Traction Control System (TCS)* on page 8-21.
- J. *Content Theft-Deterrent* on page 2-10.
- K. *Driver Storage Compartment* on page 3-3.
- L. *Hood Release* on page 9-5.
- M. *Audio Steering Wheel Controls* on page 6-13.
- N. *Tilt Wheel* on page 4-4.
- O. *Horn* on page 4-3.
- P. *Cruise Control* on page 4-4 (If Equipped).
- Q. *Ignition Positions* on page 8-2.
- R. *Tire Pressure Reset Button (Out of View). See Tire Pressure Monitor Operation* on page 9-50.
- S. *Power Outlet 115 Volt Alternating Current* on page 4-10 On/Off Button.
- T. *Cigarette Lighter (If Equipped) or Accessory Power Outlet. Ashtray(s)* on page 4-10 or *Accessory Power Outlet(s)* on page 4-9.
- U. *Shift Lever. Automatic Transmission Operation (Four Speed)* on page 8-6 or *Automatic Transmission Operation (Five Speed)* on page 8-8 or *Manual Transmission Operation* on page 8-11.
- V. *Power Outlet 115 Volt Alternating Current* on page 4-10.
- W. *Climate Control System* on page 7-1.
- X. *Hooks* on page 3-3.
- Y. *Glove Box* on page 3-1.

Hazard Warning Flashers

(Hazard Warning Flasher):

Press this button located on the instrument panel, to make the front and rear turn signal lamps flash on and off. This warns others that you are having trouble.

Press  again to turn the flashers off.

Horn

Press near or on the horn symbols on the steering wheel pad to sound the horn.

4-4 Instruments and Controls

Tilt Wheel

A tilt and telescope wheel lets the steering wheel position be adjusted.

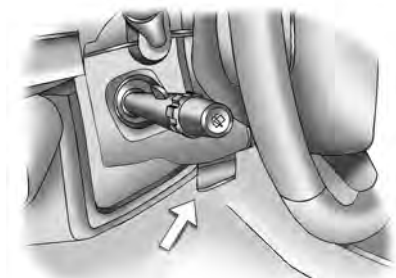

The adjustment lever is located on the left side of the steering column.

Pull the lever down to move the steering wheel up or down and in or out. Pull the lever up to lock the steering wheel in place.

Do not adjust the tilt and telescope lever while driving.

Turn Signal/Multifunction Lever



The lever on the left side of the steering column includes the following:

☀ : Exterior Lamps.

↔ : Turn and Lane-Change Signals.

☾ : Headlamp High/Low-Beam Changer.

☁ : Fog Lamps (If Equipped).

Flash-to-Pass Feature.

Information for these features is on the pages following.

Cruise Control



For vehicles with cruise control, the lever is located on the right side of the steering wheel.

Cruise control, lets a speed of 25 mph (40 km/h) or more be maintained without keeping your foot on the accelerator. Cruise control does not work at speeds below 25 mph (40 km/h).

 **CAUTION**

Cruise control can be dangerous where you cannot drive safely at a steady speed. So, do not use the cruise control on winding roads or in heavy traffic.

Cruise control can be dangerous on slippery roads. On such roads, fast changes in tire traction can cause excessive wheel slip, and you could lose control. Do not use cruise control on slippery roads.

Setting Cruise Control **CAUTION**

If you leave your cruise control on when you are not using cruise, you might hit a button and go into cruise when you do not want to. You could be startled and even lose control. Keep the cruise control switch off until you want to use cruise control.

1. Press the ON-OFF button at the end of the lever. The CRUISE light on the instrument panel cluster comes on. See *Cruise Control Light on page 4-23*.
2. Get to the desired speed.
3. Move the lever down to -SET and release it.
4. Take your foot off the accelerator pedal.

If the cruise control indicator light flashes, press the ON-OFF button once to deactivate the system, and then press the button back on. If the cruise control speed cannot be set or the cruise control cancels immediately after being activated, there may be a problem with the cruise control system. See your dealer/retailer.

Resuming a Set Speed

If the brakes are applied after the cruise control is set, the cruise control is turned off.

If the vehicle speed is 25 mph (40 km/h) or greater, push the lever up to +RES (Resume/Accelerate) to return to the previously set speed.

4-6 Instruments and Controls

Increasing Speed While Using Cruise Control

There are three ways to increase the vehicle speed:

- Use the accelerator pedal to get to the higher speed. Move the lever down to –SET. Release the lever and the accelerator pedal.
- Move the cruise lever up to +RES. Hold it there until the desired speed is reached, and then release the lever.
- To increase the vehicle speed in very small amounts, move the lever to +RES briefly and then release it. Each time this is done, the vehicle goes about 1 mph (1.6 km/h) faster.

Reducing Speed While Using Cruise Control

There are two ways to reduce the vehicle speed while using cruise control:

- Push and hold the lever to –SET until the desired lower speed is reached, then release it.
- To slow down in very small amounts, push the lever down briefly. Each time this is done, the vehicle will go about 1 mph (1.6 km/h) slower.

Passing Another Vehicle While Using Cruise Control

Use the accelerator pedal to increase the vehicle speed. When you take your foot off the pedal, the vehicle slows down to the cruise control speed set earlier.

Using Cruise Control on Hills

The cruise control performance will vary depending upon the vehicle speed, load, and the steepness of the hills.

When going up steep hills, you might have to step on the accelerator pedal to maintain the vehicle speed.

When going downhill, you might have to brake or shift to a lower gear to keep the vehicle speed down. Applying the brake or downshifting to 2 SECOND or L LOW turns off the cruise control.

Ending Cruise Control

There are several ways to turn off the cruise control:

- Step on the brake pedal or push the clutch pedal, if the vehicle has a manual transmission.
- Press the ON-OFF button.
- Pull the cruise control lever toward you.

Erasing Speed Memory

The cruise control set speed memory is erased when the cruise control or the ignition is turned off.

Turn and Lane-Change Signals

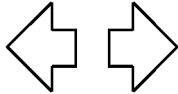

An arrow on the instrument panel cluster flashes in the direction of the turn or lane change.

Move the lever all the way up or down to signal a turn.

Raise or lower the lever until the arrow starts to flash to signal a lane change. Hold it there until the lane change is completed.

The lever returns to its starting position whenever it is released.

If after signaling a turn or a lane change the arrow flashes rapidly or does not come on, a signal bulb may be burned out.

Have the bulbs replaced. If the bulb is not burned out, check the fuse. See *Fuses and Circuit Breakers* on page 9-36.

Headlamp High/Low-Beam Changer

The headlamps must be on for this feature to work.

Push the turn signal lever away from you to turn the high beams on.

This instrument panel cluster light  comes on while the high beam headlamps are on.

Pull the lever towards you to return to low beams.

Flash-to-Pass

This feature is used to signal to the vehicle ahead that you want to pass. With the lever in the low-beam position, pull the lever toward you to momentarily switch to high-beams. If the headlamps are on when the lever is released, the high-beams will return to low-beam.

Windshield Wipers



The windshield wiper/washer lever is located on the right side of the steering column.

Move the lever to one of the following positions:

 **(Mist):** Move the lever to mist, for a single wiping cycle and then release. The wipers stop after one wipe.

 **(Off):** Move the lever to this position to turn the wipers off.

4-8 Instruments and Controls

 **(Intermittent):** Move the lever to choose a delayed wiping cycle.

For vehicles with the variable intermittent feature, the time between wipes can be adjusted.

Turn the  band for a longer or shorter delay interval.

 **(Low):** Use for steady wiping at low speed.

 **(High):** Use for steady wiping at high speed.

Clear snow and ice from the wiper blades before using them. If the blades are frozen to the windshield, loosen or thaw them. If they become damaged, get new blades or blade inserts. See *Windshield Wiper Blade Replacement on page 9-25*.

Heavy snow or ice can overload the wipers. A circuit breaker stops them until the motor cools.

Windshield Washer

Pull the lever toward you to spray washer fluid on the windshield. The spray continues until the lever is released. The wipers will run a few times. See *Windshield Washer Fluid on page 9-24* for information on filling the windshield washer fluid reservoir.

CAUTION

In freezing weather, do not use your washer until the windshield is warmed. Otherwise the washer fluid can form ice on the windshield, blocking your vision.

Rear Window Wiper/Washer

 **Rear Wiper:** Turn the end of the lever to low or high, to turn on the rear window wiper.

... **(Low):** For steady rear wiping at low speed.

— **(High):** For steady rear wiping at high speed.

 **(Rear Washer):** Turn the end of the lever up or down as far as it will go, to squirt washer fluid on the rear window. The knob automatically returns from these positions after it is released.

The windshield washer reservoir is used for the windshield and the rear window. Check the fluid level in the reservoir if either washer is not working. See *Windshield Washer Fluid on page 9-24*.

 **CAUTION**

In freezing weather, do not use your washer until the windshield is warmed. Otherwise the washer fluid can form ice on the windshield, blocking your vision.

Accessory Power Outlet(s)

Accessory power outlets can be used to plug in auxiliary electrical equipment.

The vehicle has an accessory power outlet on the center floor console below the shift lever.

To use the outlet, the ignition must be in ON/RUN or ACC/ACCESSORY. Pull down the small cover to access the outlet.

Notice: Leaving electrical equipment on for extended periods will drain the battery. Always turn off electrical equipment when not in use and do not plug in equipment that exceeds the maximum amperage rating.

This circuit is protected by a fuse and has a maximum current level. Do not use equipment exceeding the maximum amperage rating.

Certain power accessory plugs may not be compatible to the power accessory outlet and could result in a blown vehicle or adapter fuse. See your dealer/retailer for additional information on the power accessory plugs.

Notice: Adding any electrical equipment to the vehicle can damage it or keep other components from working as they should. The repairs would not be covered by the vehicle warranty. Do not use equipment exceeding maximum amperage rating of 20 amperes. Check with your dealer/retailer before adding electrical equipment.

When adding electrical equipment, be sure to follow the proper installation instructions included with the equipment.

Notice: Improper use of the power outlet can cause damage not covered by the warranty. Do not hang any type of accessory or accessory bracket from the plug because the power outlets are designed for accessory power plugs only.

4-10 Instruments and Controls

Power Outlet 115 Volt Alternating Current

Electrical equipment with a maximum limit of 115 VAC can be plugged into this power outlet. If the equipment used requires more than the limit, a protection circuit will cut the power supply. The power automatically restarts when equipment that operates within the limit is plugged in.



The power outlet is located below the shift lever.

Before using the outlet, turn on the ignition and press the button located on the instrument panel below the climate control system.

An indicator light in the button comes on. After using the outlet, press the button again to turn it off.



The power outlet is not designed for the following electrical equipment and they may not work properly:

- Equipment with high initial peak wattage: cathode-ray tube type televisions, compressor-driven refrigerators, or electric power tools.
- Other equipment requiring an extremely stable power supply: microcomputer-controlled electric blankets, touch sensor lamps, etc.

Ashtray(s)

For vehicles with a removable ashtray, it is located in the front cupholder in the center console storage area.

Notice: If papers, pins, or other flammable items are put in the ashtray, hot cigarettes or other smoking materials could ignite them and possibly damage the vehicle. Never put flammable items in the ashtray.

For vehicles with a lighter, push the lighter down and it will pop up when it is ready to be used. The ignition switch must be in the ACC/ACCESSORY or ON/RUN position to use the lighter.

Notice: Holding a cigarette lighter in while it is heating does not let the lighter back away from the heating element when it is hot. Damage from overheating can occur to the lighter or heating element, or a fuse could be blown. Do not hold a cigarette lighter in while it is heating.

It is not recommended to use the cigarette lighter to plug in auxiliary electrical equipment. Use the accessory power outlet for phones and other electrical equipment. See *Accessory Power Outlet(s)* on page 4-9 or *Power Outlet 115 Volt Alternating Current* on page 4-10.

Warning Lights, Gages, and Indicators

Warning lights and gages can signal that something is wrong before it becomes serious enough to cause an expensive repair or replacement. Paying attention to the warning lights and gages could prevent injury.

Warning lights come on when there may be or is a problem with one of the vehicle's functions. Some warning lights come on briefly when the engine is started to indicate they are working.

Gages can indicate when there may be or is a problem with one of the vehicle's functions. Often gages and warning lights work together to indicate a problem with the vehicle.

When one of the warning lights comes on and stays on while driving, or when one of the gages shows there may be a problem, check the section that explains what to do. Follow this manual's advice. Waiting to do repairs can be costly and even dangerous.

4-12 Instruments and Controls

Instrument Panel Cluster

This feature is designed to show at a glance how the vehicle is running. It shows vehicle speed, how much fuel is left in the fuel tank and many other things needed to drive safely and economically.

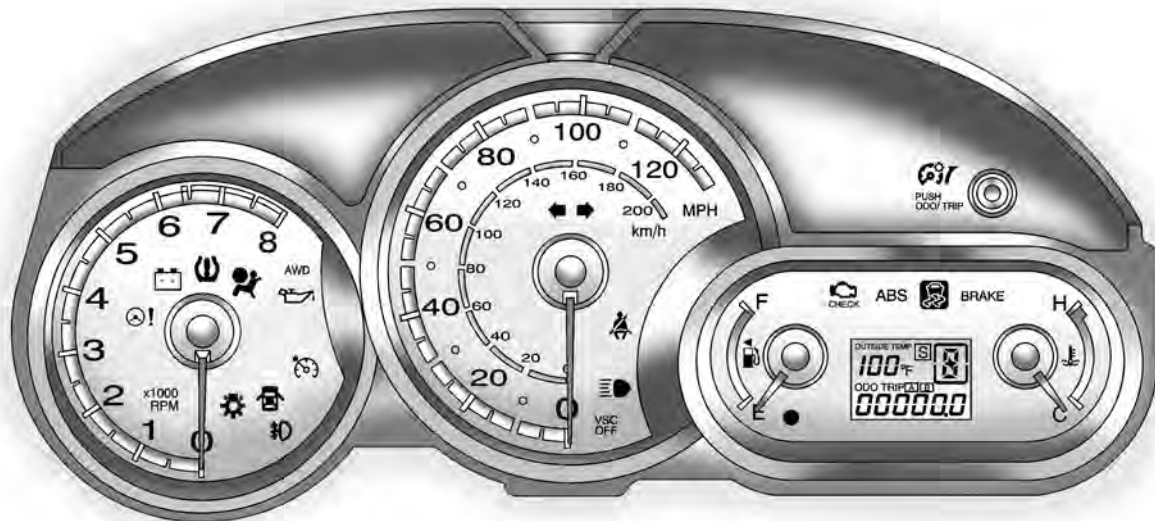

United States Base Cluster shown, Canada similar

Speedometer and Odometer

The speedometer shows the vehicle speed in both miles per hour (mph) and kilometers per hour (km/h). The odometer shows how far the vehicle has been driven.

If the vehicle needs a new odometer installed, the new one must be set to the mileage total of the old odometer. If it cannot be reset, then it must be set at zero and a label put on the driver door to show the old mileage reading when the new odometer was installed. See your dealer/retailer for more information.

Trip Odometer(s)

The trip odometer shows how far the vehicle has been driven since the trip odometer was last set to zero.



The button located above the odometer allows switching between the odometer and the trip odometer.



To set the trip odometer to zero, press and hold the button.

Temperature Display

The outside air temperature is displayed on the center of the instrument panel, within the trip odometer. The display shows the outside air temperature in Fahrenheit with a range from -40°F to 122°F (-40°C to 50°C).

Tachometer

The tachometer shows engine speed in thousands of revolutions per minute (rpm).

Notice: If the engine is operated while the tachometer is in the shaded warning area, the vehicle could be damaged, and the damages would not be covered by the vehicle warranty. Do not operate the engine with the tachometer in the shaded warning area.

Safety Belt Reminders

When the engine is started, a chime will sound for several seconds to remind people to fasten their safety belts, unless the driver safety belt is already buckled.



The safety belt light will also flash until the driver belt is buckled. If the driver belt is already buckled, neither the chime nor the light comes on.

The vehicle also has a safety belt reminder light for the right front passenger position next to the passenger airbag status indicator. See *Passenger Airbag Status Indicator* on page 4-15.

This light is located on the center of the instrument panel, next to the audio system.

When the key is turned to ON/RUN or START, this light comes on as a reminder for the right front passenger to fasten their safety belt. This light flashes until the right front passenger safety belt is buckled. The passenger safety belt reminder light will not come on if the right front passenger belt is already buckled or if a sensor does not detect the weight of a passenger in that seat.

If something is placed on the right front passenger seat, the sensors in the seat may detect that object and cause the right front passenger safety belt reminder light to come on. If this happens, remove the object.

Airbag Readiness Light

There is an airbag readiness light on the instrument panel cluster, which shows the airbag symbol. The system checks the airbag's electrical system for malfunctions. The light stays on if there is an electrical problem. The system monitors the airbag sensor assembly, front airbag sensors, seat-mounted side impact and roof-mounted airbag sensors, driver seat position sensor, driver seat belt buckle switch, right front occupant sensing system and indicator light, front passenger seat belt buckle switch, seat belt pretensioner assemblies, inflators, interconnecting wiring and power sources. For more information on the airbag system, see *Airbag System* on page 1-21.



This light will come on briefly when the vehicle is started, then it should go out indicating the system is ready.

CAUTION

If the airbag readiness light stays on or keeps flashing after you start your vehicle, it means the airbag system and safety belt pretension system may not be working properly. The airbags in your vehicle may not inflate in a crash, or they could even inflate without a crash. To help avoid injury to yourself or others, have your vehicle serviced right away if the airbag readiness light stays on after you start your vehicle.

Passenger Airbag Status Indicator

The vehicle has the passenger sensing system. See *Passenger Sensing System* on page 1-28 for important safety information.

The instrument panel has a passenger airbag status indicator.

PASSENGER

AIR BAG OFF AIR BAG ON

When the vehicle is started, the passenger airbag status indicator will light ON and OFF for several seconds as a system check.

Then, after several more seconds, the status indicator will light either ON or OFF if there is weight on the seat, to let you know the

status of the right front passenger frontal and seat-mounted side impact airbags (if equipped). If the seat is unoccupied, the light will not be visible after the system check.

If the word ON is lit on the passenger airbag status indicator, it means that the right front passenger frontal and seat-mounted side impact airbags (if equipped) are enabled (may inflate).

If the word OFF is lit on the passenger airbag status indicator, it means that the passenger sensing system has turned off the right front passenger's frontal airbag and seat-mounted side impact airbag (if equipped). See *Passenger Sensing System* on page 1-28 for more on this, including important safety information.

4-16 Instruments and Controls

If, after several seconds, all status indicator lights remain on, there may be a problem with the lights or the passenger sensing system. See your dealer/retailer for service.

CAUTION

If the airbag readiness light in the instrument panel cluster ever comes on and stays on, it means that something may be wrong with the airbag system. If this ever happens, have the vehicle serviced promptly, because an adult-size person sitting in the right front passenger's seat may not have the protection of the airbag(s). See *Airbag Readiness Light on page 4-14* for more on this, including important safety information.

Service Airbag Notification System Message

If the Service Airbag Notification System message appears on the radio display, the vehicle may not be able to provide the Automatic Notification of Airbag Deployment feature. See *OnStar® System on page 4-25* for information on this feature. See your dealer/retailer for service.

Charging System Light



The charging system light comes on briefly when the ignition is turned on, but the engine is not running, as a check to show the light is working. It should go out when the engine is started.

If the light stays on, or comes on while driving, there could be a problem with the electrical charging system. Have it checked by your dealer/retailer. Driving while this light is on could drain the battery.

If a short distance must be driven with the light on, be sure to turn off all accessories, such as the radio and air conditioner.

Brake System Warning Light

The vehicle's hydraulic brake system is divided into two parts. If one part is not working, the other part can still work and stop the vehicle. For good braking both parts need to be working well.

If the warning light comes on, there is a brake problem. Have the brake system inspected right away.

BRAKE



United States

Canada

If the vehicle has anti-lock brakes, this light should come on when the key is turned to START.

If it does not come on, have it fixed so it will be ready to warn if there is a problem.

When the ignition is on, the brake system warning light also comes on when the parking brake is set. The light will stay on if the parking brake does not fully release. If it stays on after the parking brake is fully released, it means there is a brake problem.

CAUTION

The brake system might not be working properly if the brake system warning light is on. Driving with the brake system warning light on can lead to a crash. If the light is still on after the vehicle has been pulled off the road and carefully stopped, have the vehicle towed for service.

See Antilock Brake System (ABS) Warning Light later in this section and *Towing Your Vehicle on page 9-75*.

Antilock Brake System (ABS) Warning Light

ABS



United States

Canada

The ABS warning light comes on briefly when the ignition key is turned to ON/RUN. This is normal. If the light does not come on then, have it fixed so it will be ready to warn you if there is a problem.

If the light stays on, turn the ignition to LOCK/OFF. If the light comes on while driving, stop as soon as possible and turn the ignition off. Then start the engine again to reset the system. If the light still stays on, or comes on again while driving, the vehicle needs service. If the regular brake system warning light is not on, there are still brakes, but no antilock brakes.

If the regular brake system warning light is also on, there are no antilock brakes and there is a problem with the regular brakes. See *Brake System Warning Light* on page 4-17.

Speed Sensitive Power Steering (SSPS) Warning Light



Vehicles with this feature, have a warning light that comes on briefly when the ignition is turned to ON/RUN as a check to show it is working.

If the warning light does not come on, have it fixed so it will be able to warn if there is a problem.

If the warning light stays on, or comes on while driving, the Speed Sensitive Power Steering may not be working. See your dealer/retailer for service.

Low Tire Pressure Warning Light



This light should come on briefly as the engine is started.

If there is a tire with low tire pressure, the light will stay on or come back on.

See *Tire Pressure Monitor System* on page 9-48 for more information.

Traction Control System (TCS) Warning Light



This warning light comes on briefly when the ignition is turned to ON/RUN.

It also comes on when the Traction Control System is turned off by pressing the TRAC OFF button. See *Traction Control System (TCS)* on page 8-21 for more information.

If it stays on or comes on while driving, there is a problem with the Traction Control System (TCS), contact your dealer/retailer.

StabiliTrak® Indicator Light

VSC
OFF

This light warns that there is a problem with the Traction Control System (TCS) or the Vehicle Stability Control (VSC) system.

The light comes on when the ignition is turned to ON/RUN.

If the light comes on while driving, the system is not working.

The TCS light comes on when the VSC system warning light comes on, even if the TRAC OFF button is not pressed.

See *StabiliTrak® System* on page 8-22 for more information on Vehicle Stability Control System.

See *Traction Control System (TCS)* on page 8-21 for more information.

Contact your dealer/retailer, if the light does not come on or if it stays on.

Engine Coolant Temperature Gage



United States



Canada

This gage shows the engine coolant temperature. If the gage pointer moves into the red area, the engine is too hot. Pull off the road, stop the vehicle, and turn off the engine as soon as possible. See *Engine Overheating* on page 9-22.

Malfunction Indicator Lamp

Check Engine Light

A computer system called OBD II (On-Board Diagnostics-Second Generation) monitors operation of the fuel, ignition, and emission control systems. It makes sure that emissions are at acceptable levels for the life of the vehicle, helping to produce a cleaner environment.



United States



Canada

This light comes on when the ignition is on, but the engine is not running, as a check to show it is working. If it does not, have the vehicle serviced by your dealer/retailer.

If the check engine light comes on and stays on, when the engine is running, this indicates that there is an OBD II problem and service is required.

Malfunctions often are indicated by the system before any problem is apparent. Heeding the light can prevent more serious damage to the vehicle. This system assists the service technician in correctly diagnosing any malfunction.

Notice: If the vehicle is continually driven with this light on, after a while, the emission controls might not work as well, the vehicle's fuel economy might not be as good, and the engine might not run as smoothly. This could lead to costly repairs that might not be covered by the vehicle warranty.

Notice: Modifications made to the engine, transmission, exhaust, intake, or fuel system of the vehicle or the replacement of the original tires with other than those of the same Tire Performance Criteria (TPC) can affect the vehicle's emission controls and can cause this light to come on. Modifications to these systems could lead to costly repairs not covered by the vehicle warranty. This could also result in a failure to pass a required Emission Inspection/Maintenance test. See *Accessories and Modifications on page 9-3*.

This light comes on during a malfunction in one of two ways:

Light Flashing: A misfire condition has been detected. A misfire increases vehicle emissions and could damage the emission control system on the vehicle. Diagnosis and service might be required.

The following can prevent more serious damage to the vehicle:

- Reduce vehicle speed.
- Avoid hard accelerations.
- Avoid steep uphill grades.
- If towing a trailer, reduce the amount of cargo being hauled as soon as it is possible.

If the light continues to flash, when it is safe to do so, stop the vehicle. Find a safe place to park the vehicle. Turn the key off, wait at least 10 seconds, and restart the engine. If the light is still flashing, follow the previous steps and see your dealer/retailer for service as soon as possible.

Light On Steady: An emission control system malfunction has been detected on the vehicle. Diagnosis and service might be required.

An emission system malfunction might be corrected by doing the following:

- Make sure the fuel cap is fully installed. See *Filling the Tank on page 8-38*. The diagnostic system can determine if the fuel cap has been left off or improperly installed. A loose or missing fuel cap allows fuel to evaporate into the atmosphere. A few driving trips with the cap properly installed should turn the light off.
- If the vehicle has been driven through a deep puddle of water, the vehicle's electrical system might be wet. The condition is usually corrected when the electrical system dries out. A few driving trips should turn the light off.

- Make sure to fuel the vehicle with quality fuel. Poor fuel quality causes the engine not to run as efficiently as designed and may cause: stalling after start-up, stalling when the vehicle is changed into gear, misfiring, hesitation on acceleration, or stumbling on acceleration. These conditions might go away once the engine is warmed up.

If one or more of these conditions occurs, change the fuel brand used. It will require at least one full tank of the proper fuel to turn the light off.

See *Gasoline Octane on page 8-36*.

If none of the above have made the light turn off, your dealer/retailer can check the vehicle. The dealer/retailer has the proper test equipment and diagnostic tools to fix any mechanical or electrical problems that might have developed.

4-22 Instruments and Controls

Emissions Inspection and Maintenance Programs

Some state/provincial and local governments have or might begin programs to inspect the emission control equipment on the vehicle. Failure to pass this inspection could prevent getting a vehicle registration.

Here are some things to know to help the vehicle pass an inspection:

- The vehicle will not pass this inspection if the check engine light is on with the engine running, or if the key is in the ON/RUN and the light is not on.
- The vehicle will not pass this inspection if the OBD II (on-board diagnostic) system determines that critical emission control systems have not been completely diagnosed by the system. The vehicle would be considered not ready for

inspection. This can happen if the battery has recently been replaced or if the battery has run down. The diagnostic system is designed to evaluate critical emission control systems during normal driving. This can take several days of routine driving. If this has been done and the vehicle still does not pass the inspection for lack of OBD II system readiness, your dealer/retailer can prepare the vehicle for inspection.

Security Light

SECURITY 

For information regarding this light and the vehicle's security system, see *Content Theft-Deterrent* on page 2-10.

Oil Pressure Light

 CAUTION

Do not keep driving if the oil pressure is low. The engine can become so hot that it catches fire. Someone could be burned. Check the oil as soon as possible and have the vehicle serviced.

Notice: Lack of proper engine oil maintenance can damage the engine. The repairs would not be covered by the vehicle warranty. Always follow the maintenance schedule in this manual for changing engine oil.



The oil pressure light should come on briefly as the engine is started. If it does not come on have the vehicle serviced by your dealer/retailer.

If the light comes on and stays on, it means that oil is not flowing through the engine properly. The vehicle could be low on oil and might have some other system problem.

Fog Lamp Light



For vehicles with this feature, this light comes on whenever the front fog lamps are on.

See *Exterior Lamps Controls* on page 5-1 for more information.

Lights On Reminder

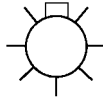

This light comes on whenever the headlights are on.

See *Exterior Lamps Controls* on page 5-1 for more information.

Taillamp Indicator Light



Canada Only

This light will come on when your taillamps are on.

See *Exterior Lamps Controls* on page 5-1 for more information.

Cruise Control Light

CRUISE

The CRUISE light comes on when the cruise control is on.

See *Cruise Control* on page 4-4 for more information.

Low Washer Fluid Warning Light

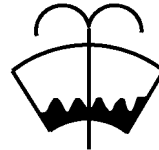

Canada Only

This light comes on when the windshield washer fluid is low. See *Windshield Washer Fluid* on page 9-24 for more information.

Service All-Wheel Drive Light

AWD

This light will come on briefly when the ignition is turned on, and the engine is not running, as a check to show you it is working.

It should go out when the engine is started. It should go out when the engine is started. If it stays on, or comes on while you are driving, you may have a problem with the system. Have it checked by your dealer/retailer.

The four-wheel-drive indicator will light up when the All-Wheel drive is active.

Highbeam On Light



This light comes on when the high-beam headlamps are in use.

See *Headlamp High/Low-Beam Changer* on page 4-7 for more information.

Door Ajar Light



This light comes on if any door, the rear liftgate, or the rear liftglass are not completely closed.

Fuel Gage



United States



Canada

The fuel gage shows about how much fuel is in the fuel tank. An arrow on the fuel gage indicates that the fuel filler door is on the driver side of the vehicle. The fuel gage works only when the ignition switch is turned to ON/RUN. When the gage first indicates E or empty, there is still about 2 gallons (7.6 L) of fuel left, but more needs to be added right away. When the vehicle is low on fuel the low fuel warning light, located below the empty mark, comes on.

Five things that do not indicate a problem with the fuel gage:

- At the gas station, the fuel pump shuts off before the gage reads F or full.
- It takes a little more or less fuel to fill up than the gage indicated. For example, the gage may have indicated the tank was half full, but it actually took more or less than half the tank's capacity to fill it.
- It takes the gage several minutes to read F or full after filling the vehicle with fuel.
- The gage moves a little when you turn, stop or speed up.
- The gage does not go back to E or empty when you turn off the ignition.

Low Fuel Warning Light



United States



Canada

This light, on the fuel gage, comes on when the fuel tank is low on fuel. To turn it off, add fuel to the fuel tank.

OnStar[®] System



OnStar uses several innovative technologies and live advisors to provide a wide range of safety, security, information, and convenience services. If the airbags deploy, the system is designed to make an automatic call to OnStar Emergency advisors who can request emergency services be sent to your location. If the keys are locked in the vehicle, call OnStar at 1-888-4-ONSTAR to have a signal sent to unlock the doors. OnStar Hands-Free Calling, including 30 trial minutes good for 60 days, is available on most vehicles. Press the OnStar button to have an OnStar advisor contact Roadside Service.

4-26 Instruments and Controls

OnStar service is provided subject to the OnStar Terms and Conditions included in the OnStar Subscriber glove box literature.

Some services such as Remote Door Unlock or Stolen Vehicle Location Assistance may not be available until the owner of the vehicle registers with OnStar. After the first prepaid year, contact OnStar to select a monthly or annual subscription payment plan. If a payment plan is not selected, the OnStar system and all services, including airbag notification and emergency services, may be deactivated and no longer available. For more information visit www.onstar.com (U.S.) or www.onstar.ca (Canada), or press the OnStar button to speak with an advisor.

Not all OnStar services are available on all vehicles. To check if this vehicle is able to provide the services described below, or for a full description of OnStar services

and system limitations, see the OnStar Owner's Guide in the glove box or visit www.onstar.com (U.S.) or www.onstar.ca (Canada), contact OnStar at 1-888-4-ONSTAR (1-888-466-7827) or TTY 1-877-248-2080, or press the OnStar button to speak with an OnStar advisor 24 hours a day, 7 days a week.

OnStar Services Available with the Safe & Sound Plan

- Automatic Notification of Airbag Deployment
- Link to Emergency Services
- Roadside Assistance
- Stolen Vehicle Location Assistance
- Remote Door Unlock/Vehicle Alert
- OnStar Hands-Free Calling with 30 trial minutes
- OnStar Virtual Advisor (U.S. Only)

OnStar Services Included with Directions & Connections Plan

- All Safe and Sound Plan Services
- Driving Directions - Advisor Delivered
- RideAssist
- Information and Convenience Services

OnStar Hands-Free Calling

OnStar Hands-Free Calling allows eligible OnStar subscribers to make and receive calls using voice commands. Hands-Free Calling is fully integrated into the vehicle, and can be used with OnStar Pre-Paid Minute Packages. Most vehicles include 30 trial minutes good for 60 days. Hands-Free Calling can also be linked to a Verizon Wireless service plan in the U.S. or a Bell Mobility service plan in Canada, depending on eligibility.

To find out more, refer to the OnStar Owner's Guide in the vehicle's glove box, visit www.onstar.com or www.onstar.ca, or speak with an OnStar advisor by pressing the OnStar button or calling 1-888-4-ONSTAR (1-888-466-7827).

OnStar Virtual Advisor

OnStar Virtual Advisor is a feature of OnStar Hands-Free Calling that uses minutes to access location-based weather, local traffic reports, and stock quotes. Press the phone button and give a few simple voice commands to browse through the various topics. See the OnStar Owner's Guide for more information. This feature is only available in the continental U.S.

How OnStar Service Works

The OnStar system can record and transmit vehicle information. This information is automatically sent to an OnStar Call Center when the OnStar button is pressed, the emergency button is pressed, or if

the airbags deploy. This information usually includes the vehicle's GPS location and, in the event of a crash, additional information regarding the crash that the vehicle was involved in (e.g. the direction from which the vehicle was hit). When the Virtual Advisor feature of OnStar Hands-Free Calling is used, the vehicle also sends OnStar the vehicle's GPS location so they can provide services where it is located.

OnStar service cannot work unless the vehicle is in a place where OnStar has an agreement with a wireless service provider for service in that area. OnStar service also cannot work unless the vehicle is in a place where the wireless service provider OnStar has hired for that area has coverage, network capacity and reception when the service is needed, and technology that is compatible with the OnStar service. Not all services are available everywhere, particularly in remote or enclosed areas, or at all times.

Location information about the vehicle is only available if the GPS satellite signals are unobstructed and available.

The vehicle must have a working electrical system, including adequate battery power, for the OnStar equipment to operate. There are other problems OnStar cannot control that may prevent OnStar from providing OnStar service at any particular time or place. Some examples are damage to important parts of the vehicle in a crash, hills, tall buildings, tunnels, weather or wireless phone network congestion.

Your Responsibility

Increase the volume of the radio if the OnStar advisor cannot be heard. If the light next to the OnStar buttons is red, the system may not be functioning properly. If the light appears clear (no light is appearing), your OnStar subscription has expired and all services have been deactivated. Press the OnStar button to confirm that the OnStar equipment is active.

Lighting

Lighting





Exterior Lamps Controls	5-1
Daytime Running Lamps (DRL)	5-2
Automatic Headlamp System	5-2
Fog Lamps	5-2
Instrument Panel Brightness	5-3
Dome Lamp(s)	5-3
Entry Lighting	5-3
Reading Lamps	5-4
Battery Run-Down Protection	5-4

Lighting

Exterior Lamps Controls



The lever on the left side of the steering column operates the exterior lamps.

 /  (**Exterior Lamps**): Turn the outside band of the lever to operate the lamps. For vehicles sold in the U.S.,  appears on the instrument panel cluster when the exterior lamps are on. For vehicles first sold in Canada,  appears in the instrument panel cluster. See *Lights On Reminder* on page 4-23.

The exterior lamp switch has three positions:

 (**Off**): Turns off all lamps, except the Daytime Running Lamps (DRL).

 (**Parking Lamps**): Turns on the parking lamps together with the following:

- Sidemarkers Lamps
- Taillamps
- License Plate Lamp
- Instrument Panel Lights

 (**Headlamps**): Turns on the headlamps, together with the previously listed lamps and lights.

Headlamps on Reminder

A tone sounds when the ignition is turned to LOCK/OFF, the driver door is opened and the key is removed from the ignition while the lamps are on.

5-2 Lighting

Daytime Running Lamps (DRL)

Daytime Running Lamps (DRL) can make it easier for others to see the front of your vehicle during the day. Fully functional DRL are required on all vehicles first sold in Canada.

The DRL system makes the headlamps come on at a reduced brightness when the following conditions are met:

- The ignition is on with the engine running.
- The exterior lamps switch is off.
- The parking brake is released.

When the exterior lamp switch is turned to the headlamp position, the DRL go off and the headlamps come on. The other lamps that come on with the headlamps also come on.

The headlamps automatically switch from DRL to the regular headlamps depending on the darkness of the surroundings. See “Automatic Headlamp System” following.

DRL also comes on if only the parking lamps are being used.

Automatic Headlamp System



When it is dark enough outside, the automatic headlamp system turns on the low-beam headlamps at the normal brightness along with other lamps such as the taillamps, sidemarker, parking lamps and instrument panel lights. An indicator light on the instrument panel comes on when the headlamps are on.

See *Instrument Panel Cluster* on page 4-12.

If the vehicle is driven through a parking garage, overcast weather, or a tunnel, the automatic headlamp system may turn on. There is a delay before the lights turn on when starting the car at night.

Do not cover the automatic light sensor, located on the top left corner of the instrument panel. If the sensor is covered the headlamps will stay on continuously.

Fog Lamps

 **(Fog Lamps):** For vehicles with fog lamps, move the band on the turn signal/multifunction lever to  to turn them on. The fog lamps only come on when the headlamps are on low beam.

Some localities have laws that require the headlamps to be on along with the fog lamps.

Instrument Panel Brightness



Use the trip odometer knob located on the right side of the instrument panel cluster to adjust the instrument panel brightness.

Turn the knob clockwise or counterclockwise to brighten or dim the instrument panel.

The brightness of the instrument panel lights decreases when the headlamps are on.

Dome Lamp(s)

The interior lamps control is located on the overhead lamp. To change the interior lamps setting, slide the switch to one of the following positions:

OFF: Turns the lamp off.

ON: Keeps the lamp on all the time.

Door: Turns the lamp on when any door or the liftgate is opened. The lamp goes off when all the side doors and the liftgate are closed.

If the lamp switch is in the door position and a door is left open, the lamps will go off automatically after 20 minutes.

Entry Lighting

After all the doors and liftgate are closed, and the key is out of the ignition, in LOCK/OFF or ACC/ACCESSORY, the light remains on for about 15 seconds and then goes out, except under the following conditions:

- The ignition is turned to ACC/ACCESSORY or ON/RUN after all the doors and liftgate are closed.
- All the doors and the liftgate are locked and the light is still on.

When any door is unlocked with the key or Remote Keyless Entry (RKE) system transmitter, the light comes on for 15 seconds, even if the door is not opened.

5-4 Lighting

Reading Lamps

For vehicles with a sunroof, there is a reading lamp near the sunroof switch.

OFF: Turns the lamp off.

ON: Keeps the lamp on all the time.

Door: Turns the lamp on when any door or the liftgate is opened. The lamp goes off when all the side doors and the liftgate are closed.

Battery Run-Down Protection

The vehicle has a battery saver feature designed to protect the vehicle's battery.

This feature will only work with the dome lamp in the Door position.

When any interior lamp is left on and the ignition is turned off, the battery rundown protection system automatically turns the lamp off after 20 minutes. This prevents draining of the battery.

Infotainment

Audio System(s)

Audio System(s)	6-1
Setting the Clock	6-2
Radio(s)	6-3
Using an MP3	6-9
XM Radio Messages	6-12
Audio Steering Wheel	
Controls	6-13
Radio Reception	6-14
Fixed Mast Antenna	6-14
XM™ Satellite Radio	
Antenna System	6-14

Audio System(s)

Determine which radio the vehicle has and read the following pages to become familiar with its features.

 **CAUTION**

Taking your eyes off the road for extended periods could cause a crash resulting in injury or death to you or others. Do not give extended attention to entertainment tasks while driving.

This system provides access to many audio and non audio listings.

To minimize taking your eyes off the road while driving, do the following while the vehicle is parked:

- Become familiar with the operation and controls of the audio system.
- Set up the tone, speaker adjustments, and preset radio stations.

For more information, see *Defensive Driving* on page 8-17.

Setting the Clock





The radio has a CLOCK button for adjusting the time and date.

The date does not automatically display. To see the date press CLOCK while the radio is on.

The date with display times out after a few seconds and goes back to the normal radio and time display.

To adjust the time and date:

1. Turn the ignition key to ACC/ACCESSORY or ON/RUN.
2. Press the PWR VOL (Power/Volume) knob to turn on the radio.
3. Press the CLOCK button, and the HR, MIN, MM, DD, YYYY (hour, minute, month, day, and year) categories display.
4. Press the button under the category to be adjusted.

5. To increase the time or date, do one of the following: turn the TUNE ADJ (Tune/Adjust) knob clockwise, press SEEK/TRACK , press FWD  (Forward), or continue to press the button under the category to be adjusted.
6. To decrease the time or date, do one of the following: turn the TUNE ADJ knob counterclockwise, press SEEK/TRACK , or press REV  (Reverse).
7. To save the settings, press the CLOCK button, or let the display time out.

To change the time default setting from 12 hour to 24 hour, and to change the date default setting from month/day/year to day/month/year:

1. Press the CLOCK button and then the button below the forward arrow label on the display. The 12H and 24H, and the date MMDD (month and day) and DDMM (day and month) categories will display.
2. Press the button below the 12H or 24H label, and the date MMDD (month and day) or DDMM (day and month) label to choose how the radio displays the time and date.
3. To save the settings, press the CLOCK button, or let the screen time out.

Radio(s)

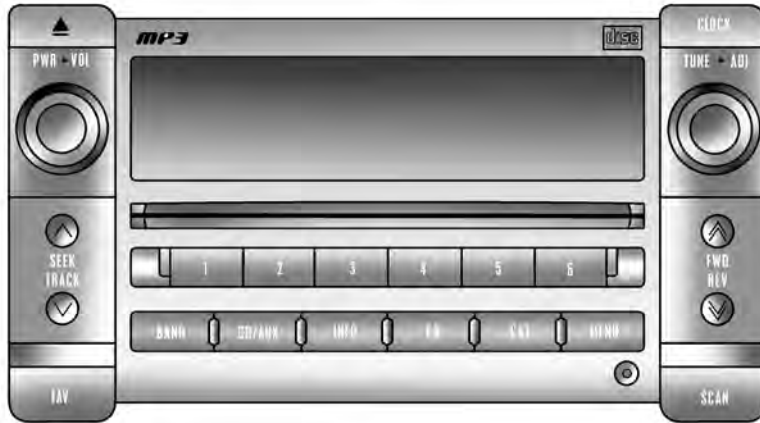

Radio with CD (MP3) shown, Radio with CD (Base) similar

Playing the Radio

PWR VOL (Power/Volume): Press to turn the radio on and off. Turn the PWR VOL knob to adjust the volume.

CLOCK: Press to adjust the time. See *Setting the Clock* on page 6-2 for more information.

Finding a Station

BAND: Press to select AM, FM, or XM.

TUNE ADJ (Tune/Adjust): Turn to select radio stations.

^ SEEK TRACK V: Press to go to the previous or next radio station. The radio only stops at stations with a strong signal.

SCAN: Press to enter scan mode. The radio will display Scanning, then goes to the next station, plays for a few seconds, then continues on to the next station. Press SCAN again to stop scanning. The radio only stops at stations with a strong signal.

INFO (Information) (FM-RDS, XM™ Satellite Radio Service, and MP3 Features): Press to display information for the current FM-RDS, XM station, or MP3 song. Choose from Channel, Song, Artist, and CAT (category).

NO INFO displays when information is not available from the station.

6-4 Infotainment

Setting Preset Stations

FAV (Favorites): Press to select up to six pages of favorites. Each page contains six favorite stations, and each page of favorites can contain any combination of AM, FM, or XM™ stations.

For vehicles without XM, only four pages of favorites are available.

To setup the number of favorites pages:

1. Press the MENU button to display the radio setup menu.
2. Press the button located below the FAV 1-6 label.
3. Select the desired number of favorites pages by pressing the button located below the displayed page numbers.
4. Press the FAV button, or let the menu time out, to return to the radio screen.

To store a radio station as a favorite:

1. Tune to the desired radio station.
2. Press the FAV button to display the page where it can be stored.
3. Press and hold one of the six buttons until a beep sounds.
4. Repeat the steps to store another radio station.

Setting the Tone (Bass/Midrange/Treble)

To adjust the bass, midrange, and treble:

1. Press the TUNE ADJ knob.
2. Turn the TUNE ADJ knob, or press the button below BASS, MID, or TREB so it is highlighted.
3. Press the TUNE ADJ knob to select BASS, MID, or TREB.
4. Turn the TUNE ADJ knob to adjust the level.
5. Press the TUNE ADJ knob to set the adjustment.

EQ (Equalization): To select customized equalization settings:

1. Press EQ.
2. Press the button below the label: POP, ROCK, COUNTRY, TALK, JAZZ, and CLASSICAL.

Adjusting the Speakers (Balance/Fade)

To adjust the balance or fade, perform the following steps:

1. Press the TUNE ADJ knob.
2. Turn the TUNE ADJ knob or press the button below BAL FADE so it is highlighted.
3. Press the TUNE ADJ knob to select the tone to adjust.
4. Turn the TUNE ADJ knob to adjust the audio balance to the right or the left speakers and the fade to adjust the audio volume to the front or rear speakers.
5. Press the TUNE ADJ knob to set the adjustment.

Finding a Category (CAT) Station (XM Satellite Radio Service Only)

If CAT times out and is no longer on the display, return to Step 1.

To select and find a desired category:

1. Press the CAT button.
2. Turn the TUNE ADJ knob to select a category.
3. Press \wedge or \vee to go to the category's first station, when the desired category is displayed.
4. Press \wedge or \vee to go to another station within the selected category.
5. Press CAT to exit the category select mode or wait for CAT to time out.

NOT FOUND displays if the desired category cannot be found.

Scanning Categories (CAT) (XM Satellite Radio Service Only)

To scan a desired category:

1. Press the CAT button to enter the category select mode.
2. Turn the TUNE ADJ knob to select a category.
3. Press \wedge or \vee for two seconds to scan the stations in the selected category.
4. Press \wedge or \vee again to stop scanning.

NOT FOUND displays if the desired category cannot be found.

XM Satellite Radio Service

XM is a satellite radio service that is based in the 48 contiguous United States and 10 Canadian provinces. XM Satellite Radio has a wide variety of programming and commercial-free music, coast-to-coast, and in digital-quality sound. During your trial or when you subscribe, you will get unlimited access to XM Radio Online for when you are not in your vehicle. A service fee is required to receive the XM service. For more information, contact XM at www.xmradio.com or call 1-800-929-2100 in the U.S. and www.xmradio.ca or call 1-877-438-9677 in Canada.

6-6 Infotainment

Radio Data System (RDS)

The audio system has Radio Data System (RDS). RDS features are available for use only on FM stations that broadcast RDS information.

With RDS:

- Stations can be selected based on programming.
- Stations with traffic announcements can be selected.
- Announcements concerning local and national emergencies can be received.
- Messages display from radio stations.

RDS relies on receiving specific information from radio stations and only works when the information is available. In rare cases, a radio station could broadcast incorrect information that causes the radio features to work improperly. Contact the radio station if this happens.

When the radio is tuned to an RDS station, the station name or call letters display instead of the frequency. RDS stations can also provide the time of day, a program type (PTY) for current programming, and the name of the program being broadcast.

RDS Messages

ALERT: Displays when local or national emergency announcements are received. If the radio tunes to a related network station for the announcement, it returns to the original station when the announcement ends. The announcement should be heard even if the volume is low or a CD is playing. If a CD is playing, it will stop playing during the announcement.

- The RDS alert feature is not supported by all RDS radio stations.

- The RDS alert feature cannot be turned off.
- Alert is not affected by tests of the emergency broadcast system.

MSG (Message): Displays if the current RDS station has a message. The message displays the artist, song title, call in phone numbers, etc. If the entire message does not display, parts of the message appear every three seconds until the message is completed. MSG disappears from the display once the completed message has displayed.

Radio Messages for XM Only

See *XM Radio Messages* on page 6-12 later in this section for further detail.

Playing a CD

The CD player can play the smaller 3 inch (8 cm) single CDs with an adapter ring.

1. Insert a CD label side up partway into the slot.
2. The CD player pulls the CD in and begins playing.
3. The CD symbol and track number displays.
4. The CD stays in the player if the ignition or radio is turned off.
5. If the CD was the last source selected, it resumes playing when the radio is turned on.

EJECT: Press and release to eject a CD. Once ejected it can be removed. If the CD is not removed after several seconds the CD player automatically pulls the disc back into the player and starts playing.

TUNE ADJ: Turn the TUNE ADJ knob to select tracks on the CD.

SEEK TRACK: Press **^** to go to the start of the current track, if more than ten seconds have played. Press **v** to go to the next track. Holding or pressing **^** or **v** multiple times causes the player to continue moving backward or forward through the tracks on the CD.

FWD REV (**Fast Forward/ Fast Reverse**): Press and hold **⏩** to advance playback quickly within a track. Release to resume playing the track. Press and hold **⏪** to reverse playback quickly within a track. Release to resume playing the track.

BAND: Press to listen to the radio when a CD is playing.

CD/AUX (CD/Auxiliary): Press to play a CD when listening to the radio.

Press the CD/AUX button again and the system begins playing audio from the connected portable audio player. If a portable audio player is not connected, "No Input Device Found" displays.

See "Using the Auxiliary Input Jack" later in this section.

INFO (Information): Press to switch the display between the track number, elapsed time of the track, and the time. When the ignition is off, press this button to display the time.

EQ (Equalization): Press to select an equalization setting while playing a CD. See "EQ" listed previously for more information. If an EQ setting is selected for a CD, it is activated each time a CD is played.

6-8 Infotainment

Care of CDs

The sound quality of the CD player can be reduced because of:

- The CD-R quality.
- The method of recording the CD-R.
- The quality of the music that has been recorded on the CD-R.
- The way the CD-R has been handled.

Store CD-R(s) in their original cases or other protective cases and away from dust and direct sunlight. The CD player scans the bottom surface of the disc. If the surface of a CD is damaged, such as cracked, broken, or scratched, the CD may not play properly or at all. Do not touch the bottom side of a CD while handling it; this could damage the surface. Pick up CDs by grasping the outer edges or the edge of the hole and the outer edge.

To clean a CD, use a soft lint free cloth, or dampen a clean soft cloth in a mild neutral detergent solution mixed with water. Wipe the CD from the center to the edge.

Care of The CD Player

Use a marking pen to identify CDs, do not add labels.

Do not use CD lens cleaners; they could damage the CD player.

Notice: If a label is added to a CD, or more than one CD is inserted into the slot at a time, or an attempt is made to play scratched or damaged CDs, the CD player could be damaged. While using the CD player, use only CDs in good condition without any label, load one CD at a time, and keep the CD player and the loading slot free of foreign materials, liquids, and debris.

If an error displays, see "CD Messages" later in this section.

Playing an MP3 CD-R Disc

Radios with the MP3 feature are capable of playing an MP3 CD-R disc. For more information on how to play an MP3 CD-R disc, see Using an MP3 later in this section.

CD Messages

If the CD ejects, it could be for one of the following reasons:

- The CD player is very hot. When the temperature returns to normal, the CD should play.
- The road is very rough. When the road becomes smoother, the CD should play.
- The CD is dirty, scratched, wet, or upside down.
- The air is very humid. If so, wait about an hour and try again.
- The format of the CD might not be compatible. See Using an MP3 later in this section.

- A problem may have occurred while burning the CD.
- The label could be caught in the CD player.

If any error occurs repeatedly or if an error cannot be corrected, contact your dealer/retailer. If the radio displays an error message, write it down and provide it to your dealer/retailer when reporting the problem.

Using the Auxiliary Input Jack

The radio has an auxiliary input jack located on the lower right side of the faceplate. This is not an audio output; do not plug the headphone set into the front auxiliary input jack. An external audio device such as an iPod, laptop computer, MP3 player, CD changer, etc. can be connected to the auxiliary input jack for use as another audio source.

To use a portable audio player, connect a 3.5 mm (1/8 inch) cable to the radio's front auxiliary input jack. When a device is connected, press the radio CD/AUX button to begin playing audio from the device over the vehicle speakers.

PWR VOL (Power/Volume): Turn to adjust the volume. Additional volume adjustments may have to be made from the portable device if the volume is too quiet or not loud.

BAND: Press to listen to the radio when a portable audio device is playing.

CD/AUX (CD/Auxiliary): Press to play a CD when a portable audio device is playing. Press again and the system begins playing audio from the connected portable audio player.

Using an MP3

MP3 CD-R Disc

MP3 Format

The MP3 player will only play CD-R discs. It can read and play a maximum of:

- 50 folders
- 11 folders in depth
- 50 playlists
- 10 sessions
- 255 files

All folders, playlists, sessions and files over the maximum are ignored.

Record an MP3 disc:

- Onto a CD-R disc.
- Record playlists with an .m3u or .wpl extension.
- Do not mix standard audio and MP3 files on the same disc.
- Record the entire disc at once.
- Finalize the disc when recording an MP3 disc with multiple sessions.

Root Directory

The root directory is treated as a folder. All .mp3 files in the root directory are accessed before folders in the root directory.

Empty Directory or Folder

Empty folders and directories do not display. The system ignores empty directories and folders and advances to the next directory or folder that has .mp3 files in it.

No Folder

On a CD that contains only .mp3 files in the root directory the next and previous folder functions do not work.

On a CD that contains playlists and .mp3 files the next and previous folder functions search playlists first and then search .mp3 files in the root folder.

Order of Play

CDs that have playlists play the tracks in the following order:

1. After the first track in the first playlist ends, play continues sequentially through all tracks in each playlist
2. After the last track of the last playlist ends, play restarts from the first track of the first playlist.

CDs that do not have playlists play the tracks in the following order:

1. The first file in the root directory plays.
2. After all files from the root directory have played, files in the folders play.
3. After playing the last file from the last folder, play restarts with the first file in the root directory.

File System and Naming

The radio display shows, track names that are shorter than 39 characters. Names that are longer are shortened. The track name appears as:

- The song name that is in the ID3 tag.
- The file name without the file extension if the song name is not in the ID3 tag.

Preprogrammed Playlists

Playlists are accessed before files or folders in the root directory.

Preprogrammed playlists created by WinAmp™, MusicMatch™, or Real Jukebox™ software can be accessed and are treated as special folders containing compressed audio song files.

Music Navigator

The music navigator feature lets MP3 CDs play in order by artist or album.

- The MP3 player scans the disc to sort the files by artist and album ID3 tag information.
- It can take several minutes to scan the disc depending on the number of MP3 files recorded to the CD-R.
- The radio starts playing while the disc is being scanned.
- After the scan is finished, the disc starts playing.

Playing an MP3

The MP3 player can play the smaller 3 inch (8 cm) single CDs with an adapter ring.

1. Insert a CD label side up partway into the slot.
2. The CD player pulls the CD in and begins playing.

3. The CD stays in the player if the ignition or radio is turned off.
4. If the CD was the last source selected, it resumes playing when the radio is turned on.

▲ (EJECT): Press and release to eject a CD. Once the disc is ejected it can be removed. If the CD is not removed after several seconds the CD player automatically pulls the disc back into the player and starts playing.

∧ SEEK TRACK ∨: Press to go to the start of the current track, if more than ten seconds have played. Press ∨ to go to the next track.

Holding or pressing ∧ or ∨ multiple times will cause the player to continue moving backward or forward through the tracks on the CD.

⏮ FWD REV ⏭ (Fast Forward/Fast Reverse): Press and hold ⏭ to advance playback quickly within a track. Release ⏮ to resume playing the track. Press and hold ⏮ to reverse playback quickly within a track. Release ⏭ to resume playing the track.

BAND: Press to listen to the radio when a CD is playing.

INFO (Information): Press when an MP3 CD is loaded, then press the button below the Song, Artist, Album, or Folder label to view the information.

CD/AUX (CD/Auxiliary): Press to play a CD when listening to the radio.

Press the CD/AUX button again and the system begins playing audio from the connected portable audio player. If a portable audio player is not connected, "No Input Device Found" displays.

RDM (Random): Press the button below the RDM label to hear the tracks in random order.

 **(Previous Folder):** Press the button below to go to the first track in the previous folder.

 **(Next Folder):** Press the button below to go to the first track in the next folder.

 **(Music Navigator):** Press the button below to play MP3 files in order by artist or album.

SORT: Press the button below the SORT label to change between playback by artist or album while using the Music Navigator.

BACK: Press the button below the BACK label to return to the main music navigator screen.

 **(Previous/Next):** Press the button below to go to the next or previous artist or album in alphabetical order while using the Music Navigator.

XM Radio Messages

XL (Explicit Language Channels):

These channels, or any others, can be blocked at a customer's request, by calling 1-800-852-XXMM (9696).

Updating: The encryption code in the receiver is being updated, and no action is required. This process should take no longer than 30 seconds.

No Signal: The system is functioning correctly, but the vehicle is in a location that is blocking the XM™ signal. When the vehicle is moved into an open area, the signal should return.

Loading XM: The audio system is acquiring and processing audio and text data. No action is needed. This message should disappear shortly.

CH Off Air: This channel is not currently in service. Tune to another channel.

CH Unavail: This previously assigned channel is no longer assigned. Tune to another station. If this station was one of the presets, choose another station for that preset button.

No Info: No artist, song title, category, or text information is available at this time on this channel. The system is working properly.

No Info: No text or informational messages are available at this time on this channel. The system is working properly.

Not Found: There are no channels available for the selected category. The system is working properly.

XM Locked: The XM™ receiver in your vehicle may have previously been in another vehicle. For security purposes, XM™ receivers cannot be swapped between vehicles. If this message is received after having your vehicle serviced, check with your dealer/retailer.

Radio ID: If tuned to channel 0, this message alternates with the XM™ Radio eight digit radio ID label. This label is needed to activate the service.

Unknown: If this message is received when tuned to channel 0, there may be a receiver fault. Consult with your dealer/retailer.

Chk XMRCvr: If this message does not clear within a short period of time, the receiver may have a fault. Consult with your dealer/retailer.

Audio Steering Wheel Controls



For vehicles with audio steering wheel controls some audio controls can be adjusted at the steering wheel. They include the following:

– **🔊 + (Volume):** Press to decrease or increase the volume.

∨ ∟ (Next/Previous): Press to select the next or previous radio station, CD track, or MP3 folder.

- Press ∨ or ∟ to go to the next or previous preset station.
- Press and hold ∨ or ∟ until a beep is heard to go to the next or previous radio station. Only stations with a strong signal will be selected.
- Press ∨ or ∟ to go to the next or previous CD track.
- Press and hold ∨ or ∟ until a beep is heard to go to the next or previous MP3 folder.

MODE: Press to turn the audio system on or to select between AM, FM, XM, CD, or AUX.

Press and hold to turn the audio system off.

Radio Reception

Frequency interference and static can occur during normal radio reception if items such as cell phone chargers, vehicle convenience accessories, and external electronic devices are plugged into the accessory power outlet. If there is interference or static, unplug the item from the accessory power outlet.

AM

The range for most AM stations is greater than for FM, especially at night. The longer range can cause station frequencies to interfere with each other. For better radio reception, most AM radio stations boost the power levels during the day, and then reduce these levels during the night. Static can also occur when things like storms and power lines interfere with radio reception. When this happens, try reducing the treble on the radio.

FM Stereo

FM stereo gives the best sound, but FM signals only reach about 10 to 40 miles (16 to 65 km). Tall buildings or hills can interfere with FM signals, causing the sound to fade in and out.

XM™ Satellite Radio Service

XM Satellite Radio Service gives digital radio reception from coast-to-coast in the 48 contiguous United States, and in Canada. Just as with FM, tall buildings or hills can interfere with satellite radio signals, causing the sound to fade in and out. In addition, traveling or standing under heavy foliage, bridges, garages, or through tunnels could cause loss of the XM signal for a period of time. The radio may display NO XM SIGNAL to indicate interference.

Fixed Mast Antenna

The fixed mast antenna can withstand most car washes without being damaged. If the mast should ever become slightly bent, straighten it out by hand. If the mast is badly bent, replace it.

Check occasionally to make sure the mast is still tightened to the antenna base located on the roof of the vehicle. If tightening is required, tighten by hand.

XM™ Satellite Radio Antenna System

The XM Satellite Radio antenna is located on the roof of the vehicle. Keep this antenna clear of snow and ice build up for clear radio reception.

If the vehicle has a sunroof, the performance of the XM system may be affected if the sunroof is open.

Loading items onto the roof of the vehicle can interfere with the performance of the XM system. Make sure the XM Satellite Radio antenna is not obstructed.

Climate Controls

Climate Controls

Climate Control System	7-1
Outlet Adjustment	7-3
Passenger Compartment Air Filter	7-4

Climate Controls

Climate Control System

The heating, cooling, and ventilation for the vehicle can be controlled with this system.



Fan Control

 **(Fan):** Turn the center knob toward 4 to turn the system on or increase fan speed.

If the airflow seems low when the fan is at the highest setting, the passenger compartment air filter may need to be replaced. For more information, see *Passenger Compartment Air Filter* on page 7-4 and *Scheduled Maintenance* on page 11-4.

7-2 Climate Controls

Temperature Control

Turn the right knob clockwise or counterclockwise to increase or decrease the temperature inside the vehicle.

Air Delivery Mode Control

Turn the left knob to select from the following modes:

 **(Vent):** Air is directed to the upper instrument panel outlets.

 **(Bi-Level):** Air is directed to the upper instrument panel outlets and the floor outlets.

 **(Floor):** Air is directed to the floor and side window outlets.

 **(Defog):** Air is directed between the windshield, side windows, instrument panel outlets and the floor outlets.

Use the defog mode to clear the inside of the windshield of fog or moisture and to warm the passengers. The air conditioning compressor runs automatically in this setting without pressing A/C, unless the outside temperature is at or below 32°F (0°C).

 **(Defrost):** Air is directed to the windshield, instrument panel outlets and the side windows.

Use the defrost mode to remove fog or frost from the outside of the windshield more quickly. The air conditioning compressor runs automatically in this setting without pressing A/C, unless the outside temperature is at or below 32°F (0°C).

Do not drive the vehicle until all the windows are clear.

Air Conditioning

For vehicles with this feature, there will be the following controls:

A/C (Air Conditioning): Press to turn the air conditioning system on or off. An indicator light shows that it is on.

MAX A/C (Maximum Air Conditioning): Press the A/C and recirculation buttons at the same time to select MAX A/C.

On hot days, open the windows to let hot inside air escape; then close them. The vehicle will cool quicker and the A/C system operates more efficiently.

Because the A/C system removes moisture from the air, it is normal for a small amount of water to drip under the vehicle while idling or just after turning the engine off.

Recirculation

 **(Recirculation):** Press to turn the recirculation mode on or off. An indicator light shows that it is on. This mode recirculates the air inside the vehicle and helps to heat or cool the air more quickly. It can be used to prevent outside air and odors from entering the vehicle.

Press the button again to turn the recirculation mode off and the outside air mode on. Recirculation is automatically turned off when the climate control system mode knob is turned to defog, defrost, or is positioned between modes.

Rear Window Defogger

The rear window defogger uses a warming grid to clear fog from the rear window. It will only work when the ignition is in the ON/RUN position.

 **(Rear Defogger):** Press to turn the rear window defogger on or off. An indicator light shows that it is on. The rear window defogger stays on until it is manually turned off. Clear any snow from the rear window.

If the ignition is turned off, while the rear window defogger is on, the defogger turns back on automatically when the ignition is in the ON/RUN position again.

Notice: Do not use a razor blade or sharp object to clear the inside rear window. Do not adhere anything to the defogger grid lines in the rear glass. These actions may damage the rear defogger. Repairs would not be covered by your warranty.

Outlet Adjustment

Use the air outlets located in the center and outboard sides of the instrument panel, to change the direction of the air flowing through the vents.

Operation Tips

- Clear away any ice, snow or leaves from the outside air inlets at the base of the windshield.
- Use of non-GM approved hood deflectors can adversely affect the performance of the system.
- Keep the area under the front seats clear of objects for more effective air circulation.
- If the airflow seems low when the fan is at the highest setting, the passenger compartment air filter might need to be replaced. For more information, see Passenger Compartment Air Filter later in this section.

Passenger Compartment Air Filter

Both outside and recirculated air are routed through a passenger compartment air filter. Pollen, dust particles and other contaminants are removed by the filter. Airflow reductions indicate that the filter needs to be replaced. For a replacement filter see your dealer/retailer. See *Scheduled Maintenance* on page 11-4 for replacement intervals.

The access panel for the air filter is behind the glove box. To replace the filter:

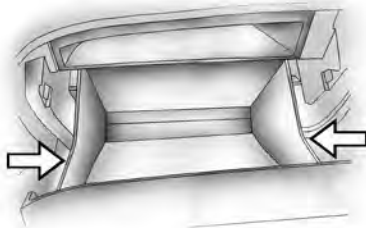

1. Open the glove box door. Push each side of the glovebox in and pull out to remove.

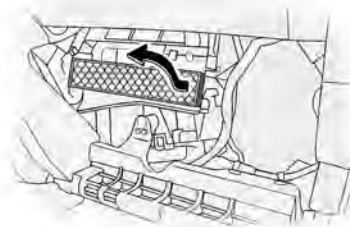

2. Push the side fastener to release and remove the filter cover.



3. Remove the air filter.
4. Install a new air filter and reassemble the unit by reversing the steps.

Replacing the air filter is recommended, but will not damage the vehicle if it is not.

Driving and Operating

Starting and Operating Your Vehicle

New Vehicle Break-In	8-2
Ignition Positions	8-2
Retained Accessory Power (RAP)	8-4
Starting the Engine	8-4
Engine Coolant Heater	8-5
Automatic Transmission Operation (Four Speed)	8-6
Automatic Transmission Operation (Five Speed)	8-8
Manual Transmission Operation	8-11
Parking Brake	8-12
Shifting Into Park	8-13
Shifting Out of Park	8-14

Parking the Vehicle (Manual Transmission)	8-15
Parking Over Things That Burn	8-16
Engine Exhaust	8-16
Running the Vehicle While Parked	8-17

Driving Your Vehicle

Defensive Driving	8-17
Drunk Driving	8-18
Control of a Vehicle	8-18
Braking	8-19
Antilock Brake System (ABS)	8-20
Traction Control System (TCS)	8-21
All-Wheel Drive (AWD) System	8-22
StabiliTrak [®] System	8-22
Steering	8-23
Off-Road Recovery	8-24
Passing	8-25
Loss of Control	8-25
Driving at Night	8-26

Driving in Rain and on Wet Roads	8-27
Before Leaving on a Long Trip	8-28
Highway Hypnosis	8-28
Hill and Mountain Roads ...	8-28
Winter Driving	8-29
If Your Vehicle is Stuck in Sand, Mud, Ice, or Snow ...	8-31
Rocking Your Vehicle to Get It Out	8-31
Loading the Vehicle	8-32

Fuel

Fuel	8-36
Gasoline Octane	8-36
Gasoline Specifications	8-36
California Fuel	8-36
Additives	8-37
Fuels in Foreign Countries	8-37
Filling the Tank	8-38
Filling a Portable Fuel Container	8-40

Starting and Operating Your Vehicle

New Vehicle Break-In

Notice: The vehicle does not need an elaborate break-in. But it will perform better in the long run if you follow these guidelines:

- Do not drive at any one constant speed, fast or slow, for the first 500 miles (805 km). Do not make full-throttle starts. Avoid downshifting to brake or slow the vehicle.

- Avoid making hard stops for the first 200 miles (322 km) or so. During this time the new brake linings are not yet broken in. Hard stops with new linings can mean premature wear and earlier replacement. Follow this breaking-in guideline every time you get new brake linings.
- Do not tow a trailer during break-in. See *Towing a Trailer* on page 9-77 for the trailer towing capabilities of your vehicle and more information.

Following break-in, engine speed and load can be gradually increased.

Ignition Positions

The ignition switch has four different positions.

To shift out of P (Park), turn the ignition to ON/RUN and apply the brake pedal.



Notice: Using a tool to force the key to turn in the ignition could cause damage to the switch or break the key. Use the correct key, make sure it is all the way in, and turn it only with your hand. If the key cannot be turned by hand, see your dealer/retailer.

LOCK/OFF: This is the only position from which you can remove the key. This locks the steering wheel, ignition and automatic transmission. Push in the ignition switch as you turn the key toward you.

On vehicles with an automatic transmission, the shift lever must be in P (Park) to turn the ignition switch to the LOCK/OFF position.

A warning tone will sound if the driver door is opened with the key in the ignition.

The ignition switch can bind in the LOCK/OFF position with your wheels turned off center. If this happens, move the steering wheel from right to left while turning the key to ACC/ACCESSORY. If this doesn't work, then the vehicle needs service.

 **CAUTION**

On manual transmission vehicles, turning the key to LOCK/OFF and removing it will lock the steering column and result in a loss of ability to steer the vehicle. This could cause a collision. If you need to turn the engine off while the vehicle is moving, turn the key only to ACC/ACCESSORY. Do not push the key in while the vehicle is moving.

ACC/ACCESSORY: This position provides power to some of the electrical accessories. It unlocks the steering wheel and ignition. To move the key from ACC/ACCESSORY to LOCK/OFF, push in the key and then turn it to LOCK/OFF.

A warning tone will sound when the driver door is opened when the ignition is still in ACC/ACCESSORY or LOCK/OFF and the key is in the ignition.

ON/RUN: The ignition switch stays in this position when the engine is running. This position can be used to operate the electrical accessories, including the ventilation fan and 115 volt power outlet, as well as to display some warning and indicator lights. The transmission is also unlocked in this position on automatic transmission vehicles.

The battery could be drained if you leave the key in the ACC/ACCESSORY or ON/RUN position with the engine off. You may not be able to start the vehicle if the battery is allowed to drain for an extended period of time.

START: This position starts the engine. When the engine starts, release the key. The ignition switch will return to ON/RUN for normal driving.

Retained Accessory Power (RAP)

These vehicle accessories may be used for less than a minute after the engine is turned off.

- Power Windows, if equipped
- Sunroof, if equipped

The power windows and sunroof will continue to work for less than a minute or until either front door is opened. The radio will work when the key is in ON/RUN or ACC/ACCESSORY.

Starting the Engine

Automatic Transmission

Move the shift lever to P (Park) or N (Neutral). The engine will not start in any other position. To restart when you are already moving, use N (Neutral) only.

Notice: Shifting into P (Park) with the vehicle moving could damage the transmission. Shift into P (Park) only when your vehicle is stopped.

Manual Transmission

The shift lever should be in NEUTRAL and the parking brake engaged. Hold the clutch pedal to the floor and start the engine. The vehicle will not start if the clutch pedal is not all the way down.

Starting Procedure

1. With your foot off the accelerator pedal, turn the ignition to START. When the engine starts, let go of the key. The idle speed will go down as the engine gets warm.

Vehicles equipped with the 1.8L engine have a Computer-Controlled Cranking System. This feature assists in starting the engine and protects components. If the ignition key is turned to the START position, and then released when the engine begins cranking, the engine will continue cranking for a about 30 seconds or until the vehicle starts. If the engine does

not start and the key is held in START for many seconds, cranking will be stopped after 25 seconds to prevent cranking motor damage. To prevent gear damage, this system also prevents cranking if the engine is already running. Engine cranking can be stopped by turning the ignition switch to ACC/ACCESSORY or LOCK/OFF.

Vehicles equipped with the 2.4L engine should not be cranked for more than 30 seconds at a time. This may overheat the starter and wiring systems.

Notice: Holding the key in START for longer than 15 seconds at a time will cause the battery to be drained much sooner. And the excessive heat can damage the starter motor. Wait about 15 seconds between each try to help avoid draining the battery or damaging the starter.

2. If the engine does not start, wait about 15 seconds and try again to start the engine by turning the ignition to START. Wait about 15 seconds between each try.

When the engine has run about 10 seconds to warm up, the vehicle is ready to be driven. Do not run the engine at high speed when it is cold.

If the weather is below freezing (32°F or 0°C), let the engine run for a few minutes to warm up.

3. If the engine still will not start, or starts but then stops, it could be flooded with too much gasoline. Try pushing the accelerator pedal all the way to the floor and holding it there as you hold the key in START for about three seconds. If the vehicle starts briefly but then stops again, do the same thing, but this time keep the pedal down for five or six seconds. This clears the extra gasoline from the engine.

Notice: The engine is designed to work with the electronics in the vehicle. If electrical parts or accessories are added, you could change the way the engine operates. Before adding electrical equipment, check with your dealer/retailer. If you do not, the engine might not perform properly. Any resulting damage would not be covered by the vehicle warranty.

Engine Coolant Heater

The engine coolant heater, if available, can help in cold weather conditions at or below 0°F (-18°C) for easier starting and better fuel economy during engine warm-up. Plug in the coolant heater at least four hours before starting the vehicle.

To Use the Engine Coolant Heater

1. Turn off the engine.
2. Open the hood and unwrap the electrical cord. The electrical cord is located on the driver side of the engine compartment.
3. Plug it into a normal, grounded 110-volt AC outlet.



Plugging the cord into an ungrounded outlet could cause an electrical shock. Also, the wrong kind of extension cord could overheat and cause a fire. You could be seriously injured. Plug the cord into a properly grounded three-prong 110-volt AC outlet. If the cord will not reach, use a heavy-duty three-prong extension cord rated for at least 15 amps.

8-6 Driving and Operating

4. Before starting the engine, be sure to unplug and store the cord as it was before to keep it away from moving engine parts. If you do not, it could be damaged.

The length of time the heater should remain plugged in depends on several factors. Ask a dealer/retailer in the area where you will be parking the vehicle for the best advice on this.

Automatic Transmission Operation (Four Speed)

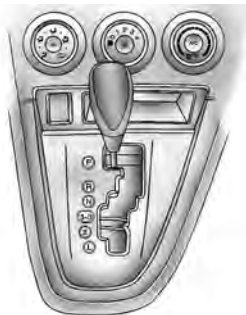

The shift lever is located on the console between the seats.

P (Park): This position locks the front wheels. It is the best position to use when you start the engine because the vehicle cannot move easily.

CAUTION

It is dangerous to get out of the vehicle if the shift lever is not fully in P (Park) with the parking brake firmly set. The vehicle can roll.

Do not leave the vehicle when the engine is running unless you have to. If you have left the engine running, the vehicle can move suddenly. You or others could be injured. To be sure the vehicle will not move, even when you are on fairly level ground, always set the parking brake and move the shift lever to P (Park). See *Shifting Into Park* on page 8-13. If you are pulling a trailer, see *Towing a Trailer* on page 9-77.

Make sure the shift lever is fully in P (Park) before starting the engine. The vehicle has an automatic transmission shift lock control system.

You must fully apply the regular brake first and move the shift lever to the right before you can shift from P (Park) when the ignition key is in ON/RUN. If you cannot shift out of P (Park), ease pressure on the shift lever, then push the shift lever all the way into P (Park) as you maintain brake application. Then move the shift lever to the right and move the shift lever into another gear. See *Shifting Out of Park* on page 8-14.

R (Reverse): Use this gear to back up.

Notice: Shifting to R (Reverse) while the vehicle is moving forward could damage the transmission. The repairs would not be covered by the vehicle warranty. Shift to R (Reverse) only after the vehicle is stopped.

To rock the vehicle back and forth to get out of snow, ice or sand without damaging the transmission, see *If Your Vehicle is Stuck in Sand, Mud, Ice, or Snow* on page 8-31.

N (Neutral): In this position, the engine does not connect with the wheels. To restart the vehicle when it is already moving, use N (Neutral) only. Also, use N (Neutral) when the vehicle is being towed.

CAUTION

Shifting into a drive gear while the engine is running at high speed is dangerous. Unless your foot is firmly on the brake pedal, the vehicle could move very rapidly. You could lose control and hit people or objects. Do not shift into a drive gear while the engine is running at high speed.

Notice: Shifting out of P (Park) or N (Neutral) with the engine running at high speed may damage the transmission. The repairs would not be covered by the vehicle warranty. Be sure the engine is not running at high speed when shifting the vehicle.

D (Drive): This position is for normal driving. It provides the best fuel economy. If you need more power for passing, and you are:

- Going less than 35 mph (56 km/h), push the accelerator pedal about halfway down.
- Going about 35 mph (56 km/h) or more, push the accelerator all the way down.

Notice: If the vehicle seems to start up rather slowly or not shift gears when you go faster, and you continue to drive the vehicle that way, you could damage the transmission. Have the vehicle serviced right away. You can drive in L2 (Low) when you are driving less than 35 mph (56 km/h) and D (Drive) for higher speeds until then.

2 (Second): This position reduces vehicle speed more than D (Drive) without using the brakes. You can use 2 (Second) on hills.

8-8 Driving and Operating

It can help control vehicle speed as you go down steep mountain roads, but then you would also want to use the brakes off and on.

L (Low): This position reduces vehicle speed even more than 2 (Second) without using the brakes. You can use it on very steep hills, or in deep snow or mud. If the shift lever is put in L (Low), the transmission will not shift into low gear until the vehicle is going slow enough.

Automatic Transmission Operation (Five Speed)

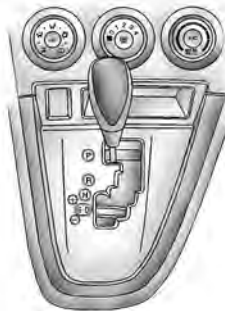

The shift lever is located on the console between the seats.

P (Park): This position locks the front wheels. It is the best position to use when starting the engine because the vehicle cannot move easily.

CAUTION

It is dangerous to get out of the vehicle if the shift lever is not fully in P (Park) with the parking brake firmly set. The vehicle can roll.

Do not leave the vehicle when the engine is running unless you have to. If you have left the engine running, the vehicle can move suddenly. You or others could be injured. To be sure the vehicle will not move, even when you are on fairly level ground, always set the parking brake and move the shift lever to P (Park). See *Shifting Into Park* on page 8-13. If you are pulling a trailer, see *Towing a Trailer* on page 9-77.

Make sure the shift lever is fully in P (Park) before starting the engine. The vehicle has an automatic transmission shift lock control system.

You must fully apply the regular brake first and move the shift lever to the right before shifting from P (Park) while the ignition key is in ON/RUN. If you cannot shift out of P (Park), ease pressure on the shift lever and push the shift lever all the way into P (Park) as you maintain brake application. Then move the shift lever into another gear. See *Shifting Out of Park* on page 8-14.

R (Reverse): Use this gear to back up.

Notice: Shifting to R (Reverse) while the vehicle is moving forward could damage the transmission. The repairs would not be covered by the vehicle warranty. Shift to R (Reverse) only after the vehicle is stopped.

To rock your vehicle back and forth to get out of snow, ice, or sand without damaging the transmission, see *If Your Vehicle is Stuck in Sand, Mud, Ice, or Snow* on page 8-31.

N (Neutral): In this position, the engine does not connect with the wheels. To restart the engine when the vehicle is already moving, use N (Neutral) only. Also, use N (Neutral) when the vehicle is being towed.

CAUTION

Shifting into a drive gear while the engine is running at high speed is dangerous. Unless your foot is firmly on the brake pedal, the vehicle could move very rapidly. You could lose control and hit people or objects. Do not shift into a drive gear while the engine is running at high speed.

Notice: Shifting out of P (Park) or N (Neutral) with the engine running at high speed may damage the transmission. The repairs would not be covered by the vehicle warranty. Be sure the engine is not running at high speed when shifting the vehicle.

D (Drive): This position is for normal driving. It provides the best fuel economy from the vehicle. If you need more power for passing, and you are:

- Going less than 35 mph (55 km/h), push the accelerator pedal about halfway down.
- Going about 35 mph (55 km/h) or more, push the accelerator all the way down.

8-10 Driving and Operating

Driver Shift Control (DSC)

DSC mode allows you to choose the top gear limit of the vehicle's transmission and the vehicle's speed while driving down hill or towing a trailer. To use this feature, do the following:

1. Move the shift lever from D (Drive) left to S (Shift Control).

While driving in this mode, the transmission will remain in the driver selected range.

When coming to a stop, the vehicle will automatically shift into 1 (First) gear.

2. Move the shift lever forward to increase the gear range, or rearward to decrease the gear range available based upon your current driving conditions and needs.

The number displayed in the instrument cluster is the highest gear that the transmission will be allowed to operate in. However, your vehicle can automatically shift to lower gears as required by various driving conditions. This means that all gears below that number are available.

The display in the instrument cluster will change from the currently displayed message to 4 (Fourth) when you enter S (Shift Control), and change to indicate the requested gear range when moving the shift lever forward or rearward.

While using the DSC feature the transmission will have firmer shifting and sportier performance. You can use this for sport driving or when climbing hills to stay in gear longer or to downshift for more power or engine braking.

The transmission will only allow shifting into gears appropriate for the vehicles speed and engine revolutions per minute (RPM):

- The transmission will not automatically shift to the next higher gear if the vehicle speed or engine RPM is too high.
- The transmission will not allow shifting to the next lower gear if the vehicle speed or engine RPM is too high. An audible warning will sound and the downshift will not be allowed. The downshift request will have to be made again once the vehicle reaches an acceptable speed.

Downshift Requested	Required Vehicle Speed
4 (Fourth) to 3 (Third)	Below 95 mph (153 km/h)
3 (Third) to 2 (Second)	Below 60 mph (97 km/h)
2 (Second) to 1 (First)	Below 30 mph (48 km/h)

Manual Transmission Operation

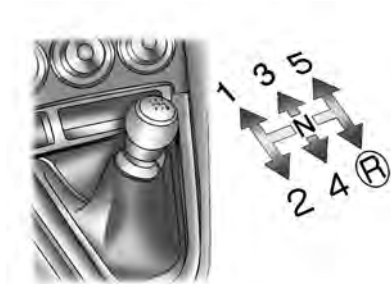

1 (First): Press the clutch pedal and shift into 1 (First). Then, slowly let up on the clutch pedal as you press the accelerator pedal.

You can shift into 1 (First) when you are going less than 20 mph (32 km/h). If you have come to a complete stop and it is hard to shift into 1 (First), put the shift lever in NEUTRAL and let up on the clutch. Press the clutch pedal back down. Then shift into 1 (First).

2 (Second): Press the clutch pedal as you let up on the accelerator pedal and shift into 2 (Second). Then, slowly let up on the clutch pedal as you press the accelerator pedal.

3 (Third), 4 (Fourth), 5 (Fifth): Shift into 3 (Third), 4 (Fourth) and 5 (Fifth) the same way you do for 2 (Second). Slowly let up on the clutch pedal as you press the accelerator pedal.

To stop, let up on the accelerator pedal and press the brake pedal. Just before the vehicle stops, press the clutch pedal and the brake pedal, and shift to NEUTRAL.

Neutral: Use this position when you start or idle the engine.

R (Reverse): To back up, press down on the clutch pedal and shift into R (Reverse). Let up on the clutch pedal slowly while pressing the accelerator pedal.

Notice: Shifting to R (Reverse) while the vehicle is moving forward could damage the transmission. The repairs would not be covered by the vehicle warranty. Shift to R (Reverse) only after the vehicle is stopped.

Also, use R (Reverse) along with the parking brake for parking your vehicle.

8-12 Driving and Operating

Shift Speeds

CAUTION

If you skip a gear when you downshift, you could lose control of your vehicle. You could injure yourself or others. Do not shift down more than one gear at a time when you downshift.

This chart shows the maximum allowable speeds in each gear when maximum acceleration is necessary.

Manual Transmission Recommended Shift Speeds

Engine	1.8L
1 to 2	34 mph (55 km/h)
2 to 3	56 mph (91 km/h)
3 to 4	82 mph (132 km/h)
4 to 5	121 mph (195 km/h)

Engine	2.4L
1 to 2	31 mph (50 km/h)
2 to 3	53 mph (86 km/h)
3 to 4	82 mph (132 km/h)
4 to 5	112 mph (181 km/h)

If your speed drops below 20 mph (32 km/h), or if the engine is not running smoothly, you should downshift to the next lower gear. You may have to downshift two or more gears to keep the engine running smoothly or for good performance.

Parking Brake

To set the parking brake, hold the brake pedal down and pull up on the parking brake lever. If the ignition is on, the brake system warning light will come on.



To release the parking brake, hold the brake pedal down. Pull the parking brake lever up until you can press the release button. Hold the release button in as you move the lever all the way down.

Notice: Driving with the parking brake on can overheat the brake system and cause premature wear or damage to brake system parts. Make sure that the parking brake is fully released and the brake warning light is off before driving.

If you are towing a trailer, see *Towing a Trailer on page 9-77*.

Shifting Into Park

⚠ CAUTION

It can be dangerous to get out of the vehicle if the shift lever is not fully in P (Park) with the parking brake firmly set. The vehicle can roll. If you have left the engine running, the vehicle can move suddenly. You or others could be injured. To be sure the vehicle will not move, even when you are on fairly level ground, use the steps that follow. If you are pulling a trailer, see *Towing a Trailer on page 9-77*.

To shift into P (Park), do the following:

1. Hold the brake pedal down and set the parking brake. See *Parking Brake on page 8-12* for more information.
2. Move the shift lever into P (Park) by pushing the lever all the way toward the front of the vehicle and to the left.
3. Turn the ignition key to LOCK/OFF.
4. Remove the key and take it with you. If you can leave the vehicle with the key in your hand, the vehicle is in P (Park).

Leaving Your Vehicle With the Engine Running (Automatic Transmission)

 **CAUTION**

It can be dangerous to leave the vehicle with the engine running. The vehicle could move suddenly if the shift lever is not fully in P (Park) with the parking brake firmly set. And, if you leave the vehicle with the engine running, it could overheat and even catch fire. You or others could be injured. Do not leave the vehicle with the engine running.

If you have to leave an automatic transmission vehicle with the engine running, be sure the vehicle is in P (Park) and the parking brake is firmly set before you leave it.

Torque Lock (Automatic Transmission)

If you are parking on a hill and you do not shift into P (Park) properly, the weight of the vehicle may put too much force on the parking pawl in the transmission. You may find it difficult to pull the shift lever out of P (Park). This is called “torque lock.” To prevent torque lock, set the parking brake and then shift into P (Park) properly before you leave the driver seat. To find out how, see *Shifting Into Park on page 8-13*.

Move the shift lever out of P (Park) before you release the parking brake.

If torque lock does occur, you may need to have another vehicle push yours a little uphill to take some of the pressure from the parking pawl in the transmission, so you can pull the shift lever out of P (Park).

Shifting Out of Park

This vehicle has an electronic shift lock release system. The shift lock release is designed to:

- Prevent ignition key removal unless the shift lever is in P (Park).
- Prevent movement of the shift lever out of P (Park), unless the ignition is in ON/RUN and the brake pedal is applied.

The shift lock release is always functional except in the case of an uncharged or low voltage (less than 9 volt) battery.

If the vehicle has an uncharged battery or a battery with low voltage, try charging or jump starting the battery. See *Jump Starting on page 9-71* for more information.

To shift out of P (Park) use the following:

1. Apply the brake pedal.
2. Move the shift lever to the desired position.

If you still are unable to shift out of P (Park):

1. Fully release the shift lever.
2. Hold the brake pedal down.
3. Move the shift lever to the desired position.

If you still cannot move the shift lever from P (Park), consult your dealer/retailer or a professional towing service.

Parking the Vehicle (Manual Transmission)

Before you get out of the vehicle, move the shift lever into R (Reverse), and firmly apply the parking brake. Once the shift lever has been placed into R (Reverse) with the clutch pedal pressed in, you can turn the ignition key to LOCK/OFF, remove the key and release the clutch.

If you are parking on a hill, or if the vehicle is pulling a trailer, see *Towing a Trailer on page 9-77*.

Evaporation Pump

The vehicle is equipped with a vacuum pump for the fuel evaporation system. This pump performs a fuel evaporation leakage test approximately five hours after the engine is turned off. You may hear a sound coming from underneath the rear cargo compartment for several minutes.

The noise is normal and does not signify a malfunction. See your dealer/retailer with any questions.

Parking Over Things That Burn

 **CAUTION**

Things that can burn could touch hot exhaust parts under the vehicle and ignite. Do not park over papers, leaves, dry grass, or other things that can burn.

Engine Exhaust

 **CAUTION**

Engine exhaust contains Carbon Monoxide (CO) which cannot be seen or smelled. Exposure to CO can cause unconsciousness and even death.

(Continued)

CAUTION (Continued)

Exhaust may enter the vehicle if:

- The vehicle idles in areas with poor ventilation (parking garages, tunnels, deep snow that may block underbody airflow or tail pipes).
- The exhaust smells or sounds strange or different.
- The exhaust system leaks due to corrosion or damage.
- The vehicle's exhaust system has been modified, damaged or improperly repaired.
- There are holes or openings in the vehicle body from damage or after-market modifications that are not completely sealed.

(Continued)

CAUTION (Continued)

If unusual fumes are detected or if it is suspected that exhaust is coming into the vehicle:

- Drive it only with the windows completely down.
- Have the vehicle repaired immediately.

Never park the vehicle with the engine running in an enclosed area such as a garage or a building that has no fresh air ventilation.

Running the Vehicle While Parked

It is better not to park with the engine running. But if you ever have to, here are some things to know.

CAUTION

Idling a vehicle in an enclosed area with poor ventilation is dangerous. Engine exhaust may enter the vehicle. Engine exhaust contains Carbon Monoxide (CO) which cannot be seen or smelled. It can cause unconsciousness and even death. Never run the engine in an enclosed area that has no fresh air ventilation. For more information, see Engine Exhaust *Engine Exhaust* on page 8-16.

CAUTION

It can be dangerous to get out of the vehicle if the automatic transmission shift lever is not fully in P (Park) with the parking brake firmly set. The vehicle can roll. Do not leave the vehicle when the engine is running unless you have to. If you have left the engine running, the vehicle can move suddenly. You or others could be injured. To be sure the vehicle will not move, even when you are on fairly level ground, always set the parking brake and move the shift lever to P (Park).

Follow the proper steps to be sure the vehicle will not move. See *Shifting Into Park* on page 8-13.

If parking on a hill and pulling a trailer, see *Towing a Trailer* on page 9-77.

Driving Your Vehicle Defensive Driving

Defensive driving means “always expect the unexpected.” The first step in driving defensively is to wear your safety belt, see *Safety Belts* on page 1-8.

CAUTION

Assume that other road users (pedestrians, bicyclists, and other drivers) are going to be careless and make mistakes. Anticipate what they might do and be ready. In addition:

- Allow enough following distance between you and the driver in front of you.
- Focus on the task of driving.

Driver distraction can cause collisions resulting in injury or possible death. These simple defensive driving techniques could save your life.

Drunk Driving

CAUTION

Drinking and then driving is very dangerous. Your reflexes, perceptions, attentiveness, and judgment can be affected by even a small amount of alcohol. You can have a serious — or even fatal — collision if you drive after drinking. Do not drink and drive or ride with a driver who has been drinking. Ride home in a cab; or if you are with a group, designate a driver who will not drink.

Death and injury associated with drinking and driving is a global tragedy.

Alcohol affects four things that anyone needs to drive a vehicle: judgment, muscular coordination, vision, and attentiveness.

Police records show that almost 40 percent of all motor vehicle-related deaths involve alcohol. In most cases, these deaths are the result of someone who was drinking and driving. In recent years, more than 17,000 annual motor vehicle-related deaths have been associated with the use of alcohol, with about 250,000 people injured.

For persons under 21, it is against the law in every U.S. state to drink alcohol. There are good medical, psychological, and developmental reasons for these laws.

The obvious way to eliminate the leading highway safety problem is for people never to drink alcohol and then drive.

Medical research shows that alcohol in a person's system can make crash injuries worse, especially injuries

to the brain, spinal cord, or heart. This means that when anyone who has been drinking — driver or passenger — is in a crash, that person's chance of being killed or permanently disabled is higher than if the person had not been drinking.

Control of a Vehicle

The following three systems help to control your vehicle while driving — brakes, steering, and accelerator. At times, as when driving on snow or ice, it is easy to ask more of those control systems than the tires and road can provide. Meaning, you can lose control of your vehicle.

Adding non-dealer/non-retailer accessories can affect your vehicle's performance. See *Accessories and Modifications on page 9-3*.

Braking

See *Brake System Warning Light* on page 4-17.

Braking action involves perception time and reaction time. First, you have to decide to push on the brake pedal. That is perception time. Then you have to bring up your foot and do it. That is reaction time.

Average reaction time is about three-fourths of a second. But that is only an average. It might be less with one driver and as long as two or three seconds or more with another. Age, physical condition, alertness, coordination, and eyesight all play a part. So do alcohol, drugs, and frustration. But even in three-fourths of a second, a vehicle moving at 60 mph (100 km/h) travels 66 feet (20 m). That could be a lot of distance in an emergency, so keeping enough space between your vehicle and others is important.

And, of course, actual stopping distances vary greatly with the surface of the road, whether it is pavement or gravel; the condition of the road, whether it is wet, dry, or icy; tire tread; the condition of the brakes; the weight of the vehicle; and the amount of brake force applied.

Avoid needless heavy braking. Some people drive in spurts — heavy acceleration followed by heavy braking — rather than keeping pace with traffic. This is a mistake. The brakes might not have time to cool between hard stops. The brakes will wear out much faster if you do a lot of heavy braking. If you keep pace with the traffic and allow realistic following distances, you will eliminate a lot of unnecessary braking. That means better braking and longer brake life.

If your vehicle's engine ever stops while you are driving, brake normally but do not pump the brakes. If you do, the pedal could get harder to push down. If the engine stops, you will still have some power brake assist. But you will use it when you brake. Once the power assist is used up, it can take longer to stop and the brake pedal will be harder to push.

Adding non-dealer/non-retailer accessories can affect your vehicle's performance. See *Accessories and Modifications* on page 9-3.

Antilock Brake System (ABS)

Your vehicle has the Antilock Brake System (ABS), an advanced electronic braking system that will help prevent a braking skid.

When you start the engine and begin to drive away, ABS will check itself. You might hear a momentary motor or clicking noise while this test is going on, and you might even notice that the brake pedal moves a little. This is normal.

ABS



United States

Canada

If there is a problem with ABS, this warning light will stay on. See *Antilock Brake System (ABS) Warning Light* on page 4-18.

Let us say the road is wet and you are driving safely. Suddenly, an animal jumps out in front of you. You slam on the brakes and continue braking. Here is what happens with ABS:

A computer senses that the wheels are slowing down. If one of the wheels is about to stop rolling, the computer will separately work the brakes at each wheel.

ABS can change the brake pressure to each wheel, as required, faster than any driver could. This can help you steer around the obstacle while braking hard.

As you brake, the computer keeps receiving updates on wheel speed and controls braking pressure accordingly.

Remember: ABS does not change the time you need to get your foot up to the brake pedal or always

decrease stopping distance. If you get too close to the vehicle in front of you, you will not have time to apply the brakes if that vehicle suddenly slows or stops. Always leave enough room up ahead to stop, even though you have ABS.

Using ABS

Do not pump the brakes. Just hold the brake pedal down firmly and let antilock work for you. You might hear the antilock pump or motor operate, and feel the brake pedal pulsate, but this is normal.

Braking in Emergencies

With ABS, you can steer and brake at the same time. In many emergencies, steering can help you more than even the very best braking.

Traction Control System (TCS)

Your vehicle has a traction control system that limits wheel spin. This is especially useful in slippery road conditions. The system operates only if it senses that one or both of the drive wheels are spinning or beginning to lose traction. When this happens, the system works the front brakes and reduces engine power to limit wheel spin.

You may feel or hear the system working, but this is normal. Leave the system on during ordinary driving so that it can operate when needed. When the ignition is turned to ON/RUN, the system automatically turns on. If the system has been turned off, it will automatically turn on at 35 mph (55 km/h). TCS cannot be turned off above 35 mph (55 km/h).





This light should come on briefly when the engine is started.

The traction control system warning light flashes and an alarm will sound intermittently when the system is limiting wheel spin.



The  switch is located to the left of the steering wheel below the instrument panel cluster.

When getting the vehicle out of mud or newly fallen snow, turn off the traction control system. The system that controls engine performance interferes with the process of freeing

the front wheels. To turn off traction control, press and release the  switch. The traction control system warning light will come on. To turn the traction control system back on, press the  switch again or increase vehicle speed and the system will automatically turn back on. The traction control system warning light will go off. See *Traction Control System (TCS) Warning Light on page 4-19* Traction Control System (TCS) Warning Light for more information.

VSC OFF

To turn off both the traction control system and StabiliTrak[®], press and hold the  switch while the vehicle is stopped. The traction control system warning light and the VSC OFF light will come on.

8-22 Driving and Operating

To turn the systems back on, press the  switch again. If both systems are turned off, they will not turn back on automatically when vehicle speed increases.

If the VSC OFF light flashes, there is a problem in the traction control system or StabiliTrak.

Adding non-GM accessories can affect your vehicle's performance. See *Accessories and Modifications* on page 9-3 Accessories and Modifications for more information.

All-Wheel Drive (AWD) System

If your vehicle has this feature, engine power is sent to all four wheels all the time. This is like four-wheel drive, but it is fully automatic.

StabiliTrak[®] System

Your vehicle has StabiliTrak. This system helps provide integrated control of systems such as the Antilock Brake System, traction control and engine control. This system automatically controls the brakes and engine to help prevent the vehicle from skidding when cornering on a slippery road surface or turning the steering wheel abruptly.

This system activates when your vehicle speed reaches or exceeds 9 mph (15 km/h), and deactivates when the vehicle speed reduces to below 9 mph (15 km/h).

You may hear a sound in the engine compartment for a few seconds when the engine is started or just after the vehicle begins to move. This means that the system is in the self-check mode, but does not indicate a problem.



If the vehicle is going to skid during driving, the traction control system warning light flashes and an alarm sounds intermittently. Adjust your driving accordingly.



To turn off both the traction control system and StabiliTrak, press and hold the  switch while the vehicle is stopped.

VSC OFF

The traction control system warning light and the VSC OFF light will come on. To turn the systems back on, press the  switch again. If both systems are turned off, they will not turn back on automatically when vehicle speed increases.

If the VSC OFF light flashes, there is a problem in the traction control system or StabiliTrak.

Steering

If the engine stalls while you are driving, the power steering assist system will continue to operate until you are able to stop your vehicle. If you lose power steering assist because the electric power steering system is not functioning, you can steer, but it will take more effort.

If you turn the steering wheel in either direction several times until it stops, or hold the steering wheel in the stopped position for an extended amount of time, you may notice a reduced amount of power steering assist. The normal amount of power steering assist should return shortly after a few normal steering movements.

The electric power steering system does not require regular maintenance. If you suspect steering system problems, contact your dealer/retailer for service repairs.

Steering Tips

It is important to take curves at a reasonable speed.

Traction in a curve depends on the condition of the tires and the road surface, the angle at which the curve is banked, and your speed. While in a curve, speed is the one factor you can control.

If you need to reduce speed, do it before you enter the curve, while the front wheels are straight ahead.

Try to adjust the speed so you can drive through the curve. Maintain a reasonable, steady speed. Wait to accelerate until you are out of the curve, and then accelerate gently into the straightaway.

Steering in Emergencies

There are times when steering can be more effective than braking. For example, you come over a hill and find a truck stopped in your lane, or a car suddenly pulls out from nowhere, or a child darts out from between parked cars and stops right in front of you. You can avoid these problems by braking — if you can stop in time. But sometimes you cannot; there is not room. That is the time for evasive action — steering around the problem.

Your vehicle can perform very well in emergencies like these. First apply the brakes. See *Braking on page 8-19*. It is better to remove as much speed as you can from a possible collision. Then steer around the problem, to the left or right depending on the space available.



An emergency like this requires close attention and a quick decision. If you are holding the steering wheel at the recommended 9 and 3 o'clock positions, you can turn it a full 180 degrees very quickly without removing either hand. But you have to act fast, steer quickly, and just as quickly straighten the wheel once you have avoided the object.

The fact that such emergency situations are always possible is a good reason to practice defensive driving at all times and wear safety belts properly.

Off-Road Recovery

Your vehicle's right wheels can drop off the edge of a road onto the shoulder while driving.

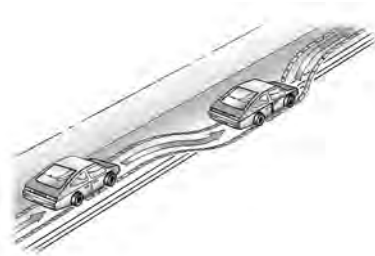

If the level of the shoulder is only slightly below the pavement, recovery should be fairly easy. Ease off the accelerator and then, if there is nothing in the way, steer so that your vehicle straddles the edge of the pavement. Turn the steering wheel 3 to 5 inches, 76 to 127 mm, (about one-eighth turn) until the right front tire contacts the pavement edge. Then turn the steering wheel to go straight down the roadway.

Passing

Passing another vehicle on a two-lane road can be dangerous. To reduce the risk of danger while passing:

- Look down the road, to the sides, and to crossroads for situations that might affect a successful pass. If in doubt, wait.
- Watch for traffic signs, pavement markings, and lines that could indicate a turn or an intersection. Never cross a solid or double-solid line on your side of the lane.
- Do not get too close to the vehicle you want to pass. Doing so can reduce your visibility.
- Wait your turn to pass a slow vehicle.
- When you are being passed, ease to the right.

Loss of Control

Let us review what driving experts say about what happens when the three control systems — brakes, steering, and acceleration — do not have enough friction where the tires meet the road to do what the driver has asked.

In any emergency, do not give up. Keep trying to steer and constantly seek an escape route or area of less danger.

Skidding

In a skid, a driver can lose control of the vehicle. Defensive drivers avoid most skids by taking reasonable care suited to existing conditions, and by not overdriving those conditions. But skids are always possible.

The three types of skids correspond to your vehicle's three control systems. In the braking skid, the wheels are not rolling. In the steering or cornering skid, too much speed or steering in a curve causes tires to slip and lose cornering force. And in the acceleration skid, too much throttle causes the driving wheels to spin.

If your vehicle starts to slide, ease your foot off the accelerator pedal and quickly steer the way you want the vehicle to go. If you start steering quickly enough, your vehicle may straighten out. Always be ready for a second skid if it occurs.

8-26 Driving and Operating

Of course, traction is reduced when water, snow, ice, gravel, or other material is on the road. For safety, you want to slow down and adjust your driving to these conditions. It is important to slow down on slippery surfaces because stopping distance is longer and vehicle control more limited.

While driving on a surface with reduced traction, try your best to avoid sudden steering, acceleration, or braking, including reducing vehicle speed by shifting to a lower gear. Any sudden changes could cause the tires to slide. You might not realize the surface is slippery until your vehicle is skidding. Learn to recognize warning clues — such as enough water, ice, or packed snow on the road to make a mirrored surface — and slow down when you have any doubt.

Remember: Any Antilock Brake System (ABS) helps avoid only the braking skid.

Driving at Night

Night driving is more dangerous than day driving because some drivers are likely to be impaired — by alcohol or drugs, with night vision problems, or by fatigue.

Night driving tips include:

- Drive defensively.
- Do not drink and drive.
- Reduce headlamp glare by adjusting the inside rearview mirror.
- Slow down and keep more space between you and other vehicles because headlamps can only light up so much road ahead.

- Watch for animals.
- When tired, pull off the road.
- Do not wear sunglasses.
- Avoid staring directly into approaching headlamps.
- Keep the windshield and all glass on your vehicle clean — inside and out.
- Keep your eyes moving, especially during turns or curves.

No one can see as well at night as in the daytime. But, as we get older, these differences increase.

A 50-year-old driver might need at least twice as much light to see the same thing at night as a 20-year-old.

Driving in Rain and on Wet Roads

Rain and wet roads can reduce vehicle traction and affect your ability to stop and accelerate. Always drive slower in these types of driving conditions and avoid driving through large puddles and deep-standing or flowing water.

CAUTION

Wet brakes can cause crashes. They might not work as well in a quick stop and could cause pulling to one side. You could lose control of the vehicle.

After driving through a large puddle of water or a car/vehicle wash, lightly apply the brake pedal until the brakes work normally.

(Continued)

CAUTION (Continued)

Flowing or rushing water creates strong forces. Driving through flowing water could cause your vehicle to be carried away. If this happens, you and other vehicle occupants could drown. Do not ignore police warnings and be very cautious about trying to drive through flowing water.

Hydroplaning

Hydroplaning is dangerous. Water can build up under your vehicle's tires so they actually ride on the water. This can happen if the road is wet enough and you are going fast enough. When your vehicle is hydroplaning, it has little or no contact with the road.

There is no hard and fast rule about hydroplaning. The best advice is to slow down when the road is wet.

Other Rainy Weather Tips

Besides slowing down, other wet weather driving tips include:

- Allow extra following distance.
- Pass with caution.
- Keep windshield wiping equipment in good shape.
- Keep the windshield washer fluid reservoir filled.
- Have good tires with proper tread depth. See *Tires on page 9-41*.
- Turn off cruise control, if equipped.

Before Leaving on a Long Trip

To prepare your vehicle for a long trip, consider having it serviced by your dealer/retailer before departing.

Things to check on your own include:

- *Windshield Washer Fluid:* Reservoir full? Windows clean — inside and outside?
- *Wiper Blades:* In good shape?
- *Fuel, Engine Oil, Other Fluids:* All levels checked?
- *Lamps:* Do they all work and are lenses clean?
- *Tires:* Are treads good? Are tires inflated to recommended pressure?
- *Weather and Maps:* Safe to travel? Have up-to-date maps?

Highway Hypnosis

Always be alert and pay attention to your surroundings while driving. If you become tired or sleepy, find a safe place to park your vehicle and rest.

Other driving tips include:

- Keep the vehicle well ventilated.
- Keep interior temperature cool.
- Keep your eyes moving — scan the road ahead and to the sides.
- Check the rearview mirror and vehicle instruments often.

Hill and Mountain Roads

Driving on steep hills or through mountains is different than driving on flat or rolling terrain. Tips for driving in these conditions include:

- Keep the vehicle serviced and in good shape.
- Check all fluid levels and brakes, tires, cooling system, and transmission.
- Going down steep or long hills, shift to a lower gear.

CAUTION

If you do not shift down, the brakes could get so hot that they would not work well. You would then have poor braking or even none going down a hill. You could crash. Shift down to let the engine assist the brakes on a steep downhill slope.

 **CAUTION**

Coasting downhill in N (Neutral) or with the ignition off is dangerous. The brakes will have to do all the work of slowing down and they could get so hot that they would not work well. You would then have poor braking or even none going down a hill. You could crash. Always have the engine running and the vehicle in gear when going downhill.

- Stay in your own lane. Do not swing wide or cut across the center of the road. Drive at speeds that let you stay in your own lane.
- Top of hills: Be alert — something could be in your lane (stalled car, accident).
- Pay attention to special road signs (falling rocks area, winding roads, long grades, passing or no-passing zones) and take appropriate action.

Winter Driving

Driving on Snow or Ice

Drive carefully when there is snow or ice between the tires and the road, creating less traction or grip. Wet ice can occur at about 32°F (0°C) when freezing rain begins to fall, resulting in even less traction. Avoid driving on wet ice or in freezing rain until roads can be treated with salt or sand.

Drive with caution, whatever the condition. Accelerate gently so traction is not lost. Accelerating too quickly causes the wheels to spin and makes the surface under the tires slick, so there is even less traction.

Try not to break the fragile traction. If you accelerate too fast, the drive wheels will spin and polish the surface under the tires even more.

The *Antilock Brake System (ABS)* on page 8-20 improves vehicle stability during hard stops on a slippery roads, but apply the brakes sooner than when on dry pavement.

Allow greater following distance on any slippery road and watch for slippery spots. Icy patches can occur on otherwise clear roads in shaded areas. The surface of a curve or an overpass can remain icy when the surrounding roads are clear. Avoid sudden steering maneuvers and braking while on ice.

Turn off cruise control, if equipped, on slippery surfaces.

Blizzard Conditions

Being stuck in snow can be in a serious situation. Stay with the vehicle unless there is help nearby. If possible, use the *Roadside Assistance Program on page 12-5*. To get help and keep everyone in the vehicle safe:

- Turn on the *Hazard Warning Flashers on page 4-3*.
- Tie a red cloth to an outside mirror.

CAUTION

Snow can trap engine exhaust under the vehicle. This may cause exhaust gases to get inside. Engine exhaust contains carbon monoxide (CO) which cannot be seen or smelled. It can cause unconsciousness and even death.

(Continued)

CAUTION (Continued)

If the vehicle is stuck in the snow:

- Clear away snow from around the base of your vehicle, especially any that is blocking the exhaust pipe.
- Check again from time to time to be sure snow does not collect there.
- Open a window about two inches on the side of the vehicle that is away from the wind to bring in fresh air.
- Fully open the air outlets on or under the instrument panel.
- Adjust the Climate Control system to a setting that circulates the air inside the vehicle and set the fan speed to the highest setting. See Climate Control System in the Index.

(Continued)

CAUTION (Continued)

For more information about carbon monoxide, see *Engine Exhaust on page 8-16*.

Snow can trap exhaust gases under your vehicle. This can cause deadly CO (carbon monoxide) gas to get inside. CO could overcome you and kill you. You cannot see it or smell it, so you might not know it is in your vehicle. Clear away snow from around the base of your vehicle, especially any that is blocking the exhaust

Run the engine for short periods only as needed to keep warm, but be careful.

To save fuel, run the engine for only short periods as needed to warm the vehicle and then shut the engine off and close the window most of the way to save heat. Repeat this until help arrives but only when you feel really uncomfortable from the cold. Moving about to keep warm also helps.

If it takes some time for help to arrive, now and then when you run the engine, push the accelerator pedal slightly so the engine runs faster than the idle speed. This keeps the battery charged to restart the vehicle and to signal for help with the headlamps. Do this as little as possible to save fuel.

If Your Vehicle is Stuck in Sand, Mud, Ice, or Snow

Slowly and cautiously spin the wheels to free the vehicle when stuck in sand, mud, ice, or snow. See *Rocking Your Vehicle to Get It Out* on page 8-31.

CAUTION

If you let your vehicle's tires spin at high speed, they can explode, and you or others could be injured. The vehicle can overheat, causing an engine compartment fire or other damage. Spin the wheels as little as possible and avoid going above 35 mph (55 km/h) as shown on the speedometer.

For information about using tire chains on the vehicle, see *Tire Chains* on page 9-60.

Rocking Your Vehicle to Get It Out

Turn the steering wheel left and right to clear the area around the front wheels. Turn off any traction or stability system. Shift back and forth between R (Reverse) and a forward gear, or with a manual transmission, between 1 (First) or 2 (Second) and R (Reverse), spinning the wheels as little as possible. To prevent transmission wear, wait until the wheels stop spinning before shifting gears. Release the accelerator pedal while shifting, and press lightly on the accelerator pedal when the transmission is in gear. Slowly spinning the wheels in the forward and reverse directions causes a rocking motion that could free the vehicle. If that does not get the vehicle out after a few tries, it might need to be towed out. If the vehicle does need to be towed out, see *Towing Your Vehicle* on page 9-75.

Loading the Vehicle

It is very important to know how much weight your vehicle can carry. Two labels on the vehicle show how much weight it may properly carry, the Tire and Loading Information label and the Certification label.

CAUTION

Do not load the vehicle any heavier than the Gross Vehicle Weight Rating (GVWR), or either the maximum front or rear Gross Axle Weight Rating (GAWR). If you do, parts on the vehicle can break, and it can change the way your vehicle handles. These could cause you to lose control and crash. Also, overloading can shorten the life of the vehicle.

Tire and Loading Information Label

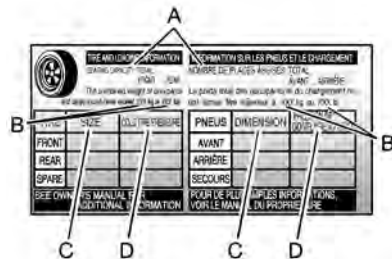

TIRE SIZE		TYRE TYPE		TIRE DIMENSION		TIRE PRESSURE	
FRONT	REAR	SPARE	SEE OWNERS MANUAL FOR TIRE INFORMATION	AVANT	ARRIERE	SECOURS	POUR DE PLUS VOSSE MANUELS PROPRIETAIRES

Label Example

A vehicle specific Tire and Loading Information label is attached to the vehicle's center pillar (B-pillar). With the driver's door open you will find the label attached below the door lock post (striker). The Tire and Loading Information label shows the number of occupant seating

positions (A), and the maximum vehicle capacity weight (B) in kilograms and pounds. This weight includes the weight of all occupants, cargo, and all nonfactory-installed options.

The Tire and Loading Information label also shows the tire size of the original equipment tires (C), and the recommended cold tire inflation pressures (D). For more information on tires and inflation see *Tires on page 9-41* and *Inflation - Tire Pressure on page 9-47*.

There is also important loading information on the Certification label. It tells you the Gross Vehicle Weight Rating (GVWR) and the Gross Axle Weight Rating (GAWR) for the front and rear axle. See "Certification Label" later in this section.

Steps for Determining Correct Load Limit

1. Locate the statement "The combined weight of occupants and cargo should never exceed XXX kg or XXX lbs" on your vehicle's placard.
2. Determine the combined weight of the driver and passengers that will be riding in your vehicle.
3. Subtract the combined weight of the driver and passengers from XXX kg or XXX lbs.
4. The resulting figure equals the available amount of cargo and luggage load capacity. For example, if the "XXX" amount equals 1400 lbs and there will be five 150 lb passengers in your vehicle, the amount of available cargo and luggage load capacity is 650 lbs (1400 – 750 (5 x 150) = 650 lbs).

5. Determine the combined weight of luggage and cargo being loaded on the vehicle. That weight may not safely exceed the available cargo and luggage load capacity calculated in Step 4.
6. If your vehicle will be towing a trailer, the load from your trailer will be transferred to your vehicle. Consult this manual to determine how this reduces the available cargo and luggage load capacity of your vehicle.

If your vehicle can tow a trailer, see *Towing a Trailer on page 9-77* for important information on towing a trailer, towing safety rules and trailering tips.

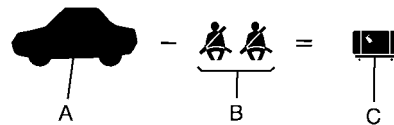

Example 1

- A. Vehicle Capacity Weight for Example 1 = 1,000 lbs (453 kg).
- B. Subtract Occupant Weight 150 lbs (68 kg) × 2 = 300 lbs (136 kg).
- C. Available Occupant and Cargo Weight = 700 lbs (317 kg).

8-34 Driving and Operating

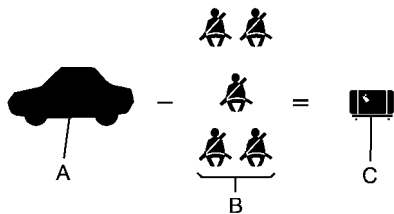

Example 2

- A. Vehicle Capacity Weight for Example 2 = 1,000 lbs (453 kg).
- B. Subtract Occupant Weight
 $150 \text{ lbs (68 kg)} \times 5 = 750 \text{ lbs (340 kg)}$.
- C. Available Cargo Weight = 250 lbs (113 kg).

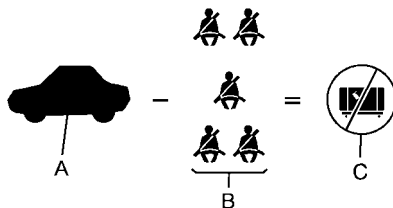

Example 3

- A. Vehicle Capacity Weight for Example 3 = 1,000 lbs (453 kg).
- B. Subtract Occupant Weight
 $200 \text{ lbs (91 kg)} \times 5 = 1,000 \text{ lbs (453 kg)}$.
- C. Available Cargo Weight = 0 lbs (0 kg).

Refer to your vehicle's Tire and Loading Information label for specific information about the vehicle's capacity weight and seating positions.

The combined weight of the driver, passengers, and cargo should never exceed the vehicle's maximum vehicle capacity weight.

Certification Label



Label Example

A vehicle specific Certification label is attached to the center pillar, near the driver's door latch. It tells you the gross weight capacity of your vehicle, called the Gross Vehicle Weight Rating (GVWR).

The GVWR includes the weight of the vehicle, all occupants, fuel, and cargo. Never exceed the GVWR for the vehicle, or the Gross Axle Weight Rating (GAWR) for either the front or rear axle.

And, if you do have a heavy load, you should spread it out. See “Steps for Determining Correct Load Limit” earlier in this section.

 **CAUTION**

Do not load the vehicle any heavier than the Gross Vehicle Weight Rating (GVWR), or either the maximum front or rear Gross Axle Weight Rating (GAWR). If you do, parts on the vehicle can break, and it can change the way your vehicle handles. These could cause you to lose control and crash. Also, overloading can shorten the life of the vehicle.

Notice: Overloading your vehicle may cause damage. Repairs would not be covered by your warranty. Do not overload your vehicle.

If you put things inside your vehicle — like suitcases, tools, packages, or anything else — they will go as fast as the vehicle goes. If you have to stop or turn quickly, or if there is a crash, they will keep going.

 **CAUTION**

Things you put inside your vehicle can strike and injure people in a sudden stop or turn, or in a crash.

- Put things in the rear area of your vehicle. Try to spread the weight evenly. If you have fold-down rear seats, you will find four anchors on the back wall

(Continued)

CAUTION (Continued)

of your trunk. You can use these anchors to tie down lighter loads. They are not strong enough for heavy things, however, so put them as far forward as you can in the trunk or rear area.

- Never stack heavier things, like suitcases, inside the vehicle so that some of them are above the tops of the seats.
- Do not leave an unsecured child restraint in your vehicle.
- When you carry something inside the vehicle, secure it whenever you can.
- Do not leave a seat folded down unless you need to.

Fuel

Use of the recommended fuel is an important part of the proper maintenance of this vehicle. To help keep the engine clean and maintain optimum vehicle performance, we recommend the use of gasoline advertised as TOP TIER Detergent Gasoline.

Gasoline Octane

Use regular unleaded gasoline with a posted octane rating of 87 or higher. If the octane rating is less than 87, you might notice an audible knocking noise when you drive, commonly referred to as spark knock. If this occurs, use a gasoline rated at 87 octane or higher as soon as possible. If you are using gasoline rated at 87 octane or higher and you hear heavy knocking, the engine needs service.

Gasoline Specifications

At a minimum, gasoline should meet ASTM specification D 4814 in the United States or CAN/CGSB-3.5 or 3.511 in Canada. Some gasolines contain an octane-enhancing additive called methylcyclopentadienyl manganese tricarbonyl (MMT). We recommend against the use of gasolines containing MMT. See *Additives on page 8-37* for additional information.

California Fuel

If the vehicle is certified to meet California Emissions Standards, it is designed to operate on fuels that meet California specifications.

See the underhood emission control label. If this fuel is not available in states adopting California emissions standards, the vehicle will operate satisfactorily on fuels meeting federal specifications, but emission control system performance might be affected. The malfunction indicator lamp could turn on and the vehicle might fail a smog-check test. See *Malfunction Indicator Lamp on page 4-20*. If this occurs, return to your authorized dealer/retailer for diagnosis. If it is determined that the condition is caused by the type of fuel used, repairs might not be covered by the vehicle warranty.

Additives

To provide cleaner air, all gasolines in the United States are now required to contain additives that help prevent engine and fuel system deposits from forming, allowing the emission control system to work properly. In most cases, you should not have to add anything to the fuel. However, some gasolines contain only the minimum amount of additive required to meet U.S. Environmental Protection Agency regulations. To help keep fuel injectors and intake valves clean, or if the vehicle experiences problems due to dirty injectors or valves, look for gasoline that is advertised as TOP TIER Detergent Gasoline. Also, your dealer/retailer has additives that will help correct and prevent most deposit-related problems.

Gasolines containing oxygenates, such as ethers and ethanol, and reformulated gasolines might be available in your area.

We recommend that you use these gasolines, if they comply with the specifications described earlier. However, E85 (85% ethanol) and other fuels containing more than 10% ethanol must not be used in vehicles that were not designed for those fuels.

Notice: This vehicle was not designed for fuel that contains methanol. Do not use fuel containing methanol. It can corrode metal parts in the fuel system and also damage plastic and rubber parts. That damage would not be covered under the vehicle warranty.

Some gasolines that are not reformulated for low emissions can contain an octane-enhancing additive called methylcyclopentadienyl manganese tricarbonyl (MMT); ask the attendant where you buy gasoline whether the fuel contains MMT. We recommend against the use of such gasolines.

Fuels containing MMT can reduce the life of spark plugs and the performance of the emission control system could be affected. The malfunction indicator lamp might turn on. If this occurs, return to your dealer/retailer for service.

Fuels in Foreign Countries

If you plan on driving in another country outside the United States or Canada, the proper fuel might be hard to find. Never use leaded gasoline or any other fuel not recommended in the previous text on fuel. Costly repairs caused by use of improper fuel would not be covered by the vehicle warranty.

To check the fuel availability, ask an auto club, or contact a major oil company that does business in the country where you will be driving.

Filling the Tank

CAUTION

Fuel vapor burns violently and a fuel fire can cause bad injuries. To help avoid injuries to you and others, read and follow all the instructions on the pump island. Turn off the engine when you are refueling. Do not smoke if you are near fuel or refueling the vehicle. Do not use cellular phones. Keep sparks, flames, and smoking materials away from fuel. Do not leave the fuel pump unattended when refueling the vehicle. This is against the law in some places. Do not re-enter the vehicle while pumping fuel. Keep children away from the fuel pump; never let children pump fuel.



The fuel door release lever is near the floor under the driver seat on the outboard side.

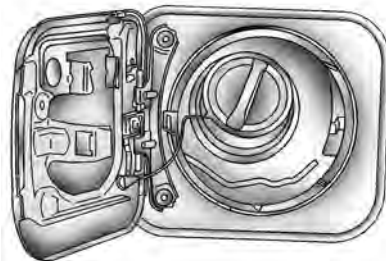

The tethered fuel cap is located behind a hinged fuel door on the driver side of the vehicle.

To remove the fuel cap, turn it slowly counterclockwise. On some vehicles you may have to push in while turning the cap.

While refueling, hang the fuel cap inside of the fuel door.

 **CAUTION**

Fuel can spray out on you if you open the fuel cap too quickly. If you spill fuel and then something ignites it, you could be badly burned. This spray can happen if the tank is nearly full, and is more likely in hot weather. Open the fuel cap slowly and wait for any hiss noise to stop. Then unscrew the cap all the way.

Do not to spill fuel. Do not top off or overfill the tank and wait a few seconds to remove the nozzle. Clean fuel from painted surfaces as soon as possible. See *Exterior Cleaning* on page 9-86.

When replacing the fuel cap, turn it clockwise until it clicks. Make sure the cap is fully installed. The diagnostic system can determine if the fuel cap has been left off or improperly installed. This would allow fuel to evaporate into the atmosphere. See *Malfunction Indicator Lamp* on page 4-20.

 **CAUTION**

If a fire starts while you are refueling, do not remove the nozzle. Shut off the flow of fuel by shutting off the pump or by notifying the station attendant. Leave the area immediately.

Notice: If you need a new fuel cap, be sure to get the right type. Your dealer/retailer can get one for you. If you get the wrong type, it may not fit properly. This may cause the malfunction indicator lamp to light and may damage the fuel tank and emissions system. See *Malfunction Indicator Lamp* on page 4-20.

Filling a Portable Fuel Container

CAUTION

Never fill a portable fuel container while it is in the vehicle. Static electricity discharge from the container can ignite the fuel vapor. You can be badly burned and the vehicle damaged if this occurs. To help avoid injury to you and others:

- Dispense fuel only into approved containers.
- Do not fill a container while it is inside a vehicle, in a vehicle's trunk, pickup bed, or on any surface other than the ground.

(Continued)

CAUTION (Continued)

- Bring the fill nozzle in contact with the inside of the fill opening before operating the nozzle. Contact should be maintained until the filling is complete.
- Do not smoke while pumping fuel.
- Do not use a cellular phone while pumping fuel.

Vehicle Service and Care

Service

- Service9-2
- Accessories and Modifications9-3
- California Proposition 65 Warning9-3
- California Perchlorate Materials Requirements9-3
- Doing Your Own Service Work9-4
- Adding Equipment to the Outside of the Vehicle9-4

Owner Checks

- Owner Checks9-5
- Hood Release9-5
- Engine Compartment Overview9-6
- Engine Oil9-9
- Engine Air Cleaner/Filter9-12

- Automatic Transmission Fluid9-14
- Manual Transmission Fluid9-16
- Hydraulic Clutch9-17
- Cooling System9-18
- Engine Coolant9-18
- Pressure Cap9-22
- Engine Overheating9-22
- Power Steering Fluid9-24
- Windshield Washer Fluid9-24
- Windshield Wiper Blade Replacement9-25
- Brakes9-27
- Battery9-30

Headlamp Aiming

- Headlamp Aiming9-30

Bulb Replacement

- Bulb Replacement9-31
- Halogen Bulbs9-31
- Headlamps and Parking Lamps9-31
- Taillamps9-33
- License Plate Lamp9-34
- Replacement Bulbs9-35

Electrical System

- Add-On Electrical Equipment9-35
- Headlamp Wiring9-35
- Windshield Wiper Fuses9-36
- Power Windows and Other Power Options9-36
- Fuses and Circuit Breakers9-36
- Instrument Panel Fuse Block9-36
- Engine Compartment Fuse Block9-39

Tires

- Tires9-41
- Tire Sidewall Labeling9-42
- Tire Terminology and Definitions9-44
- Inflation - Tire Pressure9-47
- Tire Pressure Monitor System9-48
- Tire Pressure Monitor Operation9-50
- Tire Inspection and Rotation9-53
- When It Is Time for New Tires9-54

9-2 Vehicle Service and Care

Buying New Tires	9-54
Different Size Tires and Wheels	9-56
Uniform Tire Quality Grading	9-56
Wheel Alignment and Tire Balance	9-58
Wheel Replacement	9-59
Tire Chains	9-60

Tire Changing

If a Tire Goes Flat	9-61
Changing a Flat Tire	9-62
Removing the Spare Tire and Tools	9-63
Removing the Flat Tire and Installing the Spare Tire	9-64
Storing a Flat or Spare Tire and Tools	9-68
Compact Spare Tire	9-70

Jump Starting

Jump Starting	9-71
---------------------	------

Towing

Towing Your Vehicle	9-75
Recreational Vehicle Towing	9-75
Towing a Trailer	9-77

Appearance Care

Interior Cleaning	9-83
Exterior Cleaning	9-86
Sheet Metal Damage	9-89
Finish Damage	9-89
Underbody Maintenance	9-90
Chemical Paint Spotting	9-90

Service

For service and parts needs, visit your dealer/retailer. You will receive genuine GM parts and GM-trained and supported service people.

Genuine GM parts have one of these marks:



ACDelco.



GM Parts



GM Goodwrench.



GM Accessories

Accessories and Modifications

When non-dealer/non-retailer accessories are added to the vehicle, they can affect vehicle performance and safety, including such things as airbags, braking, stability, ride and handling, emissions systems, aerodynamics, durability, and electronic systems like antilock brakes, traction control, and stability control. Some of these accessories could even cause malfunction or damage not covered by the vehicle warranty.

GM Accessories are designed to complement and function with other systems on the vehicle. Your GM dealer/retailer can accessorize the vehicle using genuine GM Accessories. When

you go to your GM dealer/retailer and ask for GM Accessories, you will know that GM-trained and supported service technicians will perform the work using genuine GM Accessories.

Also, see *Adding Equipment to Your Airbag-Equipped Vehicle* on page 1-34.

California Proposition 65 Warning

Most motor vehicles, including this one, contain and/or emit chemicals known to the State of California to cause cancer and birth defects or other reproductive harm. Engine exhaust, many parts and systems (including some inside the vehicle), many fluids, and some component wear by-products contain and/or emit these chemicals.

California Perchlorate Materials Requirements

Certain types of automotive applications, such as airbag initiators, seat belt pretensioners, and lithium batteries contained in remote keyless transmitters, may contain perchlorate materials. Special handling may be necessary. For additional information, see www.dtsc.ca.gov/hazardouswaste/perchlorate.

Doing Your Own Service Work



You can be injured and the vehicle could be damaged if you try to do service work on a vehicle without knowing enough about it.

- Be sure you have sufficient knowledge, experience, the proper replacement parts, and tools before attempting any vehicle maintenance task.
- Be sure to use the proper nuts, bolts, and other fasteners. English and metric fasteners can be easily confused. If the wrong fasteners are used, parts can later break or fall off. You could be hurt.

If doing some of your own service work, use the proper service manual. It tells you much more about how to service the vehicle than this manual can. To order the proper service manual, see *Service Publications Ordering Information on page 12-16*.

This vehicle has an airbag system. Before attempting to do your own service work, see *Servicing Your Airbag-Equipped Vehicle on page 1-33*.

Keep a record with all parts receipts and list the mileage and the date of any service work performed. See *Part E: Maintenance Record on page 11-20*.

Adding Equipment to the Outside of the Vehicle

Things added to the outside of the vehicle can affect the airflow around it. This can cause wind noise and can affect fuel economy and windshield washer performance. Check with your dealer/retailer before adding equipment to the outside of the vehicle.

Owner Checks

CAUTION

An electric fan under the hood can start up and injure you even when the engine is not running. Keep hands, clothing, and tools away from any underhood electric fan.

CAUTION

Things that burn can get on hot engine parts and start a fire. These include liquids like fuel, oil, coolant, brake fluid, windshield washer and other fluids, and plastic or rubber. You or others could be burned. Be careful not to drop or spill things that will burn onto a hot engine.

Hood Release

To open the hood:

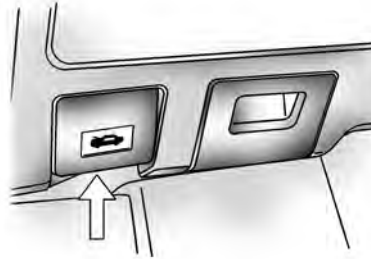

1. Pull the release handle, located below the instrument panel to the left of the steering wheel.

2. From the front of the vehicle, pull up on the secondary hood release located near the middle of the hood.
3. Lift the hood.
4. Release the hood prop rod from its retainer and insert into the slot, moving it straight up. If it is moved to the side or toward the inside of the vehicle, it may become detached.

Before closing the hood, be sure all the filler caps are on properly. Return the hood prop rod carefully back to its retainer to avoid damaging the vehicle.

9-6 Vehicle Service and Care

Engine Compartment Overview

When you open the hood on the 1.8L L4 engine, this is what you see.

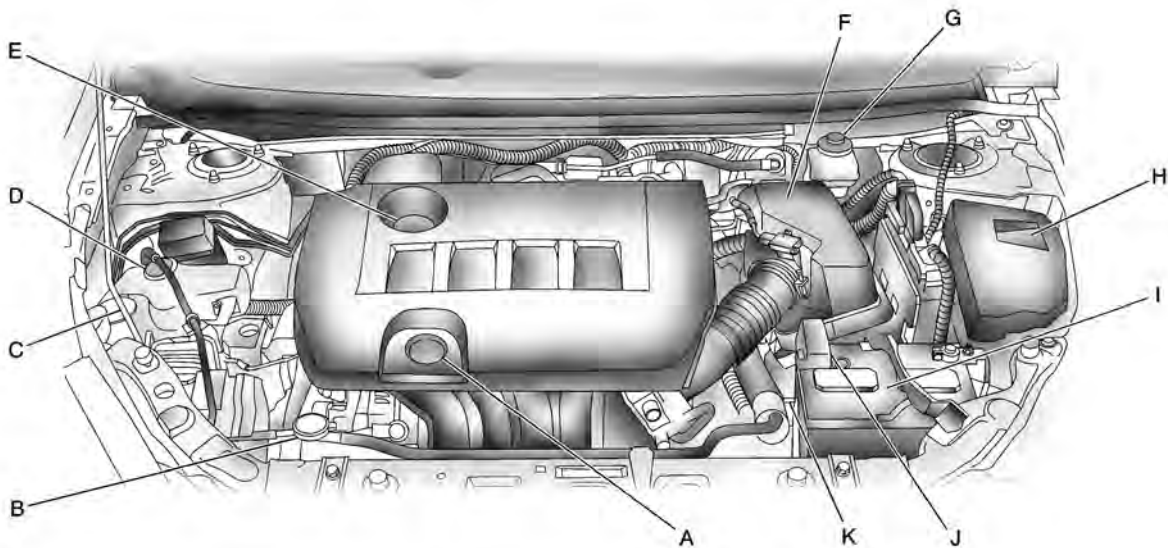

- A. Engine Oil Dipstick. See "Checking Engine Oil" under *Engine Oil* on page 9-9.
- B. Pressure Cap on page 9-22.
- C. Windshield Washer Fluid on page 9-24.
- D. Coolant Recovery Tank. See *Engine Coolant* on page 9-18.
- E. Engine Oil Fill Cap. See "When to Add Engine Oil" under *Engine Oil* on page 9-9.
- F. *Engine Air Cleaner/Filter* on page 9-12.
- G. *Brakes* on page 9-27 and *Hydraulic Clutch* on page 9-17 (If Equipped).
- H. *Engine Compartment Fuse Block* on page 9-39.
- I. *Battery* on page 9-30.
- J. Remote Positive (+) Terminal. See *Jump Starting* on page 9-71.
- K. Automatic Transmission Fluid Dipstick. See "Checking the Fluid Level" under *Automatic Transmission Fluid* on page 9-14 (If Equipped) (Out of View).

9-8 Vehicle Service and Care

When you open the hood on the 2.4L L4 engine, this is what you see.

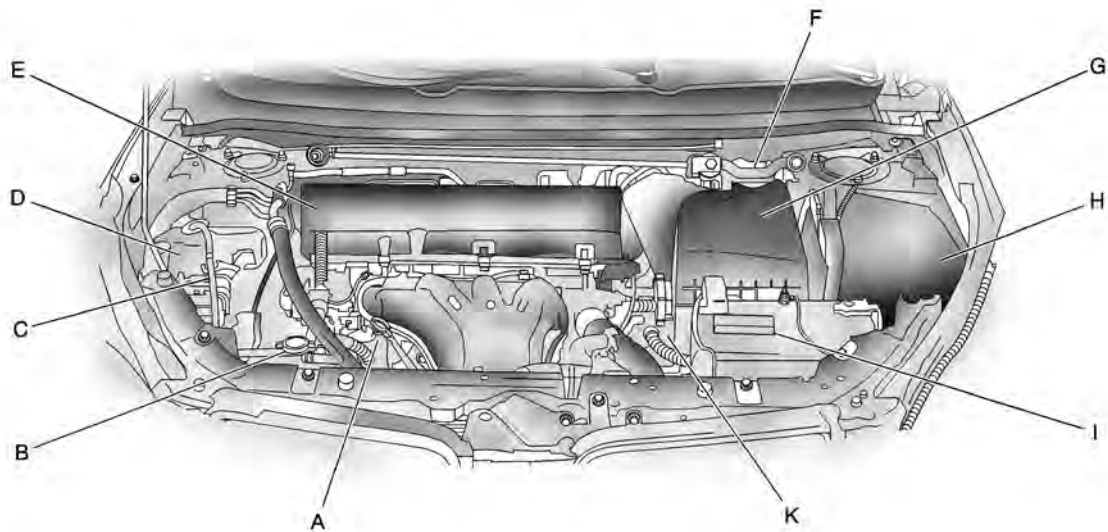

- A. Engine Oil Dipstick. See "Checking Engine Oil" under *Engine Oil* on page 9-9.
- B. Pressure Cap on page 9-22.
- C. Windshield Washer Fluid on page 9-24.
- D. Coolant Recovery Tank. See *Engine Coolant* on page 9-18.
- E. Engine Oil Fill Cap. See "When to Add Engine Oil" under *Engine Oil* on page 9-9.
- F. Brakes on page 9-27 and *Hydraulic Clutch* on page 9-17 (If Equipped).
- G. *Engine Air Cleaner/Filter* on page 9-12.
- H. *Engine Compartment Fuse Block* on page 9-39.

- I. *Battery* on page 9-30.
- J. Remote Positive (+) Terminal. See *Jump Starting* on page 9-71.
- K. Automatic Transmission Fluid Dipstick. See "Checking the Fluid Level" under *Automatic Transmission Fluid* on page 9-14 (If Equipped) (Out of View).

Engine Oil

Checking Engine Oil

It is a good idea to check the engine oil every time you get fuel. In order to get an accurate reading, the oil must be warm and the vehicle must be on level ground.

The engine oil dipstick handle is a yellow loop. See *Engine Compartment Overview* on page 9-6 for the location of the engine oil dipstick.

1. Turn off the engine and give the oil several minutes to drain back into the oil pan. If you do not do this, the oil dipstick might not show the actual level.
2. Pull out the dipstick and clean it with a paper towel or cloth, then push it back in all the way. Remove it again, keeping the tip down, and check the level.

When to Add Engine Oil



1.8L Engine



2.4L Engine

If the oil is below the indent at the tip of the dipstick, add at least one quart/liter of the recommended oil. This section explains what kind of oil to use. For engine oil crankcase capacity, see *Capacities and Specifications on page 10-2*.

Notice: Do not add too much oil. If the engine has so much oil that the oil level gets above the upper hole, the engine could be damaged.

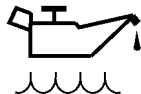

See *Engine Compartment Overview on page 9-6* for the location of the engine oil fill cap.

Add enough oil to put the level somewhere in the proper operating range. Push the dipstick all the way back in when you are through.

What Kind of Engine Oil to Use

Look for three things:

- GM6094M
Use only an oil that meets GM Standard GM6094M.
- SAE 5W-20
SAE 5W-20 is best for the vehicle.

RECOMMENDED SAE VISCOSITY GRADE

HOT WEATHER

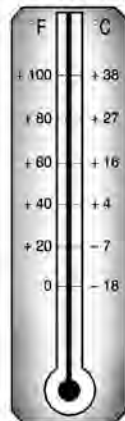

SAE 5W-20
SAE 0W-20

COLD WEATHER

DO NOT USE SAE 10W-40, SAE 20W-50
OR ANY OTHER VISCOSITY GRADE
OIL NOT RECOMMENDED

These numbers on an oil container show its viscosity, or thickness. Do not use other viscosity oils such as SAE 20W-50.

- Oils meeting these requirements should have the starburst symbol on the container. This symbol indicates that the oil has been certified by the American Petroleum Institute (API).



Notice: Use only engine oil identified as meeting GM Standard GM6094M and showing the American Petroleum Institute Certified For Gasoline Engines starburst symbol. Failure to use the recommended oil can result in engine damage not covered by the vehicle warranty.

If you are in an area of extreme cold, where the temperature falls below -20°F (-29°C), it is recommend that you use an SAE 0W-20 oil. SAE 0W-20 oil provides easier cold starting and better protection for the engine at extremely low temperatures.

Engine Oil Additives / Engine Oil Flushes

Do not add anything to the oil. The recommended oils with the starburst symbol that meet GM Standard GM6094M are all you need for good performance and engine protection.

Engine oil system flushes are not recommended and could cause engine damage not covered by the vehicle warranty.

When to Change Engine Oil

Change the oil and filter every 5,000 miles (8 000 km) or 3 months, whichever occurs first. See *Scheduled Maintenance on page 11-4*.

What to Do with Used Oil

Used engine oil contains certain elements that can be unhealthy for your skin and could even cause cancer. Do not let used oil stay on your skin for very long. Clean your skin and nails with soap and water, or a good hand cleaner. Wash or properly dispose of clothing or rags containing used engine oil. See the manufacturer's warnings about the use and disposal of oil products.

Used oil can be a threat to the environment. If you change your own oil, be sure to drain all the oil from the filter before disposal. Never dispose of oil by putting it in the trash, pouring it on the ground, into sewers, or into streams or bodies of water. Recycle it by taking it to a place that collects used oil.

Engine Air Cleaner/Filter

The engine air cleaner/filter is in the engine compartment on the driver side of the vehicle. See *Engine Compartment Overview* on page 9-6 for more information on location.

When to Inspect the Engine Air Cleaner/Filter

If you are driving in dusty/dirty conditions, inspect the air cleaner/filter at each engine oil change. Replace the filter every 30,000 miles (48 000 km) or 24 months, whichever occurs first. See *Part A: Scheduled Maintenance Services* on page 11-3 for more information.

How to Inspect the Engine Air Cleaner/Filter

To inspect the air cleaner/filter remove the filter from the vehicle and lightly shake the filter to release loose dust and dirt. If the filter remains caked with dirt, a new filter is required.

To inspect or replace the engine air cleaner/filter:

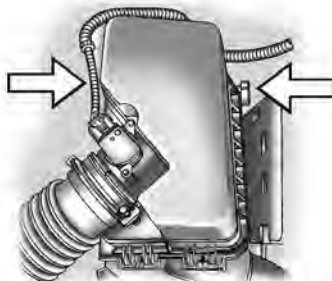

1.8L Engine

1. Release the two clips that hold the cover.



2. Lift the cover.
3. Inspect or replace the engine air cleaner/filter.
4. Reinstall the cover.

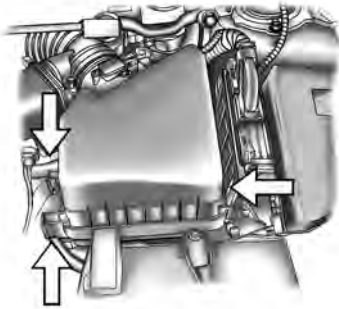

2.4L Engine

1. Release the three clips that hold the cover.

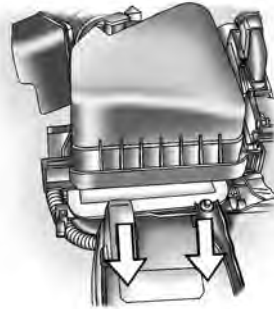

2. Lift the cover.
3. Inspect or replace the engine air cleaner/filter.
4. Reinstall the cover.

CAUTION

Operating the engine with the air cleaner/filter off can cause you or others to be burned. The air cleaner not only cleans the air; it helps to stop flames if the engine backfires. If it is not there and the engine backfires, you could be burned. Do not drive with it off, and be careful working on the engine with the air cleaner/filter off.

Notice: If the air cleaner/filter is off, a backfire can cause a damaging engine fire. And, dirt can easily get into the engine, which will damage it. Always have the air cleaner/filter in place when you are driving.

Automatic Transmission Fluid

When to Check and Change Automatic Transmission Fluid

Check the fluid in the transmission and differential at the intervals listed in *Part A: Scheduled Maintenance Services* on page 11-3, and be sure to use the transmission fluid listed in *Part D: Recommended Fluids and Lubricants* on page 11-18.

How to Check Automatic Transmission Fluid

This operation can be difficult, you may choose to have this done at the dealer/retailer service department.

If you do it yourself, be sure to follow all the instructions here, or you could get a false reading on the dipstick.

Notice: Use of the incorrect automatic transmission fluid may damage your vehicle, and the damages may not be covered by your warranty. Always use the automatic transmission fluid listed in *Part D: Recommended Fluids and Lubricants* on page 11-18.

Wait at least 30 minutes before checking the transmission fluid level if you have been driving:

- When outside temperatures are above 90°F (32°C).
- At high speed for quite a while.
- In heavy traffic — especially in hot weather.
- While pulling a trailer.

To get the right reading, the fluid should be at normal operating temperature, which is 158°F to 176°F (70°C to 80°C).

Get the vehicle warmed up by driving about 15 miles (24 km) when outside temperatures are above 50°F (10°C). If it is colder than 50°F (10°C), you may have to drive longer.

Checking the Fluid Level

Prepare your vehicle as follows:

1. Park your vehicle on a level place. Keep the engine running.
2. With the parking brake applied, place the shift lever in P (Park).
3. With your foot on the brake pedal, move the shift lever through each gear range, pausing for about three seconds in each range. Then, position the shift lever in P (Park).
4. Let the engine run at idle for three to five minutes.

Then, without shutting off the engine, follow these steps:

The automatic transmission dipstick has an orange handle and is located near the front of the engine compartment. See *Engine Compartment Overview* on page 9-6 for more information on location.

1. Release the tab and pull out the dipstick and wipe it with a clean rag or paper towel.
2. Push it back in all the way, wait three seconds and then pull it back out again.



1.8L shown

3. Check both sides of the dipstick, and read the lower level. The fluid level must be between the two dimples in the hot range.

4. If the fluid level is in the acceptable range, push the dipstick back in all the way; then press the tab down to lock the dipstick in place.

How to Add Automatic Transmission Fluid

Refer to the Maintenance Schedule to determine what kind of transmission fluid to use. *Part D: Recommended Fluids and Lubricants* on page 11-18.

If the fluid level is low, add only enough of the proper fluid to bring the level into the area between dimples on the dipstick.

1. Pull out the dipstick.
2. Using a long-neck funnel, add enough fluid at the dipstick hole to bring it to the proper level.

It does not take much fluid, generally less than one pint (0.5 L). Do not overfill.

Notice: Too much or too little fluid can damage your transmission. Too much can mean that some of the fluid could come out and fall on hot engine parts or exhaust system parts, starting a fire. Too little fluid could cause the transmission to overheat. Be sure to get an accurate reading if you check your transmission fluid.

3. After adding fluid, recheck the fluid level as described under "How to Check Automatic Transmission Fluid," earlier in this section.
4. When the correct fluid level is obtained, push the dipstick back in all the way; then press the tab down to lock the dipstick in place.

Manual Transmission Fluid

When to Check

A good time to have your manual transmission fluid level checked is when the engine oil is changed. However, the fluid in your manual transmission does not require changing.

How to Check

This operation can be difficult, you may choose to have this done at your dealer/retailer service department.

If you do it yourself, be sure to follow all the instructions here, or you could get a false reading.

Notice: Too much or too little fluid can damage your transmission. Too much can mean that some of the fluid could

come out and fall on hot engine parts or exhaust system parts, starting a fire. Too little fluid could cause the transmission to overheat. Be sure to get an accurate reading if you check your transmission fluid.

Check the fluid level only when your engine is off, the vehicle is parked on a level place and the transmission is cool enough for you to rest your fingers on the transmission case.

Then, follow these steps:

1. Remove the filler plug.
2. Check that the lubricant level is up to the bottom of the filler plug hole.
3. If the fluid level is good, install the plug and be sure it is fully seated. If the fluid level is low, add more fluid as described in the next steps.

How to Add Fluid

Here is how to add fluid. Refer to the Maintenance Schedule to determine what kind of fluid to use. *Part D: Recommended Fluids and Lubricants on page 11-18.*

1. Remove the filler plug.
2. Add fluid at the filler plug hole. Add only enough fluid to bring the fluid level up to the bottom of the filler plug hole.
3. Install the filler plug. Be sure the plug is fully seated.

Hydraulic Clutch

The hydraulic clutch linkage in your vehicle is self-adjusting. The master cylinder reservoir is filled with DOT-3 brake fluid.

It is not necessary to regularly check the fluid unless you suspect there is a leak in the system. Adding fluid will not correct a leak.

The hydraulic clutch and brake master cylinder use the same reservoir.

A fluid loss in this system could indicate a problem. Have the system inspected and repaired.

When to Check and What to Use

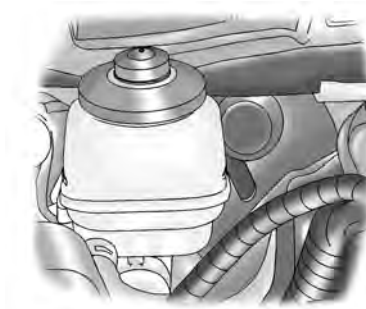

The reservoir is located at the back of the engine compartment, on the driver side of the vehicle. *Engine Compartment Overview on page 9-6.*

Refer to the Maintenance Schedule to determine how often you should check the fluid level in your master cylinder reservoir and for the proper fluid. *Part B: Owner Checks and Services on page 11-12 and Part D: Recommended Fluids and Lubricants on page 11-18.*

How to Check and Add Fluid

Check that the fluid level is at or above the MIN mark. If the level is below the MIN mark, see the instructions on the reservoir cap.

Cooling System

When it is safe lift the hood:

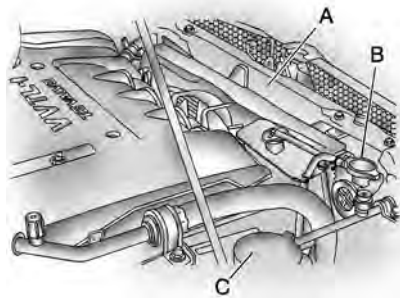

- A. Electric Engine Cooling Fans
- B. Pressure Cap
- C. Engine Coolant Recovery Tank

CAUTION

An electric engine cooling fan under the hood can start up even when the engine is not running and can cause injury. Keep hands, clothing, and tools away from any underhood electric fan.

CAUTION

Heater and radiator hoses, and other engine parts, can be very hot. Do not touch them. If you do, you can be burned.

Do not run the engine if there is a leak. If you run the engine, it could lose all coolant. That could cause an engine fire, and you could be burned. Get any leak fixed before you drive the vehicle.

Engine Coolant

The coolant in the vehicle should last for five years or 150,000 miles (240 000 km), whichever occurs first. When coolant is added or changed, use DEX-COOL[®] coolant.

The following explains the cooling system and how to add coolant when it is low. If there is a problem with engine overheating, see *Engine Overheating* on page 9-22 Engine Overheating.

What to Use

Use a 50/50 mixture of clean, drinkable water and DEX-COOL[®] coolant, which will not damage aluminum parts. If this coolant mixture is used, nothing else needs to be added.

 **CAUTION**

Adding only plain water to the cooling system can be dangerous. Plain water, or some other liquid such as alcohol, can boil before the proper coolant mixture will. The vehicle's coolant warning system is set for the proper coolant mixture. With plain water or the wrong mixture, the engine could get too hot but would not get the overheat warning. The engine could catch fire and you or others could be burned. Use a 50/50 mixture of clean, drinkable water and DEX-COOL[®] coolant.

Notice: If an improper coolant mixture is used, the engine could overheat and be badly damaged. The repair cost would not be covered by the vehicle warranty. Too much water in the mixture can freeze and crack the engine, radiator, heater core, and other parts.

Notice: If you use extra inhibitors and/or additives in your vehicle's cooling system, you could damage your vehicle. Use only the proper mixture of the engine coolant listed in this manual for the cooling system. See *Part D: Recommended Fluids and Lubricants on page 11-18* for more information.

- Gives freezing protection down to -34°F (-38°C).
- Gives boiling protection up to 265°F (129°C).
- Protects against rust and corrosion.
- Helps keep the proper engine temperature.
- Lets the warning lights and gages work as they should.

Notice: Using coolant other than DEX-COOL can cause premature engine, heater core or radiator corrosion. In addition, the engine

coolant may require changing sooner, at 30,000 miles (50 000 km) or 24 months, whichever occurs first. Any repairs would not be covered by the vehicle warranty. Always use DEX-COOL (silicate-free) coolant in your vehicle.

Checking Coolant

The vehicle must be on a level surface. When the engine is cold, the coolant level should be at LOW, or a little higher. When the engine is warm, the level should be up to FULL, or a little higher. If it is not, there could be a leak at the pressure cap or in the radiator hoses, heater hoses, radiator, water pump, or somewhere else in the cooling system.

See *Engine Compartment Overview on page 9-6* Engine Compartment Overview for the location of the coolant recovery tank.

How to Add Coolant to the Coolant Recovery Tank

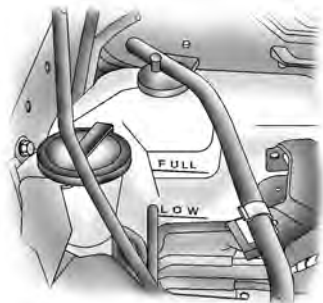

If you need more coolant, add the proper DEX-COOL[®] coolant mixture at the coolant recovery tank, but be careful not to spill it.

Occasionally check the coolant level in the radiator. For information on how to add coolant to the radiator, see *Cooling System on page 9-18 Cooling System*.

CAUTION

You can be burned if you spill coolant on hot engine parts. Coolant contains ethylene glycol, and it will burn if the engine parts are hot enough. Do not spill coolant on a hot engine.

CAUTION

Adding only plain water to your cooling system can be dangerous. Plain water, or some other liquid such as alcohol, can boil before the proper coolant mixture will. Your vehicle's coolant warning system is set for the proper coolant mixture. With plain water or the wrong mixture, your engine could get too hot but you would not get the overheat warning. Your engine could catch fire and

(Continued)

CAUTION (Continued)

you or others could be burned. Use a 50/50 mixture of clean, drinkable water and a proper coolant.

Notice: In cold weather, water can freeze and crack the engine, radiator, heater core and other parts. Use the recommended coolant and the proper coolant mixture.

How to Add Coolant to the Radiator

When the coolant in the coolant recovery tank is at the FULL mark, start the vehicle.

If the overheat warning continues, there is one more thing that can be done. Add the proper coolant mixture directly to the radiator but be sure the cooling system is cool before you do it.

⚠ CAUTION

Steam and scalding liquids from a hot cooling system can blow out and burn you badly. They are under pressure, and if you turn the radiator pressure cap — even a little — they can come out at high speed. Never turn the cap when the cooling system, including the radiator pressure cap, is hot. Wait for the cooling system and radiator pressure cap to cool if you ever have to turn the pressure cap.

⚠ CAUTION

Turning the radiator pressure cap when the engine and radiator are hot can allow steam and scalding liquids to blow out and burn you badly. With the coolant recovery tank, you will almost never have to add coolant at the radiator. Never turn the radiator pressure cap — even a little — when the engine and radiator are hot.

1. Remove the pressure cap when the cooling system, including the pressure cap and upper radiator hose, is no longer hot. Turn the pressure cap slowly counterclockwise until it first stops. Do not press down while turning the pressure cap.



- If you hear a hiss, wait for that to stop. A hiss means there is still some pressure left.
2. Keep turning the pressure cap, but now push down while turning. Remove the pressure cap.
 3. Fill the radiator with the proper coolant mixture, up to the base of the filler neck. For more information about the proper coolant mixture look earlier in this section.

9-22 Vehicle Service and Care

4. Then fill the coolant recovery tank to the FULL mark.
5. Put the cap back on the coolant recovery tank, but leave the pressure cap off.
6. Start the engine and let it run until you can feel the upper radiator hose getting hot. Watch out for the engine cooling fan.
7. By this time, the coolant level inside the radiator filler neck may be lower. If the level is lower, add more of the proper coolant mixture through the filler neck until the level reaches the base of the filler neck.
8. Then replace the pressure cap. At any time during this procedure if coolant begins to flow out of the filler neck, reinstall the pressure cap. Be sure the ears on the pressure cap are in line with the vent tube.

Pressure Cap

Notice: If the pressure cap is not tightly installed, coolant loss and possible engine damage may occur. Be sure the cap is properly and tightly secured.

See *Engine Compartment Overview on page 9-6* for more information on location.

Engine Overheating

A coolant temperature gage is located on the vehicle's instrument panel. See *Engine Coolant Temperature Gage on page 4-19*.

Check to see if the electric engine cooling fan is running. If the engine is overheating, the fan should be running. If it is not, the vehicle needs service.

If no problem is apparent, but the coolant level is not at or above the FULL mark, add a 50/50 mixture of clean, drinkable water and DEX-COOL[®] coolant at the coolant recovery tank. See *Engine Coolant on page 9-18* for more information about the proper coolant mixture.

If the coolant inside the coolant recovery tank is boiling, do not do anything else until it cools down. The vehicle should be parked on a level surface.

If Steam Is Coming From Your Engine

CAUTION

Steam from an overheated engine can burn you badly, even if you just open the hood. Stay away from the engine if you see or hear steam coming from it. Just turn it off and get everyone away from the vehicle until it cools down. Wait until there is no sign of steam or coolant before you open the hood.

If you keep driving when your engine is overheated, the liquids in it can catch fire. You or others could be badly burned. Stop your engine if it overheats, and get out of the vehicle until the engine is cool.

Notice: If the engine catches fire because of being driven with no coolant, your vehicle can be badly damaged. The costly repairs would not be covered by the vehicle warranty.

If No Steam Is Coming From Your Engine

If an engine overheat warning is displayed but steam is not heard or seen escaping, the problem may not be too serious. Sometimes the engine can get a little too hot when the vehicle:

- Climbs a long hill on a hot day.
- Stops after high-speed driving.
- Idles for long periods in traffic.
- Tows a trailer.

If the overheat warning is displayed with no sign of steam, try this for a minute or so:

1. In heavy traffic, let the engine idle in N (Neutral) while stopped. If it is safe to do so, pull off the road, shift to P (Park) or N (Neutral) and let the engine idle.
2. Turn on the heater to full hot at the highest fan speed and open the windows as necessary.

If the overheat warning is no longer displayed, the vehicle can be driven. Just to be safe, drive slower for about 10 minutes. If the warning does not come back on, continue to drive.

If the warning continues, pull over, stop, and park the vehicle right away.

If there is still no sign of steam, idle the engine for three minutes while the vehicle is parked. If the warning is still displayed, turn off the engine and get everyone out of the vehicle until it cools down.

9-24 Vehicle Service and Care

You may decide not to lift the hood but to get service help right away.

Power Steering Fluid

The vehicle has electronic power steering and does not use power steering fluid. If you suspect a problem, see your dealer/retailer.

Windshield Washer Fluid

What to Use

When you need windshield washer fluid, be sure to read the manufacturer's instructions before use. If you will be operating your vehicle in an area where the temperature may fall below freezing, use a fluid that has sufficient protection against freezing.

How to Check Windshield Washer Fluid



To check windshield washer fluid.

1. Pull dipstick out of windshield washer reservoir.
2. Washer fluid should fill the holes between the LOW (B) and NORMAL (A) mark.
3. If the fluid reads LOW (B) add fluid.

Adding Washer Fluid



Open the cap with the washer symbol on it. Add washer fluid until the holes of the dipstick are filled between the LOW (B) and NORMAL (A). See *Engine Compartment Overview* on page 9-6 for reservoir location.

Notice:

- When using concentrated washer fluid, follow the manufacturer's instructions for adding water.
- Do not mix water with ready-to-use washer fluid. Water can cause the solution to freeze and damage your washer fluid tank and other parts of the washer system. Also, water does not clean as well as washer fluid.
- Fill the washer fluid tank only three-quarters full when it is very cold. This allows for fluid expansion if freezing occurs, which could damage the tank if it is completely full.
- Do not use engine coolant (antifreeze) in your windshield washer. It can damage the vehicle's windshield washer system and paint.

Windshield Wiper Blade Replacement

Front Windshield Wiper

Windshield wiper blades should be inspected at least twice a year for wear or cracking. See *At Least Twice a Year* on page 11-13.

Replacement blades come in different types and are removed in different ways. To remove the wiper blade:

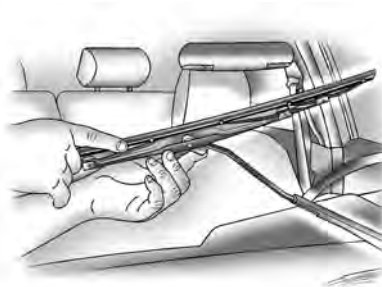

1. Pull the windshield wiper arm away from the windshield.

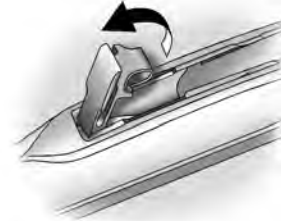

2. Push the release lever and slide the wiper assembly toward the driver side of the vehicle.

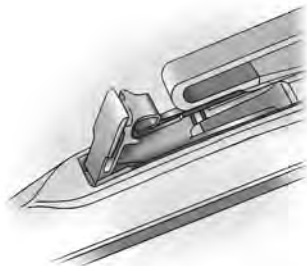

3. Slide the new wiper assembly into place.
4. Push the release lever down to lock into place.

Rear Windshield Wiper

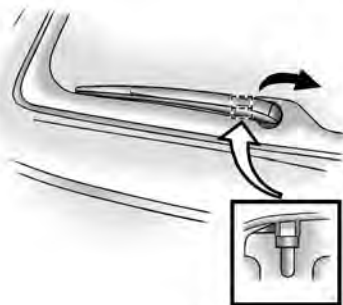

1. Disengage the two pins and disconnect the rear wiper arm by pulling them up.



2. Raise the wiper arm until it comes off.
You will hear a clicking sound when the arm comes off.

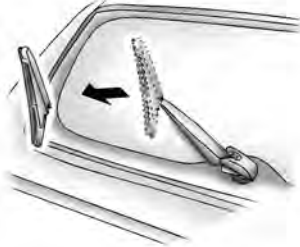

3. Push the rear wiper assembly straight into the rear wiper arm.
4. Reengage the two pins to the rear wiper arm by pushing them down.

Brakes

Brake Fluid

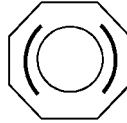

The brake master cylinder and, on manual transmission vehicles, the clutch hydraulic system use the same reservoir. The reservoir is filled with DOT-3 brake fluid.

There are only two reasons why the brake fluid level in the reservoir might go down:

- The brake fluid level goes down because of normal brake lining wear. When new linings are installed, the fluid level goes back up.
- A fluid leak in the brake and/or clutch hydraulic system can also cause a low fluid level. Have the brake and/or clutch hydraulic system fixed, since a leak means that sooner or later the brakes and/or clutch will not work well.

9-28 Vehicle Service and Care

Do not top off the brake/clutch fluid. Adding fluid does not correct a leak. If fluid is added when the brake linings are worn, there will be too much fluid when new brake linings are installed. Add or remove fluid, as necessary, only when work is done on the brake/clutch hydraulic system.

CAUTION

If too much brake fluid is added, it can spill on the engine and burn, if the engine is hot enough. You or others could be burned, and the vehicle could be damaged. Add brake fluid only when work is done on the brake hydraulic system.

When the brake fluid falls to a low level, the brake warning light comes on. See *Brake System Warning Light* on page 4-17.

What to Add

Use only new DOT-3 brake fluid from a sealed container. See *Part D: Recommended Fluids and Lubricants* on page 11-18.

Always clean the brake fluid reservoir cap and the area around the cap before removing it. This helps keep dirt from entering the reservoir.

CAUTION

With the wrong kind of fluid in the brake or clutch hydraulic system, the brakes or clutch might not work well. This could cause a crash. Always use the proper brake fluid.

Notice:

- **Using the wrong fluid can badly damage brake or clutch hydraulic system parts. For example, just a few drops of mineral-based oil, such as engine oil, in the brake or clutch hydraulic system can damage brake or clutch hydraulic system parts so badly that they will have to be replaced. Do not let someone put in the wrong kind of fluid.**
- **If brake fluid is spilled on the vehicle's painted surfaces, the paint finish can be damaged. Be careful not to spill brake fluid on the vehicle. If you do, wash it off immediately. See *Exterior Cleaning* on page 9-86.**

Brake Wear

This vehicle has disc brakes. Disc brake pads have built-in wear indicators that make a high-pitched warning sound when the brake pads are worn and new pads are needed. The sound can come and go or be heard all the time the vehicle is moving, except when applying the brake pedal firmly.

 **CAUTION**

The brake wear warning sound means that soon the brakes will not work well. That could lead to an accident. When the brake wear warning sound is heard, have the vehicle serviced.

Notice: Continuing to drive with worn-out brake pads could result in costly brake repair.

Some driving conditions or climates can cause a brake squeal when the brakes are first applied or lightly applied. This does not mean something is wrong with the brakes.

Properly torqued wheel nuts are necessary to help prevent brake pulsation. When tires are rotated, inspect brake pads for wear and evenly tighten wheel nuts in the proper sequence to torque specifications in *Capacities and Specifications on page 10-2*.

Brake linings should always be replaced as complete axle sets.

Brake Pedal Travel

See your dealer/retailer if the brake pedal does not return to normal height, or if there is a rapid increase in pedal travel. This could be a sign that brake service might be required.

Brake Adjustment

Every time the brakes are applied, with or without the vehicle moving, the brakes adjust for wear.

Replacing Brake System Parts

The braking system on a vehicle is complex. Its many parts have to be of top quality and work well together if the vehicle is to have really good braking. The vehicle was designed and tested with top-quality brake parts. When parts of the braking system are replaced — for example, when the brake linings wear down and new ones are installed — be sure to get new approved replacement parts. If this is not done, the brakes might not work properly. For example, if someone puts in brake linings that are wrong for the vehicle, the balance between the front and rear brakes can change — for the worse. The braking performance expected can change in many other ways if the wrong replacement brake parts are installed.

Battery

This vehicle has a maintenance free battery. When it is time for a new battery, see your dealer/retailer for one that has the replacement number shown on the original battery's label. See *Engine Compartment Overview* on page 9-6 for battery location.

Warning: Battery posts, terminals, and related accessories contain lead and lead compounds, chemicals known to the State of California to cause cancer and reproductive harm. Wash hands after handling.

Vehicle Storage



Batteries have acid that can burn you and gas that can explode. You can be badly hurt if you are not careful. See *Jump Starting* on page 9-71 for tips on working around a battery without getting hurt.

Infrequent Usage: If the vehicle is driven infrequently, remove the black, negative (-) cable from the battery. This helps keep the battery from running down.

Extended Storage: For extended storage of the vehicle, remove the black, negative (-) cable from the battery or use a battery trickle charger. This helps maintain the charge of the battery over an extended period of time.

Headlamp Aiming

Headlamp aim has been preset at the factory and should need no further adjustment.

However, if your vehicle is damaged in a crash, the headlamp aim may be affected. Aim adjustment to the low-beam headlamps may be necessary if oncoming drivers flash their high-beam headlamps at you (for vertical aim).

If the headlamps need to be re-aimed, it is recommended that you take the vehicle to your dealer/retailer for service.

Bulb Replacement

For the proper type of replacement bulbs, see *Replacement Bulbs* on page 9-35.

For any bulb changing procedure not listed in this section, contact your dealer/retailer.

Halogen Bulbs

⚠ CAUTION

Halogen bulbs have pressurized gas inside and can burst if you drop or scratch the bulb. You or others could be injured. Be sure to read and follow the instructions on the bulb package.

Headlamps and Parking Lamps

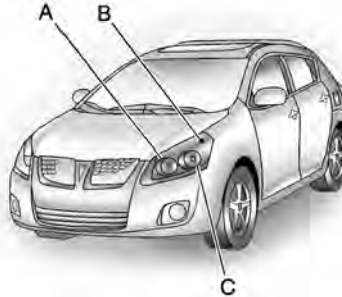

- A. High-beam Headlamp
- B. Turn Signal Lamp/Parking Lamp
- C. Low-beam Headlamp

High-beam and Low-beam Headlamps

To replace the High-beam or Low-beam Headlamp:

1. Open the hood. See *Hood Release* on page 9-5.

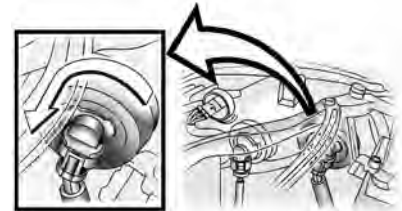

2. Turn the bulb socket counterclockwise and pull it out of the headlamp assembly.

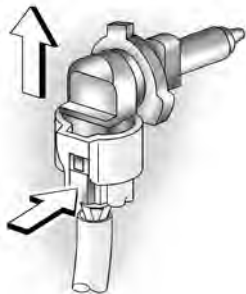

3. Unplug the connector while pressing down on the release tab.
4. Pull the old bulb straight out.
5. Push the new bulb straight in until it clicks.
6. Push the bulb socket into the headlamp assembly and turn it clockwise to secure it in its original location.

Front Turn Signal Lamp and Parking Lamp

To replace the Front Turn Signal Lamp or Parking Lamp:

1. Open the hood. See *Hood Release* on page 9-5.

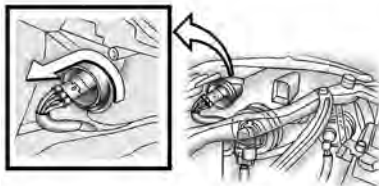

2. Turn the bulb socket counterclockwise and pull it out of the lamp assembly.

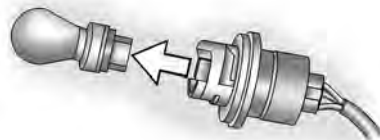

3. Pull the old bulb straight out of the bulb socket.
4. Push the new bulb straight in until it clicks.
5. Push the bulb socket into the lamp assembly and turn clockwise to secure it in its original location.

Taillamps

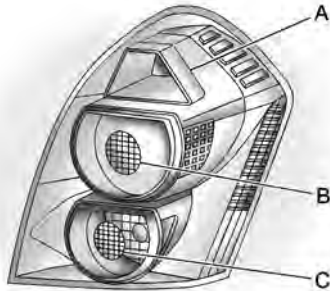

- A. Turn Signal Lamp
- B. Stoplamp/Sidemarkers Lamp/Taillamp
- C. Back-up Lamp

To replace one of these lamps:

1. Open the liftgate.



Passenger Side

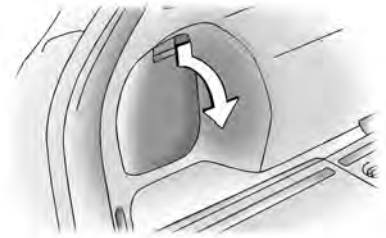

Driver Side

2. Remove the storage compartment cover in the rear cargo area of the vehicle to access the bulbs.
3. Turn the bulb socket counterclockwise and pull it out.

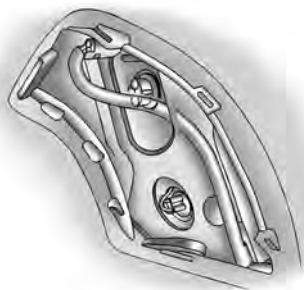

4. Pull the bulb straight out of the socket.
5. Push the new bulb straight in until it clicks to secure.
6. Push the bulb socket in and turn it clockwise to secure.
7. Reinstall the cover.

License Plate Lamp

To replace the license plate lamp bulb:



1. Press the tabs in to disengage them and remove the license plate lamp assembly.

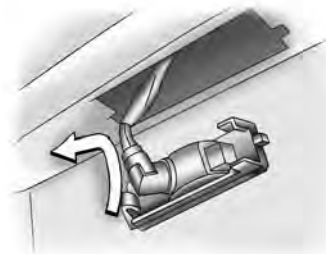

2. Turn the bulb socket counterclockwise to remove it from the license plate assembly.
3. Pull the bulb straight out of the bulb socket.
4. Push the new bulb straight in the bulb socket until it clicks.
5. Push the bulb socket straight into the license plate assembly and turn it clockwise to secure it.
6. Reinstall the license plate assembly into its original location making sure the tabs reengage.

Replacement Bulbs

Exterior Lamp	Bulb Number
High-beam Headlamps	9005
Low-beam Headlamps	9006
Sidemarkers Lamp/Stoplamp/ Taillamp	7443

For replacement bulbs not listed here, contact your dealer/retailer.

Electrical System

Add-On Electrical Equipment

Notice: Do not add anything electrical to the vehicle unless you check with your dealer/retailer first. Some electrical equipment can damage the vehicle and the damage would not be covered by the vehicle's warranty. Some add-on electrical equipment can keep other components from working as they should.

Add-on equipment can drain the vehicle battery, even if the vehicle is not operating.

The vehicle has an airbag system. Before attempting to add anything electrical to the vehicle, see *Servicing Your Airbag-Equipped Vehicle* on page 1-33.

Headlamp Wiring

The headlamp wiring is protected by a circuit breaker. An electrical overload will cause the lamps to go on and off, or in some cases to remain off. If this happens, have your headlamp wiring checked right away.

Windshield Wiper Fuses

The windshield wiper motor is protected by a circuit breaker and a fuse. If the motor overheats due to heavy snow or ice, the wiper will stop until the motor cools. If the overload is caused by some electrical problem, and not snow or ice, be sure to get it fixed.

Power Windows and Other Power Options

Circuit breakers in the fuse block protect the power windows and other power accessories. When the current load is too heavy, the circuit breaker opens and closes, protecting the circuit until the problem is fixed or goes away.

Fuses and Circuit Breakers

The wiring circuits in the vehicle are protected from short circuits by a combination of fuses, circuit breakers and fusible thermal links. This greatly reduces the chance of fires caused by electrical problems.

Look at the silver-colored band inside the fuse. If the band is broken or melted, replace the fuse. Be sure you replace a bad fuse with a new one of the identical size and rating.

Fuses of the same amperage can be temporarily borrowed from another fuse location, if a fuse goes out. Replace the fuse as soon as you can.

Instrument Panel Fuse Block

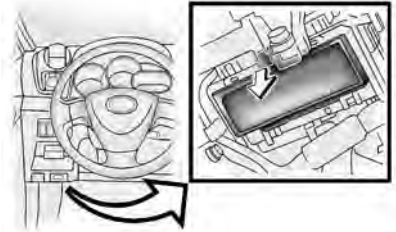

The fuse block is located under the instrument panel on the driver side of the vehicle.

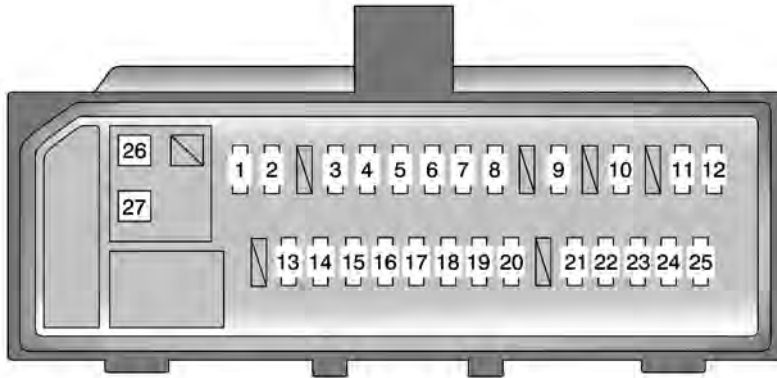

Fuses	Usage
1	Parking Lamps, License Plate Lamps, Taillamp, Multiport Fuel Injection System/ Sequential Multiport Fuel Injection System, Instrument Panel Lights
2	Switch Illumination

Fuses	Usage
3	Power Windows
4	Power Windows
5	Power Windows
6	Sunroof
7	Cigarette Lighter, Accessory Power Outlet

Fuses	Usage
8	Outside Rearview Mirrors, Audio System, Main Body Engine Control Unit (ECU), Clock, Brake Transmission Shift Interlock
9	Empty
10	Empty
11	Airbag System, Multiport Fuel Injection System/ Sequential Multiport Fuel Injection System, Front Passenger Occupant Classification System
12	Gages and Meters
13	Air Conditioning System, Rear Window Defogger
14	Windshield Wipers
15	Rear Window Wipers
16	Windshield Washer

9-38 Vehicle Service and Care

Fuses	Usage
17	Main Body ECU, Electric Power Steering, Electric Cooling Fans, Brake Transmission Shift Interlock, Antilock Braking System (ABS), Multiport Fuel Injection System/Sequential Multiport Fuel Injection System, Tire Pressure Monitoring System (TPMS), Vehicle Stability Control System
18	Back-up Lamps, Charging System, Rear Window Defogger
19	Onboard Diagnosis System

Fuses	Usage
20	Stoplamps, Center High-Mounted Stoplamps (CHMSL), ABS, Vehicle Stability Control System, Multiport Fuel Injection System/Sequential Multiport Fuel Injection System, Brake Transmission Shift Interlock
21	Power Door Lock System
22	Outside Rearview Mirrors, Audio System, Main Body ECU, Clock, Brake Transmission Shift Interlock, Cigarette Lighter

Fuses	Usage
23	All-Wheel Drive System
24	Front Foglamps
25	Ignition, Outside Rearview Mirrors, Audio System, Main Body ECU, Clock, Brake Transmission Shift Interlock, Cigarette Lighter
26	Rear Window Defogger, Heated Mirrors, Multiport Fuel Injection System/Sequential Multiport Fuel Injection System
27	Power Windows

Engine Compartment Fuse Block

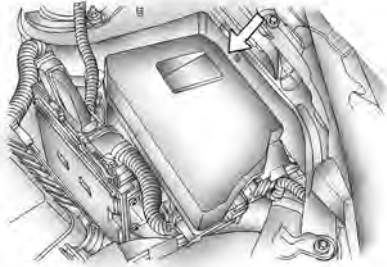

This engine compartment fuse block is located in the engine compartment on the driver side of the vehicle near the air cleaner. See *Engine Compartment Overview* on page 9-6.

Notice: Spilling liquid on any electrical components on the vehicle may damage it. Always keep the covers on any electrical component.

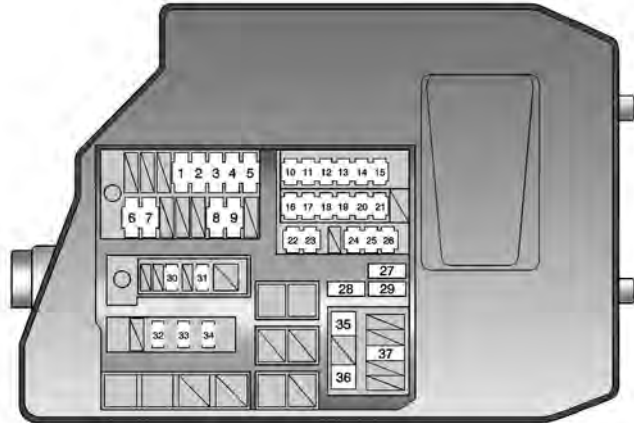

Fuses	Usage
1	Electric Cooling Fans
2	Electric Cooling Fans
3	Antilock Braking System (ABS), Vehicle Stability Control System

Fuses	Usage
4	ABS, Vehicle Stability Control System
5	Air Conditioning System
6	Charging System
7	Electric Power Steering

9-40 Vehicle Service and Care

Fuses	Usage
8	Emission Control System Main, Horn, Ignition 2
9	Headlamp Main
10	Emission Control System 2
11	Multiport Fuel Injection System/ Sequential Multiport Fuel Injection System
12	Driver Side Headlamp
13	Passenger Side Headlamp
14	Driver Side Low-Beam Headlamp, Front Foglamps
15	Passenger Side Low-Beam Headlamp

Fuses	Usage
16	Multiport Fuel Injection System/Sequential Multiport Fuel Injection System
17	Turn Signal Lamps, Hazard Lamps
18	Charging System
19	Starting System, Multiport Fuel Injection System/ Sequential Multiport Fuel Injection System
20	Starting System, Multiport Fuel Injection System/ Sequential Multiport Fuel Injection System
21	Empty
22	Starting System

Fuses	Usage
23	Engine Immobilizer System
24	Main Body ECU, Gages, Daytime Running Lights (DRL), Air Conditioning System, Wireless Remote Control, Theft Deterrent System
25	Audio System
26	Interior Lamps, Personal Lamps, Clock
27	Spare
28	Spare
29	Spare
30	Audio System
31	OnStar®

Fuses	Usage
32	Multiport Fuel Injection System/Sequential Multiport Fuel Injection System, Horn, Emission Control System 1, Emission Control System 2
33	Horn
34	Multiport Fuel Injection System/Sequential Multiport Fuel Injection System, Horn, Ignition, Meter
35	PTC Heater 1
36	PTC Heater 3
37	Air Conditioning Inverter

Tires

Your new vehicle comes with high-quality tires made by a leading tire manufacturer. If you ever have questions about your tire warranty and where to obtain service, see your vehicle Warranty booklet for details. For additional information refer to the tire manufacturer.

CAUTION

Poorly maintained and improperly used tires are dangerous.

- Overloading your vehicle's tires can cause overheating as a result of too much flexing. You could have an air-out and a serious accident. See *Loading the Vehicle on page 8-32.*

(Continued)

CAUTION (Continued)

- Underinflated tires pose the same danger as overloaded tires. The resulting accident could cause serious injury. Check all tires frequently to maintain the recommended pressure. Tire pressure should be checked when your vehicle's tires are cold. See *Inflation - Tire Pressure on page 9-47.*
- Overinflated tires are more likely to be cut, punctured, or broken by a sudden impact — such as when you hit a pothole. Keep tires at the recommended pressure.
- Worn, old tires can cause accidents. If the tire's tread is badly worn, or if your vehicle's tires have been damaged, replace them.

Tire Sidewall Labeling

Useful information about a tire is molded into its sidewall. The examples show a typical passenger vehicle tire and a compact spare tire sidewall.

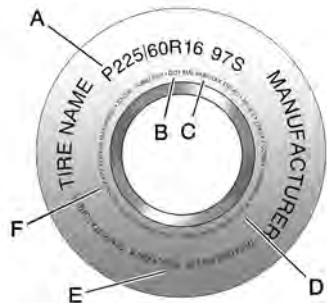

Passenger (P-Metric) Tire Example

(A) Tire Size: The tire size is a combination of letters and numbers used to define a particular tire's width, height, aspect ratio, construction type, and service description. See the "Tire Size" illustration later in this section for more detail.

(B) DOT (Department of Transportation): The Department of Transportation (DOT) code indicates that the tire is in compliance with the U.S. Department of Transportation Motor Vehicle Safety Standards.

(C) Tire Identification Number (TIN): The letters and numbers following DOT (Department of Transportation) code is the Tire Identification Number (TIN). The TIN shows the manufacturer and plant code, tire size, and date the tire was manufactured. The TIN is molded onto both sides of the tire, although only one side may have the date of manufacture.

(D) Tire Ply Material: The type of cord and number of plies in the sidewall and under the tread.

(E) Uniform Tire Quality Grading (UTQG): Tire manufacturers are required to grade tires based on three performance factors: treadwear, traction, and temperature resistance. For more information see *Uniform Tire Quality Grading* on page 9-56.

(F) Maximum Cold Inflation Load Limit: Maximum load that can be carried and the maximum pressure needed to support that load.

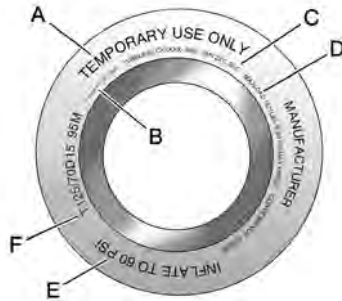

Compact Spare Tire Example

(A) Temporary Use Only: The compact spare tire or temporary use tire has a tread life of approximately 3,000 miles (5 000 km) and should not be driven at speeds over 65 mph (105 km/h). The compact spare tire is for emergency use when a regular road tire has lost air and gone flat. If your vehicle has a compact spare tire. See *Compact Spare Tire on page 9-70* and *If a Tire Goes Flat on page 9-61*.

(B) Tire Ply Material: The type of cord and number of plies in the sidewall and under the tread.

(C) Tire Identification Number (TIN): The letters and numbers following the DOT (Department of Transportation) code is the Tire Identification Number (TIN). The TIN shows the manufacturer and plant code, tire size, and date the tire was manufactured. The TIN is molded onto both sides of the tire, although only one side may have the date of manufacture.

(D) Maximum Cold Inflation Load Limit: Maximum load that can be carried and the maximum pressure needed to support that load.

(E) Tire Inflation: The temporary use tire or compact spare tire should be inflated to 60 psi (420 kPa). For more information on tire pressure and inflation see *Inflation - Tire Pressure on page 9-47*.

(F) Tire Size : A combination of letters and numbers define a tire's width, height, aspect ratio, construction type, and service description. The letter T as the first character in the tire size means the tire is for temporary use only.

Tire Size

The following illustration shows an example of a typical passenger vehicle tire size.

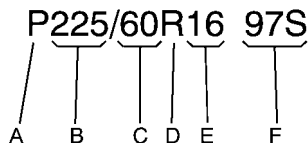

(A) Passenger (P-Metric) Tire:

The United States version of a metric tire sizing system. The letter P as the first character in the tire size means a passenger vehicle tire engineered to standards set by the U.S. Tire and Rim Association. Tires engineered to European standards do not use the letter P as the first character in the tire size.

(B) Tire Width: The three-digit number indicates the tire section width in millimeters from sidewall to sidewall.

(C) Aspect Ratio: A two-digit number that indicates the tire height-to-width measurements. For example, if the tire size aspect ratio is 60, as shown in item C of the illustration, it would mean that the tire's sidewall is 60 percent as high as it is wide.

(D) Construction Code: A letter code is used to indicate the type of ply construction in the tire. The letter R means radial ply construction; the letter D means diagonal or bias ply construction; and the letter B means belted-bias ply construction.

(E) Rim Diameter: Diameter of the wheel in inches.

(F) Service Description: These characters represent the load range and speed rating of the tire. The load index represents the load carry capacity a tire is certified to carry. The load index can range from 1 to 279. The speed rating is the maximum speed a tire is certified to carry a load. Speed ratings range from A to Z.

Tire Terminology and Definitions

Air Pressure: The amount of air inside the tire pressing outward on each square inch of the tire. Air pressure is expressed in pounds per square inch (psi) or kilopascal (kPa).

Accessory Weight: This means the combined weight of optional accessories. Some examples of optional accessories are, automatic transmission, power steering, power brakes, power windows, power seats, and air conditioning.

Aspect Ratio: The relationship of a tire's height to its width.

Belt: A rubber coated layer of cords that is located between the plies and the tread. Cords may be made from steel or other reinforcing materials.

Bead: The tire bead contains steel wires wrapped by steel cords that hold the tire onto the rim.

Bias Ply Tire: A pneumatic tire in which the plies are laid at alternate angles less than 90 degrees to the centerline of the tread.

Cold Tire Pressure: The amount of air pressure in a tire, measured in pounds per square inch (psi) or kilopascals (kPa) before a tire has built up heat from driving. See *Inflation - Tire Pressure* on page 9-47.

Curb Weight: The weight of a motor vehicle with standard and optional equipment including the maximum capacity of fuel, oil, and coolant, but without passengers and cargo.

DOT Markings: A code molded into the sidewall of a tire signifying that the tire is in compliance with the U.S. Department of Transportation (DOT) motor vehicle safety standards. The DOT code includes the Tire Identification Number (TIN), an alphanumeric designator which can also identify the tire manufacturer, production plant, brand, and date of production.

GVWR: Gross Vehicle Weight Rating. See *Loading the Vehicle* on page 8-32.

GAWR FRT: Gross Axle Weight Rating for the front axle. See *Loading the Vehicle* on page 8-32.

GAWR RR: Gross Axle Weight Rating for the rear axle. See *Loading the Vehicle* on page 8-32.

Intended Outboard Sidewall: The side of an asymmetrical tire, that must always face outward when mounted on a vehicle.

Kilopascal (kPa): The metric unit for air pressure.

Light Truck (LT-Metric) Tire: A tire used on light duty trucks and some multipurpose passenger vehicles.

Load Index: An assigned number ranging from 1 to 279 that corresponds to the load carrying capacity of a tire.

Maximum Inflation Pressure: The maximum air pressure to which a cold tire can be inflated. The maximum air pressure is molded onto the sidewall.

Maximum Load Rating:

The load rating for a tire at the maximum permissible inflation pressure for that tire.

Maximum Loaded Vehicle

Weight: The sum of curb weight, accessory weight, vehicle capacity weight, and production options weight.

Normal Occupant Weight: The number of occupants a vehicle is designed to seat multiplied by 150 lbs (68 kg). See *Loading the Vehicle on page 8-32*.

Occupant Distribution:

Designated seating positions.

Outward Facing Sidewall: The side of an asymmetrical tire that has a particular side that faces outward when mounted on a vehicle. The side of the tire that contains a whitewall, bears white lettering, or bears manufacturer, brand, and/or model name molding that is higher or deeper than the same moldings on the other sidewall of the tire.

Passenger (P-Metric) Tire:

A tire used on passenger cars and some light duty trucks and multipurpose vehicles.

Recommended Inflation

Pressure: Vehicle manufacturer's recommended tire inflation pressure as shown on the tire placard. See *Inflation - Tire Pressure on page 9-47* and *Loading the Vehicle on page 8-32*.

Radial Ply Tire: A pneumatic tire in which the ply cords that extend to the beads are laid at 90 degrees to the centerline of the tread.

Rim: A metal support for a tire and upon which the tire beads are seated.

Sidewall: The portion of a tire between the tread and the bead.

Speed Rating: An alphanumeric code assigned to a tire indicating the maximum speed at which a tire can operate.

Traction: The friction between the tire and the road surface. The amount of grip provided.

Tread: The portion of a tire that comes into contact with the road.

Treadwear Indicators: Narrow bands, sometimes called wear bars, that show across the tread of a tire when only 1/16 inch (1.6 mm) of tread remains. See *When It Is Time for New Tires on page 9-54*.

UTQGS (Uniform Tire Quality Grading Standards): A tire information system that provides consumers with ratings for a tire's traction, temperature, and treadwear. Ratings are determined by tire manufacturers using government testing procedures. The ratings are molded into the sidewall of the tire. See *Uniform Tire Quality Grading on page 9-56*.

Vehicle Capacity Weight:

The number of designated seating positions multiplied by 150 lbs (68 kg) plus the rated cargo load. See *Loading the Vehicle on page 8-32*.

Vehicle Maximum Load on the Tire:

Load on an individual tire due to curb weight, accessory weight, occupant weight, and cargo weight.

Vehicle Placard: A label permanently attached to a vehicle showing the vehicle's capacity weight and the original equipment tire size and recommended inflation pressure. See "Tire and Loading Information Label" under *Loading the Vehicle on page 8-32*.

Inflation - Tire Pressure

Tires need the correct amount of air pressure to operate effectively.

Notice: Do not let anyone tell you that under-inflation or over-inflation is all right. It is not. If your tires do not have enough air (under-inflation), you can get the following:

- Too much flexing
- Too much heat
- Tire overloading
- Premature or irregular wear
- Poor handling
- Reduced fuel economy

If your tires have too much air (over-inflation), you can get the following:

- Unusual wear
- Poor handling
- Rough ride
- Needless damage from road hazards

A vehicle specific Tire and Loading Information label is attached to your vehicle. This label shows your vehicle's original equipment tires and the correct inflation pressures for your tires when they are cold. The recommended cold tire inflation pressure, shown on the label, is the minimum amount of air pressure needed to support your vehicle's maximum load carrying capacity.

For additional information regarding how much weight your vehicle can carry, and an example of the Tire and Loading Information label, see *Loading the Vehicle on page 8-32*.

How you load your vehicle affects vehicle handling and ride comfort. Never load your vehicle with more weight than it was designed to carry.

When to Check

Check your tires once a month or more. Do not forget to check the compact spare tire, it should be at 60 psi (420 kPa). For additional information regarding the compact spare tire, see *Compact Spare Tire on page 9-70*.

How to Check

Use a good quality pocket-type gage to check tire pressure. You cannot tell if your tires are properly inflated simply by looking at them. Radial tires may look properly inflated even when they are under-inflated. Check the tire's inflation pressure when the tires are cold. Cold means your vehicle has been sitting for at least three hours or driven no more than 1 mile (1.6 km).

Remove the valve cap from the tire valve stem. Press the tire gage firmly onto the valve to get a pressure measurement. If the cold tire inflation pressure matches the recommended pressure on the Tire and Loading Information label, no further adjustment is necessary. If the inflation pressure is low, add air until you reach the recommended amount.

If you overfill the tire, release air by pushing on the metal stem in the center of the tire valve. Re-check the tire pressure with the tire gage.

Be sure to put the valve caps back on the valve stems. They help prevent leaks by keeping out dirt and moisture.

Tire Pressure Monitor System

The Tire Pressure Monitor System (TPMS) uses radio and sensor technology to check tire pressure levels. The TPMS sensors monitor the air pressure in your vehicle's tires and transmit tire pressure readings to a receiver located in the vehicle.

Each tire, including the spare (if provided), should be checked monthly when cold and inflated to the inflation pressure recommended by the vehicle manufacturer on the vehicle placard or tire inflation pressure label. (If your vehicle has tires of a different size than the size indicated on the vehicle placard or tire inflation pressure label, you should determine the proper tire inflation pressure for those tires.)

As an added safety feature, your vehicle has been equipped with a tire pressure monitoring system (TPMS) that illuminates a low tire pressure telltale when one or more of your tires is significantly under-inflated.

Accordingly, when the low tire pressure telltale illuminates, you should stop and check your tires as soon as possible, and inflate them to the proper pressure. Driving on a significantly under-inflated tire causes the tire to overheat and can lead to tire failure. Under-inflation also reduces fuel efficiency and tire tread life, and may affect the vehicle's handling and stopping ability.

Please note that the TPMS is not a substitute for proper tire maintenance, and it is the driver's responsibility to maintain correct tire pressure, even if under-inflation has not reached the level to trigger illumination of the TPMS low tire pressure telltale.

Your vehicle has also been equipped with a TPMS malfunction indicator to indicate when the system is not operating properly. The TPMS malfunction indicator is combined with the low tire pressure telltale. When the system detects a malfunction, the telltale will flash for approximately one minute and then remain continuously illuminated. This sequence will continue upon subsequent vehicle start-ups as long as the malfunction exists.

When the malfunction indicator is illuminated, the system may not be able to detect or signal low tire pressure as intended. TPMS malfunctions may occur for a variety of reasons, including the installation of replacement or alternate tires or wheels on the vehicle that prevent the TPMS from functioning properly. Always check the TPMS malfunction telltale after replacing one or more tires or wheels on your vehicle to ensure that the replacement or

alternate tires and wheels allow the TPMS to continue to function properly.

See *Tire Pressure Monitor Operation* on page 9-50 for additional information.

Federal Communications Commission (FCC) and Industry and Science Canada

The Tire Pressure Monitor System (TPMS) operates on a radio frequency and complies with Part 15 of the FCC Rules. Operation is subject to the following two conditions:

1. This device may not cause harmful interference.
2. This device must accept any interference received, including interference that may cause undesired operation.

The TPMS operates on a radio frequency and complies with RSS-210 of Industry and Science Canada. Operation is subject to the following two conditions:

1. This device may not cause interference.
2. This device must accept any interference received, including interference that may cause undesired operation of the device.

Changes or modifications to this system by other than an authorized service facility could void authorization to use this equipment.

Tire Pressure Monitor Operation

The Tire Pressure Monitor System (TPMS) warns the driver when a low tire pressure condition exists. TPMS sensors are mounted onto each tire and wheel assembly, excluding the spare tire and wheel assembly.



When a low tire pressure condition is detected, the low tire pressure warning light, located on the instrument panel cluster, comes on.

This light also comes on for a few seconds and then goes off when you turn the ignition to ON/RUN. This indicates the TPMS is functioning properly. If the low-tire pressure warning light comes on while driving the vehicle, the system may have detected a low-tire condition. You need to stop as soon as possible and check the tires.

The low tire pressure warning light may come on in cool weather when the vehicle is first started, and then turn off as you start to drive.

This could be an early indicator that the air pressure in the tire(s) are getting low and need to be inflated to the proper pressure.

A Tire and Loading Information label, attached to the vehicle, shows the size of the vehicle's original equipment tires and the correct inflation pressure for the tires when they are cold. See *Loading the Vehicle* on page 8-32, for an example of the Tire and Loading Information label and its location on your vehicle. Also see *Inflation - Tire Pressure* on page 9-47.

The vehicle's TPMS can warn you about a low tire pressure condition but it does not replace normal tire maintenance. See *Tire Inspection and Rotation* on page 9-53 and *Tires* on page 9-41.

TPMS Malfunction Light

The TPMS will not function properly if one or more of the TPMS sensors are missing or inoperable. When the system detects a malfunction, the low tire warning light flashes for about one minute and then stays on for the remainder of the ignition cycle. The low tire warning light comes on at each ignition cycle until the problem is corrected. Some of the conditions that can cause the malfunction light to come on are:

- One of the road tires has been replaced with the spare tire. The spare tire does not have a TPMS sensor. The TPMS malfunction light and DIC message should go off once you re-install the road tire containing the TPMS sensor.

- The initialization (reset) procedure failed. See “TPMS Reset” later in this section.
- One or more TPMS sensors are missing or damaged. The TPMS malfunction light should go off when the TPMS sensors are installed and the sensor matching process is performed successfully. See your dealer/retailer for service.
- Replacement tires or wheels do not match the vehicle’s original equipment tires or wheels. Tires and wheels other than those recommended for your vehicle could prevent the TPMS from functioning properly. See *Buying New Tires* on page 9-54.

- Operating electronic devices or being near facilities using radio wave frequencies similar to the TPMS could cause the TPMS sensors to malfunction.
- If tire chains are installed on the vehicle.
- If there is a lot of snow or ice around the wheels or wheel housings.
- If a window tint that affects the radio wave signals is installed.

If the TPMS is not functioning it cannot detect or signal a low tire condition. See your dealer/retailer for service if the TPMS malfunction light comes on and stays on.

TPMS Reset

The TPMS sensors and transmitters have unique identification codes. Anytime you replace a TPMS sensor or transmitter the identification codes need to be registered and the TPMS needs to be reset (initialized). When the system is initialized, the current air pressure in the tires is set as the tire pressure benchmark. The tire pressure warning system determines decreased air pressure by comparing tire pressure to the benchmark pressure stored in the TPMS.

Do not reset the TPMS without first correcting the cause of a low-tire condition.

To reset the system:

1. Park the vehicle at a safe place and apply the parking brake. Turn the engine off.
2. Turn the ignition to ACC/ACCESSORY or LOCK/OFF.

3. Adjust the tire pressure of all the installed tires to the specified cold tire inflation pressure level indicated on the Tire and Loading Information label attached to the vehicle.
4. Turn the ignition to ON/RUN with the engine off.



5. Press and hold the tire pressure warning reset switch until the tire pressure warning light flashes slowly on/off three times.

Wait for a few minutes with the ignition in ON/RUN, and then turn the ignition to ACC/ACCESSORY or LOCK/OFF.

If the low-tire pressure warning light does not flash three times while you press and hold the reset button, the reset has failed. Repeat the reset process. If the reset cannot be performed, see your dealer/retailer for service.

If you press the tire pressure reset switch while the vehicle is moving, the reset is not performed. If you press the tire pressure reset switch accidentally and initialization is performed, adjust the tire pressure to the specified level and perform the reset procedure again.

Tire Inspection and Rotation

We recommend that you regularly inspect the vehicle's tires, including the spare tire, for signs of wear or damage. See *When It Is Time for New Tires on page 9-54* for more information.

Tires should be rotated every 5,000 to 8,000 miles (8 000 to 13 000 km). See *Part A: Scheduled Maintenance Services on page 11-3*.

The purpose of a regular tire rotation is to achieve a uniform wear for all tires on the vehicle. This will ensure that the vehicle continues to perform most like it did when the tires were new.

Any time you notice unusual wear, rotate the tires as soon as possible and check wheel alignment. Also check for damaged tires or wheels. See *When It Is Time for New*

Tires on page 9-54 and Wheel Replacement on page 9-59 for more information.

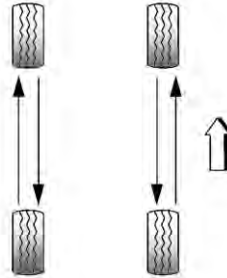

When rotating the vehicle's tires, always use the correct rotation pattern shown here.

Tires should only be moved from front to rear and rear to front on the same side of the vehicle.

Do not include the compact spare tire in the tire rotation.

After the tires have been rotated, adjust the front and rear inflation pressures to the amounts shown on the Tire and Loading Information label.

See *Inflation - Tire Pressure on page 9-47* and *Loading the Vehicle on page 8-32*.

CAUTION

Rust or dirt on a wheel, or on the parts to which it is fastened, can make wheel nuts become loose after time. The wheel could come off and cause an accident. When you change a wheel, remove any rust or dirt from places where the wheel attaches to the vehicle. In an emergency, you can use a cloth or a paper towel to do this; but be sure to use a scraper or wire brush later, if needed, to get all the rust or dirt off. See *Changing a Flat Tire on page 9-62*.

Make certain that all wheel nuts are properly tightened. See "Wheel Nut Torque" under *Capacities and Specifications on page 10-2*.

When It Is Time for New Tires

Various factors, such as maintenance, temperatures, driving speeds, vehicle loading, and road conditions influence when you need new tires.

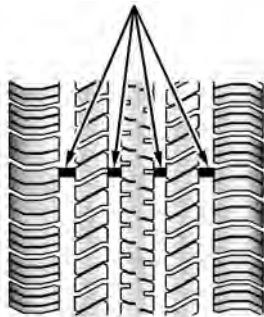

One way to tell when it is time for new tires is to check the treadwear indicators, which will appear when the tires have only 1/16 inch (1.6 mm) or less of tread remaining.

You need new tires if any of the following statements are true:

- You can see the indicators at three or more places around the tire.
- You can see cord or fabric showing through the tire's rubber.
- The tread or sidewall is cracked, cut, or snagged deep enough to show cord or fabric.
- The tire has a bump, bulge, or split.
- The tire has a puncture, cut, or other damage that cannot be repaired well because of the size or location of the damage.

The rubber in tires degrades over time, even if they are not being used. This is also true for the spare tire, if the vehicle has one. Multiple conditions affect how fast this aging takes place, including temperatures,

loading conditions, and inflation pressure maintenance. With proper care and maintenance tires typically wear out before they degrade due to age. If you are unsure about the need to replace the tires as they get older, consult the tire manufacturer for more information.

Buying New Tires

GM has developed and matched specific tires for the vehicle. If you need replacement tires, GM strongly recommends that you get tires that are the same size, brand, load range, speed rating, and construction type (radial and bias-belted tires) as the vehicle's original tires. This way, the vehicle will continue to have tires that are designed to give the same performance and vehicle safety, during normal use, as the original tires. See *Tire Sidewall Labeling on page 9-42* for additional information.

GM recommends replacing tires in sets of four. This is because uniform tread depth on all tires will help keep the vehicle performing most like it did when the tires were new. Replacing less than a full set of tires can affect the braking and handling performance of the vehicle. See *Tire Inspection and Rotation on page 9-53*.

 **CAUTION**

Mixing tires could cause you to lose control while driving. If you mix tires of different sizes, brands, or types (radial and bias-belted tires), the vehicle may not handle properly, and you could have a crash. Using tires of different sizes, brands, or types may also cause

(Continued)

CAUTION (Continued)

damage to the vehicle. Be sure to use the correct size, brand, and type of tires on all wheels. It is all right to drive with the compact spare temporarily, as it was developed for use on the vehicle. See *Compact Spare Tire on page 9-70*.

 **CAUTION**

If you use bias-ply tires on the vehicle, the wheel rim flanges could develop cracks after many miles of driving. A tire and/or wheel could fail suddenly, causing a crash. Use only radial-ply tires with the wheels on the vehicle.

Vehicles that have a tire pressure monitoring system could give an inaccurate low-pressure warning if tires not recommended for the vehicle are installed. Tires that do not match the original equipment tires could give a low-pressure warning that is higher or lower than the proper warning level you would get with original equipment tires. See *Tire Pressure Monitor System on page 9-48*.

The vehicle's original equipment tires are listed on the Tire and Loading Information Label. See *Loading the Vehicle on page 8-32*, for more information about the Tire and Loading Information label and its location on the vehicle.

Different Size Tires and Wheels

If you add wheels or tires that are a different size than your original equipment wheels and tires, this may affect the way your vehicle performs, including its braking, ride and handling characteristics, stability, and resistance to rollover. Additionally, if your vehicle has electronic systems such as, antilock brakes, traction control, and electronic stability control, the performance of these systems can be affected.

CAUTION

If you add different sized wheels, your vehicle may not provide an acceptable level of performance and safety if tires not recommended for those wheels are selected. You may increase the chance that you will crash and suffer serious injury. Only use GM specific wheel and tire systems developed for your vehicle, and have them properly installed by a GM certified technician.

See *Buying New Tires on page 9-54* and *Accessories and Modifications on page 9-3* for additional information.

Uniform Tire Quality Grading

Quality grades can be found where applicable on the tire sidewall between tread shoulder and maximum selection width. For example:

Treadwear 200 Traction AA Temperature A

The following information relates to the system developed by the United States National Highway Traffic Safety Administration (NHTSA), which grades tires by treadwear, traction, and temperature performance. This applies only to vehicles sold in the United States.

The grades are molded on the sidewalls of most passenger car tires. The Uniform Tire Quality Grading (UTQG) system does not apply to deep tread, winter-type snow tires, space-saver, or temporary use spare tires, tires with nominal rim diameters of 10 to 12 inches (25 to 30 cm), or to some limited-production tires.

While the tires available on General Motors passenger cars and light trucks may vary with respect to these grades, they must also conform to federal safety requirements.

Treadwear

The treadwear grade is a comparative rating based on the wear rate of the tire when tested under controlled conditions on a specified government test course. For example, a tire graded 150 would wear one and a half ($1\frac{1}{2}$) times as well on the government course as a tire graded 100. The relative performance of tires depends upon the actual conditions of their use, however, and may depart significantly from the norm due to variations in driving habits, service practices, and differences in road characteristics and climate.

Traction — AA, A, B, C

The traction grades, from highest to lowest, are AA, A, B, and C. Those grades represent the tire's ability to stop on wet pavement as measured under controlled conditions on specified government test surfaces of asphalt and concrete. A tire marked C may have poor traction performance.

WARNING

The traction grade assigned to this tire is based on straight-ahead braking traction tests, and does not include acceleration, cornering, hydroplaning, or peak traction characteristics.

Temperature — A, B, C

The temperature grades are A (the highest), B, and C, representing the tire's resistance to the generation of heat and its ability to dissipate heat when tested under controlled conditions on a specified indoor laboratory test wheel. Sustained high temperature can cause the material of the tire to degenerate and reduce tire life, and excessive temperature can lead to sudden tire failure. The grade C corresponds to a level of performance which all passenger car tires must meet under the Federal Motor

Vehicle Safety Standard No. 109. Grades B and A represent higher levels of performance on the laboratory test wheel than the minimum required by law.

WARNING

The temperature grade for this tire is established for a tire that is properly inflated and not overloaded. Excessive speed, underinflation, or excessive loading, either separately or in combination, can cause heat buildup and possible tire failure.

Wheel Alignment and Tire Balance

The tires and wheels on your vehicle were aligned and balanced carefully at the factory to give you the longest tire life and best overall performance. Adjustments to wheel alignment and tire balancing will not be necessary on a regular basis. However, if you notice unusual tire wear or your vehicle pulling to one side or the other, the alignment might need to be checked. If you notice your vehicle vibrating when driving on a smooth road, the tires and wheels might need to be rebalanced. See your dealer/retailer for proper diagnosis.

Wheel Replacement

Replace any wheel that is bent, cracked or badly rusted or corroded. If wheel nuts keep coming loose, the wheel, wheel bolts and wheel nuts should be replaced. If the wheel leaks air, replace it (except some aluminum wheels, which can sometimes be repaired). See your dealer/retailer if any of these conditions exist.

Your dealer/retailer will know the kind of wheel you need.

Each new wheel should have the same load-carrying capacity, diameter, width, offset and be mounted the same way as the one it replaces.

If you need to replace any of the wheels, wheel bolts or wheel nuts, replace them only with new GM original equipment parts. This way, you will be sure to have the right wheel, wheel bolts and wheel nuts for the vehicle.

CAUTION

Using the wrong replacement wheels, wheel bolts, or wheel nuts on your vehicle can be dangerous. It could affect the braking and handling of your vehicle, make your tires lose air and make you lose control. You could have a collision in which you or others could be injured. Always use the correct wheel, wheel bolts, and wheel nuts for replacement.

Notice: The wrong wheel can also cause problems with bearing life, brake cooling, speedometer or odometer calibration, headlamp aim, bumper height, vehicle ground clearance, and tire or tire chain clearance to the body and chassis.

See *Changing a Flat Tire* on page 9-62 for more information.

Used Replacement Wheels

CAUTION

Putting a used wheel on the vehicle is dangerous. You cannot know how it has been used or how far it has been driven. It could fail suddenly and cause a crash. If you have to replace a wheel, use a new GM original equipment wheel.

Tire Chains

 **CAUTION**

If the vehicle has P215/45R18 size tires, do not use tire chains. There is not enough clearance.

Tire chains used on a vehicle without the proper amount of clearance can cause damage to the brakes, suspension or other vehicle parts. The area damaged by the tire chains could cause you to lose control of the vehicle and you or others may be injured in a crash.

(Continued)

CAUTION (Continued)

Use another type of traction device only if its manufacturer recommends it for use on the vehicle and tire size combination and road conditions. Follow that manufacturer's instructions. To help avoid damage to the vehicle, drive slowly, readjust or remove the device if it is contacting the vehicle, and do not spin the wheels.

If you do find traction devices that will fit, install them on the front tires.

Notice: If the vehicle has a tire size other than P215/45R18 size tires, use tire chains only where legal and only when you must. Use only SAE Class "S" type chains that are the proper size for the tires. Install them on the front tires and tighten them as tightly as possible with the ends securely fastened. Drive slowly and follow the chain manufacturer's instructions. If you can hear the chains contacting the vehicle, stop and retighten them. If the contact continues, slow down until it stops. Driving too fast or spinning the wheels with chains on will damage the vehicle.

Tire Changing

If a Tire Goes Flat

It is unusual for a tire to blowout while you are driving, especially if you maintain your vehicle's tires properly. If air goes out of a tire, it is much more likely to leak out slowly. But if you should ever have a blowout, here are a few tips about what to expect and what to do:

If a front tire fails, the flat tire creates a drag that pulls the vehicle toward that side. Take your foot off the accelerator pedal and grip the

steering wheel firmly. Steer to maintain lane position, and then gently brake to a stop well out of the traffic lane.

A rear blowout, particularly on a curve, acts much like a skid and may require the same correction you would use in a skid. In any rear blowout remove your foot from the accelerator pedal. Get the vehicle under control by steering the way you want the vehicle to go. It may be very bumpy and noisy, but you can still steer. Gently brake to a stop, well off the road if possible.

CAUTION

Lifting a vehicle and getting under it to do maintenance or repairs is dangerous without the appropriate safety equipment and training. If a jack is provided with the vehicle, it is designed only for changing a flat tire. If it is used for anything else, you or others could be badly injured or killed if the vehicle slips off the jack. If a jack is provided with the vehicle, only use it for changing a flat tire.

If a tire goes flat, the next part shows how to use the jacking equipment to change a flat tire safely.

Changing a Flat Tire

If a tire goes flat, avoid further tire and wheel damage by driving slowly to a level place. Turn on the hazard warning flashers. See *Hazard Warning Flashers on page 4-3*.

CAUTION

Changing a tire can be dangerous. The vehicle can slip off the jack and roll over or fall on you or other people. You and they could be badly injured or even killed. Find a level place to change your tire. To help prevent the vehicle from moving:

1. Set the parking brake firmly.
2. Put an automatic transmission shift lever in P (Park), or shift a manual transmission to 1 (First) or R (Reverse).

(Continued)

CAUTION (Continued)

3. Turn off the engine and do not restart while the vehicle is raised.
4. Do not allow passengers to remain in the vehicle.

To be certain the vehicle will not move, put blocks at the front and rear of the tire farthest away from the one being changed. That would be the tire on the other side, at the opposite end of the vehicle.

When you have a flat tire, use the following example as a guide to assist you in the placement of wheel blocks.

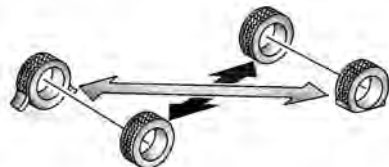

The following information tells you how to use the jack and change a tire.

Removing the Spare Tire and Tools

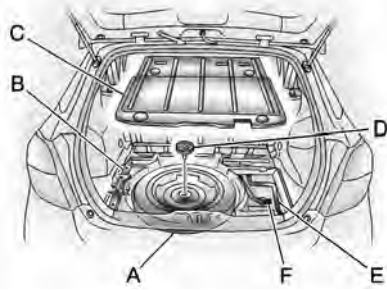

- A. Compact Spare Tire
- B. Jack
- C. Cargo Area Floor(s)
- D. Tire/Wheel Retainer Nut
- E. Jack Handle
- F. Wheel Wrench

To remove the spare tire and tools:

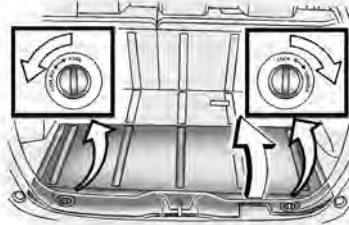

1. Turn the two lock knobs on the cargo area floor (C) to UNLOCK.
2. Lift up and remove the both of the cargo area floors (C).



3. Remove the hook holding the jack (B) and remove the jack (B).
4. Remove the jack handle (E) and wheel wrench (F) from the passenger side of the cargo area.



5. Remove the tire/wheel retainer (D) from the compact spare tire (A) and remove the compact spare tire (A). See *Compact Spare Tire* on page 9-70.
6. Place the compact spare tire (A) next to the flat tire.

Removing the Flat Tire and Installing the Spare Tire

1. Do a safety check before proceeding. See *Changing a Flat Tire* on page 9-62.
2. If the vehicle has steel wheels with plastic wheel nut caps, loosen the plastic wheel nut caps. You may need the wheel wrench to loosen them. Do not pry off wheel covers that have plastic wheel nut caps.
3. Remove the wheel cover and set it off to the side.
4. Attach the jack handle to the jack and turn clockwise to raise the lift head a little.



5. Loosen all the wheel nuts. Do not remove them yet.

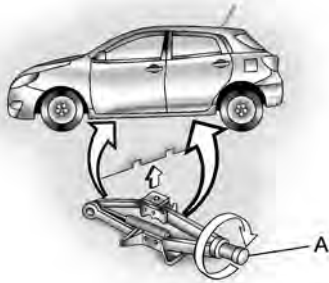

6. Position the jack and raise the jack lift head to fit over the car flange between the two notches.

⚠ CAUTION

Getting under a vehicle when it is jacked up is dangerous. If the vehicle slips off the jack you could be badly injured or killed. Never get under a vehicle when it is supported only by a jack.

⚠ CAUTION

Raising your vehicle with the jack improperly positioned can damage the vehicle and even make the vehicle fall. To help avoid personal injury and vehicle damage, be sure to fit the jack lift head into the proper location before raising the vehicle.

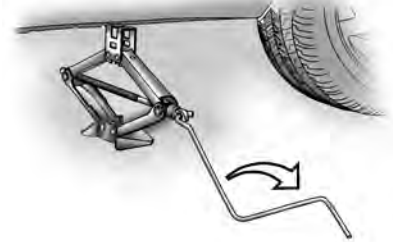

7. Turn the jack handle clockwise. Raise the vehicle far enough off the ground so there is enough room for the compact spare tire to fit underneath the wheel well.

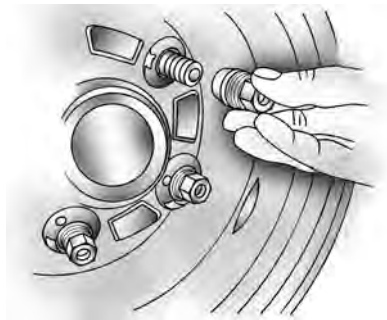

8. Remove the wheel nuts and the flat tire.
9. Install the spare tire.

⚠ CAUTION

Rust or dirt on a wheel, or on the parts to which it is fastened, can make wheel nuts become loose after time. The wheel could come off and cause an accident. When you change a wheel, remove any rust or dirt from places where the wheel attaches to the vehicle. In an emergency, you can use a cloth or a paper towel to do this; but be sure to use a scraper or wire brush later, if needed, to get all the rust or dirt off. See *Changing a Flat Tire* on page 9-62.

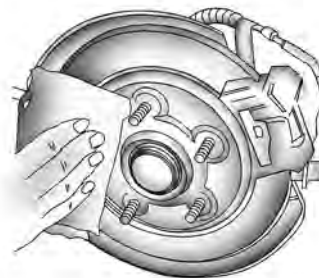

10. Remove any rust or dirt from the wheel bolts, mounting surfaces and spare wheel.
11. Place the compact spare tire on the wheel-mounting surface.

⚠ CAUTION

Never use oil or grease on bolts or nuts because the nuts might come loose. The vehicle's wheel could fall off, causing a crash.

12. Reinstall the wheel nuts with the rounded end of the nuts toward the wheel. Tighten each nut by hand until the wheel is held against the hub.



13. Turn the jack handle counterclockwise. Lower the jack completely.

⚠ CAUTION

Incorrect or improperly tightened wheel nuts can cause the wheel to come loose and even come off. This could lead to a crash. If you have to replace them, be sure to get new original equipment wheel nuts. Stop somewhere as soon as you can and have the nuts tightened with a torque wrench to the proper torque specification. See *Capacities and Specifications on page 10-2* for wheel nut torque specification.

Notice: Improperly tightened wheel nuts can lead to brake pulsation and rotor damage. To avoid expensive brake repairs, evenly tighten the wheel nuts in the proper sequence and to the proper torque specification. See *Capacities and Specifications on page 10-2* for the wheel nut torque specification.



14. Tighten the wheel nuts firmly in a crisscross sequence as shown.

Storing a Flat or Spare Tire and Tools

Storing the Compact Spare Tire

⚠ CAUTION

Storing a jack, a tire, or other equipment in the passenger compartment of the vehicle could cause injury. In a sudden stop or collision, loose equipment could strike someone. Store all these in the proper place.

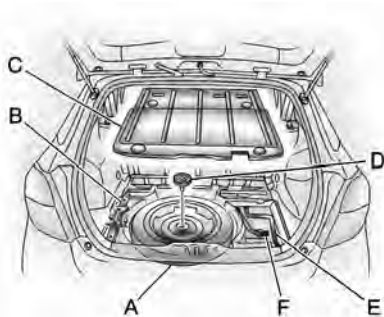

- A. Compact Spare Tire
(Valve Stem Pointed Down)
 - B. Jack
 - C. Cargo Area Floor
 - D. Tire/Wheel Retainer Nut
 - E. Jack Handle
 - F. Wheel Wrench
1. Place the jack handle (E) and wheel wrench (F) back in their original location in the passenger side of the cargo area.

2. Place the jack (B) back in its original location on the driver side of the cargo area and close the latch over the jack (B).
3. Place the compact spare tire (A), valve stem pointed down, back in its original location in the center of the cargo area.
4. Turn the tire/wheel retainer nut (D) clockwise to secure it on the compact spare tire (A).
5. Close the cargo area floor (C).

Storing the Full-Size Flat Tire

⚠ CAUTION

Storing a jack, a tire, or other equipment in the passenger compartment of the vehicle could cause injury. In a sudden stop or collision, loose equipment could strike someone. Store all these in the proper place.

The standard tire cannot be stored in the compact spare tire storage area.

To store the standard flat tire:

1. If your vehicle has aluminum wheels, remove the center wheel cap before storing the flat tire.
2. Place the flat tire on the rear cargo area floor panel with the valve stem facing up.

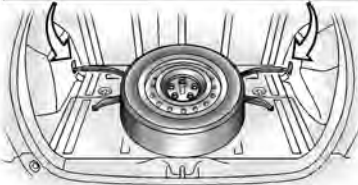

3. Use the tire tie-down straps located under the floor panel to secure the flat tire.

4. Hook the end closest to the buckle, to the front cargo hooks.

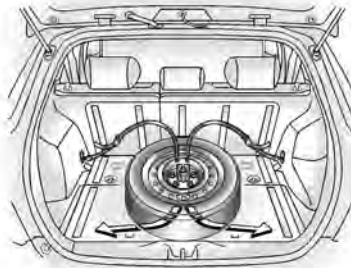

5. Pass the straps through the center hole of the wheel.



6. Attach the other end of the straps to the cargo hooks.
7. Position the tire edge against the rear center end of the floor panel. Pull the end of the straps to make sure the tire is secure.

Store the compact spare tire properly after use.

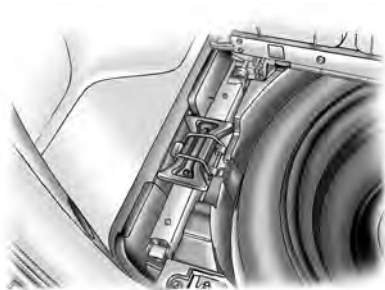

Return the jack and tools to the left side of the compartment after use.

Compact Spare Tire

The compact spare tire was fully inflated when the vehicle was new, it can lose air after a time. Check the inflation pressure regularly. It should be 60 psi (414 kPa).

After installing the compact spare on your vehicle, you should stop as soon as possible and make sure your spare tire is correctly inflated. The compact spare is intended to perform well at speeds up to 50 mph (80 km/h), so you can finish your trip and have your full-size tire repaired or replaced where you want. Replace your spare with a full-size tire as soon as you can.

Notice: When the compact spare is installed, do not take the vehicle through an automatic car wash with guide rails. The compact spare can get caught on the rails which can damage the tire, wheel and other parts of the vehicle.

Do not use your compact spare on other vehicles.

Do not mix your compact spare tire or wheel with other wheels or tires. Keep your spare tire and its wheel together.

Notice: Tire chains will not fit the compact spare. Using them can damage the vehicle and can damage the chains too. Do not use tire chains on the compact spare.

Jump Starting

If your vehicle's battery has run down, you may want to use another vehicle and some jumper cables to start your vehicle. Be sure to use the following steps to do it safely.

CAUTION

Batteries can hurt you. They can be dangerous because:

- They contain acid that can burn you.
- They contain gas that can explode or ignite.
- They contain enough electricity to burn you.

If you do not follow these steps exactly, some or all of these things can hurt you.

Notice: Ignoring these steps could result in costly damage to your vehicle that would not be covered by your warranty.

Trying to start your vehicle by pushing or pulling it will not work, and it could damage your vehicle.

1. Check the other vehicle. It must have a 12-volt battery with a negative ground system.

Notice: If the other vehicle's system is not a 12-volt system with a negative ground, both vehicles can be damaged. Only use vehicles with 12-volt systems with negative grounds to jump start your vehicle.

2. Get the vehicles close enough so the jumper cables can reach, but be sure the vehicles are not touching each other. If they are, it could cause a ground connection you do not want. You would not be able to start your vehicle, and the bad grounding could damage the electrical systems.

To avoid the possibility of the vehicles rolling, set the parking brake firmly on both vehicles involved in the jump start procedure. Put an automatic transmission in P (Park) or a manual transmission in NEUTRAL before setting the parking brake.

Notice: If you leave the radio or other accessories on during the jump starting procedure, they could be damaged. The repairs would not be covered by the warranty. Always turn off the radio and other accessories when jump starting the vehicle.

3. Turn off the ignition on both vehicles. Unplug unnecessary accessories plugged into the cigarette lighter. Turn off the radio and all lamps that are not needed. This will avoid sparks and help save both batteries. And it could save the radio!

9-72 Vehicle Service and Care

4. Open the hoods and locate the batteries. Find the positive (+) and negative (-) terminal locations on each vehicle. See *Engine Compartment Overview* on page 9-6 for more information on location.

CAUTION

An electric fan can start up even when the engine is not running and can injure you. Keep hands, clothing and tools away from any underhood electric fan.

CAUTION

Using a match near a battery can cause battery gas to explode. People have been hurt doing this, and some have been blinded. Use a flashlight if you need more light.

(Continued)

CAUTION (Continued)

Be sure the battery has enough water. You do not need to add water to the battery installed in your new vehicle. But if a battery has filler caps, be sure the right amount of fluid is there. If it is low, add water to take care of that first. If you don't, explosive gas could be present.

Battery fluid contains acid that can burn you. Do not get it on you. If you accidentally get it in your eyes or on your skin, flush the place with water and get medical help immediately.

CAUTION

Fans or other moving engine parts can injure you badly. Keep your hands away from moving parts once the engine is running.

5. Check that the jumper cables do not have loose or missing insulation. If they do, you could get a shock. The vehicles could be damaged too.

Before you connect the cables, here are some basic things you should know. Positive (+) will go to positive (+) or to a remote positive (+) terminal if the vehicle has one. Negative (-) will go to a heavy, unpainted metal engine part or to a remote negative (-) terminal if the vehicle has one.

Do not connect positive (+) to negative (-) or you will get a short that would damage the battery and maybe other parts too. And do not connect the negative (-) cable to the negative (-) terminal on the dead battery because this can cause sparks.

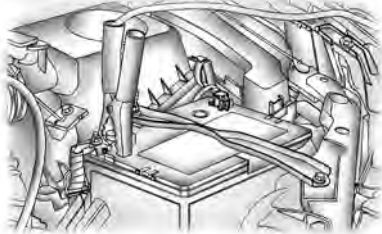

6. Connect the red positive (+) cable to the positive (+) terminal of the dead battery. Use a remote positive (+) terminal if the vehicle has one.
7. Do not let the other end touch metal. Connect it to the positive (+) terminal of the good battery. Use a remote positive (+) terminal if the vehicle has one.

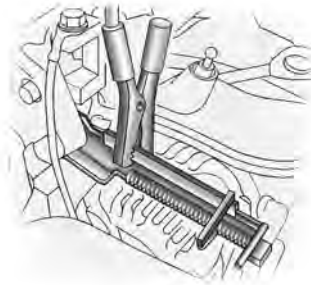

1.8 L4 Engine

8. To access the remote negative on the 1.8L engine, the cover will need to be removed. To remove the engine cover raise the rear of the engine cover to remove the rear clips and the front of the engine cover to remove the two front clips



2.4L L4 Engine

Now connect the black negative (-) cable to the negative terminal of the good battery. Use a remote negative (-) terminal if the vehicle has one. Do not let the other end touch anything until the next step. The other end of the negative (-) cable does not go to the dead battery. It goes to a heavy, unpainted metal engine part or to a remote negative (-) terminal on the vehicle with the dead battery.

9-74 Vehicle Service and Care

9. Connect the other end of the negative (-) cable at least 18 inches (45 cm) away from the dead battery, but not near engine parts that move. The electrical connection is just as good there, and the chance of sparks getting back to the battery is much less.
10. Now start the vehicle with the good battery and run the engine for a while.
11. Try to start the vehicle that had the dead battery. If it will not start after a few tries, it probably needs service.

Notice: If the jumper cables are connected or removed in the wrong order, electrical shorting may occur and damage the vehicle. The repairs would not be covered by your warranty. Always connect and remove the jumper cables in the correct order, making sure that the cables do not touch each other or other metal.

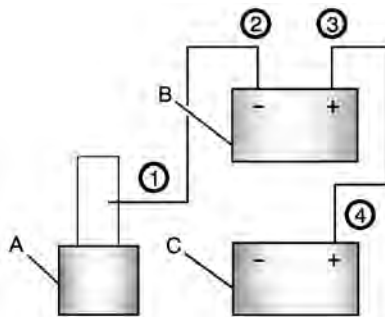

Jumper Cable Removal

- A. Heavy, Unpainted Metal Engine Part
- B. Good Battery
- C. Dead Battery

To disconnect the jumper cables from both vehicles, do the following:

1. Disconnect the black negative (-) cable from the vehicle that had the dead battery.
2. Disconnect the black negative (-) cable from the vehicle with the good battery.
3. Disconnect the red positive (+) cable from the vehicle with the good battery.
4. Disconnect the red positive (+) cable from the other vehicle.

Towing

Towing Your Vehicle

To avoid damage, the disabled vehicle should be towed with all four wheels off the ground. Consult your dealer/retailer or a professional towing service if the disabled vehicle must be towed. See *Roadside Assistance Program on page 12-5*.

To tow the vehicle behind another vehicle for recreational purposes (such as behind a motorhome), see “Recreational Vehicle Towing” following.

Recreational Vehicle Towing

Recreational vehicle towing means towing your vehicle behind another vehicle – such as behind a motorhome. The two most common types of recreational vehicle towing

are known as “dinghy towing” (towing your vehicle with all four wheels on the ground) and “dolly towing” (towing your vehicle with two wheels on the ground and two wheels up on a device known as a “dolly”).

With the proper preparation and equipment, many vehicles can be towed in these ways. See “Dinghy Towing” and “Dolly Towing,” following.

Here are some important things to consider before you do recreational vehicle towing:

- What is the towing capacity of the towing vehicle?
Be sure you read the tow vehicle manufacturer’s recommendations.
- How far will you tow? Some vehicles have restrictions on how far and how long they can tow.

- Do you have the proper towing equipment? See your dealer/retailer or trailering professional for additional advice and equipment recommendations.
- Is your vehicle ready to be towed? Just as you would prepare your vehicle for a long trip, you will want to make sure your vehicle is prepared to be towed. See “Before Leaving On A Long Trip” in the Index.

Dinghy Towing

If your vehicle has an automatic transmission, it cannot be dinghy towed. See “Dolly Towing” for more information regarding towing your vehicle.

If your vehicle has a manual transmission, it can be dinghy towed.



When dinghy towing, be sure to follow the posted legal speed limit.

1. Put the shift lever in Neutral.
2. Turn the ignition to ACC/ACCESSORY to avoid locking the steering wheel. Make sure the audio system is turned off and that nothing is plugged into the power outlets.
3. Release the parking brake.

After dinghy towing, let the engine idle for more than three minutes before driving the vehicle.



Do not tow your vehicle from the rear. Your vehicle could be badly damaged and the repairs would not be covered by your warranty.

Dolly Towing (All-Wheel-Drive Vehicles)

All-wheel-drive vehicles must not be towed with two wheels on the ground. To properly tow these vehicles, they should be placed on a platform trailer with all four wheels off of the ground.

Dolly Towing (Front-Wheel-Drive Vehicles Only)



To tow your front-wheel-drive vehicle using a dolly, follow these steps:

1. Put the front wheels on a dolly.
2. Move the shift lever to P (Park) for an automatic transmission or Neutral for a manual transmission.
3. Set the parking brake.

4. Clamp the steering wheel in a straight-ahead position with a clamping device designed for towing.
5. Remove the key from the ignition.
6. Secure the vehicle to the dolly.
7. Release the parking brake.

Towing a Trailer

 **CAUTION**

The driver can lose control when pulling a trailer if the correct equipment is not used or the vehicle is not driven properly. For example, if the trailer is too heavy, the brakes may not work well or even at all. The driver and passengers could be seriously

(Continued)

CAUTION (Continued)

injured. The vehicle may also be damaged; the resulting repairs would not be covered by the vehicle warranty. Pull a trailer only if all the steps in this section have been followed. Ask your dealer/retailer for advice and information about towing a trailer with the vehicle.

Your vehicle can tow a trailer if it is equipped with the proper trailer towing equipment. To identify the vehicle trailering capacity of your vehicle, you should read the information in "Weight of the Trailer" that appears later in this section. Trailering is different than just driving your vehicle by itself. Trailering means changes in handling,

acceleration, braking, durability and fuel economy. Successful, safe trailering takes correct equipment, and it has to be used properly.

That is the reason for this part. In it are many time-tested, important trailering tips and safety rules. Many of these are important for your safety and that of your passengers. So please read this section carefully before you pull a trailer.

Load-pulling components such as the engine, transmission, wheel assemblies and tires are forced to work harder against the drag of the added weight. The engine is required to operate at relatively higher speeds and under greater loads, generating extra heat. In addition, the trailer adds considerably to wind resistance, increasing the pulling requirements.

If You Do Decide To Pull A Trailer

If you do, here are some important points:

- There are many different laws, including speed limit restrictions, having to do with trailering. Make sure the rig will be legal, not only where you live but also where you will be driving. A good source for this information can be state or provincial police.
- Consider using a sway control. Ask a hitch dealer about sway controls.
- Do not tow a trailer at all during the first 1,000 miles (1 600 km) the new vehicle is driven. The engine, axle or other parts could be damaged.

- Then, during the first 500 miles (800 km) that trailer is towed, do not drive over 50 mph (80 km/h) and do not make starts at full throttle. This helps the engine and other parts of the vehicle wear in at the heavier loads.
- Obey speed limit restrictions when towing a trailer. Do not drive faster than the maximum posted speed for trailers, or no more than 55 mph (90 km/h), to save wear on the vehicle's parts.

Three important considerations have to do with weight:

- the weight of the trailer
- the weight of the trailer tongue
- and the total weight on your vehicle's tires

Weight of the Trailer

How heavy can a trailer safely be?

It should never weigh more than 1,500 lbs (680 kg). But even that can be too heavy.

It depends on how you plan to use your rig. For example, speed, altitude, road grades, outside temperature and how much your vehicle is used to pull a trailer are all important. It can also depend on any special equipment that you have on your vehicle, and the amount of tongue weight the vehicle can carry. See "Weight of the Trailer Tongue" later in this section for more information.

Maximum trailer weight is calculated assuming only the driver is in the tow vehicle and it has all the required trailering equipment. The weight of additional optional equipment, passengers and cargo in the tow vehicle must be subtracted from the maximum trailer weight.

You can ask your dealer/retailer for our trailering information or advice, or you can write us at our Customer Assistance Offices. See *Customer Assistance Offices on page 12-4* for more information.

Weight of the Trailer Tongue

The tongue load (A) of any trailer is an important weight to measure because it affects the total or gross weight of your vehicle. The Gross Vehicle Weight (GVW) includes the curb weight of the vehicle, any cargo you may carry in it, and the people who will be riding in the vehicle.

And if you tow a trailer, you must add the tongue load to the GVW because your vehicle will be carrying that weight, too. See *Loading the Vehicle on page 8-32* for more information about your vehicle's maximum load capacity.

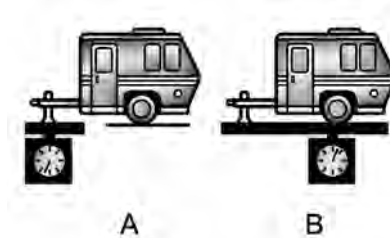

If using a weight-carrying hitch or a weight-distributing hitch, the trailer tongue (A) should weigh 10 to 15 percent of the total loaded trailer weight (B).

After the trailer is loaded, weigh the trailer and then the tongue, separately, to see if the weights are proper. If they are not, you may be able to get them right simply by moving some items around in the trailer.

Total Weight on Your Vehicle's Tires

Be sure your vehicle's tires are inflated to the upper limit for cold tires. These numbers are located on the Tire and Loading Information label located on the vehicle's center pillar (B-pillar). See *Loading the Vehicle on page 8-32*. Then be sure you do not go over the GVW limit for your vehicle, including the weight of the trailer tongue.

Hitches

It is important to have the correct hitch equipment. Crosswinds, large trucks going by and rough roads are a few reasons why you will need the right hitch. Here are some rules to follow:

- Do not let the steel in a hitch contact the aluminum on your bumper because it can corrode. Use something like paint or plastic tape to separate the steel and aluminum. The same steel to aluminum problem can happen with fasteners too.
- Will you have to make any holes in the body of your vehicle when you install a trailer hitch? If you do, then be sure to seal the holes later when you remove the hitch. If you do not seal them, deadly carbon monoxide (CO) from the exhaust can get into your vehicle. See “Engine Exhaust” in the Index. Dirt and water can too.

Safety Chains

You should always attach chains between your vehicle and your trailer. Cross the safety chains under the tongue of the trailer so that the tongue will not drop to the road if it becomes separated from the hitch. Instructions about safety chains may be provided by the hitch manufacturer or by the trailer manufacturer. Follow the manufacturer's recommendation for attaching safety chains and do not attach them to the bumper. Leave sufficient slack in the chain for turns. Never allow safety chains to drag on the ground.

Trailer Brakes

Does your trailer have its own brakes?

Be sure to read and follow the instructions for the trailer brakes so you will be able to install, adjust and maintain them properly. If you have antilock brakes, do not tap into your vehicle's brake system. If you do, both systems will not work well, or at all.

Driving with a Trailer

Towing a trailer requires a certain amount of experience. Get to know the rig before setting out for the open road. Acquaint yourself with the feel of handling and braking with the added weight of the trailer. And always keep in mind that the vehicle you are driving is now a good deal longer and not nearly as responsive as your vehicle is by itself.

Before you start, check the trailer hitch, platform and attachments, safety chains, electrical connector, lamps, tires and mirror adjustment. If the trailer has electric brakes, start your vehicle and trailer moving and then apply the trailer brake controller by hand to be sure the brakes are working. This lets you check your electrical connection at the same time.

During your trip, check occasionally to be sure that the load is secure, and that the lamps and any trailer brakes are still working.

Following Distance

Stay at least twice as far behind the vehicle ahead as you would when driving your vehicle without a trailer. This can help you avoid situations that require heavy braking and sudden turns.

Passing

More distance in front is needed to pass when towing a trailer. And, because the tow vehicle and trailer are longer, you will need to go farther beyond the passed vehicle before you can return to your lane.

Backing Up

Hold the bottom of the steering wheel with one hand. Then, to move the trailer to the left, just move that hand to the left. To move the trailer to the right, move your hand to the right. Always back up slowly and, if possible, have someone guide you.

Making Turns

Notice: Making very sharp turns while trailering could cause the trailer to come in contact with the vehicle. The vehicle could be damaged. Avoid making very sharp turns while trailering.

When you are turning with a trailer, make wider turns than normal. Do this so your trailer will not strike soft shoulders, curbs, road signs, trees or other objects. Avoid jerky or sudden maneuvers. Signal well in advance.

Turn Signals When Towing a Trailer

When you tow a trailer, your vehicle may need a different turn signal flasher and/or extra wiring. Check with your dealer/retailer. The arrows on the instrument panel flash whenever you signal a turn or lane change. Properly hooked up, the trailer lamps also flash, telling other drivers you are about to turn, change lanes or stop.

When towing a trailer, the arrows on the instrument panel will flash for turns even if the bulbs on the trailer are burned out. Thus, you may think drivers behind you are seeing your signal when they are not. It is important to check occasionally to be sure the trailer bulbs are still working.

Driving On Grades

Reduce speed and shift to a lower gear *before* you start down a long or steep downgrade. If you do not shift down, you might have to use your brakes so much that they would get hot and no longer work well.

On a long uphill grade, shift down and reduce your speed to around 45 mph (70 km/h) to reduce the possibility of the engine and the transmission overheating.

Parking on Hills

 **CAUTION**

Parking the vehicle on a hill with the trailer attached can be dangerous. If something goes wrong, the rig could start to move. People can be injured, and both the vehicle and the trailer can be damaged. When possible, always park the rig on a flat surface.

To park your rig on a hill:

1. Apply your regular brakes, but do not shift into P (Park) for an automatic transmission or into gear for a manual transmission, yet. When parking uphill, turn your wheels away from the curb. When parking downhill, turn your wheels into the curb.
2. Have someone place chocks under the trailer wheels.

3. When the chocks are in place, release the regular brakes until the chocks absorb the load.
4. Reapply the regular brakes. Then apply your parking brake and shift into P (Park) for an automatic transmission or R (Reverse) for a manual transmission.
5. Release the regular brakes.

When You Are Ready to Leave After Parking on a Hill

1. Apply your regular brakes and hold the pedal down while you:
 - start your engine
 - shift the transmission into gear
 - release the parking brake
2. Let up on the brake pedal.
3. Drive slowly until the trailer is clear of the chocks.
4. Stop and have someone pick up and store the chocks.

Maintenance When Trailer Towing

Your vehicle will need service more often when you are pulling a trailer. See the Maintenance Schedule for more on this. Things that are especially important in trailer operation are automatic transmission fluid (do not overfill), engine oil, drive belt, cooling system and brake system. Each of these is covered in this manual, and the Index will help find them quickly. If you are trailering, it is a good idea to review this information before starting your trip.

Check periodically to see that all hitch nuts and bolts are tight.

Engine Cooling When Trailer Towing

The cooling system could temporarily overheat during severe operating conditions. See *Engine Overheating on page 9-22*.

Appearance Care

Interior Cleaning

Your vehicle's interior will continue to look its best if it is cleaned often. Although not always visible, dust and dirt can accumulate on your upholstery. Dirt can damage carpet, fabric, leather, and plastic surfaces. Regular vacuuming is recommended to remove particles from the upholstery. It is important to keep your upholstery from becoming and remaining heavily soiled. Soils should be removed as quickly as possible. Your vehicle's interior may experience extremes of heat that could cause stains to set rapidly.

Lighter colored interiors may require more frequent cleaning. Use care because newspapers and garments that transfer color to your home furnishings may also transfer color to your vehicle's interior.

When cleaning your vehicle's interior, only use cleaners specifically designed for the surfaces being cleaned. Permanent damage may result from using cleaners on surfaces for which they were not intended. Use glass cleaner only on glass. Remove any accidental over-spray from other surfaces immediately. To prevent over-spray, apply cleaner directly to the cleaning cloth.

Notice: If you use abrasive cleaners when cleaning glass surfaces on your vehicle, you could scratch the glass and/or cause damage to the rear window defogger. When cleaning the glass on your vehicle, use only a soft cloth and glass cleaner.

Many cleaners contain solvents that may become concentrated in your vehicle's breathing space. Before using cleaners, read and adhere to all safety instructions on the label. While cleaning your vehicle's interior,

maintain adequate ventilation by opening your vehicle's doors and windows.

Dust may be removed from small buttons and knobs using a small brush with soft bristles.

Your dealer/retailer has a product for cleaning your vehicle's glass. You can also obtain a product from your dealer/retailer to remove odors from your vehicle's upholstery.

Do not clean your vehicle using the following cleaners or techniques:

- Never use a knife or any other sharp object to remove a soil from any interior surface.
- Never use a stiff brush. It can cause damage to your vehicle's interior surfaces.
- Never apply heavy pressure or rub aggressively with a cleaning cloth. Use of heavy pressure can damage the interior and does not improve the effectiveness of soil removal.

- Use only mild, neutral-pH soaps. Avoid laundry detergents or dishwashing soaps with degreasers. Using too much soap will leave a residue that leaves streaks and attracts dirt. For liquid cleaners, about 20 drops per gallon (3.78 L) of water is a good guide.
- Do not heavily saturate the upholstery while cleaning.
- Damage to your vehicle's interior may result from the use of many organic solvents such as naphtha, alcohol, etc.

Fabric/Carpet

Use a vacuum cleaner with a soft brush attachment frequently to remove dust and loose dirt. A canister vacuum with a beater bar in the nozzle may only be used on floor carpet and carpeted floor mats. For soils, always try to remove them first with plain water or club soda. Before cleaning, gently remove as much of the soil as possible using one of the following techniques:

- For liquids: gently blot the remaining soil with a paper towel. Allow the soil to absorb into the paper towel until no more can be removed.
- For solid dry soils: remove as much as possible and then vacuum.

To clean, use the following instructions:

1. Saturate a lint-free, clean white cloth with water or club soda.
2. Wring the cloth to remove excess moisture.
3. Start on the outside edge of the soil and gently rub toward the center. Continue cleaning, using a clean area of the cloth each time it becomes soiled.
4. Continue to gently rub the soiled area until the cleaning cloth remains clean.
5. If the soil is not completely removed, use a mild soap solution and repeat the cleaning process that was used with plain water.

If any of the soil remains, a commercial fabric cleaner or spot lifter may be necessary. When a commercial upholstery cleaner or spot lifter is to be used, test a small hidden area for colorfastness first. If the locally cleaned area gives any impression that a ring formation may result, clean the entire surface.

After the cleaning process has been completed, a paper towel can be used to blot excess moisture from the fabric or carpet.

Leather

A soft cloth dampened with water can be used to remove dust. If a more thorough cleaning is necessary, a soft cloth dampened with a mild soap solution can be used. Allow the leather to dry naturally. Do not use heat to dry. Never use steam to clean leather. Never use spot lifters or spot removers on leather. Many commercial leather cleaners and coatings that are sold to preserve and protect leather may permanently change the appearance and feel of your leather and are not recommended. Do not use silicone or wax-based products, or those containing organic solvents to clean your vehicle's interior because they can alter the appearance by increasing the gloss in a non-uniform manner. Never use shoe polish on leather.

Instrument Panel, Vinyl, and Other Plastic Surfaces

A soft cloth dampened with water may be used to remove dust. If a more thorough cleaning is necessary, a clean soft cloth dampened with a mild soap solution can be used to gently remove dust and dirt. Never use spot lifters or removers on plastic surfaces. Many commercial cleaners and coatings that are sold to preserve and protect soft plastic surfaces may permanently change the appearance and feel of your interior and are not recommended. Do not use silicone or wax-based products, or those containing organic solvents to clean your vehicle's interior because they can alter the appearance by increasing the gloss in a non-uniform manner.

Some commercial products may increase gloss on your instrument panel. The increase in gloss may cause annoying reflections in the windshield and even make it difficult to see through the windshield under certain conditions.

Exterior Cleaning

Cleaning Exterior Lamps/Lenses

Use only lukewarm or cold water, a soft cloth and a car washing soap to clean exterior lamps and lenses. Follow instructions under “Washing Your Vehicle” later in this section.

Finish Care

Occasional waxing or mild polishing of your vehicle by hand may be necessary to remove residue from the paint finish. You can get approved cleaning products from your dealer/retailer.

If your vehicle has a basecoat/clearcoat paint finish, the clearcoat gives more depth and gloss to the colored basecoat. Always use waxes and polishes that are non-abrasive and made for a basecoat/clearcoat paint finish.

Notice: Machine compounding or aggressive polishing on a basecoat/clearcoat paint finish may damage it. Use only non-abrasive waxes and polishes that are made for a basecoat/clearcoat paint finish on your vehicle.

Foreign materials such as calcium chloride and other salts, ice melting agents, road oil and tar, tree sap, bird droppings, chemicals from industrial chimneys, etc., can damage your vehicle’s finish if they remain on painted surfaces. Wash the vehicle as soon as possible. If necessary, use non-abrasive cleaners that are marked safe for painted surfaces to remove foreign matter.

Exterior painted surfaces are subject to aging, weather and chemical fallout that can take their toll over a period of years. You can help to keep the paint finish looking new by keeping your vehicle garaged or covered whenever possible.

Protecting Exterior Bright Metal Parts

Bright metal parts should be cleaned regularly to keep their luster. Wash with water or use chrome polish on chrome or stainless steel trim, if necessary.

Use special care with aluminum trim. To avoid damaging protective trim, never use auto or chrome polish, steam or caustic soap to clean aluminum. A coating of wax, rubbed to high polish, is recommended for all bright metal parts.

Washing Your Vehicle

The best way to preserve your vehicle's finish is to keep it clean by washing it often.

Do not wash the vehicle in direct sunlight. Use a car washing soap.

Notice: Certain cleaners contain chemicals that can damage the emblems or nameplates on your vehicle. Check the cleaning product label. If it states that it should not be used on plastic parts, do not use it on your vehicle or damage may occur and it would not be covered by the warranty.

Do not use cleaning agents that are petroleum based or that contain acid or abrasives, as they can damage the paint, metal or plastic on your vehicle. Approved cleaning products can be obtained from your dealer/retailer. Follow all manufacturers' directions regarding correct product usage, necessary safety precautions and appropriate disposal of any vehicle care product.

Rinse the vehicle well, before washing and after to remove all cleaning agents completely. If they are allowed to dry on the surface, they could stain.

Dry the finish with a soft, clean chamois or an all-cotton towel to avoid surface scratches and water spotting.

High pressure car washes may cause water to enter the vehicle. Avoid using high pressure washes closer than 12 inches (30 cm) to the surface of the vehicle. Use of power washers exceeding 1,200 psi (8 274 kPa) can result in damage or removal of paint and decals.

Weatherstrips

Silicone grease on weatherstrips will make them last longer, seal better, and not stick or squeak. Apply silicone grease with a clean cloth. During very cold, damp weather frequent application may be required. See "Fluids and Lubricants" in the Index of the "Maintenance and Warranty and Owner assistance Information" manual.

Wheels and Trim — Aluminum or Chrome

Your vehicle may have either aluminum or chrome-plated wheels.

Keep the wheels clean using a soft clean cloth with mild soap and water. Rinse with clean water. After rinsing thoroughly, dry with a soft clean towel. A wax may then be applied.

Notice: Chrome wheels and other chrome trim may be damaged if you do not wash your vehicle after driving on roads that have been sprayed with magnesium, calcium or sodium chloride. These chlorides are used on roads for conditions such as ice and dust. Always wash your vehicle's chrome with soap and water after exposure.

Notice: If you use strong soaps, chemicals, abrasive polishes, cleaners, brushes, or cleaners that contain acid on aluminum or chrome-plated wheels, you could damage the surface of the wheel(s). The repairs would not be covered by your warranty. Use only approved cleaners on aluminum or chrome-plated wheels.

The surface of these wheels is similar to the painted surface of your vehicle. Do not use strong soaps, chemicals, abrasive polishes, abrasive cleaners, cleaners with acid, or abrasive cleaning brushes on them because you could damage the surface. Do not use chrome polish on aluminum wheels.

Notice: Using chrome polish on aluminum wheels could damage the wheels. The repairs would not be covered by your warranty. Use chrome polish on chrome wheels only.

Use chrome polish only on chrome-plated wheels, but avoid any painted surface of the wheel, and buff off immediately after application.

Notice: If you drive your vehicle through an automatic car wash that has silicone carbide tire cleaning brushes, you could damage the aluminum or chrome-plated wheels. The repairs would not be covered by your warranty. Never drive a vehicle equipped with aluminum or chrome-plated wheels through an automatic car wash that uses silicone carbide tire cleaning brushes.

Windshield and Wiper Blades

Clean the outside of the windshield with glass cleaner.

Clean the rubber blades using a lint free cloth or paper towel soaked with windshield washer fluid or a mild detergent. Wash the windshield thoroughly when cleaning the blades. Bugs, road grime, sap, and a buildup of vehicle wash/wax treatments may cause wiper streaking. Replace the wiper blades if they are worn or damaged.

Wipers can be damaged by:

- Extreme dusty conditions
- Sand and salt
- Heat and sun
- Snow and ice, without proper removal

Tires

To clean the tires, use a stiff brush with tire cleaner.

Notice: Using petroleum-based tire dressing products on your vehicle may damage the paint finish and/or tires. When applying a tire dressing, always wipe off any overspray from all painted surfaces on your vehicle.

Sheet Metal Damage

If the vehicle is damaged and requires sheet metal repair or replacement, make sure the body repair shop applies anti-corrosion material to parts repaired or replaced to restore corrosion protection.

Original manufacturer replacement parts will provide the corrosion protection while maintaining the vehicle warranty.

Finish Damage

Any stone chips, fractures or deep scratches in the finish should be repaired right away. Bare metal will corrode quickly and may develop into major repair expense.

Minor chips and scratches can be repaired with touch-up materials available from your dealer/retailer. Larger areas of finish damage can be corrected in your dealer's/retailer's body and paint shop.

Underbody Maintenance

Chemicals used for ice and snow removal and dust control can collect on the underbody. If these are not removed, corrosion and rust can develop on the underbody parts such as fuel lines, frame, floor pan, and exhaust system even though they have corrosion protection.

At least every spring, flush these materials from the underbody with plain water. Clean any areas where mud and debris can collect. Dirt packed in close areas of the frame should be loosened before being flushed. Your dealer/retailer or an underbody car washing system can do this for you.

Chemical Paint Spotting

Some weather and atmospheric conditions can create a chemical fallout. Airborne pollutants can fall upon and attack painted surfaces on the vehicle. This damage can take two forms: blotchy, ring-shaped discolorations, and small, irregular dark spots etched into the paint surface.

Although no defect in the paint job causes this, we will repair, at no charge to the owner, the surfaces of new vehicles damaged by this fallout condition within 12 months or 12,000 miles (20 000 km) of purchase, whichever occurs first.

Technical Data

Vehicle Identification

Vehicle Identification Number (VIN)	10-1
Service Parts Identification Label	10-1

Capacities and Specifications

Capacities and Specifications	10-2
-------------------------------------	------

Normal Maintenance Replacement Parts

Maintenance Replacement Parts	10-4
Engine Drive Belt Routing	10-5

Vehicle Identification

Vehicle Identification Number (VIN)



This is the legal identifier for your vehicle. It appears on a plate in the front corner of the instrument panel, on the driver side. It can be seen through the windshield from outside the vehicle. The VIN also appears on the Vehicle Certification and Service Parts labels and the certificates of title and registration.

Engine Identification

The eighth character in the VIN is the engine code. This code helps identify the vehicle's engine, specifications, and replacement parts. See "Engine Specifications" under *Capacities and Specifications on page 10-2* for your vehicle's engine code.

Service Parts Identification Label

This label is on the inside of the glove box. It is very helpful if you ever need to order parts. The label has the following information:

- Vehicle Identification Number (VIN)
- Model designation
- Paint information
- Production options and special equipment

Do not remove this label from the vehicle.

10-2 Technical Data

Capacities and Specifications

The following approximate capacities are given in English and metric conversions. Please refer to *Part D: Recommended Fluids and Lubricants on page 11-18* for more information.

Application	Capacities	
	English	Metric
Air Conditioning Refrigerant R134a	For the air conditioning system refrigerant charge amount, see the refrigerant caution label located under the hood. See your dealer/retailer for more information.	
Cooling System		
1.8L L4 Engine	5.8 qt	5.5 L
2.4L L4 Engine	6.0 qt	5.7 L
Engine Oil with Filter		
1.8L L4 Engine	4.4 qt	4.2 L
2.4L L4 Engine	4.5 qt	4.3 L
Fuel Tank	13.2 gal	50 L
Transmission, Automatic (Complete Drain and Refill)		
1.8L L4 Engine	3.1 qt	2.9 L
2.4L L4 Engine	3.7 qt	3.5 L

Application	Capacities	
	English	Metric
Transmission, Manual (Complete Drain and Refill)		
1.8L L4 Engine	2.0 qt	1.9 L
2.4L L4 Engine	2.6 qt	2.5 L
Wheel Nut Torque	76 lb ft	103 N•m
All capacities are approximate. When adding, be sure to fill to the approximate level, as recommended in this manual.		

Engine Specifications

Engine	VIN Code	Transmission	Spark Plug Gap
1.8L L4	8	Automatic Manual	0.043 in (1.10 mm)
2.4L L4	0	Automatic Manual	0.043 in (1.10 mm)

Normal Maintenance Replacement Parts

Maintenance Replacement Parts

Replacement parts identified below by name, part number, or specification can be obtained from your dealer/retailer.

Part	GM Part Numbers	Other Part Numbers
Engine Air Cleaner/Filter		
1.8L L4 Engine	88975792	—
2.4L L4 Engine	88975799	—
Engine Oil Filter		
1.8L L4 Engine*	19185485	—
2.4L L4 Engine	88969580	—
Passenger Compartment Air Filter	19184673	—
Spark Plugs**		
1.8L L4 Engine	19185438	SK20HR11†
2.4L L4 Engine	88969636	SK20R11† IFR6A11††

*Oil Filter Element Kit includes element and seal.

**The engine is fitted with iridium-tipped spark plugs. Use only iridium-tipped spark plugs for better engine performance.

† DENSO

†† NGK

Engine Drive Belt Routing

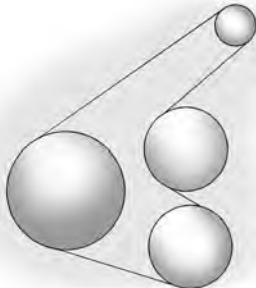

1.8L L4 Engine

The 1.8L L4 engine drive belt requires the use of a special kind of tool to service. See your dealer/retailer for service.

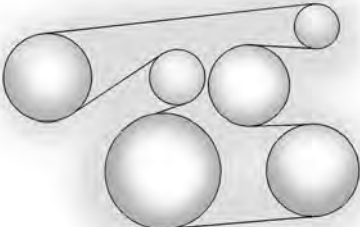

2.4L L4 Engine

Service and Maintenance

Service and Maintenance

Introduction11-1
 Maintenance
 Requirements11-2
 Your Vehicle and the
 Environment11-2
 How This Section is
 Organized11-2
 Part A: Scheduled
 Maintenance Services11-3
 Using the Maintenance
 Schedule11-3
 Scheduled Maintenance11-4
 Part B: Owner Checks
 and Services11-12
 At Each Fuel Fill11-12

At Least Once a Month ...11-13
 At Least Twice a Year11-13
 At Least Once a Year11-13
 Part C: Periodic
 Maintenance
 Inspections11-16
 Steering, Suspension and
 Front Drive Axle Boot
 and Seal Inspection11-16
 Exhaust System
 Inspection11-16
 Fuel System Inspection ...11-16
 Engine Cooling System
 Inspection11-17
 Throttle System
 Inspection11-17
 Brake System
 Inspection11-17
 Part D: Recommended
 Fluids and Lubricants11-18
 Part E: Maintenance
 Record11-20

Service and Maintenance

Introduction

Important: Keep engine oil at the proper level and change as recommended.



Have you purchased the GM Protection Plan? The Plan supplements the vehicle warranties. See the Warranty and Owner Assistance booklet or your dealer/retailer for details.

Maintenance Requirements

Maintenance intervals, checks, inspections and recommended fluids and lubricants as prescribed in this manual are necessary to keep this vehicle in good working condition. Any damage caused by failure to follow scheduled maintenance may not be covered by the vehicle warranty.

Your Vehicle and the Environment

Proper vehicle maintenance not only helps to keep the vehicle in good working condition, but also helps the environment. Improper vehicle maintenance can even affect the quality of the air we breathe. Improper fluid levels or the wrong tire inflation can increase the level of emissions from the vehicle. To help protect the environment, and to keep the vehicle in good condition, be sure to maintain the vehicle properly.

How This Section is Organized

This maintenance schedule is divided into five parts:

“Part A: Scheduled Maintenance Services” explains what to have done and how often. Some of these services can be complex, so unless you are technically qualified and have the necessary equipment, you should let your dealer/retailer do these jobs.

Your dealer/retailer has trained and supported service people that will perform the work using genuine parts.

CAUTION

Performing maintenance work on a vehicle can be dangerous. In trying to do some jobs, you can be seriously injured. Do your own maintenance work only if you have the required know-how and the proper tools and equipment for the job. If you have any doubt, have a qualified technician do the work. See *Doing Your Own Service Work* on page 9-4.

To purchase service information, see *Service Publications Ordering Information* on page 12-16.

“Part B: Owner Checks and Services” tells what should be checked and when. It also explains what can easily be done to help keep the vehicle in good condition.

“Part C: Periodic Maintenance Inspections” explains important inspections that your dealer/retailer can perform for you.

“Part D: Recommended Fluids and Lubricants” lists some recommended products necessary to help keep the vehicle properly maintained. These products, or their equivalents, should be used whether you do the work yourself or have it done.

“Part E: Maintenance Record” is a place to record and keep track of the maintenance performed on the vehicle. Keep the maintenance receipts. They may be needed to qualify the vehicle for warranty repairs.

Part A: Scheduled Maintenance Services

In this part are scheduled maintenance services which are to be performed at the mileage intervals specified.

Using the Maintenance Schedule

We want to help keep this vehicle in good working condition. But we do not know exactly how you will drive it. You might drive short distances only a few times a week. Or you might drive long distances all the time in very hot, dusty weather. You might use the vehicle in making deliveries. Or you might drive it to work, to do errands, or in many other ways.

Because of the different ways people use their vehicles, maintenance needs vary. You might need more frequent checks and replacements. So please read the following and note how you drive. If you have questions on how to keep the vehicle in good condition, see your dealer/retailer.

This part tells you the maintenance services that should be done and when to schedule them.

When you go to your dealer/retailer for service, trained and supported service people will perform the work using genuine parts.

11-4 Service and Maintenance

The proper fluids and lubricants to use are listed in Part D. Make sure whoever services the vehicle uses these. All parts should be replaced and all necessary repairs done before you or anyone else drives the vehicle.

These schedules are for vehicles that:

- carry passengers and cargo within recommended limits on the Tire and Loading Information label. See *Loading the Vehicle* on page 8-32.
- are driven on reasonable road surfaces within legal driving limits.
- use the recommended fuel. See *Gasoline Octane* on page 8-36.

Scheduled Maintenance

The services shown in this schedule up to 120,000 miles (192 000 km) should be repeated after 120,000 miles (192 000 km) at the same intervals for the life of this vehicle.

See *Part B: Owner Checks and Services* on page 11-12, *Part C: Periodic Maintenance Inspections* on page 11-16, and *Part D: Recommended Fluids and Lubricants* on page 11-18.

Footnotes

† *The U.S. Environmental Protection Agency or the California Air Resources Board has determined that the failure to perform this maintenance item will not nullify the emissions warranty or limit recall liability prior to the completion of the vehicle's useful life. We, however, urge that all recommended maintenance services be performed at the indicated intervals and the maintenance be recorded.*

+ *A good time to check your brakes is during tire rotation. See Brake System Inspection* on page 11-17.

5,000 Miles (8 000 km)

- Change engine oil and filter (or every 3 months, whichever occurs first). *An Emission Control Service.*
- Rotate tires. See *Tire Inspection and Rotation* on page 9-53 for proper rotation pattern and additional information. (See footnote +.)
- Inspect engine air cleaner filter if you are driving in dusty conditions. Replace filter if necessary.

10,000 Miles (16 000 km)

- Change engine oil and filter (or every 3 months, whichever occurs first). *An Emission Control Service.*

- ❑ Rotate tires. See *Tire Inspection and Rotation on page 9-53* for proper rotation pattern and additional information. (See footnote +.)

- ❑ Inspect engine air cleaner filter if you are driving in dusty conditions. Replace filter if necessary.

15,000 Miles (24 000 km)

- ❑ Change engine oil and filter (or every 3 months, whichever occurs first). *An Emission Control Service.*
- ❑ Rotate tires. See *Tire Inspection and Rotation on page 9-53* for proper rotation pattern and additional information. (See footnote +.)
- ❑ Inspect engine air cleaner filter if you are driving in dusty conditions. Replace filter if necessary.
- ❑ Inspect passenger compartment air filter.

20,000 Miles (32 000 km)

- ❑ Change engine oil and filter (or every 3 months, whichever occurs first). *An Emission Control Service.*
- ❑ Rotate tires. See *Tire Inspection and Rotation on page 9-53* for proper rotation pattern and additional information. (See footnote +.)
- ❑ Inspect engine air cleaner filter if you are driving in dusty conditions. Replace filter if necessary.

25,000 Miles (40 000 km)

- ❑ Change engine oil and filter (or every 3 months, whichever occurs first). *An Emission Control Service.*
- ❑ Rotate tires. See *Tire Inspection and Rotation on page 9-53* for proper rotation pattern and additional information. (See footnote +.)

- ❑ Inspect engine air cleaner filter if you are driving in dusty conditions. Replace filter if necessary.

30,000 Miles (48 000 km)

- ❑ Change engine oil and filter (or every 3 months, whichever occurs first). *An Emission Control Service.*
- ❑ Rotate tires. See *Tire Inspection and Rotation on page 9-53* for proper rotation pattern and additional information. (See footnote +.)
- ❑ Replace engine air cleaner filter (or every 24 months, whichever occurs first). See *Engine Air Cleaner/Filter on page 9-12* for more information.

11-6 Service and Maintenance

- ❑ Check restraint system. Make sure the safety belt reminder light and safety belt assemblies are working properly. Look for any other loose or damaged safety belt system parts. If you see anything that might keep a safety belt system from doing its job, have it repaired. Have any torn or frayed safety belts replaced. Also see *Airbag System Check on page 1-35*.
- ❑ Replace passenger compartment air filter.
- ❑ Inspect fuel tank, cap, cap gasket, and lines for damage or leaks (or every 24 months, whichever occurs first). Replace parts as needed. *An Emission Control Service. (See footnote †.)*
- ❑ Change manual transmission fluid every 30,000 miles (48 000 km) only if your vehicle is used to tow a trailer.

35,000 Miles (56 000 km)

- ❑ Change engine oil and filter (or every 3 months, whichever occurs first). *An Emission Control Service.*
- ❑ Rotate tires. See *Tire Inspection and Rotation on page 9-53* for proper rotation pattern and additional information. *(See footnote +.)*
- ❑ Inspect engine air cleaner filter if you are driving in dusty conditions. Replace filter if necessary.

40,000 Miles (64 000 km)

- ❑ Change engine oil and filter (or every 3 months, whichever occurs first). *An Emission Control Service.*
- ❑ Rotate tires. See *Tire Inspection and Rotation on page 9-53* for proper rotation pattern and additional information. *(See footnote +.)*

- ❑ Inspect engine air cleaner filter if you are driving in dusty conditions. Replace filter if necessary.

45,000 Miles (72 000 km)

- ❑ Change engine oil and filter (or every 3 months, whichever occurs first). *An Emission Control Service.*
- ❑ Rotate tires. See *Tire Inspection and Rotation on page 9-53* for proper rotation pattern and additional information. *(See footnote +.)*
- ❑ Inspect engine air cleaner filter if you are driving in dusty conditions. Replace filter if necessary.
- ❑ Inspect passenger compartment air filter.

50,000 Miles (80 000 km)

- ❑ Change engine oil and filter (or every 3 months, whichever occurs first). *An Emission Control Service.*

- ❑ Rotate tires. See *Tire Inspection and Rotation* on page 9-53 for proper rotation pattern and additional information. (See footnote +.)
- ❑ Inspect engine air cleaner filter if you are driving in dusty conditions. Replace filter if necessary.

55,000 Miles (88 000 km)

- ❑ Change engine oil and filter (or every 3 months, whichever occurs first). *An Emission Control Service.*
- ❑ Rotate tires. See *Tire Inspection and Rotation* on page 9-53 for proper rotation pattern and additional information. (See footnote +.)
- ❑ Inspect engine air cleaner filter if you are driving in dusty conditions. Replace filter if necessary.

60,000 Miles (96 000 km)

- ❑ Change engine oil and filter (or every 3 months, whichever occurs first). *An Emission Control Service.*
- ❑ Rotate tires. See *Tire Inspection and Rotation* on page 9-53 for proper rotation pattern and additional information. (See footnote +.)
- ❑ Replace engine air cleaner filter (or every 24 months, whichever occurs first). See *Engine Air Cleaner/Filter* on page 9-12 for more information.
- ❑ Check restraint system. Make sure the safety belt reminder light and safety belt assemblies are working properly. Look for any other loose or damaged safety belt system parts. If you see anything that might keep a safety belt system from doing its job, have it repaired. Have any torn or frayed safety belts replaced. Also see *Airbag System Check* on page 1-35.

- ❑ Replace passenger compartment air filter.
- ❑ Inspect engine accessory drive belts (or every 48 months, whichever occurs first). Visually inspect belt for fraying, excessive cracks, or obvious damage. Replace belt if necessary. *An Emission Control Service.*
- ❑ Inspect for tappet noise and engine vibration. Adjust valve clearance to factory specifications if necessary (or every 48 months, whichever occurs first). *An Emission Control Service.*
- ❑ Inspect fuel tank, cap, cap gasket, and lines for damage or leaks (or every 24 months, whichever occurs first). Replace parts as needed. *An Emission Control Service.* (See footnote †.)
- ❑ Change manual transmission fluid every 30,000 miles (48 000 km) only if your vehicle is used to tow a trailer.

11-8 Service and Maintenance

- Change automatic transmission fluid every 60,000 miles (96 000 km) if the vehicle is mainly driven under one or more of these conditions:
 - In heavy city traffic where the outside temperature regularly reaches 90°F (32°C) or higher.
 - In hilly or mountainous terrain.
 - When doing frequent trailer towing.
 - Uses such as found in taxi, police, or delivery service.

If you do not use your vehicle under any of these conditions, the fluid does not require changing. See Part D: Recommended Fluids and Lubricants on page 11-18 for the proper fluid to use.

65,000 Miles 104 000 km)

- Change engine oil and filter (or every 3 months, whichever occurs first). *An Emission Control Service.*

- Rotate tires. See *Tire Inspection and Rotation on page 9-53* for proper rotation pattern and additional information. (See footnote +.)
- Inspect engine air cleaner filter if you are driving in dusty conditions. Replace filter if necessary.

70,000 Miles (112 000 km)

- Change engine oil and filter (or every 3 months, whichever occurs first). *An Emission Control Service.*
- Rotate tires. See *Tire Inspection and Rotation on page 9-53* for proper rotation pattern and additional information. (See footnote +.)
- Inspect engine air cleaner filter if you are driving in dusty conditions. Replace filter if necessary.

75,000 Miles (120 000 km)

- Change engine oil and filter (or every 3 months, whichever occurs first). *An Emission Control Service.*
- Rotate tires. See *Tire Inspection and Rotation on page 9-53* for proper rotation pattern and additional information. (See footnote +.)
- Inspect engine air cleaner filter if you are driving in dusty conditions. Replace filter if necessary.
- Inspect passenger compartment air filter.
- Inspect engine accessory drive belts (or 12 months since last inspection). *An Emission Control Service.*

80,000 Miles (128 000 km)

- Change engine oil and filter (or every 3 months, whichever occurs first). *An Emission Control Service.*

- ❑ Rotate tires. See *Tire Inspection and Rotation* on page 9-53 for proper rotation pattern and additional information. (See footnote +.)
- ❑ Inspect engine air cleaner filter if you are driving in dusty conditions. Replace filter if necessary.

85,000 Miles (136 000 km)

- ❑ Change engine oil and filter (or every 3 months, whichever occurs first). *An Emission Control Service.*
- ❑ Rotate tires. See *Tire Inspection and Rotation* on page 9-53 for proper rotation pattern and additional information. (See footnote +.)
- ❑ Inspect engine air cleaner filter if you are driving in dusty conditions. Replace filter if necessary.

90,000 Miles (144 000 km)

- ❑ Change engine oil and filter (or every 3 months, whichever occurs first). *An Emission Control Service.*
- ❑ Rotate tires. See *Tire Inspection and Rotation* on page 9-53 for proper rotation pattern and additional information. (See footnote +.)
- ❑ Replace engine air cleaner filter (or every 24 months, whichever occurs first). See *Engine Air Cleaner/Filter* on page 9-12 for more information.
- ❑ Check restraint system. Make sure the safety belt reminder light and safety belt assemblies are working properly. Look for any other loose or damaged safety belt system parts. If you see anything that might keep

a safety belt system from doing its job, have it repaired. Have any torn or frayed safety belts replaced. Also see *Airbag System Check* on page 1-35.

- ❑ Replace passenger compartment air filter.
- ❑ Inspect engine accessory drive belts (or 12 months since last inspection). *An Emission Control Service.*
- ❑ Inspect fuel tank, cap, cap gasket, and lines for damage or leaks (or every 24 months, whichever occurs first). Replace parts as needed. *An Emission Control Service.* (See footnote †.)
- ❑ Change manual transmission fluid every 30,000 miles (48 000 km) only if your vehicle is used to tow a trailer.

11-10 Service and Maintenance

95,000 Miles (152 000 km)

- ❑ Change engine oil and filter (or every 3 months, whichever occurs first). *An Emission Control Service.*
- ❑ Rotate tires. See *Tire Inspection and Rotation on page 9-53* for proper rotation pattern and additional information. (See footnote +.)
- ❑ Inspect engine air cleaner filter if you are driving in dusty conditions. Replace filter if necessary.

100,000 Miles (160 000 km)

- ❑ Change engine oil and filter (or every 3 months, whichever occurs first). *An Emission Control Service.*
- ❑ Rotate tires. See *Tire Inspection and Rotation on page 9-53* for proper rotation pattern and additional information. (See footnote +.)

- ❑ Inspect engine air cleaner filter if you are driving in dusty conditions. Replace filter if necessary.

105,000 Miles (168 000 km)

- ❑ Change engine oil and filter (or every 3 months, whichever occurs first). *An Emission Control Service.*
- ❑ Rotate tires. See *Tire Inspection and Rotation on page 9-53* for proper rotation pattern and additional information. (See footnote +.)
- ❑ Inspect engine air cleaner filter if you are driving in dusty conditions. Replace filter if necessary.
- ❑ Inspect passenger compartment air filter.

- ❑ Inspect engine accessory drive belts (or every 48 months, whichever occurs first). Visually inspect belt for fraying, excessive cracks, or obvious damage. Replace belt if necessary. *An Emission Control Service.*

110,000 Miles (176 000 km)

- ❑ Change engine oil and filter (or every 3 months, whichever occurs first). *An Emission Control Service.*
- ❑ Rotate tires. See *Tire Inspection and Rotation on page 9-53* for proper rotation pattern and additional information. (See footnote +.)
- ❑ Inspect engine air cleaner filter if you are driving in dusty conditions. Replace filter if necessary.

115,000 Miles (184 000 km)

- ❑ Change engine oil and filter (or every 3 months, whichever occurs first). *An Emission Control Service.*
- ❑ Rotate tires. See *Tire Inspection and Rotation on page 9-53* for proper rotation pattern and additional information. (See footnote +.)
- ❑ Inspect engine air cleaner filter if you are driving in dusty conditions. Replace filter if necessary.

120,000 Miles (192 000 km)

- ❑ Change engine oil and filter (or every 3 months, whichever occurs first). *An Emission Control Service.*
- ❑ Rotate tires. See *Tire Inspection and Rotation on page 9-53* for proper rotation pattern and additional information. (See footnote +.)

- ❑ Replace engine air cleaner filter (or every 24 months, whichever occurs first). See *Engine Air Cleaner/Filter on page 9-12* for more information.
- ❑ Replace passenger compartment air filter.
- ❑ Inspect engine accessory drive belts (or every 48 months, whichever occurs first). Visually inspect belt for fraying, excessive cracks, or obvious damage. Replace belt if necessary. *An Emission Control Service.*
- ❑ Replace spark plugs. *An Emission Control Service.*
- ❑ Inspect for tappet noise and engine vibration. Adjust valve clearance to factory specifications if necessary (or every 48 months, whichever occurs first). *An Emission Control Service.*
- ❑ Inspect fuel tank, cap, cap gasket, and lines for damage or leaks (or every 24 months, whichever occurs first). Replace parts as needed. *An Emission Control Service. (See footnote †.)*

- ❑ Change manual transmission fluid every 30,000 miles (48 000 km) only if your vehicle is used to tow a trailer.
- ❑ Change automatic transmission fluid every 60,000 miles (96 000 km) if the vehicle is mainly driven under one or more of these conditions:
 - In heavy city traffic where the outside temperature regularly reaches 90°F (32°C) or higher.
 - In hilly or mountainous terrain.
 - When doing frequent trailer towing.
 - Uses such as found in taxi, police, or delivery service.

If you do not use your vehicle under any of these conditions, the fluid does not require changing. See Part D: Recommended Fluids and Lubricants on page 11-18 for the proper fluid to use.

150,000 Miles (240 000 km)

- ❑ Drain, flush, and refill the cooling system (or every 5 years, whichever occurs first). This service can be complex; you should have your dealer/retailer perform this service. See *Engine Coolant on page 9-18* for what to use. Inspect hoses. Clean radiator, condenser, pressure cap, and neck. Pressure test cooling system and pressure cap. *An Emission Control Service.*

Part B: Owner Checks and Services

These owner checks and services should be performed at the intervals specified to help ensure vehicle safety, dependability, and emission control performance.

Be sure any necessary repairs are completed at once. Whenever any fluids or lubricants are added to the vehicle, make sure they are the proper ones, as shown in Part D.

At Each Fuel Fill

It is important to perform these underhood checks at each fuel fill.

Engine Oil Level Check

Notice: It is important to check the engine oil regularly and keep it at the proper level. Failure to keep the engine oil at the proper level can cause damage to the engine not covered by the vehicle warranty.

Check the engine oil level and add the proper oil if necessary. See *Engine Oil on page 9-9.*

Engine Coolant Level Check

Check the engine coolant level and add DEX-COOL[®] coolant mixture if necessary. See *Engine Coolant on page 9-18.*

Windshield Washer Fluid Level Check

Check the windshield washer fluid level in the windshield washer fluid reservoir and add the proper fluid if necessary. See *Windshield Washer Fluid on page 9-24.*

Hood Latch Operation Check

Pull the primary hood latch release handle inside the vehicle. The secondary latch should keep the hood from opening all the way when the primary latch is released. Make sure the hood closes firmly. See *Hood Release on page 9-5.*

At Least Once a Month

Tire Inflation Check

Inspect the tires and make sure the tires are inflated to the correct pressures. Do not forget to check the spare tire. See *Inflation - Tire Pressure* on page 9-47.

At Least Twice a Year

Wiper Blade Check

Inspect wiper blades for wear, cracking, or contamination. Clean the windshield and wiper blades, if contaminated. Replace wiper blades that are worn or damaged. See *Windshield Wiper Blade Replacement* on page 9-25 and *Exterior Cleaning* on page 9-86 for more information.

Weatherstrip Lubrication

Silicone grease on weatherstrips will make them last longer, seal better, and not stick or squeak. Apply silicone grease with a clean cloth. During very cold, damp weather more frequent application may be required. See *Part D: Recommended Fluids and Lubricants* on page 11-18.

Fluid Level Check

Check the power steering pump, rear axle, transfer case, and automatic or manual transmission fluid levels and add as needed. See *Automatic Transmission Fluid* on page 9-14 or *Manual Transmission Fluid* on page 9-16. Check for leaks. A fluid loss in these systems could indicate a problem. Have the system inspected and repaired at once.

At Least Once a Year

Key Lock Cylinders Service

Lubricate the key lock cylinders with the lubricant specified in Part D.

Seat Operation Check

Make sure the head restraints stay in position and all seat latches lock. Check that the recliner holds by pushing and pulling the seatback while it is reclined.

Body Lubrication Service

Lubricate all hood latch assembly, secondary latch, pivots, spring anchor, release pawl, hood and body door hinges, rear compartment, and any folding seat hardware. Part D tells you what to use. More frequent lubrication might be required when exposed to a corrosive environment.

Starter Switch Check

 **CAUTION**

When you are doing this inspection, the vehicle could move suddenly. If the vehicle moves, you or others could be injured.

1. Before starting this check, be sure there is enough room around the vehicle.
2. Firmly apply both the parking brake and the regular brake. See *Parking Brake on page 8-12*. Do not use the accelerator pedal, and be ready to turn off the engine immediately if it starts.

3. For automatic transmission vehicles, try to start the engine in each gear. The vehicle should start only in P (Park) or N (Neutral). If the vehicle starts in any other position, contact your dealer/retailer for service.

For manual transmission vehicles, put the shift lever in Neutral, push the clutch pedal down halfway, and try to start the engine. The vehicle should start only when the clutch pedal is pushed down all the way to the floor. If the vehicle starts when the clutch pedal is not pushed all the way down, contact your dealer/retailer for service.

Automatic Transmission Shift Lock Control System Check

 **CAUTION**

When you are doing this inspection, the vehicle could move suddenly. If the vehicle moves, you or others could be injured.

1. Before starting this check, be sure there is enough room around the vehicle. It should be parked on a level surface.
2. Firmly apply the parking brake. See *Parking Brake on page 8-12*. Be ready to apply the regular brake immediately if the vehicle begins to move.
3. With the engine off, turn the ignition to ON/RUN, but do not start the engine. Without applying the regular brake, try to move the shift lever out of P (Park) with normal effort. If the shift lever moves out of P (Park), contact your dealer/retailer for service.

Ignition Transmission Lock Check

While parked, and with the parking brake set, try to turn the ignition to LOCK/OFF in each shift lever position.

- For automatic transmission vehicles, the ignition should turn to LOCK/OFF only when the shift lever is in P (Park).
- For manual transmission vehicles, the ignition should turn to LOCK/OFF only if you push the ignition key in farther, while turning it toward LOCK/OFF.

Contact your dealer/retailer if service is required.

Parking Brake and Automatic Transmission P (Park) Mechanism Check



When you are doing this check, the vehicle could begin to move. You or others could be injured and property could be damaged. Make sure there is room in front of the vehicle in case it begins to roll. Be ready to apply the regular brake at once should the vehicle begin to move.

Park on a fairly steep hill, with the vehicle facing downhill. Keeping your foot on the regular brake, set the parking brake.

- To check the parking brake's holding ability: With the engine running and transmission in N (Neutral), slowly remove foot pressure from the regular brake pedal. Do this until the vehicle is held by the parking brake only.

- To check the P (Park) mechanism's holding ability: With the engine running, shift to P (Park). Then release the parking brake followed by the regular brake.

Contact your dealer/retailer if service is required.

Underbody Flushing Service

At least every spring, use plain water to flush any corrosive materials from the underbody. Take care to clean thoroughly any areas where mud and other debris can collect.

Part C: Periodic Maintenance Inspections

Listed in this part are inspections and services which should be performed at least twice a year, for instance, each spring and fall. *You should let your dealer/retailer do these jobs. Make sure any necessary repairs are completed at once.*

Proper procedures to perform these services can be found in a service manual. See *Service Publications Ordering Information* on page 12-16.

Steering, Suspension and Front Drive Axle Boot and Seal Inspection

Inspect the front and rear suspension and steering system for damaged, loose, or missing parts or signs of wear. Inspect power steering cables for proper hook-up, binding, cracks, chafing, etc. Clean and then inspect the drive axle boot seals for damage, tears, or leakage. Replace seals if necessary.

Exhaust System Inspection

Inspect the complete exhaust system. Inspect the body near the exhaust system. Look for broken, damaged, missing, or out-of-position parts as well as open seams, holes, loose connections, or other conditions which could cause a heat build-up in the floor pan or could let exhaust fumes into the vehicle. See *Engine Exhaust* on page 8-16.

Fuel System Inspection

Inspect the complete fuel system for damage or leaks.

Engine Cooling System Inspection

Inspect the hoses and have them replaced if they are cracked, swollen or deteriorated. Inspect all pipes, fittings and clamps; replace as needed. Clean the outside of the radiator and air conditioning condenser. To help ensure proper operation, a pressure test of the cooling system and pressure cap is recommended at least once a year.

Throttle System Inspection

Inspect the throttle system for interference or binding, and for damaged or missing parts. Replace parts as needed. Replace any components that have high effort or excessive wear. Do not lubricate accelerator and cruise control cables.

Brake System Inspection

Inspect the complete system. Inspect brake lines and hoses for proper hook-up, binding, leaks, cracks, chafing, etc. Inspect disc brake pads for wear and rotors for surface condition. Inspect other brake parts, including calipers, parking brake, etc. You may need to have your brakes inspected more often if your driving habits or conditions result in frequent braking.

11-18 Service and Maintenance

Part D: Recommended Fluids and Lubricants

Fluids and lubricants identified below by name, part number, or specification can be obtained from your dealer/retailer.

Usage	Fluid/Lubricant
Engine Oil	Engine oil which meets GM Standard GM6094M and displays the American Petroleum Institute Certified for Gasoline Engines starburst symbol. To determine the proper viscosity for your vehicle's engine, see <i>Engine Oil on page 9-9</i> .
Engine Coolant	50/50 mixture of clean, drinkable water and use only DEX-COOL [®] Coolant. See <i>Engine Coolant on page 9-18</i> .
Hydraulic Brake/Clutch System	Delco [®] Supreme 11 Brake Fluid or equivalent DOT-3 brake fluid.
Windshield Washer Solvent	Optikleen [®] Washer Solvent.
Manual Transmission	GM Goodwrench [®] Synthetic Manual Transmission Fluid (GM Part No. U.S. 12346190, in Canada 10953477 — 1 quart) or SAE 75W-90 GL-5 gear oil.
Automatic Transmission	Use only T-IV Automatic Transmission Fluid (GM Part No. U.S. 88900925, in Canada 22689186).
Key Lock Cylinders	Multi-Purpose Lubricant, Superlube (GM Part No. U.S. 12346241, in Canada 10953474).
Manual Transmission Shift Linkage	Chassis Lubricant (GM Part No. U.S. 12377985, in Canada 88901242) or lubricant meeting requirements of NLGI #2, Category LB or GC-LB.

Usage	Fluid/Lubricant
Clutch Linkage Pivot Points	Chassis Lubricant (GM Part No. U.S. 12377985, in Canada 88901242) or lubricant meeting requirements of NLGI #2, Category LB or GC-LB.
Floor Shift Linkage	Lubriplate Lubricant Aerosol (GM Part No. U.S. 12346293, in Canada 992723) or lubricant meeting requirements of NLGI #2 Category LB or GC-LB.
Chassis Lubrication	Chassis Lubricant (GM Part No. U.S. 12377985, in Canada 88901242) or lubricant meeting requirements of NLGI #2, Category LB or GC-LB.
Hood Latch Assembly, Secondary Latch, Pivots, Spring Anchor, and Release Pawl	Lubriplate Lubricant Aerosol (GM Part No. U.S. 12346293, in Canada 992723) or lubricant meeting requirements of NLGI #2, Category LB or GC-LB.
Hood and Door Hinges	Multi-Purpose Lubricant, Superlube (GM Part No. U.S. 12346241, in Canada 10953474).
Weatherstrip Conditioning	Weatherstrip Lubricant (GM Part No. U.S. 3634770, in Canada 10953518) or Dielectric Silicone Grease (GM Part No. U.S. 12345579, in Canada 992887).

Customer Information

Customer Information

Customer Satisfaction Procedure	12-1
Online Owner Center	12-3
Customer Assistance for Text Telephone (TTY) Users	12-4
Customer Assistance Offices	12-4
GM Mobility Reimbursement Program	12-5
Roadside Assistance Program	12-5
Scheduling Service Appointments (for Service)	12-8
Scheduling Service Appointments (for Vehicle Customization)	12-8

Courtesy Transportation ...	12-10
Collision Damage Repair	12-11

Reporting Safety Defects

Reporting Safety Defects to the United States Government	12-15
Reporting Safety Defects to the Canadian Government	12-15
Reporting Safety Defects to General Motors	12-16
Service Publications Ordering Information	12-16

Vehicle Data Recording and Privacy

Vehicle Data Recording and Privacy	12-17
Event Data Recorders	12-17
OnStar®	12-18
Navigation System	12-18
Radio Frequency Identification (RFID)	12-18

Customer Information

Customer Satisfaction Procedure

Your satisfaction and goodwill are important to your dealer and to Pontiac. Normally, any concerns with the sales transaction or the operation of the vehicle will be resolved by the dealer's sales or service departments. Sometimes, however, despite the best intentions of all concerned, misunderstandings can occur. If your concern has not been resolved to your satisfaction, the following steps should be taken:

STEP ONE: Discuss your concern with a member of dealership management. Normally, concerns can be quickly resolved at that level. If the matter has already been reviewed with the sales, service, or parts manager, contact the owner of the dealership or the general manager.

12-2 Customer Information

STEP TWO: If after contacting a member of dealership management, it appears your concern cannot be resolved by the dealership without further help, in the U.S., call the Pontiac Customer Assistance Center at 1-800-762-2737. In Canada, call General Motors of Canada Customer Communication Centre at 1-800-263-3777 (English) or 1-800-263-7854 (French).

We encourage you to call the toll-free number in order to give your inquiry prompt attention. Have the following information available to give the Customer Assistance Representative:

- Vehicle Identification Number (VIN). This is available from the vehicle registration or title, or the plate at the top left of the instrument panel and visible through the windshield.
- Dealership name and location.
- Vehicle delivery date and present mileage.

When contacting Pontiac, remember that your concern will likely be resolved at a dealer's facility. That is why we suggest you follow Step One first.

STEP THREE — U.S. Owners:

Both General Motors and your dealer are committed to making sure you are completely satisfied with your new vehicle. However, if you continue to remain unsatisfied after following the procedure outlined in Steps One and Two, you can file with the BBB Auto Line Program to enforce your rights.

The BBB Auto Line Program is an out of court program administered by the Council of Better Business Bureaus to settle automotive disputes regarding vehicle repairs or the interpretation of the New Vehicle Limited Warranty. Although you may be required to resort to this informal dispute resolution program prior to filing a court action, use of the program is free of charge and your case will generally be

heard within 40 days. If you do not agree with the decision given in your case, you may reject it and proceed with any other venue for relief available to you.

You can contact the BBB Auto Line Program using the toll-free telephone number or write them at the following address:

BBB Auto Line Program
Council of Better Business
Bureaus, Inc.
4200 Wilson Boulevard
Suite 800
Arlington, VA 22203-1838

Telephone: 1-800-955-5100
www.dr.bbb.org/goauto

This program is available in all 50 states and the District of Columbia. Eligibility is limited by vehicle age, mileage and other factors. General Motors reserves the right to change eligibility limitations and/or discontinue its participation in this program.

STEP THREE — Canadian

Owners: In the event that you do not feel your concerns have been addressed after following the procedure outlined in Steps One and Two, General Motors of Canada Limited wants you to be aware of its participation in a no-charge Mediation/Arbitration Program. General Motors of Canada Limited has committed to binding arbitration of owner disputes involving factory-related vehicle service claims. The program provides for the review of the facts involved by an impartial third party arbiter, and may include an informal hearing before the arbiter. The program is designed so that the entire dispute settlement process, from the time you file your complaint to the final decision, should be completed in approximately 70 days. We believe our impartial program offers advantages over courts in most jurisdictions because it is informal, quick, and free of charge.

For further information concerning eligibility in the Canadian Motor Vehicle Arbitration Plan (CAMVAP), call toll-free 1-800-207-0685, or call the General Motors Customer Communication Centre, 1-800-263-3777 (English), 1-800-263-7854 (French), or write to:

Mediation/Arbitration Program
c/o Customer Communication Centre
General Motors of Canada Limited
Mail Code: CA1-163-005
1908 Colonel Sam Drive
Oshawa, Ontario L1H 8P7

Your inquiry should be accompanied by the Vehicle Identification Number (VIN).

**Online Owner Center
(United States only)**

The Owner Center is a resource for your GM ownership needs. Specific vehicle information can be found in one place.

The Online Owner Center allows you to:

- Get e-mail service reminders.
- Access information about your specific vehicle, including tips and videos and an electronic version of this owner manual.
- Keep track of your vehicle's service history and maintenance schedule.
- Find GM dealers/retailers for service nationwide.
- Receive special promotions and privileges only available to members.

Refer to MyGMLink.com on the web for updated information and to register your vehicle.

12-4 Customer Information

My GM Canada (Canada only)

My GM Canada is a password-protected section of gmcanada.com where you can save information on GM vehicles, get personalized offers, and use handy tools and forms with greater ease.

Here are a few of the valuable tools and services you will have access to:

- **My Showroom:** Find and save information on vehicles and current offers in your area.
- **My Dealers/Retailers:** Save details such as address and phone number for each of your preferred GM Dealers or Retailers.
- **My Driveway:** Receive service reminders and helpful advice on owning and maintaining your vehicle.

- **My Preferences:** Manage your profile, subscribe to E-News and use tools and forms with greater ease.

To sign up to My GM Canada, visit the My GM Canada section within gmcanada.com.

Customer Assistance for Text Telephone (TTY) Users

To assist customers who are deaf, hard of hearing, or speech-impaired and who use Text Telephones (TTYs), Pontiac has TTY equipment available at its Customer Assistance Center. Any TTY user in the U.S. can communicate with Pontiac by dialing: 1-800-833-PONT (7668). (TTY users in Canada can dial 1-800-263-3830.)

Customer Assistance Offices

Pontiac encourages customers to call the toll-free number for assistance. However, if a customer wishes to write or e-mail Pontiac, the letter should be addressed to:

United States — Customer Assistance

Pontiac Customer Assistance Center
P.O. Box 33172
Detroit, MI 48232-5172

www.Pontiac.com
1-800-762-2737 or
1-800-833-7668
(For Text Telephone devices (TTYs))
Roadside Assistance:
1-800-ROADSIDE (762-3743)

From Puerto Rico:
1-800-496-9992 (English)
1-800-496-9993 (Spanish)

From U.S. Virgin Islands:
1-800-496-9994

Canada — Customer Assistance

General Motors of Canada Limited
Customer Communication Centre,
CA1-163-005

1908 Colonel Sam Drive
Oshawa, Ontario L1H 8P7

www.gmcanada.com
1-800-263-3777 (English)
1-800-263-7854 (French)
1-800-263-3830 (For Text
Telephone devices (TTYs))
Roadside Assistance:
1-800-268-6800

Overseas — Customer Assistance

Please contact the local General
Motors Business Unit.

Mexico, Central America and Caribbean Islands/ Countries (Except Puerto Rico and U.S. Virgin Islands) — Customer Assistance

General Motors de Mexico,
S. de R.L. de C.V.
Customer Assistance Center
Paseo de la Reforma #2740
Col. Lomas de Bezares
C.P. 11910, Mexico, D.F.
01-800-508-0000
Long Distance: 011-52-53 29 0 800

GM Mobility Reimbursement Program



This program, available to qualified applicants, can reimburse you up to \$1,000 of the cost of eligible aftermarket adaptive equipment required for your vehicle, such as hand controls or a wheelchair/scooter lift.

The offer is available for a very limited period of time from the date of vehicle purchase/lease. For more details, or to determine your vehicle's eligibility, visit gmmobility.com or call the GM Mobility Assistance Center at 1-800-323-9935. Text telephone (TTY) users, call 1-800-833-9935.

General Motors of Canada also has a Mobility Program. Call 1-800-GM-DRIVE (463-7483) for details. TTY users call 1-800-263-3830.

Roadside Assistance Program

For U.S. purchased vehicles, call **1-800-ROADSIDE (762-3743)**; (Text telephone (TTY): **1-888-889-2438**).

For Canadian purchased vehicles, call **1-800-268-6800**.

Service is available 24 hours a day, 365 days a year.

12-6 Customer Information

Calling for Assistance

When calling Roadside Assistance, have the following information ready:

- Your name, home address, and home telephone number
- Telephone number of your location
- Location of the vehicle
- Model, year, color, and license plate number of the vehicle
- Odometer reading, Vehicle Identification Number (VIN), and delivery date of the vehicle
- Description of the problem

Coverage

Services are provided up to 5 years/100,000 miles (160 000 km), whichever comes first.

In the U.S., anyone driving the vehicle is covered. In Canada, a person driving the vehicle without permission from the owner is not covered.

Roadside Assistance is not a part of the New Vehicle Limited Warranty. Pontiac and General Motors of Canada Limited reserve the right to make any changes or discontinue the Roadside Assistance program at any time without notification.

Pontiac and General Motors of Canada Limited reserve the right to limit services or payment to an owner or driver if they decide the claims are made too often, or the same type of claim is made many times.

Services Provided

- **Emergency Fuel Delivery:** Delivery of enough fuel for the vehicle to get to the nearest service station.
- **Lock-Out Service:** Service is provided to unlock the vehicle if you are locked out. A remote unlock may be available if you have OnStar[®]. For security reasons, the driver must present identification before this service is given.

- **Emergency Tow From a Public Road or Highway:** Tow to the nearest Pontiac dealer for warranty service, or if the vehicle was in a crash and cannot be driven. Assistance is also given when the vehicle is stuck in sand, mud, or snow.
- **Flat Tire Change:** Service is provided to change a flat tire with the spare tire. The spare tire, if equipped, must be in good condition and properly inflated. It is the owner's responsibility for the repair or replacement of the tire if it is not covered by the warranty.
- **Battery Jump Start:** Service is provided to jump start a dead battery.

- **Trip Interruption Benefits and Assistance:** If your trip is interrupted due to a warranty failure, incidental expenses may be reimbursed during the 5 years/100,000 miles (160 000 km) Powertrain warranty period. Items considered are hotel, meals, and rental car.

Services Not Included in Roadside Assistance

- Impound towing caused by violation of any laws.
- Legal fines.
- Mounting, dismounting or changing of snow tires, chains, or other traction devices.
- Towing or services for vehicles driven on a non-public road or highway.

Services Specific to Canadian Purchased Vehicles

- **Fuel delivery:** Reimbursement is approximately \$5 Canadian. Diesel fuel delivery may be restricted. Propane and other fuels are not provided through this service.
- **Lock-Out Service:** Vehicle registration is required.
- **Trip Routing Service:** Detailed maps of North America are provided when requested either with the most direct route or the most scenic route. There is a limit of six requests per year. Additional travel information is also available. Allow three weeks for delivery.

- **Trip Interruption Benefits and Assistance:** Must be over 250 kilometres from where your trip was started to qualify. General Motors of Canada Limited requires pre-authorization, original detailed receipts, and a copy of the repair orders. Once authorization has been received, the Roadside Assistance advisor will help you make arrangements and explain how to receive payment.
- **Alternative Service:** If assistance cannot be provided right away, the Roadside Assistance advisor may give you permission to get local emergency road service. You will receive payment, up to \$100, after sending the original receipt to Roadside Assistance. Mechanical failures may be covered, however any cost for parts and labor for repairs not covered by the warranty are the owner responsibility.

Scheduling Service Appointments (for Service)

When your vehicle requires warranty service, contact your dealer/retailer and request an appointment. By scheduling a service appointment and advising your service consultant of your transportation needs, your dealer/retailer can help minimize your inconvenience.

If your vehicle cannot be scheduled into the service department immediately, keep driving it until it can be scheduled for service, unless, of course, the problem is safety-related. If it is, please call your dealership/retailer, let them know this, and ask for instructions.

If the dealer/retailer requests you to bring the vehicle for service, you are urged to do so as early in the work day as possible to allow for the same day repair.

Scheduling Service Appointments (for Vehicle Customization)

Your vehicle may have lighting and door lock features that can be programmed to your preference. You will need to schedule an appointment with your dealer/retailer if you would like to change the way these features are currently programmed. The following is a list of the features that can be programmed. See your dealer/retailer to change the programming of these features:

Driver Door Key Unlock Switch:

If this feature is programmed on, all of the doors will unlock when the key is turned twice in the driver's door lock cylinder. When the vehicle left the factory this feature was programmed on.

Courtesy Lamp Timer: This feature allows for changing how long the courtesy lamps stay on when all the doors and liftgate are closed and the key is out of the ignition, in LOCK/OFF, or in ACC/ACCESSORY. When the vehicle left the factory the courtesy lamps were programmed to stay on for 15 seconds. This can be changed to 7.5 seconds or 30 seconds.

Interior Lamps when Ignition

Off: If this feature is programmed on, the interior lamps will come on when the ignition is turned off when it is dark outside. When the vehicle left the factory this feature was programmed on.

Interior Lamps on with Door

Key Unlock: If this feature is programmed on, the interior lamps will come on when the doors are unlocked when it is dark outside. When the vehicle left the factory this feature was programmed on.

Key Fob Signal: If this feature is programmed on, the Remote Keyless Entry (RKE) transmitter can be used to lock and unlock the vehicle. When the vehicle left the factory this feature was programmed on.

RFA Visual Feedback: If this feature is programmed on, the hazard lights will flash when you lock and unlock the vehicle with the RKE transmitter. When the vehicle left the factory this feature was programmed on.

RFA All Unlock Enable: If this feature is programmed on, pressing the RKE unlock button twice within three seconds will unlock all of the doors. When the vehicle left the factory this feature was programmed on.

Remote Panic Command: If this feature is programmed on, pressing and holding the RKE panic button will cause the horn to sound and the lights to flash. When the vehicle left the factory this feature was programmed on.

Automatic Door Locking: If this feature is programmed on, the doors will automatically lock when the vehicle is shifted out of P (Park) or when the vehicle speed is greater than 8 mph (13 km/h).

Automatic Door Unlocking: If this feature is programmed on, the doors will automatically unlock when the vehicle is shifted into P (Park) or when the ignition is turned off.

All Door Unlock Command: If this feature is programmed on, the doors will all unlock when the driver's door is opened.

Lock-out Timer: This feature allows for changing how long of a delay there is before all of the doors lock when pressing the lock button on the RKE transmitter. When the vehicle left the factory the delay was set for 1 minute. This can be changed to 30 seconds or 2 minutes.

Courtesy Transportation

To enhance your ownership experience, we and our participating dealers are proud to offer Courtesy Transportation, a customer support program for vehicles with the Bumper to Bumper (Base Warranty Coverage period in Canada) and extended powertrain warranty in both the U.S. and Canada.

Several courtesy transportation options are available to assist in reducing your inconvenience when warranty repairs are required.

Courtesy Transportation is not a part of the New Vehicle Limited Warranty. A separate booklet entitled "Warranty and Owner Assistance Information" furnished with each new vehicle provides detailed warranty coverage information.

Transportation Options

Warranty service can generally be completed while you wait. However, if you are unable to wait, GM helps to minimize your inconvenience by providing several transportation options. Depending on the circumstances, your dealer can offer you one of the following:

Shuttle Service

Shuttle service is the preferred means of offering Courtesy Transportation. Dealers may provide you with shuttle service to get you to your destination with minimal interruption of your daily schedule. This includes one-way or round trip shuttle service within reasonable time and distance parameters of the dealer's area.

Public Transportation or Fuel Reimbursement

If your vehicle requires overnight warranty repairs, and public transportation is used instead of the dealer's shuttle service, the expense must be supported by original receipts and can only be up to the maximum amount allowed by GM for shuttle service. In addition, for U.S. customers, should you arrange transportation through a friend or relative, limited reimbursement for reasonable fuel expenses may be available. Claim amounts should reflect actual costs and be supported by original receipts. See your dealer for information regarding the allowance amounts for reimbursement of fuel or other transportation costs.

Courtesy Rental Vehicle

Your dealer may arrange to provide you with a courtesy rental vehicle or reimburse you for a rental vehicle that you obtain if your vehicle is kept for an overnight warranty repair. Rental reimbursement will be limited and must be supported by original receipts. This requires that you sign and complete a rental agreement and meet state/provincial, local, and rental vehicle provider requirements. Requirements vary and may include minimum age requirements, insurance coverage, credit card, etc. You are responsible for fuel usage charges and may also be responsible for taxes, levies, usage fees, excessive mileage, or rental usage beyond the completion of the repair.

It may not be possible to provide a like-vehicle as a courtesy rental.

Additional Program Information

All program options, such as shuttle service, may not be available at every dealer. Please contact your dealer for specific information about availability. All Courtesy Transportation arrangements will be administered by appropriate dealer personnel.

General Motors reserves the right to unilaterally modify, change or discontinue Courtesy Transportation at any time and to resolve all questions of claim eligibility pursuant to the terms and conditions described herein at its sole discretion.

Collision Damage Repair

If your vehicle is involved in a collision and it is damaged, have the damage repaired by a qualified technician using the proper equipment and quality replacement parts. Poorly performed collision repairs diminish your vehicle's resale value, and safety performance can be compromised in subsequent collisions.

Collision Parts

Genuine GM Collision parts are new parts made with the same materials and construction methods as the parts with which your vehicle was originally built. Genuine GM Collision parts are your best choice to ensure that your vehicle's designed appearance, durability, and safety are preserved. The use of Genuine GM parts can help maintain your GM New Vehicle Warranty.

12-12 Customer Information

Recycled original equipment parts may also be used for repair. These parts are typically removed from vehicles that were total losses in prior crashes. In most cases, the parts being recycled are from undamaged sections of the vehicle. A recycled original equipment GM part, may be an acceptable choice to maintain your vehicle's originally designed appearance and safety performance, however, the history of these parts is not known. Such parts are not covered by your GM New Vehicle Limited Warranty, and any related failures are not covered by that warranty.

Aftermarket collision parts are also available. These are made by companies other than GM and may not have been tested for your vehicle. As a result, these parts may fit poorly, exhibit premature durability/corrosion problems, and may not perform properly in subsequent collisions. Aftermarket parts are not covered by your

GM New Vehicle Limited Warranty, and any vehicle failure related to such parts are not covered by that warranty.

Repair Facility

We recommend that you choose a collision repair facility that meets your needs before you ever need collision repairs. Your dealer/retailer may have a collision repair center with GM-trained technicians and state of the art equipment, or be able to recommend a collision repair center that has GM-trained technicians and comparable equipment.

Insuring Your Vehicle

Protect your investment in your GM vehicle with comprehensive and collision insurance coverage. There are significant differences in the quality of coverage afforded by various insurance policy terms.

Many insurance policies provide reduced protection to your GM vehicle by limiting compensation for damage repairs by using aftermarket collision parts. Some insurance companies will not specify aftermarket collision parts. When purchasing insurance, we recommend that you assure your vehicle will be repaired with GM original equipment collision parts. If such insurance coverage is not available from your current insurance carrier, consider switching to another insurance carrier.

If your vehicle is leased, the leasing company may require you to have insurance that assures repairs with Genuine GM Original Equipment Manufacturer (OEM) parts or Genuine Manufacturer replacement parts. Read your lease carefully, as you may be charged at the end of your lease for poor quality repairs.

If a Crash Occurs

Here is what to do if you are involved in a crash.

- Check to make sure that you are all right. If you are uninjured, make sure that no one else in your vehicle, or the other vehicle, is injured.
- If there has been an injury, call emergency services for help. Do not leave the scene of a crash until all matters have been taken care of. Move your vehicle only if its position puts you in danger or you are instructed to move it by a police officer.
- Give only the necessary and requested information to police and other parties involved in the crash. Do not discuss your personal condition, mental frame of mind, or anything unrelated to the crash. This will help guard against post-crash legal action.

- If you need roadside assistance, call GM Roadside Assistance. See *Roadside Assistance Program* on page 12-5 for more information.
- If your vehicle cannot be driven, know where the towing service will be taking it. Get a card from the tow truck operator or write down the driver's name, the service's name, and the phone number.
- Remove any valuables from your vehicle before it is towed away. Make sure this includes your insurance information and registration if you keep these items in your vehicle.
- Gather the important information you will need from the other driver. Things like name, address, phone number, driver's license number, vehicle license

plate, vehicle make, model and model year, Vehicle Identification Number (VIN), insurance company and policy number, and a general description of the damage to the other vehicle.

- If possible, call your insurance company from the scene of the crash. They will walk you through the information they will need. If they ask for a police report, phone or go to the police department headquarters the next day and you can get a copy of the report for a nominal fee. In some states/provinces with "no fault" insurance laws, a report may not be necessary. This is especially true if there are no injuries and both vehicles are driveable.

12-14 Customer Information

- Choose a reputable collision repair facility for your vehicle. Whether you select a dealer/retailer or a private collision repair facility to fix the damage, make sure you are comfortable with them. Remember, you will have to feel comfortable with their work for a long time.
- Once you have an estimate, read it carefully and make sure you understand what work will be performed on your vehicle. If you have a question, ask for an explanation. Reputable shops welcome this opportunity.

Managing the Vehicle Damage Repair Process

In the event that your vehicle requires damage repairs, GM recommends that you take an active role in its repair. If you have a pre-determined repair facility of choice, take your vehicle there, or have it towed there. Specify to the facility that any required replacement collision parts be original equipment parts, either new Genuine GM parts or recycled original GM parts. Remember, recycled parts will not be covered by your GM vehicle warranty.

Insurance pays the bill for the repair, but you must live with the repair. Depending on your policy limits, your insurance company may initially value the repair using aftermarket parts.

Discuss this with your repair professional, and insist on Genuine GM parts. Remember if your vehicle is leased you may be obligated to have the vehicle repaired with Genuine GM parts, even if your insurance coverage does not pay the full cost.

If another party's insurance company is paying for the repairs, you are not obligated to accept a repair valuation based on that insurance company's collision policy repair limits, as you have no contractual limits with that company. In such cases, you can have control of the repair and parts choices as long as cost stays within reasonable limits.

Reporting Safety Defects

Reporting Safety Defects to the United States Government

If you believe that your vehicle has a defect which could cause a crash or could cause injury or death, you should immediately inform the National Highway Traffic Safety Administration (NHTSA) in addition to notifying General Motors.

If NHTSA receives similar complaints, it may open an investigation, and if it finds that a safety defect exists in a group of vehicles, it may order a recall and remedy campaign.

However, NHTSA cannot become involved in individual problems between you, your dealer/retailer, or General Motors.

To contact NHTSA, you may call the Vehicle Safety Hotline toll-free at 1-888-327-4236 (TTY: 1-800-424-9153); go to <http://www.safercar.gov>; or write to:

Administrator, NHTSA
1200 New Jersey Avenue, S.E.
Washington D.C., 20590

You can also obtain other information about motor vehicle safety from <http://www.safercar.gov>.

Reporting Safety Defects to the Canadian Government

If you live in Canada, and you believe that your vehicle has a safety defect, notify Transport Canada immediately, in addition to notifying General Motors of Canada Limited. Call them at 1-800-333-0510 or write to:

Transport Canada
Road Safety Branch
2780 Sheffield Road
Ottawa, Ontario K1B 3V9

Reporting Safety Defects to General Motors

In addition to notifying NHTSA (or Transport Canada) in a situation like this, please notify General Motors.

Call 1-800-762-2737, or write:

Pontiac Customer Assistance Center
P.O. Box 33172
Detroit, MI 48232-5172

In Canada, call 1-800-263-3777
(English) or 1-800-263-7854
(French), or write:

General Motors of Canada Limited
Customer Communication Centre,
CA1-163-005
1908 Colonel Sam Drive
Oshawa, Ontario L1H 8P7

Service Publications Ordering Information

Service Manuals

Service Manuals have the diagnosis and repair information on engines, transmission, axle suspension, brakes, electrical, steering, body, etc.

Service Bulletins

Service Bulletins give additional technical service information needed to knowledgeably service General Motors cars and trucks. Each bulletin contains instructions to assist in the diagnosis and service of your vehicle.

Owner Information

Owner publications are written specifically for owners and intended to provide basic operational information about the vehicle.

The owner manual includes the Maintenance Schedule for all models.

In-Portfolio: Includes a Portfolio, Owner Manual, and Warranty Booklet.

RETAIL SELL PRICE:
\$35.00 (U.S.) plus processing fee

Without Portfolio: Owner Manual only.

RETAIL SELL PRICE:
\$25.00 (U.S.) plus processing fee

Current and Past Model Order Forms

Technical Service Bulletins and Manuals are available for current and past model GM vehicles. To request an order form, specify year and model name of the vehicle.

ORDER TOLL FREE:
1-800-551-4123 Monday-Friday
8:00 AM - 6:00 PM Eastern Time

For Credit Card Orders Only
(VISA-MasterCard-Discover),
visit Helm, Inc. on the World Wide
Web at: helminc.com

Or you can write to:

Helm, Incorporated
P.O. Box 07130
Detroit, MI 48207

Prices are subject to change
without notice and without incurring
obligation. Allow ample time for
delivery.

Note to Canadian Customers:
All listed prices are quoted in
U.S. funds. Canadian residents
are to make checks payable in
U.S. funds.

Vehicle Data Recording and Privacy

Your GM vehicle has a number of sophisticated computers that record information about the vehicle's performance and how it is driven. For example, your vehicle uses computer modules to monitor and control engine and transmission performance, to monitor the conditions for airbag deployment and deploy airbags in a crash and, if so equipped, to provide antilock braking to help the driver control the vehicle. These modules may store data to help your dealer/retailer technician service your vehicle. Some modules may also store data about how you operate the vehicle, such as rate of fuel consumption or average speed. These modules may also retain the owner's personal preferences, such as radio pre-sets, seat positions, and temperature settings.

Event Data Recorders

This vehicle has an Event Data Recorder (EDR). The main purpose of an EDR is to record, in certain crash or near crash-like situations, such as an airbag deployment or hitting a road obstacle, data that will assist in understanding how a vehicle's systems performed. The EDR is designed to record data related to vehicle dynamics and safety systems for a short period of time, typically 30 seconds or less. The EDR in this vehicle is designed to record such data as:

- How various systems in your vehicle were operating
- Whether or not the driver and passenger safety belts were buckled/fastened
- How far, if at all, the driver was pressing the accelerator and/or brake pedal
- How fast the vehicle was traveling

12-18 Customer Information

This data can help provide a better understanding of the circumstances in which crashes and injuries occur.

Important: EDR data is recorded by your vehicle only if a non-trivial crash situation occurs; no data is recorded by the EDR under normal driving conditions and no personal data (e.g., name, gender, age, and crash location) is recorded. However, other parties, such as law enforcement, could combine the EDR data with the type of personally identifying data routinely acquired during a crash investigation.

To read data recorded by an EDR, special equipment is required, and access to the vehicle or the EDR is needed. In addition to the vehicle manufacturer, other parties, such as law enforcement, that have the special equipment, can read the information if they have access to the vehicle or the EDR.

GM will not access this data or share it with others except: with the consent of the vehicle owner or, if the vehicle is leased, with the consent of the lessee; in response to an official request of police or similar government office; as part of GM's defense of litigation through the discovery process; or, as required by law. Data that GM collects or receives may also be used for GM research needs or may be made available to others for research purposes, where a need is shown and the data is not tied to a specific vehicle or vehicle owner.

OnStar®

If your vehicle has OnStar and you subscribe to the OnStar services, please refer to the OnStar Terms and Conditions for information on data collection and use.

Navigation System

If your vehicle has a navigation system, use of the system may result in the storage of destinations, addresses, telephone numbers, and other trip information. Refer to the navigation system operating manual for information on stored data and for deletion instructions.

Radio Frequency Identification (RFID)

RFID technology is used in some vehicles for functions such as tire pressure monitoring and ignition system security, as well as in connection with conveniences such as key fobs for remote door locking/unlocking and starting, and in-vehicle transmitters for garage door openers. RFID technology in GM vehicles does not use or record personal information or link with any other GM system containing personal information.

A

- | | | |
|---|--|--|
| <ul style="list-style-type: none"> Accessories and Modifications 9-3 Accessory Power Outlets 4-9 Adding Equipment to Your Airbag-Equipped Vehicle 1-34 Additives, Fuel 8-37 Add-On Electrical Equipment 9-35 Air Cleaner/Filter, Engine 9-12 Air Conditioning 7-1 Airbag <ul style="list-style-type: none"> Passenger Status Indicator 4-15 Readiness Light 4-14 System, Replacing Parts <ul style="list-style-type: none"> After a Crash 1-35 Airbag System 1-21 <ul style="list-style-type: none"> Adding Equipment to Your Airbag-Equipped Vehicle 1-34 Check 1-35 How Does an Airbag Restrain? 1-26 | <ul style="list-style-type: none"> Airbag System (cont.) <ul style="list-style-type: none"> Passenger Sensing System 1-28 Servicing Your Airbag-Equipped Vehicle 1-33 What Makes an Airbag Inflate? 1-26 What Will You See After an Airbag Inflates? 1-26 When Should an Airbag Inflate? 1-24 Where Are the Airbags? 1-23 All-Wheel-Drive (AWD) System 8-22 All-Wheel-Drive Service Light 4-24 Antenna, Fixed Mast 6-14 Antenna, XM™ Satellite Radio Antenna System 6-14 Antilock Brake System (ABS) 8-20 Antilock Brake, System Warning Light 4-18 | <ul style="list-style-type: none"> Appearance Care <ul style="list-style-type: none"> Chemical Paint Spotting 9-90 Exterior Cleaning 9-86 Finish Damage 9-89 Interior Cleaning 9-83 Sheet Metal Damage 9-89 Underbody Maintenance 9-90 Appointments, Scheduling Service 12-8 Ashtray(s) 4-10 Audio System 6-1 <ul style="list-style-type: none"> Audio Steering Wheel Controls 6-13 Fixed Mast Antenna 6-14 Radio Reception 6-14 Setting the Clock 6-2 XM™ Satellite Radio Antenna System 6-14 Audio System(s) 6-3 Automatic Headlamp System ... 5-2 Automatic Transmission <ul style="list-style-type: none"> Fluid 9-14 Operation 8-6, 8-8 |
|---|--|--|

B

Battery	9-30
Run-Down Protection	5-4
Brake	
System Inspection	11-17
Brake Fluid	9-27
Brakes	9-27
System Warning Light	4-17
Braking	8-19
Break-In, New Vehicle	8-2
Bulb Replacement	9-31
Halogen Bulbs	9-31
Headlamp Aiming	9-30
Headlamps and Parking Lamps	9-31
License Plate Lamps	9-34
Replacement Bulbs	9-35
Taillamps	9-33
Buying New Tires	9-54

C

California Fuel	8-36
California Perchlorate Materials Requirements	9-3
California Proposition 65 Warning	9-3
Canadian Owners	ii

Capacities and Specifications	10-2
Carbon Monoxide	8-16, 8-29
Care, Safety Belts	1-20
Cargo Cover	3-4
Cargo Management System	3-6
Cargo Tie Downs	3-6
Cautions and Notices	iii
CD, MP3	6-9
Center Console Storage Area ...	3-2
Chains, Tire	9-60
Charging System Light	4-16
Check	
Engine Lamp	4-20
Chemical Paint Spotting	9-90
Child Restraints	
Child Restraint Systems	1-41
Infants and Young Children	1-38
Lower Anchors and Tethers for Children	1-44
Older Children	1-36
Securing	1-50, 1-53
Where to Put the Restraint	1-43
Cleaning	
Exterior	9-86
Interior	9-83
Underbody Maintenance	9-90

Climate Control System	7-1
Air Filter, Passenger Compartment	7-4
Outlet Adjustment	7-3
Clock, Setting	6-2
Clutch, Hydraulic	9-17
Collision Damage Repair	12-11
Compact Spare Tire	9-70
Content Theft-Deterrent	2-10
Control of a Vehicle	8-18
Coolant	
Engine	9-18
Engine Temperature Gage	4-19
Cooling System	9-18
Cruise Control	4-4
Cruise Control Light	4-23
Cupholders	3-1
Customer Assistance Information Courtesy Transportation	12-4, 12-10
Customer Assistance Offices	12-4
Customer Satisfaction Procedure	12-1

Customer Assistance Information
 (cont.)
 GM Mobility
 Reimbursement
 Program 12-5
 Reporting Safety Defects
 to General Motors 12-16
 Reporting Safety Defects
 to the Canadian
 Government 12-15
 Reporting Safety Defects
 to the United States
 Government 12-15
 Roadside Assistance
 Program 12-5
 Service Publications
 Ordering Information 12-16

D

Daytime Running Lamp 5-2
 Defensive Driving 8-17
 Disc, MP3 6-9
 Doing Your Own
 Service Work 9-4
 Dome Lamps 5-3

Door
 Ajar Light 4-24
 Locks 2-6
 Power Door Locks 2-7
 Rear Door Security Locks 2-7
 Driver Storage Compartment 3-3
 Driving
 At Night 8-26
 Before a Long Trip 8-28
 Defensive 8-17
 Drunken 8-18
 Highway Hypnosis 8-28
 Hill and Mountain Roads 8-28
 In Rain and on Wet
 Roads 8-27
 Rocking Your Vehicle to
 Get it Out 8-31
 Winter 8-29

E

EDR 12-17
 Electrical System
 Add-On Equipment 9-35
 Engine Compartment
 Fuse Block 9-39
 Fuses and Circuit
 Breakers 9-36

Electrical System (cont.)
 Headlamp Wiring 9-35
 Instrument Panel
 Fuse Block 9-36
 Power Windows and
 Other Power Options 9-36
 Windshield Wiper Fuses 9-36
 Engine
 Air Cleaner/Filter 9-12
 Check and Service Engine
 Soon Lamp 4-20
 Coolant 9-18
 Coolant Heater 8-5
 Coolant
 Temperature Gage 4-19
 Cooling System
 Inspection 11-17
 Drive Belt Routing 10-5
 Engine Compartment
 Overview 9-6
 Exhaust 8-16
 Oil 9-9
 Overheating 9-22
 Starting 8-4
 Entry Lighting 5-3
 Event Data Recorders 12-17
 Extender, Safety Belt 1-19
 Exterior Lamps 5-1

F

Filter	
Engine Air Cleaner	9-12
Finish Damage	9-89
Fixed Mast Antenna	6-14
Flashers, Hazard Warning	4-3
Flash-to-Pass	4-7
Flat Tire	9-61
Flat Tire, Changing	9-62
Flat Tire, Storing	9-68
Floor Mats	3-3
Fluid	
Automatic Transmission	9-14
Power Steering	9-24
Windshield Washer	9-24
Fog Lamp	
Fog	5-2
Fog Lamp Light	4-23
Folding Seatback, Passenger ...	1-4
Fuel	8-36
Additives	8-37
California Fuel	8-36
Filling a Portable Fuel Container	8-40
Filling the Tank	8-38
Fuels in Foreign Countries	8-37
Gage	4-24

Fuel (cont.)

Gasoline Octane	8-36
Gasoline Specifications	8-36
Low Warning Light	4-25
System Inspection	11-16
Fuses	
Engine Compartment Fuse Block	9-39
Fuses and Circuit Breakers	9-36
Instrument Panel Fuse Block	9-36
Windshield Wiper	9-36

G

Gage	
Engine Coolant Temperature	4-19
Fuel	4-24
Speedometer	4-13
Tachometer	4-13
Gasoline	
Octane	8-36
Specifications	8-36
Glove Box	3-1
GM Mobility Reimbursement Program	12-5

H

Hazard Warning Flashers	4-3
Head Restraints	1-6
Headlamp	
Aiming	9-30
Headlamp Wiring	9-35
Headlamps	
Bulb Replacement	9-31
Daytime Running Lamp	5-2
Exterior Lamps	5-1
Flash-to-Pass	4-7
Halogen Bulbs	9-31
Headlamps and Parking Lamps	9-31
High/Low Beam Changer	4-7
Heater	7-1
Engine Coolant	8-5
Height Adjuster, Seat	1-2
Highbeam On Light	4-24
Highway Hypnosis	8-28
Hill and Mountain Roads	8-28
Hood	
Release	9-5
Hooks	3-3
Horn	4-3
How to Wear Safety Belts Properly	1-11
Hydraulic Clutch	9-17

I

Ignition Positions	8-2
Immobilizer	2-9
Immobilizer Operation	2-9
Infants and Young Children, Restraints	1-38
Inflation - Tire Pressure	9-47
Inspection	
Brake System	11-17
Engine Cooling System	11-17
Exhaust System	11-16
Fuel System	11-16
Part C - Periodic Maintenance	11-16
Steering, Suspension and Front Drive Axle Boot and Seal	11-16
Throttle System	11-17
Instrument Panel	
Brightness	5-3
Cluster	4-12
Overview	4-2

J

Jump Starting	9-71
---------------------	------

K

Keyless Entry System	2-3
Keys	2-2

L

Labeling, Tire Sidewall	9-42
Lamp	
Malfunction Indicator	4-20
Lamps	
Dome	5-3
Reading	5-4
Lap-Shoulder Belt	1-16
LATCH System	
Replacing Parts After a Crash	1-49
LATCH System for Child	
Restraints	1-44
License Plate Lamps	9-34
Liftgate	
Carbon Monoxide	2-8
Light	
Airbag Readiness	4-14
Antilock Brake System (ABS) Warning	4-18
Brake System Warning	4-17
Charging System	4-16

Light (cont.)

Cruise Control	4-23
Door Ajar	4-24
Fog Lamp	4-23
Highbeam On	4-24
Lights On Reminder	4-23
Low Fuel Warning	4-25
Low Tire Pressure Warning Light	4-18
Low Washer Fluid Warning	4-23
Oil Pressure	4-22
Passenger Airbag Status Indicator	4-15
Safety Belt Reminders	4-14
Security	4-22
Service All-Wheel-Drive	4-24
Speed Sensitive Power Steering (SSPS) Warning Light	4-18
StabiliTrak [®] Indicator	4-19
Taillamp Indicator	4-23
TCS Warning Light	4-19
Traction Control System (TCS) Warning	4-19
Lighting	
Entry	5-3

Lights	
Exterior Lamps	5-1
Flash-to-Pass	4-7
High/Low Beam Changer	4-7
Loading Your Vehicle	8-32
Locks	
Door	2-6
Power Door	2-7
Rear Door Security Locks	2-7
Loss of Control	8-25
Low Fuel Warning Light	4-25
Low Washer Fluid Warning Light	4-23
Lower Anchors and Tethers for Children	1-44
Luggage Carrier	3-2

M

Maintenance Schedule	
At Each Fuel Fill	11-12
At Least Once a Month	11-13
At Least Once a Year	11-13
At Least Twice a Year	11-13
Brake System	
Inspection	11-17
Engine Cooling System	
Inspection	11-17

Maintenance Schedule (cont.)	
Exhaust System	
Inspection	11-16
Fuel System Inspection	11-16
How This Section is Organized	11-2
Introduction	11-1
Maintenance Replacement Parts	10-4
Maintenance Requirements	11-2
Part A - Scheduled Maintenance Services	11-3
Part B - Owner Checks and Services	11-12
Part C - Periodic Maintenance Inspections	11-16
Part D - Recommended Fluids and Lubricants	11-18
Part E - Maintenance Record	11-20
Scheduled Maintenance	11-4
Steering, Suspension and Front Drive Axle Boot and Seal Inspection	11-16

Maintenance Schedule (cont.)	
Throttle System	
Inspection	11-17
Using	11-3
Your Vehicle and the Environment	11-2
Malfunction Indicator Lamp	4-20
Manual Seats	1-2
Manual Transmission Fluid	9-16
Operation	8-11
Mirrors	
Manual Rearview Mirror	2-13
Outside Power Mirrors	2-14
MP3	6-9
MyGMLink.com	12-3

N

Navigation System, Privacy	12-18
New Vehicle Break-In	8-2
Notices and Cautions	iii
Notification Service Airbag Message	4-16

O

- Odometer 4-13
- Odometers, Trip 4-13
- Off-Road Recovery 8-24
- Oil
 - Engine 9-9
 - Pressure Light 4-22
- Older Children, Restraints 1-36
- Online Owner Center 12-3
- OnStar, Privacy 12-18
- OnStar® System, see
 - OnStar® Manual 4-25
- Outlet Adjustment 7-3
- Outlets
 - Accessory Power 4-9
- Outside
 - Power Mirrors 2-14
- Overhead Console 3-2
- Owner Checks, Service 9-5
- Owners, Canadian ii

P

- Paint, Damage 9-89
- Park
 - Shifting Into 8-13
 - Shifting Out of 8-14
- Park Brake 8-12

- Parking
 - Over Things That Burn 8-16
- Parking Your Vehicle 8-15
- Part A - Scheduled
 - Maintenance Services 11-3
- Part B - Owner Checks
 - and Services 11-12
- Part C - Periodic Maintenance
 - Inspections 11-16
- Part D - Recommended
 - Fluids and Lubricants 11-18
- Part E - Maintenance
 - Record 11-20
- Passenger Airbag Status
 - Indicator 4-15
- Passenger Compartment
 - Air Filter 7-4
- Passenger Sensing System ... 1-28
- Passing 8-25
- Perchlorate Materials
 - Requirements, California 9-3
- Power
 - Door Locks 2-7
 - Electrical System 9-36
 - Outlet 115 Volt Alternating
 - Current 4-10
 - Retained Accessory 8-4
 - Steering Fluid 9-24
 - Windows 2-12

- Pressure Cap 9-22
- Privacy 12-17
 - Event Data Recorders 12-17
 - Navigation System 12-18
- OnStar 12-18
- Radio Frequency
 - Identification 12-18

R

- Radio Frequency Identification
 - (RFID), Privacy 12-18
- Radio(s) 6-3
- Radios
 - Reception 6-14
 - Setting the Clock 6-2
- Reading Lamps 5-4
- Rear Door Security Locks 2-7
- Rear Seat Operation 1-7
- Rear Windshield Washer/
 - Wiper 4-8
- Rearview Mirrors 2-13
- Reclining Seatbacks 1-3
- Recreational Vehicle Towing ... 9-75
- Remote Keyless Entry (RKE)
 - System 2-3
- Remote Keyless Entry (RKE)
 - System, Operation 2-4

Removing the Flat Tire and Installing the Spare Tire	9-64
Removing the Spare Tire and Tools	9-63
Replacement Bulbs	9-35
Replacement Parts, Maintenance	10-4
Replacing LATCH System Parts After a Crash	1-49
Reporting Safety Defects Canadian Government	12-15
General Motors	12-16
United States Government	12-15
Restraint System Check Replacing Airbag System Parts After a Crash	1-35
Replacing Safety Belt System Parts After a Crash	1-20
Retained Accessory Power	8-4
Roadside Assistance Program	12-5
Rocking Your Vehicle to Get it Out	8-31
Routing, Engine Drive Belt	10-5
Running the Vehicle While Parked	8-17

S

Safety Belt Reminders	4-14
Safety Belts	1-8
Care of	1-20
Check	1-20
How to Wear Safety Belts Properly	1-11
Lap-Shoulder Belt	1-16
Replacing Parts After a Crash	1-20
Safety Belt Extender	1-19
Safety Belt Use During Pregnancy	1-19
Scheduled Maintenance	11-4
Seatback, Folding Passenger ...	1-4
Seats Head Restraints	1-6
Height Adjuster	1-2
Passenger Folding Seatback	1-4
Rear Seat Operation	1-7
Reclining Seatbacks	1-3
Securing Child Restraints	1-50, 1-53
Security Light	4-22

Service	9-2
Accessories and Modifications	9-3
Adding Equipment to the Outside of the Vehicle	9-4
All-Wheel-Drive Light	4-24
California Perchlorate Materials Requirements	9-3
California Proposition 65 Warning	9-3
Doing Your Own Work	9-4
Engine Soon Lamp	4-20
Owner Checks	9-5
Publications Ordering Information	12-16
Service Airbag Notification System Message	4-16
Service, Scheduling Appointments	12-8
Servicing Your Airbag-Equipped Vehicle	1-33
Setting the Clock	6-2
Sheet Metal Damage	9-89
Shifting Into Park	8-13
Shifting Out of Park	8-14
Signals, Turn and Lane-Change	4-7

Spare Tire
 Compact 9-70
 Installing 9-64
 Removing 9-63
 Storing 9-68
 Specifications, Capacities 10-2
 Speed Sensitive Power
 Steering (SSPS)
 Warning Light 4-18
 Speedometer 4-13
 StabiliTrak[®] Indicator Light 4-19
 Stabilitrak[®] System 8-22
 Starting the Engine 8-4
 Steering 8-23
 Steering, Suspension and
 Front Drive Axle Boot and
 Seal Inspection 11-16
 Steering Wheel Controls,
 Audio 6-13
 Steering Wheel, Tilt Wheel 4-4
 Storage Areas
 Cargo Management
 System 3-6
 Center Console
 Storage Area 3-2
 Cupholders 3-1
 Driver Storage
 Compartment 3-3
 Glove Box 3-1

Storage Areas (cont.)
 Luggage Carrier 3-2
 Overhead Console 3-2
 Stuck in Sand, Mud, Ice, or
 Snow 8-31
 Sun Visors 2-13
 Sunroof 2-14

T

Tachometer 4-13
 Taillamp Indicator Light 4-23
 Taillamps 9-33
 TCS Warning Light 4-19
 Theft-Deterrent Systems 2-9
 Content Theft-Deterrent 2-10
 Immobilizer 2-9
 Immobilizer Operation 2-9
 Throttle System Inspection ... 11-17
 Tilt Wheel 4-4
 Time, Setting 6-2
 Tires 9-41
 Buying New Tires 9-54
 Chains 9-60
 Changing a Flat Tire 9-62
 Compact Spare Tire 9-70
 Different Size 9-56

Tires (cont.)
 If a Tire Goes Flat 9-61
 Inflation - Tire Pressure 9-47
 Inspection and Rotation 9-53
 Installing the Spare Tire 9-64
 Pressure Monitor
 Operation 9-50
 Pressure Monitor System ... 9-48
 Removing the Flat Tire 9-64
 Removing the Spare Tire
 and Tools 9-63
 Storing a Flat or Spare Tire
 and Tools 9-68
 Tire Sidewall Labeling 9-42
 Tire Terminology and
 Definitions 9-44
 Uniform Tire Quality
 Grading 9-56
 Wheel Alignment and Tire
 Balance 9-58
 Wheel Replacement 9-59
 When It Is Time for
 New Tires 9-54
 Towing
 Recreational Vehicle 9-75
 Towing a Trailer 9-77
 Your Vehicle 9-75

Traction	
Control System (TCS)	8-21
Control System Warning	
Light	4-19
Stabilitrak® System	8-22
Transmission	
Fluid, Automatic	9-14
Fluid, Manual	9-16
Transmission Operation,	
Automatic	8-6, 8-8
Transmission Operation,	
Manual	8-11
Trip Odometers	4-13
Turn and Lane-Change	
Signals	4-7
Turn Signal/Multifunction	
Lever	4-4

U

Uniform Tire Quality	
Grading	9-56

V

Vehicle	
Control	8-18
Loading	8-32
Parking Your	8-15
Running While Parked	8-17
Vehicle Data Recording and	
Privacy	12-17
Vehicle Identification	
Number (VIN)	10-1
Service Parts Identification	
Label	10-1
Ventilation Adjustment	7-3
Visors	2-13

W

Warning Lights, Gages and	
Indicators	4-11
Warnings	
Hazard Warning Flashers	4-3
Washer Fluid, Low Warning	
Light	4-23
Wheels	
Alignment and	
Tire Balance	9-58
Different Size	9-56
Replacement	9-59

Where to Put the Restraint	1-43
Windows	2-12
Power	2-12
Windshield	
Washer	4-8
Washer Fluid	9-24
Wiper Blade	
Replacement	9-25
Wiper Fuses	9-36
Wipers	4-7
Windshield, Rear Washer/	
Wiper	4-8
Winter Driving	8-29

X

XM Radio Messages	6-12
XM™ Satellite Radio	
Antenna System	6-14

Y

Your Vehicle and the	
Environment	11-2