

## Forward

---

This supplement contains a detailed description and instructions for proper operation of the following systems:

- Navigation System
- Audio and Visual System
- Handsfree System
- Vehicle Information System

Please read this supplement carefully before using any of the systems it describes that may be present in your vehicle.

Please keep this supplement with your Owner's Manual and leave it in the vehicle at the time of resale. The next owner will need the information it contains.

The information, specifications and illustrations found in this supplement are those in effect at the time of printing. FUJI HEAVY INDUSTRIES LTD. reserves the right to change specifications and designs at any time without prior notice and without incurring any obligation to make the same or similar changes on vehicles previously sold.

This Owner's Manual supplement applies to all models and covers all equipment, including factory installed options. Some explanations, therefore may be for equipment not installed in your vehicle.

FUJI HEAVY INDUSTRIES LTD., TOKYO, JAPAN

 **SUBARU** is a registered trademark of FUJI HEAVY INDUSTRIES LTD.  
Copyright © 2007, FUJI HEAVY INDUSTRIES LTD.

# Contents

---

## Introduction

---

<b>Safety Warnings</b> .....	<b>6</b>
<b>System Components and Controls</b> .....	<b>7</b>
<b>Loading the map disc</b> .....	<b>9</b>

## Navigation

---

<b>Before Use</b> .....	<b>12</b>
<b>Starting Up the Navigation System</b> .....	<b>16</b>
<b>Volume</b> .....	<b>18</b>
<b>Markers and Controls Displayed on Maps</b> .....	<b>19</b>
Screens During Route Setting .....	19
Screens During Route Guidance .....	21
<b>Menu Screen Keys and Functions</b> .....	<b>22</b>
<b>Map Operations</b> .....	<b>24</b>
Selecting Map Orientation .....	24
Changing Map Scale .....	25
<b>Setting Route</b> .....	<b>27</b>
Setting Destination .....	27
■ Setting destination/waypoints by scrolling the map .....	27
■ Setting the destination from the navigation menu .....	29
<b>Route Guidance</b> .....	<b>43</b>
Route Guidance Screen .....	43
Zoom-in Map at Intersection .....	44
Dual Map Display .....	45

Freeway Information .....	46
Replaying Voice Guidance .....	47
Compass Mode .....	48
<b>Route Options</b> .....	<b>49</b>
Setting Route Options .....	49
■ Search condition .....	50
■ Detour .....	51
■ Route preferences .....	52
■ Destination and waypoints .....	52
■ Display route .....	56
■ Route preview .....	57
<b>Navigation Setup</b> .....	<b>60</b>
Setting Your Navigation System .....	60
■ User settings .....	61
■ Quick POI selection .....	63
■ Language Selection .....	64
■ Calibration .....	64
■ Set clock .....	66
■ Vehicle signal .....	67
■ Restore system defaults .....	67
<b>Stored Locations</b> .....	<b>69</b>
■ Memory points .....	70
■ Avoid area .....	75
■ Previous destination (deleting stored locations) .....	77
<b>Other Functions</b> .....	<b>79</b>
■ Displaying POIs on a map .....	79
■ Displaying POI data .....	81
■ Deleting POI markers .....	82
■ Editing Quick POI categories .....	82
■ SUBARU dealership search .....	84

<b>Version and Initialization .....</b>	<b>87</b>
Version .....	87
Initialization of the navigation settings.....	88
<b>General Information .....</b>	<b>90</b>
When a Problem Occurs.....	93

## Audio and Visual

<b>Before using the Audio and Visual.....</b>	<b>96</b>
Precautions when using the system.....	96
Discs that can be used .....	99
Player.....	101
Character information displayed .....	102
<b>Basic operation of the Audio and Visual .....</b>	<b>103</b>
Name of each part.....	103
Turning on the power .....	106
Selecting the source .....	107
■ Pressing the button for selection.....	107
■ Making a selection by touching .....	109
Setting and adjusting the sound .....	110
■ Adjusting the sound volume.....	110
■ Turning off the sound .....	110
Handling the disc.....	111
■ Setting the disc.....	111
■ Taking out the disc.....	112
<b>Listening to the radio.....</b>	<b>113</b>
Listening to the radio .....	113
■ FM radio screen displayed.....	113
■ AM radio screen displayed .....	114

Selecting a station.....	116
■ Selecting a station that is preset .....	116
■ Setting the frequency.....	116
■ Searching a station automatically.....	117
■ Searching a FM station from a category of interest.....	117
Presetting a station.....	119
■ Presetting a station that is now being tuned in to.....	119
■ Presetting a station that can receive radio waves automatically .....	119
<b>Listening to the CD .....</b>	<b>120</b>
Listening to a tune in the CD .....	120
CD screen displayed.....	121
Selecting a tune .....	123
■ Selecting the preceding tune.....	123
■ Selecting the succeeding tune.....	123
■ Selecting a tune from the list.....	124
■ Searching a tune while listening.....	125
■ Fast-rewinding or fast-forwarding a tune .....	125
Listening to a tune repeatedly .....	126
Listening to tunes in random order.....	127
<b>Listening to MP3/WMA disc .....</b>	<b>128</b>
MP3/WMA.....	128
Listening to tunes (file) in the MP3/WMA disc.....	131
MP3/WMA disc screen displayed .....	132
Selecting a tune .....	134
■ Selecting a folder that you want to hear .....	134
■ Selecting a tune (file) you want to hear .....	135
■ Fast-rewinding or fast-forwarding a tune .....	137
■ Listening to a tune repeatedly .....	138
■ Listening the tunes in random order .....	139

<b>Looking at the DVD .....</b>	<b>140</b>
<b>What must be known .....</b>	<b>141</b>
■ Operations while in the playback of the disc.....	141
■ DVD video and DVD audio.....	141
<b>Playing back the DVD .....</b>	<b>142</b>
<b>DVD control screen displayed.....</b>	<b>143</b>
<b>Selecting the title and the chapter.....</b>	<b>145</b>
■ Selecting the chapter.....	145
■ Searching a title with the title number specified.....	145
<b>Controlling the playback of the DVD .....</b>	<b>147</b>
<b>Operating the menu screen.....</b>	<b>149</b>
■ Selecting the menu .....	149
■ Changing over the position of the menu operation key .....	150
<b>Changing the language and the angle.....</b>	<b>151</b>
■ Changing the superimposed language.....	151
■ Changing the voice language .....	152
■ Changing over the angle .....	153
<b>Setting the screen .....</b>	<b>154</b>
■ Adjusting the image quality.....	154
■ Setting the SCREEN MODE.....	155
<b>Looking at the VIDEO .....</b>	<b>156</b>
<b>Satellite radio operation (if equipped).....</b>	<b>157</b>
<b>Setting the audio.....</b>	<b>158</b>
<b>Setting the equalizer .....</b>	<b>158</b>
■ Setting the equalizer with ease.....	158
■ Setting the equalizer in detail .....	159
■ Invoking the equalizer setting that has been preset .....	160
<b>Setting the balance of the audio volume .....</b>	<b>162</b>
<b>Setting the surround .....</b>	<b>164</b>
<b>Setting the speaker .....</b>	<b>166</b>

<b>Initializing the DVD.....</b>	<b>168</b>
■ Setting the screen .....	169
■ Setting the dynamic range.....	170
■ Setting the language.....	171
■ Setting the password of the parental level .....	172
■ Setting the parental level .....	173

## Handsfree

<b>Before using the Handsfree .....</b>	<b>176</b>
<b>What can be made with the handsfree .....</b>	<b>176</b>
■ What cannot be done with the handsfree .....	176
<b>Precautions to be taken when using the Bluetooth equipment.....</b>	<b>177</b>
<b>Name of each part.....</b>	<b>178</b>
<b>Phone voice.....</b>	<b>179</b>
<b>Various types of displays .....</b>	<b>180</b>
■ Reception level display .....	180
■ Battery indicator .....	180
■ Bluetooth connection status display.....	181
■ Roaming display.....	181
<b>When parting with your car.....</b>	<b>182</b>
<b>Making preparations of the handsfree .....</b>	<b>183</b>
<b>Registering the Bluetooth Phone.....</b>	<b>183</b>
<b>Connecting the Bluetooth Phone .....</b>	<b>185</b>
<b>Speaking over the handsfree .....</b>	<b>187</b>
<b>Making a phone call .....</b>	<b>187</b>
■ Entering a phone number to make a phone call .....	187
■ Making a phone call from the outgoing or incoming call history.....	188
■ Making a phone call from the phone book .....	190

■ Making a phone call from the Speed Dial .....	192
■ Making a phone call to the phone number of the Memory Point.....	193
■ Making a phone call from the Bluetooth Phone.....	194
<b>Taking a phone call and declining a incoming call .....</b>	<b>195</b>
■ Taking a phone call.....	195
■ Putting an incoming phone call on hold.....	195
■ Hanging up an incoming call before answering it (Denial of an incoming call).....	196
<b>Speaking over the phone .....</b>	<b>197</b>
■ Adjusting the tonal volume.....	197
■ Muting the voice on this side.....	197
■ Transmitting the phone call.....	198
■ Hanging up the phone.....	198
<b>Using the outgoing or incoming call history .....</b>	<b>199</b>
Checking the outgoing or incoming call history .....	199
Deleting all the outgoing and incoming call history .....	200
<b>Using the phone book.....</b>	<b>201</b>
<b>Registering the phone book data.....</b>	<b>201</b>
■ Transmitting the phone book of the Bluetooth Phone.....	201
■ Registering a new data with the phone book.....	203
■ Registering data with the phone book from the outgoing or incoming call history .....	206
<b>Editing or deleting a phone book data.....</b>	<b>208</b>
■ Editing a phone book data .....	208
■ Selecting a phone book data to delete it .....	210
■ Deleting all the phone book data.....	212
<b>Other Bluetooth settings .....</b>	<b>214</b>
Deleting the registered Bluetooth Phone from the in-vehicle equipment .....	214
Changing the Device Name of the in-vehicle equipment displayed in the Bluetooth Phone.....	216

<b>Editing the Speed Dial setting .....</b>	<b>218</b>
■ Adding the phone number to the Speed Dial memory .....	218
■ Deleting the phone number from the Speed Dial memory .....	220
<b>Changing the Pass-Key used when certifying the Bluetooth Phone .....</b>	<b>222</b>

## Vehicle Information

<b>Before Use.....</b>	<b>226</b>
Precautions when using the system .....	226
<b>Displaying Vehicle Information Screen.....</b>	<b>229</b>
<b>Displaying Vehicle Information and Programming Vehicle System Functions.....</b>	<b>230</b>
■ Displaying fuel consumption information and programming for the automatic alarm display .....	230
■ Displaying, retaining, and erasing driving record data .....	232
■ Displaying three meters .....	237
■ Maintenance schedule.....	238
■ Programming vehicle system functions .....	239
■ The calculator functions.....	242
■ The calendar functions.....	244
<b>Adjusting Brightness/Contrast .....</b>	<b>245</b>
■ Adjusting brightness/contrast.....	245

The image features three vertical gray bars of varying widths and positions. On the left side, there is a thin vertical bar and a wider, taller vertical bar. On the right side, there is a single thin vertical bar. The word "Introduction" is centered horizontally between the two main bars on the left.

# Introduction

## Safety Warnings

---

You will find a number of WARNINGS, CAUTIONs and NOTEs in this supplement.

These safety warnings alert you to potential hazards that could result in injury to you or others.

Please read these safety warnings as well as all other portions of this supplement carefully in order to gain a better understanding of how to safely use the systems it describes.

### WARNING

A WARNING indicates a situation in which serious injury or death could result if the warning is ignored.

### CAUTION

A CAUTION indicates a situation in which injury or damage to your vehicle including the systems described in this supplement, or both, could result if the caution is ignored.

### NOTE

A NOTE gives information or suggestions how to make better use of the systems described in this supplement.

## System Components and Controls

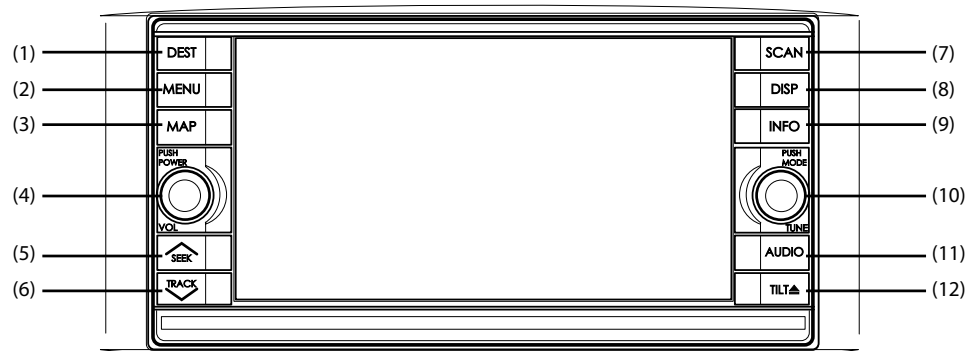

- (1) **DEST**  
This button is used to display the destination entry screen of the navigation system.
- (2) **MENU**  
This button is used to display the menu screen of the navigation system.
- (3) **MAP**  
This button is used to switch to the navigation system's current map screen from any other screen.
- (4) **POWER/VOL**  
This button is used to operate the audio system.

- (5) **SEEK**  
This button is used to operate the audio system.
- (6) **TRACK**  
This button is used to operate the audio system.
- (7) **SCAN**  
This button is used to operate the audio system.
- (8) **DISP**  
This button allows you to display SCREEN in which adjustments can be made to the screen.
- (9) **INFO**  
This button is used to display the vehicle information screen.



(10) **MODE/TUNE**

This button is used to operate the audio system.

(11) **AUDIO**

This button is used to operate the audio system.

(12) **TILT▲**

This button is used to take out a disc and/or adjust the tilt of the monitor.

## Loading the map disc

When changing the map disc with a disc appropriate to the present location, or when updating the map disc while in the version upgrade of a map disc, it is necessary to change it with another map disc by following the procedure as described below.

### NOTE

- When changing a map disc with another one, be sure to stop your vehicle in a safe place.
- For details of the map discs, see "Map Discs" on (See Page 41).

1 Press the **TILT▲** button.

2 Select **DISC IN** (MAP).

The monitor section is tilted and, when a disc has been set, it is ejected.



3 When the map disc is ejected, take it out.

4 Insert a map disc that contains the area showing the current position.

The monitor automatically gets back to the normal condition to start the playback of the disc.

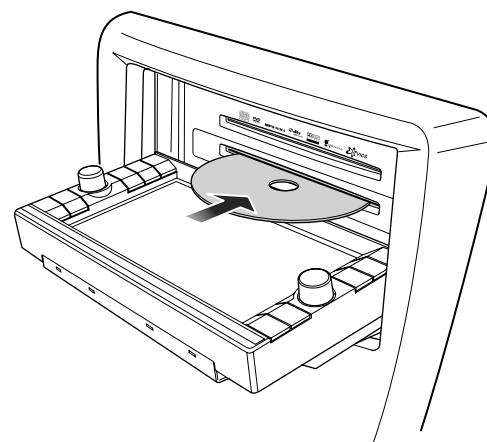

### CAUTION

- You must insert the map disc into the second slot from the top.
- When inserting a map disc, do not insert 2 or more map discs in piles. This may cause a malfunction to the machine, resulting in the take-off of the discs unavailable.

Loading the map disc

---

10 Introduction

The image features three vertical gray bars of varying widths and positions. On the left side, there is a thin vertical bar and a wider, taller vertical bar. On the right side, there is a single thin vertical bar. The word "Navigation" is centered horizontally between the two main bar groups.

# Navigation

## Before Use

---

### WARNING

#### READ THIS MANUAL FIRST

Read this supplement carefully before using your navigation system. We are not liable for accidents or other problems resulting from failure to follow the instructions in this supplement.

#### OBEY LOCAL ROAD SIGNS AND REGULATIONS

Always obey local road signs and regulations while following instructions given by the navigation system. Some of the data on the DVD-ROM disc may be outdated due to changes in local road signs and regulations. Furthermore, the data on the DVD-ROM disc does not take into account variable factors such as the weather, road congestion at different times of the day, temporary road closures due to road construction, and special events. Local road signs and regulations always take precedence over directions given by the system. Failure to obey them could place you in physical danger or in violation of the law.

#### DRIVE SAFELY

- Before following an instruction (for example, in the case of changing direction) given by the system, check that the action would be safe to take in the current traffic conditions. Continue to pay attention to safety while following any instruction.
- Do not be distracted by the navigation screen. Failure to keep your attention on the road could lead to an accident. When you need to look at the screen while driving, do so for the shortest time possible and avoid staring at the screen.

- You must stop the vehicle in a safe place before operating the navigation system. For safety's sake, some of the navigation system's controls and functions cannot be used unless the vehicle is stationary.
- When you need to look at the navigation screen, do so for the shortest time possible. Looking away from the road for too long could lead to an accident.
- Use this system only in locations where it is legal to do so. Some states/provinces may have laws prohibiting video screens within sight of the driver.
- If you stare at the display with too much enthusiasm or operate the switches of the system while in driving, the navigation system could cause your attention to be distracted from the current traffic conditions. Please be sure to input in the system as much information as possible before taking your departure. And also please be sure to bring your car to a stop in a safe place if you need to input information.
- The buttons for the touch screen that cannot be used are displayed in light color (tone down). Operating the navigation system while in driving could cause your attention to be distracted from the current traffic conditions. And in consequence, this could result in a severe or fatal accident. Follow the descriptions of all operations and the instructions for safety given in this manual without fail.

#### VOLUME LEVEL

- Keep the system's volume level low enough for you to be able to hear outside sounds while driving. To do otherwise may prevent you from reacting appropriately to traffic conditions and could result in an accident.

**⚠ CAUTION****FOREIGN OBJECTS**

Do not allow foreign objects to enter the disc insertion slot, including your fingers.  
Foreign objects inside the system's main unit could cause an electric shock or a fire. If the main unit emits smoke or an unusual smell, stop using the system immediately and you contact the nearest SUBARU dealer.

**NEVER DISASSEMBLE OR MODIFY THE SYSTEM**

Any attempt to disassemble or modify any part of the system could lead to an electric shock or a fire, or some other type of accident.

**Do not continue using the navigation system if it malfunctions**

If the system shows any sign of malfunctioning (for example, the navigation system gives no picture), stop using it immediately and contact the nearest SUBARU dealer.  
Continuing to use the system could lead to a fire, an electric shock, or some other type of accident.

**⚠ CAUTION****If the navigation system gets contaminated, emits smoke or an odd smell, stop using it**

If a foreign object gets inside the system, liquid is spilled onto the system, or the system emits smoke or an unusual smell, stop using it immediately and contact the nearest SUBARU dealer. Continuing to use the system could lead to a fire, an electric shock, or some other type of accident.

**NOTE**

- In the interest of safety, the use of some functions may be unavailable while in driving. The button for a touch screen that cannot be used will be displayed in tint color (toned down).
- Liquid-crystal displays may be difficult to read when wearing polarized glasses.

### ■ Points to note before use

#### **Starting the engine before using the system**

The navigation system can be used with the ignition key in either the ON position or the ACC position. To preserve the battery, however, it should be used with the engine running whenever possible. Using the system for a long time with the engine off can cause the battery to run down.

#### **Delay before display of current position**

The system will not immediately display a correct indication of your vehicle's current position after being switched on for the first time or after the battery has been disconnected for a long time. It will display a correct current position indication as soon as it receives Global Positioning System (GPS) signals.

#### **Program reloading after battery disconnection**

The navigation program will be erased from the system's memory if the battery is disconnected. If this happens, load the provided DVD-ROM disc in the system's main unit and turn the ignition switch to the ON or ACC position. The system will automatically reload the program and start operating normally again.

#### **Incorrect operation on rough roads**

The system may operate incorrectly or be unable to read the data on the DVD-ROM disc when subjected to severe vibration caused by driving on rough roads.

#### **Handling the GPS antenna**

Do not paint the antenna. Doing so could impair or prevent signal reception.

#### **Disabled switches**

Some switches are disabled during operation of the system. These switches are displayed in fainter colors and no messages are displayed for them.

#### **Risk of damage to the main unit**

Be mindful of the occupant compartment temperature. Using the system when the occupant compartment temperature is extremely high or low can damage it or cause it to malfunction. Also, note that the system's main unit can be damaged by strong vibration and by any metallic object or water that gets inside.

#### **Condensation**

Condensation can form on the lens inside the main unit when there is a rapid change in occupant compartment temperature (for example, when the heater is switched on in cold weather). Such condensation can cause the system to operate abnormally. If you wait an hour or so for the condensation to disappear, the system should start working normally again. If normal operation is still not restored after several hours, we recommend that you contact the nearest SUBARU dealer.

#### **Replacing the DVD-ROM disc**

If you need to replace the DVD-ROM disc, make sure the replacement disc is compatible with your system's main unit. Inserting an incompatible disc could damage the unit.

---

**■ Handling precautions for DVD-ROM discs**

- Handle DVD-ROM discs carefully. Any DVD-ROM disc with excessive warping or scratches on its surface can cause reading errors.
- Store DVD-ROM discs away from direct sunlight, which can cause warping and render them unusable.
- DVD-ROM discs rotate at high speeds inside the system's main unit. Never use a cracked or badly warped disc; doing so could damage the unit.
- To clean a DVD-ROM disc, lightly wipe it with a soft cloth in straight lines from the center hole toward the outer edge.
- Never clean DVD-ROM discs with benzene, thinner, record spray, antistatic spray, or chemical swabs.
- Do not touch the DVD-ROM disc's data surface (the surface without a printed label). A dirty data surface can cause reading errors. Always hold a DVD-ROM disc by the center hole and at one point on the outer edge, or by two points on the outer edge.
- Do not write anything on DVD-ROM discs or affix anything, such as stickers, to them.





## Starting Up the Navigation System

Use the following procedure to start up the navigation system and display the current map screen.

### 1 Start the engine.

The CAUTION screen will appear, followed by the opening screen.

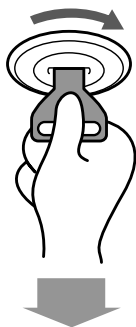

### 2 Carefully read the instructions on the CAUTION screen (cited below), then select **Agree**.

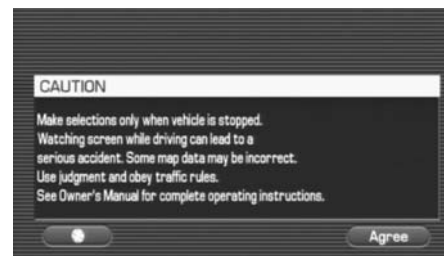

#### **⚠ CAUTION**

**Make selections only when vehicle is stopped.**  
**Watching screen while driving can lead to a serious accident.**  
**Some map data may be incorrect.**  
**Use judgment and obey traffic rules.**  
**See Owner's Manual for complete operating instructions.**

The current map screen will appear.



**NOTE**

- To make a selection, touch the desired key displayed on the screen.
- The CAUTION screen remains on the display unless you select  .
- When you use the navigation system for the first time, Eastern Standard Time (EST) will be displayed. Adjust the system's clock to the right time using the clock setting screen ("SET CLOCK") as described on Page 66.



## Volume

---

Use this function if you want to change the voice guidance volume setting from the default setting.

1 Press the **MENU** button.



2 Select **◀** or **▶** to adjust the sound volume.



- Each time **◀** is selected, the sound volume turns down.  
Each time **▶** is selected, the sound volume turns up.
- If you want to turn off the sound of the navigation system, select **◀** to display "OFF".

18 Navigation



## Markers and Controls Displayed on Maps

### Screens During Route Setting

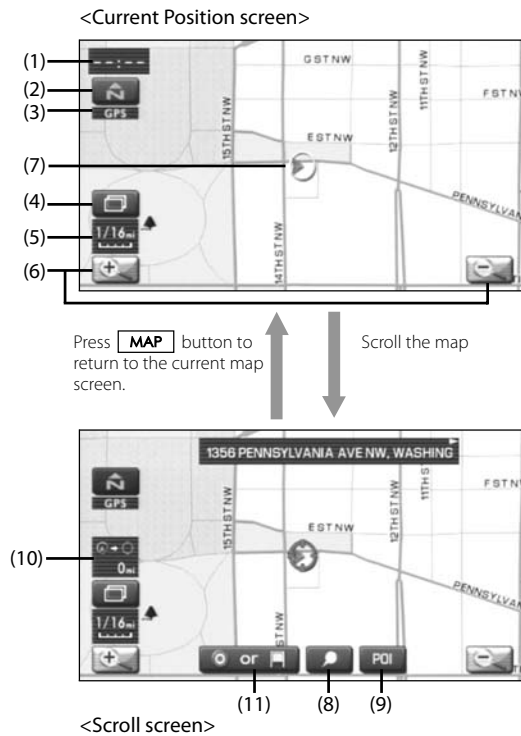
Touch a point on the map. A crosshair (scroll mark) will appear on the screen. Then touch a desired point on the map. The map will scroll with the selected point at the center.



- (1) **Time**  
Indicates the current time.
- (2) **Map orientation control**  
Used to select either a "north up" display or "heading up" display of the map. (See Page 24.)
- (3) **GPS marker**  
Shows the status of the signal from GPS satellites. When this marker appears, your navigation system is receiving GPS signals and using them to calculate the position of your vehicle.
- (4) **Screen configuration control**  
Allows you to select a preferred display type for route guidance. (See Page 43.)
- (5) **Map scale**  
Used to display the map scale.
- (6) **Zoom-out/zoom-in control**  
+ or - is used to zoom out or zoom in the map.  
Select + or - to select the map scale.
- (7) **Vehicle marker**  
Indicates the current position and direction of your vehicle.

- (8) "Store memory point" key**  
Stores markers on the map.  
This key appears just for a few seconds after a map screen is selected.
- (9) Point of interest (POI) key**  
Allows you to display the POI selection screen (See Page 79).  
On the screen, you can program POIs to appear on a map as markers. This key appears just for a few seconds after a map screen is selected.
- (10) Distance from current position**  
Indicates the distance from the current position to the position marked by .
- (11) Destination/waypoint key**  
Used to program a destination or waypoint at the position marked by  on a scroll screen.

## Screens During Route Guidance

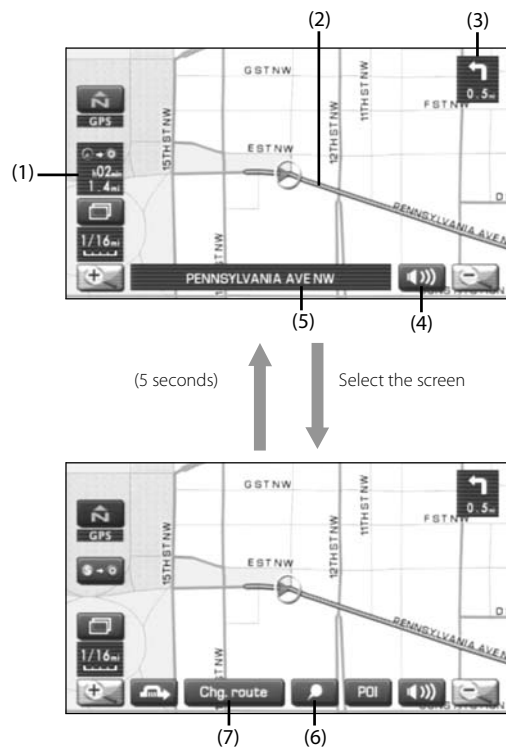

- (1) **Distance and time to destination**  
Indicates the time (either approximate time required or time of arrival) and the distance to the destination or a waypoint.
- (2) **Route**  
A thick blue line indicates the route you should follow.
- (3) **Turn guidance arrow**  
Indicates the direction of your turn at the next intersection/ intersection as well as the distance to the intersection/inter-section.
- (4) **"Repeat voice" key**  
If this key is selected, the last voice guidance will be repeated.
- (5) **Current road name**  
Shows the name of the road you are currently driving on.
- (6) **"Display whole route" key**  
If this key is selected, a map containing the entire route will be displayed. (See Page 56.)
- (7) **"Change route" key**  
Selecting this key displays the route option menu. Selecting a new route option causes the system to calculate the selected route.

## Menu Screen Keys and Functions

<Current map screen>





Press **MENU** button to display the menu screen.



Select  to return to the current map screen.



<Menu screen>

The table below shows the keys displayed on the MENU screen, the functions accessible by selecting these keys, and the pages of this manual that describe the instructions you should follow when using these functions.

Menu screen key	Function	Reference page
	Memory Points	page 70
	Avoid Area	page 75
	Previous Dest.	page 77
	User Settings	page 61
	Quick POI Selection	page 63
	Language Selection	page 64
	Calibration	page 64
	Set Clocks	page 66
	Vehicle Signal	page 67
	Restore System Defaults	page 67
	Search Condition	page 50
	Detour	page 51
	Route Pref.	page 52
	Dest. & Way Pt.	page 52
	Display Route	page 56
	Route Preview	page 57

Menu screen key	Function	Reference page
<b>Phone</b>	Bluetooth Phone	page 187
	Redial List	page 199
	Received Calls	page 199
	Phone Book	page 201
	Memory Points	page 193
	Bluetooth Settings	page 183
<b>Version</b>	Version	page 87
		
<b>VOL</b>	Volume	page 18



## Map Operations

### Selecting Map Orientation

You can select either "heading up" or "north up" display on the current map screen by using the following procedure.

1 Select  or .



<"North up" display>

If you select  ("north up" display), the system rotates the map so that north is always directly upwards on the screen.



<"Heading up" display>

If you select  ("heading up" display), the system rotates the map so that the direction in which you are heading is always directly upwards on the screen (the red arrow points to the north).

## Changing Map Scale

You can increase or decrease the scale of the map using the following procedure:

- 1 Select  or  to change the map scale.





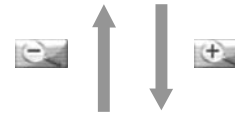



- 2 Selecting  or  changes the scale as shown below.



## Map Operations

---

### NOTE

- Selecting  or  allows you to change the map scale.
- You can keep selecting  or  allows you to change the map scale.
- Selecting either of the following on the scale bar displayed by selecting  or  allows you to change to the specified map scale.

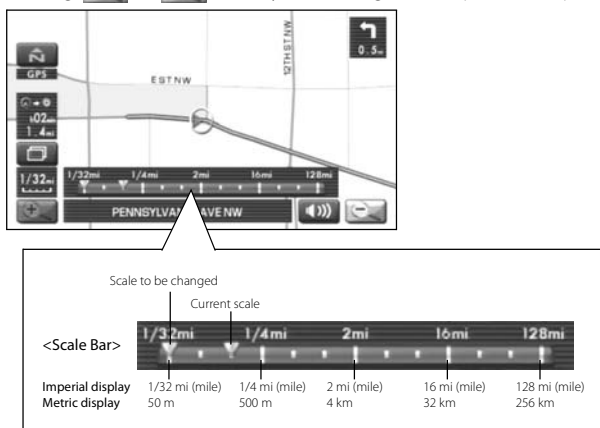

- The scale can be displayed in Imperial or metric units. To change the units, See Page 61.

## Setting Route



### Setting Destination

#### Setting destination/waypoints by scrolling the map



Even if you do not know the exact address of your destination or a waypoint on your route to the destination, you can set it by scrolling the map as follows:

- 1 Touch the screen and scroll the map until the crosshair  reaches the destination or a waypoint.

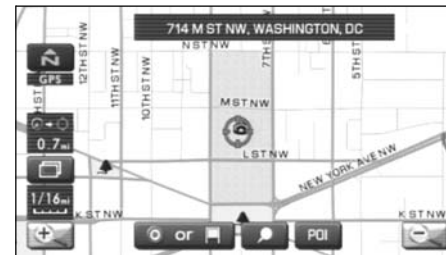

- 2 Select the  or  (destination or waypoint) key.  
The key will separate into the destination key and the waypoint key.



- 3 Select  for setting the destination  
The system will calculate the route and display the entire route to the destination on the map.  
Select  for a waypoint. The system will program the address of the waypoint on your route (See Page 69). You can set up to 5 waypoints per trip.



**4** Select **Start** (start).

Route guidance will begin along the displayed route.

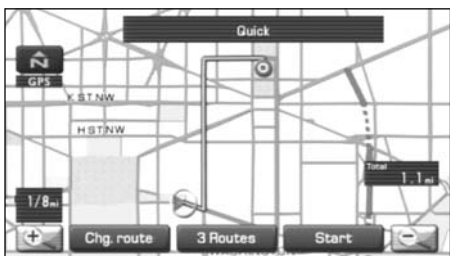

**NOTE**

- If the system cannot find your desired route, select **Chg. Route** (change route). This will allow you to access the ROUTE OPTIONS screen, from which you can prompt the system to calculate a new route. (See Page 49.)
- Selecting **Start** (start) for more than 5 seconds will start the demonstration mode operation.

**■ Selecting route**

Upon setting the destination, the system prepares to calculate three types of routes to the destination (Quick, Alt., and Short). You can select from any of the three options as follows:

**1** Select **3 Routes** (3 routes).

The system will be ready for calculation of any route you select from the three options, namely, Quick (the fastest route), Alt. (alternative route), and Short (the shortest route).

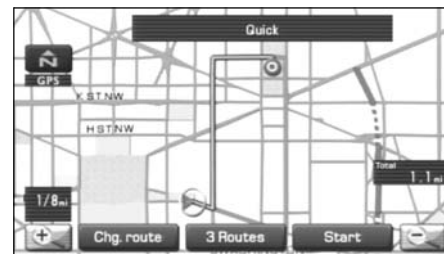

**2** Select **Info.** (information).

The screen will display details (required time, total distance, roads used, etc.) regarding each option.

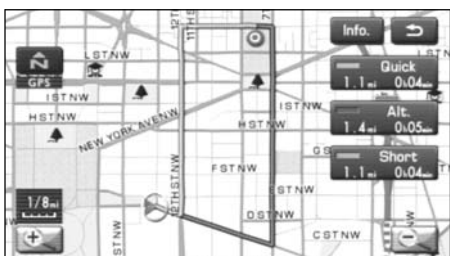

**3** Select **Quick** (Quick), **Alt.** (Alt.), **Short** (Short) or as you desire, and then select **Start** (Start) to confirm your selection.

INFO FOR 3 ROUTES			
	Quick	Alt.	Short
	0 h 04 m	0 h 05 m	0 h 04 m
	1.1 mi	1.4 mi	1.1 mi
	0 mi	0 mi	0 mi
	0 mi	0 mi	0 mi
	0 mi	0 mi	0 mi

**Setting the destination from the navigation menu**





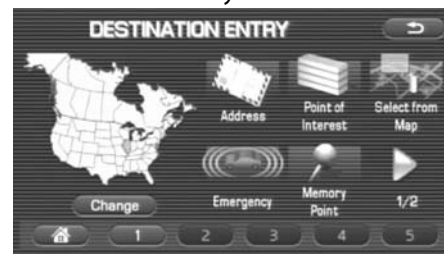







You can set your destination using a variety of methods if you start setting from the DESTINATION ENTRY screen. Before you can use any of these methods, perform the following steps:



- 1 Press the **DEST** button.
- 2 Select the method you want to use.





## Setting Route

---

	(Address)*	See Page 31.
	(Point of Interests)*	See Page 34.
	(Select from Map)	See Page 35.
	(Emergency)	See Page 37.
	(Memory Point)	See Page 33.
	(Previous Destination)	See Page 35.
	(Intersection)*	See Page 39.
	(Freeway Ent/Exit)	See Page 36.
	(Phone number)	See Page 40.
	(Coordinates)	See Page 38.
	(Home)	See Page 33.
	1 -	
	5 (Category1) - (Category5)	

You can switch between screens by selecting  (next page) or  (previous page).

### NOTE

- If the set destination area is different from the one displayed under "Search Area" in the right part of the screen, you must select the  (change) key and specify the desired area again.
- For the methods marked with an asterisk (\*), you can use the "Change Search Area" function to narrow the area where a destination or waypoint is located by selecting the  (change) key (See Page 41).

- Depending on the method used or the status of the map displayed, the located point may differ from where the facility you want to visit actually exists.

## 30 Navigation

■ "Address" method

- 1 Press the **DEST** button and select  (address).
- 2 Enter a house number using the keypad on the house number input screen and select **OK**.



- 3 Enter the street name. If you enter enough letters to identify a street name and advance to Step 4, a list showing several street names will be displayed. Select the desired street name from the list.



 : Use this key to delete the last character entered. Select it repeatedly if you want to delete all the characters entered.

You can switch between keypad screens showing different characters by selecting **Others** (others), **Sym.** (symbols) or **A-Z** (alphabet).

- 4 Select **List** (list).



- 5 Select the desired street from the list. If the same street name exists in more than one city, a list of these cities will be shown.





**6** Select the correct city from the list.

 (input name): Use this key to input the city name from the keypad.



**7** Select  (destination) to set the address entered in the above steps as your final destination

The system will calculate the route and display the entire route on the map.





Select  (waypoint) to set the address entered in the above steps as a waypoint on your route. You can program up to five waypoints per trip.



**8** Select  (start).

Route guidance begins along the displayed route.

**NOTE**

- If the system cannot find your desired route, select  (change route). This will allow you to access the ROUTE OPTIONS screen, from which you can prompt the system to calculate a new route. (See Page 49.)
- If your DVD-ROM disc does not contain the relevant house number data, an error message will be displayed and a street map will appear, allowing you to set the destination using the map.
- If your destination is not on a road, set a destination point on a main road nearest to your true destination.
- Selecting the  (city) will display a screen that searches the destination on a city basis.



-  : Search the destination from all cities.
-  : Search the destination from the nearby five cities within 20 miles from the current position.
-  : Search the destination by inputting the city name. You can also search the destination from the five cities that you searched in the past.

### ■ "Memory Point" method

If you have saved some locations in the system's memory, you can make use of an appropriate one to set the destination.

- 1 Press the **DEST** button and select  (memory point).

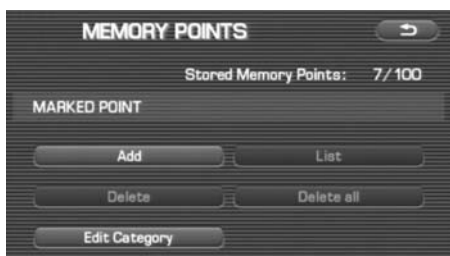

- 2 Select the address of the desired location (memory point).



 : Use this key to display up to five previous suggestions.

 : Use this key to display the previous suggestion.

 : Use this key to display the next suggestion.

 : Use this key to display up to five of the next suggestions.

- 3 Select  (destination) or  (waypoint).

#### NOTE

- Select the **Attribute** (Attribute), **Icon** (icon), **Name** (name), or **Date** (date) key to change the sequence in which memory points are displayed.
- You cannot use the "Memory Point" method unless there are memory points stored. To store memory points, See Page 70.

### ■ "Home" method or method using stored destinations

If you have stored your home address in the system's memory, you can use it for your destination or a waypoint. Similarly, if other locations are stored in the memory, they can be conveniently used for quick setting of destination and waypoints.

- 1 First, choose either of the two procedures below to follow the "home" method.

Press the **DEST** button.



- 2 Select  (home) or one of the locations programmed to keys **1** (Category 1) through **5** (Category 5).

The map including your home location or the selected location will be displayed.



3 Select  (destination) or  (waypoint).

**NOTE**

Icon  (home) and keys  (Category 1) through  (Category 5) are displayed only when you have stored your home location and other locations in the memory. For instructions on how to store your home location and other locations.

■ **"Point of Interest" method**

You can use a selection from the "Point of Interest" listing as your destination or a waypoint.

1 First, choose either of the two procedures below to follow the "point of interest" method.

Press the  button and select  (point of interest).

2 Enter the name of the desired point of interest and select .

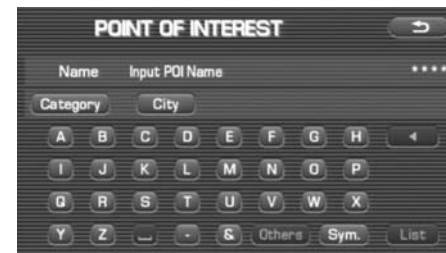

3 Select the desired point of interest from the list.





: Use this key to display up to five previous suggestions.

: Use this key to display the previous suggestion.

: Use this key to display the next suggestion.

: Use this key to display up to five of the next suggestions.

4 Select  (destination) or  (waypoint).

**NOTE**

- If two or more points of interest share the same name, they will both be listed on the screen. Choose an appropriate one from the list.
- If there are two or more points of interest with the same name, select **Category** (category) or **Town** (Town) to shorten the list.
- Displayed information about a specific facility might not include recent changes. It is recommended that you check the location or business days/ hours of a desired point of interest before departure.

■ **"Previous Destination" method**

This method allows you to choose one of the most recently used 100 destinations or waypoints as your new destination or waypoint.

- 1 Press the **DEST** button, select **▶**, and then select **▼** (previous destination).
- 2 Select a desired location from the Previous Destination list.



**▲**: Use this key to display up to five previous suggestions.

**▼**: Use this key to display the previous suggestion.

**▼**: Use this key to display the next suggestion.

**▼**: Use this key to display up to five of the next suggestions.

- 3 Select **○** (destination) or **■** (waypoint).

**NOTE**



- You can select **Name** (name) or **Date** (date) to change the sequence in which previous destinations are displayed.
- Selecting **Previous Start Point** displays the start point of the previous guide.

■ **"Select from Map" method**

You can specify a location on the map that was last displayed and use it for setting the destination or a waypoint.



- 1 Press the **DEST** button and select **🗺️** (select from map).
- 2 Scroll the map until the crosshair **✖** is at the desired destination or waypoint.



3 Select  (destination) or  (waypoint).

■ "Freeway Entrance/Exit" method

You can use the name of a Freeway entrance or exit selected from the "Freeway Ent./Exit" list for setting your destination or a waypoint.

1 Press the  button, select , and then select  (Freeway Ent./Exit).

2 Enter the name of the desired freeway and select .



3 Select the name of the freeway from the list.





: Use this key to display up to five previous suggestions.

: Use this key to display the previous suggestion.

: Use this key to display the next suggestion.



: Use this key to display up to five of the next suggestions.



4 Select  (entrance) or  (exit).



5 Select the name of the street from which you will enter the freeway or to which you will go after leaving the freeway.





-  : You must select this key before you can enter the street name.
-  : Use this key to search through the list by distance.
-  : Use this key to search through the list by name (alphabetical search)

6 Select  (destination) or  (waypoint).

■ "Emergency" method

This function allows the nearest police station or hospital to be set as the destination.







- 1 Press the  button and select  (emergency).
- 2 Select either  (Police station) or  (Hospital).

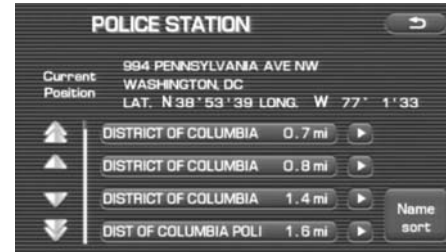

The nearest police stations or hospitals will be displayed accordingly.



3 Select the desired institution from the list.



-  : Use this key to display up to five previous suggestions.
-  : Use this key to display the previous suggestion.
-  : Use this key to display the next suggestion.
-  : Use this key to display up to five of the next suggestions.
-  : Sorts the list by distance.
-  : Sorts the list in alphabetical order by name.



4 Select  (destination) or  (waypoint).

NOTE

Displayed information about each facility might be changed. It is recommended that you check the location or business days/hours before departure.

■ **"Coordinates" method**

You can set destinations or waypoints using their latitudes and longitudes as follows:

- 1 Press the **DEST** button, select , and then select  (coordinates).

- 2 Enter the latitude of the desired location.

Use the numeric keys together with the [°] (degrees), ['] (minutes), and ["] (seconds) keys.





- 3 Enter the longitude of the location.



- N** : Use this key to switch over to the north latitude.
- S** : Use this key to switch over to the south latitude.
- W** : Use this key to switch over to the west longitude.
- E** : Use this key to switch over to the east longitude.
-  : Use this key to delete the character last entered. Select it repeatedly if you want to delete all the characters entered.



- 4 Select **OK** (OK).



5 Select  (destination) or  (waypoint).

■ **"Intersection" method**

You can use an intersection defined by two street names as a location for setting your destination or a waypoint.

1 Press the **DEST** button, select , and then select  (Intersection).

2 Enter the name of the first street and then select **List** .



3 Select the street from the "Intersection" list.



 : Use this key to display up to five previous suggestions.

 : Use this key to display the previous suggestion.

 : Use this key to display the next suggestion.

 : Use this key to display up to five of the next suggestions.

4 Specify the second street using the same procedure as the first street. Select **List** (List).

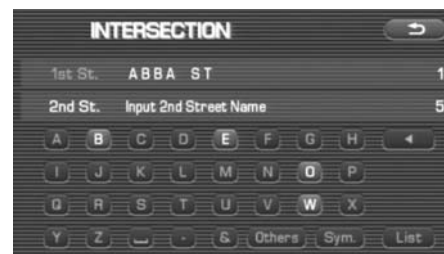



- 5** When there are two or more candidates, a list of intersections will be displayed. Select an intersection of your destination.



- 6** Select  (destination) or  (waypoint).



**NOTE**

No intersection is defined if

- the two streets do not cross each other,
- the two streets are a freeway and a highway,
- either street is for right or left turns only,
- both are one-way streets,
- either street is for U-turns,
- the two streets cross on the inside lane,
- either street is an on/off ramp,
- either street is a frontage street, and/or

■ **"Phone number" method**

This function allows buildings and the like to be located using their phone numbers.

- 1** Press the  button, select , and then select  (phone number).
- 2** Enter the phone number starting with the area code.



- 3** Select .



#### 4 Select your destination.

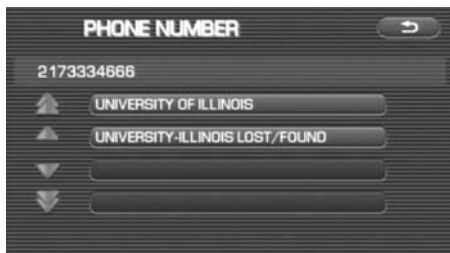

#### 5 Select (destination) or (waypoint).



##### NOTE

If a number of candidates exist as a result of, for example, different area codes, these will be displayed in a list. Your desired destination can then be selected from the list.

##### ■ Using "Change Search Area" function

This function designates a general geographical area where the destination or waypoint you want to set is located.

This function can be used in the methods marked with an asterisk (\*) on Page 30.

1 Press the  button and select  (change).

2 Select the desired area.

The DESTINATION ENTRY menu screen will appear.



##### NOTE

- The SEARCH AREA screen shown above is a sample image. It may be slightly different from the actual screen image.
- Three map discs are contained in this system. When performing a search for a different area in your destination search, it is necessary to change the map disc with another map disc. If an area you want to find is not displayed on the screen shown above, take out the map disc and change it with a map disc containing the relevant area.

For details of the map disc, refer to the description below.

##### ■ Map Discs

The three map discs contain different areas, respectively. (West, Mid and East) Select the map disc containing the destination area you wish and insert the disc in the navigation system.

Make sure to reselect your destination when you change the map disc. Refer to the section Set Route in the Instruction Manual for instructions on reselecting the destination.

■ **Area (West)**



Arizona, California, Colorado, Idaho, Kansas, Montana, Nebraska, Nevada, New Mexico, North Dakota, Oklahoma, Oregon, South Dakota, Texas, Utah, Washington, Wyoming, Canada

■ **Area (Mid)**



Alabama, Arkansas, Illinois, Indiana, Iowa, Kansas, Kentucky, Louisiana, Michigan, Minnesota, Mississippi, Missouri, Nebraska, North Dakota, Ohio, Oklahoma, South Dakota, Tennessee, Texas, Wisconsin, Canada

■ **Area (East)**

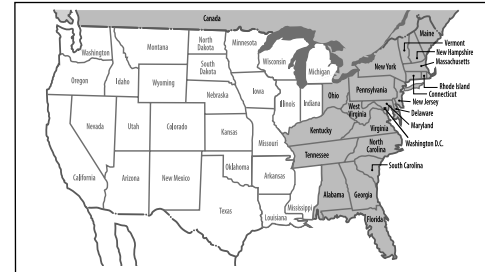

Alabama, Connecticut, Delaware, Florida, Georgia, Kentucky, Maine, Massachusetts, Maryland, New Hampshire, New Jersey, New York, North Carolina, Ohio, Pennsylvania, Rhode Island, South Carolina, Tennessee, Vermont, Virginia, Washington D.C., West Virginia, Canada

**NOTE**

- Road information for all of the above locations is included on the map discs. This means that the following operations can be performed regardless of which map disc is loaded in the system;
  - Scrolling Map to Select Destination (Select from Map)
  - Selecting Destination from the previously registered points as a memory point (Home, Memory Point, Previous Destination) within the same area.
  - Selecting Destination by Latitude and Longitude (Coordinates), Phone number, Emergency, and Quick POI.
- After replacing the map disc, stored data including the POI icon on the map and stored Avoid Street settings will be deleted, and Quick POI selections will return to default.
- In the Current Location display, the arrival time and the distance to the destination are displayed for Next Way Point.

## Route Guidance

### Route Guidance Screen

During route guidance, the system can indicate on a second screen the directions in which you must make turns at the next and following intersection in either of two ways: "turn arrow" or "turn list". Specify your preferred method of indication as follows:

<Turn arrow>

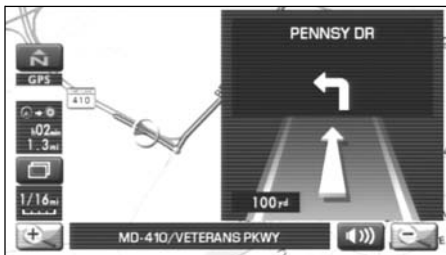



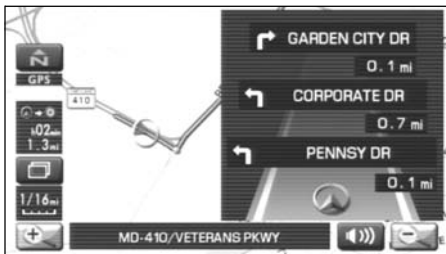

Turn direction is indicated by an arrow.

<Turn list>



Turn directions are indicated in a list.

- 1 Select  (screen configuration).
- 2 Select  for turn arrow indication or  for turn list indication.

If you need not make any further selection, select . The relevant keys will disappear.

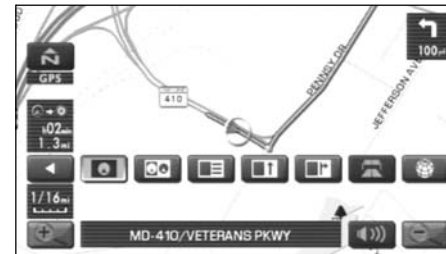

## Zoom-in Map at Intersection

Before you arrive at an intersection, the system will automatically show a zoom-in map of the intersection on a second screen to make the guidance clearer.

As you approach an intersection during route guidance, a zoom-in map of the intersection automatically appears on a second screen. After you drive past the intersection, the zoom-in map disappears.

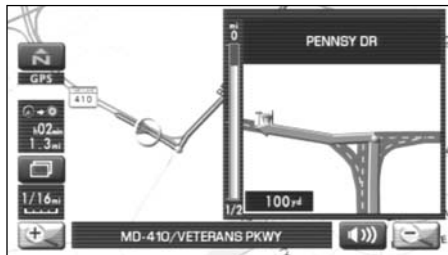

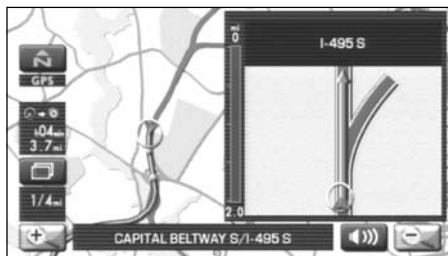

As you approach a fork on a freeway during route guidance, a zoom-in map of the freeway automatically appears on a second screen, making the route guidance clearer.



### NOTE

Use the following procedure to recall the most recently displayed zoom-in map of an intersection or a freeway fork.

1. Select  (screen configuration).
2. Select  (re-display of intersection/range guidance).

If you need not make any further selection, select . The relevant keys will disappear.

## Dual Map Display

You can configure the screen for a dual map display.

<Single map display>



<Dual map display>



1 Select  (screen configuration).

2 Select  (dual map).

If you wish to return to the single map display, select  (single map).

If you need not make any further selection, select . The relevant keys will disappear.

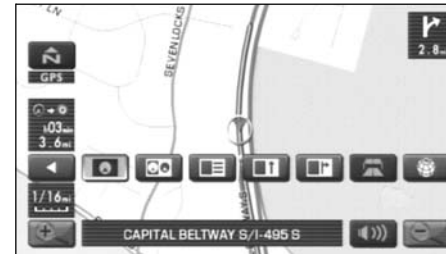

### NOTE

If you wish to modify the display selections that have been made for a second screen, touch the top of the screen. After completing the modification, select .

- See Page 25 for details on scale changes.
- See Page 79 for details on setting with .

## Freeway Information

A list of buildings and facilities along a freeway can be displayed on the screen.

1 Select  (screen configuration).

2 Select  (freeway information).

If you need not make any further selection, select  .  
The relevant keys will disappear.

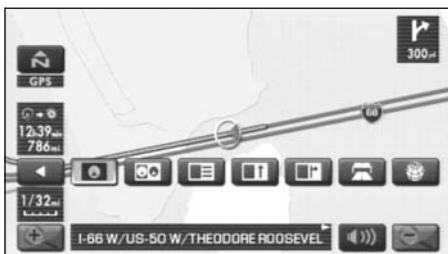

The information of a freeway is displayed.

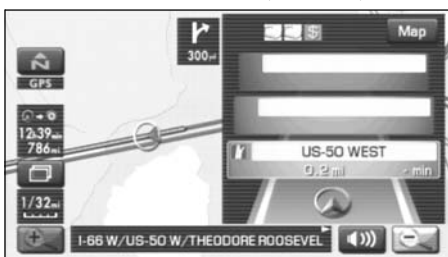

Select **MAP** to display the map in the neighborhood together with the icons of hotels and banks.



This map allows you to set your destination and waypoints. It also allows you to register them with the Memory Point with the cursor placed on the icon.

## Replaying Voice Guidance

If you want to listen to the last voice guidance again during route guidance, use the following procedure:

- 1 Select .

You can hear the voice guidance again.

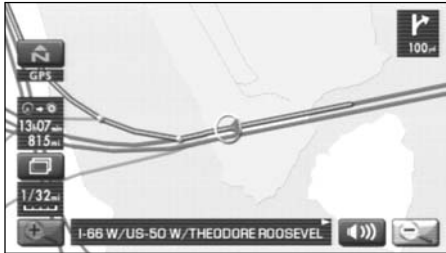



## Compass Mode

Longitude and latitude of present location can be displayed on the screen.

- 1 Select  (screen configuration).

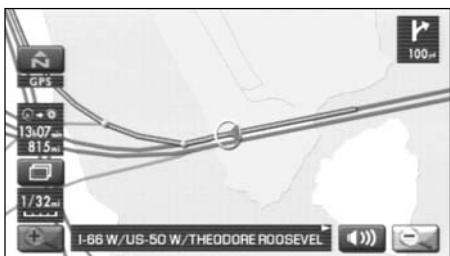

- 2 Select  (compass).

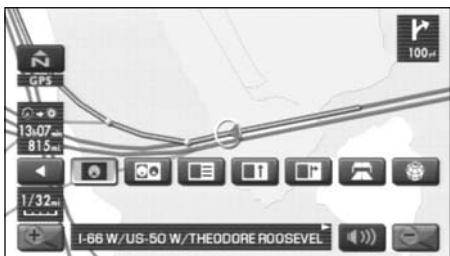

- 3 Longitude and latitude of present location are displayed at upper right of the screen.

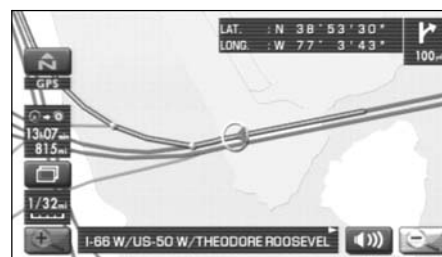

## Route Options

### Setting Route Options

Using the functions available from the Route Options screen, you can change the route options, stop the route guidance or check the route. Use the following procedures:

- 1 Press the **MENU** button.



- 2 Select  (route options).

The Route Options screen will appear. Select any of the following displayed functions as necessary:



(search condition):

This function allows you to specify the way in which the system calculates the route to the destination. (See Page 50.)



(detour):

This function allows you to prompt the system to calculate an alternative route from your current position within a specified distance. (See Page 51.)



(route preferences):

This function allows you to prompt the system to alter the route search conditions and recalculate the route accordingly. (See Page 52.)



(destination and waypoint):

This function allows you to modify the destination and waypoints, and prompt the system to recalculate the route accordingly. (See Page 52.)



(display route):

This function allows you to confirm the entire route and, if necessary, prompt the system to recalculate the route according to your specification. (See Page 56.)



(route preview):

This function allows you to simulate a drive along the system-calculated route before departure. (See Page 57.)



(calculate):

Selecting this key prompts the system to recalculate the route.

**Cancel Guidance** (cancel guidance):



Selecting this key prompts the system to stop route guidance. Note that this erases the destination and waypoints. To prompt the system to start guidance again, select **Calculate** (calculate).

**NOTE**

A recalculated route will sometimes be the same route as the one displayed before recalculation.

## Search condition

You can specify the way in which the system calculates your route.

- 1 Press the **MENU** button, then select  (route options), and then select  (search condition).
- 2 Select **Quick** (Quick), **Alt.** (Alt.), or **Short** (Short) to specify the way of calculating the route to reach the next waypoint or the destination from the current point.

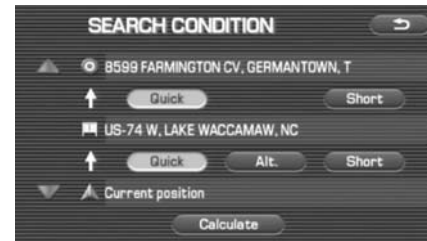

**Quick** : The system will calculate a route with the shortest driving time required.

**Alt.** : The system will calculate an alternative route.

(You can select **Quick** , **Alt.** or **Short** for the first waypoint. Only **Quick** or **Short** can be specified for the second and subsequent waypoints.)



**Short** : The system will calculate a route with the shortest driving distance.

3 Select **Calculate** (calculate)

4 Select **Start** (start).

## Detour

You can specify a detour distance from your current position. The system will calculate an alternative route according to the distance specification, enabling you to take a detour.

1 Press the **MENU** button, then select  (route options), and then select  (detour).

2 Select a detour distance using **1 mi**, **3 mi**, **5 mi**, or **Whole route** (whole route).

The system will then calculate an alternative route that detours from the current location within the specified distance.



When driving on the freeway, make a selection from among

**5 mi**, 15 mi, 25 mi and **Whole route**.

3 Select **Start** (start).

### NOTE

If you are driving off the route, it is not possible to calculate a detour route.

## Route preferences

Use this function to specify preferred route search conditions. The system will start recalculating the route according to your specified conditions.

1 Press the **MENU** button, then select  (route options), and then select  (route preferences).

2 Specify conditions by selecting keys.

Each time you select a key, it will toggle between "usage" and "non-usage" of the corresponding roads or ferries.

3 Select  (calculate).



### NOTE



- The  (calculate) key can be selected during route guidance.
- The route calculation will not always be able to follow the specified conditions.

## Destination and waypoints

You can change the destination or waypoints for the route calculation by using this function.

### ■ Addition of waypoints

Use the following procedure to add new waypoints to the current route for recalculation.

1 Press the **MENU** button, then select  (route options), and then select  (destination and waypoints).

2 Select  (add).



- 3 Set a waypoint using any method available from the screen.



- 4 Specify the order in which all the set waypoints are to be visited.

Choose the location of the waypoint to be added, and then select **Add** (add).

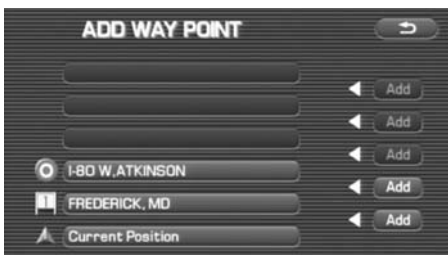

- 5 Select **Calculate** (calculate).

#### NOTE

- When a new destination is set using **Destination** (destination), it will replace the current destination and the route calculation will be carried out again.
- Step 4 must be performed for the second and any subsequent waypoints.
- Repeat Steps 1 to 4 for each waypoint to be set.

#### ■ Modifying destination or waypoint positions

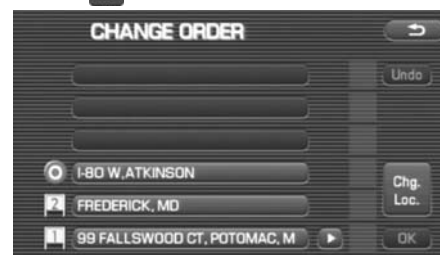

Use this procedure to modify the destination or waypoint positions. The screen will display the calculated route and the positions of the destination or waypoints that you will be able to modify.

- 1 Press the **MENU** button, then select **Route Options** (route options), and then select **Destination and Waypoints** (destination and waypoints).
- 2 Select **List** (list).
- 3 Select **Change Location** (change location).



- 4 Select the key corresponding to the location that is to be modified.

The map for the area around your current location will be displayed.



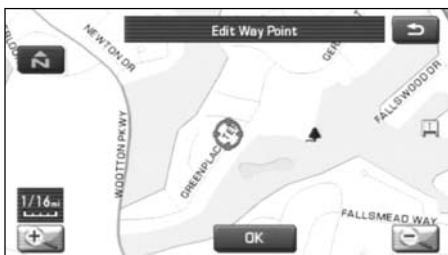

- 5 Scroll the map to bring the crosshair  to the location and then select .



- 6 Select  (calculate).

### ■ Modifying visiting order

You can change the order for visiting your waypoints by using this procedure.

- 1 Press the  button, then select  (route options), and then select  (destination and waypoints)
- 2 Select  (list).

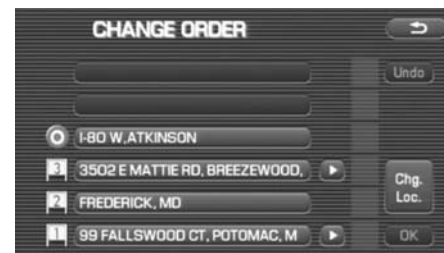

- 3 Select the waypoint keys according to the order of your visit.

If you wish to cancel the visiting order number indication, select  (undo).



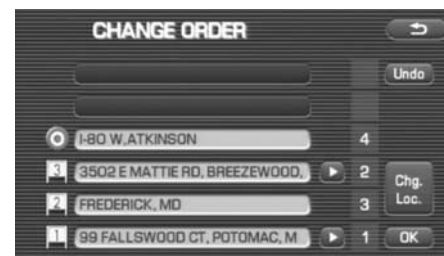

- 4 When you complete the sequencing, the visiting order will be updated automatically.



- 5 Select .
- 6 Select  (calculate).

### ■ Deleting destination or waypoints

Use this procedure when you wish to delete the previously set destination or waypoint.

- 1 Press the **MENU** button, then select  (route options), and then select  (destination and waypoints).
- 2 Select **Delete** (delete).
- 3 Select the key corresponding to the destination or waypoint you wish to delete.

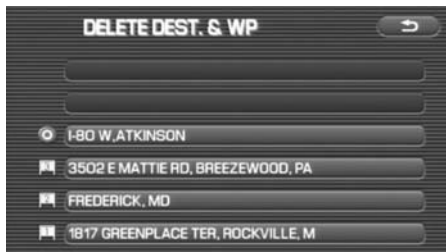

- 4 Confirmation message will be displayed. Select **Yes** (yes).

Select **No** (no) to cancel the deletion.





- 5 Select **Calculate** (calculate).



### ■ Deleting destination and all waypoints

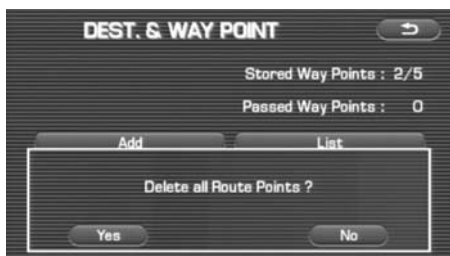

You can delete the destination and all previously set waypoints in a single process.

- 1 Press the **MENU** button, then select  (route options), and then select  (destination and waypoints).
- 2 Select **Del.All** (delete all).
- 3 Confirmation message will be displayed. Select **Yes** (yes).  
Select **No** (no) to cancel the deletion.



### Display route

Use this function to display the entire route. You can also specify an area you wish to avoid and prompt the system to recalculate the route accordingly.

- 1 Press the **MENU** button, then select  (route options), and then select  (display route).
- 2 Select **Turn List** (turn list).

The entire route screen will appear and then it will change to the Turn List screen.





**Avoid (avoid):**

Select this key if you wish to specify any areas to avoid from the list of street names.

**Reroute (Reroute):**



The system will recalculate the route.

If the data for the route cannot be shown on one screen, scroll the screen using the ▲ and ▼ keys.



- 3 When the Reroute is selected: Select **Start** (start).



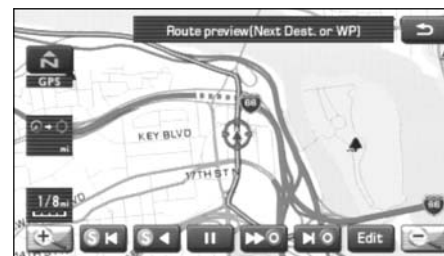

## Route preview

The system can show you an automated simulation of the calculated route.





- 1 Press the **MENU** button, then select  (route options), and then select  (route preview).
- 2 Start the simulation drive according to the calculated route using the keys on the screen as follows:



  : Move to the start point.

  : The simulation drive will start toward the start point. After the start, this key will be displayed as  , and when it is selected, the simulation drive will switch to high-speed driving.

 : The simulation drive will stop.

  : The simulation drive will start toward the destination. After the start, this key will be displayed as  , and when it is selected, the simulation drive will switch to high-speed driving.

## Route Options

 : Move to the destination.





 : The EDIT ROUTE PREVIEW screen will be displayed. (See Page 58.)

### NOTE

The visual speed of the simulation vehicle varies with the map scale selected. The speed appears to be faster with a wide-area map than with a zoom-in map.

## ■ Setting conditions for simulation drive

You can change the simulation drive conditions using this procedure.

- 1 Press the  button, then select  (route options), and then select  (route preview).
- 2 Select  (edit).

The EDIT ROUTE PREVIEW screen will appear.



 (to destination or next waypoint):  
The simulation drive will stop at the destination or the next waypoint.

 (to next POI):  
The simulation drive will stop at a point of interest that has been set up on the route.

 (delete):  
A selected POI will be deleted.

**POI keys:**

When you select one of the six POI category keys, the system will retrieve the selected POI from the Quick POI storage and display it on the map. When you select the **Others** key, you can find POIs of other categories. For more details, See Page 63.

If, for example, the **To next POI** (to next POI) category key is selected and a simulation drive is started, your simulation vehicle will then stop at a restaurant on the route.

If you then select **Info.** (information), the system will display information on the restaurant.

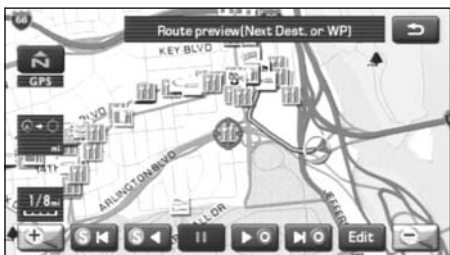

Selecting **Phone** allows you to make a phone call to the phone number displayed.

\* The Bluetooth Phone is required to be set in advance.

**NOTE**

You must finish the simulation drive before you actually start to drive. Although the simulation drive will automatically stop when you actually start to drive, not finishing it properly can lead to an error in the display of your vehicle's current position.

# Navigation Setup

## Setting Your Navigation System

Using the functions available from the Navigation Setup screen, you can change the map display conditions and alter the route guidance conditions.



1 Press the **MENU** button.





2 Select  (navigation setup).

The NAVIGATION SET UP screen will appear.

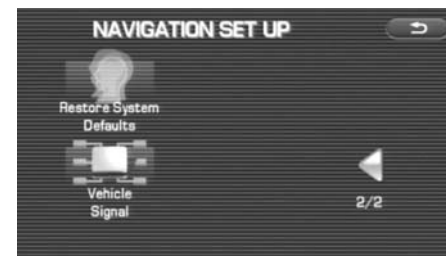
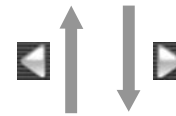

Select any of the displayed functions as necessary. This screen consists of two pages. Change the page by using the  or  keys.



 (user settings):

This function allows you to change the screen display and sound settings. (See Page 61.)

 (quick POI selection):

This function allows you to set the point of interest categories that are displayed when you select the menu from the current position screen. (See Page 63.)

 (language):

This function allows you to change the language for the menu screens and the voice guidance. (See Page 64.)

 (calibration):

You can use this function to correct display errors in the vehicle's position and direction. (See Page 64.)

 (set clock):

This function allows you to set the time. (See Page 66.)

 (Vehicle Signal):



This function allows you to confirm the vehicle signal, the version of the DVD-ROM disc. (See Page 67.)



 (restore system defaults):

This function allows you to change the system's current settings back to the default settings (factory settings). (See Page 67.)

## User settings

You can change the screen display and sound settings using this procedure.

- 1 Press the **MENU** button, then select  (navigation setup), and then select  (user settings).
- 2 Select the setting item you wish to change.

The USER SETTINGS screen consists of three pages. Use the  or  keys to change the screen page when selecting a setting item.

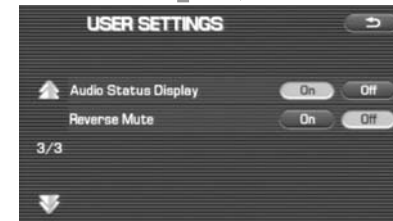

**Distance:**

Units of distance can be selected from **km** (km) and **mile** (mile).



**Road Restriction Warnings:**

You can select or deselect display of traffic restriction warnings during route guidance.

**Keyboard layout:**

The layout of input keys can be selected from **ABC** ("ABC" layout) or **QWERTY** ("QWERTY" layout).

**Arrival Time:**

Time of arrival at the destination or a waypoint can be displayed in two different ways: estimated arrival time or remaining driving time. Select  for the estimated arrival time display or  for the remaining time display.



<Estimated arrival time>

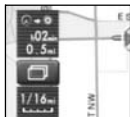

<Required remaining time>

**Map Mode:**

The map display mode can be set to any of the automatic, daytime, and nighttime modes.

**Auto (automatic):**

The brightness of the display will automatically change to daytime brightness and nighttime brightness when the headlights are turned off and on, respectively.

**Day (daytime):**

The brightness of the display is fixed at the daytime setting regardless of whether the headlights are on or off.

**Night (nighttime):**

The brightness of the display is fixed at the nighttime setting regardless of whether the headlights are on or off.

**Guidance Screen:**

This function allows you to select or deselect display of guidance messages on the screen.

**Freeway Information:**

This function allows you to select or deselect display of guidance messages when driving on freeway.

**Auto Volume:**

A setting can be made so that the sound volume of the navigation system automatically increases as the speed of the vehicle increases.

**Beep:**

A setting can be made so that a beep sounds.

**Clock Display:**

A setting can be made so that the clock is displayed.

**Audio Status Display:**



A setting can be made so that the status of the audio system is displayed.

**Reverse Mute:**

A setting can be made so that the sound volume of the audio system is reduced while reversing the vehicle.

## Quick POI selection

Using this function, you can set the point of interest categories that are displayed when you select the Point of Interest menu key on the current map screen. Set up to six different categories that you use most frequently. (See Page 79 for the method of displaying POI categories on the map and searching for the nearest points of interest.)

- 1 Press the **MENU** button, then select  (navigation setup), and then select .
- 2 Select one of the six category keys you wish to program into the Quick POI storage.



**Default** (default):  
Use this key to restore the factory settings.

### 3 Select a category.

Once you have selected a category key, subcategories will be displayed.



**All category list** (all category list):  
Subcategories from all individual categories will be displayed together.

### 4 Select the subcategories to be displayed on the map.





#### NOTE

Repeat Steps 1 to 4 to add more POI categories for display on the menu screen.



## Language Selection

Use the following procedure to select your preferred language for the menu screens and the voice guidance.



- 1 Press the **MENU** button, then select  (navigation setup), and then select  (language)
- 2 Select your preferred language from the list.





## Calibration

This function allows you to correct any display errors in the position and direction of your vehicle on the map display.

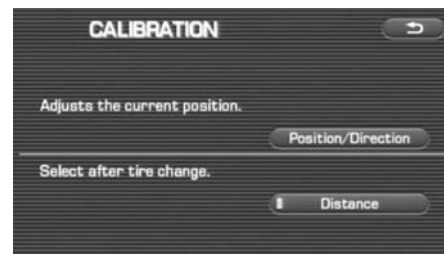

### ■ Adjusting current position and direction

- 1 Press the **MENU** button, then select  (navigation setup), and then select  (calibration).
- 2 Select **Position/Direction** (position/direction).



- 3 Move the crosshair  to the correct position, and then select .







- 4 Use  or  to adjust the direction in which you are heading, and then select .



### ■ Distance

When selected, this function automatically corrects an error in the current position display that might occur after tire replacement.

- 1 Press the  button, then select  (navigation setup), and then select  (calibration).
- 2 Select .

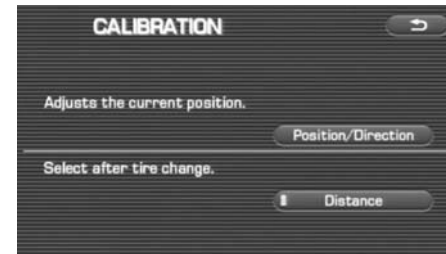



### NOTE

You will have to drive about 6 miles (10 km) before the distance correction is complete.



## Set clock



Since the adjustments for minutes and seconds are made automatically using the time data provided by GPS satellites, you can set your clock by simply performing a time-zone and daylight saving time adjustment using this function.

- 1 Press the **MENU** button, then select  (navigation setup), and then select  (set clock).
- 2 Select **24H** if you prefer 24-hour display; select **12H** for 12-hour display.



- 3 Select the time-zone by pressing  or .

### NOTE

Initial time-zone setting of this navigation unit is Eastern (Disc A)/Mid (Disc B)/Pacific (Disc C).



- 4 Select the daylight saving time mode by pressing **On** or **Off**.

### NOTE

Select **On** to advance the time by one hour.

## Vehicle signal

This function allows certain vehicle data and GPS satellite data to be displayed.

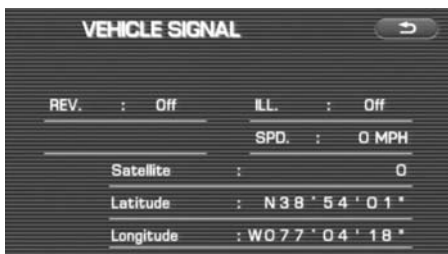

- 1 Press the **MENU** button, then select  (navigation setup), select  and then select  (vehicle signal).

The VEHICLE SIGNAL screen will appear.



## Restore system defaults

Use this function if you want to change all of the system's current settings back to the default settings.

- 1 Press the **MENU** button, then select  (navigation setup), select  and then select  (restore system defaults).
- 2 Select **OK** to return all current systems settings to default.  
Select **Default** (default) to return average speed setting to default.

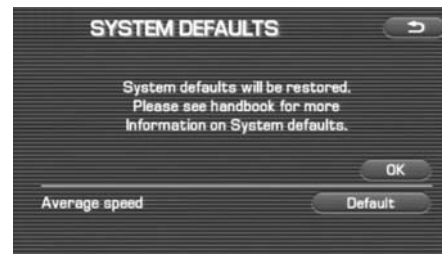

### NOTE

If you select this function, all your settings will be deleted.

Navigation Setup

**[Default List]**

Item	Initial condition
<b>Map display</b>	
Search Area	Disc A (WEST): CA Disc B (MID): IL Disc C (EAST): DC
Display Guidance Language	US English, female
Map Orientation (1 and 2 screen)	North up
Map Display Mode	Single-screen display
Map Display Scale	Single-screen: 10,000 map (1/16 mi) (100 m) Dual-screen: 40,000 map (1/4 mi) (500 m)
Map Configuration	Arrow Mode
Q-POI Map Display	Off
Show POI Icon Display	Off
Right Screen Setting, POI	On
Passage Point Display/ Current Location, Map Screen (Time Requirement, Time, Direction / Distance)	Next passage point
Passage Point Display/ Full Route, Map Screen (Time Requirement, Time, Direction / Distance)	Destination
Restricted Road	On
Freeway Information	Off
<b>Volume Control</b>	
Volume Preset	4

Item	Initial condition
<b>Navigation Setup Menu</b>	
Distance	mile
Road Restriction Warnings	On
Reverse Mute	Off
Keyboard Layout	ABC
Arrival Time	Required remaining time
<b>Item</b>	
Map Mode	Auto
Guidance Screen	On
Q-POI Selection	A: Gas station B: ATM C: Parking D: Grocery store E: All Restaurants F: Hotel
Language Selection	US English, female, male, French, Español
<b>Route Options</b>	
Search Condition	Quick
Route Preferences	Allow Toll Road: Off Allow Ferry: Off Allow Major Roads: On Allow Time Restricted Road: Off

## Stored Locations

You can store, edit, or delete any destinations, waypoints, and other marked points using the procedures described in this section.

1 Press the **MENU** button.

2 Select  (stored locations).



3 Select the desired item.



 (Memory Points):

Use this function to place markers on the map. (See Page 70.)

 (Avoid Area):

Use this function to store into the system's memory any areas you want to avoid. (See Page 75.)

 (Previous Destination):

Use this function to delete previously stored destinations and waypoints. (See Page 77.)

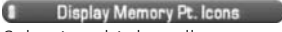
 (Display memory point icons):  
Selecting this key allows you to display icons for memory points.

Each of the above six functions has some or all of the following four standard editing functions (see the table below):

 (add):  
You can store a new location into memory.

 (list):  
You can see a list of the stored locations.

 (delete):  
You can delete stored locations.

 (delete all):  
You can delete all stored locations.

## Stored Locations

Editing keys displayed for each function are as follows:

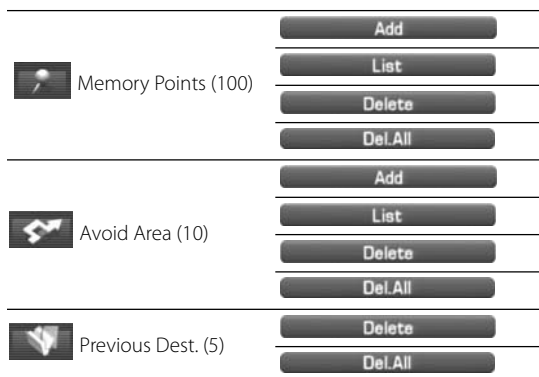



The numbers in parentheses following the function names indicate the maximum locations you can store in the memory.

## Memory points

### ■ Storing new memory points

Memory points can be stored into any of the six categories (including Home) of storage locations.

- 1 Press the **MENU** button, then select  (stored locations), and then select  (memory points).
- 2 Select  (add).

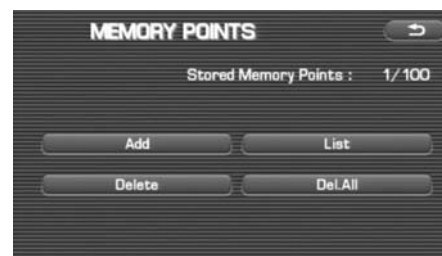

- 3 Set the memory point using the preferred method available on the displayed screen.

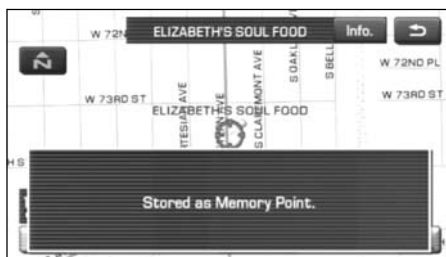



**NOTE**

Up to 100 memory points can be stored. Once that number has been reached, you must delete memory points that you no longer require (See Page 74) before you can store new memory points. The number of memory points you can store is indicated on the screen.

**■ Reviewing and modifying memory points**

Using this function, you can review the stored memory points in the form of a list on the screen and modify names, icons, telephone numbers, and other memory point data.

- 1 Press the **MENU** button, then select  (stored locations), and then select  (memory points).
- 2 Select **List** (list).

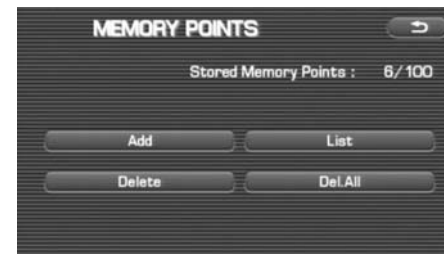



**3** Select the memory point to be modified.

You can change the sequence in which memory points are listed by selecting **Attribute** (Attribute), **Icon** (icon), **Name** (name), or **Date** (date).





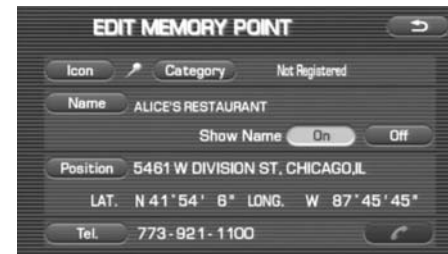



**4** Select the category key corresponding to the memory point to be modified.



**Icon** (icon): Selecting this key allows you to choose a display icon. **Page 1** (Page 1) and **Page 2** (Page 2) of the CHANGE ICON screen contain standard icons, whereas the "With Sound" (with sound) page contains icons that are accompanied by response sounds. Select **With sound** (with sound) to listen to these sounds.

**NOTE**

The "With direction" (  /  ) keys in the "With Sound" page are used to activate response sounds only when you come near the memory point from the specified direction. Select  or  and set the direction using  or . Selecting  allows you to listen to respective sounds.

**Category** (category): Use this key to change the storage category. After selecting this key, select either key of HOME or Preset Destinations 1 to 5.

For memory points to which the category has been set, it is possible to set them quickly as a destination. It is convenient to set in advance the category to your home or a spot to which you go frequently. When setting it as a destination, select the relevant key on the DESTINATION ENTRY screen. See Page 29.



**Name** (name): Select this key to change the name of a memory point. When the change has been completed, select **OK** (OK). Then select **On** (on) if the name is to be displayed on the map, or **Off** (off) if it is not to be displayed.

**Position** (position): Select this key to review the memory points and modify a memory point on the map screen. After checking or modifying it, select **OK** (OK).





**Tel.** (Tel): Select this key to modify a telephone number. When the modification has been completed, select **OK** (OK).



### ■ Deleting memory points

You can delete stored memory points by using this function.

- 1 Press the **MENU** button, then select  (stored locations), and then select  (memory points).
- 2 Select the category of the memory point to be deleted.
- 3 Select **Delete** (delete).
- 4 Select the memory point to be deleted.



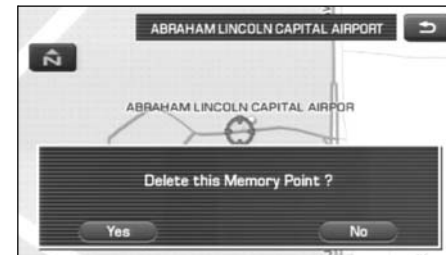

- 5 Confirmation message will be displayed. Select **Yes** (yes).

Select **No** (no) to cancel the deletion.



### ■ Deleting all memory points

Using this function, you can delete all memory points.

- 1 Press the **MENU** button, then select  (stored locations), and then select  (memory points).
- 2 Select the category of the memory points to be deleted.
- 3 Select **Del.All** (delete all).



- 4** Confirmation message will be displayed. Select **Yes** (yes).  
 Select **No** (no) to cancel the deletion.



## Avoid area

### ■ Storing avoid areas

If you use this function to store into the system's memory the areas you want to avoid, the system will avoid the areas when calculating routes.

- 1** Press the **MENU** button, then select  (stored locations), and then select  (avoid area).
- 2** Select **Add** (add).



- 3** Set an avoid area using your preferred method.  
 A map including the specified avoid area will appear.  
 The method of setting avoid areas is identical to that of setting destinations.

4 Select **Reduce** (reduce) or **Enlarge** (enlarge).



**Reduce** (reduce): Reduces the size of the avoid area.

**Enlarge** (enlarge): Increases the size of the avoid area.



5 Select **OK** (OK).

**NOTE**

- Reduce the scale of the map to specify a larger area.
- Avoid areas can be set only when the scale of the map is 0.6 mile (1 km) or less.

**■ Reviewing and modifying avoid areas**

Using this function, you can review the stored avoid areas in the form of a list and modify them if necessary.

1 Press the **MENU** button, then select  (stored locations), and then select  (avoid area).

2 Select **List** (list).

3 Select the avoid area to be modified.

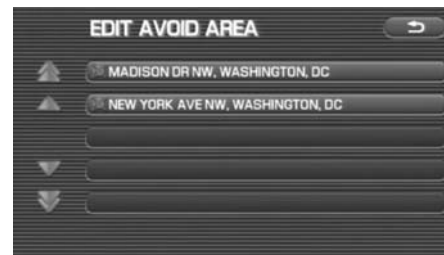

4 Select the key corresponding to the item to be modified.

For details regarding the function of each key, refer to "Reviewing and modifying memory points" on Page 71.

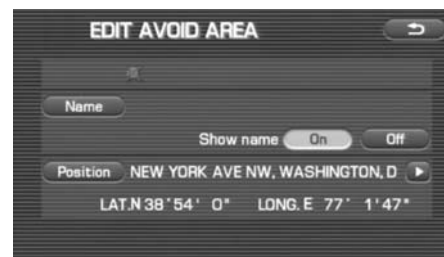



**NOTE**

The methods for deleting individual and all avoid areas are the same as those described on Page 74 for memory points.

## Previous destination (deleting stored locations)

Use this function to delete previously set destinations.

1 Press the **MENU** button, then select  (stored locations), and then select  (previous destinations).

2 Select **Delete** (delete).

If **Del.All** (all delete) is selected, all previously set destinations will be deleted.



3 Select the destination to be deleted.



: Use this key to display up to five previous destinations.

: Use this key to display the previous destination.

: Use this key to display the next destination.

: Use this key to display up to five of the next destinations.

**Name** (name): Use this key to search through the list by name (alphabetical search).

**Date** (date): Use this key to search through the list by date.

**4** Confirmation message will be displayed. Select **Yes** (yes).

Select **No** (no) to cancel the deletion.



## Other Functions

### Displaying POIs on a map

Using this function, you can display POIs on the current map screen.

- 1 Touch the current map screen.
- 2 Select **POI** (points of interest).



- 3 Select desired POIs using the displayed category keys.  
When selecting two or more categories, select **List Categories** to make a selection of them. The selection of up to five categories is available.

**All Local POI's** (all local POIs): Use this key to search for all local points of interest (see below).



Once you have made your selection of POIs, corresponding markers will appear on the current map screen.  
To delete the markers for these POIs, See Page 82.

#### NOTE

Displayed information about each POI facility might not include recent changes. It is recommended that you check the location or business days/hours before departure.



■ **Local search**

- 1 Touch the current map screen.
- 2 Select **POI** (points of interest).



- 3 Select **All Local POI's** (all local points of interest).

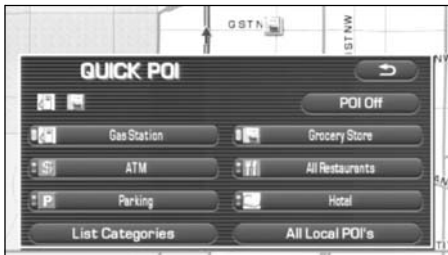

When searching local points of interest, it is necessary to set in advance the category you want to make a search to the Quick POI. (See Page 63.)

- 4 Select the POI you want to find from the list of categories.



- : Use this key to display up to five previous POIs.
- : Use this key to display the previous POI.
- : Use this key to display the next POI.
- : Use this key to display up to five of the next POIs.
- Dist.** : Use this key to search through the list by distance.
- Icons** : Use this key to search through the list by icon type.
- Name** : Use this key to search through the list by name (alphabetical search).
- Route** : Use this key to display a list of POIs only along the route up to the destination.

Once you have made your selection of POIs, corresponding markers will appear on the map.

## Displaying POI data

You can display the information on a POI, such as the name, address and telephone number.

- 1 Display the desired POI markers on the current map screen. (See Page 63 and 79 for the procedure.)
- 2 Select the POI marker for which you want information by moving the crosshair over it.

The name of the POI will appear.  
If no data is stored for the selected POI, no name is displayed.

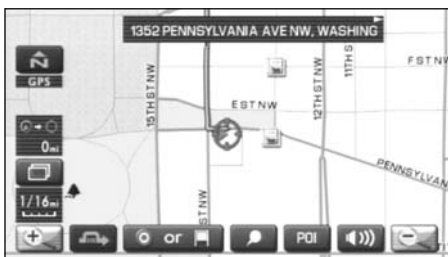

- 3 Select **Info.** (information).

The information on the POI will be displayed.



 : Use this key to store the POI location as a memory point.



## Deleting POI markers

Use this function when you want to delete any POI markers on the map.

- 1 Touch the current map screen.
- 2 Select **POI** (point of interest).
- 3 Select **POI Off** (point of interest off).  
The marker for the POI will disappear from the map.



## Editing Quick POI categories

Use this function when you want to edit the Quick POI categories on this unit.

- 1 Select **MENU** (menu).



- 2 Select **NAV. MENU** (navigation set up).



3 Select  (quick POI selection).



4 Select the item that you want to edit.

(Following procedure show how to change the category from ATM to SUBARU dealership on Quick POI for example.)



5 Select  Automotive (automotive).



6 Select  SUBARU DEALERSHIP (SUBARU dealership).





ATM bookmarked as  SUBARU DEALER to Quick POI.



Selecting [Default] returns the Q-POI SELECTION items to their default settings.

## SUBARU dealership search

### ■ SUBARU dealership search from POI

- 1 Press the  button and select  (point of interest).
- 2 Press the  (category).

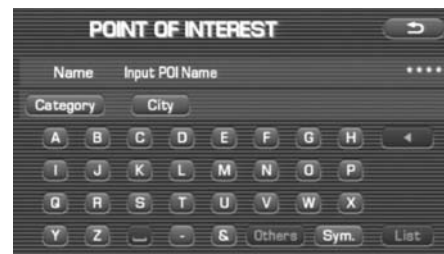

- 3 Press the  (automotive).



- 4 Select **SUBARU DEALERSHIP** (SUBARU dealership) from the list.



**NOTE**

- Displayed information about a specific facility might not include recent changes. It is recommended that you check the location or business days/hours of a desired point of interest before departure.

- 5 The system refine the destination search only for SUBARU dealership.



■ **Displaying SUBARU dealership on map**

- 1 Touch the current map screen.
- 2 Select **POI** (points of interest).





- 3 Select **List Categories** (list categories).



- If **SUBARU DEALER** (SUBARU DEALER) has been registered as a quick POI on the screen shown above, turn it on and then proceed to step 6.

- 4 Select  Automotive (automotive).



- 5 Select  SUBARU DEALERSHIP (SUBARU dealership) and press  Show (show).

The POI marker of SUBARU dealership will appear.



- 6 Select the SUBARU dealership marker by moving the cross hair  over it.



- 7 Select  Info. (info).

- 8 The information of SUBARU dealership will be displayed.



## Version and Initialization

---

### Version

Use this function to check the version of the DVD-ROM disc you are presently using.

- 1 Press the **MENU** button.
- 2 Select  (version).



- 3 The version of the DVD-ROM disc will be displayed on the screen.





## Initialization of the navigation settings

The settings of the navigation system can be initialized. When initialized, data such as memory points, travel history and telephone numbers are all deleted. Data once deleted cannot be restored.

1 Press the **MENU** button.

2 Select  (version).



3 Select **Default**.



4 Select **Agree**.



5 Select **Yes**.



6 The navigation system is restarted automatically.  
All of the settings are initialized.



## General Information

---

### ■ Accuracy of vehicle position

#### **Area in which GPS signals cannot be received**

Because the radiowave signals from the GPS satellites travel primarily by line of sight, the navigation system might not be able to receive the signals in the areas described below. (If the GPS mark does not appear on the map screen, it means that the GPS radiowave signals are not being properly received.)

- (1) Inside a tunnel
  - (2) Inside a building
  - (3) Under a three-dimensional road system such as for high speed roads
  - (4) On boulevards lined with trees
  - (5) Between buildings
  - (6) Under a cliff or in a cave
- If the GPS antenna or its surroundings are blocked by an obstacle (including cargo), it might not be possible for the system to receive the GPS radiowave signals.
  - If multiple paths are created due to the reflection from buildings, a large measurement error could occur, causing the vehicle's mark to deviate from its actual position.

#### **Deviation of the vehicle's position mark**

The vehicle's position mark could deviate from its actual position when the vehicle is being driven under the conditions listed below or due to conditions of the GPS satellites.

If the vehicle travels on a road whose actual shape differs from that in the map data, the vehicle's mark could deviate from the actual posi-

tion. The correct position will eventually appear on the screen through the correction function. If the screen does not show the correct position for an excessively long time, correct the current position or make an automatic correction.

- (1) The vehicle's mark could appear on a parallel road.
- (2) When the road splits into a narrow Y, the vehicle's mark could appear on the other fork of the Y.
- (3) When the vehicle makes a right or left turn, the vehicle's mark could appear on one street ahead or behind.
- (4) If the vehicle is transported by means other than the vehicle's own power, such as on a ferryboat, the vehicle's mark will remain in the position it was before the transport until the system can calculate the position through the GPS.
- (5) When the vehicle is driven on a steep incline, the vehicle's mark could deviate from its actual position.
- (6) If there are continuous gradual curves in the same direction, the vehicle's mark could deviate from its actual position.
- (7) If the vehicle is driven in a zigzag pattern, such as through frequent lane changes, the vehicle's mark could deviate from its actual position.
- (8) If the vehicle is placed on a turntable, such as in a parking area, and turned with the ignition OFF, the vehicle's mark could deviate from its actual orientation. The vehicle's mark could also deviate even after the vehicle has exited the parking area.
- (9) The vehicle's mark could deviate from its actual position if the vehicle is driven using tire chains or snow tires on a snow-covered road or on a mountainous road.

- (10) The vehicle's mark could deviate from its actual position after the tires have been replaced.

### ■ How the vehicle position is detected

#### **Detecting the vehicle's position through the GPS**

GPS stands for "Global Positioning System", which is a system used for detecting an object's position through the use of satellites of the U.S. Department of Defense.

Radiowave signals from three or more satellites are received by the navigation system, which utilizes the principle of triangulation to detect the position at which the radiowave signals are received.

When the navigation unit is receiving the GPS radiowave signals, a "GPS" mark will appear on the map screen.

#### **Detecting the vehicle's position through self-contained navigation**

Self-contained navigation is a system that detects the vehicle's position by calculating the vehicle's driven distance and turning angle through the use of various types of sensors that are mounted on the vehicle.

Through the use of self-contained navigation, the vehicle's position can be detected even in an area where the GPS radiowave signals cannot be received.

#### **Making corrections to the detection of the vehicle's position through map matching**

- In map matching, the position information resulting from the detection of the vehicle's position and the locus of the travel of the vehicle up to the present are constantly compared to the

shape of the roads on the map in order to correct the vehicle's position mark to the most appropriate road.

- If the vehicle is driven on a road whose actual shape differs from its map data, the vehicle's position mark on the map could deviate from its actual position.

Occasionally, the correction of the vehicle's position mark to the actual road on the map can be observed, particularly after the vehicle has turned at an intersection or has exited from a parking area.

### ■ Accuracy of the route guidance

**The conditions listed below do not indicate a malfunction.**

- (1) The guidance might prompt the driver to drive straight even though the vehicle is being driven on a straight road.
- (2) The directional guidance could display multiple place names.
- (3) If the vehicle makes a turn at an intersection before the guided route, the wrong type of voice guidance could be outputted.
- (4) The guidance might not be outputted while the vehicle is making a turn at an intersection.
- (5) The system might not be able to search for the proper route.
- (6) If there is no road to the destination or if there is only a narrow road, the route might be indicated up to an area that is short of the destination.
- (7) The repeat search could take a long time while the vehicle is being driven at high speeds.
- (8) While the system is searching again for the route, the route indication might not appear in time for the next right or left turn.
- (9) The route might not change even if a search is made again.

## General Information

---

- (10) The system might guide the driver to make a U-turn.
- (11) The system might guide the driver to a road that cannot actually be travelled (such as a road to which entry is prohibited).
- (12) The system might not output guidance even if the vehicle is driven in reverse on the guided route.
- (13) The system might not use a local ferryboat even if the ferry priority is selected.
- (14) If the intersection that you're being guided to is near the end of the route search, the system might not be able to provide guidance.
- (15) The route might not go on a toll road even if the toll-road priority is selected.  
Similarly, a route that uses a toll road could appear on the screen even if the toll-road priority is not selected. (The driver may or may not be able to select "toll-road priority" if both toll and free roads are available.)

## When a Problem Occurs

Confirm whether the problem is due to a minor operational error or a malfunction in the system by referring to the table below before you contact your SUBARU dealer for any repair service.

### The map does not scroll even when the vehicle is moving.

The screen shown might not be the current map screen.

See Page 19 of this manual for instructions on displaying the current map screen.

### The vehicle marker does not appear.

The screen shown might not be the current map screen.

See Page 19 of this manual for instructions on displaying the current map screen.

### The GPS marker is not displayed.

The GPS antenna or your vehicle might be in a position where GPS signals cannot be received.

Try moving the GPS antenna or your vehicle to a position where there are no obstacles around.

### There is no voice guidance.

- Route guidance might be suspended.
- The guidance volume might be too low.

• See "Volume" on Page 18.

### Small spots or bright flashes appear on the screen display.

This is probably due to the natural characteristics of the liquid crystal display (LCD).

There is nothing wrong with the display and no need for concern.

### The DVD-ROM disc cannot be ejected.

The disc might be incompatible or might have been inserted incorrectly.



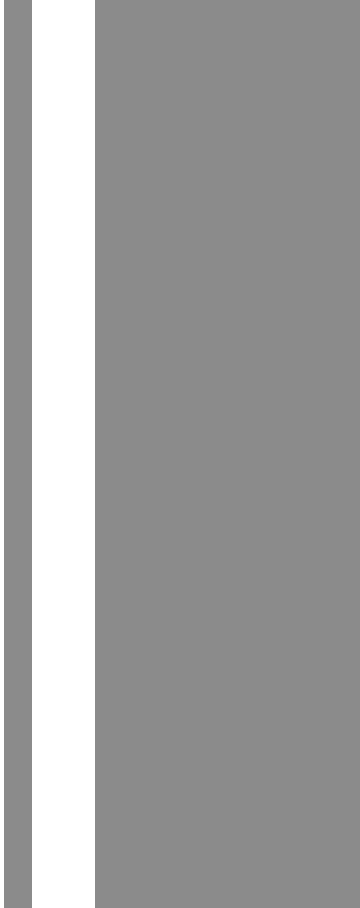

# **Audio and Visual**





## Before using the Audio and Visual

### Precautions when using the system

#### WARNING

##### READ THIS MANUAL FIRST

Read this supplement carefully before using your audio and visual system. We are not liable for accidents or other problems resulting from failure to follow the instructions in this supplement.

##### AVOID OPERATING THE AUDIO AND VISUAL system WHILE DRIVING

You should stop the vehicle in a safe place before operating the audio and visual system. For safety's sake, some of the audio and visual system's functions cannot be used unless the vehicle is stationary.

If you stare at the display with too much enthusiasm or operate the switches of the system while in driving, the navigation system could cause your attention to be distracted from the current traffic conditions. Please be sure to input in the system as much information as possible before taking your departure. And also please be sure to bring your car to a stop in a safe place if you need to input information.

The buttons for the touch screen that cannot be used are displayed in light color (tone down).

Operating the navigation system while in driving could cause your attention to be distracted from the current traffic conditions. And in consequence, this could result in a severe or fatal accident. Follow the descriptions of all operations and the instructions for safety given in this manual without fail.

##### LOOK AT THE AUDIO AND VISUAL SCREEN ONLY WHEN NECESSARY

When you need to look at the audio and visual screen, do so for the shortest time possible. Looking away from the road for too long could lead to an accident.

##### KEEP THE VOLUME LOW ENOUGH FOR YOU TO HEAR OUTSIDE SOUNDS

Keep the system's volume level low enough for you to be able to hear outside sounds while driving. To do otherwise may mean that you are unable to react appropriately to traffic conditions thus resulting in an accident.

**⚠ CAUTION****NEVER DISASSEMBLE OR MODIFY THE AUDIO AND VISUAL SYSTEM**

**Any attempt to disassemble or modify the audio and visual system could lead to a fire, an electric shock, or some other type of accident.**

**Do not continue using the audio and visual system if it malfunctions**

**If the system shows any sign of malfunctioning (for example, the monitor gives no picture), stop using it immediately and contact the nearest SUBARU dealer. Continuing to use the system could lead to a fire, an electric shock, or some other type of accident.**

**If the audio and visual system gets contaminated, emits smoke or an odd smell, stop using it**

**If a foreign object gets inside the system, liquid is spilled onto the system, or the system emits smoke or an unusual smell, stop using it immediately and contact the nearest SUBARU dealer. Continuing to use the system could lead to a fire, an electric shock, or some other type of accident.**

**■ About the audio and visual screen**

- Subjecting the control buttons or liquid crystal display to excessive shock could result in audio and visual screen deformation or other damage.
- Keep any heat source (including lighted cigarettes) away from the audio and visual screen. If a heat source is brought into contact with the audio and visual system cabinet and panel, they could be deformed or otherwise degraded.
- In extreme cold, the audio and visual screen may operate sluggishly and the display may dim. Such conditions do not indicate a problem. They will disappear when the cabin temperature rises to a normal temperature.
- Tiny black and white dots may occasionally appear in the liquid crystal display. These dots are a normal characteristic of the display. They do not indicate a problem.
- When the audio and visual screen requires cleaning, gently wipe it with a silicone cloth or other soft cloth. If necessary, spray the cloth with neutral cleaning fluid. Be sure to wipe away any cleaning fluid left on the audio and visual screen. Do not spray the cleaning fluid directly onto the audio and visual screen. Spraying cleaning fluid directly onto the audio and visual screen could cause an adverse effect on internal components. It is also not a good idea to wipe the audio and visual screen with a stiff cloth or attempt to clean it using thinners, alcohol, or any other volatile solvent. Doing so could leave scratches and/or erase the control button labels.
- Do not allow the audio and visual screen to get wet. If it gets wet (allowing, for example, to a spilled drink or wet umbrella), its internal electronic circuitry may malfunction.

#### Before using the Audio and Visual

---

- In hot weather, cool the passenger compartment down before using the audio and visual system. The liquid crystal display operates correctly at temperatures between 0°C and 60°C (32°F and 140°F). When the temperature exceeds 60°C (140°F), the audio and visual system circuit protection function is activated, causing the display to dim.

#### **NOTE**

- In the interest of safety, the use of some functions may be unavailable while in driving. The button for a touch screen that cannot be used will be displayed in tint color (toned down).
- Liquid-crystal displays may be difficult to read when wearing polarized glasses.

## Discs that can be used

For the in-vehicle equipment, it is possible to look and listen to discs attached with the marks shown below.

Music CD



DVD Video



### NOTE

- Special discs are not supported that are not compliant with the formal CD specifications such as the copy control CD.
- Discs such as CD-R(CD-Recordable) and CD-RW(CD-ReWritable) may not be played back when they are inferior in their recording condition and characteristics, when they get scratched or stained, or when they get deteriorated due to being left in the vehicle for a long time. And when CD-R and CD-RW has not been treated for finalization, they cannot be played back.

### ⚠ CAUTION

- Handle the disc with care so that it does not get smeared with fingerprints and stain, or does not get scratched.
- When handling the disc, be sure to hold it at the center hole and the edge with the labeled side up.
- When the disc gets stained, wipe it lightly with a soft, dry cloth for spectacles with plastic lenses. Pressing the disc hard with your hand or rubbing it with a hard cloth may cause scratches on the surface. And, avoid the use of a solution such as record spray, antistatic agent, alcohol, benzine and thinner, or chemical duster. This may cause damage to the disc, rendering it unusable.
- After pressing the disc eject switch, do not leave it in the ejected condition for a long stretch of time. This may cause warp to the disc, thus rendering it unusable.
- Store the disc away from direct sunlight, which may cause warp to it, thus rendering it unusable.
- Discs that can be played back are limited only to those with a circular form 12 or 8 cm in diameter. Avoid using irregular sized discs, which may cause malfunction to the equipment.

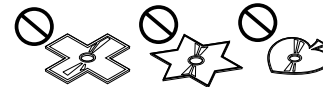

- The DualDisc is not supported. Avoid using it, which may cause malfunction to the equipment.

- **Avoid the use of discs of which the recording section is transparent or translucent. These discs may not be inserted or ejected, or played back normally.**

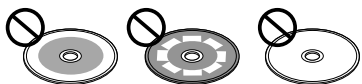

- **Using lens cleaner may cause malfunction to the pick-up section of the player. Be sure not to use it.**
- **Do not use discs attached with scotch tape, seal or CD-R label, or those having traces of them. Using these discs may cause malfunction to the player with the ejection of discs unavailable.**



## Player

When there occurs an abnormal condition, the player stops automatically to protect the inside mechanism of the player. Even when conducting the operation according to the message displayed on the screen and the function is stopped, a malfunction may result. Get a checkup of the player at Subaru Dealer.

In the following cases other than malfunction, the player may not operate normally.

- When the disc can not read due to it being stained.
- When the player is out of order.
- When an abnormal temperature of the player has been detected. (When the sign disappears after the temperature of the player gets back to the normal temperature, the player can be used.)
- When there occurs a dew condensation. (When it is cold or rains, there occurs a dew condensation inside the player just as the inner surface of the vehicle glass clouds up. In such a case, the audio sound may be disturbed or the playback may be stopped. Ventilate or dehumidify the player for a while before using it.)
- When vibrated severely due to driving on rough roads. (The sound may be disturbed.)

### **Character information displayed**

The number of characters that can be displayed as information on various screens and the audio display is limited, and it sometimes occurs that all of the characters cannot be displayed. And also, they may not be, or cannot be, displayed correctly depending on the contents of the recorded information like these.

And the contents of the character information like these may sometimes differ for various screens and the audio display.

## Basic operation of the Audio and Visual

### Name of each part

The following are the name of each part that is used when using the audio and visual function.

#### ■ In-vehicle equipment

Operating the touch switches and buttons of the in-vehicle equipment allows you to use the audio function.

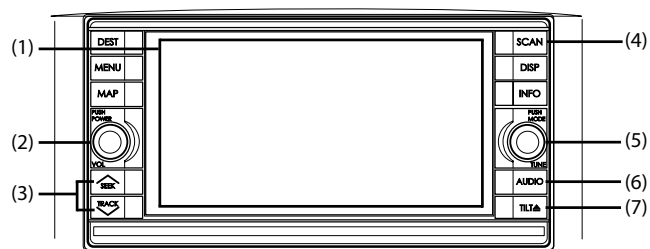

(1) **Touch Switch**

Selecting the touch switch displayed on the screen allows you to play back the disc and/or tune in to a radio station.

(2) **POWER/VOLUME**

Pressing this button allows you to turn on/off the audio function, and turning it allows you to adjust the sound volume.

(3) **SEEK / TRACK**

Pressing these buttons allows you to select a tune, track and/or radio station with the source that you are now looking and listening to. And pressing them continuously for more than

0.5 seconds allows you to fast-forward or fast-rewind a tune, and/or search a radio station automatically.

(4) **SCAN**

Using this button allows you to search a tune, track or radio station with the source that you are now looking and listening to.

(5) **MODE/TUNE**

Pressing this button allows you to select a source such as CD, radio, SAT and VIDEO. (When selecting SAT or VIDEO, it is necessary for the relevant unit to be connected.) And turning it in either direction allows you to tune in on a radio station or forward/rewind a CD track.

(6) **AUDIO**

Used to switch over to the screen of the source that you are now looking and listening to.

(7) **TILT**

This allows you to set a disc and eject it, and it also allows you to tilt the screen.



### ■ Audio control buttons (if equipped)

These buttons are located on the spokes of the steering wheel. They allow the driver to control audio functions without taking his/her hands off the steering wheel.

#### MODE button

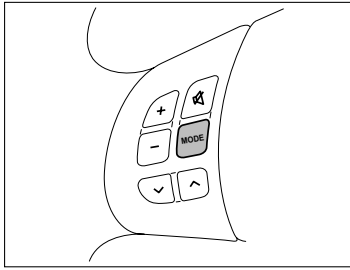

This button is used to select the desired audio mode. Each time it is pressed, the mode changes to the next one in the following sequence:

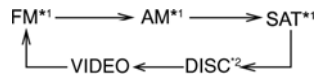

\*1: The frequency last received in the selected waveband will be displayed.

\*2: Only when a DISC is in the player.

#### ^ and v buttons

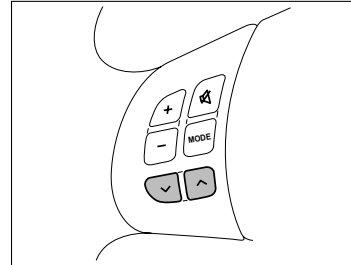

These are used for various operations within each source of the audio and visual.

- With radio mode selected  
Pressing the ^ button or v button for a short time allows you to skip to a preset channel, and pressing it for a long time also allows you to seek a next receivable station.
- With CD mode selected  
Press the ^ button to skip forward in the track/file (track) order.  
Press the v button to skip backward in the track/file (track) order.  
The track/file (track) number will be shown on the audio display.
- With SAT mode selected  
Press the ^ button to skip forward in the channel order. Press the v button to skip backward in the channel order. The channel will be shown on the audio display.

### Volume control buttons

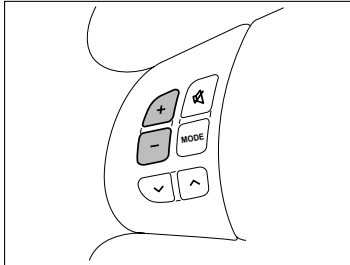

Press the "+" button to increase the volume. Press the "-" button to reduce the volume.  
A number indicating the volume will be shown on the audio display.

### MUTE button

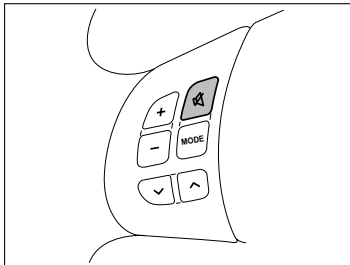

Press this button if you wish to immediately cut the volume to zero.  
The audio display will show "MUTE".  
If you press the button again, the original sound volume will return and "MUTE" goes off.

## Turning on the power

Turn on the power for the audio and visual.

**1** Conduct either of the following operations.

- Press the [POWER/VOL] button.
- Press the [MODE/TUNE] button.
- Press the [MODE] switch of the steering switch.
- With the **AUDIO** button pressed, select the source.

**NOTE**

- Each time the [POWER/VOL] button or the [MODE] switch of the steering switch is pressed, the audio function is turned on and off.
- Inserting the disc turns on the power automatically to start the playback of the disc.

## Selecting the source

It is possible to make a switch among AM radio, FM radio, SAT, VIDEO, CD, DVD, MP3/WMA and other externally connected equipment for looking and listening. When selecting SAT and VIDEO, it is necessary for the relevant units to be connected.

## Pressing the button for selection

Pressing the button or the steering switch of the in-vehicle equipment allows you to switch over the source.

- 1 Press the [MODE/TUNE] button or the [MODE] button of the steering switch.

Each time the button is pressed, the source is changed over. When the operations above are conducted on other than the audio screen, the brief description of the audio is displayed in the upper section of the screen for a few seconds.

Example of the CD information displayed while in the map display



When the operations above are conducted on the audio screen, each source screen is displayed as following example.

FM radio screen

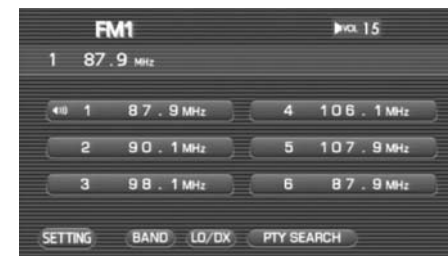

AM radio screen



CD screen



DVD screen



MP3/WMA screen



VIDEO screen (The display varies with the externally connected equipment.)

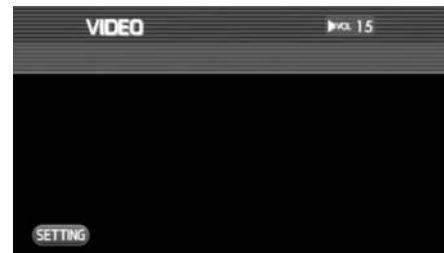

**NOTE**

- When the disc is not set or when no externally connected equipment is provided, the source is not displayed.
- When the satellite radio is connected, it is displayed on the dedicated source screen in the same manner as with the AM or FM radio.

## Making a selection by touching

Touching the source display allows you to select a source.

- 1** Press the **AUDIO** button.  
When the source display is shown, proceed to step 3.
- 2** Press again the **AUDIO** button.
- 3** Select a source.



Each of the source screens is displayed.

**NOTE**  
Sources displayed vary with the equipment connected.

## Setting and adjusting the sound

### Adjusting the sound volume

It is possible to adjust the sound volume while looking and listening to the source.

#### NOTE

When the voice of the navigation system breaks in, the sound volume is automatically reduced temporarily.

#### 1 Rotate the [POWER/VOL] button in either direction or press the [+] [-] switches of the steering switch.

- Turning the [POWER/VOL] button counterclockwise decreases the sound volume while turning it clockwise increases the sound volume.
- Each time the [-] button of the steering switch is pressed, the sound volume decreases, and each time the [+] button is pressed, it increases.
- The volume level is displayed in figures on the upper right section of the screen.

#### NOTE

For detailed setting of the sound quality and balance, refer to "Setting the audio" on Page 158.



### Turning off the sound

It is possible to mute temporarily.

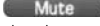
#### 1 Press the (mute) switch of the steering switch.

Press again the  (mute) switch of the steering switch or adjust the sound volume to cancel the mute.

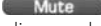
#### NOTE

- When pressing the  (mute) switch while in the use of the hands-free function, the audio sound volume turns off automatically and the following operations are available.
- Pressing the  (mute) switch while in the incoming call with the handsfree allows you to take a phone call.
- Pressing the switch continuously for more than 0.5 seconds while in the incoming call with the handsfree allows you to put a phone call on hold.
- While in the incoming call with the handsfree, pressing the switch continuously for more than 0.5 seconds with a phone call put on hold allows you to hang up the phone.
- For details of the sound volume adjustment, refer to "Adjusting the sound volume" on Page 110.

## Handling the disc

### Setting the disc

Set a CD, DVD, or MP3/WMA disc.  
For details of the discs that can be used, refer to "Discs that can be used" on Page 99.

**1** Press the **TILT▲** button.

**2** Select **NO DISC** (DVD/CD).

The monitor section is tilted and, when a disc has been set, it is ejected.



**3** When the disc is ejected, take it out.

**4** Insert the disc.

The monitor automatically gets back to the normal condition to start the playback of the disc.

### ⚠ CAUTION

**When inserting a CD, do not insert 2 or more CD's in piles. This may cause a malfunction to the player, resulting in the take-off of the discs unavailable.**



## Taking out the disc

.....

Take out a CD, DVD or MP3/WMA disc from the in-vehicle equipment.

**1** Press the **TILT▲** button.

**2** Select  (DVD/CD).

The monitor section is tilted and the disc is ejected.

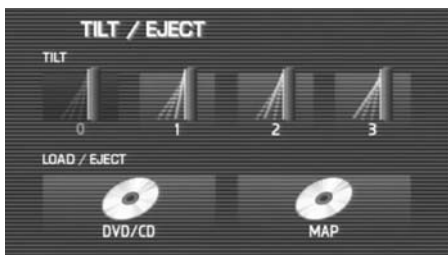

**3** Take out the disc.

**4** Press the **TILT▲** button.

The monitor will get back to the normal condition.

## Listening to the radio

### Listening to the radio

It is possible to tune in to a radio station to listen to the AM or FM radio.

**1** Change the source over to the FM radio or AM radio.  
(See Page 107.)

**2** Tune in to a station. (See Page 116.)

### FM radio screen displayed

When no FM radio screen is displayed while listening to the FM radio, press the **AUDIO** button to display the FM radio screen.

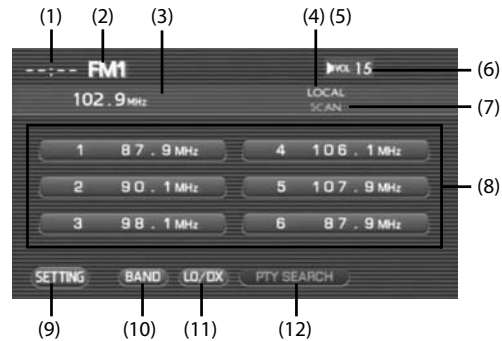

- (1) **Clock**  
The current time is displayed.
- (2) **FM display**  
The difference between the FM1 and FM2 frequency bands is displayed.
- (3) **Station tuned in to**  
The name of the station tuned in to and its frequency are displayed. When the station is preset, the preset number is also displayed.
- (4) **LOCAL**  
Displayed while in the LOCAL mode.
- (5) **ST**  
Displayed while in the stereophonic broadcast.
- (6) **VOL**  
The volume level is displayed. (See Page 110.)
- (7) **SCAN**  
Displayed when scanning a station to which you can tune in. (See Page 117.)
- (8) **Preset keys 1 to 6**  
It is possible to preset a station and invoke it later. (See Page 119.)

- (9) **SETTING** (SETTING)  
Select this to display the screen set for the audio. (See Page 158.)
- (10) **BAND** (BAND)  
Each time this is selected the discrimination of the frequency band (FM1/FM2) changes over.
- (11) **LO/DX** (LO/DX)  
Each time this is selected, the local mode can be turned on and off. When the local mode is set, the search of a station can be made starting with a station that is located in the area receiving higher-intensity radio waves clearly.
- (12) **PTY SEARCH** (PTY SEARCH)  
Selecting this allows you to search a station with a category of interest selected. (See Page 117.)

### AM radio screen displayed

When the AM radio screen is not displayed while listening to the AM radio, press the **AUDIO** button to display the AM radio screen.

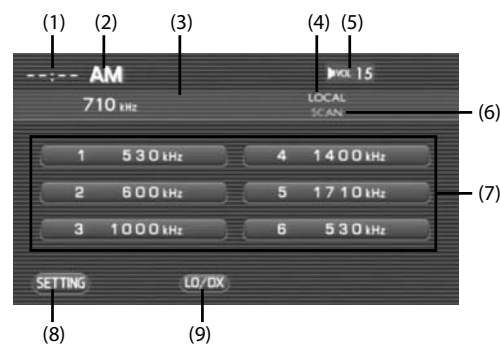



- (1) **Clock**  
The current time is displayed.
- (2) **AM display**  
AM is displayed.
- (3) **Station tuned in to**  
The name of the station tuned in to and its frequency are displayed. When the station is preset, the preset number is also displayed.
- (4) **LOCAL**  
Displayed while in the LOCAL mode.

- 
- (5) **VOL**  
The volume level is displayed. (See Page 110.)
  - (6) **SCAN**  
Displayed when scanning a station to which you can tune in.  
(See Page 117.)
  - (7) **Preset keys 1 to 6**  
It is possible to preset a station and invoke it later. (See Page 119.)
  - (8) **SETTING (SETTING)**  
Select this to display the screen set for the audio. (See Page 158).
  - (9) **LO/DX (LO/DX)**  
Each time this is selected, the local mode is turned on and off.  
When the local mode is set, the search of a station can be made starting with a station that is located in the area receiving radio waves clearly.





## Selecting a station

### Selecting a station that is preset

Presetting a station in advance in the in-vehicle equipment allows you to invoke that station.

- 1 Select the station preset on the FM radio screen or AM radio screen, or press the  or  button of the steering switch.



- When the FM radio screen or AM radio screen is not displayed, press the **AUDIO** button.
- Each time the  or  button of the steering switch is pressed, the station preset changes over. Pressing the  button changes over the station in the descending order of the preset number, while pressing the  button changes it over in ascending order of the preset number.

#### NOTE

For detailed method for presetting a station, refer to "Presetting a station" on Page 119.

### Setting the frequency



It is possible to set the frequency manually to listen to the radio.

- 1 Rotate the [MODE/TUNE] button in either direction.
  - Turning the [MODE/TUNE] button counterclockwise lowers the frequency and turning it clockwise heighten the frequency.
  - For the FM radio, select **BAND** (BAND) to make selection of the BAND. Each time **BAND** (BAND) is selected, a changeover is made between FM1 and FM2.

## Searching a station automatically

It is possible to search a station that can be tuned in to automatically to listen to a radio.

### 1 Press the or button.

- Pressing the  button allows you to search a station that can be tuned in to in the higher-intensity frequency direction, while pressing the  button allows you to make a search of a station in the lower-intensity frequency direction.
- Conducting this operation with "LOCAL" displayed on the FM screen after selecting **LO/DX** (LO/DX) allows you to search a station with excellent radio waves in the surrounding. However, in the condition in which "LOCAL" is displayed, a radio station is searched with the detection sensitivity of radio waves reduced. Accordingly, it becomes difficult to search a station in the area with low-intensity radio waves.
- For the FM radio, select **BAND** (BAND) to make selection of the BAND. Each time **BAND** (BAND) is selected, a changeover is made between FM1 and FM2.

## Searching a FM station from a category of interest

It is possible to select a category of interest and make search of a station to listen to a radio.

### 1 Select **PTY SEARCH** (PTY SEARCH).



### 2 Select a category of interest and then select [SEARCH].





Categories that can be selected are as shown below.

- INFO
- WEATHER

## Listening to the radio

---

- ROCK
  - SOFT
  - TOP40
  - COUNTRY
  - OLDIES
  - JAZZ
  - CLASSIC
  - R&B
  - RELIGIOUS
  - MISC
  - ALL
- Selecting  scrolls the display to display a category 5 positions ahead.
  - Selecting  scrolls the display to display a category 5 positions behind.

A station corresponding to the category is selected.

### **NOTE**

- This function is available only for the FM radio.
- Each time [SEARCH] is selected, another station can be searched.

## Presetting a station

It is possible to store in the memory a station frequently listened to and invoke it later.

### Presetting a station that is now being tuned in to

It is possible to preset a station that is now being tuned in to. Conducting this operation with a key that is preset already causes the preset key to be overwritten.

#### 1 Press the preset key for more than 2 seconds.

- When the FM radio screen or AM radio screen is not displayed, press the **AUDIO** button (12).
- For the FM radio, select **BAND** (BAND) to make selection of the BAND. Each time **BAND** (BAND) is selected, a changeover is made between FM1 and FM2.

The frequency preset is displayed in the preset key.

#### NOTE

For detailed method for invoking a station preset, refer to "Selecting a station that is preset" on Page 116.

## Presetting a station that can receive radio waves automatically

It is possible to search and preset a station that can receive radio waves automatically.

#### 1 Press the **SCAN** button.



- SCAN is displayed on the screen. Pressing the **SCAN** button again terminates the search of a station.
- Conducting this operation with "LOCAL" displayed on the FM screen after selecting **LO/DX** (LO/DX) allows you to make search of a station with excellent radio waves in the surrounding.
- For the FM radio, select **BAND** (BAND) to make selection of the BAND. Each time **BAND** (BAND) is selected, a changeover is made between FM1 and FM2.

The frequency preset is displayed in the preset key.



## Listening to the CD

---

### Listening to a tune in the CD

It is possible to set the CD in the in-vehicle equipment to listen to a tune in the CD.

**1** Change the source over to the disc. (See Page 107.)

The track of the CD is played back from the start.

When the track of the CD is played back to the last, the playback resumes from the start.

**NOTE**

When no CD is set in the in-vehicle equipment, set the CD. (See Page 111.)

## CD screen displayed

When the CD screen is not displayed while looking and listening to the CD, press the **AUDIO** button to display the CD screen.

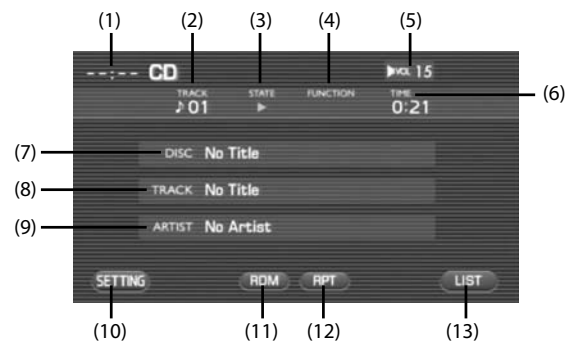

- (1) **Clock**  
The current time is displayed.
- (2) **TRACK**  
The track number is displayed.
- (3) **STATE**  
The playback status is displayed.  
▶: Playback is going on.  
◀◀: Fast rewind is going on.  
▶▶: Fast forward is going on.  
⏸: Pause

- (4) **FUNCTION**  
The playback status such as repeat and random is displayed.  
RPT: A tune is being played back repeatedly.  
RDM: Tunes in the CD are being played back in random order.  
SCAN: Each of the tunes in the CD is being played back for 10 seconds.
- (5) **VOL**  
The volume level is displayed. (See Page 110.)
- (6) **TIME**  
The playback time of a tune is displayed.
- (7) **DISC**  
When corresponding to the CD text, the disc name is displayed.
- (8) **TRACK**  
When corresponding to the CD text, the title of a tune is displayed.
- (9) **ARTIST**  
When corresponding to the CD text, the name of an artist is displayed.

◀◀: Displayed when the contents of the CD text cannot be displayed for each item. Selecting this scrolls the characters. When scrolled up to the end of the text, ▶ is displayed.

- (10) **SETTING** (SETTING)  
Selecting this displays the screen set for the audio. (See Page 158.)
- (11) **RDM** (RDM)  
The playback method of tunes is changed over in random order. (See Page 127.)
- (12) **RPT** (RPT)  
The playback method of tunes is changed over to the repeated playback. (See Page 126.)
- (13) **LIST** (LIST)  
Tunes contained in the CD are displayed in the list. (See Page 124.)



## Selecting a tune

### Selecting the preceding tune

.....

It is possible to play back a tune preceding the one that is now being played back.

**1** Conduct either of the following operations while playing back a tune.

- Press the  button.
- Rotate the [MODE/TUNE] button counterclockwise.
- Press the  button of the steering switch.



A tune preceding the one that is now being played back is played back.

### Selecting the succeeding tune

.....

It is possible to play back a tune succeeding to the one that is now being played back.

**1** Conduct either of the following operations while playing back a tune.

- Press the  button.
- Rotate the [MODE/TUNE] button counterclockwise.
- Press the  button of the steering switch.

The succeeding tune is played back.

## Selecting a tune from the list

It is possible to display in the list tunes contained in the CD, and select a tune from the list to play it back.

### 1 Press the **AUDIO** button.



When the CD screen has been displayed, this operation is not required. Proceed to step 2.

### 2 Select **LIST** (LIST).



### 3 Select a tune you want to listen to.



- Selecting  scrolls the display to display a tune 5 positions ahead.
- Selecting  scrolls the display to display a tune 5 positions behind.

A tune that is selected is played back.

#### NOTE

- Selecting **HOME** (HOME) displays a page containing a tune that is now being played back.
- Selecting **CONTROL** (CONTROL) gets back to the screen in which the tune information is displayed.

## Searching a tune while listening

It is possible to search a tune you want to hear while listening to each tune in the CD for 10 seconds.

- 1 Press the **SCAN** button while playing back a tune.

"SCAN" is displayed for the FUNCTION on the CD screen.





After a tune you want to hear is played back, press again the **SCAN** button.

## Fast-rewinding or fast-forwarding a tune

It is possible to fast-rewind or fast-forward a tune that is now being played back.

### ■ To rewind a tune quickly

- 1 Keep pressing the  button while playing back a tune.

A tune is rewound quickly while the button is kept pressed. When releasing the  button, the tune is played back from the point to which the tune was fast-rewound.

### ■ To fast-forward a tune

- 1 Keep pressing the  button while playing back a tune.

A tune is forwarded quickly while the button is kept pressed. When releasing the  button, the tune is played back from the point to which the tune was fast-forwarded.

## Listening to a tune repeatedly

It is possible to play back a tune repeatedly.

- 1 Select **RPT** (RPT) while playing back a tune.

"RPT" is displayed for FUNCTION on the CD screen to play back a tune repeatedly.



Selecting again **RPT** (RPT) releases the repeated playback.

## Listening to tunes in random order

It is possible to play back the tunes in the CD in random order.

- 1 Select **RDM** (RDM) while playing back a tune.

With "RDM" displayed for FUNCTION on the CD screen, tunes are played back in random order.



Selecting again **RDM** (RDM) releases the playback in random order.



## Listening to MP3/WMA disc

---

### MP3/WMA

MP3/WMA can be played back by this in-vehicle equipment. However, media and formats are limited in which MP3/WMA files that can be used are recorded. Please note the following when writing MP3/WMA files. The limited number of characters given below is the number of characters when using 1-byte characters.

#### ■ Media that can be used

Media used to include MP3/WMA that can be used are CD-R and CD-RW.

Media created in a simplified format cannot be played back with this in-vehicle equipment.

#### ■ MP3 formats that can be played back

MP3 formats that can be played back with this in-vehicle equipment are as shown below.

##### Specification

MPEG-1 Layer 3

MPEG-2 Layer 3

MPEG-2.5 Layer 3

##### Sampling frequency

8, 11.025, 12, 16, 22.05, 24, 32, 44.1, 48 (kHz)

##### Bit rate

8 to 320 (kbps)

Variable bit rate compliant

#### ■ WMA formats that can be played back

WMA files that can be played back with the in-vehicle equipment are as shown below.

##### Specifications

WMA Ver. 7, 8 and 9

##### Sampling frequency

Ver. 7: 44.1, 48 (kHz)

Ver. 8 and 9: 32, 44.1, 48 (kHz)

##### Bit rate

Ver. 7: 64 to 192 (kbps)

Ver. 8 and 9: 48 to 192 (kbps)

Variable bit rate compliant

#### ■ Disc formats that can be used

Discs that can be used with this in-vehicle equipment are as shown below. The number of characters following the format name is the maximum number of characters (a delimiter "." and 3 characters of extension included) specified for the file name.

- ISO 9660 Level 1: 12 characters
- ISO 9660 Level 2: 31 characters
- Joliet: 64 characters
- Romeo: 128 characters

And when written in a long file name format, it is possible to display up to the number of characters as shown below.

64 character (all 1-byte characters)

For details of the characters that can be used, refer to the instruction manual of the writing software and "Input of file name and folder name."

However, characters that can be displayed are as shown below.

- Half size characters (alphanumeric, and ASCII codes)

Characters other than the above are displayed with an asterisk "?."

However, discs that can be played back with this in-vehicle equipment are accompanied by the following restrictions.

- Maximum directory layers: 8 layers
- Maximum number of files in a folder: 255
- Maximum number of folders: 254 (including the ROOT)
- Maximum number of characters used in a folder name: 64 characters

MP3/WMA files that are written in formats other than the above may not be played back normally, and the file name and the folder name of which may not be displayed correctly.

### ■ Setting of the compression software and the writing software

When compressed into an MP3/WMA file, it is recommended that the setting of the transfer bit rate of the compression software is "fixed" to "128 kbps."

When recording a blank media up to the maximum capacity at once, make a setting to "Disc at Once."

### ■ Input of a file name and a folder name

When inputting a file name and a folder name, input them in half size alphanumeric characters. File names and folder names that are written in characters other than the above may not be displayed correctly. And depending on a writing software or a disc format used, characters that can be displayed are restricted. For details, refer to the instruction manual of the writing software. And files that can be acknowledged and played back are restricted only to those attached with an extension ".MP3" or ".WMA." When saving an MP3/WMA file, be sure to attach it with an extension ".MP3" or ".WMA."

#### Forbidden



If a file other than MP3/WMA is attached with an extension ".MP3" or ".WMA," it may be mistakenly acknowledged as an MP3/WMA file, thus causing the generation of loud noises to damage the speaker. So, do not attach any file other than MP3/WMA with an extension ".MP3" or ".WMA."

### ■ ID3/WMA Tag

ID3/WMA Tag is compliant (Ver.1.0, 1.1).

■ **Files that are written into media**

When media that contains MP3/WMA files is inserted, first of all, all the files in the disc are checked.

So, when a lot of folders and files other than MP3/WMA are written into the media to be played back, a lot of time is required before starting the playback of the media.

And time may be required before proceeding to the playback of the next MP3/WMA file, and a file search and a folder search cannot be conducted smoothly.

■ **Sequence in which MP3/WMA files are played back.**

The sequence in which files and folders are selected while in the playback, folder search, file search and the folder selection is in the order in which they are written with the writing software. Accordingly, the sequence in which the files are expected to be played back may not conform to the sequence in which the files are actually played back.

Depending on the writing software, entering "01" to "90" at the head of the file name as a playback sequence with it written in CD-R may allow you to set the sequence in which files are played back. Conducting a folder search, a file search and a folder selection in the media of the following folder/file layer results in a media hierarchy as shown below.

■ **Example of Media hierarchy**

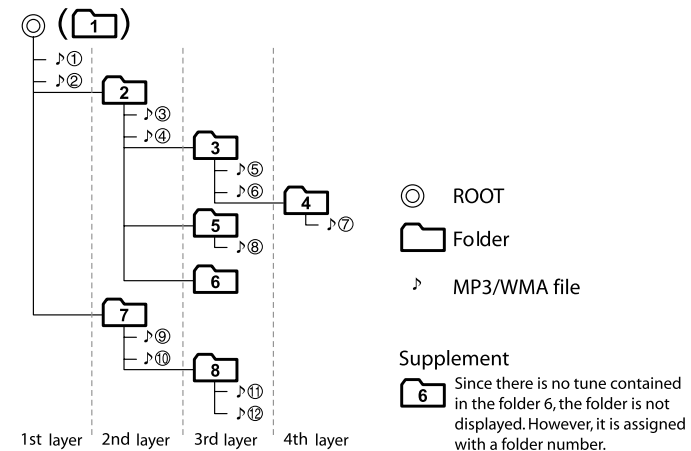

---

## Listening to tunes (file) in the MP3/WMA disc

It is possible to set the MP3/WMA disc in the in-vehicle equipment to listen to tunes (files) in the disc.

### **1** Change the source over to the disc. (See Page 107.)

The first tune in the lead folder in the MP3/WMA disc is played back from the start.

When the tunes in the folder are played back to the last, the first tune in the lower-order or next folder is played back.

When the tunes in the MP3/WMA disc are played back to the last, the playback is resumed from the first tune in the lead folder.

#### **NOTE**

When no MP3/WMA disc is set in the in-vehicle equipment, set the MP3/WMA disc. (See Page 111.)

## MP3/WMA disc screen displayed

When no MP3/WMA disc screen is displayed while looking and listening to the MP3/WMA disc, press the **AUDIO** button to display the MP3/WMA disc screen.

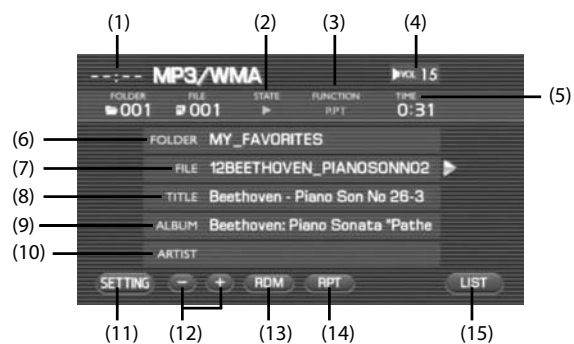



- (1) **Clock**  
The current time is displayed.
- (2) **STATE**  
The playback status is displayed.
  - [Play]: Play back is going on.
  - [Fast Rewind]: Fast rewind is going on.
  - [Fast Forward]: Fast forward is going on.
  - Pause
- (3) **FUNCTION**  
The playback status such as repeat and random is displayed.

- RPT: A tune is being played back repeatedly.
- RDM: Tunes in the MP3/WMA disc are being played back in random order.
- SCAN: Each of the tunes in the MP3/WMA disc is being played back for 10 seconds.

- (4) **VOL**  
The volume level is displayed. (See Page 110.)
- (5) **TIME**  
The playback time of a tune is displayed.
- (6) **FOLDER**  
The folder name is displayed.
- (7) **FILE**  
The file name is displayed.
- (8) **TITLE**  
The title of a tune is displayed.
- (9) **ALBUM**  
The name of an album is displayed.

- 
- (10) **ARTIST**  
The name of an artist is displayed.
- (11) **SETTING (SETTING)**  
Selecting this displays the screen set for the audio. (See Page 158.)
- (12) **- +**  
Used to play back the first tune in the succeeding/preceding folder. (See Page 134.)
- (13) **RDM (RDM)**  
Used to change over the playback method of tunes in random order. (See Page 127.)
- (14) **RPT (RPT)**  
Used to change the playback method of tunes over to the repeated playback. (See Page 126.)
- (15) **LIST (LIST)**  
Used to display the folders or tunes in the MP3/WMA disc in the list. (See Page 134 and 136.)

:Displayed when the contents of the CD text cannot be displayed for each item. Selecting this scrolls the characters. When scrolled up to the end of the text,  is displayed.

## Selecting a tune

### Selecting a folder that you want to hear

Select a folder in the MP3/WMA disc.

#### To select a folder

1 Select **+** or **-**.

Selecting **+** plays back the first tune in the succeeding folder.  
Selecting **-** plays back the first tune in the preceding folder.

#### To select a folder from the list

1 Select **LIST** (LIST).



2 Select **UP** (UP).



3 Select the folder name.

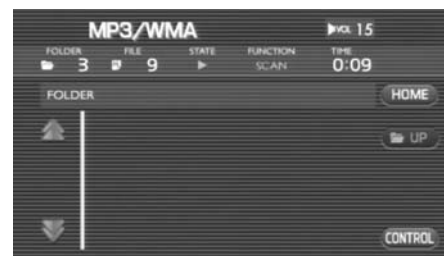

- Selecting **▲** scrolls the display to display a folder 5 positions ahead.
- Selecting **▼** scrolls the display to display a folder 5 positions behind.
- Selecting **HOME** (HOME) displays in the list the tunes in the folder in which a tune that is now being played back is contained.

- When the tunes are displayed in the list, selecting [UP] displays the folder list.
- Selecting **CONTROL** (CONTROL) gets back to the MP3/WMA disc in which the tune information is displayed.

The first tune in the folder selected is played back.



## Selecting a tune (file) you want to hear

Select a tune (file) in the MP3/WMA disc.

### ■ To select the preceding tune

It is possible to play back a tune in the high-order folder of the tune that is now being played back or the preceding tune.

#### 1 Conduct either of the following operations while playing back a tune.



- Press the  button.
- Rotate the [MODE/TUNE] button counterclockwise.
- Press the  button of the steering switch.

The preceding tune is played back.

### ■ To select the succeeding tune

It is possible to play back a tune succeeding the tune that is now being played back.

#### 1 Conduct either of the following operations while playing back a tune.

- Press the  button.
- Rotate the [MODE/TUNE] button clockwise.
- Press the  button of the steering switch.

The succeeding tune is played back.



■ To select a tune from the list

1 Select **LIST** (LIST).



- When the tunes are displayed in the list, selecting up displays the folder list.
- Selecting **CONTROL** (CONTROL) gets back to the MP3/WMA disc in which the tune information is displayed.

The tunes in the folder are displayed in the list.

A tune selected is played back.

2 Select the tune name.



- Selecting **▲** scrolls the display to display a folder 5 positions ahead.
- Selecting **▼** scrolls the display to display a folder 5 positions behind.
- Selecting **HOME** (HOME) displays in the list the tunes in the folder in which the tune that is now being played back is contained.

### ■ To search a tune while listening to tunes in the folder

It is possible to search a tune you want to hear while listening to each of the tunes in the folder for 10 seconds. After all the tunes in the folder are played back, the player gets back to the normal playback mode.

- 1 Press the **SCAN** button while playing back a tune.

"SCAN" is displayed for FUNCTION on the MP3/WMA screen.



After completion of the playback of a tune you want to hear, press again the **SCAN** button.

### Fast-rewinding or fast-forwarding a tune

It is possible to rewind or forward quickly a tune that is now being played back.

#### ■ To rewind a tune quickly

- 1 Keep pressing the **↶** button while playing back a tune.

A tune is rewound quickly while the button is kept pressed. When releasing the **↶** button, the tune is played back from the point to which the tune was rewound.

#### ■ To forward a tune quickly

- 1 Keep pressing the **↷** button while playing back a tune.

A tune is forwarded quickly while the button is kept pressed. When releasing the **↷** button, the tune is played back from the point to which the tune was forwarded.

## Listening to a tune repeatedly



It is possible to listen to the same tune or the tunes in the folder repeatedly.

### ■ To listen to the same tune repeatedly

It is possible to play back the same tune repeatedly.

- 1 Select **RPT** (RPT) while playing back a tune.

With "RPT" displayed for FUNCTION on the MP3/WMA screen, the tune is played back repeatedly.



- Selecting **RPT** (RPT) allows you to listen to the tunes in the folder repeatedly. Select again **RPT** (RPT) to release the repeated playback.
- When "RPT" is displayed for FUNCTION, the MP3/WMA is set to the mode for listening to the tunes in the folder.

### ■ To listen to the tunes in the folder repeatedly

It is possible to play back the tunes in the folder repeatedly.

- 1 Select **RPT** (RPT) twice while playing back a tune.

With "F.RPT" displayed for FUNCTION on the MP3/WMA screen, the tunes in the folder are played back repeatedly.

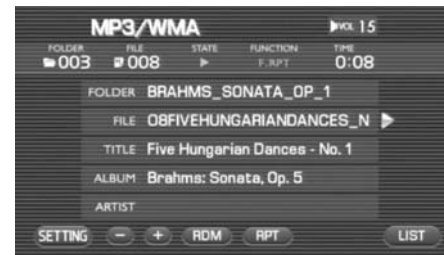

- Selecting again **RPT** (RPT) releases the repeated playback.
- When "RPT" is displayed for FUNCTION, the mode is set in which the same tune is played back repeatedly. Select **RPT** (RPT) again.

## Listening the tunes in random order

It is possible to play back the tunes in the folder in random order. After all the tunes in the folder are played back, the tunes in the next folder are played back in random order.

### 1 Select **RDM** (RDM) while playing back a tune.

With "RDM" displayed for FUNCTION on the MP3/WMA screen, the tunes in the folder are played back in random order.



- After all the tunes in the folder are played back, the tunes in the next folder are played back in random order.
- Selecting **RDM** (RDM) again releases the random playback.

## Looking at the DVD

---

### WARNING

- **Never try watching videos or using other entertainment programs with your Audio and Visual System by keeping the vehicle engine running in a garage or other enclosed area. Exhaust gases accumulated in such an area or entering the vehicle are dangerous, or even lethal.**
- **The driver must not attempt to operate or watch the DVD while the vehicle is in motion. Doing so will distract attention from driving and the road, and could lead to an accident.**
- **If you wish to park your vehicle and enjoy an entertainment program on this system, select a safe place that does not hinder traffic and has no parking ban.**

### NOTE

- Using the Audio and Visual System with the engine stopped could lower the battery's electricity level. If the initial charge level is too low, the engine may not start the next time. It is recommended that the system be used only when the engine is running expect when the vehicle is parked in a garage or other enclosed area.
- In the interest of safety, the use of some functions may be unavailable while in driving. The button for a touch screen that cannot be used will be displayed in tint color (toned down).
- Liquid-crystal displays may be difficult to read when wearing polarized glasses.

## What must be known

Manufactured under license from Dolby Laboratories.  
 "Dolby," "Pro Logic," and the double-D symbol are trademarks of Dolby Laboratories.  
 Non disclosed confidential writings: Copyright: Dolby Laboratories, 1992 to 1997  
 No reproduction allowed  
 "DTS" and "DTS Digital Surround" are registered trademarks of Digital Theater Systems, Inc.

## Operations while in the playback of the disc

For DVD video, DVD audio and video CD, the playback condition has been specified according to the instruction of software manufacturers. This DVD player, because of it being played back according to the instructions intended by the software manufacturer, may not sometimes function as intended when operated. Be sure also to read through the instruction manual attached to a disc to be played back.

## DVD video and DVD audio

They are compliant with the NTSC color television format.

### ■ Region code of discs that can be played back

For some discs, a region code is displayed that stands for a region (country) of the player in which a disc can be played back.

Of discs attached with a region code, those with "1" (a code standing for North America) not included in its region code list or those with "ALL" (for worldwide use) not displayed cannot be played back with this DVD player.

When playing back a disc like this, a message "REGION CODE ERROR" is displayed on the screen. And for discs with no region code displayed, their region for use may have been restricted. On an occasion like this, the playback with this DVD player may not be available.

## **Playing back the DVD**

It is possible to set a DVD on the in-vehicle equipment to look at and listen to it.

**1** Change the source over to the disc. (See Page 107.)

When a DVD is not yet set on the in-vehicle equipment, set a DVD.  
(See Page 111.)

The DVD is played back.

## DVD control screen displayed

When the DVD screen is not displayed while in the playback of a DVD, press the **AUDIO** button to display the DVD screen. And then selecting the screen displays the DVD control screen.

### NOTE

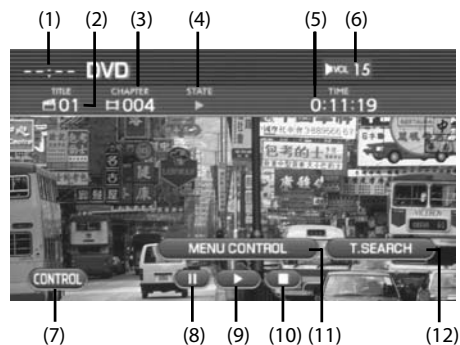

When 10 seconds has elapsed with no key selected, the display disappears.



- (1) **Clock**  
The current time is displayed.
- (2) **TITLE**  
The title number of the DVD that is being played back is displayed.

- (3) **CHAPTER**  
The chapter number of the DVD that is being played back is displayed.
- (4) **STATE**  
The playback condition of the chapter is displayed.
  - ▶: The playback is in progress.
  - : The playback is stopped.
  - R: The playback is stopped while keeping the playback condition just before stop.
  - ||: The playback is stopped temporarily.
  - ◀◀: The DVD is rewinding quickly.
  - ▶▶: The DVD is forwarding quickly.
- (5) **TIME**  
The playback time of the chapter is displayed.
- (6) **VOLUME**  
The volume level is displayed.
- (7) **CONTROL (CONTROL)**  
Selecting this displays the DVD setting screen.
- (8) **PAUSE**  
The DVD image is stopped temporarily.
- (9) **PLAY**  
The playback of the DVD image is started.





- (10)  (STOP)  
The playback of the DVD image is stopped.
- (11)  (MENU CONTROL)  
The screen is changed over in which the menu is operated.  
See Page 149.
- (12)  (T.SEARCH)  
The DVD image can be played back with the title specified.  
See Page 145.

## Selecting the title and the chapter

### Selecting the chapter

#### ■ To play back the preceding chapter



- 1 Conduct either of the following operations while in the DVD playback.

- Press the  button.
- Rotate the [MODE/TUNE] button counterclockwise.
- Press the  button of the steering switch.

A chapter preceding the chapter that is now being played back will be played back.

#### ■ To play back the succeeding chapter

- 1 Conduct either of the following operations while in the DVD playback.

- Press the  button.
- Rotate the [MODE/TUNE] button clockwise.
- Press the  button of the steering switch.

A chapter succeeding the chapter that is now being played back will be played back.

### Searching a title with the title number specified

It is possible to search a title with the title number specified and then play it back.

- 1 Select the screen while in the DVD playback.



- 2 Select **T.SEARCH** (T.SEARCH).



Looking at the DVD

---

- 3 Select **-10**, **-1**, **+1**, **+10** to enter a title number and then select **ENTER** (ENTER).



A title selected is played back.

**NOTE**

When selecting **ENTER** (ENTER) with a title number entered that is not in the DVD, the screen displayed is not changed.

## Controlling the playback of the DVD

It is possible to pause, stop, rewind quickly or forward quickly the DVD for control.

### ■ To stop the DVD temporarily

- 1 Select the DVD screen while in the DVD playback.
- 2 Select .  
The DVD stops temporarily.

#### NOTE

Selecting  or  gets back to the normal playback mode.

### ■ To stop the DVD

- 1 Select the DVD screen while in the DVD playback.
- 2 Select .  
The DVD is stopped.

#### NOTE

Selecting  resumes the playback.

### ■ To rewind the DVD image quickly

- 1 Keep pressing the  button while in the DVD playback.



While the button is being pressed, the DVD image is rewound quickly. Releasing the  button resumes the playback of the DVD image from the point to which the DVD image was rewound quickly.

### ■ To forward the DVD image quickly

- 1 Keep pressing the  button while in the DVD playback.

While the button is being pressed, the DVD image is forwarded quickly. Releasing the  button resumes the playback of the DVD image from the point to which the DVD image was forwarded quickly.

■ **To forward the DVD image in single frame step**

- 1** Select the screen while in the DVD playback.
- 2** Select .  
The DVD is stopped temporarily.
- 3** Conduct either of the following operations while in the DVD playback.
  - Press the  button.
  - Rotate the [MODE/TUNE] button clockwise.
  - Press the  button of the steering switch.

The DVD image is played back in single frame forward step.

**NOTE**

Selecting  or  gets back to the normal playback mode.

## Operating the menu screen

### Selecting the menu

It is possible to operate the menu screen of the DVD.

- 1 Select the screen while in the DVD playback.



- 2 Select **MENU CONTROL** (MENU CONTROL).



- 3 Selecting **RETURN** (RETURN), **TOP MENU** (TOP MENU), **MENU** (MENU), and **ENTER** (ENTER) to select a menu item, and then select **ENTER** (ENTER).



- Selecting **RETURN** (RETURN) starts the playback from a point specified for each DVD.
- Selecting **TOP MENU** (TOP MENU) displays the top menu.
- Selecting **MENU** (MENU) displays the menu.
- The configurations of the top menu and the menu vary with the DVDs.

The image is played back as a menu is selected.

## Changing over the position of the menu operation key

The menu operation key is used to operate the menu of the DVD. It is possible to relocate the position of the menu operation key so that it does not interfere with the DVD image.

- 1 Select the screen while in the DVD playback.



- 2 Select **MENU CONTROL** (MENU CONTROL).



- 3 Select **CHANGE** (CHANGE).



The location of the menu handling key is changed over.

Selecting **CHANGE** (CHANGE) again gets back to the original menu location.



## Changing the language and the angle

### Changing the superimposed language

It is possible to change over the superimposed language while in the playback of a DVD.

- 1 Select the screen while in the DVD playback.



- 2 Select **CONTROL** (CONTROL).



- 3 Select **SUB** (SUB).



Each time selecting **SUB** (SUB), the superimposed language is changed over.

#### NOTE

- The superimposed language is indicated by a numeric character. When a numeric character is not displayed, the DVD is not compliant with multiple languages.
- Selecting the screen allows you to check the superimposed language on the playback screen.



## Changing the voice language

It is possible to change the voice language while in the DVD playback.

1 Select the screen while in the DVD playback.



2 Select **CONTROL** (CONTROL).



3 Select **AUDIO** (AUDIO).



Each time **AUDIO** (AUDIO) is selected, the voice is changed over.

### NOTE

- The voice language is indicated by a numeric character. When a numeric character is not displayed, the DVD is not compliant with multiple languages.
- Selecting the image section in the screen allows you to check the voice language on the playback screen.

## Changing over the angle

It is possible to change over the angle to look at the DVD image in the multi-angle scene while in the playback of the DVD compliant with multi-angle.

- 1 In the scene compliant with multi-angle, select the screen while in the DVD playback.



When a setting is made in the initial setting of the DVD so that the  (angle mark) is displayed, an angle mark is displayed in the scene compliant with multi-angle. (See Page 169.)

- 2 Select **CONTROL** (CONTROL).



- 3 Select **ANGLE** (ANGLE).



Each time **ANGLE** (ANGLE) is selected, the DVD is played back with the angle changed over.

### NOTE

- The type of the angle is indicated by a numeric character. When a numeric character is not displayed, or when it is displayed as 1/1, the DVD is not compliant with multiple languages.
- Selecting the image section in the screen allows you to check the angle on the playback screen.

## Setting the screen











### Adjusting the image quality











The image quality can be adjusted while looking and listening to the DVD.

1 Press [DISP].

2 Select  or  of each item to adjust the image quality.



- Selecting  or  of  allows you to adjust the tint of a color.  
Each time  is selected, the tint of red is increased and each time  is selected, the tint of green is increased.
- Selecting  or  of  allows you to adjust the shade of a color.  
Each time  is selected, the shade of a color is increased and each time  is selected, the shade of a color is decreased.

- Selecting  or  of  allows you to adjust the brightness.  
Each time  is selected, the brightness is increased and each time  is selected, the brightness is decreased.
- Selecting  or  of  allows you to adjust the contrast.  
Each time  is selected, the contrast is increased and each time  is selected, the contrast is decreased.

#### NOTE

Selecting  (DEFAULT) returns the settings to the default settings.

## Setting the SCREEN MODE

The screen mode can be set while looking and listening to the DVD.

- 1 Press [DISP].
- 2 Select **MODE** (MODE).



- 3 Select either of the SCREEN MODE's below.

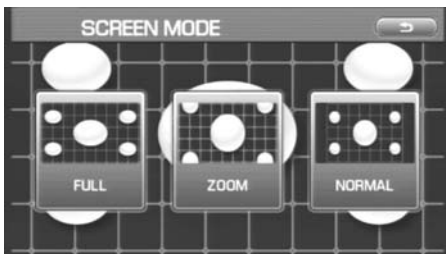

### **NORMAL** (NORMAL):

Displayed in the horizontal to vertical ratio of 3:4 screen (normal size of TV screen) with both ends black.

### **FULL** (FULL):

Displayed in the horizontal to vertical ratio of 3:4 screen (normal size of TV screen) that is expanded uniformly in the left and right directions.

### **ZOOM** (ZOOM):

Displayed in the horizontal to vertical ratio of 3:4 screen (normal size of TV screen) that is expanded uniformly in the top and bottom directions and the left and right directions.

When receiving a wide screen broadcast, change over to this mode.

**There is no legal restriction imposed so long as you enjoy the DVD personally. However, if the screen is compressed or expanded for a commercial purpose, or with the view of letting the general public enjoy the DVD, please note that this may infringe the right of authorship that is protected by the copyright law.**

### **NOTE**

Pressing the **AUDIO** button allows you to look and listen to the DVD in the size set.

## Looking at the VIDEO

It is possible to look at the VIDEO with the VIDEO equipment externally connected.

**1** Change the source over to VIDEO. (See Page 107.)

### NOTE

- The VTR equipment is required to be connected externally.
- When "VIDEO" is displayed even after the source is changed over to VIDEO, the VIDEO equipment is not externally connected.

## Satellite radio operation (if equipped)

---

To receive satellite radio, it is necessary to install the Subaru genuine satellite receiver (dealer option) and to enter into a contract. For details, please contact your SUBARU dealer.

### ■ XM™ satellite radio

XM™ is a continental U.S. based satellite radio service that offers more than 160 coast to coast channels, including music, news, sports, talk and children's programming.

XM™ provides digital quality audio and text information, including song title and artist name. A service fee is required to receive the XM™ service. For more information, contact XM™ at [www.xmradio.com](http://www.xmradio.com) or call 1-800-XMRADIO (1-800-967-2346) for U.S., [www.xmradio.ca](http://www.xmradio.ca) or 1-877-GET-XMSR (1-877-438-9677) for Canada.

### ■ Sirius satellite radio

Sirius satellite radio is a recent innovation that allows the listener to experience digital sound quality and to have a greater variety of channels to choose from (more than 160 channels with the relevant subscription).

Use of satellite radio (Sirius) requires a tuner, antenna and a service contract. For details, please contact your SUBARU dealer or visit Sirius Satellite Radio at [www.sirius.com](http://www.sirius.com) or call 1-888-539-SIRIUS (7474) for more information. Sirius, the Sirius dog logo, channel names and logos are trademarks of SIRIUS Satellite Radio Inc.

### ■ Satellite radio reception

Satellite radio signals are best received in areas with a clear view of the open sky. In areas where there are tall buildings, trees, tunnels or other structures that may obstruct the signal of the satellites, there may be signal interruptions. Other circumstances that may result in signal loss include driving near a wall, steep cliff, hill or driving on the lower level of a multi-tiered road or inside of a parking garage.

To help reduce this condition, satellite radio providers have installed ground-based repeaters in heavily populated areas. However, you may still experience reception problems in some areas.

## Setting the audio

### Setting the equalizer

It is possible to set the audio to the sound quality of your preference.

### Setting the equalizer with ease

.....

It is possible to select a sound category to set the equalizer with ease.

1 Press the **AUDIO** button.

2 Select **SETTING** (SETTING).



- Even when each source screen is displayed, select **SETTING** (SETTING) to operate it in the same way.
- When the DVD playback screen is displayed, press the **AUDIO** button again to display the screen shown above.

3 Select **EQUALIZER** (EQUALIZER) in the SETTING screen.



4 Select either of the categories.



NATURAL: Suitable for natural sound like voice of people.

ROCK: Suitable for rock music

POPS: Suitable for pop music

EASY: Suitable for easy listening music

JAZZ: Suitable for jazz music

## Setting the equalizer in detail

Setting the numeric value of the equalizer in detail allows you to enjoy a sound quality more suited to your taste. Presetting the equalizer allows you to invoke it later.

1 Press the **AUDIO** button.

2 Select **SETTING** (SETTING).



- Even when each source screen is displayed, select **SETTING** (SETTING) to operate it in the same way.
- When the DVD playback screen is displayed, press the **AUDIO** button again to display the screen shown above.

3 Select **EQUALIZER** (EQUALIZER) in the SETTING screen.



4 Select either of the BANDs 1 to 4 and then select **◀ ▶** to set a numeric value for each band.



FREQ:	BAND1
Used to set the frequency.	60/80/100/120/160/200
	BAND2
	250/315/400/500/630/800/1k
	BAND3
	1.25k/1.6k/2k/2.5k/3.15k/4k
	BAND4
	5k/6.3k/8k/10k/12.5k/16k



## Setting the audio

Q:	0.25/0.5/1/2
Used to set the degree of acumination.	
GAIN:	-9/-7/-5/-3/-2/-1/0/1/2/3/5/7/9
Used to set the value of gain.	

The larger the value of Q factor (degree of acumination) is, the more the gain of the center frequency is enhanced.

- 5 When presetting the equalizer setting, select either of **1** to **3** of the USER PRESET for more than 2 second.



### NOTE

When not preset, it is not possible to invoke the setting later. However, you can enjoy the audio as you have set it.

## Invoking the equalizer setting that has been preset

It is possible to invoke the equalizer preset to make use of it.

- 1 Press the **AUDIO** button.
- 2 Select **SETTING** (SETTING).



- Even when each source screen is displayed, select **SETTING** (SETTING) to operate it in the same way.
- When the DVD playback screen is displayed, press the **AUDIO** button again to display the screen shown above.

- 3 Select  (EQUALIZER) in the SETTING screen.



- 4 Select either of  to  of USER PRESET.



## Setting the balance of the audio volume

Set the balance of the audio volume and the sound volume of the sub woofer in the vehicle.

1 Press the **AUDIO** button.

2 Select **SETTING** (SETTING).



- Even when each source screen is displayed, select **SETTING** (SETTING) to operate it in the same way.
- When the DVD playback screen is displayed, press the **AUDIO** button again to display the screen shown above.

3 Select **BALANCE/FADER** (BALANCE/FADER) in the SETTING screen.



4 Select **▲** **◀** **▶** **▼** given in the in-vehicle illustration to set the balance of the sound volume. And then select **◀** **▶** of the SUB WOOFER LEVEL to set the sound volume of the SUB WOOFER.

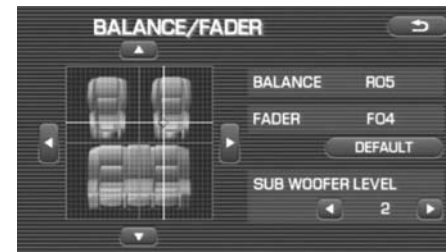

Set "+" to the position at which you want to tone up the sound volume most.

**NOTE**

- Selecting **DEFAULT** (DEFAULT) gets "+" back to the center position.
- The setting of the sub woofer level is available only when the sub woofer is connected. (See Page 166.)
- The larger the numeric value of the sub woofer level, the bigger the sub woofer volume.



## Setting the surround

The setting of the surround is made for each source. Set the surround for the source currently selected.

- 1 Press the [MODE/TUNE] button to select the source for which the surround is to be set.
- 2 Press the **AUDIO** button.
- 3 Select **SETTING** (SETTING).



Even when each source screen is displayed, select **SETTING** (SETTING) to operate it in the same way.



- 4 Select  (SURROUND) in the SETTING screen.



- 5 Select either of the surround modes.

**Bypass:** Selected when no surround setting is made.

**Music:** In the Music mode, it is possible to use the mode controllers such as "Dimension," "Center Width" and "Panorama" to adjust the sound space to the optimum condition according to your taste.

- "Dimension": This is used to adjust the condition of the sound space back and forth. The more  is selected, the more the distribution of the sound volume to the front speaker is increased, and the more  is selected, the more the distribution of the sound volume to the rear speaker is increased.
- "Center Width": This is used to adjust the balance of the left and right speakers and the center speaker (sold separately). The larger the value gets, the more the distribution of the sound volume is increased.

- "Panorama": This enhances greatly the stereo effect in front including the surround speaker. With the entire vehicle used, you can enjoy the feeling like "being wrapped in sound." It is recommended that you use this mode when playing back the stereo signals of an audio CD.
- Movie: The MOVIE mode of PRO LOGIC II is programmed so that the playback is made in the calculated high quality sound. It is recommended that you use this mode when playing back a DVD video attached with the mark.
- Matrix: In the Matrix mode, the directionally enhanced circuit is turned off. So, it is possible to enhance monaural signals to make them look large. It is recommended that you use this mode when the reception condition of the stereo signals of FM radio and TV is unstable and is offensive to the ear, or when playing back monaural signals.
- Dolby PL: The PRO LOGIC mode is used when the sound quality of source contents is not optimal, or when you want to listen to a program in the "familiar" sound quality.



## Setting the speaker

Make a setting for the connection of the center speaker and the sub woofer.

The center speaker and the sub woofer are sold separately. When using them, contact the Subaru dealer.

1 Press the **AUDIO** button.

2 Select **SETTING** (SETTING).



- Even when each source screen is displayed, select **SETTING** (SETTING) to operate it in the same way.
- When the DVD playback screen is displayed, press the **AUDIO** button again to display the screen shown above.

3 Select **SET UP** (SET UP).



4 Select **SPEAKER** (SPEAKER).



- 5 Make a setting to decide whether or not the SUB WOOFER and the center speaker are connected.



- Select [ON] of the SUB WOOFER when connecting the sub woofer. And select **OFF** (OFF) when not connecting it.
- Select [ON] of the CENTER when connecting the center speaker. And select **OFF** (OFF) when not connecting it.
- A speaker that is set to be connected is displayed lit on the illustration left.



## Initializing the DVD

The DVD player is initialized. The selection of the superimposed language and the sound can be set while in the looking and listening of the DVD. However, it is convenient if you initialize in advance the settings frequently used.

1 Press the **AUDIO** button.

2 Select **SETTING** (SETTING).



- Even when each source screen is displayed, select **SETTING** (SETTING) to operate it in the same way.
- When the DVD playback screen is displayed, press the **AUDIO** button again to display the screen shown above.

3 Select **SET UP** (SET UP).



4 Select **DVD** (DVD).



The DVD SET UP screen is displayed.

- 5** When "After changing settings, system may not play back" is displayed, select **Yes** (Yes).

**NOTE**

The following can be conducted in this screen.

- Setting the screen (See Page 154.)
- Setting the dynamic range (See Page 170.)
- Setting the language (See Page 171.)
- Setting the parental level (See Page 173.)

## Setting the screen

.....

It is possible to make a setting to decide whether or not the angle mark is displayed. And it is also possible to set the type of the image.

The angle mark is a mark displayed when the angle can be changed while playing back a DVD compliant with multi-angle.

- 1** Select **SCREEN** (SCREEN) in the DVD SET UP screen.
- 2** Make a setting to decide whether or not the angle mark is displayed, and also set the type of the screen.

Select **On** (ON) of the ANGLE MARK to display the angle mark. And select **OFF** (OFF) not to display the ANGLE MARK.



Select either of the following to set the type of the image.

- **16:9** : The width and height of the image is displayed in the ratio of 16:9.

## Setting the audio

- **4:3LB** : With a black frame attached to the top and bottom of the image in the ratio of 16:9, the width and height is displayed in the ratio of 4:3.
- **4:3PS** : The width and height is displayed in the ratio of 4:3.

## Setting the dynamic range

The dynamic range is set. The setting of the dynamic range is effective when playing back Dolby digital image.

**1** Select **AUDIO** (AUDIO) in the DVD SET UP screen.

**2** Set the dynamic range.



Select either of the following to set the dynamic range.

- **WIDE** : Used to enhance the high-pitched sounds and the low-pitched sounds so that the dynamic range is played back in the sound modulated for effect.
- **NORMAL** : Used to play back the dynamic range in the normal mode.
- **NARROW** : Used to suppress the high-pitched sounds and the low-pitched sounds to make speeches listener-friendly.

## Setting the language

It is possible to initialize the voice language, the superimposed language and the language to be displayed on the menu.

For detailed method for changing the language while in the looking and listening of the DVD, refer to "Changing the voice language" on Page 152 and "Changing the superimposed language" on Page 151.

1 Select **LANGUAGE** (LANGUAGE) in the DVD SET UP screen.

2 Select the language item you want to set.



- AUDIO LANGUAGE** : Used to set the voice language.
- SUBTITLE LANGUAGE** : Used to set the superimposed language.
- MENU LANGUAGE** : Used to set the language to be displayed on the menu.

3 Select the voice you want to set. When there is no language found you want to set, select **OTHERS** (OTHERS).



Selecting the language terminates this operation.

4 Enter the LANGUAGE CODE of the language you want to set and then select **OK** (OK).



## Setting the password of the parental level

The parental level is used to restrict the looking and listening of the DVD according to the level set. To set the parental level, it is necessary to register a password in advance.

When setting the parental level, it sometimes occurs that a password is asked for while in the looking and listening of the DVD. In that case, enter the password you used when setting the parental level.

1 Select **PARENTAL** (PARENTAL) in the DVD SET UP screen.

2 Select **REGISTER PASSWORD** (REGISTER PASSWORD).



When the password has been set and you want to change it, select **CHANGE PASSWORD** (CHANGE PASSWORD).

3 Select the numeric key to enter a 4-digit password, and then select **OK** (OK).



Selecting **CLEAR** (CLEAR) deletes what has been entered.

4 As a password for confirmation, enter a 4-digit password that is the same as the one used in step 3 and then select **OK** (OK).



When setting the parental level, follow the procedure given at step 4 and the succeeding steps on Page 173.

## Setting the parental level

Set the parental level to restrict the looking and listening of the DVD according to the level set. In order to set the parental level, a password is used. When a password is not yet set, it is necessary to register a password. (See Page 172.)

- 1 Select **PARENTAL** (PARENTAL) in the DVD SET UP screen.
- 2 Select **CHANGE LEVEL** (CHANGE LEVEL).



- 3 Select the numeric keys to enter a 4-digit password and then select **OK** (OK).



Selecting **CLEAR** (CLEAR) deletes what has been entered.

- 4 Select **◀ ▶** of the PARENTAL LEVEL.  
The smaller the numeric value of the parental level, the more severe the restriction. And the larger the numeric value, the more gentle the restriction.
- 5 Select the numeric keys to enter a 4-digit password and then select **OK** (OK).  
If you want to change the password, select [CHANGE PASSWORD], and then change it referring to "Setting the password of the parental level" on Page 172.

Setting the audio

---

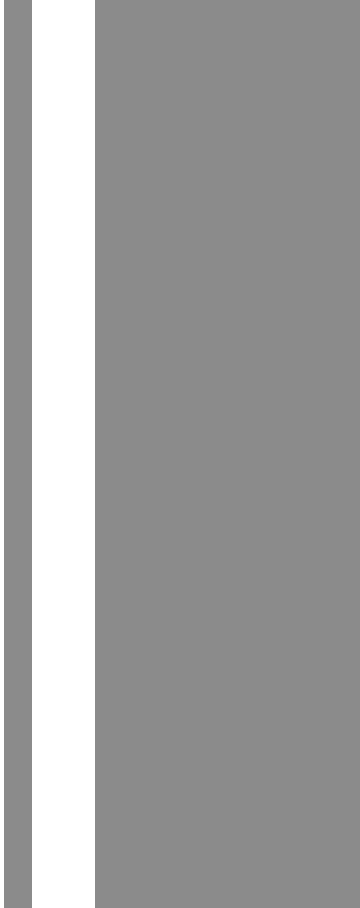

**Handsfree**





## Before using the Handsfree

---

### What can be made with the handsfree

It is possible to connect the Bluetooth Phone of which the operation has been confirmed to the in-vehicle equipment through the Bluetooth format (wireless) to make a phone call from the in-vehicle equipment or take an incoming phone call.

Since the Bluetooth format is wireless, a connection between the in-vehicle equipment and the Bluetooth Phone can be made without placing them in the close vicinity of each other. The Bluetooth Phone can be used with it left in the breast pocket or bag.

The Bluetooth Phone that is compliant with the in-vehicle equipment must meet the following requirements.

- Bluetooth Specification Ver. 1.1 or above (Ver. 1.2 or above is recommended.)
- Corresponding Profiles are as shown below.
  - HFP (Hands Free Profile) Ver. 1.0 (Ver. 2.0 or above is recommended.)
  - OPP (Object Push Profile) Ver. 1.1



"Bluetooth" is a trademark of Bluetooth SIG, Inc.

### What cannot be done with the handsfree

.....

In the following cases, the functions of the handsfree cannot be used.

- While not in the phone call area.
- While in the phone call being restricted due to the lines congested.
- When the phone book data is being transmitted from the Bluetooth Phone.
- When the Bluetooth Phone is being used, due to data communication.
- When the Bluetooth Phone is out of order.
- When the Bluetooth Phone is not connected to the in-vehicle equipment.
- When the battery of the Bluetooth Phone has run down.
- When the power switch of the Bluetooth Phone is turned off.
- When the Bluetooth Phone is not set to the handsfree mode.
- When a changeover is made on the in-vehicle side from the phone book transmission to the handsfree.
- When the Bluetooth Phone cannot be used for other reasons.

## Precautions to be taken when using the Bluetooth equipment

Please take note of the following when using the Bluetooth equipment.

### WARNING

- For safety's sake, the driver should avoid the operation of the Bluetooth Phone while driving.
- Do not make a phone call while driving. When you have an incoming call, bring your car to a stop in a safe place in a calm manner before taking the incoming phone call. When you have to absolutely take a phone call, tell the caller "I'll call you back" by handsfree. And then call him back after stopping the car in a safe place.
- The buttons for the touch screen that cannot be used are displayed in light color (tone down).  
Operating the navigation system while in driving could cause your attention to be distracted from the current traffic conditions. And in consequence, this could result in a severe or fatal accident. Follow the descriptions of all operations and the instructions for safety given in this manual without fail.
- Please comply with the instructions specified in the laws and regulations concerning the use of the telephone in the vehicle.

### CAUTION

- Do not leave the Bluetooth Phone in the vehicle. (The temperature in a sun-heated car may go up extremely high.)
- When using the Bluetooth Phone, be careful not to get it close to the in-vehicle equipment. Getting it too close to the in-vehicle equipment may result in deterioration in tone quality or a poor connecting condition.
- The frequency band used by this equipment is the same band on which other industrial, scientific and medical equipment such as microwave ovens, radio stations (a license required) to be used by the production line in the factory to identify movable bodies, specific small power radio stations (a license not required) and amateur radio stations (a license required) is being operated. (These three type radio stations mentioned above are hereinafter referred to as "other radio stations.") Before using this equipment, be sure to check to see if "other radio stations" are being operated in the vicinity. Should there be a detrimental radio interference from this equipment to "other radio stations," move the equipment to another location as soon as possible to avoid radio interference. The frequency band used by this equipment is in the 2.4 GHz zone. The FH-SS modulation is employed as a modulation method. The expected inflicting interference distance is less than 10m. This equipment uses a full band and can avoid a band used by a movable body identification device.

## Name of each part



The name of each part used by the functions of the handsfree is as shown below.

### ■ In-vehicle equipment

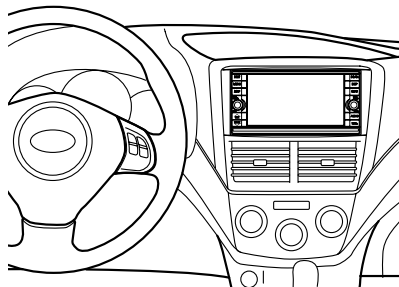
Operating the touch switches displayed on the screen allows you to use the functions of the handsfree.



### ■ Steering switches

Pressing the  switch short allows you to answer an incoming phone call. Pressing the  switch long allows you to hang up the phone.

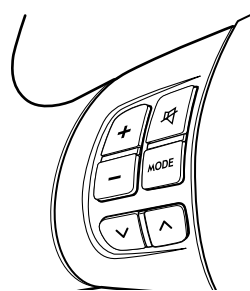

### ■ Microphone

Used while in the phone call. (dealer option)  
For details, check with the dealer.

## Phone voice

After making a phone call or having a phone call, you can talk over the phone through mike and speaker.

- An incoming call notice and a voice output while in the phone call are output from the speaker on the driver's seat side and passenger's seat.
- When a voice or an incoming call signal is issued by the handsfree, the sound from the audio and the navigation system is muted.

## Various types of displays

Selecting  (Phone) with the **MENU** button pressed displays the PHONE MENU screen, in which you can set and operate the functions of the handsfree. The explanation here is given of the various kinds of displays shown on the PHONE MENU screen.

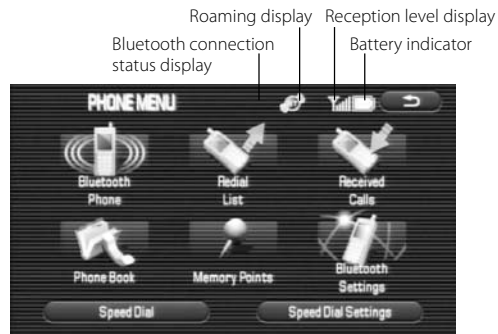

- When "Out of the range" is being displayed, you are now out of the service area, or in the location to which no radio waves get through. On occasions like this, you cannot use the Bluetooth Phone. Move to a location where a clear reception can be obtained.
- The reception level does not always conform to the display of the Bluetooth Phone. The reception level may not be displayed for some model types.

## Battery indicator

This shows a rough battery capacity of the Bluetooth Phone. However, this is not displayed while in the transmission of the phone book data.

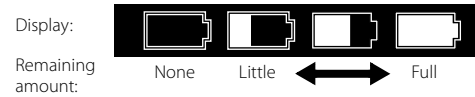

- The display of the battery capacity may not sometimes conform to that of the Bluetooth Phone. And also, the battery capacity may not be displayed for some model types.
- This system is not provided with a charging function for a cell phone.

## Reception level display

This shows a rough standard of the reception level of radio waves. However, this is not displayed while in the transmission of the phone book data.



## Bluetooth connection status display

---

This displays the Bluetooth connection status of the Bluetooth Phone.



The Bluetooth Phone is correctly connected to the in-vehicle equipment.



The Bluetooth Phone is connected to the in-vehicle equipment, but radio waves are weak.



The Bluetooth Phone is not connected to the in-vehicle equipment. When using the handsfree, register the Bluetooth Phone and the in-vehicle equipment, and then connect them each other. (See "Registering the Bluetooth Phone" on Page 183)

## Roaming display

---

Roaming is a service that provides a continuous use of the system by using the facilities of a company with which the telephone company ties up when you are out of the stipulated service area.

When the roaming function is being used, "Rm" is displayed.

### **When parting with your car**

When using the handsfree, a lot of personal information is registered.

When parting with your car, delete your personal information and data referring to the following.

And data once deleted cannot be restored to their original state. Be careful not delete data mistakenly.

Deleting all the outgoing and incoming call history. (See Page 200.)

Deleting all the phone book data. (See Page 212.)

Deleting the registered Bluetooth Phone from the in-vehicle equipment. (See Page 214.)

Changing the Device Name of the in-vehicle equipment displayed in the Bluetooth Phone. (See Page 216.)

Changing the Pass-Key to be used when certifying the Bluetooth Phone. (See Page 222.)

## Making preparations of the handsfree

### Registering the Bluetooth Phone

To use the Bluetooth Phone in interlock with the in-vehicle equipment, it is necessary to register the Bluetooth Phone with the in-vehicle equipment in advance.

#### NOTE

It is possible to register up to five Bluetooth Phones with the in-vehicle equipment. However, Bluetooth Phones that can be used with the in-vehicle equipment are restricted only to those selected by the phone selection.

1 Press the **MENU** button.

2 Select  (Phone).



3 Select  (Bluetooth Settings).



4 Select **Register** (Register).



5 Register the Bluetooth equipment from the Bluetooth Phone and then enter the PASS-KEY displayed on the screen for it to be transmitted.



## Making preparations of the handsfree

---

The device name of the Bluetooth Phone is displayed on the DEVICE LIST.

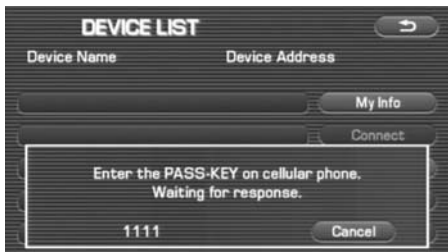

The Bluetooth Phone most recently registered is selected as a Bluetooth Phone to be used with the in-vehicle equipment.



### NOTE

- For detailed method for the transmission of the PASS-KEY from the Bluetooth Phone, refer to the instruction manual of the Bluetooth Phone.
- With **Autoconnect** (Autoconnect) set to "ON" on the DEVICE LIST screen in advance, the in-vehicle equipment automatically accept the connection of the Bluetooth Phone. Selecting **Autoconnect** (Autoconnect) makes a changeover between ON and OFF.
- When registering two or more Bluetooth Phones, it is necessary to select a Bluetooth Phone for connection.

## Connecting the Bluetooth Phone

To use the Bluetooth Phone in interlock with the in-vehicle equipment, the Bluetooth Phone registered with the in-vehicle equipment is required to be connected to the in-vehicle equipment. When  is displayed on the PHONE MENU screen, or when changing a Bluetooth Phone to be connected, conduct this operation.

With "Autoconnect" set to "ON" in advance, a connection is made automatically to the Bluetooth Phone most recently connected. It is recommended that "Autoconnect" is set to "ON" in advance.

1 Press the **MENU** button.

2 Select  (Phone).



3 Select  (Bluetooth Settings).



4 Select the Bluetooth Phone you want to connect.



Making preparations of the handsfree

---

**5** Select **Connect** (Connect).



**NOTE**

- With **Autoconnect** (Autoconnect) set to "ON" on the DEVICE LIST screen in advance, the in-vehicle equipment automatically accept the connection of the Bluetooth Phone. Selecting **Autoconnect** (Autoconnect) makes a changeover between ON and OFF.
- When a connection has been made to another Bluetooth Phone, a confirmation message is displayed.

**6** Select **Yes** (Yes).



The Bluetooth Phone selected is connected by the Bluetooth.

## Speaking over the handsfree

### Making a phone call

#### Entering a phone number to make a phone call

It is possible to select the in-vehicle equipment to enter a phone number and make a phone call.

1 Press the **MENU** button.

2 Select  (Phone).



3 Select  (Bluetooth Phone).



4 Select numeric keys to enter a phone number and then select .



**NOTE**

- Selecting **\*/+** briefly allows you to enter "\*". And then selecting **\*/+** for more than two seconds allows you to enter "+".
- Selecting **◀** allows you to delete a digit entered.

**5** Select **Yes** (Yes).



You have a phone call. Speak over the phone.



When the phone call is over, hang up the phone. (See Page 198.)

## Making a phone call from the outgoing or incoming call history

It is possible to make a phone call to a phone number in the outgoing or incoming call history.

**1** Press the **MENU** button.

**2** Select **Phone**.



**3** Select **Redial List** or **Received Calls**.



4 Select the phone number and then select .



You have a phone call. Speak over the phone.



When the phone call is over, hang up the phone. (See Page 198.)

**NOTE**

The following can be conducted from this screen.

- It is possible to register a phone number with the phone book. (See Page 206.)
- It is possible to delete an outgoing or incoming call history. (See Page 200.)

5 Select  (Yes).



## Making a phone call from the phone book

It is possible to select a phone number from the phone book registered with the in-vehicle equipment to make a phone call.

### NOTE

It is possible to copy the data in the phone book from the phone book of the Bluetooth Phone into that of the in-vehicle equipment. (See Page 201.)

1 Press the **MENU** button.

2 Select  (Phone).







3 Select  (Phone Book).



4 Select the name or phone number of a person to whom you want to make a phone call.



- Selecting alphabets, numerical characters or [Others] displays a phone book data to which the acronym has relevance.
- Selecting  scrolls the display to display a phone book data 5 positions ahead.
- Selecting  scrolls the display to display a phone book data 1 position ahead.
- Selecting  scrolls the display to display a phone book data 1 position behind.

- Selecting  scrolls the display to display a phone book data 5 position behind.

**NOTE**

The following can be conducted from this screen.

- It is possible to register the phone book data. (See Page 203.)
- It is possible to register the phone book data from the Bluetooth Phone. (See Page 201.)
- It is possible to delete all the phone book data. (See Page 212.)

**5** Select the phone number and then select .



**NOTE**

The following can be conducted from this screen.

- It is possible to edit the phone book data. (See Page 208.)
- It is possible to delete the phone book data. (See Page 210 and 212.)

**6** Select  (Yes).

You have a phone call. Speak over the phone.



When the phone call is over, hang up the phone.

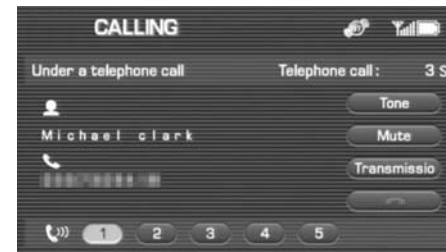



## Making a phone call from the Speed Dial

It is possible to select a phone number from the Speed Dial registered with the in-vehicle equipment to make a phone call.

### NOTE

To use the Speed Dial, the phone number needs to be registered onto Speed Dial beforehand. (See page 218)

- 1 Press the **MENU** button.
- 2 Select  (Phone).



- 3 Select  (Speed Dial).



- 4 Select the name or phone number of a person to whom you want to make a phone call.

You have a phone call. Speak over the phone.



When the phone call is over, hang up the phone.



## Making a phone call to the phone number of the Memory Point

It is possible to make a phone call to the phone number registered as a memory point.

- 1 Press the **MENU** button.
- 2 Select  (Phone).







- 3 Select  (Memory Points).

When the Memory Points is not stored in the in-vehicle equipment,  (Memory Points) cannot be selected.



- 4 Select the Memory Point.



- Selecting  scrolls the display to display a memory point 5 position ahead.
- Selecting  scrolls the display to display a memory point 1 position ahead.
- Selecting  scrolls the display to display a memory point 1 position behind.
- Selecting  scrolls the display to display a memory point 5 position behind.
- Selecting **Attribute** (Attribute) sorts the memory points in the order of shorter distances.
- Selecting **Icon** (Icon) sorts the memory points in icon order.
- Selecting **Name** (Name) sorts the memory points in name order.
- Selecting **Date** (Date) sorts the memory points in registered data order.

5 Select .



6 Select  (Yes).

You have a phone call. Speak over the phone.  
When the phone call is over, hang up the phone. (See Page 198.)



## Making a phone call from the Bluetooth Phone

It is possible to directly operate the Bluetooth Phone connected to the in-vehicle equipment to make a phone call.

Even while speaking over the Bluetooth Phone, operating either of the following, when connected to the in-vehicle equipment, displays the handsfree screen in the in-vehicle equipment.

- Press the phone switch.
- Select  (Phone) on the menu screen.

In this case, it is not possible to conduct any operations in relation to the handsfree from the in-vehicle equipment.

### **WARNING**

**For safety's sake, the driver should refrain from the operation of a cell phone while driving.**

## Taking a phone call and declining an incoming call

When you have a phone call, the information of a caller is displayed together with an incoming call sign. When the name of a caller is registered with the phone book, the name of the caller is displayed. On an occasion other than the above, a phone number is displayed. For a caller with no outgoing call notice, no information is displayed.



## Taking a phone call

It is possible to take an incoming phone call and talk over the phone.

- 1 Select **Call** (Call) or press the phone switch of the steering switch.  
You can take a phone call. Speak over the phone.  
When the phone call is over, hang up the phone. (See Page 198.)

## Putting an incoming phone call on hold

It is possible to put an incoming phone call on hold to take it later.

- 1 Select **Hold** (Hold) or keep pressing the phone switch of the steering switch for more than 2 seconds.
- 2 When taking it later, select **Phone** or press the phone switch.

When the phone call is over, hang up the phone. (See Page 198.)



## Hanging up an incoming call before answering it (Denial of an incoming call)



It is possible to hang up an incoming call before answering it. And it is also possible, while putting a phone call on hold, to conduct the following operations to hang up the phone call.

- 1 Select **Disconnect** (Disconnect) or keep pressing the phone switch of the steering switch for more than 2 seconds.

The phone call is hanged up.

## Speaking over the phone

### Adjusting the tonal volume

It is possible to adjust the tonal volume.

- 1 While speaking over the phone, select either of the figures **1** to **5** shown on the lower section of the screen or press the volume adjusting switch of the steering switch.



#### NOTE

- The larger the figure you select, the larger the tonal volume.
- Pressing the [+] button of the volume switch of the steering switch increases the tonal volume, while pressing the [-] button decreases the tonal volume.

### Muting the voice on this side

It is possible to make your voice unheard to the other party (Mute). However, you can hear the voice of the other party.

- 1 Select **Mute** (Mute) while speaking over the phone.



Select **Mute** (Mute) again to cancel the mute.

## Transmitting the phone call

It is possible to transmit the phone call of the in-vehicle equipment to the Bluetooth Phone. And also, the phone call of the Bluetooth Phone can be transmitted to the in-vehicle equipment.

- 1 Select **Speaker** (Speaker) while speaking over the phone or putting the answer on hold.



You can speak over the Bluetooth Phone.

### NOTE

- While speaking over the Bluetooth Phone, the only operation that can be made is to transmit the phone call again to the in-vehicle equipment.
- If you want to speak over the in-vehicle equipment, select **Speaker** (Speaker).

## Hanging up the phone

Hang up the phone while speaking over the phone or after the phone call is over.

- 1 Select  or keep pressing the phone switch of the steering switch for more than 2 seconds.



### NOTE

It is also possible to hang up the phone on the Bluetooth Phone.

## Using the outgoing or incoming call history



### Checking the outgoing or incoming call history

It is possible to check the outgoing or incoming call history.

1 Press the **MENU** button.

2 Select  (Phone).



3 Select  (Redial List) or  (Received Calls).



4 Check the outgoing or incoming call history.



- The maximum number of calls in the history items that can be checked is five for each of the outgoing calls and the incoming calls.
- The history of phone calls directly sent out from the Bluetooth Phone and the history of phone calls received when not connected to the in-vehicle equipment are not displayed.

#### NOTE

The following can be conducted from this screen.

- It is possible to make a phone call to the number displayed. (See Page 188.)
- It is possible to register a phone number with the phone book. (See Page 206.)
- It is possible to delete an outgoing or incoming call history displayed. (See Page 200.)





## Deleting all the outgoing and incoming call history

Delete all the outgoing and incoming call history. History once deleted cannot be restored to its original state.

1 Press the **MENU** button.

2 Select  (Phone).



3 Select  (Redial List) or  (Received Calls).



4 Select .

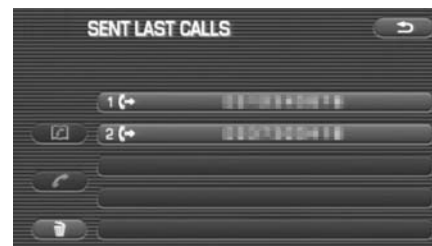

### NOTE

The following can be conducted from this screen.

- It is possible to make a phone call to the phone number displayed. (See Page 188.)
- It is possible to register a phone number with the phone book. (See Page 206.)

5 Select **Yes** (Yes).



All of the outgoing or incoming call history are deleted.

### NOTE

It is necessary to delete the outgoing call history and the incoming call history separately.

## Using the phone book

---

### Registering the phone book data

Up to 1000 phone book data can be registered with the phone book of the in-vehicle equipment. Contents that can be registered as phone book data are as shown below.

- **Name:** It is possible to register up to 24 characters. They can be clipped.
- **Phone number 1, phone number 2:** Up to 25 digits can be registered. Any letter other than "0 to 9, \*, #" cannot be used.

### Transmitting the phone book of the Bluetooth Phone

.....

It is possible to transmit the phone book data from the phone book of the Bluetooth Phone to that of the in-vehicle equipment. Phone book data that can be transmitted are as shown below.

- **Name**

When the name of the phone book data of the Bluetooth Phone is in excess of 24 character, up to 24 characters from the start are registered with the phone book of the in-vehicle equipment.

When a non-corresponding character is registered in the name of the phone book data of the Bluetooth Phone, this is registered with the phone book of the in-vehicle equipment as a blank.
- **Phone number 1**
- **Phone number 2**

When more than 3 phone numbers are registered with the phone book data of the Bluetooth Phone, with two or more phone book data of the same name created, they are divided to be registered with the phone book of the in-vehicle equipment.

When any letters other than "0 to 9, \*, #" are included in the phone book data of the Bluetooth Phone, those relevant letters are deleted to be registered with the phone book of the in-vehicle equipment.

When the phone book data of the Bluetooth Phone is a phone number in excess of 25 digits, it is not registered with the phone book of the in-vehicle equipment.

1 Press the **MENU** button.

2 Select  (Phone).



3 Select  (Phone Book).



4 Select **Download** (Download).



5 Select **Add** (Add).

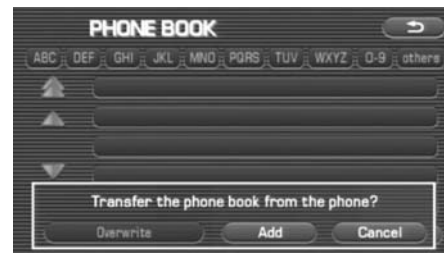

**NOTE**

When there is a phone book data already in the phone book, select **Overwrite** (Overwrite) or **Add** (Add). Selecting **Overwrite** (Overwrite) overwrites the existing phone book. And selecting **Add** (Add) adds a phone book data to the existing phone book data as a new data.

**6** Transmit the phone number data from the Bluetooth Phone.



The phone book data is displayed in the phone book



**NOTE**

For detail method for transmitting the phone book data from the Bluetooth Phone, refer to the instruction manual of the Bluetooth Phone.

**Registering a new data with the phone book**

Register a new phone book data with the phone book. It is possible to register a name and up to 2 phone numbers as phone book data.

- 1 Press the **MENU** button to edit the phone book data registered.
- 2 Select  (Phone).



- 3 Select  (Phone Book).



4 Select **New** (New).



5 Select **Name** (Name).

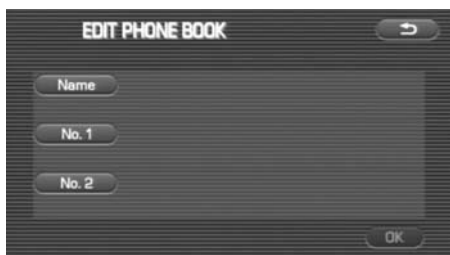

**NOTE**

The Name doesn't need to be entered. When not entered, the phone number is displayed on the phone book. And when not entered, proceed to step 7.

6 Enter the name of the phone book data and select **OK** (OK).



- Selecting **←** deletes 1 character.
- Selecting **Others** (Others) displays other characters. Then selecting **←** or **→** displays the preceding or succeeding screen.
- Selecting **Sym.** (Sym.) displays figures and symbols. Then selecting **←** or **→** displays the preceding or succeeding screen.
- Selecting **a - z** displays alphabets and symbols.
- Selecting **Caps** (Caps) allows you to make a changeover between upper case and lower case.

7 Select **No. 1** (No.1) or **No. 2** (No.2).

- 8 Enter the phone number and select **OK** (OK).



- Selecting **\*/+** briefly allows you to enter "\*" and selecting **\*/+** for more than 2 seconds allows you to enter "+".
- Selecting **◀** deletes 1 character.

- 9 Select **OK** (OK).



A phone book data is added.





## Registering data with the phone book from the outgoing or incoming call history

It is possible to register a phone number of the outgoing or incoming call history with the phone book.

1 Press the **MENU** button.

2 Select  (Phone).



3 Select  (Redial List) or  (Received Calls).



4 Select the phone number and then select .



### NOTE

The following can be conducted from this screen.

- It is possible to make a phone call to a phone number displayed. (See Page 188.)
- It is possible to delete an incoming or outgoing call history displayed. (See Page 200.)

5 Select **Name** (Name).



- 6 Enter the name of a phone book data and select **OK** (OK).

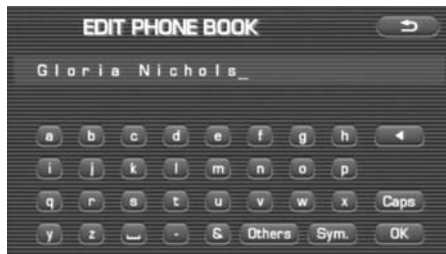

- Selecting **←** deletes 1 character.
- Selecting **Others** (Others) displays other characters. Then selecting **←** or **→** displays the preceding or succeeding screen.
- Selecting **Sym.** (Sym.) displays figures and symbols. Then selecting **←** or **→** displays the preceding or succeeding screen.
- Selecting **a - z** displays alphabets.
- Selecting **Caps** (Caps) allows you to make a changeover between upper case and lower case.

- 7 Select **OK** (OK).

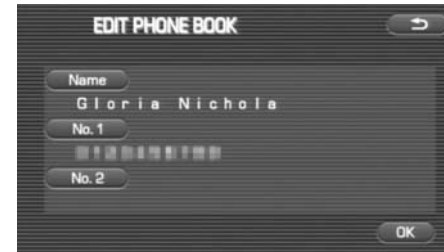

The phone number is registered with the phone book data.

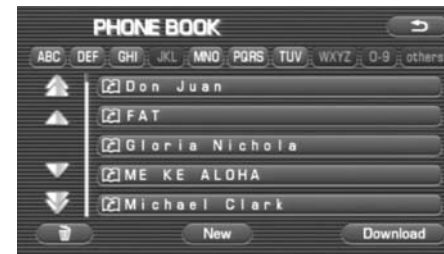



## Editing or deleting a phone book data

### Editing a phone book data

It is possible to edit the name of a phone book data and a phone number.

1 Press the **MENU** button.

2 Select  (Phone).







3 Select  (Phone Book).

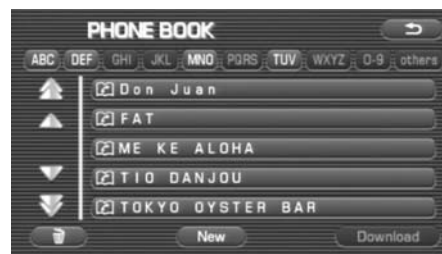

4 Select the phone book data you want to edit.



- Selecting alphabets, figures or **Others** (Others) given in the upper section displays a phone book data to which the acronym has relevance.
- Selecting  scrolls the display to display a phone book data 5 positions ahead.
- Selecting  scrolls the display to display a phone book data 1 position ahead.

- Selecting  scrolls the display to display a phone book data 1 position behind.
- Selecting  scrolls the display to display a phone book data 5 positions behind.

**NOTE**



The following can be conducted from this screen.

- It is possible to register a phone book data. (See Page 203.)
- It is possible to register a phone book data from the Bluetooth Phone. (See Page 201.)
- It is possible to delete all the phone book data. (See Page 212.)

**5** Select  (Edit).**NOTE**

The following can also be conducted from this screen.

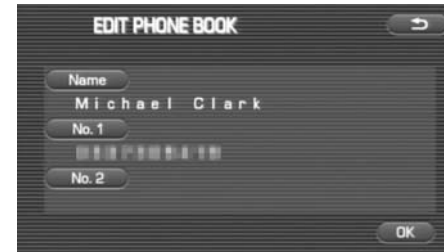
- It is possible to delete a phone book data. (See Page 210 and 212.)
- It is possible to make a phone call to the phone number selected. (See Page 190.)

**6** Select an item you want to edit.**7** Enter a new data and select  (OK).**NOTE**

For details of the editing method, refer to "Registering a new data with the phone book." (See Page 203.)

- 8 Select **OK** (OK).

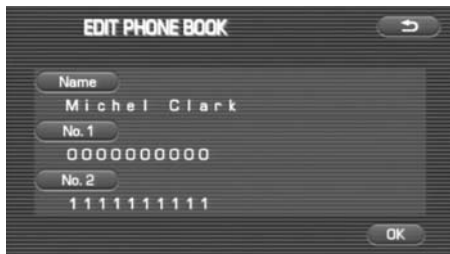

The result of the edit is reflected in the phone book data.

## Selecting a phone book data to delete it

Select a phone book data registered and delete it.

### NOTE

A phone book data once deleted cannot be restored to its original state.

- 1 Press the **MENU** button.
- 2 Select  (Phone).



- 3 Select  (Phone Book).



#### 4 Select a phone book data you want to edit.



- Selecting alphabets, figures or **Others** (Others) given in the upper section displays a phone book data to which the acronym has relevance.
- Selecting scrolls the display to display a phone book data 5 positions ahead.
- Selecting scrolls the display to display a phone book data 1 position ahead.
- Selecting scrolls the display to display a phone book data 1 position behind.
- Selecting scrolls the display to display a phone book data 5 positions behind.

#### NOTE

The following can be conducted from this screen.

- It is possible to register a phone book data. (See Page 203.)
- It is possible to register a phone book data from the Bluetooth Phone. (See Page 201.)
- It is possible to delete all the phone book data. (See Page 212.)

#### 5 Select **Delete** (Delete).



#### NOTE

The following can be conducted from this screen.

- It is possible to edit a phone book data. (See Page 208.)
- It is possible to make a phone call to the phone number selected. (See Page 190.)

#### 6 Select **Yes** (Yes).

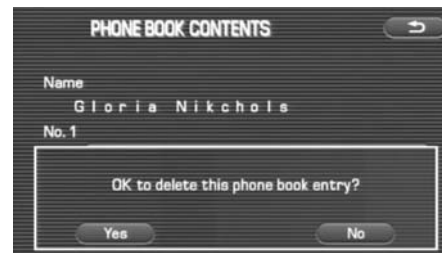

The phone book data selected is deleted.

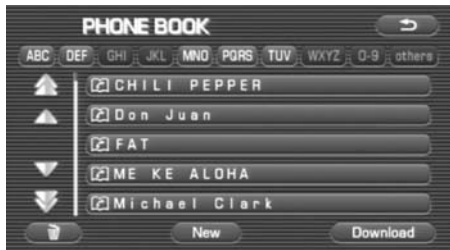

## Deleting all the phone book data

It is possible to delete all the phone book data.

### NOTE

Phone book data once deleted cannot be restored to their original state.

- 1 Press the **MENU** button.
- 2 Select  (Phone).



- 3 Select  (Phone Book).



4 Select .



5 Select  (Yes).

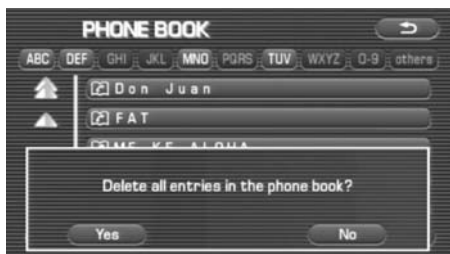

All the phone book data are deleted.

## Other Bluetooth settings

### Deleting the registered Bluetooth Phone from the in-vehicle equipment

Delete the Bluetooth Phone registered with the in-vehicle equipment.

#### NOTE

When deleting the Bluetooth Phone with the Bluetooth Phone connected to the in-vehicle equipment, no automatic connection is made.

1 Press the **MENU** button.

2 Select  (Phone).



3 Select  (Bluetooth Settings).



4 Select a Bluetooth Phone name you want to delete.



5 Select .



6 Select  (Yes).



The Bluetooth Phone registered is deleted.

**NOTE**

- When you want to use again the deleted Bluetooth Phone in interlock with the in-vehicle equipment, register and connect it again.
- Even when the Bluetooth Phone is deleted from the in-vehicle equipment, the phone book data transmitted from the Bluetooth Phone and the outgoing and incoming call history remain as they are.



## Changing the Device Name of the in-vehicle equipment displayed in the Bluetooth Phone

It is possible to change the Device Name of the in-vehicle equipment displayed in the Bluetooth setting of the Bluetooth Phone.

1 Press the **MENU** button.

2 Select **Phone** (Phone).



3 Select **Bluetooth Settings** (Bluetooth Settings).



4 Select **My Info** (My Info).



5 Select **Device Name** (Device Name).



**6** Enter a new Device Name and select **OK** (OK).

- Selecting **←** deletes 1 character.
- The number of characters that can be entered is up to 20 characters.
- Selecting **Others** (Others) displays other characters. Then selecting **←** or **→** displays the preceding or succeeding screen.
- Selecting **Sym.** (Sym.) displays figures and symbols. Then selecting **←** or **→** displays the preceding or succeeding screen.
- Selecting **a - z** displays alphabets.
- Selecting **Caps** (Caps) allows you to make a changeover between upper case and lower case.

## Editing the Speed Dial setting

### Adding the phone number to the Speed Dial memory

It is possible to add the phone number from the Phone Book to Speed Dial memory.

#### NOTE

To add the phone number to the Speed Dial memory, the phone number needs to be registered onto Phone Book beforehand. (See page 201)

1 Press the **MENU** button.

2 Select  (Phone).



3 Select  (Speed Dial Settings).



4 Select  (Add).

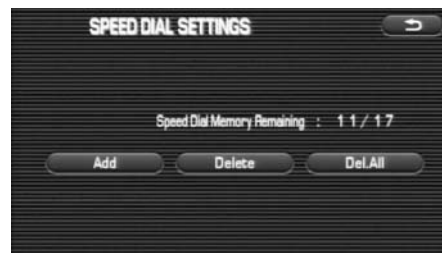

- 5 Select a name on a Phone Book whom you want to add to the Speed Dial memory.

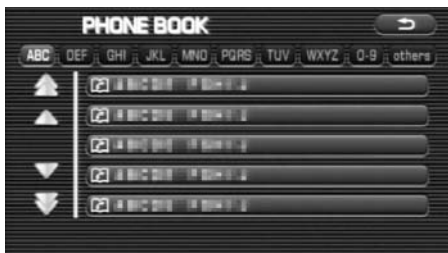

- 7 Select a registering position where you want to add to the Speed Dial memory.



- 6 Select a phone number which you want to add to the Speed Dial memory.



- 8 If you are going to overwrite the Speed Dial memory, select **Yes** (Yes) to finish the adding.



## Deleting the phone number from the Speed Dial memory

It is possible to delete the phone number from the Speed Dial memory.

1 Press the **MENU** button.

2 Select **Phone**.



3 Select **Speed Dial Settings** (Speed Dial Settings).



4 Select **Delete** (Delete).



5 Select a Speed Dial memory which you want to delete.



6 Select **Yes** (Yes).



8 Select **Yes** (Yes).



7 If you need to delete all memories from Speed Dial, select **Del.All** (Delete all) on step 4.



## Changing the Pass-Key used when certifying the Bluetooth Phone

When connecting the Bluetooth Phone to the in-vehicle equipment, the Pass-key is used for certification. It is possible to change the Pass-Key used for certification.

1 Press the **MENU** button.

2 Select  (Phone).



3 Select  (Bluetooth Settings).



4 Select  (My Info).



5 Select  (Pass-key).



6 Enter a new Pass-key and then select **OK** (OK).



**NOTE**

- Selecting  deletes 1 character.
- What can be entered as a Pass-key are limited only to numeric characters "0 to 9" in 4 to 8 digits.



Other Bluetooth settings

---

224 Handsfree

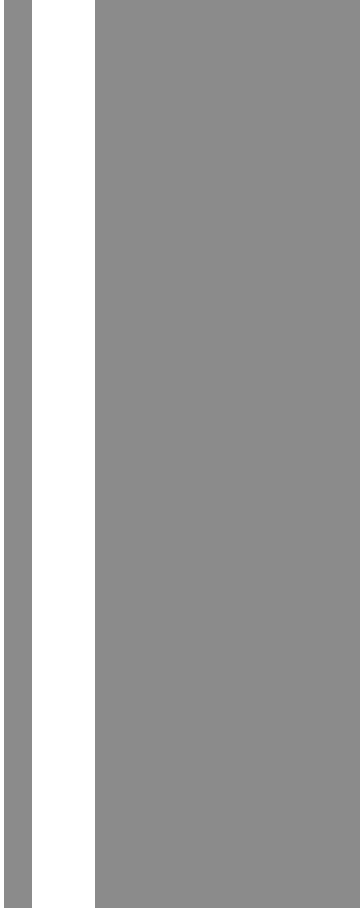

# **Vehicle Information**



## Before Use

### Precautions when using the system

#### WARNING

##### READ THIS MANUAL FIRST

Read this supplement carefully before using your vehicle information system. We are not liable for accidents or other problems resulting from failure to follow the instructions in this supplement.

##### AVOID OPERATING THE VEHICLE INFORMATION SYSTEM WHILE DRIVING

You should stop the vehicle in a safe place before operating the vehicle information system. For safety's sake, some of the vehicle information system's functions cannot be used unless the vehicle is stationary.

If you stare at the display with too much enthusiasm or operate the switches of the system while in driving, the navigation system could cause your attention to be distracted from the current traffic conditions. Please be sure to input in the system as much information as possible before taking your departure. And also please be sure to bring your car to a stop in a safe place if you need to input information.

The buttons for the touch screen that cannot be used are displayed in light color (tone down).

Operating the navigation system while in driving could cause your attention to be distracted from the current traffic conditions. And in consequence, this could result in a severe or fatal accident. Follow the descriptions of all operations and the instructions for safety given in this manual without fail.

##### LOOK AT THE AUDIO AND VISUAL SCREEN ONLY WHEN NECESSARY

When you need to look at the audio and visual screen, do so for the shortest time possible. Looking away from the road for too long could lead to an accident.

##### KEEP THE VOLUME LOW ENOUGH FOR YOU TO HEAR OUTSIDE SOUNDS

Keep the system's volume level low enough for you to be able to hear outside sounds while driving. To do otherwise may mean that you are unable to react appropriately to traffic conditions thus resulting in an accident.

**⚠ CAUTION****NEVER DISASSEMBLE OR MODIFY THE VEHICLE INFORMATION SYSTEM**

Any attempt to disassemble or modify the vehicle information system could lead to a fire, an electric shock, or some other type of accident.

**Do not continue using the vehicle information system if it malfunctions**

If the system shows any sign of malfunctioning (for example, the monitor gives no picture), stop using it immediately and contact the nearest SUBARU dealer. Continuing to use the system could lead to a fire, an electric shock, or some other type of accident.

**If the vehicle information system gets contaminated, emits smoke or an odd smell, stop using it**

If a foreign object gets inside the system, liquid is spilled onto the system, or the system emits smoke or an unusual smell, stop using it immediately and contact the nearest SUBARU dealer. Continuing to use the system could lead to a fire, an electric shock, or some other type of accident.

### ■ About the vehicle information screen

- Subjecting the control buttons or liquid crystal display to excessive shock could result in vehicle information screen deformation or other damage.
- Keep any heat source (including lighted cigarettes) away from the vehicle information screen. If a heat source is brought into contact with the vehicle information system cabinet and panel, they could be deformed or otherwise degraded.
- In extreme cold, the vehicle information screen may operate sluggishly and the display may dim. Such conditions do not indicate a problem. They will disappear when the cabin temperature rises to a normal temperature.
- Tiny black and white dots may occasionally appear in the liquid crystal display. These dots are a normal characteristic of the display. They do not indicate a problem.
- When the vehicle information screen requires cleaning, gently wipe it with a silicone cloth or other soft cloth. If necessary, spray the cloth with neutral cleaning fluid. Be sure to wipe away any cleaning fluid left on the vehicle information screen. Do not spray the cleaning fluid directly onto the vehicle information screen. Spraying cleaning fluid directly onto the vehicle information screen could cause an adverse effect on internal components. It is also not a good idea to wipe the vehicle information screen with a stiff cloth or attempt to clean it using thinners, alcohol, or any other volatile solvent. Doing so could leave scratches and/or erase the control button labels.
- Do not allow the vehicle information screen to get wet. If it gets wet (allowing, for example, to a spilled drink or wet umbrella), its internal electronic circuitry may malfunction.

- In hot weather, cool the passenger compartment down before using the vehicle information system. The liquid crystal display operates correctly at temperatures between 0°C and 60°C (32°F and 140°F). When the temperature exceeds 60°C (140°F), the vehicle information system circuit protection function is activated, causing the display to dim.

#### NOTE

- In the interest of safety, the use of some functions may be unavailable while in driving. The button for a touch screen that cannot be used will be displayed in tint color (toned down).
- Liquid-crystal displays may be difficult to read when wearing polarized glasses.

## Displaying Vehicle Information Screen

The vehicle information screen provides a variety of information on your vehicle and driving. It also gives ways to program certain functions available in your vehicle.

- 1 First, press the **INFO** button, then select any of the keys on the screen.

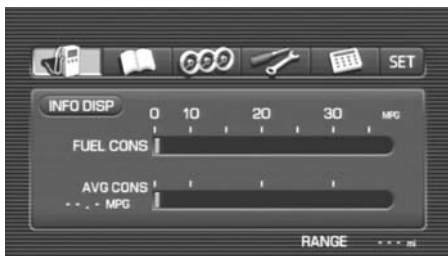

The screen displays the current fuel consumption rate, average fuel consumption rate, and the range you can drive on the remaining fuel. See Pages 230 through 231.



The screen displays the driving record data. The monitor system can retain the record data. See Pages 232 through 237.



The screen displays the reading of the following three meters: average fuel consumption rate, current fuel consumption rate and throttle opening percentage. See Page 237.



You can program your maintenance schedule and other maintenance-related items from this screen. See Pages 238 through 239.



You can use a calculator. You can also convert units, for example, between miles and kilometers. See Page 242.



You can program certain monitor and other system functions. See Pages 239 through 242.

### NOTE

- You may not be able to use the vehicle information screen if data cannot be properly retrieved from the relevant vehicle systems.

## Displaying Vehicle Information and Programming Vehicle System Functions

### Displaying fuel consumption information and programming for the automatic alarm display

#### ■ Displaying fuel consumption information

Use the following procedure to display the current fuel consumption rate, average fuel consumption rate, and range you can drive on the remaining fuel.

1 Press the **INFO** button.

2 Select .

The fuel consumption information screen will be displayed.

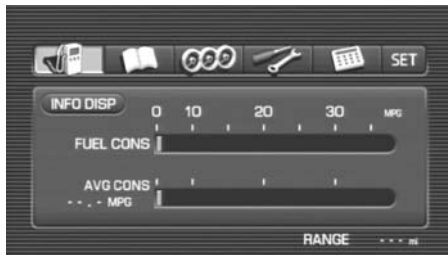

This completes the procedure.

#### NOTE

- Current and average fuel consumption rates will change all time due to driving and other conditions. The displayed data, including remaining fuel range data, may be different from the actual values. It is advisable that you refuel well in advance of reaching a displayed distance.

- Displayed current and average fuel consumption rates are based on estimates during running, not on accurate measurements.
- The average fuel consumption rate is associated with the driving after the last resetting of each trip meter. If the A or B trip meter is reset, the average fuel consumption rate will also be reset. After resetting the trip meter, the average fuel consumption rate will not be displayed until the vehicle has been driven approximately 1 mile from the reset point.

#### ■ Programming automatic alarm display for low remaining fuel level

You can program the display to make it automatically alert you of the correspondingly low fuel level remaining.

1 Press the **INFO** button and then select .

2 Select **INFO DISP**.

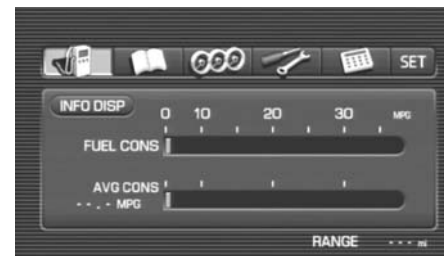

**3** Select  (off) for the desired alarm display item ("FUEL").

The selected  (off) should change to  (on).



**4** Select .

This completes the procedure.

**NOTE**

- If  (on) is displayed for "FUEL" (remaining fuel level), the automatic alarm display function has been activated for that item. To deactivate the function, select  (on). The indication should change from  (on) to  (off).

- The current fuel consumption rate alarm will be displayed only when the navigation screen is being used.



- The screen displaying an alarm looks like this:

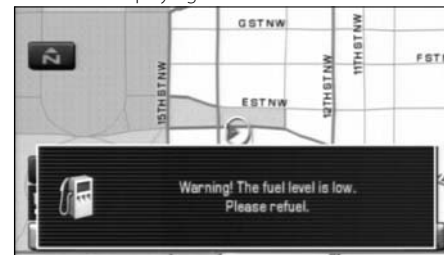



## Displaying, retaining, and erasing driving record data

### ■ Displaying driving record data

Use the following procedure to display the current driving record data (distance, time, and average fuel consumption rate).

1 Press the **INFO** button.

2 Select .

The driving record screen will be displayed.



This completes the procedure.

### NOTE

- If a vehicle's trip meter is reset, the corresponding drive distance and time display ("TRIP A" or "TRIP B") will also be reset.
- The drive time display is associated with the amount of time the ignition switch has stayed on since the trip meter was reset.

- When the vehicle battery is removed for repair or other purposes, the time is reset, but the distance is not reset. To reset the distance, press the trip meter knob. Please refer to the vehicle owner's manual for further details.
- The maximum time display possible is 240 hours (10 days).



### ■ Retaining driving record data

Use the following procedure to retain the current driving record data.

1 Press the **INFO** button and then select .

2 Select **LIST** (list) below the trip meter designation (TRIP A or TRIP B) of the driving record data you wish to keep.



- 3 Select  or  to specify the number of the history frame (data storage location) where the driving record data are to be retained.



- 4 Select **STORE** (store).
- 5 **Yes** (yes) will appear, requesting you to confirm your selection. Select it.



- 6 Select .

This completes the procedure.

**NOTE**



- A maximum of three different driving record data sets can be retained for each of the trip meters (TRIP A and TRIP B).
- Driving record data can be retained while viewing the retained driving record data list (See Page 235).
- If the data storage location (history frame) specified in Step 3 is already occupied by data, this data will be replaced with new data once you have confirmed Step 5.
- When driving record data have been successfully retained in a history frame, the history frame's heading will change from a number to the date of data retention.

**Erasing driving record data**

Use the following procedure to erase retained driving record data.

- 1 Press the **INFO** button and then select .
- 2 Select **LIST** (list) below the trip meter designation (TRIP A or TRIP B) about which you wish to erase the driving record data.



- 3 Select  or  to specify the number of the history frame (data storage location) where the driving record data to be erased are retained.



- 4 Select **RESET** (reset).
- 5 **Yes** (yes) will appear, requesting you to confirm your selection. Select it.



- 6 Select .

This completes the procedure.

**NOTE**

There is no way to restore erased driving record data. Please use this procedure with caution so as not to accidentally erase any important data.

**■ Displaying retained driving record data list**

Use the following procedure to display a retained driving record data list.

- 1 Press the **INFO** button and then select .
- 2 Select **TABLE** (table) for the trip meter (TRIP A or TRIP B) about which you wish to display the list.





This completes the procedure.

**NOTE**

Selecting  on a driving record data list screen will cause the monitor system to go back to the driving record screen.

**Retaining driving record data while viewing a retained driving record data list**

Use the following procedure if you want to retain driving record data while viewing a relevant data list.

- 1 Press the **INFO** button and then select .

- 2 Select **TABLE** (table) for the trip meter (TRIP A or TRIP B) about which you wish to retain the driving record data.



- 3 Select **STORE** (store).



- 4 Select the history frame (data storage location) in which the data are to be retained.

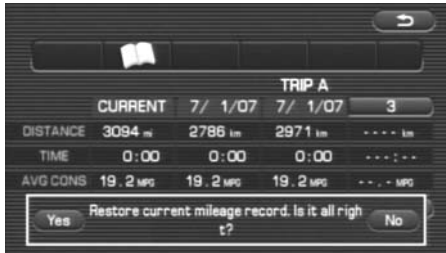

- 5 **Yes** (yes) will appear, requesting you to confirm your selection. Select it if the selection is correct.

- 6 Select **→**.

This completes the procedure.

**NOTE**

- A maximum of three different driving record data sets can be retained for each of the trip meters (TRIP A and TRIP B).
- When the data storage location (history frame) specified in Step 4 is already occupied by data, this data will be replaced with new data once you have confirmed Step 5.
- When the driving record data has been successfully retained in a history frame, the history frame's heading will change from a number to the date of the data retention.
- Data retention is cancelled if you select **No** (no) in the "Select data **No** (no) "box.

■ **Erasing driving record data while viewing a retained driving record data list**

Use the following procedure if you want to erase retained driving record data while viewing a driving record data list.

- 1 Press the **INFO** button and then select **📖**.
- 2 Select **TABLE** (table) for the trip meter (TRIP A or TRIP B) about which you wish to erase the driving record data.



- 3 Select **RESET** (reset).



- 4 Select the history frame (data storage location) where the data to be erased are retained.

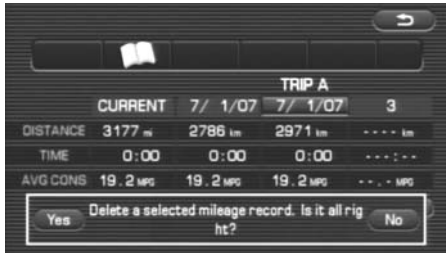

- 5 **Yes** (yes) will appear, requesting you to confirm your selection. Select it.

- 6 Select **→**.

This completes the procedure.

**NOTE**

- There is no way to restore erased driving record data. Please use this procedure with caution so as not to accidentally erase any important data.
- Data erasure is cancelled if you select **No** (no) in the "Select data **No** (no) "box.

### Displaying three meters

Use the following procedure to display the three meters showing the average fuel consumption rate, current fuel consumption rate and throttle opening percentage.

- 1 Press the **INFO** button.

- 2 Select **⊙**.

The three meters will be displayed on the screen.



This completes the procedure.

**NOTE**

- The average fuel consumption rate, current fuel consumption rate and throttle opening percentage indications are based on data retrieved from the relevant vehicle systems. For this reason, the status represented by meter readings may lag behind the current status.
- If data cannot be properly retrieved from the relevant vehicle systems, there will be no readings displayed on the meters.

## Maintenance schedule

### ■ Programming maintenance schedule

You can program your maintenance schedule into the monitor system for any of the following items, in terms of period and distance intervals.

- Maintenance
- Fluids check
- Tire pressure
- Engine oil

Use the following procedure:

- 1 Press the **INFO** button.
- 2 Select  .  
The maintenance information screen will be displayed.
- 3 Select the item (maintenance, fluids check, tire pressure, or engine oil) for which you wish to program the schedule.



- 4 Select  to enter the maintenance schedule date.



- 5 Select **SET** (set).
- 6 **Yes** (yes) will appear on the screen. Select it if the date is correct.
- 7 Select **NEXT** (next).
- 8 Select  to enter the maintenance schedule distance.



- 9 Select **SET** (set).
- 10 **Yes** (yes) will appear on the screen. Select it if the selection is correct.
- 11 Select **→**.

This completes the procedure.

**NOTE**

- You may program in either the date first (Steps 4 through 6) or distance (Steps 7 through 10). You may also program in a date or a distance only.
- Do not fail to select **SET** (set) whenever a date or distance has been entered, otherwise the entry will not be enabled.
- The date or distance entry can be cancelled by selecting **RESET** (reset) in Step 4 or 8.
- The programmed date and/or distance will be displayed in the maintenance information screen.
- The icon(s) in the reminder messages for expired date and/or distance will be displayed in red.

## Programming vehicle system functions

### ■ Programming other vehicle system functions

You can program the vehicle system functions described below by using the following procedure:

- 1 Press the **INFO** button and then select **SET** (set).
- 2 Select **☛**.

Select or set the following items.



#### KEY ALERT

Select or deselect this key to enable or disable the key lock-in prevention function. Please see the vehicle owner's manual for details of the key lock-in prevention function.

#### ROOMLAMP (interior light)

You can choose the delay time before extinction of the interior light when the doors are unlocked using the keyless entry system transmitter, or when the doors are closed.



### DEFOGGER

You can program the rear window defogger for two operation modes: continuous and 15-minute. When the continuous operation mode is programmed, the rear window defogger will operate for 15 minutes, stop for two minutes, and again operate for 15 minutes and so on. Even in under continuous operation mode, the defogger shuts off if certain conditions are met. (Refer to the vehicle owner's manual for these conditions.) In the 15-minute mode, the defogger will automatically shut off after about 15 minutes. You can shut it off before that time if you push the rear window defogger switch.

### DEICER

You can program the windshield wiper deicer for two operation modes: continuous and 15-minute. When the continuous operation mode is programmed, pressing the windshield wiper deicer switch means that the deicer will continue to function. It will, however, stop operating automatically if certain conditions are met. (Refer to the vehicle owner's manual for these conditions.) In the 15-minute mode, the windshield wiper deicer will automatically shut off after about 15 minutes. You can shut it off before that time if you push the switch.

### RESET

Select this key to revert all the three settings you performed on this screen to the default settings.

This completes the procedure.

### NOTE

- All selections and settings become effective as soon as they are made.
- The monitor system returns to the vehicle information screen when you select .
- Setting the windshield wiper deicer is only enabled when your vehicle has the windshield wiper deicer function.
- Interior light extinction delay time can be programmed as follows:

	After unlocking doors with keyless entry transmitter	After closing doors
0 SEC	0 second	0 second
SHORT	35 seconds	12 seconds
NORMAL	35 seconds	22 seconds
LONG	35 seconds	32 seconds

### ■ Keyless entry system programming

You can program certain items related to the keyless entry system using the following procedure:

1 Press the **INFO** button and then select **SET** (set).

2 Select .

Select or set the following items.

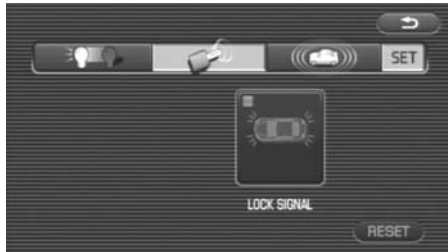

#### LOCK SIGNAL

The keyless entry system has an answerback signaling function, which notifies the driver by electronic chirp and the turn signal lights when locking or unlocking operation performed. Please select or deselect the activation or deactivation of the electronic chirp and turn signal lights. The electronic chirp can be selected using the “BEEP” icon, and the turn signal lights using the “LIGHT” icon.

#### RESET

Select this button to revert all settings performed on this screen to the default settings.

This completes the procedure.

#### NOTE

- Each setting becomes effective as soon as you make it.
- The monitor system returns to the vehicle information screen when you select .
- The answerback signaling setting is only enabled when your vehicle has that function.
- For detailed information on how to operate the keyless entry system, refer to your vehicle owner's manual.

### ■ Alarm system and shock sensor

You can activate or deactivate the alarm system and the dealer optional shock sensor. Also, you can select the monitoring start delay time and the sensitivity level for detection of impact to the vehicle.

1 Press the **INFO** button and then select **SET** (set).

2 Select .

Select or set the following items.



**ALARM**

Set the alarm system ON or OFF.

**DELAY**

Set the monitoring start delay time (after closure of doors).

**NOTE**

- The settings for shock sensor can only be performed on a vehicle equipped with the dealer optional shock sensor.
- It takes around 5 seconds for the sensitivity level to be adjusted. During this time, the security indicator light will flash to indicate the adjustment is being performed.
- If the sensitivity adjustment has not been performed correctly, the buzzer (beeping sound) will sound four times. If the buzzer continues to sound frequently, please have the system inspected by a SUBARU dealer.

**The calculator functions**

A calculator with an 8-digit display is available. The calculator also performs unit conversions between miles and kilometers, pounds and kilograms, etc.

- 1 Press the **INFO** button and then select .



To perform a unit conversion, enter a number, then select the key for the unit you wish to convert from, then the key for the unit you wish to convert to.

Example: Convert 100 miles into kilometers: 100 → [mile] → [km] = 160.9 km

Below is a description of each key and what it does.

Key	Description	Action
0-9	Numbers	The numbers 0 to 9
.	Decimal point	Begin entering numbers below the decimal point
=	Equals sign	Display the results of the calculation

Displaying Vehicle Information and Programming Vehicle System Functions

Key	Description	Action
+	Addition operator	Perform addition
-	Subtraction operator	Perform subtraction
÷	Division operator	Perform division
×	Multiplication operator	Perform multiplication
MR	Memory recall	Retrieve a number from memory, and overwriting the current display
M+	Memory add	Add the currently displayed number to the memory
C	Clear	Clear the currently displayed number. If you have entered a number after pressing an operator, pressing this button returns the calculator to the state of having pressed the operator.
AC	All clear	Return to the initial state (clear the current display, operator state, memory number, etc.)
°F	Fahrenheit	Convert the entered number from Celsius to Fahrenheit*
°C	Celsius	Convert the entered number from Fahrenheit to Celsius*
gal	Gallons	Convert the entered number from liters to gallons*
L	Liters	Convert the entered number from gallons to liters*
lb	Pounds	Convert the entered number from kilograms to pounds*

Key	Description	Action
kg	Kilograms	Convert the entered number from pounds to kilograms*
mi	Miles	Convert the entered number from kilometers to miles*
km	Kilometers	Convert the entered number from miles to kilometers*
ft	Feet	Convert the entered number from meters to feet*
m	Meters	Convert the entered number from feet to meters*
in	Inches	Convert the entered number from centimeters to inches*
cm	Centimeters	Convert the entered number from inches to centimeters*
acre	Acres	Convert the entered number from square meters to acres*
m <sup>2</sup>	Square meters	Convert the entered number from acres to square meters*
psi	Pounds per square inch	Convert the entered number from kilopascals to pounds per square inch*
kPa	Kilopascals	Convert the entered number from pounds per square inch to kilopascals*

\* Results of unit conversions may include rounding errors.

## The calendar functions



A calendar feature is available.

### ■ Displaying calendar

1 Press the **DISP** button.

2 Select **CALENDAR** (calender).

The calendar will appear.

A mark will appear on today's date.



#### NOTE

Use the arrow buttons (  ) to display the previous and following months.

## Adjusting Brightness/Contrast

### Adjusting brightness/contrast

Use the following procedure to adjust the brightness/contrast of the image on each screen:

**1** Press the **DISP** button.

**2** Adjust the image contrast/brightness as follows:

Select **+** and then **-** or **+** to adjust the brightness.

Select **▾** and then **-** or **+** to adjust the contrast.

Select **DEFAULT** to restore the default settings.

Select **OFF** to turn off the brightness/contrast on the screen.

Press **MENU**, **MAP**, **INFO** or **AUDIO** button to turn on the display.



**3** Select **→**.

The previous screen will be displayed.

This completes the procedure.

#### NOTE

- All adjustments take effect as soon as you make them and can be visually confirmed.
- The system saves the adjustments for individual screens (vehicle information screen and navigation screen) as well as for a situation with and without illumination from headlights or parking lights.

**⚠ CAUTION**

Use of controls or adjustments or performance of procedures other than those specified herein may result in hazardous radiation exposure. In compliance with Federal Regulations, following are reproductions of labels on, or inside the product relating to laser product safety.

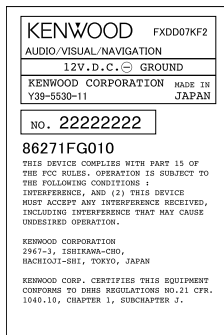

**FCC WARNING**

This equipment may generate or use radio frequency energy. Changes or modifications to this equipment may cause harmful interference unless the modifications are expressly approved in the instruction manual. The user could lose the authority to operate this equipment if an unauthorized change or modification is made.

**IC Regulatory Information**

Operation is subject to the following two conditions: (1) this device may not cause interference, and (2) this device must accept any interference, including interference that may cause undesired operation of the device.

This device complies with RSS210 of Industry Canada. Operation is subject to the following two condition: (1) this device may not cause interference, and (2) this device must accept any interference, including interference that may cause undesired operation of this device.

**NOTE**

This equipment has been tested and found to comply with the limits for a Class B digital device, pursuant to Part 15 of the FCC Rules.

These limits are designed to provide reasonable protection against harmful interference in a residential installation. This equipment may cause harmful interference to radio communications, if it is not installed and used in accordance with the instructions. However, there is no guarantee that interference will not occur in a particular installation. If this equipment does cause harmful interference to radio or television reception, which can be determined by turning the equipment off and on, the user is encouraged to try to correct the interference by one or more of the following measures:

- Reorient or relocate the receiving antenna.
- Increase the separation between the equipment and receiver.
- Connect the equipment into an outlet on a circuit different from that to which the receiver is connected.
- Consult the dealer or an experienced radio/TV technician for help.

**NOTE**

This Class B digital apparatus complies with Canadian ICES-003.

