

MY.SUBARU.COM

Your Subaru vehicle comes with a unique online resource that helps make your ownership experience more convenient and enjoyable. MySubaru.com is a personalized website that offers useful features and content that makes it easy for you to manage your vehicle care and enjoy all the benefits of Subaru ownership. Log on to MySubaru.com and access features such as: automated service history, e-mail maintenance reminders, online Owner's Manual, warranty information, maintenance schedules and much more... Access your site today @ MySubaru.com

For Roadside Assistance, please call our 24-hour toll-free number at 1-800-261-2155. Subaru of America, Inc. Subaru Plaza P.O. Box 6000 Cherry Hill, NJ 08034-6000

All information contained within this Legacy/Outback Navigation System Owner Reference Guide was accurate at the time of publication. We reserve the right to change features, operation and/or functionality of any vehicle specification at any time. Your Subaru dealer is the best source for the most current information.

For detailed operating and safety information, please consult your Owner's Manual.

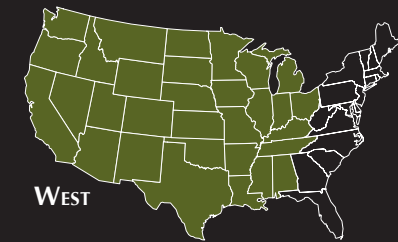

WEST

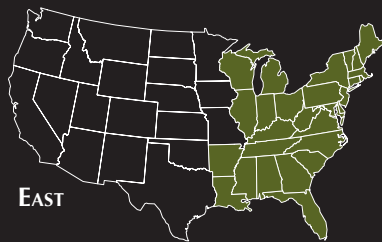

EAST

ABOUT THE MAP DISCS.

This navigation system includes two map discs covering different areas (West and East). Select the map disc containing the destination area you wish and insert it in the Navigation System. Make sure to reselect your destination when you change the map disc.



MSA5B1011A
Printed in USA 05/09
Issued 05/09



2010 LEGACY/OUTBACK

Navigation System Owner Reference Guide



NAVIGATION

DYNAMIC. PROGRESSIVE. REAL WORLD VERSATILITY.

Your Subaru vehicle represents state-of-the-art design and technology. Your Navigation System helps you find travel routes, create maps, store addresses, and more. Prior to using the system, be sure to read the full Navigation System Owner's Manual so you have a complete understanding of the system. This Owner Reference Guide offers a quick guide for regularly used features, for your convenience. Subaru delivers style and technology to provide you with a satisfying owner experience.

Your control panel is your access to the Navigation System. You must stop your vehicle in a safe place before operating the system. Some of the controls and functions cannot be used unless the vehicle is stationary.

1 DEST

Press this to display the destination screen of your Navigation System.

2 MENU

Press this to display the menu screen of your Navigation System.

3 MAP

Press this to switch the screen to a Navigation System screen from any other screen.

4 INFO

Press this to display the vehicle information screen.

5

Press this to adjust the brightness/contrast of the image and to display a calendar.

NAVIGATION SYSTEM MAIN UNIT

The main unit is located under the driver's seat. Load a DVD-ROM disc into the system's main unit through the slot and press the eject button to eject the disc. Use the reset button in the event of a problem, or to upgrade the program.



SAFETY

Your Navigation System will assist you in reaching your destination and, if used properly, can do so with speed and ease. To use the system as safely as possible, follow all safety directions.

- **Before attempting to use this system while driving, learn how to use it.** Make sure you read the **entire** Navigation System Owner's Manual. Do not allow others to use this system until they read the manual and understand the instructions.
- You can program your destination and select your route only when your vehicle is **not moving**. While driving, listen to the voice instructions as much as possible and only glance at the screen briefly and when it is safe to do so.
- The data in the system may occasionally be incomplete as road conditions and driving restrictions (no left turns, road closures, etc.) change. Before you follow system instructions, make sure to check whether you can comply with the instruction legally and safely. Do not be distracted by the navigation screen. Failure to keep your attention on the road could lead to an accident.
- The system cannot warn you of environmental or street hazards or the availability of emergency systems. If you are unsure about the safety of an area, don't drive into it.
- Use this system only where it is legal to do so. Some states/provinces may have laws prohibiting video screens within the driver's sight.

And remember, this system is never a substitute for the driver's personal judgment.



EMERGENCY SCREEN

This function allows you to set the location of the nearest police station or hospital. To start the Navigation System, start the engine. The opening screen will appear, followed by the CAUTION screen. Read the instructions on the screen and press **AGREE**. The current map screen will appear. To select a language, press **MENU** on the screen, followed by **LANGUAGE SELECTION** and then select English or French by touching the screen.

To access the emergency screen, press **MENU**, then press **DESTINATION ENTRY**, then select **EMERGENCY**.

Select between **POLICE STATION** and **HOSPITAL**.

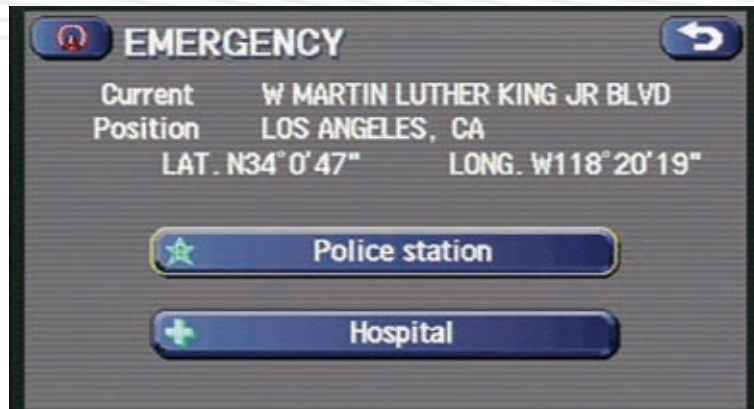
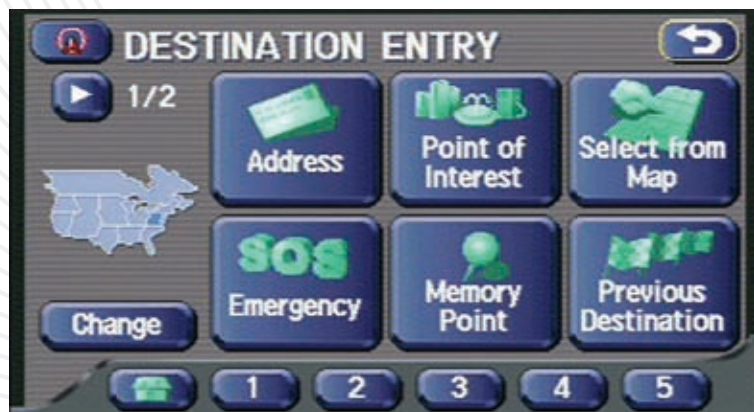

EMERGENCY SCREEN

The screen now displays several options:

Use **▲** to display the five previous suggestions.

Use **▲** to display the previous suggestion.

Use **▼** to display the next suggestion.

Use **▼** to display up to five of the next suggestions.

DIST. SORT sorts the list by distance.

NAME SORT sorts the list alphabetically.

Then select **📍** (destination) or **📍** (waypoint).

The system will route you to the nearest location automatically.

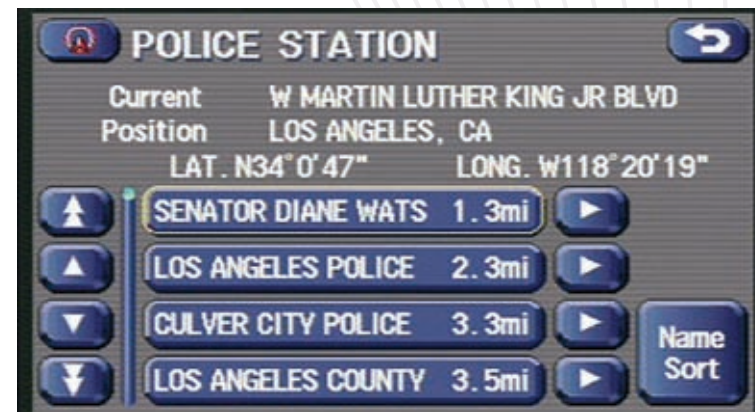

FINDING AN ADDRESS

1 To start the Navigation System, start the engine. The opening screen will appear, followed by the CAUTION screen. Read the instructions on the screen and press **AGREE**. The current map screen will appear. To select a language, press **MENU** on the screen followed by **LANGUAGE SELECTION** and then select English or French by touching the screen.

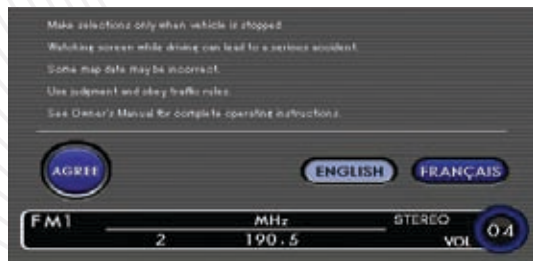

2 To find an address, press **MENU** on the screen, then select **DESTINATION ENTRY**.



3 Make sure you are in the desired search area and touch **MENU** to access the address input screen.

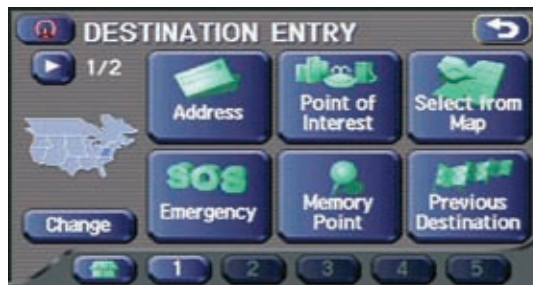

FINDING AN ADDRESS

4 Touch **CITY** to display the city selection preference screen.

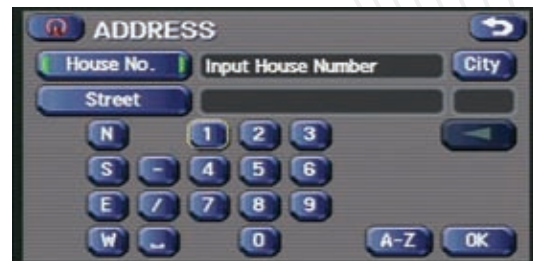

5 Touch **INPUT CITY NAME** to enter the city name or select from a previously registered city.



6 Enter the city name by using the letter keys and touching **LIST**.

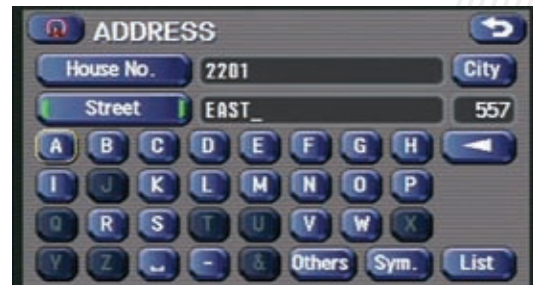

FINDING AN ADDRESS

7 Use ▲▼ to scroll to the selected city. Touch the desired city.



8 Touch **STREET**, then enter the street name using the letter keys and touch **LIST**.

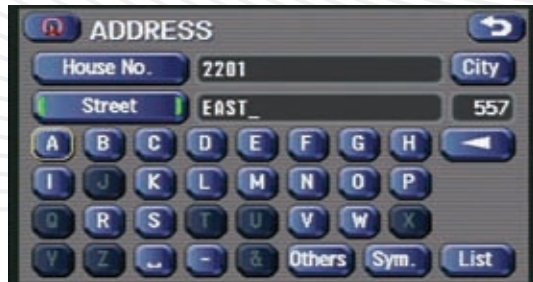

9 Use ▲▼ to scroll to the selected street. Select the street by touching the screen.



FINDING AN ADDRESS

10 Enter the street address by using the number keys, and then touch **OK**.

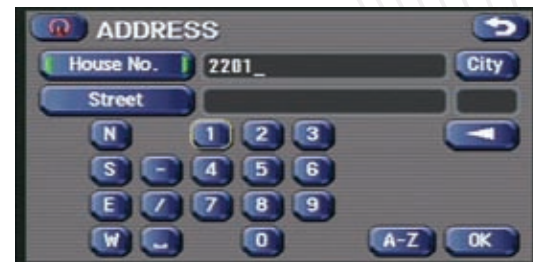

11 Continue to select the desired route by touching **R**.



12 The Navigation System searches the route. Display the route on the screen by touching **START** and begin to drive.



FINDING A POINT OF INTEREST

1 To start the Navigation System, start the engine. The opening screen will appear, followed by the CAUTION screen. Read the instructions on the screen and press **MENU**. The current map screen will appear. To select a language, press **MENU** on the screen, followed by **LANGUAGE SELECTION** and then select English or French by touching the screen.

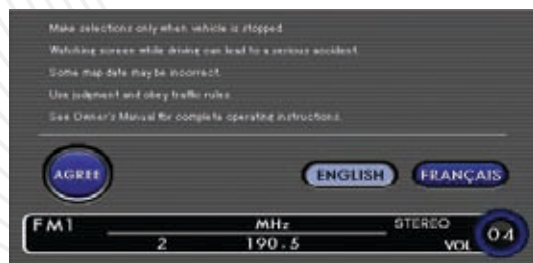

2 To find a point of interest (POI) press **DEST** on the navigation face plate.



3 Make sure you are in the desired search area, and then touch **POINT OF INTEREST** to select.



You can also find addresses by using the point of interest (POI) function. You can use this in the event you do not have a specific address but can refer to a specific shopping mall, airport, museum, etc.

FINDING A POINT OF INTEREST

4 Enter the POI name by using the letter keys on the screen and then touch **LIST**.

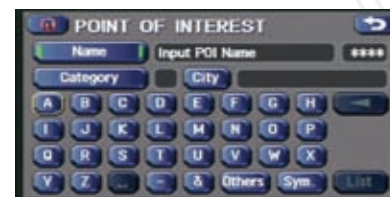

5 Use **▲▼** to scroll up or down for the POI name. The screen will display suggested routes.

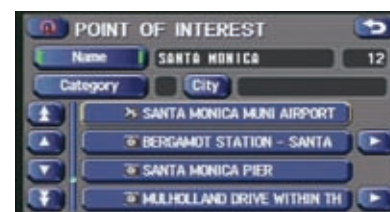

6 Select the route preference you want to take, and then touch **START**.



7 The system searches the route and displays it on the screen. Once completed, touch **START** and begin driving.



HOME REGISTRATION

If you have stored your home address in the system's memory, you can use it for your destination or a waypoint. Other locations stored in the memory can be used for quick setting of destinations and waypoints.

1 Press MENU on the screen and touch **STORED LOCATIONS**.



2 Next, press **HOME**.



HOME REGISTRATION

3 Then touch **ADD**.

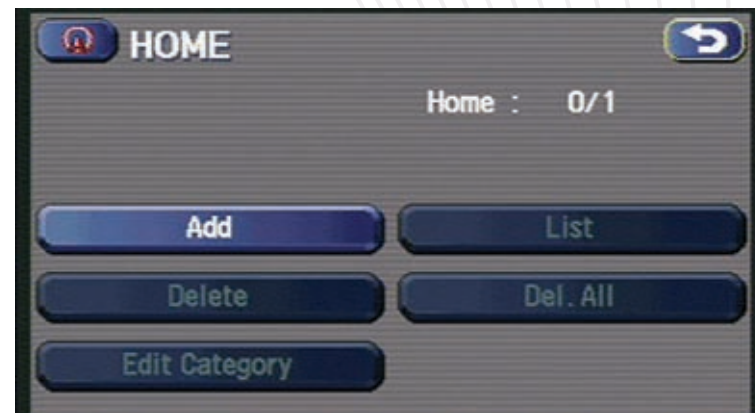

4 Touch **ADDRESS** and continue to steps 4-12 in the **FINDING AN ADDRESS** section earlier in this Owner Reference Guide.

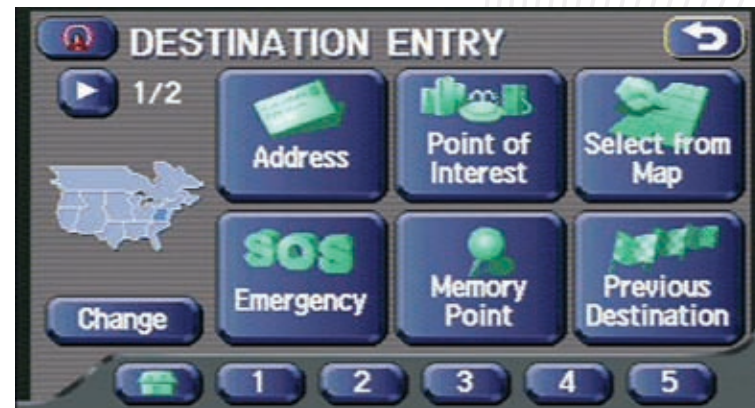

ADDITIONAL QUICK TIPS

SCREEN PREFERENCES

From the map screen, touch . This expands the window to provide up to seven screen selections, including:

-  Single Map Mode
-  Dual Map Mode
-  Turn List Mode
-  Arrow Guidance Mode
-  Intersection Guidance Mode
-  Freeway Exit Info Mode

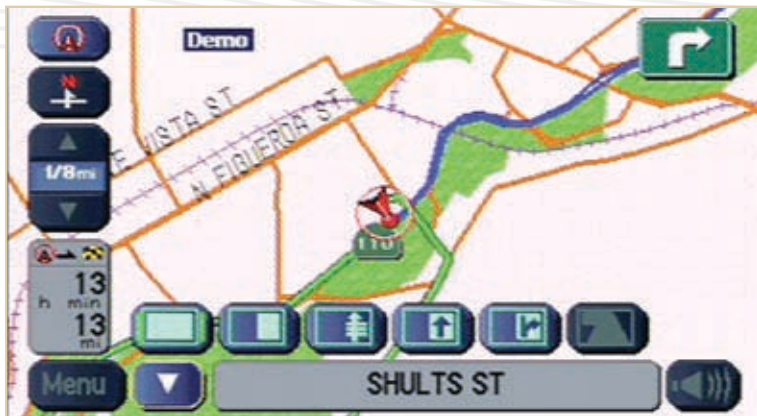

ADDITIONAL QUICK TIPS

DEMONSTRATION MODE

1 To view the Demonstration mode after setting a destination, touch and hold **START** for 10 seconds. A beep indicates that the Demonstration mode has begun.

2 To end the Demonstration mode, press MAP on the navigation face plate or  on the screen.



SEARCH AREA

1 To change your search area, press DEST on the navigation face plate, then touch **CHANGE** on the screen.

2 Touch the desired search area icon located to the left of the map, then touch **OK**.



Foreword

This supplement contains a detailed description and instructions for proper operation of the following systems:

- Navigation System
- Audio and Visual System
- Voice Activation System
- Handsfree System
- Other Function

Please read this supplement carefully before using any of the systems it describes that may be present in your vehicle.

Please keep this supplement with your Owner's Manual and leave it in the vehicle at the time of resale. The next owner will need the information it contains.

The information, specifications and illustrations found in this supplement are those in effect at the time of printing. FUJI HEAVY INDUSTRIES LTD. reserves the right to change specifications and designs at any time without prior notice and without incurring any obligation to make the same or similar changes on vehicles previously sold.

This Owner's Manual supplement applies to all models and covers all equipment, including factory installed options. Some explanations, therefore may be for equipment not installed in your vehicle.

FUJI HEAVY INDUSTRIES LTD., TOKYO, JAPAN

 **SUBARU** is a registered trademark of FUJI HEAVY INDUSTRIES LTD.
Copyright © 2009, FUJI HEAVY INDUSTRIES LTD.

Contents

Introduction

Safety Warnings	8
System Components and Controls	9
■ Note on Handling	12
Adjusting Screen	13
■ Adjusting brightness/contrast	13

Navigation

Before Use	16
Navigation System Controls	20
Map Disc Loading	22
Starting Up the Navigation System	23
Voice Guidance Volume	25
Markers and Controls Displayed on Maps	26
Screens During Route Setting	26
Screens During Route Guidance	28
Menu Screen Keys and Functions	29
Map Operations	31
Selecting Map Orientation	31
Changing Map Scale	32
Setting Route	34
Setting Destination	34
■ Setting destination/waypoints by scrolling the map	34
■ Setting destination from the navigation menu	36

Route Guidance	51
Route Guidance Screen	51
Zoom-in Map at Intersection	52
Dual Map Display	53
Freeway Information	54
Replaying Voice Guidance	55
Compass Mode	56
Route Options	57
Setting Route Options	57
■ Search condition	58
■ Detour	59
■ Route preferences	60
■ Destination and waypoints	60
■ Display route	64
■ Route preview	65
Navigation Setup	68
Setting Navigation System	68
■ User settings	69
■ Quick POI selection	71
■ Language Selection	72
■ Calibration	73
■ Set clock	74
■ Vehicle signal	75
■ Restore system defaults	75
Stored Locations	77
■ Memory points	78
■ Avoid area	83
■ Previous destination (deleting stored locations)	85
Other Functions	87
■ Displaying POIs on a map	87

■ Displaying POI data.....	89
■ Deleting POI markers.....	90
■ Editing Quick POI categories.....	91
■ SUBARU dealership search.....	93
Version and Initialization	96
Version.....	96
Initialization of the navigation settings.....	97
General Information	99
When a Problem Occurs.....	102
Voice activation system	103
■ Basic operations of voice recognition.....	103

Audio and Visual

Before using the Audio and Visual system.....	106
Precautions when using the system.....	106
Discs that can be used.....	109
Player.....	111
Character information displayed.....	112
Voice activation system.....	113
Basic operation of the Audio and Visual system	114
Steering remote control.....	116
Turning on the power.....	117
Selecting the audio source.....	118
■ Pressing the button for selection.....	118
■ Audio source selection.....	120
Setting and adjusting the sound.....	121
■ Adjusting the sound volume.....	121

■ Mute the sound.....	121
Radio functions	123
Listening to the radio.....	123
■ FM radio screen is displayed.....	123
■ AM radio screen displayed.....	124
Selecting a station.....	126
■ Selecting a preset station.....	126
■ Setting the frequency.....	126
■ Searching a station automatically.....	127
■ Searching a FM station from a category of interest.....	127
Presetting a station.....	129
■ Manual storing.....	129
■ Auto store.....	129
Compact disc functions	130
Setting the disc.....	130
■ Loading the disc.....	130
Listening to a tune in the CD.....	131
CD screen displayed.....	132
Selecting a tune.....	134
■ Selecting the preceding tune.....	134
■ Selecting the succeeding tune.....	134
■ Selecting a tune from the list.....	135
■ Searching a tune while listening.....	136
■ Reverse or fast-forward a tune.....	136
Listening to a tune repeatedly.....	137
Listening to tunes in random order.....	138
MP3/WMA disc functions.....	139
MP3/WMA.....	139
Listening to tunes (file) in the MP3/WMA disc.....	142
MP3/WMA disc screen displayed.....	143

Selecting a tune.....	145
■ Selecting a folder that you want to hear.....	145
■ Selecting a tune (file) you want to hear.....	146
■ Reverse or fast-forwarding a tune.....	148
■ Listening to a tune repeatedly.....	149
■ Listening the tunes in random order.....	150
DVD functions.....	151
What must be known.....	152
■ Operations while in the playback of the disc.....	152
■ DVD video and DVD audio.....	152
Playing back the DVD.....	153
DVD control screen displayed.....	154
Selecting the title and the chapter.....	156
■ Selecting the chapter.....	156
■ Searching a title with the title number specified.....	156
Controlling the playback of the DVD.....	158
Operating the menu screen.....	160
■ Selecting the menu.....	160
■ Changing over the position of the menu operation key.....	161
Changing the language and the angle.....	162
■ Changing the superimposed language.....	162
■ Changing the voice language.....	163
■ Changing over the angle.....	164
Setting the screen.....	165
■ Adjusting the image quality.....	165
■ Setting the SCREEN MODE.....	166
Looking at the VIDEO.....	167
Satellite radio operation (if equipped).....	168
Bluetooth AUDIO functions.....	169
■ Setting the Bluetooth audio.....	169
Playing back the Bluetooth audio.....	172

Selecting a tune.....	174
■ Selecting the preceding tune.....	174
■ Selecting the succeeding tune.....	174
■ Searching for a tune while listening.....	175
■ Listening to a tune repeatedly.....	176
■ Listening to tunes in random order.....	176
iPod functions.....	177
Setting the iPod.....	178
■ Media format.....	178
■ Connection cables.....	178
iPod control screen displayed.....	179
Playing the iPod-Music.....	181
Selecting a tune (track) you want to hear.....	183
■ Reversing or fast-forwarding a tune.....	183
■ Listening to a tune repeatedly.....	184
■ Listening the tunes in random order.....	184
AUX functions.....	185
Playing back the AUX.....	185
USB storage device functions.....	186
■ Setting the USB storage device.....	186
Playing the USB storage device.....	187
USB control screen displayed.....	188
Selecting a tune.....	190
■ Selecting a tune (file) you want to hear.....	191
■ Reversing or fast-forwarding a tune.....	193
■ Listening to a tune repeatedly.....	193
■ Listening to the tunes in random order.....	194
Setting the audio.....	195
■ Setting.....	195
Setting the equalizer.....	196

■ Setting the equalizer with ease	196
■ Setting the equalizer in detail	197
■ Invoking the equalizer setting that has been preset	198
Setting the balance/fader	199
Select the portable player	200
■ Referring to the Bluetooth audio device information	201
■ Editing the Bluetooth audio device information	202
Initializing the DVD	203
■ Setting the screen	204
■ Setting the dynamic range	205
■ Setting the language	206
■ Setting the password of the parental level	207
■ Setting the parental level	209
Setting the Bluetooth audio	210
■ Registering the Bluetooth audio devices	210
■ Deleting the Bluetooth audio device registration	212
■ Connecting the Bluetooth audio device automatically	213
■ Setting the connection method of the Bluetooth audio device	214
■ Referring to the device information of the Bluetooth audio system	215
■ Editing the device information of the Bluetooth audio system	216
■ Setting the A/V-IN	218

Voice Activation

Voice activation system	220
■ Basic operations of voice recognition	220
Voice command list	222

Hands-Free Phone System

Before using the Hands-Free Phone System	232
What can be made with the Hands-Free Phone System	232
■ What cannot be done with the Hands-Free Phone System	232
Precautions to be taken when using the Bluetooth equipment	233
Name of each part	235
Phone voice	236
Various types of displays	237
■ Reception level display	237
■ Battery indicator	237
■ Bluetooth connection status display	238
■ Roaming display	238
When parting with your car	239
Making preparations of the Hands-Free Phone System	240
Registering the Bluetooth Phone	240
Connecting the Bluetooth Phone	242
Speaking over the Hands-Free Phone System	244
Making a phone call	244
■ Entering a phone number to make a phone call	244
■ Making a phone call from the outgoing or incoming call history	245
■ Making a phone call from the phone book	247
■ Making a phone call from the Speed Dial	249
■ Making a phone call to the phone number of the Memory Point	250
■ Making a phone call from the Bluetooth Phone	252
■ Making a call by the voice recognition system	252
■ Making a call using name recognition:	253
■ Making a call using phone number recognition:	254
Taking a phone call and declining an incoming call	255
■ Taking a phone call	255

■ Putting an incoming phone call on hold.....	255
■ Hanging up an incoming call before answering it (Denial of an incoming call).....	256
Speaking over the phone	257
■ Adjusting the tonal volume.....	257
■ Muting the voice on this side.....	257
■ Transmitting the phone call.....	258
■ Hanging up the phone.....	258
Using the outgoing or incoming call history	259
Checking the outgoing or incoming call history	259
Deleting all the outgoing and incoming call history.....	260
Using the phone book.....	261
Registering the phone book data.....	261
■ Transmitting the phone book of the Bluetooth Phone.....	261
■ Registering a new data with the phone book	263
■ Voice tag registration.....	266
■ Registering data with the phone book from the outgoing or incoming call history.....	267
Editing or deleting a phone book data.....	269
■ Editing a phone book data	269
■ Selecting a phone book data to delete it	271
■ Deleting all the phone book data.....	273
Other Bluetooth settings	275
Deleting the registered Bluetooth Phone from the in-vehicle equipment	275
Changing the Device Name of the in-vehicle equipment displayed in the Bluetooth Phone.....	277
Editing the Speed Dial setting	279
■ Adding the phone number to the Speed Dial memory.....	279
■ Deleting the phone number from the Speed Dial memory.....	281

Changing the Pass-Key used when certifying the Bluetooth Phone	283
----------------------------------------------------------------------	-----

Other Functions

The calculator functions	286
The calendar functions	288





Introduction

Safety Warnings

You will find a number of WARNINGS, CAUTIONs and NOTEs in this supplement.

These safety warnings alert you to potential hazards that could result in injury to you or others.

Please read these safety warnings as well as all other portions of this supplement carefully in order to gain a better understanding of how to safely use the systems it describes.

WARNING

A WARNING indicates a situation in which serious injury or death could result if the warning is ignored.

CAUTION

A CAUTION indicates a situation in which injury or damage to your vehicle including the systems described in this supplement, or both, could result if the caution is ignored.

NOTE

A NOTE gives information or suggestions how to make better use of the systems described in this supplement.

System Components and Controls

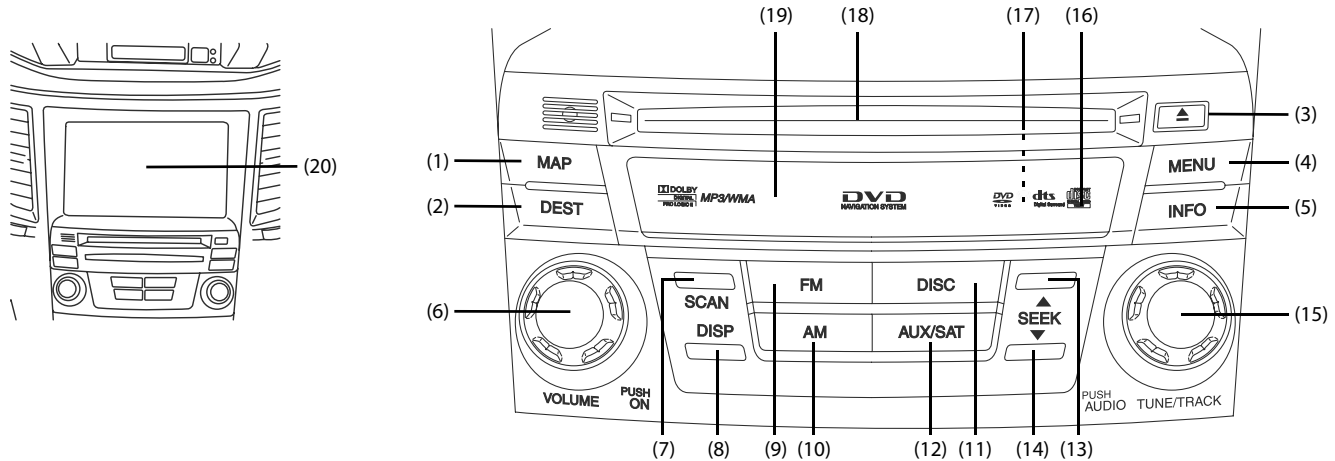

(1) **MAP**

This button is used to display the current map screen of the navigation system.

(2) **DEST**

This button is used to display the destination entry screen of the navigation system.

(3) **[EJECT]**

This button is used to eject an audio disc.

(4) **MENU**

This button is used to display the menu screen of the navigation system.

(5) **INFO**

This button is used to display the information screen.

(6) **[VOL / POWER]**

This button is used to turn the system on or off and adjust the sound volume.

(7) **SCAN**

This button is used to operate the audio system.

(8) **DISP**

This button is used to display the SCREEN function in which setting adjustments can be made to the screen.

- (9) **FM**
This button is used to receive the FM band.
- (10) **AM**
This button is used to receive the AM band.
- (11) **DISC**
This button is used to operate the audio system.
- (12) **AUX/SAT**
This button is used to operate the audio system.
- (13) **SEEK+**
This button is used to seek up from the current audio source.
- (14) **SEEK-**
This button is used to seek down from the current audio source.
- (15) **[TUNE / TRACK]**
This button is used to operate the audio system.
- (16) **[MAP DISC EJECT]**
This button is used to eject a map disc for the navigation system.
- (17) **RESET**
This button is used to reset all settings to return to the factory settings. This button is located on behind the map disc slot cover.
- (18) **CD / DVD drive loading slot**
Insert a playback CD/DVD here.

(19) **Map disc drive loading slot**

Insert a map disc here.

(20) **Display touch screen**

Multi function screens appear here.

■ **Steering remote control**

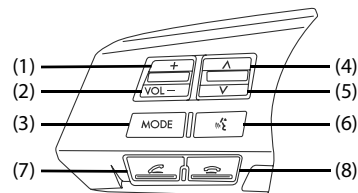

- (1) **VOL+**
This button is used to increase the sound volume.
- (2) **VOL-**
This button is used to decrease the sound volume.
- (3) **MODE**
This button is used to select the audio source.
- (4) **[TRACK/SEEK UP]**
This button is used to seek up from the current audio source.
- (5) **[TRACK/SEEK DOWN]**
This button is used to seek down from the current audio source.

(6) 

This button is used to enter the voice recognition mode.

(7) [TEL ON]

This button is used to hang up the phone.

(8) [TEL OFF]

This button is used to make a phone call.

■ USB and AUX connector

This unit can be used to control a connected USB and external input audio source device.

Use the USB connector to connect the USB device.

Use the AUX connector to connect the external input audio device.

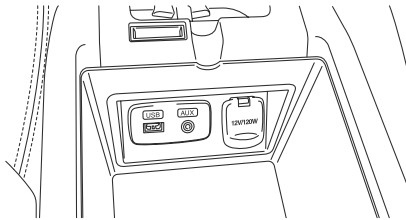

■ Voice activation system

The voice activation system allows the system to be operated using spoken commands.

For details regarding this function, refer to "Voice activation system".
(See Page 220.)

Note on Handling

.....

■ Liquid crystal panel

Carefully read the following information for a longer service life of the system.

- The touch keys on the display operate when slightly touched. Do not press the touch key screen with a strong force.
- Do not push the case surrounding the touch key panel with a strong force. This may cause the touch keys to malfunction.
- Subjecting the operation panel to shocks may result in breakage, deformation or other damage.
- Do not use a protection film on the display to avoid damage. The system may not work properly or may not accept touching operations performed on the screen.
- Do not burn the display by cigarettes, cigars, etc. Doing so may damage or deform the cabinet.
- Do not get the system wet from drinks, umbrellas, etc. Doing so may damage the internal circuitry.
- Do not insert objects or poke in the space between the operation panel and the main unit.
- Do not disassemble or modify the unit in any way. Doing so may result in damage.
- In extremely cold weather conditions, the display movement may become slower and the display may darken. This is not a malfunction. The display will work normally when the temperature increases.
- Small black and shiny spots inside the liquid crystal panel are normal for LCD products.

- If any problems occur, contact the nearest SUBARU dealer.

■ Cleaning the liquid crystal panel

The liquid crystal panel tends to collect dust, so wipe it off occasionally with a soft cloth. The surface is easily scratched, so do not rub it with a hard object.

Adjusting Screen

Adjusting brightness/contrast

Use the following procedure to adjust the brightness/contrast of the image on each screen:

1 Press the **DISP** button.

2 Adjust the image contrast/brightness as follows:

Select **+** (Brightness) and then **-** or **+** to adjust the brightness.

Select **0** (Contrast) and then **-** or **+** to adjust the contrast.

Select **DEFAULT** to restore the default settings.

Select **OFF** to turn off the brightness/contrast on the screen.

Press **MENU**, **MAP**, **INFO** or [TUNE/TRACK] button to turn on the display.



3 Select **→**.

The previous screen will be displayed.

This completes the procedure.

NOTE

- All adjustments take effect as soon as you make them and can be visually confirmed.
- The system saves the adjustments for individual screens (vehicle information screen and navigation screen) as well as for a situation with and without illumination from headlights or parking lights.



Navigation

WARNING

READ THIS MANUAL FIRST

Read this supplement carefully before using the navigation system. We are not liable for accidents or other problems resulting from failure to follow the instructions in this supplement.

OBEY LOCAL ROAD SIGNS AND REGULATIONS

Always obey local road signs and regulations while following instructions given by the navigation system. Some of the data on the DVD-ROM disc may be outdated due to changes in local road signs and regulations. Furthermore, the data on the DVD-ROM disc does not take into account variable factors such as the weather, road congestion at different times of the day, temporary road closures due to road construction, and special events. Local road signs and regulations always take precedence over directions given by the system. Failure to obey them could place you in physical danger or in violation of the law.

DRIVE SAFELY

- Before following an instruction (for example, in the case of changing direction) given by the system, check that the action would be safe to take in the current traffic conditions. Continue to pay attention to safety while following any instruction.
- Do not be distracted by the navigation screen. Failure to keep your attention on the road could lead to an accident. When you need to look at the screen while driving, do so for the shortest time possible and avoid staring at the screen.

- You must stop the vehicle in a safe place before operating the navigation system. For safety's sake, some of the navigation system's controls and functions cannot be used unless the vehicle is stationary.
- When you need to look at the navigation screen, do so for the shortest time possible. Looking away from the road for too long could lead to an accident.
- Use this system only in locations where it is legal to do so. Some states/provinces may have laws prohibiting video screens within sight of the driver.
- If you stare at the display with too much enthusiasm or operate the switches of the system while in driving, the navigation system could cause your attention to be distracted from the current traffic conditions. Please be sure to input in the system as much information as possible before taking your departure. And also please be sure to bring your car to a stop in a safe place if you need to input information.
- The buttons for the touch screen that cannot be used are greyed out. Operating the navigation system while in driving could cause your attention to be distracted from the current traffic conditions. And in consequence, this could result in a severe or fatal accident. Follow the descriptions of all operations and the instructions for safety given in this manual without fail.

VOLUME LEVEL

- Keep the system's volume level low enough for you to be able to hear outside sounds while driving. To do otherwise may prevent you from reacting appropriately to traffic conditions and could result in an accident.

⚠ CAUTION**FOREIGN OBJECTS**

Do not allow foreign objects to enter the disc insertion slot, including your fingers.

Foreign objects inside the system's main unit could cause an electric shock or a fire. If the main unit emits smoke or an unusual smell, stop using the system immediately and contact the nearest SUBARU dealer.

NEVER DISASSEMBLE OR MODIFY THE SYSTEM

Any attempt to disassemble or modify any part of the system could lead to an electric shock or a fire, or some other type of accident.

Do not continue using the navigation system if it malfunctions.

If the system shows any sign of malfunctioning (for example, the navigation system gives no picture), stop using it immediately and contact the nearest SUBARU dealer.

Continuing to use the system could lead to a fire, an electric shock, or some other type of accident.

⚠ CAUTION**If the navigation system gets contaminated, emits smoke or an odd smell, stop using it.**

If a foreign object gets inside the system, liquid is spilled onto the system, or the system emits smoke or an unusual smell, stop using it immediately and contact the nearest SUBARU dealer. Continuing to use the system could lead to a fire, an electric shock, or some other type of accident.

NOTE

- For safety reasons, the use of some functions may be unavailable while in driving. The button for a touch screen that cannot be used will be greyed out.
- Liquid crystal displays may be difficult to read when wearing polarized glasses.

■ Points to note before use

Starting the engine before using the system

The navigation system can be used with the ignition key in either the ON position or the ACC position. To preserve the battery, however, it should be used with the engine running whenever possible. Using the system for a long time with the engine off can cause the battery to run down.

Delay before display of current position

The system will not immediately display a correct indication of your vehicle's current position after being switched on for the first time or after the battery has been disconnected for a long time. It will display a correct current position indication as soon as it receives Global Positioning System (GPS) signals.

Program reloading after battery disconnection

The navigation program will be erased from the system's memory if the battery is disconnected. If this happens, load the provided DVD-ROM disc in the system's main unit and turn the ignition switch to the ON or ACC position. The system will automatically reload the program and start operating normally again.

Incorrect operation on rough roads

The system may operate incorrectly or be unable to read the data on the DVD-ROM disc when subjected to severe vibration caused by driving on rough roads.

Handling the GPS antenna

Do not paint the antenna. Doing so could impair or prevent signal reception.

Disabled switches

Some switches are disabled during operation of the system. These switches are displayed in fainter colors and no messages are displayed for them.

Risk of damage to the main unit

Be mindful of the occupant compartment temperature. Using the system when the occupant compartment temperature is extremely high or low can damage it or cause it to malfunction. Also, note that the system's main unit can be damaged by strong vibration and by any metallic object or water that gets inside.

Condensation

Condensation can form on the lens inside the main unit when there is a rapid change in occupant compartment temperature (for example, when the heater is switched on in cold weather). Such condensation can cause the system to operate abnormally. If you wait an hour or so for the condensation to disappear, the system should start working normally again. If normal operation is still not restored after several hours, we recommend that you contact the nearest SUBARU dealer.

Replacing the DVD-ROM disc

If you need to replace the DVD-ROM disc, make sure the replacement disc is compatible with your system's main unit. Inserting an incompatible disc could damage the unit.

■ Handling precautions for DVD-ROM discs

- Handle DVD-ROM discs carefully. Any DVD-ROM disc with excessive warping or scratches on its surface can cause reading errors.
- Store DVD-ROM discs away from direct sunlight, which can cause warping and render them unusable.
- DVD-ROM discs rotate at high speeds inside the system's main unit. Never use a cracked or badly warped disc; doing so could damage the unit.
- To clean a DVD-ROM disc, lightly wipe it with a soft cloth in straight lines from the center hole toward the outer edge.
- Never clean DVD-ROM discs with benzene, thinner, record spray, antistatic spray, or chemical swabs.
- Do not touch the DVD-ROM disc's data surface (the surface without a printed label). A dirty data surface can cause reading errors. Always hold a DVD-ROM disc by the center hole and at one point on the outer edge, or by two points on the outer edge.
- Do not write anything on DVD-ROM discs or affix anything, such as stickers, to them.

Navigation System Controls

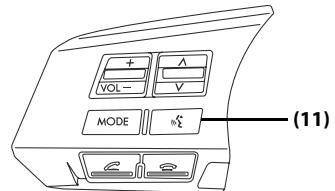
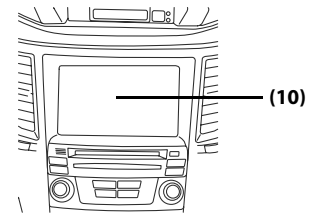
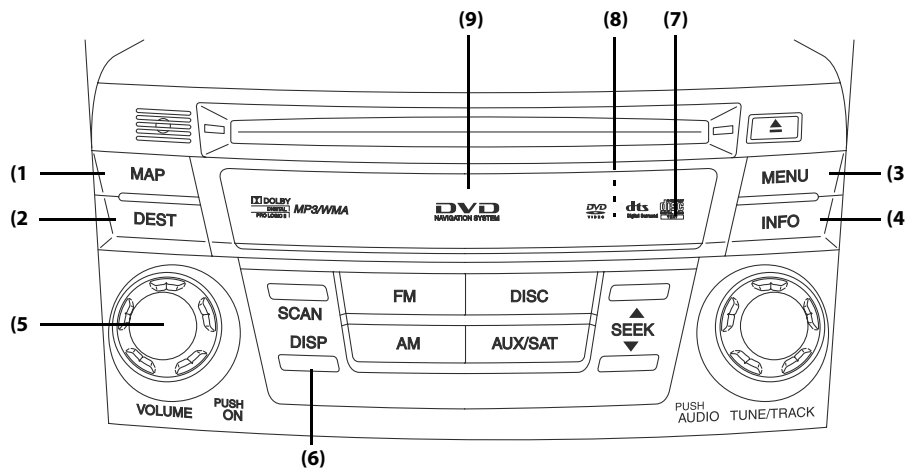

(1) **MAP**

This button is used to display the current map screen. During route guidance, this button is used to repeat the last voice guidance.

(2) **DEST**

This button is used to display the destination entry screen.

(3) **MENU**

This button is used to display the menu screen.

(4) **INFO**

This button is used to display the information screen.

(5) **[VOL / POWER]**



This button is used to turn the system on or off.

(6) **DISP**

This button is used to display the SCREEN function in which setting adjustments can be made to the screen.

(7) **[MAP DISC EJECT]**

This button is used to eject a map disc for the navigation system.

-
- (8)  This button is used to revert all settings performed on the system to the default settings. This button is located on behind the map disc slot cover.
- (9) **Map disc drive loading slot**
Insert a map disc here.
- (10) **Display screen**
Multi function screens appear here.
- (11)  This button is used to enter the voice recognition mode.

Map Disc Loading

When changing the map disc with a disc that is appropriate to the current location, or when updating the map disc while in the version upgrade of a map disc, it is necessary to change it with another map disc by following the procedure described below.

NOTE

- When changing a map disc with another one, be sure to stop the vehicle in a safe location.
- For details of the map discs, see "Map Discs". (See Page 49.)

- 1** With the ignition switch on, open the cover of the map disc slot.

NOTE

Support the upper side of the cover with your thumb, pull the notch located on the center of the under side of the cover, and then remove the cover.

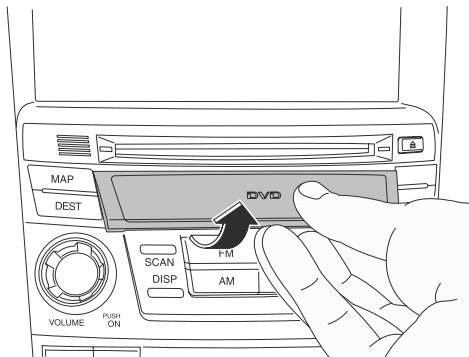

- 2** Press the map disc eject button.
- 3** When the map disc is ejected, take it out.
- 4** Insert a map disc that contains the area showing the current position.

The monitor automatically returns to the normal condition to start the loading of the disc.

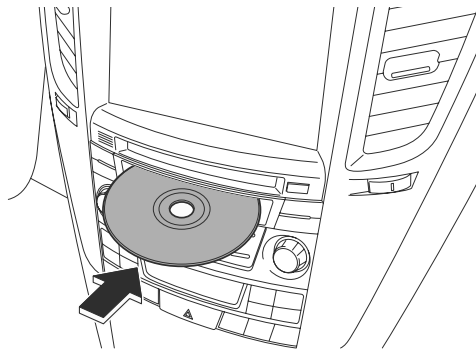

CAUTION

- You must insert the map disc into the second slot from the top.
- When inserting a map disc, do not insert 2 or more map discs together. This may cause the mechanism to malfunction.

Starting Up the Navigation System

Use the following procedure to start up the navigation system and display the current map screen.

1 Start the engine.

2 Press the [VOL/POWER] button while the system is off.

The CAUTION screen will appear, followed by the opening screen.



NOTE

- When the system is started, a loading status bar will appear on the screen while the system loads the programs from the map disc.
- When the system is started without the map disc loaded, the functions of the system will be restricted.



3 Carefully read the instructions on the CAUTION screen (shown below), then select  (agree).



CAUTION

Make selections only when vehicle is stopped.
Watching screen while driving can lead to a serious accident.
Some map data may be incorrect.
Use judgment and obey traffic rules.
See Owner's Manual for complete operating instructions.

NOTE

- The CAUTION screen remains on the display unless you select  (agree).
- Selecting the  button allows you to change the language displayed in the navigation system. (See Page 72)

4 The current map screen will appear.

To make a selection, touch the desired key that is displayed on the screen.



NOTE

- When you use the navigation system for the first time, Central Time will be displayed. Adjust the system's clock to the local time using the clock setting screen ("SET CLOCK") described on Page 74.

Voice Guidance Volume

Use this function if you want to change the voice guidance volume setting from the default setting.

1 Press the **MENU** button.



2 Select **◀** or **▶** to adjust the sound volume.



- Each time **◀** is selected, the sound volume decreases. Each time **▶** is selected, the sound volume increases.
- If you want to turn off the sound of the navigation system, select **◀** to display "OFF".
- To make sure the volume level, select **◀▶▶**.

Markers and Controls Displayed on Maps

Screens During Route Setting

Touch a point on the map. A crosshair (scroll mark) will appear on the screen. Then touch a desired point on the map. The map will scroll with the selected point at the center.

<Current Position screen>





Press **MAP** button to return to the current map screen.

Scroll the map



<Scroll screen>

- (1) **Time**
Indicates the current time.
- (2) **Map orientation control**
Allows you to select either a "north up" display or "heading up" display of the map. (See Page 31.)
- (3) **GPS marker**
Shows the status of the signal from GPS satellites. When this marker appears, the navigation system is receiving GPS signals.
- (4) **Screen configuration control**
Allows you to select a preferred display type for route guidance. (See Page 51.)
- (5) **Map scale**
Displays the map scale.
- (6) **Zooming control**
Use **+** or **-** to zoom out or zoom in the map.
Select **+** or **-** to select the map scale. (See Page 32.)
- (7) **Vehicle position marker**
Indicates the current vehicle position and direction.

-
- (8) **"Store memory point" key**
Stores the marked position on the map as a memory point.
 - (9) **Point of interest (POI) key**
Allows you to display the POI selection screen (See Page 87).
On the screen, you can program POIs to appear on a map as markers.
 - (10) **Distance from current position**
Indicates the distance from the current vehicle position to the position marked by .
 - (11) **Destination/waypoint key**
Programs a destination or waypoint at the position marked by  on a scroll screen.

Screens During Route Guidance

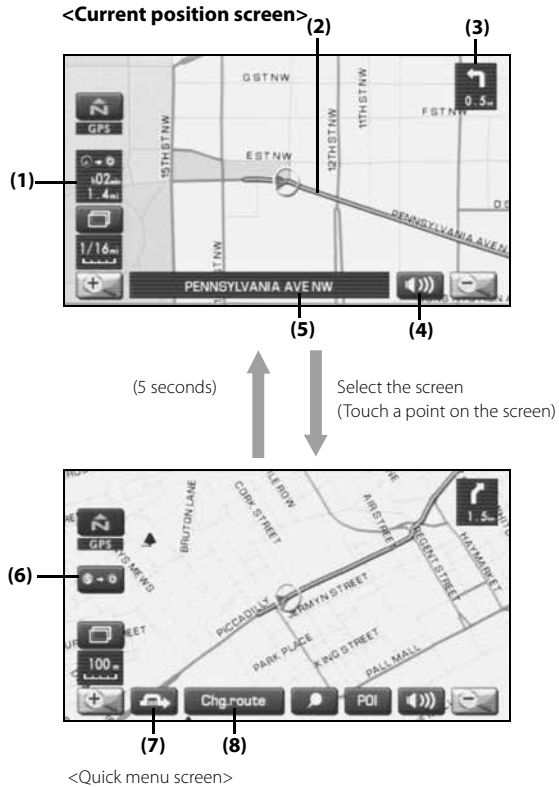

- (1) **Distance and time to destination**
Indicates the time (either approximate time required or estimated time of arrival) and the distance to the destination or a waypoint.
- (2) **Route**
Indicates the route guide with blue line.
- (3) **Turn guidance arrow**
Indicates the direction of your turn at the next intersection/intersection as well as the distance to the intersection/intersection.
- (4) **"Repeat voice guidance" key**
Repeats the last voice guidance.
- (5) **Current road name**
Shows the name of the road you are currently driving on.
- (6) **"Display whole route" key**
Displays a map containing the entire route. (See Page 64.)
- (7) **Detour**
Calculates an alternative route that detours from the current location.
- (8) **"Change route" key**
Displays the route option menu. Selecting a new route option causes the system to calculate the selected route.

Menu Screen Keys and Functions

<Current position screen>



Select  to return to the current map screen.







Press **MENU** button to display the menu screen.



<NAVI MENU screen>

The table below shows the keys displayed on the NAVI MENU screen, the functions accessible by selecting these keys, and the pages of this manual that describe the instructions you should follow when using these functions.

Menu screen key	Function	Reference page
Stored Locations 	Memory Points	page 78
	Avoid Area	page 83
	Previous Dest.	page 85
Navigation Set Up 	User Settings	page 69
	Quick POI Selection	page 71
	Language Selection	page 72
	Calibration	page 73
	Set Clocks	page 74
	Vehicle Signal	page 75
	Restore System Defaults	page 75
Route Options 	Search Condition	page 58
	Detour	page 59
	Route Pref.	page 60
	Dest. & Way Point	page 60
	Display Route	page 64
	Route Preview	page 65

Menu screen key	Function	Reference page
Phone 	Bluetooth Phone	page 240
	Redial List	page 259
	Received Calls	page 259
	Phone Book	page 261
	Memory Points	page 250
	Bluetooth Settings	page 252
Version 	Version	page 96
VOL	Voice guidance volume	page 25

Map Operations

Selecting Map Orientation

You can select either "heading up" or "north up" display on the current map screen by using the following procedure.

- 1 Select  or .



<"North up" display>

If you select  ("north up" display), the system rotates the map so that north is always directly upwards on the screen.

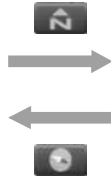

<"Heading up" display>

If you select  ("heading up" display), the system rotates the map so that the direction in which you are heading is always directly upwards on the screen (note that the red arrow points to the north).

Changing Map Scale

You can increase or decrease the scale of the map using the following procedure:







- 1 Select  or  to change the map scale.



- 2 Selecting  or  changes the scale as shown below.



NOTE

- Briefly touching  or  allows you to change the map scale.
- Touching  or  for a long time allows you to change the map scale.
- Selecting either of the following on the scale bar displayed by selecting  or  allows you to change to the specified map scale.

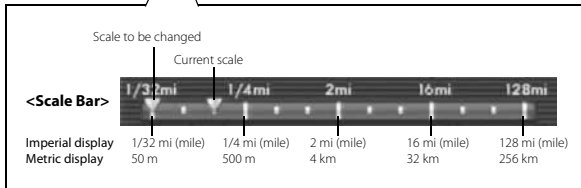
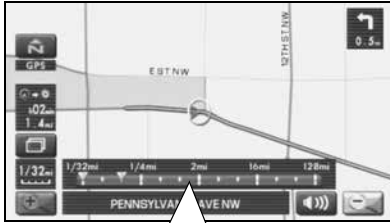

- The scale can be displayed in Imperial or metric units. To change the units, See Page 69.

Setting Route



Setting Destination

Setting destination/waypoints by scrolling the map

Even if you do not know the exact address of your destination or a waypoint on your route to the destination, you can set it by scrolling the map as follows:

- 1 Touch the screen and scroll the map until the crosshair  reaches the destination or a waypoint.



- 2 Select the  or  (destination or waypoint) key.
The key will separate into the destination key and the waypoint key.



- 3 Select  for setting the destination
The system will calculate the route and display the entire route to the destination on the map.



Select  for a waypoint. The system will program the address of the waypoint on your route. (See Page 60.) You can set up to 5 waypoints per trip.

4 Select **Start** (start).

Route guidance will begin along the displayed route.

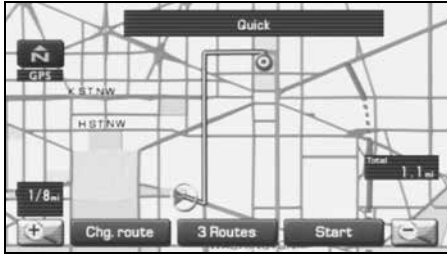

NOTE

- If the system cannot find the desired route, select **Chg. Route** (change route). This will allow you to access the ROUTE OPTIONS screen, from which you can prompt the system to calculate a new route. (See Page 57.)
- Selecting **Start** (start) for more than 5 seconds will start the demonstration mode operation.

■ Selecting route

Upon setting the destination, the system prepares to calculate three types of routes to the destination (Quick, Alt., and Short). You can select from any of the three options as follows:

1 Select **3 Routes** (3 routes).

The system will be ready for calculation of any route you select from the three options, namely, Quick (the fastest route), Alt. (alternative route), and Short (the shortest route).

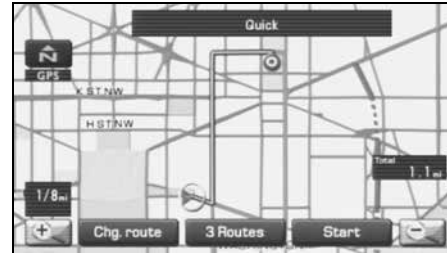

2 Select **Info.** (information).

The screen will display details (required time, total distance, roads used, etc.) regarding each option.



3 Select **Quick** (Quick), **Alt.** (Alt.), **Short** (Short) or as you desire, and then select **Start** (Start) to confirm your selection.









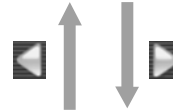



INFO FOR 3 ROUTES			
	Quick	Alt.	Short
	0 h 04 m	0 h 05 m	0 h 04 m
	1.1 mi	1.4 mi	1.1 mi
	0 mi	0 mi	0 mi
	0 mi	0 mi	0 mi
	0 mi	0 mi	0 mi
	0 mi	0 mi	0 mi



Setting destination from the navigation menu

You can set the destination using a variety of categories if you start setting from the DESTINATION ENTRY screen. Before you can use any of these categories, perform the following steps:

- 1 Press the **DEST** button.
- 2 Select the desired search category.



	(Address)	See Page 38.
	(Point of Interests)	See Page 41.
	(Select from Map)	See Page 43.
	(Emergency)	See Page 44.
	(Memory Point)	See Page 40.
	(Previous Destination)	See Page 42.
	(Intersection)	See Page 46.
	(Freeway Ent/Exit)	See Page 43.
	(Phone number)	See Page 48.
	(Coordinates)	See Page 45.
	(Home)	See Page 40.
 - 	(Preset1) - (Preset5)	

You can switch between screens by selecting  (next page) or  (previous page).

NOTE

- If the set destination area is different from the one displayed under "Search Area" in the right part of the screen, you must select the  (change) key and specify the desired area again.
- Depending on the category used or the status of the map displayed, the point that is located may differ from the location where the facility you want to visit actually exists.

■ "Address" category

- 1 Press the **DEST** button and select  (address).
- 2 Enter a house number using the keypad on the house number input screen and select **OK**.



- 3 Enter the street name and select **List** (list).



 : Use this key to delete the last character entered. Select it repeatedly if you want to delete all the characters entered.

You can switch between keypad screens showing different characters by selecting **Others** (others), **Sym.** (symbols) or **A-Z** (alphabet).

- 4 Select the desired street from the list.

If the same street name exists in more than one city, a list of these towns will be shown.



- 5 Select the correct town from the list.



6 Select (destination) to set the address entered in the above steps as the final destination.

The system will calculate the route and display the entire route on the map.





Select  (waypoint) to set the address entered in the above steps as a waypoint on your route. You can program up to five waypoints per trip.

7 Select (start).

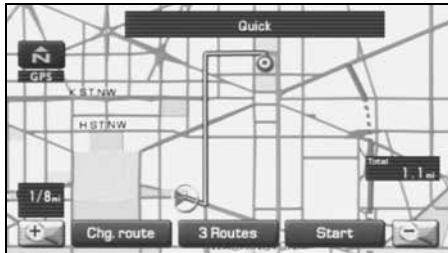



Route guidance begins along the displayed route.

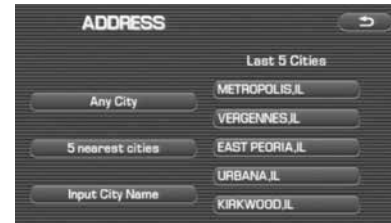

NOTE

- If the system cannot find your desired route, select  (change route). This will allow you to access the ROUTE OPTIONS screen, from which you can prompt the system to calculate a new route. (See Page 57.)
- If the map disc does not contain the relevant house number data, an error message will be displayed and a street map will appear, allowing you to set the destination using the map disc.
- If the destination is not on a road, set a destination point on a main road nearest to the actual destination.
- Selecting the  (city) will display a screen that searches the destination on a city basis.



-  : Search the destination from all cities.
-  : Search the destination from the nearby five cities from the current position.
-  : Search the destination by inputting the city name.
-  : You can also search the destination from the five cities that you searched in the past.

■ "Memory Point" category

If you have saved some locations in the system's memory, you can make use of an appropriate one to set the destination.

1 Press the **DEST** button and select  (memory point).

2 Select **List** (list).

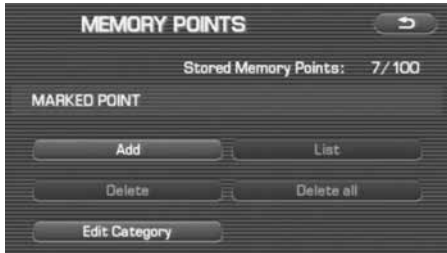

3 Select the desired location (memory point).



 : Use this key to display up to five previous suggestions.



 : Use this key to display the previous suggestion.

 : Use this key to display the next suggestion.

 : Use this key to display up to five of the next suggestions.

NOTE

- Select the **Attribute** (Attribute), **Icon** (icon), **Name** (name), or **Date** (date) key to change the sequence in which memory points are displayed.
- You cannot use the "Memory Point" method unless there are memory points stored. To store memory points, See Page 78.

4 Select  (destination) or  (waypoint).



■ "Home" category or "Preset" category using stored destinations

If you have stored the home address in the system's memory, you can use it for your destination or a waypoint. Similarly, if other locations are stored in the memory, they can be conveniently used for quick setting of destination and waypoints.

- 1 First, choose either of the two procedures below to follow the "home" category.

Press the **DEST** button.

- 2 Select **Home** (home) or the preset keys **1** (Preset 1) through **5** (Preset 5).



NOTE

Home (home) and the preset keys **1** (Preset 1) through **5** (Preset 5) are displayed only when you have stored the home location and other locations in the memory.

- 3 Select **Destination** (destination) or **Waypoint** (waypoint).

The map including the home location or the selected location will be displayed.

■ "Point of Interest" category

You can use a selection from the "Point of Interest" listing as the destination or a waypoint.

- 1 Press the **DEST** button and select **Point of Interest** (point of interest).

- 2 Enter the name of the desired point of interest and select **List**.

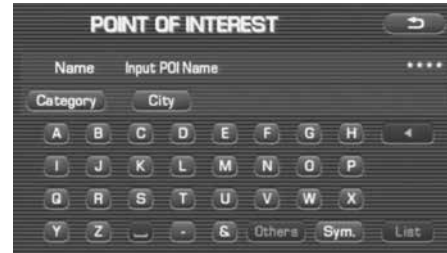

Back Arrow : Use this key to delete the character last entered. Select it repeatedly if you want to delete all of the characters entered.

NOTE

During character entry, the system shows the point of interest list automatically when the amount of matching points of interest is four or less.

3 Select the desired point of interest from the list.



: Use this key to display up to five previous suggestions.

: Use this key to display the previous suggestion.

: Use this key to display the next suggestion.

: Use this key to display up to five of the next suggestions.

NOTE

- If two or more points of interest share the same name, they will both be listed on the screen. Choose an appropriate one from the list.
- If there are two or more points of interest with the same name, select **Category** (category) or **City** (City) to shorten the list.
- Displayed information about a specific facility might not include recent changes. It is recommended that you check the location or business days/hours of a desired point of interest before departure.

4 Select (destination) or (waypoint).

■ "Previous Destination" category

This method allows you to choose one of the most recently used 100 destinations or waypoints as the new destination or waypoint.

1 Press the **DEST** button, select , and then select (previous destination).

2 Select a desired location from the Previous Destination list.



: Use this key to display up to five previous suggestions.

: Use this key to display the previous suggestion.

: Use this key to display the next suggestion.

: Use this key to display up to five of the next suggestions.

NOTE

- You can select **Name** (name) or **Date** (date) to change the sequence in which previous destinations are displayed.
- Selecting **Previous Start Point** displays the start point of the previous route guide.

3 Select (destination) or (waypoint).



■ "Select from Map" category

You can specify a location on the map that was last displayed and use it for setting the destination or a waypoint.

1 Press the **DEST** button and select  (select from map).



2 Scroll the map until the crosshair  is at the desired destination or waypoint.



3 Select  (destination) or  (waypoint).

■ "Freeway Entrance/Exit" category

You can use the name of a Freeway entrance or exit selected from the "Freeway Ent./Exit" list for setting the destination or a waypoint.

1 Press the **DEST** button, select , and then select  (Freeway Ent./Exit).

2 Enter the name of the desired freeway and select  .





 : Use this key to delete the character last entered. Select it repeatedly if you want to delete all of the characters entered.

NOTE

During character entry, the system shows the freeway name list automatically when the amount of matching freeways is four or less.

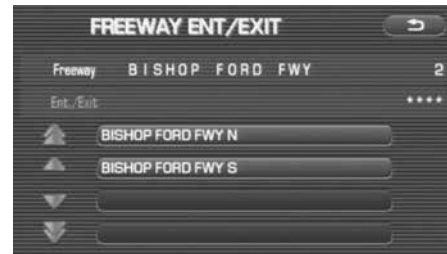
3 Select the name of the freeway from the list.



 : Use this key to display up to five previous suggestions.

 : Use this key to display the previous suggestion.

 : Use this key to display the next suggestion.

 : Use this key to display up to five of the next suggestions.

4 Select  (entrance) or  (exit).





5 Select the name of the street from which you will enter the freeway or to which you will go after leaving the freeway.



 : Select this key before you can enter the street name.



 : Use this key to search through the list by distance.

 : Use this key to search through the list by name (alphabetical search)

6 Select  (destination) or  (waypoint).

■ "Emergency" category

This function allows the nearest police station or hospital to be set as the destination.

1 Press the  button and select  (emergency).

2 Select either  (Police station) or  (Hospital).

The nearest police stations or hospitals will be displayed accordingly.



3 Select the desired institution from the list.

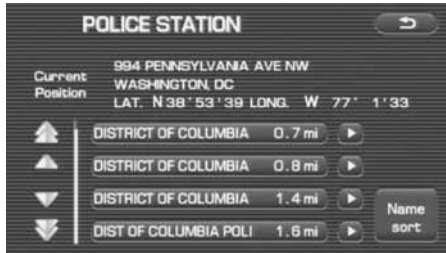

: Use this key to display up to five previous suggestions.

: Use this key to display the previous suggestion.

: Use this key to display the next suggestion.

: Use this key to display up to five of the next suggestions.

: Sorts the list by distance.

: Sorts the list in alphabetical order by name.

4 Select (destination) or (waypoint).

NOTE

Displayed information about each facility might be changed. It is recommended that you check the location or business days/hours before departure.

■ "Coordinates" category

You can set destinations or waypoints using their latitudes and longitudes as follows:

1 Press the button, select , and then select (coordinates).

2 Enter the latitude of the desired location.

Use the numeric keys together with the [°] (degrees), ['] (minutes), and ["] (seconds) keys.



: Use this key to delete the character last entered. Select it repeatedly if you want to delete all of the characters entered.

3 Enter the longitude of the location.



N : Use this key to switch over to the north latitude.

S : Use this key to switch over to the south latitude.

W : Use this key to switch over to the west longitude.

E : Use this key to switch over to the east longitude.

← : Use this key to delete the character last entered. Select it repeatedly if you want to delete all the characters entered.

4 Select **OK** (OK).

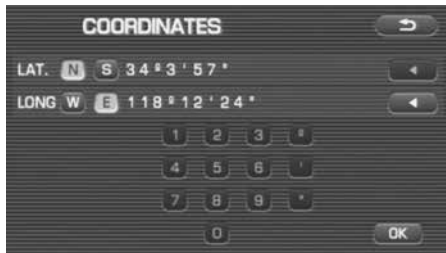

5 Select **📍** (destination) or **📌** (waypoint).

■ "Intersection" category

You can use an intersection defined by two street names as a location for setting your destination or a waypoint.

1 Press the **DEST** button, select **▶**, and then select **▲** (Intersection).

2 Enter the name of the first street and then select **List**.



← : Use this key to delete the character last entered. Select it repeatedly if you want to delete all of the characters entered.

NOTE

During character entry, the system shows the street name list automatically when the amount of matching streets is four or less.

3 Select the street from the "Intersection" list.



: Use this key to display up to five previous suggestions.

: Use this key to display the previous suggestion.

: Use this key to display the next suggestion.

: Use this key to display up to five of the next suggestions.

4 Specify the second street using the same procedure as the first street. Select (List).

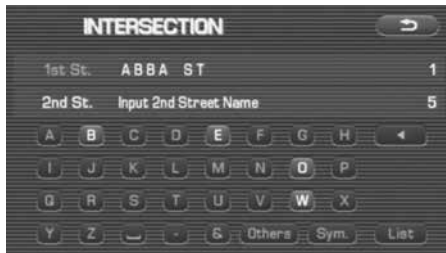

5 When there are two or more candidates, a list of intersections will be displayed. Select an intersection of the destination.



NOTE



No intersection is defined if

- the two streets do not cross each other,
- the two streets are a freeway and a highway,
- either street is for right or left turns only,
- both are one-way streets,
- either street is for U-turns,
- the two streets cross on the inside lane,
- either street is an on/off ramp, and/or
- either street is a frontage street.

6 Select (destination) or (waypoint).

■ "Phone number" category

This function allows buildings and the like to be located using their phone numbers.

1 Press the **DEST** button, select , and then select  (phone number).

2 Enter the phone number starting with the area code.



 : Use this key to delete the character last entered. Select it repeatedly if you want to delete all of the characters entered.

3 Select  .



4 Select your destination.



NOTE

If a number of candidates exist as a result of, for example, different area codes, these will be displayed in a list. The desired destination can then be selected from the list.

5 Select  (destination) or  (waypoint).

■ Using "Change Search Area" function

This function designates a general geographical area where the destination or waypoint you want to set is located.

1 Press the **DEST** button and select **Change** (change).

2 Select the desired area.

The DESTINATION ENTRY menu screen will appear.



NOTE

- The SEARCH AREA screen shown above is a sample image. It may be slightly different from the actual screen image.
 - Three map discs are contained in this system. When performing a search for a different area in your destination search, it is necessary to change the map disc with another map disc. If an area you want to find is not displayed on the screen shown above, take out the map disc and change it with a map disc containing the relevant area.
- For details of the map disc, refer to the description below.

■ Map Discs

The three map discs contain different areas, respectively. (West, Mid and East) Select the map disc containing the destination area you wish and insert the disc in the navigation system.

Make sure to reselect the destination when changing the map disc.

Refer to the section Set Route in the Instruction Manual for instructions on reselecting the destination.

■ Area (West)



Arizona, California, Colorado, Idaho, Kansas, Montana, Nebraska, Nevada, New Mexico, North Dakota, Oklahoma, Oregon, South Dakota, Texas, Utah, Washington, Wyoming, Canada

■ Area (Mid)



Alabama, Arkansas, Illinois, Indiana, Iowa, Kansas, Kentucky, Louisiana, Michigan, Minnesota, Mississippi, Missouri, Nebraska, North Dakota, Ohio, Oklahoma, South Dakota, Tennessee, Texas, Wisconsin, Canada

■ Area (East)



Alabama, Connecticut, Delaware, Florida, Georgia, Kentucky, Maine, Massachusetts, Maryland, New Hampshire, New Jersey, New York, North Carolina, Ohio, Pennsylvania, Rhode Island, South Carolina, Tennessee, Vermont, Virginia, Washington D.C., West Virginia, Canada

NOTE

- Road information for all of the above locations is included on the map discs. This means that the following operations can be performed regardless of which map disc is loaded in the system;
 - Scrolling Map to Select Destination (Select from Map)
 - Selecting Destination from the previously registered points as a memory point (Home, Memory Point, Previous Destination) within the same area.
 - Selecting Destination by Latitude and Longitude (Coordinates), Phone number, Emergency, and Quick POI.
- After replacing the map disc, stored data including the POI icon on the map and stored Avoid Street settings will be deleted, and Quick POI selections will return to default.
- In the Current Location display, the arrival time and the distance to the destination are displayed for Next Way Point.

Route Guidance

Route Guidance Screen

During route guidance, the system can indicate on a second screen the directions in which you must make turns at the next and following intersection in either of two ways: "turn arrow" or "turn list". Specify your preferred method of indication as follows:

<Turn arrow>

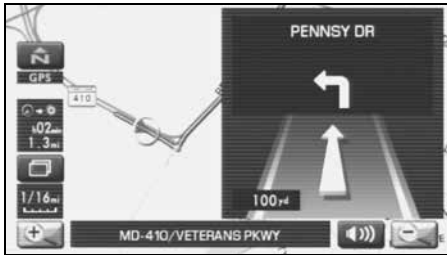



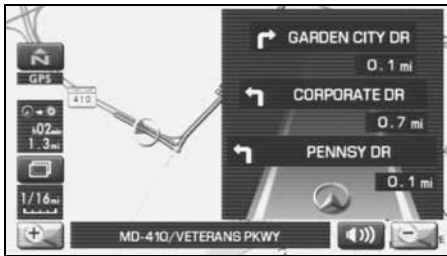

Turn direction is indicated by an arrow.

<Turn list>



Turn directions are indicated in a list.

- 1 Select  (screen configuration).
- 2 Select  for turn arrow indication or  for turn list indication.

If you do not need to make any further selections, select  .
The displayed keys will be hidden.



Zoom-in Map at Intersection

Before you arrive at an intersection, the system will automatically show a zoom-in map of the intersection on a second screen to make the guidance clearer.

As you approach an intersection during route guidance, a zoom-in map of the intersection automatically appears on a second screen. After you past the intersection, the zoom-in map disappears.

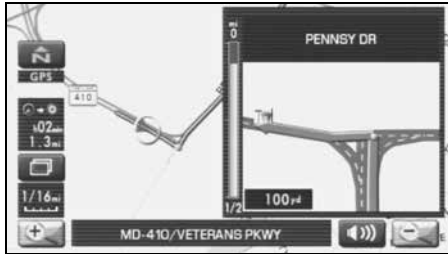

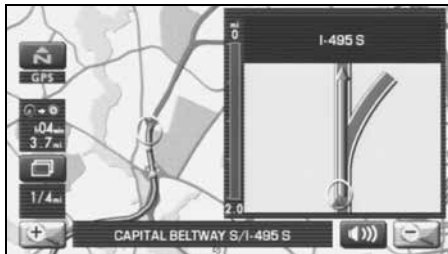

As you approach a fork on a freeway during route guidance, a zoom-in map of the freeway automatically appears on a second screen, making the route guidance clearer.



NOTE

Use the following procedure to recall the most recently displayed zoom-in map of an intersection or a freeway fork.

1. Select  (screen configuration).
2. Select  (re-display of intersection/range guidance).
If you do not need to make any further selections, select . The displayed keys will be hidden.

Dual Map Display

You can configure the screen for a dual map display.

<Single map display>



<Dual map display>

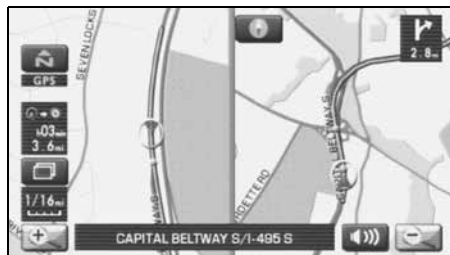

1 Select  (screen configuration).

2 Select  (dual map).

If you wish to return to the single map display, select  (single map).

If you need not make any further selection, select . The relevant keys will disappear.

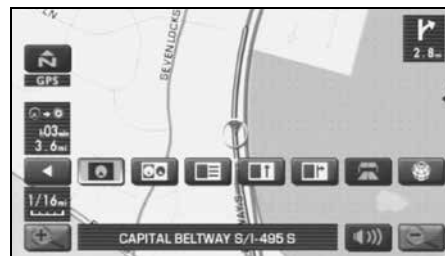

NOTE

If you wish to modify the display selections that have been made for a second screen, touch the top of the screen. After completing the modification, select .

- See Page 32 for details on scale changes.
- See Page 87 for details on setting with .

Freeway Information

A list of buildings and facilities along a freeway can be displayed on the screen.

1 Select  (screen configuration).

2 Select  (freeway information).

If you need not make any further selection, select  .
The relevant keys will disappear.

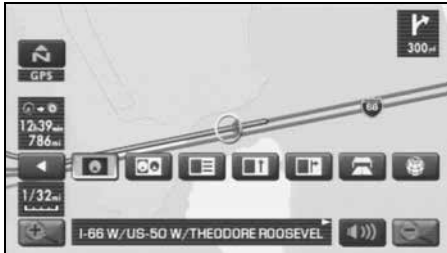

The information of a freeway is displayed.

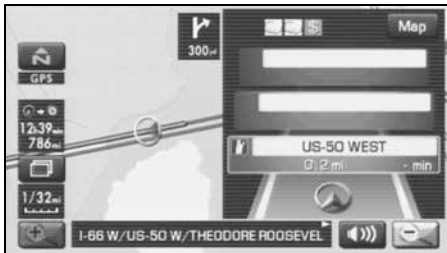

Select  to display the map in the neighborhood together with the icons of hotels and banks.



This map allows you to set the destination and waypoints. It also allows you to register them with the Memory Point with the cursor placed on the icon.

Replaying Voice Guidance

If you want to listen to the last voice guidance again during route guidance, use the following procedure:

- 1 Select .

You can hear the voice guidance again.

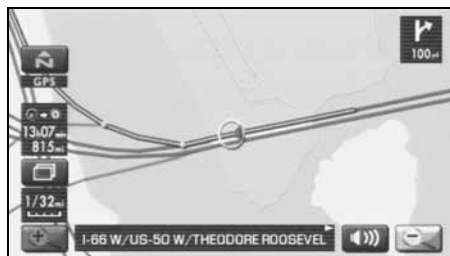

Compass Mode

Longitude and latitude of present location can be displayed on the screen.

1 Select  (screen configuration).

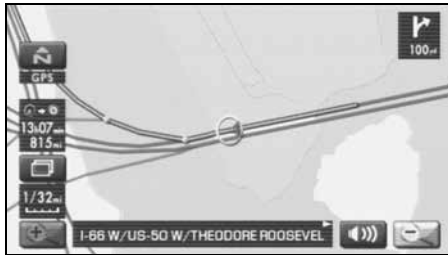

2 Select  (compass).

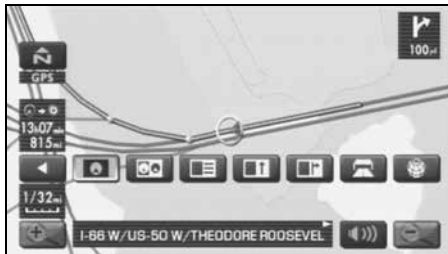

3 Longitude and latitude of present location are displayed at upper right of the screen.

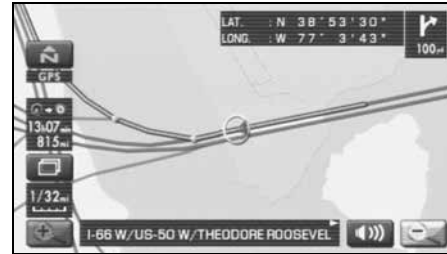

Route Options

Setting Route Options

Using the functions available from the Route Options screen, you can change the route options, stop the route guidance or check the route. Use the following procedures:

1 Press the **MENU** button.



2 Select  (route options).



3 The Route Options screen will appear. Select any of the following displayed functions as necessary:



 (search condition):

This function allows you to specify the way in which the system calculates the route to the destination. (See Page 58.)

 (detour):

This function allows you to prompt the system to calculates an alternative route from the current position within a specified distance. (See Page 59.)

 (route preferences):

This function allows you to prompt the system to alter the route search conditions and recalculate the route accordingly. (See Page 60.)

**(destination and waypoint):**

This function allows you to modify the destination and waypoints, and prompt the system to recalculate the route accordingly. (See Page 60.)

**(display route):**

This function allows you to confirm the entire route and, if necessary, prompt the system to recalculate the route according to your specification. (See Page 64.)

**(route preview):**

This function allows you to simulate a drive along the route that is calculated by the system before departure. (See Page 65.)

**(calculate):**

Selecting this key prompts the system to recalculate the route.

**(cancel guidance):**







Selecting this key prompts the system to stop route guidance. Note that this erases the destination and waypoints. To prompt the system to start guidance again, select  (calculate).

NOTE

A recalculated route will sometimes be the same route as the one displayed before recalculation.

Search condition

You can specify the way in which the system calculates the route.

- 1 Press the  button, then select  (route options), and then select  (search condition).
- 2 Select  (Quick),  (Alt.), or  (Short) to specify the way of calculating the route to reach the next waypoint or the destination from the current point.



 : The system will calculate a route with the shortest driving time required.

 : The system will calculate an alternative route.

(You can select ,  or  for the first waypoint. Only  or  can be specified for the second and subsequent waypoints.)

 : The system will calculate a route with the shortest driving distance.

3 Select **Calculate** (calculate)

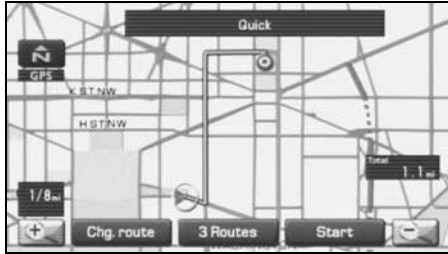

4 Select **Start** (start).

Route guidance will begin along the displayed route.



Detour

You can specify a detour distance from your current position. The system will calculate an alternative route according to the distance specification, enabling you to take a detour.

1 Press the **MENU** button, then select  (route options), and then select  (detour).

2 Select a detour distance using **1 mi**, **3 mi**, **5 mi**, or **Whole route** (whole route).

The system will then calculate an alternative route that detours from the current location within the specified distance.



When driving on the freeway, make a selection from among



3 Select **Start** (start).

NOTE

If you are driving off the route, it is not possible to calculate a detour route.

Route preferences

Use this function to specify preferred route search conditions. The system will start recalculating the route according to your specified conditions.

1 Press the **MENU** button, then select  (route options), and then select  (route preferences).

2 Specify conditions by selecting keys.

Each time you select a key, it will toggle between "usage" and "non-usage" of the corresponding roads or ferries.

3 Select  (calculate).

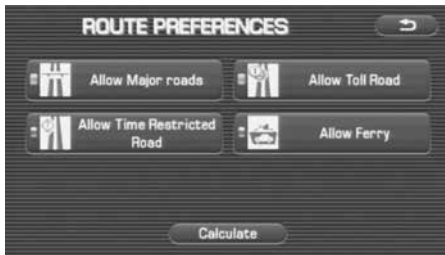

NOTE



- The  (calculate) key can be selected during route guidance.
- The route calculation will not always be able to follow the specified conditions.

Destination and waypoints

You can change the destination or waypoints for the route calculation by using this function.

■ Addition of waypoints

Use the following procedure to add new waypoints to the current route for recalculation.

1 Press the **MENU** button, then select  (route options), and then select  (destination and waypoints).

2 Select  (add).



- 3 Set a waypoint using any method available from the screen.



- 4 Specify the order in which all the set waypoints are to be visited.

Choose the location of the waypoint to be added, and then select **Add** (add).



- 5 Select **Calculate** (calculate).

NOTE

- When a new destination is set using **Change Location** (destination), it will replace the current destination and the route calculation will be carried out again.
- Step 4 must be performed for the second and any subsequent waypoints.
- Repeat Steps 1 to 4 for each waypoint to be set.

■ Modifying destination or waypoint positions

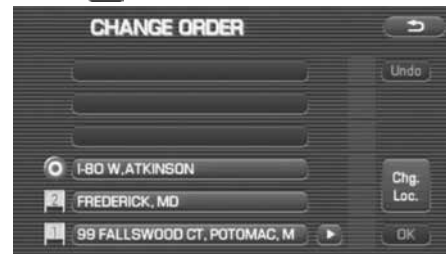

Use this procedure to modify the destination or waypoint positions. The screen will display the calculated route and the positions of the destination or waypoints that you will be able to modify.

- 1 Press the **MENU** button, then select **Route Options** (route options), and then select **Destination and Waypoints** (destination and waypoints).
- 2 Select **List** (list).
- 3 Select **Change Location** (change location).



- 4 Select the key corresponding to the location that is to be modified.

The map for the area around current location will be displayed.





- 5 Scroll the map to bring the crosshair  to the location and then select .



- 6 Select  (calculate).

■ Modifying visiting order

You can change the order for visiting your waypoints by using this procedure.

- 1 Press the  button, then select  (route options), and then select  (destination and waypoints)
- 2 Select  (list).

- 3 Select the waypoint keys according to the order of your visit.

If you wish to cancel the visiting order number indication, select  (undo).

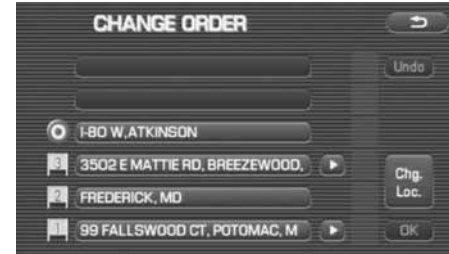

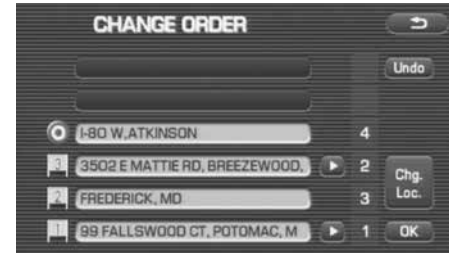

- 4 When you complete the sequencing, the visiting order will be updated automatically.



- 5 Select .
- 6 Select  (calculate).

■ Deleting destination or waypoints

Use this procedure when you wish to delete the previously set destination or waypoint.

- 1 Press the **MENU** button, then select  (route options), and then select  (destination and waypoints).
- 2 Select **Delete** (delete).
- 3 Select the key corresponding to the destination or waypoint you wish to delete.



- 4 Confirmation message will be displayed. Select **Yes** (yes).



Select **No** (no) to cancel the deletion.



- 5 Select **Calculate** (calculate).

■ Deleting destination and all waypoints

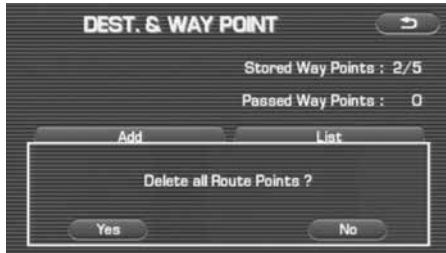

You can delete the destination and all previously set waypoints in a single process.

- 1 Press the **MENU** button, then select  (route options), and then select  (destination and waypoints).
- 2 Select **Del.All** (delete all).
- 3 Confirmation message will be displayed. Select **Yes** (yes).
Select **No** (no) to cancel the deletion.



Display route

Use this function to display the entire route. You can also specify an area you wish to avoid and prompt the system to recalculate the route accordingly.

- 1 Press the **MENU** button, then select  (route options), and then select  (display route).
- 2 Select **Turn List** (turn list).

The entire route screen will appear and then it will change to the Turn List screen.





Avoid (avoid):

Select this key if you wish to specify any areas to avoid from the list of street names.

Reroute (Reroute):



The system will recalculate the route.

If the data for the route cannot be shown on one screen, scroll the screen using the ▲ and ▼ keys.

3 When the Reroute is selected: Select **Start** (start).

Route preview

The system can show you an automated simulation of the calculated route.

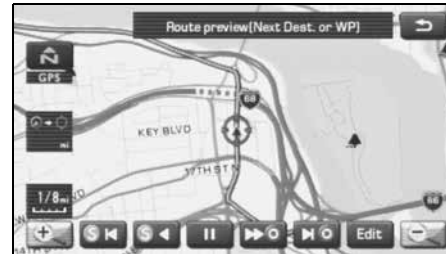

- 1 Press the **MENU** button, then select  (route options), and then select .
- 2 Start the simulation drive according to the calculated route using the keys on the screen as follows:





 : Move to the start point.

 : The simulation drive will start toward the start point. After the start, this key will be displayed as , and when it is selected, the simulation drive will switch to high-speed driving.

 : The simulation drive will stop.

 : The simulation drive will start toward the destination. After the start, this key will be displayed as , and when it is selected, the simulation drive will switch to high-speed driving.

 : Move to the destination.





 : The EDIT ROUTE PREVIEW screen will be displayed. (See Page 66.)

NOTE

The visual speed of the simulation vehicle varies with the map scale selected. The speed appears to be faster with a wide-area map than with a zoom-in map.

■ Setting conditions for simulation drive

You can change the simulation drive conditions using this procedure.

- 1 Press the  button, then select  (route options), and then select  (route preview).
- 2 Select  (edit).

The EDIT ROUTE PREVIEW screen will appear.



 (to destination or next waypoint):

The simulation drive will stop at the destination or the next waypoint.

 (to next POI):

The simulation drive will stop at a point of interest that has been set up on the route.

 (delete):

A selected POI will be deleted.

POI keys:

When you select one of the six POI category keys, the system will retrieve the selected POI from the Quick POI storage and display it on the map. When selecting the **Others** (others) key, POIs of other categories can be found. For more details, see Page 71.

If, for example, the **To next POI** (to next POI) category key is selected and a simulation drive is started, the simulation vehicle will then stop at a restaurant on the route.

If you then select **Info.** (information), the system will display information on the restaurant.

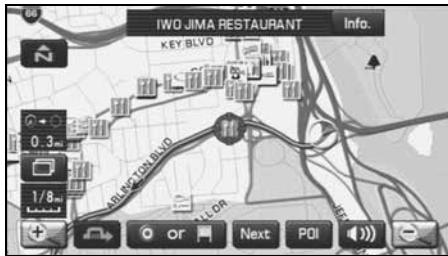

Selecting **Info.** allows you to make a phone call to the phone number displayed.

* The Bluetooth Phone is required to be set in advance.

NOTE

You must finish the simulation drive before you actually start to drive. Although the simulation drive will automatically stop when you actually start to drive, not finishing it properly can lead to an error in the display of the current position of the vehicle.

Navigation Setup

Setting Navigation System

Using the functions available from the Navigation Setup screen, you can change the map display conditions and alter the route guidance conditions.



- 1 Press the **MENU** button.



- 2 Select  (navigation setup).

The NAVIGATION SET UP screen will appear.



Select any of the displayed functions as necessary. This screen consists of two pages. Change the page by using the  or  keys.

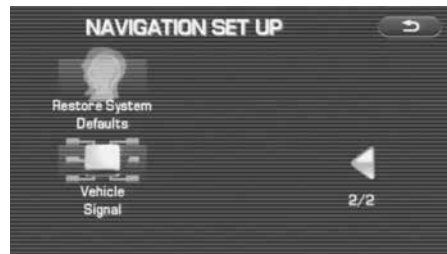
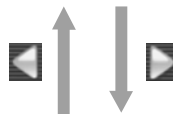

**(user settings):**

This function allows you to change the screen display and sound settings. (See Page 69.)

**(quick POI selection):**

This function allows you to set the point of interest categories that are displayed when selecting the menu from the current position screen. (See Page 71.)

**(language):**

This function allows you to change the language for the menu screens and the voice guidance. (See Page 72.)

**(calibration):**

You can use this function to correct display errors in the vehicle's position and direction. (See Page 73.)

**(set clock):**

This function allows you to set the time. (See Page 74.)

**(Vehicle Signal):**

This function allows you to confirm the vehicle signal, the version of the DVD-ROM disc. (See Page 75.)

**(restore system defaults):**

This function allows you to change the system's current settings back to the default settings (factory settings). (See Page 75.)

User settings

.....

You can change the screen display and sound settings using this procedure.

- 1 Press the **MENU** button, then select (navigation setup), and then select (user settings).
- 2 Select the setting item you wish to change.

The USER SETTINGS screen consists of three pages. Use the or keys to change the screen page when selecting a setting item.

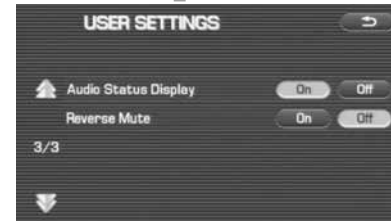

Distance:

Units of distance can be selected from **km** (km) and **mile** (mile).



Road Restriction Warnings:

You can select or deselect display of traffic restriction warnings during route guidance.

Keyboard layout:

The layout of input keys can be selected from **ABC** ("ABC" layout) or **QWERTY** ("QWERTY" layout).

Arrival Time:

Time of arrival at the destination or a waypoint can be displayed in two different ways: estimated arrival time or remaining driving time. Select  for the estimated arrival time display or  for the remaining time display.



<Estimated arrival time>



<Required remaining time>

Map Mode:

The map display mode can be set to any of the automatic, daytime, and nighttime modes.

Auto (automatic):

The brightness of the display will automatically change to daytime brightness and nighttime brightness when the headlights are turned off and on, respectively.

Day (daytime):

The brightness of the display is fixed at the daytime setting regardless of whether the headlights are on or off.

Night (nighttime):

The brightness of the display is fixed at the nighttime setting regardless of whether the headlights are on or off.

Guidance Screen:

This function allows you to select or deselect display of guidance messages on the screen.

Freeway Information:

This function allows you to select or deselect display of guidance messages when driving on freeway.

Auto Volume:

A setting can be made so that the sound volume of the navigation system automatically increases as the speed of the vehicle increases.

Beep:

A setting can be made so that a beep sounds.

Clock Display:

A setting can be made so that the clock is displayed.

Audio Status Display:



A setting can be made so that the status of the audio system is displayed.

Reverse Mute:

A setting can be made so that the sound volume of the audio system is reduced while reversing the vehicle.

Quick POI selection

Using this function, you can set the point of interest categories that are displayed when selecting the Point of Interest menu key on the current map screen. Set up to six different categories that are used most frequently. (See Page 87 for displaying POI categories on the map and searching for the nearest points of interest.)

- 1 Press the **MENU** button, then select  (navigation setup), and then select  (quick POI selection).
- 2 Select one of the six category keys you wish to program into the Quick POI storage.



Default (default):

Use this key to restore the factory settings.

3 Select a category.

Once you have selected a category key, subcategories will be displayed.



All category list

(all category list):

Subcategories from all individual categories will be displayed together.

4 Select the subcategories to be displayed on the map.





NOTE

Repeat Steps 1 to 4 to add more POI categories for display on the menu screen.

Language Selection

.....

Perform the following procedure to select your preferred language for the menu screens, voice guidance and voice recognition.

- 1 Press the **MENU** button, then select  (navigation setup), and then select  (language)

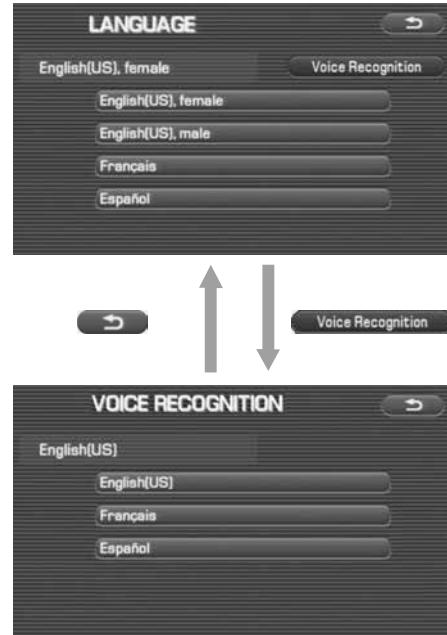

- 2 Select your preferred language from the list.



Calibration

This function allows you to correct any display errors in the position and direction of your vehicle on the map display.



■ Adjusting current position and direction

- 1 Press the **MENU** button, then select  (navigation setup), and then select  (calibration).
- 2 Select **Position/Direction** (position/direction).



- 3 Move the crosshair  to the correct position, and then select **OK**.





- 4 Use  or  to adjust the direction in which you are heading, and then select **OK**.



■ Distance

When selected, this function automatically corrects an error in the current position display that might occur after tire replacement.



1 Press the **MENU** button, then select  (navigation setup), and then select  (calibration).

2 Select **Distance** (Distance).





Set clock

Since the adjustments for minutes and seconds are made automatically using the time data provided by GPS satellites, you can set your clock by simply performing a time-zone and daylight saving time adjustment using this function.

1 Press the **MENU** button, then select  (navigation setup), and then select  (set clock).

2 Select **24H** if you prefer 24-hour display; select **12H** for 12-hour display.



3 Select the time-zone by pressing  or .

NOTE

Initial time-zone setting of this navigation unit is Eastern (Disc A)/Mid (Disc B)/Pacific (Disc C).



- 4 Select the daylight saving time mode by pressing **On** or **Off**.

NOTE

Select **On** to advance the time by one hour.

Vehicle signal

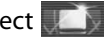
This function allows certain vehicle data and GPS satellite data to be displayed.

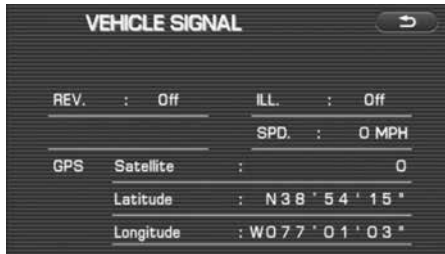

- 1 Press the **MENU** button, then select  (navigation setup), select  and then select  (vehicle signal).

The VEHICLE SIGNAL screen will appear.



Restore system defaults

Use this function if you want to change all of the system's current settings back to the default settings.

- 1 Press the **MENU** button, then select  (navigation setup), select  and then select  (restore system defaults).
- 2 Select **OK** to return all current systems settings to default.

**NOTE**

If you select this function, all your settings will be deleted.

[Default List]

Item	Initial condition
Map display	
Search Area	Disc A (WEST): CA Disc B (MID): IL Disc C (EAST): DC
Display Guidance Language	US English, female
Voice Recognition Language	US English
Map Orientation (1 and 2 screen)	North up
Map Display Mode	Single-screen display
Map Display Scale	Single-screen: 10,000 map (1/16 mi) (100 m) Dual-screen: 40,000 map (1/4 mi) (500 m)
Map Configuration	Arrow Mode
Q-POI Map Display	Off
Show POI Icon Display	Off
Right Screen Setting, POI	On
Passage Point Display/ Current Location, Map Screen (Time Requirement, Time, Direction / Distance)	Next passage point
Passage Point Display/ Full Route, Map Screen (Time Require- ment, Time, Direction / Distance)	Destination
Restricted Road	On
Freeway Information	Off
Volume Control	
Volume Preset	4

Item	Initial condition
Navigation Setup Menu	
Distance	mile
Road Restriction Warnings	On
Reverse Mute	Off
Keyboard Layout	ABC
Arrival Time	Required remaining time
Item	
Initial condition	
Map Mode	Auto
Guidance Screen	On
Q-POI Selection	A: Gas station B: ATM C: Parking D: Grocery store E: All Restaurants F: Hotel
Language Selection	US English, female, male, French, Español
Route Options	
Search Condition	Quick
Route Preferences	Allow Toll Road: Off Allow Ferry: Off Allow Major Roads: On Allow Time Restricted Road: Off

Stored Locations

You can store, edit, or delete any destinations, waypoints, and other marked points using the procedures described in this section.

1 Press the **MENU** button.

2 Select  (stored locations).



3 Select the desired item.



 (Memory Points):

Use this function to place markers on the map. (See Page 78.)

 (Avoid Area):

Use this function to store into the system's memory any areas you want to avoid. (See Page 83.)

 (Previous Destination):

Use this function to delete previously stored destinations and waypoints. (See Page 85.)

 (Display memory point icons):

Selecting this key allows you to display icons for memory points.

Each of the above three functions has some or all of the following four standard editing functions (see the table below):

 (add):

You can store a new location into memory.

 (list):

You can see a list of the stored locations.

 (delete):

You can delete stored locations.

 (delete all):

You can delete all stored locations.

Editing keys displayed for each function are as follows:

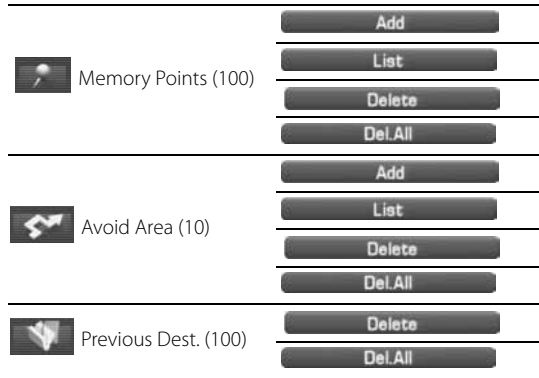

The numbers in parentheses following the function names indicate the maximum locations you can store in the memory.

Memory points

■ Storing new memory points

Memory points can be stored into any of the six categories (including Home) of storage locations.

- 1 Press the **MENU** button, then select (stored locations), and then select (memory points).
- 2 Select (add).

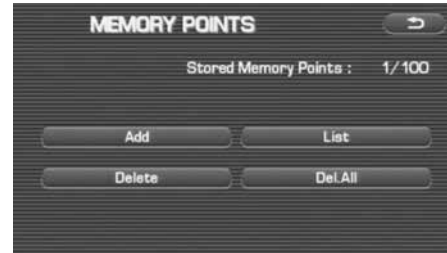

3 Set the memory point using the preferred category available on the displayed screen.



4 A confirmation message will be displayed.

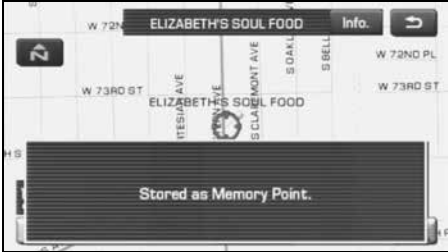



NOTE

Up to 100 memory points can be stored. Once that number has been reached, you must delete memory points that you no longer require (See Page 82) before you can store new memory points. The number of memory points you can store is indicated on the screen.

■ **Editing memory points**

Using this function, you can review the stored memory points in the form of a list on the screen and modify names, icons, telephone numbers, and other memory point data.

- 1 Press the **MENU** button, then select  (stored locations), and then select  (memory points).
- 2 Select  (list).

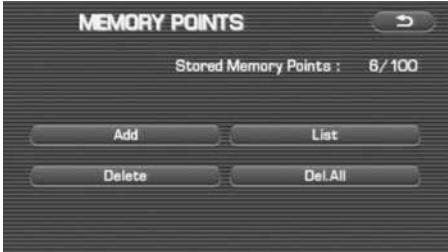

3 Select the memory point to be edited.

You can sort the sequence in which memory points are listed by selecting **Attribute** (Attribute), **Icon** (icon), **Name** (name), or **Date** (date).









4 Select the category key corresponding to the memory point to be edited.



Icon (icon): Selecting this key allows you to choose a display icon. **Page 1** (Page 1) and **Page 2** (Page 2) of the CHANGE ICON screen contain standard icons, whereas the **With sound** (with sound) page contains icons that are accompanied by response sounds. Select **Sound** (sound) to listen to these sounds.

NOTE

The "With direction" ( / ) keys in the "With Sound" page are used to activate response sounds only when you come near the memory point from the specified direction. Select  or  and set the direction using  or . Selecting  allows you to listen to respective sounds.

Category (category): Use this key to change the storage category. After selecting this key, select either key of HOME or presets 1 to 5.

For memory points to which the category has been set, it is possible to set them quickly as a destination. It is convenient to set in advance the category to the home or a location to which you go frequently. When setting it as a destination, select the relevant key on the DESTINATION ENTRY screen. See Page 36.

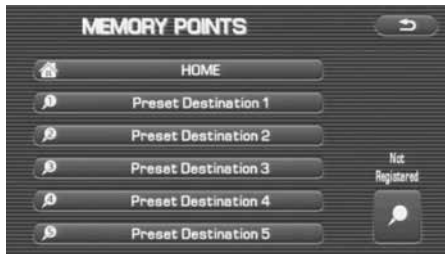

Name (name): Select this key to change the name of a memory point. When the change has been completed, select **OK** (OK). Then select **On** (on) if the name is to be displayed on the map screen, or **Off** (off) if it is not to be displayed.

Position (position): Select this key to review the memory points and modify a memory point on the map screen. After checking or modifying it, select **OK** (OK).





Tel. (Tel): Select this key to modify a telephone number. When the modification has been completed, select **OK** (OK).



 : Use this key to delete the character last entered. Select it repeatedly if you want to delete all of the characters entered.

■ Deleting memory points

You can delete stored memory points by using this function.

- 1 Press the **MENU** button, then select  (stored locations), and then select  (memory points).
- 2 Select the category of the memory point to be deleted.
- 3 Select **Delete** (delete).
- 4 Select the memory point to be deleted.





- 5 Confirmation message will be displayed. Select **Yes** (yes).

Select **No** (no) to cancel the deletion.



■ Deleting all memory points

Using this function, you can delete all memory points.

- 1 Press the **MENU** button, then select  (stored locations), and then select  (memory points).
- 2 Select the category of the memory points to be deleted.
- 3 Select **Del.All** (delete all).

- 4 Confirmation message will be displayed. Select **Yes** (yes).



Select **No** (no) to cancel the deletion.



Avoid area

■ Storing avoid areas

If you use this function to store into the system's memory the areas you want to avoid, the system will avoid the areas when calculating routes.

- 1 Press the **MENU** button, then select  (stored locations), and then select  (avoid area).
- 2 Select **Add** (add).



- 3 Set an avoid area using preferred method.

A map including the specified avoid area will appear. The method of setting avoid areas is identical to that of setting destinations.

4 Select **Reduce** (reduce) or **Enlarge** (enlarge).

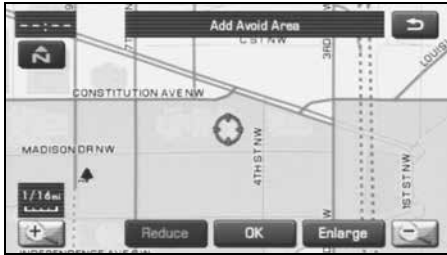

Reduce (reduce): Reduces the size of the avoid area.

Enlarge (enlarge): Increases the size of the avoid area.



5 Select **OK** (OK).

NOTE

- Reduce the scale of the map to specify a larger area.
- Avoid areas can be set only when the scale of the map is 1/32-1/2 mile (50 m-1 km) or less.

■ Editing avoid areas

Using this function, you can review the stored avoid areas in the form of a list and modify them if necessary.

1 Press the **MENU** button, then select  (stored locations), and then select  (avoid area).

2 Select **List** (list).

3 Select the avoid area to be modified.

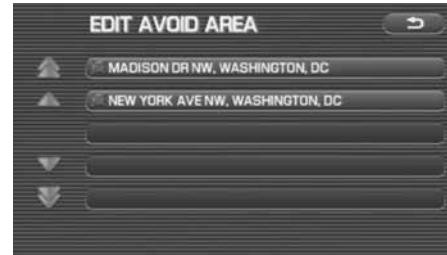

4 Select the key corresponding to the item to be modified.

For details regarding the function of each key, refer to "Editing memory points" on Page 79.



NOTE

The methods for deleting individual and all avoid areas are the same as those described on Page 82 for memory points.

Previous destination (deleting stored locations)

Use this function to delete previously set destinations.

1 Press the **MENU** button, then select  (stored locations), and then select  (previous destinations).

2 Select **Delete** (delete).

If **Del.All** (all delete) is selected, all previously set destinations will be deleted.



3 Select the destination to be deleted.

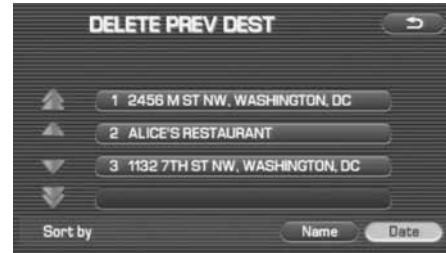

: Use this key to display up to five previous destinations.

: Use this key to display the previous destination.

: Use this key to display the next destination.

: Use this key to display up to five of the next destinations.

Name (**name**): Use this key to search through the list by name (alphabetical search).

Date (**date**): Use this key to search through the list by date.

4 Confirmation message will be displayed. Select **Yes** (yes).

Select **No** (no) to cancel the deletion.



Other Functions

Displaying POIs on a map

Using this function, you can display POIs on the current map screen.

- 1 Touch the current map screen.
- 2 Select **POI** (points of interest).



- 3 Select desired POIs using the displayed category keys.



When selecting two or more categories, select **List Categories** (list category) to make a selection of them.

All Local POI's (all local POIs): Use this key to search for all local points of interest (refer to "Local POI search" on Page 88).

- 4 Once you have made the selection of POIs, corresponding markers will appear on the current map screen.



- 5 When selecting two or more categories, select **List Categories** (list categories) to make a selection of them. The selection of up to five categories is available.

6 Select desired POIs using the displayed category keys.



7 Select desired POIs using the displayed category keys.



NOTE

- To delete the markers for these POIs, see Page 90.
- Displayed information about each POI facility might not include recent changes. It is recommended that you check the location or business days/hours before departure.

Delete (delete): Use this key to hide the POI that was the last item set of the POIs that are selected.

■ **Local POI search**

1 Touch the current map screen.

2 Select **POI** (points of interest).



3 Select **All Local POI's** (all local points of interest).

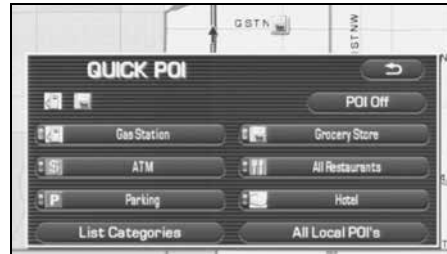

When searching local points of interest, it is necessary to set in advance the category you want to make a search to the Quick POI. (See Page 71.)

- 4** Select the POI you want to find from the list of categories.



- : Use this key to display up to five previous POIs.
- : Use this key to display the previous POI.
- : Use this key to display the next POI.
- : Use this key to display up to five of the next POIs.
- : Use this key to search through the list by distance.
- : Use this key to search through the list by icon type.
- : Use this key to search through the list by name (alphabetical search).
- : Use this key to display a list of POIs only along the route up to the destination.

Once you have made your selection of POIs, corresponding markers will appear on the map.

Displaying POI data

You can display the information on a POI, such as the name, address and telephone number.

- 1** Display the desired POI markers on the current map screen. (See Page 71 and 87 for the procedure.)
- 2** Select the POI marker for which you want information by moving the crosshair over it.

The name of the POI will appear.

If no data is stored for the selected POI, no name is displayed.



3 Select **Info.** (information).

The information on the POI will be displayed.



 : Use this key to store the POI location as a memory point.



Deleting POI markers

Use this function when you want to delete any POI markers on the map.

- 1 Touch the current map screen.
- 2 Select **POI** (point of interest).
- 3 Select **POI Off** (point of interest off).

The marker for the POI will disappear from the map.

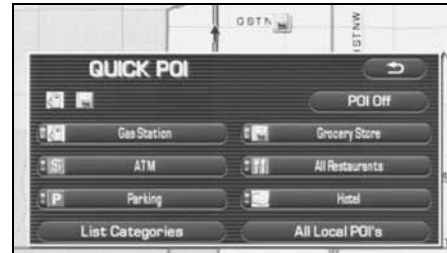

Editing Quick POI categories

Use this function when you want to edit the Quick POI categories on this unit.

- 1 Select  (menu).



- 2 Select  (navigation set up).



- 3 Select  (quick POI selection).



- 4 Select the item that you want to edit.

(Following procedure show how to change the category from ATM to SUBARU dealership on Quick POI for example.)



5 Select  **Automotive** (automotive).



6 Select  **SUBARU DEALERSHIP** (SUBARU dealership).



ATM bookmarked as  **SUBARU DEALER** (SUBARU dealer) to Quick POI.



Selecting  **Default** (default) returns the Q-POI SELECTION items to their default settings.

SUBARU dealership search

■ SUBARU dealership search from POI

- 1 Press the **DEST** button and select  (point of interest).
- 2 Press the **Category** (category).



- 3 Press the  **Automotive** (automotive).



- 4 Select  **SUBARU DEALERSHIP** (SUBARU dealership) from the list.



NOTE

- Displayed information about a specific facility might not include recent changes. It is recommended that you check the location or business days/hours of a desired point of interest before departure.

- 5 The system refine the destination search only for SUBARU dealership.

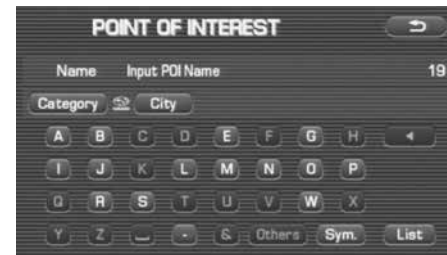

■ Displaying SUBARU dealership on map

1 Touch the current map screen.

2 Select **POI** (points of interest).



3 Select **List Categories** (list categories).



If **SUBARU DEALER** (SUBARU DEALER) has been registered as a quick POI on the screen shown above, turn it on and then proceed to step 6.

4 Select **Automotive** (automotive).



5 Select **SUBARU DEALERSHIP** (SUBARU dealership) and press **Show** (show).

The POI marker of SUBARU dealership will appear.



- 6 Select the SUBARU dealership marker by moving the crosshair  over it.



- 7 Select **Info.** (info).
- 8 The information of SUBARU dealership will be displayed.



Version and Initialization

Version

Use this function to check the version of the DVD-ROM disc you are presently using.

1 Press the **MENU** button.

2 Select  (version).



3 The version of the DVD-ROM disc will be displayed on the screen.



Initialization of the navigation settings

The settings of the navigation system can be initialized. When initialized, data such as memory points, travel history and telephone numbers are all deleted. Data once deleted cannot be restored.

1 Press the **MENU** button.

2 Select  (version).



3 Select **DEFAULT** (default).

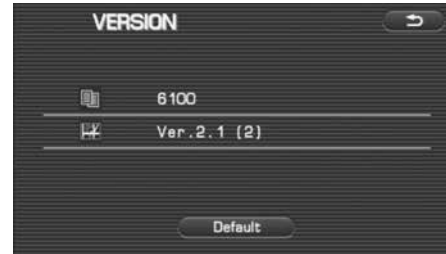

4 Select **Agree** (agree).



5 Select **Yes** (yes).

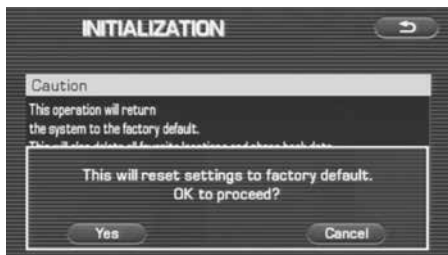

6 The navigation system is restarted automatically.

All of the settings are initialized.

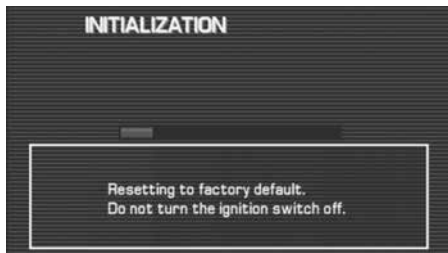

General Information

■ Accuracy of vehicle position

Area in which GPS signals cannot be received

Because the radiowave signals from the GPS satellites travel primarily by line of sight, the navigation system might not be able to receive the signals in the areas described below. (If the GPS mark does not appear on the map screen, it means that the GPS radiowave signals are not being properly received.)

- (1) Inside a tunnel
 - (2) Inside a building
 - (3) Under a three-dimensional road system such as for high speed roads
 - (4) On boulevards lined with trees
 - (5) Between buildings
 - (6) Under a cliff or in a cave
- If the GPS antenna or its surroundings are blocked by an obstacle (including cargo), it might not be possible for the system to receive the GPS radiowave signals.
 - If multiple paths are created due to the reflection from buildings, a large measurement error could occur, causing the vehicle's mark to deviate from its actual position.

Deviation of the vehicle's position mark

The vehicle's position mark could deviate from its actual position when the vehicle is being driven under the conditions listed below or due to conditions of the GPS satellites.

If the vehicle travels on a road whose actual shape differs from that in the map data, the vehicle's mark could deviate from the actual posi-

tion. The correct position will eventually appear on the screen through the correction function. If the screen does not show the correct position for an excessively long time, correct the current position or make an automatic correction.

- (1) The vehicle's mark could appear on a parallel road.
- (2) When the road splits into a narrow Y, the vehicle's mark could appear on the other fork of the Y.
- (3) When the vehicle makes a right or left turn, the vehicle's mark could appear on one street ahead or behind.
- (4) If the vehicle is transported by means other than the vehicle's own power, such as on a ferryboat, the vehicle's mark will remain in the position it was before the transport until the system can calculate the position through the GPS.
- (5) When the vehicle is driven on a steep incline, the vehicle's mark could deviate from its actual position.
- (6) If there are continuous gradual curves in the same direction, the vehicle's mark could deviate from its actual position.
- (7) If the vehicle is driven in a zigzag pattern, such as through frequent lane changes, the vehicle's mark could deviate from its actual position.
- (8) If the vehicle is placed on a turntable, such as in a parking area, and turned with the ignition OFF, the vehicle's mark could deviate from its actual orientation. The vehicle's mark could also deviate even after the vehicle has exited the parking area.
- (9) The vehicle's mark could deviate from its actual position if the vehicle is driven using tire chains or snow tires on a snow-covered road or on a mountainous road.

- (10) The vehicle's mark could deviate from its actual position after the tires have been replaced.
- (11) While driving on a public road, if an expressway that is under construction travels over the public road, the position mark of the vehicle may be indicated on a different road.
- (12) If other electronic devices are installed on the instrument panel, these devices may adversely affect the GPS signal communication and the position of the vehicle may not be indicated correctly.

■ How the vehicle position is detected

Detecting the vehicle's position through the GPS

GPS stands for "Global Positioning System", which is a system used for detecting an object's position through the use of satellites of the U.S. Department of Defense.

Radiowave signals from three or more satellites are received by the navigation system, which utilizes the principle of triangulation to detect the position at which the radiowave signals are received.

When the navigation unit is receiving the GPS radiowave signals, a "GPS" mark will appear on the map screen.

Detecting the vehicle's position through self-contained navigation

Self-contained navigation is a system that detects the vehicle's position by calculating the vehicle's driven distance and turning angle through the use of various types of sensors that are mounted on the vehicle.

Through the use of self-contained navigation, the vehicle's position can be detected even in an area where the GPS radiowave signals cannot be received.

Making corrections to the detection of the vehicle's position through map matching

- In map matching, the position information resulting from the detection of the vehicle's position and the locus of the travel of the vehicle up to the present are constantly compared to the shape of the roads on the map in order to correct the vehicle's position mark to the most appropriate road.
- If the vehicle is driven on a road whose actual shape differs from its map data, the vehicle's position mark on the map could deviate from its actual position.
Occasionally, the correction of the vehicle's position mark to the actual road on the map can be observed, particularly after the vehicle has turned at an intersection or has exited from a parking area.

■ Accuracy of the route guidance

The conditions listed below do not indicate a malfunction.

- (1) The guidance might prompt the driver to drive straight even though the vehicle is being driven on a straight road.
- (2) The directional guidance could display multiple place names.
- (3) If the vehicle makes a turn at an intersection before the guided route, the wrong type of voice guidance could be outputted.
- (4) The guidance might not be outputted while the vehicle is making a turn at an intersection.
- (5) The system might not be able to search for the proper route.

- (6) If there is no road to the destination or if there is only a narrow road, the route might be indicated up to an area that is short of the destination.
- (7) The repeat search could take a long time while the vehicle is being driven at high speeds.
- (8) While the system is searching again for the route, the route indication might not appear in time for the next right or left turn.
- (9) The route might not change even if a search is made again.
- (10) The system might guide the driver to make a U-turn.
- (11) The system might guide the driver to a road that cannot actually be travelled (such as a road to which entry is prohibited).
- (12) The system might not output guidance even if the vehicle is driven in reverse on the guided route.
- (13) The system might not use a local ferryboat even if the ferry priority is selected.
- (14) If the intersection that you're being guided to is near the end of the route search, the system might not be able to provide guidance.
- (15) The route might not go on a toll road even if the toll-road priority is selected.
Similarly, a route that uses a toll road could appear on the screen even if the toll-road priority is not selected. (The driver may or may not be able to select "toll-road priority" if both toll and free roads are available.)

When a Problem Occurs

Confirm whether the problem is due to a minor operational error or a malfunction in the system by referring to the table below before you contact your SUBARU dealer for any repair service.

The map does not scroll even when the vehicle is moving.

The screen shown might not be the current map screen.

See Page 26 of this manual for instructions on displaying the current map screen.

The vehicle marker does not appear.

The screen shown might not be the current map screen.

See Page 26 of this manual for instructions on displaying the current map screen.

The GPS marker is not displayed.

The GPS antenna or your vehicle might be in a position where GPS signals cannot be received.

Try moving the GPS antenna or your vehicle to a position where there are no obstacles around.

There is no voice guidance.

- Route guidance might be suspended.
- The guidance volume might be too low.

• See "Voice Guidance Volume" on Page 25.

Small spots or bright flashes appear on the screen display.

This is probably due to the natural characteristics of the liquid crystal display (LCD).

There is nothing wrong with the display and no need for concern.

The DVD-ROM disc cannot be ejected.

The disc might be incompatible or might have been inserted incorrectly.

Voice activation system

The voice recognition function allows you to operate the navigation system, audio system and hands-free phone system using your voice instead of display screen handling. This section includes instructions about how to perform the voice commands. The commands that can be recognized by this system are restricted. (See Page 222.) For each function, refer to the corresponding items.

■ Correct voice recognition

The interior circumstances of the vehicle will adversely affect the correct recognition of the voice. Note the following items in order for the system to correctly recognize the voice.

- Speak clearly into the microphone. Speaking faster or slower and pausing between words will cause incorrect recognition.
- Close the windows to eliminate outside noise. Traffic noises, driving sounds and wind noises may affect correct recognition of the voice.
- Speak the voice commands correctly. The commands that can be recognized by this system are restricted. Any terms other than the recognized terms for the system or dull sounds that are incorrectly spoken will not be recognized by the system. If the name of a facility is pronounced different from the recognized terms for the system, the command will not be recognized by the system.
- The microphone is located at the best distance and in the best direction for each model to gain the maximum voice recognition performance. Speak commands in a correct driving posture.
- Do not speak commands during navigation voice guidance. This causes sounds to overlap and results in incorrect voice recognition.

Basic operations of voice recognition

.....

- 1 Press the  button located on the steering switch.

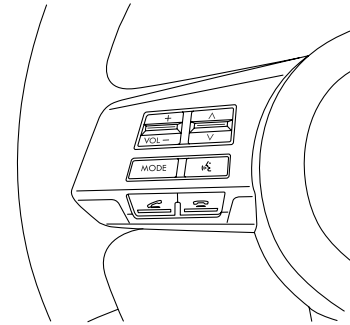

The voice recognition mode is activated, and the icon of voice recognition will be displayed on the upper left side of the screen.

- 2 While the icon is displayed, speak a voice command.



During the voice recognition mode, the sound from the audio system is muted.



(voice input waiting mode):

shows the status of waiting for a voice command.



(during a calculation):

shows the status of accepting and processing a voice command.

After a voice command is spoken, the system recognizes the voice and activates the function input by the voice command. Then the system confirms your command by voice guidance.

Pressing the  button located on the steering wheel for a long time during voice recognition will cancel the voice recognition mode.



Audio and Visual

Before using the Audio and Visual system

Precautions when using the system

WARNING

READ THIS MANUAL FIRST

Read this supplement carefully before using the audio and visual system. We are not liable for accidents or other problems resulting from failure to follow the instructions in this supplement.

AVOID OPERATING THE AUDIO AND VISUAL system WHILE DRIVING

You should stop the vehicle in a safe place before operating the audio and visual system. For safety's sake, some of the audio and visual system's functions cannot be used unless the vehicle is stationary.

If you stare at the display with too much enthusiasm or operate the switches of the system while in driving, the navigation system could cause your attention to be distracted from the current traffic conditions. Please be sure to input in the system as much information as possible before departure. And also please be sure to bring the vehicle to a stop in a safe place if you need to input information.

The buttons for a touch screen that cannot be used are displayed greyed out.

Operating the navigation system while in driving could cause your attention to be distracted from the current traffic conditions. And in consequence, this could result in a severe or fatal accident. Always follow the descriptions of all operations and the instructions for safety given in this manual.

LOOK AT THE AUDIO AND VISUAL SCREEN ONLY WHEN NECESSARY

When you need to look at the audio and visual screen, do so for the shortest time possible. Looking away from the road for too long could lead to an accident.

KEEP THE VOLUME LOW ENOUGH FOR YOU TO HEAR OUTSIDE SOUNDS

Keep the system's volume level low enough for you to be able to hear outside sounds while driving. To do otherwise may mean that you are unable to react appropriately to traffic conditions thus resulting in an accident.

⚠ CAUTION**NEVER DISASSEMBLE OR MODIFY THE AUDIO AND VISUAL SYSTEM**

Any attempt to disassemble or modify the audio and visual system could lead to a fire, an electric shock, or some other type of accident.

Do not continue using the audio and visual system if it malfunctions

If the system shows any sign of malfunctioning (for example, the monitor gives no picture), stop using it immediately and contact the nearest SUBARU dealer. Continuing to use the system could lead to a fire, an electric shock, or some other type of accident.

If the audio and visual system gets contaminated, emits smoke or an odd smell, stop using it

If a foreign object gets inside the system, liquid is spilled onto the system, or the system emits smoke or an unusual smell, stop using it immediately and contact the nearest SUBARU dealer. Continuing to use the system could lead to a fire, an electric shock, or some other type of accident.

■ About the audio and visual screen

- Subjecting the control buttons or liquid crystal display to excessive shock could result in audio and visual screen deformation or other damage.
- Keep any heat source (including lighted cigarettes) away from the audio and visual screen. If a heat source is brought into contact with the audio and visual system cabinet and panel, they could be deformed or otherwise degraded.
- In extreme cold, the audio and visual screen may operate sluggishly and the display may dim. Such conditions do not indicate a problem. They will disappear when the cabin temperature rises to a normal temperature.
- Tiny black and white dots may occasionally appear in the liquid crystal display. These dots are a normal characteristic of the display. They do not indicate a problem.
- When the audio and visual screen requires cleaning, gently wipe it with a silicone cloth or other soft cloth. If necessary, spray the cloth with neutral cleaning fluid. Be sure to wipe away any cleaning fluid left on the audio and visual screen. Do not spray the cleaning fluid directly onto the audio and visual screen. Spraying cleaning fluid directly onto the audio and visual screen could cause an adverse effect on internal components. It is also not a good idea to wipe the audio and visual screen with a stiff cloth or attempt to clean it using thinners, alcohol, or any other volatile solvent. Doing so could leave scratches and/or erase the control button labels.
- Do not allow the audio and visual screen to get wet. If it gets wet (allowing, for example, to a spilled drink or wet umbrella), its internal electronic circuitry may malfunction.

- In hot weather, cool the passenger compartment down before using the audio and visual system. The liquid crystal display operates correctly at temperatures between 0°C and 60°C (32°F and 140°F). When the temperature exceeds 60°C (140°F), the audio and visual system circuit protection function is activated, causing the display to dim.

NOTE

- In the interest of safety, the use of some functions may be unavailable while in driving. The buttons for a touch screen that cannot be used are displayed greyed out.
- Liquid-crystal displays may be difficult to read when wearing polarized glasses.

Discs that can be used

For the in-vehicle equipment, it is possible to look and listen to discs attached with the marks shown below.

Music CD



DVD Video



NOTE

- Special discs are not supported that are not compliant with the formal CD specifications such as the copy control CD.
- Discs such as CD-R (CD-Recordable) and CD-RW (CD-ReWritable) may not be played back when they are inferior in their recording condition and characteristics, when they get scratched or stained, or when they get deteriorated due to being left in the vehicle for a long time. And when CD-R and CD-RW has not been treated for finalization, they cannot be played back.
- The DVD which formatted with DVD-VR (Video Recording) mode, or DVD-VR product can not be played in this system.

⚠ CAUTION

- Handle the disc with care so that it does not get smeared with fingerprints and stain, or does not get scratched.
- When handling the disc, be sure to hold it at the center hole and the edge with the labeled side up.
- When the disc gets stained, wipe it lightly with a soft, dry cloth for spectacles with plastic lenses. Pressing the disc hard with your hand or rubbing it with a hard cloth may cause scratches on the surface. And, avoid the use of a solution such as record spray, antistatic agent, alcohol, benzine and thinner, or chemical duster. This may cause damage to the disc, rendering it unusable.
- After pressing the disc eject switch, do not leave it in the ejected condition for a long stretch of time. This may cause warp to the disc, thus rendering it unusable.
- Store the disc away from direct sunlight, which may cause warp to it, thus rendering it unusable.
- Discs that can be played back are limited only to those with a circular form 12 cm in diameter. Avoid using irregular sized discs, which may cause malfunction to the equipment.

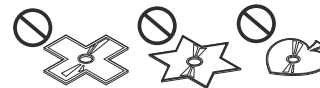

- The DualDisc is not supported. Avoid using it, which may cause malfunction to the equipment.

- **Avoid the use of discs of which the recording section is transparent or translucent. These discs may not be inserted or ejected, or played back normally.**



- **Using lens cleaner may cause malfunction to the pick-up section of the player. Be sure not to use it.**
- **Do not use discs attached with scotch tape, seal or CD-R label, or those having traces of them. Using these discs may cause malfunction to the player with the ejection of discs unavailable.**

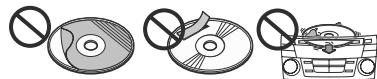

Player

When there occurs an abnormal condition, the player stops automatically to protect the inside mechanism of the player. Even when conducting the operation according to the message displayed on the screen and the function is stopped, a malfunction may result. Get a checkup of the player at Subaru Dealer.

In the following cases other than malfunction, the player may not operate normally.

- When the disc can not read due to it being stained.
- When the player is out of order.
- When an abnormal temperature of the player has been detected. (When the sign disappears after the temperature of the player gets back to the normal temperature, the player can be used.)
- When there occurs a dew condensation. (When it is cold or rains, there occurs a dew condensation inside the player just as the inner surface of the vehicle glass clouds up. In such a case, the audio sound may be disturbed or the playback may be stopped. Ventilate or dehumidify the player for a while before using it.)
- When vibrated severely due to driving on rough roads. (The sound may be disturbed.)

Character information displayed

The number of characters that can be displayed as information on various screens and the audio display is limited, and it sometimes occurs that all of the characters cannot be displayed. And also, they may not be, or cannot be, displayed correctly depending on the contents of the recorded information like these.

And the contents of the character information like these may sometimes differ for various screens and the audio display.

Voice activation system

The voice activation system allows the system to be operated using spoken commands.

For details regarding the function, refer to "Voice activation system" on Page 220.

Basic operation of the Audio and Visual system

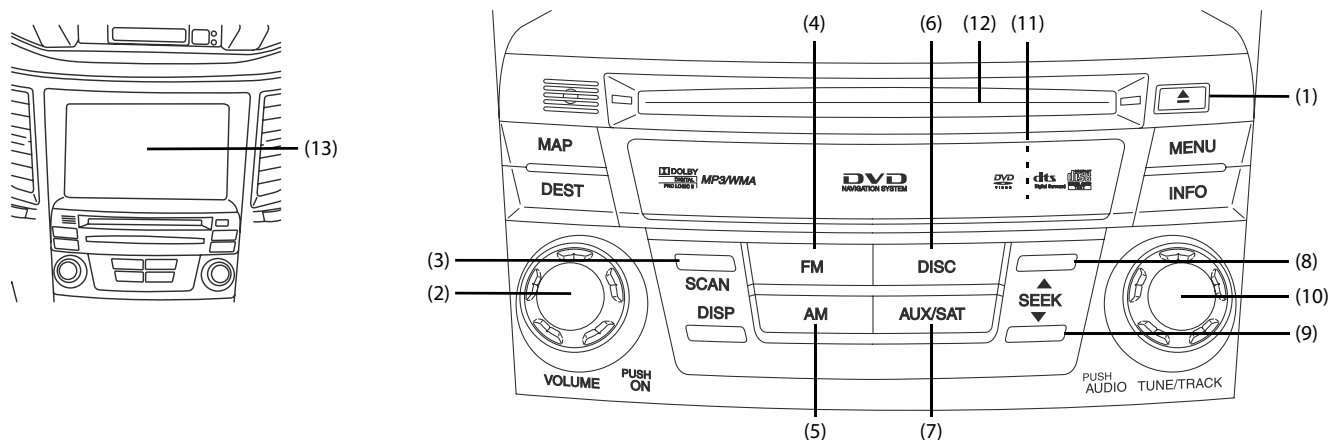

- (1) **[EJECT]**
This button is used to eject an audio disc.
- (2) **[VOL/POWER]**
This button is used to operate the system ON or OFF and adjust volume.
- (3) **[SCAN]**
This button is used to search a tune, track or radio station (for Radio, CD, CD changer, MP3/WMA, USB, Bluetooth).
- (4) **[FM]**
This button is used to receive the FM waveband.
- (5) **[AM]**
This button is used to receive the AM waveband.
- (6) **[DISC]**
This button is used to operate the audio disc (VIDEO, CD, DVD, MP3/WMA).
- (7) **[AUX/SAT]**
This button is used to operate the externally connected audio equipment for looking and listening.

(8) [SEEK+]

This button is used to seek up from the current audio source.

Briefly press:

- Radio - Auto seek
- CD, CD changer, Bluetooth, iPod - Forward track search
- MP3/WMA, USB - Forward file search
- DVD - Forward chapter search

Press and hold:

- All audio source - Forward manual search

(9) [SEEK-]

This button is used to seek down from the current audio source.

Briefly press:

- Radio - Auto search
- CD, CD changer, Bluetooth, iPod - Reverse track search
- MP3/WMA, USB - Reverse file search
- DVD - Reverse chapter search

Press and hold:

- All audio source - Reverse manual search

(10) [TUNE/TRACK]

Rotate:

This button is used to seek up/down from the current audio source.

- Radio - Manual search (up/down)
- CD, CD changer, Bluetooth, iPod - Track search (up/down)
- MP3/WMA, USB - File search (up/down)
- DVD - Chapter search (up/down)

Press:

This button is used to select the screen set for the audio.

(11) [RESET]

This button is used to reset all settings to return to the factory settings.

(12) DVD/CD drive loading slot

Insert CD/DVD here to play back.

(13) Display touch screen

Multi-function screens appear here.

Steering remote control

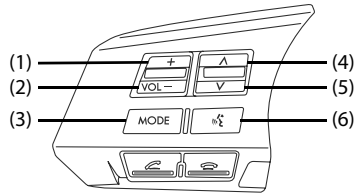

(1) 

This button is used to adjust volume (increase).

(2) 

This button is used to adjust volume (decrease)

(3) 

This button is used to select the audio source.

(4)  (SEEK UP)

This button is used to seek up from the current audio source.

Briefly press:

- Radio - Auto seek
- CD, CD changer, Bluetooth, iPod - Forward track search
- MP3/WMA, USB - Forward file search
- DVD - Forward chapter search

Press and hold:

- All audio source - Forward manual search

(5)  (SEEK DOWN)

This button is used to seek down from the current audio source.

Briefly press:

- Radio - Auto preset down search
- CD, CD changer, Bluetooth, iPod - Reverse track search
- MP3/WMA, USB - Reverse file search
- DVD - Reverse chapter search

Press and hold:

- All audio source - Reverse manual search

(6) 

This button is used to enter voice recognition mode.

Turning on the power

Turn on the power for the Audio and Visual system.

1 The audiovisual system is turned on when one of the following operations is performed while the system is off.

- Press the [VOL/POWER] button.
- Press the [TUNE/TRACK] button, select the source.
- Press the [MODE] button on the steering switch.
- Press the [FM], [AM] or [AUX/SAT] button.
- Insert the audio disc.
- Connect the USB device.
- Connect the iPod.

The audiovisual system is turned off when one of the following operations is performed.

- Press the [VOL/POWER] button.
- Press the [MODE] button on the steering switch.

NOTE

- Each time the [VOL/POWER] button or the [MODE] button of the steering switch is pressed, the audio function is turned on and off.
- Inserting the disc turns on the power automatically to start the playback of the disc.
- The audiovisual system can be operated using the voice recognition functions. Refer to the "Voice Recognition" section.

Selecting the audio source

It is possible to select the AM radio, FM radio, SAT, CD, DVD, MP3/WMA and other externally connected equipment for viewing and listening. When selecting SAT and other externally connected equipment, it is necessary for the relevant units to be connected.

Pressing the button for selection

Pressing the button on the externally connected equipment or the steering switch to select the audio source.

- 1 Press the desired button or the **MODE** button on the steering switch.

Each time the button is pressed, the audio source changes. When the operations above are conducted on other than the audio screen, a brief description of the audio is displayed in the upper section of the screen for a few seconds.

Example of the CD information being displayed while in the map is displayed.



When the operations above are conducted on the audio screen, each source screen is displayed as following example.

FM radio screen

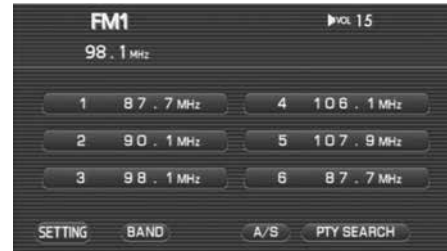

AM radio screen



CD screen



DVD screen



MP3/WMA screen



Other externally connected equipment

The display varies depending on the externally connected equipment.

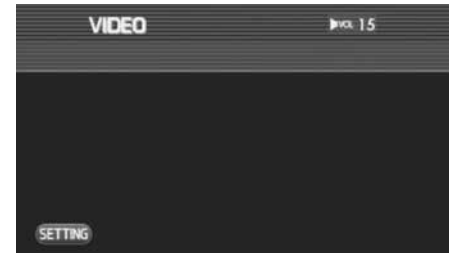
**NOTE**

- When the disc is not set or when no externally connected equipment is provided, the source is not displayed.
- When the satellite radio is connected, it is displayed on the dedicated source screen in the same manner as the AM or FM radio.

Audio source selection

Touching the source display allows you to select a source.

1 Press the [TUNE/TRACK] button.

When the source display is shown, proceed to step 3.

2 Press the [TUNE/TRACK] button again.

3 Select a source.



Each of the source screens is displayed.

NOTE

Sources displayed vary depending on the equipment connected.

The **FM**, **AM**, **DISC** or **AUX/SAT** button can be used to select an audio source.

- **FM** button: Toggles between FM1 and FM3.

FM (\rightarrow FM1 \rightarrow FM2 \rightarrow FM3 \leftarrow)

- **DISC** button: Toggles between disc and CD changer.

\rightarrow DISC \rightarrow CDCHANGER \leftarrow

- **AUX/SAT** button: Toggle between SAT and Bluetooth audio.

\rightarrow SAT \rightarrow AUX \rightarrow USB/iPod \rightarrow BTAUDIO \leftarrow

The **MODE** button on the steering wheel control can be used to select an audio source.

- **MODE** button: Toggles between FM and AUX.

\rightarrow FM \rightarrow AM \rightarrow SAT \rightarrow DISC \rightarrow CDCHANGER \leftarrow
AUX \leftarrow BTAUDIO \leftarrow iPod \leftarrow USB \leftarrow

NOTE

- When the disc is not set or when no externally connected equipment is provided, the source is not displayed.
- When the USB or iPod equipment is connected and during suspend mode, the source is not displayed.

Setting and adjusting the sound

Adjusting the sound volume

It is possible to adjust the sound volume while looking and listening to the source.

The sound volume setting has the following independent settings.

- A volume setting for the audio sources except for the auxiliary input audio source.
- A volume setting for the auxiliary input audio source.

NOTE

When the voice of the navigation system breaks in, the sound volume is automatically reduced temporarily.

1 Rotate the [VOL/POWER] button in either direction or press the **[VOL+]** **[VOL-]** buttons of the steering switch.

- Turning the [VOL/POWER] button counterclockwise decreases the sound volume while turning it clockwise increases the sound volume.
- Each time the **[VOL-]** button of the steering switch is pressed, the sound volume decreases, and each time the **[VOL+]** button is pressed, it increases.
- The volume level is displayed in figures on the upper right section of the screen.

Mute the sound

The audio sound volume is automatically reduced temporarily under the following conditions.

- ATT mute: The sound volume is slightly reduced when voice guidance is performed by the navigation system or the gearshift lever is placed in the reverse position.
- TEL mute: The sound volume is muted when using a hands-free phone.
- PTT mute: The sound volume is muted during the Voice Recognition mode (when pressing the **[PTT]** button that is located on the steering remote control).

NOTE

ATT mute

- The amount of reduced volume during ATT mode depends on the setting value of the audio sound volume.
- The ATT mute mode is cancelled when the audio sound volume is increased using the volume control button or the volume adjusting button located on the steering remote control.
- The ATT mute mode is not cancelled when the audio sound volume is decreased using the volume control button or the volume adjusting button located on the steering remote control.

TEL mute

- The TEL mute mode is cancelled when the hands-free phone is disconnected.
- The TEL mute mode is cancelled when the audio sound volume is increased using the volume control button or the volume adjusting button located on the steering remote control.

PTT mute

- The PTT mode is cancelled when the  button is pressed while the PTT mute mode is activated.

Radio functions

Listening to the radio

It is possible to tune in to a radio station to listen to the AM or FM radio.

1 Change the source over to the FM or AM radio.

(See Page 118.)

2 Tune in to a station. (See Page 126.)

FM radio screen is displayed

When no FM radio screen is displayed while listening to the FM radio, press the **FM** button or the **MODE** button on the steering switch to display the FM radio screen.

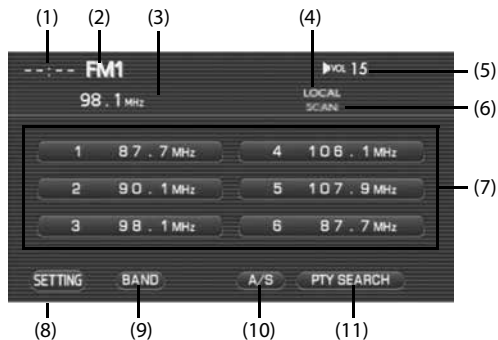

- (1) Clock**
The current time is displayed.
- (2) Waveband display**
The difference between the FM1 and FM3 frequency bands is displayed.
- (3) Station tuned in to**
The name of the station tuned in to and its frequency are displayed. When the station is preset, the preset number is also displayed.
- (4) ST**
Displayed while in the stereophonic.
- (5) VOL**
The volume level is displayed. (See Page 121.)
- (6) SCAN**
Displayed when scanning a station to which you can tune in. (See Page 127.)
- (7) Preset keys 1 to 6**
It is possible to preset a station and select it later. (See Page 129.)
- (8) SETTING (SETTING)**
Select this key to display the screen set for the audio. (See Page 195.)

- (9) **BAND** (BAND)
Each time this key is selected the frequency band (FM1/FM2/FM3) changes.
- (10) **A/S** (AUTO STORE)
Using this key, the preset buttons can automatically be allocated to the stations with the strongest reception.
- (11) **PTY SEARCH** (PTY SEARCH)
Selecting this key allows you to search a station with a category of interest selected. (See Page 127.)

AM radio screen displayed

When the AM waveband screen is not displayed while listening to the AM radio, press the **AM** button or the **MODE** button on the steering switch to display the AM radio screen.

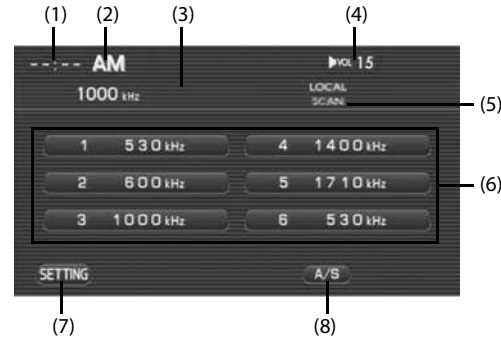

- (1) **Clock**
The current time is displayed.
- (2) **Waveband display**
AM is displayed.
- (3) **Station tuned in to**
The name of the station tuned in to and its frequency are displayed. When the station is preset, the preset number is also displayed.
- (4) **VOL**
The volume level is displayed. (See Page 121.)



-
- (5) **SCAN**
Displayed when scanning a station that you can tune into.
(See Page 127.)
 - (6) **Preset keys 1 to 6**
It is possible to preset a station and invoke it later. (See Page 129.)
 - (7) **SETTING (SETTING)**
Select this key to display the selected audio screen. (See Page 195.)
 - (8) **A/S (AUTO STORE)**
Using this key, the preset buttons can automatically be allocated to the stations with the strongest reception.

Selecting a station





Selecting a preset station

.....

Presetting a station in advance in the in-vehicle equipment allows you to select that station.

- 1 Select the station preset on the FM or AM radio screen, or press the  or  button on the steering switch.



- When the FM or AM radio screen is not displayed, press the desired button.
- Each time the  or  button in the steering switch is pressed, the station preset changes. Pressing the  button changes the station in the descending order of the preset number, while pressing the  button changes it over in the ascending order of the preset number.

NOTE

For detailed method for presetting a station, refer to "Presetting a station" on Page 129.

Setting the frequency

.....



It is possible to manually set the frequency to listen to the radio.

- 1 Rotate the [TUNE/TRACK] button in either direction.
 - Turning the [TUNE/TRACK] button counterclockwise lowers the frequency and turning it clockwise increases the frequency.
 - For the FM waveband, select **BAND** (BAND) to select the waveband. Each time **BAND** (BAND) is selected, the waveband alternates between FM1 and FM3.

Searching a station automatically

It is possible to search a station that can be tuned in to automatically to listen to a radio.

1 Press the or button.

- Pressing the  button allows you to select a station that can be tuned in to in the higher-intensity frequency direction, while pressing the  button allows you to select a station in the lower-intensity frequency direction.
- For the FM waveband, select **BAND** (BAND) to select of the waveband. Each time **BAND** (BAND) is selected, the waveband alternates between FM1 and FM3.

Searching a FM station from a category of interest

It is possible to select a category of interest and select a station to listen to on the radio.

1 Select **PTY SEARCH** (PTY SEARCH).

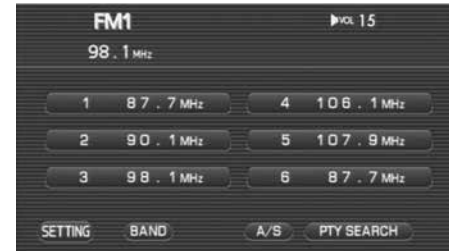



2 Select a category of interest and then select **SEARCH**.



Categories that can be selected are shown below.

- INFO
- WEATHER

- ROCK
 - SOFT
 - TOP 40
 - COUNTRY
 - OLDIES
 - JAZZ
 - CLASSIC
 - R&B
 - RELIGIOUS
 - MISC
 - ALL
- Selecting  scrolls the display to display a category 5 positions above.
 - Selecting  scrolls the display to display a category 5 positions below.

A station corresponding to the category is selected.

NOTE

- This function is available only for the FM radio.
- Each time  is selected, another station can be searched.

Presetting a station

It is possible to store a station frequently listened to in the memory and select it later.

Manual storing

It is possible to preset a station that is now being tuned in to. Conducting this operation with a key that is already preset causes the preset key to be overwritten.

1 Press the preset key for more than 2 seconds.

- When the FM or AM radio screen is not displayed, press the desired button.
- For the FM radio, select **BAND** (BAND) to select the BAND. Each time **BAND** (BAND) is selected, the waveband alternates between FM1 and FM3.

The frequency preset is displayed in the preset key.

NOTE

For a detailed description of how to select a preset station, refer to "Selecting a preset station" on Page 126.

Auto store

It is possible to automatically search and preset a station that has radio reception.

1 Select the FM or AM radio screen, press the **A/S** (AUTO STORE) for more than 2 seconds.



- The preset buttons can automatically be allocated to the stations with the strongest reception.
- For the FM radio, select **BAND** (BAND) to select the BAND. Each time **BAND** (BAND) is selected, the waveband alternates between FM1 and FM3.

The frequency preset is displayed in the preset key.

Compact disc functions

Setting the disc

Loading the disc

.....

Set a CD, DVD, or MP3/WMA disc.

For details of the discs that can be used, refer to "Discs that can be used" on Page 109.

When changing a disc, it is necessary to follow the procedure described below.

NOTE

When changing a disc with another one, be sure to stop the vehicle in a safe place.

- 1 With the ignition switch on, open the cover of the disc slot.
- 2 Press the  [EJECT] button.
- 3 When the disc is ejected, take it out.

- 4 Insert a disc that contains the area information of the current position. The monitor automatically returns to the default display and begins to load the disc.

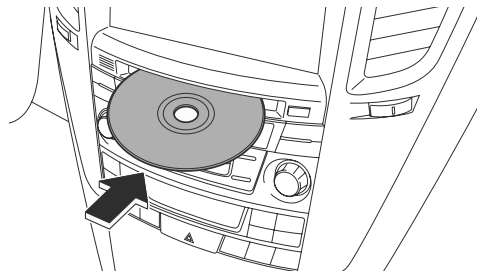

CAUTION

When inserting a CD, do not insert 2 or more CD's in piles. This may cause a malfunction to the player, resulting in the take-off of the discs unavailable.

CAUTION

Do not press the  [EJECT] button while the system is loading a disc.

NOTE

Reload function: If the disc is not removed from the slot within 15 seconds after the disc is ejected, the disc will be reloaded into the slot to protect it.

Listening to a tune in the CD

It is possible to set the CD in the in-vehicle equipment to listen to a tune in the CD.

1 Change the source over to the disc. (See Page 118.)

The track of the CD is played back from the start.

When the track of the CD is played back to the last, the playback resumes from the start.

NOTE

When no CD is set in the in-vehicle equipment, set the CD. (See Page 130.)

CD screen displayed

When the CD screen is not displayed while looking and listening to the CD, press the **DISC** button or the **MODE** button of the steering switch to display the CD screen.

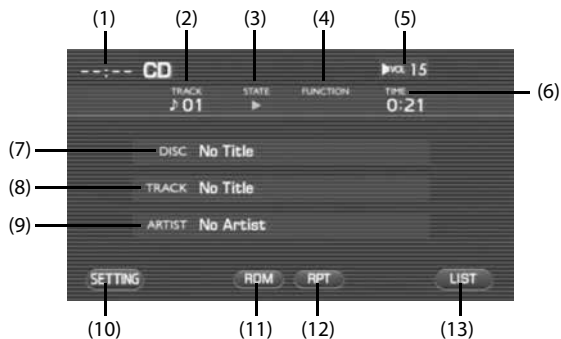

- (1) **Clock**
The current time is displayed.
- (2) **TRACK**
The track number is displayed.
- (3) **STATE**
The playback status is displayed.
 - ▶: Playback is operating.
 - ◀: Reverse is operating.
 - ▶▶: Fast forward is operating.

- (4) **FUNCTION**
The playback status such as repeat and random is displayed.
 - RPT: A tune is being played back repeatedly.
 - RDM: Tunes in the CD are being played back in random order.
 - SCAN: Each of the tunes in the CD is being played back for 10 seconds.

- (5) **VOL**
The volume level is displayed. (See Page 121.)
- (6) **TIME**
The playback time of a tune is displayed.

- (7) **DISC**
When corresponding to the CD text, the disc title is displayed.
- (8) **TRACK**
When corresponding to the CD text, the name of a tune is displayed.
- (9) **ARTIST**
When corresponding to the CD text, the name of an artist is displayed.

◀: Displayed when the contents of the CD text cannot be displayed for each item. Selecting this scrolls the characters. When scrolled up to the end of the text, ▶ is displayed.

-
- (10) **SETTING** (SETTING)
Selecting this key displays the screen set for the audio. (See Page 195.)
- (11) **RDM** (RDM)
The playback method of tunes is changed over in random order. (See Page 138.)
- (12) **RPT** (RPT)
The playback method of tunes is changed over to the repeated playback. (See Page 137.)
- (13) **LIST** (LIST)
Tunes contained in the CD are displayed in the list. (See Page 135.)



Selecting a tune

Selecting the preceding tune

.....

It is possible to play back a tune preceding the one that is now being played back.

1 Conduct either of the following operations while playing back a tune.

- Press the  button.
- Rotate the [TUNE/TRACK] button counterclockwise.
- Press the  button of the steering switch.



A tune preceding the one that is now being played back is played back.

Selecting the succeeding tune

.....

It is possible to play back a tune succeeding to the one that is now being played back.

1 Conduct either of the following operations while playing back a tune.

- Press the  button.
- Rotate the [TUNE/TRACK] button clockwise.
- Press the  button of the steering switch.

The succeeding tune is played back.

Selecting a tune from the list

It is possible to display in the list tunes contained in the CD, and select a tune from the list to play it back.

1 Press the **DISC** button.



When the CD screen has been displayed, this operation is not required. Proceed to step 2.

2 Select **LIST** (LIST).



3 Select a tune you want to listen to.



- Selecting  scrolls the display to display a tune 5 positions ahead.
- Selecting  scrolls the display to display a tune 5 positions behind.

A tune that is selected is played back.

NOTE

- Selecting **HOME** (HOME) displays a page containing a tune that is now being played back.
- Selecting **CONTROL** (CONTROL) gets back to the screen in which the tune information is displayed.

Searching a tune while listening

It is possible to search a tune you want to hear while listening to each tune in the CD for 10 seconds.

- 1 Press the **SCAN** button while playing back a tune.

"SCAN" is displayed for the FUNCTION on the CD screen.



After a tune you want to hear is played back, press again the **SCAN** button.

Reverse or fast-forward a tune

It is possible to reverse or fast-forward a tune that is now being played back.

■ To reverse a tune quickly

- 1 Keep pressing the  button while playing back a tune.

A tune is reversed quickly while the button is pressed. When releasing the  button, the tune is played back from the point to which the tune was reversed.

■ To fast-forward a tune

- 1 Keep pressing the  button while playing back a tune.

A tune is forwarded quickly while the button is pressed. When releasing the  button, the tune is played back from the point to which the tune was fast-forwarded.

Listening to a tune repeatedly

It is possible to play back a tune repeatedly.

- 1 Select **RPT** (RPT) while playing back a tune.

"RPT" is displayed for FUNCTION on the CD screen to play back a tune repeatedly.



Selecting again **RPT** (RPT) releases the repeated playback.

Listening to tunes in random order

It is possible to play back the tunes in the CD in random order.

1 Select **RDM** (RDM) while playing back a tune.

With "RDM" displayed for FUNCTION on the CD screen, tunes are played back in random order.



Selecting again **RDM** (RDM) releases the playback in random order.

MP3/WMA disc functions

MP3/WMA

MP3/WMA can be played back by this in-vehicle equipment. However, media and formats are limited in which MP3/WMA files that can be used are recorded. Please note the following when writing MP3/WMA files. The limited number of characters given below is the number of characters when using 1-byte characters.

■ Media that can be used

Media used to include MP3/WMA that can be used are CD-R and CD-RW.

Media created in a simplified format cannot be played back with this in-vehicle equipment.

■ MP3 formats that can be played back

MP3 formats that can be played back with this in-vehicle equipment are as shown below.

Specification

MPEG-1 Layer 3

MPEG-2 Layer 3

Sampling frequency

MPEG-1 Layer 3 32, 44.1, 48 (kHz)

MPEG-2 Layer 3 16, 22.05, 24 (kHz)

Bit rate

MPEG-1 Layer 3 32 to 320 (kbps)

MPEG-2 Layer 3 8 to 160 (kbps)

Variable bit rate compliant

■ WMA formats that can be played back

WMA files that can be played back with the in-vehicle equipment are as shown below.

Specifications

WMA Ver. 7, 8 and 9

Sampling frequency

Ver. 7: 44.1, 48 (kHz)

Ver. 8 and 9: 32, 44.1, 48 (kHz)

Bit rate

Ver. 7: 64 to 192 (kbps)

Ver. 8 and 9: 48 to 192 (kbps)

Variable bit rate compliant

■ Disc formats that can be used

Discs that can be used with this in-vehicle equipment are as shown below. The number of characters following the format name is the maximum number of characters (a delimiter "." and 3 characters of extension included) specified for the file name.

- ISO 9660 Level 1: 12 characters
- ISO 9660 Level 2: 31 characters
- Joliet: 64 characters
- Romeo: 128 characters

And when written in a long file name format, it is possible to display up to the number of characters as shown below.

64 character (all 1-byte characters)

For details of the characters that can be used, refer to the instruction manual of the writing software and "Input of file name and folder name."

However, characters that can be displayed are as shown below.

- Half size characters (alphanumeric, and ASCII codes)

Characters other than the above are displayed with an asterisk "?."

However, discs that can be played back with this in-vehicle equipment are accompanied by the following restrictions.

- Maximum directory layers: 8 layers
- Maximum number of files in a folder: 255
- Maximum number of folders: 254 (including the ROOT)
- Maximum number of characters used in a folder name: 64 characters

MP3/WMA files that are written in formats other than the above may not be played back normally, and the file name and the folder name of which may not be displayed correctly.

■ Setting of the compression software and the writing software

When compressed into an MP3/WMA file, it is recommended that the setting of the transfer bit rate of the compression software is "fixed" to "128 kbps."

When recording a blank media up to the maximum capacity at once, make a setting to "Disc at Once."

■ Input of a file name and a folder name

When inputting a file name and a folder name, input them in half size alphanumeric characters. File names and folder names that are written in characters other than the above may not be displayed correctly. And depending on a writing software or a disc format used, characters that can be displayed are restricted. For details, refer to the instruction manual of the writing software. And files that can be acknowledged and played back are restricted only to those attached with an extension ".MP3" or ".WMA." When saving an MP3/WMA file, be sure to attach it with an extension ".MP3" or ".WMA."

Forbidden



If a file other than MP3/WMA is attached with an extension ".MP3" or ".WMA," it may be mistakenly acknowledged as an MP3/WMA file, thus causing the generation of loud noises to damage the speaker. So, do not attach any file other than MP3/WMA with an extension ".MP3" or ".WMA."

■ ID3/WMA Tag

ID3/WMA Tag is compliant (Ver.1.0, 1.1).

Files that are written into media

When media that contains MP3/WMA files is inserted, first of all, all the files in the disc are checked.

So, when a lot of folders and files other than MP3/WMA are written into the media to be played back, a lot of time is required before starting the playback of the media.

And time may be required before proceeding to the playback of the next MP3/WMA file, and a file search and a folder search cannot be conducted smoothly.

Sequence in which MP3/WMA files are played back.

The sequence in which files and folders are selected while in the playback, folder search, file search and the folder selection is in the order in which they are written with the writing software. Accordingly, the sequence in which the files are expected to be played back may not conform to the sequence in which the files are actually played back.

Depending on the writing software, entering "01" to "90" at the head of the file name as a playback sequence with it written in CD-R may allow you to set the sequence in which files are played back. Conducting a folder search, a file search and a folder selection in the media of the following folder/file layer results in a media hierarchy as shown below.

Example of Media hierarchy

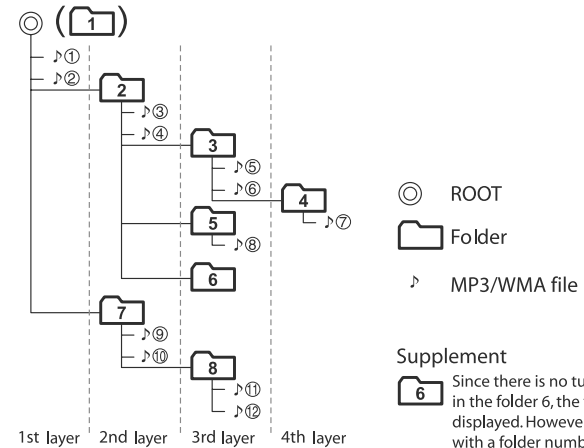

Listening to tunes (file) in the MP3/WMA disc

It is possible to set the MP3/WMA disc in the in-vehicle equipment to listen to tunes (files) in the disc.

1 Change the source over to the disc. (See Page 118.)

The first tune in the lead folder in the MP3/WMA disc is played back from the start.

When the tunes in the folder are played back to the last, the first tune in the lower-order or next folder is played back.

When the tunes in the MP3/WMA disc are played back to the last, the playback is resumed from the first tune in the lead folder.

NOTE

When no MP3/WMA disc is set in the in-vehicle equipment, set the MP3/WMA disc. (See Page 130.)

MP3/WMA disc screen displayed

When no MP3/WMA disc screen is displayed while looking and listening to the MP3/WMA disc, press the [TUNE/TRACK] or [DISC] button to display the MP3/WMA disc screen.

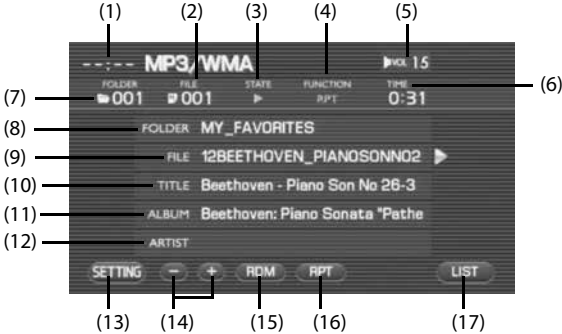

- (1) **Clock**
The current time is displayed.
- (2) **The file number is displayed.**
- (3) **STATE**
The playback status is displayed.
▶: Play back is operating.
◀◀: Reverse is operating.
▶▶: Fast forward is operating.

- (4) **FUNCTION**
The playback status is displayed.
RPT: A tune is being played back repeatedly.
FRPT: Tunes in the folder are being played back repeatedly.
RDM: Tunes in the MP3/WMA disc are being played back in random order.
SCAN: Each of the tunes in the MP3/WMA disc is being played back for 10 seconds.

- (4) **VOL**
The volume level is displayed. (See Page 121.)

- (5) **TIME**
The playback time of a tune is displayed.

- (6) **FOLDER**
The folder name is displayed.

- (7) **FILE**
The file name is displayed.

- (8) **TITLE**
The title of a tune is displayed.

- (9) **ALBUM**
The name of an album is displayed.

(10) **ARTIST**

The name of an artist is displayed.

(11) **SETTING** (SETTING)

Selecting this displays the screen set for the audio. (See Page 195.)

(12) **- +** (FOLDER UP/DOWN)

Used to play back the first tune in the succeeding/preceding folder. (See Page 145.)

(13) **RDM** (RDM)



Used to change over the playback method of tunes in random order. (See Page 150.)

(14) **RPT** (RPT)

Used to change the playback method of tunes over to the repeated playback. (See Page 149.)

(15) **LIST** (LIST)

Used to display the list in the MP3/WMA disc. (See Page 145 and 147.)

: Displayed when the contents of the CD text cannot be displayed for each item. Selecting this scrolls the characters. When scrolled up to the end of the text,  is displayed.

Selecting a tune

Selecting a folder that you want to hear

Select a folder in the MP3/WMA disc.

To select a folder

1 Select **+** or **-**.

Selecting **+** plays back the first tune in the succeeding folder.
Selecting **-** plays back the first tune in the preceding folder.

To select a folder from the list

1 Select **LIST** (LIST).



2 Select **UP** (UP).



3 Select the folder name.

The screen will display the folder list.



- Selecting **UP** scrolls the display to display a folder 5 positions ahead.
- Selecting **DOWN** scrolls the display to display a folder 5 positions behind.

- Selecting **HOME** (HOME) displays in the list the tunes in the folder in which a tune that is now being played back is contained.
- When the tunes are displayed in the list, selecting **UP** (UP) displays the folder list.
- Selecting **CONTROL** (CONTROL) gets back to the MP3/WMA disc in which the tune information is displayed.

The first tune in the folder selected is played back.



Selecting a tune (file) you want to hear

Select a tune (file) in the MP3/WMA disc.

■ To select the preceding tune

It is possible to play back a tune in the high-order folder of the tune that is now being played back or the preceding tune.

1 Conduct either of the following operations while playing back a tune.



- Press the  button.
- Rotate the [TUNE/TRACK] button counterclockwise.
- Press the  button of the steering switch.

The preceding tune is played back.

■ To select the succeeding tune

It is possible to play back a tune succeeding the tune that is now being played back.

1 Conduct either of the following operations while playing back a tune.

- Press the  button.
- Rotate the [TUNE/TRACK] button clockwise.
- Press the  button of the steering switch.

The succeeding tune is played back.

■ To select a tune from the list

1 Select **LIST** (LIST).



- When the tunes are displayed in the list, selecting **UP** (UP) displays the folder list.
- Selecting **CONTROL** (CONTROL) gets back to the MP3/WMA disc in which the tune information is displayed.

The tunes in the folder are displayed in the list.

A tune selected is played back.

2 Select the tune name.



- Selecting **▲** scrolls the display to display a folder 5 positions ahead.
- Selecting **▼** scrolls the display to display a folder 5 positions behind.
- Selecting **HOME** (HOME) displays in the list the tunes in the folder in which the tune that is now being played back is contained.

■ To search a tune while listening to tunes in the folder

It is possible to search a tune you want to hear while listening to each of the tunes in the folder for 10 seconds. After all the tunes in the folder are played back, the player gets back to the normal playback mode.

- 1 Press the **SCAN** button while playing back a tune.

"SCAN" is displayed for FUNCTION on the MP3/WMA screen.





After completion of the playback of a tune you want to hear, press again the **SCAN** button.

Reverse or fast-forwarding a tune

It is possible to reverse or forward quickly a tune that is now being played back.

■ To reverse a tune quickly

- 1 Keep pressing the  button while playing back a tune.

A tune is reversed quickly while the button is pressed. When releasing the  button, the tune is played back from the point to which the tune was reversed.

■ To forward a tune quickly

- 1 Keep pressing the  button while playing back a tune.

A tune is forwarded quickly while the button is kept pressed. When releasing the  button, the tune is played back from the point to which the tune was forwarded.

Listening to a tune repeatedly

It is possible to listen to the same tune or the tunes in the folder repeatedly.

■ To listen to the same tune repeatedly

It is possible to play back the same tune repeatedly.

- 1 Select **RPT** (RPT) while playing back a tune.

With "RPT" displayed for FUNCTION on the MP3/WMA screen, the tune is played back repeatedly.



- Selecting **RPT** (RPT) allows you to listen to the tunes in the folder repeatedly. Select again **RPT** (RPT) to release the repeated playback.
- When "F.RPT" is displayed for FUNCTION, the MP3/WMA is set to the mode for listening to the tunes in the folder.

■ To listen to the tunes in the folder repeatedly

It is possible to play back the tunes in the folder repeatedly.

- 1 Select **F.RPT** (F.RPT) twice while playing back a tune.

With "F.RPT" displayed for FUNCTION on the MP3/WMA screen, the tunes in the folder are played back repeatedly.



- Selecting again **F.RPT** (F.RPT) releases the repeated playback.
- When "RPT" is displayed for FUNCTION, the mode is set in which the same tune is played back repeatedly. Select **RPT** (RPT) again.

Listening the tunes in random order

.....

It is possible to play back the tunes in the folder in random order. After all the tunes in the folder are played back, the tunes in the next folder are played back in random order.

1 Select **RDM** (RDM) while playing back a tune.

With "RDM" displayed for FUNCTION on the MP3/WMA screen, the tunes in the folder are played back in random order.



- After all the tunes in the folder are played back, the tunes in the next folder are played back in random order.
- Selecting **RDM** (RDM) again releases the random playback.

DVD functions

WARNING

- **Never try watching videos or using other entertainment programs with the Audio and Visual System by keeping the vehicle engine running in a garage or other enclosed area. Exhaust gases accumulated in such an area and entering the vehicle are dangerous, and even lethal.**
- **The driver must not attempt to operate or watch the DVD while the vehicle is in motion. Doing so will distract attention from driving and the road, and could lead to an accident.**
- **If you wish to park the vehicle and enjoy an entertainment program on this system, select a safe place that does not hinder traffic and has a legal parking area.**

NOTE

- Using the Audio and Visual System with the engine stopped could lower the battery electricity level. If the initial charge level is too low, the engine may not start the next time. It is recommended that the system be used only while the engine is running, except when the vehicle is parked in a garage or other enclosed area.
- In the interest of safety, the use of some functions may be unavailable while in driving. The buttons for a touch screen that cannot be used are displayed greyed out.
- Liquid-crystal displays may be difficult to read when wearing polarized glasses.

What must be known

Manufactured under license from Dolby Laboratories.
"Dolby," "Pro Logic," and the double-D symbol are trademarks of Dolby Laboratories.
Non disclosed confidential writings: Copyright: Dolby Laboratories, 1992 to 1997
No reproduction allowed
"DTS" and "DTS Digital Surround" are registered trademarks of Digital Theater Systems, Inc.

Operations while in the playback of the disc

For DVD video, DVD audio and video CD, the playback condition has been specified according to the instruction of software manufacturers. This DVD player, because of it being played back according to the instructions intended by the software manufacturer, may not sometimes function as intended when operated. Be sure also to read through the instruction manual attached to a disc to be played back.

DVD video and DVD audio

They are compliant with the NTSC color television format.
DVDs that are formatted in the VR mode cannot be played back.

■ Region code of discs that can be played back

For some discs, a region code is displayed that stands for a region (country) of the player in which a disc can be played back.
Of discs attached with a region code, those with "1" (a code standing for North America) not included in its region code list or those with "ALL" (for worldwide use) not displayed cannot be played back with this DVD player.
When playing back a disc like this, a message "REGION CODE ERROR" is displayed on the screen. And for discs with no region code displayed, their region for use may have been restricted. On an occasion like this, the playback with this DVD player may not be available.

Playing back the DVD

It is possible to set a DVD on the in-vehicle equipment to look at and listen to it.

1 Change the source over to the disc. (See Page 118.)

When a DVD is not yet set on the in-vehicle equipment, set a DVD.
(See Page 130.)

The DVD is played back.

DVD control screen displayed

When the DVD screen is not displayed while in the playback of a DVD, press the [TUNE/TRACK] or **DISC** button to display the DVD screen. And then selecting the screen displays the DVD control screen.

NOTE

When 10 seconds has elapsed with no key selected, the display disappears.

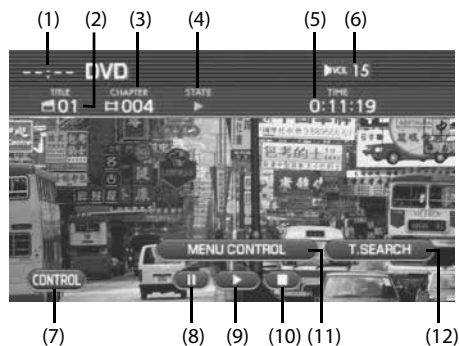

(1) Clock

The current time is displayed.

(2) TITLE

The title number of the DVD that is being played back is displayed.

(3) CHAPTER

The chapter number of the DVD that is being played back is displayed.

(4) STATE

The playback condition of the chapter is displayed.

: The playback is in progress.

: The playback is stopped.

: The playback is stopped while keeping the playback condition just before stop.

: The playback is stopped temporarily.

: The DVD is reversing quickly.

: The DVD is forwarding quickly.

(5) TIME

The playback time of the chapter is displayed.

(6) VOLUME

The volume level is displayed.

(7) **CONTROL** (CONTROL)



Selecting this displays the DVD setting screen.

(8) (PAUSE)

The DVD playback is stopped temporarily.

(9) (PLAY)

The playback of the DVD starts.



-
- (10)  (STOP)
The playback of the DVD stops.
- (11)  (MENU CONTROL)
The screen is changed over in which the menu is operated.
See Page 160.
- (12)  (T.SEARCH)
The DVD image can be played back with the title specified.
See Page 156.

Selecting the title and the chapter

Selecting the chapter

■ To play back the preceding chapter



1 Conduct either of the following operations while in the DVD playback.

- Press the  button.
- Rotate the [TUNE/TRACK] button counterclockwise.
- Press the  button of the steering switch.

A chapter preceding the chapter that is now being played back will be played back.

■ To play back the succeeding chapter

1 Conduct either of the following operations while in the DVD playback.

- Press the  button.
- Rotate the [TUNE/TRACK] button clockwise.
- Press the  button of the steering switch.

A chapter succeeding the chapter that is now being played back will be played back.

Searching a title with the title number specified

It is possible to search a title with the title number specified and then play it back.

1 Select the screen while in the DVD playback.



2 Select  (T.SEARCH).



- 3 Select **-10**, **-1**, **+1**, **+10** to enter a title number and then select **ENTER** (ENTER).



A title selected is played back.

NOTE

- When selecting **ENTER** (ENTER) with a title number entered that is not in the DVD, the screen displayed is not changed.
- Select **↩** (return) to return to the previous screen.

Controlling the playback of the DVD

It is possible to pause, stop, reverse quickly or forward quickly the DVD for control.

■ To stop the DVD temporarily

- 1 Select the DVD screen while in the DVD playback.
- 2 Select .



The DVD stops temporarily.

NOTE

Selecting  or  returns to the normal playback mode.

■ To stop the DVD

- 1 Select the DVD screen while in the DVD playback.
- 2 Select .
The DVD stops.

NOTE

Selecting  resumes the playback.

- 3 Select  again.
The DVD stops.

■ To reverse the DVD image quickly

- 1 Press and hold the  button while the DVD is playback.

While the button is being pressed, the DVD image is reversed quickly. Releasing the  button resumes the playback of the DVD image from the point to which the DVD image was reversed.

■ To forward the DVD image quickly

- 1 Press and hold the  button while in the DVD playback.

While the button is being pressed, the DVD image is forwarded quickly. Releasing the  button resumes the playback of the DVD image from the point to which the DVD image was forwarded quickly.

■ To forward the DVD image in single frame step

- 1 Select the screen while in the DVD playback.
- 2 Select .



The DVD is stops temporarily.



- 3 Conduct either of the following operations while in the DVD playback.

- Press the  button.
- Rotate the [TUNE/TRACK] button clockwise.

- Press the  button of the steering switch.

The DVD image is played back in single frame forward step.

NOTE

Selecting  or  returns to the normal playback mode.

Operating the menu screen

Selecting the menu

It is possible to operate the menu screen of the DVD.

- 1 Select the screen while in the DVD playback.



- 2 Select **MENU CONTROL** (MENU CONTROL).



- 3 Selecting **RETURN** (RETURN), **TOP MENU** (TOP MENU), **MENU** (MENU), or **CHANGE** (CHANGE) to select a menu item, and then select **ENTER** (ENTER).



- Selecting **RETURN** (RETURN) starts the playback from a point specified for each DVD.
- Selecting **TOP MENU** (TOP MENU) displays the top menu.
- Selecting **MENU** (MENU) displays the menu.
- The configurations of the top menu and the menu vary with the DVDs.
- Selecting **CHANGE** (CHANGE) switches the arrangement of the keys displayed on the screen. (See the next page.)

The image is played back as a menu is selected.

Changing over the position of the menu operation key

.....

The menu operation key is used to operate the menu of the DVD. It is possible to relocate the position of the menu operation key so that it does not interfere with the DVD image.

- 1 Select the screen while in the DVD playback.



- 2 Select **MENU CONTROL** (MENU CONTROL).



- 3 Select **CHANGE** (CHANGE).



The location of the menu key is changed.

Selecting **CHANGE** (CHANGE) again gets back to the original menu location.



Changing the language and the angle

Changing the superimposed language

It is possible to change over the superimposed language while in the playback of a DVD.

1 Select the screen while in the DVD playback.



2 Select **CONTROL** (CONTROL).



3 Select **SUB** (SUB).



Each time selecting **SUB** (SUB), the superimposed language is changed.

NOTE

- The superimposed language is indicated by a numeric character. When a numeric character is not displayed, the DVD is not compliant with multiple languages.
- Selecting the screen allows you to check the superimposed language on the playback screen.

Changing the voice language

It is possible to change the voice language while in the DVD playback.

1 Select the screen while in the DVD playback.



2 Select **CONTROL** (CONTROL).



3 Select **AUDIO** (AUDIO).



Each time **AUDIO** (AUDIO) is selected, the voice is changed.

NOTE

- The voice language is indicated by a numeric character. When a numeric character is not displayed, the DVD is not compliant with multiple languages.
- Selecting the image section in the screen allows you to check the voice language on the playback screen.

Changing over the angle

It is possible to change over the angle to look at the DVD image in the multi-angle scene while in the playback of the DVD compliant with multi-angle.

- 1 In the scene compliant with multi-angle, select the screen while in the DVD playback.



When a setting is made in the initial setting of the DVD so that the  (angle mark) is displayed, an angle mark is displayed in the scene compliant with multi-angle. (See Page 204.)

- 2 Select **CONTROL** (CONTROL).



- 3 Select **ANGLE** (ANGLE).



Each time **ANGLE** (ANGLE) is selected, the DVD is played back with the angle changed.

NOTE

- The type of the angle is indicated by a numeric character. When a numeric character is not displayed, or when it is displayed as 1/1, the DVD is not compliant with multiple angles.
- Selecting the image section in the screen allows you to check the angle on the playback screen.

Setting the screen



Adjusting the image quality



The image quality can be adjusted while looking and listening to the DVD.

1 Press **DISP**.

2 Select **-** or **+** of each item to adjust the image quality.



- Selecting **-** or **+** of  (tint) allows you to adjust the tint of a color.
Each time **-** is selected, the tint of red is increased and each time **+** is selected, the tint of green is increased.
- Selecting **-** or **+** of  (color) allows you to adjust the shade of a color.
Each time **+** is selected, the shade of a color is increased and each time **-** is selected, the shade of a color is decreased.

- Selecting **-** or **+** of  (brightness) allows you to adjust the brightness.
Each time **+** is selected, the brightness is increased and each time **-** is selected, the brightness is decreased.
- Selecting **-** or **+** of  (contrast) allows you to adjust the contrast.
Each time **+** is selected, the contrast is increased and each time **-** is selected, the contrast is decreased.

NOTE

Selecting **DEFAULT** (DEFAULT) returns the settings to the default settings.

Setting the SCREEN MODE

The screen mode can be set while looking and listening to the DVD.

1 Press **DISP**.

2 Select **MODE** (MODE).



3 Select either of the SCREEN MODE's below.

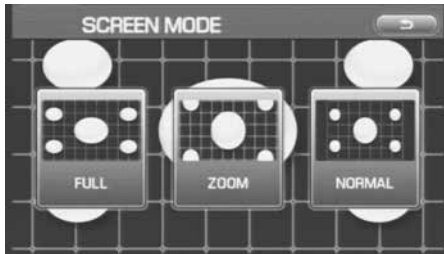

NORMAL (NORMAL):

Displayed in the horizontal to vertical ratio of 3:4 screen (normal size of TV screen). The image is expanded so that the top and bottom edges of the image fit inside the screen.

FULL (FULL):

Displayed in the horizontal to vertical ratio of 3:4 screen (normal size of TV screen) that is expanded uniformly in the left and right directions.

ZOOM (ZOOM):

Displayed in the horizontal to vertical ratio of 3:4 screen (normal size of TV screen) that is expanded uniformly in the top and bottom directions and the left and right directions.

When receiving a wide screen broadcast, change over to this mode.

There is no legal restriction imposed so long as you enjoy the DVD personally. However, if the screen is compressed or expanded for a commercial purpose, or with the view of letting the general public enjoy the DVD, please note that this may infringe the right of authorship that is protected by the copyright law.

NOTE

Pressing the [TUNE/TRACK] button allows you to look and listen to the DVD in the size set.

Looking at the VIDEO

It is possible to look at the VIDEO with the VIDEO equipment externally connected.

1 Change the source over to VIDEO. (See Page 118.)

NOTE

- The VTR equipment is required to be connected externally.
- When "VIDEO" is displayed even after the source is changed over to VIDEO, the VIDEO equipment is not externally connected.

Satellite radio operation (if equipped)

To receive satellite radio, it is necessary to install the Subaru genuine satellite receiver (dealer option) and to enter into a contract. For details, please contact your SUBARU dealer.

■ XM™ satellite radio

XM™ is a continental U.S. based satellite radio service, including music, news, sports, talk and children's programming.

XM™ provides digital quality audio and text information, including song title and artist name. A service fee is required to receive the XM™ service. For more information, contact XM™ at www.xmradio.com or call 1-800-XMRADIO (1-800-967-2346) for U.S., www.xmradio.ca or 1-877-GET-XMSR (1-877-438-9677) for Canada.

■ Sirius satellite radio

Sirius satellite radio is a recent innovation that allows the listener to experience digital sound quality and to have a greater variety of channels.

Use of satellite radio (Sirius) requires a tuner, antenna and a service contract. For details, please contact your SUBARU dealer or visit Sirius Satellite Radio at www.sirius.com or call 1-888-539-SIRIUS (7474) for more information. Sirius, the Sirius dog logo, channel names and logos are trademarks of SIRIUS Satellite Radio Inc.

■ Satellite radio reception

Satellite radio signals are best received in areas with a clear view of the open sky. In areas where there are tall buildings, trees, tunnels or other structures that may obstruct the signal of the satellites, there may be signal interruptions. Other circumstances that may result in signal loss include driving near a wall, steep cliff, hill or driving on the lower level of a multi-tiered road or inside of a parking garage.

To help reduce this condition, satellite radio providers have installed ground-based repeaters in heavily populated areas. However, you may still experience reception problems in some areas.

Bluetooth AUDIO functions

WARNING

The driver must not attempt to operate or watch the screen while the vehicle is in motion. Doing so will distract attention from driving and the road, and could lead accident.

NOTE

- Using the Audio and Visual System with the engine stopped could lower the battery electricity level. If the initial charge level is too low, the engine may not start. It is recommended that the system be used only while the engine is running, except when the vehicle is parked in a garage or other enclosed area.
- In the interest of safety, the use of some functions may be unavailable while driving. The button for a touch screen item that cannot be used will be displayed greyed out.
- Liquid-crystal displays may be difficult to read when wearing polarized glasses.

Setting the Bluetooth audio

.....

This function enables you to play back audio sources recorded in Bluetooth audio devices.

You need to register the in-vehicle equipment and Bluetooth audio device before using it. If you have registered two audio devices, you need to select one of them. (See Page 200)

■ About media format

Bluetooth audio devices cannot be connected if they are not compatible with the following Bluetooth profiles.

A2DP (Advanced Audio Distribution Profile)

AVRCP (Audio/Video Remote Control Profile)

NOTE

The available functions are different between the AVRCP 1.0 compatible device and the AVRCP 1.3 compatible device.

■ Bluetooth audio control screen display

When the Bluetooth audio screen is not displayed while playing back a Bluetooth audio file, press the [TUNE/TRACK] button to display the Bluetooth audio screen.

NOTE:

Some of the controls that are described in the following instructions depend on the Bluetooth audio device. Therefore, some of the controls may not be displayed or may be incorrectly displayed on the screen.

Selecting the screen displays the Bluetooth audio control screen.

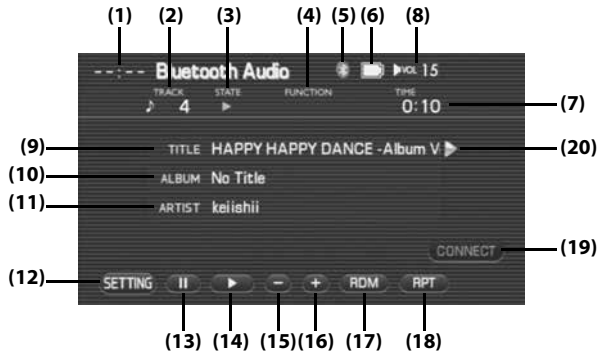

(1) Clock

The current time is displayed. Refer to clock setting screen "SET CLOCK" as described on Page 74.

(2) TRACK

The number of the track being played back is displayed.

(3) STATE

The status of the track being played back is displayed.

▶: Play

⏸: Pause

⏹: Stop

⏭: Forward search

⏮: Reverse search

(4) FUNCTION

The status of the file being played back is displayed.

RPT: Repeat

RDM: Random playback

SCAN: Scan

(5) Bluetooth

The status of Bluetooth connection is displayed. One of the following three icons is displayed to show the connection status.

Signal strength 1 icon: Bluetooth link is not connected.

Signal strength 2 icon: Poor sound quality

Signal strength 3 icon: Good sound quality

- (6) **Battery**
The status of the battery of Bluetooth devices is displayed. One of the following five icons is displayed to show the current status.
Remaining battery level 1: 0 (CRITICAL) is indicated.
Remaining battery level 2: 1 (WARNING) is indicated.
Remaining battery level 3: 2 (NORMAL) is indicated.
Remaining battery level 4: 3 (FULL CHARGE) is indicated.
Remaining battery level 5: External power supply is connected (EXTERNAL).
- (7) **TIME**
The playback time is displayed.
- (8) **VOL**
Sound volume level is displayed. (See Page 121.)
- (9) **TITLE**
The title name is displayed.
- (10) **ALBUM**
The album name is displayed.
- (11) **ARTIST**
The artist name is displayed.
- (12) **SETTING (setting)**
Displays the screen set for the Bluetooth audio. (See Page 195.)
- (13) **II (PAUSE)**
The Bluetooth audio is stopped temporarily.
- (14) **▶ (play)**
Used to playback the first tune in the folder. (See Page 172.)
- (15) **◀ (GROUP DOWN - folder search)**
Used to search for tunes in a group backward.
- (16) **▶ (GROUP UP - folder search)**
Used to search for tunes in a group forward.
- (17) **RDM (random)**
Used to change the playback method of tunes in random order. (See Page 176.)
- (18) **RPT (repeat)**
Used to change the playback method of tunes to repeated playback. (See Page 176.)
- (19) **Connect (connect)**
Used to start the connection process, and the display will be switched to the Bluetooth audio connection screen.
- (20) **☐ (name)**
Displayed when the contents of the text cannot be displayed for each item. Selecting this scrolls the characters. When scrolled, all of the text is displayed.

Playing back the Bluetooth audio

It is possible to set Bluetooth audio device on the in-vehicle equipment to listen to it. When a Bluetooth audio device is not yet set on the in-vehicle equipment, set the Bluetooth audio device. (See Page 210.)

1 Change the audio source to the Bluetooth audio.

2 Select **CONNECT** (connect).



3 Select **▶** (play).



■ To stop the playback temporarily

Bluetooth audio being played back can be paused.

1 Select **⏸** (pause).



■ To stop the playback

Bluetooth audio being played back can be stopped.

When switching the audio source from Bluetooth audio to others, the playback of the connected Bluetooth audio device will be stopped.



Selecting a tune

Selecting the preceding tune

.....

It is possible to play back a tune preceding the one that is now being played.

1 Perform either of the following operations while playing back a tune.

- Press the  button.
- Rotate the [TUNE/TRACK] button counterclockwise.
- Press the  (seek down) button of the steering switch.



The preceding track will now play.

Selecting the succeeding tune

.....

It is possible to play back a tune succeeding the one that is now being played.

1 Perform either of the following operations while playing a tune.

- Press the  button.
- Rotate the [TUNE/TRACK] button clockwise.
- Press the  (seek up) button of the steering switch.

The succeeding track will now play.

Searching for a tune while listening

It is possible to search for a tune you want to hear while listening to a tune in the Bluetooth audio device for few seconds.

■ Forward manual search

A tune is forwarded quickly while the **SEEK+** button is pressed and hold.

When releasing the **SEEK+** button, the tune is played back from the point to which the tune was fast forwarded.

■ Reverse manual search

A tune is reverse quickly while the **SEEK-** button is pressed and hold. When releasing the **SEEK-** button, the tune is played back from the point to which the tune was reverse.

■ Group up search

A tune contained in the group that is next to the present group will be played back. (GROUP is referred to as a unit of tracks defined by the Bluetooth audio devices.)

- Group is being searched forward while **+** (group up) is pressed during playback.

■ Group down search

A tune contained in the group that is previous to the present group will be played back. (GROUP is referred to as a unit of tracks defined by the Bluetooth audio devices.)

- Group is being searched backward while **-** (group down) is pressed during playback.

Listening to a tune repeatedly

It is possible to listen to the same tune repeatedly.

■ To listen to the same tune repeatedly

It is possible to playback the same tune repeatedly.

1 Select **RPT** (repeat) while playing back a tune.

With "RPT" displayed as the FUNCTION on the Bluetooth audio screen, the tune is played back repeatedly.



- Selecting **RPT** (repeat) allows you to listen to the tunes in a folder repeatedly. Select again **RPT** (repeat) to deselect repeated playback.

Listening to tunes in random order

It is possible to play back the tunes in a folder in random order.

1 Select **RDM** (random) while playing back a tune.

With "RDM" displayed as the FUNCTION on the Bluetooth audio screen, the tunes in the folder are played back in random order.



- Selecting **RDM** (random) again deselect random playback.

iPod functions

 **WARNING**

The driver must not attempt to operate or watch the screen while the vehicle is in motion. Doing so will distract attention from driving and the road, and could lead to an accident.

NOTE

- Using the Audio and Visual System with the engine stopped could lower the battery electricity level. If the initial charge level is too low, the engine may not start. It is recommended that the system be used only while the engine is running, except when the vehicle is parked in a garage or other enclosed area.
- In the interest of safety, the use of some functions may be unavailable while driving. The button for a touch screen that cannot be used will be displayed greyed out.
- Liquid-crystal displays may be difficult to read when wearing polarized glasses.

Setting the iPod

MUSIC files stored in the memory of an iPod can be played back.

Media format

■ Connectable iPod models and compatible firmware versions.

iPod model	Firmware version
•nano	1.3.1
•5G	1.3
•2G nano	1.1.3
•classic	1.1.2
•3G nano	1.1.2
•touch	1.1.4

Connection cables

■ Connection cables specific to the USB storage devices

Used to connect USB mass-storage class devices or iPods. Video content stored in the iPod with the video cannot be played back.

iPod control screen displayed

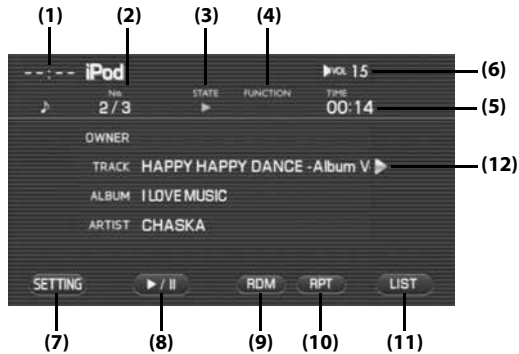

(1) Clock

The current time is displayed.

Refer to clock setting screen "SET CLOCK" as described on Page 74.

(2) No.

The content index being played back is displayed.

(3) STATE

The play status of the file being played back is displayed.

: Play

: Pause

: Forward search

: Reverse search

(4) FUNCTION

The play status of the content being played back is displayed.

RPT: Repeating

RDM: Random playback

A.RDM: Album random playback

RPT RDM: Repeat and random playback

RPT A.RDM: Repeat and album random playback

(5) TIME

The playback time of the file is displayed.

(6) VOL

The sound volume level is displayed. (See Page 121.)

(7) **SETTING** (setting)

Selecting this displays the screen set for the iPod audio.

(8) **▶ / ||** (play/pause)

The playback is stopped temporarily or played.

(9) **RDM** (random)

Used to change the playback method of tunes in random order. (See Page 184.)

(10) **RPT** (repeat)

Used to change the playback method of tunes to repeated playback. (See Page 184.)

(11)  (list)

Used to display the list in iPod audio.

(12)  (name)

Displayed when the contents of the text cannot be displayed for each item. Selecting this scrolls the characters. When scrolled, all of the text is displayed.

Playing the iPod-Music

Music files stored in the memory of an externally connected iPod can be played back.

- 1 Change the audio source to the iPod.

NOTE



When no iPod device is set in the in-vehicle equipment, set the iPod device.

- 2 Select **MUSIC** (music).



- 3 Select the desired category from the list.



Selecting   scrolls to display 5 category positions ahead or behind.

- 4 Select the desired category from the list.



NOTE

When briefly pressing  (category play) of the category to be played back, all the items contained in the category will be played back from the first one.

5 Select the desired file from the list.



The file selected is played back.

The first tune in the first folder in the iPod device is played back from the start.

When the last tune in the folder is played back, the first tune in the next folder is played back.

When the last tune in the iPod device is played back, the playback is resumed from the first tune in the lead folder.

6 Select **CONTROL** (control).



7 The tune information is displayed.



■ To stop playing back temporarily

An item being played back on an iPod will be paused.

1 Select **▶/||** (pause).



■ To stop playing back

An item being played back on an iPod will be stopped.



When switching the iPod source to other sources, the playback of the connected iPod will be pause.

Selecting a tune (track) you want to hear

■ To select the preceding tune

It is possible to reverse or fast-forward a tune that is now being played back.

1 Conduct either of the following operations while playing back a tune.



- Press the  button.
- Rotate the [TUNE/TRACK] button counterclockwise.
- Press the  button of the steering switch.

The preceding tune is played back.

■ To select the succeeding tune

It is possible to play back a tune succeeding the tune that is now being played back.

1 Conduct either of the following operations while playing back a tune.

- Press the  button.
- Rotate the [TUNE/TRACK] button counterclockwise.
- Press the  button of the steering switch.

The preceding tune is played back.

Reversing or fast-forwarding a tune



It is possible to reverse or fast-forward quickly a tune that is now being played back.

■ To reverse a tune quickly

1 Keep pressing the button while playing back a tune.

The tune is reverse quickly while the button is pressed and held. When releasing the  button is released, the tune is played back from the point to which the tune was reverse.

■ To forward a tune quickly

1 Keep pressing the button while playing back a tune.

The tune is fast-forwarded quickly while the button is pressed and held. When the  button is released, the tune is played back from the point to which the tune was fast-forwarded.

Listening to a tune repeatedly

■ To listen to the same tune repeatedly

It is possible to play back the same tune repeatedly.

1 Select **RPT** (repeat) while playing back a tune.

With "RPT" displayed for FUNCTION on the iPod screen, the tune is played back repeatedly.



NOTE

Each time you select a key, it will toggle between "usage" and "non-usage" of the corresponding roads or ferries.

Listening the tunes in random order

It is possible to play back the tunes in the folder in random order.

NOTE

The random order function is available only for music contents.

1 Select **RDM** (random) while playing back a tune.

With "RDM" displayed for FUNCTION on the iPod screen, the tunes in the folder are played back in random order.



• Selecting **RDM** (random) again releases the random playback.

2 Select **RDM** (random) again.

The albums in the list are rearranged in random order, and the tracks in an album are played in order.

NOTE

The function will be toggled as shown below by briefly pressing **RDM** (random) repeatedly.

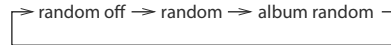

AUX functions

Playing back the AUX

The external input sound can be output. The external input sound is regarded as "AUX" that is one of the audio sources. To activate this function, AUXBOX connection should be detected and A/V-IN setting is changed to "AUX".

1 Switch the external input source.

When a AUX is not yet set on the in-vehicle equipment, set a AUX.
Connect a mini pin plug (3,5φ).
Refer to the Owner's Manual of the vehicle.



Select **SETTING** (setting) to display the screen set for the audio. (See Page 195.)

USB storage device functions

WARNING

The driver must not attempt to operate or watch the screen while the vehicle is in motion. Doing so will distract attention from driving and the road, and could lead to an accident.

NOTE

- Using the Audio and Visual System with the engine stopped could lower the battery's electricity level. If the initial charge level is too low, the engine may not start the next time. It is recommended that the system be used only when the engine is running expect when the vehicle is parked in a garage or other enclosed area.
- In the interest of safety, the use of some functions may be unavailable while driving. The buttons for a touch screen that cannot be used are displayed greyed out.
- Liquid-crystal displays may be difficult to read when wearing polarized glasses.

Setting the USB storage device

Using this system, MP3/WMA/AAC files stored in the memory of USB storage devices can be played back. To activate this function, externally connect a USB storage device.

■ Media format

Supported file systems are FAT16 (128 MB or more) and FAT32 (256 MB or more). NTFS is not supported.

MP3: MPEG1 Audio Layer 3, 32 to 320 kbps, 44.1/48/32 kHz

WMA: Windows Media Audio 9.2 supported

AAC: AAC-LC 8 to 320 kbps, 8 to 48 kHz

NOTE

In the following cases, play back is not possible.

A USB connection device that:

- is connected to a hub in between,
- requires more than 500 mA operating current,
- is compatible only with USB 1.1,
- requires an additional power supply except for the USB power supply (bus power),
- is a digital audio player except for an iPod,
- is formatted on NTFS,
- is a card reader for a memory card,
- includes a file that is protected by Digital Rights Management (DRM), or
- is of poor quality (is not compatible with USB 2.0).

■ Connecting or disconnecting the USB storage device

Connection of a USB storage device is detected when a USB storage device is installed with the connection cable specific to the USB storage devices that was attached to the vehicle. Disconnection of a USB storage device is detected when a USB storage device is removed from the connection cable or USB connection is suspended.

Playing the USB storage device

It is possible to play back MP3/WMA/AAC audio files stored in the memory of the USB storage devices.

- 1** Connect the USB storage devices with the connection cable specific to the USB storage devices that was attached to the vehicle. Playback will automatically start.

The first tune in the lead folder in the USB storage device is played back from the start.

When the tunes in the folder are played back to the last, the first tune in the lower-order or next folder is played back.

When the tunes in the USB storage device are played back to the last, the playback is resumed from the first tune in the lead folder.

NOTE

When no USB storage device is set in the in-vehicle equipment, set the USB storage device.

USB control screen displayed

When the USB screen is not displayed while playing back of a USB audio file, press the [TUNE/TRACK] button to display the USB screen.

And then selecting the screen displays the USB control screen.

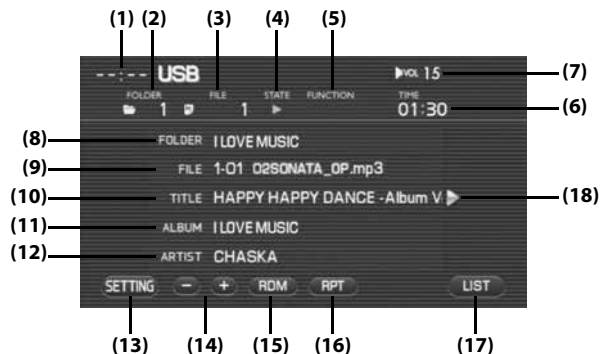

- (1) **Clock**
The current time is displayed.
Clock setting screen "SET CLOCK" as described on Page 74.
- (2) **FOLDER**
The folder number of the file being played back is displayed.
- (3) **FILE**
The file number of the file being played back is displayed.

- (4) **STATE**
The play status of the file being played back is displayed.

- ▶: Play
- ⏸: Pause
- ⏭: Forward search
- ⏮: Reverse search

- (5) **FUNCTION**
The play status of the file being played back is displayed.

- RPT: Repeating
- F.RPT: Folder repeating
- RDM: Random playback
- SCAN: Scanning

- (6) **TIME**
The playback time of the file is displayed.

- (7) **VOL**
Sound volume level is displayed. (See Page 121.)

- (8) **FOLDER**
The folder name is displayed.

- (9) **FILE**
The file name is displayed.

- (10) **TITLE**
The title of a tune is displayed.

- (11) **ALBUM**
The name of an album is displayed.
- (12) **ARTIST**
The name of an artist is displayed.
- (13) **SETTING (setting)**
Selecting this displays the screen set for the audio. (See Page 195.)
- (14) **+ - (folder search)**
Used to play back the first tune in the succeeding/preceding folder. (See Page 190.)
- (15) **ADM (random)**
Used to change over the playback method of tunes in random order. (See Page 194.)
- (16) **RPT (repeat)**
Used to change the playback method of tunes over to the repeated playback. (See Page 193.)
The function will be toggled as shown below.
OFF -> RPT -> F.RPT -> OFF
- (17) **LIST (list)**
Used to display the list in the USB. (See Page 190.)
- (18) **▶ (Name)**
Displayed when the contents of the text cannot be displayed for each item. Selecting this scrolls the characters. When scrolled up to the end of the text, ▶ is displayed.

Selecting a tune

Select a folder in the USB storage device.

To select a folder

1 Select **+** (folder up search) or **-** (folder down search).

Selecting **+** (folder up search) plays back the first tune in the succeeding folder.

Selecting **-** (folder down search) plays back the first tune in the preceding folder.

To select a folder from the list

1 Select **LIST** (list).



2 Select **UP** (up).



3 Select the folder name.



- Selecting **▲** scrolls the display to display a folder 5 positions ahead.
- Selecting **▼** scrolls the display to display a folder 5 positions behind.

- Selecting **HOME** (home) displays in the list the tunes in the folder in which a tune that is now being played back is contained.
- Selecting **UP** (up) displays the folder list when the tunes are displayed in the list.
- Selecting **CONTROL** (control) gets back to the USB in which the tune information is displayed.

The first tune in the folder selected is played back.

Selecting a tune (file) you want to hear

Select a tune (file) in the USB storage device.

■ To select the preceding tune

It is possible to play back a tune in the high-order folder of the tune that is now being played back or the preceding tune.

1 Conduct either of the following operations while playing back a tune.

- Press the **SEEK-** button.
- Rotate the [TUNE/TRACK] button counterclockwise.
- Press the  (SEEK DOWN) button of the steering switch.

The preceding tune is played back.

■ To select the succeeding tune

It is possible to play back a tune succeeding the tune that is now being played back.

1 Conduct either of the following operations while playing back a tune.

- Press the **SEEK+** button.
- Rotate the [TUNE/TRACK] button counterclockwise.
- Press the  (SEEK UP) button of the steering switch.

The preceding tune is played back.



■ To select a tune from the list

1 Select **List** (list).



2 Select the tune name.



- Selecting  scrolls the display to display a folder 5 positions ahead.
- Selecting  scrolls the display to display a folder 5 positions behind.

- Selecting **HOME** (home) displays in the list the tunes in the folder in which a tune that is now being played back is contained.
- When the tunes are displayed in the list, selecting **UP** (up) displays the folder list.
- Selecting **CONTROL** (control) gets back to the USB in which the tune information is displayed. The tunes in the folder are displayed in the list. A tune selected is played back.

■ To search a tune while listening to tunes in the folder

It is possible to search a tune you want to hear while listening to each of the tunes in the folder for 10 seconds. After all the tunes in the folder are played back, the player gets back to the normal playback mode.

1 Press the **SCAN** button while playing back a tune.



After completion of the playback of tune you want to hear, press the **SCAN** button again.

Reversing or fast-forwarding a tune

It is possible to reverse or forward quickly a tune that is now being played back.

■ To reverse a tune quickly

- 1 Keep pressing the **SEEK-** button while playing back a tune.

A tune is reversed quickly while the button is kept pressed. When releasing the **SEEK-** button, the tune is played back from the point to which the tune was reversed.

■ To forward a tune quickly

- 1 Keep pressing the **SEEK+** button while playing back a tune.

A tune is forwarded quickly while the button is kept pressed. When releasing the **SEEK+** button, the tune is played back from the point to which the tune was forwarded.

Listening to a tune repeatedly

It is possible to listen to the same tune or the tunes in the folder repeatedly.

■ To listen to the same tune repeatedly

It is possible to play back the same tune repeatedly.

- 1 Select **RPT** (repeat) while playing back a tune.

With "RPT" displayed for FUNCTION on the USB audio screen, the tune is played back repeatedly.



- Selecting **RPT** (repeat) allows you to listen to the tunes in the folder repeatedly. Select **RPT** (repeat) again to release the repeated playback.
- When "F.RPT" is displayed for FUNCTION, the USB audio is set to the mode for listening to the tunes in the folder.
- The function will be toggled as shown below by pressing **RPT** (repeat) repeatedly.
repeat OFF -> file repeat -> folder repeat -> repeat OFF

■ To listen to the tunes in the folder repeatedly

It is possible to play back the tunes in the folder repeatedly.

1 Select **RPT** (repeat) twice while playing back a tune.

With "F.RPT" displayed for FUNCTION on the USB audio screen, the tunes in the folder are played back repeatedly.



- Selecting **RPT** (repeat) again releases the repeated playback.
- When "RPT" is displayed for FUNCTION, the mode is set in which the same tune is played back repeatedly. Select **RPT** again.
- The function will be toggled as shown below by pressing **RPT** (repeat) repeatedly.
repeat OFF -> file repeat -> folder repeat -> repeat OFF

Listening to the tunes in random order

It is possible to play back the tunes in the folder in random order. After all the tunes in the folder are played back, the tunes in the next folder are played back in random order.

1 Select **RDM** (random) while playing back a tune.

With "RDM" displayed for FUNCTION on the USB audio screen, the tunes in the folder are played back in random order.



- After all the tunes in the folder are played back, the tunes in the next folder are played back in random order.
- Selecting **RDM** (random) again releases the random playback.

Setting the audio

To adjust the audio settings, observe the following instructions to go to the menu screens regarding each setting. For more details about each setting, refer to the corresponding section.

Setting

.....

NOTE

Sources displayed vary with the equipment connected.

1 Press the [TUNE/TRACK] button.

When the source display is shown, proceed to step 3.

2 Select **SETTING** (setting).



3 Select the desired source or  (set up).



4 Select the desired source.

Each of the source screens are displayed.



(DVD)
(BT AUDIO)
(A/V-IN)

See Page 153
See Page 170
See Page 218

Setting the equalizer

It is possible to set the audio to the sound quality of your preference.

Setting the equalizer with ease

It is possible to select a sound category to set the equalizer with ease.

1 Select  (EQUALIZER).



2 Select either of the categories.



 (default): All items are configured to the default settings at the same time.

Setting the equalizer in detail

Setting the numeric value of the equalizer in detail allows you to enjoy a sound quality more suited to your taste. Presetting the equalizer allows you to invoke it later.

- 1 Select either of the BANDs 1 to 4 and then select ◀ ▶ to set a numeric value for each band.



FREQ:
Used to set the frequency.

BAND1
60/80/100/120/160/200

BAND2
250/315/400/500/630/800/1k

BAND3
1.25k/1.6k/2k/2.5k/3.15k/4k

BAND4
5k/6.3k/8k/10k/12.5k/16k

Q:
Used to set the degree of acumination.

0.25/0.5/1/2

GAIN: -9/-7/-5/-3/-2/-1/0/1/2/3/5/7/9
Used to set the value of gain.

The larger the value of Q factor (degree of acumination) is, the more the gain of the center frequency is enhanced.

- 2 When presetting the equalizer setting, select either of 1 to 3 of the USER PRESET for more than 2 second.



NOTE

When not preset, it is not possible to invoke the setting later. However, you can enjoy the audio as you have set it.

Invoking the equalizer setting that has been preset



It is possible to invoke the equalizer preset to make use of it.

- 1 Select  (EQUALIZER) in the SETTING screen.



- 2 Select either of  to  of USER PRESET.





Setting the balance/fader





It is possible to set the audio to the sound balance of your preference.

- 1 Select  (BALANCE/FADER).



NOTE

- Selecting  (DEFAULT) gets  (cross point) back to the center position.

- 2 Select     given in the in-vehicle illustration to set the balance level and fader level.

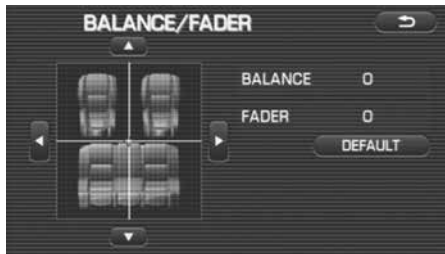

Set  (cross point) to the position at which you want to tone up the sound level the most.

Select the portable player

To switch the Bluetooth audio devices that were already registered, perform the following procedure. For more details about Bluetooth audio, refer to the "Bluetooth audio" section. This function is available when more than one Bluetooth audio device was registered. Only one Bluetooth audio device can be connected at once. The switching procedures to connect a Bluetooth audio device are shown below.

- 1 Select  (select portable player).



- 2 Select the Bluetooth audio device to be used, and then select **OK** (OK).



Referring to the Bluetooth audio device information

Perform the following procedure to refer to and edit the information of the Bluetooth audio devices that were already registered.

- 1 Select  (select portable player).



- 2 Select the Bluetooth audio device to be referred to.

Select **Portable Player Info** (portable player information), and then select **OK** (ok).



- 3 The information about the Bluetooth audio device is displayed.



Editing the Bluetooth audio device information

Perform the following procedure to edit the information of the Bluetooth audio devices that were already registered.

■ Device name editing

- 1 Display the information of the Bluetooth audio devices on the information screen.
- 2 Select **Edit** (edit) of the device name.



- 3 Input a new device name, and then select **OK** (ok).



- 4 Select **Save** (save).



Initializing the DVD

The DVD player is initialized. The selection of the superimposed language and the sound can be set while in the looking and listening of the DVD. However, it is convenient if you initialize in advance the settings frequently used.

- 1 Select  (SET UP).



- 2 Select  (DVD).



The DVD SET UP screen is displayed.

- 3 Select the desired setting.



NOTE

The following can be conducted in this screen.

- Setting the screen (See Page 204.)
- Setting the dynamic range (See Page 205.)
- Setting the language (See Page 206.)
- Setting the parental level (See Page 209.)

- 4 When "After changing settings, system may not play back" is displayed, select  (Yes).

Setting the screen

It is possible to make a setting to decide whether or not the angle mark is displayed. And it is also possible to set the type of the image.

The angle mark is a mark displayed when the angle can be changed while playing back a DVD compliant with multi-angle.

1 Select **SCREEN** (SCREEN).



2 Make a setting to decide whether or not the angle mark is displayed, and also set the type of the screen.

Select **On** (ON) of the ANGLE MARK to display the angle mark. And select **OFF** (OFF) not to display the ANGLE MARK.



Select either of the following to set the type of the image.

- **16:9** : The width and height of the image is displayed in the ratio of 16:9.
- **4:3LB** : With a black frame attached to the top and bottom of the image in the ratio of 16:9, the width and height is displayed in the ratio of 4:3.
- **4:3PS** : The width and height is displayed in the ratio of 4:3.

Setting the dynamic range

The dynamic range is set. The setting of the dynamic range is effective when playing back Dolby digital image.

1 Select **AUDIO** (AUDIO).



2 Set the dynamic range.



Select either of the following to set the dynamic range.

- **WIDE** : Used to enhance the high-pitched sounds and the low-pitched sounds so that the dynamic range is played back in the sound modulated for effect.
- **NORMAL** : Used to play back the dynamic range in the normal mode.
- **NARROW** : Used to suppress the high-pitched sounds and the low-pitched sounds to make speeches listener-friendly.

Setting the language

It is possible to initialize the voice language, the superimposed language and the language to be displayed on the menu.

For detailed method for changing the language while in the looking and listening of the DVD, refer to "Changing the voice language" on Page 163 and "Changing the superimposed language" on Page 162.

- 1 Select **LANGUAGE** (LANGUAGE) in the DVD SET UP screen.



- 2 Select the language item you want to set.



- AUDIO LANGUAGE** : Used to set the voice language.
- SUBTITLE LANGUAGE** : Used to set the superimposed language.
- MENU LANGUAGE** : Used to set the language to be displayed on the menu.

- 3 Select the voice you want to set. When there is no language found you want to set, select **OTHERS** (OTHERS).



Selecting the language terminates this operation.

- 4 Enter the LANGUAGE CODE of the language you want to set and then select **OK** (OK).



Setting the password of the parental level

.....

The parental level is used to restrict the looking and listening of the DVD according to the level set. To set the parental level, it is necessary to register a password in advance.

When setting the parental level, it sometimes occurs that a password is asked for while in the looking and listening of the DVD. In that case, enter the password you used when setting the parental level.

- 1 Select **PARENTAL** (PARENTAL).



- 2 Select **REGISTER PASSWORD** (REGISTER PASSWORD).



When the password has been set and you want to change it, select **CHANGE PASSWORD** (CHANGE PASSWORD).

- 3 Select the numeric key to enter a 4-digit password, and then select **OK** (OK).



Selecting **CLEAR** (CLEAR) deletes what has been entered.

- 4 As a password for confirmation, enter a 4-digit password that is the same as the one used in step 3 and then select **OK** (OK).



When setting the parental level, follow the procedure given at step 4 and the succeeding steps on Page 209.

Setting the parental level

Set the parental level to restrict the looking and listening of the DVD according to the level set. In order to set the parental level, a password is used. When a password is not yet set, it is necessary to register a password. (See Page 207.)

- 1 Select **PARENTAL** (PARENTAL) in the DVD SET UP screen.
- 2 Select **CHANGE LEVEL** (CHANGE LEVEL).



- 3 Select the numeric keys to enter a 4-digit password and then select **OK** (OK).



Selecting **CLEAR** (CLEAR) deletes what has been entered.

- 4 Select **◀ ▶** of the PARENTAL LEVEL.
The smaller the numeric value (1-8) of the parental level, the more severe the restriction. And the larger the numeric value, the more gentle the restriction.
- 5 Select the numeric keys to enter a 4-digit password and then select **OK** (OK).
If you want to change the password, select [CHANGE PASSWORD], and then change it referring to "Setting the password of the parental level" on Page 207.

Setting the Bluetooth audio

Registering the Bluetooth audio devices

Before using a Bluetooth audio device, registering (pairing) the Bluetooth audio device in the system is required. A maximum number of two devices can be registered.

1 Select  (set up).



2 Select  (BT audio).



3 Select  (register).



If another Bluetooth audio device is connected, the BT audio confirmation message is displayed. Select  (yes) to cancel the connection of the device.



- 4** While the Bluetooth audio screen is displayed, operate the Bluetooth audio device to search and connect to the in-vehicle equipment. (When connecting, use the pass-key shown on the Bluetooth audio screen.)



NOTE

If your Bluetooth audio device is not equipped with the pass-key input interface, register the device after changing the pass-key of the in-vehicle equipment to the one of the Bluetooth audio device.

- 5** When the connection is successful, a confirmation message is displayed and the registration is completed.



NOTE

- If you select **Cancel** (cancel) shown on the Bluetooth audio screen or move to other screens during registration, the ongoing registration process will be canceled.
- After the registration is completed, the registered Bluetooth audio device is automatically connected.
- Registration cannot be performed while a hands-free phone is receiving a call or when talking on a hands-free phone.
- The registered Bluetooth audio device can be used on the interface of the BT audio function. If you want to use the device on the interface of the hands-free phone function, perform the registration of hands-free phone devices.
- Regarding the operation of the Bluetooth audio device that is registered and connected, refer to the owner's manual that comes with the Bluetooth audio device.

Deleting the Bluetooth audio device registration

Specify a registered Bluetooth audio device and delete the registration from the system.

- 1 Select  (set up).



- 2 Select  (BT audio).



- 3 Select  (remove).



- 4 Select the device to be deleted on the list, and then select  (ok).



5 A confirmation message is displayed.

Select **YES** (yes).



NOTE

- If **NO** (no) is selected, the deletion process is canceled.
- If the device to be deleted is connected to the system, a confirmation message is displayed. Select **YES** (yes) to cancel the connection, and then perform the deletion process.
- If **NO** (no) is selected, the deletion process is canceled.

6 A confirmation message is displayed while deleting the registration, and another confirmation message is displayed when the deletion process is successful.

NOTE

- After the deletion is completed, another registered Bluetooth audio device is not automatically connected.
- Deletion cannot be performed while a hands-free phone is receiving a call or when talking on a hands-free phone.

Connecting the Bluetooth audio device automatically

The Bluetooth audio device that was already registered in the system can be automatically connected.

NOTE

- If the connection method was set to "From portable player", operating the Bluetooth audio device is required for connection after the ignition key is turned to the ACC or ON position.
- Automatic connection will not be performed if no Bluetooth audio device is registered.

1 Select (set up).

The "setup" menu is displayed.

2 Select (BT audio).



- 3 Select **On** (on) of the "Auto Bluetooth connect", and then select **Save** (save).



NOTE

Select **Default** (default) to use the default of the automatic connection setting.

Setting the connection method of the Bluetooth audio device

The connection method (connecting from either the system or Bluetooth audio device) can be set up independently on each registered Bluetooth audio device.

- 1 Select  (select portable player).



2 Select the Bluetooth audio device to be set.

Select **Portable Player Info** (portable player information), and then select **OK** (ok).



3 Select **From Vehicle** (from vehicle) or **From Portable Player** (from portable player), and then select **Save** (save).



From Vehicle : Connection is performed from the vehicle.

From Portable Player : Connection is performed from the player.

Referring to the device information of the Bluetooth audio system

Perform the following to refer to and edit the information of the Bluetooth audio system stored in the in-vehicle equipment and the information of the Bluetooth audio devices that were already registered.

■ In-vehicle equipment information display

1 Select (set up).



- 2 Select  (BT audio).



- 3 The device information is displayed.





Editing the device information of the Bluetooth audio system

.....

Perform the following procedure to edit the information of the in-vehicle equipment that has already been registered.

■ Device name editing

- 1 Select  (set up) and select  (BT audio).

- 2 Select  (edit) of the device name.



- 3 Input a new device name, and then select **OK** (ok).



- 4 Select **Save** (save).



NOTE

Select **Default** (default) to use the default of the automatic connection setting.

■ Pass-key editing

- 1 Perform steps 1 and 2 in the previous section, and then display the editing screen.
- 2 Select **Edit** (edit) of "Pass-key".



- 3 Input a new pass-key, and then select **OK** (ok).



4 Select **Save** (save).



NOTE

Select **DEFAULT** (default) to use the default setting.

Setting the A/V-IN

The procedure to set up external input sources is given in this section.

1 Select **SET UP** (set up).



2 Select **A/V-IN** (A/V-IN).



3 Select the external input source to be switched.



When **VIDEO** (video) is selected, the key name of the external input source turns to "VIDEO" and video sources (video screens) can be selected.

When **AUX** (aux) is selected, the key name of the external input source turns to "AUX" and auxiliary sources screens can be selected.



Voice Activation

Voice activation system

The voice recognition function allows you to operate the navigation system, audio system and hands-free phone system using your voice instead of display screen handling. This section includes instructions about how to perform the voice commands. The commands that can be recognized by this system are restricted. (See Page 222.) For each function, refer to the corresponding items.

■ Correct voice recognition

The circumstance of the interior of the vehicle will adversely affect the correct recognition of the voice. Note the following items in order for the system to correctly recognize the voice.

- Speak clearly into the microphone. Speaking faster or slower and pausing between words will cause incorrect recognition.
- Close the windows to eliminate outside noise. Traffic noise, driving sounds and wind noise may affect the correct recognition of the voice.
- Speak the voice commands correctly. The commands that can be recognized by this system are restricted. Any terms other than the recognized terms for the system or dull sounds that are incorrectly spoken will not be recognized by the system. If the name of a facility is pronounced differently from the recognized terms for the system, the command will not be recognized by the system.
- The microphone is located at the best distance and in the best direction for each model to gain the maximum voice recognition performance. Speak commands in the correct driving posture.
- Do not speak commands during navigation voice guidance or voice recognition talk back. This causes sounds to overlap and results in incorrect voice recognition.

Basic operations of voice recognition

- 1 Press the  button located on the steering switch.

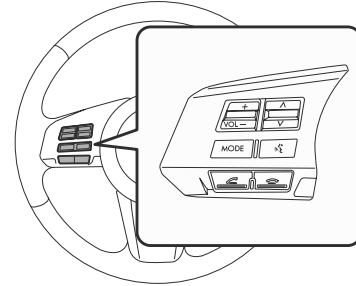

The voice recognition mode is activated, and the icon for voice recognition will be displayed on the upper left side of the screen.

- 2 While the icon is displayed, speak a voice command.



During the voice recognition mode, the sound from the audio system is muted.

**(voice input waiting mode):**

shows the status of waiting for a voice command.

**(during a calculation):**

shows the status of accepting and processing a voice command.

After a voice command is spoken, the system recognizes the voice and activates the function input by the voice command. Then the system will announce the operated function during voice recognition talk back.

Pressing the  button located on the steering wheel during voice recognition will cancel the voice recognition mode.

Voice command list

The voice commands that are available for the voice recognition function are listed in this section. Speak the voice commands correctly. The commands that can be recognized by this system are restricted. Any terms other than the recognized terms for the system or dull sounds that are incorrectly spoken will not be recognized by the system. If the name of a facility is pronounced differently from the recognized terms for the system, the command will not be recognized by the system.

■ Types of commands

1. Common

Operation commands that are common to the system

2. Shortcut

Commands to switch the screen

3. Function direct (map operation)

Commands to perform the functions of "map operation"

4. Function direct (POI)

Commands to perform the functions of "POI"

5. Function direct (destination)

Commands to perform the functions of "destination setting"

6. Function direct (guidance)

Commands to perform the functions of "guidance"

7. Audio mode

Commands that can be used when an audio device that is compatible with the system is connected

8. Audio radio

Commands that can be used when the current audio source is the radio

9. Audio media

Commands that can be used when the current audio source is a media device

10. Hands-Free Phone System

Commands to operate the Hands-Free Phone using voice recognition

When the voice recognition system can recognize several phrases for a command, these phrases are distinguished by the following categories in this section.

1. Selection

Several phrases that can be recognized by the system for a command are shown with the mark "|".

Example 1: A | B A or B

Example 2: A | B | C A or B or C

2. Grouping

When the range of selection is limited, the beginning of the selection group is shown with the mark "(", and the end is shown with the mark ")".

Example 3: (A | B) The range of selection is limited to A | B.

Example 4: A (B | C) AB or AC



3. Omission

When some phrases can be omitted, the beginning of the omission is shown with the mark "[", and the end is shown with the mark "]".

Example 5: [AB] A and B can be omitted.

Example 6: A (B | C [D]) AB or AC or ACD

1. Common

- When the  button is briefly pressed, a beep (a single note) will sound and the voice recognition mode will start.
- When the  button is pressed, the voice recognition mode will be canceled.

2. Shortcut

Commands to switch the screen

Voice commands

[Show] Map

[Show] Current (Position | Location)

Repeat [Voice][Guidance]

Cancel

3. Function direct (map operation)

Commands to perform the functions of "map operation"

Voice commands

Zoom In

Zoom Out

Right [Screen] Map Zoom In

Right [Screen] Map Zoom Out

[Change to | Show] North up [Mode]

[Change to | Show] Heading up [Mode]

[Change] Map Direction

Right [Screen] Map [Change to | Show] North up [Mode]

Right Map [Change to | Show] Heading Up [Mode]

Right [Screen] Map [Change] Map Direction

[Change to] Dual Map [Mode]

[Change to] Single Map [Mode]

Store This Point | Mark This Point | Memory Point

Zoom In Maximum

Zoom Out Maximum

Right [Screen] Map (Zoom In Maximum | Minimum Scale)

Right [Screen] Map (Zoom Out Maximum | Minimum Scale)

4. Function direct (POI)

Commands to perform the functions of "POI"

Command (US English)

(Automobile Club | Triple A)

(Gas Station | Gas)

(Parking | Parking Lot | Parking Garage | Car Park)

(Auto Service & Maintenance | Auto Service)

SUBARU DEALERSHIP

ATM

Bank

(Town Center | City Center)

Convention Center | Exhibition Center)

Court House

Government Offices

(Higher Education | University | College)

Hospital

Library

(Parks & Recreation | Park & Recreation)

Police Station

School	Grocery Store
Amusement Park	Shopping Mall
Casino	Airport
Golf Course	Bus Station
Historical Monument	Ferry Terminal
Marina	Hotel
Museum	Rental Car Agency
(Ski Resort Skiing)	Rest Area
(Sports Complex Stadium)	Train Station
Performing Arts	Business Facility
Tourist Attraction	Convenience Store
Tourist Information	Department Store
Winery	Home and Garden
(Restaurant I'm Hungry Show Restaurant)	Pharmacy
(American Restaurant American Food)	Specialty Food Store
(Chinese Restaurant Chinese Food)	Other Retail Stores
(Continental Restaurant Continental Food)	Car wash
(Fast Food Fast Food Restaurant)	Campground
(French Restaurant French Food)	Botanical/Zoological Gardens
(Italian Restaurant Italian Food)	Cinema
(Japanese Restaurant Japanese Food)	Horse Racing
(Mexican Restaurant Mexican Food)	National and State Parks
(Seafood Restaurant Seafood)	Speedway
(Thai Restaurant Thai Food)	Video Rental
(Other Restaurant Other Food)	Post Office

Other Financial Services

Coffee House

Dry Cleaning

Health and Fitness Club

Ice Cream Parlor

Beauty and Barber shops

The nearest POIs are listed from the next item.

Nearest (Automobile Club | Triple A)

Nearest (Gas Station | Gas)

Nearest (Parking | Parking Lot | Parking Garage | Car Park)

Nearest (Auto Service & Maintenance | Auto Service)

Nearest SUBARU DEALERSHIP

Nearest ATM

Nearest Bank

Nearest (Town Center | City Center)

Nearest (Convention Center | Exhibition Center)

Nearest Court House

Nearest Government office

Nearest (Higher Education | University | College)

Nearest Hospital

Nearest Library

Nearest (Parks & Recreation | Park & Recreation)

Nearest Police Station

Nearest School

Nearest Amusement Park

Nearest Casino

Nearest Golf Course

Nearest Historical Monument

Nearest Marina

Nearest Museum

Nearest (Ski Resort | Skiing)

Nearest (Sports Complex | Stadium)

Nearest Performing Arts

Nearest Tourist Attraction

Nearest Tourist Information

Nearest Winery

Nearest (Restaurant | I'm Hungry | Show Restaurant)

Nearest (American Restaurant | American Food)

Nearest (Chinese Restaurant | Chinese Food)

Nearest (Continental Restaurant | Continental Food)

Nearest (Fast Food | Fast Food Restaurant)

Nearest (French Restaurant | French Food)

Nearest (Italian Restaurant | Italian Food)

Nearest (Japanese Restaurant | Japanese Food)

Nearest (Mexican Restaurant | Mexican Food)

Nearest (Seafood Restaurant | Seafood)

Nearest (Thai Restaurant | Thai Food)

Nearest (Other Restaurant | Other Food)

Nearest Grocery Store

Nearest Shopping Mall

Nearest Airport
Nearest Bus Station
Nearest Ferry Terminal
Nearest Hotel
Nearest Rental Car Agency
Nearest Rest Area
Nearest Train Station
Nearest Business Facility
Nearest Convenience Store
Nearest Department Store
Nearest Home and Garden
Nearest Pharmacy
Nearest Specialty Food Store
Nearest Other Retail Stores
Nearest Car wash
Nearest Campground
Nearest Botanical/Zoological Gardens
Nearest Cinema
Nearest Horse Racing
Nearest National and State Parks
Nearest Speedway
Nearest Video Rental
Nearest Post Office
Nearest Other Financial Services
Nearest Coffee House

Nearest Dry Cleaning
Nearest Health and Fitness Club
Nearest Ice Cream Parlor
Nearest Beauty and Barber shops
Cancel
No beeps / no items found by the voice recognition
[Enter] Destination
[Add to] Way Point
[Show] list
Set
Other
POI Off

5. Function direct (destination)

Commands to perform the functions of "destination setting"

Command

[Go] Home
Cancel
No beeps / no items found by the voice recognition
[Enter] Destination
[Add to] Way Point
(Go to | Previous)(Starting | Start) Point
Cancel
No beeps / no items found by the voice recognition
[Enter] Destination
[Add to] Way Point

Set
 Other
 [Go to] Previous Destination
 Cancel

No beeps / no items found by the voice recognition

[Enter] Destination
 [Add to] Way Point

Set
 Other
 [Go to] Preset Destination [Number] One
 Cancel

No beeps / no items found by the voice recognition

[Enter] Destination
 [Add to] Way Point
 [Go to] Preset Destination [Number] 2
 Cancel

No beeps / no items found by the voice recognition

[Enter] Destination
 [Add to] Way Point
 [Go to] Preset Destination [Number] 3
 Cancel

No beeps / no items found by the voice recognition

[Enter] Destination
 [Add to] Way Point
 [Go to] Preset Destination [Number] 4

Cancel
No beeps / no items found by the voice recognition
 [Enter] Destination
 [Add to] Way Point
 [Go to] Preset Destination [Number] 5
 Cancel

No beeps / no items found by the voice recognition

[Enter] Destination
 [Add to] Way Point

6. Function direct (guidance)

Commands to perform the functions of "guidance"

Command

Louder
 Softer
 [Change to] Arrow [Guide | Guidance | mode]
 [Change to] Turn List [Guide | Guidance | mode]
 [Show](Whole | Entire | Display) Route [Map]
 [Show] Next Way Point [Map]
 Show First Way Point [Map]
 Show Second Way Point [Map]
 Show Third Way Point [Map]
 Show Fourth Way Point [Map]
 Show Fifth Way Point [Map]
 Show Destination [Map]
 (Delete | Cancel) Next Way Point

Yes
No
(Delete | Cancel) Destination
Yes
No
(Delete | Cancel) All Way Points and Destination
Yes
No
Voice Guidance Off
Voice Guidance On
Quick
Short
Alternative
Detour
Detour (Entire | Whole) Route
[Change to] Freeway [Information] On
[Change to] Junction Detail On
[Change to] Compass mode
[Change to] Freeway [Information] Off
[Change to] Junction Detail Off

7. Audio mode

Commands that can be used when an audio device that is compatible with the system is connected

Command

radio
AM [radio]
FM [radio]
FM1
FM2
FM3
(Disc | CD | DVD | MP3 | WMA)
Audio [on | off]
Satellite radio
SAT
AUX | Auxiliary
Video
USB Audio
iPod
Bluetooth audio | BT audio

8. Audio radio

Commands that can be used when the current audio source is the radio

Command

Seek up

Seek down

Category up

Category down

9. Audio media

Commands that can be used when the current audio source is a media device

Command

Track up | Next track

Track down

Previous track

Folder up

Folder down

Group up

Group down

10. Hands-free

Commands to operate the hands-free phone using voice recognition

Command

Dial by Name

Dial by Number

No beeps / no items found by the voice recognition

Cancel

Dial by Name

Dial by Number

No beeps / no items found by the voice recognition

○○○ (Name)

No beeps / no items found by the voice recognition

Cancel

Dial Next Candidate

No beeps / no items found by the voice recognition

Cancel

○○○ (Number)

No beeps / no items found by the voice recognition

Cancel

Correction

Delete

Dial

○○○ (Number)



Hands-Free Phone System



Before using the Hands-Free Phone System

What can be made with the Hands-Free Phone System

It is possible to connect the Bluetooth Phone of which the operation has been confirmed to the in-vehicle equipment through the Bluetooth format (wireless) to make a phone call from the in-vehicle equipment or take an incoming phone call.

Since the Bluetooth format is wireless, a connection between the in-vehicle equipment and the Bluetooth Phone can be made without placing them in the close vicinity of each other. The Bluetooth Phone can be used with it left in the breast pocket or bag.

The Bluetooth Phone that is compliant with the in-vehicle equipment must meet the following requirements.

- Bluetooth Specification Ver. 1.1 or above (Ver. 1.2 or above is recommended.)
- Corresponding Profiles are as shown below.
 - HFP (Hands Free Profile) Ver. 1.0 (Ver. 1.5 or above is recommended.)
 - OPP (Object Push Profile) Ver. 1.1



"Bluetooth" is a trademark of Bluetooth SIG, Inc.

What cannot be done with the Hands-Free Phone System



In the following cases, the functions of the handsfree cannot be used.

- While not in the phone call area.
- While in the phone call being restricted due to the lines congested.
- When the phone book data is being transmitted from the Bluetooth Phone.
- When the Bluetooth Phone is being used, due to data communication.
- When the Bluetooth Phone is out of order.
- When the Bluetooth Phone is not connected to the in-vehicle equipment.
- When the battery of the Bluetooth Phone has run down.
- When the power switch of the Bluetooth Phone is turned off.
- When the Bluetooth Phone is not set to the handsfree mode.
- When a changeover is made on the in-vehicle side from the phone book transmission to the handsfree.
- When the Bluetooth Phone cannot be used for other reasons.

Precautions to be taken when using the Bluetooth equipment

Please take note of the following when using the Bluetooth equipment.

WARNING

- For safety's sake, the driver should avoid the operation of the Bluetooth Phone while driving.
- Do not make a phone call while driving. When you have an incoming call, bring your car to a stop in a safe place in a calm manner before taking the incoming phone call. When you have to absolutely take a phone call, tell the caller "I'll call you back" by handsfree. And then call him back after stopping the car in a safe place.
- The buttons for the touch screen that cannot be used are displayed greyed out.
Operating the navigation system while in driving could cause your attention to be distracted from the current traffic conditions. And in consequence, this could result in a severe or fatal accident. Follow the descriptions of all operations and the instructions for safety given in this manual without fail.
- Please comply with the instructions specified in the laws and regulations concerning the use of the telephone in the vehicle.

CAUTION

- Do not leave the Bluetooth Phone in the vehicle. (The temperature in a sun-heated car may go up extremely high.)
- When using the Bluetooth Phone, be careful not to get it close to the in-vehicle equipment. Getting it too close to the in-vehicle equipment may result in deterioration in tone quality or a poor connecting condition.
- The frequency band used by this equipment is the same band on which other industrial, scientific and medical equipment such as microwave ovens, radio stations (a license required) to be used by the production line in the factory to identify movable bodies, specific small power radio stations (a license not required) and amateur radio stations (a license required) is being operated. (These three type radio stations mentioned above are hereinafter referred to as "other radio stations.") Before using this equipment, be sure to check to see if "other radio stations" are being operated in the vicinity. Should there be a detrimental radio interference from this equipment to "other radio stations," move the equipment to another location as soon as possible to avoid radio interference. The frequency band used by this equipment is in the 2.4 GHz zone. The FH-SS modulation is employed as a modulation method. The expected inflicting interference distance is less than 10m. This equipment uses a full band and can avoid a band used by a movable body identification device.

NOTE

- Depending on the type of cell phone that is used, the screen illumination of the cell phone remains on while the ignition switch is in the "ON" position. If this occurs, turn the illumination off by operating the cell phone settings. For cell phone setting information, refer to the cell phone owner's manual.
- Depending on the setting of the cell phone, the dial lock may activate after connection. Deactivate the dial lock of the cell phone before use.
- Depending on the cell phone to be connected, operation and the sound volume may be different from those of cell phones currently used.
- When the ignition switch is turned to the "OFF" or "LOCK" position during a call, the call may be disconnected or continued on the cell phone depending on the type of cell phone that is used. Note that operation of the cell phone may be necessary if the call is continued on the cell phone.
- Do not speak at the same time with the other party during a call. If you and the party speak at the same time, your voice may be difficult to be heard by the party and vice versa. This does not indicate that there is a malfunction.
- The receiver sound volume should be set as low as possible. Otherwise, the party you are calling may notice an undesirable echo sound. Speak clearly and loudly.
- Your voice may be difficult to be heard by the party under the following conditions.
 - Driving on a rough road.
 - Driving on an expressway.
 - Driving with a window open.
 - Air from the ventilator blows directly towards the microphone.
 - The sound coming from the fan of the heater/cooler is loud.
 - The cell phone is too close to the microphone.
- The sound quality may be degraded and noise or an echo will occur due to the influence of the cell phone that is connected to the system or the circumstances of the Bluetooth network.
- When another Bluetooth device (such as a portable audio device) is simultaneously connected, noise may occur in the voice from the hands-free phone.

Name of each part

The name of each part used by the functions of the handsfree is as shown below.

■ In-vehicle equipment

Operating the touch switches displayed on the screen allows you to use the functions of the handsfree.

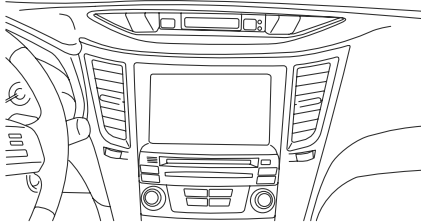

■ Steering switches

Pressing the  button short allows you to answer an incoming phone call.

Pressing the  button short allows you to hang up the phone.

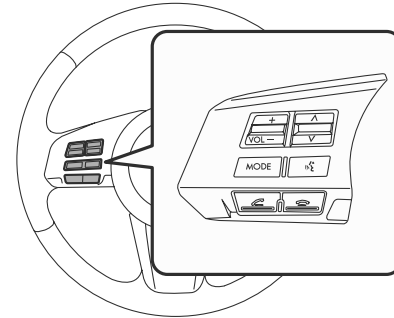

■ Microphone

Used while in the phone call. (dealer option)

For details, check with the dealer.

Phone voice

After making a phone call or having a phone call, you can talk over the phone through microphone and speaker.

- An incoming call notice and a voice output while in the phone call are output from the speaker on the driver's seat side and passenger's seat.
- When a voice or an incoming call signal is issued by the handsfree, the sound from the audio and the navigation system is muted.

Various types of displays

Selecting  (Phone) with the **[MENU]** button pressed displays the PHONE MENU screen, in which you can set and operate the functions of the handsfree. The explanation here is given of the various kinds of displays shown on the PHONE MENU screen.

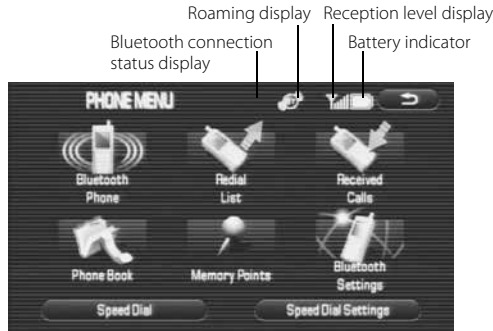

- When "Out of the range" is being displayed, you are now out of the service area, or in the location to which no radio waves get through. On occasions like this, you cannot use the Bluetooth Phone. Move to a location where a clear reception can be obtained.
- The reception level does not always conform to the display of the Bluetooth Phone. The reception level may not be displayed for some model types.

Battery indicator

This shows a rough battery capacity of the Bluetooth Phone. However, this is not displayed while in the transmission of the phone book data.



- The display of the battery capacity may not sometimes conform to that of the Bluetooth Phone. And also, the battery capacity may not be displayed for some model types.
- This system is not provided with a charging function for a cell phone.

Reception level display

This shows a rough standard of the reception level of radio waves. However, this is not displayed while in the transmission of the phone book data.



Bluetooth connection status display

.....

This displays the Bluetooth connection status of the Bluetooth Phone.



The Bluetooth Phone is correctly connected to the in-vehicle equipment.



The Bluetooth Phone is connected to the in-vehicle equipment, but radio waves are weak.



The Bluetooth Phone is not connected to the in-vehicle equipment. When using the handsfree, register the Bluetooth Phone and the in-vehicle equipment, and then connect them each other. (See "Registering the Bluetooth Phone" on Page 240)

Roaming display

.....

Roaming is a service that provides a continuous use of the system by using the facilities of a company with which the telephone company ties up when you are out of the stipulated service area.

When the roaming function is being used, "Rm" is displayed.

When parting with your car

When using the handsfree, a lot of personal information is registered.

When parting with your car, delete your personal information and data referring to the following.

And data once deleted cannot be restored to their original state. Be careful not delete data mistakenly.

Deleting all the outgoing and incoming call history. (See Page 260.)

Deleting all the phone book data. (See Page 273.)

Deleting the registered Bluetooth Phone from the in-vehicle equipment. (See Page 275.)

Changing the Device Name of the in-vehicle equipment displayed in the Bluetooth Phone. (See Page 277.)

Changing the Pass-Key to be used when certificating the Bluetooth Phone. (See Page 283.)

Making preparations of the Hands-Free Phone System

Registering the Bluetooth Phone

To use the Bluetooth Phone in interlock with the in-vehicle equipment, it is necessary to register the Bluetooth Phone with the in-vehicle equipment in advance.

NOTE

It is possible to register up to five Bluetooth Phones with the in-vehicle equipment. However, Bluetooth Phones that can be used with the in-vehicle equipment are restricted only to those selected by the phone selection.

1 Press the **MENU** button.

2 Select  (Phone).



3 Select  (Bluetooth Settings).



4 Select **Register** (Register).



5 Register the Bluetooth equipment from the Bluetooth Phone and then enter the PASS-KEY displayed on the screen for it to be transmitted.

The device name of the Bluetooth Phone is displayed on the DEVICE LIST.

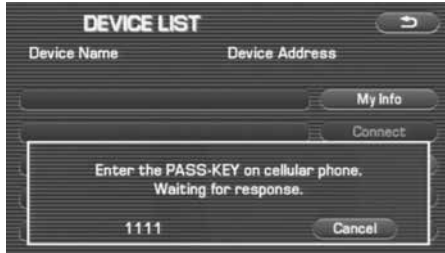

The Bluetooth Phone most recently registered is selected as a Bluetooth Phone to be used with the in-vehicle equipment.



NOTE

- For detailed method for the transmission of the PASS-KEY from the Bluetooth Phone, refer to the instruction manual of the Bluetooth Phone.

- With **Autoconnect** (Autoconnect) set to "ON" on the DEVICE LIST screen in advance, the in-vehicle equipment automatically accept the connection of the Bluetooth Phone. Selecting **Autoconnect** (Autoconnect) makes a changeover between ON and OFF.
- When registering two or more Bluetooth Phones, it is necessary to select a Bluetooth Phone for connection.

Connecting the Bluetooth Phone

To use the Bluetooth Phone in interlock with the in-vehicle equipment, the Bluetooth Phone registered with the in-vehicle equipment is required to be connected to the in-vehicle equipment. When  (Bluetooth connection status) is displayed on the PHONE MENU screen, or when changing a Bluetooth Phone to be connected, conduct this operation.

With "Autoconnect" set to "ON" in advance, a connection is made automatically to the Bluetooth Phone most recently connected. It is recommended that "Autoconnect" is set to "ON" in advance.

1 Press the MENU button.

2 Select  (Phone).



3 Select  (Bluetooth Settings).



4 Select the Bluetooth Phone you want to connect.



5 Select **Connect** (Connect).



NOTE

- With **Autoconnect** (Autoconnect) set to "ON" on the DEVICE LIST screen in advance, the in-vehicle equipment automatically accept the connection of the Bluetooth Phone. Selecting **Autoconnect** (Autoconnect) makes a changeover between ON and OFF.
- When a connection has been made to another Bluetooth Phone, a confirmation message is displayed.

6 Select **Yes** (Yes).



The Bluetooth Phone selected is connected by the Bluetooth.

Speaking over the Hands-Free Phone System

Making a phone call

Entering a phone number to make a phone call

It is possible to select the in-vehicle equipment to enter a phone number and make a phone call.

1 Press the **MENU** button.

2 Select  (Phone).



3 Select  (Bluetooth Phone).



4 Select numeric keys to enter a phone number and then select .



NOTE

- Selecting ***/+** briefly allows you to enter ".*". And then selecting ***/+** for more than two seconds allows you to enter "+."
- Selecting **◀** allows you to delete a digit entered.

5 Select **Yes** (Yes).

You have a phone call. Speak over the phone.



When the phone call is over, hang up the phone. (See Page 258.)

Making a phone call from the outgoing or incoming call history

.....

It is possible to make a phone call to a phone number in the outgoing or incoming call history.

1 Press the **MENU** button.**2** Select **Phone** (Phone).**3** Select **Phone** (Redial List) or **Phone** (Received Calls).

4 Select the phone number and then select .



You have a phone call. Speak over the phone.



NOTE

The following can be conducted from this screen.

- It is possible to register a phone number with the phone book. (See Page 267.)
- It is possible to delete an outgoing or incoming call history. (See Page 260.)

When the phone call is over, hang up the phone. (See Page 258.)

5 Select  (Yes).



Making a phone call from the phone book

It is possible to select a phone number from the phone book registered with the in-vehicle equipment to make a phone call.

NOTE

It is possible to copy the data in the phone book from the phone book of the Bluetooth Phone into that of the in-vehicle equipment. (See Page 261.)

1 Press the **MENU** button.

2 Select  (Phone).







3 Select  (Phone Book).



4 Select the name or phone number of a person to whom you want to make a phone call.



- Selecting alphabets, numerical characters or [Others] displays a phone book data to which the acronym has relevance.
- Selecting  scrolls the display to display a phone book data 5 positions ahead.
- Selecting  scrolls the display to display a phone book data 1 position ahead.
- Selecting  scrolls the display to display a phone book data 1 position behind.

- Selecting  scrolls the display to display a phone book data 5 position behind.

NOTE

The following can be conducted from this screen.

- It is possible to register the phone book data. (See Page 263.)
- It is possible to register the phone book data from the Bluetooth Phone. (See Page 261.)
- It is possible to delete all the phone book data. (See Page 273.)

5 Select the phone number and then select .



NOTE

The following can be conducted from this screen.

- It is possible to edit the phone book data. (See Page 269.)
- It is possible to delete the phone book data. (See Page 271 and 273.)

6 Select (Yes).

You have a phone call. Speak over the phone.

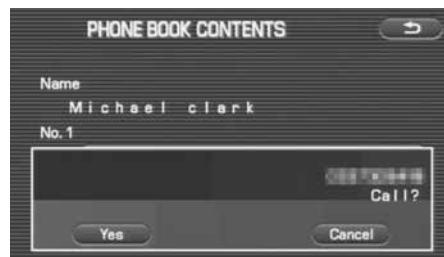

When the phone call is over, hang up the phone.



Making a phone call from the Speed Dial

It is possible to select a phone number from the Speed Dial registered with the in-vehicle equipment to make a phone call. Up to 17 phone numbers can be stored in the memory.

NOTE

To use the Speed Dial, the phone number needs to be registered onto Speed Dial beforehand. (See page 279)

1 Press the **MENU** button.

2 Select  (Phone).



3 Select  (Speed Dial).



4 Select the name or phone number of a person to whom you want to make a phone call.

You have a phone call. Speak over the phone.



When the phone call is over, hang up the phone.



Making a phone call to the phone number of the Memory Point

It is possible to make a phone call to the phone number registered as a memory point.

- 1 Press the **MENU** button.
- 2 Select  (Phone).



- 3 Select  (Memory Points).

When the Memory Points is not stored in the in-vehicle equipment,  (Memory Points) cannot be selected.



4 Select the Memory Point.



- Selecting scrolls the display to display a memory point 5 position ahead.
- Selecting scrolls the display to display a memory point 1 position ahead.
- Selecting scrolls the display to display a memory point 1 position behind.
- Selecting scrolls the display to display a memory point 5 position behind.
- Selecting (Attribute) sorts the memory points in the order of shorter distances.
- Selecting (Icon) sorts the memory points in icon order.
- Selecting (Name) sorts the memory points in name order.
- Selecting (Date) sorts the memory points in registered data order.

5 Select .

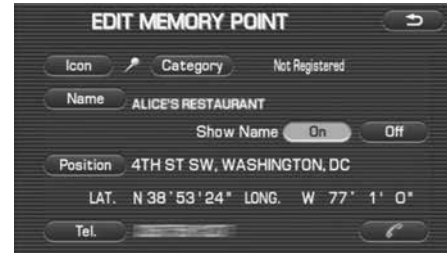

6 Select (Yes).

You have a phone call. Speak over the phone.
When the phone call is over, hang up the phone. (See Page 258.)



Making a phone call from the Bluetooth Phone

It is possible to directly operate the Bluetooth Phone connected to the in-vehicle equipment to make a phone call.

Even while speaking over the Bluetooth Phone, operating either of the following, when connected to the in-vehicle equipment, displays the handsfree screen in the in-vehicle equipment.

- Press the phone switch.
- Select  (Phone) on the menu screen.

In this case, it is not possible to conduct any operations in relation to the handsfree from the in-vehicle equipment.

 **WARNING**

For safety's sake, the driver should refrain from the operation of a cell phone while driving.

Making a call by the voice recognition system

The voice recognition system allows you to make a call with your voice. Perform the following two calling methods by voice recognition.

- Making a call using name recognition:
When the user speaks a name, the system searches for the phone number attached with a voice tag (user's voice) that was registered for the name in the phone book.
- Making a call using phone number recognition:
When the user speaks a phone number, the system dials the number.

Making a call using name recognition:

NOTE

- When pressing the  button located on the steering wheel while the phone book screen is displayed, voice recognition (name recognition) for the hands-free phone system will start. The screen does not change.
- The terms that can be used for voice recognition (name recognition) for the hands-free phone system are "Name", "Cancel", "Next candidate" and "Dial".

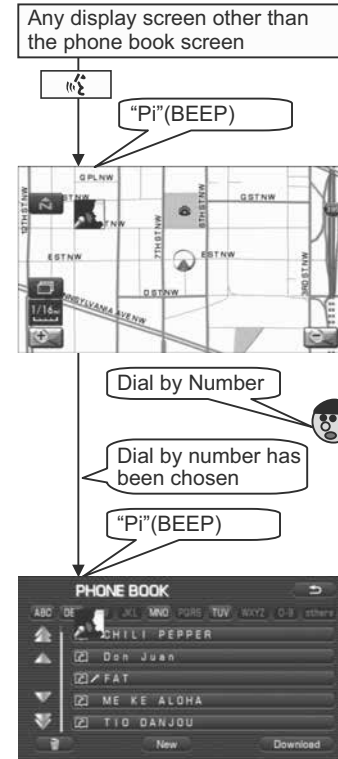

Making a call using phone number recognition:

NOTE

- When pressing the  button located on the steering wheel while the dial screen is displayed, voice recognition (phone number recognition) for the hands-free phone system will start. The screen does not change.
- The terms that can be used for voice recognition (name recognition) for the hands-free phone system are "Name", "Cancel", "Next candidate" and "Dial".

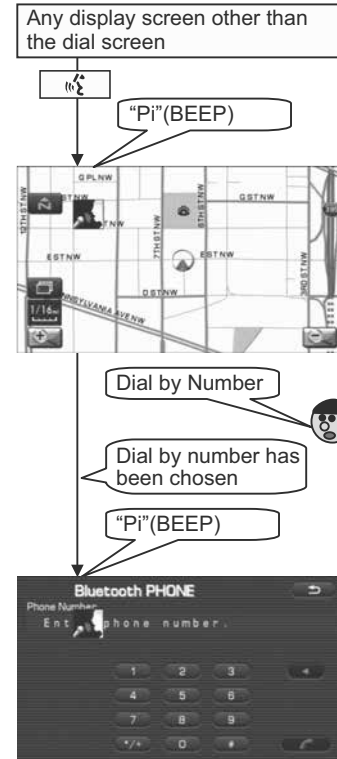

Taking a phone call and declining a incoming call

When you have a phone call, the information of a caller is displayed together with an incoming call sign. When the name of a caller is registered with the phone book, the name of the caller is displayed. On an occasion other than the above, a phone number is displayed. For a caller with no outgoing call notice, no information is displayed.



Taking a phone call

It is possible to take an incoming phone call and talk over the phone.



- 1 Select **Call** (Call) or press the  button of the steering switch.

You can take a phone call. Speak over the phone.

When the phone call is over, hang up the phone. (See Page 258.)

Putting an incoming phone call on hold

It is possible to put an incoming phone call on hold to take it later.

- 1 Select **Hold** (Hold) or briefly press the  button of the steering switch.
- 2 When taking it later, select  or briefly press the  button.



When the phone call is over, hang up the phone. (See Page 258.)



Hanging up an incoming call before answering it (Denial of an incoming call)

.....

It is possible to hang up an incoming call before answering it. And it is also possible, while putting a phone call on hold, to conduct the following operations to hang up the phone call.

- 1 Select  (Disconnect) or keep pressing the  button of the steering switch for more than 2 seconds.

The phone call is hanged up.

Speaking over the phone

Adjusting the tonal volume

It is possible to adjust the tonal volume.

- 1 While speaking over the phone, select either of the figures **1** to **5** shown on the lower section of the screen or press the volume adjusting switch of the steering switch.



NOTE

- The larger the figure you select, the larger the tonal volume.
- Pressing the **VOL+** button of the volume switch of the steering switch increases the tonal volume, while pressing the **VOL-** button decreases the tonal volume.

Muting the voice on this side

It is possible to make your voice unheard to the other party (Mute). However, you can hear the voice of the other party.

- 1 Select **Mute** (Mute) while speaking over the phone.



Select **Mute** (Mute) again to cancel the mute.

Transmitting the phone call

It is possible to transmit the phone call of the in-vehicle equipment to the Bluetooth Phone. And also, the phone call of the Bluetooth Phone can be transmitted to the in-vehicle equipment.

- 1 Select **Speaker** (Speaker) while speaking over the phone or putting the answer on hold.





You can speak over the Bluetooth Phone.

NOTE

- While speaking over the Bluetooth Phone, the only operation that can be made is to transmit the phone call again to the in-vehicle equipment.
- If you want to speak over the in-vehicle equipment, select **Speaker** (Speaker).

Hanging up the phone

Hang up the phone while speaking over the phone or after the phone call is over.

- 1 Select  or pressing the  button of the steering switch for more than 2 seconds.



NOTE

It is also possible to hang up the phone on the Bluetooth Phone.

Using the outgoing or incoming call history



Checking the outgoing or incoming call history

It is possible to check the outgoing or incoming call history.

1 Press the **MENU** button.

2 Select  (Phone).



3 Select  (Redial List) or  (Received Calls).



4 Check the outgoing or incoming call history.



- The maximum number of calls in the history items that can be checked is five for each of the outgoing calls and the incoming calls.
- The history of phone calls directly sent out from the Bluetooth Phone and the history of phone calls received when not connected to the in-vehicle equipment are not displayed.

NOTE

The following can be conducted from this screen.

- It is possible to make a phone call to the number displayed. (See Page 245.)
- It is possible to register a phone number with the phone book. (See Page 267.)
- It is possible to delete an outgoing or incoming call history displayed. (See Page 260.)



Deleting all the outgoing and incoming call history

Delete all the outgoing and incoming call history. History once deleted cannot be restored to its original state.

1 Press the **MENU** button.

2 Select  (Phone).



3 Select  (Redial List) or  (Received Calls).



4 Select .



NOTE

The following can be conducted from this screen.

- It is possible to make a phone call to the phone number displayed. (See Page 245.)
- It is possible to register a phone number with the phone book. (See Page 267.)

5 Select  (Yes).



All of the outgoing or incoming call history are deleted.

NOTE

It is necessary to delete the outgoing call history and the incoming call history separately.

Using the phone book

Registering the phone book data

Up to 1000 phone book data can be registered with the phone book of the in-vehicle equipment. Contents that can be registered as phone book data are as shown below.

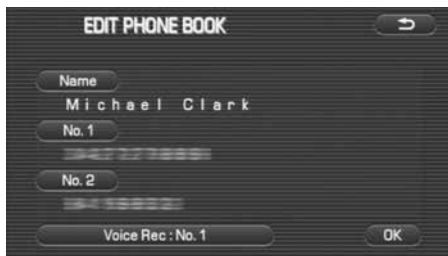

- **Name:** It is possible to register up to 24 characters. They can be clipped.
- **Phone number 1, phone number 2:** Up to 25 digits can be registered. Any letter other than "0 to 9, *, #" cannot be used.
- **Voice Rec. No. 1** (voice record: No.1) : A voice tag can be registered.

Transmitting the phone book of the Bluetooth Phone

It is possible to transmit the phone book data from the phone book of the Bluetooth Phone to that of the in-vehicle equipment. Phone book data that can be transmitted are as shown below.

- **Name**
When the name of the phone book data of the Bluetooth Phone is in excess of 24 character, up to 24 characters from the start are registered with the phone book of the in-vehicle equipment.
When a non-corresponding character is registered in the name of the phone book data of the Bluetooth Phone, this is registered with the phone book of the in-vehicle equipment as a blank.
- **Phone number 1**
- **Phone number 2**
When more than 3 phone numbers are registered with the phone book data of the Bluetooth Phone, with two or more phone book data of the same name created, they are divided to be registered with the phone book of the in-vehicle equipment.
When any letters other than "0 to 9, *, #" are included in the phone book data of the Bluetooth Phone, those relevant letters are deleted to be registered with the phone book of the in-vehicle equipment.
When the phone book data of the Bluetooth Phone is a phone number in excess of 25 digits, it is not registered with the phone book of the in-vehicle equipment.

1 Press the **MENU** button.

2 Select  (Phone).



3 Select  (Phone Book).



4 Select **Download** (Download).



5 Select **Add** (Add).

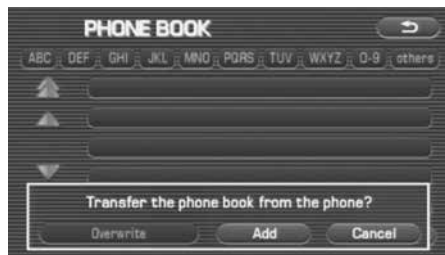

NOTE

When there is a phone book data already in the phone book, select

Overwrite (Overwrite) or **Add** (Add). Selecting

Overwrite (Overwrite) overwrites the existing phone book. And selecting **Add** (Add) adds a phone book data to the existing phone book data as a new data.

6 Transmit the phone number data from the Bluetooth Phone.



The phone book data is displayed in the phone book



NOTE

For detail method for transmitting the phone book data from the Bluetooth Phone, refer to the instruction manual of the Bluetooth Phone.

Registering a new data with the phone book

Register a new phone book data with the phone book. It is possible to register a name and up to 2 phone numbers as phone book data.

- 1 Press the **MENU** button to edit the phone book data registered.
- 2 Select  (Phone).



- 3 Select  (Phone Book).



4 Select **New** (New).



5 Select **Name** (Name).



NOTE

The Name doesn't need to be entered. When not entered, the phone number is displayed on the phone book. And when not entered, proceed to step 7.

6 Enter the name of the phone book data and select **OK** (OK).

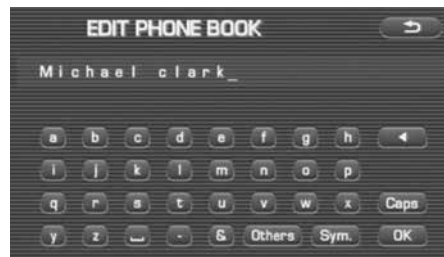

- Selecting **←** deletes 1 character.
- Selecting **Others** (Others) displays other characters. Then selecting **←** or **→** displays the preceding or succeeding screen.
- Selecting **Sym.** (Sym.) displays figures and symbols. Then selecting **←** or **→** displays the preceding or succeeding screen.
- Selecting **a - z** displays alphabets and symbols.
- Selecting **Caps** (Caps) allows you to make a changeover between upper case and lower case.

7 Select **No. 1** (No.1) or **No. 2** (No.2).

8 Enter the phone number and select **OK** (OK).



- Selecting ***/+** briefly allows you to enter "*" and selecting ***/+** for more than 2 seconds allows you to enter "+."
- Selecting **◀** deletes 1 character.

9 Select **OK** (OK).

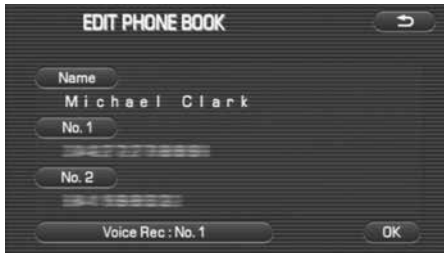

A phone book data is added.

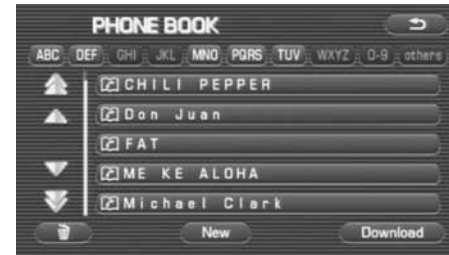

Voice tag registration

.....

The user's voice can be registered as a voice tag that is added to a phone number in the phone book. Voice tags will be stored in the system when you speak a party's name after voice guidance is announced and the voice tag screen is displayed. A maximum of 20 voice tags can be registered in the system, and it takes a maximum of 5 seconds per registration.

1 Refer to the procedure of phone book data editing to go to the editing screen.

2 Select **Voice Rec : No. 1** (Voice record).

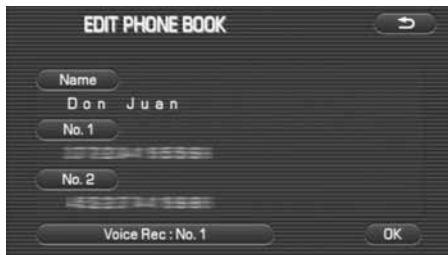

NOTE

- Select the phone number to be added with a voice tag.

3 Select **Rec** (record), and then speak the preferred voice tag to record it in the system.



NOTE

- When the recording is completed, a message is displayed on the screen and voice guidance starts. When the recording has been completed, the system will announce via voice guidance whether the recording was completed correctly or incorrectly. Press **OK** (ok) to finish the registration procedure.
- Select a voice tag and press **Play** (play) to play back the registered voice tag.
- A confirmation message is displayed when selecting a voice tag and pressing **Delete** (delete). Press the **Yes** (yes) to delete the voice tag.



Registering data with the phone book from the outgoing or incoming call history

It is possible to register a phone number of the outgoing or incoming call history with the phone book.

1 Press the **MENU** button.

2 Select  (Phone).



3 Select  (Redial List) or  (Received Calls).



4 Select the phone number and then select .



NOTE

The following can be conducted from this screen.

- It is possible to make a phone call to a phone number displayed. (See Page 245.)
- It is possible to delete an incoming or outgoing call history displayed. (See Page 260.)

5 Select **Name** (Name).



- 6 Enter the name of a phone book data and select **OK** (OK).

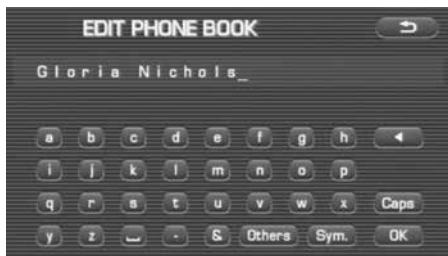

- Selecting **←** deletes 1 character.
- Selecting **Others** (Others) displays other characters. Then selecting **←** or **→** displays the preceding or succeeding screen.
- Selecting **Sym.** (Sym.) displays figures and symbols. Then selecting **←** or **→** displays the preceding or succeeding screen.
- Selecting **a - z** displays alphabets.
- Selecting **Caps** (Caps) allows you to make a changeover between upper case and lower case.

- 7 Select **OK** (OK).



The phone number is registered with the phone book data.



Editing or deleting a phone book data

Editing a phone book data

It is possible to edit the name of a phone book data and a phone number.

1 Press the **MENU** button.

2 Select **Phone** (Phone).





3 Select **Phone Book** (Phone Book).

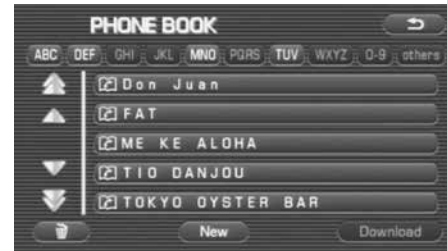

4 Select the phone book data you want to edit.



- Selecting alphabets, figures or **Others** (Others) given in the upper section displays a phone book data to which the acronym has relevance.
- Selecting **▲** scrolls the display to display a phone book data 5 positions ahead.
- Selecting **▲** scrolls the display to display a phone book data 1 position ahead.

- Selecting  scrolls the display to display a phone book data 1 position behind.
- Selecting  scrolls the display to display a phone book data 5 positions behind.

NOTE

The following can be conducted from this screen.

- It is possible to register a phone book data. (See Page 263.)
- It is possible to register a phone book data from the Bluetooth Phone. (See Page 261.)
- It is possible to delete all the phone book data. (See Page 273.)

5 Select  (Edit).



NOTE

The following can also be conducted from this screen.

- It is possible to delete a phone book data. (See Page 271 and 273.)
- It is possible to make a phone call to the phone number selected. (See Page 247.)

6 Select an item you want to edit.



7 Enter a new data and select  (OK).



NOTE

For details of the editing method, refer to "Registering a new data with the phone book." (See Page 263.)

8 Select **OK** (OK).



The result of the edit is reflected in the phone book data.

Selecting a phone book data to delete it

Select a phone book data registered and delete it.

NOTE

A phone book data once deleted cannot be restored to its original state.

1 Press the **MENU** button.

2 Select  (Phone).



3 Select  (Phone Book).



4 Select a phone book data you want to edit.



- Selecting alphabets, figures or **Others** (Others) given in the upper section displays a phone book data to which the acronym has relevance.
- Selecting scrolls the display to display a phone book data 5 positions ahead.
- Selecting scrolls the display to display a phone book data 1 position ahead.
- Selecting scrolls the display to display a phone book data 1 position behind.
- Selecting scrolls the display to display a phone book data 5 positions behind.

NOTE

The following can be conducted from this screen.

- It is possible to register a phone book data. (See Page 263.)
- It is possible to register a phone book data from the Bluetooth Phone. (See Page 261.)
- It is possible to delete all the phone book data. (See Page 273.)

5 Select (Delete).



NOTE

The following can be conducted from this screen.

- It is possible to edit a phone book data. (See Page 269.)
- It is possible to make a phone call to the phone number selected. (See Page 247.)

6 Select (Yes).



The phone book data selected is deleted.

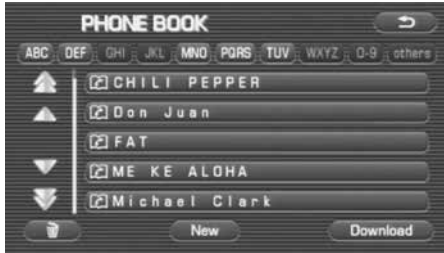

Deleting all the phone book data

It is possible to delete all the phone book data.

NOTE

Phone book data once deleted cannot be restored to their original state.

- 1 Press the **MENU** button.
- 2 Select  (Phone).



- 3 Select  (Phone Book).



4 Select .



5 Select  (Yes).

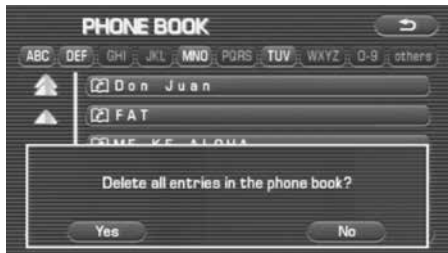

All the phone book data are deleted.

Other Bluetooth settings

Deleting the registered Bluetooth Phone from the in-vehicle equipment

Delete the Bluetooth Phone registered with the in-vehicle equipment.

NOTE

When deleting the Bluetooth Phone with the Bluetooth Phone connected to the in-vehicle equipment, no automatic connection is made.

1 Press the **MENU** button.

2 Select  (Phone).



3 Select  (Bluetooth Settings).



4 Select a Bluetooth Phone name you want to delete.



5 Select  (Delete).



6 Select  (Yes).



The Bluetooth Phone registered is deleted.

NOTE

- When you want to use again the deleted Bluetooth Phone in interlock with the in-vehicle equipment, register and connect it again.
- Even when the Bluetooth Phone is deleted from the in-vehicle equipment, the phone book data transmitted from the Bluetooth Phone and the outgoing and incoming call history remain as they are.

Changing the Device Name of the in-vehicle equipment displayed in the Bluetooth Phone

It is possible to change the Device Name of the in-vehicle equipment displayed in the Bluetooth setting of the Bluetooth Phone.

1 Press the **MENU** button.

2 Select  (Phone).



3 Select  (Bluetooth Settings).



4 Select **My Info** (My Info).



5 Select **Device Name** (Device Name).



6 Enter a new Device Name and select **OK** (OK).

- Selecting **←** deletes 1 character.
- The number of characters that can be entered is up to 20 characters.
- Selecting **Others** (Others) displays other characters. Then selecting **←** or **→** displays the preceding or succeeding screen.
- Selecting **Sym.** (Sym.) displays figures and symbols. Then selecting **←** or **→** displays the preceding or succeeding screen.
- Selecting **a - z** displays alphabets.
- Selecting **Caps** (Caps) allows you to make a changeover between upper case and lower case.

Editing the Speed Dial setting

Adding the phone number to the Speed Dial memory

It is possible to add the phone number from the Phone Book to Speed Dial memory. Up to 17 phone numbers can be stored in the memory.

NOTE

To add the phone number to the Speed Dial memory, the phone number needs to be registered onto Phone Book beforehand. (See page 261)

1 Press the **MENU** button.

2 Select  (Phone).



3 Select **Speed Dial Settings** (Speed Dial Settings).



4 Select **Add** (Add).

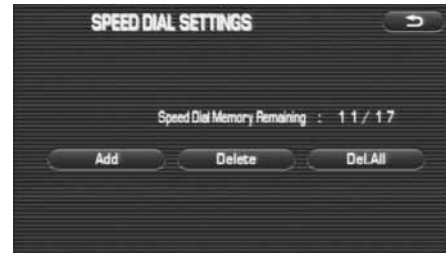

- 5 Select a name on a Phone Book whom you want to add to the Speed Dial memory.

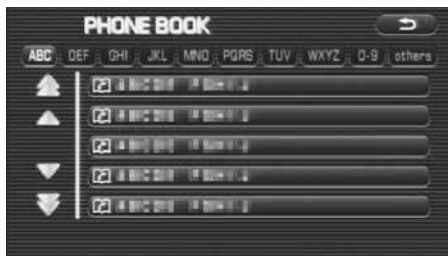

- 6 Select a phone number which you want to add to the Speed Dial memory.



- 7 Select a registering position where you want to add to the Speed Dial memory.



- 8 If you are going to overwrite the Speed Dial memory, select **Yes** (Yes) to finish the adding.

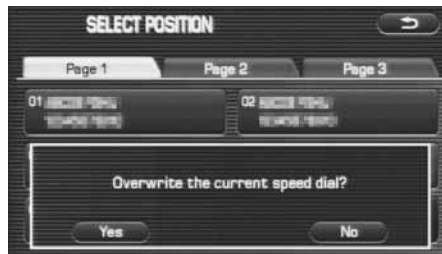

Deleting the phone number from the Speed Dial memory

It is possible to delete the phone number from the Speed Dial memory.

1 Press the **MENU** button.

2 Select  (Phone).



3 Select **Speed Dial Settings** (Speed Dial Settings).



4 Select **Delete** (Delete).



5 Select a Speed Dial memory which you want to delete.



6 Select **Yes** (Yes).



8 Select **Yes** (Yes).



7 If you need to delete all memories from Speed Dial, select **Del.All** (Delete all) on step 4.

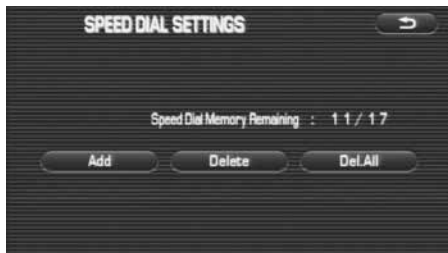

Changing the Pass-Key used when certifying the Bluetooth Phone

When connecting the Bluetooth Phone to the in-vehicle equipment, the Pass-key is used for certification. It is possible to change the Pass-Key used for certification.

1 Press the **MENU** button.

2 Select  (Phone).



3 Select  (Bluetooth Settings).



4 Select **MyInfo** (My Info).



5 Select **Pass-key** (Pass-key).



6 Enter a new Pass-key and then select **OK** (OK).



NOTE

- Selecting **←** (Backspace) deletes 1 character.
- What can be entered as a Pass-key are limited only to numeric characters "0 to 9" in 4 to 8 digits.



Other Functions

The calculator functions

A calculator with an 8-digit display is available. The calculator also performs unit conversions between miles and kilometers, pounds and kilograms, etc.

1 Press the **INFO** button.

2 Select  (calculator).



To perform a unit conversion, enter a number, then select the key for the unit you wish to convert from, then the key for the unit you wish to convert to.

Example: Convert 100 miles into kilometers: 100 → [mile] → [km] = 160.9 km

Below is a description of each key and what it does.

Key	Description	Action
0-9	Numbers	The numbers 0 to 9
.	Decimal point	Begin entering numbers below the decimal point
=	Equals sign	Display the results of the calculation
+	Addition operator	Perform addition
-	Subtraction operator	Perform subtraction
/	Division operator	Perform division
*	Multiplication operator	Perform multiplication
MR	Memory recall	Retrieve a number from memory, and overwriting the current display
M+	Memory add	Add the currently displayed number to the memory
C	Clear	Clear the currently displayed number. If you have entered a number after pressing an operator, pressing this button returns the calculator to the state of having pressed the operator.
AC	All clear	Return to the initial state (clear the current display, operator state, memory number, etc.)
°F	Fahrenheit	Convert the entered number from Celsius to Fahrenheit*

Key	Description	Action
°C	Celsius	Convert the entered number from Fahrenheit to Celsius*
gal	Gallons	Convert the entered number from liters to gallons*
L	Liters	Convert the entered number from gallons to liters*
lb	Pounds	Convert the entered number from kilograms to pounds*
kg	Kilograms	Convert the entered number from pounds to kilograms*
mi	Miles	Convert the entered number from kilometers to miles*
km	Kilometers	Convert the entered number from miles to kilometers*
ft	Feet	Convert the entered number from meters to feet*
m	Meters	Convert the entered number from feet to meters*
in	Inches	Convert the entered number from centimeters to inches*
cm	Centimeters	Convert the entered number from inches to centimeters*
acre	Acres	Convert the entered number from square meters to acres*
m ²	Square meters	Convert the entered number from acres to square meters*

Key	Description	Action
psi	Pounds per square inch	Convert the entered number from kilopascals to pounds per square inch*
kPa	Kilopascals	Convert the entered number from pounds per square inch to kilopascals*

* Results of unit conversions may include rounding errors.

The calendar functions

A calendar feature is available.

■ Displaying calendar

1 Press the **INFO** button.

2 Select  (calendar).



3 The calendar will appear.

A mark will appear on today's date.



NOTE

Use the arrow buttons (  ) to display the previous and following months.

CAUTION

Use of controls or adjustments or performance of procedures other than those specified herein may result in hazardous radiation exposure. In compliance with Federal Regulations, following are reproductions of labels on, or inside the product relating to laser product safety.



FCC WARNING

This equipment may generate or use radio frequency energy. Changes or modifications to this equipment may cause harmful interference unless the modifications are expressly approved in the instruction manual. The user could lose the authority to operate this equipment if an unauthorized change or modification is made.

NOTE

This equipment has been tested and found to comply with the limits for a Class B digital device, pursuant to Part 15 of the FCC Rules. These limits are designed to provide reasonable protection against harmful interference in a residential installation. This equipment may cause harmful interference to radio communications, if it is not installed and used in accordance with the instructions. However, there is no guarantee that interference will not occur in a particular installation. If this equipment does cause harmful interference to radio or television reception, which can be determined by turning the equipment off and on, the user is encouraged to try to correct the interference by one or more of the following measures:

- Reorient or relocate the receiving antenna.
- Increase the separation between the equipment and receiver.
- Connect the equipment into an outlet on a circuit different from that to which the receiver is connected.
- Consult the dealer or an experienced radio/TV technician for help.

IC (Industry Canada) Notice

Operation is subject to the following two conditions: (1) This device may not cause interference, and (2) this device must accept any interference, including interference that may cause undesired operation of the device. The term "IC:" before the certification/registration number only signifies that the Industry Canada technical specification were met.

Note de IC (Industrie Canada)

"L'utilisation de ce dispositif est autorisée seulement aux conditions suivantes : (1) il ne doit pas produire de brouillage et (2) l'utilisateur du dispositif doit être prêt à accepter tout brouillage radioélectrique reçu, même si ce brouillage est susceptible de compromettre le fonctionnement du dispositif." L'expression "IC:" avant le numéro d'homologation/enregistrement signifie seulement que les spécifications techniques d'Industrie Canada ont été respectées.