



AUDIO VIDEO & NAVIGATION SYSTEM OWNER'S MANUAL



The symbols described below are found in this instruction manual as well as on the device itself to ensure its proper and safe usage and to prevent injury or damage to properties. Make sure you understand the meanings of these symbols before reading the rest of this manual.

Handling Notes

The illustrations of screens shown in this manual may differ from the actual screens of this product.

Basic safety rules that you must follow and useful operational information are provided with the following symbols.

WARNING

This symbol indicates a situation in which incorrect handling through disregard of a symbol may result in death or serious personal injury.

CAUTION

This symbol indicates a situation in which incorrect handling through disregard of a symbol may result in personal injury or may result solely in damage to property.

IMPORTANT

Follow this advice to prevent malfunctions or damage to the device.
Perform the indicated action in the event of a malfunction.

ATTENTION

Useful information for smooth operation

CHECK

Facts to keep in mind when operating

- Please read all materials such as manuals and warranties that have come with the product.
Subaru will not be responsible for unsatisfactory product performance due to a failure to follow these instructions.
- Changes to product specifications may result in differences between the content of the manual and features of the product.

Please exercise care when handling the manual.

Forcefully spreading or pulling on pages may result in some pages falling out of the binding.
Use the manual carefully.

1-Before Use

Safety precautions	5
Before use	7
Discs	9
PND	12
Accessories	12

2-Operation

About This Receiver	13
Control Names and Operations	13
Turning the POWER ON or OFF	14
Switching Between the Audio and Navigation Screen	14
Turning the PND Display ON and OFF	15
Attachment and Detachment the PND	15
Using the Audio Cover	16
Hands-Free Microphone and Light Sensor	16
Adjusting the Display Angle	17
Loading/Unloading a Disc	17
Sub-display	19

Operation Conditions of this Receiver	19
---	----

Setup of This Receiver

Setup of This Receiver	20
Screen Adjustment and Setting	21
Adjusting the Screen	22

Switching the Audio Source

Switching the audio source	24
----------------------------------	----

Volume Control

Adjusting the audio volume	25
Muting the Volume	25

Adjusting the sound quality

Switching Audio Control Modes	26
-------------------------------------	----

3-Radio Operations

Using the Radio

Listening to the Radio	28
Tune a Desired Station	28
Selecting a Radio Band	29

Saving a Station in Memory.....	29
Preset Scan	30
Displaying the information	30
Turning the Radio OFF	30

4-CD Player Operations

Using the CD Player.....	31
Listening To a CD	31
Selecting a Desired Track	31
Fast Forward/Rewind	32
Finding a Desired Title.....	32
Repeating the Same Track.....	32
Random Play	32
Track Data Display	33
Switching Between CD-DA and MP3/WMA.....	33
Stopping the CD Play	33

5-MP3/WMA Player Operations

Using the MP3/WMA Player	34
Playing an MP3/WMA File.....	34

Selecting a Desired Folder.....	34
Selecting a Desired Music File.....	35
Fast Forward/Rewind.....	35
Returning To the Root Directory	35
Finding a Desired Music File.....	36
Repeating a Music File	36
Random Play	37
Displaying of Music File Information	38
Switching Between CD-DA and MP3/WMA	38
Stopping the MP3/WMA File.....	38
MP3/WMA.....	38
Creating and Playing MP3/WMA Files.....	41

6-USB Music File Player Operations

Using the USB Music File Player.....	43
Playing USB Music Files.....	43
Fast Forward/Rewind.....	43
Selecting a Desired Music File.....	44
Finding a Desired Music File.....	44
Repeatedly Playing the Same Music File	45
Random Play of Music Files	45
About the TEXT button	45

Stopping the USB Music File Player.....	45
Playable USB Memory Standards	45
Playable MP3 File Standards	45
ID3 Tags	46
Format of USB Memory.....	46

7-DVD Player Operations

Before Using the DVD Player..... 47

Advantages of Digital Versatile Disc (DVD).....	47
Discs.....	48
Products equipped with Macrovision	49
Operation Flow	50

Using the DVD Player 51

Watching a DVD Video.....	51
Video Operations.....	51
Disc Menu Operations	52
About the TEXT button	52
Stopping a DVD.....	52
Finding a Desired Video	53
Changing the Touch Switch Display.....	54
Changing the Screen Display and Audio Mode	54

DVD Player Setting.....	55
Language Code List.....	60

8-iPod Player Operations

Using the iPod Player.....61

Listening to the iPod	61
Fast Forward/Rewind.....	62
Selecting the Desired Music or Video File	62
Finding a Desired Music File.....	62
Setting to the iPod Video Mode	63
Playing	64
Pausing	64
Repeatedly Playing the Same Music File	64
Random Play of Music Files	64
Switching Aspect Ratio of Screen.....	64
About the TEXT button	64
Compatible iPod models	65
Stopping the iPod.....	65

9- AUX Operations

Using the AUX	66
Switching the AUX Mode ON and OFF	66
Listening to the Portable Audio Player	67
TEXT Button	67
Turning off the Portable Audio Player.....	67

10-Steering Wheel Switch Operations

About the Steering Wheel Switches.....	68
Compatibility with Steering Wheel Switches.....	68

11-Rearview Camera Operations

Rearview Camera Operations	70
Playing a Video through the Rearview Camera.....	71

12-Reference

Troubleshooting Guide	72
If the Following Messages Appear.....	72
Basic Trouble Shooting.....	75
How to Contact Subaru	78
Contact information.....	78
Defective products/Warranty.....	78

Safety precautions

WARNING

- Note that the data for roads, location names, facility information, and charges, etc. may not be the most recent and that there may be inadequacies.
- Do not modify this system for any uses other than that specified herein. Subaru will not be held liable for damages including, but not limited to serious injury, death or property damage resulting from modifications that enable unintended operation.
- For safety, make selections only when vehicle is stopped. Use judgment and obey traffic rules. Some map data may be incorrect. See user manual for complete instructions.
- When the vehicle is in motion, never take your eyes off the road to make adjustments to the main unit. You must pay attention to the road at all times to avoid accidents; do not let operation or adjustment of the main unit distract you from operating the vehicle responsibly.
- The driver should not look at the screen while driving. Doing so may result in an accident.
- Do not place foreign objects in the disc insertion slot or USB input terminal. Fire or shocks may result.

WARNING

- Do not disassemble or alter this main unit. An accident, fires or shock may result.
- Do not let water or foreign objects enter the internal parts of this main unit. Doing so may result in smoke, fire or shock.
- Do not use when main unit is malfunctioning (the screen is not lit or no sound comes out). Doing so may result in an accident, fire or shock.
- If foreign objects or water enters the main unit, smoke or a strange odor may be emitted. If this occurs, stop using the main unit immediately and contact your dealer. Accidents, fire, or shocks may result if you continue to use the main unit under these conditions.
- The driver should not change the CD or USB memory while driving. Doing so may result in an accident. You must first stop or park your car in a safe location and then proceed to remove or insert the CD and/or USB.
- Be sure to park the vehicle in a safe location and set the parking brake before watching DVDs or videos. For safety reasons, only the sound of DVDs or videos will be emitted while the vehicle is in motion.

CAUTION

- Keep volume to a reasonable level so that you can hear sounds from outside the vehicle, including warning sounds, voices, and sirens. Failure to do so may cause an accident.
- Be careful that your hands and fingers do not get pinched when adjusting the tilting angle or closing the display. Otherwise injuries may result.
- Do not put your hands or fingers into the disc insertion slot or USB input terminal. Injuries may result.
- Do not touch heat dissipating parts of the main unit as you may be burnt.
- The volume should be set at a moderate level to avoid hearing damage when the main unit is powered on.
- Do not operate when sound such as distortion is being emitted.

⚠ CAUTION

- This main unit uses invisible laser light. Do not disassemble or alter this main unit. If any problems occur, contact the dealer where you purchased the main unit. Altering this main unit may cause exposure to laser emissions (which may damage your eyesight), or result in an accident, fire or shocks.
- Using the vehicle speed pulse signal, you can use the route guidance function even in locations where normally no guidance is given (e.g.: in a tunnel). However, the accuracy of the guidance is not guaranteed since the guidance is performed using the information about road surface conditions and vehicle speed.

⚠ IMPORTANT

- When there is a lot of vibration – when driving on a bad road for example – the main unit may become inoperable due to it not being able to read data from the disc.
- If using this receiver immediately after having purchased it or after having stored it disconnected from the vehicle battery, the present location may not be displayed accurately. Wait a short while and the GPS positioning will correct the displayed position.
- This device is a precision-engineered equipment and the information that you record on it after purchase can be lost as a result of static electricity, electrical noise, vibration and other influences. It is recommended that you keep a separate record of the information you store in the main unit.

⚠ IMPORTANT

- Note that the following events are not covered by the warranty.
 - 1 Corruption or loss of the data stored in the main unit by the purchaser resulting from failure or incorrect operation of the main unit, or any problems associated with it, or due to the effects of electrical noise or other influences.
 - 2 Corruption or loss of the data stored in the main unit by the purchaser resulting from misuse of the main unit by the purchaser or a third party.
 - 3 Corruption or loss of data stored in the main unit by the purchaser resulting from failure / repair of the main unit.
- Please note that by installing or using the main unit, you are regarded as having consented to the points above.

Before use

⚠ CAUTION

- Be very careful and pay full attention to safety when operating the audio controls while driving, otherwise accidents may occur. Also, be sure to set the volume so that you can still adequately hear sounds outside the vehicle. Improper use may result in a traffic accident.

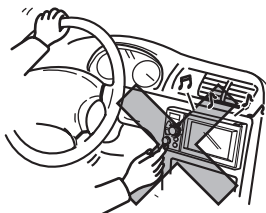

⚠ CAUTION

- Never continue to use the system if it is malfunctioning in any way. If smoke, abnormal noises or abnormal odors are noticed, turn off the power immediately. Immediately turn off the audio in such situations. Exercise caution regarding the temperature inside the vehicle.

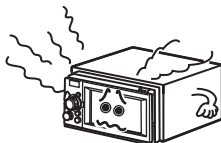

- Do not use volatile chemicals such as benzene or thinners when cleaning the main unit. The main unit may be damaged and the paintwork may be affected. Please use a soft cloth (silicon cross, etc.) to clean the main unit. Please follow the directions when you use a chemical dust cloth.

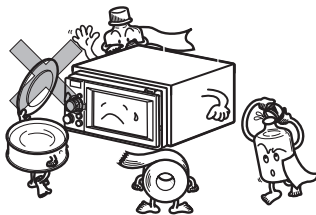

⚠ CAUTION

- Do not disassemble or modify this receiver. The main unit has a precisely designed structure, so consult your dealer in the event any unsatisfactory performance is observed.

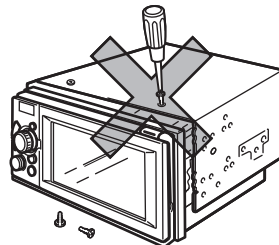

- Do not apply excessive force to the monitor. Otherwise damage may result.

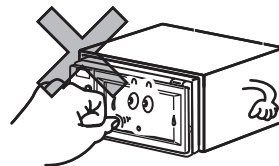

⚠ CAUTION

- Do not leave the monitor in tilt position when you are not using it. Otherwise, it may be damaged.

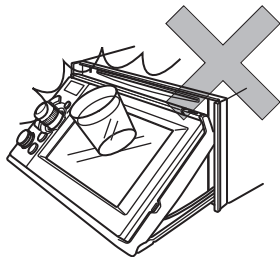

- Do not insert any objects other than discs into the disc slot. Otherwise damage may result.

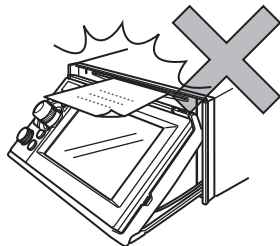

⚠ CAUTION

- Be careful not to get your fingers or other objects caught behind the monitor when it is being retracted into place. Interference can cause an injury or damage the main unit.

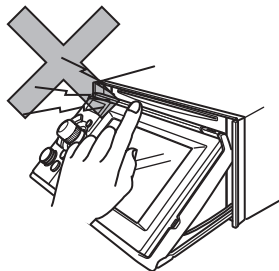

⚠ CAUTION

- When removing a disc from the main unit, remove it in the horizontally level direction. Do not pull them up or press down on them forcibly while removing them. Improper removal may result in the disc becoming scratched, cause the receiver to emit unusual noises, or result in other damage.

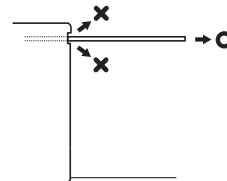

Discs

ATTENTION

- In cold or rainy weather, just as the interior glass surface becomes fogged, dew (water condensation) may also settle on the main unit. (Condensing) When this occurs, disc playback may become intermittent or impossible. Dehumidify the air in the vehicle for a while before resuming playback.
- If a problem occurs, the player function stops automatically to protect its internal parts. If the player does not operate even when you follow the on-screen messages, the player may have failed. Consult the dealer you purchased it from.
- Playback may be intermittent when the player is subjected to severe vibrations while traveling over a rough surface.
- Please do not use a commercially available lens cleaner because it may cause damage to the pickup of the player.

Format of discs

- An audio disc or DVD video disc bearing one of the marks below can be played.

When using a DVD±R/RW (DVD±Recordable/ReWritable) disc, note that only the disc whose contents were recorded in the video mode can be played. Discs whose contents were recorded in the video recording (VR) mode and audio mode cannot be played.



- The DolbyDigital format is supported and discs with the logo shown below can be played.



This product is manufactured under license from Dolby Laboratories. Dolby and the double-D symbol are registered trademarks of Dolby Laboratories.

- It is possible that a CD-R (CD-Recordable) or CD-RW (CD-ReWritable) disc will not play on the main unit due to the characteristics of the recording or special disc, scratches, dirt or deterioration caused by long-term storage in the vehicle. Also, a CD-R or CD-RW disc that has not yet been finalized and a CD-R or CD-RW disc recorded in UDF format cannot be played.
- It is possible that a DVD±R/RW (DVD±Recordable/ReWritable) disc will not play on this receiver due to the characteristics of the recording or special disc, scratches, dirt or deterioration caused by long storage in the vehicle. Also, a DVD±R/RW disc that has not yet been finalized cannot be played. It may not be possible to play a disc that has been recorded on a personal computer, depending on the application setting and the environment.
- The CD-TEXT function can be used only for CD-text CDs available on the market. Characters written on a CD-R and CD-RW discs may not be displayed correctly.
- Do not use a CD or C-thruDisc with a transparent or semi-transparent recording area as they may fail to load or unload or play their contents.

- A Copy Control CD (CCCD) may not be played as it does not meet the official CD Standard.



■ Handling discs

- Do not place discs in direct sunlight. They should be stored in their protective cases. Otherwise, they may warp and fail to play.

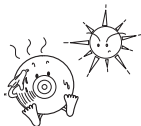

- Do not apply paper-based tape to either the recording side or label side of a disc. Damage could result.

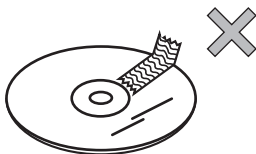

- Keep cracked or warped discs out of the player to avoid damaging the main unit.



- Do not touch the recording area (the rainbow color) side of a disc. Otherwise, the disc may be soiled and the playback may be intermittent.



- If you play a dirty disc, the disc surface may be scratched and its play may be intermittent. Use a commercially available compact disc cleaner to clean a CD, wiping gently from the center to the edge.



■ Brand new CDs

- You may notice that some brand new discs are rough around the center hole or outside. In this case, remove burrs or flakes around the edge using the side of a ballpoint pen before using a new disc. Not doing so may result in burrs or flakes becoming stuck on the recording side, preventing playback.

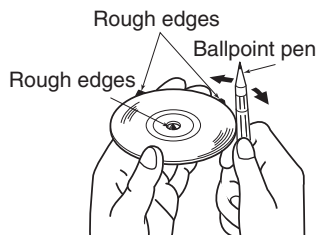

■ Rental discs

- Do not use a rental disc with glue or remnants of adhesive tape or labels. They may cause the disc to get stuck inside or damage the main unit.

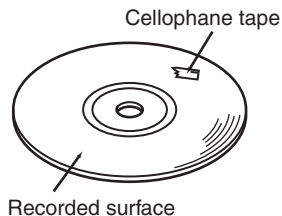

■ Irregularly-shaped CDs

- Specially-shaped or octagonal CDs, like heart-shaped cannot be played. Do not attempt to play them, even with an adapter, since they may damage the player.

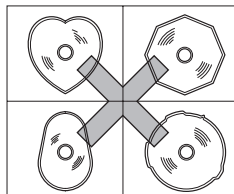

■ Disc accessories



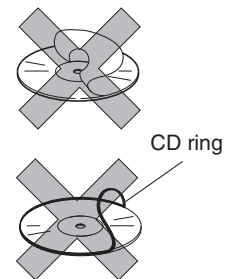

- Do not use accessories (stabilizers, protective seals, laser lens cleaners, etc.) sold for "improving sound performance" or "protecting CDs." The changes in CD thickness or outside dimensions made by these accessories may cause problems in the player.
- Please be sure NOT to attach any ring-shape protector (or other accessory) to your discs. Those protectors are commercially available and said to protect discs and to improve sound quality (and antivibration effect), but they can do more harm than good in regular uses. The most common problems are Insert/Eject related problems and "No playback" problems due to the protector ring that may have come off in a disc mechanism.

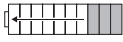

PND**⚠ IMPORTANT**

To protect the battery, the temperature range within which the battery can be charged is 32°F to +113°F (0°C to +45°C). When the PND battery temperature falls outside of this range, battery charging rate will be reduced to a trickle charge. To help prevent the PND from exceeding the charging temperature, remove the PND from vehicle when not in use. If necessary, please use the supplied USB cable and continue charging from a PC.

PND battery charging status indication

Battery condition	Indicator
Charging ↓ Full	 (Green with Moving) "Charging" ↓
	 (Green) " — " (No indication)
Charging in High Temp	 (Green half) " — " (No indication)
Empty High Temp	 (Red) " — " (No indication)

📖 ATTENTION

For your convenience, it is recommended to regularly update the PND on the TomTom Web site. (www.tomtom.com)

Please see the instructions in the TomTom HOME CD for details.

Accessories

① Your TomTom

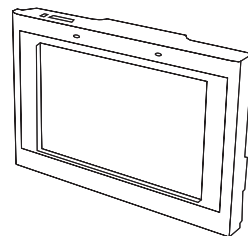

② Documentation pack

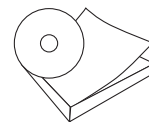

③ Connector cover

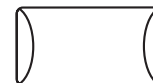

④ USB cable

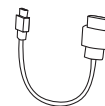

About This Receiver

Control Names and Operations

You can operate this receiver by pressing the panel buttons (panel switches) or by touching the switches displayed on the screen (touch switches).

■ Panel Switches

Identification of controls and functions.

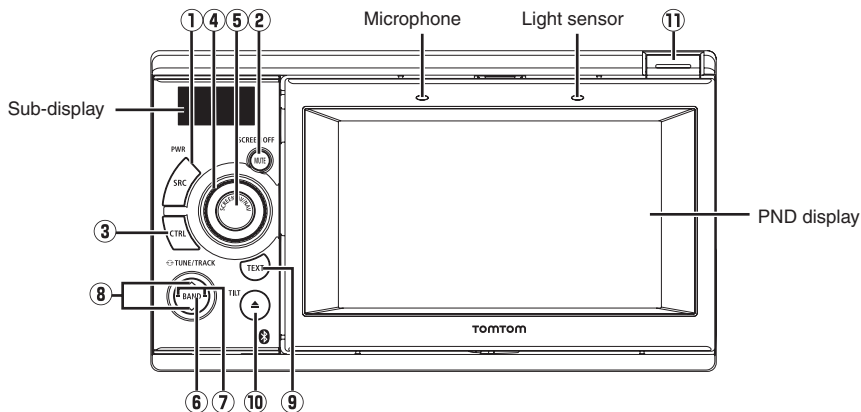

- ① **[SRC] button**
 Short press: Switches SOURCE.
 Press and hold: Turns the audio mode OFF.
 Press and long hold (more than 5 seconds): Turns the power completely OFF.
- ② **[MUTE] button**
 Short press: Turns MUTE ON or OFF.
 Press and hold: Turns the PND display OFF.
- ③ **[CTRL] button**
 Short press: Switches the audio controls.
 Press and hold: Switches to the Screen setting menu. You can switch to the setting mode when PND is connected and the audio power is off.
- ④ **[VOL] rotary knob**
 Adjusts volume.
- ⑤ **[SCREEN AV/NAV] button**
 Short press: Switches between the NAVI screen and AV screen. Turns the PND display ON when it is OFF.
 Press and hold: Displays the CAMERA screen when a camera is connected.
- ⑥ **[BAND] button**
 Changes radio bands, or playback format between CD-DA and MP3/WMA.

⑦ **[SELECT (Right/Left)] button**

Short press: Tunes radio stations, selects CD/MP3/WMA, iPod and USB tracks, or selects DVD chapters.

Press and hold: Tunes preset radio stations, or fast forward or rewind a DVD, CD, MP3, WMA, iPod and USB.

⑧ **[SELECT (Upper/Lower)] button**

Short press: Tunes radio stations by SEEK UP/DOWN. Selects folders in the CD (MP3/WMA) mode.

Long press: Continues SEEK UP/DOWN of radio stations.

Long press of the DOWN button: Returns to the root directory in the MP3/WMA mode.

⑨ **[TEXT] button**

Displays frequency, Track No., or current audio mode on the Subdisplay when the PND is attached.

Track No., elapsed time, volume level and title will be shown when the PND is disconnected.

⑩ **[▲ (OPEN/EJECT)] button**

Short press: Ejects the disc or opens and closes the front panel.

Press and hold: Tilts the front panel step by step or forcibly ejects the disc when the front panel is open.

⑪ **[Release] button**

Removes the right side of the PND from the main unit.

Turning the POWER ON or OFF

When the power is turned OFF the last mode on the main unit (CD and Tuner) will be restored.

⚠ WARNING

When the main unit's power is turned on for the first time or if the battery terminals have been disconnected, e.g. for vehicle maintenance, and the power is then turned back on, the main unit will start up in the FM mode.

⚠ IMPORTANT

Even though the audio source is turned off, the navigation screen is displayed continuously as long as it is selected.

(1) When the power is OFF, press [SRC].

The power will come ON.

(2) Press and hold the [SRC] button until a beep is heard while the power is on, and release the button.

All audio sources will be turned OFF.

(3) When the power is ON, hold down the [SRC] button for 5 or more seconds.

The audio and navigation will be turned off.

Switching Between the Audio and Navigation Screen

(1) Each time you press the [SCREEN AV/NAV] button, the display switches between the AUDIO and NAVIGATION screen.



Turning the PND Display ON and OFF

- (1) When the PND display is OFF, press the [SCREEN AV/NAV] button.

The PND display will come ON.

- (2) When the PND display is ON, hold down the [MUTE] button for 1 or more seconds.

The PND display will go OFF.

Attachment and Detachment the PND

■ Using the PND

CAUTION

To avoid injury, use the audio cover when the PND is removed.

■ How to Detach the PND from the Main Unit

IMPORTANT

- When detaching the PND, Do not touch the PND rear connector.
- After detaching the PND, mount the connector cover to the PND rear side.

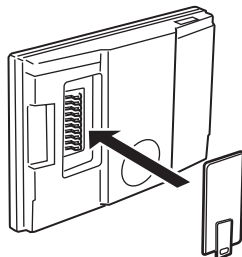

- Do not attach the PND to the audio unit when connector cover is mounted.
- When attaching the PND, do not press the monitor display.
- If the PND gets wet, do not attach it to the main unit.
- When the PND is detached, the audio cover should be installed.

- (1) Press the [Release] button.

The right-hand side of PND will be unlatched from this receiver.

- (2) Remove the PND.

Hold the PND on the right side, lift up and pull it toward you to remove it.

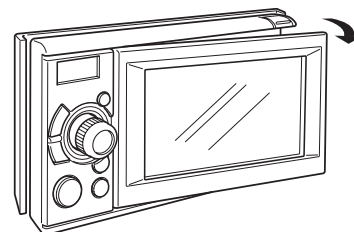

■ **Attaching the PND**

- (1) **Latch the left-hand side of PND to the receiver.**

Engage the catch at the left end of the PND with the lock on the main unit.

- (2) **Attach the PND to the receiver.**

Press the right-hand side of PND until it clicks in position.

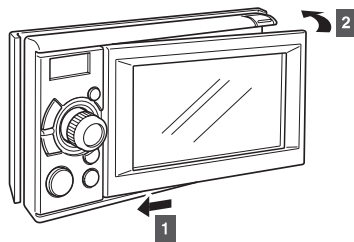

Using the Audio Cover

■ **Using the Audio Cover**

After detaching the PND, we recommend you to use the audio cover for this receiver.

■ **Fitting the Audio Cover**

- (1) **Mount the left end of audio cover on this receiver.**

Engage the catch at the left end of the audio cover with the lock on the main unit.

- (2) **Mount the entire audio cover on this receiver.**

Press the right-hand side of audio cover so that it fits and clicks.

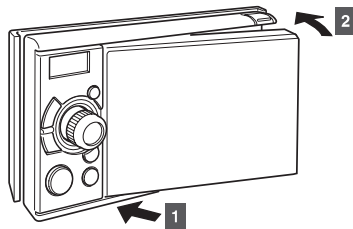

■ **How to Detach the Audio Cover from the Main Unit**

- (1) **Press the [Release] button.**

This removes the right edge of the audio cover from the main unit.

- (2) **Remove the audio cover.**

Hold the audio cover on the right side, lift it up and pull it toward you to remove it.

Hands-Free Microphone and Light Sensor

The PND is equipped with a built-in hands-free microphone and a light sensor. For details on how to use the hands-free call function or configure light sensor settings, refer to the operation manual of the PND.

⚠ IMPORTANT

Pressing a sharp object against the hands-free microphone or the light sensor may damage them.

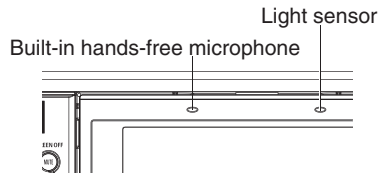

Adjusting the Display Angle

When the screen shines due to ambient sunlight, you can adjust the angle of the display.

⚠ CAUTION

When adjusting its angle, take care not to pinch your fingers. Otherwise you may hurt yourself or cause mechanical damage.

⚠ IMPORTANT

Do not mount a disc when the display is tilted. Otherwise the disc or this receiver will be scratched and damaged.

(1) Hold down the [**▲** (OPEN/EJECT)] button for 2-3 second until BEEP sound.

- You can change the tilt angle in one step each time you press the button.
- The angle can be changed in 5° increments, and can be tilted up to 30°.

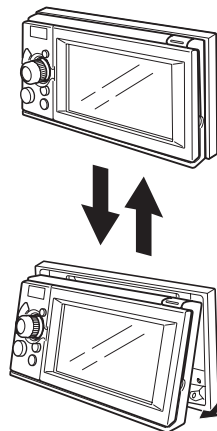

📖 ATTENTION

- You can open the display even when it is tilted. When you close the display, it returns to the preset angle.
- If you tilt the display and turn the ACC OFF, the display will return to the upright position. However, when you turn the ACC ON, the display returns to the preset angle.

Loading/Unloading a Disc

To listen to music, insert the music CD in the slot, and to play a DVD, insert the DVD disc in the slot.

■ Loading Steps

⚠ CAUTION

- Do not place a cup or can on the display while the display is opened. Doing so may damage the display.
- Do not press the [**▲** (OPEN/EJECT)] button while inserting a disc into the slot.

⚠ IMPORTANT

This receiver can play 8cm CDs and 8cm DVDs. To avoid disc problems, insert a disc without using an adapter.

(1) Press the [▲ (OPEN/EJECT)] button.

The display will open and the disc insertion slot will open.

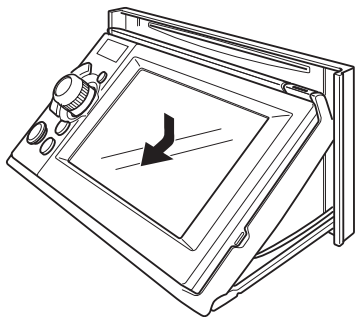

(2) Insert a disc into the slot.

- The display will close automatically when the disc is inserted.
- Hold a DVD or CD correctly (by inserting your finger in its center hole and by holding the disc edge by another finger), face the disc label side upward, and insert the disc into the slot.
- When you insert a DVD into slot, its movie will be played in the DVD mode.

- When you insert a CD into slot, its music will be played or the MP3/WMA play will start.

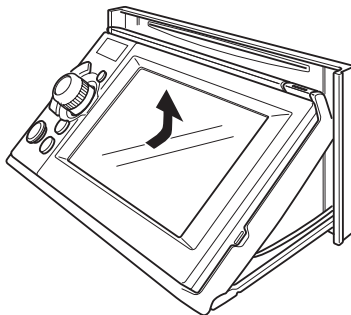
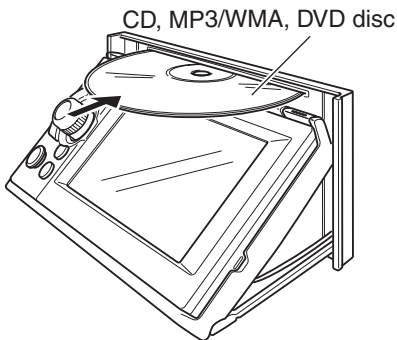

■ CD/DVD unloading steps

⚠ IMPORTANT

- Do not close the display when the ejected disc remains in the slot. Doing so may damage the unit or the disc.
- Do not push and close the display by hand, or the display will be damaged.
- Wipe and clean the display immediately if juice or another liquid drops on it. If not the display will be damaged.
- To protect the display from heat and dust, keep the display closed except when you load or unload a disc.
- If the disc does not eject (for example, if it is jammed), hold down the [▲ (OPEN/EJECT)] button for more than 5 seconds.

(1) Press the [▲ (OPEN/EJECT)] button.

This will open the display and ejects the disc.

(2) After the disc has been ejected, remove the disc and then press the [▲ (OPEN/EJECT)] button.

📖 ATTENTION

As this receiver has a single disc slot, you can load only one CD or DVD disc at a time.

Sub-display

- Sub-display may look white or black when viewed from an angle.
- Also, the screen may shine and became difficult to watch due to ambient sunlight.

Operation Conditions of this Receiver

You can or cannot operate this receiver in the following conditions (the ignition key positions).

○: Operable; x: Inoperable

	Engine switch position				
	OFF (LOCK)	ACC	ON when stopped	ON when running	Display opened
Audio function	x	○	○ ^{*1}	Some functions are inoperable for safety reasons. Voice guidance and music play are active.	x Audio is played. Disc is ejected. Only Vol is enabled for operation.
Video function	x	○	○ ^{*1}	Some functions are inoperable for safety reasons. For your safety, only voice guidance and music play are active.*2	x Both image and audio (iPod-Video only) are played. Disc is ejected. Only Vol is enabled for operation.

*1 When the parking brake is engaged

*2 DVD and iPod-video are not displayed during driving.

Setup of This Receiver

Setup of This Receiver

You can select the guide tone, illumination and another useful functions of this receiver.

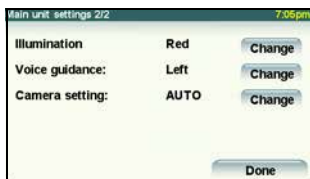
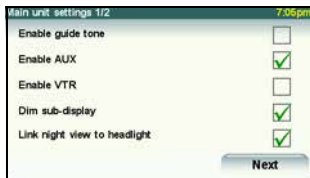

ATTENTION

The VTR function cannot be used.

■ Enable guide tone

Turn the “Guide tone” ON or OFF. If turned ON, a guidance tone can be heard when you operate a button.

- (1) Hold down the [SRC] button for 1 or more seconds.

Audio mode will be turned OFF.

- (2) Hold down the [CTRL] button for 1 or more seconds.

- (3) Touch **Enable guide tone** .

It turns ON and OFF each time you touch **Enable guide tone** . (Default is OFF.)

- (4) Touch **Next**.

- (5) Touch **Done**.

ATTENTION

- If the DISC is not removed within 15 seconds after ejecting the DISC, a BEEP is sounded regardless of whether this setting is ON or OFF.
- A BEEP is sounded regardless of whether this setting is ON or OFF when the audio mode is set to OFF.

■ Enable AUX

Turn the “AUX setting” ON or OFF. It is recommended that the AUX setting is left in the “ON” setting. If it is ON, you can select source from the AUX input.

- (1) Hold down the [SRC] button for 1 or more seconds.

Audio mode will be turned OFF.

- (2) Hold down the [CTRL] button for 1 or more seconds.

- (3) Touch **Enable AUX** .

It turns ON and OFF each time you touch **Enable AUX** . (Default is ON.)

- (4) Touch **Next**.

- (5) Touch **Done**.

■ Dim sub-display

If “Enabled”, the sub-display brightness changes when you turn the car lights (side marker light, tail light, and license plate light) ON.

- (1) Hold down the [SRC] button for 1 or more seconds.

Audio mode will be turned OFF.

- (2) Hold down the [CTRL] button for 1 or more seconds.

- (3) Touch **Dim sub-display** .

It turns ON and OFF each time you touch **Dim sub-display** . (Default is ON.)

- (4) Touch **Next**.

- (5) Touch **Done**.

■ Link night view to headlights

If it is set to “Enabled” and if the Dim sub-display is ON, the PND display switches to the night view mode when you turn the car lights ON.

- (1) Hold down the [SRC] button for 1 or more seconds.

Audio mode will be turned OFF.

- (2) Hold down the [CTRL] button for 1 or more seconds.

- (3) Touch

Link night view to headlight

It turns ON and OFF each time you touch

Link night view to headlight

(Default is ON.)

- (4) Touch **Next**.

- (5) Touch **Done**.

■ Illumination

The illumination colors can be switched.

- (1) Hold down the [SRC] button for 1 or more seconds.

Audio mode will be turned OFF.

- (2) Hold down the [CTRL] button for 1 or more seconds.

- (3) Touch **Next**.

- (4) Touch **Change**.

The illumination is switched as follows each time you touch the **Change**.

Red (Default) ↔ Blue

- (5) Touch **Done**.

ATTENTION

The illumination brightness of the main unit changes as the vehicle's illumination brightness is adjusted using the vehicle's illumination control dial.

■ Voice guidance

Select the Right or Left navigation voice channel.

- (1) Hold down the [SRC] button for 1 or more seconds.

Audio mode will be turned OFF.

- (2) Hold down the [CTRL] button for 1 or more seconds.

- (3) Touch **Next**.

- (4) Touch **Change**.

The Right and Left navigation voice channels are switched each time you touch the **Change**. (Right channel is selected by default.)

- (5) Touch **Done**.

■ Camera setting

Set the camera to the AUTO or MANUAL operation mode.

In the AUTO mode, camera view is displayed on the PND when you shift the lever to reverse position or when you long press the [SCREEN AV/NAV] button. In the manual mode, camera view is displayed when you long press the [SCREEN AV/NAV] button.

- (1) Hold down the [SRC] button for 1 or more seconds.

Audio mode will be turned OFF.

- (2) Hold down the [CTRL] button for 1 or more seconds.

- (3) Touch **Next**.

- (4) Touch **Change**.

The AUTO and MANUAL operations are switched each time you touch **Change**. (AUTO is set by default.)

- (5) Touch **Done**.

Screen Adjustment and Setting

■ Turn Display OFF

- (1) Press and hold the [MUTE] button.

Press the [SCREEN AV/NAV] button to return to the previous screen.

Adjusting the Screen

When you have stopped the car, you can switch from DVD or iPod-video image to the Adjustment screen and you can adjust the display contrast and brightness.

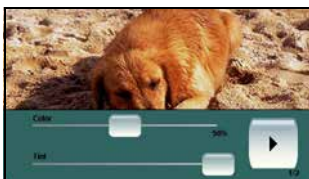



Contrast

- (1) Press and hold the [CTRL] button during DVD image display.
- (2) Slide  to the right to enhance the contrast, and slide it to the left to reduce the contrast.



Brightness

- (1) Press and hold the [CTRL] button during DVD image display.
- (2) Slide  to the right to make the display brighter, and slide it to the left to make the display darker.

Color

- (1) Press and hold the [CTRL] button during DVD image display.
- (2) Touch .
- (3) Slide  to the right to enrich the color, and slide it to the left to lighten the color.

Tint (only for NTSC video)

- (1) Press and hold the [CTRL] button during DVD image display.
- (2) Touch .
- (3) Slide  to the right to enrich the green, and slide it to the left to enrich the red.

ATTENTION

If no adjustments are made within 6 seconds, the image quality adjustment screen will be canceled.

■ Setting the Aspect Ratio of Screen

CHECK

You can set an aspect ratio of DVD, iPod-video screen.

- (1) Touch **16:9**, **4:3** or **Zoom**.

You can display the switch as follows.

DVD:

Touch **Next** on the operation screen, and touch **Display**.

iPod-video:

Touch **Display** on the operation screen.



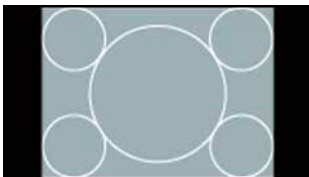

- 4:3 mode

Enlarges or reduces the screen with the 3 (vertical) by 4 (horizontal) aspect ratio. Black stripes are displayed at both sides.



- 16:9 mode

Enlarges or reduces the screen with the 9 (vertical) by 16 (horizontal) aspect ratio. (This is the normal DVD display screen size).



- Zoom mode

Enlarges or reduces the screen equally in the vertical and horizontal directions, fitting the width to the screen size.

**ATTENTION**

The user should not experience any problems when watching a video on the wide screen on a personal basis. If you compress or enlarge the screen for commercial purposes or to display to the public, it may infringe a copyright that is protected by copyright laws.

Switching the Audio Source

Switching the audio source

(1) Press the [SRC] button.

The audio source is switched as follows each time you press the [SRC] button.

FM/AM → DISC (CD or DVD)^{*2} → USB^{*1*4} →
AUX^{*3} → iPod^{*1*4} → FM/AM → ...

*1 Cannot be selected if the corresponding device is not connected to the main unit.

*2 Cannot be selected if no disc is loaded.

*3 Cannot be selected if the AUX setting is set to OFF.

*4 If the PND is not connected to the main unit, you cannot select the USB mode or iPod mode.

Volume Control

Adjusting the audio volume

CAUTION

Do not perform operations such as adjusting of the audio volume while driving a vehicle. Operate after parking the vehicle in a safe place.

(1) Turn the [VOL] rotary knob.

Turn to the right to increase the audio volume.

Turn to the left to decrease the audio volume.

ATTENTION

- Adjust the volume to a level that does not compromise safe driving.
- You can control the volume level from 0 to 80.
- The actual sound level may vary based on selected source. Adjust the sound level appropriately according to the audio source you select. For volume control, see “Adjusting the SVC (Source Volume Control)” on page 27.

Muting the Volume

(1) Press the [MUTE] button.

- The sound is muted.
- Press the [MUTE] button again to return to the previous sound level.
- If you increase the volume during muting, the muting is canceled and the sound level increases from the previous volume level.
- The navigation voice guidance can be heard even when you have muted the audio system.

Adjusting the sound quality

You can fine-tune the audio sound using the audio control mode.

Switching Audio Control Modes

IMPORTANT

- The audio control mode is cancelled if no button is pressed within 6 seconds.
- You can check your settings on the PND screen when it is attached. When detached, you can check the settings on the sub-display.

■ Adjusting the BASS

You can adjust the bass (low sounds).

- (1) **Press the [CTRL] button repeatedly until “BASS” is displayed.**
- (2) **Adjust the audio bass (low sounds) by turning the [VOL] rotary knob.**

To the right:

Emphasizes low sounds.

To the left:

De-emphasize low sounds.

(Center position is set by default.)

■ Adjusting the MIDDLE

You can adjust the mid-range sounds.

- (1) **Press the [CTRL] button repeatedly until “MID” is displayed.**
- (2) **Adjust the mid-range sounds by turning the [VOL] rotary knob.**

To the right:

Emphasizes mid range sounds.

To the left:

De-emphasize mid range sounds.

(Center position is set by default.)

■ Adjusting the TREBLE

You can adjust the treble (high sounds).

- (1) **Press the [CTRL] button repeatedly until “TREB” is displayed.**
- (2) **Adjust the treble (high sounds) by turning the [VOL] rotary knob.**

To the right:

Emphasizes high sounds.

To the left:

De-emphasize high sounds.

(Center position is set by default.)

■ Balancing Between Right and Left Speakers (BALANCE)

You can adjust the balance of right and left speakers.

- (1) **Press the [CTRL] button repeatedly until “BAL” is displayed.**
- (2) **Adjust the R and L speaker balance by turning the [VOL] rotary knob.**

To the right:

Emphasizes right speakers.

To the left:

Emphasizes left speakers.

(Center position is set by default.)

■ Balancing Between Front and Rear Speakers (FADER)

You can adjust the balance (fading) of front and rear speakers.

- (1) **Press the [CTRL] button repeatedly until “FAD” is displayed.**
- (2) **Adjust the front and rear speaker balance by turning the [VOL] rotary knob.**

To the right:

Emphasizes front speakers.

To the left:

Emphasizes rear speakers.

(Center position is set by default.)

■ Setting the loudness mode (LOUDNESS)

Accentuate low and high frequencies when the volume is low.

When loudness is ON, the apparent deficiency in the high sounds is compensated for.

- (1) **Press the [CTRL] button repeatedly until “LOUD” is displayed.**
- (2) **Set the loudness control to ON or OFF by turning the [VOL] rotary knob.**

To the right:

Turns ON.

To the left:

Turns OFF.

(Turned ON by default.)

■ Adjusting the SVC (Source Volume Control)

In this mode you can set the volume level for each audio source by taking the FM radio volume level as the reference level.

(The volume level of the audio source you are currently listening to is adjusted.)



IMPORTANT

If the DVD sound level is too low, adjust the SVC for it.

- (1) **Press the [CTRL] button repeatedly until “SVC” is displayed.**

- (2) **Adjust the SVC level by turning the [VOL] rotary knob.**

To the right:

Increases the sound level of current audio source.

To the left:

Decreases the sound level of current audio source.

(The same sound level as FM radio (± 0 dB) is set by default.)

Using the Radio

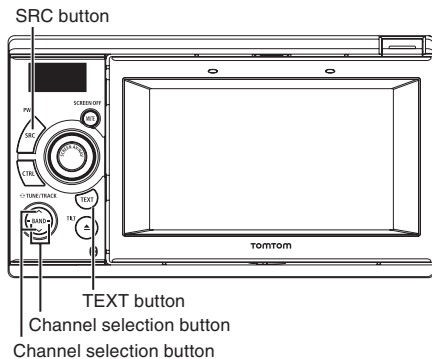

Listening to the Radio

- (1) Press the [SRC] button repeatedly until "FM" or "AM" is displayed on the sub-display.
- (2) Press the [BAND] button to switch a desired band.

Tune a Desired Station

⚠ CAUTION

If the vehicle's battery is disconnected (for repairs to the vehicle or for removing the main unit), all stations in memory will be lost. In such a case, set stations in memory again.

⚠ IMPORTANT

At times, it may be difficult to maintain optimum reception because the antenna affixed to your vehicle is in motion constantly (relative to the broadcast antenna), encountering continuous variation in the strength of received radio signals. Other factors affecting reception include interference from natural obstacles, sign posts, etc.

■ Manual Tuning

- (1) Press the [SELECT (Right)] or [SELECT (Left)] button.

To the right:

Tunes up for one step.

To the left:

Tunes down for one step.

One step (AM):

10kHz

One step (FM):

200kHz

■ Station Seek

- (1) Press the [SELECT (Up)] or [SELECT (Down)] button.

- When a station having the strong reception station closest to the one shown on the screen is tuned, the auto tuning stops. To cancel auto tuning, press the button again.
- Tuning continues while the [SELECT (Up)] or [SELECT (Down)] button is held down, even if there is a station that can be received. When the button is released, the main unit receives the station whose frequency is closest to the frequency from when the button was released.

📖 ATTENTION

Auto tuning may fail if the received signal is weak.

■ Selecting a Preset Channel

- (1) Press and hold the [SELECT (Right)] or [SELECT (Left)] button for 1 or more seconds.

To the right:

Switches to the next higher preset channel.

To the left:

Switches to the next lower preset channel.

■ Touching a Preset Switch

- (1) Touch a preset memory switch.



The registered preset station will be selected and the corresponding station will then be received.

Selecting a Radio Band

- (1) Press the [BAND] button.

The receiver band is switched as following each time you press the [BAND] button.

FM1 → FM2 → FM3 → AM → FM1 → ...

Saving a Station in Memory

You can save a radio station in memory in the auto or manual mode.

■ Manual Saving

- (1) Select a station you wish to save by Manual tuning or Auto tuning.
- (2) Touch the preset switch for 1 or more seconds to store a radio station into memory. If Guide Tone is enabled, a “BEEP” sound will be heard.



The selected station will be saved, and the preset channel number and frequency will be shown on the display.

To manually set additional selected stations for the remaining preset channels, repeat this procedure for each channel.

Six stations can be memorized for each of FM 1, 2 and 3, and six stations can be memorized for AM, making a total of 24 stations.

If the stations have been stored in memory, a station can be selected by touching a preset switch.

■ Auto Saving



IMPORTANT

- You can select a station by simply touching a preset switch (any of [1] to [6]). The frequency of the selected station is shown on the display.
- When you save a new station in memory, the existing station will be replaced.
- If you can tune fewer than six stations, the remaining stations are kept in memory.

- (1) Touch **Preferences**.



(2) Touch **ASM**.

The automatic station selection will start when a beep is heard. A search will be conducted from the lowest frequency through progressively higher frequencies and stations with strong reception will be memorized for preset registration numbers [1] to [6]. When the registration procedure has been completed, a BEEP sound once and the station memorized last (i.e. the one memorized for P6) will continue to be received. Subsequently, when you listen to the radio you will be able to select stations by calling up preset numbers.

To stop ASM, touch **Stop ASM**.

Preset Scan

This function enables reception of all the stations in the preset switches to be played for five seconds each.

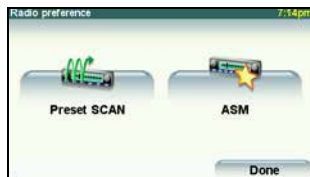
(1) Touch **Preferences**.(2) Touch **Preset SCAN**.

The stations of preset switches P1 to P6 will be scanned sequentially. Each station is turned for five seconds.

To cancel the preset scan, touch **Stop SCAN**.

Displaying the information

You can display the current frequency on the Sub-display.

(1) Press the [TEXT] button.

- Current frequency is displayed on the Sub-display for 2 seconds if the [TEXT] button is pressed and the PND is connected.
- The current frequency is displayed on the Sub-display constantly and the PND is not connected.

Turning the Radio OFF

(1) Hold down the [SRC] button for 1 or more seconds.

Press the [SRC] button again and the station prior to power off will resume.

Using the CD Player

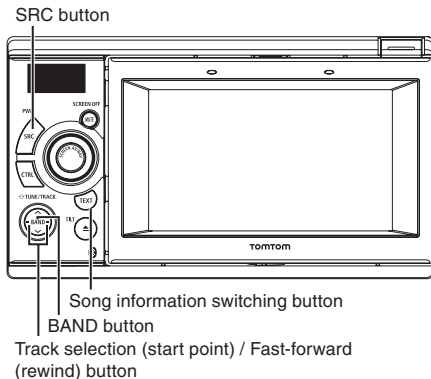

Listening To a CD

Insert a CD into the disc slot, and it will start playing.

⚠ CAUTION

- Do not press the [▲] (OPEN/EJECT) button when you are inserting a CD into disc slot. This may cause a personal injury and damage to the front panel.
- Do not drive your car while the front panel of this receiver is kept open. The panel may cause unexpected personal injury in the case of a sudden stop or similar event.
- Do not attempt to close the front panel by hand. Doing so may damage the panel.

⚠ IMPORTANT

- Playback may be intermittent when there is a scratch on a CD or when the recorded side is dirty.
- If the following CD name and logo are shown, the disc title and track titles are also recorded on the disc. Text information will be displayed during playback.



- (1) Press the [SRC] button repeatedly until "CD" is displayed on the sub-display.

Play the CD.

📖 ATTENTION

- If track titles and other data are recorded in the CD-Text, you can display them.
- Note that the CD-Text of a CD-R/RW disc may not be displayed.

Selecting a Desired Track

You can cue a desired track.

- (1) Press the [SELECT (Right)] or [SELECT (Left)] button.

To the right: Advances to the next track.

To the left (pressing once): Returns to the beginning of the track being played.

To the left (pressing more than two times): Returns to the previous track.

Fast Forward/Rewind

You can fast forward or rewind the track currently being played.

- (1) Hold down the [SELECT (Right)] or [SELECT (Left)] button for 1 or more seconds.

To the right:

Fast forwards a track.

To the left:

Rewinds a track.

Fast Forwarding or Rewinding continues until the button is released. If Guide Tone is enabled, a "BEEP" sound will be heard when the fast forward or rewind action is initiated.

Finding a Desired Title

- (1) Touch **SCAN**.

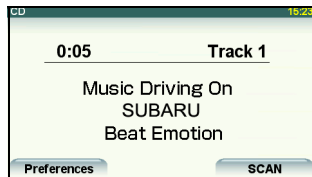

The main unit will play the first 10 seconds of each track. Touch **Stop SCAN** again to continue playing a current track.

Repeating the Same Track

- (1) Touch **Preferences**.

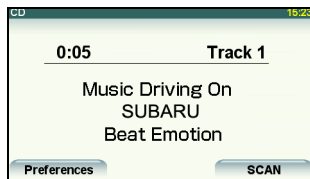

- (2) Touch **Repeat song** .

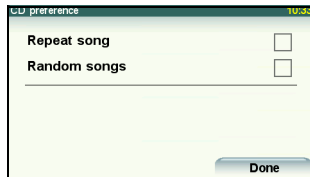

- The track repeats to play.
- When you touch **Repeat song** , the track repeats until you cancel it. Touch **Repeat song** again to cancel the repeat play.

Random Play

- (1) Touch **Preferences**.

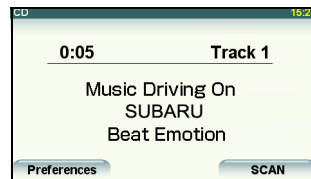

- (2) Touch **Random songs** .

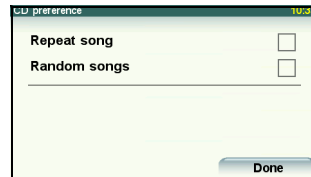

- All titles in the CD are played in random order.
- When you touch **Random songs** , the random play continues until you cancel it. When you touch **Random songs** again, the random play is canceled.

Track Data Display

The current track number and the elapsed time can be shown on the sub-display.

(1) Press the [TEXT] button.

- Track No. is displayed on the Sub-display for 2 seconds if the [TEXT] button is pressed and the PND is connected.
- Display on the Sub-display will be as following if the [TEXT] button is pressed and the PND is disconnected.

Track No. ↔ Elapsed time

Switching Between CD-DA and MP3/WMA

If a disc contains both sound data (CD-DA) and MP3/WMA music files, you can switch among them.

(1) Press the [BAND] button.

Display is switched as following each time you press the [BAND] button.

CD-DA → MP3/WMA → CD-DA ...

Stopping the CD Play

(1) Hold down the [SRC] button for 1 or more seconds.

When you press the [SRC] button again, the music restarts from the stopped position.

Using the MP3/WMA Player

SRC button

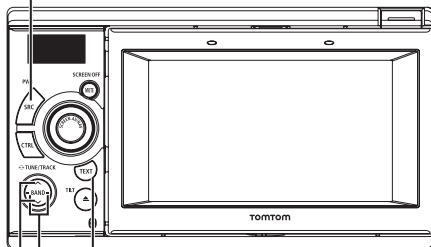

Song information switching button

Track selection (start point) /

Fast-forward (rewind) / File selection button

Folder selection button

Playing an MP3/WMA File

When you insert a CD-R/RW disc having an MP3/WMA file into disc slot, the file is played.

⚠ CAUTION

- Do not press the [▲ (OPEN/EJECT)] button when you are inserting a CD into disc slot. This may cause a personal injury and damage to the front panel.
- Do not drive your car while the front panel of this receiver is kept open. The panel may cause unexpected personal injury in the case of a sudden stop or similar event.
- Do not attempt to close the front panel by hand. Doing so may damage the panel.
- If a non-MP3/WMA file has the ".mp3" or ".wma" file extension, it may be recognized erroneously as an MP3/WMA file. When such a file is played, a high level of noise output may occur and may damage the speakers. Take care not to assign the ".mp3" and ".wma" extensions to non-MP3/WMA files.

⚠ IMPORTANT

- Playback may be intermittent when there is a scratch on a CD or when the recorded side is dirty.
- The CD-ROM supports a folder or file selection function.

- (1) Press the [SRC] button repeatedly until "CD" is displayed while a CD-R/RW disc is in the drive slot.

- Play the file.
- The files are usually played in the following sequence: [1] → [2] → [3] → [4] → [5] → [6] → "[A configuration example of MP3/WMA supported CD]" on page 40.
- If multiple MP3/WMA files and folders are located in the same hierarchy, they are played in the ascending order of file and folder names.
- If you try to insert a non-MP3/WMA format file, "NO SUPPORT" warning is displayed.

Selecting a Desired Folder

You can select a desired folder from the disc.

- (1) Press the [SELECT (Up)] or [SELECT (Down)] button.

Up: Goes to the next higher folder and plays the first track of this folder.

Down: Goes to the next lower folder and plays the first track of this folder.

Selecting a Desired Music File

You can select a desired music file from the folder.

IMPORTANT

If music data (CD-DA) and MP3/WMA data are mixed on the same disc, you can switch the playback file format by pressing the [BAND] button.

(1) Press the [SELECT (Right)] or [SELECT (Left)] button.

To the right: Advances to the next file.

To the left (Press once.): Returns to the beginning of the playing file.

To the left (Press twice or more.): Returns to the previous file.

Fast Forward/Rewind

You can fast forward or rewind the currently playing track.

(1) Hold down the [SELECT (Right)] or [SELECT (Left)] button for 1 or more seconds.

To the right:

Fast forwards a track.

To the left:

Rewinds a track.

Fast Forwarding or Rewinding continues until the button is released. If Guide Tone is enabled, a "BEEP" sound will be heard when the fast forward or rewind action is initiated.

Returning To the Root Directory

You can return to the root directory and play its file.

IMPORTANT

If no file is found in the root directory, a file in the first folder is played.

(1) Hold down the [SELECT (Down)] button for 1 or more seconds.

- You can return to the root directory and play its file.
- For an MP3/WMA file creation example, see "[A configuration example of MP3/WMA supported CDJ]" on page 40.

Finding a Desired Music File

IMPORTANT

- To continue playing a desired track or file, turn the Scan function OFF.
- The entire disc is scanned once, and the normal play starts from the position where you started to scan.
- When you select "Playing the Start of Tracks/Files", "Repeated Playing", or "Playing the Tracks/Files in Random Order", its function is shown as "SCAN", "ALL", "RPT", or "RAND" on the display.

(1) Touch **SCAN**.

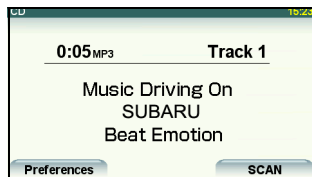

(2) Touch **Current folder** or **First song of each folder** .

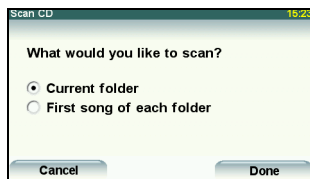

- Touch **Cancel** to return to the previous page.
- Current folder: Plays the first 10 seconds of each track contained in the same folder layer.
First song of each folder: Plays the first 10 seconds of track in each folder.
When you touch **Stop SCAN**, the current track continues to play.

Repeating a Music File

IMPORTANT

When you select "Playing the Start of Tracks/Files", "Repeated Playing", or "Playing the Tracks/Files in Random Order", its function is shown as "SCAN", "ALL", "RPT", or "RAND" on the display.

(1) Touch **Preferences**.

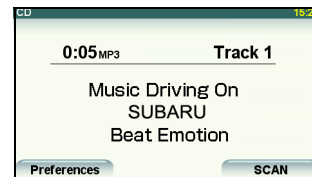

(2) Touch **Repeat** .

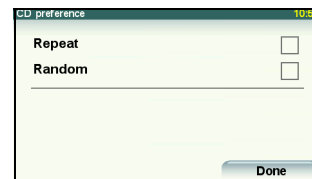

(3) Touch **Current song** or
Current folder .

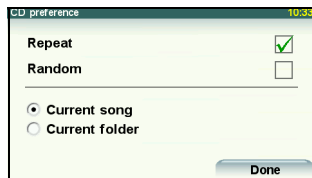

- Current song: Repeats the current file.
 Current folder: Repeats files of the current folder.
- When you set "Repeat song", the file is repeated until you cancel it. Touch **Repeat** again to cancel repeating.

or **Random Play**

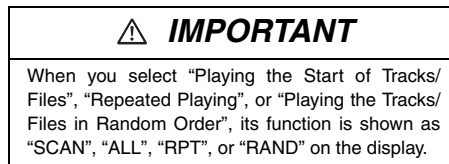

(1) Touch **Preferences**.

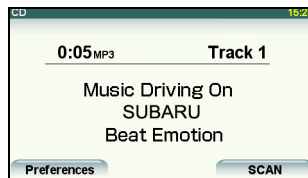

(2) Touch **Random** .

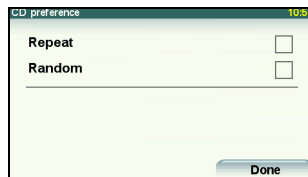

(3) Touch **Current folder** or
All songs .

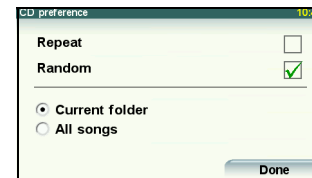

Current folder: Plays files in random order contained in the same layer of the current folder.

All songs: Plays files of all folders in random order.

When you touch **Random** , the random play continues until you cancel it. When you touch **Random** again, the random play is canceled.

If you touch **Repeat** during random play, the current track is repeated. When you touch **Repeat** again, random play restarts.

Displaying of Music File Information

The current track number and the elapsed time can be shown on the sub-display.

(1) Press the [TEXT] button.

- Track No. is displayed on the Sub-display for 2 seconds if the [TEXT] button is pressed and the PND is connected.
- Display on the Sub-display will be as follows when the [TEXT] button is pressed and the PND is disconnected.
Track No. ↔ Elapsed time

Switching Between CD-DA and MP3/WMA

If a disc contains both sound data (CD-DA) and MP3/WMA music files, you can switch between them.

(1) To play an MP3/WMA music file, press the [BAND] button.

Press the [BAND] button again to play the CD-DA data.

Stopping the MP3/WMA File

(1) Hold down the [SRC] button for 1 or more seconds.

When you press the [SRC] button again, the last track is played.

MP3/WMA

MP3 (MPEG Audio Layer 3) is a standard format for audio compression technology. By using MP3, a file can be compressed to one-tenth the size of the original.

WMA (Windows Media™ Audio) is Microsoft's voice compression technology. WMA files can be compressed to a size smaller than MP3 files. This receiver accepts certain MP3/WMA file standards, recorded media and formats. Use the following notes when you write MP3/WMA files on a disc.

■ **Playable MP3 File Standards**

- Supported standards:
MPEG-1 Audio Layer III
- Supported sampling frequencies:
8, 11.025, 12, 16, 22.05, 24, 32, 44.1, 48 kHz
- Supported bit rates:
8 to 320kbps
 - Supports VBR.
 - Does not support free format.
 - The MPEG-1 and MPEG-2 standards define different bit rates.
- Supported channel modes:
Stereo, Joint Stereo, Dual channels, Monaural

■ Playable WMA File Standards

- Supported standards:
WMA Ver. 9 Standard Decoder Class 3 satisfied
- Supported sampling frequencies:
22.05, 32, 44.1, 48 kHz
- Supported bit rates:
20 to 320 kbps
 - Supports VBR. (5 to 320kbps)
 - Does not support lossless compression.
- Playable sampling frequencies and supported bitrates

		Sampling frequencies (Hz)	
		48k	44.1k
		2 (ch)	2 (ch)
Bitrates (bps)	192k	○	○
	160k	○	○
	128k	○	○
	96k	×	○
	80k	—	○
	64k	×	○
	48k	×	○
	VBR	○	○
	192k Max	192k Max	

○: Playable

×: Cannot be played.

—: Combination not available

■ ID3/WMA Tags

You can store ID3/WMA tag character information such as track titles and artist names in an MP3 and in a WMA file.

This receiver supports ID3v.1.0 and ID3v.1.1 tags. Use only ASCII code to record tags, since only ASCII code is supported by this receiver. Always use ASCII code characters to record tags. If you use non-ASCII code characters, their display may be unreadable.

This receiver supports the WMA tag (v1.20.02). WMA tags having only Unicode are supported. Always use Unicode characters to enter the information.

■ Supported Media Types

You can play MP3/WMA files recorded on a CD-ROM, CD-R or CD-RW disc. Compared to CD-ROM media commonly used for music discs, CD-R and CD-RW discs are fragile in high temperature/high humidity environments and one section of the CD-R/CD-RW may become incapable of playback. Fingerprints or scratches on the disc may prevent playback or cause skipping during playback.

Sections of CD-R/CD-RW may deteriorate if left inside a vehicle for long periods of time. We recommend that you store UV-sensitive CD-R and CD-RW discs in shielded cases.

■ Format of Discs

You can use the following format discs on the player.

- Disc formats:
CD-ROM Mode 1, CD-ROM XA Mode 2 (Form 1)
- File formats:
ISO9660 Level 1 or Level 2
ROMEO system, JOLIET system
MP3/WMA files recorded in a format other than the one explained above may result in files that cannot be played normally and in file names and folder names that do not display properly.
Limitations in addition to standards are as follows.
- Maximum directory layers:
8 layers
- Maximum characters for folder and file names:
30 characters (including delimiter “.” and 3 characters of file extension) for MP3, but 15 characters (including delimiter “.” and 3 characters of file extension) for WMA.
- Supported characters for folder and file names:
A to Z, 0 to 9, and underscore (_)
- Number of files that can be stored on a single disc:
512
- Number of folders that can be stored on a single disc:
255

[A configuration example of MP3/WMA supported CD]

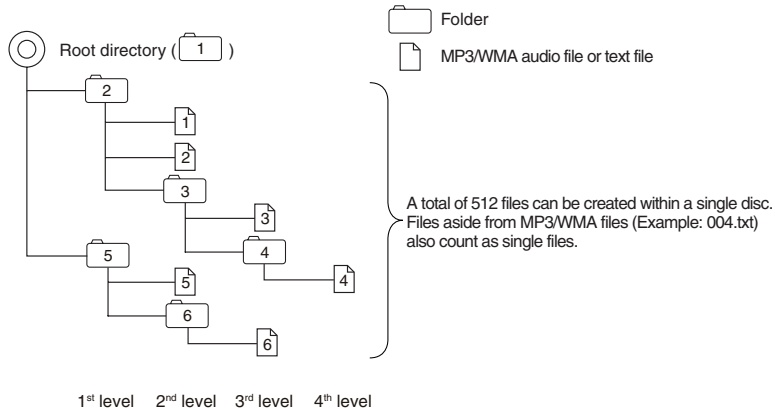

■ File Names

Only a file with the “.mp3” or “.wma” extension is recognized as an MP3 or WMA file. Always save an MP3/WMA file with the “.mp3”/“.wma” extension.

The “.mp3” or “.wma” file extension must be **single-byte lowercase** letters.

ATTENTION

If a non-MP3/WMA file has the “.mp3” or “.wma” file extension, it may be recognized erroneously as an MP3/WMA file. When such file is played, a very large noise is output and speakers may be damaged. Do not save a non-MP3/WMA file with the “.mp3” or “.wma” extension.

■ Multi-sessions

Multisessions are supported and CD-R/RW with recorded MP3/WMA files can be played.

When written with “Track at once”, however, finalize the disc with session close or write protect.

■ Playing MP3/WMA

When you load a disc with MP3/WMA files, the system first checks all files recorded on the disc. If the disc has many files and folders, the system may take a certain time to check them.

While the system is checking the disc, the music that had been playing continues to play.

To quickly check files, we recommend that you do not save non-MP3/WMA files and not to create unnecessary folders on the disc.

Also, we recommend you to write the entire data in a single session as the system takes a longer time to read the CD control information of a multi-session disc.

■ MP3/WMA Playing Time Display

It is possible that playing time will not be correct, depending on the writing condition of the MP3/WMA file.

- It is possible that playing time will not be correct when VBR Fast Up/Down is operated.

■ Display Sequence of MP3/WMA File and Folder Names

Names of MP3/WMA folders and files at the same layer are listed in the following order.

- 1 First, MP3/WMA files are listed in the ascending order of numbers and letters.
- 2 Then, folders are listed in the ascending order of numbers and letters.

Creating and Playing MP3/WMA Files

The making of MP3/WMA files by recording from sources such as broadcasts, records, recordings, videos and live performances without permission from the copyright holder for uses other than personal enjoyment is prohibited.

■ Downloading From an MP3/WMA Music Site on the Internet

You can find various types of MP3/WMA music distribution sites including online shopping, trial listening, and free downloading sites on the Internet. You can download music files from those sites by following their payment and other downloading rules.

■ Converting a Music CD to MP3/WMA Files

Prepare a PC and a market-available MP3/WMA encoder (conversion) software. (Some of them are free.) Load a music CD on the PC's CD-ROM drive and compress the music CD by following the specified procedure of the MP3/WMA encoder software. MP3/WMA-format music data files are created. A 12cm music CD (having a maximum of 74 minutes of recording/650MB of data) can be compressed to 65MB (about 1/10 of the original size).

■ **Writing MP3/WMA Files On a CD-R/RW Disc**

MP3/WMA files can be recorded on CD-R/RW by using a CD-R/RW drive connected to a computer. Record by setting the recording format of the recording software to ISO9660 level 1 or level 2 (not including extension format).

Select CD-ROM (mode1) or CD-ROM XA (mode2) for the disc format.

■ **When Playing Back CD-R/RW**

Insert a CD-R/RW disc having recorded MP3/WMA files. When you load a disc, This Receiver automatically determines whether it is a music CD or a CD-R/RW disc having MP3/WMA files and plays it correctly. Also, This Receiver can play a music CD written on a CD-R/RW disc. However, depending on the type of disc being used, the disc may not play.

 **CAUTION**

- The 128kbps fixed bit rate and 44.1-kHz sampling frequency are recommended for a high quality of playback sound.
- Note that some CD-R and CD-RW discs may not be read due to their characteristics.
- Because there are many types of MP3/WMA encoding software available, including commercial and freeware programs, audio quality may deteriorate, noise may be generated when playing starts and some recordings may not play, depending on the condition of the encoder and the file format.
- When files other than MP3/WMA files are recorded on a disc, the system may take some time to recognize the disc and it may not play the disc.

Using the USB Music File Player

This receiver can play a music file stored in a USB memory drive. Only MP3 formatted files can be played from USB memory. WMA and other formats are not supported.

IMPORTANT

- Music from USB memory can only be played when the PND is attached to the receiver.
- Please be sure to disconnect or turn off any external devices such as USB memory when turning the vehicle off. Otherwise, the main unit may not recognize these devices when the vehicle is turned back on. If this does happen, please disconnect and reconnect the device to start playback.
- There is the possibility that some files in a USB memory will not be played back normally (eg. only the first 1 second is played back, or the count display stops) if a lot of small MP3 files (1 minute or less) are stored in the USB memory. However, this does not signify a fault in this product or the USB memory.

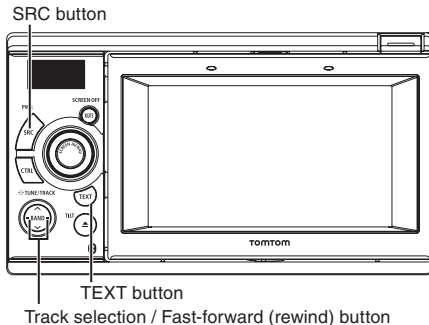

Playing USB Music Files

CAUTION

- Connect the USB cable correctly so that it does not interfere with the safe operation of your vehicle.
- After connecting USB memory, the message “Don’t remove the storage device until scanning is finished” is displayed. Never turn off the power or remove the PND or USB memory during scanning. It may destroy the data in the USB memory. When removing the USB memory drive, always switch the display to the audio screen and touch .

- (1) **Connect the USB memory to the USB connector.**
- (2) **Press the [SRC] button repeatedly until “USB” is displayed on the sub-display.**
Playback will begin.

Fast Forward/Rewind

It is possible to fast forward/rewind the track currently being played.

- (1) **Hold down the [SELECT (Right)] or [SELECT (Left)] button for 1 or more seconds.**

To the right:

Fast forwards a track.

To the left:

Rewinds a track.

This switches to the fast forward or rewind mode, and continues fast forwarding or rewinding until you remove your finger from the button.

Selecting a Desired Music File

You can select a track you want to play.

(1) Press the [SELECT (Right)] or [SELECT (Left)] button.

- To the right:
Advances to the next file.
To the left:
Returns to the beginning of the file being played.
- To the left (Press more than two times):
Returns to the previous file.
- The selected track (file) will be played.

Finding a Desired Music File

⚠ CAUTION

- Folder selections using the audio buttons are not supported in USB mode, unlike in CD-ROM playback mode.
- In the case of navigation voice guidance, USB playback will be interrupted. Guidance will come from the selected speaker. (Default: Front left speaker)

(1) Touch **Select**.

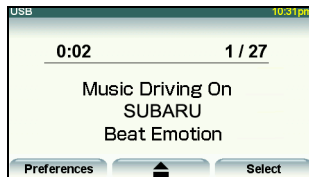

(2) To select a track to play, touch **Playlist**, **Artist**, **Album**, **Song**, or **Genre**.

This displays the list screen of the selected mode.



(3) Touch the name of the music file to be played.

- This plays the selected music file.
- When **▲** or **▼** appears, touch them to change the page of the music file list.

- You can search for a file or artist name by touching **Find**.



- You can search for a music file by entering alphanumeric characters.



Repeatedly Playing the Same Music File

(1) Touch **Preferences**.

(2) Touch **Repeat song** .

- This repeatedly plays the currently played music file.
- Once you touch **Repeat song** , the selected music file will be repeated until the repeat function is released. Touch **Repeat song** again to cancel the random play.

Random Play of Music Files

(1) Touch **Preferences**.

(2) Touch **Shuffle songs** .

- Once you touch **Shuffle songs** , the random play continues until you cancel it. Touch **Shuffle songs** again to cancel the random play.

About the TEXT button

Display the USB mode on the Sub-display.

(1) **Press the [TEXT] button.**



USB mode is displayed on the Sub-display for 2 seconds when the [TEXT] button is pressed when the PND is connected.

Stopping the USB Music File Player

(1) **Hold down the [SRC] button for 1 or more seconds.**

■ Removing of the USB Memory

CAUTION

- Make sure to follow the following procedures when removing the USB memory. Failure to follow the specified procedure may result in the loss of data in the USB memory.
- To remove the USB memory, make sure to switch the display to the audio screen and touch  before removing. Data in the USB memory may be destroyed if the USB memory is removed without touching the .

(1) **Switch the display to audio mode screen, then touch .**

(2) **Remove the USB Memory.**

Playable USB Memory Standards

- Supported file format:
FAT 16/32
- Supported audio format:
MP3
- Maximum current:
500mA
- Compatibility:
USB 1.1/2.0 (The MAX transfer rate is 12M bps for USB1.1.)
- Mass memory support:
USB mass storage (such as an externally attached HDD) is not supported.

Playable MP3 File Standards

- Supported standards:
MPEG-1, MPEG-2, and MPEG-2.5
- Supported sampling frequencies:
MPEG-1:32,44.1,48 kHz
MPEG-2:16,22.05,24 kHz
MPEG-2.5:8,11.025,12 kHz
- Supported bit rates:
8, 16, 24, 32, 40, 48, 56, 64, 80, 96, 112, 128, 160, 192, 224, 256, 288, 320kbps
 - Supported VBR (64 to 320kbps)
 - Does not support free format.
- Supported channel modes:
Monaural, Stereo, Joint Stereo, Dual-Channel

ID3 Tags

MP3 files have an "ID3 Tag" that allows input of information so that data such as a track title and artist can be saved.

This receiver supports ID3v. 1.0, 1.1, 2.2, 2.3 and 2.4.

Format of USB Memory

USB memory files must have the ISO 9660 Level-1 or Level-2 format.

The following explains the definitions of these standards.

- Maximum directory layers:
8 layers
- Maximum characters for file names:
Up to 256 characters (Total of folder name, file name, ".", and 3-character file extension)
- File name characters that you can use:
A to Z, 0 to 9, and underscore (_)
- Max number of files that can be stored in a single memory:
2000 files

001.mp3
002.mp3
003.mp3
004.txt
005.mp3
⋮
1498.mp3
1499.mp3
⋮
2000.mp3

A total of 2000 files can be created within a single USB memory drive. Files aside from MP3 files (Example: 004.txt) are included in the 2000 files.

Before Using the DVD Player

This receiver can play high quality images and high quality digital sound from DVD videos. Also, you can select any of the languages (such as dubbing and subtitles) recorded on the DVD by switching the video and audio channels. If the same scene is recorded in different angles, you can select an angle and play the video in the desired angle.

Advantages of Digital Versatile Disc (DVD)

■ Multi-Audio Function

Some DVDs support the multi-audio function that enables you to use multiple languages and change the audio language to the desired one.

- The user's ability to change the audio language depends on the DVD.



■ Multi-Angle Function

Some DVDs support the multi-angle function that enables you to play the same video scene with multiple angles and change to the desired angles while playing.

- The user's ability to view multiple video angles depends on the DVD.

CHECK

This function is available only in the DVD video mode.



- The video angle changes.

■ Subtitle Display Function

Some DVDs support the multi-subtitle display function that enables you to change the subtitle language to the desired one while playing. If necessary, you can disable the subtitle function to play a video.



- The user's ability to display subtitles depends on the DVD.



Discs

■ Types of Playable Discs

This receiver supports the NTSC or PAL color television system; therefore, please use the type of discs labeled "NTSC" or "PAL" on the discs or packages. This receiver cannot play discs that support a color television system (SECAM, etc.) other than NTSC or PAL.

Type and mark of playable disc	Size/playing side	Max. playing time
	12cm/1 side 1 layer 2 layers	<MPEG system> 2 133 min. 242 min.
	12cm/2 sides 1 layer 2 layers	<MPEG system> 2 266 min. 484 min.

ATTENTION



The playback status may be determined in response to the DVD or software creator's intention. This receiver plays disc contents intended by the software creator; therefore, functions may not operate as you intend. Be sure to read the user's guide that comes with the disc to be played.



■ Region Code of Playable Disc

 (region code), which is indicated on some DVDs, represents areas they can be played in. This receiver cannot play discs that do not have "1" or "ALL" indicated on this mark. If you attempt to play such a disc, the message "you cannot play this disc." will appear. Note also that some discs may be subject to regional restrictions, meaning that this receiver will not play them, even though they list or state a region code.

■ Mark Indicated on Disc

The following table shows the marks that are indicated on DVDs or packages.

Mark	Description
	Indicates the number of audio tracks.
	Indicates the number of subtitles.
	Indicates the number of angles.

Mark	Description
	Indicates the image aspect ratio (ratio between the height and width of the TV screen) able to be selected. <ul style="list-style-type: none"> "16:9" indicates a wide screen, and "4:3" indicates a standard screen.
	Indicates by use of a number regions where the disc can be played. <ul style="list-style-type: none"> "ALL" indicates that the disc can be played anywhere in the world, and the number indicates a region code. "1" is the region number for North America.

■ Disc Configuration

The videos and tracks recorded on a DVD are divided into sections.

A large section is referred to as a title, to which a title number is assigned. A title is divided into chapters, to which chapter numbers are assigned.

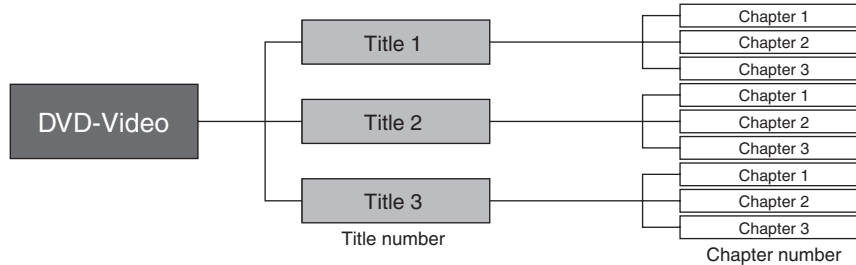

Products equipped with Macrovision

This receiver is equipped with copyright protection technology that is protected under U.S.A. patents and other intellectual property rights, which are held by Macrovision Corporation or other rights holders. Using the copyright protection technology requires the permission of Macrovision Corporation, and the technology must be used only in general households and other limited viewing environments, except when expressly permitted by Macrovision Corporation. Remodeling or disassembly of this machine is prohibited.

Operation Flow

The section explains how to operate the DVD player or search for images or default settings.

- Touching touch switches displays the operation screens shown below.

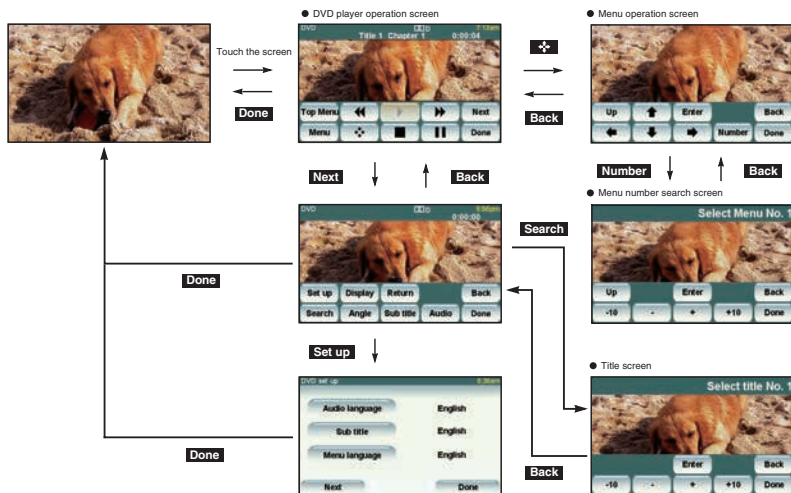

Using the DVD Player

IMPORTANT

To ensure driving safety, you cannot watch a video while driving.

CHECK

You can watch a video on a DVD only when you have stopped your vehicle and applied the parking brake for safety reasons while the engine switch or ACC is turned on. (If the source is switched to the DVD player while the car is moving, only the audio function becomes active.)

SRC button

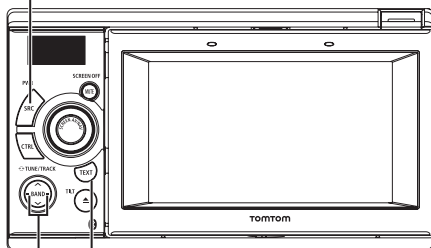

TEXT button

Chapter selection / Fast-forward (rewind) button

Watching a DVD Video

Insert a DVD into the disc slot, and it will start playing.

(1) Press the [SRC] button repeatedly until "DVD" is displayed on the sub-display.

- The disc starts to play.
- If the operation switches (touch switches) are not being displayed, touch the screen.
- If you try to play an invalid DVD, "NO SUPPORT" appears.

Video Operations

IMPORTANT

- The touch buttons and other operation icons are shown for approximately 6 seconds. Touching the screen will display them again.
- Depending on the disc, automatic playback may not function, or playback may not function unless a menu recorded on the disc is selected. See "Disc Menu Operations" on page 52.

■ Playing a Video

(1) Touch .



■ Fast Forward/Rewind

It is possible to fast forward or rewind through the video being played.

Fast Forwarding or Rewinding Using Panel Switch

(1) Hold down the [SELECT (Right)] or [SELECT (Left)] button for 1 or more seconds.

To the right:

Fast forwards a video.

To the left:

Rewinds a video.

Fast Forwarding or Rewinding continues until the switch is released. If Guide Tone is enabled, a "BEEP" sound will be heard when the fast forward or rewind action is initiated.

Fast Forwarding or Rewinding Using Touch Switches



(1) Hold down or .

Fast Forwarding or Rewinding continues until the switch is released. If Guide Tone is enabled, a "BEEP" sound will be heard when the fast forward or rewind action is initiated.



■ Pausing a Video

(1) Touch .

When video is paused (), press . Slow Play frame-by-frame play starts.



■ Stopping a Video

(1) Touch .



Disc Menu Operations

You can operate the menu recorded on the disc.

(1) Touch **Menu** or **Top Menu**.

(2) Touch .



(3) Touch , , , or , and select the playback menu.

(4) Touch **Enter**.

ATTENTION

The recorded menu items vary depending on the disc. This machine plays what is recorded on the inserted disc; therefore, functions may not operate as intended.

About the TEXT button

(1) Press the [TEXT] button.

- Chapter No. is displayed on the Sub-display for 2 seconds when the [TEXT] button is pressed and the PND is connected.
- Display on the Sub-display will be as follows when the [TEXT] button is pressed and the PND is disconnected.
Chapter No. ↔ Elapsed time

Stopping a DVD

(1) Hold down the [SRC] button for 1 or more seconds.

Press the [SRC] button again to play the last video.

Finding a Desired Video

You can search for a desired video with a title, chapter, or menu number (number assigned for each content).

■ Finding by Chapter

- (1) Press the [SELECT (Right)] or [SELECT (Left)] button.

To the right:

Selects the next chapter.

To the left (pressing once):

Returns to the beginning of the chapter being played.

To the left (Press two or more times):

Returns to the previous chapter.

■ Finding by Title Number

- (1) Touch **Search**.



- (2) Touch **-**, **+**, **-10**, or **+10**, and enter the title number.

- If you touch **-** or **+**, the title number is decreased or increased by one.
- If you touch **-10** or **+10**, the title number is decreased or increased by 10.



- (3) Touch **Enter**.

■ Finding by Menu Number

- (1) Touch **+**.



- (2) Touch **Number**.



- (3) Touch **-**, **+**, **-10**, or **+10**, and enter the menu number.

- If you touch **-** or **+**, the menu number is decreased or increased by one.
- If you touch **-10** or **+10**, the menu number is decreased or increased by 10.



- (4) Touch **Enter**.

Changing the Touch Switch Display

You can change or hide the touch switch display while playing.

■ Hiding the Touch Switch

(1) Touch **Done**.

Touching the screen will display the touch switches again.



■ Relocating the Touch Switch Display

(1) Touch **+**.

(2) Touch **Up** or **Down**.

The touch switch display moves up or down each time you touch **Up** or **Down**.



Changing the Screen Display and Audio Mode

You can change the subtitle language, audio language, or display angle of a video being played.

■ Changing the Angle

If the target disc supports multiple angles, you can change them when displaying a video.

CHECK

While the multi-angle mark appears on the DVD operation screen, you can change the currently displayed angle.

(1) Touch **Next**.

(2) Touch **Angle**.



(3) Touch **Change angle**.

Each time you touch **Change angle**, the angle number is changed, and the angles recorded on the disc are toggled in sequence.



■ Changing the Subtitle Language

If the target disc supports multiple subtitle languages, you can change them.

IMPORTANT

Depending on the disc, it may only be possible to change subtitles from the top menu.

(1) Touch **Next**.

(2) Touch **Sub title**.



(3) Touch **Change subtitle.**

Each time you touch **Change subtitle**, the subtitle number is changed, and the subtitle languages recorded on the disc are toggled in sequence.

**■ Changing the Audio Language**

If the target disc supports multiple audio languages, you can change them while playing.

IMPORTANT

- Depending on the disc, it may only be possible to change subtitles from the top menu.
- This receiver does not support the dts (digital theater system) format; therefore, no audio will be emitted when "dts audio" is selected for a disc that contains dts audio. If audio is securely recorded on the DVD video with no audio emitted, select "Dolby Digital audio".
- dts is a registered trademark of the US company Digital Theater Systems, Inc.

(1) Touch **Next.****(2) Touch **Audio**.****(3) Touch **Change audio**.**

Each time you touch **Change audio**, the audio number is changed, and the audio languages recorded on the disc are toggled in sequence.

**DVD Player Setting**

You can pre-specify the play-back audio mode or the language used to display subtitles or menus. You can also configure settings to display or hide the multi-angle mark or specify the parental screening level.

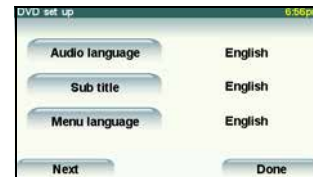
(1) Touch **Next.****(2) Touch **Set up**.****(3) Touch on each switch to configure the following setting.**

Touch switch	Function	Page
Audio language	Specifies the audio language of a video to be played.	56
Sub title	Specifies the subtitle language of a video to be played.	57
Menu language	Specifies the language used to display the menu.	57
Parental setting	Limits DVD videos that can be played.	58
Video out	Switching of the aspect ratio of Screen for rear seat monitor is performed when a rear seat monitor is connected.	59

- To display **Parental setting** or **Video out**, touch **Next**.

- To return to the previous screen, touch **Back**.

(4) Touch **Done**.

■ **Specifying the Audio Language**

You can watch the playback video in the desired language.

(1) Touch **Audio language** on the initial setting screen.

(2) Touch the desired language.

If you touch **Other**, you can specify a language other than the one displayed on the screen.



(3) Touch **Done**.

Entering the Code

(1) Touch **Other** on the preferential audio language setting screen.

(2) Enter the desired language code.

- For the language code, see "Language Code List" on page 60.
- To cancel your entry, touch **Back**.



(3) Touch **Select**.

Touch **Back** to return to the previous page.

ATTENTION

If the selected language is not compatible with the disc, you will not be able to change to that language.

■ Specifying the Subtitle Language

You can view the playback video in the desired subtitle.

(1) Touch **Sub title** on the initial setting screen.

(2) Touch the desired language.

- If you touch **Other**, you can specify a language other than the one displayed on the screen.
- If you touch **OFF**, you can play a video without viewing subtitle on the screen.



(3) Touch **Done**.

Entering the Code

(1) Touch **Other** on the preferential subtitle language setting screen.

(2) Enter the desired language code.

- For the language code, see "Language Code List" on page 60.
- To cancel your entry, touch **Back**.



(3) Touch **Select**.

Touch **Back** to return to the previous page.

ATTENTION

If the selected language is not compatible with the disc, you will not be able to change to that language.

■ Specifying the Menu Language

You can specify the language to display menus recorded on the disc.

(1) Touch **Menu language** on the initial setting screen.

(2) Touch the desired language.

If you touch **Other**, you can specify a language other than the one displayed on the screen.



(3) Touch **Done**.

Entering the Code

(1) Touch **Other** on the menu language setting screen.

(2) Enter the desired language code.

- For the language code, see "Language Code List" on page 60.
- To cancel your entry, touch .



(3) Touch **Select**.

Touch **Back** to return to the previous page.

ATTENTION

If the selected language is not compatible with the disc, you will not be able to change to that language.

■ Specifying the Parental Screening Level

You can restrict viewing of scenes that are inappropriate for children, for example, adult-themed or violent scenes. The parental screening levels can be specified in stages depending on levels.

CHECK

This function is not available for discs that do not support the parental screening level function.

(1) Touch **Next** on the initial setting screen.

(2) Touch **Parental setting**.

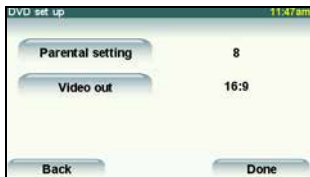

(3) Touch the number digit by digit to enter the code number.

If the code number has not yet been set, "----" is displayed in the upper field.

If the code number has not yet been set, the input number will be registered as the code number.



(4) Touch **Select**.

Touch **Back** to return to the previous page.

(5) Touch the desired parental screening level.

If you have entered an incorrect code number, eject the disc once, and specify the parental screening level again.

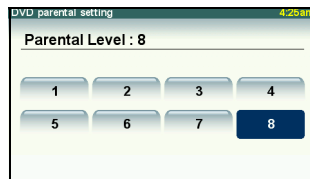

 **ATTENTION**

- The code number is necessary. If a number is not entered, setting of viewer restriction will not be activated.
- Once a code number is specified, you must enter it when using this item next time and after. Be careful not to forget the code number. If you forget the code number, touch  10 times while the code number field remains blank; you can initialize (clear) the current code number.
- Parental screening levels are classified into the following three groups / categories.
 - Level 1
Plays only DVD software created specifically for children. (Prohibits playing general and adult-themed DVD software.)
 - Levels 2 to 7
Plays only the general and child-friendly DVD software. (Prohibits playing adult-themed DVD software.)
 - Level 8
Plays all DVD software. (Default)

■ Switching the Video Output

- (1) Touch **Next** on the setting screen.
- (2) Touch **Video out**.
 - The screen output setting can be changed by touching **Video out**.
4:3 (LETTER BOX) → 4:3 (PAN&SCAN) → 16:9 → 4:3 (LETTER BOX) ...
 - 4:3 (PAN&SCAN)
The left and the right edges of the video image are cropped. DVDs recorded with the 4:3 ratio are displayed in the original ratio, which fits the screen perfectly.
 - 4:3 (LETTER BOX)
Displayed in the usual wide size mode. DVDs recorded with the 4:3 ratio are displayed with a black strip on the left and the right edges or in a horizontally spread proportion.
 - 16:9
Displayed with a black strip on the upper and the lower edges. DVDs recorded with the 4:3 ratio are displayed in the original ratio, which fits the screen perfectly.

 **ATTENTION**

The user should not experience any problems when watching a video on the wide screen on a personal basis. If you compress or enlarge the screen for commercial purposes or to display to the public, it may infringe upon a copyright that is protected by copyright laws.

Language Code List

These codes are used to specify the language for audio tracks, subtitles and on-screen menu displays.

Code	Language	Code	Language	Code	Language	Code	Language	Code	Language
1001	Japanese	0315	Corsican	0923	Hebrew	1415	Norwegian	1922	Swedish
0514	English	0319	Czech	1009	Yiddish	1503	Occitan	1923	Swahili
0618	French	0325	Welsh	1023	Javanese	1513	Oromo	2001	Tamil
0405	German	0401	Danish	1101	Georgian	1518	Oriya	2005	Telugu
0920	Italian	0426	Bhutani	1111	Kazakh	1601	Panjabi	2007	Tajik
0519	Spanish	0515	Esperanto	1112	Greenlandic	1612	Polish	2008	Thai
1412	Dutch	0520	Estonian	1113	Cambodian	1619	Pashto	2009	Tigrinya
1821	Russian	0521	Basque	1114	Kannada	1620	Portuguese	2011	Turkmen
2608	Chinese	0601	Persian	1119	Kashmiri	1721	Quechua	2012	Tagalog
1115	Korean	0609	Finnish	1121	Kurdish	1813	Rhaeto-Romance	2014	Setswana
0512	Greek	0610	Fiji	1125	Kirghiz	1814	Kirundi	2015	Tonga
0101	Afar	0615	Faroese	1201	Latin	1815	Romanian	2018	Turkish
0102	Abkhazian	0625	Frisian	1214	Lingala	1823	Kinyarwanda	2019	Tsonga
0106	Afrikaans	0701	Irish	1215	Loathian	1901	Sanskrit	2020	Tatar
0113	Amharic	0704	Scots-Gaelic	1220	Lithuanian	1904	Sindhi	2023	Twi
0118	Arabic	0712	Galician	1222	Latvian	1907	Sangho	2111	Ukrainian
0119	Assamese	0714	Guarani	1307	Malagasy	1908	Serbo-Croatian	2118	Urdu
0125	Aymara	0721	Gujarati	1309	Maori	1909	Sinhalese	2126	Uzbek
0126	Azerbaijani	0801	Hausa	1311	Macedonian	1911	Slovak	2209	Vietnamese
0201	Bashkir	0809	Hindi	1312	Malayalam	1912	Slovenian	2215	Volapuk
0205	Byelorussian	0818	Croatian	1314	Mongolian	1913	Samoan	2315	Wolof
0207	Bulgarian	0821	Hungarian	1315	Moldavian	1914	Shona	2408	Xhosa
0208	Bihari	0825	Armenian	1318	Marathi	1915	Somali	2515	Yoruba
0209	Bislama	0901	Interlingua	1319	Malay	1917	Albanian	2621	Zulu
0214	Bengali	0905	Interlingue	1320	Maltese	1918	Serbian		
0215	Tibetan	0911	Inupiak	1325	Burmese	1919	Siswati		
0218	Breton	0914	Indonesian	1401	Nauru	1920	Sesotho		
0301	Catalan	0919	Icelandic	1405	Nepali	1921	Sundanese		

Using the iPod Player

Music files or video files on the iPod can be played when the receiver is switched to iPod mode and an iPod is connected. Using this receiver, you can perform operations such as selecting a file from a list or changing to the shuffle playback mode.

IMPORTANT

- For details on the iPod functions, refer to the iPod operation manual.
- This section explains the operation of the iPod and assumes that the iPod is connected to the receiver.
- To ensure driving safety, you cannot watch a video while driving.
- Music or video files in the iPod can be played only when the PND is attached to the main unit.
- Please be sure to disconnect or turn off any external devices such as an iPod when turning the vehicle off. Otherwise, the main unit may not recognize these devices when the vehicle is turned back on. If this does happen, please disconnect and reconnect the device to start playback.

IMPORTANT

- Please be sure to disconnect or turn off any external devices such as iPods or USB memory devices when turning the vehicle off. Otherwise, the navigation system may not recognize these devices when the vehicle is turned back on. If this does happen, please disconnect and reconnect the device to start playback.

- Do not make any illegal or unauthorized copies of music or video files.
- iPod is a trademark of Apple Inc., registered in the U.S. and other countries.
- iPod is for legal or rightholder-authorized copying only. Don't steal music.
- "Made for iPod" means that an electronic accessory has been designed to connect specifically to iPod and has been certified by the developer to meet Apple performance standards.



- Apple is not responsible for the operation of this device or its compliance with safety and regulatory standards.

SRC button

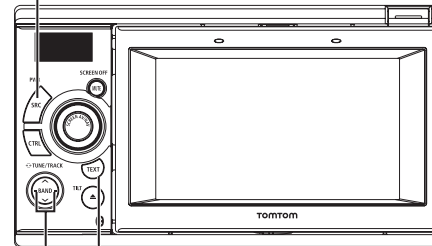

TEXT button

Track selection / Fast-forward (rewind) button

Listening to the iPod

CAUTION

- Disconnect headphones and other accessories from the iPod before connecting it to this receiver. Failure to do so may make it impossible to operate the iPod from this receiver.
- If the iPod's equalizer has been preset, sound output may be distorted when it is connected to the connection cable.

IMPORTANT

- Music files or video files playing on the iPod when connected are played when the iPod is connected.
- When the iPod (and PND) is reconnected and switched to iPod mode, or when the iPod is connected and it is switched to iPod mode from other modes, playback of the music file or the video file that was playing during the previous iPod mode will be started. However, if the receiver cannot detect the music file or video file that was playing previously, it will begin playing from the first music file or video file.

■ When the iPod is not connected

- (1) **Connect the iPod to the receiver using the interface cable.**
- (2) **Press the [SRC] button repeatedly until "IPOD" is displayed on the subdisplay.**
Playback will begin.

■ When the iPod is connected

- (1) **Press the [SRC] button repeatedly until "IPOD" is displayed on the sub-display.**
Playback will begin.

Fast Forward/Rewind

You can fast forward or rewind the track or the video currently being played.

- (1) **Hold down the [SELECT (Right)] or [SELECT (Left)] button for 1 or more seconds.**

To the right:

Forwards a music or video file.

To the left:

Rewinds a music or video file.

This switches to the fast forward or rewind mode, and continues fast forwarding or rewinding until you remove your finger from the button.

Selecting the Desired Music or Video File

You can select a desired song or video.

- (1) **Press the [SELECT (Right)] or [SELECT (Left)] button.**

To the right:

Advances to the next file.

To the left:

Returns to the beginning of the file being played.

To the left (Press more than two times):

Returns to the previous file.

The selected music or video file will be played.

Finding a Desired Music File

CAUTION

If the iPod or PND is disconnected from the receiver while playing a music file on the iPod, the receiver will return to the previously selected mode.

- (1) **Touch **Select**.**

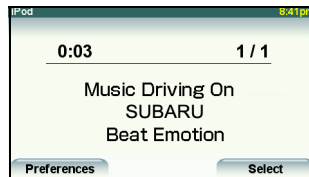

- (2) **To select a track or program to play, touch **Playlist**, **Artist**, **Album**, **Song**, **Genre**, or **Audio books**.**

This displays the list screen of the selected mode.



(3) Touch on the desired song name.

- The Selected music start playing.
- When ▲ or ▼ appears, touch them to change the page of the music file list.
- You can search for a file or artist name by touching **Find**.



- You can search for a music file by entering alphanumeric characters.
- Special characters cannot be used.

**Setting to the iPod Video Mode**

You can select the desired video file from Video Playlists, Movies, Music videos, or Video Podcasts.

CAUTION

- You can play a video file on the iPod only when the PND is connected to the receiver.
- If the iPod or PND is disconnected from the receiver while playing a video file on the iPod, the receiver will return to the previously selected mode.

- (1) Touch **Select**.
- (2) Touch **Video**.
- (3) To select the video you want to play, touch **Video Playlist**, **Movies**, **Music Videos**, or **Video Podcasts**.

The iPod video selection screen appears.

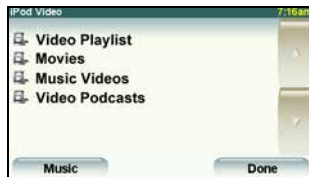
**(4) Touch on the desired video name.**

- This plays the selected video file.
- If ▲ or ▼ appears, touch them to change the page of the video file list.
- You can search for a file or artist name by touching **Find**.



- You can search for a video file by entering alphanumeric characters.



Playing

This function is available in the iPod video mode.

- (1) Touch .





Pausing

This function is available in the iPod video mode.



- (1) Touch .



Touch  to pause the display. Touch  to resume playing.

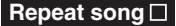

Repeatedly Playing the Same Music File

- (1) Touch **Preferences**.
- (2) Touch **Repeat song** .

- This repeatedly plays the currently played music file.
- Once you touch **Repeat song** , the selected music file will be repeated until the repeat function is released. Touch **Repeat song**  again to cancel the random play.

Random Play of Music Files

- (1) Touch **Preferences**.
- (2) Touch **Shuffle songs** .

Once you touch **Shuffle songs** , the random play continues until you cancel it. Touch **Shuffle songs**  again to cancel the random play.

Switching Aspect Ratio of Screen

- (1) Touch **Display**.
- (2) Touch **16:9**, **4:3** or **Zoom**.

After the screen size has been switched, the iPod setting screen appears for approximately 6 seconds.

About the TEXT button

Display the iPod mode on the Sub-display.

- (1) Press the [TEXT] button.

iPod mode is displayed on the Sub-display for 2 seconds if the [TEXT] button is pressed and the PND is connected.

Compatible iPod models

The following iPod models can be used with the main unit.

iPods not shown in the following table may not function properly when connected to the receiver.

iPod model	Minimum iPod software version
iPod 4G*	3.1.1
iPod 5G Video	1.3
iPod Classic 80G	1.1.2
iPod Classic 120G	2.0.1
iPod Classic 160G	1.1.2
iPod Nano*	1.3.1
iPod Nano 2G	1.1.2
iPod Nano 3G	1.1.2
iPod Mini*	1.4.1
iPod Touch*	1.1.4

* Video function not available

Stopping the iPod

- (1) Hold down the [SRC] button for 1 or more seconds.

Using the AUX

IMPORTANT

- While the AUX mode is activated, actions such as turning off the audio player or pulling out the connection cord may cause noise spikes that can damage the system speakers. Be sure to avoid this possibility by turning off system power or switching from the AUX mode to another mode before shutting off or disconnecting the portable audio player.
- Audio output levels will differ for the various devices that can be connected using the AUX input. Carefully adjust the volume until the output level of the connected player is known.
- Before using a portable audio player inside a vehicle, read the player's operation manual carefully and confirm that you will be able to easily operate the device in the vehicle before proceeding.

SRC button

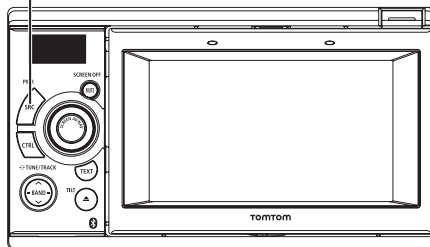

Switching the AUX Mode ON and OFF

CHECK

If the NAVIGATION screen is displayed, press the [SCREEN AV/NAV] button to switch to the AUDIO screen.

- (1) **Hold down the [SRC] button for 1 or more seconds.**
Audio mode will be turned OFF.
- (2) **Hold down the [CTRL] button for 1 or more seconds.**

- (3) Touch **Enable AUX** that appears on the PND display.

Checked: AUX setting ON

Not checked: AUX setting OFF

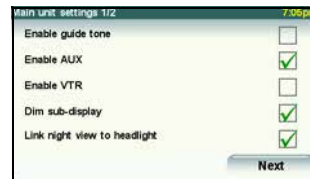

- (4) Touch **Next**.
- (5) Touch **Done**.

Listening to the Portable Audio Player

For details on how to operate the portable audio player, refer to the instruction manual that came with the portable audio player.

CAUTION

- Do not operate the portable audio player while driving.
- The audio output level varies depending on the connected device. Be aware of the volume.

- (1) Turn on the connected portable audio player to start music playback.**
- (2) Press the [SRC] button repeatedly until "AUX" is displayed on the sub-display.**
 - The sound from the connected portable audio player will be output.
 - If the Enable AUX setting is OFF, "AUX" will not be displayed even if the [SRC] button is pressed. Set Enable AUX to ON. For details, see "Enable AUX" on page 20.

ATTENTION

It is recommended that the portable audio player be powered by its battery when used for music playback through the AUX mode. If music playback is attempted while charging the battery using a vehicle power charger or accessory socket, additional noises may be heard.

TEXT Button

Displays the AUX mode on the Sub-display.

- (1) Press [TEXT] button.**
 - AUX mode is displayed on the Sub-display when the [TEXT] button is pressed and the PND is connected.
 - AUX mode is displayed on the Sub-display constantly and the PND is not connected.

Turning off the Portable Audio Player

- (1) Hold down the [SRC] button for 1 or more seconds.**

Press the [SRC] button again to output audio sound from the portable audio player.

About the Steering Wheel Switches

Compatibility with Steering Wheel Switches

The table below shows the compatibility between the steering wheel switches and this receiver.

Operation	Switch	Name	Function	Explanation of operation
Common operations	(+) (-)	Volume switch	Each momentary actuation of these switches changes the volume one step. Hold a switch down for a continuous volume change.	(+): Volume UP (-): Volume DOWN
	(MODE)	Mode selection switch	<ul style="list-style-type: none"> When this switch is pressed while the power is turned off, the power is turned on. Power is turned off when this switch is held down while the power is on. The mode changes in the following order. Returns to FM/AM → DISC (CD or DVD) → USB → AUX → iPod → FM/AM 	When the power is on, the mode changes each time (MODE) is pressed.
	(MUTE)	Mute switch	Mute audio except navigation voice and Bluetooth phone call.	Press (MUTE) when audio is on to mute audio. Press (MUTE) when audio is muted to cancel muting.
Radio operations	(^) (v)	Channel selection switch	<ul style="list-style-type: none"> Calls up the preset broadcast channels in order. Starts the automatic channel selection operation. 	Press (^) or (v) briefly to select the next or previous preset channel. Press and hold (^) or (v) longer to start the automatic channel selection operation.
CD Player operation	(^) (v)	Track selection switches	<ul style="list-style-type: none"> Selects the next track or previous track or beginning of the current track. Fast forward, or rewind 	Press (^) or (v) briefly to select the next or previous track. Press and hold (^) or (v) longer to fast forward or rewind a track.

Operation	Switch	Name	Function	Explanation of operation
MP3/WMA Player operations	(^) (v)	File or folder selection switches	<ul style="list-style-type: none"> • Selects the next or previous file. • Moves to the next or previous folder. 	Press (^) or (v) briefly to select the next or previous file. Press and hold (^) or (v) longer to select the next or previous folder.
USB operations	(^) (v)	File or folder selection switches	<ul style="list-style-type: none"> • Selects the next or previous file. • Moves to the next or previous folder. 	Press (^) or (v) briefly to select the next or previous file. Press and hold (^) or (v) longer to select the next or previous folder.
iPod operations	(^) (v)	Track selection switches	<ul style="list-style-type: none"> • Selects the next track or previous track or beginning of the current track. • Fast forward, or rewind 	Press (^) or (v) briefly to select the next or previous track. Press and hold (^) or (v) longer to fast forward or rewind a track.
Function DVD operations	(^) (v)	Chapter selection and fast forward or rewind switch	<ul style="list-style-type: none"> • Selects the next or previous chapter. • Fast forward or rewind 	Press (^) or (v) briefly to select the next or previous chapter. Press and hold (^) or (v) longer to fast forward or rewind a track.

Rearview Camera Operations

If a separately sold rearview camera is installed, you can display the area behind the vehicle on the PND when shifting into reverse gear.

CAUTION

The rearview camera plays a mirror-reversed video image in the same way a rear or side mirror reflects a scene.

ATTENTION

- Do not rely solely on the rearview camera, use it as additional tool to check for obstacles.
- Raindrops on the camera unit may result in a poor video image being displayed.
- The Rear View Camera is strictly a driver assistance device, and should not be relied upon as a substitute for safe driving practices. Use common sense when driving in reverse and always follow recommended safe driving guidelines from your state or local Department of Motor Vehicles regarding the engagement of reverse gear. To help prevent accidents, always use caution when driving in reverse by visually checking to ensure that your path is clear. When applicable, that may include conducting a visual check before you enter your vehicle.
- When the display is cold, it may be difficult to recognize the contents of the video due to the screening of a darker image or an image lag. Make sure to visually check that conditions are safe around your vehicle while driving.
- The person or obstacle displayed on the screen may be different from the actual position due to the characteristics of the camera lens.
- If you rub or polish the camera cover strongly with an abrasive or brush with hard bristles, it may damage the cover, which may affect the video.
- The camera cover is made of resin. Do not allow any organic solvents, body wax, oil film remover, or glass coating solvent to come in contact with the camera cover. If contacted, wipe off the camera immediately.
- Hitting the camera unit may result in a rearview camera malfunction due to camera failure. Have your authorized dealer check the problem early.
- The photographs used in this manual are examples of displayed images. The actual field of view displayed on the screen may differ for your model.
- When you change to reverse gear, the screen will turn white and then the image will quickly return to the screen.
- If the camera unit is exposed to strong light such as sunlight or headlights, a vertically-oriented white zone may appear.
- If the camera is used for a long period of time, white scratches or vertical lines may appear as the temperature rises. note that these phenomena are caused due to the CCD characteristics.
- The rearview camera is equipped with a special lens; therefore, distances perceived through viewing the video screen will be different from actual distances.

Playing a Video through the Rearview Camera

■ When the Camera Is Set to MANUAL or AUTO

(1) Hold down the [SCREEN AV/NAV] knob.

This changes to the rearview camera screen.



■ When the Camera Is Set to AUTO

(1) Shift to the reverse gear.

This changes to the rearview camera screen.



ATTENTION

- The image field of view displayed on the screen may vary depending on vehicle or road surface conditions.
- The image field of view displayed on the screen is limited; for example, you cannot display something that is located near both ends of the bumper or under the bumper.
- Colors shown in the rearward image may be different from the actual colors of the objects shown.
- In the following cases, Rearview Camera vision may be reduced:
 - In dark places (at night, etc.)
 - The temperature near the lens is high or low.
 - When there are water drops on the camera, or when humidity is high (during rain showers, etc.)
 - Foreign substances (mud, etc.) have become attached to locations on or near the camera.
 - The camera lens has been exposed directly to sunlight or the rays of headlights.

- If a high-intensity point (sunlight reflected on the vehicle body, etc.) is reflected on the camera, it may result in a smearing phenomenon* particular to the CCD camera.

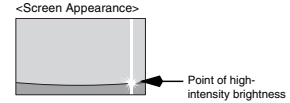

- * Smearing phenomenon: Refers to an image lag that is caused in the vertical direction of a high-intensity point (sunlight reflected on the vehicle body, etc.) reflected on the camera.

Troubleshooting Guide

For details on how to use the navigation and hands-free call function, refer to the TomTom manual on the CD-ROM supplied as an accessory or download it from the URL shown below.

(<http://download.tomtom.com/open/manuals/eclipse2/eclipse2/refman/TomTom-en-US.pdf>)

If the Following Messages Appear

If the following messages appear, check the status again, referring to the cause and action.

■ CD/MP3/WMA/DVD Modes

Message	Cause	Action
DISC CHECK (PND) INF3 (Sub-display)	Discs are dirty or damaged.	The loaded disc is dirty or upside down. Check it for proper orientation and verify it is clean.
DISC CHECK (PND) INF5 (Sub-display)	CD player fails mechanically.	The CD player is inoperative for some reason.
DISC ERROR (PND) INF6 (Sub-display)	When the CD player internal temperature is high. (To protect pickup unit)*	<ul style="list-style-type: none"> The temperature in the CD player is too high for operation to continue. Wait until it cools down. Resume playing after the "High temperature sensed and CD stopped" message disappears. If the CD still cannot play, have your dealer repair it.
DISC ERROR (PND) INF7 (Sub-display)	An internal power supply failure is occurring.	<ul style="list-style-type: none"> Turn off the vehicle's accessory power and turn it back on to resume operation. If this condition persists, please contact your dealer.
NO SUPPORT (PND) ERR (Sub-display)	No correct file in CD.	Confirm that the file is present and in a supported format.

Message	Cause	Action
PROTECT (PND) PROTECT (Sub-display)	A license-controlled file is included.	Switch the mode, or change the track.
DISC CHECK (PND) INF3 (Sub-display)	The CD/MP3-WMA/DVD is dirty, scratched, warped or upside down.	Clean the disc if it is dirty. Insert the disc correctly if it is upsidedown. Do not use a scratched or warped disc.
DISC ERROR (PND) INF5 (Sub-display)	The CD/MP3-WMA or DVD player is not operating for some reason.	Eject the disc.
DISC ERROR (PND) INF6 (Sub-display)	The temperature of the CD/MP3-WMA or DVD player has become unusually high*.	Without performing any other operations, wait until the temperature comes down*.
Pass code incorrect (PND)	This message is displayed when the pass code that has been entered is not correct.	Enter the correct pass code. (See page 58)
Parental lock enabled (PND) ERR (Sub-display)	Viewing restrictions are enabled.	Change the setting for viewing restrictions and start again. (See page 58)
Currently this function is disabled. (PND)	A function that has been disabled was selected with the menu.	Follow the directions on the screen and start again.
Currently this function is disabled. (PND)	A function that cannot be used while the vehicle is in motion was selected.	Stop the vehicle and set the emergency / parking brake.
Invalid code (PND)	A number not supported was input for selecting a language code.	Input a valid language code.
Region code error (PND) ERR (Sub-display)	The region code (controlled region for playback) of the disc is not acceptable.	Check that the DVD has a region code that can be played on this equipment. (See page 48)
Requested chapter or title not found. (PND)	The selected chapter/title does not exist.	Select a chapter/title that is on the disc.

* If this happens, wait for a brief period. When the temperature inside the equipment returns to normal, the message will disappear and playback will start. If the message does not disappear after a long period of waiting, contact your dealer.

■ USB Mode

Message	Causes	Remedial action
Don't remove the storage device until scanning is finished (PND)	This machine is currently reading USB data.	Wait for a brief period.
No songs found (PND) ERR (Sub-display)	The USB memory does not include any supported audio files.	Import tracks onto the USB memory to play them.
External USB device is not supported (PND) ERR (Sub-display)	Communication or play-back error	Wait until the error is corrected, or change the mode.

■ iPod Mode

Message	Causes	Remedial action
This device cannot be connected in this way - use a different cable (PND) ERR (Sub-display)	The iPod has been connected to the USB port.	Connect the iPod to the iPod dock cable instead of the USB port.
READING (PND)	This machine is currently detecting iPod data.	Wait for a brief period.
No songs found (PND) ERR (Sub-display)	The iPod include no tracks.	Import tracks to the iPod to play them.
No videos found (PND) ERR (Sub-display)	The iPod contains no video.	Import a video file for the iPod to play.
No songs or videos found (PND) ERR (Sub-display)	The iPod contains neither tracks nor video.	Import a track or video file for the iPod to play.
Unable connect to iPod (PND) ERR (Sub-display)	A communication error, playback error, iPod software incompatibility, or control error occurred.	Connect a playable iPod.

Basic Trouble Shooting

A slight difference in operation may be mistaken for a malfunction. Please check the items in the following table first. If the unit does not work, even after the appropriate remedial action has been taken, please contact your dealer.

⚠ CAUTION

If a problem occurs, for instance when the main unit does not respond to any button presses, or the display does not work correctly, press the [Reset] button using a paper clip or similar item.

Pressing the [Reset] button will delete all the entries from memory. The settings will return to those made at the factory prior to shipment.

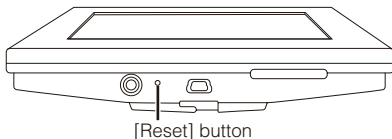

Phenomenon	Possible cause	Action
The screen is dark for a brief period when the power is turned on at low temperatures.	This is a characteristic of the PND-display.	This is not a malfunction. Wait for a brief period.
The display is distorted for a brief period after the power is turned on.	This is a characteristic of the PND-display backlighting.	This is not a malfunction. The display will stabilize after a brief period.
No sound comes out.	Volume is poorly adjusted or MUTE is functioning.	Turn the VOL rotary knob to adjust the volume, or release MUTE.
	The music is muted when the PND is attached to the main unit and when: <ul style="list-style-type: none"> the voice guidance is ON. talking in the hands-free mode* 	This is not a malfunction. The music can be heard again when the voice guidance finishes or the hands-free mode is turned off.
Sound comes out of only one side (left or right, front or back).	A speaker wire is disconnected.	Check the connections of the speaker wires.
	Volume is poorly adjusted.	Check the balance and fader adjustments.

Phenomenon	Possible cause	Action
Sound quality does not change even after making adjustments.	The adjusted audio quality is not included in the radio broadcast or disc.	Check by changing the radio station or disc.
A CD/DVD will not go into the deck.	Power is not turned on.	Turn the vehicle ignition switch to [ACC] or [ON].
	A disc is already inserted and you are trying to insert a second disc.	Eject the previously inserted CD/DVD and insert the preferred CD/DVD.
A CD/DVD cannot be played.	There is water condensation inside the equipment.	Stop using the equipment for a short time and then try using it again. (See page 9)
	There is a large scratch or warp in the CD/DVD.	Insert a different CD/DVD.
	The CD/DVD is very dirty.	Clean the CD/DVD. (See page 9)
	The CD/DVD is upside down. A non-supported type of CD/DVD has been inserted.	Insert the CD/DVD with the proper orientation. Insert a CD/DVD that is supported in the deck. (See page 9)
Audio is output, but not video.	The screen has been turned off with the screen OFF button.	Press the [SCREEN AV/NAV] button. (See page 15)
Audio is output, but not DVD video. (With vehicle stopped.)	The emergency / parking brake has not been set.	Set the emergency / parking brake.
Neither video nor audio is output.	The vehicle ignition switch has not been turned on.	Turn the vehicle ignition switch to [ACC] or [ON].
	The connection wires and cables are not completely connected.	Check the connections to each connection wire and cable.
There is a point of light on the display.	At least 99.99% of the pixels on the PND-display are effective, but it is possible that 0.01% of the pixels may not light or may stay lighted.	This is not a defect, so please use the equipment in this condition.

Phenomenon	Possible cause	Action
There is no "BEEP" sound or audible feedback when setting presets or when performing certain functions.	The Guide Tone has not been enabled.	Enable the Guide Tone. (See page 20)
AUX input mode cannot be accessed.	AUX input is not enabled.	Enable the AUX input. (See page 66)
An MP3/WMA file cannot be played.	A disc which contains MP3/WMA files that are not able to be played using this deck has been inserted.	Insert a disc that is able to be played using this deck. (See page 38)
A music file stored in the USB memory device cannot be played.	Music files that are not able to be played using this deck are stored in the USB memory device.	Store music files that are able to be played using this deck in the USB memory device.. (See page 45)
A music file in the iPod cannot be played.	A non-supported type of iPod has been connected.	Check the software version of the iPod. (See page 65)
iPod & USB playback do not start automatically when the vehicle ignition is cycled on.	This is normal operation.	None.
iPod & USB Shuffle & Repeat settings are not remembered when the vehicle's ignition is cycled off and on.	This is normal operation.	None.
Certain functions such as browsing are not allowed.	The vehicle is in motion and/or the parking brake has not been set.	Stop the vehicle in a safe location and set the parking brake. (See page 19)

* Depending on your mobile phone, the mute function may not work correctly. If it does not, press the [MUTE] button on the main unit.

How to Contact Subaru

Contact information

<Location>

In the Continental US & Alaska

<Contact>

Web: www.subaru.com

Email: www.subaru.com/contactus

Defective products/Warranty

<Defective product / What to do?>

If you suspect that you have a defective product:

1. Before returning to your Subaru Dealer, refer to the page “Troubleshooting Guide” on page 72 and perform the checks and solutions listed.
2. Make an appointment at a Subaru Dealership to have the system inspected in order to determine if the product is malfunctioning.

<Warranty>

This product is covered under the terms of the Subaru Limited Warranty for Genuine Accessories. Please refer to the Warranty and Maintenance booklet included with your Owner Information Kit for full details.

Memo

NOTICE TO OWNER

Please retain this booklet and write the serial number of this product for identification and accurate reporting to your local police in the event of theft.

The serial number is labeled or stamped on the chassis.

Please confirm this number at your car dealer or service shop when the unit has been reinstalled or exchanged to you after repair or readjustment.

Serial No. _____

Manufactured for SUBARU
by FUJITSU TEN LIMITED

090002-33240700
1005(Y)