

2013  
**BRZ**



**Quick Reference Guide**



Complete U.S. specifications and illustrations may not have been available at time of publication. Specifications are based on the latest product information available at time of publication. Some images shown are for illustration purposes only. Some equipment shown may be optional at extra cost. Specific options may be available only in combination with other options. Specific combinations of equipment or features may vary from time to time and by geographic area. Certain accessories and equipment may not be available at the time of publication.

This Quick Reference Guide applies to all BRZ models. Therefore, some explanations may be for equipment not installed on your vehicle. Subaru of America, Inc., reserves the right to change or discontinue at any time, without notice, prices, colors, materials, equipment, accessories, specifications, models and packages without incurring any obligation to make the same or similar changes on vehicles previously sold. Colors shown may vary due to reproduction process.

For detailed operating and safety information, please consult the Owner's Manual.

Subaru, Outback, Legacy, Forester, Impreza, WRX, WRX/STI, BRZ, BOXER, SI-DRIVE, Lineartronic, Alcantara, Circle Surround, XM and Sirius are registered trademarks.

All rights reserved. Contents may not be reprinted or electronically reproduced in whole or in part without prior written approval of Subaru of America, Inc.



# Table of Contents

<b>Getting Started</b>	—	○	2 - 3
<b>Instrument Panel</b>	—	○	4 - 5
<b>Gauges</b>	—	○	6 - 7
<b>Personalize</b>	—	○	8 - 9
<b>Controls</b>	—	○	10 - 19
<b>While Operating</b>	—	○	20 - 23
<b>Safety/In Case of Emergency</b>	—	○	24 - 25
<b>Additional Information</b>	—	○	26 - 27



# Getting Started

## Remote Keyless Entry

### Lock/Arm

- Press to lock all doors and trunk and activate the security alarm.
- If any of the doors or the trunk are not fully closed, an electronic chirp will sound to alert you that the doors or the trunk are not properly closed.

### Opening the Trunk Lid

Press and hold to unlock the trunk lid. An electronic chirp will sound.

### Panic Alarm

- Press and hold, the horn will sound and the hazard lights will flash.
- Press any button on the remote to deactivate.

### Unlock/Disarm

- Press once to unlock the driver's door.
- Press twice (within five seconds) to unlock all doors.
- When the "Unlock/Disarm" button is pressed, the dome and map lights will illuminate if the dome light switch is in the middle position.



# Seating



## Seat Controls

### 1. Forward/Backward

Pull up on the lever below the front of the driver's seat to move the seat forward or backward.

### 2. Raise/Lower Seat Cushion

To adjust the height of the driver's seat, push or pull the seat height adjustment lever located on the lower left side front of the seat.

### 3. Recline Seatback

To adjust the seatback to the desired position, pull up on the recline lever located on the lower left side rear of the driver's seat or lower right side rear side of the passenger's seat. Do not adjust seats while driving.

### 4. Seatback Fold Strap

To get in and out of the back seats, pull the seat strap to fold the desired seat. When finished, push the seatback until it locks in place.



## Heated Seats (if equipped)

Switches are located on the center console between the driver and passenger seats. Choose low (bottom of switch) for normal heating or high (top of switch) for rapid heating. Choose the center position to turn off the seat heaters.

## Folding Down the Rear Seats

Lower the headrests. Open the trunk and pull the release strap on the seat side that you want to fold down. To return the seatback to its original position, raise the seatback until it locks into place and make sure that it is securely locked.



# Instrument Panel



pg. 10

pg. 20

pg. 10

pg. 9

pg. 6-7

pg. 19

pg. 20



pg. 11

pg. 12-15

pg. 16

pg. 21

### Clock

Press the "H" button to adjust the hours and the "M" button to adjust the minutes. Vehicles with a navigation system, please refer to the separate booklet "Operating Instructions for Navigation System."

# Gauges

■ Immediate Attention

■ Caution

■ Informational

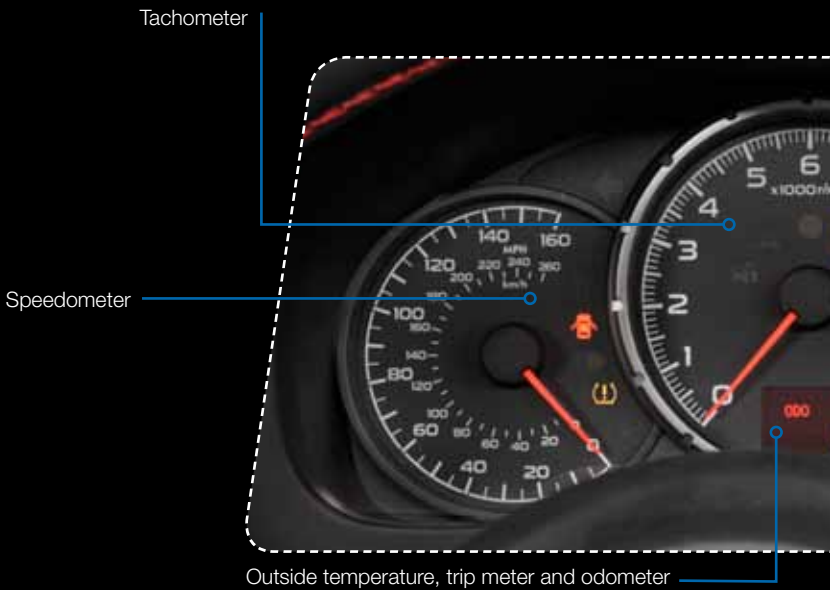

Seatbelt warning



REV indicator



Front passenger seatbelt warning



Hot coolant temperature/  
Cold coolant temperature



SRS airbag system



High beam indicator light



Engine immobilizer indicator light



AT OIL TEMP  
(Automatic Transmission)



Door open



ABS warning



Charge warning



Low fuel



Oil pressure warning



SNOW indicator  
(Automatic Transmission)



Power steering warning



Slip indicator

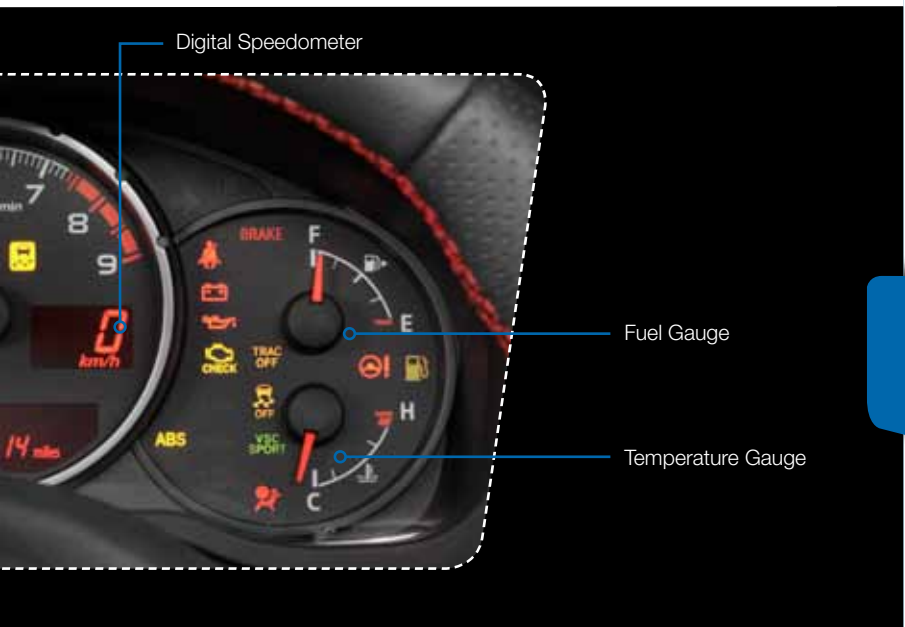

VSC off



Turn signals

CHECK engine/  
Malfunction indicatorFront fog light indicator  
light (if equipped)

Tire pressure warning light

Cruise control  
indicator lightFront passenger frontal  
airbag OFF/ONCruise control set  
indicator lightHeadlight leveler  
(if equipped)SPORT indicator  
(Automatic Transmission)

TRAC OFF indicator



VSC SPORT indicator

Smart key system  
(if equipped)

# Personalize



## Tilt Steering Column

Push the lever down firmly to adjust the height position of the column; firmly push the lever back up to lock the column in place. Do not adjust while driving.

## Power Exterior Mirrors

Turn the knob to the "L" to adjust the left-hand mirror or to the "R" to adjust the right-hand mirror. Move the knob in the direction you want to move the mirror. Then return the knob to the neutral/center position.

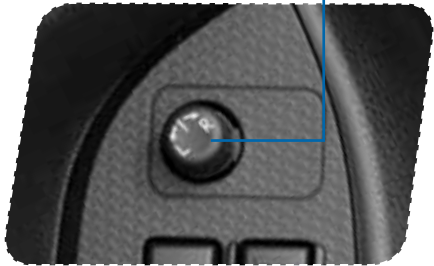

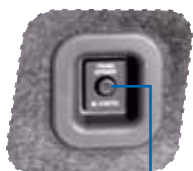

### Trunk lid cancel button

Prevent unauthorized entry into the trunk by locking the trunk release lever. Press the trunk lid cancel button to lock the trunk release lever. The trunk can only be opened using the master key. Press the button in to unlock the trunk release lever.



### km/h - MPH, ODO - TRIP, DISP Buttons

1. Press this button to change the digital display from km/h to MPH. Press again to switch back.
2. Press this button to cycle through the odometer, trip meter A, trip meter B, setting screen for the tachometer needle or the setting screen for the shift position indicator.
3. Press this button to cycle through the outside temperature, current fuel consumption, average fuel consumption or the setting screen for the REV indicator.



# Controls

## Light Controls

Push up for right turn signal.

Turns on instrument panel lights, tail lights, parking lights and license plate lights.

Turns on headlights, instrument panel illumination, parking lights, tail lights and license plate lights.

Push down for left turn signal.

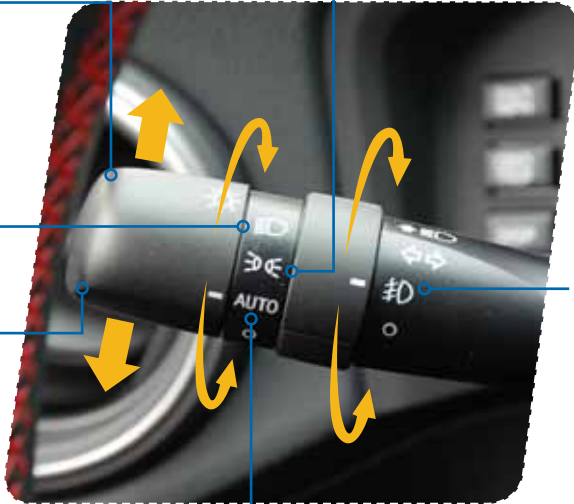

Turns on fog lights (if equipped).

AUTO: The vehicle's lights are automatically on or off depending on the level of the outside light.

## Illumination Brightness Control

While the light switch is on, rotate the dial downward to dim the instrument panel illumination. Rotate the dial upward to make the illumination brighter. When the dial is fully rotated upward, the instrument panel illumination becomes full bright.



## Headlight Beam Leveler



High-Intensity Discharge (HID) headlights generate more light than conventional halogen headlights. Therefore, a driver of an oncoming vehicle may experience too much glare when your headlight beam height adjustment is high because the vehicle is carrying a heavy load. The headlight beam leveler can be used to adjust beam height to avoid such a condition. To lower the beam, turn the knob to the higher numbers.



## Windshield Wipers

To turn on the wipers, press the wiper control lever down one level for intermittent, two levels for low, or three levels for high speed. Return the lever to the “OFF” position to stop the wipers. For a single wipe, move the lever up. To spray washer fluid, pull and hold the lever toward you.

## Daytime Running Lights

Daytime running lights are standard on your vehicle. Only a reduced brightness high beam will be automatically turned on when the engine has started and the parking brake is fully released or the light switch is in the “OFF” or “” position. The brightness of the illumination of the high beam headlights is reduced by the daytime running light system. You must always switch on your headlights when it’s dark outside by turning the light switch to the  position.

# Controls



## Manual Climate Control

### 1. Air Flow Control Dial

The air flow control dial allows you to choose the direction of air flow. Rotate the dial for the desired air flow position.

#### Defrost/Defog

To clear the windshield and front door windows of fog or frost, rotate the air flow control dial to the defrost position, set the temperature control to the red position, and set the fan speed control to the fastest speed.

### 2. Rear Window Defogger Button

Press the rear window defogger button to turn on the defogger. The defogger will automatically shut off after about 15 minutes. If the window clears before that time, you can press the button again to turn it off.

### 3. Fan Speed Control Dial

Rotate the fan speed control dial to select one of four fan speeds.

### 4. Air Conditioning Button

Press the "A/C" button to activate the air conditioning. Press it again to turn off the air conditioning.



#### 5. Recirculated/Outside Air Button

Press the air inlet selection button to prevent outside air from being drawn into the passenger compartment. If the button is pushed in, press it again to draw outside air into the compartment. TO PREVENT WINDSHIELD FOGGING, DO NOT REMAIN IN THE RECIRCULATED MODE FOR AN EXTENDED PERIOD OF TIME.

#### 6. Temperature Control Dial

Rotate the temperature control dial from blue for cool, to red for warm.

# Controls



## Automatic Climate Control (if equipped)

### 1. Automatic On and Off

This system automatically controls outlet air temperature, fan speed, air flow distribution, air inlet control, and air conditioner compressor operation. Press “AUTO” to activate. Push “OFF” to turn off the system.

### 2. Temperature Control Dials

Rotate the dial to select a temperature and maintain a comfortable climate within the driver and passenger compartment. Temperature is displayed digitally on the screen. Separate temperature settings

can be adjusted for the driver's side and passenger's side.

## Operation in Manual Mode

### 3. Recirculated/Outside Air Switch

Push the air inlet selection button to prevent outside air from being drawn into the passenger compartment. Push the button again to allow outside air into the compartment. TO PREVENT WINDSHIELD FOGGING, DO NOT REMAIN IN THE RECIRCULATED MODE FOR AN EXTENDED PERIOD OF TIME.

### 4. Fan Speed Control Dial

On the automatic setting, the system determines the fan speed to achieve



the desired temperature or you can manually rotate the fan speed control dial to select one of seven fan speeds.

**5. Air Flow Mode Selection Button**

Press the button to select the desired air flow mode. The selected air flow mode is shown on the display above.

**6. Dual Mode Switch**

Push the "DUAL" switch to activate or deactivate the dual mode. Dual mode makes it possible to have separate temperature settings for the driver's side and passenger's side.

**7. Air Conditioner Switch**

Push the "A/C" switch to activate the air conditioning. Push it again to turn off the air conditioning.

**8. Front Defroster Button**

Press the button to defrost or dehumidify the windshield and front door windows.

**9. Rear Window Defogger Switch**

Push the switch to turn on the defogger. It will automatically shut off after about 15 minutes. If the window clears before that time, you can push the switch again to turn it off.

# Controls



## AM/FM Stereo HD Radio® with Single Disc CD Player and Navigation System\*

### Radio Functions

#### 1. Power/Volume Control

Press the power/volume control knob for on or off; rotate the knob to control the volume.

#### 2. Audio Source

Press the "AUDIO" button to display the audio screen. Touch the audio source you want to hear. Use the arrow to scroll down the list of available sources.

#### 3. Sound Settings

While in an audio operations screen touch the "Sound" key. You will be able to adjust EQ, sound position, SVC (Source Volume Control) and ASL (Automatic Sound Levelizer) settings.

### CD Player Functions

#### 4. Load

Insert a disc into the slot. The CD will automatically be drawn in and will begin play at the first track.

#### 5. Eject

Press the button to eject the disc.

\*For more detailed information on audio operation, please refer to the Navigation Owner's Manual.



### USB Storage Device/iPod® (if equipped)

The USB slot is located underneath the climate controls. You can connect a USB equipped portable music player to the USB connector and hear the music stored on it through the vehicle speakers. Press the “AUDIO” button located on the audio system and then touch the “USB” key to select the USB/iPod® mode.

### Auxiliary Input Jack

The auxiliary jack is located underneath the USB slot. You can connect a portable music player to the auxiliary jack and hear the music stored on it through the vehicle speakers. Press the “AUDIO” button located on the audio system and then touch the “AUX” key to select the auxiliary mode.



# Controls



## Driving Systems/Modes

To help enhance driving safety and performance, the following systems operate automatically in response to various driving situations.

1. If the vehicle gets stuck in mud, dirt or snow, the traction control system may reduce power from the engine to the wheels. Turning the system off may make it easier for you to rock the vehicle in order to free it. Press the button again to turn the traction control back on.
2. Your vehicle is equipped with two types of control modes to accommodate various driving preferences. The control modes can be selected with the "VSC SPORT" button. Normal mode allows secure and smooth normal driving. When the button is pressed, Vehicle stability control (VSC) SPORT mode is activated.
3. If equipped, push the switch towards the "SPORT" mode for sporty driving or when driving in mountainous regions with lots of curves. To cancel sport mode push the switch towards "SPORT" mode again.

If equipped, push the switch towards the "SNOW" mode for accelerating and driving on slippery road surfaces such as snow. To cancel snow mode, push the switch toward "SNOW" mode again.

For more detailed information, please refer to your Owner's Manual.

## Cruise Control

- To resume your speed after canceling, push the lever up to the “RES” side.

- To cancel the cruise control, pull the lever toward you, push the brake pedal or press the “ON-OFF” button. If you have a manual transmission, you can push in the clutch pedal.

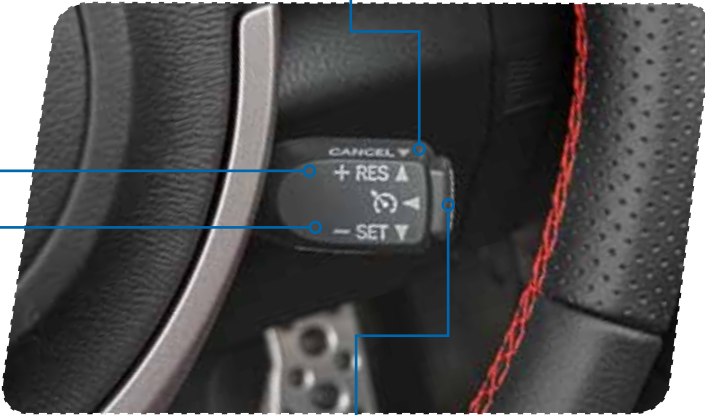

- Press the accelerator pedal until your vehicle reaches the desired speed. Push the lever down to the “SET” side and release. Ease off the accelerator pedal. Your vehicle will maintain the desired speed.

- To activate the cruise control, press the “ON-OFF” button. The cruise control indicator light on the instrument panel will turn on. To deactivate cruise control, press the “ON-OFF” button again.

### Increase speed

Push the lever up to the “RES” side; hold until your vehicle reaches the desired speed and release. To increase speed using the accelerator pedal, press the pedal until you reach the desired speed. Push the lever down to the “SET” side to set the speed.

### Decrease speed

Push the lever down to the “SET” side; hold until your vehicle slows to the desired speed and release. To decrease the speed using the brake pedal, press the pedal to release cruise control temporarily. When the speed decreases to the desired speed, push the lever down to the “SET” side to set the speed.

# While Operating

## Trunk and Fuel Filler Lid Releases

The vehicle is equipped with trunk and fuel filler lid releases. To open the trunk, press the trunk lever button. To open the fuel filler lid, pull the fuel filler lever up and release.



## Paddle Shift Control Switches

- Temporary use: Even when the selector lever is in the “D” (Drive) position, you can temporarily shift the gear by pulling the “+” or “-” paddle shift control switch. The transmission will then automatically switch back to Normal Mode.
- When the shift selector lever is in Manual Mode, shift to the next higher gear by pulling the “+” paddle shift control switch on the steering wheel. Pull the “-” paddle shift control switch to shift into the next lower gear.





## Automatic Transmission Shift Mode

The automatic transmission gives you ultimate control with two different driving modes: Normal Mode and Manual Mode.

### Normal Mode

When the selector lever is in the “D” (Drive) position, the transmission is in Normal shift mode. The shift position indicator on the instrument panel shows “D” and the transmission automatically shifts into a suitable forward gear.

### Manual Mode

In Manual Mode, you select the desired gear position to obtain necessary acceleration and engine braking. Moving the selector lever left into the manual gate ① from the “D” (Drive) position causes the transmission to change into Manual Mode. To shift, use the paddle shift control switches or gear lever. The shift position indicator shows the selected gear position.

## When Manual Shifting Operation is Possible

- Arrow-shaped indicator lights in the center of the instrument panel show whether an upshift is possible and whether a downshift is possible.
  - Both arrows are on: Upshifting and downshifting are both possible.
  - Up arrow only is on: Only upshifting is possible.
  - Down arrow only is on: Only downshifting is possible.

# BRZ Engine Compartment

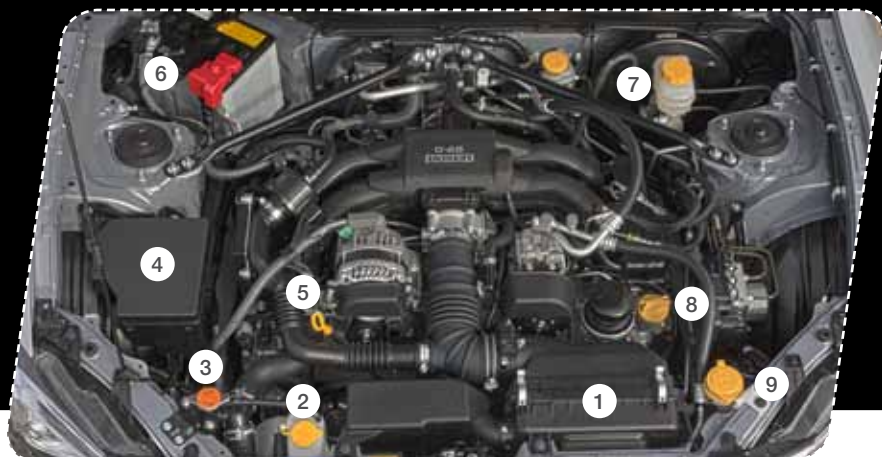

## 1. Air Cleaner Element

This element filters intake air. Follow the maintenance guidelines in your “Warranty and Maintenance” booklet. When necessary, replace this element with a genuine Subaru air cleaner.

## 2. Engine Coolant Reservoir

Check your coolant level at each fuel stop. Observe the coolant level on the outside of the reservoir while the engine is cool. If the level is close to – or lower than – the “LOW” level mark, add coolant to the “FULL” level mark. If the reserve tank is empty, remove the radiator cap and refill as required. Please refer to your Owner’s Manual for details.

## 3. Radiator Cap

If your engine overheats, safely pull off the road and stop your vehicle in a safe place. Never attempt to remove the radiator cap until the engine has been shut off and has fully cooled down. If steam is coming from the engine compartment, turn the engine off and move everyone away from the vehicle until it cools. Please refer to your Owner’s Manual for details.

## 4. Main Fuse Box

Your BRZ has two fuse boxes. One is located under the instrument panel, behind the fuse box cover on the driver’s seat side. The other is housed in the engine compartment, as shown here. Fuses are designed to melt during an overload situation in order to prevent damage to the wiring harness and electrical equipment. If any lights, accessories or electrical controls fail to operate properly, inspect the corresponding fuse. If it has melted or appears discolored, replace it in accordance with the instructions in your Owner’s Manual. The fuse puller and spare fuses are located in the main fuse box in the engine compartment.

## 5. Engine Oil Level Gauge

Check the engine oil level at each fuel stop. Pull out the dipstick, wipe it clean, and insert it again. Pull it out and check the oil level. If it’s below the lower level, add oil to bring the level up to the upper level. Use only engine oil of the recommended grade and viscosity.

Please refer to your Owner's Manual for oil recommendations and other important details.

## 6. Battery

When your vehicle does not start due to a battery that has run down, the vehicle may be jump-started by connecting your battery to another battery with jumper cables. Jump-starting is dangerous if done incorrectly. Please refer to your Owner's Manual for instructions. If you're unsure about how to jump-start your vehicle, please consult a competent mechanic.

## 7. Brake Fluid Reservoir

Check your brake fluid level monthly. Observe the fluid level on the outside of the reservoir. If the level is below the "MIN" level mark, add the recommended brake fluid (FMVSS No. 116, fresh DOT 3 or 4 brake fluid) to the "MAX" level mark. Use only brake fluid from a sealed container.

## 8. Engine Oil Filler Cap

Change your oil according to the maintenance schedule in your "Warranty and Maintenance Booklet." Your engine oil must be changed more frequently when you drive on dusty roads, frequently make short trips, or when you drive in extremely cold weather.

## 9. Windshield Washer Tank

It's a good idea to check your washer fluid every time you stop for fuel. If the level is low, fill the windshield washer tank to the neck of the reservoir with windshield washer fluid. In cold weather, use a freeze resistant windshield washer fluid.

# Safety/In Case of Emergency



## Child Restraint System

For maximum safety, first carefully read the LATCH system instructions from the device manufacturer, as well as the installation instructions in your Owner's Manual, to properly install the LATCH compatible child restraint system. Use the appropriate seatbelts or anchorages provided in your vehicle. Children age 12 and under must properly occupy the rear seat at all times.



## Internal Safety Trunk Release with Self-Illuminating Handle

In the event that children or adults become locked inside the trunk, this luminescent handle allows them to open the lid from inside the trunk. To open, simply pull the yellow handle downward as indicated by the arrow on the handle, and then push up on the lid.



## Location of Spare Tire and Jack

A spare tire, jack, jack handle, towing eyelet, screwdriver and wheel nut wrench are stored under the floor of the trunk.

## Subaru Roadside Assistance

Subaru Roadside Assistance is free and standard on every 2013 BRZ vehicle. Coverage is automatic; there are no forms to complete. Subaru Roadside Assistance is available anytime during the 3-year/36,000-mile Subaru Limited Warranty, whichever comes first.\* A Subaru Roadside Assistance decal has been affixed to the driver's door window.

Subaru Roadside Assistance: 1-800-261-2155

### Exclusions

Specifically excluded from Subaru Roadside Assistance coverage are service requests or claims resulting from: accidents, vandalism, acts of God, violation of any laws, or vehicle modifications not recommended by the manufacturer.

\*See your dealer for details.



# Additional Information



## MY.SUBARU.COM

Your Subaru vehicle comes with a unique online resource that helps make your ownership experience more convenient and enjoyable. My.Subaru.com is a website that you can personalize and offers useful features and content that makes it easy for you to manage your vehicle care and enjoy all the benefits of Subaru ownership. Log on to My.Subaru.com to access features such as: automated service history, e-mail maintenance reminders, online Owner's Manual, warranty information, maintenance schedules and much more...

Access your site today @ My.Subaru.com.

## Fuel

Use premium unleaded gasoline with an octane rating of 91 AKI or higher.

## Fuel Capacity

- 13.2 US gal (50 liters, 11 Imp gal)
- When the low fuel indicator light is displayed on the instrument panel, approximately 1.8 US gallons (7.0 liters, or 1.5 Imp gal) of fuel remain.
- If you have recently fueled your vehicle, the check engine light on the instrument panel may stay on due to a missing or loose fuel filler cap (the cap should be tightened until a click is heard).

## Engine Oil

Use only the following oils:

- ILSAC GF-4 or GF-5, which can be identified with the ILSAC certification mark (Starburst mark).
- Or API classification SN or SM with the words “ENERGY CONSERVING”.
  - Use 0W 20 synthetic, replacement interval 7,500 miles; no requirement at the first 3,000 miles.

## Engine Oil Capacity

- Without filter: 5.5 US qt (5.2 liters, 4.6 Imp qt)
- With filter: 5.8 US qt (5.5 liters, 4.8 Imp qt)



# Subaru Delivery Checklist

## Owner Information

VEHICLE ID #

DELIVERY DATE

OWNER NAME

OWNER NAME

## Owner Resources & Warranty

- Present the Subaru Owner's Manual & Quick Reference Guide (detailed review in "Operation & Controls" section)
- Review Subaru Roadside Assistance, Owner Cards & Provide Toll-Free Number 1-800-261-2155
- Explain 3/36 BASIC Warranty / 5/60 Powertrain Warranty / Explain Wear Items & Adjustments / Review Rust Perforation Warranty / Tire Warranty
- Review Service & Maintenance Schedules & Terms  
Explain Normal vs. Extreme Schedules (if applicable)
- Review New Owner's MY.SUBARU.COM Website
- Review The Subaru Mastercard Program from CHASE & Explain The Card Benefits
- Explain Dealership's New Owner Follow Up Procedure

## Customer Signature

- Review Dealership Service Department Location, Payment Options & Hours of Operation
- Introduce The Subaru Service Advisor & Provide Their Business Card
- Explain Dealership Service Appointment Scheduling & Early Morning Service Drop Off Procedures
- Review Dealership Parts Department Location & Hours

## Vehicle Condition

- Exterior Condition Approval (New Owner indicates exterior of vehicle is clean & undamaged)
- Interior Condition Approval (New Owner indicates interior of vehicle is clean & undamaged)
- Operational Condition Approval (New Owner has driven vehicle & approves it is ready for delivery)

NEW OWNER SIGNATURE

SALES CONSULTANT SIGNATURE

SALES MANAGER SIGNATURE

Fold back and remove this checklist from the QRG. Place this completed checklist in the deal jacket for future reference. Additional copies of this checklist can be made by photocopying.

## Operation & Controls

Please use & reference the **SUBARU OWNER'S MANUAL**  
& **QUICK REFERENCE GUIDE**

### OPERATION & CONTROLS

- Review Master & Valet Keys
- Show Keyless Entry, Alarm System & Remote Start (if equipped)
- Show Hood & Gas Door Releases
- Show Yellow Caps & Explain Checking & Filling of Vehicle Fluids
- Show Fuel Filler Door & Gas Cap Operation
- Show Location of both Fuse Boxes

### REAR & SIDE

- Show Trunk Release & Valet Feature
- Show Spare Tire, Tools & Jack Location
- Explain Temporary Spare Tire Usage & Limitations
- Explain Towing Requirements & Limitations
- Show LATCH System & Tethers
- Show Child Safety Lock Operation

### INTERIOR

- Explain Operation of Manual Transmission
- Explain Operation of Automatic Transmission & Review Manual Mode (if equipped)
- Show Seatbelt & Head Restraint Functions
- Explain the Subaru Advanced Frontal Airbag System (SRS), Front Seat Side Pelvis/Torso Airbags (SRS) & Side-Curtain Airbags (SRS)
- Show Tilt Steering Column Feature (if equipped)
- Show All Weather Package - Heated Front Seats, Windshield Wiper De-Icer & Heated Side Mirrors (if equipped)

### DRIVER CONTROLS & OPERATION

- Show Power Windows, Door Locks & Side-View Mirror Operation
- Explain Cruise Control
- Show Headlights, Daytime Running Lights, Parking Lights, Hazard Lights & Fog Lights (if equipped)
- Show Interior Lighting, Map Light & Clock
- Show Windshield Wiper & Washer Controls
- Show Climate Control System Including Front & Rear Defrosters
- Show & Explain Operation of VSC Control Switches
- Review Instrument Panel Gauges & Warning Lights
- Explain Tire Pressure Monitoring System Light
- Show Audio System, Station Presets, Tone, Balance & Fade Controls
- Show GPS Navigation System (if equipped)
- Explain Operation of Other Vehicle Options, Equipment, or Genuine Subaru Accessories Not Referenced Above Where Applicable

Subaru of America, Inc., Subaru Plaza,  
P.O. Box 6000, Cherry Hill, NJ 08034-6000



MSA5B1310A  
Issued February 2012  
Printed in USA 03/12



2013

**BRZ**

**Consumer Electronics/  
Bluetooth® & Audio Technology**



**Quick Reference Guide**



# Bluetooth Basics

- The hands-free system may not operate properly under the following conditions:
  - The cell phone is turned off.
  - The cell phone is not connected to the hands-free system.
  - The cell phone is not in the phone call area.
  - The battery of the cell phone has run down.
  - The cell phone is behind the seat or in the glove box.
  - A metal material covers or touches the cell phone.
- Depending on the type of cell phone that is used, the screen on the cell phone may remain illuminated while the ignition switch is in the "ON" position. If this occurs, consult your cell phone manual to adjust the cell phone settings.
- Depending on the setting of the cell phone, the dial lock function may be activated after making a call. Deactivate the automatic dial lock function of the cell phone before using the hands-free system. Do not perform this operation while driving.
- Depending on the type of cell phone that is used, operation and the sound volume may vary.
- Depending on the type of cell phone that is used, not all phone functions may be compatible with your vehicle.
- When the ignition switch is turned to the "LOCK/OFF" position during a call, the call may be disconnected or continued on the cell phone, depending on the type of cell phone that is used. Note that operation of the cell phone may be necessary if the call is continued on the cell phone.



- Do not speak at the same time as the other party during a call. If you and the other party speak at the same time, it may be difficult for the other party to hear your voice and vice versa. This is normal.
- The receiver sound volume should be set as low as possible. Otherwise, the party you are calling may notice an undesirable echo sound.
- Speak clearly and loudly.
- Your voice may be difficult to be heard by the receiving party under the following conditions:
  - o Driving on a rough road.
  - o Driving at a high speed.
  - o Driving with a window open.
  - o When air from the ventilator blows directly toward the microphone.
  - o When the sound coming from the ventilator is loud.
  - o When the cell phone is positioned too closely to the microphone.
- The sound quality may degrade due to the influence of the cell phone that is connected to the system or the circumstances of the Bluetooth network.
- When another Bluetooth device is simultaneously connected, noise may be heard in the voice coming from the hands-free phone.

# Bluetooth for AM/FM Stereo with HD Radio™, Single Disc CD Player and Navigation System



AUDIO button

## Pairing Your Cell Phone

Press the AUDIO button; then touch the “Info” soft key on the touch screen.



Then touch “Bluetooth.”



Now touch "Registered Devices."



Touch "Add New."

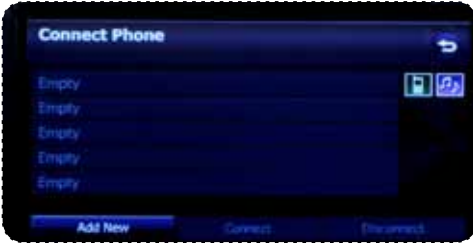

A pass-key pairing number will appear on the screen. Put your phone into Bluetooth pairing mode and pair your phone to the system using the pass-key provided.



When the phone is successfully paired, the screen will show the phone's name on the list.

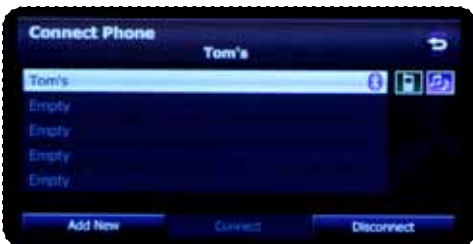

# Making a Call

Press the AUDIO button; then touch the “Phone” soft key. A numeric keypad will be displayed.



Touch the numbers for the phone number you wish to call. When complete, touch the green “Phone” soft key to make the call.



## During a Call



Red phone symbol – Touch this to end a call.

Dial Tone – Touch to enable numeric key input.

Mic Level – Touch to change the volume of the call.

Transfer – Touch to switch the phone conversation back to your cell phone.

## Receiving a Call



Touch "Disconnect" to decline the incoming call.

When a call comes in, the incoming call screen appears automatically. Touch the green "Phone" soft key to answer the call.

All information contained within this Consumer Electronics/Bluetooth® & Audio Technology Quick Reference Guide was accurate at the time of publication. We reserve the right to change features, operation and/or functionality of any vehicle specification at any time without incurring any obligation to make the same or similar changes to products previously sold. Your Subaru dealer is the best source for the most current information. For detailed operating and safety information, please consult your Owner's Manual.



MSA5B1309A  
Printed in USA 03/12



2013  
**BRZ**  
Navigation System



Quick Reference Guide









# Table of Contents

<b>Safety</b>	—	○	2
<b>Navigation Introduction</b>	—	○	3
<b>Emergency Screen</b>	—	○	4 - 5
<b>Finding an Address</b>	—	○	6 - 9
<b>Finding a Point of Interest</b>	—	○	10 - 11
<b>Setting HOME as a Favorite</b>	—	○	12 - 13
<b>Notes</b>	—	○	14

# Safety

Your Navigation System will assist you in reaching your destination and, if used properly, can do so with speed and ease. To use the system as safely as possible, follow all safety directions.

- **Before attempting to use this system while driving, learn how to use it.** Make sure you read the **entire** Navigation System Owner's Manual Supplement. Do not allow others to use this system until they read the manual and understand the instructions.
- You should program your destination and select your route only when your vehicle is **not moving**. While driving, listen to the voice instructions as much as possible and only glance at the screen briefly and when it is safe to do so.
- The data in the system may occasionally be incomplete as road conditions and driving restrictions (no left turns, road closures, etc.) change. Before you follow system instructions, make sure to check whether you can comply with the instructions legally and safely. Do not be distracted by the navigation screen. Failure to keep your attention on the road could lead to an accident.
- The system cannot warn you of environmental or street hazards or the availability of emergency systems. If you are unsure about the safety of an area, don't drive into it.
- Use this system only where it is legal to do so. Some states may have laws prohibiting the use of video screens within the driver's sight.

And remember, this system is never a substitute for the driver's personal judgment.

To start the Navigation System, start the engine. The opening screen will appear, followed by the CAUTION screen. Read the instructions on the screen, if not previously selected, touch **LANGUAGES** to select a language. Then touch **I AGREE** when illuminated.



# Navigation Introduction

Your Navigation System helps you find and store addresses, places and attractions based on your map location and more. Prior to using the system, be sure to read the entire Navigation System Owner's Manual Supplement so you have a complete understanding of the system. For your convenience, this Quick Reference Guide offers a quick guide for regularly used features.

Your control panel is your access to the Navigation System. Some of the controls and functions cannot be used unless the vehicle is stationary.



## 1 Map Hard Button

Press the Map button to access the map screen. Then touch **MENU** to access the screen above.

## 2 Show Map

Touch **SHOW MAP** to access the map screen and to start navigation on the map. The map shows the current position, recommended route if previously selected, and reduces the surrounding area to display on the map being used.

## 3 Traffic Summary

Touch to open the Traffic Summary screen. XM Traffic® customer subscription required.

## 4 Find

Touch **FIND**, and then select which method to use to reach your destination by entering the address, selecting a

favorite place, selecting a position on the map, or selecting from the destination history list.

## 5 My Route

Touch **MY ROUTE**. You can also perform various route related functions such as editing or canceling the route, adding way points, selecting a different route, avoiding a part of the route or performing a navigation simulation.

## 6 More...

Touch **MORE** to select navigation settings, get help, start a system demo, or start various other auxiliary applications.

Emergency  
Screen

Finding an  
Address

Finding a Point  
of Interest

Setting HOME  
as a Favorite

# Emergency Screen (Where Am I?)

From the map screen, touch the  icon at upper right corner of screen, then touch **WHERE AM I?**.



This screen shows the latitude and longitude of your current position. Touch **HELP NEARBY**



Select between **CAR REPAIR**, **POLICE**, **HEALTH** or **GAS STATION**.



The screen now displays several options:

Use  to display the previous suggestion.

Use  to display the next suggestion.

Touch **FILTER** to help refine the search. A keyboard appears so you can input a specific location, such as "Subaru".

Touch **BACK** to return to the map.

Find the item you want on the list, and then touch that item.



The name and address of the location are displayed in the black bar at the top of the screen and the entire route is displayed on the map. Touch **MORE** to change the route plan or to review route alternatives, or touch **GO!** to start navigation.



# Finding an Address

- 1 Touch the Map Hard Button to display the Map screen, then touch **MENU** to access the navigation menu screen.



- 2 On the navigation menu, touch **FIND**.



- 3 Touch **FIND ADDRESS**.



- 4 By default, the country and state for your current position are displayed. If necessary, touch **COUNTRY OR STATE**, a keyboard appears and then enter the first few letters of the country name.



- 5 Type United States. As you type, look to the bottom right of the screen and touch **RESULTS**.



- 6 Touch the up/down arrows to the right to scroll up/down until you find the country and state. Touch the line with the correct country and state.





# Finding an Address

- 7 Touch **CITY/ZIP CODE**. A keyboard appears. Type the city name or input the city zip code, if known. As you type the city name, touch **RESULTS** at the lower right of the screen and a list appears with possible city choices. Scroll to find the city name. When the correct city is found, touch **DONE** and the city name is automatically transferred to the address screen.



- 8 Touch **STREET**. A keyboard appears. Then type the street name. As you type the street name, touch **RESULTS** at the lower right of the screen and a list appears with possible choices. Scroll to find the street name. When the correct street is found, touch **DONE** and the street name is automatically transferred to the address screen. **Note:** For streets that are preceded by a direction such as North, South, etc., type the street name first.



- 9 Touch **HOUSE NUMBER**. A keyboard appears. Then type the house number. Touch **DONE** and the house number is automatically transferred to the address screen. **Note:** If the house number is not found, the center of the street is selected as the destination.

- 10 The map is displayed with the selected point at the center. Touch **NEXT** to set the destination, or touch **BACK** to select another destination.



**Note:** If the destination will be used frequently, you can save it to favorites as follows, before touching **NEXT**. Touch **MORE**, and then touch **ADD TO FAVORITES**. A keyboard appears with the destination address. You can store that address or type a name for that address. Touch the arrow to the right of the address. This clears the address from only the screen so that you can give the address a name. Then touch **DONE**.



You are automatically returned to the map with the destination now set as a favorite. Touch **NEXT**, then touch **GO!**. The map screen appears with the route. Start driving following the navigation.



# Finding a Point of Interest

You can also find addresses by using Find Places. You can use this in the event you do not have a specific address but can refer to a specific place, such as a gas station, restaurant, accommodation, etc.

- 1 Touch the Map Hard button to display the map screen. Touch **MENU**, touch **FIND**, then touch **FIND PLACES**. You can select from the four preset categories shown or touch **QUICK SEARCH AROUND HERE**. A keyboard appears for you to enter the name of a specific location.



- 2 After entering the first few characters, touch **RESULTS** at the lower right of the screen to view a list of names of characters you entered.

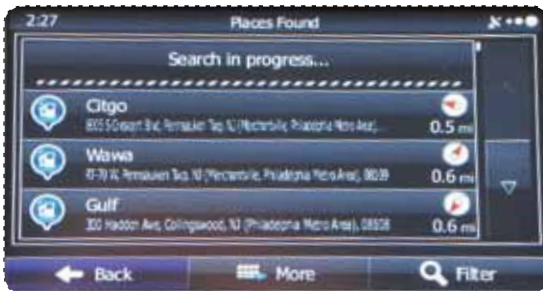

- 3 You can display locations on the list in name order, in order of the distance from the current position or previously confirmed position. If you want to change the order in which entries are presented in the list, touch **MORE** at the lower center of the screen and select the style that you want.



- 4 Find the item you want on the list, and then touch that item. The map is displayed with the selected point at the center. The name and address of the location are displayed in the black bar at the top of the screen. **Note:** Touch **i** to display the longitude and latitude about the selected spot. Touch **BACK** to return to the map.

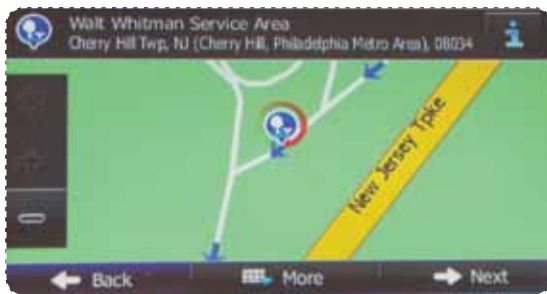

- 5 After a summary of the route plan is displayed, the entire route is displayed on the map. The route is researched automatically. Touch **MORE** to change the route plan, or touch **GO!** to start navigation.



# Setting HOME as a Favorite

**1** Follow steps 1 through 10 on pages 6-9 (Finding an Address) of this guide.

**2** Touch **ADD TO FAVORITES** a keyboard will appear. Enter the name HOME for the destination and then touch **DONE**. You are automatically returned to the map with the destination set. Start driving following the navigation.



## Choosing HOME from the destination list

- 1 If the Map screen is displayed, touch **MENU**, then touch **FIND** and then touch **FAVORITES**. The destination list is displayed.



- 2 Touch HOME to select it as the destination. The map is displayed in full-screen mode with HOME at the center. Touch **NEXT**. After a summary of the route plan is displayed, the entire route is displayed on the map. Touch **GO!** to start navigation.

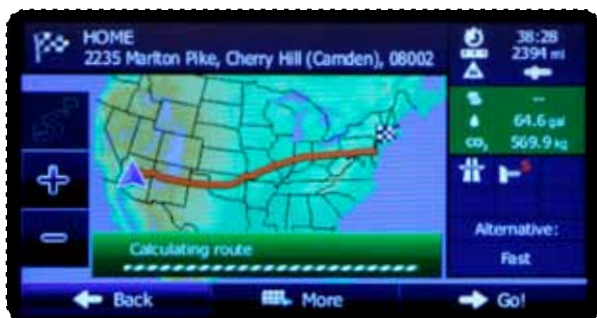









## About the Map SD Card

When driving using guidance from the navigation system, be sure to follow the actual road signs and traffic regulations. If road signs and traffic regulations are changed, the data on the map SD card may be out of date. Also, the data on the map SD card does not take into account factors such as weather, time zones, and occurrences such as differences in congestion situations and temporary road closures due to construction work. Always give precedence to road signs and traffic rules over instructions from the navigation system.

Not following the road signs and traffic rules could lead to injury or traffic violations.

---

All information contained within this Navigation System Quick Reference Guide was accurate at the time of publication. We reserve the right to change features, operation and/or functionality of any vehicle specification at any time without incurring any obligation to make the same or similar changes to products previously sold. Your Subaru dealer is the best source for the most current information. For detailed operating and safety information, please consult your Owner's Manual.



MSA5B1308A  
Issued May 2011  
Printed in USA 03/12  
2013A



2013  
BRZ



Owner Manual



## Foreword

---

Congratulations on choosing a SUBARU vehicle. This Owner's Manual has all the information necessary to keep your SUBARU in excellent condition and to properly maintain the emission control system for minimizing emission pollutants. We urge you to read this manual carefully so that you may understand your vehicle and its operation. For information not found in this Owner's Manual, such as details concerning repairs or adjustments, please contact the SUBARU dealer from whom you purchased your SUBARU or the nearest SUBARU dealer.

The information, specifications and illustrations found in this manual are those in effect at the time of printing. FUJI HEAVY INDUSTRIES LTD. reserves the right to change specifications and designs at any time without prior notice and without incurring any obligation to make the same or similar changes on vehicles previously sold. This Owner's Manual applies to all models and covers all equipment, including factory installed options. Some explanations, therefore may be for equipment not installed in your vehicle.

Please leave this manual in the vehicle at the time of resale. The next owner will need the information found herein.

FUJI HEAVY INDUSTRIES LTD., TOKYO, JAPAN

 **SUBARU** is a registered trademark of FUJI HEAVY INDUSTRIES LTD.

© Copyright 2011 FUJI HEAVY INDUSTRIES LTD.

***Vehicles shown on the cover of this booklet may not be available in all markets. Please see your Subaru dealer for a Product Brochure detailing all currently available models.***

## TABLE OF CONTENTS

1	<b>Before driving</b>	Adjusting and operating features such as door locks, mirrors, and steering column.
2	<b>When driving</b>	Driving, stopping and safe-driving information.
3	<b>Interior features</b>	Air conditioning and audio systems, as well as other interior features for a comfortable driving experience.
4	<b>Maintenance and care</b>	Cleaning and protecting your vehicle, performing do-it-yourself maintenance, and maintenance information.
5	<b>When trouble arises</b>	What to do if the vehicle needs to be towed, gets a flat tire, or is involved in an accident.
6	<b>Vehicle specifications</b>	Detailed vehicle information.
7	<b>For owners</b>	Reporting safety defects for US owners, and seatbelt and SRS airbag instructions for Canadian owners
	<b>Index</b>	Alphabetical listing of information contained in this manual.

**1 Before driving**

**1-1. Key information**  
 Keys ..... 20

**1-2. Opening, closing and locking the doors and trunk lid**  
 Keyless access with push button start system..... 23  
 Remote keyless entry system..... 37  
 Doors..... 42  
 Trunk lid ..... 45

**1-3. Adjustable components (seats, mirrors, steering wheel)**  
 Front seats ..... 51  
 Rear seats ..... 54  
 Head restraints ..... 56  
 Seatbelts ..... 58  
 Steering wheel ..... 65  
 Anti-glare inside rear view mirror..... 66  
 Outside rear view mirrors .... 67

**1-4. Opening and closing the windows**  
 Power windows ..... 70

**1-5. Refueling**  
 Opening the fuel tank cap .... 73

**1-6. Security system**  
 Engine immobilizer system ..... 77  
 Theft prevention labels (U.S.A.)..... 80  
 Alarm ..... 81

**1-7. Safety information**  
 Correct driving posture ..... 85  
 SRS airbag (Supplemental Restraint System airbag).... 87  
 Front passenger occupant detection system ..... 122  
 Child restraint systems ..... 132  
 Installing child restraints .... 136

**2 When driving**

**2-1. Driving procedures**  
 Driving the vehicle ..... 146  
 Push-button ignition switch ..... 160  
 Engine (ignition) switch..... 169  
 Automatic transmission ..... 172  
 Manual Transmission ..... 179  
 Turn signal lever ..... 182  
 Parking brake ..... 183  
 Horn ..... 184

<b>2-2. Instrument cluster</b>	
Gauges and meters .....	185
Indicators and warning lights .....	190
Multi-information display .....	195
<b>2-3. Operating the lights and windshield wipers</b>	
Headlight switch .....	200
Fog light switch .....	206
Windshield wipers and washer .....	207
<b>2-4. Using other driving systems</b>	
Cruise control .....	210
Driving assist systems .....	215
<b>2-5. Driving information</b>	
Cargo and luggage .....	221
Vehicle load limits .....	225
Winter driving tips .....	226
Trailer towing .....	230
Dinghy towing .....	231

<b>3 Interior features</b>	
<b>3-1. Using the air conditioning system and defogger</b>	1
Manual air conditioning system .....	234
Automatic air conditioning system .....	241
Rear window and outside rear view mirror defoggers .....	250
<b>3-2. Using the audio system</b>	3
Using the AUX/USB port ....	252
<b>3-3. Using the interior lights</b>	4
Interior lights list .....	253
• Interior light .....	254
<b>3-4. Using the storage features</b>	5
List of storage features .....	255
• Glove box .....	256
• Bottle holders .....	257
• Cup holders/console tray .....	258
<b>3-5. Other interior features</b>	6
Sun visors .....	260
Vanity mirrors .....	261
Clock .....	262
Outside temperature display .....	263
Power outlets .....	264
Seat heaters .....	266
Floor mat .....	268
	7

**4 Maintenance and care**

**4-1. Maintenance and care**

- Cleaning and protecting the vehicle exterior ..... 272
- Cleaning and protecting the vehicle interior ..... 276
- Cleaning and protecting the Alcantara® area ..... 280

**4-2. Maintenance**

- Maintenance requirements ..... 282
- General maintenance ..... 285
- Emission inspection and maintenance (I/M) programs ..... 288

**4-3. Do-it-yourself maintenance**

- Do-it-yourself service precautions ..... 289
- Engine hood ..... 292
- Engine compartment ..... 294
- Tires ..... 308
- Tire inflation pressure ..... 315
- Wheels ..... 319
- Air conditioning filter ..... 322
- Transmitter/access key battery ..... 325
- Checking and replacing fuses ..... 329
- Light bulbs ..... 337

**5 When trouble arises**

**5-1. Essential information**

- Hazard warning flashers ..... 354
- If your vehicle needs to be towed ..... 355
- If you think something is wrong ..... 362
- Fuel pump shut off system ..... 363

**5-2. Steps to take in an emergency**

- If a warning light turns on or a warning buzzer sounds... ..... 364
- If you have a flat tire ..... 378
- If the engine will not start.... 389
- If the select lever cannot be shifted from P ..... 392
- If you lose your keys ..... 393
- If the access key does not operate properly ..... 394
- If the battery is discharged ..... 398
- If your vehicle overheats..... 403
- If the vehicle becomes stuck ..... 406



---

## 6 Vehicle specifications

---

### 6-1. Specifications

Maintenance data (fuel, oil level, etc.).....	410
Fuel information .....	422
Tire information .....	426

### 6-2. Customization

Customizable features .....	439
-----------------------------	-----

---

## 7 For owners

---

Reporting safety defects for U.S. owners .....	444
Seatbelt instructions for Canadian owners (in French) .....	445
SRS airbag instructions for Canadian owners (in French) .....	448

---

## Index

---

Abbreviation list .....	470
-------------------------	-----

Alphabetical index.....	471
-------------------------	-----

What to do if... ..	481
---------------------	-----

1

2

3

4

5

6

7

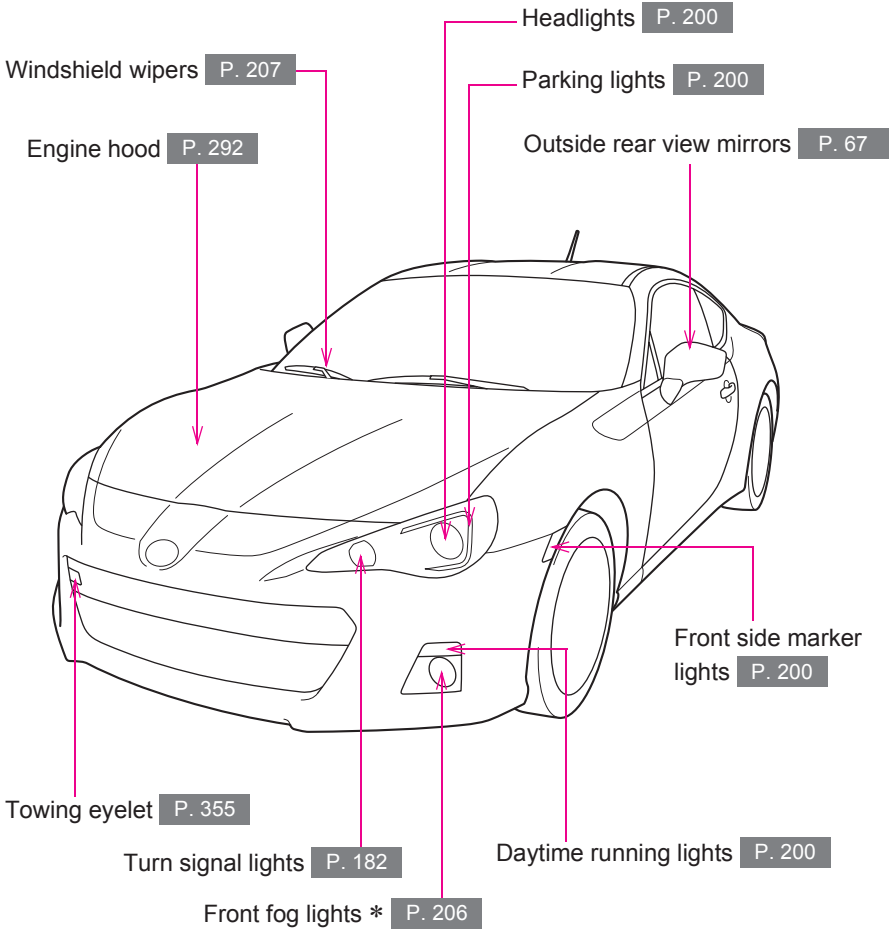

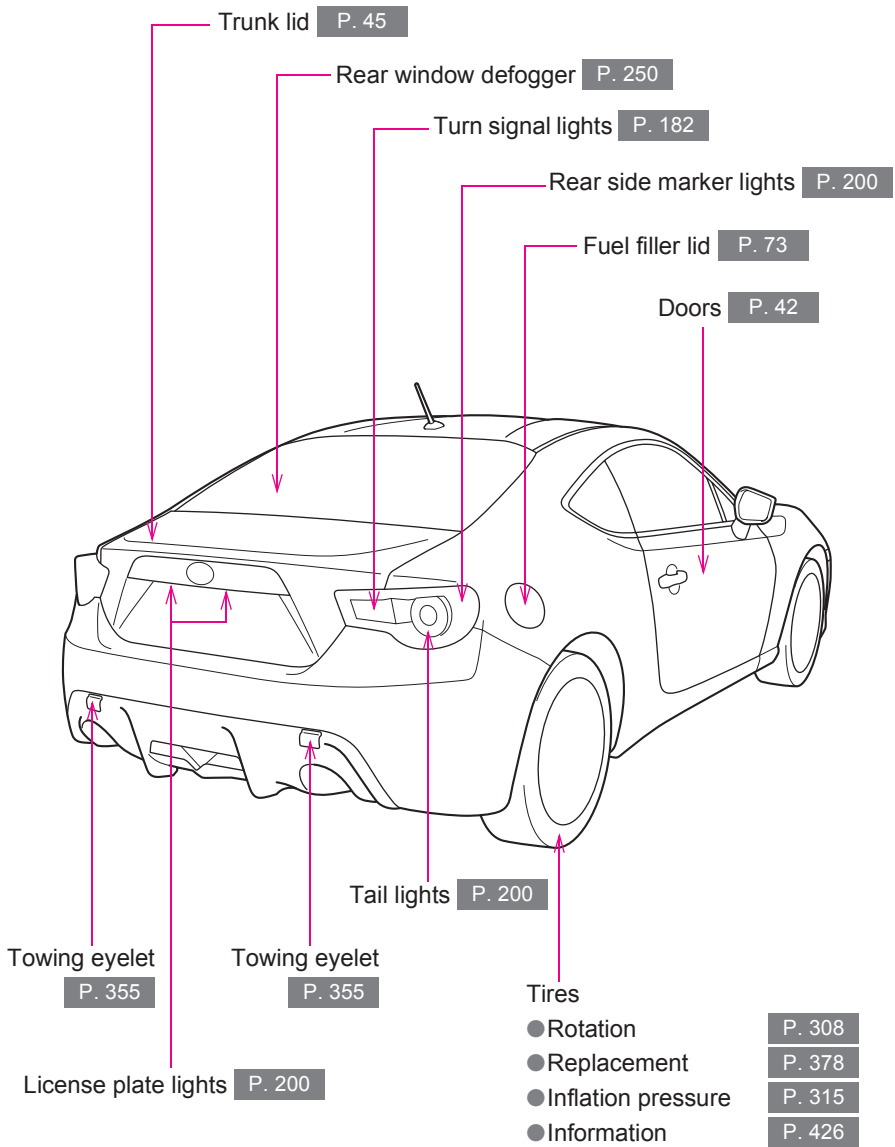

\*: If equipped

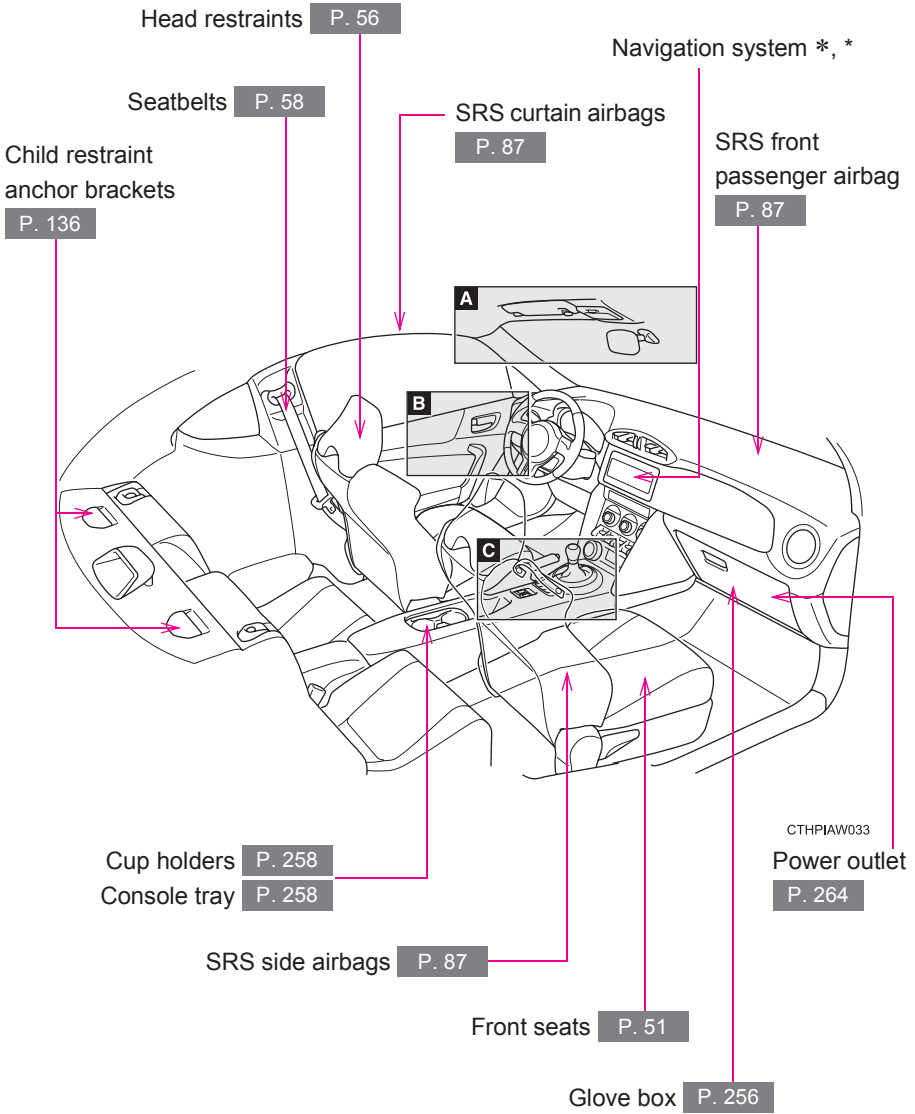

**A**

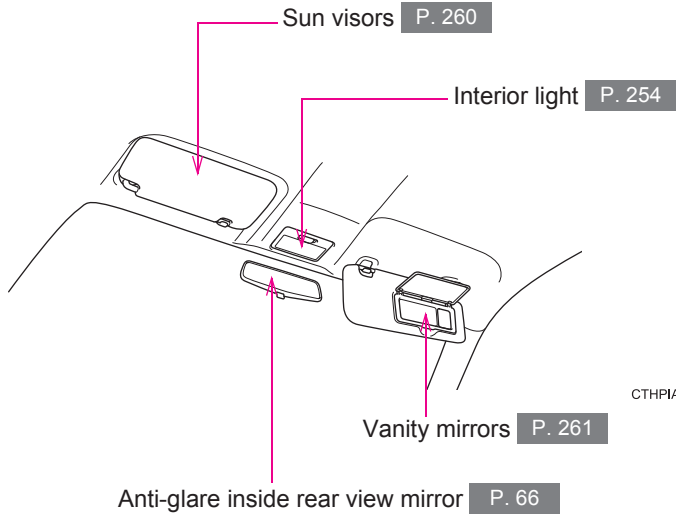

**B**

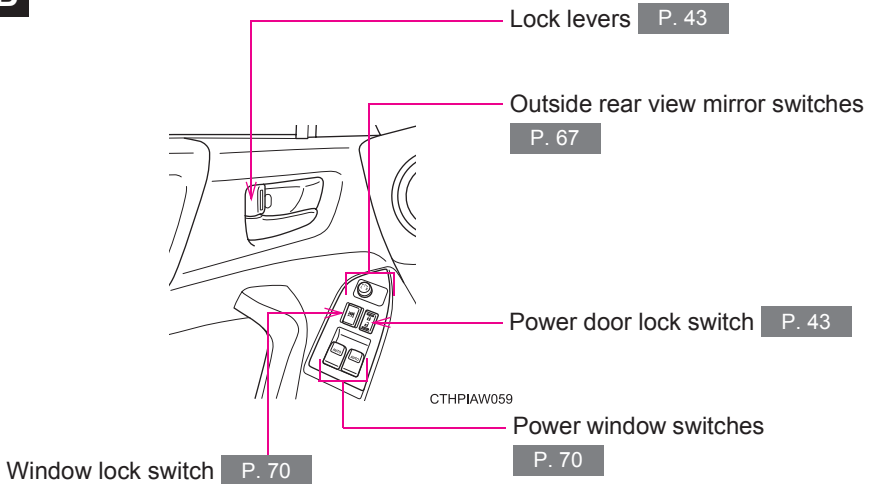

\*: If equipped

\*: Refer to "Navigation System Owner's Manual".

**C**

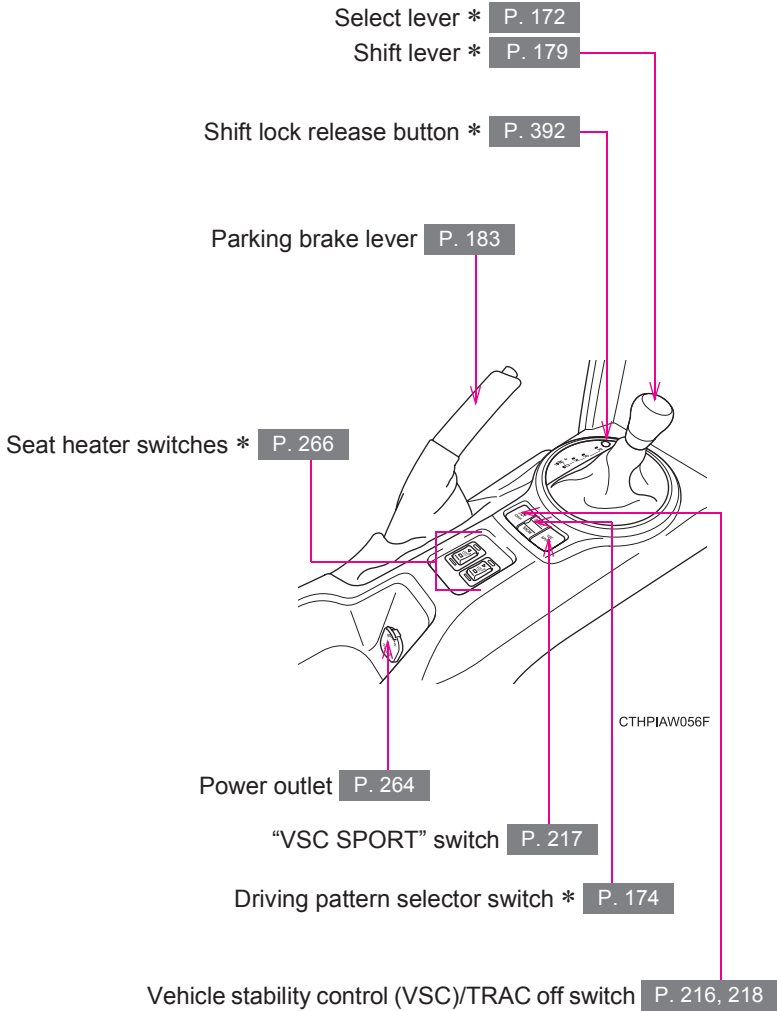

\*: If equipped

# Pictorial index

# Instrument panel

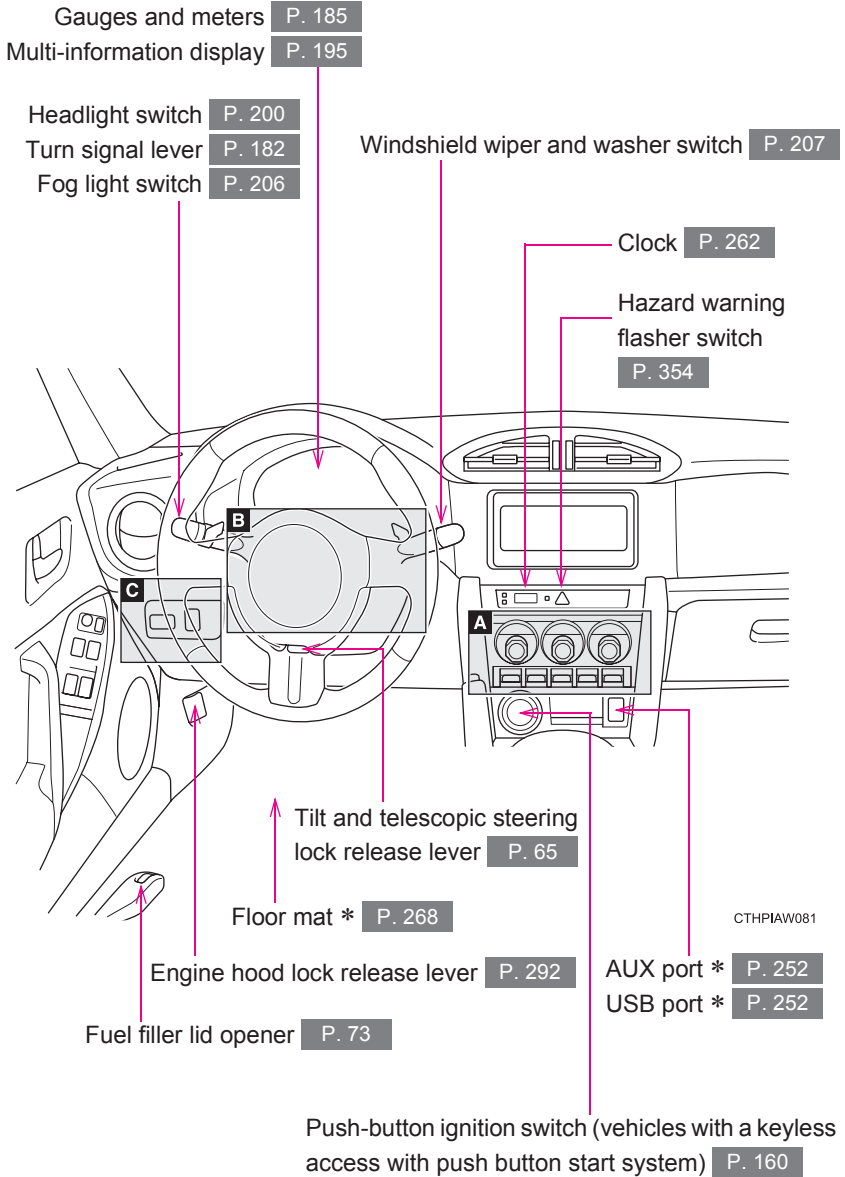

\*: If equipped

**A**

**Vehicles with a manual air conditioning system**

Air conditioning system P. 234

Rear window and outside rear view mirror defoggers switch \*/rear window defogger switch \* P. 250

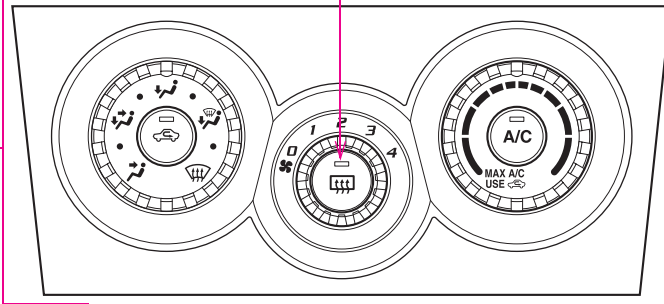

CTHPIAW040

**Vehicles with an automatic air conditioning system**

Air conditioning system P. 241

Rear window and outside rear view mirror defoggers P. 250

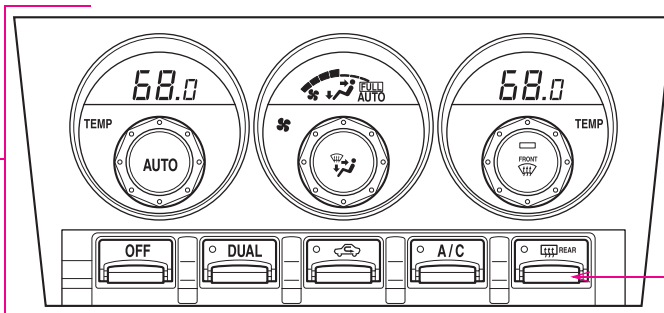

CTHPIAW083F

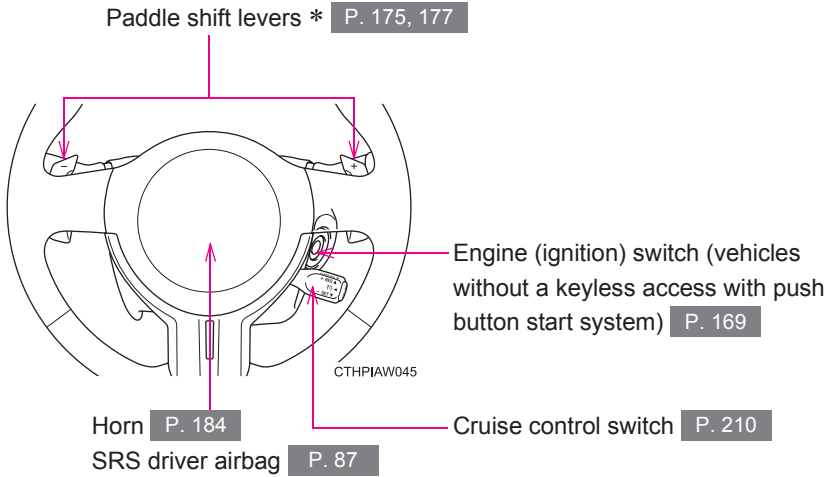
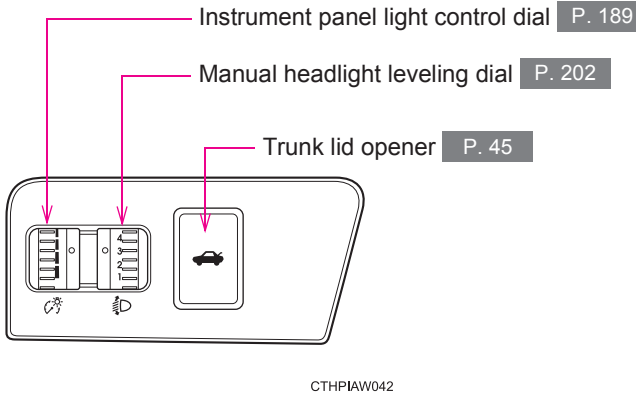

**B****C**

\*: If equipped

## For your information

### **Main Owner's Manual**

Please note that this manual applies to all models and explains all equipment, including options. Therefore, you may find some explanations for equipment not installed on your vehicle.

All specifications provided in this manual are current at the time of printing. However, because of the SUBARU policy of continual product improvement, we reserve the right to make changes at any time without notice and without incurring any obligation to make changes on vehicles previously sold.

Depending on specifications, the vehicle shown in the illustration may differ from your vehicle in terms of color and equipment.

### **Noise from under vehicle after turning off the engine**

Approximately five hours after the engine is turned off, you may hear sound coming from under the vehicle for several minutes. This is the sound of a fuel evaporation leakage check and, it does not indicate a malfunction.

### **Accessories, spare parts and modification of your SUBARU**

A wide variety of non-genuine spare parts and accessories for SUBARU vehicles are currently available in the market. You should know that SUBARU does not warrant these products and is not responsible for their performance, repair, or replacement, or for any damage they may cause to, or adverse effect they may have on, your SUBARU vehicle.

This vehicle should not be modified with non-genuine SUBARU products. Modification with non-genuine SUBARU products could affect its performance, safety or durability, and may even violate governmental regulations. In addition, damage or performance problems resulting from the modification may not be covered under warranty.

## **Installation of a mobile two-way radio system**

The installation of a mobile two-way radio system in your vehicle could affect electronic systems such as:

- Multiport fuel injection system/sequential multiport fuel injection system
- Cruise control system
- Anti-lock brake system
- SRS airbag system
- Seatbelt pretensioner system

Be sure to check with your SUBARU dealer for precautionary measures or special instructions regarding installation of a mobile two-way radio system.

## Event data recorder

This vehicle is equipped with an event data recorder (EDR). The main purpose of an EDR is to record, in certain crash or near crash-like situations, such as an air bag deployment or hitting a road obstacle, data that will assist in understanding how a vehicle's systems performed. The EDR is designed to record data related to vehicle dynamics and safety systems for a short period of time, typically 30 seconds or less.

The EDR in this vehicle is designed to record such data as:

- How various systems in your vehicle were operating;
- Whether or not the driver and passenger safety belts were buckled/fastened;
- How far (if at all) the driver was depressing the accelerator and/or brake pedal; and,
- How fast the vehicle was traveling.

These data can help provide a better understanding of the circumstances in which crashes and injuries occur.

NOTE: EDR data are recorded by your vehicle only if a non-trivial crash situation occurs; no data are recorded by the EDR under normal driving conditions and no personal data (e.g., name, gender, age, and crash location) are recorded. However, other parties, such as law enforcement, could combine the EDR data with the type of personally identifying data routinely acquired during a crash investigation.

To read data recorded by an EDR, special equipment is required, and access to the vehicle or the EDR is needed. In addition to the vehicle manufacturer, other parties, such as law enforcement, that have the special equipment, can read the information if they have access to the vehicle or the EDR.

### ● Disclosure of the EDR data

SUBARU will not disclose the data recorded in an EDR to a third party except when:

- An agreement from the vehicle's owner (or the lessee for a leased vehicle) is obtained
- In response to an official request by the police, a court of law or a government agency
- For use by SUBARU in a law suit

However, if necessary, SUBARU may:

- Use the data for research on vehicle safety performance
- Disclose the data to a third party for research purposes without disclosing information about the specific vehicle or vehicle owner

## Scrapping of your SUBARU

The SRS airbag and seatbelt pretensioner devices in your SUBARU contain explosive chemicals. If the vehicle is scrapped with the airbags and seatbelt pretensioners left as they are, this may cause an accident such as fire. Be sure to have the systems of the SRS airbag and seatbelt pretensioner removed and disposed of by a qualified service shop or by your SUBARU dealer before you scrap your vehicle.

## Perchlorate Material

Special handling may apply, See [www.dtsc.ca.gov/hazardouswaste/perchlorate](http://www.dtsc.ca.gov/hazardouswaste/perchlorate).

Your vehicle has components that may contain perchlorate. These components may include airbag, seatbelt pretensioners, and transmitter batteries.

### WARNING

#### ■ General precautions while driving

**Driving under the influence:** Never drive your vehicle when under the influence of alcohol or drugs that have impaired your ability to operate your vehicle. Alcohol and certain drugs delay reaction time, impair judgment and reduce coordination, which could lead to an accident that could result in death or serious injury.

**Defensive driving:** Always drive defensively. Anticipate mistakes that other drivers or pedestrians might make and be ready to avoid accidents.

**Driver distraction:** Always give your full attention to driving. Anything that distracts the driver, such as adjusting controls, talking on a cellular phone or reading can result in a collision with resulting death or serious injury to you, your occupants or others.

#### ■ General precaution regarding children's safety

Never leave children unattended in the vehicle, and never allow children to have or use the key.

Children may be able to start the vehicle or shift the vehicle into neutral. There is also a danger that children may injure themselves by playing with the windows or other features of the vehicle. In addition, heat build-up or extremely cold temperatures inside the vehicle can be fatal to children.

## Symbols used throughout this manual

### Warnings & Cautions

#### WARNING

This is a warning against something which, if ignored, may cause death or serious injury to people. You are informed about what you must or must not do in order to reduce the risk of death or serious injury to yourself and others.

#### CAUTION

This is a warning against something which, if ignored, may cause damage to the vehicle or its equipment. You are informed about what you must or must not do in order to avoid or reduce the risk of damage to your SUBARU and its equipment.

### Symbols used in illustrations



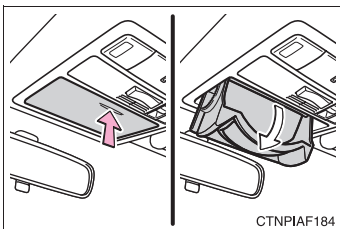

#### Safety symbol

The symbol of a circle with a slash through it means “Do not”, “Do not do this”, or “Do not let this happen.”



#### Arrows indicating operations

-  Indicates the action (pushing, turning, etc.) used to operate switches and other devices.
-  Indicates the outcome of an operation (e.g. a lid opens).

## Before driving

# 1

- 1-1. Key information**
  - Keys ..... 20
- 1-2. Opening, closing and locking the doors and trunk lid**
  - Keyless access with push button start system ..... 23
  - Remote keyless entry system ..... 37
  - Doors ..... 42
  - Trunk lid ..... 45
- 1-3. Adjustable components (seats, mirrors, steering wheel)**
  - Front seats ..... 51
  - Rear seats ..... 54
  - Head restraints ..... 56
  - Seatbelts ..... 58
  - Steering wheel ..... 65
  - Anti-glare inside rear view mirror ..... 66
  - Outside rear view mirrors ..... 67
- 1-4. Opening and closing the windows**
  - Power windows ..... 70
- 1-5. Refueling**
  - Opening the fuel tank cap ..... 73
- 1-6. Security system**
  - Engine immobilizer system ..... 77
  - Theft prevention labels (U.S.A.) ..... 80
  - Alarm ..... 81
- 1-7. Safety information**
  - Correct driving posture ..... 85
  - SRS airbag (Supplemental Restraint System airbag) ..... 87
  - Front passenger occupant detection system ..... 122
  - Child restraint systems ..... 132
  - Installing child restraints ..... 136

## 1-1. Key information

### Keys

The following keys are provided with the vehicle.

#### Vehicles without a keyless access with push button start system

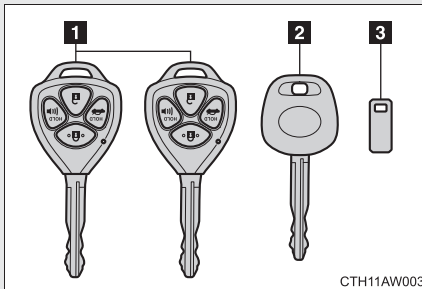

**1** Master keys

Operating the remote keyless entry system (→P. 37)

**2** Valet key

**3** Key number plate

#### Vehicles with a keyless access with push button start system

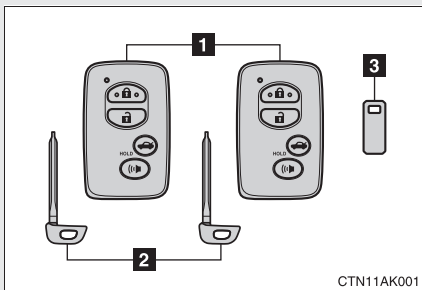

**1** Access keys

- Operating the keyless access with push button start system (→P. 23)
- Operating the remote keyless entry system (→P. 37)

**2** Mechanical keys

**3** Key number plate



### Using the mechanical key (vehicles with a keyless access with push button start system)

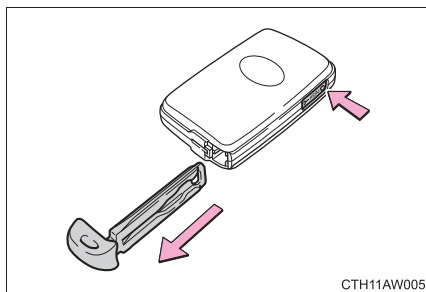

To take out the mechanical key, slide the release lever and take the key out.

After using the mechanical key, store it in the access key. Carry the mechanical key together with the access key. If the access key battery is depleted or the “keyless access” entry function does not operate properly, you will need the mechanical key. (→P. 394)

#### ■ When required to leave the vehicle's key with a parking attendant

Turn the trunk lid opener main switch off as circumstances demand.  
(→P. 46)

On vehicles without a keyless access with push button start system, provide the attendant with the valet key.

On vehicles with a keyless access with push button start system, remove the mechanical key for your own use and provide the attendant with the access key only.

#### ■ Key number plate

Keep the plate in a safe place, not in the vehicle. In the event that a key (without a keyless access with push button start system) or mechanical key (with a keyless access with push button start system) is lost, a new key can be made at your SUBARU dealer using the key number plate. (→P. 393)

#### ■ When riding in an aircraft

When bringing a key with remote keyless entry system onto an aircraft, make sure you do not press any buttons on the key while inside the aircraft cabin. If you are carrying the key in your bag etc., ensure that the buttons are not likely to be pressed accidentally. Pressing a button may cause the key to emit radio waves that could interfere with the operation of the aircraft.

 CAUTION

■ **To prevent key damage**

Observe the following:

- Do not drop the keys, subject them to strong shocks or bend them.
- Do not expose the keys to high temperatures for a long period of time.
- Do not get the keys wet or wash them in an ultrasonic washer etc.
- Do not attach metallic or magnetic materials to the keys or place the keys close to such materials.
- Do not disassemble the keys.
- Do not attach a sticker or anything else to the surface of the key.
- Vehicles with a keyless access with push button start system: Do not place the keys near objects that produce magnetic fields, such as TVs, audio systems, glass top ranges, or medical electrical equipment, such as low-frequency therapy equipment.

■ **Carrying the access key on your person (vehicles with a keyless access with push button start system)**

Carry the access key 3.9 in. (10 cm) or more away from electric appliances that are turned on. Radio waves emitted from electric appliances within 3.9 in. (10 cm) of the access key may interfere with the key, causing the key to not function properly.

■ **In case of a keyless access with push button start system malfunction or other key-related problems (vehicles with a keyless access with push button start system)**

Take your vehicle with all the access keys provided with your vehicle to your SUBARU dealer.

■ **When a vehicle key is lost**

If the key remains lost, the risk of vehicle theft increases significantly. Visit your SUBARU dealer immediately with all remaining access keys that were provided with your vehicle.

## 1-2. Opening, closing and locking the doors and trunk lid Keyless access with push button start system\*

The following operations can be performed simply by carrying the access key on your person, for example in your pocket.

(The driver should always carry the access key.)

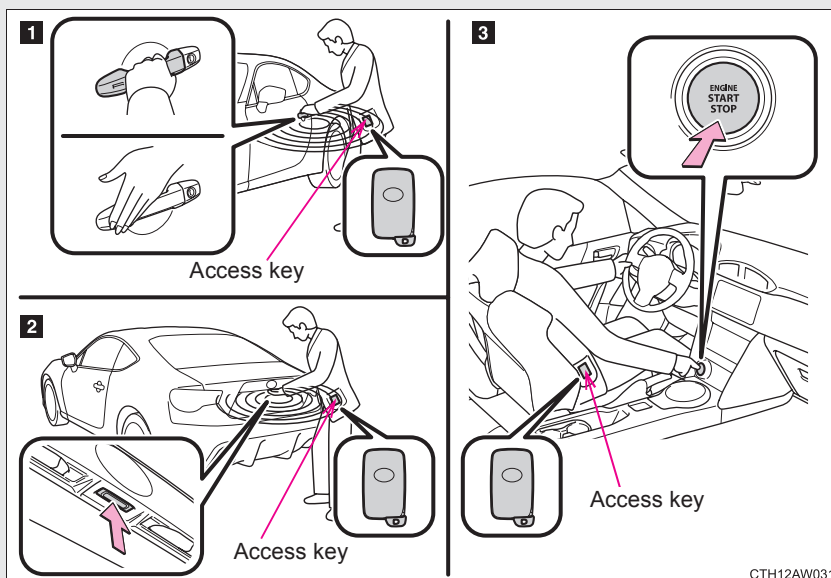

**1** Unlocks and locks the doors (→P. 24)

**2** Unlocks the trunk lid (→P. 24)

**3** Starts the engine (→P. 160)

## Unlocking and locking the doors

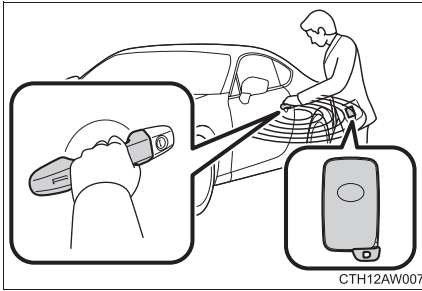

Grip the driver's door handle to unlock the door. Grip the passenger's door handle to unlock all the doors.

Make sure to touch the sensor on the back of the handle.

The doors cannot be unlocked for 3 seconds after the door is locked.

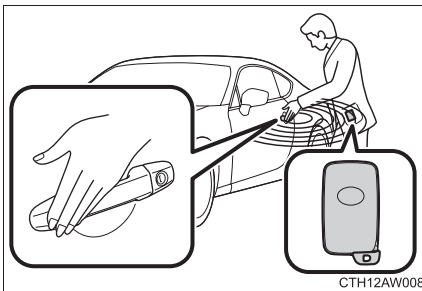

Touch the lock sensor (the indentation on the side of the door handle) to lock the doors.

## Unlocking the trunk lid

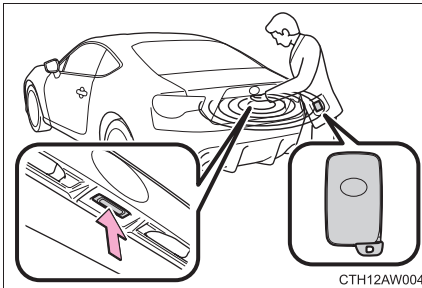

Press the button to unlock the trunk lid.

## Antenna location and effective range

### ■ Antenna location

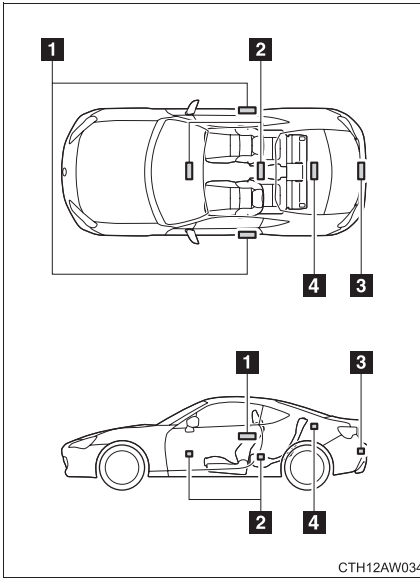

- 1** Antennas outside the cabin
- 2** Antennas inside the cabin
- 3** Antenna outside the trunk
- 4** Antenna inside the trunk

■ **Effective range (areas within which the access key is detected)**

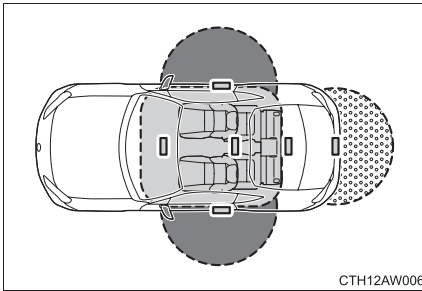

- When locking or unlocking the doors

The system can be operated when the access key is within about 1.3 - 2.6 ft. (0.4 - 0.8 m) of either of the outside door handles. (Only the doors detecting the key can be operated.)

- When unlocking the trunk lid

The system can be operated when the access key is within about 1.3 - 2.6 ft. (0.4 - 0.8 m) of the trunk lid release button.

- When starting the engine or changing push-button ignition switch modes

The system can be operated when the access key is inside the vehicle.

■ **Operation signals**

A buzzer sounds and the hazard warning flashers flash to indicate that the doors have been locked/unlocked. (Locked: once; Unlocked: twice)

■ **When the door cannot be locked by the lock sensor**

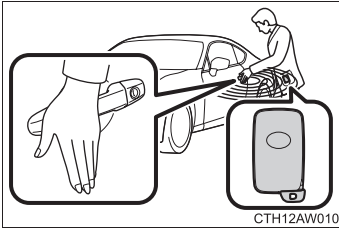

Use your palm to touch the lock sensor.

■ **Door lock buzzer**

If an attempt to lock the doors is made when a door is not fully closed, a buzzer sounds continuously. Fully close the door to stop the buzzer, and lock the vehicle once more.

■ **Alarms and warning indicators**

A combination of exterior and interior alarms as well as warning lights are used to prevent theft of the vehicle and unforeseeable accidents resulting from erroneous operation. Take appropriate measures for the warning light that comes on. (→P. 374)

The following table describes circumstances and correction procedures when only alarms are sounded.

Alarm	Situation	Correction procedure
Interior alarm pings once and exterior alarm sounds once for 10 seconds	An attempt was made to lock either door by opening a door and putting the lock lever into the lock position, then closing the door by pulling on the outside door handle with the access key still inside the vehicle.	Retrieve the access key from the vehicle and lock the doors again.

Alarm	Situation	Correction procedure
Exterior alarm sounds once for 10 seconds	An attempt was made to lock the doors using the keyless access with push button start system while the access key was still inside the vehicle.	Retrieve the access key from the vehicle and lock the doors again.
	An attempt was made to lock the vehicle while a door was open.	Close all of the doors and lock the doors again.
Interior alarm sounds continuously	The push-button ignition switch was turned to "ACC" mode while the driver's door was open (or the driver's door was opened while the push-button ignition switch was in "ACC" mode).	Turn the push-button ignition switch off and close the driver's door.
Interior alarm sounds continuously*	The driver's door was opened while any shift position other than P was selected without turning off the push-button ignition switch.	Shift the select lever to P.

\*: Vehicles with an automatic transmission only

### ■ Security feature

If a door is not opened within approximately 60 seconds after the vehicle is unlocked, the security feature automatically locks the vehicle again. (However, depending on the location of the access key, the key may be detected as being in the vehicle. In this case, vehicle may be unlocked.)



### ■ Battery-saving function

The battery-saving function will be activated in order to prevent the access key battery and the vehicle battery from being discharged while the vehicle is not in operation for a long time.

- In the following situations, the keyless access with push button start system may take some time to unlock the doors.
  - The access key has been left in an area of approximately 6 ft. (2 m) of the outside of the vehicle for 10 minutes or longer.
  - The keyless access with push button start system has not been used for 5 days or longer.
- If the keyless access with push button start system has not been used for 14 days or longer, the doors cannot be unlocked at any door except the driver's door.

In this case, take hold of the driver's door handle, or use the remote keyless entry system or the mechanical key, to unlock the doors.

### ■ Conditions affecting operation

The keyless access with push button start system uses weak radio waves. In the following situations, the communication between the access key and the vehicle may be affected, preventing the keyless access with push button start system, remote keyless entry system and engine immobilizer system from operating properly. (Way of coping →P. 394)

- When the access key battery is depleted
- Near a TV tower, electric power plant, gas station, radio station, large display, airport or other facility that generates strong radio waves or electrical noise
- When the access key is in contact with, or is covered by the following metallic objects
  - Cards to which aluminum foil is attached
  - Cigarette boxes that have aluminum foil inside
  - Metallic wallets or bags
  - Coins
  - Hand warmers made of metal
  - Media such as CDs and DVDs
- When another transmitters (that emit radio waves) are being used nearby
- When carrying the access key together with the following devices that emit radio waves
  - A portable radio, cellular phone, cordless phone or other wireless communication device
  - Another vehicle's access key or a transmitter that emits radio waves
  - Personal computers or personal digital assistants (PDAs)
  - Digital audio players
  - Portable game systems
- If window tint with a metallic content or metallic objects are attached to the rear window
- When the access key is placed near a battery charger or electronic devices

**■ Notes for the “keyless access” entry function**

- Even when the access key is within the effective range (detection areas), the system may not operate properly in the following cases:
  - The access key is too close to the window or outside door handle, near the ground, or in a high place when the doors are locked or unlocked.
  - The access key is near the ground or in a high place, or too close to the rear bumper center when the trunk lid is unlocked.
  - The access key is on the instrument panel, rear shelf or floor, in the door pockets or glove box or auxiliary box when the engine is started or push-button ignition switch modes are changed.
- Do not leave the access key on top of the instrument panel or near the door pockets when exiting the vehicle. Depending on the radio wave reception conditions, it may be detected by the antenna outside the cabin and the door will become lockable from the outside, possibly trapping the access key inside the vehicle.
- As long as the access key is within the effective range, the doors may be locked or unlocked by anyone.
- Even if the access key is not inside the vehicle, it may be possible to start the engine if the access key is near the window.
- The doors may unlock if a large amount of water splashes on the door handle, such as in the rain or in a car wash when the access key is within the effective range. (The door will automatically be locked after approximately 30 seconds if the doors are not opened and closed.)
- Gripping the door handle when wearing a glove may not unlock the door.
- If the remote keyless entry system is used to lock the doors when the access key is near the vehicle, there is a possibility that the door may not be unlocked by the “keyless access” entry function. (Use the remote keyless entry system to unlock the doors.)
- A sudden approach to the effective range or door handle may prevent the doors from being unlocked. In this case, return the door handle to the original position and check that the doors unlock before pulling the door handle again.

### ■ Notes for locking the doors

- Touching the door lock sensor while wearing gloves may delay or prevent lock operation. Remove the gloves and touch the lock sensor again.
- When the lock operation is performed using the lock sensor, recognition signals will be shown up to two consecutive times. After this, no recognition signals will be given.
- If the door handle becomes wet when washing the vehicle while the access key is within the effective range, the door may lock and unlock repeatedly. In this case, place the access key in a location 6 ft. (2 m) or more away from the vehicle (take care to ensure that the key is not stolen), and continue to wash the vehicle.
- If the access key is inside the vehicle and a door handle becomes wet during a car wash, a buzzer will sound outside the vehicle. To turn off the alarm, lock all the doors.
- The lock sensor may not work properly if it comes into contact with ice, snow, mud, etc. Clean the lock sensor and attempt to operate it again.

### ■ Notes for the unlocking function

- A sudden approach to the effective range or door handle may prevent the doors from being unlocked. In this case, return the door handle to the original position and check that the doors unlock before pulling the door handle again.
- Gripping the door handle when wearing a glove may not unlock the door. Remove the gloves and touch the sensor on the back of the handle again.
- If the door handle becomes wet when washing the vehicle while the access key is within the effective range, the door may lock and unlock repeatedly. In this case, place the access key in a location 6 ft. (2 m) or more away from the vehicle (take care to ensure that the key is not stolen), and continue to wash the vehicle.
- If there is another access key in the detection area, it may take slightly longer to unlock the doors after the door handle is gripped.

■ **When the vehicle is not driven for extended periods**

- To prevent theft of the vehicle, do not leave the access key within 6 ft. (2 m) of the vehicle.
- The keyless access with push button start system can be deactivated in advance. (→P. 439)

■ **Alarm\* (if equipped)**

Using the keyless access with push button start system to lock the doors will set the alarm system. (→P. 81)

\*: The alarm's default setting is set to off.

■ **To operate the system properly**

Make sure to carry the access key when operating the system. Do not get the access key too close to the vehicle when operating the system from the outside of the vehicle.

Depending on the position and holding condition of the access key, the key may not be detected correctly and the system may not operate properly. (The alarm may go off accidentally, or the door lock prevention function may not operate.)

■ **If the keyless access with push button start system does not operate properly**

- Locking and unlocking the doors, unlocking the trunk lid: Use the mechanical key. (→P. 394)
- Starting the engine: →P. 395

### ■ Access key battery depletion

- The standard battery life is 1 to 2 years.
- If the battery becomes low, an alarm will sound in the cabin when the engine stops. (→P. 374)
- As the access key always receives radio waves, the battery will become depleted even if the access key is not used. The following symptoms indicate that the access key battery may be depleted. Replace the battery when necessary. (→P. 325)
  - The keyless access with push button start system or the remote keyless entry system does not operate.
  - The detection area becomes smaller.
  - The LED indicator on the key surface does not turn on.
- To avoid serious deterioration, do not leave the access key close to any of the following electrical appliances that produce a magnetic field:
  - TVs
  - Personal computers
  - Cellular phones, cordless phones and battery chargers
  - Recharging cellular phones or cordless phones
  - Glass top ranges
  - Table lamps

### ■ When the access key battery is fully depleted

→P. 325

### ■ If the keyless access with push button start system has been deactivated in a customized setting

- Locking and unlocking the doors, unlocking the trunk lid: Use the remote keyless entry system or mechanical key. (→P. 37, 394)
- Starting the engine and changing push-button ignition switch modes:  
→P. 395
- Stopping the engine: →P. 397

■ **Customization that can be configured at SUBARU dealer**

Settings (e. g. keyless access with push button start system) can be changed. (Customizable features: →P. 439)

■ **Certification for keyless access with push button start system**

**For vehicles sold in the U.S.A.**

FCC ID: HYQ23AAE

FCC ID: HYQ14ACX

FCC ID: Y8PSSPLF03

**NOTE:**

This device complies with part 15 of the FCC Rules. Operation is subject to the following two conditions: (1) This device may not cause harmful interference, and (2) this device must accept any interference received, including interference that may cause undesired operation.

**FCC WARNING:**

Changes or modifications not expressly approved by the party responsible for compliance could void the user's authority to operate the equipment.

**For vehicles sold in Canada**

**NOTE:**

Operation is subject to the following two conditions: (1) this device may not cause interference, and (2) this device must accept any interference, including interference that may cause undesired operation of the device.

**NOTE:**

L'utilisation de ce dispositif est autorisée seulement aux deux conditions suivantes: (1) il ne doit pas produire de brouillage, et (2) l'utilisateur du dispositif doit être prêt à accepter tout brouillage radioélectrique reçu, même si ce brouillage est susceptible de compromettre le fonctionnement du dispositif.

 **WARNING**

■ **Caution regarding interference with electronic devices**

- People with implanted pacemakers or cardiac defibrillators should keep away from the keyless access with push button start system antennas. (→P. 25)

The radio waves may affect the operation of such devices. If necessary, the “keyless access” entry function can be disabled. Ask your SUBARU dealer for details, such as the frequency of radio waves and timing of emitting the radio waves. Then, consult your doctor to see if you should disable the “keyless access” entry function.

- Users of any electrical medical device other than implanted pacemakers and implanted cardiac defibrillators should consult the manufacturer of the device for information about its operation under the influence of radio waves.

Radio waves could have unexpected effects on the operation of such medical devices.

Ask your SUBARU dealer for details for disabling the “keyless access” entry function.



## 1-2. Opening, closing and locking the doors and trunk lid Remote keyless entry system

The remote keyless entry system can be used to lock and unlock the vehicle.

### Vehicles without a keyless access with push button start system

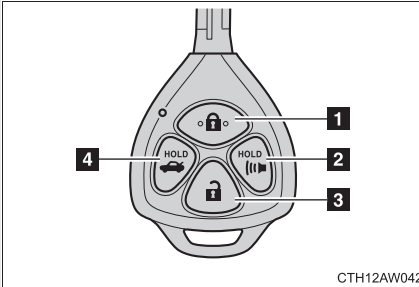

- 1** Locks both side doors
- 2** Sounds the alarm (press and hold)
- 3** Unlocks both side doors

Pressing the button unlocks the driver's door. Pressing the button again within 3 seconds unlocks the other door.

- 4** Unlocks the trunk lid (press and hold)

### Vehicles with a keyless access with push button start system

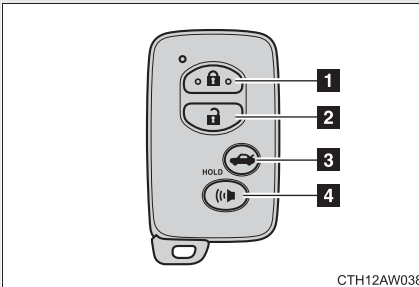

- 1** Locks both side doors
- 2** Unlocks both side doors

Pressing the button unlocks the driver's door. Pressing the button again within 3 seconds unlocks the other door.

- 3** Unlocks the trunk lid (press and hold)
- 4** Sounds alarm (press and hold)

### ■ Operation signals

Doors: A buzzer sounds and the hazard warning flashers flash to indicate that the doors have been locked/unlocked. (Locked: once; Unlocked: twice)

Trunk lid: A buzzer sounds to indicate that the trunk lid has been unlocked.

### ■ Door lock buzzer (vehicles with a keyless access with push button start system)

If an attempt to lock the doors is made when a door is not fully closed, a buzzer sounds continuously. Fully close the door to stop the buzzer, and lock the vehicle once more.

### ■ Panic mode

#### Vehicles without a keyless access with push button start system

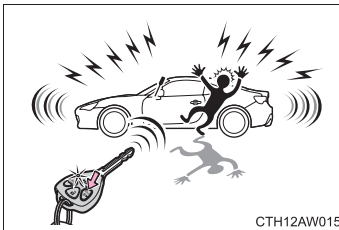

When  is pressed for longer than about one second, an alarm will sound intermittently and the vehicle lights will flash to deter any person from trying to break into or damage your vehicle.

To stop the alarm, press any button on the transmitter.

#### Vehicles with a keyless access with push button start system



When  is pressed for longer than about one second, an alarm will sound intermittently and the vehicle lights will flash to deter any person from trying to break into or damage your vehicle.

To stop the alarm, press any button on the access key.

## ■ Vehicle finder function

### Vehicles without a keyless access with push button start system

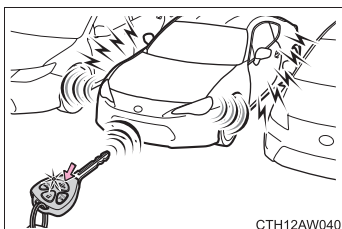

A buzzer (sounds once) and the hazard warning flashers (flash 3 times) are used to inform the driver of the vehicle's location.

Press  3 times within 5 seconds while within a circumference of approximately 30 ft. (10 m) from of the vehicle. However, if the interval between the 3 presses is short, the system may not be activated. This setting must be customized at your SUBARU dealer.

### Vehicles with a keyless access with push button start system

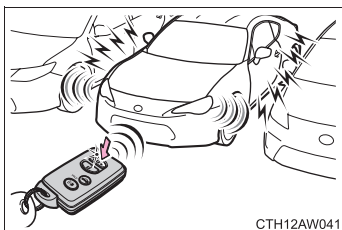

A buzzer (sounds once) and the hazard warning flashers (flash 3 times) are used to inform the driver of the vehicle's location.

Press  3 times within 5 seconds while within a circumference of approximately 30 ft. (10 m) from of the vehicle. However, if the interval between the 3 presses is short, the system may not be activated. This setting must be customized at your SUBARU dealer.

## ■ Security feature

If a door is not opened within approximately 60 seconds after the vehicle is unlocked, the security feature automatically locks the vehicle again.

### ■ Conditions affecting operation

#### **Vehicles without a keyless access with push button start system**

The remote keyless entry system may not operate normally in the following situations:

- When the transmitter battery is depleted
- Near a TV tower, electric power plant, gas station, radio station, large display, airport or other facility that generates strong radio waves or electrical noise
- When carrying a portable radio, cellular phone or other wireless communication devices
- When the transmitter is in contact with, or is covered by a metallic object
- When other transmitters (that emit radio waves) are being used nearby
- If window tint with a metallic content or metallic objects are attached to the rear window

#### **Vehicles with a keyless access with push button start system**

→P. 30

### ■ If the remote keyless entry system does not operate properly (vehicles with a keyless access with push button start system)

Locking and unlocking the doors, unlocking the trunk lid: Use the mechanical key. (→P. 394)

### ■ Key battery depletion

#### **Vehicles without a keyless access with push button start system**

If the remote keyless entry system does not operate, the battery may be depleted. Replace the battery when necessary. (→P. 325)

#### **Vehicles with a keyless access with push button start system**

→P. 34

### ■ When the access key battery is fully depleted

→P. 325

### ■ Confirmation of the registered key number

The number of keys already registered to the vehicle can be confirmed. Ask your SUBARU dealer for details.

### ■ Customization that can be configured at your SUBARU dealer

Settings (e.g. remote keyless entry system) can be changed.  
(Customizable features →P. 439)

■ **Certification for remote keyless entry system**

**For vehicles sold in the U.S.A.**

FCC ID: HYQ23AAA

FCC ID: HYQ12BBY

**NOTE:**

This device complies with part 15 of the FCC Rules. Operation is subject to the following two conditions: (1) This device may not cause harmful interference, and (2) this device must accept any interference received, including interference that may cause undesired operation.

**FCC WARNING:**

Changes or modifications not expressly approved by the party responsible for compliance could void the user's authority to operate the equipment.

**For vehicles sold in Canada**

**NOTE:**

Operation is subject to the following two conditions: (1) this device may not cause interference, and (2) this device must accept any interference, including interference that may cause undesired operation of the device.

**NOTE:**

L'utilisation de ce dispositif est autorisée seulement aux deux conditions suivantes: (1) il ne doit pas produire de brouillage, et (2) l'utilisateur du dispositif doit être prêt à accepter tout brouillage radioélectrique reçu, même si ce brouillage est susceptible de compromettre le fonctionnement du dispositif.

## 1-2. Opening, closing and locking the doors and trunk lid

### Doors

The vehicle can be locked and unlocked using the “keyless access” entry function, remote keyless entry system, key or power door lock switch.

■ **“Keyless access” entry function (vehicles with a keyless access with push button start system)**

→P. 24

■ **Remote keyless entry system**

→P. 37

■ **Key**

Turning the key operates the doors as follows:

**Vehicles without a keyless access with push button start system**

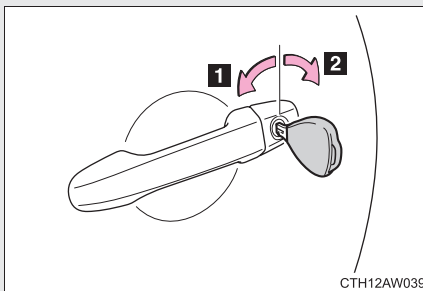

**1** Locks driver's side door

**2** Unlocks driver's side door

**Vehicles with a keyless access with push button start system**

The doors can also be locked and unlocked with the mechanical key. (→P. 394)

■ Power door lock switch

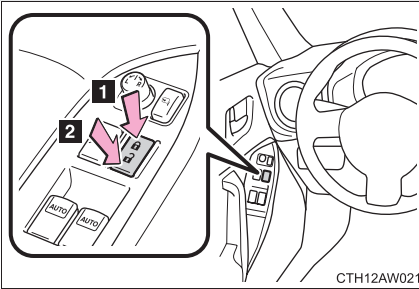

- 1 Locks both side doors
- 2 Unlocks both side doors

■ Lock lever

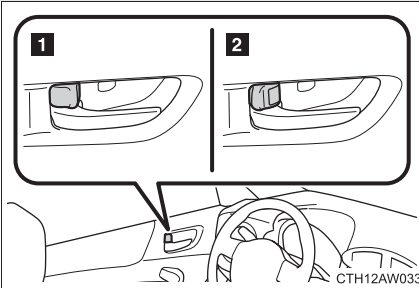

- 1 Locks the door
- 2 Unlocks the door

### Locking the doors from the outside without a key

**STEP 1** Move the lock lever to the lock position.

**STEP 2** Close the door.

### Vehicles with a keyless access with push button start system

The door cannot be locked if the access key is left inside the vehicle.

The key may not be detected correctly and the door may be locked.

#### ■ Window open/close function linked to door operation

In order to make opening and closing the doors easier, completely closed windows are linked to door operations. Therefore, when a door is opened, its window opens slightly. When a door is closed, its window closes completely.

However, if the battery has discharged or is disconnected, this function will not operate. (→P. 402)

#### ■ If the keyless access with push button start system has been deactivated in a customized setting (vehicles with a keyless access with push button start system)

Use the remote keyless entry system or mechanical key. (→P. 37, 394)

### WARNING

#### ■ To prevent an accident

Observe the following precautions while driving the vehicle.

Failure to do so may result in a door opening and an occupant falling out, resulting in death or serious injury.

- Always use a seatbelt.
- Always lock both side doors.
- Ensure that both side doors are properly closed.
- Do not pull the inside handle of the doors while driving.

The doors may be opened and the passengers are thrown out of the vehicle and it may result in serious injury or death.



## 1-2. Opening, closing and locking the doors and trunk lid

### Trunk lid

The trunk lid can be opened using the key, trunk lid opener, “keyless access” entry function or remote keyless entry system.

#### ■ Opening the trunk lid from inside the vehicle

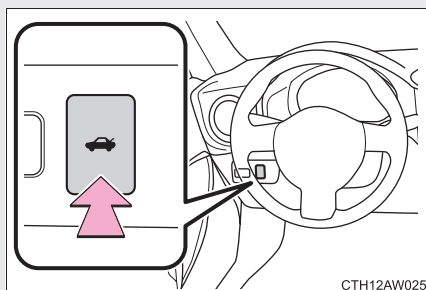

Press and hold the opener switch to release the trunk lid.

If the trunk lid cannot be opened by the opener switch:  
→P. 46

#### ■ Opening the trunk lid from outside the vehicle

**Key (vehicles without a keyless access with push button start system)**

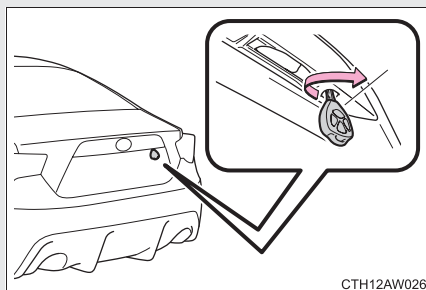

Turn the master key clockwise to release the trunk lid.

**“Keyless access” entry function (vehicles with a keyless access with push button start system)**

→P. 24

**Remote keyless entry system**

→P. 37

### Canceling the trunk lid opener feature

To protect luggage stored in the trunk lid against theft, do the following:

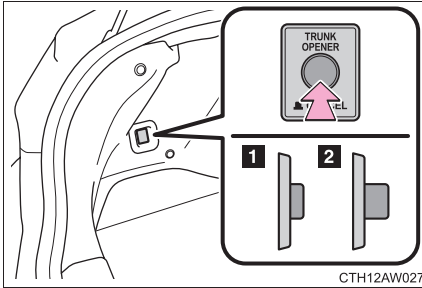

Turn the main switch in the trunk lid off to disable the trunk lid opener.

- 1** On (The trunk lid can be opened using the trunk lid opener.)
- 2** Off (The trunk lid cannot be opened using the trunk lid opener.)

Vehicles without a keyless access with push button start system:  
The trunk lid can only be opened with the master key.

Vehicles with a keyless access with push button start system:  
The trunk lid can only be opened with the mechanical key.

■ **Function to prevent the trunk lid being locked with the access key inside (vehicles with a keyless access with push button start system)**

- When all doors are being locked, closing the trunk lid with the access key left inside the trunk will sound an alarm.  
In this case, the trunk lid can be opened using the “keyless access” entry function.
- Even when the spare access key is put in the trunk with all the doors locked, the key confinement prevention function can be activated so the trunk lid can be opened. In order to prevent theft, take all access keys with you when leaving the vehicle.
- Even when the access key is put in the trunk with all the doors are locked, the key may not be detected depending on the places and the surrounding radio wave conditions. In this case, the key confinement prevention function cannot be activated, causing the doors to lock when the trunk lid is closed. Make sure to check where the key is before closing the trunk lid.
- The key confinement prevention function cannot be activated if any one of the doors is unlocked. In this case, open the trunk lid using the trunk lid opener.

■ **Internal trunk lid release lever**

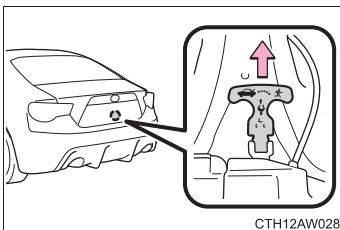

The trunk lid can be opened by pulling on the glow-in-the-dark lever located on the inside of the trunk lid.

The lever will continue to glow for some time after the trunk lid is closed.

■ **Using the mechanical key (vehicles with a keyless access with push button start system)**

The trunk lid can be also opened using the mechanical key. (→P. 394)

■ **Which key to the vehicle is to leave with a parking attendant after disabling the trunk lid opener main switch**

→P. 21

 **WARNING**

■ **Caution while driving**

- Keep the trunk lid closed while driving.  
If the trunk lid is left open, it may hit nearby objects while driving or luggage in the trunk may be unexpectedly thrown out, causing an accident. In addition, exhaust gases may enter the vehicle, causing death or a serious health hazard. Make sure to close the trunk lid before driving.
- Before driving the vehicle, make sure that the trunk lid is fully closed. If the trunk lid is not fully closed, it may open unexpectedly while driving, causing an accident.
- Never let anyone sit in the trunk. In the event of sudden braking or a collision, they are susceptible to death or serious injury.

■ **When children are in the vehicle**

Observe the following precautions.  
Failure to do so may result in death or serious injury.

- Do not allow children to enter the trunk.  
If a child is accidentally locked in the trunk, they could overheat or suffocate.
- Do not allow a child to open or close the trunk lid.  
Doing so may cause the trunk lid to operate unexpectedly, or cause the child's hands, head, or neck to be caught by the closing trunk lid.

**! WARNING****■ Using the trunk**

Observe the following precautions.

Failure to do so may cause parts of the body to be caught, resulting in serious injury.

- Remove any heavy loads, such as snow and ice, from the trunk lid before opening it. Failure to do so may cause the trunk lid to fall closed again after it is opened.
- When opening or closing the trunk lid, thoroughly check to make sure the surrounding area is safe.
- If anyone is in the vicinity, make sure they are safe and let them know that the trunk lid is about to open or close.
- Use caution when opening or closing the trunk lid in windy weather as it may move abruptly in strong wind.

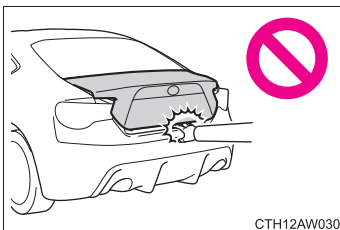
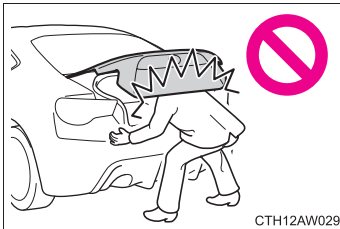

- The trunk lid may fall if it is not opened fully. It is more difficult to open or close the trunk lid on an incline than on a level surface, so beware of the trunk lid unexpectedly opening or closing by itself. Make sure that the trunk lid is fully open and secure before using the trunk.
  - When closing the trunk lid, take extra care to prevent your fingers etc. from being caught.
  - When closing the trunk lid, make sure to press it lightly on its outer surface.
- Do not attach any accessories other than genuine parts to the trunk lid. Such additional weight on the trunk lid may cause the lid to fall closed again after it is opened.

 CAUTION

■ **Trunk lid damper stays**

The trunk lid is equipped with damper stays that hold the trunk lid in place. Observe the following precautions.

Failure to do so may cause damage to trunk lid damper stays, resulting in a malfunction.

- Do not attach any foreign objects such as stickers, plastic sheets and adhesives to damper stay rods.
- Do not touch damper stay rods with gloves or other fabric items.
- Do not attach any accessories other than genuine parts to the trunk lid.
- Do not apply lateral force to damper stays or place your hand on it.

## 1-3. Adjustable components (seats, mirrors, steering wheel)

### Front seats

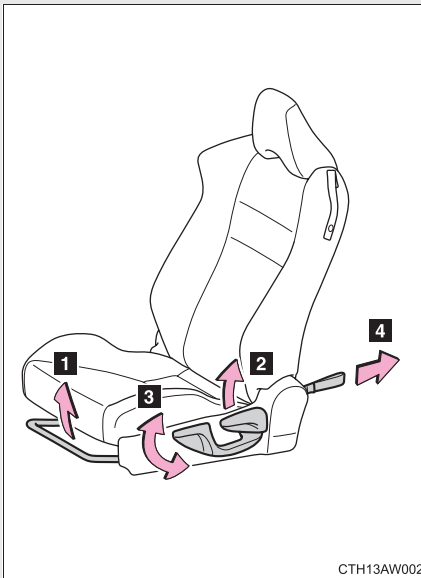

- 1 Seat position adjustment lever
- 2 Seatback angle adjustment lever
- 3 Vertical height adjustment lever (driver's side only)
- 4 Seatback fold strap

### Getting in and out of the rear seats

To get in and out of the rear seats, use the seatback angle adjustment lever or seatback fold strap.

#### ■ Before getting in or out of the rear seats

Release the seatbelt from the seatbelt guide. (→P. 59)

#### ■ Getting in the rear seats

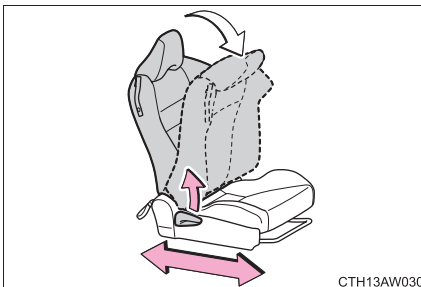

Lift the seatback angle adjustment lever.

The seatback will fold forward.

Front passenger seat only: The seat can be slid forward and backward.

### ■ Getting out of the rear seats

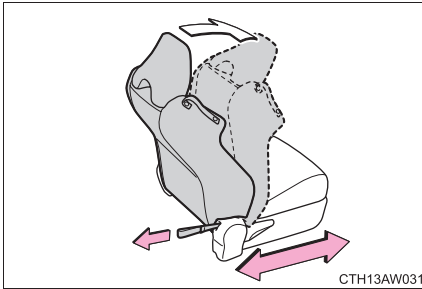

Pull the seatback fold strap.

The seatback will fold forward.

Front passenger seat only: The seat can be slid forward and backward.

### ■ After getting in or out of the rear seats

Return the seatback to the upright position until the seat locks.

Front passenger seat only: The seat will lock in position at the point where the seatback reaches the upright position.

---

### ■ Seat dust cover

Always remove the seat dust cover that may be attached at the time of purchase before using the seat.

### ⚠ WARNING

#### ■ Seat adjustment

● To reduce the risk of sliding under the lap belt during a collision, do not recline the seat more than necessary.

If the seat is too reclined, the lap belt may slide past the hips and apply restraint forces directly to the abdomen, or your neck may contact the shoulder belt, increasing the risk of death or serious injury in the event of an accident.

Adjustments should not be made while driving as the seat may unexpectedly move and cause the driver to lose control of the vehicle.



 **WARNING**

- After adjusting the seat, push it slightly to make sure it is securely locked. If the seat is not securely locked, it may move or the seatbelt may not operate properly.
- Take care not to hit passengers with the seat.  
When sliding the seat rearward, make sure not to squash the legs of the rear passengers.
- When returning the seatback upright, perform seatback angle adjustment while holding down the seatback.
- Do not pull on or use the seatbelt guide to adjust or fold the front seat.

**■ When driving the vehicle**

Never operate the seatback angle adjustment lever or seatback fold strap. Doing so could cause an accident resulting in death or serious injury.

**■ Getting in and out of the rear seats**

- When getting in or out of the rear seats, make sure not to get your hands, legs, etc. squashed in the movable or connecting parts.
- When getting in or out of the rear seats, make sure not to trip on the seat rails.
- After getting in or out of the rear seats, always make sure the front seat is locked in position.

**■ When operating the front seat from the rear seat**

Make sure that no passenger is seated in the front seat.

 **CAUTION****■ When getting in and out the vehicle**

Do not rub your back against the side support pad of backrest. Otherwise surface of the side support pad is damaged early. You can move the seat backward to prevent the contact.

## 1-3. Adjustable components (seats, mirrors, steering wheel)

### Rear seats

The seatbacks of the rear seats can be folded down.

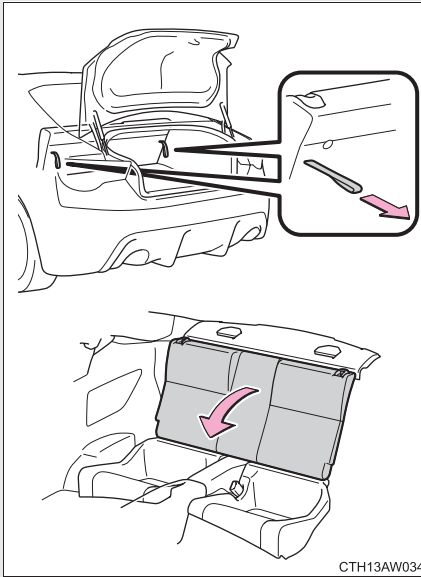

Pull the both left and right seatback lock release straps in the trunk lid to fold down the seatback.

To return the seatbacks to its original position, lift it up until it locks.

#### ■ Seat dust cover

Always remove the seat dust cover that may be attached at the time of purchase before using the seat.

**! WARNING****■ When folding the rear seatbacks down**

Observe the following precautions. Failure to do so may result in death or serious injury.

- Do not fold the seatbacks down while driving.
- Stop the vehicle on level ground, set the parking brake and shift the select lever to P (automatic transmission) or shift lever to neutral (manual transmission).
- Do not allow anyone to sit on a folded seatback or in the trunk while driving.
- Do not allow children to enter the trunk.

**■ After returning the rear seatback to the upright position**

Observe the following precautions. Failure to do so may result in death or serious injury.

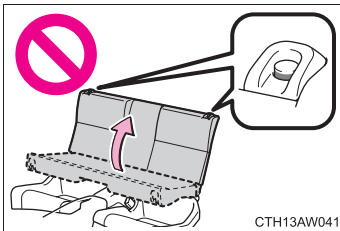

- Make sure that the seatback is securely locked in position by lightly pushing it back and forth. If the seatback is not securely locked, the red portion of the seatback lock release button will be visible. Make sure that the red portion is not visible.

- Check that the seatbelts are not twisted or caught in the seatback.

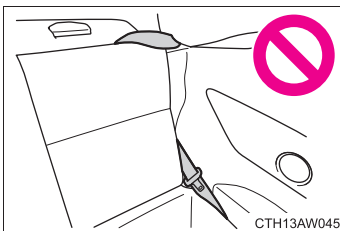
**■ Before using the rear seatbelts**

- Always make sure that the seatbelt is not caught in the seatback or twisted in one of the hooks that secure the seatback. Failure to do so may cause the seatbelt to not be fastened correctly or to become ineffective in a collision, resulting in serious injury.

## 1-3. Adjustable components (seats, mirrors, steering wheel)

### Head restraints

Head restraints are provided for front seats.

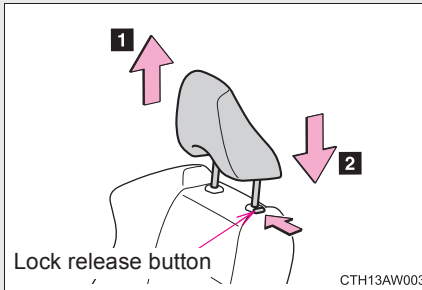

#### 1 Up

Pull the head restraints up.

#### 2 Down

Push the head restraint down while pushing the lock release button.

#### ■ Removing the head restraints

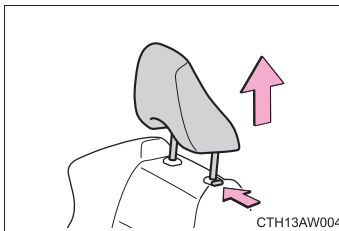

Pull the head restraint up while pressing the lock release button.

#### ■ Installing the head restraints

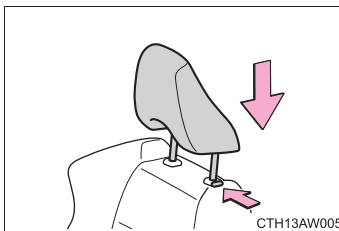

Align the head restraint with the installation holes and push it down to the lock position.

Press and hold the lock release button when lowering the head restraint.

### ■ Adjusting the height of the head restraints

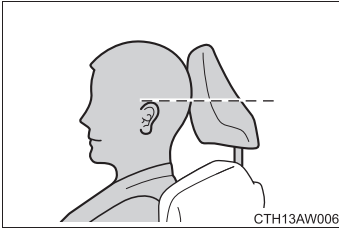

Make sure that the head restraints are adjusted so that the center of the head restraint is closest to the top of your ears.

1

Before driving

#### WARNING

#### ■ Head restraint precautions

Observe the following precautions regarding the head restraints. Failure to do so may result in death or serious injury.

- Use the head restraints designed for each respective seat.
- Adjust the head restraints to the correct position at all times.
- After adjusting the head restraints, push down on them and make sure they are locked in position.
- Do not drive with the head restraints removed.

## 1-3. Adjustable components (seats, mirrors, steering wheel)

# Seatbelts

Make sure that all occupants are wearing their seatbelts before driving the vehicle.

### ■ Correct use of the seatbelts

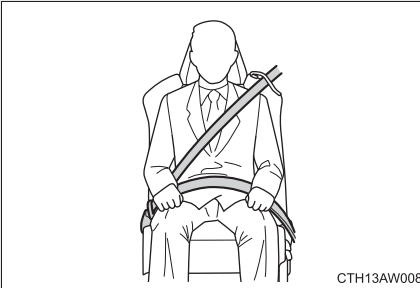

- Extend the shoulder belt so that it comes fully over the shoulder, but does not come into contact with the neck or slide off the shoulder.
- Position the lap belt as low as possible over the hips.
- Adjust the position of the seatback. Sit up straight and well back in the seat.
- Do not twist the seatbelt.

### ■ Fastening and releasing the seatbelt

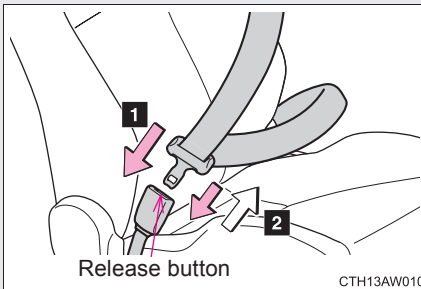

- 1** Fasten the seatbelt  
Push the plate into the buckle until a click sound is heard.
- 2** Release the seatbelt  
Press the release button.

### Front seatbelt guide

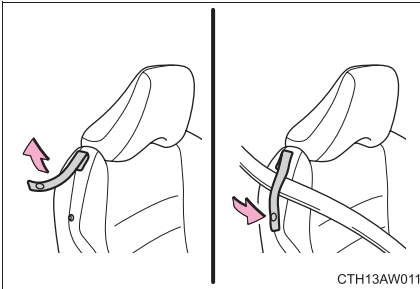

To enable the seatbelt to be easily extended, pass the seatbelt through the guide.

When getting in or out of the rear seats, release the seatbelt from the guide.

### Seatbelt pretensioners (front seats)

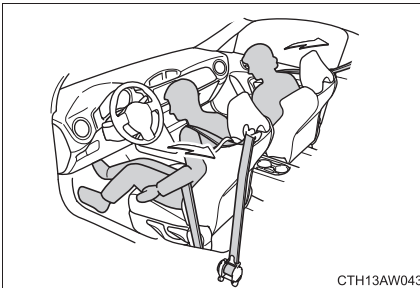

The pretensioner helps the seatbelt to quickly restrain the occupant by retracting the seatbelt when the vehicle is subjected to certain types of severe frontal collision and/or side collision.

The pretensioner may not activate in the event of a minor frontal impact, a side impact or a rear impact.

### ■ Emergency locking retractor (ELR)

The retractor will lock the belt during a sudden stop or on impact. It may also lock if you lean forward too quickly. A slow, easy motion will allow the belt to extend so that you can move around fully.

### ■ Automatic locking retractor (ALR)

When a passenger's shoulder belt is completely extended and then retracted even slightly, the belt is locked in that position and cannot be extended. This feature is used to hold the child restraint system (CRS) firmly. To free the belt again, fully retract the belt and then pull the belt out once more. (→P. 136)

### ■ Child seatbelt usage

The seatbelts of your vehicle are principally designed for persons of adult size.

- Use a child restraint system appropriate for the child, until the child becomes large enough to properly wear the vehicle's seatbelt. (→P. 132)
- When the child becomes large enough to properly wear the vehicle's seatbelt, follow the instructions on P. 58 regarding seatbelt usage.

### ■ Seatbelt pretensioners

- Seatbelt pretensioners are not designed to activate in minor frontal or side impact, in rear impacts or in roll-over accidents.
  - The following four components operate simultaneously when the vehicle is subjected to a severe frontal collision.
    - Seatbelt pretensioner for driver
    - Seatbelt pretensioner for front passenger
    - SRS front airbag for driver
    - SRS front airbag for front passenger\*
- \*: This does not operate while the occupant detection system determines to deactivate the airbag operation. For details, refer to "Front passenger's SRS frontal airbag" (→P. 95)
- The following two components operate simultaneously when the vehicle is subjected to a severe collision on the driver's seat side of the vehicle.
    - Seatbelt pretensioner for driver
    - Side airbag for driver



- The following two components operate simultaneously when the vehicle is subjected to a severe collision on the front passenger's seat side of the vehicle.
  - Seatbelt pretensioner for front passenger
  - Side airbag for front passenger
- Pretensioners are designed to function on a one-time-only basis. In the event that a pretensioner is activated, both the driver's and front passenger's seatbelt retractor assemblies must be replaced only by SUBARU dealer. When replacing seatbelt retractor assemblies, use only genuine SUBARU parts.
- If either front seatbelt does not retract or cannot be pulled out due to a malfunction or activation of the pretensioner, contact your SUBARU dealer as soon as possible.
- If the front seatbelt retractor assembly or surrounding area has been damaged, contact your SUBARU dealer as soon as possible.
- When you sell your vehicle, we urge you to explain to the buyer that it has seatbelt pretensioners by alerting the buyer to the contents of this section.

■ **Replacing the belt after the pretensioner has been activated**

If the vehicle is involved in multiple collisions, the pretensioner will activate for the first collision, but will not activate for the second or subsequent collisions.

**⚠ WARNING**

Observe the following precautions to reduce the risk of injury in the event of sudden braking, sudden swerving or an accident.  
Failure to do so may cause death or serious injury.

**■ Wearing a seatbelt**

- Ensure that all passengers wear a seatbelt.
- Always wear a seatbelt properly.
- Each seatbelt should be used by one person only. Do not use a seatbelt for more than one person at once, including children.
- SUBARU recommends that children be seated in the rear seat and always use a seatbelt and/or an appropriate child restraint system.
- To achieve a proper seating position, do not recline the seat more than necessary. The seatbelt is most effective when the occupants are sitting up straight and well back in the seats.
- Do not wear the shoulder belt under your arm.
- Always wear your seatbelt low and snug across your hips.

**■ Pregnant women**

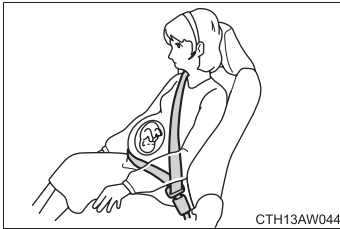

Obtain medical advice and wear the seatbelt in the proper way. (→P. 58)

Women who are pregnant should position the lap belt as low as possible over the hips in the same manner as other occupants. Extend the shoulder belt completely over the shoulder and position the belt across the chest. Avoid belt contact over the rounding of the abdominal area.

If the seatbelt is not worn properly, not only the pregnant woman, but also the fetus could suffer death or serious injury as a result of sudden braking or a collision.



**WARNING**

■ **People with a medical condition**

Obtain medical advice and wear the seatbelt in the proper way.

■ **When children are in the vehicle**

Do not allow children to play with the seatbelt. If the seatbelt becomes twisted around a child's neck, it may lead to choking or other serious injuries that could result in death.

If this occurs and the buckle cannot be unfastened, scissors should be used to cut the belt.

■ **Seatbelt pretensioners**

If the pretensioner has activated, the SRS airbag system warning light will come on. In that case, the seatbelt cannot be used again and must be replaced at your SUBARU dealer.

**⚠ WARNING**

**■ Seatbelt damage and wear**

- Do not damage the seatbelts by allowing the belt, plate, or buckle to be jammed in the door.
- Inspect the seatbelt system periodically. Check for cuts, fraying, and loose parts. Replace a damaged seatbelt immediately. Damaged seatbelts cannot protect an occupant from death or serious injury.
- Ensure that the belt and plate are locked and the belt is not twisted. If the seatbelt does not function correctly, immediately contact your SUBARU dealer.
- Replace the seat assembly, including the belts, if your vehicle has been involved in a serious accident, even if there's no obvious damage.
- Do not attempt to install, remove, modify, disassemble or dispose of the seatbelts. Have any necessary repairs carried out by your SUBARU dealer. Inappropriate handling of the pretensioner may prevent it from operating properly, resulting in death or serious injury.

**■ When using the seatbelt guide**

- Always make sure that the belt is not twisted, and runs freely through the guide.
- Regardless of whether the guide is used or not, always secure the seatbelt guide button.
- Do not hang from or pull the guide forcefully.

**■ Before using the rear seatbelts**

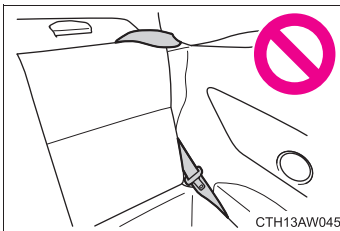

- Always make sure that the seatbelt is not caught in the seatback or twisted in one of the hooks that secure the seatback. Failure to do so may cause the seatbelt to not be fastened correctly or to become ineffective in a collision, resulting in serious injury.

## 1-3. Adjustable components (seats, mirrors, steering wheel)

### Steering wheel

The steering wheel can be adjusted to a comfortable position.

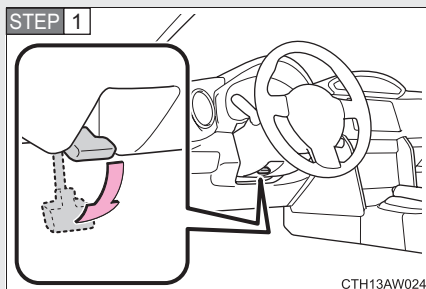

Hold the steering wheel and push the lever down.

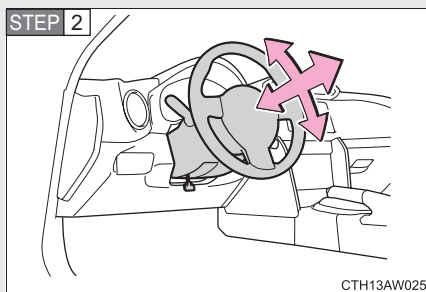

Adjust to the ideal position by moving the steering wheel horizontally and vertically.

After adjustment, pull the lever up to secure the steering wheel.

#### WARNING

##### ■ Caution while driving

Do not adjust the steering wheel while driving. Doing so may cause the driver to mishandle the vehicle and an accident, resulting in death or serious injury.

##### ■ After adjusting the steering wheel

Make sure that the steering wheel is securely locked. Otherwise, the steering wheel may move suddenly, possibly causing an accident, and resulting in death or serious injury.

### 1-3. Adjustable components (seats, mirrors, steering wheel)

## Anti-glare inside rear view mirror

The rear view mirror's position can be adjusted to enable sufficient confirmation of the rear view in accordance with the driver's seating posture.

#### Adjusting the height of rear view mirror

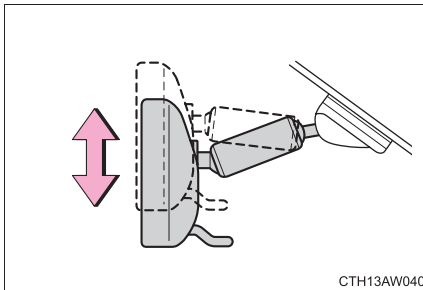

Adjust the height of the rear view mirror by moving it up and down.

#### Anti-glare function

Reflected light from the headlights of vehicles behind can be reduced by operating the lever.

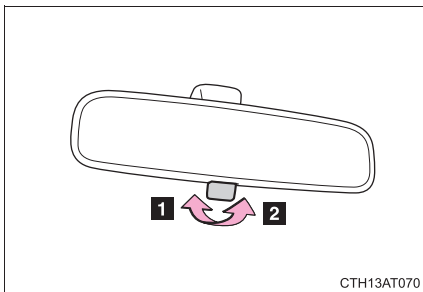

- 1** Normal position
- 2** Anti-glare position

#### **!** WARNING

##### ■ Caution while driving

Do not adjust the position of the mirror while driving. Doing so may lead to mishandling of the vehicle and cause an accident, resulting in death or serious injury.

## 1-3. Adjustable components (seats, mirrors, steering wheel) Outside rear view mirrors

Mirror angle can be adjusted using the switch.

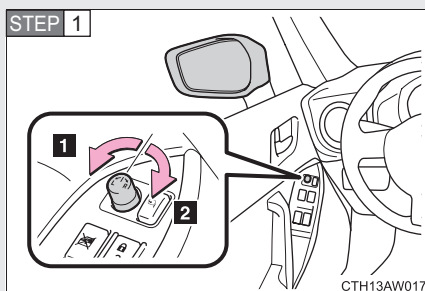

Select a mirror to adjust.

- 1** Left
- 2** Right

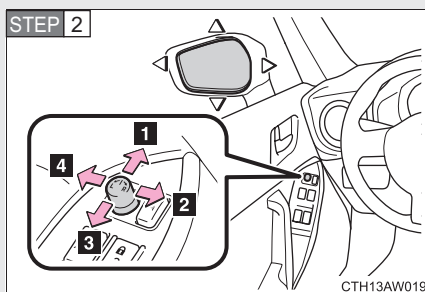

Adjust the mirror.

- 1** Up
- 2** Right
- 3** Down
- 4** Left

## Folding the mirrors

### Manual operation

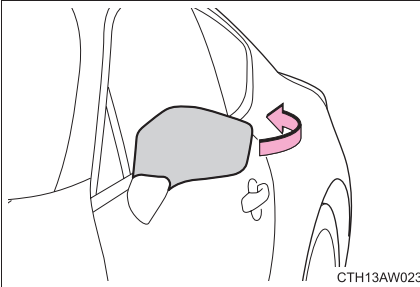

Push the mirror back in the direction of the vehicle's rear.

### Power operation (if equipped)

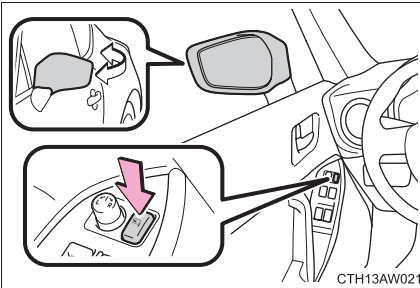

Press the switch to fold the mirrors.

Press it again to extend them to the original position.

### ■ The mirrors can be adjusted when

#### **Vehicles without a keyless access with push button start system**

The engine switch is in the "ACC" or "ON" position.

#### **Vehicles with a keyless access with push button start system**

The push-button ignition switch is in "ACC" or "ON" mode.

### ■ When the mirrors are fogged up (vehicles with outside rear view mirror defoggers)

The outside rear view mirrors can be cleared using the mirror defoggers. Turn on the rear window defogger to turn on the outside rear view mirror defoggers. (→P. 250)





**WARNING**

■ **When driving the vehicle**

Observe the following precautions while driving.

Failure to do so may result in loss of control of the vehicle and cause an accident, resulting in death or serious injury.

- Do not adjust the mirrors while driving.
- Do not drive with the mirrors folded.
- Both the driver and passenger side mirrors must be extended and properly adjusted before driving.

■ **When a mirror is moving**

To avoid personal injury and mirror malfunction, be careful not to get your hand caught by the moving mirror.

■ **When the mirror defoggers are operating (vehicles with outside rear view mirror defoggers)**

Do not touch the rear view mirror surfaces, as they can become very hot and burn you.

## 1-4. Opening and closing the windows

### Power windows

The power windows can be opened and closed using the switches.

Operating the switch moves the windows as follows:

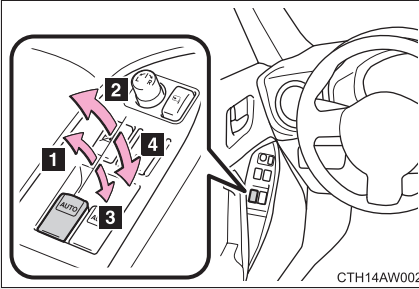

- 1** Closing
- 2** One-touch closing\*
- 3** Opening
- 4** One-touch opening\*

\*: Pushing the switch in the opposite direction will stop window travel partway.

### Window lock switch

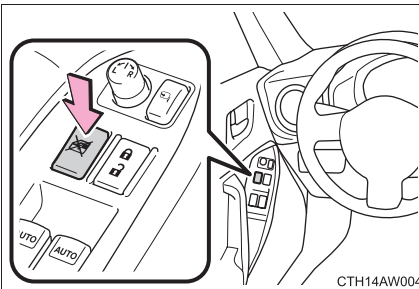

Press the switch down to lock the passenger window glasses.

Use this switch to prevent children from accidentally opening or closing a passenger window.

■ **The power windows can be operated when**

**Vehicles without a keyless access with push button start system**

The engine switch is in the “ON” position.

**Vehicles with a keyless access with push button start system**

The push-button ignition switch is in “ON” mode.

■ **Operating the power windows after turning the engine off**

**Vehicles without a keyless access with push button start system**

The power windows can be operated for approximately 45 seconds even after the engine switch is turned to the “ACC” or “LOCK” position. They cannot, however, be operated once either door is opened.

**Vehicles with a keyless access with push button start system**

The power windows can be operated for approximately 45 seconds even after the push-button ignition switch is turned to “ACC” mode or turned off. They cannot, however, be operated once either door is opened.

■ **Jam protection function**

If an object becomes caught between the window and the body, window travel is stopped and the window is opened slightly.

### ■ When the power window does not close normally

If the jam protection function is operating abnormally and a window cannot be closed, close all the doors perform the following operations using the power window switch on the relevant door.

**STEP 1** Vehicles without a keyless access with push button start system:  
After stopping the vehicle, the engine switch is turned to the “ON” position.

Vehicles with a keyless access with push button start system: After stopping the vehicle, the push-button ignition switch is turned to “ON” mode.

**STEP 2** Hold the power window switch in the one-touch closing position two consecutive times.

**STEP 3** Hold the power window switch in the one-touch closing position once again and continue holding for 1 second or more after the window closes completely.

If you push the power window switch to the opening position while the window is moving, start again from the beginning. If the window continues to close but then re-open slightly even after performing the above procedure correctly, we recommend that you have your SUBARU dealer.

### WARNING

#### ■ Closing the windows

Observe the following precautions.

Failure to do so may result in death or serious injury.

- Check to make sure that all passengers do not have any part of their body in a position where it could be caught when a window is being operated.

- Do not allow children to operate the power windows.

Closing a power window on someone can cause serious injury, and in some instances, even death.

#### ■ Jam protection function

- Never use any part of your body to intentionally activate the jam protection function.

- The jam protection function may not work if something gets caught just before the window fully closes.

## 1-5. Refueling

### Opening the fuel tank cap

Perform the following steps to open the fuel tank cap:

#### ■ Before refueling the vehicle

- Vehicles without a keyless access with push button start system: Turn the engine switch off and ensure that all the doors and windows are closed.
- Vehicles with a keyless access with push button start system: Turn the push-button ignition switch off and ensure that all the doors and windows are closed.
- Confirm the type of fuel. (→P. 74)

#### ■ Opening the fuel tank cap

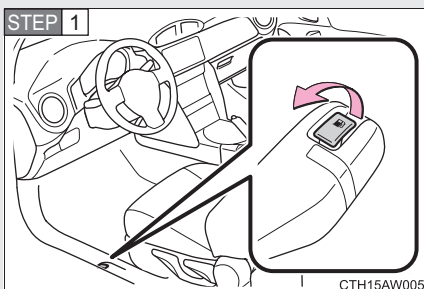

Pull up the opener to open the fuel filler lid.

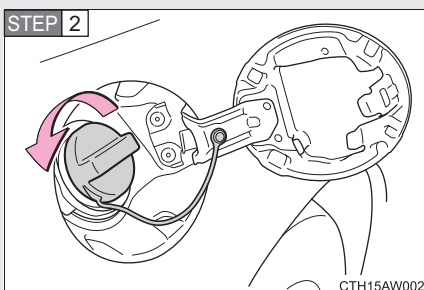

Turn the fuel tank cap slowly to open.

STEP 3

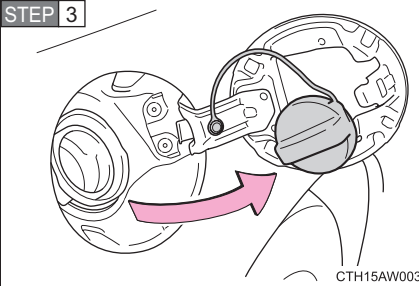

Hang the fuel tank cap on the back of the fuel filler lid.

### Closing the fuel tank cap

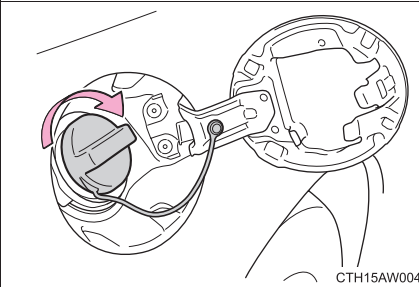

After refueling, turn the fuel tank cap until you hear a click. Once the cap is released, it will turn slightly in the opposite direction.

### Fuel types

Unleaded gasoline (93 AKI [Research Octane Number 98] or higher)

If unleaded gasoline with an octane rating of 93 AKI (98 RON) is not available, unleaded gasoline with an octane rating of 91 AKI (95 RON) may be used with no detriment to engine durability or driveability.

**WARNING****■ Refueling the vehicle**

Observe the following precautions while refueling the vehicle. Failure to do so may result in death or serious injury.

- Do not handle fuel indoors.
- After exiting the vehicle and before opening the fuel door, touch an unpainted metal surface to discharge any static electricity. It is important to discharge static electricity before refueling because sparks resulting from static electricity can cause fuel vapors to ignite while refueling.
- Always hold the grips on the fuel tank cap and turn it slowly to remove it. A whooshing sound may be heard when the fuel tank cap is loosened. Wait until the sound cannot be heard before fully removing the cap. In hot weather, pressurized fuel may spray out of the filler neck and cause injury.
- Do not allow anyone that has not discharged static electricity from their body to come close to an open fuel tank.
- Do not allow others to approach the area of the vehicle near the fuel filler pipe while refueling is in progress.
- Do not inhale vaporized fuel.  
Fuel contains substances that are harmful if inhaled.
- Do not smoke while refueling the vehicle.  
Doing so may cause the fuel to ignite and cause a fire.
- Do not return to the vehicle or touch any person or object that is statically charged.  
This may cause static electricity to build up, resulting in a possible ignition hazard.

 **WARNING**

**■ When refueling**

Observe the following precautions to prevent fuel overflowing from the fuel tank:

- Securely insert the fuel nozzle into the fuel filler neck
- Stop filling the tank after the fuel nozzle automatically clicks off
- Do not top off the fuel tank
- Observe other precautions that are posted at the service station.
- Turn the cap to the right until it clicks to ensure that it is fully tightened. If the cap is not securely tightened, fuel spillage could occur in the event of an accident, creating a fire hazard.

**■ When replacing the fuel cap**

Do not use anything but a genuine fuel tank cap designed for your vehicle. Doing so may cause a fire or other incident which may result in death or serious injury.

 **CAUTION**

**■ Refueling**

- Do not spill fuel during refueling.  
Doing so may damage the vehicle, such as causing the emission control system to operate abnormally or damaging fuel system components or the vehicle's painted surface.
- Never add any cleaning agents to the fuel tank. The addition of a cleaning agent may cause damage to the fuel system.
- Immediately put fuel in the tank whenever the low fuel warning light illuminates. Engine misfires as a result of an empty tank could cause damage to the engine.



## 1-6. Security system

### Engine immobilizer system

The vehicle's keys have built-in transponder chips that prevent the engine from starting if the key has not been previously registered in the vehicle's on-board computer.

Never leave the keys inside the vehicle when you leave the vehicle.

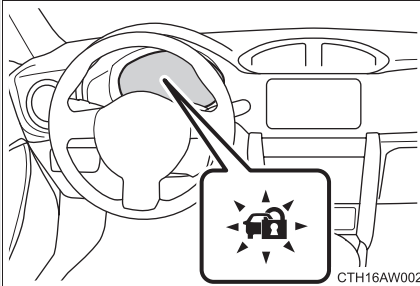

#### Vehicles without a keyless access with push button start system

The indicator light flashes after the key has been removed from the engine switch to indicate that the system is operating.

The indicator light stops flashing after the registered key has been inserted into the engine switch to indicate that the system has been canceled.

**Vehicles with a keyless access with push button start system**

The indicator light flashes after the push-button ignition switch has been turned off to indicate that the system is operating.

The indicator light stops flashing after the push-button ignition switch has been turned to “ACC” or “ON” mode to indicate that the system has been canceled.

---

■ **When the vehicle cannot be started with the registered key (vehicles without a keyless access with push button start system)**

Remove the key and try again.

■ **System maintenance**

The vehicle has a maintenance-free type engine immobilizer system.

■ **Conditions that may cause the system to malfunction**

- If the key is in contact with a metallic object
- If the key is in close proximity to or touching a key to the security system (key with a built-in transponder chip) of another vehicle

## ■ Certification for engine immobilizer system

### For vehicles sold in the U.S.A.

FCC ID: Y8PSSPIMB03

FCC ID: MOZRI-38BFH

This device complies with Part 15 of the FCC Rules. Operation is subject to the following two conditions: (1) this device may not cause harmful interference, and (2) this device must accept any interference received, including interference that may cause undesired operation.

#### FCC WARNING

Changes or modifications not expressly approved by the party responsible for compliance could void the user's authority to operate the equipment.

### For vehicles sold in Canada

#### NOTE:

Operation is subject to the following two conditions: (1) this device may not cause interference, and (2) this device must accept any interference, including interference that may cause undesired operation of the device.

#### NOTE:

L'utilisation de ce dispositif est autorisée seulement aux deux conditions suivantes: (1) il ne doit pas produire de brouillage, et (2) l'utilisateur du dispositif doit être prêt à accepter tout brouillage radioélectrique reçu, même si ce brouillage est susceptible de compromettre le fonctionnement du dispositif.

### CAUTION

#### ■ To ensure the system operates correctly

Do not modify or remove the system. If modified or removed, the proper operation of the system cannot be guaranteed.

## 1-6. Security system

### Theft prevention labels (U.S.A.)

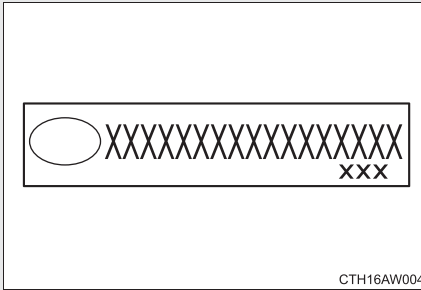

These labels are attached to the vehicle to reduce vehicle theft by facilitating the tracing and recovery of parts from stolen vehicles. Do not remove under penalty of law.

## 1-6. Security system

# Alarm\*

The alarm's default setting is set to off. To use the alarm, perform the activating the alarm system procedures.

The system sounds the alarm and flashes the lights when forcible entry is detected.

### ■ Triggering of the alarm

The alarm is triggered when a locked door or the trunk lid is unlocked or opened in any way other than using the "keyless access" entry function or remote keyless entry system while the alarm is set.

### ■ Setting the alarm system

Close the doors and/or trunk lid and perform one of the following:

- Lock the doors using the "keyless access" entry function.
- Lock the doors using the remote keyless entry system.
- Lock the doors from the outside without using a key.  
(→P. 44)

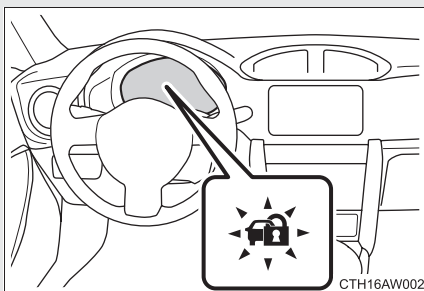

The system will be set automatically after 30 seconds or more elapse.

The indicator light changes from being on to flashing when the system is set.

\*: If equipped

■ **Deactivating or stopping the alarm**

Perform one of the following to deactivate or stop the alarm:



- Unlock the doors using the “keyless access” entry function.
- Unlock the doors using the remote keyless entry system.
- Turn the push-button ignition switch to “ACC” or “ON” mode, or start the engine. (The alarm will be deactivated or stopped after a few seconds.)

**Activating/deactivating the alarm system**

**STEP 1** Check that both side doors and the trunk lid are closed.

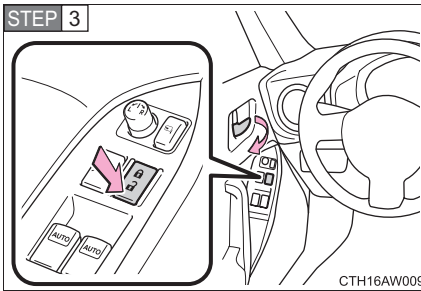
**STEP 2** Turn the push-button ignition switch to “ON” mode.



Open the driver’s door while pressing and holding  on the power door lock switch and continue to press  for approximately 10 seconds after the driver’s door has opened.

The alarm system changes between activated and deactivated as follows.

Alarm status	Horn	Multi-information display
Deactivated	Sounds twice	AL oF
Activated	Sounds once	AL on

### ■ System maintenance

The vehicle has a maintenance-free type alarm system.

### ■ Items to check before locking the vehicle

To prevent unexpected triggering of the alarm and vehicle theft, make sure of the following.

- Nobody is in the vehicle.
- The windows are closed before the alarm is set.
- No valuables or other personal items are left in the vehicle.

### ■ Opening and closing the trunk lid

- If the alarm setting operations are performed with the trunk lid left open, the alarm will not be set. After closing the trunk lid, the alarm is set after 30 seconds or more elapse.
- When the trunk lid is unlocked using the “keyless access” entry function or remote keyless entry system while the alarm is set, the alarm goes into standby mode. After closing the trunk lid, the alarm is set again after 30 seconds or more elapse.

### ■ Triggering of the alarm

The alarm may be triggered in the following situations.  
Stopping the alarm deactivates the alarm system.

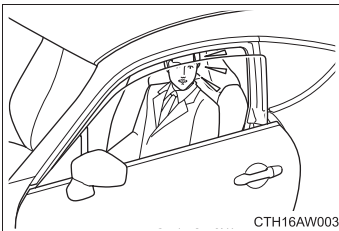

- A person inside the vehicle opens a door or the trunk lid.

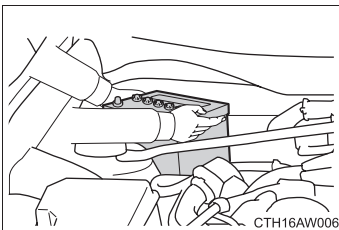

- The battery is recharged or replaced when the vehicle is locked.

■ **When the battery is disconnected**

Be sure to deactivate the alarm system.

If the battery is disconnected before deactivating the alarm system, the alarm may be triggered when the battery is reconnected.

■ **Customization that can be configured at your SUBARU dealer**

Settings (e.g. alarm system) can be changed.

(Customizable features →P. 439)

 **CAUTION**

■ **To ensure the system operates correctly**

Do not modify or remove the system. If modified or removed, the proper operation of the system cannot be guaranteed.



## 1-7. Safety information

### Correct driving posture

Drive with a good posture as follows:

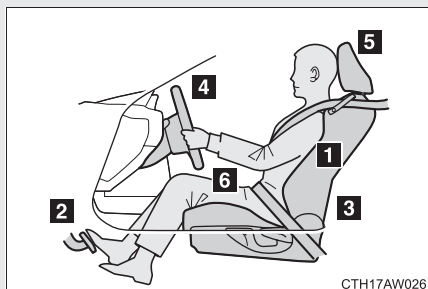

- 1** Sit upright and well back in the seat. (→P. 51)
- 2** Adjust the position of the seat forward or backward to ensure the pedals can be reached and easily depressed to the extent required. (→P. 51)
- 3** Adjust the seatback so that the controls are easily operable. (→P. 51)
- 4** Adjust the tilt and telescopic positions of the steering wheel to allow easy operation and to ensure the air-bag is facing your chest. (→P. 65)
- 5** Lock the head restraint in place with the center of the head restraint closest to the top of your ears. (→P. 56)
- 6** Wear the seatbelt correctly. (→P. 58)

 **WARNING**

■ **While driving**

- Do not adjust the position of the driver's seat.  
Doing so could cause the driver to lose control of the vehicle.
- Do not place a cushion between the driver or passenger and the seatback.  
A cushion may prevent correct posture from being achieved, and reduce the effectiveness of the seatbelt and head restraint, increasing the risk of death or serious injury to the driver or passenger.
- Do not place anything under the front seats.  
Objects placed under the front seats may become jammed in the seat tracks and stop the seat from locking in place. This may lead to an accident resulting in serious injury or death. The adjustment mechanism may also be damaged.

■ **Adjusting the seat position**

- Take care when adjusting the seat position to ensure that other passengers are not injured by the moving seat.
- Do not put your hands under the seat or near the moving parts to avoid injury.  
Fingers or hands may become jammed in the seat mechanism.

## 1-7. Safety information

### SRS airbag (Supplemental Restraint System airbag)

The SRS airbags inflate when the vehicle is subjected to certain types of severe impacts that may cause significant injury to the occupants. They work together with the seatbelts to help reduce the risk of death or serious injury.

**SRS:** This stands for supplemental restraint system. This name is used because the airbag system supplements the vehicle's seatbelts.

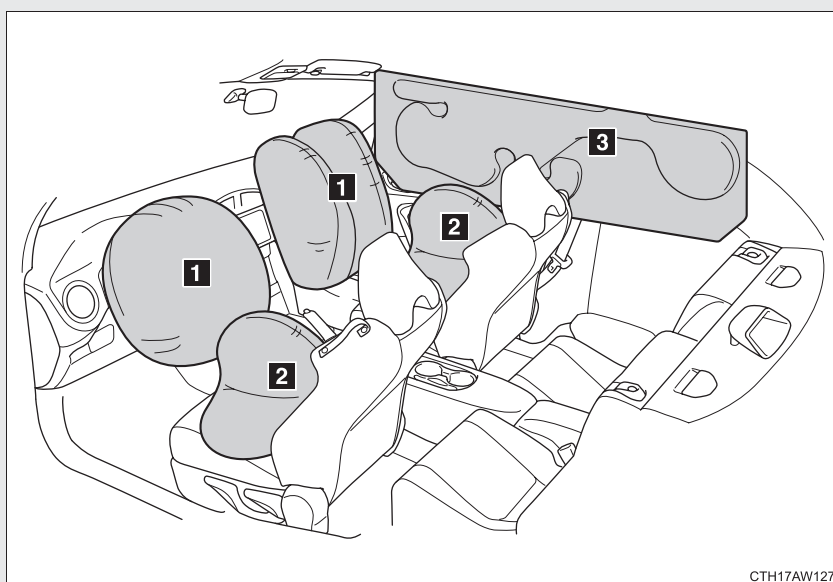

#### **Models with SRS airbags and shoulder restraints for driver, front passenger, and window-side rear passengers**

Your vehicle is equipped with a supplemental restraint system in addition to a shoulder belt at each front seating position and each rear window-side seating positions. The supplemental restraint system (SRS) consists of six airbags. The configurations are as follows.

- 1 Driver's and front passenger's frontal airbags
- 2 Driver's and front passenger's side airbags
- 3 Curtain airbags (for driver, front passenger, and window-side rear passengers)

These SRS airbags are designed only as a supplement to the primary protection provided by the seatbelt.

The system also controls front seatbelt pretensioners. For operation instructions and precautions concerning the seatbelt pretensioner, refer to "Seatbelt pretensioners". (→P. 59)

---

#### ■ When you sell your vehicle

When you sell your vehicle, we urge you to explain to the buyer that it is equipped with SRS airbags by alerting the buyer to the applicable section in this Owner's Manual.

**WARNING****■ SRS airbag**

- To obtain maximum protection in the event of an accident, the driver and all passengers in the vehicle should always wear seatbelts when the vehicle is moving. The SRS airbag is designed only to be a supplement to the primary protection provided by the seatbelt. It does not eliminate the need to fasten seatbelts. In combination with the seatbelts, it offers the best combined protection in case of a serious accident.

Not wearing a seatbelt increases the chance of severe injury or death in a crash even when the vehicle has the SRS airbag.

For instructions and precautions concerning the seatbelt system, refer to "Seatbelts". (→P. 58)

- Do not sit or lean unnecessarily close to the SRS airbag. Because the SRS airbag deploys with considerable speed - faster than the blink of an eye - and force to protect in high speed collisions, the force of an airbag can injure an occupant whose body is too close to SRS airbag.

It is also important to wear your seatbelt to help avoid injuries that can result when the SRS airbag contacts an occupant not in proper position such as one thrown forward during pre-accident braking.

Even when properly positioned, there remains a possibility that an occupant may suffer minor injury such as abrasions and bruises to the face or arms because of the SRS airbag deployment force.

- The SRS airbags deploy with considerable speed and force. Occupants who are out of proper position when the SRS airbag deploys could suffer very serious injuries. Because the SRS airbag needs enough space for deployment, the driver should always sit upright and well back in the seat as far from the steering wheel as practical while still maintaining full vehicle control and the front passenger should move the seat as far back as possible and sit upright and well back in the seat.
- Do not place any objects over or near the SRS airbag cover or between you and the SRS airbag. If the SRS airbag deploys, those objects could interfere with its proper operation and could be propelled inside the vehicle and cause injury.

**⚠ WARNING**

**■ SRS airbag**



- Put children aged 12 and under in the rear seat properly restrained at all times. The SRS airbag deploys with considerable speed and force and can injure or even kill children, especially if they are 12 years of age and under and are not restrained or improperly restrained. Because children are lighter and weaker than adults, their risk of being injured from deployment is greater.

For that reason, we strongly recommend that ALL children (including those in child seats and those that have out-grown child restraint devices) sit in the REAR seat properly restrained at all times in a child restraint device or in a seatbelt, whichever is appropriate for the child's age, height and weight.

Secure ALL types of child restraint devices (including forward facing child seats) in the REAR seats at all times.

According to accident statistics, children are safer when properly restrained in the rear seating positions than in the front seating positions.

For instructions and precautions concerning the child restraint system, refer to "Child restraint systems". (→P. 132)

**WARNING****■ SRS airbag**

- NEVER INSTALL A REARWARD FACING CHILD SEAT IN THE FRONT SEAT. DOING SO RISKS SERIOUS INJURY OR DEATH TO THE CHILD BY PLACING THE CHILD'S HEAD TOO CLOSE TO THE SRS AIRBAG.
- Never allow a child to stand up, or to kneel on the front passenger's seat, or never hold a child on your lap or in your arms. The SRS airbag deploys with considerable force and can injure or even kill the child.
- When the SRS airbag deploys, some smoke will be released. This smoke could cause breathing problems for people with a history of asthma or other breathing trouble. If you or your passengers have breathing problems after SRS airbag deploys, get fresh air promptly.
- A deploying SRS airbag releases hot gas. Occupants could get burned if they come into direct contact with the hot gas.

## SRS airbag system components

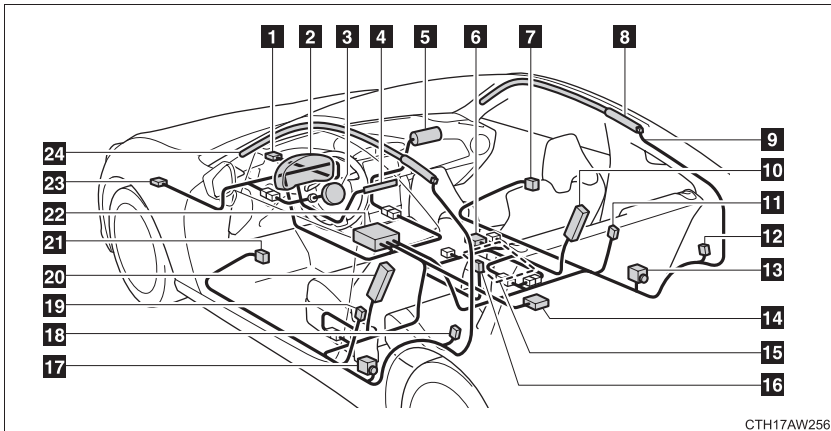

- 1** Front sub sensor (right-hand side)
- 2** SRS airbag system warning light
- 3** Frontal airbag module (driver's side) (two-stage)
- 4** Front passenger's frontal airbag ON and OFF indicator (center of instrument panel)
- 5** Frontal airbag module (front passenger's side) (two-stage)
- 6** Front passenger's occupant detection control module
- 7** Door impact sensor (right-hand side)
- 8** Curtain airbag module (right side)
- 9** Airbag wiring
- 10** Side airbag module (front passenger's side)
- 11** Side airbag sensor (center pillar right-hand side)
- 12** Curtain airbag sensor (rear wheel house right-hand side)
- 13** Seatbelt pretensioner (front passenger's side)
- 14** Satellite safing sensor (under the center of the rear seats)
- 15** Front passenger's occupant detection system sensor
- 16** Seatbelt buckle switch (front passenger's side)
- 17** Seatbelt pretensioner (driver's side)
- 18** Curtain airbag sensor (rear wheel house left-hand side)



- |  |   |
|--|---|
| 19 Side airbag sensor (center pillar left-hand side) | 22 Airbag control module (including impact sensors) |
| 20 Side airbag module (driver's side)                | 23 Front sub sensor (left-hand side)                |
| 21 Door impact sensor (left-hand side)               | 24 Curtain airbag module (left side)                |

Your vehicle is equipped with ADVANCED AIRBAGS designed based on US motor vehicle safety standards (FMVSS208). The airbag system controls airbag deployment power for the driver and front passenger. The front passenger's airbag system consists of the front passenger occupant detection control module etc.

The main SRS airbag system components are shown above. The SRS airbag system is controlled by the airbag control module. The airbag control module consists of an airbag sensor.

In certain types of severe front or side impacts, the SRS airbag system triggers the airbag inflators. A chemical reaction in the inflators quickly fills the airbags with non-toxic gas to help restrain the motion of the occupants.

---

#### ■ If the SRS airbags deploy (inflate)

- Bruising and slight abrasions may result from contact with a deploying (inflating) SRS airbag.
- A loud noise and white powder will be emitted.
- Parts of the airbag module (steering wheel hub, airbag cover and inflator) as well as the front seats, parts of the front and rear pillars, and roof side rails, may be hot for several minutes. The airbag itself may also be hot.
- The windshield may crack.

## **SUBARU advanced frontal airbag system**

Your vehicle is equipped with a SUBARU advanced frontal airbag system that complies with the new advanced frontal airbag requirements in the amended Federal Motor Vehicle Safety Standard (FMVSS) No. 208.

The SUBARU advanced frontal airbag system automatically determines the deployment force of the driver's SRS frontal airbag at the time of deployment as well as whether or not to activate the front passenger's SRS frontal airbag and, if activated, the deployment force of the SRS frontal airbag at the time of deployment.

Your vehicle has warning labels on the driver's and front passenger's sun visors beginning with the phrase "EVEN WITH ADVANCED AIR BAGS" and a tag attached to the glove box lid beginning with the phrase "Even with Advanced Air Bags". Make sure that you carefully read the instructions on the warning labels and tag.

Always wear your seatbelt. The SUBARU advanced frontal airbag system is a supplemental restraint system and must be used in combination with a seatbelt. All occupants should wear a seatbelt or be seated in an appropriate child restraint system.

The driver's SRS frontal airbag is stowed in the center portion of the steering wheel. The front passenger's SRS frontal airbag is stowed near the top of the dashboard under an "SRS AIRBAG" mark.

In a moderate to severe frontal collision, the following components deploy.

- SRS frontal airbag for driver
- SRS frontal airbag for front passenger

These components supplement the seatbelts by reducing the impact to the occupant's head and chest.

### ■ Driver's SRS frontal airbag

The driver's SRS frontal airbag uses a dual stage inflator. The inflator operates in different ways depending on the severity of impact.

Have the system inspected by your SUBARU dealer immediately if the SRS airbag system warning light illuminates.

#### NOTE

The driver's SRS side airbag and SRS curtain airbag are not controlled by the SUBARU advanced frontal airbag system.

### ■ Front passenger's SRS frontal airbag

The front passenger's SRS frontal airbag uses a dual stage inflator. The inflator operates in different ways depending on the severity of impact.

The occupant detection system sensor is installed under the seat upholstery and monitors the physique and posture of the front passenger. Using this information, the occupant detection system determines whether the front passenger's SRS frontal airbag should be deployed or not.

The occupant detection system may not inflate the front passenger's SRS frontal airbag even when the driver's SRS frontal airbag deploys. This is normal. In this case, although the front passenger's SRS frontal airbag does not operate, the front passenger's seatbelt pretensioner operates with the driver's seatbelt pretensioner. For details about the seatbelt pretensioner, refer to "Seatbelt pretensioners". (→P. 59)

Observe the following precautions. Failure to do so may prevent the SUBARU advanced frontal airbag system from functioning correctly or cause the system to fail.

- Do not apply any strong impact to the front passenger's seat.
- Do not spill liquid on the front passenger's seat. If liquid is spilled, wipe it off immediately.
- Do not remove or disassemble the front passenger's seat.
- Do not install any accessory (such as an audio amplifier) other than a genuine SUBARU accessory under the front passenger's seat.
- Do not place anything (shoes, umbrella, etc.) under the front passenger's seat.
- Do not place a magnet near the seatbelt buckle.

If the seatbelt buckle switch and/or front passenger's occupant detection system have failed, the SRS airbag system warning light will illuminate. Have the system inspected by your SUBARU dealer immediately if the SRS airbag system warning light illuminates.

If your vehicle has sustained impact, this may affect the proper function of the SUBARU advanced frontal airbag system. Have your vehicle inspected at your SUBARU dealer. Do not use the front passenger's seat while driving the vehicle to your SUBARU dealer.

### NOTE

The front passenger's SRS side airbag and SRS curtain airbag are not controlled by the SUBARU advanced frontal airbag system.

### ■ Passenger's frontal airbag ON and OFF indicators

→P. 122

### ■ Occupant detection system

The occupant detection system sensor is installed under the seat upholstery and monitors the physique and posture of the front passenger. Using this information, the occupant detection system determines whether the front passenger's SRS frontal airbag should be deployed or not.

If the front passenger's seat cushion is wet, this may adversely affect the ability of the system to determine deployment. If the seat cushion is wet, the front passenger should stop sitting on the front passenger's seat. Wipe off liquid from the seat immediately, let the seat dry naturally and then check the SRS airbag system warning light as follows.

- If the SRS airbag system warning light illuminates, keep the seat dry until the warning light turns off. If the SRS airbag system warning light stays on even when the seat has dried, do not allow anyone to sit on the front passenger's seat and have the system checked by your SUBARU dealer.
- If the SRS airbag system warning light does not illuminate, check that the front passenger's frontal airbag ON and OFF indicators work properly. If the indicators do not work properly, do not allow anyone to sit on the front passenger's seat and have the system checked by your SUBARU dealer.

Also, if luggage or electronic devices are placed on the front passenger's seat, this may adversely affect the ability of the system to determine deployment. This may prevent the front passenger's frontal airbag ON and OFF indicators from working properly. Check that the indicators work properly. When the OFF indicator turns off and the ON indicator illuminates, the front passenger's frontal airbag may deploy during a collision. Remove luggage and electronic devices from the front passenger's seat.

#### NOTE

This device complies with Part 18 of the FCC Rules. This device may cause interference. If this device causes interference, consult the nearest SUBARU dealer. Also, for maintenance of the system, consult the nearest SUBARU dealer.

#### ■ Conditions in which front passenger's SRS frontal airbag is not activated

The front passenger's SRS frontal airbag will not be activated when any of the following conditions are met regarding the front passenger's seat:

- The seat is empty.
- The seat is equipped with an appropriate child restraint system and an infant is restrained in it.
- The occupant changed their posture after the occupant load is judged.
- The front passenger's occupant detection system is malfunctioning.

#### WARNING

When the front passenger's seat is occupied by an infant in an appropriate child restraint system, observe the following precautions. Failure to do so may interfere with the proper operation of the occupant detection system, activating the front passenger's SRS frontal airbag even though that seat is occupied by the infant in the child restraint system.

- Do not place any article (including electronic devices) on the seat other than the infant in the child restraint system.
- Do not place more than one infant in the child restraint system.

■ **If the front passenger's frontal airbag ON indicator illuminates and the OFF indicator turns off even when an infant or a small child is in a child restraint system (including booster seat)**

Turn the ignition switch to the "LOCK" position (vehicles without a keyless access with push button start system), or turn the push-button ignition switch off (vehicles with a keyless access with push button start system) if the front passenger's frontal airbag ON indicator illuminates and the OFF indicator turns off even when an infant or a small child is in a child restraint system (including booster seat). Remove the child restraint system from the seat. By referring to the child restraint manufacturer's recommendations as well as the child restraint system installation procedures in "Child restraint systems" (→P. 132), correctly install the child restraint system. Turn the ignition switch to the "ON" position (vehicles without a keyless access with push button start system), or turn the push-button ignition switch to the "ON" mode (vehicles with a keyless access with push button start system) and make sure that the front passenger's frontal airbag ON indicator turns off and the OFF indicator illuminates.

If still the ON indicator remains illuminated while the OFF indicator turns off, take the following actions.

- Ensure that no article is placed on the seat other than the child restraint system and the child occupant.
- Ensure that the backward-forward position and seatback of front passenger's seat are locked into place securely by moving the seat back and forth.

If the ON indicator still remains illuminated while the OFF indicator turns off after taking relevant corrective actions described above, relocate the child restraint system to the rear seat and immediately contact your SUBARU dealer for an inspection.

**NOTE**

When a child who has outgrown a child restraint system or a small adult is seated in the front passenger's seat, the SUBARU advanced frontal airbag system may or may not activate the front passenger's SRS frontal airbag depending on the occupant's seating posture. The child should always wear the seatbelt when sitting in the seat irrespective of whether the airbag is deactivated or activated. If the front passenger's SRS frontal airbag is activated (the ON indicator remains illuminated while the OFF indicator turns off), take the following actions.

- Ensure that no article is placed on the seat other than the occupant.

If the ON indicator still remains illuminated while the OFF indicator turns off despite the fact that the actions noted above have been taken, seat the child/small adult in the rear seat and immediately contact your SUBARU dealer for an inspection. Even if the system has passed the dealer inspection, it is recommended that on subsequent trips the child/small adult always take the rear seat.

Children who have outgrown a child restraint system should always wear the seatbelt irrespective of whether the airbag is deactivated or activated.

#### ■ **Conditions in which front passenger's SRS frontal airbag is activated**

The front passenger's SRS frontal airbag will be activated for deployment upon impact when any of the following conditions are met regarding the front passenger's seat.

- When the seat is occupied by an adult.
- When a certain item(s) (e.g. jug of water) is placed on the seat.

■ **If the passenger's frontal airbag OFF indicator illuminates and the ON indicator turns off even when the front passenger's seat is occupied by an adult**

This can be caused by the adult incorrectly sitting in the front passenger's seat. Turn the ignition switch to the "LOCK" position (vehicles without a keyless access with push button start system), or turn the push-button ignition switch off (vehicles with a keyless access with push button start system). Ask the front passenger to set the seatback to the upright position, sit up straight in the center of the seat cushion, correctly fasten the seatbelt, position his/her legs out forward, and adjust the seat to the rearmost position. Turn the ignition switch to the "ON" position (vehicles without a keyless access with push button start system), or turn the push-button ignition switch to the "ON" mode (vehicles with a keyless access with push button start system). If the OFF indicator remains illuminated while the ON indicator remains off, take the following actions.

- Vehicles without a keyless access with push button start system:  
Turn the ignition switch to the "LOCK" position.
- Vehicles with a keyless access with push button start system:  
Turn the push-button ignition switch off.
- Make sure that the front passenger does not use a blanket, seat cushion, seat cover, seat heater or massager, etc.
- If wearing excessive layers of clothing, the front passenger should remove any unnecessary items before sitting in the front passenger's seat, or should sit in a rear seat.
- Next, turn the ignition switch to the "ON" position and wait 6 seconds to allow the system to complete self-checking. Following the system check, both indicators turn off for 2 seconds. Now, the ON indicator should illuminate while the OFF indicator remains off.

If the OFF indicator still remains illuminated while the ON indicator remains off, ask the occupant to move to the rear seat and immediately contact your SUBARU dealer for an inspection.



■ **How to contact the vehicle manufacturer concerning modifications for persons with disabilities that may affect the advanced airbag system (U.S. only)**

Changing or moving any parts of the front seats, rear seat, seatbelts, front bumper, front side frame, radiator panel, instrument panel, combination meter, steering wheel, steering column, tire, suspension or floor panel can affect the operation of the SUBARU advanced airbag system. If you have any questions, you may contact the following SUBARU distributors.

<Continental U.S., Alaska and the District of Columbia>

Subaru of America, Inc.

Customer Dealer Services Department

P.O. Box 6000

Cherry Hill, NJ 08034-6000

1-800-SUBARU3 (1-800-782-2783)

<Hawaii>

Servco Subaru Inc., dba Subaru Hawaii

2850 Pukoloa Street, Suite 202, Honolulu,

HI 96819

808-839-2273

<Guam>

Shen's Corporation dba Prestige Automobile

491, East Marine Drive, Route 1 Dededo,

Guam

671-633-2698

<Puerto Rico>

Trebol Motors

P.O. Box 11204, San Juan, Puerto Rico

00910

787-793-2828

There are currently no SUBARU distributors in any other U.S. territories. If you are in such an area, please contact the SUBARU distributor or dealer from which you bought your vehicle.

■ Operation

**Driver's side**

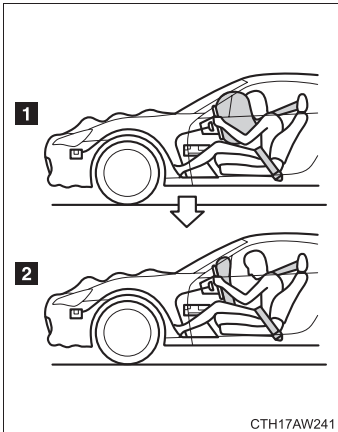

- 1** SRS AIRBAGs deploy as soon as a collision occurs.
- 2** After deployment, SRS AIRBAGs start to deflate immediately so that the driver's vision is not obstructed.

**Passenger's side**

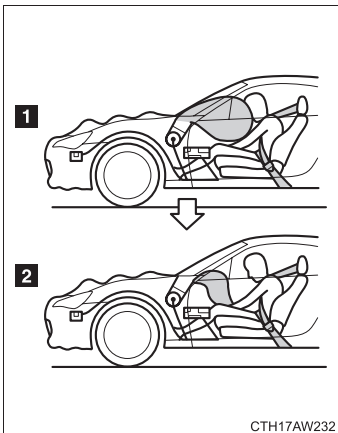

- 1** SRS AIRBAGs deploy as soon as a collision occurs.
- 2** After deployment, SRS AIRBAGs start to deflate immediately so that the driver's vision is not obstructed.

The SRS airbag can function only when the ignition switch is in the “ON” position.

The SUBARU advanced frontal airbag system is designed to determine the activation or deactivation condition of the front passenger’s SRS frontal airbag depending on the characteristic of the item(s) or person on the front passenger’s seat monitored by the front passenger’s occupant detection system sensor. For this reason, only the driver’s SRS frontal airbag may deploy in the event of a collision, but this does not mean failure of the system.

If the front sub sensors and the impact sensors in the airbag control module detect a predetermined amount of force during a frontal collision, the control module sends signals to the airbag module(s) (only driver’s module or both driver’s and front passenger’s modules) instructing the module(s) to inflate the SRS frontal airbag(s).

The driver’s and front passenger’s SRS frontal airbags use dual stage inflators. The two inflators of each airbag are triggered either sequentially or simultaneously, depending on the severity of impact, in the case of the driver’s SRS frontal airbag and depending on the severity of impact and the characteristic of the item(s) or person on the seat in the case of the front passenger’s SRS frontal airbag.

After deployment, the SRS airbag immediately starts to deflate so that the driver’s vision is not obstructed. The time required from detecting impact to the deflation of the SRS airbag after deployment is shorter than the blink of an eye.

Both when only the driver’s SRS frontal airbag deploys and the driver’s and front passenger’s SRS frontal airbags deploy, the driver’s and front passenger’s seatbelt pretensioners operate at the same time.

Although it is highly unlikely that the SRS airbag would activate in a non-accident situation, should it occur, the SRS airbag will deflate quickly, not obscuring vision and will not interfere with the driver’s ability to maintain control of the vehicle.

When the SRS airbag deploys, a sudden, fairly loud inflation noise will be heard and some smoke will be released. These occurrences are a normal result of the deployment. This smoke does not indicate a fire in the vehicle.

The driver's SRS frontal airbag and front passenger's SRS frontal airbag are designed to deploy in the event of an accident involving a moderate to severe frontal collision. They are not designed to deploy in most lesser frontal impacts because the necessary protection can be achieved by the seat-belt alone. Also, they are not designed to deploy in most side or rear impacts or in most roll-over accidents because deployment of only the driver's SRS frontal airbag or both driver's and front passenger's SRS frontal airbags would not help the occupant in those situations. The driver's and front passenger's SRS frontal airbags are designed to function on a one-time-only basis.

SRS airbag deployment depends on the level of force experienced in the passenger compartment during a collision. That level differs from one type of collision to another, and it may have no bearing on the visible damage done to the vehicle itself.

■ **Example of accident in which the driver's/driver's and front passenger's SRS frontal airbag(s) will most likely deploy**

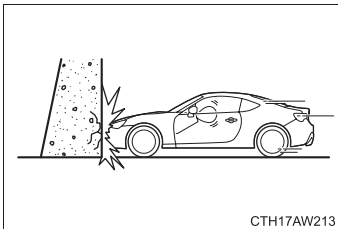

A head-on collision against a thick concrete wall at a vehicle speeds of 12 to 19 mph (20 to 30 km/h) or higher activates only the driver's SRS frontal airbag or both driver's and front passenger's SRS frontal airbags. The airbag(s) will also be activated when the vehicle is exposed to a frontal impact similar in fashion and magnitude to the collision described above.

■ **Examples of the types of accidents in which it is possible that the driver's/driver's and front passenger's SRS frontal airbag(s) will deploy**

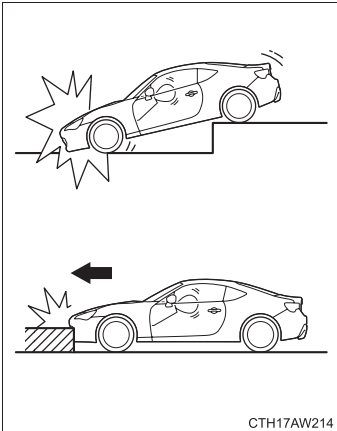

Only the driver's SRS frontal airbag or both driver's and front passenger's SRS frontal airbags may be activated when the vehicle sustains a hard impact in the undercarriage area from the road surface (such as when the vehicle plunges into a deep ditch, is severely impacted or knocked hard against an obstacle on the road such as a curb).

■ **Examples of the types of accidents in which deployment of the driver's/driver's and front passenger's SRS frontal airbag(s) is unlikely to occur**

There are many types of collisions which might not necessarily require deployment of driver's/driver's and front passenger's SRS frontal airbag(s). In the event of accidents like those illustrated, the driver's/driver's and front passenger's SRS frontal airbag(s) may not deploy depending on the level of accident forces involved.

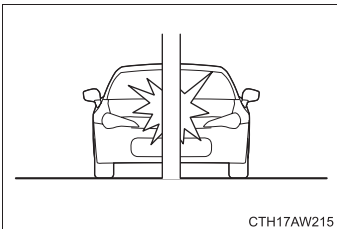

The vehicle strikes an object, such as a telephone pole or sign pole.

1-7. Safety information

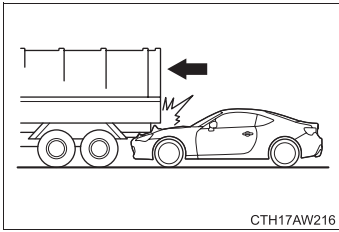

The vehicle slides under the load bed of a truck.

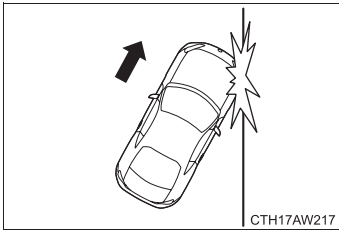

The vehicle sustains an oblique offset frontal impact.

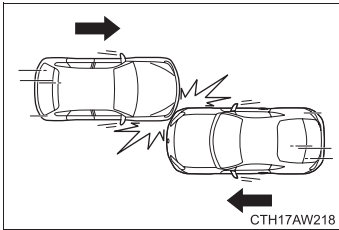

The vehicle sustains an offset frontal collision.

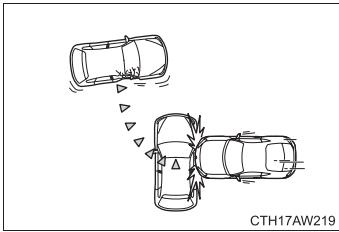

The vehicle strikes an object that can move or deform, such as a parked vehicle.

■ **Examples of the types of accidents in which the driver's/driver's and front passenger's SRS frontal airbag(s) will basically not deploy**

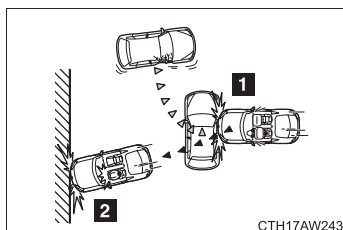
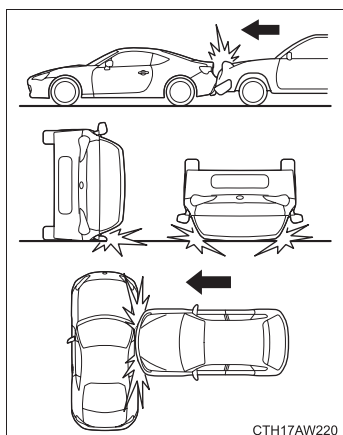

The driver's and front passenger's SRS frontal airbags are designed not to deploy in most cases if the vehicle is struck from the side or from behind, or if it rolls onto its side or roof, or if it is involved in a low-speed frontal collision.

**1** First impact

**2** Second impact

In an accident where the vehicle is impacted more than once, the driver's and/or front passenger's SRS frontal airbag(s) will deploy only once on the first impact.

Example: In the case of a double collision, first with another vehicle, then against a concrete wall in immediate succession, once either or both of the driver's and front passenger's SRS frontal airbags is/are activated on the first impact, it/they will not be activated on the second impact.

 **WARNING**

■ **If the SRS airbags deploy**

Do not touch the SRS airbag system components around the steering wheel and dashboard with bare hands right after deployment. Doing so can cause burns because the components can be very hot as a result of deployment.

■ **Child restraint precautions**

NEVER INSTALL A REARWARD FACING CHILD SEAT IN THE FRONT PASSENGER'S SEAT EVEN IF THE FRONT PASSENGER'S SRS FRONTAL AIRBAG IS DEACTIVATED. Be sure to install it in the REAR seat in a correct manner. Also, it is strongly recommended that any forward facing child seat or booster seat be installed in the REAR seat, and that even children who have outgrown a child restraint system be also seated in the REAR seat. This is because children sitting in the front passenger's seat may be killed or severely injured should the front passenger's SRS frontal airbag deploy. REAR seats are the safest place for children.



**SRS side airbag and SRS curtain airbag**

The SRS side airbag is stored in the door side of each front seat seatback, which bears an “SRS AIRBAG” label.

In a moderate to severe side impact collision, the SRS side airbag on the impacted side of the vehicle deploys between the occupant and the door panel and supplements the seatbelt by reducing the impact on the occupant’s chest and waist. The SRS side airbag operates only for front seat occupants.

The SRS curtain airbag on each side of the cabin is stored in the roof side (between the front pillar and a point over the rear seat). An “SRS AIRBAG” mark is located at the top of each center pillar.

In a moderate to severe side impact collision, the SRS curtain airbag on the impacted side of the vehicle deploys between the occupant and the side window and supplements the seatbelt by reducing the impact on the occupant’s head.

## ■ Operation

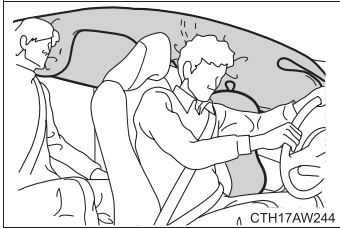

The SRS side airbag and SRS curtain airbag can function only when the ignition switch is in the “ON” position.

The driver’s and front passenger’s SRS side airbags and SRS curtain airbags deploy independently of each other since each has its own impact sensor. Therefore, they may not both deploy in the same accident. Also, the SRS side airbag and SRS curtain airbag deploys independently of the driver’s and front passenger’s SRS front airbags in the steering wheel and instrument panel.

An impact sensor, which senses impact force, is located in each of the left and right center pillars, doors and rear wheel houses. Another impact sensor, which also senses impact force, is located under the center of the rear seats.

If the impact sensor that is located under the center of the rear seats and one of the center pillar impact sensors or door impact sensors together sense an impact force above a predetermined level in a side collision, the control module causes both the SRS side airbag and curtain airbag on the impacted side to inflate regardless of whether the rear wheel house impact sensor on the same side senses an impact.

If the impact sensor that is located under the center of the rear seats and one of the rear wheel house impact sensors together sense an impact force above a predetermined level, the control module causes only the SRS curtain airbag on the impacted side to inflate.

After the deployment, the SRS side airbag immediately starts to deflate. The time required from detection of an impact to deflation of an SRS side airbag after deployment is shorter than the blink of an eye.

The SRS curtain airbag remains inflated for a while following deployment then slowly deflates.

The SRS side airbag and SRS curtain airbag deploy even when no one occupies the seat on the side on which an impact is applied.

When the SRS side airbag and SRS curtain airbag deploy, a sudden, fairly loud inflation noise will be heard and some smoke will be released. These occurrences are a normal result of the deployment. This smoke does not indicate a fire in the vehicle.

The SRS side airbag and SRS curtain airbag are designed to deploy in the event of an accident involving a moderate to severe side impact collision. They are not designed to deploy in most lesser side impact. Also, they are not designed to deploy in most frontal or most rear impacts because SRS side airbag and SRS curtain airbag deployment would not help the occupant in those situations.

Each SRS side airbag and SRS curtain airbag are designed to function on a one-time-only basis.

SRS side airbag and SRS curtain airbag deployment depend on the level of force experienced in the passenger compartment during a side impact collision. That level differs from one type of collision to another, and it may have no bearing on the visible damage done to the vehicle itself.

■ **Example of the type of accident in which the SRS side airbag and SRS curtain airbag will most likely deploy**

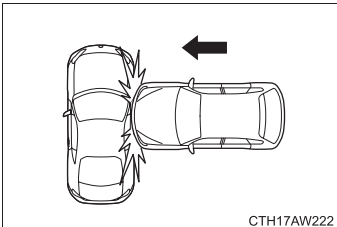

A severe side impact near the front seat activates the SRS side airbag and SRS curtain airbag.

■ **Examples of the types of accidents in which the SRS side airbag and SRS curtain airbag are unlikely to deploy**

There are many types of collisions which might not necessarily require SRS side airbag and SRS curtain airbag deployment. In the event of accidents like those illustrated, the SRS side airbag and SRS curtain airbag may not deploy depending on the level of accident forces involved.

## 1-7. Safety information

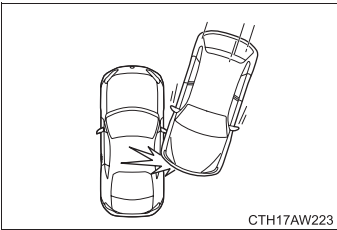

The vehicle is involved in an oblique side-on impact.

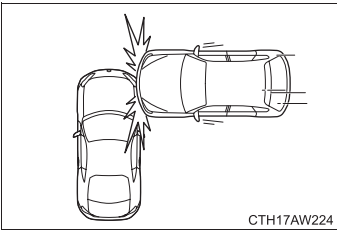

The vehicle is involved in a side-on impact in an area outside the vicinity of the passenger compartment.

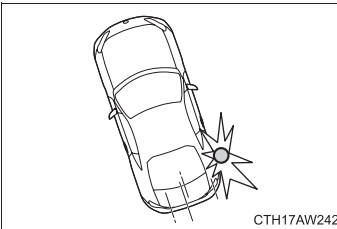

The vehicle strikes a telephone pole or similar object.

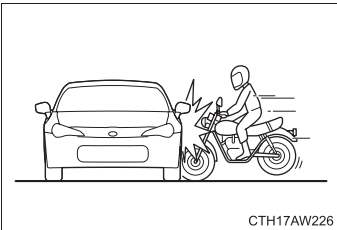

The vehicle is involved in a side-on impact from a motorcycle.

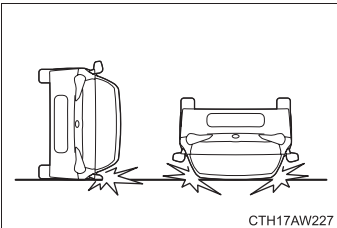

The vehicle rolls onto its side or roof.

## ■ Examples of the types of accidents in which the SRS side airbag and SRS curtain airbag will basically not deploy

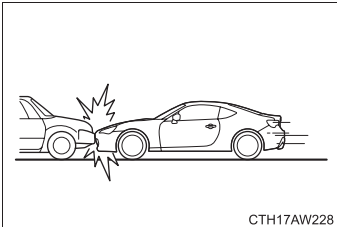

The vehicle is involved in frontal collision with another vehicle (moving or stationary).

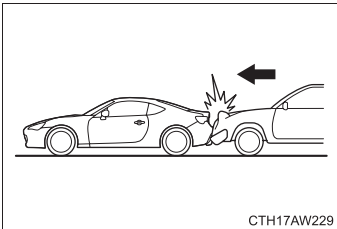

The vehicle is struck from behind.

The SRS side airbag and SRS curtain airbag are not designed to deploy in most cases if the vehicle is involved in a frontal collision or is struck from behind. Examples of such accidents are illustrated.

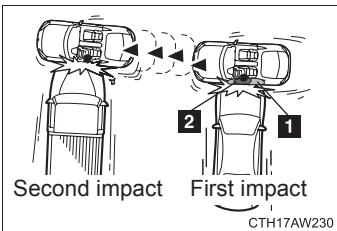

1 SRS curtain airbag

2 SRS side airbag

In an accident where the vehicle is struck from the side more than once, the SRS side airbag and SRS curtain airbag deploy only once on the first impact.

Example: In the case of a double side impact collision, first with one vehicle and immediately followed by another from the same direction, once the SRS side airbag and SRS curtain airbag are activated on the first impact, they will not be activated on the second.

**⚠ WARNING**

**■ If the SRS airbags deploy**

Do not touch the SRS side airbag system components around the front seat seatback with bare hands right after deployment. Doing so can cause burns because the components can be very hot as a result of deployment.

After deployment, do not touch any part of the SRS curtain airbag system (from the front pillar to the part of the roof side over the rear seat). Doing so can cause burns because the components can be very hot as a result of deployment.

**■ SRS side airbag and SRS curtain airbag precautions**

The SRS side airbag and SRS curtain airbag are designed only to be a supplement to the primary protection provided by the seatbelt. They do not do away with the need to fasten seatbelts. It is also important to wear your seatbelt to help avoid injuries that can result when an occupant is not seated in a proper upright position.

**■ When to contact your SUBARU dealer**

In the following cases, the vehicle will require inspection and/or repair. Contact your SUBARU dealer as soon as possible.

- Any of the SRS airbags have been inflated.

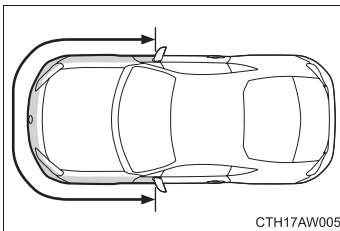

- The front of the vehicle is damaged or deformed, or was involved in an accident that was not severe enough to cause the SRS airbags to inflate.

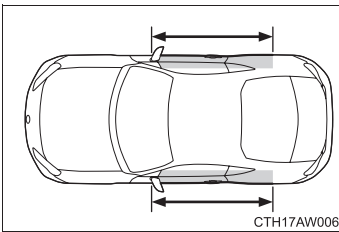

- A portion of a door is damaged or deformed, or the vehicle was involved in an accident that was not severe enough to cause the SRS side airbags and curtain airbags to inflate.

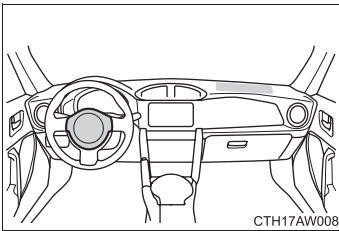

- The pad section of the steering wheel or dashboard is scratched, cracked, or otherwise damaged.

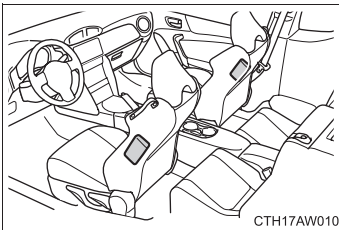

- The surface of the seats with the side airbag is scratched, cracked, or otherwise damaged.

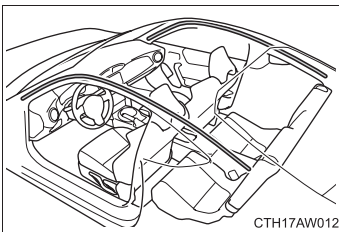

- The portion of the front pillars, rear pillars or roof side rail garnishes (padding) containing the curtain airbags inside is scratched, cracked or otherwise damaged.

 **WARNING**

■ **SRS airbag precautions**

Observe the following precautions regarding the SRS airbags.  
Failure to do so may cause death or serious injury.

- The driver and all passengers in the vehicle must wear their seatbelts properly.  
The SRS airbags are supplemental devices to be used with the seatbelts.
- The driver should always sit upright and well back in the seat as far from the steering wheel as practical while still maintaining full vehicle control and the front passenger should move the seat as far back as possible and sit upright and well back in the seat.



**! WARNING****■ SRS airbag precautions**

- The SRS front passenger airbag also deploys with considerable force, and can cause death or serious injury especially if the front passenger is very close to the airbag. The front passenger seat should be as far from the airbag as possible with the seatback adjusted, so the front passenger sits upright.
- Improperly seated and/or restrained infants and children can be killed or seriously injured by a deploying airbag. An infant or child who is too small to use a seatbelt should be properly secured using a child restraint system. SUBARU strongly recommends that all infants and children be placed in the rear seats of the vehicle and properly restrained. The rear seats are safer for infants and children than the front passenger seat. (→P. 132)

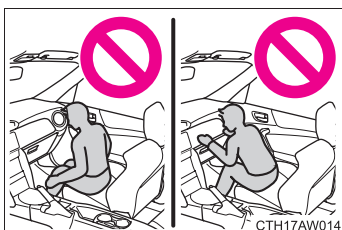

- Do not sit on the edge of the seat or lean against the dashboard.

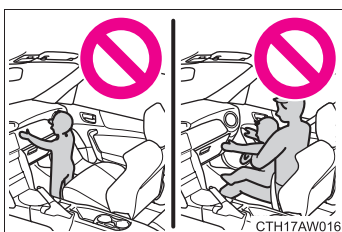

- Do not allow a child to stand in front of the SRS front passenger airbag unit or sit on the knees of a front passenger.
- Do not allow the front seat occupants to hold items on their knees.

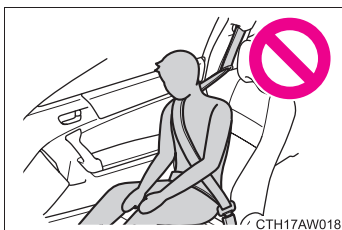

- Do not lean against the door, the roof side rail or the front, side and rear pillars.

**! WARNING**

**■ SRS airbag precautions**

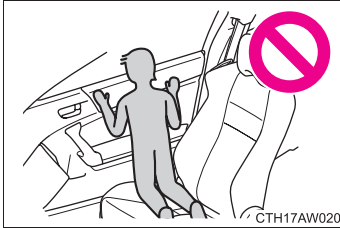

- Do not allow anyone to kneel on the passenger seat toward the door or put their head or hands outside the vehicle.

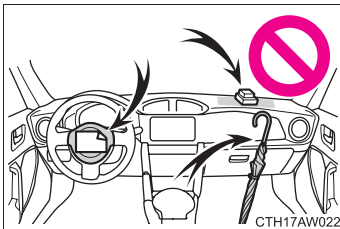

- Do not attach anything to or lean anything against areas such as the dashboard or steering wheel pad. These items can become projectiles when SRS driver and front passenger airbags deploy.

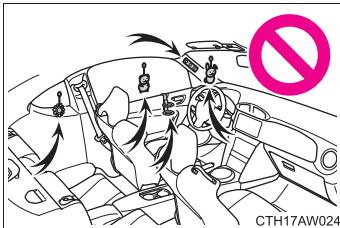

- Do not attach anything to areas such as a door, windshield glass, side door glass, rear quarter glass, front and rear pillar or roof side rail.

- Do not use seat accessories which cover the parts where the SRS side airbags inflate as they may interfere with inflation of the airbags. Such accessories may prevent the side airbags from activating correctly, disable the system or cause the side airbags to inflate accidentally, resulting in death or serious injury.
- Do not strike or apply significant levels of force to the area of the SRS airbag components (→P. 92). Doing so can cause the SRS airbags to malfunction.

**WARNING****■ SRS airbag precautions**

- Do not touch any of the component parts immediately after the SRS airbags have deployed (inflated) as they may be hot.
- If breathing becomes difficult after the SRS airbag has deployed, open a door or window to allow fresh air in, or leave the vehicle if it is safe to do so. Wash off any residue as soon as possible to prevent skin irritation.
- If the areas where the SRS airbags are stored, such as the steering wheel pad and front and rear pillar garnishes, are damaged or cracked, have them replaced by your SUBARU dealer.

**■ Modification and disposal of SRS airbag system components**

Do not dispose of your vehicle or perform any of the following modifications without consulting your SUBARU dealer.

The SRS airbags may malfunction or deploy (inflate) accidentally, causing death or serious injury.

- Installation, removal, disassembly and repair of the SRS airbags.
- Repairs, modifications, removal or replacement of the steering wheel, instrument panel, dashboard, seats or seat upholstery, front, side and rear pillars or roof side rails.
- Repairs or modifications of the front fender, front bumper, or side of the occupant compartment.
- Installation of snow plows, winches, etc. to the front grille (bull bars, kangaroo bar etc.).
- Modifications to the vehicle's suspension system.
- Installation of electronic devices such as mobile two-way radios and CD players.
- Modifications to your vehicle for a person with a physical disability.

## SRS airbag system monitors

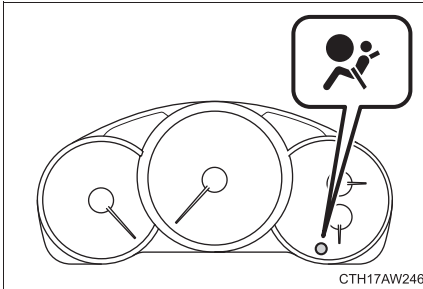

A diagnostic system continually monitors the readiness of the SRS airbag system (including front seatbelt pretensioners) while the vehicle is being driven. The SRS airbag system warning light will show normal system operation by illuminating for approximately 6 seconds when the ignition switch is turned to the “ON” position.

The following components are monitored by the indicator:

- Front sub sensor (right-hand side)
- Front sub sensor (left-hand side)
- Airbag control module (including impact sensors)
- Frontal airbag module (driver’s side)
- Frontal airbag module (front passenger’s side)
- Side airbag sensor (center pillar right-hand side)
- Side airbag sensor (center pillar left-hand side)
- Door impact sensor (right-hand side)
- Door impact sensor (left-hand side)
- Side airbag module (driver’s side)
- Side airbag module (front passenger’s side)
- Curtain airbag sensor (rear wheel house right-hand side)
- Curtain airbag sensor (rear wheel house left-hand side)
- Curtain airbag module (right-hand side)

- Curtain airbag module (left-hand side)
- Satellite safing sensor (under the center of the rear seats)
- Seatbelt pretensioner (driver's side)
- Seatbelt pretensioner (front passenger's side)
- Seatbelt buckle switch (front passenger's side)
- Front passenger's occupant detection system sensor
- Front passenger's occupant detection control module
- Front passenger's frontal airbag ON and OFF indicator
- All related wiring

 **WARNING****■ SRS warning light**

If the warning light exhibits any of the following conditions, there may be a malfunction in the seatbelt pretensioners and/or SRS airbag system. Immediately take your vehicle to your nearest SUBARU dealer to have the system checked. Unless checked and properly repaired, the seatbelt pretensioners and/or SRS airbag will not operate properly in the event of a collision, which may increase the risk of injury.

- Flashing or flickering of the warning light
- No illumination of the warning light when the ignition switch is first turned to the "ON" position.
- Continuous illumination of the warning light
- Illumination of the warning light while driving

## 1-7. Safety information

### Front passenger occupant detection system

Your vehicle is equipped with a front passenger occupant detection system. Using the sensors installed under the seat cover, the system detects the conditions of the front passenger seat and activates or deactivates the frontal airbag for front passenger seat. The occupant detection system may not inflate the front passenger's SRS frontal airbag even when the driver's SRS frontal airbag deploys. This is not a malfunction. If the seatbelt buckle switch and/or front passenger's occupant detection system have failed, the SRS airbag system warning light will illuminate. Have the system inspected by your SUBARU dealer immediately if the SRS airbag system warning light illuminates.

If your vehicle has sustained impact, this may affect the proper function of the SUBARU advanced frontal airbag system. Immediately contact your SUBARU dealer and have your vehicle inspected. Do not use the front passenger seat while driving to your SUBARU dealer.

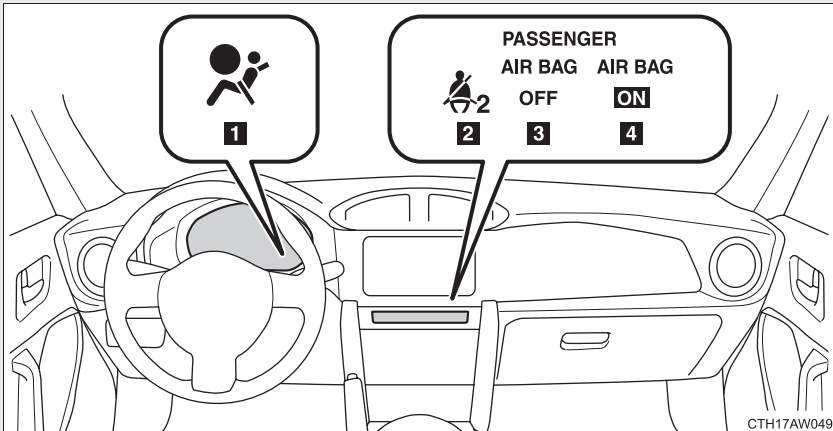

- 1 SRS airbag system warning light
- 2 Front passenger's seatbelt reminder light
- 3 "AIR BAG OFF" indicator light
- 4 "AIR BAG ON" indicator light

The front passenger's frontal airbag ON and OFF indicators show you the status of the front passenger's SRS frontal airbag. When the engine switch is turned to the "ON" position, (vehicles without a keyless access with push button start system), or the push-button ignition switch is turned to "ON" mode (vehicles with a keyless access with push button start system), both the ON and OFF indicators illuminate for 6 seconds during the system check. After the system check, both the ON and OFF indicators turn off for 2 seconds. Then, either the ON or OFF indicator illuminates depending on the condition of the front passenger's frontal airbag.

When the OFF indicator remains off and ON indicator illuminates, the front passenger's frontal airbag may deploy during a collision. When the OFF indicator illuminates and ON indicator remains off, the front passenger's frontal airbag does not deploy during a collision.

If the front passenger's frontal airbag ON and OFF indicators remain on when the engine switch is turned to the "ON" position (vehicles without a keyless access with push button start system) or the push-button ignition switch is turned to "ON" mode (vehicles with a keyless access with push button start system), or the indicators remain off after the system check, the system may be malfunctioning. Have the vehicle inspected by your SUBARU dealer immediately.

After that, one of the indicators illuminates depending on the status of the front passenger's SRS frontal airbag determined by the SUBARU advanced frontal airbag monitoring system.

**Condition and operation in the front passenger occupant detection system\*1**

■ **Adult\*2**

Indicator/ warning light	“AIR BAG ON” and “AIR BAG OFF” indicator lights	“AIR BAG ON”
	SRS airbag system warning light	Off
	Front passenger’s seatbelt reminder light	Flashing*3
Devices	Front passenger airbag	On
	Front side airbag*4	
	Front curtain airbag*4	
	Front passenger’s seatbelt pretensioner*4	

■ **Child restraint system with infant\*6, \*7, \*8**

Indicator/ warning light	“AIR BAG ON” and “AIR BAG OFF” indicator lights	“AIR BAG OFF”*9
	SRS airbag system warning light	Off
	Front passenger’s seatbelt reminder light	
Devices	Front passenger airbag	Off
	Front side airbag*4	On
	Front curtain airbag*4	
	Front passenger’s seatbelt pretensioner*4	



### ■ Child<sup>\*5, \*7</sup>

Indicator/ warning light	"AIR BAG ON" and "AIR BAG OFF" indicator lights	"AIR BAG OFF" or "AIR BAG ON" <sup>*5</sup>
	SRS airbag system warning light	Off
	Front passenger's seatbelt reminder light	Off or flashing <sup>*3, *5</sup>
Devices	Front passenger airbag	Off or on <sup>*5</sup>
	Front side airbag <sup>*4</sup>	On
	Front curtain airbag <sup>*4</sup>	
	Front passenger's seatbelt pretensioner <sup>*4</sup>	

1

Before driving

### ■ Unoccupied

Indicator/ warning light	"AIR BAG ON" and "AIR BAG OFF" indicator lights	"AIR BAG OFF"
	SRS airbag system warning light	Off
	Front passenger's seatbelt reminder light	
Devices	Front passenger airbag	Off
	Front side airbag <sup>*4</sup>	On
	Front curtain airbag <sup>*4</sup>	
	Front passenger's seatbelt pretensioner <sup>*4</sup>	

### ■ There is a malfunction in the system

Indicator/ warning light	"AIR BAG ON" and "AIR BAG OFF" indicator lights	"AIR BAG OFF"
	SRS airbag system warning light	On
	Front passenger's seatbelt reminder light	Off
Devices	Front passenger airbag	Off
	Front side airbag <sup>*4</sup>	On
	Front curtain airbag <sup>*4</sup>	
	Front passenger's seatbelt pretensioner <sup>*4</sup>	

- \*1: The occupant detection system does not operate during self-checking.
- \*2: The system judges a person of adult size as an adult. When a smaller adult sits in the front passenger seat, the system may not recognize him/her as an adult depending on his/her physique and posture.
- \*3: In the event the front passenger does not wear a seatbelt.
- \*4: The front passenger's SRS side airbag, SRS curtain airbag and seatbelt pretensioner are not controlled by the occupant detection system.
- \*5: For some children, child in seat, child in booster seat or child in convertible seat, the system may not recognize him/her as a child. Factors which may affect this can be the physique or posture.  
Children who have outgrown a child restraint system should always wear the seatbelt when sitting in the seat irrespective of whether the airbag is deactivated or activated.
- \*6: When a child restraint system is installed on the front passenger seat, do not place any article on the seat other than the child occupant and a child restraint system.  
Failure to do so may prevent the front passenger occupant detection system from functioning correctly or cause the system to fail.
- \*7: Do not place more than one child on the front passenger seat.  
Failure to do so may prevent the front passenger occupant detection system from functioning correctly.
- \*8: Never install a child restraint system on the front passenger seat. See the caution that follows regarding installation of a child restraint system. (→P. 136)
- \*9: In case the indicator is not illuminated, consult this manual on how to installing the child restraint system properly. (→P. 136)

**If the passenger's frontal airbag OFF indicator illuminates and the ON indicator turns off even when the front passenger's seat is occupied by an adult**

This can be caused by an adult incorrectly sitting in the front passenger's seat. Perform the following.

**STEP 1** Vehicles without a keyless access with push button start system:

The engine switch is turned to the "LOCK" position.

Vehicles with a keyless access with push button start system:

Turn the push-button ignition switch off.

**STEP 2** Ask the front passenger to set the seatback to the upright position, sit up straight in the center of the seat cushion, correctly wear the seatbelt, position his/her legs out forward, and adjust the seat to the rearmost position.

**STEP 3** Vehicles without a keyless access with push button start system:

The engine switch is turned to the "ON" position.

Vehicles with a keyless access with push button start system:

The push-button ignition switch is turned to "ON" mode.

**STEP 4** Turn the OFF indicator remains illuminated while the ON indicator remains off, perform the following.

- Vehicles without a keyless access with push button start system:

The engine switch is turned to the "LOCK" position.

Vehicles with a keyless access with push button start system:

Turn the push-button ignition switch off.

- Make sure that the front passenger is not using a blanket, seat cushion, seat cover or seat heater, etc.
- If wearing excessive layers of clothing, the front passenger should remove any unnecessary items before sitting in the front passenger seat, or should sit in a rear seat.

**STEP 5** Turn the engine switch to the “ON” position (vehicles without a keyless access with push button start system), or the push-button ignition switch to “ON” mode (vehicles with a keyless access with push button start system). The ON and OFF indicators illuminate for 6 seconds during the system check and after the system check is performed, the ON and OFF indicators turn off for 2 seconds. Then, the OFF indicator remains off while the ON indicator is illuminated. If the ON indicator remains off and the OFF indicator is illuminated, move the occupant to the rear seat backwards and immediately contact your SUBARU dealer and have the vehicle inspected.

**If the front passenger's frontal airbag ON indicator illuminates and the OFF indicator turns off even when an infant or a small child is in a child restraint system (including booster seat)**

This can be caused by the child restraint system being installed incorrectly. Perform the following.

**STEP 1** Vehicles without a keyless access with push button start system:

The engine switch is turned to the “LOCK” position.

Vehicles with a keyless access with push button start system:

Turn the push-button ignition switch off.

**STEP 2** Remove the child restraint system from the seat. By referring to the child restraint manufacturer’s recommendations as well as the child restraint system installation procedure in “child restraint system”, correctly reinstall the child restraint system.

**STEP 3** Vehicles without a keyless access with push button start system:

The engine switch is turned to the “ON” position and make sure that the front passenger’s frontal airbag ON indicator turns off and the OFF indicator illuminates.

Vehicles with a keyless access with push button start system:

The push-button ignition switch is turned to “ON” mode and make sure that the front passenger’s frontal airbag ON indicator turns off and the OFF indicator illuminates.

**STEP 4** If the ON indicator still remains illuminated while the OFF indicator turns off, perform the following.

- Ensure that no article is placed on the seat other than the child restraint system and the child occupant.
- Ensure that the backward-forward position and seatback of front passenger seat are locked into place securely by moving the seat back and forth.

**STEP 5** If the ON indicator still remains illuminated while the OFF indicator turns off after taking the relevant corrective actions described above, relocate the child restraint system to the rear seat and immediately contact your SUBARU dealer for an inspection.

 **WARNING**

**■ Front passenger occupant detection system precautions**

Observe the following precautions regarding front passenger occupant detection system.

Failure to do so may cause the occupant detection system to not function correctly, resulting in death or serious injury.

- Wear the seatbelt properly.
- Do not apply excessive force to the seat.
- Do not put sharp object(s) on the seat or pierce the seat upholstery.
- Do not put objects under the front passenger seat.
- Do not use a seat accessory, such as a cushion or seat cover, that covers the seat cushion surface.
- Do not spill liquid on the front passenger seat. If liquid is spilled, wipe it off immediately and dry the seat. If the airbag warning light illuminates, dry the seat until the warning light turns off. If the airbag warning light stays on even when the seat has dried, do not allow anyone to sit on the front passenger seat and have the system checked by your SUBARU dealer. If the airbag warning light does not illuminate, check that the airbag ON/OFF indicator light works properly. If the indicator light does not work properly, do not allow anyone to sit in the front passenger's seat and have the system inspected by your SUBARU dealer.
- Do not remove or disassemble the front passenger seat. Also, do not replace or modify the seat upholstery or foam inside the seat.
- Do not install any accessory (such as an audio amplifier) other than a genuine SUBARU accessory under the front passenger's seat.
- Do not place a magnetized items near the seatbelt buckle.

 **WARNING****■ Front passenger occupant detection system precautions**

- Never install a rearward facing child seat in the front passenger's seat even if the front passenger's SRS frontal airbag is deactivated. Be sure to install it in the rear seat in a correct manner. Also, it is strongly recommended that any forward facing child seat or booster seat be installed in the rear seat, and that even children who have outgrown a child restraint system be also seated in the rear seat. This is because children sitting in the front passenger's seat may be killed or severely injured should the front passenger's SRS frontal airbag deploy. SUBARU believes that the rear seats are the safest place for children
- If luggage or electronic devices are placed on the front passenger seat, the OFF indicator may turn off and the ON indicator may illuminate. If this occurs, the front passenger's airbag may deploy during a collision. If this is not desirable, remove the luggage or electronic devices from the front passenger seat.
- Modifications for persons with disabilities that may affect the front passenger occupant detection system. (U.S. only) Removing, replacing or modifying any parts of the front seats, seatbelts, front bumper, front side frame, instrument panel, combination meter, steering wheel, steering column, tires, suspension or floor panel can affect the operation of the SUBARU front passenger occupant detection system.

## 1-7. Safety information

# Child restraint systems

A child restraint system for a small child or baby must itself be properly restrained on the seat with the lap portion of the lap/shoulder belt.

The laws of all 50 states of the U.S.A. and Canada now require the use of child restraint systems.

### Points to remember

Studies have shown that installing a child restraint on a rear seat is much safer than installing one to the front passenger seat.

- Choose a child restraint system that suits your vehicle and is appropriate to the age and size of the child.
- For installation details, follow the instructions provided with the child restraint system.

General installation instructions are provided in this manual.

(→P. 136)

### Types of child restraints

Child restraint systems are classified into the following 3 types according to the age and size of the child.

#### Rear facing — Infant seat/convertible seat

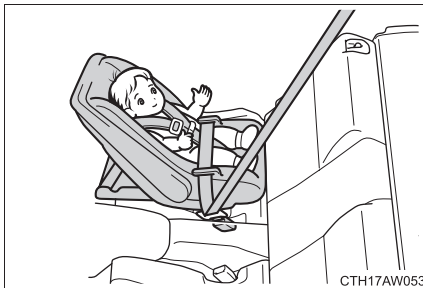

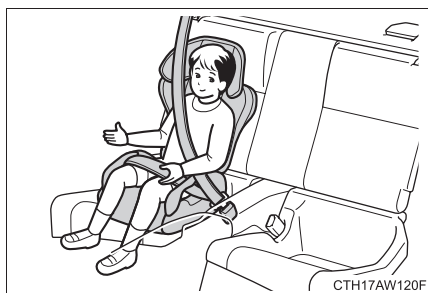

**Forward facing — Convertible seat****Booster seat****■ Selecting an appropriate child restraint system**

- Use a child restraint system appropriate for the child until the child becomes large enough to properly wear the vehicle's seatbelt.
- If a child is too large for a child restraint system, sit the child on a rear seat and use the vehicle's seatbelt. (→P. 58)

**■ Where to place a child restraint system**

The following are SUBARU's recommendations on where to place a child restraint system in your vehicle.

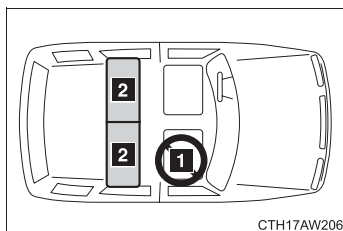

- 1** Front passenger's seat
- 2** Rear seat seating positions

● Front passenger's seat

Do not install a child restraint system (including a booster cushion) due to the hazard to children posed by the passenger's airbag.

● Rear seat seating positions

Recommended installing positions for the child restraint systems.

In these positions, the following equipment is provided for installing a child restraint system.

- Automatic/Emergency Locking Retractor (ALR/ELR) seatbelts
- ISOFIX anchor bars
- Top tether anchorages

Some types of child restraints might not be able to be secured firmly due to projection of the seat cushion.

In this seating position, you should use only a child restraint system that has a bottom base that fits snugly against the contours of the seat cushion and can be securely retained using the seatbelt.

 **WARNING**

■ **Child restraint precautions**

- For effective protection in automobile accidents and sudden stops, a child must be properly restrained, using a seatbelt or child restraint system depending on the age and size of the child. Holding a child in your arms is not a substitute for a child restraint system. In an accident, the child can be crushed against the windshield, or between you and the vehicle's interior.
- SUBARU strongly urges the use of a proper child restraint system that conforms to the size of the child, installed on the rear seat. According to accident statistics, the child is safer when properly restrained in the rear seat than in the front seat.
- Never install a rear-facing child restraint system on the front passenger seat even if the "AIR BAG OFF" indicator light is illuminated. In the event of an accident, the force of the rapid inflation of the front passenger airbag can cause death or serious injury to the child if the rear-facing child restraint system is installed on the front passenger seat.

 **WARNING****■ Child restraint precautions**

- Do not allow the child to lean his/her head or any part of his/her body against the door or the area of the seat, front and rear pillars or roof side rails from which the SRS side airbags or SRS curtain airbags deploy even if the child is seated in the child restraint system. It is dangerous if the SRS side airbags and curtain airbags inflate, and the impact could cause death or serious injury to the child.
- Make sure you have complied with all installation instructions provided by the child restraint manufacturer and that the system is properly secured. If it is not secured properly, it may cause death or serious injury to the child in the event of a sudden stop, sudden swerve or an accident.

**■ When children are in the vehicle**

Do not allow children to play with the seatbelt. If the seatbelt becomes twisted around a child's neck, it may lead to choking or other serious injuries that could result in death.

If this occurs and the buckle cannot be unfastened, scissors should be used to cut the belt.

**■ When the child restraint system is not in use**

- Keep the child restraint system properly secured on the seat even if it is not in use. Do not store the restraint unsecured in the passenger compartment.
- If it is necessary to detach the child restraint system, remove it from the vehicle or store it securely in the trunk. This will prevent it from injuring passengers in the event of a sudden stop, sudden swerve or accident.

## 1-7. Safety information

### Installing child restraints

Follow the child restraint system manufacturer's instructions. Firmly secure child restraints to the rear seats using the LATCH anchors or a seatbelt. Attach the top tether strap when installing a child restraint.

The lap/shoulder belt can be used if your child restraint system is not compatible with the LATCH (Lower Anchors and Tethers for Children) system.

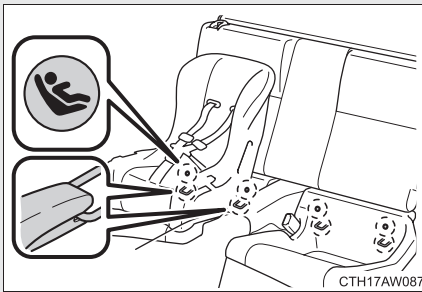

#### Child restraint LATCH anchors

LATCH anchors are provided for both rear seats. (Buttons displaying the location of the anchors are attached to the seats.)

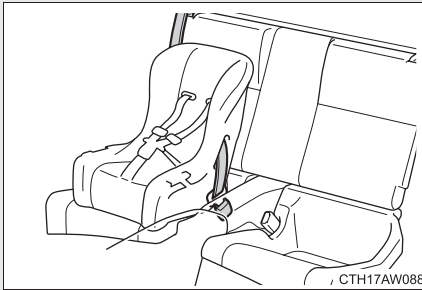

Seatbelts equipped with a child restraint locking mechanism (ALR/ELR belts except driver's seatbelt) (→P. 58)

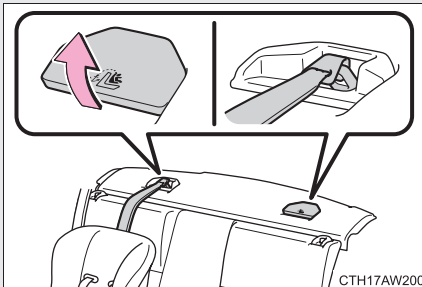

#### Anchor bracket (for top tether strap)

Anchor brackets are provided for both rear seats.

## Installation with LATCH system

### Type A

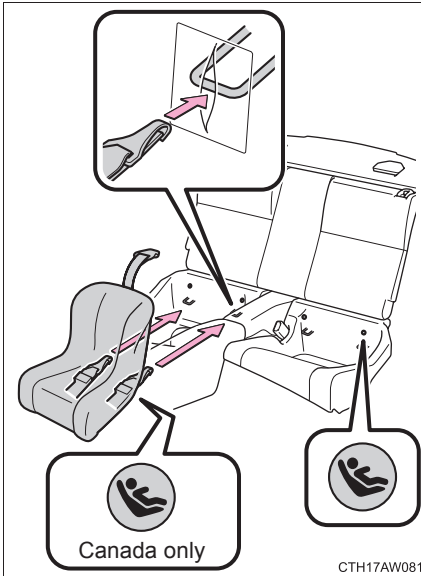

**STEP 1** Latch the hooks of the lower straps onto the LATCH anchors.

**STEP 2** If the child restraint has a top tether strap, the top tether strap should be latched onto the top tether strap anchors.

For owners in Canada:

The symbol on a child restraint system indicates the presence of a lower connector system.

1

Before driving

## Type B

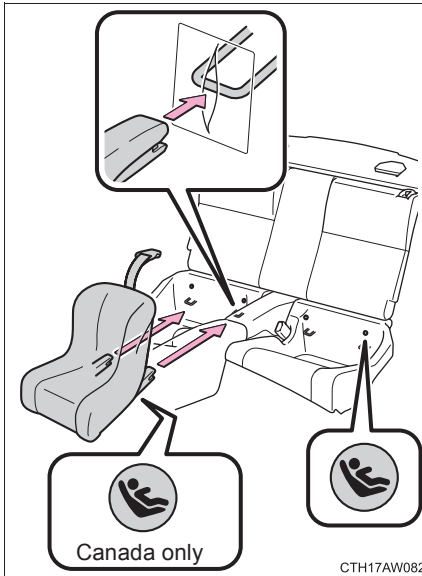

**STEP 1** Latch the buckles onto the LATCH anchors.

**STEP 2** If the child restraint has a top tether strap, the top tether strap should be latched onto the top tether strap anchors.

For owners in Canada:

The symbol on a child restraint system indicates the presence of a lower connector system.

## Installing child restraints using a seatbelt (child restraint lock function belt)

### ■ Rear facing — Infant seat/convertible seat

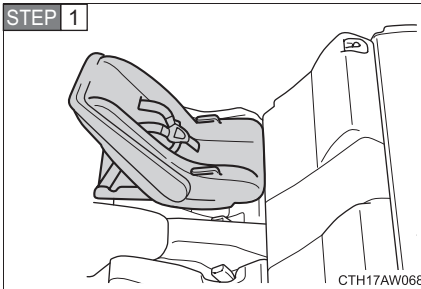

Place the child restraint system on the rear seat facing the rear of the vehicle.

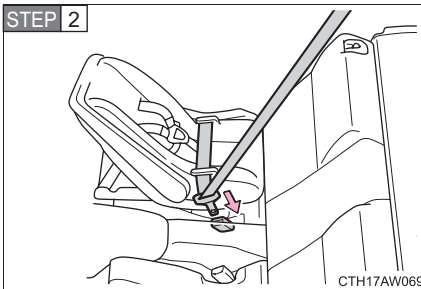

Run the seatbelt through the child restraint system and insert the plate into the buckle. Make sure that the belt is not twisted.

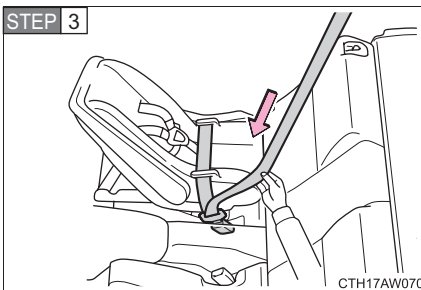

Fully extend the shoulder belt and allow it to retract to put it in lock mode. In lock mode, the belt cannot be extended.

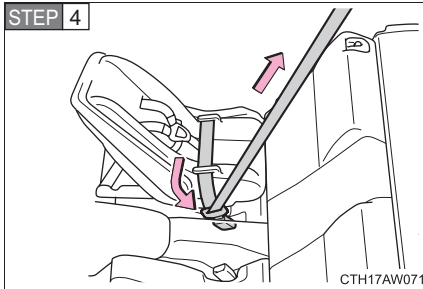

While pushing the child restraint system down into the rear seat, allow the shoulder belt to retract until the child restraint system is securely in place.

After the shoulder belt has retracted to a point where there is no slack in the belt, pull the belt to check that it cannot be extended.

### ■ Forward facing — Convertible seat

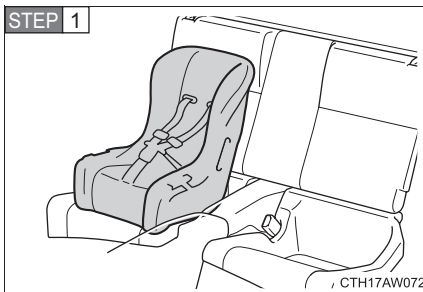

Place the child restraint system on the seat facing the front of the vehicle.

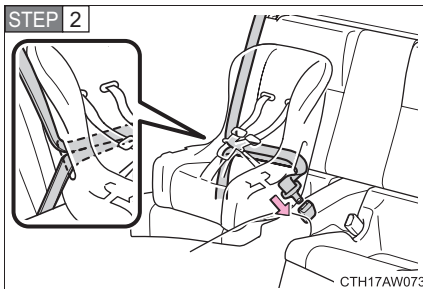

Run the seatbelt through the child restraint system and insert the plate into the buckle. Make sure that the belt is not twisted.

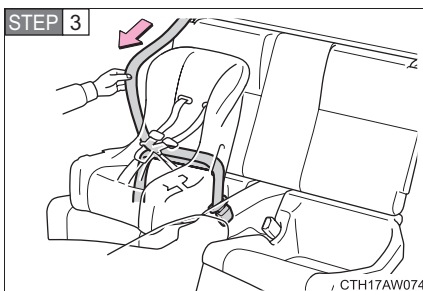

Fully extend the shoulder belt and allow it to retract to put it in lock mode. In lock mode, the belt cannot be extended.



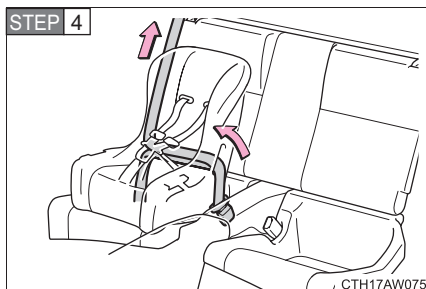

While pushing the child restraint system into the rear seat, allow the shoulder belt to retract until the child restraint system is securely in place.

After the shoulder belt has retracted to a point where there is no slack in the belt, pull the belt to check that it cannot be extended.

**STEP 5** If the child restraint has a top tether strap, the top tether strap should be latched onto the top tether strap anchor. (→P. 142)

### ■ Booster seat

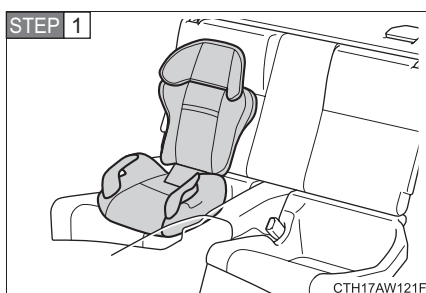

Place the child restraint system on the seat facing the front of the vehicle.

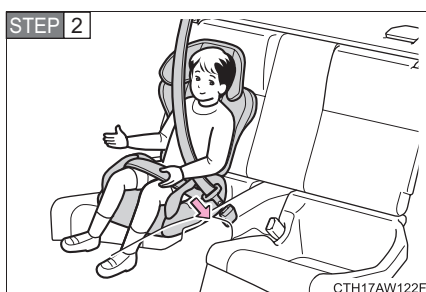

Sit the child in the child restraint system. Fit the seatbelt to the child restraint system according to the manufacturer's instructions and insert the plate into the buckle. Make sure that the belt is not twisted.

Check that the shoulder belt is correctly positioned over the child's shoulder and that the lap belt is as low as possible. (→P. 58)

### Removing a child restraint installed with a seatbelt

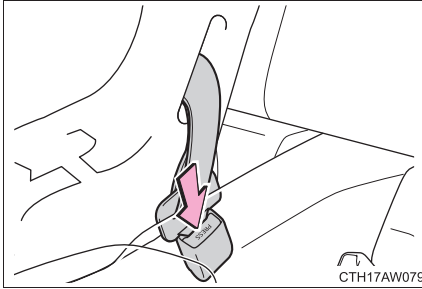

Push the buckle release button and fully retract the seatbelt.

### Child restraint systems with a top tether strap

**STEP 1** Secure the child restraint using a seatbelt or the LATCH anchors.

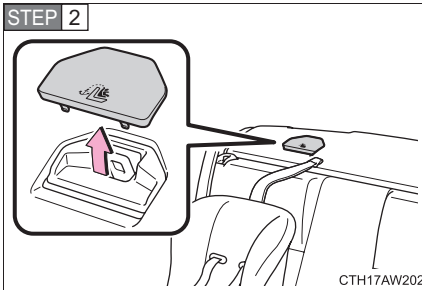

Remove the anchor bracket cover.

Store the removed cover in a safe place.

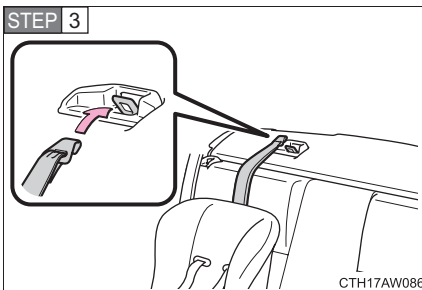

Latch the hook onto the anchor bracket and tighten the top tether strap.

Make sure the top tether strap is securely latched.

### ■ When installing a child restraint system with LATCH anchors and a top tether strap

Depending on the child restraint system's size and shape, if the child restraint system is installed to the LATCH anchors first, it may not be possible to attach the top tether strap to the anchor bracket.

In that case, first temporarily attach the top tether strap to the anchor bracket, install the child restraint system using the lower anchors and then tighten the top tether strap.

### ■ Laws and regulations pertaining to anchorages

The LATCH system conforms to FMVSS225 or CMVSS210.2.

Child restraint systems conforming to FMVSS213 or CMVSS213 specifications can be used.

This vehicle is designed to conform to the SAE J1819.

## ⚠ WARNING

### ■ When installing a booster seat

To prevent the belt from going into ALR lock mode, do not fully extend the shoulder belt. ALR mode causes the belt to tighten only. This could cause injury or discomfort to the child. (→P. 60)

### ■ When installing a child restraint system

Follow the directions given in the child restraint system installation manual and fix the child restraint system securely in place.

If the child restraint system is not correctly fixed in place, the child or other passengers may be injured or even killed in the event of sudden braking, sudden swerving or an accident.

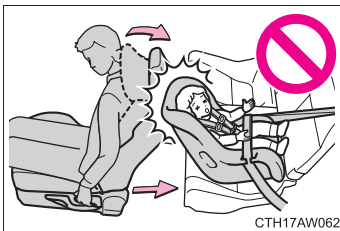

CTH17AW062

- If the driver's seat interferes with the child restraint system and prevents it from being attached correctly, attach the child restraint system to the right-hand rear seat.
- Adjust the front passenger seat so that it does not interfere with the child restraint system.

 **WARNING**

■ **When installing a child restraint system**

- Ensure that the belt and plate are securely locked and the seatbelt is not twisted.
- Shake the child restraint system left and right, and forward and backward to ensure that it has been securely installed.
- When adjusting the front passenger seat position after installing a child restraint system, do so slowly.
- Follow all installation instructions provided by the child restraint system manufacturer.

■ **To correctly attach a child restraint system to the anchors**

When using the LATCH anchors, be sure that there are no foreign objects around the anchors and that the seatbelt is not caught behind the child restraint. Make sure the child restraint system is securely attached, or it may cause death or serious injury to the child or other passengers in the event of sudden braking, sudden swerve or an accident.

## When driving

# 2

### 2-1. Driving procedures

Driving the vehicle.....	146
Push-button ignition switch.....	160
Engine (ignition) switch....	169
Automatic transmission....	172
Manual Transmission.....	179
Turn signal lever .....	182
Parking brake.....	183
Horn .....	184

### 2-2. Instrument cluster

Gauges and meters .....	185
Indicators and warning lights .....	190
Multi-information display.....	195

### 2-3. Operating the lights and windshield wipers

Headlight switch .....	200
Fog light switch .....	206
Windshield wipers and washer .....	207

### 2-4. Using other driving systems

Cruise control.....	210
Driving assist systems .....	215

### 2-5. Driving information

Cargo and luggage .....	221
Vehicle load limits .....	225
Winter driving tips .....	226
Trailer towing .....	230
Dinghy towing .....	231

## 2-1. Driving procedures

# Driving the vehicle

The following procedures should be observed to ensure safe driving:

### ■ Starting the engine

→P. 160, 169

### ■ Driving

#### Vehicles with an automatic transmission

**STEP 1** With the brake pedal depressed, shift the select lever to D.  
(→P. 172)

**STEP 2** Release the parking brake. (→P. 183)

**STEP 3** Gradually release the brake pedal and gently depress the accelerator pedal to accelerate the vehicle.

#### Vehicles with a manual transmission

**STEP 1** While depressing the clutch pedal, shift the shift lever to 1.  
(→P. 179)

**STEP 2** Release the parking brake. (→P. 183)

**STEP 3** Gradually release the clutch pedal. At the same time, gently depress the accelerator pedal to accelerate the vehicle.

### ■ Stopping

#### Vehicles with an automatic transmission

**STEP 1** With the select lever in D, depress the brake pedal.

**STEP 2** If necessary, set the parking brake.

If the vehicle is to be stopped for an extended period of time, shift the select lever to P or N. (→P. 172)

#### Vehicles with a manual transmission

**STEP 1** While depressing the clutch pedal, depress the brake pedal.

**STEP 2** If necessary, set the parking brake.

If the vehicle is to be stopped for an extended period of time, shift the shift lever to neutral. (→P. 179)

## ■ Parking the vehicle

### Vehicles with an automatic transmission

- STEP 1** With the select lever in D, depress the brake pedal.
- STEP 2** Shift the select lever to P. (→P. 172)
- STEP 3** Set the parking brake. (→P. 183)
- STEP 4** Vehicles without a keyless access with push button start system:  
Turn the engine switch to the “LOCK” position to stop the engine.  
Vehicles with a keyless access with push button start system:  
Press the push-button ignition switch to stop the engine.
- STEP 5** Lock the door, making sure that you have the key on your person.  
If parking on a hill, block the wheels as needed.

### Vehicles with a manual transmission

- STEP 1** While depressing the clutch pedal, depress the brake pedal.
- STEP 2** Shift the shift lever to neutral. (→P. 179)
- STEP 3** Set the parking brake. (→P. 183)
- STEP 4** Vehicles without a keyless access with push button start system:  
Turn the engine switch to the “LOCK” position to stop the engine.  
Vehicles with a keyless access with push button start system:  
Press the push-button ignition switch to stop the engine.
- STEP 5** Lock the door, making sure that you have the key on your person.  
If parking on a hill, shift the shift lever to 1 or R and block the wheels as needed.

## Starting off on a steep uphill

### Vehicles with an automatic transmission

- STEP 1** Make sure that the parking brake is set and shift the select lever to D.
- STEP 2** Gently depress the accelerator pedal.
- STEP 3** Release the parking brake.

### Vehicles with a manual transmission

- STEP 1** With the parking brake firmly set and the clutch pedal fully depressed, shift the shift lever to 1.
  - STEP 2** Lightly depress the accelerator pedal at the same time as gradually releasing the clutch pedal.
  - STEP 3** Release the parking brake.
- 

### ■ Driving in the rain

- Drive carefully when it is raining, because visibility will be reduced, the windows may become fogged-up, and the road will be slippery.
- Drive carefully when it starts to rain, because the road surface will be especially slippery.
- Refrain from high speeds when driving on an expressway in the rain, because there may be a layer of water between the tires and the road surface, preventing the steering and brakes from operating properly.

### ■ Engine speed while driving (vehicles with an automatic transmission)

In the following conditions, the engine speed may become high while driving. This is due to automatic up-shifting control or down-shifting implementation to meet driving conditions. It does not indicate sudden acceleration.

- The vehicle is judged to be driving uphill or downhill
- When the accelerator pedal is released
- When driving on curves
- When the brake pedal is firmly depressed



### ■ New vehicle break-in driving (the first 1000 miles [1600 km])

The performance and long life of your vehicle are dependent on how you handle and care for your vehicle while it is new. Follow these instructions during the first 1000 miles (1600 km):

- Do not allow the engine speed to exceed 4000 rpm except in an emergency.
- Do not drive at one constant engine or vehicle speed for a long time, either fast or slow.
- Avoid starting suddenly and rapid acceleration, except in an emergency.
- Avoid hard braking, except in an emergency.

The same break-in procedures should be applied to an overhauled engine, newly mounted engine or when brake pads or brake linings are replaced with new ones.

### ■ Replacement of brake pad and lining

The front disc brake and the rear disc brake have audible wear indicators on the brake pads. If the brake pads wear close to their service limit, the wear indicator makes a very audible scraping noise when the brake pedal is applied.

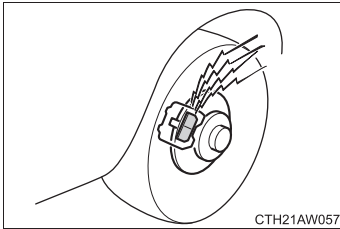

If you hear this scraping noise each time you apply the brake pedal, have the brake pads serviced by your SUBARU dealer as soon as possible.

### ■ Breaking-in of new brake pads and linings

When replacing the brake pad or lining, use only genuine SUBARU parts. After replacement, the new parts must be broken in as follows.

#### Brake pad and lining

While maintaining a speed of 30 to 40 mph (50 to 65 km/h), step on the brake pedal lightly. Repeat this five or more times.

### Parking brake lining

- STEP 1** Drive the vehicle at a speed of approximately 22 mph (35 km/h).
- STEP 2** With the parking brake release button pushed in, pull the parking brake lever SLOWLY and GENTLY (pulling with a force of approximately 33.7 lbf [150 N, 15.3 kgf]).
- STEP 3** Drive the vehicle for approximately 220 yards (200 meters) in this condition.
- STEP 4** Wait 5 to 10 minutes for the parking brake to cool down. Repeat this procedure.
- STEP 5** Check the parking brake lever travel. If the parking brake lever travel is out of the specified range, adjust it by turning the adjusting nut located on the parking brake lever.  
Parking brake lever travel: →P. 419

### ■ Drum-in-disc type parking brake system

Your vehicle has a drum-in-disc type parking brake system. This type of brake system needs bedding-down of the brake shoes periodically or whenever the parking brake shoes and/or drum are replaced. Have your SUBARU dealer perform the bedding down. (→P. 149)

### ■ After the engine starts

In order to secure a rich exhaust sound when starting the vehicle and environmental performance, air intake and exhaust sounds become loud and vibrations may increase for a little while after the engine starts. This is not a malfunction.

### ■ Operating your vehicle in a foreign country

Comply with the relevant vehicle registration laws and confirm the availability of the correct fuel. (→P. 413)

### ■ REV indicator

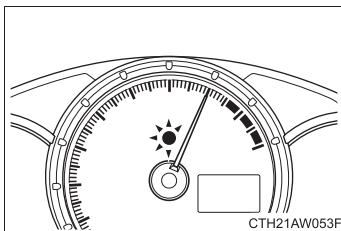

When the set engine speed is reached the REV indicator comes on and a buzzer sounds to inform the driver. (→P. 197)

(When the engine speed enters the red zone, the REV indicator flashes regardless of settings.)

**WARNING****■ When starting the vehicle (vehicles with an automatic transmission)**

- Always keep your foot on the brake pedal while stopped with the engine running. This prevents the vehicle from creeping.
- Firmly depress the brake pedal because engine speed may increase immediately after starting the engine, when the air conditioning system is operating, when turning the steering wheel, etc., thereby causing creeping to become stronger. Apply the parking brake as necessary.

**■ When driving the vehicle**

- Do not drive if you are unfamiliar with the location of the brake and accelerator pedals to avoid depressing the wrong pedal.
  - Accidentally depressing the accelerator pedal instead of the brake pedal will result in sudden acceleration that may lead to an accident that could result in death or serious injury.
  - When backing up, you may twist your body around, leading to a difficulty in operating the pedals. Make sure to operate the pedals properly.
  - Make sure to keep a correct driving posture even when moving the vehicle only slightly. This allows you to depress the brake and accelerator pedals properly.
  - Depress the brake pedal using your right foot. Depressing the brake pedal using your left foot may delay response in an emergency, resulting in an accident.
- Do not drive the vehicle over or stop the vehicle near flammable materials. The exhaust system and exhaust gases can be extremely hot. These hot parts may cause a fire if there is any flammable material nearby.
- On vehicles with an automatic transmission, do not let the vehicle roll backward while the select lever is in a driving position, or roll forward while the select lever is in R.  
Doing so may cause the engine to stall or lead to poor brake and steering performance, resulting in an accident or damage to the vehicle.
- If the smell of exhaust is noticed inside the vehicle, open the windows and check that the trunk lid is closed. Large amounts of exhaust in the vehicle can cause driver drowsiness and an accident, resulting in death or a serious health hazard. Have the vehicle inspected by your SUBARU dealer immediately.

 **WARNING**

- On vehicles with a manual transmission, do not shift the shift lever to R while the vehicle is moving forward.  
Doing so can damage the transmission and may result in a loss of vehicle control.
- Do not shift the select lever to D (vehicles with an automatic transmission) or shift lever to 1 (vehicles with a manual transmission) while the vehicle is moving backward.  
Doing so can damage the transmission and may result in a loss of vehicle control.
- On vehicles with a manual transmission, do not release the clutch pedal too quickly. Doing so may propel the vehicle forward, possibly causing an accident.
- Moving the select lever to N (vehicles with an automatic transmission) or shift lever to neutral (vehicles with a manual transmission) while the vehicle is moving will disengage the engine from the transmission. Engine braking is not available when N or neutral is selected.
- During normal driving, do not turn off the engine. Turning the engine off while driving will not cause loss of steering or braking control, but the power assist to these systems will be lost. This will make it more difficult to steer and brake, so you should pull over and stop the vehicle as soon as it is safe to do so.
- Use engine braking (downshift) to maintain a safe speed when driving down a steep hill.  
Using the brakes continuously may cause the brakes to overheat and lose effectiveness. (→P. 173, 179)
- Do not adjust the position of the steering wheel, the seat, or the inside or outside rear view mirrors while driving.  
Doing so may result in a loss of vehicle control that can cause accidents, resulting in death or serious injury.

 **WARNING**

- Always check that all passengers' arms, heads or other parts of their body are not outside the vehicle, as this may result in death or serious injury.
- Do not drive in excess of the speed limit. Even if the legal speed limit permits it, do not drive over 85 mph (140 km/h) unless your vehicle has high-speed capability tires. Driving over 85 mph (140 km/h) may result in tire failure, loss of control and possible injury. Be sure to consult a tire dealer to determine whether the tires on your vehicle are high-speed capability tires or not before driving at such speeds.

**■ When driving on slippery road surfaces**

- Sudden braking, acceleration and steering may cause tire slippage and reduce your ability to control the vehicle, resulting in an accident.
- Sudden acceleration, engine braking due to shift changing, or changes in engine speed could cause the vehicle to skid, resulting in an accident.
- After driving through a puddle, lightly depress the brake pedal to make sure that the brakes are functioning properly. Wet brake pads may prevent the brakes from functioning properly. If the brakes on only one side are wet and not functioning properly, steering control may be affected, resulting in an accident.

**■ When shifting the select lever or shift lever**

- On vehicles with an automatic transmission, be careful not to shift the select lever with the accelerator pedal depressed. Shifting the select lever to a gear other than P or N may lead to unexpected rapid acceleration of the vehicle that may cause an accident and result in death or serious injury.
- Do not place items in the select lever's or shift lever's surrounding area. It may cause incorrect operation.
- If the select lever's or shift lever's boot is pulled out during cleaning, return it to its previous position. If the select lever's or shift lever's boot is left pulled out, the select lever or shift lever may become difficult to operate.

 **WARNING**

■ **If you hear a squealing or scraping noise (brake pad wear limit indicators)**

Have your SUBARU dealer check and replace the brake pads as soon as possible.

Rotor damage may result if the pads are not replaced when needed.

It is dangerous to drive the vehicle when the wear limits of the brake pads and/or those of the brake discs are exceeded. (→P. 149)

■ **Breaking-in of new brake pads and linings**

A safe location and situation should be selected for break-in driving.

■ **When the vehicle is stopped**

- Do not race the engine.

If the vehicle is in any gear other than P or N (vehicles with an automatic transmission only) or neutral (vehicles with a manual transmission), the vehicle may accelerate suddenly and unexpectedly, causing an accident.

- Do not leave the vehicle with the engine running for a long time.

If such a situation cannot be avoided, park the vehicle in an open space and check that exhaust fumes do not enter the vehicle interior.

- On vehicles with an automatic transmission, in order to prevent accidents due to the vehicle rolling away, always keep depressing the brake pedal while the engine is running, and apply the parking brake as necessary.

- If the vehicle is stopped on an incline, in order to prevent accidents caused by the vehicle rolling forward or backward, always depress the brake pedal and securely apply the parking brake as needed.

- Avoid revving or racing the engine.

Running the engine at high speed while the vehicle is stopped may cause the exhaust system to overheat, which could result in a fire if combustible material is nearby.

**WARNING****■ When the vehicle is parked**

- Do not leave glasses, cigarette lighters, spray cans, or soft drink cans in the vehicle when it is in the sun.  
Doing so may result in the following:
  - Gas may leak from a cigarette lighter or spray can, and may lead to a fire.
  - The temperature inside the vehicle may cause the plastic lenses and plastic material of glasses to deform or crack.
  - Soft drink cans may fracture, causing the contents to spray over the interior of the vehicle, and may also cause a short circuit in the vehicle's electrical components.
- Do not leave cigarette lighters in the vehicle. If a cigarette lighter is in a place such as the glove box or on the floor, it may be lit accidentally when luggage is loaded or the seat is adjusted, causing a fire.
- Do not attach suction cups to the windshield or windows. Do not place containers such as air fresheners on the instrument panel or dashboard. Suction cups or containers may act as lenses, causing a fire in the vehicle.
- Do not leave a door or window open if the curved glass is coated with a metallized film such as a silver-colored one. Reflected sunlight may cause the glass to act as a lens, causing a fire.
- Always apply the parking brake, shift the select lever to P (vehicles with an automatic transmission only), stop the engine and lock the vehicle.  
Do not leave the vehicle unattended while the engine is running.
- Do not touch the exhaust pipe while the engine is running or immediately after turning the engine off.  
Doing so may cause burns.
- Do not leave the engine running in an area with snow build-up, or where it is snowing. If snowbanks build up around the vehicle while the engine is running, exhaust gases may collect and enter the vehicle. This may lead to death or a serious health hazard.

 **WARNING**

■ **Exhaust gases**

Exhaust gases include harmful carbon monoxide (CO), which is colorless and odorless. Inhaling exhaust gases may lead to death or a serious health hazard.

- If the vehicle is in a poorly ventilated area, stop the engine. In a closed area, such as a garage, exhaust gases may collect and enter the vehicle. This may lead to death or a serious health hazard.
- The exhaust system should be checked occasionally. If there is a hole or crack caused by corrosion, damage to a joint or abnormal exhaust noise, be sure to have the vehicle inspected and repaired by your SUBARU dealer. Failure to do so may allow exhaust gases to enter the vehicle, resulting in death or a serious health hazard.

■ **When taking a nap in the vehicle**

Always turn the engine off. Otherwise, you may accidentally move the select lever or shift lever, or depress the accelerator pedal, this could cause an accident or fire due to engine overheating. Additionally, if the vehicle is parked in a poorly ventilated area, exhaust gases may collect and enter the vehicle, leading to death or a serious health hazard.



 **WARNING****■ When braking**

- When the brakes are wet, drive more cautiously.  
Braking distance increases when the brakes are wet, and this may cause one side of the vehicle to brake differently than the other side. Also, the parking brake may not securely hold the vehicle.
- If the power brake assist function does not operate, do not follow other vehicles closely and avoid hills or sharp turns that require braking.  
In this case, braking is still possible, but the brake pedal should be depressed more firmly than usual. Also, the braking distance will increase.
- Do not pump the brake pedal if the engine stalls.  
Each push on the brake pedal uses up the reserve for the power-assisted brakes.
- The brake system consists of 2 individual hydraulic systems; if one of the systems fails, the other will still operate. In this case, the brake pedal should be depressed more firmly than usual and the braking distance will increase.  
If this happens, do not continue to drive the vehicle. Have your brakes fixed immediately.

 **CAUTION****■ When driving the vehicle****Vehicles with an automatic transmission**

- Do not depress the accelerator and brake pedals at the same time during driving, as this may restrain driving torque.
- Do not use the accelerator pedal or depress the accelerator and brake pedals at the same time to hold the vehicle on a hill.

 CAUTION

**Vehicles with a manual transmission**

- Do not depress the accelerator and brake pedals at the same time during driving, as this may restrain driving torque.
- Do not shift gears unless the clutch pedal is fully depressed. After shifting, do not release the clutch pedal abruptly. Doing so may damage the clutch, transmission and gears.
- Observe the following to prevent the clutch from being damaged.
  - Do not rest your foot on the clutch pedal while driving. Doing so may cause clutch trouble.
  - Do not use any gear other than the 1st gear when starting off and moving forward. Doing so may damage the clutch.
  - Do not use the clutch to hold the vehicle when stopping on an uphill grade. Doing so may damage the clutch.
- Do not shift the shift lever to R when the vehicle is still moving. Doing so may damage the clutch, transmission and gears.
- Do not release the clutch pedal too quickly. Doing so may damage the transmission.

■ **When parking the vehicle (vehicles with an automatic transmission)**

Always shift the select lever to P. Failure to do so may cause the vehicle to move or the vehicle may accelerate suddenly if the accelerator pedal is accidentally depressed. Also set the parking brake.

■ **Avoiding damage to vehicle parts**

- Do not turn the steering wheel fully in either direction and hold it there for an extended period of time. Doing so may damage the power steering motor.
- When driving over bumps in the road, drive as slowly as possible to avoid damaging the wheels, underside of the vehicle, etc.
- On vehicles with an automatic transmission, do not race the engine for more than 5 seconds in any position except the N or P position when the brake is applied or when chocks are used in the wheels. This may cause the transmission fluid to overheat.

 CAUTION

**■ Replacement of brake pad and lining**

If you continue to drive despite the scraping noise from the audible brake pad wear indicator, it will result in the need for costly brake rotor repair or replacement.

**■ Breaking-in of new brake pads and linings**

Pulling the parking brake lever too forcefully may cause the rear wheels to lock. To avoid this, be certain to pull the lever up slowly and gently.

**■ If you get a flat tire while driving**

A flat or damaged tire may cause the following situations. Hold the steering wheel firmly and gradually depress the brake pedal to slow down the vehicle.

- It may be difficult to control your vehicle.
- The vehicle will make abnormal sounds or vibrations.
- The vehicle will lean abnormally.

Information on what to do in case of a flat tire (→P. 378)

**■ When encountering flooded roads**

Do not drive on a road that has flooded after heavy rain etc. Doing so may cause the following serious damage to the vehicle:

- Engine stalling
- Short in electrical components
- Engine damage caused by water immersion

In the event that you drive on a flooded road and the vehicle is flooded, be sure to have your SUBARU dealer check the following:

- Brake function
- Changes in quantity and quality of oil and fluid used for the engine, transmission, differential, etc.
- Lubricant condition for the propeller shaft, bearings and suspension joints (where possible) and the function of all joints, bearings, etc.

## 2-1. Driving procedures

### Push-button ignition switch (vehicles with a keyless access with push button start system)

Performing the following operations when carrying the access key on your person starts the engine or changes push-button ignition switch modes.

#### ■ Starting the engine

##### Vehicles with an automatic transmission

**STEP 1** Check that the parking brake is set.

**STEP 2** Check that the select lever is set in P.

If the select lever is not set in P, the engine may not be started.  
(→P. 172)

**STEP 3** Firmly depress the brake pedal.

The keyless access with push button start system indicator light (green) will turn on. If the indicator light does not turn on, the engine cannot be started.

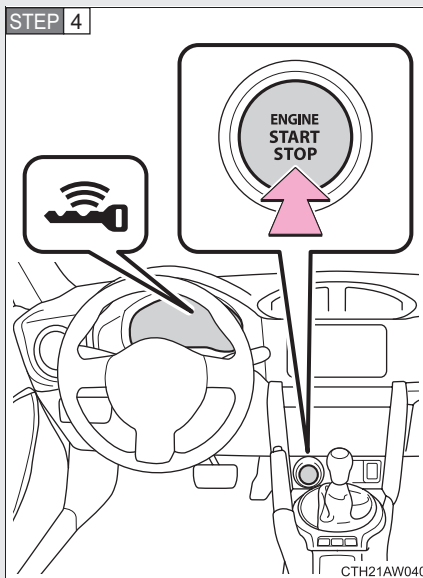

Press the push-button ignition switch.

The engine will crank until it starts or for up to 10 seconds, whichever is less.

Continue depressing the brake pedal until the engine is completely started.

The engine can be started from any push-button ignition switch mode.

### Vehicles with a manual transmission

**STEP 1** Check that the parking brake is set.

**STEP 2** Check that the shift lever is set in neutral.

**STEP 3** Firmly depress the clutch pedal.

The keyless access with push button start system indicator light (green) will turn on. If the indicator light does not turn on, the engine cannot be started.

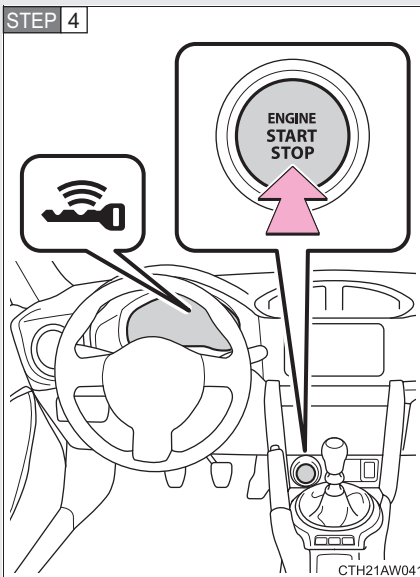

Press the push-button ignition switch.

The engine will crank until it starts or for up to 10 seconds, whichever is less.

Continue depressing the clutch pedal until the engine is completely started.

The engine can be started from any push-button ignition switch mode.

## ■ Stopping the engine

### Vehicles with an automatic transmission

- STEP 1** Stop the vehicle.
- STEP 2** Shift the select lever to P.
- STEP 3** Set the parking brake. (→P. 183)
- STEP 4** Release the brake pedal.
- STEP 5** Press the push-button ignition switch.
- STEP 6** Check that the keyless access with push button start system indicator light (green) is off.

### Vehicles with a manual transmission

- STEP 1** While depressing the clutch pedal, stop the vehicle.
- STEP 2** Shift the shift lever to neutral.
- STEP 3** Set the parking brake. (→P. 183)
- STEP 4** Release the clutch pedal.
- STEP 5** Press the push-button ignition switch.
- STEP 6** Check that the keyless access with push button start system indicator light (green) is off.

## ■ Changing push-button ignition switch mode

Modes can be changed by pressing the push-button ignition switch with the brake pedal (vehicles with an automatic transmission) or clutch pedal (vehicles with a manual transmission) released. (The mode changes each time the switch is pressed.)

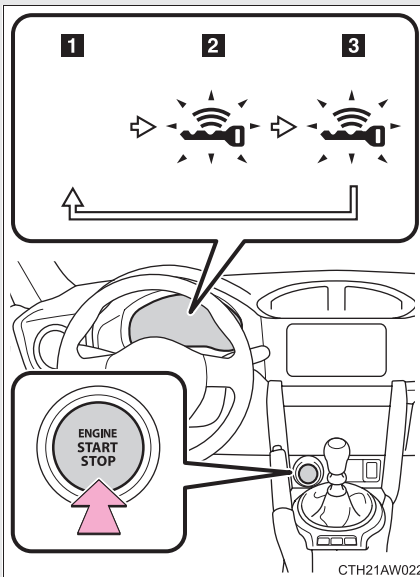

### 1 Off\*

The hazard warning flashers can be used.

The keyless access with push button start system indicator light (green) is off.

### 2 “ACC” mode

Some electrical components such as the power outlet can be used.

The keyless access with push button start system indicator light (green) flashes slowly.

### 3 “ON” mode

All electrical components can be used.

The keyless access with push button start system indicator light (green) flashes slowly.

\*: Vehicles with an automatic transmission: If the select lever is in a position other than P when turning off the engine, the push-button ignition switch will be turned to “ACC” mode, not to off.

**When stopping the engine with the select lever in a position other than P (vehicles with an automatic transmission)**

If the engine is stopped with the select lever in a position other than P, the push-button ignition switch will not be turned off but instead be turned to “ACC” mode. Perform the following procedure to turn the switch off:

**STEP 1** Check that the parking brake is set.

**STEP 2** Shift the select lever to P.

**STEP 3** Check that the keyless access with push button start system indicator light (green) flashes slowly and then press the push-button ignition switch once.

**STEP 4** Check that the keyless access with push button start system indicator light (green) is off.

---

■ **Auto power off function**

**Vehicles with an automatic transmission**

If the vehicle is left in “ACC” or “ON” mode (the engine is not running) for more than an hour with the select lever in P, the push-button ignition switch will automatically turn off. However, this function cannot entirely prevent battery discharge. Do not leave the vehicle with the push-button ignition switch in “ACC” or “ON” mode for long periods of time when the engine is not running.

**Vehicles with a manual transmission**

If the vehicle is left in “ACC” or “ON” mode (the engine is not running) for more than an hour, the push-button ignition switch will automatically turn off. However, this function cannot entirely prevent battery discharge. Do not leave the vehicle with the push-button ignition switch in “ACC” or “ON” mode for long periods of time when the engine is not running.



### ■ Operation of the push-button ignition switch

When operating the push-button ignition switch, one short, firm press is enough. If the switch is pressed improperly, the engine may not start or the push-button ignition switch mode may not change. It is not necessary to press and hold the switch.

### ■ Access key battery depletion

→P. 34

### ■ Conditions affecting operation

→P. 30

### ■ Note for the “keyless access” entry function

→P. 31

### ■ If the engine does not start

The engine immobilizer system may not have been deactivated. (→P. 77)  
Contact your SUBARU dealer.

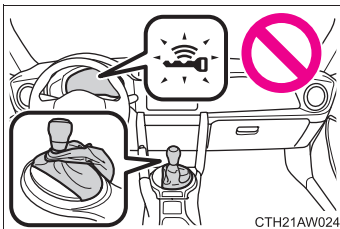

Vehicles with an automatic transmission: Check that the select lever is securely set in P. The engine may not start if the select lever is displaced out of P. The keyless access with push button start system indicator light (green) will flash quickly.

### ■ Steering lock

After turning the push-button ignition switch off and opening and closing the doors, the steering wheel will be locked due to the steering lock function. Operating the push-button ignition switch again automatically cancels the steering lock.

■ **When the steering lock cannot be released**

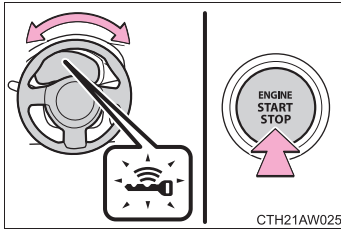

The keyless access with push button start system indicator light (green) will flash quickly.

■ **Vehicles with an automatic transmission**

Check that the select lever is set in P. Press the push-button ignition switch while turning the steering wheel left and right.

■ **Vehicles with a manual transmission**

Press the push-button ignition switch while turning the steering wheel left and right.

■ **Steering lock motor overheating prevention**

To prevent the steering lock motor from overheating, the motor may be suspended if the engine is turned on and off repeatedly in a short period of time. In this case, refrain from operating the engine. After about 10 seconds, the steering lock motor will resume functioning.

■ **When the keyless access with push button start system indicator light flashes in yellow**

The system may be malfunctioning. Have the vehicle inspected by your SUBARU dealer immediately.

■ **If the access key battery is depleted**

→P. 325

■ **If the keyless access with push button start system has been deactivated in a customized setting**

→P. 395

■ **Immediately after reconnecting the battery terminals due to replacing the battery and so forth**

The engine may not start. If this occurs, turn the push-button ignition switch to "ON" mode, and start the engine after waiting at least 10 seconds. Idling may be unstable immediately after the engine starts, however, this is not a malfunction.

**WARNING****■ When starting the engine**

- Always start the engine while sitting in the driver's seat. Do not depress the accelerator pedal while starting the engine under any circumstances. Doing so may cause an accident resulting in death or serious injury.
- If the keyless access with push button start system indicator light flashes in green after the engine has started, never drive the vehicle. The steering wheel is still locked, and it may result in an accident.

**■ Caution while driving**

If engine failure occurs while the vehicle is moving, do not lock or open the doors until the vehicle reaches a safe and complete stop. Activation of the steering lock in this circumstance may lead to an accident, resulting in death or serious injury.

**■ Stopping the engine**

Do not touch the push-button ignition switch during driving.

When the push-button ignition switch is pressed for 3 seconds or longer or pressed 3 times successively, the engine will stop. When the engine stops, the brake booster will not function. A greater foot pressure will be required on the brake pedal.

The power steering system will not operate either. A greater force will be required to steer, and it may result in an accident.

 CAUTION

■ **To prevent battery discharge**

- Do not leave the push-button ignition switch in “ACC” or “ON” mode for long periods of time without the engine running.
- If the keyless access with push button start system indicator light (green) is illuminated, the push-button ignition switch is not off. When exiting the vehicle, always check that the push-button ignition switch is off.
- Vehicles with an automatic transmission: Do not stop the engine when the select lever is in a position other than P. If the engine is stopped in another select lever position, the push-button ignition switch will not be turned off but instead be turned to “ACC” mode. If the vehicle is left in “ACC” mode, battery discharge may occur.

■ **When starting the engine**

- Do not race a cold engine.
- If the engine becomes difficult to start or stalls frequently, have your vehicle checked by your SUBARU dealer immediately.

■ **Symptoms indicating a malfunction with the push-button ignition switch**

If the push-button ignition switch seems to be operating somewhat differently than usual, such as the switch sticking slightly, there may be a malfunction. Contact your SUBARU dealer immediately.

## 2-1. Driving procedures

### Engine (ignition) switch (vehicles without a keyless access with push button start system)

#### ■ Starting the engine

##### Vehicles with an automatic transmission

- STEP 1** Check that the parking brake is set.
- STEP 2** Check that the select lever is set in P.
- STEP 3** Firmly depress the brake pedal.
- STEP 4** Turn the engine switch to the “START” position to start the engine.

##### Vehicles with a manual transmission

- STEP 1** Check that the parking brake is set.
- STEP 2** Check that the shift lever is set in neutral.
- STEP 3** Firmly depress the clutch pedal.
- STEP 4** Turn the engine switch to the “START” position to start the engine.

#### ■ Changing the engine switch positions

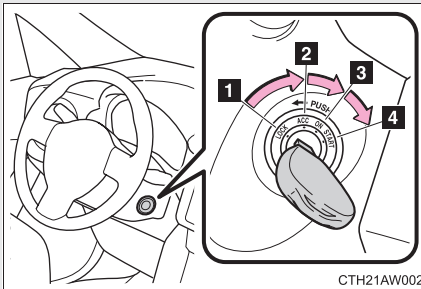

##### 1 “LOCK”

The steering wheel is locked and the key can be removed. (Vehicles with an automatic transmission: The key can be removed only when the select lever is in P.)

##### 2 “ACC”

Some electrical components such as the power outlet can be used.

##### 3 “ON”

All electrical components can be used.

##### 4 “START”

For starting the engine.

■ **Turning the key from “ACC” to “LOCK”**

**STEP 1** Vehicles with an automatic transmission: Shift the select lever to P.  
(→P. 172)

Vehicles with a manual transmission: Shift the shift lever to neutral.  
(→P. 179)

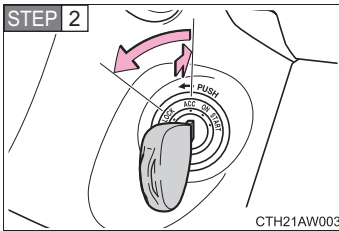

Push in the key and turn to the “LOCK” position.

■ **If the engine does not start**

Remove the key and try again. If the engine does not start, the engine immobilizer system may not have been deactivated. (→P. 77)  
Contact your SUBARU dealer.

■ **When the steering lock cannot be released**

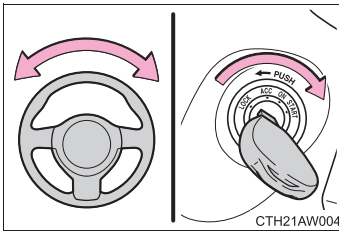

When starting the engine, the engine switch may seem stuck in the “LOCK” position. To free it, turn the key while turning the steering wheel slightly left and right.

■ **Key reminder function**

A buzzer sounds if the driver’s door is opened while the engine switch is in the “LOCK” or “ACC” position to remind you to remove the key.

■ **Immediately after reconnecting the battery terminals due to replacing the battery and so forth**

The engine may not start. If this occurs, turn the engine switch to the “ON” position, and start the engine after waiting at least 10 seconds. Idling may be unstable immediately after the engine starts, however, this is not a malfunction.

 **WARNING****■ When starting the engine**

Always start the engine while sitting in the driver's seat. Do not depress the accelerator pedal while starting the engine under any circumstances. Doing so may cause an accident resulting in death or serious injury.

**■ Caution when driving**

Do not turn the engine switch to the "LOCK" position while driving. If, in an emergency, you must turn the engine off while the vehicle is moving, turn the engine switch only to the "ACC" position to stop the engine. An accident may result if the engine is stopped while driving.

 **CAUTION****■ To prevent battery discharge**

Do not leave the engine switch in the "ACC" or "ON" position for long periods of time without the engine running.

**■ When starting the engine**

- Do not crank the engine for more than 10 seconds at a time. This may overheat the starter and wiring system.  
If the engine does not start, turn the engine switch to the "LOCK" position and try to start the engine again after waiting for 10 seconds or more.
- Do not race a cold engine.
- If the engine becomes difficult to start or stalls frequently, have your vehicle checked by your SUBARU dealer immediately.

## 2-1. Driving procedures

# Automatic transmission \*

Select a shift position appropriate for the driving conditions.

### ■ Shifting the select lever

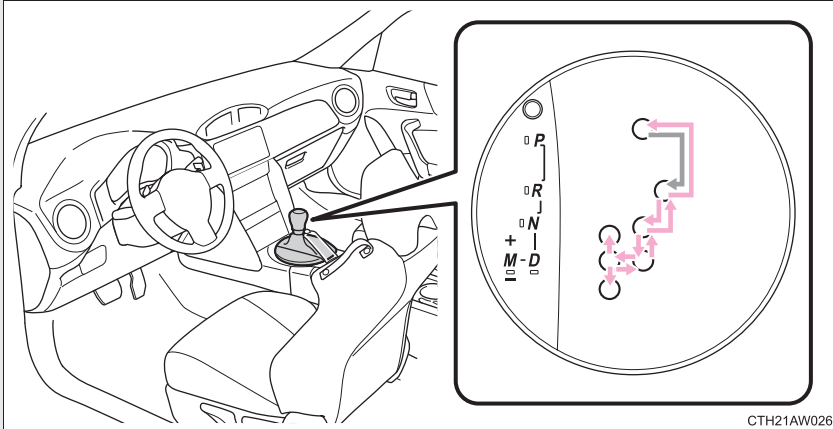

### **Vehicles without a keyless access with push button start system**

While the engine switch is in the “ON” position, move the select lever with the brake pedal depressed.

When shifting the select lever between P and D, make sure that the vehicle is completely stopped.

### **Vehicles with a keyless access with push button start system**







While the push-button ignition switch is in “ON” mode, move the select lever with the brake pedal depressed.

When shifting the select lever between P and D, make sure that the vehicle is completely stopped.

\*: If equipped



### ■ Shift position uses

Shift position	Meter display	Function
P		Parking the vehicle/starting the engine
R		Reversing
N		Neutral
D		Normal D position driving* (gears between “1” and “6” are automatically selected)
	 (paddle shift levers activated)	Temporary manual mode driving (→P. 177)
M		Manual mode driving (→P. 175)

\*: Shifting to the D position allows the system to select a gear suitable for the driving conditions. Setting the select lever to the D position is recommended for normal driving.

## ■ Selecting a driving mode

By pressing the driving pattern selector switch the following modes can be selected to suit driving and usage conditions:

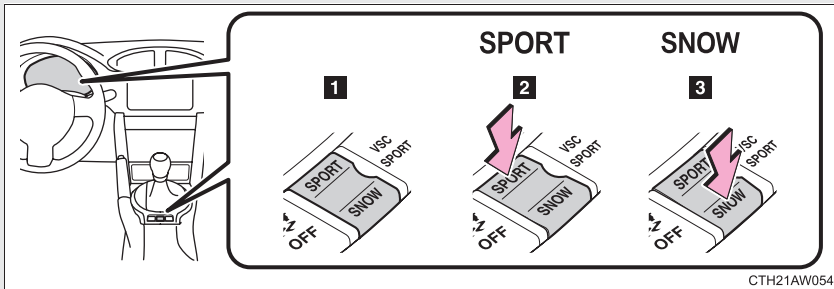

### 1 Normal mode

### 2 Sport mode

The "SPORT" indicator comes on.

Use sport mode for sporty driving or when driving in mountainous regions with lots of curves.

### 3 Snow mode

The "SNOW" indicator comes on.

Use snow mode for accelerating and driving on slippery road surfaces such as snow.

To cancel sport mode or snow mode, press the same side of the switch again.

## Manual mode driving

To enter manual mode, shift the select lever to the M position.

While the upshift/downshift indicator light is illuminated, gears can be selected by operating the select lever or paddle shift levers, allowing you to drive in the gear of your choosing.

Even if upshifting operations are performed, if vehicle speed is too low for the requested gear, the gear will not change.

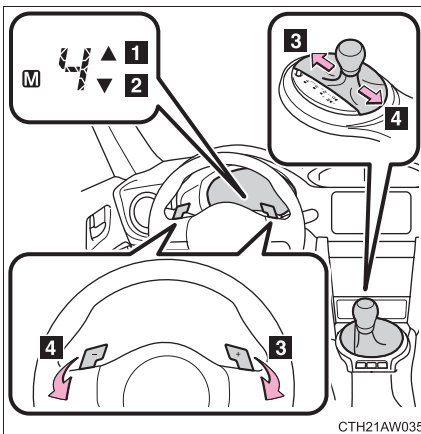

- 1 Upshift indicator
- 2 Downshift indicator
- 3 Upshifting (+)
- 4 Downshifting (-)

Each time the select lever or paddle shift levers are operated, the gear changes up or down one gear and the selected gear, "1" through "6", will be set.

The selected gear, from "1" to "6", and "M" will be displayed on the shift position and shift range indicator.

When in manual mode, the gear will not change unless the select lever or paddle shift levers are operated.

However, even when in manual mode, the gears will be automatically changed in the following situations:

- When vehicle speed drops (downshift only).
- When engine oil temperature is high and engine speed rises close to the red zone.

■ **When moving the select lever out of P**

If the select lever is pushed sideways before the brake pedal is depressed, select lever operation may not be possible. Depress the brake pedal before shifting the select lever out of P.

■ **Downshifting restrictions warning buzzer**

If downshifting operations are performed at a vehicle speed by which downshifting is not possible (when downshifting will cause the engine speed to enter the red zone), a buzzer will sound to warn the driver that downshifting cannot be performed.

■ **When driving with cruise control activated**

Downshifting can be performed even when using cruise control. After downshifting, the set speed continues. (→P. 175, 177)

■ **Sport mode**

- In sport mode, lower gears are used and gears change at a higher engine speed.
- If sport mode is changed to while the select lever is in the M position, the “SPORT” indicator will come on but sport mode controls will not be carried out. Shift the select lever to the D position.
- Sport mode cannot be changed to when driving with cruise control activated.

■ **Snow mode**

To prevent slipping, 1<sup>st</sup> gear cannot be selected when in snow mode.

■ **Sport mode and snow mode automatic deactivation**

In the following situations, the driving mode is automatically deactivated:

- When the engine is turned off after driving in sport mode or snow mode.
- When cruise control is activated while driving in sport mode.

■ **If the select lever cannot be shifted from P**

→P. 392

### ■ Automatic gear selection when the vehicle is stopped

When the vehicle is idling at high rpm in order to warm up, and the vehicle is on a slippery road, the transmission may automatically shift to 2<sup>nd</sup> gear for stopping and starting off.

### ■ Temporary manual mode driving

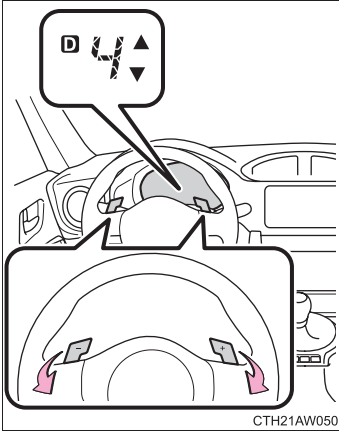

Temporary manual mode driving can be changed to by operating the paddle shift levers while the select lever is in the D position.

When this occurs, the selected gear and “D” are displayed on the shift position and shift range indicator.

(When engine speed rises close to the red zone, upshifting will be automatically performed.)

Temporary manual mode driving will be deactivated and normal D position driving will be returned to in the following situations:

- When driving for longer than the set time (the set time differs according to driving conditions).
- When the vehicle comes to a stop.
- When the accelerator pedal is continually depressed for longer than the set time.
- When the accelerator pedal is fully, or near-fully, depressed.

### ■ Adaptive control

In order to realize smoother driving while driving in D position, an appropriate gear is automatically selected by limiting upshifting and performing downshifting operations according to driver operations and driving conditions.

- When driving uphill, prevents unnecessary upshifting and downshifting.
- When driving downhill, downshifting is performed at engine speeds higher than usual.
- When driving on curves, prevents upshifting even when accelerating.
- When the brake pedal is depressed firmly, downshifting is automatically performed, fully utilizing engine braking.
- When the accelerator pedal is suddenly released, prevents upshifting.

Adaptive control operates automatically when the select lever is in the D position. (The function is canceled when the paddle shift levers are operated or the select lever is shifted to the M position.)

#### WARNING

##### ■ When driving on slippery road surfaces

Be careful of downshifting and sudden acceleration, as this could result in the vehicle skidding to the side or spinning.

##### ■ To prevent incorrect operation

Do not attach items such as accessories to the paddle shift levers. Doing so may unintentionally move the paddle shift levers.

## 2-1. Driving procedures

# Manual Transmission\*

### ■ Shifting the shift lever

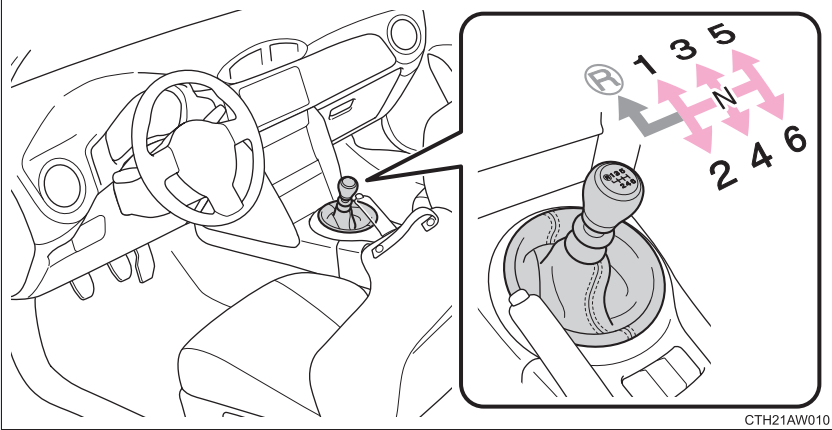

Fully depress the clutch pedal before operating the shift lever, and then release it slowly.

### ■ Shifting the shift lever to R

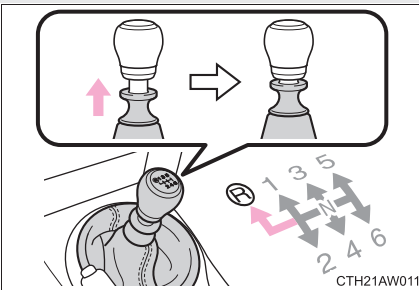

Shift the shift lever to R while lifting up the ring section.

### Shift-up indicator

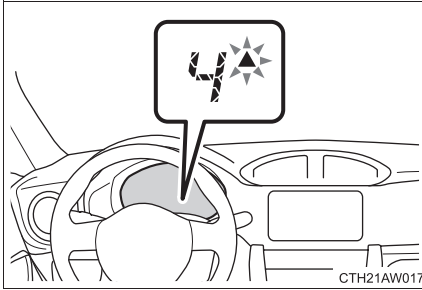

To help enable fuel-efficient driving, the shift-up indicator flashes 3 times to indicate upshift timing.

The indicator's default setting is off. The indicator can be turned on/off. (→P. 188)



 CAUTION

■ To prevent damage to the transmission

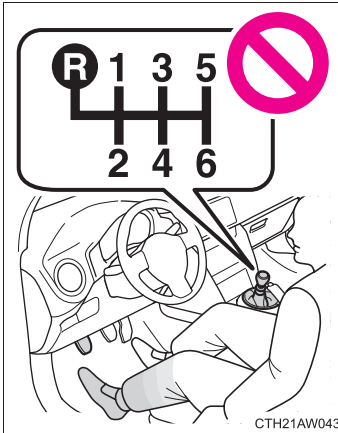

- Do not shift the shift lever without depressing the clutch pedal.

- Do not lift up the ring section except when shifting the lever to R.
- Shift the shift lever to R only when the vehicle is stationary and the clutch pedal is fully depressed.

## 2-1. Driving procedures

### Turn signal lever

The turn signal lever can be used to show the following intentions of the driver:

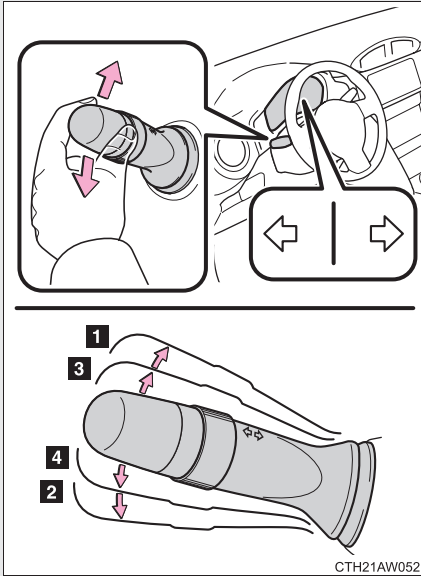

- 1 Right turn
- 2 Left turn
- 3 Lane change to the right (push and hold the lever partway)

The right hand signals will flash until you release the lever.

- 4 Lane change to the left (push and hold the lever partway)

The left hand signals will flash until you release the lever.

#### ■ Turn signals can be operated when

##### **Vehicles without a keyless access with push button start system**

The engine switch is in the “ON” position.

##### **Vehicles with a keyless access with push button start system**

The push-button ignition switch is in “ON” mode.

#### ■ If the indicators flash faster than usual

Check that a light bulb in the turn signal lights has not burned out.

## 2-1. Driving procedures

### Parking brake

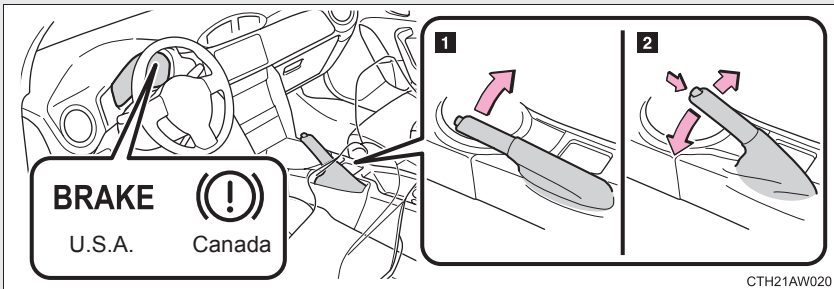

- 1** To set the parking brake, fully pull the parking brake lever while depressing the brake pedal.
- 2** To release the parking brake, slightly raise the lever and lower it completely while pressing the button.

#### ■ Usage in winter time

→P. 226

#### CAUTION

##### ■ Before driving

Fully release the parking brake.

Driving the vehicle with the parking brake set will lead to brake components overheating, which may affect braking performance and increase brake wear.

## 2-1. Driving procedures

### Horn

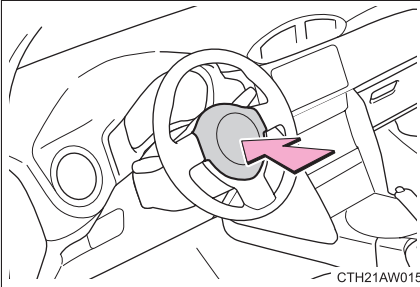

To sound the horn, press on or close to the  mark.

#### ■ After adjusting the steering wheel

Make sure that the steering wheel is securely locked.

The horn may not sound if the steering wheel is not securely locked.

(→P. 65)

## 2-2. Instrument cluster

# Gauges and meters

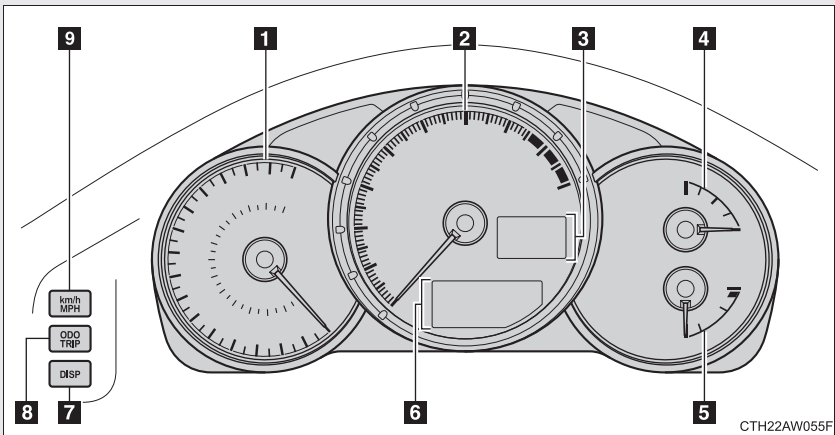

### 1 Analog Speedometer

Displays the vehicle speed.

### 2 Tachometer

Displays the engine speed in revolutions per minute.

### 3 Digital Speedometer

Displays the vehicle speed.

### 4 Fuel gauge

Displays the quantity of fuel remaining in the tank.

### 5 Engine coolant temperature gauge

Displays the engine coolant temperature.

### 6 Odometer, trip meter and multi-information display

Odometer: Displays the total distance the vehicle has been driven.

Trip meter: Displays the distance the vehicle has been driven since the meter was last reset. Trip meters A and B can be used to record and display different distances independently.

Multi-information display: Presents the driver with a variety of driving-related data. (→P. 195)

**7** “DISP” switch

→P. 196

**8** “ODO/TRIP” switch

→P. 187

**9** “km/h MPH” switch

Each time the switch is pressed, the display inside the meter changes between km/h and MPH.

## Switch the display

Each time the “ODO/TRIP” switch is pressed, the display changes as follows.

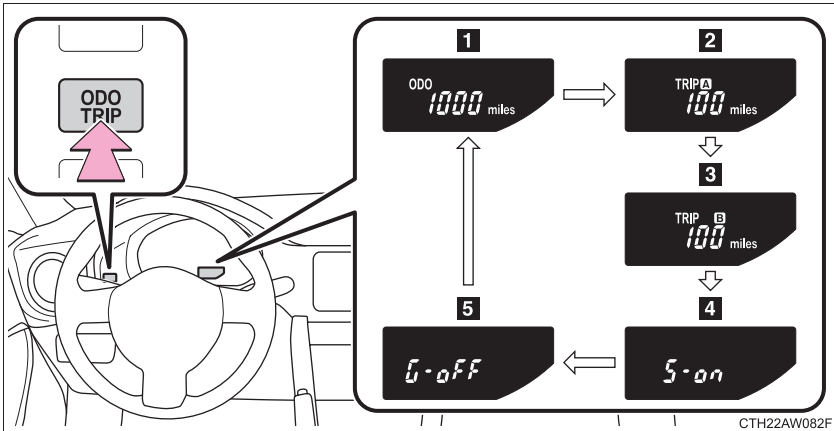

**1** Odometer

**2** Trip meter A\*<sup>1</sup>

**3** Trip meter B\*<sup>1</sup>

**4** Setting screen for tachometer indicator needle movement function when starting the vehicle\*<sup>2</sup>

**5** Setting screen for the shift position indicator and shift-up indicator\*<sup>2</sup> (vehicles with a manual transmission)

\*<sup>1</sup>: Pressing and holding the “ODO/TRIP” switch will reset the trip meter that is currently displayed.

\*<sup>2</sup>: Only displayed when the engine switch is in the “ACC” or “LOCK” position (vehicles without a keyless access with push button start system), or when the push-button ignition switch is in “ACC” mode or turned off (vehicles with a keyless access with push button start system).

### **Tachometer indicator needle movement function when starting the vehicle**

When the engine switch is turned to “ON” position (vehicles without a keyless access with push button start system), or the push-button ignition switch is turned to “ON” mode (vehicles with a keyless access with push button start system), the tachometer indicator needle points to the highest value once and then quickly returns.

#### **■ Changing between activated/deactivated**

**STEP 1** Press the “ODO/TRIP” switch repeatedly until the setting screen is displayed. (→P. 187)

**STEP 2** Each time the switch is pressed and held, the function changes between activated/deactivated.

“S-on”: Activated

“S-off”: Deactivated

### **Setting the shift position indicator and shift-up indicator (vehicles with a manual transmission)**

Displaying of the shift position indicator and shift-up indicator can be turned on/off.

**STEP 1** Press the “ODO/TRIP” switch repeatedly until the setting screen is displayed. (→P. 187)

**STEP 2** Each time the switch is pressed and held, the display changes between on/off.

“G-on”: Display on

“G-off”: Display off



## Instrument panel light control

The brightness of the instrument panel lights can be adjusted.

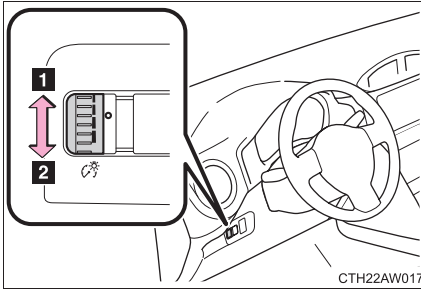

**1** Brighter

**2** Darker

### ■ The brightness of the instrument panel lights

When the parking lights or the headlights turn on, the instrument panel lights will dim. However, when the instrument panel brightness control dial is turned to the up most position, the instrument panel lights will not dim even when the parking lights or headlights turn on.

### ■ Fuel gauge

- When the indicator needle is close to “E”, promptly refuel the vehicle.
- The relationship between the indicator needle and the consumed amount (remaining fuel) is not always accurate. Only use it as a reference.
- When the vehicle is on an incline or curve, sudden acceleration and stops and so forth cause the fuel inside the tank to move which may cause the indicator needle to move up and down.

### ⚠ CAUTION

#### ■ To prevent damage to the engine and its components

- Do not let the indicator needle of the tachometer enter the red zone, which indicates the maximum engine speed.
- The engine may be overheating if the temperature gauge is in the red zone (H). In this case, immediately stop the vehicle in a safe place, and check the engine after it has cooled completely. (→P. 403)

## 2-2. Instrument cluster

# Indicators and warning lights

The indicator and warning lights on the instrument cluster and center panel inform the driver of the status of the vehicle's various systems.

For the purpose of explanation, the following illustration displays all indicators and warning lights illuminated.

### Instrument cluster

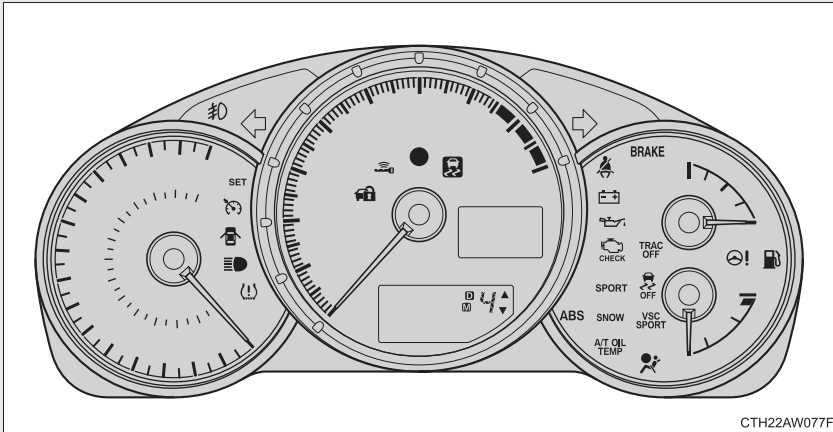

### Center panel

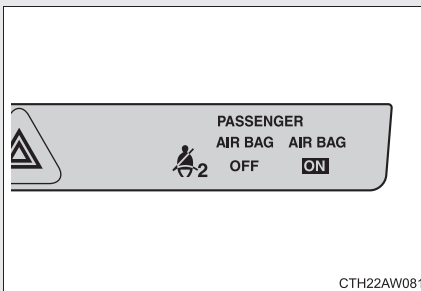

## ■ Indicators

The indicators inform the driver of the operating state of the vehicle's various systems.



Turn signal indicator  
(→P. 182)



Headlight high beam indicator (→P. 201)



(If equipped)

Front fog light indicator  
(→P. 206)



Security indicator  
(→P. 77, 81)



(If equipped)

Keyless access with push button start system indicator light  
(→P. 160)



(Vehicles with an automatic transmission)

Shift position and shift range indicator  
(→P. 173)



(Vehicles with an automatic transmission)

Upshift/downshift indicator (→P. 175, 177)



(Vehicles with an automatic transmission)

“SPORT” indicator  
(→P. 174)



(Vehicles with an automatic transmission)

“SNOW” indicator  
(→P. 174)



(Vehicles with a manual transmission)

Shift position indicator  
(→P. 179)



(Vehicles with a manual transmission)

Shift-up indicator  
(→P. 180)



\*1, 2

Slip indicator  
(→P. 215)



\*1

Traction Control System OFF indicator light  
(→P. 216)



\*1

Vehicle stability control (VSC) off indicator  
(→P. 218)



\*1

“VSC SPORT” indicator  
(→P. 217)



REV indicator  
(→P. 150)



Cruise control indicator  
(→P. 210)



“SET” indicator  
(→P. 210)

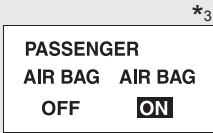

Airbag on-off indicator (→P. 122)

**\*1: Vehicles without a keyless access with push button start system**

These lights turn on when the engine switch is turned to the “ON” position to indicate that a system check is being performed. They will turn off after the engine is started, or after a few seconds. There may be a malfunction in a system if a light does not come on, or if the lights do not turn off. Have the vehicle inspected by your SUBARU dealer.

**Vehicles with a keyless access with push button start system**

These lights turn on when the push-button ignition switch is turned to “ON” mode to indicate that a system check is being performed. They will turn off after the engine is started, or after a few seconds. There may be a malfunction in a system if a light does not come on, or if the lights do not turn off. Have the vehicle inspected by your SUBARU dealer.

\*2: The light flashes to indicate that the system is operating.

\*3: The front passenger’s frontal airbag ON and OFF indicators show you the status of the front passenger’s SRS frontal airbag. When the engine switch is turned to the “ON” position, (vehicles without a keyless access with push button start system), or the push-button ignition switch is turned to “ON” mode (vehicles with a keyless access with push button start system), both the ON and OFF indicators illuminate for 6 seconds during the system check. After the system check, both the ON and OFF indicators turn off for 2 seconds. Then, either the ON or OFF indicator illuminates depending on the condition of the front passenger’s frontal airbag.

When the OFF indicator remains off and ON indicator illuminates, the front passenger’s frontal airbag may deploy during a collision. When the OFF indicator illuminates and ON indicator remains off, the front passenger’s frontal airbag does not deploy during a collision.

If the front passenger’s frontal airbag ON and OFF indicators remain on when the engine switch is turned to the “ON” position (vehicles without a keyless access with push button start system) or the push-button ignition switch is turned to “ON” mode (vehicles with a keyless access with push button start system), or the indicators remain off after the system check, the system may be malfunctioning. Have the vehicle inspected by your SUBARU dealer immediately.

## ■ Warning lights

Warning lights inform the driver of malfunctions in any of the vehicle's systems. (→P. 364)

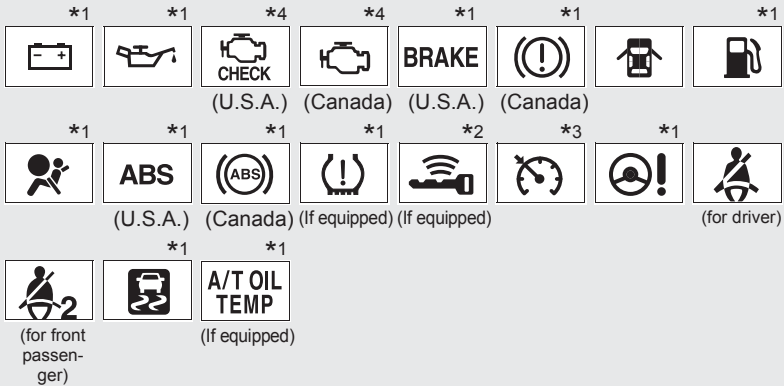

### \*1: Vehicles without a keyless access with push button start system

These lights turn on when the engine switch is turned to the “ON” position to indicate that a system check is being performed. They will turn off after the engine is started, or after a few seconds. There may be a malfunction in a system if a light does not come on, or if the lights do not turn off. Have the vehicle inspected by your SUBARU dealer for details.

### Vehicles with a keyless access with push button start system

These lights turn on when the push-button ignition switch is turned to “ON” mode to indicate that a system check is being performed. They will turn off after the engine is started, or after a few seconds. There may be a malfunction in a system if a light does not come on, or if the lights do not turn off. Have the vehicle inspected by your SUBARU dealer for details.

\*2: The light flashes in yellow to indicate a malfunction. The light flashes quickly in green to indicate that the steering lock has not been released.

\*3: The light comes on in yellow to indicate a malfunction.

**\*4. Vehicles without a keyless access with push button start system**

These lights turn on when the engine switch is turned to the “ON” position to indicate that a system check is being performed. They will turn off after the engine is started. There may be a malfunction in a system if a light does not come on, or if the lights do not turn off. Have the vehicle inspected by your SUBARU dealer for details.

**Vehicles with a keyless access with push button start system**

These lights turn on when the push-button ignition switch is turned to “ON” mode to indicate that a system check is being performed. They will turn off after the engine is started. There may be a malfunction in a system if a light does not come on, or if the lights do not turn off. Have the vehicle inspected by your SUBARU dealer for details.

 **WARNING**

**■ If a safety system warning light does not come on**

Should a safety system light such as the ABS and SRS airbag system warning light not come on when you start the engine, this could mean that these systems are not available to help protect you in an accident, which could result in death or serious injury. Have the vehicle inspected by your SUBARU dealer immediately if this occurs.

## 2-2. Instrument cluster

### Multi-information display

The multi-information display presents the driver with a variety of driving-related data, including the current outside air temperature.

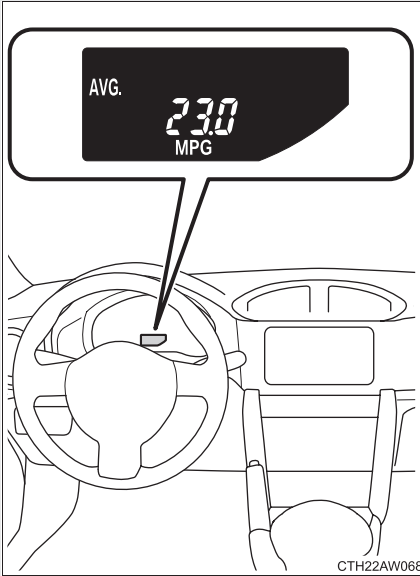

- Outside temperature
- Current fuel consumption
- Average fuel consumption
- Setting screen for the REV indicator

## Switch the display

Each time the “DISP” switch is pressed, the display changes as follows.

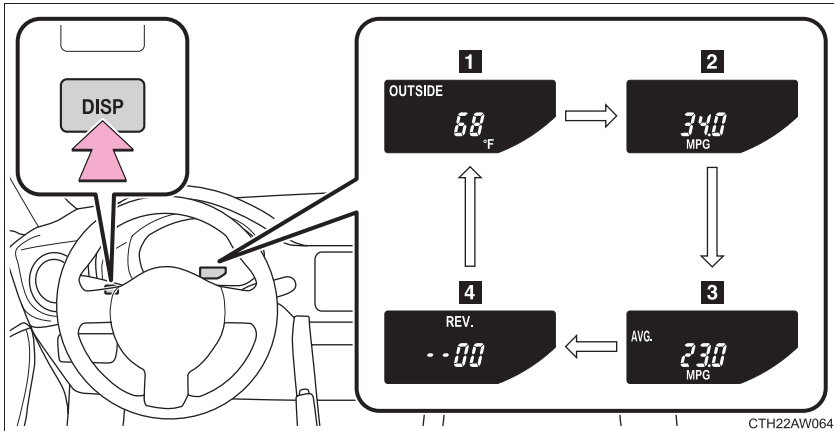

**1** Outside temperature

→P. 263

**2** Current fuel consumption

Displays the current rate of fuel consumption.

**3** Average fuel consumption

Displays the average fuel consumption since the function was reset.

- The function can be reset by pushing the “DISP” switch for longer than one second when the average fuel consumption is displayed.
- Use the displayed average fuel consumption as a reference.

**4** Setting screen for the REV indicator\*

→P. 197

\*: Only displayed when the vehicle is stopped.



## Setting the REV indicator

### ■ Changing the REV indicator settings

The engine speed at which the REV indicator turns on at and whether a buzzer sounds or not when the light turns on can be set.

Engine speed setting range: From 2000 to 7400 rpm (r/min)

**STEP 1** Press the “DISP” switch repeatedly until the setting screen is displayed. (→P. 196)

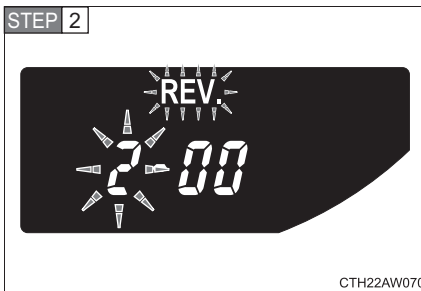

Press and hold the “DISP” switch.

“REV.” and the thousandth place flash. After flashing, the number changes each time the button is pressed and held.

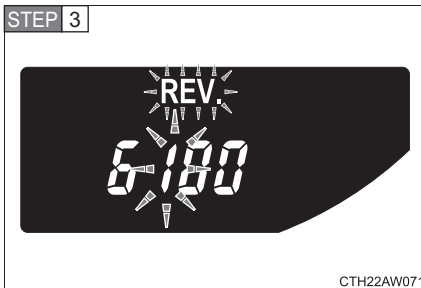

Press the “DISP” switch.

The hundredth place flashes. After flashing, the number changes each time the button is pressed and held.

**STEP 4** Press the “DISP” switch.

A buzzer sounds once, and setting of the engine speed value is complete.



Press and hold the "DISP" switch.

Each time the "DISP" switch is pressed and held, the buzzer changes between activated and deactivated.

"b-on": Buzzer activated

"b-off": Buzzer deactivated

When the setting changes from "b-off" to "b-on", the buzzer sounds 3 times.

STEP 6 Press the "DISP" switch.

When the buzzer sounds, all settings have been completed. The settings are displayed.

### ■ Deactivating the REV indicator settings

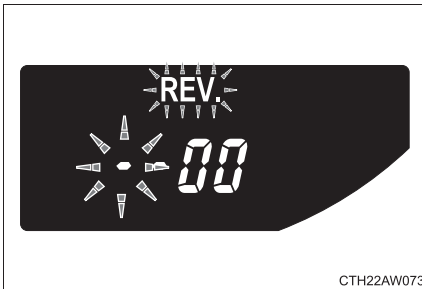

After setting the thousandth place to "-", press the "DISP" switch once.

**■ The multi-information display operate when****Vehicles without a keyless access with push button start system**

The engine switch is in the “ON” position.

**Vehicles with a keyless access with push button start system**

The push-button ignition switch is in “ON” mode.

**WARNING****■ The information display at low temperatures**

Allow the interior of the vehicle to warm up before using the liquid crystal information display. At extremely low temperatures, the information display monitor may respond slowly, and display changes may be delayed.

For example, there is a lag between the driver's shifting and the new shift position number appearing on the display. In this case, wait until the display changes and take care not to downshift again, causing rapid and excessive engine braking and possibly an accident resulting in death or serious injury.

## 2-3. Operating the lights and windshield wipers

### Headlight switch

The headlights can be operated manually or automatically.

Turning the end of the lever turns on the lights as follows:

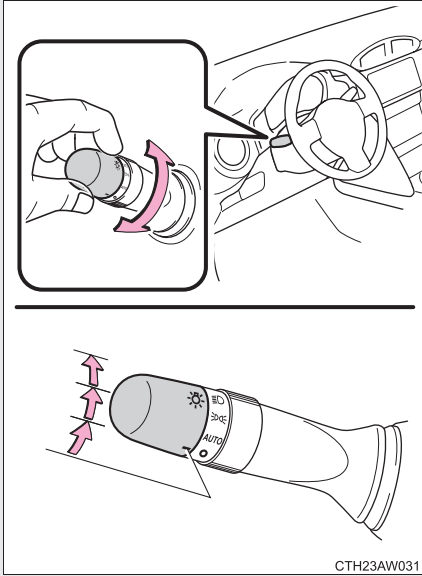

○ Off

The daytime running lights turn on.

**AUTO** The headlights, parking, daytime running lights and so on turn on and off automatically. (Vehicles without a keyless access with push button start system: When the engine switch is in the "ON" position

Vehicles with a keyless access with push button start system: When the push-button ignition switch is in "ON" mode)

☰ The side marker, parking, tail, license plate, daytime running lights and instrument panel lights turn on.

☰ The headlights and all the lights listed above (except daytime running lights) turn on.

## Turning on the high beam headlights

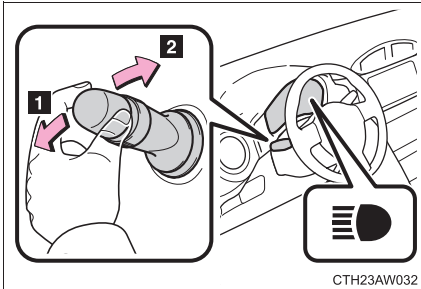

- 1 With the headlights on, push the lever forward to turn on the high beams.

Pull the lever back to the center position to turn the high beams off.

- 2 Pull the lever toward you and release it to flash the high beams once.

You can flash the high beams with the headlights on or off.

2

When driving

### Manual headlight leveling dial

The level of the headlights can be adjusted according to the number of passengers and the loading condition of the vehicle.

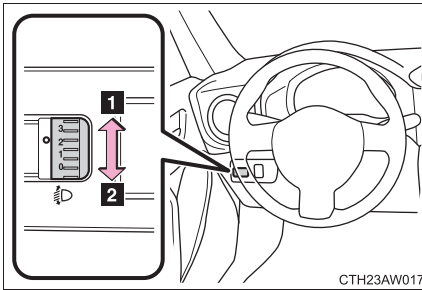

- 1** Raises the level of the headlights
- 2** Lowers the level of the headlights

CTH23AW017

#### ■ Guide to dial settings

Occupancy and luggage load conditions		Dial position
Occupants	Luggage load	
Driver	None	0
Driver and front passenger	None	0
All seats occupied	None	1
All seats occupied	Full luggage loading	1
Driver	Full luggage loading	2

### ■ Daytime running light system

- Vehicles with an automatic transmission: To make your vehicle more visible to other drivers, the daytime running lights turn on automatically whenever the engine is started, the select lever is shifted out of P and the parking brake is released. Daytime running lights are not designed for use at night.
- Vehicles with a manual transmission: To make your vehicle more visible to other drivers, the daytime running lights turn on automatically whenever the engine is started and the parking brake is released. Daytime running lights are not designed for use at night.
- Compared to turning on the headlights, the daytime running light system offers greater durability and consumes less electricity, so it can help improve fuel economy.

### ■ Headlight control sensor

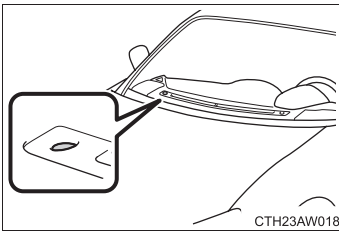

Headlight control sensor is located on the passenger's side.



The sensor may not function properly if an object is placed on the sensor, or anything that blocks the sensor is affixed to the windshield.

Doing so interferes with the sensor detecting the level of ambient light and may cause the automatic headlight system to malfunction.

■ **Automatic light off system**



**Vehicles without a keyless access with push button start system**

The light switch is in **AUTO**, the headlights and tail lights turn off 30 seconds after a door is opened and closed if the key is removed from the engine switch. (The lights turn off immediately if  on the key is pressed after all the doors are locked.)

To turn the lights on again, turn the engine switch to the “ON” position, or turn the lights off and then back to  or .

**Vehicles with a keyless access with push button start system**

The light switch is in **AUTO**, the headlights and tail lights turn off 30 seconds after a door is opened and closed if the push-button ignition switch is turned off. (The lights turn off immediately if  on the key is pressed after all the doors are locked.)

To turn the lights on again, turn the push-button ignition switch to “ON” mode, or turn the light switch off and then back to  or .

■ **Light reminder buzzer**

**Vehicles without a keyless access with push button start system**

A buzzer sounds when the engine switch is turned to “LOCK” position and the driver's door is opened with the key removed from the engine switch while the lights are turned on.



**Vehicles with a keyless access with push button start system**

A buzzer sounds when the push-button ignition switch is turned off or turned to “ACC” mode and the driver's door is opened while the lights are turned on.



### ■ Battery-saving function

In the following conditions, the headlights and the other remaining lights will go off automatically after 20 minutes in order to prevent the vehicle battery from being discharged:

- The headlights and/or tail lights are on.
- The key is removed from the engine switch (vehicles without a keyless access with push button start system) or the push-button ignition switch is turned off (vehicles with a keyless access with push button start system).
- The light switch is in ,  or **AUTO**.

This function will be canceled in any of the following situations:

- When the engine switch is turned to the “ON” position (vehicles without a keyless access with push button start system) or the push-button ignition switch is turned to “ON” mode (vehicles with a keyless access with push button start system)
- When the light switch is operated
- When the door is opened or closed

### ■ Customization that can be configured at your SUBARU dealer

Settings (e.g. light sensor sensitivity) can be changed.  
(Customizable features →P. 439)

#### CAUTION

#### ■ To prevent battery discharge

Do not leave the lights on longer than necessary when the engine is not running.

## 2-3. Operating the lights and windshield wipers

### Fog light switch\*

The fog lights secure excellent visibility in difficult driving conditions, such as in rain and fog.

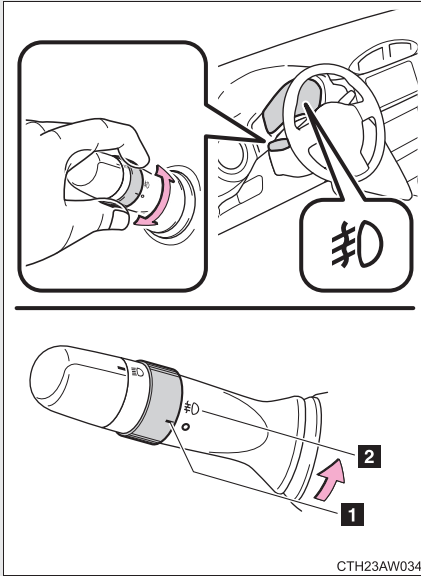

- 1 Turns the front fog lights off
- 2 Turns the front fog lights on

CTH23AW034

#### ■ Fog lights can be used when

The headlights are on in low beam.

\*: If equipped

## 2-3. Operating the lights and windshield wipers

### Windshield wipers and washer

When intermittent windshield wiper operation is selected, the wiper interval can be adjusted.

The wiper operation is selected by moving the lever as follows.

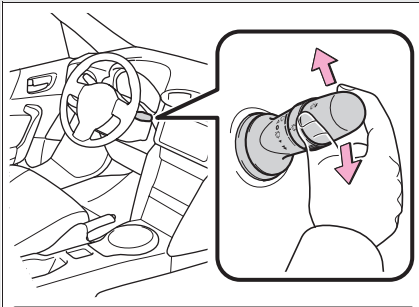

- 1 Intermittent windshield wiper operation
- 2 Low speed windshield wiper operation
- 3 High speed windshield wiper operation
- 4 Temporary operation

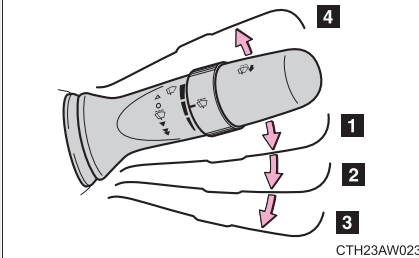

CTH23AW023

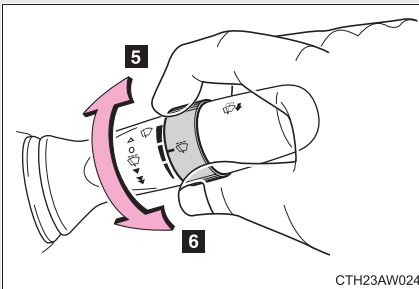

CTH23AW024

- 5 Decreases the intermittent windshield wiper frequency
- 6 Increases the intermittent windshield wiper frequency

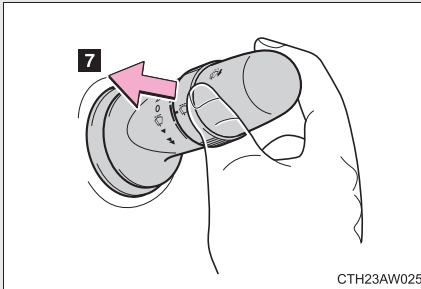

**7 Washer/wiper dual operation**

The wipers will automatically operate a couple of times after the washer squirts.

■ **The windshield wipers and washer can be operated when**

**Vehicles without a keyless access with push button start system**

The engine switch is in the “ON” position.

**Vehicles with a keyless access with push button start system**

The push-button ignition switch is in “ON” mode.

■ **If no windshield washer fluid sprays**

Check that the washer nozzles are not blocked if there is washer fluid in the windshield washer fluid reservoir.

**⚠ WARNING**

■ **Caution regarding the use of washer fluid**

When it is cold, do not use the washer fluid until the windshield becomes warm. The fluid may freeze on the windshield and cause low visibility. This may lead to an accident, resulting in death or serious injury.

 CAUTION

■ **When the windshield is dry**

Do not use the wipers, as they may damage the windshield.

■ **When the washer fluid tank is empty**

Do not operate the switch continually as the washer fluid pump may over-heat.

■ **When a nozzle becomes blocked**

In this case, contact your SUBARU dealer.

Do not try to clear it with a pin or other object. The nozzle will be damaged.

## 2-4. Using other driving systems

### Cruise control

Use the cruise control to maintain a set speed without depressing the accelerator pedal.

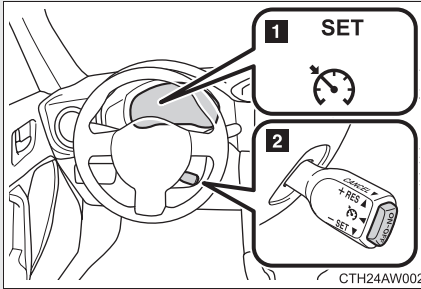

- 1 Indicators
- 2 Cruise control switch

#### ■ Setting the vehicle speed

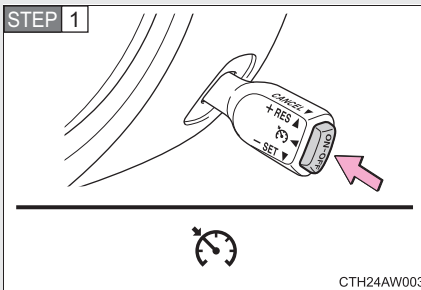

Press the “ON-OFF” button to activate the cruise control.

Cruise control indicator (green) will come on.

Press the button again to deactivate the cruise control.

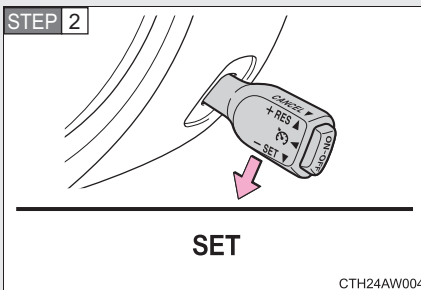

Accelerate or decelerate the vehicle to the desired speed, and push the lever down to set the speed.

“SET” indicator will come on.

The vehicle speed at the moment the lever is released becomes the set speed.

### ■ Adjusting the set speed

To change the set speed, operate the lever until the desired set speed is obtained.

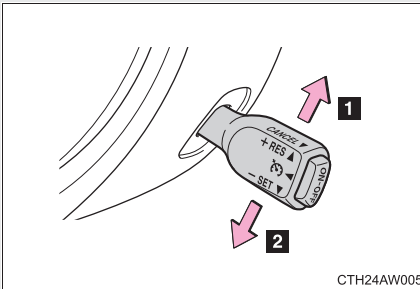

**1** Increases the speed

**2** Decreases the speed

Fine adjustment: Momentarily move the lever in the desired direction.

Large adjustment: Hold the lever in the desired direction.

The set speed will be increased or decreased as follows:

Fine adjustment (U.S.A.): By approximately 1 mph (1.6 km/h) each time the lever is operated.

Fine adjustment (Canada): By approximately 0.6 mph (1 km/h) each time the lever is operated.

Large adjustment: The vehicle speed can be increased or decreased continually until the lever is released. Then, release the lever. The vehicle speed at that moment will be memorized and treated as the new set speed.

### ■ Canceling and resuming the constant speed control

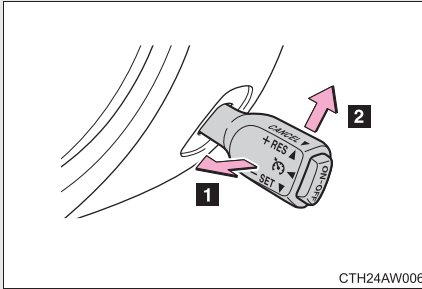

**1** Pulling the lever toward you cancels the constant speed control.

The speed setting is also canceled when:

- The brakes are applied.
- The clutch pedal is depressed (manual transmission only).

**2** Pushing the lever up resumes the constant speed control.

Resuming is available when the vehicle speed is more than approximately 20 mph (32 km/h).

---

### ■ Cruise control can be set when

#### **Vehicles with an automatic transmission**

- The select lever is in D or M and the vehicle is in the 2<sup>nd</sup> gear or higher.
- Vehicle speed is above approximately 25 mph (40 km/h).

#### **Vehicles with a manual transmission**

- The vehicle is in the 2<sup>nd</sup> gear or higher.
- Vehicle speed is above approximately 25 mph (40 km/h).



**■ Accelerating after setting the vehicle speed**

- The vehicle can be accelerated normally. After acceleration, the set speed resumes.
- Even without canceling the cruise control, the set speed can be increased by first accelerating the vehicle to the desired speed and then pushing the lever down to set the new speed.

**■ Automatic cruise control cancelation**

Cruise control will stop maintaining the vehicle speed in any of the following situations.

- Actual vehicle speed is below approximately 20 mph (32 km/h).
- Vehicle stability control (VSC) is activated.

**■ The system may be malfunctioning when**

In the following situations, the system may be malfunctioning. Have the vehicle inspected by your SUBARU dealer.

- The cruise control indicator light comes on in yellow.
- The cruise control indicator does not come on even when the “ON-OFF” button is pressed while the engine is running.

 **WARNING**

■ **Cruise control precaution (vehicles with an automatic transmission)**

You can cancel the cruise control by shifting the select lever into the N position. However, do not shift the lever into the N position while driving except in case of emergency. If the select lever is shifted into the N position, the engine brake will no longer work. This could result in an accident.

■ **To avoid operating the cruise control by mistake**

Switch the cruise control off using the “ON-OFF” button when not in use.

■ **Situations unsuitable for cruise control**

Do not use cruise control in any of the following situations.

Doing so may result in loss of control and could cause an accident resulting in death or serious injury.

- In heavy traffic
- On roads with sharp bends
- On winding roads
- On slippery roads, such as those covered with rain, ice or snow
- On steep hills  
Vehicle speed may exceed the set speed when driving down a steep hill.
- During emergency towing

## 2-4. Using other driving systems

### Driving assist systems

To help enhance driving safety and performance, the following systems operate automatically in response to various driving situations. Be aware, however, that these systems are supplementary and should not be relied upon too heavily when operating the vehicle.

#### ■ ABS (Anti-lock Brake System)

Helps to prevent wheel lock when the brakes are applied suddenly, or if the brakes are applied while driving on a slippery road surface

#### ■ Brake assist

Generates an increased level of braking force after the brake pedal is depressed when the system detects a panic stop situation

#### ■ Vehicle stability control (VSC)

Helps the driver to control skidding when swerving suddenly or turning on slippery road surfaces

#### ■ TRAC (Traction Control)

Helps to maintain drive power and prevent the drive wheels from spinning when starting the vehicle or accelerating on slippery roads. The TRAC system is also equipped with the brake LSD function.

#### ■ Electric power steering

Employs an electric motor to reduce the amount of effort needed to turn the steering wheel

#### When the TRAC/Vehicle stability control (VSC) systems are operating

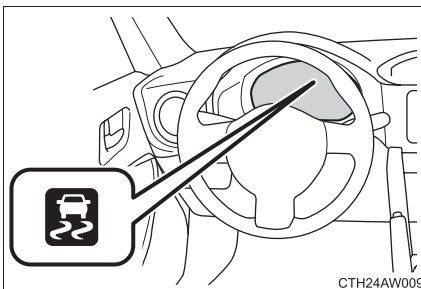

The slip indicator light will flash while the TRAC (brake LSD function)/Vehicle stability control (VSC) systems are operating.

### Disabling the TRAC system

If the vehicle gets stuck in mud, dirt or snow, the TRAC system may reduce power from the engine to the wheels. Pressing  to turn the system off may make it easier for you to rock the vehicle in order to free it.

In this case, the brake LSD function remains on.

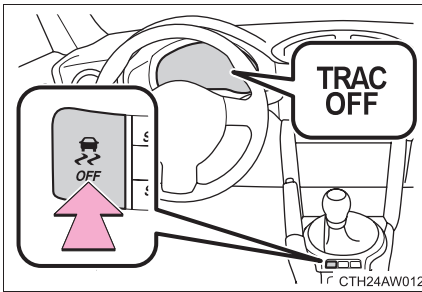

To turn the TRAC system off, quickly press and release the button.

The Traction Control System OFF indicator light will come on.

Press the button again to turn the system back on.

## Vehicle stability control (VSC) SPORT mode

Your vehicle is equipped with two types of control modes to accommodate various driving preferences. The control modes can be selected with the “VSC SPORT” switch. Normal mode allows secure and smooth normal driving. When the switch is pressed, Vehicle stability control (VSC) SPORT mode is activated. Control characteristics such as the Vehicle stability control (VSC) and TRAC are adjusted to afford maneuverability closer to what a driver may have imagined, while a sense of security is retained.

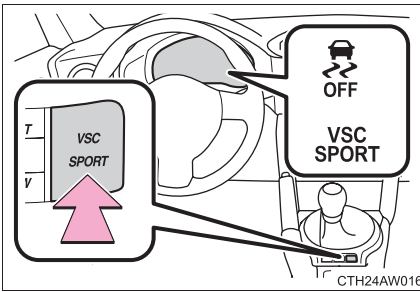

### Vehicle stability control (VSC) SPORT mode/Normal mode

The “VSC SPORT” indicator and Vehicle stability control (VSC) off indicator come on when in Vehicle stability control (VSC) SPORT mode.

2

When driving

---

■ **Turning off both TRAC and Vehicle stability control (VSC) systems**

To turn the TRAC and Vehicle stability control (VSC) systems off, press and

hold  for more than 3 seconds while the vehicle is stopped.

The Traction Control System OFF indicator light and the Vehicle stability control (VSC) off indicator light will come on.

In this case, the brake LSD function remains on.

Press the button again to turn the systems back on.

■ **Automatic reactivation of TRAC and Vehicle stability control (VSC) systems**

After turning the TRAC and Vehicle stability control (VSC) systems off, the systems will be automatically reactivated in the following situations:

- Vehicles without a keyless access with push button start system: When the engine switch is turned to “LOCK” position
- Vehicles with a keyless access with push button start system: When the push-button ignition switch is turned off
- If only the TRAC system is turned off, the TRAC will turn on when vehicle speed is more than approximately 31 mph (50 km/h).  
If both the TRAC and Vehicle stability control (VSC) systems are turned off, automatic reactivation will not occur when vehicle speed increases.

■ **Automatic deactivation of Vehicle stability control (VSC) SPORT mode**

**Vehicles without a keyless access with push button start system**

When the engine switch is turned to “LOCK” position after driving in Vehicle stability control (VSC) SPORT mode, the mode is automatically deactivated.

**Vehicles with a keyless access with push button start system**

When the push-button ignition switch is turned off after driving in Vehicle stability control (VSC) SPORT mode, the mode is automatically deactivated.

■ **Sounds and vibrations caused by the ABS, brake assist, TRAC and Vehicle stability control (VSC) systems**

- A sound may be heard from the engine compartment when the brake pedal is depressed repeatedly, when the engine is started or just after the vehicle begins to move. This sound does not indicate that a malfunction has occurred in any of these systems.

- Any of the following conditions may occur when the above systems are operating. None of these indicates that a malfunction has occurred.
  - Vibrations may be felt through the vehicle body and steering.
  - A motor sound may be heard after the vehicle comes to a stop.
  - The brake pedal may pulsate slightly after the ABS is activated.
  - The brake pedal may move down slightly after the ABS is activated.

#### ■ Electric power steering operation sound

When the steering wheel is operated, a motor sound (whirring sound) may be heard. This does not indicate a malfunction.

#### ■ Reduced effectiveness of the electric power steering system

The effectiveness of the electric power steering system is reduced to prevent the system from overheating when there is frequent steering input over an extended period of time. The steering wheel may feel heavy as a result. Should this occur, refrain from excessive steering input or stop the vehicle and turn the engine off. The electric power steering system should return to normal after a little while.

### WARNING

#### ■ The ABS does not operate effectively when

- Tires with inadequate gripping ability are used (such as excessively worn tires on a snow covered road).
- The vehicle hydroplanes while driving at high speed on wet or slick roads.

#### ■ Stopping distance when the ABS is operating may exceed that of normal conditions

The ABS is not designed to shorten the vehicle's stopping distance. Always maintain a safe distance from the vehicle in front of you in the following situations:

- When driving on dirt, gravel or snow-covered roads
- When driving with tire chains
- When driving over bumps in the road
- When driving over roads with potholes or uneven surfaces

 **WARNING**

■ **TRAC may not operate effectively when**

Directional control and power may not be achievable while driving on slippery road surfaces, even if the TRAC system is operating.

Do not drive the vehicle in conditions where stability and power may be lost.

■ **When the Vehicle stability control (VSC) and/or brake LSD function is activated**

The slip indicator light flashes. Always drive carefully. Reckless driving may cause an accident. Exercise particular care when the indicator light flashes.

■ **When the TRAC/Vehicle stability control (VSC) systems are turned off**

Be especially careful and drive at a speed appropriate to the road conditions. As these are the systems to ensure vehicle stability and driving force, do not turn the TRAC/Vehicle stability control (VSC) systems off unless necessary.

■ **Replacing tires**

Make sure that all tires are of the specified size, brand, tread pattern and total load capacity. In addition, make sure that the tires are inflated to the recommended tire inflation pressure level.

The ABS, TRAC and Vehicle stability control (VSC) systems will not function correctly if different tires are installed on the vehicle.

Contact your SUBARU dealer for further information when replacing tires or wheels.

■ **Handling of tires and suspension**

Using tires with any kind of problem or modifying the suspension will affect the driving assist systems, and may cause a system to malfunction.



## 2-5. Driving information

# Cargo and luggage

**Take notice of the following information about storage precautions, cargo capacity and load:**

- Stow cargo and luggage in the trunk whenever possible.
- Be sure all items are secured in place.
- To maintain vehicle balance while driving, position luggage evenly within the luggage compartment.
- For better fuel economy, do not carry unnecessary weight.

### Capacity and distribution

Cargo capacity depends on the total weight of the occupants.

(Cargo capacity) = (Total load capacity) - (Total weight of occupants)

#### **Steps for Determining Correct Load Limit—**

- (1) Locate the statement “The combined weight of occupants and cargo should never exceed XXX kg or XXX lbs.” on your vehicle’s placard.
- (2) Determine the combined weight of the driver and passengers that will be riding in your vehicle.
- (3) Subtract the combined weight of the driver and passengers from XXX kg or XXX lbs.
- (4) The resulting figure equals the available amount of cargo and luggage load capacity.  
For example, if the “XXX” amount equals 1400 lbs. and there will be five 150 lb passengers in your vehicle, the amount of available cargo and luggage load capacity is 650 lbs. (1400 - 750 (5 × 150) = 650 lbs.)
- (5) Determine the combined weight of luggage and cargo being loaded on the vehicle. That weight may not safely exceed the available cargo and luggage load capacity calculated in Step 4.

(6) If your vehicle will be towing a trailer, load from your trailer will be transferred to your vehicle. Consult this manual to determine how this reduces the available cargo and luggage load capacity of your vehicle.

(→P. 410)

SUBARU does not recommend towing a trailer with your vehicle. Your vehicle is not designed for trailer towing.

### Example on your vehicle

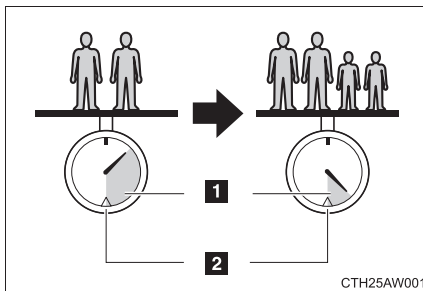

- 1 Cargo capacity
- 2 Total load capacity

When 2 people with the combined weight of 366 lb. (166 kg) are riding in your vehicle, which has a total load capacity of 699 lb. (317 kg), the available amount of cargo and luggage load capacity will be as follows:

$$699 \text{ lb.} - 366 \text{ lb.} = 333 \text{ lb.} \quad (317 \text{ kg} - 166 \text{ kg} = 151 \text{ kg})$$

In this condition, if 2 more passengers with the combined weight of 258 lb. (117 kg) get on, the available cargo and luggage load will be reduced as follows:

$$333 \text{ lb.} - 258 \text{ lb.} = 75 \text{ lb.} \quad (151 \text{ kg} - 117 \text{ kg} = 34 \text{ kg})$$

As shown in the example above, if the number of occupants increases, the cargo and luggage load will be reduced by an amount that equals the increased weight due to the additional occupants. In other words, if an increase in the number of occupants causes an excess of the total load capacity (combined weight of occupants plus cargo and luggage load), you must reduce the cargo and luggage on your vehicle.

**WARNING****■ Things that must not be carried in the trunk**

The following things may cause a fire if loaded in the trunk:

- Receptacles containing gasoline
- Aerosol cans

**■ Storage precautions**

Observe the following precautions.

Failure to do so may result in death or serious injury.

- Stow cargo and luggage in the trunk whenever possible.
- To prevent cargo and luggage from sliding forward during braking, do not stack anything in the enlarged trunk. Keep cargo and luggage low, as close to the floor as possible.
- When you fold down the rear seats, long items should not be placed directly behind the front seats.
- Never allow anyone to ride in the enlarged trunk. It is not designed for passengers. They should ride in their seats with their seatbelts properly fastened. Otherwise, they are much more likely to suffer death or serious bodily injury, in the event of sudden braking, sudden swerving or an accident.
- Do not place cargo or luggage in or on the following locations as the item may get under the clutch, brake or accelerator pedal and prevent the pedals from being depressed properly, block the driver's vision, or hit the driver or passengers, causing an accident:
  - At the feet of the driver
  - On the front passenger or rear seats (when stacking items)
  - On the rear shelf
  - On the instrument panel
  - On the dashboard
- Secure all items in the occupant compartment, as they may shift and injure someone during sudden braking, sudden swerving or an accident.

 **WARNING**

■ **Capacity and distribution**

- Do not exceed the maximum axle weight rating or the total vehicle weight rating.
- Even if the total load of occupant's weight and the cargo load is less than the total load capacity, do not apply the load unevenly. Improper loading may cause deterioration of steering or braking control which may cause death or serious injury.

## 2-5. Driving information

# Vehicle load limits

Vehicle load limits include total load capacity, seating capacity, towing capacity and cargo capacity.

### ■ Total load capacity

Total load capacity means the combined weight of occupants, cargo and luggage.

### ■ Seating capacity

Seating capacity means the maximum number of occupants whose estimated average weight is 150 lb. (68 kg) per person.

### ■ Towing capacity

SUBARU does not recommend towing a trailer with your vehicle.

### ■ Cargo capacity

Cargo capacity may increase or decrease depending on the weight and the number of occupants.

2

When driving

### ■ Total load capacity and seating capacity

These details are described on the tire and loading information label. (→P. 315)

### WARNING

#### ■ Overloading the vehicle

Do not overload the vehicle.

It may not only cause damage to the tires, but also degrade steering and braking ability, resulting in an accident.

## 2-5. Driving information

### Winter driving tips

Carry out the necessary preparations and inspections before driving the vehicle in winter. Always drive the vehicle in a manner appropriate to the prevailing weather conditions.

#### ■ Pre-winter preparations

- Use fluids that are appropriate to the prevailing outside temperatures.
  - Engine oil
  - Washer fluid
- Have a service technician inspect the condition of the battery.
- Have the vehicle fitted with four snow tires.

Make sure to install 4 tires that are of the specified size, and that all 4 tires are the same size, same maker, same brand and tread pattern.

#### ■ Before driving the vehicle

Perform the following according to the driving conditions.

- Do not try to forcibly open a window or move a wiper that is frozen. Pour warm water over the frozen area to melt the ice. Wipe away the water immediately to prevent it from freezing.
- To ensure proper operation of the climate control system fan, remove any snow that has accumulated on the air inlet vents in front of the windshield.
- Check for and remove any excess ice or snow that may have accumulated on the exterior lights, vehicle's roof, chassis, around the tires or on the brakes.
- Remove any snow or mud from the bottom of your shoes before getting in the vehicle.

- If a door is opened and closed when its side window is frozen, the window safety device will operate and the side window open/close function linked to door operation may not operate correctly. If this occurs, perform the following after the ice has melted.

**STEP 1** Open the side window until it is approximately halfway open with the door closed.

**STEP 2** Fully close the window by pulling the switch up to the one-touch closing position and continue holding the switch for 1 second or more after the window fully closes.

The window position is reset and the safety device operations will be released.

#### ■ When driving the vehicle

Accelerate the vehicle slowly, keep a safe distance between you and the vehicle ahead, and drive at a reduced speed suitable to road conditions.

#### ■ When parking the vehicle (in the winter time or in the cold latitudes)

Park the vehicle and move the select lever to P (automatic transmission) or shift lever to 1 or R (manual transmission) without setting the parking brake. The parking brake may freeze up, preventing it from being released. If necessary, block the wheels to prevent inadvertent sliding or creeping.

## **Tire chains**

Tire chains cannot be used on your vehicle because of the lack of clearance between the tires and vehicle body.

When tire chains cannot be used, use of another type of traction device (such as spring chains) may be acceptable if use on your vehicle is recommended by the device manufacturer, taking into account tire size and road conditions.

Follow the device manufacturer's instructions, especially regarding maximum vehicle speed.

To help avoid damage to your vehicle, drive slowly, readjust or remove the device if it is contacting your vehicle, and do not spin your wheels. Damage caused to your vehicle by use of a traction device is not covered under warranty.

Make certain that any traction device you use is an SAE class "S" device, and use it on the rear wheels only.

Always use the utmost care when driving with a traction device. Overconfidence because you are using a traction device could easily lead to a serious accident.



**■ Refueling in cold weather**

To help prevent moisture from forming in the fuel system and the risk of its freezing, use of an antifreeze additive in the fuel tank is recommended during cold weather.

Use only additives that are specifically designed for this purpose. When an antifreeze additive is used, its effect lasts longer if the tank is refilled whenever the fuel level reaches half empty.

**WARNING****■ Driving with snow tires**

Observe the following precautions to reduce the risk of accidents.

Failure to do so may result in a loss of vehicle control and cause death or serious injury.

- Use tires of the specified size, and that are the same size, same maker, same brand and tread pattern.
- Maintain the recommended level of air pressure.
- Use snow tires on all, not just some wheels.

## 2-5. Driving information

### Trailer towing

Your vehicle is neither designed nor intended to be used for trailer towing. Therefore, never tow a trailer with your vehicle.

SUBARU assumes no responsibility for injuries or vehicle damage that may result from trailer towing, from any trailer towing equipment or from any errors or omissions in the instructions accompanying such equipment. SUBARU warranties do not apply to vehicle damage or malfunction caused by trailer towing.

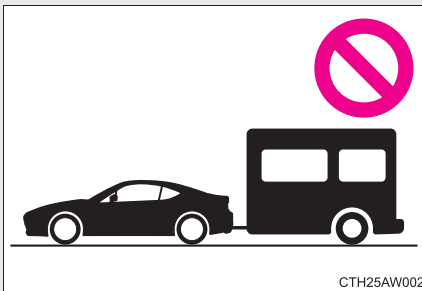

## 2-5. Driving information

### Dinghy towing

Your vehicle is not designed to be dinghy towed behind a motor home or other vehicle with the wheels (2 or 4) on the ground. Serious damage can result.

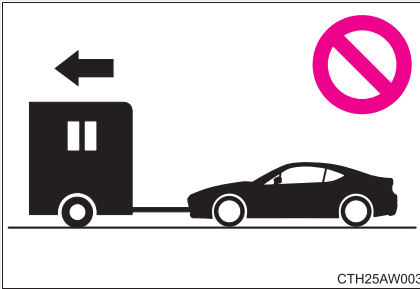



## Interior features

# 3

### 3-1. Using the air conditioning system and defogger

Manual air conditioning system .....	234
Automatic air conditioning system .....	241
Rear window and outside rear view mirror defoggers .....	250

### 3-2. Using the audio system

Using the AUX/USB port .....	252
------------------------------	-----

### 3-3. Using the interior lights

Interior lights list .....	253
• Interior light .....	254

### 3-4. Using the storage features

List of storage features ....	255
• Glove box .....	256
• Bottle holders .....	257
• Cup holders/console tray .....	258

### 3-5. Other interior features

Sun visors .....	260
Vanity mirrors .....	261
Clock .....	262
Outside temperature display .....	263
Power outlets .....	264
Seat heaters .....	266
Floor mat .....	268

### 3-1. Using the air conditioning system and defogger Manual air conditioning system\*

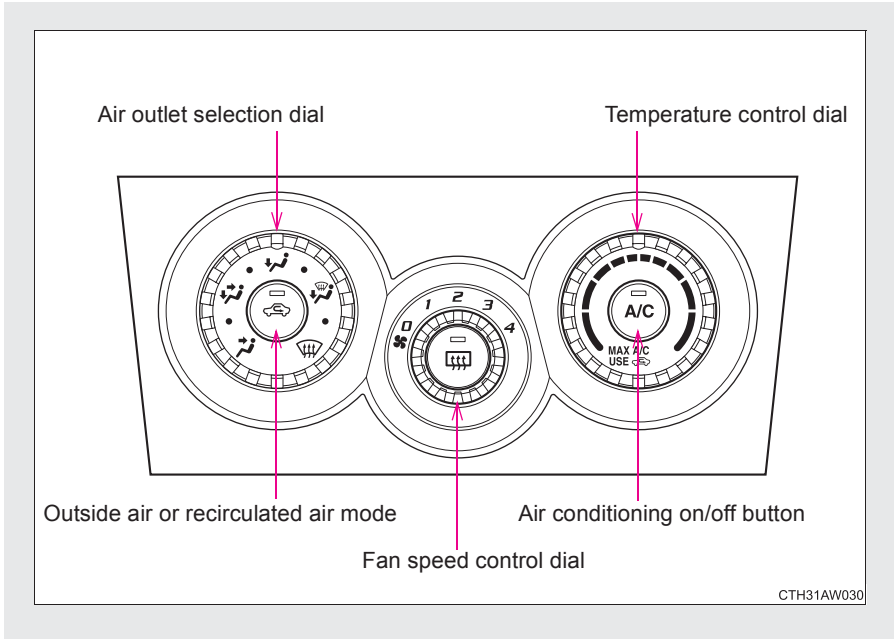

#### Adjusting the settings

**STEP 1** To adjust the fan speed, turn the fan speed control dial clockwise (increase) or counterclockwise (decrease).  
Turning the dial to "0" turns off the fan.

**STEP 2** To adjust the temperature setting, turn the temperature control dial clockwise (warm) or counterclockwise (cool).

 is not pressed, the system will blow ambient temperature air or heated air.

**STEP 3** To select the air outlets, set the air outlet selection dial to the desired position.

The positions between the air outlet selections shown below can also be selected for more delicate adjustment.

\*: If equipped

## Defogging the windshield

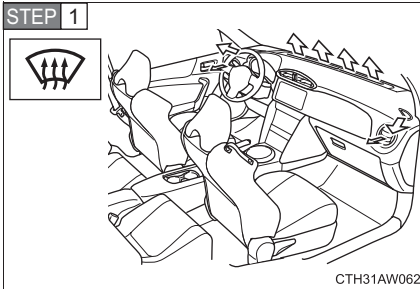

Set the air outlet selection dial to  position.

The air intake is automatically switched to outside air mode. It is not possible to return to recirculated air mode when the switch is on.

**STEP 2** Perform the following operations accordingly:

- To adjust the fan speed, turn the fan speed control dial.
- To adjust the temperature setting, turn the temperature control dial.
- If the dehumidification function is not operating, press



to operate the dehumidification function.

To defog the windshield and the side windows early, turn the air flow and temperature up.

■ Air outlets and air flow

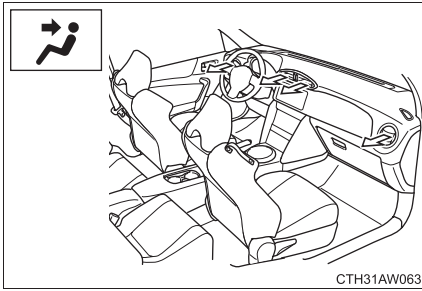

Air flows to the upper body.

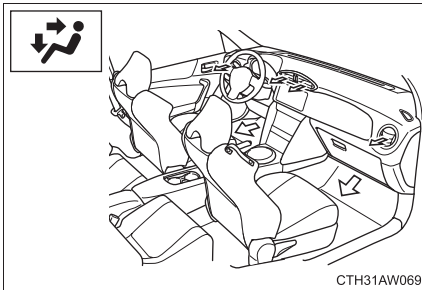

Air flows to the upper body and feet.

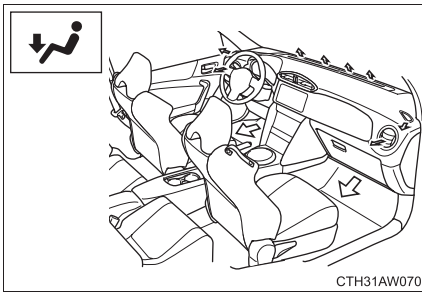

Air flows to the feet.

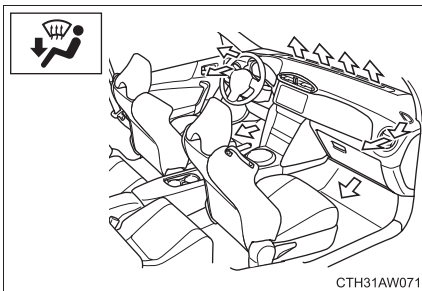

Air flows to the feet and the windshield defogger operates.

The air intake is automatically switched to outside air mode. It is not possible to return to recirculated air mode when the switch is on.



### Switching between outside air and recirculated air modes

Press  .

The mode switches between outside air mode (introduces air from outside the vehicle) (indicator off) and recirculated air mode (recycles air inside the vehicle) (indicator on) each time the button is pressed.

### Adjusting the position of the air outlets

#### Center outlets

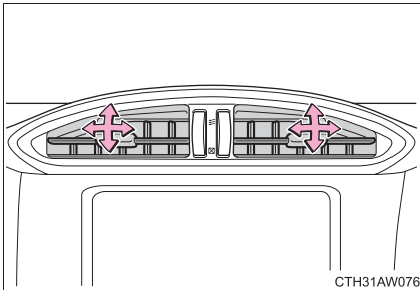

Direct air flow to the left or right, up or down.

#### Right and left side outlets

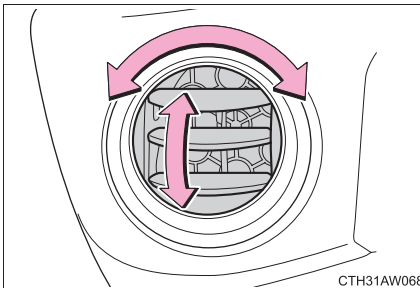

Direct air flow to the left or right, up or down.

When defrosting the side windows, face the right and left side outlets toward them.

**Opening and closing the air outlets**

**Center outlets**

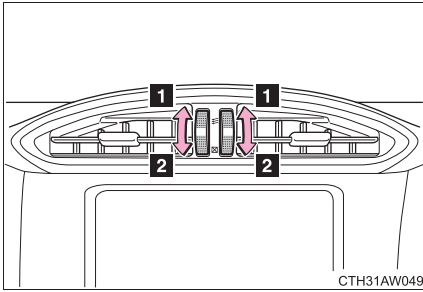

- 1** Open the air outlet.
- 2** Close the air outlet.

**Right and left side outlets**

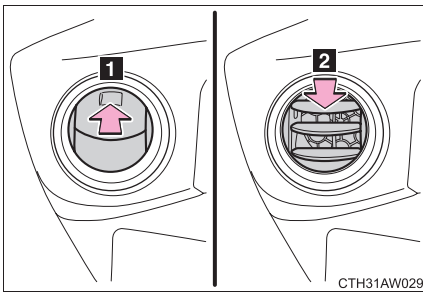

- 1** Open the vent.
- 2** Close the vent.

**■ For quick cooling**

Turn the temperature control dial to the “MAX A/C” position and select the recirculated air mode.

**■ Fogging up of the windows**

- The windows will easily fog up when the humidity in the vehicle is high.

Turning  on will dehumidify the air from the outlets and defog the windshield effectively.

- If you turn  off, the windows may fog up more easily.
- The windows may fog up if the recirculated air mode is used.

**■ Outside/recirculated air mode**

When driving on dusty roads such as tunnels or in heavy traffic, set the outside/recirculated air mode button to the recirculated air mode. This is effective in preventing outside air from entering the vehicle interior. During cooling operation, setting the recirculated air mode will also cool the vehicle interior effectively.

**■ When the outside temperature falls to nearly 32°F (0°C)**

The dehumidification function may not operate even when  is pressed.

**■ Air conditioning odors**

- During use, various odors from inside and outside the vehicle may enter into and accumulate in the air conditioning system. This may then cause odor to be emitted from the vents.
- To reduce potential odors from occurring:  
It is recommended that the air conditioning system be set to outside air mode prior to turning the vehicle off.

**■ Air conditioning filter**

→P. 322

 **WARNING**

■ **To prevent the windshield from fogging up**

Do not set the air outlet selection dial to  during cool air operation in extremely humid weather. The difference between the temperature of the outside air and that of the windshield can cause the outer surface of the windshield to fog up, blocking your vision.

 **CAUTION**

■ **To prevent battery discharge**

Do not leave the air conditioning system on longer than necessary when the engine is stopped.

### 3-1. Using the air conditioning system and defogger Automatic air conditioning system\*

Air outlets, fan speed, air inlet control and the air conditioner compressor are automatically operated.

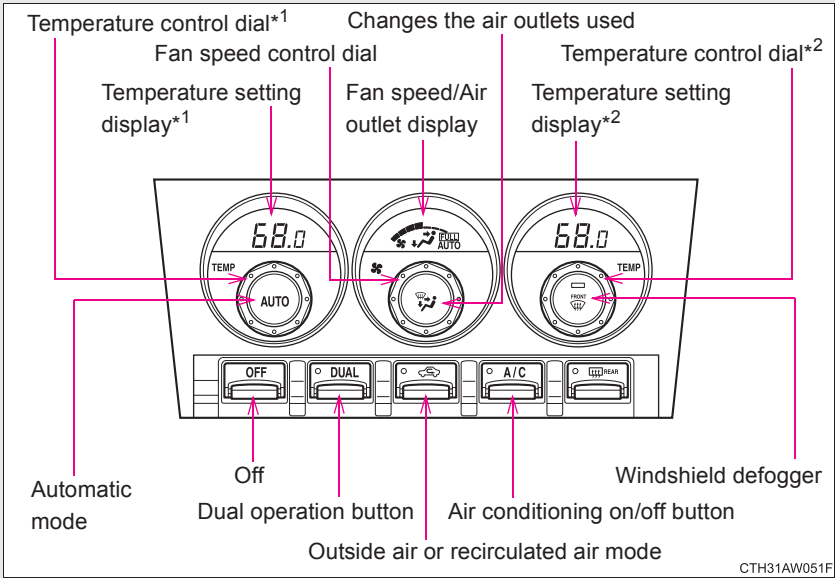

\*1: For the driver's side



\*2: For the front passenger's side

## Using the automatic air conditioning system

**STEP 1** Press  .

The dehumidification function begins to operate. Air outlets, fan speed, air inlet control and the air conditioner compressor are automatically adjusted according to the temperature setting.

**STEP 2** Turn temperature control dial clockwise to increase the temperature and turn temperature control dial counterclockwise to decrease the temperature on the driver's side.

When  is pressed (the indicator on  is on) or the passenger's side temperature control dial is turned, the temperature for the driver and passenger seats can be adjusted separately.



## Adjusting the settings manually

**STEP 1** To adjust the fan speed, turn the fan speed control dial clockwise (increase) or counter-clock wise (decrease).

Press  to turn the fan off.

**STEP 2** To adjust the temperature settings, turn the temperature control dial clockwise (warm) or counter-clock wise (cool).

To adjust the temperature control dial clockwise (warm) or counter-clockwise (cool) on the passenger side to separately adjust the temperature for the passenger and driver sides (dual mode).

Press  (the indicator on  turns off) to return the driver and passenger side temperatures to the same setting (simultaneous mode).

The air conditioning system switches between dual and simultaneous modes each time  is pressed.

**STEP 3** To change the air outlets, press .

The air outlets used are switched each time either side of the button is pressed.

## Defogging the windshield

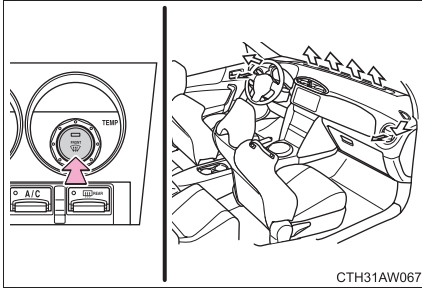

Press .

The dehumidification function operates and fan speed increases.

Set the outside/recirculated air mode button to outside air mode if the recirculated air mode is used. (It may switch automatically.)

To defog the windshield and the side windows early, turn the air flow and temperature up.

To return to the previous mode,

press  again when the windshield is defogged.



## Air outlets and air flow

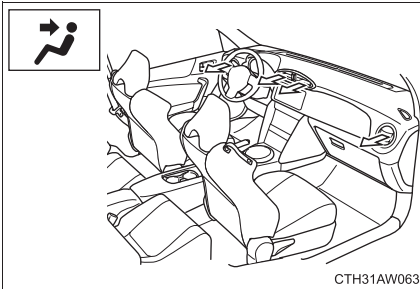

Air flows to the upper body.

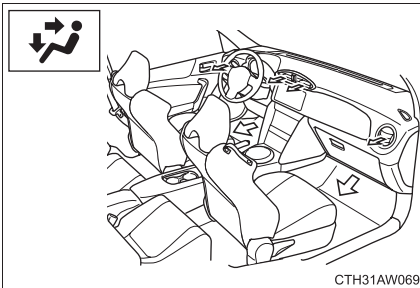

Air flows to the upper body and feet.

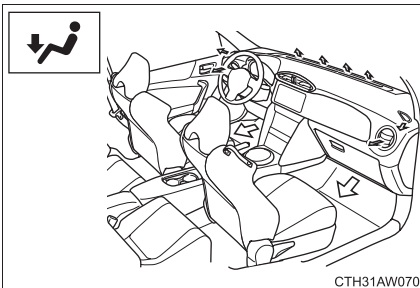

Air flows to the feet.

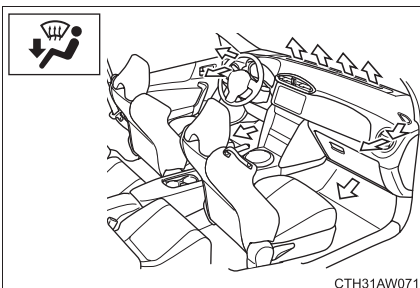

Air flows to the feet and the windshield defogger operates.

If the recirculated air mode is used, it may automatically switch to the outside air mode.

### Switching between outside air mode and recirculated air mode

Press .

The mode switches between outside air mode (indicator off) and recirculated air mode (indicator on) each time  is pressed.

### Adjusting the position of the air outlets

#### Center outlets

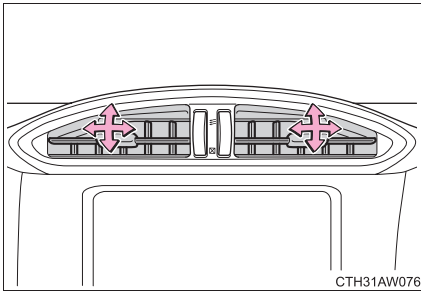

Direct air flow to the left or right, up or down.

#### Right and left side outlets

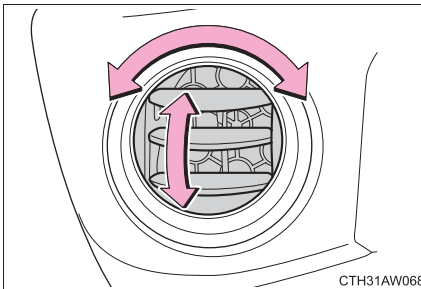

Direct air flow to the left or right, up or down.

When defrosting the side windows, face the right and left side outlets toward them.

## Opening and closing the air outlets

### Center outlets

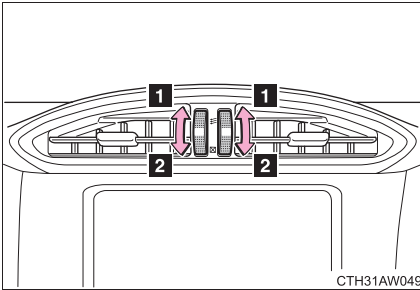

- 1 Open the air outlet.
- 2 Close the air outlet.

### Right and left side outlets

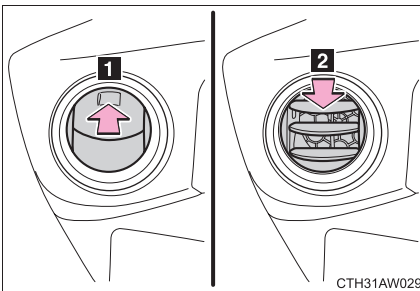

- 1 Open the vent.
- 2 Close the vent.

■ **Using automatic mode**

Fan speed is adjusted automatically according to the temperature setting and the ambient conditions.

Therefore, the fan may stop for a while until warm or cool air is ready to flow immediately after  is pressed.

■ **Fogging up of the windows**

- The windows will easily fog up when the humidity in the vehicle is high.

Turning  on will dehumidify the air from the outlets and defog the windshield effectively.

- If you turn  off, the windows may fog up more easily.
- The windows may fog up if the recirculated air mode is used.

■ **Outside/recirculated air mode**

- When driving on dusty roads such as tunnels or in heavy traffic, set the outside/recirculated air mode button to the recirculated air mode. This is effective in preventing outside air from entering the vehicle interior. During cooling operation, setting the recirculated air mode will also cool the vehicle interior effectively.
- Outside/recirculated air mode may automatically switch depending on the temperature setting or the inside temperature.

■ **When the outside temperature falls to nearly 32°F (0°C)**

The dehumidification function may not operate even when  is pressed.

### ■ Air conditioning odors

- During use, various odors from inside and outside the vehicle may enter into and accumulate in the air conditioning system. This may then cause odor to be emitted from the vents.
- To reduce potential odors from occurring:
  - It is recommended that the air conditioning system be set to outside air mode prior to turning the vehicle off.
  - The start timing of the blower may be delayed for a short period of time immediately after the air conditioning system is started in automatic mode.

### ■ Air conditioning filter

→P. 322

#### WARNING

##### ■ To prevent the windshield from fogging up

Do not use  during cool air operation in extremely humid weather. The difference between the temperature of the outside air and that of the windshield can cause the outer surface of the windshield to fog up, blocking your vision.

#### CAUTION

##### ■ To prevent battery discharge

Do not leave the air conditioning system on longer than necessary when the engine is stopped.

### 3-1. Using the air conditioning system and defogger Rear window and outside rear view mirror defoggers

The rear window defogger is used to defog the rear window. The outside rear view mirror defoggers\* are used to remove frost, dew or raindrops from the outside rear view mirrors.

#### Vehicles with a manual air conditioning system

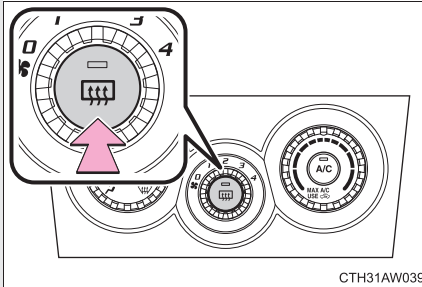

CTH31AW039

On/off

The defoggers will automatically turn off after approximately 15 minutes.

#### Vehicles with an automatic air conditioning system

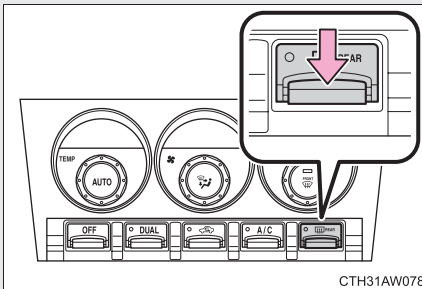

CTH31AW078

On/off

The defoggers will automatically turn off after approximately 15 minutes.

\*: Vehicles with outside rear view mirror defoggers

■ **The defoggers can be operated when**

**Vehicles without a keyless access with push button start system**

The engine switch is in the “ON” position.

**Vehicles with a keyless access with push button start system**

The push-button ignition switch is in “ON” mode.

■ **The outside rear view mirror defoggers (vehicles with outside rear view mirror defoggers)**

Turning the rear window defogger on will turn the outside rear view mirror defoggers on.

■ **When continuous operation is set (vehicles with an automatic air conditioning system)**

During continuous operation, the defogger stops operating for 2 minutes after every 15 minutes of continual operation. Even during the 2 minutes that operation stops, the operating light remains illuminated. The rear window defogger will continue to operate in this cycle until it is turned off.

■ **Customization that can be configured at SUBARU dealer (vehicles with an automatic air conditioning system)**

The rear window defogger can be set to 15-minute operation or continuous operation. (Customizable features →P. 439)

 **WARNING**

■ **When the outside rear view mirror defoggers are on (vehicles with outside rear view mirror defoggers)**

Do not touch the outside surface of the rear view mirrors, as they can become very hot and burn you.

 **CAUTION**

■ **To prevent battery discharge**

Do not leave the rear window defogger on longer than necessary when the engine is stopped.

## 3-2. Using the audio system

### Using the AUX/USB port\*

This port can be used to connect a portable audio device and listen to it through the vehicle's speakers.

For more information, please refer to the "Navigation System Owner's Manual".

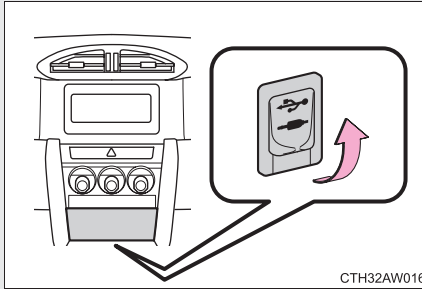

Open the cover and connect the portable audio device.

#### ■ Operating portable audio devices connected to the audio system

The volume and sound quality can be adjusted using the vehicle's audio controls. All other adjustments must be made on the portable audio device itself.

#### ■ When using a portable audio device connected to the power outlet

Noise may occur during playback. Use the battery power source of the portable audio device to reduce noise.

\*: If equipped



### 3-3. Using the interior lights

## Interior lights list

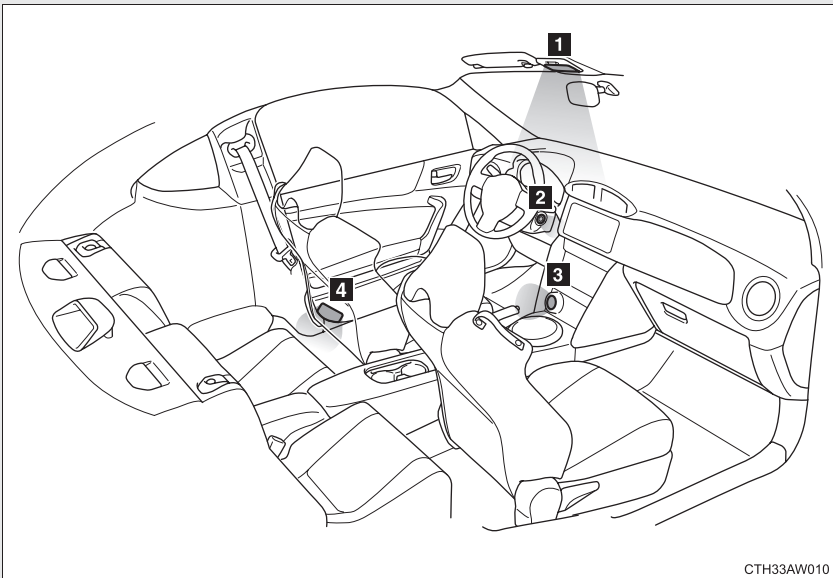

- 1** Interior light (→P. 254)
- 2** Engine switch light (vehicles without a keyless access with push button start system)
- 3** Push-button ignition switch light (vehicles with a keyless access with push button start system)
- 4** Door courtesy lights (if equipped)

## Interior light

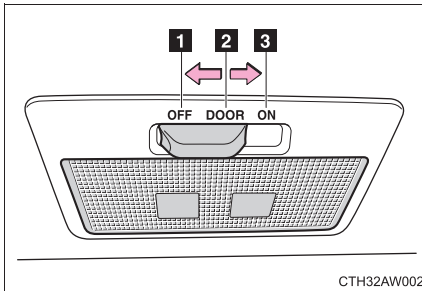

- 1** Turns the light off
- 2** Turns light on when door is open
- 3** Turns the light on

### ■ Illuminated entry system

#### **Vehicles without a keyless access with push button start system**

The lights automatically turn on/off according to the engine switch position, whether the doors are locked/unlocked, and whether the doors are open/closed.

#### **Vehicles with a keyless access with push button start system**

The lights automatically turn on/off according to push-button ignition switch mode, the presence of the access key, whether the doors are locked/unlocked, and whether the doors are open/closed.

### ■ To prevent battery discharge

If the following lights remain on when the door is not fully closed, the lights will go off automatically after 20 minutes:

- Interior light (when the switch is in the “DOOR” position)
- Engine switch light (vehicles without a keyless access with push button start system)
- Push-button ignition switch light (vehicles with a keyless access with push button start system)
- Door courtesy lights (if equipped)

### ■ Customization that can be configured at your SUBARU dealer

Settings (e.g. the time elapsed before lights turn off) can be changed. (Customizable features →P. 439)

### 3-4. Using the storage features

## List of storage features

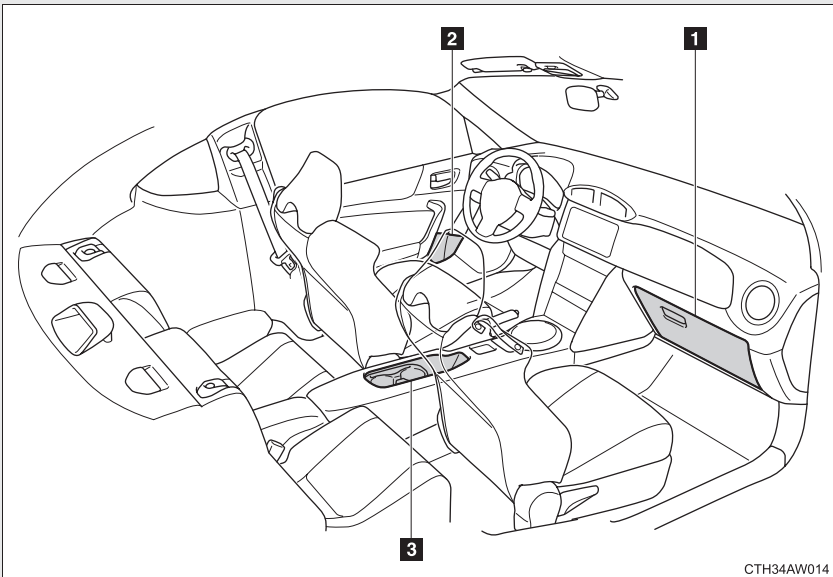

CTH34AW014

- 1** Glove box
- 2** Bottle holders
- 3** Cup holders/console tray

3

Interior features

#### **! WARNING**

##### **■ Items that should not be left in the storage spaces**

Do not leave glasses, lighters or spray cans in the storage spaces, as this may cause the following when cabin temperature becomes high:

- Glasses may be deformed by heat or cracked if they come into contact with other stored items.
- Lighters or spray cans may explode. If they come into contact with other stored items, the lighter may catch fire or the spray can may release gas, causing a fire hazard.

## Glove box

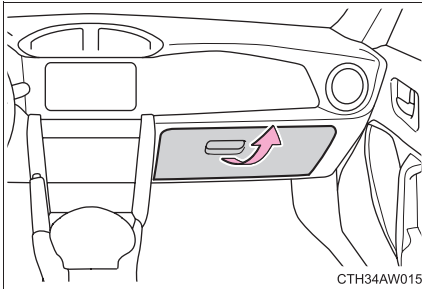

Pull up the lever to open the glove box.

### WARNING

#### ■ Caution while driving

Keep the glove box closed. In the event of sudden braking or sudden swerving, an accident may occur due to an occupant being struck by the open glove box or the items stored inside.

## Bottle holders

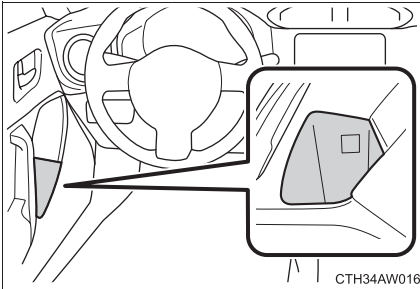

### ■ When using the bottle holder

- When storing a bottle, close the cap.
- The bottle may not be stored depending on its size or shape.

### ⚠ WARNING

#### ■ Items unsuitable for the bottle holder

Do not place anything other than a PET bottle in the bottle holders. Other items may be thrown out of the holders in the event of an accident or sudden braking and cause injury.

### ⚠ CAUTION

#### ■ Items unsuitable for the bottle holder

Put the cap on before stowing a bottle. Do not place open bottles in the bottle holders, or glasses and paper cups containing liquid. The contents may spill and glasses may break.

**Cup holders/console tray**

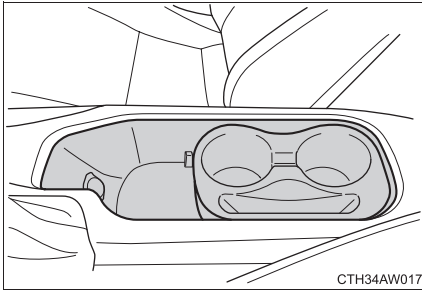

**■ Changing the cup holder position**

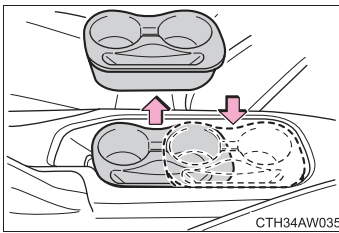

Remove the cup holder and change the holder position.

**■ Changing the console tray size**

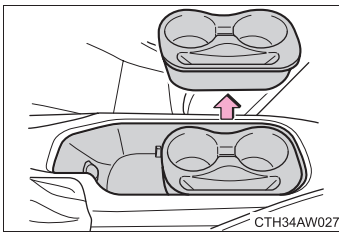

Remove the cup holder.

**! WARNING****■ Caution while driving**

Observe the following precautions.

Failure to do so may cause an accident resulting in death or serious injury.

- Before driving, place the cup holder in the rear position so that it does not hinder select lever or shift lever operation.

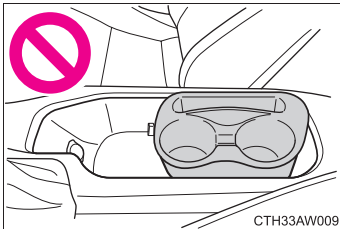

- When placing the cup holder, make sure it is facing the correct direction. Failure to do so will cause the cup holder to not be secure in the console tray and hinder select lever or shift lever operation.

**■ Items unsuitable for the cup holder**

Do not place anything other than cups or aluminum cans in the cup holders. Other items may be thrown out of the holders in the event of an accident or sudden braking, causing injury. If possible, cover hot drinks to prevent burns.

### 3-5. Other interior features

## Sun visors

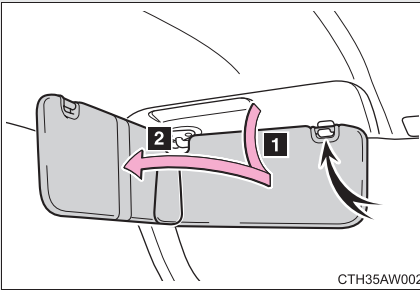

- 1** To set the visor in the forward position, flip it down.
- 2** To set the visor in the side position, flip down, unhook, and swing it to the side.



### 3-5. Other interior features

## Vanity mirrors

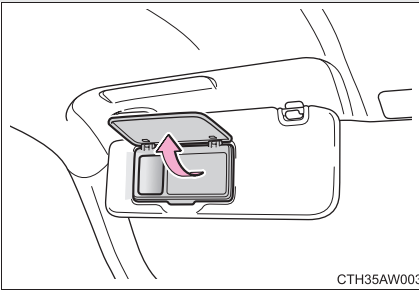

Open the cover to use.

Vehicles with vanity lights: The light turns on when the cover is opened.

 CAUTION

■ **To prevent battery discharge (vehicles with vanity lights)**

Do not leave the vanity lights on for extended periods while the engine is off.

### 3-5. Other interior features

## Clock

The clock can be adjusted by pressing the buttons.

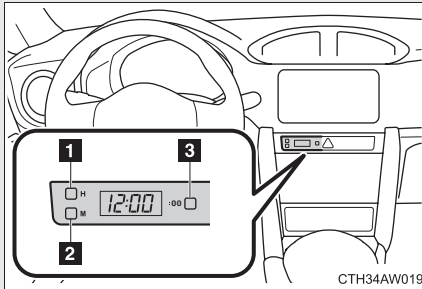

- 1** Adjusts the hours
- 2** Adjusts the minutes
- 3** Rounds to the nearest hour\*

\*: e.g. 1:00 to 1:29 → 1:00  
1:30 to 1:59 → 2:00

#### ■ The clock is displayed when

##### **Vehicles without a keyless access with push button start system**

The engine switch is in the “ACC” or “ON” position.

##### **Vehicles with a keyless access with push button start system**

The push-button ignition switch is in “ACC” or “ON” mode.

#### ■ When disconnecting and reconnecting battery terminals

The clock data will be reset.

### 3-5. Other interior features

## Outside temperature display

The temperature display shows temperatures within the range of -40°F (-40°C) and 122°F (50°C).

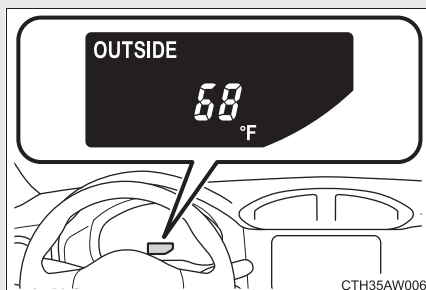

The outside temperature display can be switched by pressing the “DISP” switch. (→P. 196)

#### ■ The outside temperature is displayed when

##### **Vehicles without a keyless access with push button start system**

The engine switch is in the “ON” position.

##### **Vehicles with a keyless access with push button start system**

The push-button ignition switch is in “ON” mode.

#### ■ Display

In the following situations, the correct outside temperature may not be displayed, or the display may take longer than normal to change:

- When the vehicle is stopped, or moving at low speeds (less than 12 mph [20 km/h])
- When the outside temperature has changed suddenly (at the entrance/exit of a garage, tunnel, etc.)

#### ■ When “- .-” is displayed more than 1 minute or the outside temperature is not displayed

The system may be malfunctioning. Take your vehicle to your SUBARU dealer.

### 3-5. Other interior features

## Power outlets

The power outlet can be used for 12 V accessories that run on 10 A or less.

#### In the console tray

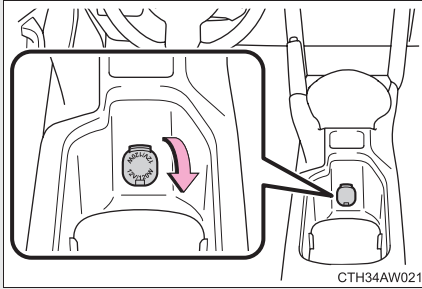

#### In the glove box

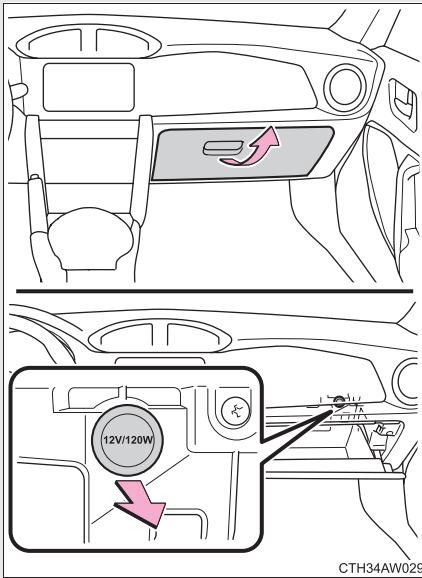

**■ The power outlet can be used when****Vehicles without a keyless access with push button start system**

The engine switch is in the “ACC” or “ON” position.

**Vehicles with a keyless access with push button start system**

The push-button ignition switch is in “ACC” or “ON” mode.

 **CAUTION****■ To avoid damaging the power outlet**

Close the power outlet lid when the power outlet is not in use.

Foreign objects or liquids that enter the power outlet may cause a short circuit.

**■ To prevent the fuse from being blown**

Do not use an accessory that uses more than 12 V 10 A.

**■ To prevent battery discharge**

Do not use the power outlet longer than necessary when the engine is not running.

### 3-5. Other interior features

## Seat heaters\*

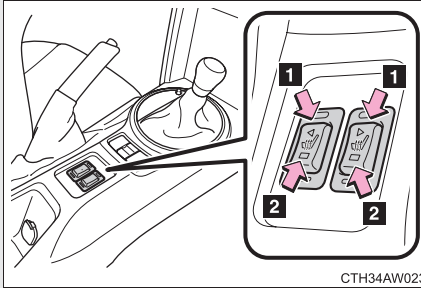

Press the switch to warm the seats.

The indicator light comes on when a seat heater is turned on.

- 1** Rapid heating
- 2** Normal heating

---

#### ■ The seat heaters can be used when

The push-button ignition switch is in “ON” mode.

#### ■ When not in use

Turn the seat heater off. The indicator light goes off.

\*: If equipped

**WARNING****■ Burns**

- Use caution when seating the following persons in a seat with the seat heater on to avoid the possibility of burns:
  - Babies, small children, the elderly, the sick and the physically challenged
  - Persons with sensitive skin
  - Persons who are fatigued
  - Persons who have taken alcohol or drugs that induce sleep (sleeping drugs, cold remedies, etc.)
- Do not cover the seat with anything when using the seat heater. Using the seat heater with a blanket or cushion increases the temperature of the seat and may lead to overheating.
- Do not use the seat heater more than necessary. Doing so may cause minor burns or overheating.

**CAUTION****■ To prevent seat heater damage**

Do not put heavy objects that have an uneven surface on the seat and do not stick sharp objects (needles, nails, etc.) into the seat.

**■ To prevent battery discharge**

Turn the seat heaters off when the engine is not running.

### 3-5. Other interior features

## Floor mat\*

Make sure to only use floor mats that are specifically designed for use with the same model and model year as your vehicle. Fix them securely in place on top of the carpet.

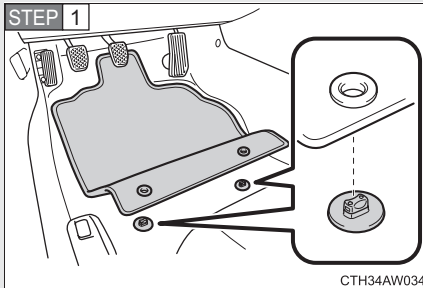

Insert the retaining hooks (clips) into the floor mat eyelets.

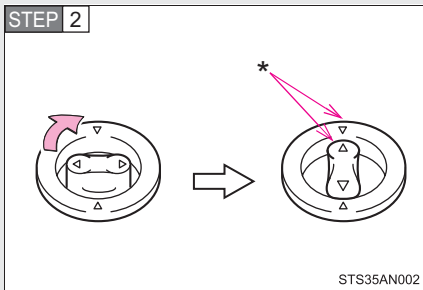

Turn the upper knob of each retaining hook (clip) to secure the floor mats in place.

\*: Always align the  $\Delta$  marks.

The shape of the retaining hooks (clips) may differ from that shown in the illustration. For details on the fixing procedure, refer to the instructions supplied with the floor mat.

\*: If equipped



**⚠ WARNING**

Observe the following precautions.

Failure to do so may cause the driver's floor mat to slip, possibly interfering with the pedals while driving. An unexpectedly high speed may result or it may become difficult to stop the vehicle, leading to a serious accident.

**■ When installing the driver's floor mat**

- Do not use floor mats designed for other models or different model year vehicles, even if they are SUBARU Genuine floor mats.
- Only use floor mats designed for the driver's seat.
- Always install the floor mat securely using the retaining hooks (clips) provided.
- Do not use two or more floor mats on top of each other.
- Do not place the floor mat bottom-side up or upside-down.

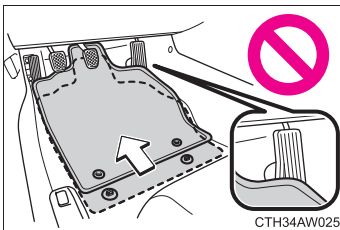
**■ Before driving**

- Check that the floor mat is securely fixed in the correct place with all the provided retaining hooks (clips). Be especially careful to perform this check after cleaning the floor.
- With the engine stopped and the select lever in P (automatic transmission) or shift lever in neutral (manual transmission), fully depress each pedal to the floor to make sure it does not interfere with the floor mat.



## Maintenance and care

# 4

### 4-1. Maintenance and care

- Cleaning and protecting the vehicle exterior..... 272
- Cleaning and protecting the vehicle interior..... 276
- Cleaning and protecting the Alcantara® area ..... 280

### 4-2. Maintenance

- Maintenance requirements..... 282
- General maintenance..... 285
- Emission inspection and maintenance (I/M) programs..... 288

### 4-3. Do-it-yourself maintenance

- Do-it-yourself service precautions ..... 289
- Engine hood..... 292
- Engine compartment..... 294
- Tires ..... 308
- Tire inflation pressure ..... 315
- Wheels ..... 319
- Air conditioning filter..... 322
- Transmitter/access key battery ..... 325
- Checking and replacing fuses ..... 329
- Light bulbs..... 337

## 4-1. Maintenance and care

### Cleaning and protecting the vehicle exterior

Perform the following to protect the vehicle and maintain it in prime condition.

- Working from top to bottom, liberally apply water to the vehicle body, wheel wells and underside of the vehicle to remove any dirt and dust.
- Wash the vehicle body using a sponge or soft cloth, such as a chamois.
- For hard-to-remove marks, use car wash soap and rinse thoroughly with water.
- Wipe away any water.
- Wax the vehicle when the waterproof coating deteriorates.

If water does not bead on a clean surface, apply wax when the vehicle body is cool.

#### Handling the antenna

Before washing the vehicle, the antenna can be removed.

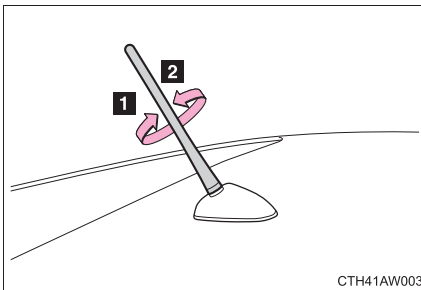

**1** Removal

**2** Installation

---

**■ Automatic car washes**

- Fold the mirrors and remove the antenna before washing the vehicle. Start washing from the front of the vehicle. Make sure to re-install the antenna and extend the mirrors before driving.
- When having your vehicle washed in an automatic car wash, make sure beforehand that the car wash is of suitable type to avoid scratches to the vehicle surface and harm to your vehicle's paint.
- Vehicles with a rear spoiler: In certain automatic car washes, the rear spoiler may interfere with machine operation. This may prevent the vehicle from being cleaned properly or result in damage to the rear spoiler.

**■ High pressure car washes**

- Do not allow the nozzles of the car wash to come within close proximity of the windows and door frames as water may enter the cabin.
- Before car wash, check that the fuel filler lid on your vehicle is closed properly.

**■ Aluminum wheels (if equipped)**

- Remove any dirt immediately by using a neutral detergent. Do not use hard brushes or abrasive cleaners. Do not use strong or harsh chemical cleaners. Use the same mild detergent and wax as used on the paint.
- Do not use detergent on the wheels when they are hot, for example after driving for long distance in the hot weather.
- Wash detergent from the wheels immediately after use.

**■ Parts containing resin such as the bumper**

Do not scrub with abrasive cleaners.

 **WARNING**

■ **When washing the vehicle**

- Do not wash the engine compartment and area adjacent to it. If water enters the engine air intake or electrical parts it will cause engine trouble or a malfunction of the power steering.
- When washing the vehicle, the brakes may get wet. As a result, the brake stopping distance will be longer. To dry the brakes, drive the vehicle at a safe speed while lightly depressing the brake pedal to heat up the brakes.

■ **Precautions regarding the exhaust pipes**

Exhaust gasses cause the exhaust pipes and rear bumper diffusers to become quite hot.

When washing the vehicle, be careful not to touch the pipes and diffusers until they have cooled sufficiently, as touching hot exhaust pipes and rear bumper diffusers can cause burns.

 **CAUTION**

■ **To prevent paint deterioration and corrosion on the body and components (aluminum wheels etc.)**

- Wash the vehicle immediately in the following cases:
  - After driving near the sea coast
  - After driving on salted roads
  - If you see coal tar or tree sap on the paint surface
  - If you see dead insects, insect droppings or bird droppings on the paint
  - After driving in an area contaminated with soot, oily smoke, mine dust, iron powder or chemical substances
  - If the vehicle becomes heavily soiled in dust or mud
  - If liquids such as benzene and gasoline are spilled on the paint surface
- If the paint is chipped or scratched, have it repaired immediately.
- To prevent the wheels from corroding, remove any dirt and store in a place with low humidity when storing the wheels.

■ **Protective film for side sill plates**

Make sure to remove the protective film. Failure to do so may cause rust, depending on conditions.

 CAUTION**■ Cleaning the exterior lights**

- Wash carefully. Do not use organic substances or scrub with a hard brush. This may damage the surfaces of the lights.
- Do not apply wax on the surfaces of the lights. Wax may cause damage to the lenses.

**■ Antenna installation and removal precautions**

- Before driving, ensure that the antenna is installed.
- When the antenna is removed, such as before entering an automatic car wash, make sure to store it in a suitable place so as not to lose it. Also, before driving, make sure to reinstall the antenna in its original position.

**■ To prevent damage to the windshield wiper arms**

When lifting the wiper arms away from the windshield, pull the driver side wiper arm upward first, and repeat for the passenger side. When returning the wipers to their original position, do so from the passenger side first.

**■ To prevent damage to the antenna**

Remove the antenna in the following situations:

- When the antenna will touch the ceiling of a garage or other such places
- When a car cover is to be used to cover the vehicle
- When using an automatic car wash

# Cleaning and protecting the vehicle interior

The following procedures will help protect your vehicle's interior and keep it in top condition:

### ■ Protecting the vehicle interior

- Remove dirt and dust using a vacuum cleaner. Wipe dirty surfaces with a cloth dampened with lukewarm water.
- When the interior is extremely dirty, wipe away the dirt using a soft cloth slightly dampened with diluted neutral detergent.

### ■ Cleaning the leather areas

- Remove dirt and dust using a vacuum cleaner.
- Wipe any excess dirt and dust with a soft cloth dampened with diluted detergent.

Use a diluted water solution of approximately 5% neutral wool detergent.

- Wring out any excess water from the cloth and thoroughly wipe off all remaining traces of detergent.
- Wipe the surface with a dry, soft cloth to remove any remaining moisture. Allow the leather to dry in a shaded ventilated area.

### ■ Synthetic leather areas

- Remove loose dirt using a vacuum cleaner.
- Apply a mild soap solution to the synthetic leather.
- Allow the solution to soak in for a few minutes. Remove the dirt and wipe off the solution with a clean, damp cloth.



### ■ Caring for leather areas

SUBARU recommends cleaning the interior of the vehicle at least twice a year to maintain the quality of the vehicle's interior.

### ■ Shampooing the carpets

There are several commercial foaming-type cleaners available. Use a sponge or brush to apply the foam. Rub in overlapping circles. Do not apply water. Excellent results are obtained by keeping the carpet as dry as possible.

### ■ Seatbelts

Clean with mild soap and lukewarm water using a cloth or sponge. Also check the belts periodically for excessive wear, fraying or cuts.

## WARNING

### ■ Water in the vehicle

- Do not splash or spill liquid in the vehicle.  
Doing so may cause electrical components etc. to malfunction or catch fire.

- Do not get any of the SRS components or wiring in the vehicle interior wet. (→P. 92)

Electrical malfunction may cause the airbags to deploy or not function properly, resulting in death or severe injury.

### ■ Cleaning the interior (especially instrument panel)

Do not use polish wax or polish cleaner. The instrument panel may reflect off the windshield, obstructing the driver's view and leading to an accident, resulting in death or serious injury.

 CAUTION

■ **Cleaning detergents**

- Do not use organic substances such as benzene or gasoline, acidic or alkaline solutions, dye, bleach or other detergent. Doing so may discolor the vehicle interior or cause streaks or damage to painted surfaces.
- Do not use polish wax or polish cleaner. The instrument panel's or other interior part's painted surface may be damaged.
- Do not use a chemical agent containing silicone (highly-polymerized silicon compound) when cleaning any of the electrical appliances such as the air conditioning, all switches and their surrounding areas.  
If silicon (highly-polymerized silicon compound) contacts these components, it may cause the electrical appliances to malfunction.

■ **Preventing damage to leather surfaces**

Observe the following precautions to avoid damage to and deterioration of leather surfaces.

- Remove any dust, dirt, sand, oil spots etc. on leather surfaces immediately.
- Do not expose the vehicle to direct sunlight for extended periods of time. Park the vehicle in the shade, especially during summer.
- Do not place items made of vinyl, plastic, or that contain wax on the upholstery, as they may stick to the leather surface if the vehicle interior heats up significantly.

■ **Water on the floor**

Do not wash the vehicle floor with water.

Vehicle systems such as the audio system may be damaged if water comes into contact with electrical components under the floor of the vehicle, and may also cause the body to rust.

 CAUTION**■ Cleaning the inside of the rear window**

- Be careful not to scratch or damage the heater wires.
- Do not use glass cleaner to clean the rear window, as this may cause damage to the rear window defogger heater wires. Use a cloth dampened with lukewarm water to gently wipe the window clean. Wipe the window in strokes running parallel to the heater wires.

**■ When cleaning the instrument panel**

When small grains of sand and so forth have gotten into instrument panel's surface and cannot be wiped away using a cloth, use a clay bar without adding water. Forcibly trying to wipe the surface clean with a brush or sponge may scratch the surface or fragments of the cloth may be left in the surface.

## 4-1. Maintenance and care

# Cleaning and protecting the Alcantara® area\*

The following procedures will protect and keep your vehicle's Alcantara® upholstery in top condition:

### ■ Day-to-day cleaning

Perform the following procedures regularly (approximately once a month).

**STEP 1** Wipe the entire Alcantara® area with a soft cloth that has been dampened with lukewarm water (approximately 104°F [40°C]) and squeezed out.

Do not wipe too hard. Doing so may make the Alcantara® upholstery surface become uneven. Also, only use a clean cloth.

**STEP 2** Once dry, brush the area with a soft brush.

### ■ Liquid stains

- If liquid is spilled, lightly pat the area with a tissue paper or similar to soak up the liquid.
- When mud, coffee, etc., has dried on the Alcantara® upholstery, remove it by lightly brushing the area with a soft brush or similar.

We recommend using a vacuum cleaner to clean up the area after the above has been performed.

When a stain cannot be removed using the above procedures, remove it by performing the following:

**STEP 1** Lightly wipe the stained area from the outside to the inside from multiple angles with a soft cloth that has been dampened with lukewarm water (approximately 104°F [40°C]) and squeezed out.

Do not wipe the area so strongly that it causes the Alcantara® upholstery surface to become uneven. Also, prepare a clean cloth, and always use a clean area of the cloth.

\*: If equipped

**STEP 2** If the Alcantara® upholstery surface becomes uneven, lightly brush it with a soft brush.

**STEP 3** Allow the surface to dry completely.

#### ■ Oil stains

You will need the following items:

- A cloth that has been dampened with benzene
- A dry cloth

**STEP 1** Using a dry cloth or tissue paper, wipe away as much of the oil as possible to prevent the stained area from expanding.

**STEP 2** After patting the area from the outside to the inside from multiple angles using the cloth dampened with benzene, soak up the oil and benzene that floats up by patting the area with a dry cloth.

**STEP 3** If the Alcantara® upholstery surface becomes uneven, lightly brush it with a soft brush.

#### ■ When removing dirt or dust from the Alcantara® areas

Remove dirt or dust from the Alcantara® areas by lightly brushing with a soft brush. If this does not remove the dirt or dust, remove it using adhesive tape.

#### CAUTION

#### ■ When soaking up spilled liquids

Do not press down too firmly with the cloth, tissue paper etc., as doing so may cause the liquid to further penetrate the material, making soaking up the liquid more difficult.

## 4-2. Maintenance

# Maintenance requirements

To ensure safe and economical driving, day-to-day care and regular maintenance is essential. It is the owner's responsibility to perform regular checks. SUBARU recommends the following maintenance.

### ■ General maintenance

Should be performed on a daily basis. This can be done by yourself or by a SUBARU dealer.

### ■ Scheduled maintenance

Should be performed at specified intervals according to the maintenance schedule.

For details about maintenance items and schedules, refer to the "Warranty and Maintenance Booklet".

### ■ Do-it-yourself maintenance

You can perform some maintenance procedures yourself. Please be aware that do-it-yourself maintenance may affect warranty coverage.

The use of SUBARU Service Manuals is recommended.

For details about warranty coverage, see the separate "Warranty and Maintenance Booklet".

---

### ■ Repair and replacement

It is recommended that genuine SUBARU parts be used for repair to ensure performance of each system. If non-SUBARU parts are used in replacement or if a repair shop other than a SUBARU dealer performs repairs, warranty coverage may be affected.

**■ Allow inspection and repairs to be performed by a SUBARU dealer**

- SUBARU technicians are well-trained specialists and are kept up to date with the latest service information. They are well informed about the operations of all systems on your vehicle.
- Keep a copy of the repair order. It proves that the maintenance that has been performed is under warranty coverage. If any problem should arise while your vehicle is under warranty, your SUBARU dealer will promptly take care of it.

 **WARNING**

■ **If your vehicle is not properly maintained**

It could result in serious damage to the vehicle and possible serious injury or death.

■ **Warning in handling of battery**

- Before beginning work on or near any battery, be sure to extinguish all cigarettes, matches, and lighters. Never expose a battery to an open flame or electric sparks. Batteries give off a gas which is highly flammable and explosive.
- For safety, in case an explosion does occur, wear eye protection or shield your eyes when working near any battery. Never lean over a battery.
- Do not let battery fluid contact eyes, skin, fabrics, or paint because battery fluid is a corrosive acid. If battery fluid gets on your skin or in your eyes, immediately flush the area with water thoroughly. Seek medical help immediately if acid has entered the eyes.  
If battery fluid is accidentally swallowed, immediately drink a large amount of milk or water, and seek medical attention immediately.
- To lessen the risk of sparks, remove rings, metal watchbands, and other metal jewelry. Never allow metal tools to contact the positive battery terminal and anything connected to it WHILE you are at the same time in contact with any other metallic portion of the vehicle because a short circuit will result.
- Keep everyone including children away from the battery.
- Charge the battery in a wellventilated area.
- Battery posts, terminals and related accessories contain lead and lead compounds, chemicals known to the State of California to cause cancer and reproductive harm. Batteries also contain other chemicals known to the State of California to cause cancer. Wash hands after handling.



## 4-2. Maintenance

### General maintenance

Listed below are the general maintenance items that should be performed at the intervals specified in the “Warranty and Maintenance Booklet”. It is recommended that any problem you notice should be brought to the attention of your SUBARU dealer or qualified service shop for advice.

#### Engine compartment

Items	Check points
Battery	Check the connections. (→P. 302)
Brake fluid	At the correct level? (→P. 300)
Engine coolant	At the correct level? (→P. 298)
Engine oil	At the correct level? (→P. 295)
Exhaust system	No fumes or strange sounds?
Radiator/condenser/hoses	Not blocked with foreign matter? (→P. 300)
Washer fluid	At the correct level? (→P. 306)

**Vehicle interior**

Items	Check points
Accelerator pedal	<ul style="list-style-type: none"> <li>• Moves smoothly (without uneven pedal effort or catching)?</li> </ul>
Automatic transmission “Park” mechanism	<ul style="list-style-type: none"> <li>• Can the vehicle be held securely on an incline with the select lever in P?</li> </ul>
Brake pedal	<ul style="list-style-type: none"> <li>• Moves smoothly?</li> <li>• Does it have appropriate clearance and correct amount of free play?</li> </ul>
Brakes	<ul style="list-style-type: none"> <li>• Not pull to one side when applied?</li> <li>• Loss of brake effectiveness?</li> <li>• Spongy feeling brake pedal?</li> <li>• Pedal almost touches floor?</li> </ul>
Clutch pedal	<ul style="list-style-type: none"> <li>• Moves smoothly?</li> </ul>
Head restraints	<ul style="list-style-type: none"> <li>• Move smoothly and lock securely?</li> </ul>
Indicators/buzzers	<ul style="list-style-type: none"> <li>• Function properly?</li> </ul>
Lights	<ul style="list-style-type: none"> <li>• Do all the lights come on?</li> </ul>
Parking brake	<ul style="list-style-type: none"> <li>• Moves smoothly?</li> <li>• Can hold the vehicle securely on an incline?</li> </ul>
Seatbelts	<ul style="list-style-type: none"> <li>• Does the seatbelt system operate smoothly?</li> <li>• Are the belts undamaged?</li> </ul>
Seats	<ul style="list-style-type: none"> <li>• Do the seat controls operate properly?</li> </ul>
Steering wheel	<ul style="list-style-type: none"> <li>• Moves smoothly?</li> <li>• Has correct free play?</li> <li>• No strange noises?</li> </ul>

## Vehicle exterior

Items	Check points
Door/trunk lid	<ul style="list-style-type: none"> <li>• Operate smoothly?</li> </ul>
Engine hood	<ul style="list-style-type: none"> <li>• The lock system works properly?</li> </ul>
Fluid leaks	<ul style="list-style-type: none"> <li>• Is there any leakage after parking?</li> </ul>
Tire	<ul style="list-style-type: none"> <li>• Inflation pressure is correct?</li> <li>• Tire surfaces not worn or damaged?</li> <li>• Tires rotated according to the maintenance schedule?</li> <li>• Wheel nuts are not loose?</li> </ul>



### WARNING

#### ■ If the engine is running

Turn the engine off and ensure that there is adequate ventilation before performing maintenance checks.

## 4-2. Maintenance

### Emission inspection and maintenance (I/M) programs

Some states have vehicle emission inspection programs which include OBD (On Board Diagnostics) checks. The OBD system monitors the operation of the emission control system.

#### ■ If the malfunction indicator lamp comes on

The OBD system determines that a problem exists somewhere in the emission control system. Your vehicle may not pass the I/M test and may need to be repaired. Contact your SUBARU dealer to service the vehicle.

#### ■ Your vehicle may not pass the I/M test:

- When the battery is disconnected or discharged

Readiness codes that are set during ordinary driving are erased.

Also, depending on your driving habits, the readiness codes may not be completely set.

- When the fuel tank cap is loose

The malfunction indicator lamp comes on as a temporary malfunction and your vehicle may not pass the I/M test.

#### ■ When the malfunction indicator lamp goes off after several driving trips

The error code in the OBD system will not be cleared unless the vehicle is driven 40 or more times.

#### ■ If your vehicle does not pass the I/M test

Contact your SUBARU dealer to prepare the vehicle for re-testing.

### 4-3. Do-it-yourself maintenance

## Do-it-yourself service precautions

If you perform maintenance yourself, be sure to follow the correct procedure as given in these sections.

Items	Parts and tools
Battery condition (→P. 302)	<ul style="list-style-type: none"><li>• Warm water</li><li>• Baking soda</li><li>• Grease</li><li>• Conventional wrench (for terminal clamp bolts)</li><li>• Distilled water</li></ul>
Brake fluid level (→P. 300)	<ul style="list-style-type: none"><li>• FMVSS No.116 fresh DOT 3 or DOT 4 brake fluid</li><li>• Rag or paper towel</li><li>• Funnel (used only for adding brake fluid)</li></ul>
Engine coolant level (→P. 298)	<ul style="list-style-type: none"><li>• SUBARU Super Coolant or similar high-quality ethylene glycol-based non-silicate, non-amine, non-nitrite and non-borate coolant with long-life hybrid organic acid technology.</li></ul> <p>SUBARU Super Coolant is premixed with 50% coolant and 50% deionized water.</p> <ul style="list-style-type: none"><li>• Funnel (used only for adding engine coolant)</li></ul>
Engine oil level (→P. 295)	<ul style="list-style-type: none"><li>• SUBARU approved engine oil or equivalent</li><li>• Rag or paper towel, funnel (used only for adding engine oil)</li></ul>
Fuses (→P. 329)	<ul style="list-style-type: none"><li>• Fuse with same amperage rating as original</li></ul>

Items	Parts and tools
Light bulbs (→P. 337)	<ul style="list-style-type: none"> <li>• Bulb with same number and wattage rating as original</li> <li>• Phillips-head screwdriver</li> <li>• Flathead screwdriver</li> </ul>
Radiator and condenser (→P. 300)	—
Tire inflation pressure (→P. 315)	<ul style="list-style-type: none"> <li>• Tire pressure gauge</li> <li>• Compressed air source</li> </ul>
Washer fluid (→P. 306)	<ul style="list-style-type: none"> <li>• Water washer fluid containing anti-freeze (for winter use)</li> <li>• Funnel</li> </ul>

 **WARNING**

The engine compartment contains many mechanisms and fluids that may move suddenly, become hot, or become electrically energized. To avoid death or serious injury, observe the following precautions.

**■ When working in the engine compartment**

- Keep hands, clothing, and tools away from the moving fan and engine drive belt.
- Be careful not to touch the engine, radiator, exhaust manifold, etc. right after driving as they may be hot. Oil and other fluids may also be hot.
- Do not leave anything that may burn easily, such as paper or rags, in the engine compartment.
- Do not smoke, cause sparks or expose an open flame to fuel or the battery. Fuel and battery fumes are flammable.
- Be extremely cautious when working on the battery. It contains poisonous and corrosive sulfuric acid.

**■ When working near the electric cooling fans or radiator grille**

Vehicles without a keyless access with push button start system: Be sure the engine switch is off. With the engine switch in the "ON" position, the electric cooling fans may automatically start to run if the air conditioning is on and/or the coolant temperature is high. (→P. 300)

Vehicles with a keyless access with push button start system: Be sure the push-button ignition switch is off. With the push-button ignition switch in "ON" mode, the electric cooling fans may automatically start to run if the air conditioning is on and/or the coolant temperature is high. (→P. 300)

**■ Safety glasses**

Wear safety glasses to prevent flying or falling material, fluid spray, etc. from getting in the eyes.

 **CAUTION****■ If you remove the air cleaner filter**

Driving with the air cleaner filter removed may cause excessive engine wear due to dirt in the air. Also a backfire could cause a fire in the engine compartment.

## 4-3. Do-it-yourself maintenance

### Engine hood

Release the lock from the inside of the vehicle to open the engine hood.

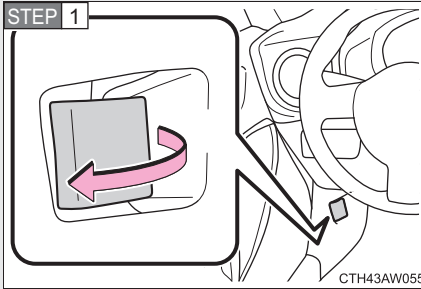

Pull the engine hood release lever.

The engine hood will pop up slightly.

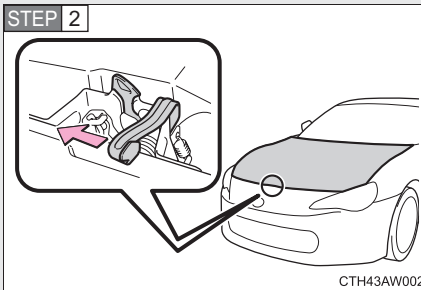

Push the auxiliary catch lever to the left and lift the engine hood.

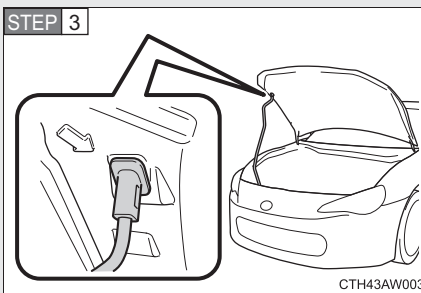

Hold the engine hood open by inserting the supporting rod into the slot.



**WARNING****■ Pre-driving check**

Check that the engine hood is fully closed and locked.

If the engine hood is not locked properly it may open while the vehicle is in motion and cause an accident, which may result in death or serious injury.

**CAUTION****■ When opening the engine hood**

Do not lift up or operate the wipers. Doing so may cause the engine hood and wipers to contact, scratching the engine hood.

**■ When closing the engine hood**

Do not apply excessive weight or force when closing the engine hood as doing so may result in damage.

## 4-3. Do-it-yourself maintenance

### Engine compartment

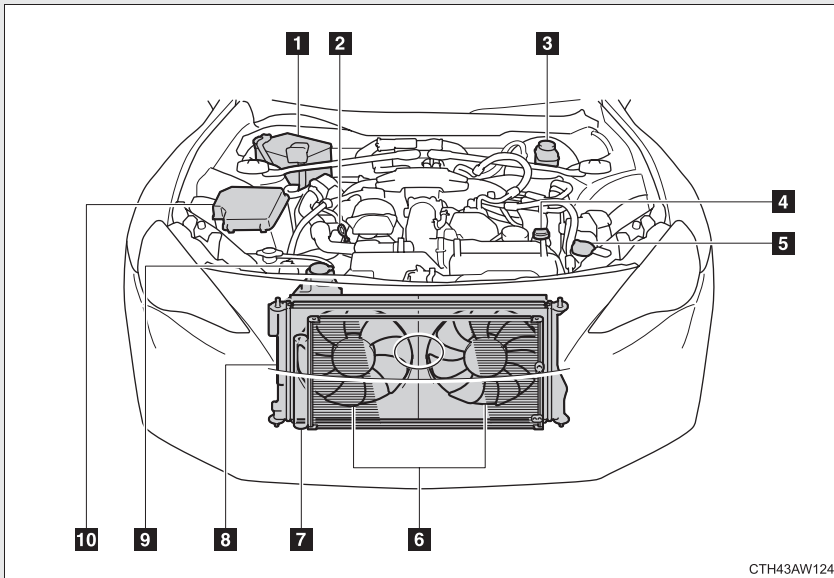

- |                                    |           |                                   |           |
|------------------------------------|-----------|-----------------------------------|-----------|
| <b>1</b> Battery                   | (→P. 302) | <b>5</b> Washer fluid tank        | (→P. 306) |
| <b>2</b> Engine oil level dipstick | (→P. 295) | <b>6</b> Electric cooling fans    |           |
| <b>3</b> Brake fluid reservoir     | (→P. 300) | <b>7</b> Condenser                | (→P. 300) |
| <b>4</b> Engine oil filler cap     | (→P. 296) | <b>8</b> Radiator                 | (→P. 300) |
|                                    |           | <b>9</b> Engine coolant reservoir | (→P. 298) |
|                                    |           | <b>10</b> Fuse box                | (→P. 329) |

## Engine oil

With the engine at operating temperature and turned off, check the oil level on the dipstick.

### ■ Checking the engine oil

**STEP 1** Park the vehicle on level ground. After warming up the engine and turning it off, wait more than five minutes for the oil to drain back into the bottom of the engine.

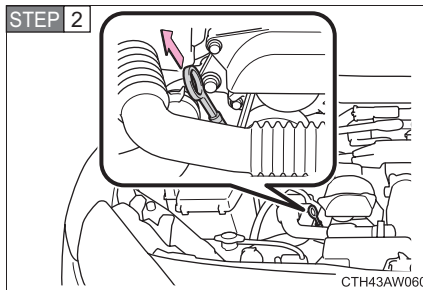

Hold a rag under the end and pull the dipstick out.

**STEP 3** Wipe the dipstick clean.

**STEP 4** Reinsert the dipstick fully.

**STEP 5** Holding a rag under the end, pull the dipstick out and check the oil level.

When checking the oil, look at both sides of the dipstick and use the lower measurement to determine the level of oil.

**STEP 6** Wipe the dipstick and reinsert it fully.

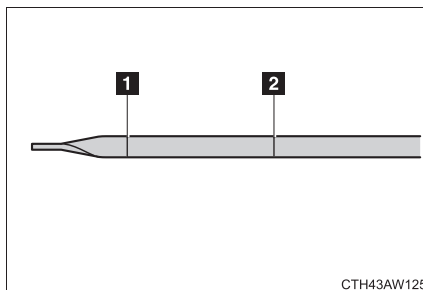

**1** Low

**2** Full

### ■ Adding engine oil

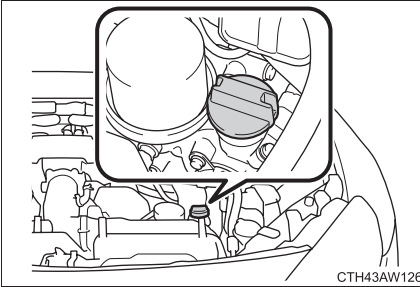

If the oil level is below or near the low level mark, add engine oil of the same type as already in the engine.

Make sure to check the oil type and prepare the items needed before adding oil.

Engine oil selection	→P. 414
Oil quantity (Low → Full)	1.1 qt. (1.0 L, 0.9 Imp. qt.)
Items	Clean funnel

**STEP 1** Remove the oil filler cap by turning it counterclockwise.

**STEP 2** Add engine oil slowly, checking the dipstick.

**STEP 3** Install the oil filler cap by turning it clockwise.

### ■ Engine oil consumption

- The amount of engine oil consumed depends on the oil viscosity, the quality of the oil and the way the vehicle is driven.
- More oil is consumed under driving conditions such as high speeds and frequent acceleration and deceleration.
- A new engine consumes more oil.
- When judging the amount of oil consumption, keep in mind that the oil may have become diluted, making it difficult to judge the true level accurately.
- If your vehicle consumes more than 1.1 qt. (1.0 L, 0.9 Imp. qt.) every 600 miles (1000 km), contact your SUBARU dealer.

### WARNING

#### ■ Used engine oil

- Used engine oil contains potentially harmful contaminants which may cause skin disorders such as inflammation or skin cancer, so care should be taken to avoid prolonged and repeated contact. To remove used engine oil from your skin, wash thoroughly with soap and water.
- Dispose of used oil and filters only in a safe and acceptable manner. Do not dispose of used oil and filters in household trash, in sewers or onto the ground.  
Call your SUBARU dealer, service station or auto parts store for information concerning recycling or disposal.
- Do not leave used engine oil within the reach of children.

 CAUTION

■ **To prevent serious engine damage**

Check the oil level on a regular basis.

■ **When replacing the engine oil**

- Be careful not to spill engine oil on the vehicle components.
- Avoid overfilling, or the engine could be damaged.
- Check the oil level on the dipstick every time you fill the oil.
- Be sure the engine oil filler cap is properly tightened.

**Engine coolant**

The coolant level is satisfactory if it is between the “FULL” and “LOW” lines on the reservoir when the engine is cold.

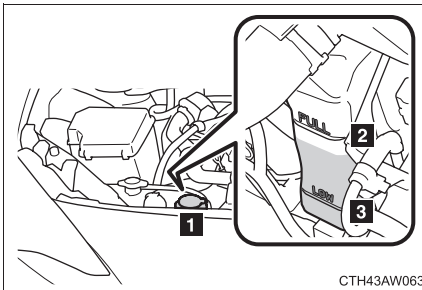

**1** Reservoir cap

**2** “FULL”

**3** “LOW”

If the level is on or below the “LOW” line, add coolant up to the “FULL” line.

■ **If the coolant level drops within a short time after replenishing**

Visually check the radiator, hoses, engine coolant filler cap, radiator cap, drain cock and water pump.

If you cannot find a leak, have your SUBARU dealer pressure test the cap and check for leaks in the cooling system.

### ■ Coolant selection

Only use SUBARU Super Coolant or similar high-quality ethylene glycol-based non-silicate, non-amine, non-nitrite, and non-borate coolant with long-life hybrid organic acid technology.

SUBARU Super Coolant is a mixture of 50% coolant and 50% deionized water. (Enabled: -31°F [-35°C])

For more details about engine coolant, contact your SUBARU dealer.

#### WARNING

##### ■ When the engine is hot

Do not remove the radiator cap.

The cooling system may be under pressure and may spray hot coolant if the cap is removed, causing serious injuries, such as burns.

#### CAUTION

##### ■ When adding engine coolant

Coolant is neither plain water nor straight antifreeze. The correct mixture of water and antifreeze must be used to provide proper lubrication, corrosion protection and cooling. Be sure to read the antifreeze or coolant label.

##### ■ If you spill coolant

Be sure to wash it off with water to prevent it damaging parts or paint.

## Radiator and condenser

Check the radiator and condenser and clear any foreign objects. If either of the above parts are extremely dirty or you are not sure of their condition, have your vehicle checked by your SUBARU dealer.

### WARNING

#### ■ When the engine is hot

Do not touch the radiator or condenser as they may be hot and cause serious injuries, such as burns.

## Brake fluid

### ■ Checking fluid level

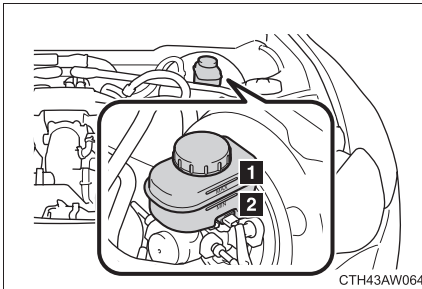

The brake fluid level should be between the “MAX” and “MIN” lines on the tank.

**1** “MAX”

**2** “MIN”



### ■ Adding fluid

Make sure to check the fluid type and prepare the necessary items.

Fluid type	FMVSS No.116 fresh DOT 3 or DOT 4 brake fluid
Items	Clean funnel

### ■ Brake fluid can absorb moisture from the air

Excess moisture in the fluid can cause a dangerous loss of braking efficiency. Use only newly opened brake fluid.

#### WARNING

##### ■ When filling the reservoir

Take care because brake fluid can harm your hands or eyes and damage painted surfaces.

If fluid gets in your eyes, flush your eyes with clean water immediately.

If you still experience discomfort, see a doctor.

#### CAUTION

##### ■ If the fluid level is low or high

It is normal for the brake fluid level to go down slightly as the brake pads wear or when the fluid level in the accumulator is high.

If the reservoir needs frequent refilling, it may indicate a serious problem.

## Battery

Check the battery as follows.

### ■ Battery exterior

Make sure that the battery terminals are not corroded and that there are no loose connections, cracks, or loose clamps.

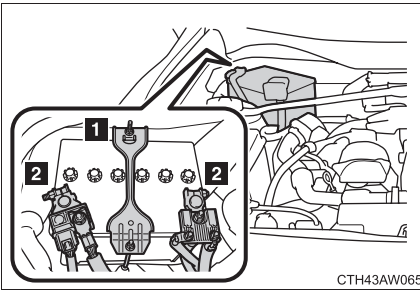

**1** Hold-down clamp

**2** Terminals

### ■ Checking battery fluid

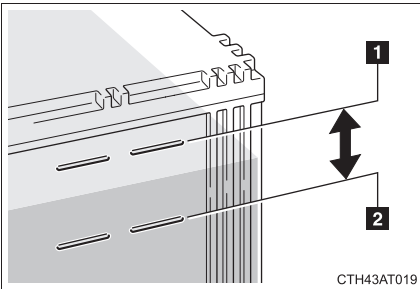

Check that the level is between “UPPER LEVEL” and “LOWER LEVEL”.

**1** “UPPER LEVEL”

**2** “LOWER LEVEL”

If the fluid level is at or below “LOWER LEVEL”, add distilled water.

### ■ Adding distilled water

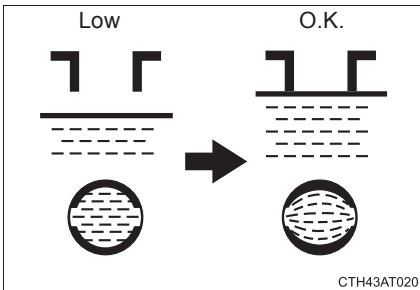

**STEP 1** Remove the vent plug.

**STEP 2** Add distilled water.

If the "UPPER LEVEL" line cannot be seen, check the fluid level by looking directly at the cell.

**STEP 3** Put the vent plug back on and close securely.

■ **Before recharging**

When recharging, the battery produces hydrogen gas which is flammable and explosive. Therefore, before recharging:

- If recharging with the battery installed on the vehicle, be sure to disconnect the ground cable.
- Make sure the power switch on the charger is off when connecting and disconnecting the charger cables to the battery.

■ **After recharging/reconnecting the battery (vehicles with a keyless access with push button start system)**

- Unlocking the doors using the keyless access with push button start system may not be possible immediately after reconnecting the battery. If this happens, use the remote keyless entry system or the mechanical key to lock/unlock the doors.
- Start the engine with the push-button ignition switch in “ACC” mode. The engine may not start with the push-button ignition switch turned off. However, the engine will operate normally from the second attempt.
- The push-button ignition switch mode is recorded by the vehicle. If the battery is reconnected, the vehicle will return the push-button ignition switch mode to the status it was in before the battery was disconnected. Make sure to turn off the engine before disconnect the battery. Take extra care when connecting the battery if the push-button ignition switch mode prior to discharge is unknown.

If the engine will not start even after multiple attempts, contact your SUBARU dealer.

 **WARNING****■ Chemicals in the battery**

A battery contains poisonous and corrosive sulfuric acid and may produce hydrogen gas which is flammable and explosive. To reduce the risk of death or serious injury, take the following precautions while working on or near the battery:

- Do not cause sparks by touching the battery terminals with tools.
- Do not smoke or light a match near the battery.
- Avoid contact with eyes, skin and clothes.
- Never inhale or swallow electrolyte.
- Wear protective safety glasses when working near the battery.
- Keep children away from the battery.

**■ Where to safely charge the battery**

Always charge the battery in an open area. Do not charge the battery in a garage or closed room where there is not sufficient ventilation.

**■ Emergency measures regarding electrolyte**

- If electrolyte gets in your eyes  
Flush your eyes with clean water for at least 15 minutes and get immediate medical attention. If possible, continue to apply water with a sponge or cloth while traveling to the nearest medical facility.
- If electrolyte gets on your skin  
Wash the affected area thoroughly. If you feel pain or burning, get medical attention immediately.
- If electrolyte gets on your clothes  
It can soak through clothing on to your skin. Immediately take off the clothing and follow the procedure above if necessary.
- If you accidentally swallow electrolyte  
Drink a large quantity of water or milk. Get emergency medical attention immediately.

 CAUTION

■ **When recharging the battery**

Never recharge the battery while the engine is running. Also, be sure all accessories are turned off.

■ **When adding distilled water**

Avoid overfilling. Water spilled during battery recharging may cause corrosion.

**Washer fluid**

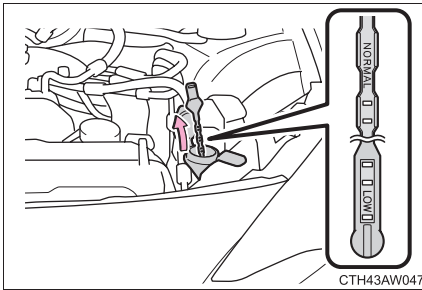

If the washer fluid level is at “LOW”, add washer fluid.

■ **Using the gauge**

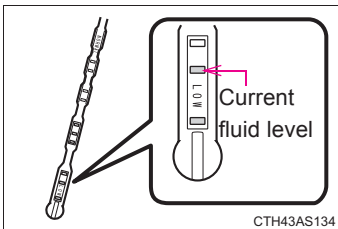

The washer fluid level can be checked by observing the position of the level on the liquid-covered holes in the gauge.

If the level falls below the second hole from the bottom (the “LOW” position), refill the washer fluid.



**WARNING**

■ **When adding washer fluid**

Do not add washer fluid when the engine is hot or running, as washer fluid contains alcohol and may catch fire if spilled on the engine etc.



**CAUTION**

■ **Washer fluid**

Do not use soapy water or engine antifreeze instead of washer fluid. Doing so may cause streaking on the vehicle's painted surfaces.

■ **Diluting washer fluid**

Dilute washer fluid with water as necessary.

Refer to the freezing temperatures listed on the label of the washer fluid bottle.

## 4-3. Do-it-yourself maintenance

### Tires

Replace or rotate tires in accordance with maintenance schedules and treadwear.

#### ■ Checking tires

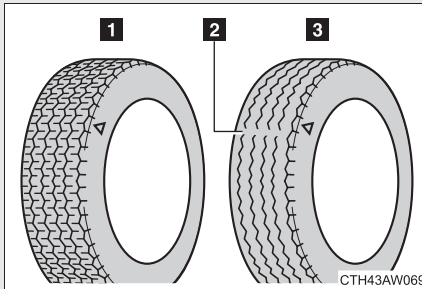

- 1 New tread
- 2 Treadwear indicator
- 3 Worn tread

The location of treadwear indicators is shown by the “TWI” or “△” marks, etc., molded on the sidewall of each tire.

Check spare tire condition and pressure if not rotated.

#### ■ Tire rotation

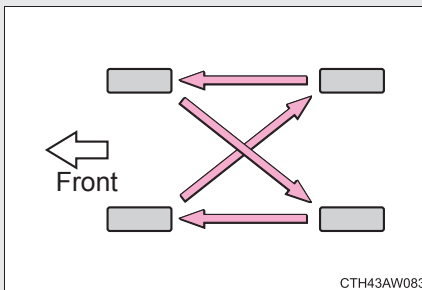

Rotate the tires in the order shown.

To equalize tire wear and extend tire life, SUBARU recommends that tire rotation is carried out at the same interval as tire inspection.

#### ■ The tire pressure monitoring system (if equipped)

Your SUBARU is equipped with a tire pressure monitoring system that uses tire pressure warning valves and transmitters to detect low tire inflation pressure before serious problems arise.

(→P. 367)



**Installing tire pressure warning valves and transmitters (vehicles with a tire pressure monitoring system)**

When replacing tires or wheels, tire pressure warning valves and transmitters must also be installed.

When new tire pressure warning valves and transmitters are installed, new tire pressure warning valve and transmitter ID codes must be registered in the tire pressure warning computer and tire pressure monitoring system must be initialized. Have tire pressure warning valve and transmitter ID codes registered by your SUBARU dealer. (→P. 310)

### **Registering ID codes (vehicles with a tire pressure monitoring system)**

The tire pressure warning valve and transmitter is equipped with a unique ID code. When replacing a tire pressure warning valve and transmitter, it is necessary to register the ID code. Have the ID code registered by your SUBARU dealer.

---

#### **■ When to replace your vehicle's tires**

Tires should be replaced if:

- You have tire damage such as cuts, splits, cracks deep enough to expose the fabric or bulges indicating internal damage
- A tire goes flat repeatedly or cannot be properly repaired due to the size or location of a cut or other damage

If you are not sure, consult with your SUBARU dealer.

#### **■ Replacing tires and wheels (vehicles with a tire pressure monitoring system)**

If the ID code of the tire pressure warning valve and transmitter is not registered, the tire pressure monitoring system will not work properly. After driving for about 20 minutes, the tire pressure warning light comes on after blinking for 1 minute to indicate a system malfunction.

#### **■ Tire life**

Any tire over 6 years old must be checked by a qualified technician even if they have seldom or never been used or damage is not obvious.

#### **■ If the tread wears down below 0.16 in. (4 mm) on snow tires**

The effectiveness of snow tires is lost.

#### **■ Low profile tires (vehicles with 17-inch tires)**

Generally, low profile tires will wear more rapidly and tire grip performance will be reduced on snowy and/or icy roads when compared to standard tires. Be sure to use snow tires or tire chains on snowy and/or icy roads and drive carefully at a speed appropriate for road and weather conditions.

## ■ Maximum load of tire

Check that the maximum load of the replacement tire is greater than 1/2 of the Gross Axle Weight Ratings (GAWR) of either the front axle or the rear axle, whichever is greater.

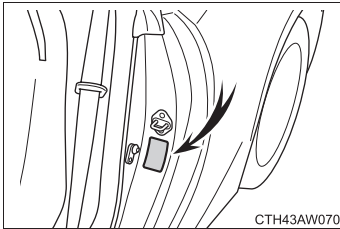

For the GAWR, see the Certification Label. For the maximum load of the tire, see the load limit at maximum cold tire inflation pressure mentioned on the sidewall of the tire. (→P. 411)

## ■ Tire types

### 1 Summer tires

Summer tires are high-speed performance tires best suited to highway driving under dry conditions. Since summer tires do not have the same traction performance as snow tires, summer tires are inadequate for driving on snow-covered or icy roads. For driving on snow-covered roads or icy roads, the use of snow tires is recommended. When installing snow tires, be sure to replace all four tires.

### 2 All season tires

All season tires are designed to provide better traction in snow and to be adequate for driving in most winter conditions, as well as for use year round. All season tires, however, do not have adequate traction performance compared with snow tires in heavy or loose snow. Also, all season tires fall short in acceleration and handling performance compared with summer tires in highway driving.

### 3 Snow tires

For driving on snow-covered roads or icy roads, we recommend using snow tires. If you need snow tires, select tires of the same size, construction and load capacity as the originally installed tires. Since your vehicle has radial tires as original equipment, make sure your snow tires also have radial construction. Do not install studded tires without first checking local regulations for possible restriction. Snow tires should be installed on all wheels. (→P. 226)

■ **Initializing the tire pressure monitoring system (if equipped)**

Initialize the system with the tire inflation pressure adjusted to the specified level.

■ **Routine tire inflation pressure checks (vehicles with a tire pressure monitoring system)**

The tire pressure monitoring system does not replace routine tire inflation pressure checks. Make sure to check tire inflation pressure as part of your routine of daily vehicle checks.

■ **Tire pressure monitoring system certification (if equipped)**

MODEL/FCC IDs:

Transmitter: PAXPMVC010

Receiver: HYQ23AAA (vehicles without a keyless access with push button start system)

HYQ23AAE (vehicles with a keyless access with push button start system)

**For vehicles sold in the U.S.A.**

This device complies with Part 15 of the FCC Rules. Operation is subject to the following two conditions: (1) this device may not cause harmful interference, and (2) this device must accept any interference received, including interference that may cause undesired operation.

**FCC WARNING:**

Changes or modifications not expressly approved by the party responsible for compliance could void the user's authority to operate the equipment.

**For vehicles sold in Canada**

Operation is subject to the following two conditions: (1) this device may not cause interference, and (2) this device must accept any interference, including interference that may cause undesired operation of the device.

**WARNING****■ Tire pressure monitoring system operation (if equipped)**

The tire pressure monitoring system may not provide warning immediately if a tire bursts or if sudden air leakage occurs.

**■ When inspecting or replacing tires**

Observe the following precautions to prevent accidents.

Failure to do so may cause damage to parts of the drive train, as well as dangerous handling characteristics, which may lead to an accident resulting in death or serious injury.

- Make sure to install 4 tires that are of the specified size, and that all 4 tires are the same size, same maker, same brand and tread pattern.
- Do not use tire sizes other than those recommended by SUBARU.
- Only use radial tires.
- Do not mix summer, all season and snow tires.
- Do not use tires that have been used on another vehicle.  
Do not use tires if you do not know how they were used previously.

**CAUTION****■ Repairing or replacing tires, wheels, tire pressure warning valves, transmitters and tire valve caps (vehicles with a tire pressure monitoring system)**

- When removing or fitting the wheels, tires or the tire pressure warning valves and transmitters, contact your SUBARU dealer as the tire pressure warning valves and transmitters may be damaged if not handled correctly.
- When replacing tire valve caps, do not use tire valve caps other than those specified. The cap may become stuck.

 CAUTION

■ **To avoid damage to the tire pressure warning valves and transmitters (vehicles with a tire pressure monitoring system)**

When a tire is repaired with liquid sealants, the tire pressure warning valve and transmitter may not operate properly. If a liquid sealant is used, contact your SUBARU dealer or other qualified service shop as soon as possible. Make sure to replace the tire pressure warning valve and transmitter when replacing the tire. (→P. 309)

■ **Driving on rough roads**

Take particular care when driving on roads with loose surfaces or pot holes.

These conditions may cause losses in tire inflation pressure, reducing the cushioning ability of the tires. In addition, driving on rough roads may cause damage to the tires themselves, as well as the vehicle's wheels and body.

■ **Low profile tires and wheels (vehicles with 17-inch tires)**

Low profile tires may cause greater damage than usual to the wheel when receiving impact from the road surface. Therefore pay attention to the following:

- Be sure to use proper tire inflation pressure. If tires are under-inflated, they may be damaged more severely.
- Avoid pot holes, uneven pavement, curbs and other road hazards. Failure to do so may lead to severe tire and wheel damage.

■ **If tire inflation pressures become low while driving**

Do not continue driving, or your tires and/or wheels may be ruined.

## 4-3. Do-it-yourself maintenance

### Tire inflation pressure

#### ■ Tire inflation pressure

The recommended cold tire inflation pressure and tire size is displayed on the tire and loading information label. (→P. 420)

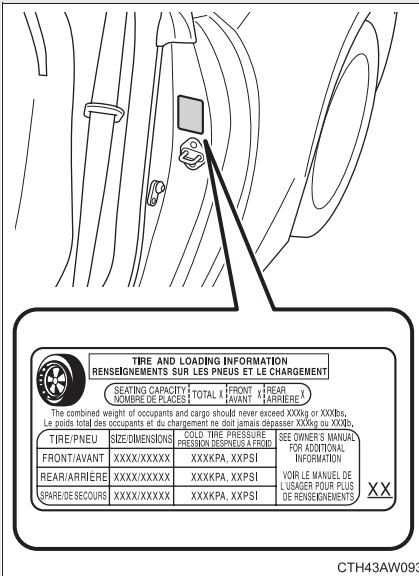

### ■ Inspection and adjustment procedure

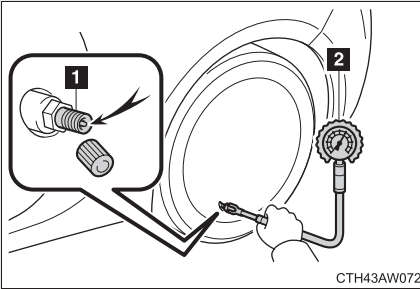

1 Tire valve

2 Tire pressure gauge

**STEP 1** Remove the tire valve cap.

**STEP 2** Press the tip of the tire pressure gauge onto the tire valve.

**STEP 3** Read the pressure using the graduations of the gauge.

**STEP 4** If the tire inflation pressure is not within the recommended levels, adjust the pressure.

If you add too much air, press the center of the valve to lower.

**STEP 5** After completing the tire inflation pressure measurement and adjustment, apply soapy water to the valve and check for leakage.

**STEP 6** Reinstall the tire valve cap.

---

### ■ Tire inflation pressure check interval

You should check tire inflation pressure every two weeks, or at least once a month.

Do not forget to check the spare.



**■ Effects of incorrect tire inflation pressure**

Driving with incorrect tire inflation pressure may result in the following:

- Reduced fuel efficiency
- Reduced driving comfort and tire life
- Reduced safety
- Damage to the drive train

If a tire needs frequent refilling, have it checked by your SUBARU dealer.

**■ Instructions for checking tire inflation pressure**

When checking tire inflation pressure, observe the following:

- Check only when the tires are cold.  
If your vehicle has been parked for at least 3 hours and has not been driven for more than 1 mile or 1.5 km, you will get an accurate cold tire inflation pressure reading.
- Always use a tire pressure gauge.  
The appearance of the tire can be misleading. In addition, tire inflation pressures that are even just a few pounds off can degrade ride and handling.
- Do not bleed or reduce tire inflation pressure after driving. It is normal for the tire inflation pressure to be higher after driving.
- Never exceed the vehicle capacity weight.  
Passengers and luggage weight should be placed so that the vehicle is balanced.

 **WARNING**

■ **Proper inflation is critical to save tire performance**

Keep your tires properly inflated. Otherwise, the following conditions may occur and result in an accident causing death or serious injury.

- Excessive wear
- Uneven wear
- Poor handling
- Possibility of blowouts resulting from overheated tires
- Poor sealing of the tire bead
- Wheel deformation and/or tire separation
- A greater possibility of tire damage from road hazards

 **CAUTION**

■ **When inspecting and adjusting tire inflation pressure**

Be sure to reinstall the tire valve caps.

Without the valve caps, dirt or moisture could get into the valve and cause air leakage, which could result in an accident. If the caps have been lost, replace them as soon as possible.

# Wheels

If a wheel is bent, cracked or heavily corroded, it should be replaced. Otherwise, the tire may separate from the wheel or cause loss of handling control.

### ■ Wheel selection

When replacing wheels, care should be taken to ensure that they are equivalent to those removed in load capacity, diameter, rim width, and inset\*.

Replacement wheels are available at your SUBARU dealer.

\*: Conventionally referred to as “offset”.

SUBARU does not recommend using:

- Wheels of different sizes or types
- Used wheels
- Bent wheels that have been straightened

### ■ Aluminum wheel precautions

- Use only SUBARU wheel nuts and wrenches designed for use with your aluminum wheels.
- When rotating, repairing or changing your tires, check that the wheel nuts are still tight after driving 1000 miles (1600 km).
- Be careful not to damage the aluminum wheels when using tire chains.
- Use only SUBARU genuine balance weights or equivalent and a plastic or rubber hammer when balancing your wheels.

■ **When replacing wheels (vehicles with a tire pressure monitoring system)**

The wheels of your SUBARU are equipped with tire pressure warning valves and transmitters that allow the tire pressure monitoring system to provide advanced warning in the event of a loss in tire inflation pressure. Whenever wheels are replaced, the tire pressure warning valves and transmitters must be installed. (→P. 309)

**⚠ WARNING**

■ **When replacing wheels**

- Do not use wheels that are a different size from those recommended in the Owner's Manual, as this may result in loss of handling control.
- Never use an inner tube in a leaking wheel which is designed for a tubeless tire. Doing so may result in an accident, causing death or serious injury.

■ **When installing the wheel nuts**

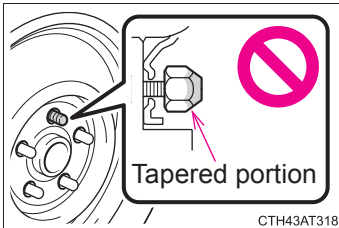

- Be sure to install the wheel nuts with the tapered ends facing inward. Installing the nuts with the tapered ends facing outward can cause the wheel to break and eventually cause the wheel to come off while driving, which could lead to an accident resulting in death or serious injury.

- Never use oil or grease on the wheel bolts or wheel nuts. Oil and grease may cause the wheel nuts to be excessively tightened, leading to bolt or disc wheel damage. In addition, the oil or grease can cause the wheel nuts to loosen and the wheel may fall off, causing an accident and resulting in death or serious injury. Remove any oil or grease from the wheel bolts or wheel nuts.

 CAUTION**■ Replacing tire inflation pressure warning valves and transmitters (vehicles with a tire pressure monitoring system)**

- Because tire repair or replacement may affect the tire pressure warning valves and transmitters, make sure to have tires serviced by your SUBARU dealer or other qualified service shop. In addition, make sure to purchase your tire pressure warning valves and transmitters at your SUBARU dealer.
- Ensure that only genuine SUBARU wheels are used on your vehicle. Tire pressure warning valves and transmitters may not work properly with non-genuine wheels.

## 4-3. Do-it-yourself maintenance

### Air conditioning filter

The air conditioning filter must be changed regularly to maintain air conditioning efficiency.

#### ■ Removal method

##### **STEP 1** Vehicles without a keyless access with push button start system

Turn the engine switch off.

##### **Vehicles with a keyless access with push button start system**

Turn the push-button ignition switch off.

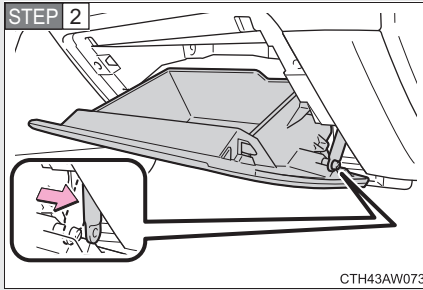

Open the glove box. Slide off the damper.

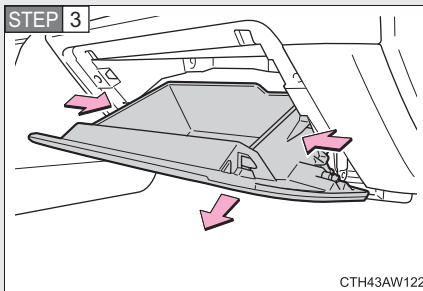

Push in each side of the glove box to disconnect the claws.

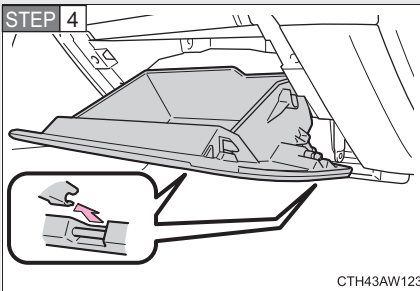

Pull out the glove box and disconnect the lower claws.

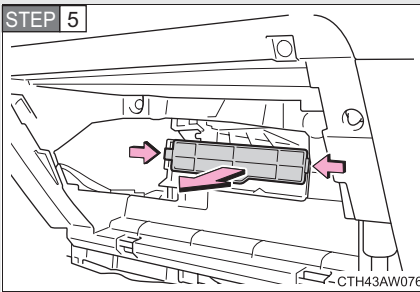

Remove the filter cover.

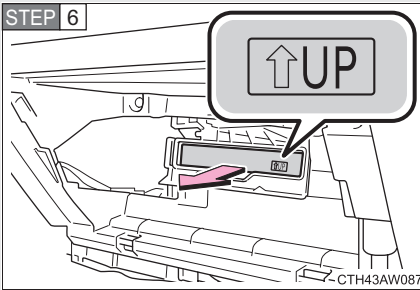

Remove the air conditioning filter and replace it with a new one.

The "↑UP" marks shown on the filter should be pointing up.

■ **Checking interval**

Inspect and replace the air conditioning filter according to the maintenance schedule. In dusty areas or areas with heavy traffic flow, early replacement may be required. (For scheduled maintenance information, please refer to the “Warranty and Maintenance Booklet”.)

■ **If air flow from the vents decreases dramatically**

The filter may be clogged. Check the filter and replace if necessary.

 **CAUTION**

■ **When using the air conditioning system**

Make sure that a filter is always installed.  
Using the air conditioning system without a filter may cause damage to the system.



## 4-3. Do-it-yourself maintenance

### Transmitter/access key battery

Replace the battery with a new one if it is depleted.

■ You will need the following items:

- Flathead screwdriver
- Lithium battery CR2016 (vehicles without a keyless access with push button start system), or CR1632 (vehicles with a keyless access with push button start system)

■ Replacing the battery (vehicles without a keyless access with push button start system)

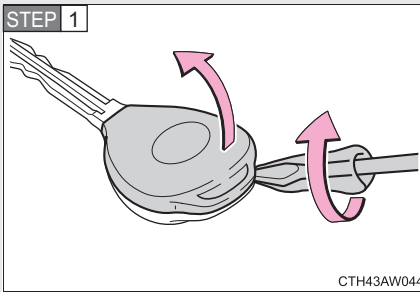

Remove the cover.

To prevent damage to the key, cover the tip of the screwdriver with a rag.

To prevent the buttons from being disassembled, face the button surface downward.

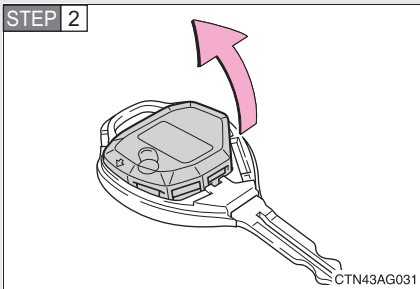

Remove the module.

STEP 3

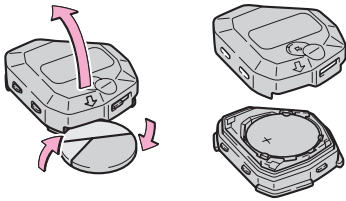

CTN43AG032

Open the case cover using a coin protected with tape and remove the depleted battery.

Insert a new battery with the “+” terminal facing up.

■ Replacing the battery (vehicles with a keyless access with push button start system)

STEP 1

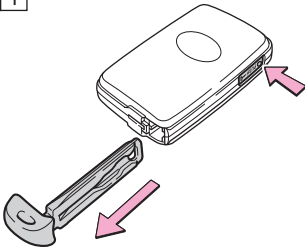

CTH11AW005

Take out the mechanical key.

STEP 2

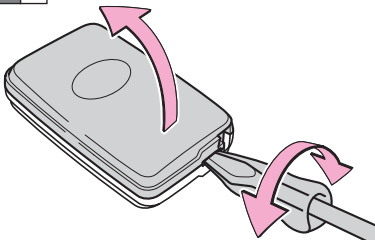

CTH43AT157

Remove the cover.

To prevent damage to the key, cover the tip of the screwdriver with a rag.

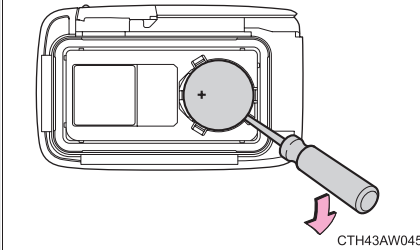
**STEP 3**

Remove the depleted battery.

Insert a new battery with the “+” terminal facing up.

■ **Use a CR2016 (vehicles without a keyless access with push button start system) or CR1632 (vehicles with a keyless access with push button start system) lithium battery**

- Batteries can be purchased at your SUBARU dealer, local electrical appliance shops or camera stores.
- Replace only with the same or equivalent type recommended by the manufacturer.
- Dispose of used batteries according to local laws.

■ **If the key battery is depleted**

The following symptoms may occur:

- The keyless access with push button start system (if equipped) and remote keyless entry system will not function properly.
- The operational range will be reduced.

■ **When putting the module back (vehicles without a keyless access with push button start system)**

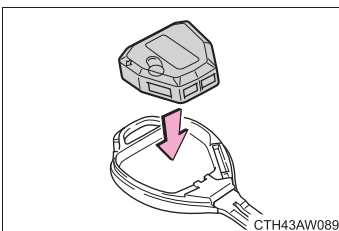

Insert the module from directly above. Inserting it on an angle may prevent the key buttons from operating properly.

 **WARNING**

■ **Removed battery and other parts**

Keep away from children. These parts are small and if swallowed by a child, they can cause choking. Failure to do so could result in death or serious injury.

 **CAUTION**

■ **For normal operation after replacing the battery**

Observe the following precautions to prevent accidents:

- Always work with dry hands.  
Moisture may cause the battery to rust.
- Do not touch or move any other component inside the remote control.
- Do not bend either of the battery terminals.

## 4-3. Do-it-yourself maintenance

### Checking and replacing fuses

If any of the electrical components do not operate, a fuse may have blown. If this happens, check and replace the fuses as necessary.

**STEP 1** Vehicles without a keyless access with push button start system

Turn the engine switch off.

Vehicles with a keyless access with push button start system

Turn the push-button ignition switch off.

**STEP 2** Open the fuse box cover.

#### Engine compartment

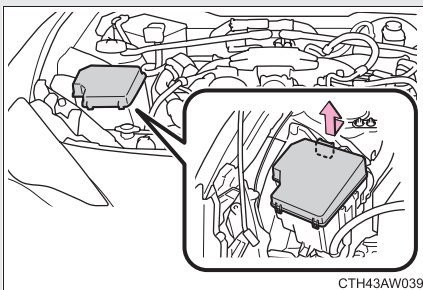

Push the tabs in and lift the lid off.

#### Instrument panel

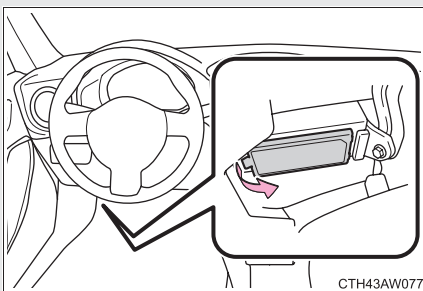

Remove the lid.

**STEP 3** After a system failure, see “Fuse layout and amperage ratings” (→P. 332) for details about which fuse to check.

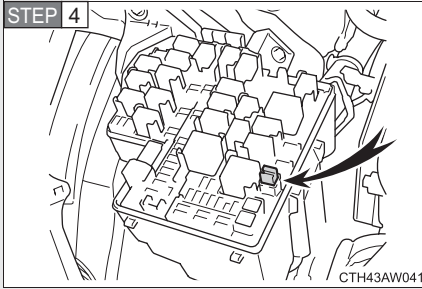

Remove the fuse with the pull-out tool.

**STEP 5** Check if the fuse has blown.

### Type A

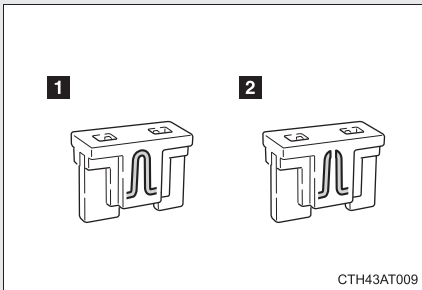

**1** Normal fuse

**2** Blown fuse

Replace it with one of an appropriate amperage rating. The amperage rating can be found on the fuse box lid.

### Type B

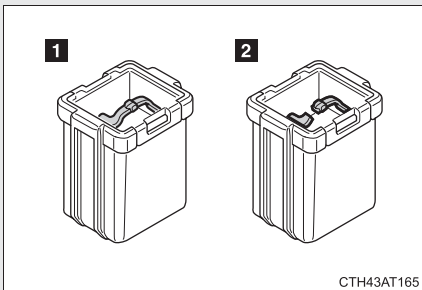

**1** Normal fuse

**2** Blown fuse

Replace it with one of an appropriate amperage rating. The amperage rating can be found on the fuse box lid.

### Type C

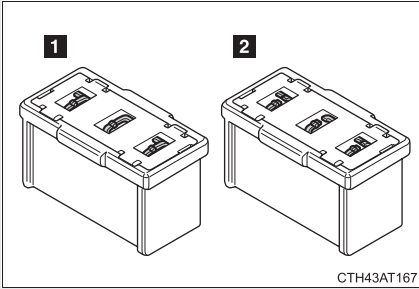

- 1** Normal fuse
- 2** Blown fuse

Contact your SUBARU dealer.

### Type D

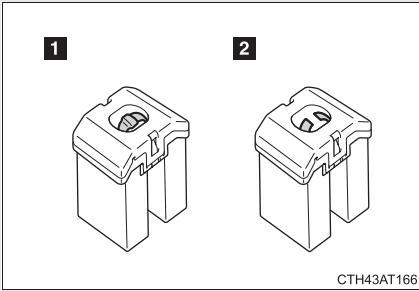

- 1** Normal fuse
- 2** Blown fuse

Contact your SUBARU dealer.

## Fuse layout and amperage ratings

### ■ Engine compartment

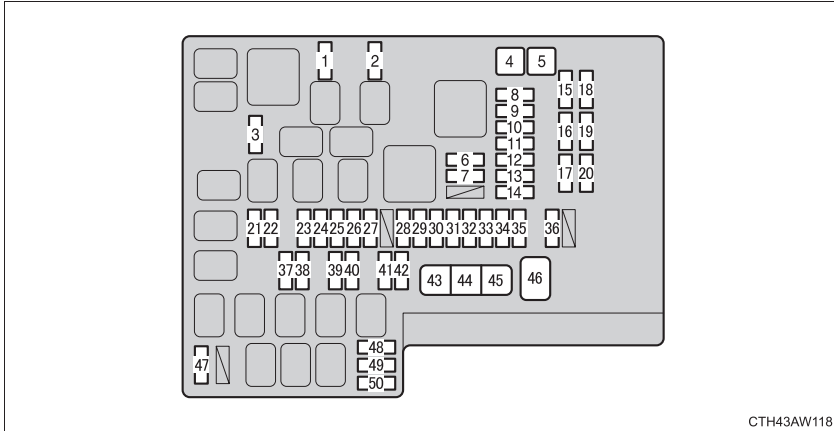

Fuse		Ampere	Circuit
1	MIR HTR	7.5 A	Outside rear view mirror defoggers
2	RDI	25 A	Electric cooling fan
3	(PUSH-AT)	7.5 A	Engine control unit
4	ABS NO. 1	40 A	ABS
5	HEATER	50 A	Air conditioning system
6	WASHER	10 A	Windshield washer
7	WIPER	30 A	Windshield wipers
8	RR DEF	30 A	Rear window defogger
9	(RR FOG)	10 A	—
10	D FR DOOR	25 A	Power window (driver's side)
11	(CDS)	25 A	Electric cooling fan
12	D-OP	25 A	—
13	ABS NO. 2	25 A	ABS
14	D FL DOOR	25 A	Power window (passenger's side)
15	SPARE	See note.	Spare fuse



Fuse		Ampere	Circuit
16	SPARE	See note.	Spare fuse
17	SPARE	See note.	Spare fuse
18	SPARE	See note.	Spare fuse
19	SPARE	See note.	Spare fuse
20	SPARE	See note.	Spare fuse
21	ST	7.5 A	Starting system
22	ALT-S	7.5 A	Charging system
23	(STR LOCK)	7.5 A	Steering lock system
24	D/L	20 A	Power door lock
25	ETCS	15 A	Engine control unit
26	(AT+B)	7.5 A	Transmission
27	(AM2 NO. 2)	7.5 A	Keyless access with push button start system
28	EFI (CTRL)	15 A	Engine control unit
29	EFI (HTR)	15 A	Multiport fuel injection system/ sequential multiport fuel injection system
30	EFI (IGN)	15 A	Starting system
31	EFI (+B)	7.5 A	Engine control unit
32	HAZ	15 A	Turn signal lights, hazard warning flashers
33	MPX-B	7.5 A	Automatic air conditioning system, gauge and meters
34	F/PMP	20 A	Multiport fuel injection system/ sequential multiport fuel injection system
35	IG2 MAIN	30 A	SRS airbag system, engine control unit
36	DCC	30 A	Interior light, remote keyless entry system, main body ECU

Fuse		Ampere	Circuit
37	HORN NO. 2	7.5 A	Horn
38	HORN NO. 1	7.5 A	Horn
39	H-LP LH LO	15 A	Left-hand headlight (low beam)
40	H-LP RH LO	15 A	Right-hand headlight (low beam)
41	H-LP LH HI	10 A	Left-hand headlight (high beam)
42	H-LP RH HI	10 A	Right-hand headlight (high beam)
43	INJ	30 A	Multiport fuel injection system/ sequential multiport fuel injection system
44	H-LP WASHER	30 A	—
45	AM2 NO. 1	40 A	Starting system, engine control unit
46	EPS	80 A	Electric power steering
47	A/B MAIN	15 A	SRS airbag system
48	ECU-B	7.5 A	Remote keyless entry system, main body ECU
49	DOME	20 A	Interior light
50	IG2	7.5 A	Engine control unit

**Note**

One of each of the following spare fuses are provided: 7.5 A, 10 A, 15 A, 20 A, 25 A, 30 A.

## ■ Instrument panel

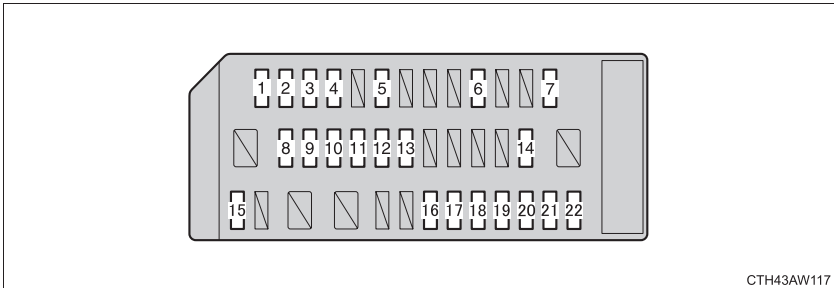

Fuse		Ampere	Circuit
1	ECU ACC	10 A	Main body ECU, outside rear view mirrors
2	P/POINT No.2	15 A	Power outlet
3	PANEL	10 A	Illumination
4	TAIL	10 A	Tail lights
5	DRL	10 A	Daytime running light system
6	STOP	7.5 A	Stop lights
7	OBD	7.5 A	On-board diagnosis system
8	HEATER-S	7.5 A	Air conditioning system
9	HEATER	10 A	Air conditioning system
10	FR FOG LH	10 A	Left-hand front fog light
11	FR FOG RH	10 A	Right-hand front fog light
12	BK/UP LP	7.5 A	Back-up lights
13	ECU IG1	10 A	ABS, electric power steering
14	AM1	7.5 A	Starting system
15	AMP	15 A	—
16	AT UNIT	15 A	Transmission
17	GAUGE	7.5 A	Gauge and meters, keyless access with push button start system
18	ECU IG2	10 A	Engine control unit
19	SEAT HTR LH	10 A	Left-hand seat heater
20	SEAT HTR RH	10 A	Right-hand seat heater
21	RADIO	7.5 A	—
22	P/POINT No.1	15 A	Power outlet

■ **After a fuse is replaced**

- If the lights do not turn on even after the fuse has been replaced, a bulb may need replacement. (→P. 337)
- If the replaced fuse blows again, have the vehicle inspected by your SUBARU dealer.

■ **If there is an overload in the circuits**

The fuses are designed to blow, protecting the wiring harness from damage.

 **WARNING**

■ **To prevent system breakdowns and vehicle fire**

Observe the following precautions.

Failing to do so may cause damage, and possibly a fire or injury.

- Never use a fuse of a higher amperage rating than indicated, or use any other object in place of a fuse.
- Always use a genuine SUBARU fuse or equivalent.
- Do not modify the fuse or the fuse box.

 **CAUTION**

■ **Before replacing fuses**

Have the cause of electrical overload determined and repaired by your SUBARU dealer.

## 4-3. Do-it-yourself maintenance

# Light bulbs

You may replace the following bulbs by yourself. The difficulty level of replacement varies depending on the bulb. If necessary bulb replacement seems difficult to perform, contact your SUBARU dealer.

### ■ Preparing a replacement light bulb

Check the wattage of the light bulb being replaced. (→P. 421)

### ■ Front bulb locations

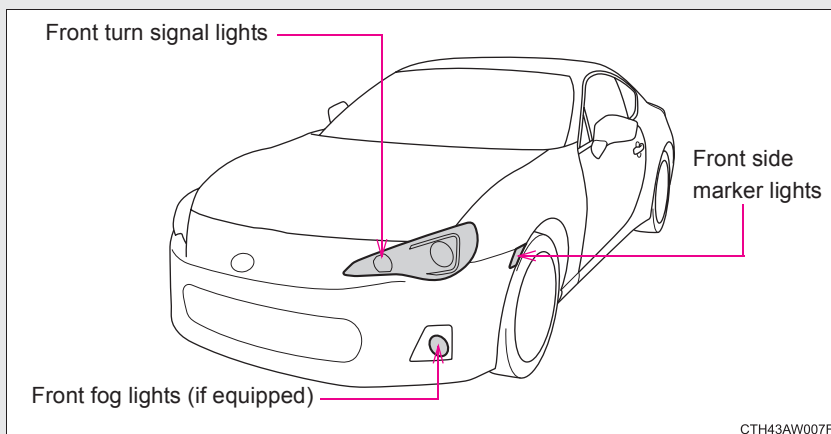

### ■ Rear bulb locations

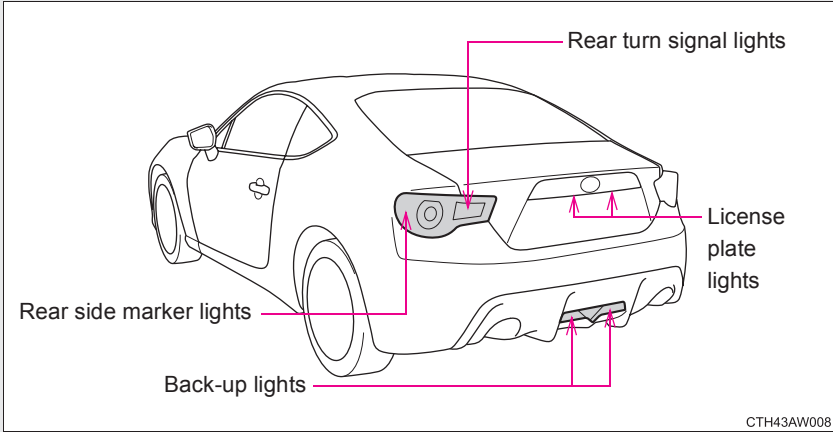

### ■ Inside bulb locations

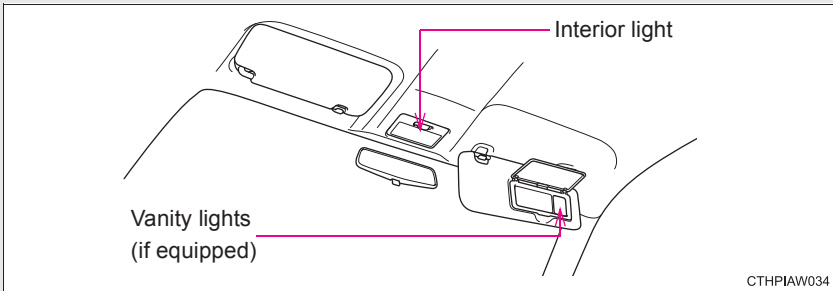

## Replacing light bulbs

### ■ Front turn signal lights

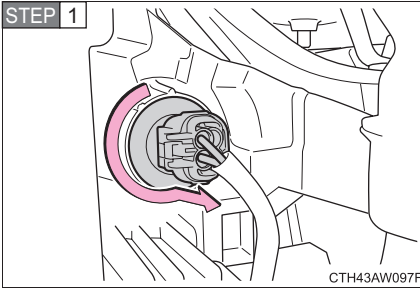

Turn the bulb base counterclockwise.

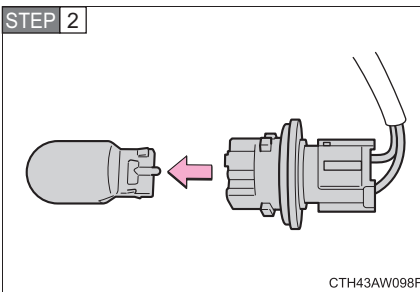

Remove the light bulb.

**STEP 3** When installing, reverse the steps listed.

### ■ Front side marker lights

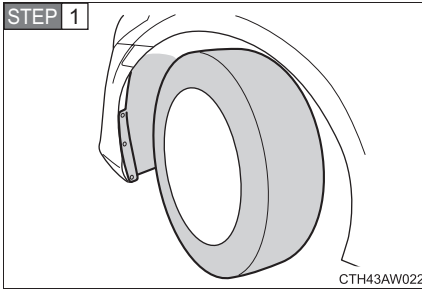

Turn the steering wheel in the opposite direction of the light to be replaced.

Turn the steering wheel to a point that allows your hand to easily fit between the tire and fender liner.

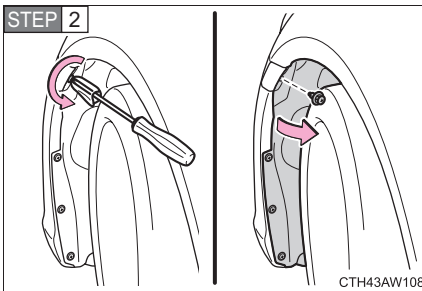

Remove the clips and partly remove the fender liner.

To prevent damage to the vehicle, cover the tip of the screwdriver with a rag.

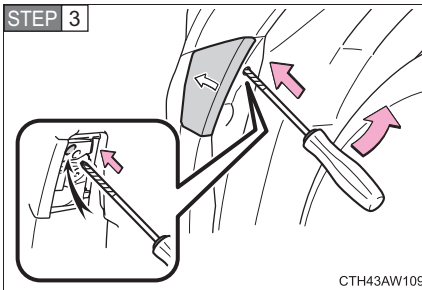

Release the light's claw.

Insert the screwdriver into the hole. While firmly pushing the screwdriver forward, move it towards the inside of the vehicle.

To prevent damage to the vehicle, wrap the tip of the screwdriver with a tape.

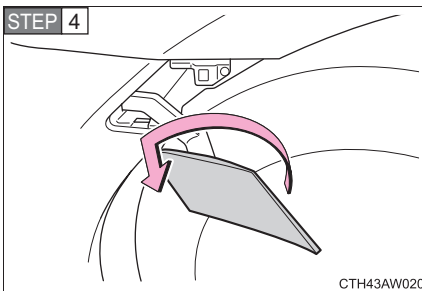

Pull out the lamp and turn the lens counterclockwise.



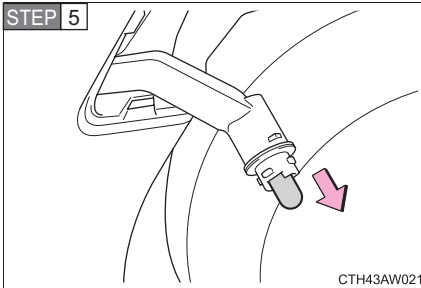

Remove the light bulb.

**STEP 6** When installing, reverse the steps listed.

■ **Front fog lights (if equipped)**

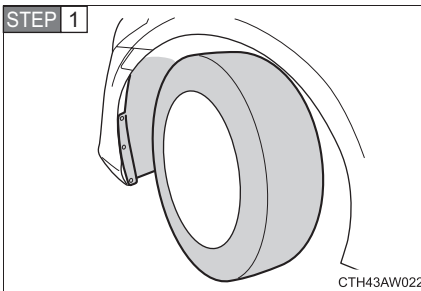

Turn the steering wheel in the opposite direction of the light to be replaced.

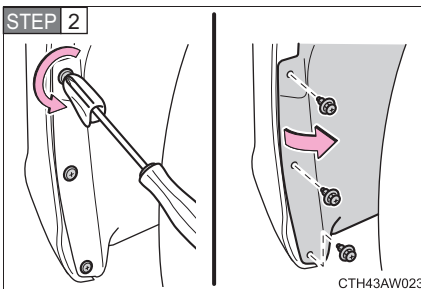

Remove the clips and partly remove the fender liner.

To prevent damage to the vehicle, cover the tip of the screwdriver with a rag.

4-3. Do-it-yourself maintenance

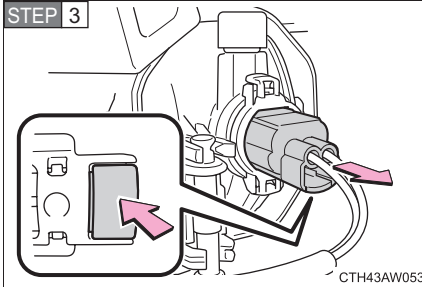

Unplug the connector while depressing the lock release.

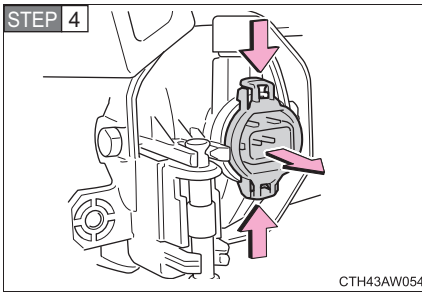

Remove the light bulb.

**STEP 5** When installing, reverse the steps listed.

### ■ Rear side marker lights

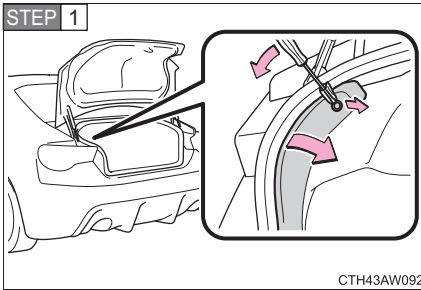

Remove a clip and partly remove the cover.

To prevent damage to the vehicle, cover the tip of the screwdriver with a rag.

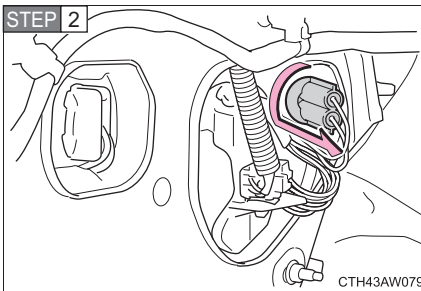

Turn the bulb base counterclockwise.

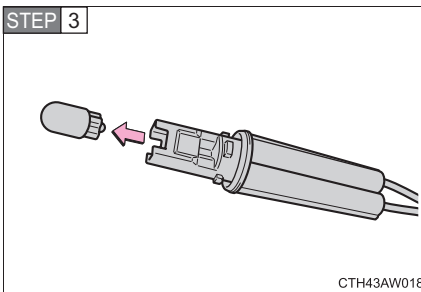

Remove the light bulb.

**STEP 4** When installing, reverse the steps listed.

### ■ Rear turn signal lights

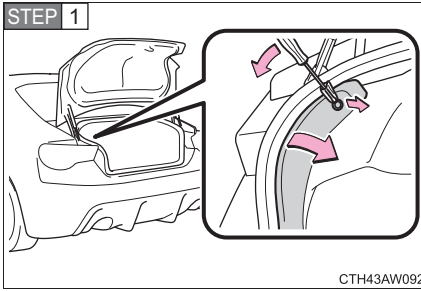

Remove a clip and partly remove the cover.

To prevent damage to the vehicle, cover the tip of the screwdriver with a rag.

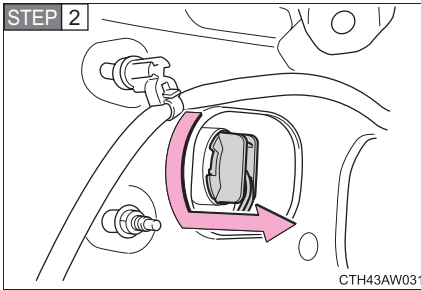

Turn the bulb base counterclockwise.

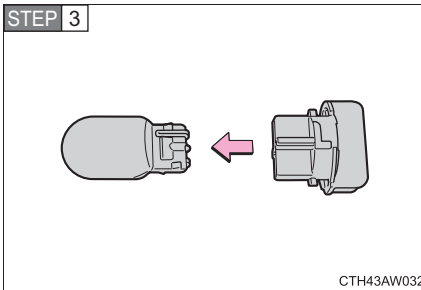

Remove the light bulb.

**STEP 4** When installing, reverse the steps listed.

### ■ Back-up lights

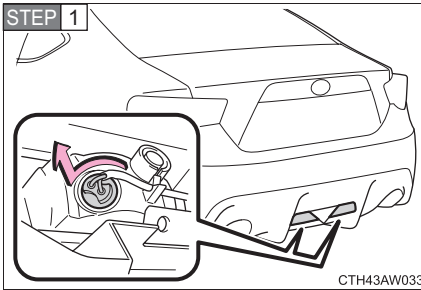

Turn the bulb base counterclockwise.

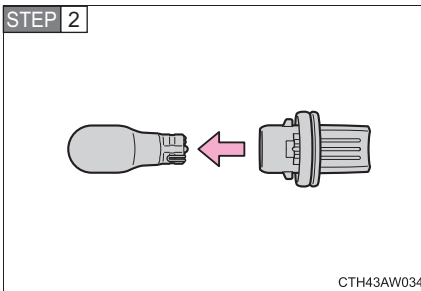

Remove the light bulb.

**STEP 3** When installing, reverse the steps listed.

### ■ License plate lights

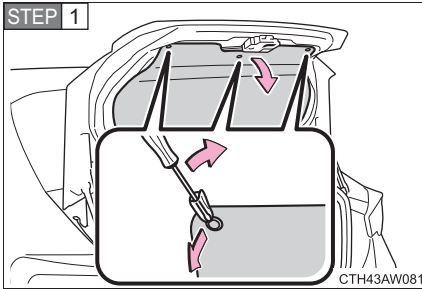

Remove the trunk lid panel cover clips and partly remove the trunk lid panel cover.

To prevent damage to the vehicle, cover the tip of the screwdriver with a rag.

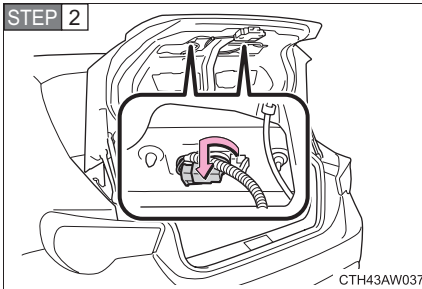

Turn the bulb base counterclockwise.

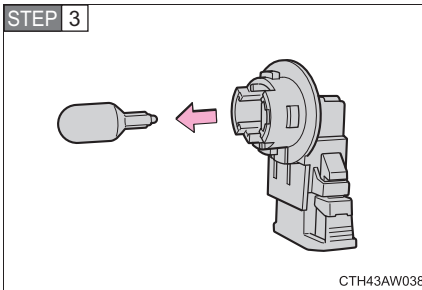

Remove the light bulb.

**STEP 4** When installing, reverse the steps listed.

## ■ Interior light

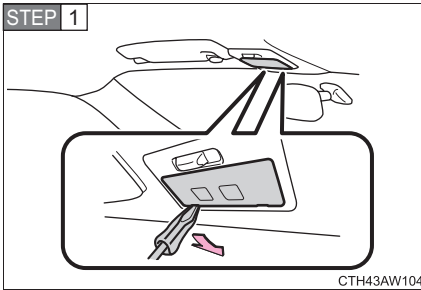

Remove the lens.

To prevent damage to the interior light, cover the tip of the screwdriver with a rag.

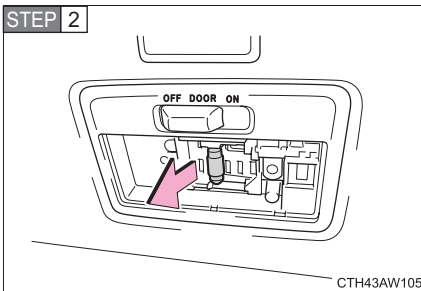

Remove the light bulb.

**STEP 3** When installing, reverse the steps listed.

■ Vanity lights (if equipped)

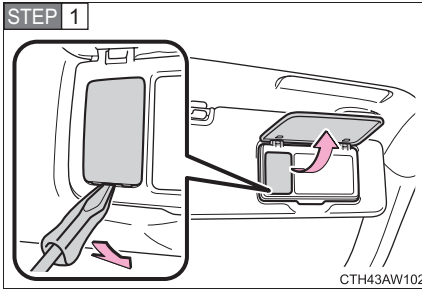

Open the cover and remove the lens.

To prevent damage to the vanity light, cover the tip of the screwdriver with a rag.

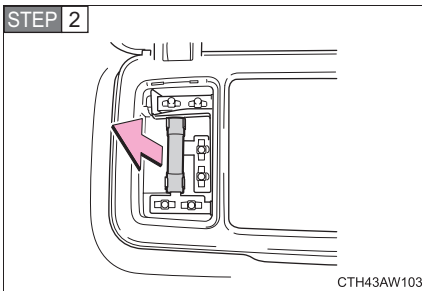

Remove the light bulb.

**STEP 3** When installing, reverse the steps listed.



### ■ Replacing the following bulbs

If any of the lights listed below has burnt out, have it replaced by your SUBARU dealer.

- Headlight high and low beams
- Parking lights
- Daytime running lights
- Stop/tail lights
- High mounted stoplight

---

### ■ Condensation build-up on the inside of the lens

Contact your SUBARU dealer for more information in the following situations. Temporary condensation build-up on the inside of the headlight lens does not indicate a malfunction.

- Large drops of water are built up on the inside of the lens.
- Water has built up inside the headlight.

### ■ Discharge headlights

If voltage to the discharge bulbs is insufficient, the bulbs may not come on, or may go out temporarily. The discharge bulbs will come on when normal power is restored.

### ■ LED light bulbs

The parking lights, daytime running lights, stop/tail lights and high mounted stoplight consist of a number of LEDs. If any of the LEDs burn out, take your vehicle to your SUBARU dealer to have the light replaced.

### ■ When replacing light bulbs

SUBARU recommends that you use genuine SUBARU products designed for this vehicle.

Because certain bulbs are connected to circuits designed to prevent overload, non-genuine parts or parts not designed for this vehicle may be unusable.

### ■ Removing and installing the luggage trim cover and trunk lid panel cover clip

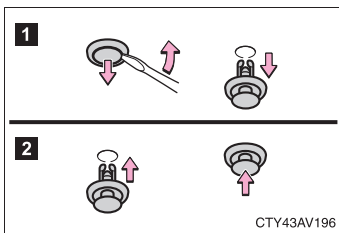

1 Removing

2 Installing

### ⚠ WARNING

#### ■ Replacing light bulbs

- Turn off the lights. Do not attempt to replace the bulb immediately after turning off the lights.  
The bulbs become very hot and may cause burns.
- Do not touch the glass portion of the light bulb with bare hands. Hold the bulb by the plastic or metal portion.  
If the bulb is scratched or dropped, it may blow out or crack.
- Fully install light bulbs and any parts used to secure them. Failure to do so may result in heat damage, fire, or water entering the headlight unit. This may damage the headlights or cause condensation to build up on the lens.

#### ■ When changing the back-up lights

Stop the engine and wait until the exhaust pipe has cooled sufficiently. The lights are located near the exhaust pipe and touching a hot exhaust pipe can cause burns.

**WARNING****■ Discharge headlights**

- Contact your SUBARU dealer before replacing the discharge headlights (including light bulbs).
- Do not touch the discharge headlight's high voltage socket when the headlights are turned on.  
An extremely high voltage of 25000 V will be discharged and could result in serious injury or death by electric shock.
- Do not attempt to take apart or repair the low beam discharge headlight bulbs, connectors, power supply circuits, or related components.  
Doing so could result in electric shock and serious injury or death.

**■ To prevent damage or fire**

Make sure bulbs are fully seated and locked.



## When trouble arises

# 5

### 5-1. Essential information

Hazard warning flashers .....	354
If your vehicle needs to be towed .....	355
If you think something is wrong .....	362
Fuel pump shut off system .....	363

### 5-2. Steps to take in an emergency

If a warning light turns on or a warning buzzer sounds... ..	364
If you have a flat tire.....	378
If the engine will not start .....	389
If the select lever cannot be shifted from P.....	392
If you lose your keys .....	393
If the access key does not operate properly.....	394
If the battery is discharged .....	398
If your vehicle overheats .....	403
If the vehicle becomes stuck .....	406

## 5-1. Essential information

# Hazard warning flashers

The hazard warning flashers are used to warn other drivers when the vehicle has to be stopped in the road due to a breakdown, etc.

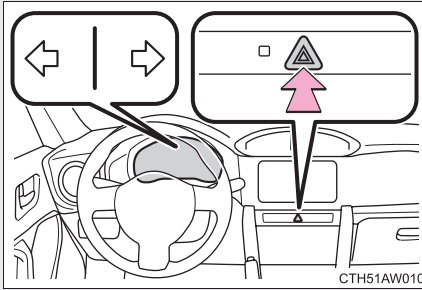

Press the switch.

All the turn signal lights will flash. To turn them off, press the switch once again.

### ■ Hazard warning flashers

If the hazard warning flashers are used for a long time while the engine is not operating, the battery may discharge.

## 5-1. Essential information

# If your vehicle needs to be towed

If towing is necessary, we recommend having your vehicle towed by your SUBARU dealer or a commercial towing service, using a flat bed truck.

The vehicle must be secured properly with safety chains. Each safety chain should be equally tightened and care must be taken not to pull the chains so tightly that the suspension bottoms out.

### Emergency towing

If a tow truck is not available in an emergency, your vehicle may be temporarily towed using a cable or chain secured to the emergency towing eyelet to move the vehicle to a safe location or to free a stuck vehicle from sand or snow. This should only be attempted on hard surfaced roads for short distances at low speeds.

A driver must be in the vehicle to steer and operate the brakes. The vehicle's wheels, drive train, axles, steering and brakes must be in good condition.

For vehicles with an automatic transmission, only the front towing eyelet may be used.

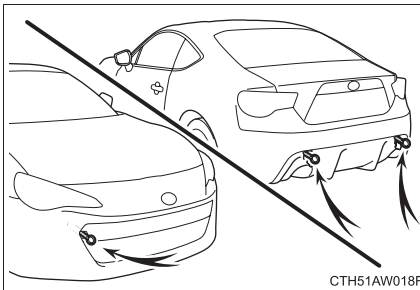

Towing eyelet

■ **Before emergency towing**

**STEP 1** Release the parking brake.

**STEP 2** Shift the select lever to N (vehicles with an automatic transmission) or shift lever to neutral (vehicles with a manual transmission).

**STEP 3** Vehicles without a keyless access with push button start system: Turn the engine switch to the “ACC” (engine off) or “ON” (engine running) position.

Vehicles with a keyless access with push button start system: Turn the push-button ignition switch to “ACC” (engine off) or “ON” (engine running) mode.

 **WARNING**

■ **Caution while towing**

- Use extreme caution when towing the vehicle.  
Avoid sudden starts or erratic driving maneuvers which place excessive stress on the emergency towing eyelets and the cables or chains. Always be cautious of the surroundings and other vehicles while towing.
- If the engine is not running, the power assist for the brakes and steering will not function, making steering and braking more difficult.



 CAUTION

■ **To prevent causing serious damage to the transmission in emergency towing (vehicles with an automatic transmission)**

Never tow a vehicle from the rear with four wheels on the ground. This may cause serious damage to the transmission.

■ **To prevent damage to the vehicle**

● When towing this vehicle, make sure to observe the following:

- Do not use a wire rope
- Keep vehicle speed below 20 mph (30 km/h) and do not tow for distances over 19 miles (30 km)
- Tow the vehicle in the forward direction
- Do not apply rope to the vehicle's suspension and so forth

● Do not tow another vehicle, boat (trailer) and so forth.

■ **When towing down a long slope**

Use a wheel lift-type or flat bed truck.

### Installing towing eyelet

**STEP 1** Remove the eyelet cover using a flathead screwdriver.

To protect the bodywork, place a rag between the screwdriver and the vehicle body, as shown in the illustration.

#### Front

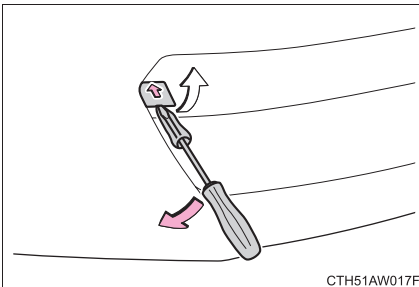

## Rear

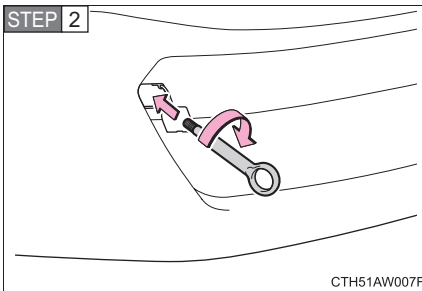
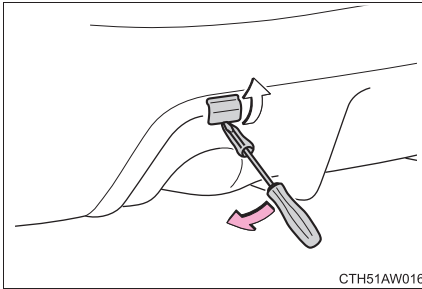

Insert the towing eyelet into the hole and tighten partially by hand.

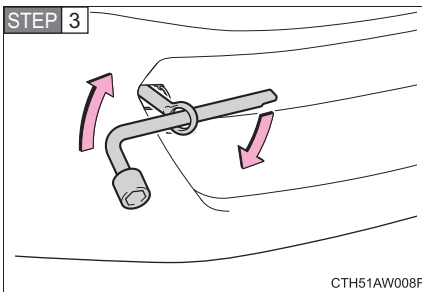

Tighten down the towing eyelet securely using a wheel nut wrench.

---

### ■ Location of the emergency towing eyelet

→P. 378

**⚠ WARNING****■ Installing towing eyelets to the vehicle**

Make sure that towing eyelet is installed securely.

If not securely installed, towing eyelets may come loose during towing. This may lead to accidents that cause serious injury or even death.

**■ After towing**

Always remove the towing eyelet. Failure to do so can cause the SRS air-bags to not operate correctly in the event of a frontal collision.

**Towing with a sling-type truck****⚠ CAUTION****■ To prevent body damage**

Do not tow with a sling-type truck, either from the front or rear.

 CAUTION

■ **Towing with a wheel lift-type truck is not recommended**

If a flat bed truck is not available, observe the following precautions to prevent damage to the drive train or body.

**From the front**

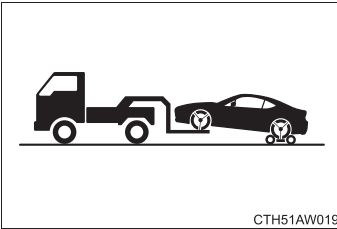

Never tow a vehicle from the front with the rear wheels on the ground. Use a towing dolly under the rear wheels.

**From the rear**

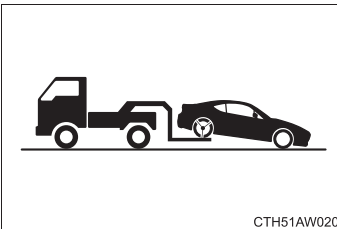

Ensure that the front lower body components have adequate clearance to prevent contact with the road surface under all conditions.

Vehicles without a keyless access with push button start system: Turn the engine switch to the “ACC” position so that the steering wheel is unlocked.

Vehicles with a keyless access with push button start system: Turn the push-button ignition switch to “ACC” mode so that the steering wheel is unlocked.

### Using a flat bed truck

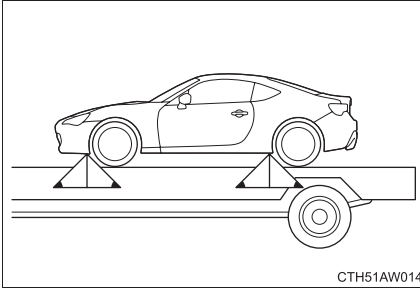

If you use chains or cables to tie down your vehicle, the angles shaded in black must be 45°.

Do not overly tighten the tie downs or the vehicle may be damaged.

## 5-1. Essential information

### If you think something is wrong

If you notice any of the following symptoms, your vehicle probably needs adjustment or repair. Contact your SUBARU dealer as soon as possible.

#### ■ Visible symptoms

- Fluid leaks under the vehicle  
(Water dripping from the air conditioning after use is normal.)
- Flat-looking tires or uneven tire wear
- Engine coolant temperature gauge needle continually points higher than normal

#### ■ Audible symptoms

- Changes in exhaust sound
- Excessive tire squeal when cornering
- Strange noises related to the suspension system
- Pinging or other noises related to the engine

#### ■ Operational symptoms

- Engine missing, stumbling or running rough
- Appreciable loss of power
- Vehicle pulls heavily to one side when braking
- Vehicle pulls heavily to one side when driving on a level road
- Loss of brake effectiveness, spongy feeling, pedal almost touches the floor

## 5-1. Essential information

# Fuel pump shut off system

To minimize the risk of fuel leakage when the engine stalls or an air-bag inflates upon collision, the fuel pump shut off system stops supplying fuel to the engine.

Follow the procedure below to restart the engine after the system is activated.

### Vehicles without a keyless access with push button start system

**STEP 1** Turn the engine switch to the “ACC” or “LOCK” position.

**STEP 2** Restart the engine.

### Vehicles with a keyless access with push button start system

**STEP 1** Turn the push-button ignition switch to “ACC” mode or turn it off.

**STEP 2** Restart the engine.

### CAUTION

#### ■ Before starting the engine

Inspect the ground under the vehicle.

If you find that fuel has leaked on to the ground, the fuel system has been damaged and is in need of repair. Do not restart the engine.



## 5-2. Steps to take in an emergency

### If a warning light turns on or a warning buzzer sounds...

Calmly perform the following actions if any of the warning lights turn on or flash. If a light turns on or flashes, but then turns off, this does not necessarily indicate a malfunction in the system.



**Stop the vehicle immediately. Continuing to drive the vehicle may be dangerous.**

The following warning indicates a possible problem in the brake system. Immediately stop the vehicle in a safe place and contact your SUBARU dealer.

Warning light	Warning light/Details
 (U.S.A.)  (Canada)	<b>Brake system warning light</b> <ul style="list-style-type: none"><li>• Low brake fluid</li><li>• Malfunction in the brake system</li></ul> This light also comes on when the parking brake is not released. If the light turns off after the parking brake is fully released the system is operating normally.

**Stop the vehicle immediately.**









The following warning indicates the possibility of damage to the vehicle that may lead to an accident. Immediately stop the vehicle in a safe place and contact your SUBARU dealer.

Warning light	Warning light/Details
	<b>Charging system warning light</b> Indicates a malfunction in the vehicle's charging system.
	<b>Low engine oil pressure warning light</b> Indicates that the engine oil pressure is too low.



**Have the vehicle inspected immediately.**

Failing to investigate the cause of the following warnings may lead to the system operating abnormally and possibly cause an accident. Have the vehicle inspected by your SUBARU dealer immediately.

Warning light	Warning light/Details
 (U.S.A.)  (Canada)	<p><b>Malfunction indicator lamp</b></p> <p>Indicates a malfunction in:</p> <ul style="list-style-type: none"> <li>• The electronic engine control system;</li> <li>• The electronic throttle control system;</li> <li>• The electronic automatic transmission control system.</li> </ul>
	<p><b>SRS airbag system warning light</b></p> <p>Indicates a malfunction in:</p> <ul style="list-style-type: none"> <li>• The SRS airbag system;</li> <li>• The seatbelt pretensioner system;</li> <li>• The front passenger occupant detection system.</li> </ul>
 (U.S.A.)  (Canada)	<p><b>ABS warning light</b></p> <p>Indicates a malfunction in:</p> <ul style="list-style-type: none"> <li>• The ABS;</li> <li>• The brake assist system.</li> </ul>
	<p><b>Electric power steering warning light (warning buzzer)</b></p> <p>Indicates a malfunction in the electric power steering system.</p>
 (Flashes in yellow for 15 seconds.)	<p><b>Keyless access with push button start system indicator light (if equipped)</b></p> <p>Indicates a malfunction in the keyless access with push button start system.</p>
	<p><b>Slip indicator</b></p> <p>Indicates a malfunction in:</p> <ul style="list-style-type: none"> <li>• The Vehicle stability control (VSC) system;</li> <li>• The TRAC system</li> </ul>

Warning light	Warning light/Details
 (Comes on in yellow)	<p><b>Cruise control indicator light</b>                      Indicates a malfunction in the cruise control system.</p>

**■ If the malfunction indicator lamp comes on while driving**

First check the following:

- Is the fuel tank empty?  
If it is, fill the fuel tank immediately.
- Is the fuel tank cap loose?  
If it is, tighten it securely.

The malfunction indicator lamp will go off after several driving trips. If the malfunction indicator lamp does not go off even after several trips, contact your SUBARU dealer as soon as possible.

**■ SRS airbag system warning light**

→P. 120

**■ Electric power steering warning light (warning buzzer)**

The electric power steering warning light may come on and the warning buzzer may sound when the voltage is low or the voltage drops.





**▲ WARNING**



**■ When the electric power steering warning light comes on**

The steering wheel may become extremely heavy. If the steering wheel becomes heavier than usual when operating, hold firmly and operate using more force than usual.

**Follow the correction procedures.**

After taking the specified steps to correct the suspected problem, check that the warning light turns off.

Warning light	Warning light/Details	Correction procedure
	<b>Open door warning light</b> Indicates that a door or the trunk lid is not fully closed.	Check that both side doors and the trunk lid are closed.
	<b>Low fuel level warning light</b> Remaining fuel (Approximately 1.8 gal. [7.0 L, 1.5 Imp. gal.] or less)	Refuel the vehicle.
 (On the instrument cluster)	<b>Driver's seatbelt reminder light (warning buzzer)*<sup>1</sup></b> Warns the driver to fasten his/her seatbelt.	Fasten the seatbelt.
 (On the center panel)	<b>Front passenger's seatbelt reminder light (warning buzzer)*<sup>2</sup></b> Warns the front passenger to fasten his or her seatbelt.	Fasten the seatbelt.

Warning light	Warning light/Details	Correction procedure
	<p><b>Tire pressure warning light (if equipped)</b></p>	
	<p>When the light comes on: Low tire inflation pressure such as</p> <ul style="list-style-type: none"> <li>• Natural causes (→P. 369)</li> <li>• Flat tire (→P. 378)</li> </ul>	<p>Adjust the tire inflation pressure to the specified level.</p> <p>The light will turn off after a few minutes. In case the light does not turn off even if the tire inflation pressure is adjusted, have the system checked by your SUBARU dealer.</p>
	<p>When the light comes on after blinking for approximately one minute: Malfunction in the tire pressure monitoring system (→P. 371)</p>	<p>Have the system checked by your SUBARU dealer.</p>
	<p><b>Automatic transmission fluid temperature warning light (if equipped)</b></p> <p>Indicates that the automatic transmission fluid temperature is too high.</p>	<p>Stop the vehicle in a safe place and shift the select lever to P.</p> <p>If the light goes off after a little while, the vehicle can be driven. If the light does not go off, contact your SUBARU dealer.</p>

**\*1: Driver’s seatbelt buzzer:**

**Vehicles without a keyless access with push button start system**

The driver’s seatbelt buzzer sounds to alert the driver that his or her seatbelt is not fastened. Once the engine switch is turned to the “ON” position, the buzzer sounds for 6 seconds. If the vehicle reaches a speed of 12 mph (20 km/h), the buzzer sounds once. If the seatbelt is still unfastened after 30 seconds, the buzzer will sound intermittently for 10 seconds. Then, if the seatbelt is still unfastened, the buzzer will sound in a different tone for 20 more seconds.

### **Vehicles with a keyless access with push button start system**

The driver's seatbelt buzzer sounds to alert the driver that his or her seatbelt is not fastened. Once the push-button ignition switch is turned to "ON" mode, the buzzer sounds for 6 seconds. If the vehicle reaches a speed of 12 mph (20 km/h), the buzzer sounds once. If the seatbelt is still unfastened after 30 seconds, the buzzer will sound intermittently for 10 seconds. Then, if the seatbelt is still unfastened, the buzzer will sound in a different tone for 20 more seconds.

#### **\*2: Front passenger's seatbelt buzzer:**

The front passenger's seatbelt buzzer sounds to alert the front passenger that his or her seatbelt is not fastened. The buzzer sounds once if the vehicle reaches a speed of 12 mph (20 km/h). If the seatbelt is still unfastened after 30 seconds, the buzzer will sound intermittently for 10 seconds. Then, if the seatbelt is still unfastened, the buzzer will sound in a different tone for 20 more seconds.

---

#### **■ Low fuel level warning light**

When the vehicle is on an incline, curve and so forth, the fuel inside the tank moves, which may cause the warning light to come on early.

#### **■ Front passenger detection sensor and passenger seatbelt reminder and warning buzzer**

- If luggage is placed on the front passenger seat, the front passenger detection sensor may cause the warning light to flash and warning buzzer to sound, even if a passenger is not sitting in the seat.
- If a cushion is placed on the seat, the sensor may not detect a passenger, and the warning light may not operate properly.

#### **■ When the tire pressure warning light comes on (if equipped)**

Check the tire inflation pressure and adjust to the appropriate level.

#### **■ The tire pressure warning light may turn on due to natural causes**

The tire pressure warning light may turn on due to natural causes such as natural air leaks or tire inflation pressure changes caused by temperature. In this case, adjusting the tire inflation pressure will turn off the warning light (after a few minutes).

■ **When a tire is replaced with a spare tire (vehicles with a tire pressure monitoring system)**

The compact spare tire is not equipped with a tire pressure warning valve and transmitter. If a tire goes flat, the tire pressure warning light will not turn off even though the flat tire has been replaced with the spare tire. Replace the spare tire with the repaired tire and adjust the tire inflation pressure. The tire pressure warning light will go off after a few minutes.

■ **If the tire pressure monitoring system is inoperative (if equipped)**

The tire pressure monitoring system will be disabled in the following conditions:

(When the condition becomes normal, the system will work properly.)

- If tires not equipped with tire pressure warning valves and transmitters are used.
- If the ID code on the tire pressure warning valves and transmitters is not registered in the tire pressure warning computer.
- If the tire inflation pressure is 55 psi (380 kPa, 3.87 kgf/cm<sup>2</sup> or bar) or higher.

The tire pressure monitoring system may be disabled in the following conditions:

(When the condition becomes normal, the system will work properly.)

- If electronic devices or facilities using similar radio wave frequencies are nearby.
- If a radio set at similar frequencies is in use in the vehicle.
- If there is a lot of snow or ice on the vehicle, in particular around the wheels or wheel housings.
- If non-genuine SUBARU wheels are used. (Even if you use SUBARU wheels, the tire pressure monitoring system may not work properly with some types of tires.)
- If tire chains are used.

■ **If the tire pressure warning light frequently comes on after blinking for approximately one minute (if equipped)**

If the tire pressure warning light frequently comes on after blinking for approximately one minute when the push-button ignition switch is turned to “ON” mode (vehicles with a keyless access with push button start system) or the engine switch is turned to the “ON” position (vehicles without a keyless access with push button start system), have it checked your SUBARU dealer.

 **WARNING**

■ **If the tire pressure warning light comes on (if equipped)**

Be sure to observe the following precautions. Failure to do so could cause loss of vehicle control and result in death or serious injury.

- Stop your vehicle in a safe place as soon as possible. Adjust the tire inflation pressure immediately.
- If the tire pressure warning light comes on even after tire inflation pressure adjustment, it is probable that you have a flat tire. Check the tires. If the tire is flat, change to the spare tire and have the flat tire repaired by the nearest SUBARU dealer.
- Avoid abrupt maneuvering and braking. If the vehicle tires deteriorate, you could lose control of the steering wheel or the brakes.

■ **If a blowout or sudden air leakage should occur (vehicles with a tire pressure monitoring system)**

The tire pressure monitoring system may not activate immediately.

 **WARNING**

**■ Maintenance of the tires (vehicles with a tire pressure monitoring system)**

Each tire, including the spare (if provided), should be checked monthly when cold and inflated to the inflation pressure recommended by the vehicle manufacturer on the vehicle placard or tire inflation pressure label (tire and load information label). (If your vehicle has tires of a different size than the size indicated on the vehicle placard or tire inflation pressure label [tire and load information label], you should determine the proper tire inflation pressure for those tires.)

As an added safety feature, your vehicle has been equipped with a tire pressure monitoring system (TPMS) that illuminates a low tire pressure telltale (tire pressure warning light) when one or more of your tires is significantly under-inflated. Accordingly, when the low tire pressure telltale (tire pressure warning light) illuminates, you should stop and check your tires as soon as possible, and inflate them to the proper pressure. Driving on a significantly under-inflated tire causes the tire to overheat and can lead to tire failure. Under-inflation also reduces fuel efficiency and tire tread life, and may affect the vehicle's handling and stopping ability.

Please note that the TPMS is not a substitute for proper tire maintenance, and it is the driver's responsibility to maintain correct tire pressure, even if under-inflation has not reached the level to trigger illumination of the TPMS low tire pressure telltale (tire pressure warning light).

Your vehicle has also been equipped with a TPMS malfunction indicator to indicate when the system is not operating properly. The TPMS malfunction indicator is combined with the low tire pressure telltale (tire pressure warning light). When the system detects a malfunction, the telltale will flash for approximately one minute and then remain continuously illuminated. This sequence will continue upon subsequent vehicle start-ups as long as the malfunction exists. When the malfunction indicator is illuminated, the system may not be able to detect or signal low tire pressure as intended.



 **WARNING**

TPMS malfunctions may occur for a variety of reasons, including the installation of replacement or alternate tires or wheels on the vehicle that prevent the TPMS from functioning properly. Always check the TPMS malfunction telltale after replacing one or more tires or wheels on your vehicle to ensure that the replacement or alternate tires and wheels allow the TPMS to continue to function properly.

 **CAUTION**



■ **Precaution when installing a different tire (vehicles with a tire pressure monitoring system)**

When a tire of a different specification or maker is installed, the tire pressure monitoring system may not operate properly.





**Follow the correction procedures. (vehicles with a keyless access with push button start system)**

After taking the specified steps to correct the suspected problem, check that the warning light goes off.

Interior buzzer	Exterior buzzer	Warning light	Warning light/Details	Correction procedure
Continuous	Continuous	 (Flashes in yellow)	<p><b>Keyless access with push button start system indicator light</b></p> <p>Vehicles with an automatic transmission:                      The access key was carried outside the vehicle and the driver's door was opened and closed while any shift position other than P was selected without turning off the push-button ignition switch.</p>	<ul style="list-style-type: none"> <li>• Change the shift position to P.</li> <li>• Bring the access key back into the vehicle.</li> </ul>

Interior buzzer	Exterior buzzer	Warning light	Warning light/Details	Correction procedure
Once	3 times	 (Flashes in yellow)	<p><b>Keyless access with push button start system indicator light</b></p> <p>Vehicles with an automatic transmission:            The access key was carried outside the vehicle and the driver's door was opened and closed while the shift position P was selected without turning off the push-button ignition switch.</p> <p>Vehicles with a manual transmission:            The access key was carried outside the vehicle and the driver's door was opened and closed while the shift position neutral was selected without turning off the push-button ignition switch.</p>	Turn the push-button ignition switch off or bring the access key back into the vehicle.
Once	3 times	 (Flashes in yellow)	<p><b>Keyless access with push button start system indicator light</b></p> <p>Indicates that a door other than the driver's door has been opened and closed with the push-button ignition switch in any mode other than off and the access key outside of the detection area.</p>	Confirm the location of the access key.

5-2. Steps to take in an emergency

Interior buzzer	Exterior buzzer	Warning light	Warning light/Details	Correction procedure
Once	Continuous (10 seconds)	 (Flashes in yellow)	<b>Keyless access with push button start system indicator light</b> An attempt was made to exit the vehicle with the access key and lock the doors without first turning the push-button ignition switch off.	Turn the push-button ignition switch off and lock the doors again.
Once	—	 (Flashes in yellow for 15 seconds.)	<b>Keyless access with push button start system indicator light</b> Indicates that the access key is not present when attempting to start the engine.	Confirm the location of the access key.
Intermittently (7 seconds)	—	 (Flashes in yellow)	<b>Keyless access with push button start system indicator light</b> An attempt was made to drive when the regular key was not inside the vehicle.	Confirm that the access key is inside the vehicle.
Once	—	 (Flashes in yellow for 15 seconds.)	<b>Keyless access with push button start system indicator light</b> Indicates that the access key battery is low.	Replace the battery. (→P. 325)
Once	—	 (Flashes quickly in green for 15 seconds.)	<b>Keyless access with push button start system indicator light</b> Indicates that the steering lock has not been released.	Release the steering lock. (→P. 166)

Interior buzzer	Exterior buzzer	Warning light	Warning light/Details	Correction procedure
Once	—	 (Flashes in yellow for 15 seconds.)	<p><b>Keyless access with push button start system indicator light</b></p> <p>The access key could not be detected in the vehicle even after the push-button ignition switch was pressed once.</p>	<p>Vehicles with an automatic transmission: Touch the access key to the push-button ignition switch while depressing the brake pedal.</p> <p>Vehicles with a manual transmission: Touch the access key to the push-button ignition switch while depressing with the clutch pedal.</p>

## 5-2. Steps to take in an emergency If you have a flat tire

**Remove the flat tire and replace it with the spare provided.**

### ■ Before jacking up the vehicle

- Stop the vehicle on a hard, flat surface.
- Set the parking brake.
- Shift the select lever to P (vehicles with an automatic transmission) or shift lever to R (vehicles with a manual transmission).
- Stop the engine.
- Turn on the hazard warning flashers.

### ■ Location of the spare tire, jack and tools

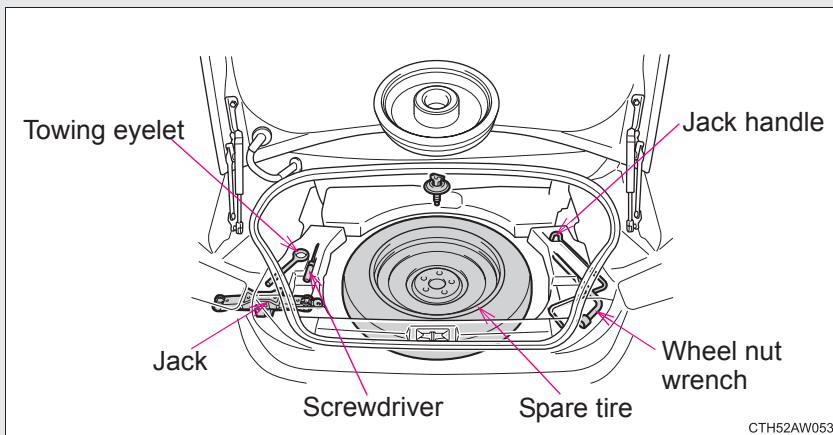

## Taking out the spare tire

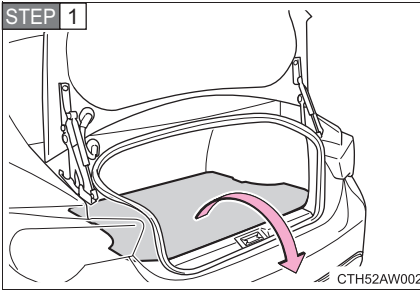

Remove the luggage mat.

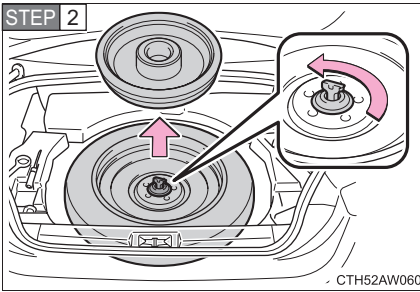

Remove the cover and loosen the center fastener that secures the spare tire.

## Replacing a flat tire

STEP 1

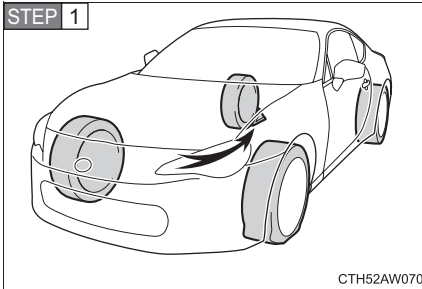

CTH52AW070

Chock the tires.

Flat tire		Wheel chock positions
Front	Left-hand side	Behind the rear right-hand side tire
	Right-hand side	Behind the rear left-hand side tire
Rear	Left-hand side	In front of the front right-hand side tire
	Right-hand side	In front of the front left-hand side tire

STEP 2

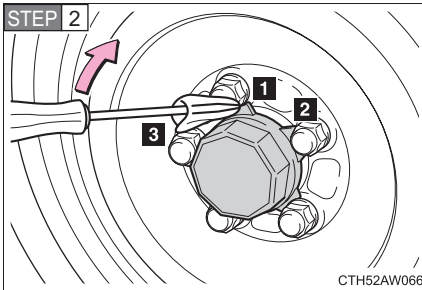

CTH52AW066

Vehicles with steel wheels:  
Remove the wheel ornament.

Using a flathead screwdriver, release the wheel ornament's claws in the order shown in the illustration.

To prevent damage to the wheel and wheel ornament, cover the tip of the screwdriver with a rag.



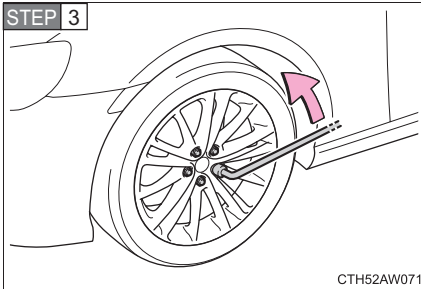

Slightly loosen the wheel nuts (one turn).

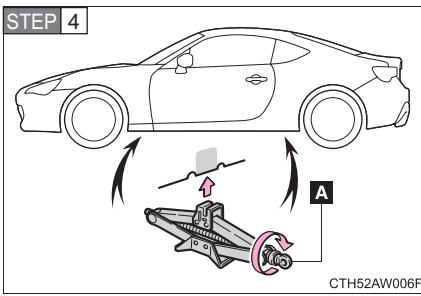

Turn the tire jack portion "A" by hand until the notch of the jack is in contact with the jack point.

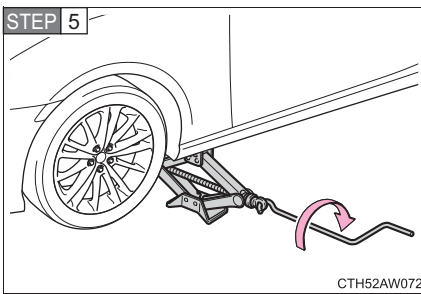

Raise the vehicle until the tire is slightly raised off the ground.

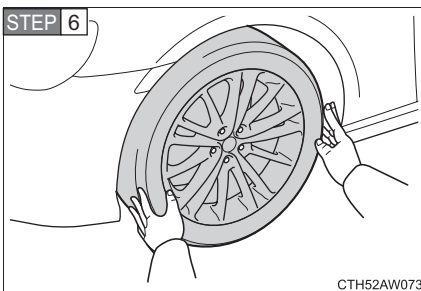

Remove all the wheel nuts and the tire.

When resting the tire on the ground, place the tire so that the wheel design faces up to avoid scratching the wheel surface.

## Installing the spare tire

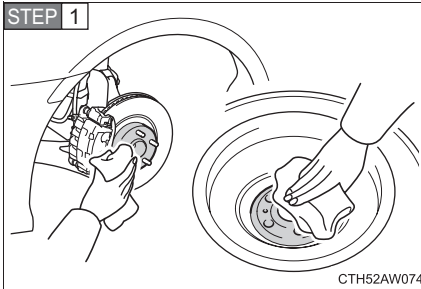

Remove any dirt or foreign matter from the wheel contact surface.

If foreign matter is on the wheel contact surface, the wheel nuts may loosen while the vehicle is in motion, and the tire may come off the vehicle.

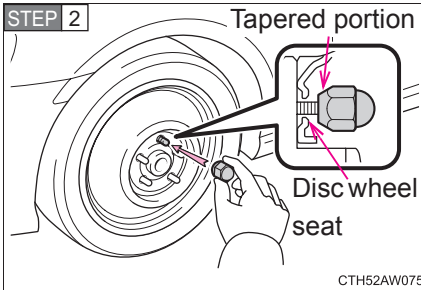

Install the spare tire and loosely tighten each wheel nut by hand to approximately the same amount.

Tighten the wheel nuts until the tapered portion comes into loose contact with the disc wheel seat.

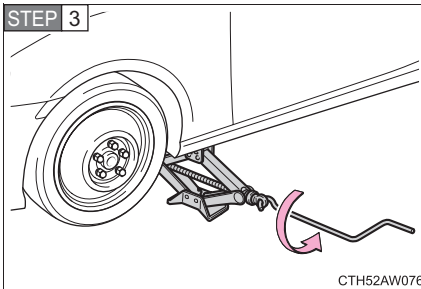

Lower the vehicle.

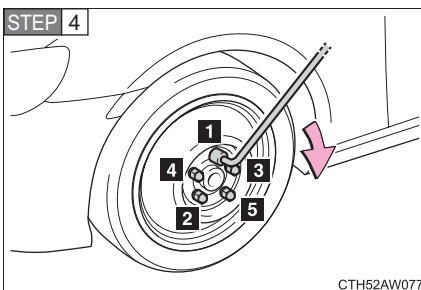

Firmly tighten each nut two or three times in the order shown in the illustration.

**Tightening torque:**  
89 ft•lbf (120 N•m, 12.2 kgf•m)

**STEP 5** Stow the flat tire, tire jack and all tools.

---

■ **The compact spare tire**

- The compact spare tire is identified by the label “TEMPORARY USE ONLY” on the tire sidewall.  
Use the compact spare tire temporarily only in an emergency.
- Make sure to check the tire pressure of the compact spare tire.  
(→P. 420)

■ **When using the compact spare tire (vehicles with a tire pressure monitoring system)**

As the compact spare tire is not equipped with the tire pressure warning valve and transmitter, low inflation pressure of the spare tire will not be warned. Also, if you replace the compact spare tire after the tire pressure warning light comes on, the light remains on.

■ **If you have a flat rear tire**

Install the compact spare tire on the front of the vehicle. Perform the following steps.

**STEP 1** Replace a front tire with the compact spare tire.

**STEP 2** Replace the flat rear tire with the tire removed from the front of the vehicle.

■ **After completing the tire change (vehicles with a tire pressure monitoring system)**

The tire pressure monitoring system must be reset. (→P. 309)

■ **Storing the tire**

Always install the center fastener as shown in the illustration below.

**Compact spare tire**

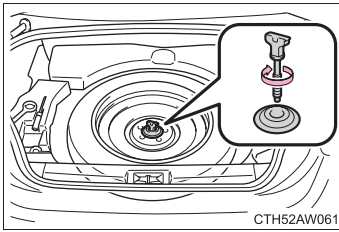

**Except compact spare tire**

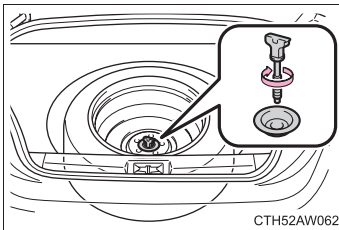

■ **Installing the wheel ornament (vehicles with steel wheels)**

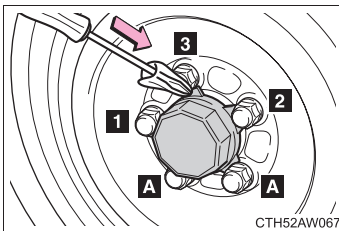

After installing “A” as shown in the illustration, push the center ornament claws in the order shown in the illustration using a flathead screwdriver.

To prevent damage to the wheel and wheel ornament, cover the tip of the flathead screwdriver with a rag.

**WARNING****■ Using the tire jack**

Improper use of the tire jack may lead to death or serious injuries due to the vehicle suddenly falling off the jack.

- Do not use the tire jack for any purpose other than replacing tires or installing and removing tire chains.
- Only use the tire jack that comes with this vehicle for replacing a flat tire.  
Do not use it on other vehicles, and do not use other tire jacks for replacing tires on this vehicle.
- Always check that the tire jack is securely set to the jack point.
- Do not put any part of your body under the vehicle supported by a jack.
- Do not start or run the engine while your vehicle is supported by the jack.
- Do not raise the vehicle while someone is in it.
- When raising the vehicle, do not put an object on or under the jack.
- Do not raise the vehicle to a height greater than that required to replace the tire.
- Use a jack stand if it is necessary to get under the vehicle.

Take particular care when lowering the vehicle to ensure that no one working on or near the vehicle may be injured.

 **WARNING**

■ **Replacing a flat tire**

- Do not touch the disc wheels or the area around the brakes immediately after the vehicle has been driven.  
After the vehicle has been driven the disc wheels and the area around the brakes will be extremely hot. Touching these areas with hands, feet or other body parts while changing a tire, etc. may result in burns.
- Do not attach a heavily damaged wheel ornament, as it may fly off the wheel while the vehicle is moving.
- Failure to follow these precautions could cause the wheel nuts to loosen and the tire to fall off, resulting in death or serious injury.
  - Have the wheel nuts tightened with a torque wrench to 89 ft•lbf (120 N•m, 12.2 kgf•m) as soon as possible after changing wheels.
  - When installing a tire, only use wheel nuts that have been specifically designed for that wheel.
  - If there are any cracks or deformations in the bolt screws, nut threads or bolt holes of the wheel, have the vehicle inspected by your SUBARU dealer.
  - When installing the wheel nuts, be sure to install them with the tapered ends facing inward. (→P. 320)

**WARNING****■ When using the compact spare tire**

- Remember that your compact spare tire is specifically designed for use with your vehicle. Do not use your compact spare tire on another vehicle.
- Do not use two compact spare tires simultaneously.
- Replace the compact spare tire with a standard tire as soon as possible.
- Avoid sudden acceleration, abrupt steering, sudden braking and shifting operations that cause sudden engine braking.
- Install the compact spare tire on a front wheel.

**■ When storing the compact spare tire**

Be careful not to catch fingers or other body parts between the compact spare tire and the body of the vehicle.

**■ Speed limit when using the compact spare tire**

Do not drive at speeds in excess of 50 mph (80 km/h) when a compact spare tire is installed on the vehicle.

The compact spare tire is not designed for driving at high speeds. Failing to observe this precaution may lead to an accident causing death or serious injury.

**■ When the spare tire is attached**

The vehicle speed may not be correctly detected, and the following systems may not operate correctly:

- ABS & brake assist
- Vehicle stability control (VSC)
- TRAC
- Electric power steering
- Navigation system (if equipped)
- Cruise control
- LSD (if equipped)

 CAUTION

■ **Do not drive the vehicle with a flat tire.**

Do not continue driving with a flat tire.

Driving even a short distance with a flat tire can damage the tire and the wheel beyond repair.

■ **Be careful when driving over bumps with the compact spare tire installed on the vehicle.**

The vehicle becomes lower when driving with the compact spare tire compared to when driving with standard tires. Be careful when driving over uneven road surfaces.

■ **Driving with tire chains and the compact spare tire**

Do not fit tire chains to the compact spare tire.

Tire chains may damage the vehicle body and adversely affect driving performance.

■ **When replacing the tires (vehicles with a tire pressure monitoring system)**

When removing or fitting the wheels, tires or the tire pressure warning valve and transmitter, contact your SUBARU dealer as the tire pressure warning valve and transmitter may be damaged if not handled correctly.

■ **To avoid damage to the tire pressure warning valves and transmitters (vehicles with a tire pressure monitoring system)**

When a tire is repaired with liquid sealants, the tire pressure warning valve and transmitter may not operate properly. If a liquid sealant is used, contact your SUBARU dealer or other qualified service shop as soon as possible. Make sure to replace the tire pressure warning valve and transmitter when replacing the tire. (→P. 309)

■ **Stowing the jack**

When stowing the jack in the jack holder, make sure that the part that the jack handle attaches to is pointing towards the inside of the trunk. Failure to do so may damage the vehicle body.



## 5-2. Steps to take in an emergency If the engine will not start

If the engine will not start even though correct starting procedures are being followed (→P. 160, 169), consider each of the following points.

■ **The engine will not start even when the starter motor operates normally.**

One of the following may be the cause of the problem.

- There may not be sufficient fuel in the vehicle's tank.  
Refuel the vehicle.
- The engine may be flooded.  
Try to restart the engine once more following correct starting procedures. (→P. 160, 169)
- There may be a malfunction in the engine immobilizer system.  
(→P. 77)

■ **The starter motor turns over slowly, the interior lights and headlights are dim, or the horn does not sound or sounds at a low volume.**

One of the following may be the cause of the problem.

- The battery may be discharged. (→P. 398)
- The battery terminal connections may be loose or corroded.

■ **The starter motor does not turn over. (vehicles with a keyless access with push button start system)**

The engine starting system may be malfunctioning due to an electrical problem such as an open circuit or a blown fuse. However, an interim measure is available to start the engine.  
(→P. 390)

■ **The starter motor does not turn over, the interior lights and headlights do not turn on, or the horn does not sound.**

One of the following may be the cause of the problem.

- One or both of the battery terminals may be disconnected.
- The battery may be discharged. (→P. 398)
- There may be a malfunction in the steering lock system. (vehicles with a keyless access with push button start system)

Contact your SUBARU dealer if the problem cannot be repaired, or if repair procedures are unknown.

**Emergency start function (vehicles with a keyless access with push button start system)**

When the engine does not start, the following steps can be used as an interim measure to start the engine if the push-button ignition switch is functioning normally:

**Vehicles with an automatic transmission**

**STEP 1** Set the parking brake.

**STEP 2** Put the select lever in P.

**STEP 3** Set the push-button ignition switch to “ACC” mode.

**STEP 4** Press and hold the push-button ignition switch about 15 seconds while depressing the brake pedal firmly.

Even if the engine can be started using the above steps, the system may be malfunctioning. Have the vehicle checked by your SUBARU dealer.

### **Vehicles with a manual transmission**

**STEP 1** Set the parking brake.

**STEP 2** Put the shift lever in neutral.

**STEP 3** Turn the push-button ignition switch to “ACC” mode.

**STEP 4** Push and hold the push-button ignition switch for about 15 seconds while depressing the brake pedal and clutch pedal firmly.

Even if the engine can be started using the above steps, the system may be malfunctioning. Have the vehicle checked by your SUBARU dealer.

## 5-2. Steps to take in an emergency

If the select lever cannot be shifted from P (vehicles with an automatic transmission)

If the select lever cannot be shifted with your foot on the brake, there may be a problem with the shift lock system (a system to prevent accidental operation of the select lever). Have the vehicle inspected by your SUBARU dealer immediately.

The following steps may be used as an emergency measure to ensure that the select lever can be shifted.

**STEP 1** Set the parking brake.

**STEP 2** Vehicles without a keyless access with push button start system: Turn the engine switch to the “ACC” position.

Vehicles with a keyless access with push button start system: Turn the push-button ignition switch to “ACC” mode.

**STEP 3** Depress the brake pedal.

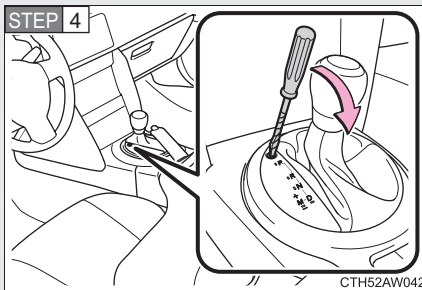

Pry the cover up with a flat-head screwdriver or equivalent.

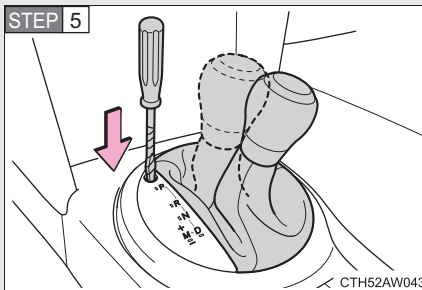

Press the shift lock release button.

The select lever can be shifted while the button is pressed.

## 5-2. Steps to take in an emergency

### If you lose your keys

New genuine keys can be made by your SUBARU dealer. For vehicles without a keyless access with push button start system, bring a master key and the key number stamped on the key number plate. For vehicles with a keyless access with push button start system, bring the other key and the key number stamped on the key number plate.

## 5-2. Steps to take in an emergency

If the access key does not operate properly (vehicles with a keyless access with push button start system)

If communication between the access key and vehicle is interrupted (→P. 30) or the access key cannot be used because the battery is depleted, the keyless access with push button start system and remote keyless entry system cannot be used. In such cases, the doors and trunk lid can be opened or the engine can be started by following the procedure below.

### Unlocking and locking the doors, unlocking the trunk lid

Use the mechanical key built in to the access keys to operate the doors and trunk lid. (→P. 21)

Vehicles with an alarm: An alarm will sound if the alarm is set when the trunk lid or doors are unlocked. (→P. 81)

#### Doors

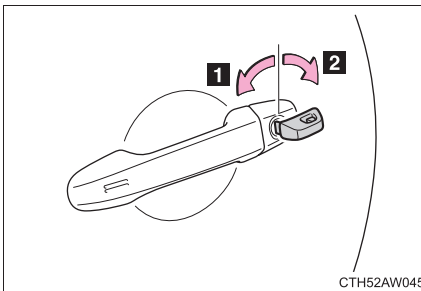

- 1 Locks driver's door
- 2 Unlocks driver's door

#### Trunk lid

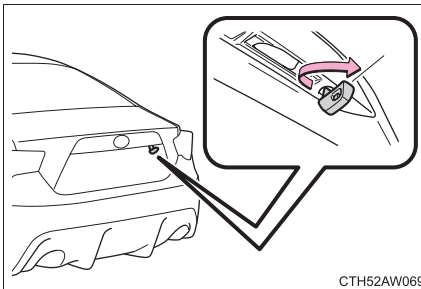

Turn the mechanical key clockwise to open.

## Starting the engine

### Vehicles with an automatic transmission

**STEP 1** Ensure that the select lever is in P and firmly depress the brake pedal.

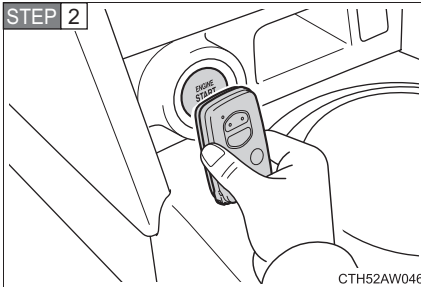

Touch the SUBARU emblem side of the access key to the push-button ignition switch.

When the access key is detected, a buzzer sounds and the push-button ignition switch will turn to "ON" mode.

When the keyless access with push button start system is deactivated in customization setting, the push-button ignition switch will turn to "ACC" mode. Modes can be changed by pressing the push-button ignition switch with the brake pedal released. (The mode changes each time the switch is pressed.)

**STEP 3** Firmly depress the brake pedal and check that the keyless access with push button start system indicator light (green) turns on.

**STEP 4** Press the push-button ignition switch.

In the event that the push-button ignition switch still cannot be operated, contact your SUBARU dealer.

### Vehicles with a manual transmission

**STEP 1** Ensure that the shift lever is in neutral and depress the clutch pedal.

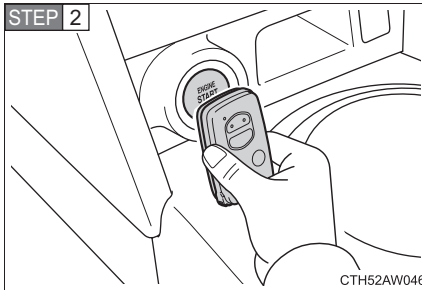

Touch the SUBARU emblem side of the access key to the push-button ignition switch.

When the access key is detected, a buzzer sounds and the push-button ignition switch will turn to “ON” mode.

When the keyless access with push button start system is deactivated in customization setting, the push-button ignition switch will turn to “ACC” mode. Modes can be changed by pressing the push-button ignition switch with the clutch pedal released. (The mode changes each time the switch is pressed.)

**STEP 3** Firmly depress the clutch pedal and check that the keyless access with push button start system indicator light (green) turns on.

**STEP 4** Press the push-button ignition switch.

In the event that the push-button ignition switch still cannot be operated, contact your SUBARU dealer.



---

**■ Stopping the engine**

Vehicles with an automatic transmission: Shift the select lever to P and press the push-button ignition switch as you normally do when stopping the engine.

Vehicles with a manual transmission: Shift the shift lever to neutral and press the push-button ignition switch as you normally do when stopping the engine.

**■ Replacing the key battery**

As the above procedure is a temporary measure, it is recommended that the access key battery be replaced immediately when the battery depletes.

(→P. 325)

**■ Alarm (if equipped)**

Using the mechanical key to lock the doors will not set the alarm system.

If a door is unlocked using the mechanical key when the alarm system is set, the alarm may be triggered. (→P. 81)

**■ If the doors cannot be locked or unlocked by the keyless access with push button start system**

Lock and unlock the doors by the mechanical key or remote keyless entry system.

## 5-2. Steps to take in an emergency If the battery is discharged

The following procedures may be used to start the engine if the vehicle's battery is discharged.

You can call your SUBARU dealer or a qualified repair shop.

If you have a set of jumper (or booster) cables and a second vehicle with a 12-volt battery, you can jump start your vehicle following the steps below.

**STEP 1** Connect the jumper cables according to the following procedures:

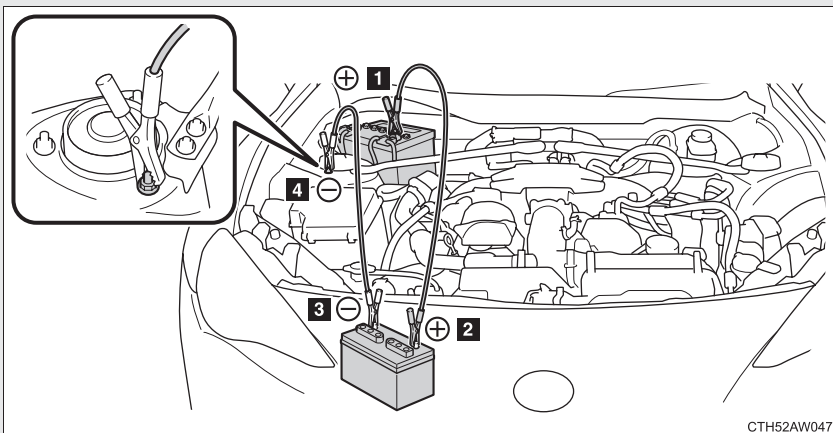

- 1** Positive (+) battery terminal on your vehicle
- 2** Positive (+) battery terminal on the second vehicle
- 3** Negative (-) battery terminal on the second vehicle
- 4** Connect the jumper cable to ground on your vehicle as shown in the illustration.

**STEP 2** Start the engine of the second vehicle. Increase the engine speed slightly and maintain at that level for approximately 5 minutes to recharge the battery of your vehicle.

**STEP 3** Vehicles with a keyless access with push button start system only: Open and close any of the doors of your vehicle with the push-button ignition switch off.

**STEP 4** Vehicles without a keyless access with push button start system: Maintain the engine speed of the second vehicle and turn the engine switch to the “ON” position, then start the vehicle's engine.

Vehicles with a keyless access with push button start system: Maintain the engine speed of the second vehicle and turn the push-button ignition switch to “ON” mode, then start the vehicle's engine.

**STEP 5** Once the vehicle's engine has started, remove the jumper cables in the exact reverse order in which they were connected.

Once the engine starts, have the vehicle checked at your SUBARU dealer as soon as possible.

■ **Starting the engine when the battery is discharged**

The engine cannot be started by push-starting.

■ **Avoiding a discharged battery**

- Turn off the headlights and the air conditioning system while the engine is off.
- Turn off any unnecessary electrical components when the vehicle is running at a low speed for an extended period, such as in heavy traffic, etc.

■ **Charging the battery**

The electricity stored in the battery will discharge gradually even when the vehicle is not in use, due to natural discharge and the draining effects of certain electrical appliances. If the vehicle is left for a long time, the battery may discharge, and the engine may be unable to start. (The battery recharges automatically during driving.)

■ **Precautions when the battery is discharged (vehicles with a keyless access with push button start system)**

- In some cases, it may not be possible to unlock the doors using the keyless access with push button start system when the battery is discharged. Use the remote keyless entry system or the mechanical key to lock or unlock the doors.
- The engine may not start on the first attempt after the battery has recharged but will start normally after the second attempt. This is not a malfunction.
- The push-button ignition switch mode is memorized by the vehicle. When the battery is reconnected, the system will return to the mode it was in before the battery was discharged. Before disconnecting the battery, turn the push-button ignition switch off.

If you are unsure what mode the push-button ignition switch was in before the battery discharged, be especially careful when reconnecting the battery.

 **WARNING****■ Avoiding battery fires or explosions**

Observe the following precautions to prevent accidentally igniting the flammable gas that may be emitted from the battery.

- Make sure the jumper cable is connected to the correct terminal and that it is not unintentionally in contact with any part other than the intended terminal.
- Do not allow the jumper cables to come into contact with the “+” and “-” terminals.
- Do not allow open flame or use matches, cigarette lighters or smoke near the battery.

**■ Battery precautions**

The battery contains poisonous and corrosive acidic electrolyte, while related parts contain lead and lead compounds. Observe the following precautions when handling the battery.

- When working with the battery, always wear safety glasses and take care not to allow any battery fluids (acid) to come into contact with skin, clothing or the vehicle body.
- Do not lean over the battery.
- In the event that battery fluid comes into contact with the skin or eyes, immediately wash the affected area with water and seek medical attention. Place a wet sponge or cloth over the affected area until medical attention can be received.
- Always wash your hands after handling the battery support, terminals, and other battery-related parts.
- Do not allow children near the battery.

**■ To prevent damage to the vehicle**

Do not pull- or push-start the vehicle as the three-way catalytic converter may overheat and become a fire hazard.

 CAUTION

■ **When handling jumper cables**

Be careful that the jumper cables do not become tangled in the cooling fans or any of the belts when connecting or disconnecting them.

■ **When closing the doors**

While pushing the door glass towards the inside of the vehicle, slowly close the door.

Because the side window open/close function linked to door operation will not operate, the window may interfere with the vehicle body, possibly scratching both the vehicle body and window, or even shattering the window.

## 5-2. Steps to take in an emergency If your vehicle overheats

### If your engine overheats:

**STEP 1** Stop the vehicle in a safe place and turn off the air conditioning system.

**STEP 2** Check to see if steam is coming out from under the engine hood.

If you see steam:

Stop the engine. Carefully lift the engine hood after the steam subsides and then restart the engine.

If you do not see steam:

Leave the engine running and carefully lift the engine hood.

**STEP 3** Check to see if the cooling fan is operating.

If the fan is operating:

Wait until the temperature of the engine (shown on the instrument cluster) begins to fall and then stop the engine.

If the fan is not operating:

Stop the engine and call your SUBARU dealer.

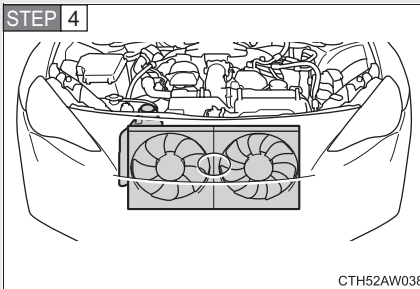

After the engine has cooled down sufficiently, check the engine coolant level and inspect the radiator core (radiator) for any leaks.

STEP 5

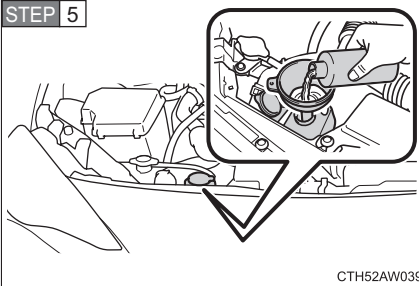

Add engine coolant if necessary.

Water can be used in an emergency if engine coolant is unavailable. (→P. 416)

Have the vehicle checked at the nearest SUBARU dealer as soon as possible.

### ■ Overheating

If you observe the following, your vehicle may be overheating.

- The engine coolant temperature gauge enters the red zone or a loss of power is experienced.
- Steam is coming from under the engine hood.

### ⚠ WARNING

#### ■ To prevent an accident or injury when inspecting under the engine hood of your vehicle

- If steam is seen coming from under the engine hood, do not open the engine hood until the steam has subsided. The engine compartment may be very hot, causing serious injury such as burns.
- Keep hands and clothing away from the fan and other belts while the engine is running.
- Do not loosen the radiator cap while the engine and radiator are hot. Serious injury, such as burns, may result from hot coolant and steam released under pressure.



 CAUTION

■ **When adding engine coolant**

Wait until the engine has cooled down before adding engine coolant.

When adding coolant, do so slowly. Adding cool coolant to a hot engine too quickly can cause damage to the engine.

## 5-2. Steps to take in an emergency If the vehicle becomes stuck

Carry out the following procedures if the tires spin or the vehicle becomes stuck in mud, dirt, or snow:

**STEP 1** Stop the engine. Set the parking brake and shift the select lever to P (vehicles with an automatic transmission) or shift lever to neutral (vehicles with a manual transmission).

**STEP 2** Remove the mud, snow or sand from around the rear wheels.

**STEP 3** Place wood, stones or some other material under the rear wheels to help provide traction.

**STEP 4** Restart the engine.

**STEP 5** Shift the select lever to the D or R position (vehicles with an automatic transmission) or shift lever to 1 or R position (vehicles with a manual transmission) and release the parking brake. Then, while exercising caution, depress the accelerator pedal.

### ■ When it is difficult to free the vehicle

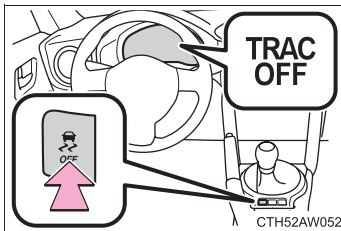

Press  to turn off TRAC. (→P. 216)

**WARNING****■ When attempting to free a stuck vehicle**

If you choose to push the vehicle back and forth to free it, make sure the surrounding area is clear to avoid striking other vehicles, objects or people. The vehicle may also lunge forward or lunge back suddenly as it becomes free. Use extreme caution.

**■ When shifting the select lever**

For vehicles with an automatic transmission, be careful not to shift the select lever with the accelerator pedal depressed.

This may lead to unexpected rapid acceleration of the vehicle that may cause an accident resulting in death or serious injury.

**CAUTION****■ To avoid damage to the transmission and other components**

- Avoid spinning the rear wheels and depressing the accelerator pedal more than necessary.
- If the vehicle remains stuck even after these procedures are performed, the vehicle may require towing to be freed.



## Vehicle specifications

# 6

### 6-1. Specifications

Maintenance data (fuel, oil level, etc.).....	410
Fuel information .....	422
Tire information .....	426

### 6-2. Customization

Customizable features .....	439
-----------------------------	-----

## 6-1. Specifications

### Maintenance data (fuel, oil level, etc.)

#### Dimensions and weight

Overall length	166.7 in. (4235 mm)	
Overall width	69.9 in. (1775 mm)	
Overall height *	<b>U.S.A.</b> 56.3 in. (1430 mm) <b>Canada</b> 56.1 in. (1425 mm)	
Wheelbase	101.2 in. (2570 mm)	
Tread	Front	59.8 in. (1520 mm)
	Rear	60.6 in. (1540 mm)
Vehicle capacity weight (Occupants + luggage)	Details are described on the tire and loading information label. (→P. 315)	

\*: Unladen vehicle

## Vehicle identification

### ■ Vehicle identification number

The vehicle identification number (VIN) is the legal identifier for your vehicle. This is the primary identification number for your SUBARU. It is used in registering the ownership of your vehicle.

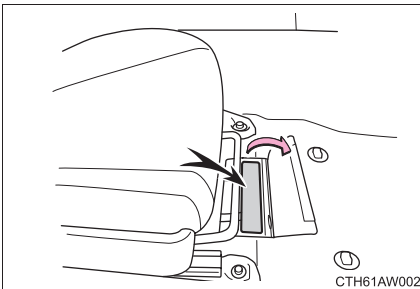

This number is stamped under the right-hand front seat.

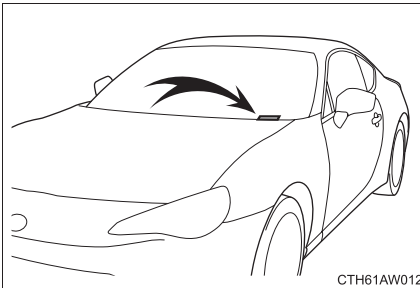

This number is located on the top left of the body panel.

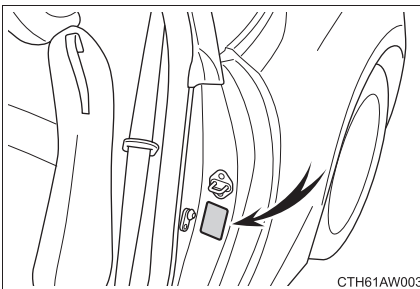

This number is also on the Certification Label.

■ **Engine number**

The engine number is stamped on the engine block as shown.

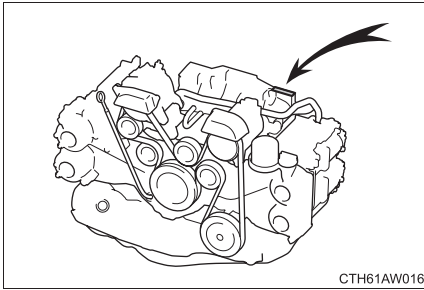



**Engine**

Model	FA20
Type	Horizontally opposed, liquid cooled 4 cylinder, 4-stroke gasoline
Bore and stroke	3.4 × 3.4 in. (86 × 86 mm)
Displacement	121.9 cu.in. (1998 cm <sup>3</sup> )
Drive belt tension	Automatic adjustment

**Fuel**

Fuel type	Unleaded gasoline only
Octane rating	93 AKI (98 RON) or higher*
Fuel tank capacity (Reference)	13.2 gal. (50 L, 11.0 Imp. gal.)

\*: If unleaded gasoline with an octane rating of 93 AKI (98 RON) is not available, unleaded gasoline with an octane rating of 91 AKI (95 RON) may be used with no detriment to engine durability or driveability.

**Lubrication system**

Oil capacity (Drain and refill — reference*)	
<ul style="list-style-type: none"> <li>• Without filter</li> <li>• With filter</li> </ul>	5.5 qt. (5.2 L, 4.6 Imp. qt.) 5.7 qt. (5.4 L, 4.8 Imp. qt.)

\*: The engine oil capacity is a reference quantity to be used when changing the engine oil. Warm up and turn off the engine, wait more than 5 minutes, and check the oil level on the dipstick.

**■ Engine oil selection**

Always use SUBARU approved engine oil. For details, we recommend that you contact your SUBARU dealer.

If approved engine oil is unavailable, another motor oil of matching quality can also be used.

Oil grade:

ILSAC multigrade engine oil

API classification SM or SN with the words “ENERGY CONSERVING” or “RESOURCE CONSERVING”

Recommended viscosity: SAE 0W-20

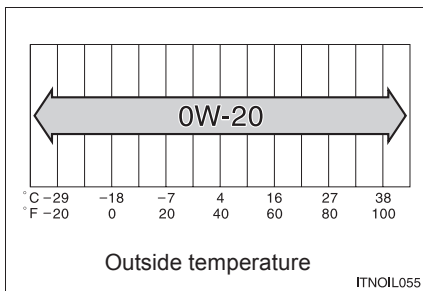

SAE 0W-20 is the best choice for good fuel economy and good starting in cold weather.

Oil viscosity (0W-20 is explained here as an example):

- The 0W in 0W-20 indicates the characteristic of the oil which allows cold startability. Oils with a lower value before the W allow for easier starting of the engine in cold weather.
- The 20 in 0W-20 indicates the viscosity characteristic of the oil when the oil is at high temperature. An oil with a higher viscosity (one with a higher value) may be better suited if the vehicle is operated at high speeds, or under extreme load conditions.

How to read oil container labels:

Either or both API registered marks are added to some oil containers to help you select the oil you should use.

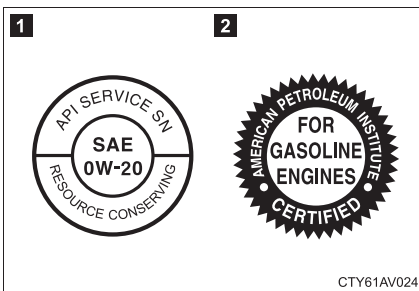

### 1 API Service Symbol

Top portion: The oil quality designation by API (American Petroleum Institute) (SN)

Center portion: The SAE viscosity grade (SAE 0W-20)

Lower portion: “RESOURCE CONSERVING” means that the oil has fuel saving and environmental protection capabilities.

### 2 ILSAC Certification Mark

The ILSAC (International Lubricant Standardization and Approval Committee) Certification Mark is displayed on the front of the container.

**Cooling system**

Capacity	<p><b>Vehicles with an automatic transmission</b> 7.9 qt. (7.5 L, 6.6 Imp. qt.)</p> <p><b>Vehicles with a manual transmission</b> 7.6 qt. (7.2 L, 6.3 Imp. qt.)</p>
Coolant type	<p>Use either of the following.</p> <ul style="list-style-type: none"> <li>• SUBARU Super Coolant</li> <li>• Similar high-quality ethylene glycol-based non-silicate, non-amine, non-nitrite, and non-borate coolant with long-life hybrid organic acid technology</li> </ul> <p>Do not use plain water alone.</p>

**Ignition system**

Spark plug	
Make	DENSO ZXE27HBR8
Gap	0.031 in. (0.8 mm)

 CAUTION

 **Iridium-tipped spark plugs**

Use only iridium-tipped spark plugs. Do not adjust gap when tuning engine.

## Electrical system

Battery	
Specific gravity reading at 68°F (20°C):	1.250 — 1.290 Fully charged 1.160 — 1.200 Half charged 1.060 — 1.100 Discharged
Charging rates	
Quick charge	15 A max.
Slow charge	5 A max.

## Differential

Oil capacity (Reference)	1.20 qt. (1.15 L, 1.01 Imp. qt.)
Oil type and viscosity	<p><b>Without LSD</b></p> <ul style="list-style-type: none"> <li>• Differential Gear Oil LT</li> <li>• Other gear oil that meets API GL-5 and SAE 75W-85 or GL-5 and SAE 75W-90 specifications</li> </ul> <p><b>With LSD</b></p> <ul style="list-style-type: none"> <li>• Differential Gear Oil LX</li> <li>• Other gear oil that meets API GL-5 and SAE 75W-85 or GL-5 and SAE 75W-90 specifications</li> </ul>

### CAUTION

#### ■ Differential gear oil

Using a differential gear oil other than Differential Gear Oil LT or LX may cause occurrences of rattling noises while idling and poor fuel consumption. Never use different brands together.

**Automatic transmission**

Fluid capacity*	7.9 qt. (7.5 L, 6.6 Imp. qt.)
Fluid type	ATF WS

\*: The fluid capacity is provided as a reference. If replacement is necessary, contact your SUBARU dealer.

**Manual transmission**

Gear oil capacity (Reference)	2.3 qt. (2.2 L, 1.9 Imp. qt.)
Gear oil type and viscosity	Use either of the following: <ul style="list-style-type: none"> <li>• “MG Gear Oil special II”</li> <li>• Other gear oil that meets API GL-3 or upper grade and SAE 75W-90 specifications</li> </ul>

 CAUTION

**Manual transmission gear oil**

Using a manual transmission gear oil other than “MG Gear Oil special II” may cause occurrences of rattling noises while idling and poor fuel consumption.

Never use different brands together.

**Clutch**

Pedal free play	0.2 — 0.6 in. (5 — 15 mm)
Fluid type	FMVSS No.116 fresh DOT 3 or DOT 4 brake fluid

## Brakes

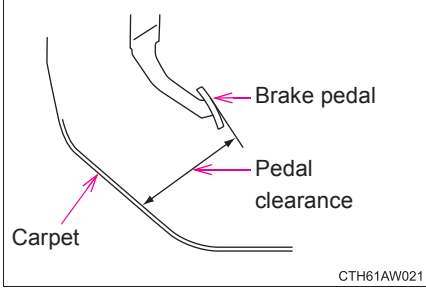
Pedal clearance* <sup>1</sup>	2.16 in. (55 mm) Min. 
Pedal free play	0.008 — 0.079 in. (0.2 — 2.0 mm)
Brake pad wear limit	0.06 in. (1.5 mm)
Parking brake lining wear limit	0.06 in. (1.5 mm)
Parking brake lever travel* <sup>2</sup>	7 — 8 clicks
Fluid type	FMVSS No.116 fresh DOT 3 or DOT 4 brake fluid

\*<sup>1</sup>: Minimum pedal clearance when depressed with a force of 110 lbf (490 N, 50 kgf) while the engine is running.

\*<sup>2</sup>: Parking brake lever travel when pulled up with a force of 45.0 lbf (200 N, 20.4 kgf).

### ■ Brake disc

If you need information on the usage limit value of brake discs and the method for measuring them, we recommend that you consult your SUBARU dealer.

**Steering**

Free play	Less than 1.2 in. (30 mm)
-----------	---------------------------

**Tires and wheels**

**Type A**

Tire size	P205/55R16 89V, T135/80D16 101M
Tire inflation pressure (Recommended cold tire inflation pressure)	Front: 35 psi (240 kPa, 2.4 kgf/cm <sup>2</sup> or bar) Rear: 35 psi (240 kPa, 2.4 kgf/cm <sup>2</sup> or bar) Spare: 60 psi (420 kPa, 4.2 kgf/cm <sup>2</sup> or bar)
Wheel size	16 × 6 1/2J, 16 × 6 1/2JJ, 16 × 4T (compact spare)
Wheel nut torque	89 ft•lbf (120 N•m, 12.2 kgf•m)

**Type B**

Tire size	215/45R17 87W, T135/80D16 101M
Tire inflation pressure (Recommended cold tire inflation pressure)	Front: 35 psi (240 kPa, 2.4 kgf/cm <sup>2</sup> or bar) Rear: 35 psi (240 kPa, 2.4 kgf/cm <sup>2</sup> or bar) Spare: 60 psi (420 kPa, 4.2 kgf/cm <sup>2</sup> or bar)
Wheel size	17 × 7 J, 16 × 4T (compact spare)
Wheel nut torque	89 ft•lbf (120 N•m, 12.2 kgf•m)



<b>Light bulbs</b>
--------------------

	Light Bulbs	Bulb No.	W	Type
Exterior	Headlights Low/high beam	D4S	35	A
	Front side marker lights	#194	3.8	C
	Front turn signal lights	WY21W	21	B
	Front fog lights	PSX24W	24	—
	License plate lights	W5W	5	C
	Rear turn signal lights	WY21W	21	B
	Back-up lights	W16W	16	C
	Rear side marker lights	W5W	5	C
Interior	Vanity lights	—	2	D
	Trunk light	W5W	5	B
	Interior light	—	10	C
	Door courtesy lights	T10	5	B

- A: D4S discharge bulbs  
 B: Wedge base bulbs (amber)  
 C: Wedge base bulbs (clear)  
 D: Double end bulbs

## 6-1. Specifications

### Fuel information

The engine is designed to operate at maximum performance using unleaded gasoline with an octane rating of 93 AKI (98 RON) or higher. If 93 AKI (98 RON) fuel is not readily available in your area, unleaded gasoline with an octane rating of 91 AKI (95 RON) may be used with no detriment to engine durability or driveability. However, you may notice a slight decrease in maximum engine performance and you may hear some knocking (pinking) of an engine while using 91 AKI (95 RON) fuel. Use of 91 AKI (95 RON) fuel will not affect your warranty coverage.

---

#### ■ Fuel tank opening for unleaded gasoline

To help prevent incorrect fueling, your SUBARU has a fuel tank opening that only accommodates the special nozzle on unleaded fuel pumps.

#### ■ If your engine knocks

- Consult your SUBARU dealer.
- You may occasionally notice light knocking for a short time while accelerating or driving uphill. This is normal and there is no need for concern.

#### ■ Gasoline quality

In very few cases, driveability problems may be caused by the brand of gasoline you are using. If driveability problems persist, try changing the brand of gasoline. If this does not correct the problem, consult your SUBARU dealer.

#### ■ Fuel octane rating

This octane rating is the average of the Research Octane and Motor Octane numbers and is commonly referred to as the Anti Knock Index (AKI).

Using a gasoline with a lower octane rating can cause persistent and heavy knocking, which can damage the engine. Do not be concerned if your vehicle sometimes knocks lightly when you drive up a hill or when you accelerate. Contact your SUBARU dealer if you use a fuel with the specified octane rating and your vehicle knocks heavily or persistently.

### ■ Gasoline for California-certified LEV

If your vehicle was certified to California's low emission vehicle (LEV) standards as indicated on the underhood tune-up label, it is designed to optimize engine and emission performance with gasoline that meets the clean burning low-sulfur California gasoline specifications. If you live in any other state than California, your vehicle will operate on gasoline meeting Federal specifications. Gasoline sold outside California is permitted to have higher sulfur levels, which may affect the performance of your vehicle's catalytic converter and may produce a sulfur exhaust odor or smell. SUBARU recommends that you try a different brand of unleaded gasoline having lower sulfur to determine if the problem is fuel related before returning your vehicle to an authorized dealer for service.

### ■ SUBARU recommends the use of gasoline containing detergent additives

- SUBARU recommends the use of gasoline that contains detergent additives to avoid build-up of engine deposits.
- All gasoline sold in the US contains detergent additives to clean and/or keep clean intake systems.

### ■ SUBARU recommends the use of cleaner burning gasoline

Cleaner burning gasoline, including reformulated gasoline that contains oxygenates such as ethanol or MTBE (Methyl Tertiary Butyl Ether) is available in many areas.

SUBARU recommends the use of cleaner burning gasoline and appropriately blended reformulated gasoline. These types of gasoline provide excellent vehicle performance, reduce vehicle emissions and improve air quality.

■ **SUBARU does not recommend blended gasoline**

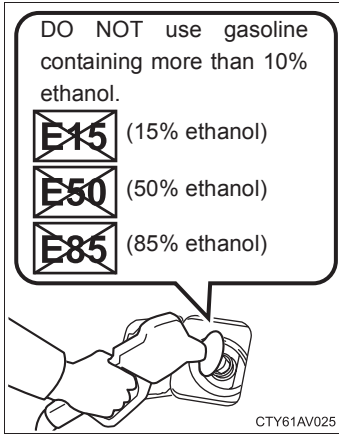

- Use only gasoline containing a maximum of 10% ethanol.

DO NOT use any flex-fuel or gasoline that could contain more than 10% ethanol, including from any pump labeled E15, E30, E50, E85 (which are only some examples of fuel containing more than 10% ethanol).

- If you use gasohol in your SUBARU, be sure that it has an octane rating no lower than 93 AKI.
- SUBARU DOES NOT recommend the use of gasoline containing methanol.

■ **SUBARU does not recommend gasoline containing MMT**

Some gasoline contains octane enhancing additive called MMT (Methylcyclopentadienyl Manganese Tricarbonyl).

SUBARU DOES NOT recommend the use of gasoline that contains MMT. If fuel containing MMT is used, your emission control system may be adversely affected.

The malfunction indicator lamp on the instrument cluster may come on. If this happens, contact your SUBARU dealer for service.

 CAUTION**■ Notice on fuel quality**

- Do not use improper fuels. If improper fuels are used the engine will be damaged.
- Do not use leaded gasoline.  
Leaded gasoline can cause damage to your vehicle's three-way catalytic converters causing the emission control system to malfunction.
- Do not use gasohol other than that stated here.  
Other gasohol may cause fuel system damage or vehicle performance problems.
- Using unleaded gasoline with an octane number or rating lower than the level previously stated will cause persistent heavy knocking.  
At worst, this will lead to engine damage.

**■ Fuel-related poor driveability**

If after using a different type of fuel, poor driveability is encountered (poor hot starting, vaporization, engine knocking, etc.), discontinue the use of that type of fuel.

**■ When refueling with gasohol**

Take care not to spill gasohol. It can damage your vehicle's paint.

# 6-1. Specifications

## Tire information

### Typical tire symbols

#### Standard tire

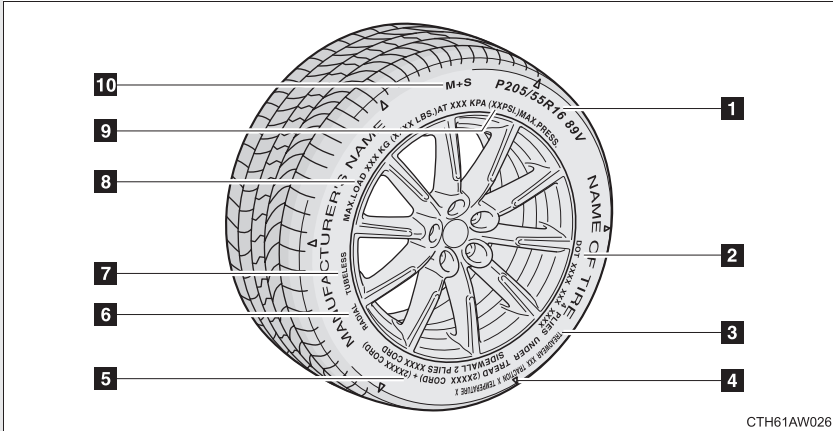

CTH61AW026

#### Compact spare tire

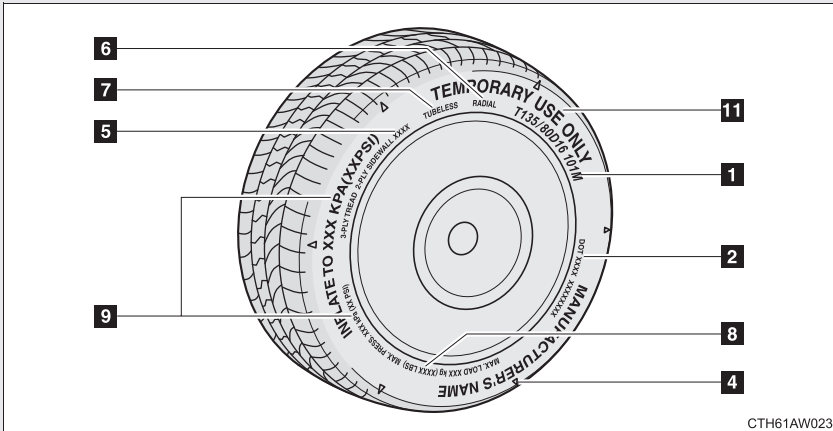

CTH61AW023

- 1** Tire size (→P. 429)
- 2** DOT and Tire Identification Number (TIN) (→P. 428)
- 3** Uniform tire quality grading  
For details, see “Uniform Tire Quality Grading” that follows.
- 4** Location of treadwear indicators (→P. 308)

**5** Tire ply composition and materials

Plies are layers of rubber-coated parallel cords. Cords are the strands which form the plies in a tire.

**6** Radial tires or bias-ply tires

A radial tire has "RADIAL" on the sidewall. A tire not marked "RADIAL" is a bias-ply tire.

**7** TUBELESS or TUBE TYPE

A tubeless tire does not have a tube and air is directly filled in the tire. A tube type tire has a tube inside the tire and the tube maintains the air pressure.

**8** Load limit at maximum cold tire inflation pressure (→P. 311)**9** Maximum cold tire inflation pressure (→P. 420)

This means the pressure to which a tire may be inflated.

**10** Summer tire or all season tire (→P. 311)

An all season tire has "M+S" on the sidewall. A tire not marked "M+S" is a summer tire.

**11** "TEMPORARY USE ONLY" (→P. 383)

A compact spare tire is identified by the phrase "TEMPORARY USE ONLY" molded into its sidewall. This tire is designed for temporary emergency use only.

**Typical DOT and tire identification number (TIN)**

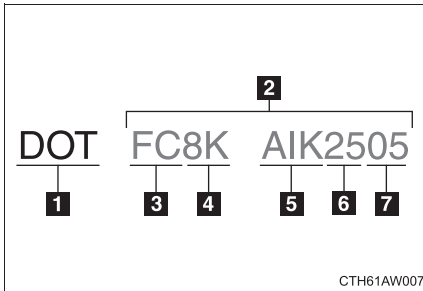

- 1** DOT symbol\*
- 2** Tire Identification Number (TIN)
- 3** Tire manufacturer's identification mark
- 4** Tire size code
- 5** Manufacturer's optional tire type code (3 or 4 letters)
- 6** Manufacturing week
- 7** Manufacturing year

\*: The DOT symbol certifies that the tire conforms to applicable Federal Motor Vehicle Safety Standards.



## Tire size

### ■ Typical tire size information

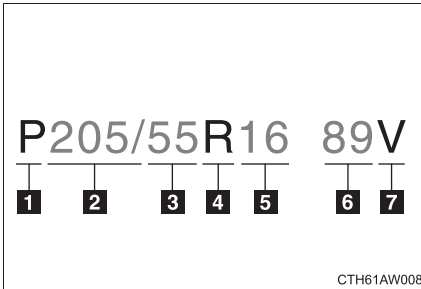

The illustration indicates typical tire size.

- 1** Tire use  
(P = Passenger car,  
T = Temporary use)
- 2** Section width (millimeters)
- 3** Aspect ratio  
(tire height to section width)
- 4** Tire construction code  
(R = Radial, D = Diagonal)
- 5** Wheel diameter (inches)
- 6** Load index (2 or 3 digits)
- 7** Speed symbol  
(alphabet with one letter)

### ■ Tire dimensions

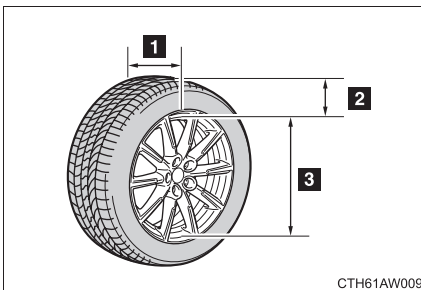

- 1** Section width
- 2** Tire height
- 3** Wheel diameter

### Tire section names

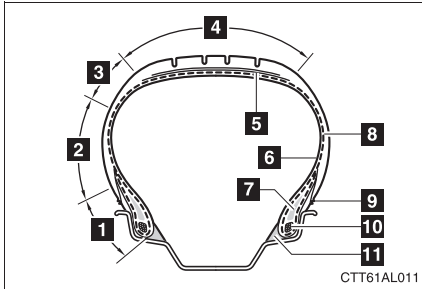

- 1 Bead
- 2 Sidewall
- 3 Shoulder
- 4 Tread
- 5 Belt
- 6 Inner liner
- 7 Reinforcing rubber
- 8 Carcass
- 9 Rim lines
- 10 Bead wires
- 11 Chafer

### Uniform Tire Quality Grading

This information has been prepared in accordance with regulations issued by the National Highway Traffic Safety Administration of the U.S. Department of Transportation.

It provides the purchasers and/or prospective purchasers of SUBARU vehicles with information on uniform tire quality grading.

Your SUBARU dealer will help answer any questions you may have as you read this information.

#### ■ DOT quality grades

All passenger vehicle tires must conform to Federal Safety Requirements in addition to these grades. Quality grades can be found where applicable on the tire sidewall between tread shoulder and maximum section width.

For example: Treadwear 200 Traction AA Temperature A

### ■ Treadwear

The treadwear grade is a comparative rating based on the wear rate of the tire when tested under controlled conditions on a specified government test course.

For example, a tire graded 150 would wear one and a half (1 - 1/2) times as well on the government course as a tire graded 100.

The relative performance of tires depends upon the actual conditions of their use. Performance may differ significantly from the norm due to variations in driving habits, service practices and differences in road characteristics and climate.

### ■ Traction AA, A, B, C

The traction grades, from highest to lowest, are AA, A, B and C, and they represent the tire's ability to stop on wet pavement as measured under controlled conditions on specified government test surfaces of asphalt and concrete.

A tire marked C may have poor traction performance.

Warning: The traction grade assigned to this tire is based on braking (straight ahead) traction tests and does not include cornering (turning) traction.

### ■ Temperature A, B, C

The temperature grades are A (the highest), B, and C, representing the tire's resistance to the generation of heat and its ability to dissipate heat when tested under controlled conditions on a specified indoor laboratory test wheel.

Sustained high temperature can cause the material of the tire to degenerate and reduce tire life, and excessive temperature can lead to sudden tire failure.

Grade C corresponds to a level of performance which all passenger car tires must meet under the Federal Motor Vehicle Safety Standard No. 109.

Grades B and A represent higher levels of performance on the laboratory test wheel than the minimum required by law.

Warning: The temperature grades of a tire assume that it is properly inflated and not overloaded.

Excessive speed, underinflation, or excessive loading, either separately or in combination, can cause heat buildup and possible tire failure.

**Glossary of tire terminology**

Tire related term	Meaning
Cold tire inflation pressure	Tire pressure when the vehicle has been parked for three hours or more, or has not been driven more than 1 mile or 1.5 km under that condition
Maximum inflation pressure	The maximum cold inflated pressure to which a tire may be inflated, shown on the sidewall of the tire
Recommended inflation pressure	Cold tire inflation pressure recommended by a manufacturer.
Accessory weight	The combined weight (in excess of those standard items which may be replaced) of automatic transmission, power steering, power brakes, power windows, power seats, radio and heater, to the extent that these items are available as factory-installed equipment (whether installed or not)
Curb weight	The weight of a motor vehicle with standard equipment, including the maximum capacity of fuel, oil and coolant, and if so equipped, air conditioning and additional weight optional engine
Maximum loaded vehicle weight	The sum of: (a) Curb weight (b) Accessory weight (c) Vehicle capacity weight (d) Production options weight

Tire related term	Meaning
Normal occupant weight	150 lb. (68 kg) times the number of occupants specified in the second column of Table 1* that follows
Occupant distribution	Distribution of occupants in a vehicle as specified in the third column of Table 1* below
Production options weight	The combined weight of installed regular production options weighing over 5 lb. (2.3 kg) in excess of the standard items which they replace, not previously considered in curb weight or accessory weight, including heavy duty brakes, ride levelers, roof rack, heavy duty battery, and special trim
Rim	A metal support for a tire or a tire and tube assembly upon which the tire beads are seated
Rim diameter (Wheel diameter)	Nominal diameter of the bead seat
Rim size designation	Rim diameter and width
Rim type designation	The industry manufacturer's designation for a rim by style or code
Rim width	Nominal distance between rim flanges
Vehicle capacity weight (Total load capacity)	The rated cargo and luggage load plus 150 lb. (68 kg) times the vehicle's designated seating capacity
Vehicle maximum load on the tire	The load on an individual tire that is determined by distributing to each axle its share of the maximum loaded vehicle weight, and dividing by two

Tire related term	Meaning
Vehicle normal load on the tire	The load on an individual tire that is determined by distributing to each axle its share of curb weight, accessory weight, and normal occupant weight (distributed in accordance with Table 1* below), and dividing by two
Weather side	The surface area of the rim not covered by the inflated tire
Bead	The part of the tire that is made of steel wires, wrapped or reinforced by ply cords and that is shaped to fit the rim
Bead separation	A breakdown of the bond between components in the bead
Bias ply tire	A pneumatic tire in which the ply cords that extend to the beads are laid at alternate angles substantially less than 90 degrees to the centerline of the tread
Carcass	The tire structure, except tread and sidewall rubber which, when inflated, bears the load
Chunking	The breaking away of pieces of the tread or sidewall
Cord	The strands forming the plies in the tire
Cord separation	The parting of cords from adjacent rubber compounds
Cracking	Any parting within the tread, sidewall, or inner-liner of the tire extending to cord material
CT	A pneumatic tire with an inverted flange tire and rim system in which the rim is designed with rim flanges pointed radially inward and the tire is designed to fit on the underside of the rim in a manner that encloses the rim flanges inside the air cavity of the tire

Tire related term	Meaning
Extra load tire	A tire designed to operate at higher loads and at higher inflation pressures than the corresponding standard tire
Groove	The space between two adjacent tread ribs
Innerliner	The layer(s) forming the inside surface of a tubeless tire that contains the inflating medium within the tire
Innerliner separation	The parting of the innerliner from cord material in the carcass
Intended outboard sidewall	(a)The sidewall that contains a whitewall, bears white lettering, or bears manufacturer, brand, and/or model name molding that is higher or deeper than the same molding on the other sidewall of the tire, or (b)The outward facing sidewall of an asymmetrical tire that has a particular side that must always face outward when mounted on a vehicle
Light truck (LT) tire	A tire designated by its manufacturer as primarily intended for use on lightweight trucks or multipurpose passenger vehicles
Load rating	The maximum load that a tire is rated to carry for a given inflation pressure
Maximum load rating	The load rating for a tire at the maximum permissible inflation pressure for that tire
Maximum permissible inflation pressure	The maximum cold inflation pressure to which a tire may be inflated
Measuring rim	The rim on which a tire is fitted for physical dimension requirements
Open splice	Any parting at any junction of tread, sidewall, or innerliner that extends to cord material
Outer diameter	The overall diameter of an inflated new tire

Tire related term	Meaning
Overall width	The linear distance between the exteriors of the sidewalls of an inflated tire, including elevations due to labeling, decorations, or protective bands or ribs
Passenger car tire	A tire intended for use on passenger cars, multipurpose passenger vehicles, and trucks, that have a gross vehicle weight rating (GVWR) of 10,000 lb. or less.
Ply	A layer of rubber-coated parallel cords
Ply separation	A parting of rubber compound between adjacent plies
Pneumatic tire	A mechanical device made of rubber, chemicals, fabric and steel or other materials, that, when mounted on an automotive wheel, provides the traction and contains the gas or fluid that sustains the load
Radial ply tire	A pneumatic tire in which the ply cords that extend to the beads are laid at substantially 90 degrees to the centerline of the tread
Reinforced tire	A tire designed to operate at higher loads and at higher inflation pressures than the corresponding standard tire
Section width	The linear distance between the exteriors of the sidewalls of an inflated tire, excluding elevations due to labeling, decoration, or protective bands
Sidewall	That portion of a tire between the tread and bead
Sidewall separation	The parting of the rubber compound from the cord material in the sidewall



Tire related term	Meaning
Snow tire	A tire that attains a traction index equal to or greater than 110, compared to the ASTM E-1136 Standard Reference Test Tire, when using the snow traction test as described in ASTM F-1805-00, Standard Test Method for Single Wheel Driving Traction in a Straight Line on Snow-and Ice-Covered Surfaces, and which is marked with an Alpine Symbol (  ) on at least one sidewall
Test rim	The rim on which a tire is fitted for testing, and may be any rim listed as appropriate for use with that tire
Tread	That portion of a tire that comes into contact with the road
Tread rib	A tread section running circumferentially around a tire
Tread separation	Pulling away of the tread from the tire carcass
Treadwear indicators (TWI)	The projections within the principal grooves designed to give a visual indication of the degrees of wear of the tread
Wheel-holding fixture	The fixture used to hold the wheel and tire assembly securely during testing

\*: Table 1 — Occupant loading and distribution for vehicle normal load for various designated seating capacities

6-1. Specifications

Designated seating capacity, Number of occupants	Vehicle normal load, Number of occupants	Occupant distribution in a normally loaded vehicle
2 through 4	2	2 in front
5 through 10	3	2 in front, 1 in second seat
11 through 15	5	2 in front, 1 in second seat, 1 in third seat, 1 in fourth seat
16 through 20	7	2 in front, 2 in second seat, 2 in third seat, 1 in fourth seat

## 6-2. Customization

### Customizable features

Your vehicle includes a variety of electronic features that can be personalized to your preferences. Programming these preferences requires specialized equipment and may be performed by your SUBARU dealer.

Some function settings are changed simultaneously with other functions being customized. Contact your SUBARU dealer.

Item	Function	Default setting	Customized setting
Keyless access with push button start system (→P. 23)	Keyless access with push button start system	On	Off
	Operation signal (Hazard warning flashers)	On	Off
	Operation signal (Buzzer)	On	Off
	Operation buzzer volume	Level 5	Level 0 to 7
	Number of permissible times of continuous smart lock	Twice	Unlimited
Remote keyless entry system (→P. 37)	Unlocking operation	Driver's door unlocked in one step, both side doors unlocked in two steps	Both side doors unlocked in one step
	Automatic door lock function to be activated if door is not opened after being unlocked	On	Off

Item	Function	Default setting	Customized setting
Remote key-less entry system (→P. 37)	Time elapsed before automatic door lock function is activated if door is not opened after being unlocked	60 seconds	30 seconds
			120 seconds
	Operation signal (Hazard warning flashers)	On	Off
	Operation signal (Buzzer)	On	Off
	Operation buzzer volume	Level 5	Level 0 to 7
	Door lock buzzer	On	Off
	Trunk lid unlocking function	On	Off
	Trunk lid unlocking operation	Push and hold (short)	Push and hold (long)
			One short push
			Two short pushes
Panic function	On	Off	
Vehicle finder function	On	Off	
Alarm (→P. 81) (vehicles with a key-less access with push button start system)	Operation when doors are unlocked using the mechanical key	Off	On

Item	Function	Default setting	Customized setting
Automatic light control system (→P. 200)	Light sensor sensitivity	±0%	-40% to +40%
	Time elapsed before headlights automatically turn off after doors are closed	30 seconds	0 second
			60 seconds
			90 seconds
Rear window defogger (→P. 251)	Time elapsed before the rear window defogger turn off (vehicles with automatic air conditioning system)	15 minutes	Continue
Illumination (→P. 253)	Time elapsed before lights turn off	15 seconds	7.5 seconds
			30 seconds
	Operation when the doors are unlocked	On	Off
	Operation after the engine switch is turned off	On	Off
	Interior light illumination upon approach (vehicles with a keyless access with push button start system)	On	Off
	Interior light illumination	On	Off



## For owners

# 7

Reporting safety defects for U.S. owners .....	444
Seatbelt instructions for Canadian owners (in French) .....	445
SRS airbag instructions for Canadian owners (in French) .....	448

## Reporting safety defects for U.S. owners

If you believe that your vehicle has a defect which could cause a crash or could cause injury or death, you should immediately inform the National Highway Traffic Safety Administration (NHTSA) in addition to notifying Subaru of America, Inc.

If NHTSA receives similar complaints, it may open an investigation, and if it finds that a safety defect exists in a group of vehicles, it may order a recall and remedy campaign. However, NHTSA cannot become involved in individual problems between you, your dealer, or Subaru of America, Inc.

To contact NHTSA, you may call the Vehicle Safety Hotline toll-free at 1-888-327-4236 (TTY: 1-800-424-9153); go to <http://www.safercar.gov>; or write to: Administrator, NHTSA, 1200 New Jersey Ave, S.E., Washington, DC 20590. You can also obtain other information about motor vehicle safety from <http://www.safercar.gov>.



## Seatbelt instructions for Canadian owners (in French)

The following is a French explanation of seatbelt instructions extracted from the seatbelt section in this manual.

See the seatbelt section for more detailed seatbelt instructions in English.

### Utilisation correcte des ceintures de sécurité

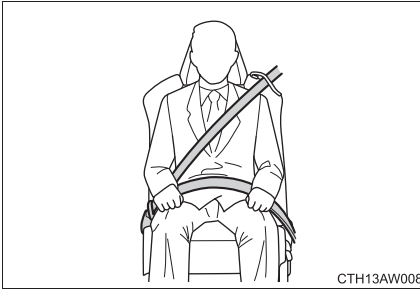

- Déroulez la sangle diagonale de telle sorte qu'elle passe bien sur l'épaule, sans pour autant être en contact avec le cou ou glisser de l'épaule.
- Placez la sangle abdominale le plus bas possible sur les hanches.
- Réglez la position du dossier de siège. Asseyez-vous le dos le plus droit possible et calez-vous bien dans le siège.
- Ne pas vriller la ceinture de sécurité.

## Guide de la ceinture de sécurité avant

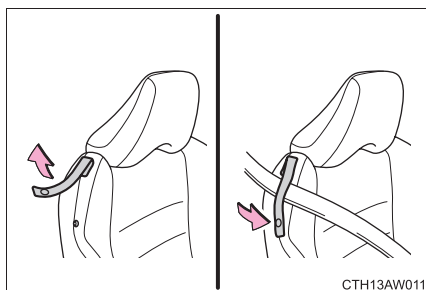

Pour faciliter le déroulage de la ceinture de sécurité, passez-la dans le guide.

Lorsque vous accédez aux sièges arrière ou en descendez, sortez la ceinture de sécurité de son guide.

## Entretien et soin

### ■ Ceintures de sécurité

Nettoyez avec un chiffon ou une éponge humectée d'eau savonneuse tiède. Vérifiez régulièrement que les ceintures ne sont pas effilochées, entaillées ou exagérément usées.

### DANGER

#### ■ État et usure des ceintures de sécurité

- Évitez d'abîmer les ceintures de sécurité en coinçant dans la porte une sangle, le pêne ou la boucle.
- Inspectez les ceintures de sécurité périodiquement. Contrôlez qu'elles ne sont pas entaillées, effilochées et que leurs ancrages ne sont pas desserrés. Remplacez immédiatement une ceinture de sécurité défectueuse. Une ceinture de sécurité défectueuse n'apporte aucune garantie de protection de l'occupant contre des blessures graves, voire mortelles.
- Vérifiez que le pêne est bien verrouillé dans la boucle de ceinture et que les sangles ne sont pas vrillées.  
Si la ceinture de sécurité ne fonctionne pas correctement, contactez immédiatement votre concessionnaire SUBARU.
- Remplacez le siège avec la ceinture au cas où votre véhicule aurait été impliqué dans un accident sérieux, même en l'absence de dommage visible.
- Ne pas essayer d'installer, démonter, modifier ou mettre au rebut les ceintures de sécurité. Faites effectuer les réparations nécessaires par votre concessionnaire SUBARU. Une mauvaise manipulation des prétensionneurs peut en altérer le fonctionnement correct, avec un risque de blessures graves, voire mortelles.

## SRS airbag instructions for Canadian owners (in French)

The following is a French explanation of SRS airbag instructions extracted from the SRS airbag section in this manual.

See the SRS airbag section for more detailed SRS airbag instructions in English.

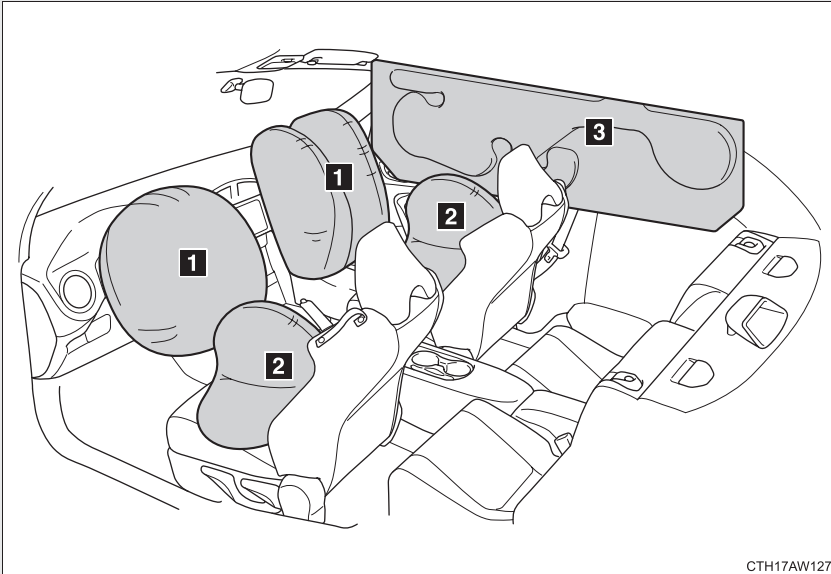

## **Modèles équipés d'airbags SRS et de retenues d'épaules pour le conducteur, le passager avant, et les passagers arrières côté vitres**

Votre véhicule est équipé d'un système de retenue supplémentaire en plus de la ceinture de sécurité à chacun des sièges avants et à chacun des sièges arrières côté vitres. Le système de retenue supplémentaire (SRS) consiste en six airbags. Les configurations sont les suivantes.

- 1** Les airbags frontaux du conducteur et du passager avant
- 2** Les airbags latéraux du conducteur et du passager avant
- 3** Les airbags rideaux (pour le conducteur, le passager avant, et les passagers arrière côté vitres)

Ces airbags SRS sont conçus uniquement comme un complément à la protection principale fournie par la ceinture de sécurité.

Ce système contrôle également les prétensionneurs des ceintures de sécurité avants.

 DANGER

■ **Airbag SRS**

- Pour obtenir la protection maximum dans le cas d'un accident, le conducteur et tous les passagers du véhicules doivent toujours porter leurs ceintures de sécurité lorsque le véhicule est en mouvement. L'airbag SRS est conçu uniquement comme un complément à la protection principale fournie par la ceinture de sécurité. Il n'annule pas le besoin d'attacher les ceintures de sécurité. En combinaison avec les ceintures de sécurité, il apporte la meilleur protection cumulée en cas d'accident grave.

Ne pas porter de ceinture de sécurité augmente les risques de blessures graves ou mortelles lors d'une collision, même lorsque le véhicule a les airbags SRS.

- Ne pas s'asseoir ou s'appuyer trop près de l'airbag SRS. Parce que l'airbag SRS se déploie à une vitesse considérable, encore plus rapidement qu'en un clin d'œil, et à une force également considérable pour vous protégez dans des collisions à grande vitesse, la puissance d'un airbag peut blesser un occupant dont le corps serait trop près de l'airbag SRS.

Il est également important de porter votre ceinture pour éviter les blessures qui peuvent résulter de l'airbag SRS entrant en contact avec un occupant dans une mauvaise position, comme projeté en avant lors du freinage avant l'accident par exemple.

Même quand positionné correctement, il reste possible que l'occupant souffre de blessures minimales, telles que des abrasions et des bleus au visage ou aux bras à cause de la puissance de déploiement de l'airbag SRS.

 DANGER

■ **Airbag SRS**

- Les airbags SRS se déploient avec une force et une vitesse considérables. Les occupants qui ne sont pas dans des positions correctes lors du déploiement des airbags pourraient souffrir de blessures graves. Puisque l'airbag SRS a besoin de suffisamment de place pour se déployer, le conducteur doit toujours se tenir droit et le plus en arrière possible dans son siège, le plus éloigné possible du volant tout en maintenant le contrôle complet du véhicule. De même, le passager avant doit déplacer son siège le plus en arrière possible et se tenir le plus droit et le plus en arrière possible dans le siège.
- Ne placez aucun objet sur ou au-dessus du cache de l'airbag SRS ou entre vous et l'airbag SRS. Si l'airbag SRS se déploie, ces objets pourraient interférer avec son bon fonctionnement et pourrait être propulsés à l'intérieur du véhicule et causer des blessures.

**! DANGER**

**■ Airbag SRS**



- Placez les enfants de 12 ans et moins dans le siège arrière, correctement attachés à tout moment. L'airbag SRS se déploie avec une vitesse et une force considérable, et peut blesser et même tuer les enfants, particulièrement s'ils ont 12 ans ou moins et qu'ils ne sont pas retenus ou mal retenus. Parce que les enfants sont plus légers et plus fragiles que les adultes, le risque qu'ils soient blessés par le déploiement est plus élevé.

Pour cette raison, nous recommandons fortement que TOUS les enfants (y compris ceux dans des sièges enfants, ou qui sont trop grands pour les sièges de sécurité enfants) s'assoient dans un siège ARRIÈRE et soient correctement attachés dans un siège de sécurité enfant ou avec une ceinture de sécurité, quel que soit le dispositif adapté pour l'âge, la taille et le poids de l'enfant.

Fixez TOUJOURS fermement TOUS les sièges de sécurité enfants (y compris les réhausseurs vers l'avant) dans le siège ARRIÈRE.

Les statistiques prouvent que les enfants sont mieux protégés lorsqu'ils sont assis à l'arrière plutôt qu'à l'avant.



 DANGER

■ **Airbag SRS**

- N'INSTALLEZ JAMAIS DE SIÈGE DE SÉCURITÉ ENFANT VERS L'ARRIÈRE DANS LE SIÈGE AVANT. LE FAIRE POURRAIT CAUSER DES BLESSURES GRAVES VOIRE MORTELLES À L'ENFANT EN PLAÇANT LA TÊTE DE L'ENFANT TROP PRÈS DE L'AIRBAG SRS.
- N'autorisez jamais un enfant à se tenir debout ou à s'agenouiller dans le siège passager avant, et ne tenez jamais un enfant sur vos genoux ou dans vos bras. L'airbag SRS se déploie avec une force considérable et peut blesser ou même tuer l'enfant.
- Quand l'airbag SRS se déploie, de la fumée se dégage. Cette fumée peut causer des problèmes respiratoires pour les individus avec des antécédents d'asthme ou d'autres problèmes respiratoires. Si vous ou vos passagers avez des problèmes respiratoires après le déploiement de l'airbag SRS, prenez l'air immédiatement.
- Un airbag SRS qui se déploie dégage du gaz chaud. Les occupants peuvent être brûlés s'ils sont en contact direct avec le gaz chaud.

## Composition du système d'airbags SRS

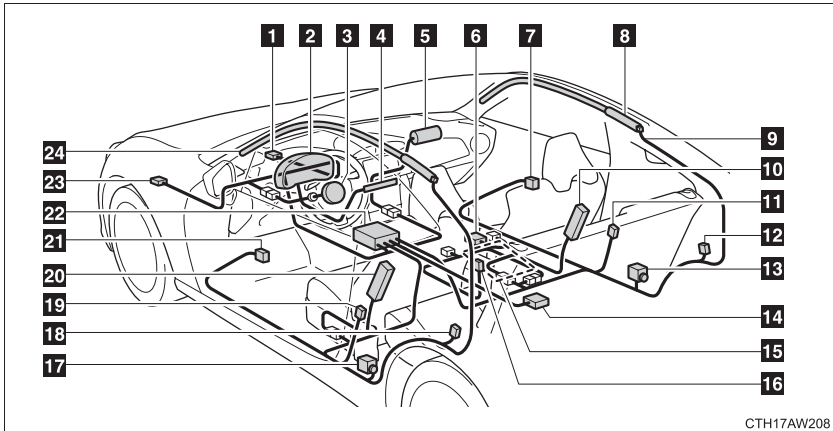

CTH17AW208

- |  |   |
|--|---|
| <b>1</b> Capteur frontal secondaire (côté droit)   | <b>7</b> Capteur d'impact de porte (côté droit)                           |
| <b>2</b> Témoin d'alerte du système d'airbags SRS  | <b>8</b> Module des airbags rideaux (côté droit)                          |
| <b>3</b> Module de l'airbag frontal (côté conducteur)(à deux étapes)                                       | <b>9</b> Circuits électriques des airbags                                 |
| <b>4</b> Témoin MARCHÉ et ARRÊT de l'airbag frontal du siège passager avant (au centre du tableau de bord) | <b>10</b> Module de l'airbag latéral (côté passager avant)                |
| <b>5</b> Module de l'airbag frontal (côté passager avant)(à deux étapes)                                   | <b>11</b> Capteur de l'airbag latéral (côté droit du montant central)     |
| <b>6</b> Module de détection de l'occupant passager avant  | <b>12</b> Capteur des airbags rideaux (côté droit de la roue arrière)     |
|  | <b>13</b> Prétensionneur de ceinture de sécurité (côté du passager avant) |

- 14** Capteur satellite de sécurité (sous le siège arrière du milieu)
- 15** Capteur du système de détection de passager du passager avant
- 16** Bouton de boucle de ceinture de sécurité (côté passager avant)
- 17** Prétensionneur de ceinture de sécurité (côté conducteur)
- 18** Capteur des airbags rideaux (côté gauche de la roue arrière)
- 19** Capteur de l'airbag latéral (côté gauche du montant central)
- 20** Module de l'airbags latéral (côté conducteur)
- 21** Capteur d'impact de porte (côté gauche)
- 22** Module de contrôle d'airbag (y-compris les capteurs d'impacts)
- 23** Capteur frontal secondaire (côté gauche)
- 24** Module des airbags rideaux (côté gauche)

Votre véhicule est équipé d'airbags avancés (ADVANCED AIRBAGS) conçus selon les normes de sécurité américaines applicables aux véhicules à moteur (FMVSS208). Le système d'airbag contrôle la puissance de déploiement des airbags pour le conducteur et le passager avant. Le système d'airbag passager avant comprend le module de contrôle de détection des occupants du siège passager avant, etc.

Les principaux éléments du système d'airbags SRS sont illustrés ci-dessus. Le système d'airbags SRS est commandé par le module de contrôle de l'airbag. Le module de contrôle d'airbag consiste en un capteur d'airbag.

Lorsque la violence du choc frontal ou latéral l'exige, le système d'airbags SRS déclenche les dispositifs de gonflage. Le déploiement rapide des airbags est obtenu au moyen d'une réaction chimique dans les dispositifs de gonflage, qui produit un gaz inoffensif permettant d'amortir le mouvement des occupants.

## Système avancé d'airbags frontaux SUBARU

Votre véhicule est équipé d'un système avancé d'airbags frontaux SUBARU, conforme aux nouvelles conditions des airbags frontaux avancés dans la norme Federal Motor Vehicle Safety amendée (FMVSS) No. 208.

Le système avancé d'airbags frontaux SUBARU détermine automatiquement la force de déploiement de l'airbag frontal SRS du conducteur au moment du déploiement, et également l'activation ou non de l'airbag frontal SRS du passager avant et, si activé, la force de déploiement de l'airbag SRS frontal et le moment de déploiement. Votre véhicule a des autocollants de sécurité sur les pare-soleils du conducteur et du passager avant commençant par les mots "EVEN WITH ADVANCED AIR BAGS" et une étiquette attachée au couvercle de la boîte à gants commençant par les mots "Even with Advanced Air Bags". Assurez-vous de lire avec attention les instructions sur les autocollants de sécurité et les étiquettes.

Attachez toujours votre ceinture de sécurité. Le système avancé d'airbags frontaux SUBARU est un système de retenue en complément qui doit être utilisé en combinaison avec une ceinture de sécurité. Tous les occupants doivent mettre leur ceinture de sécurité ou être placés dans des sièges de sécurité enfant adaptés.

L'airbag frontal SRS du conducteur est stocké dans la partie centrale du volant. L'airbag frontal SRS du passager avant est stocké près du haut du tableau de bord sous une marque "SRS AIRBAG".

Dans une collision moyenne à sévère, les composants suivant se déploient.

- Airbag SRS frontal pour le conducteur
- Airbag SRS frontal pour le passager avant

Ces composants complètent les ceintures de sécurité en réduisant l'impact à la tête et à la poitrine de l'occupant.

 **DANGER**

■ **En cas de déploiement (gonflage) des airbags SRS**

Ne touchez pas les composants du système d'airbag SRS près du volant et du tableau de bord à mains nues immédiatement après le déploiement. Le faire peut causer des brûlures car les composants peuvent être très chauds à la suite du déploiement.

■ **Précautions avec les sièges de sécurité enfant**

N'INSTALLEZ JAMAIS UN SIÈGE ENFANT VERS L'ARRIÈRE DANS LE SIÈGE PASSAGER AVANT MÊME SI L'AIRBAG FRONTAL SRS DU PASSAGER AVANT EST DÉSACTIVÉ. Veillez à l'installer correctement sur la banquette ARRIÈRE. De même, il est fortement recommandé que tout siège enfant tourné vers l'avant ou siège rehausseur soit installé sur la banquette ARRIÈRE, et que même les enfants trop grands pour utiliser un siège de sécurité enfant s'assoient sur la banquette ARRIÈRE. Un enfant assis sur le siège passager avant pourrait être tué ou gravement blessé si l'airbag frontal SRS de passager avant se déployait. La banquette ARRIÈRE est l'endroit où les enfants sont le plus en sécurité.

## Airbag latéral SRS et airbag rideau SRS

Les airbags latéraux sont stockés côté portière de chaque dossier de siège, et porte une étiquette “SRS AIRBAG”.

Dans une collision moyenne à sévère, l'airbag latéral SRS sur le côté de l'impact du véhicule se déploie entre l'occupant et la partie basse de la portière, et complémente la ceinture de sécurité en réduisant l'impact sur la poitrine et la taille de l'occupant. L'airbag latéral SRS opère uniquement pour les occupants des sièges avants.

L'airbag rideau SRS sur chaque côté de l'habitacle est stocké sur le côté toit (entre le montant frontal et un point au dessus du siège arrière). Une marque “SRS AIRBAG” se trouve au dessus de chaque montant central.

Dans une collision latérale sévère, l'airbag rideau SRS sur le côté impacté du véhicule se déploie entre l'occupant et la vitre latérale, et complémente la ceinture de sécurité en réduisant l'impact sur la tête de l'occupant.

 **DANGER**

■ **En cas de déploiement (gonflage) des airbags SRS**

Ne touchez pas les composants du système d'airbag latéral SRS autour du dossier du siège avant à mains nues immédiatement après le déploiement. Le faire peut causer des brûlures car les composants peuvent être très chauds à la suite du déploiement.

Après le déploiement, ne touchez aucune partie du système d'airbag rideau SRS (depuis le montant frontal à la partie du rail latéral de toit au dessus du siège arrière). Le faire peut causer des brûlures car les composants peuvent être très chauds à la suite du déploiement.

■ **Précautions pour l'airbag latéral SRS et airbag rideau SRS**

L'airbag latéral SRS et l'airbag rideau SRS sont conçus comme un complément à la protection principale fournie par la ceinture de sécurité. Ils n'annulent pas le besoin d'attacher les ceintures de sécurité. Il est aussi important de mettre votre ceinture pour aider à empêcher les blessures qui peuvent résulter quand un occupant n'est pas assis dans une position droite.

■ **Précautions avec les airbags SRS**

Respectez les précautions suivantes concernant les airbags SRS. À défaut, des blessures graves, voire mortelles, pourraient s'ensuivre.

- Le conducteur et tous les passagers à bord du véhicule doivent porter leur ceinture de sécurité correctement.  
Les airbags SRS sont des dispositifs de protection complémentaires aux ceintures de sécurité.
- Le conducteur doit toujours se tenir droit et bien en arrière dans le siège, le plus éloigné possible du volant, tout en conservant le contrôle complet du véhicule, et le passager avant doit déplacer son siège vers l'arrière aussi loin que possible, se tenir droit et bien en arrière dans le siège.



 DANGER

■ **Précautions avec les airbags SRS**

- L'airbag SRS passager avant se déploie également avec une violence considérable, qui peut être très dangereuse, voire mortelle, si le passager avant se trouve très près de l'airbag. Éloignez le siège passager avant au maximum de l'airbag et réglez le dossier de siège de façon à être assis bien droit dans le siège.
- Les nourrissons et les enfants qui ne sont pas correctement assis et/ou protégés peuvent être grièvement blessés ou tués par le déploiement d'un airbag. Installez dans un siège de sécurité enfant les enfants trop jeunes pour pouvoir utiliser la ceinture de sécurité. SUBARU recommande vivement d'installer tous les nourrissons et jeunes enfants aux places arrière du véhicule et de prévoir pour eux des systèmes de retenue adaptés. Les sièges arrière sont plus sûrs pour les nourrissons et les enfants que le siège passager avant.

**! DANGER**

**■ Précautions avec les airbags SRS**

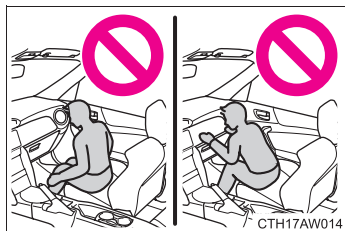

- Ne vous asseyez pas sur le bord du siège et ne vous appuyez pas contre le tableau de bord.

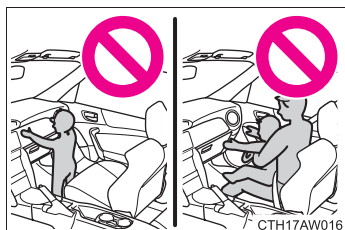

- Ne laissez pas un enfant rester debout devant l'airbag SRS passager avant ou bien s'asseoir sur les genoux du passager avant.
- Ne laissez pas les occupants des sièges avant voyager avec un objet sur les genoux.

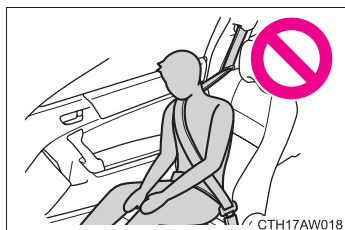

- Ne vous appuyez pas contre la porte, contre le rail latéral de toit ou contre les montants avant, latéraux et arrière.

**⚠ DANGER**

**■ Précautions avec les airbags SRS**

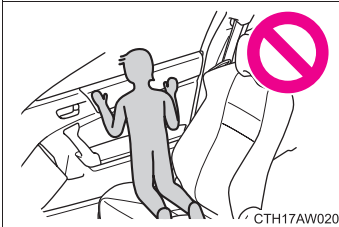

- Interdisez à quiconque de s'agenouiller sur le siège passager en appui contre la porte ou de sortir la tête ou les mains à l'extérieur du véhicule.

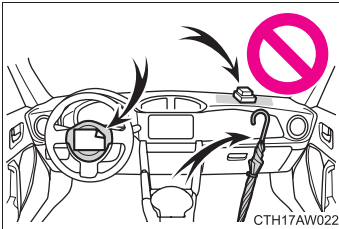

- Ne fixez ni ne posez aucun objet sur le tableau de bord ou la garniture centrale du moyeu de volant. Au déploiement des airbags SRS conducteur et passager avant, tout objet risque de se transformer en projectile.

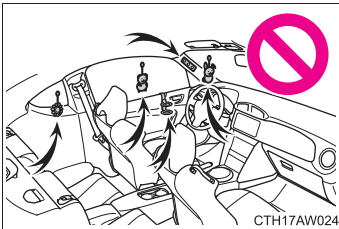

- Ne fixez rien aux portes, à la vitre de pare-brise, aux vitres latérales, à la lunette arrière, aux montants avant et arrière ni au rail latéral de toit.

 DANGER

■ **Précautions avec les airbags SRS**

- N'utilisez aucun accessoire de siège venant recouvrir les zones de déploiement des airbags SRS latéraux, car il risquerait d'en gêner le déploiement. De tels accessoires peuvent empêcher les airbags latéraux de fonctionner correctement, désactiver le dispositif ou entraîner le déploiement accidentel des airbags latéraux, entraînant la mort ou des blessures graves.
- Évitez de faire subir des chocs ou des pressions excessives aux parties renfermant les composants des airbags SRS (→P. 454).  
En effet, cela pourrait entraîner un fonctionnement anormal des airbags SRS.
- Ne touchez aucun composant du système immédiatement après le déploiement (gonflage) des airbags SRS, car ils peuvent être chauds.
- Si vous avez des difficultés à respirer après le déploiement de l'airbag SRS, ouvrez une porte ou une vitre pour faire entrer de l'air frais, ou bien descendez du véhicule si cela ne présente pas de danger. Essayez tout résidu dès que possible afin d'éviter d'éventuelles irritations de la peau.
- Si les parties renfermant les airbags SRS, telles que la garniture du volant et les garnitures de montants avant et arrière, apparaissent abîmées ou craquelées, faites-les remplacer par votre concessionnaire SUBARU.

 DANGER

■ **Modification et mise au rebut des éléments du système d'airbags SRS**

Consultez impérativement votre concessionnaire SUBARU si vous avez besoin d'intervenir sur votre véhicule ou de procéder à l'une des modifications suivantes.

Les airbags SRS risquent de ne pas fonctionner correctement ou de se déployer (gonfler) accidentellement, provoquant ainsi des blessures graves, voire mortelles.

- Installation, dépose, démontage et réparations des airbags SRS.
- Réparations, modifications, démontage ou remplacement du volant, du tableau de bord, de la planche de bord, des sièges ou de leur garnissage, des montants avant et arrière ou des rails latéraux de toit, porte, partie basse de la porte ou de la garniture de porte.
- Réparations ou modifications des ailes avant, du pare-choc avant ou des flancs de l'habitacle.
- Installation de chasse-neige, de treuils, etc., sur la calandre (pare-buffle, pare-kangourou, etc.).
- Modification du système de suspension du véhicule.
- Installation d'appareils électroniques, tels qu'un radioémetteur/récepteur ou d'un lecteur CD.
- Aménagements du véhicule pour une personne atteinte d'un handicap physique.

## Moniteurs du système d'airbags SRS

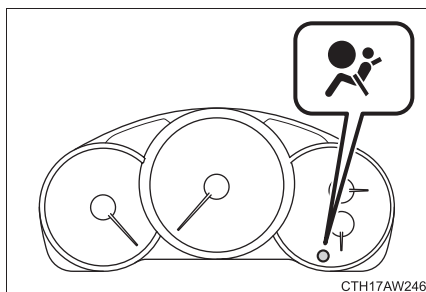

Un système de diagnostic contrôle continuellement la fonctionnalité du système d'airbag SRS (y-compris les prétensionneurs des ceintures de sécurité avants) lors de la conduite du véhicule. Le témoin lumineux du système d'airbags SRS montrera l'opération normale en s'allumant pendant environ 6 secondes quand le contacteur de démarrage est mis en position "ON".

Les composants suivants sont contrôlés par l'indicateur:

- Capteur frontal secondaire (côté droit)
- Capteur frontal secondaire (côté gauche)
- Module de contrôle d'airbag (y-compris les capteurs d'impacts)
- Module de l'airbag frontal (côté conducteur)
- Module de l'airbag frontal (côté passager avant)
- Capteur de l'airbag latéral (côté droit du montant central)
- Capteur de l'airbag latéral (côté gauche du montant central)
- Capteur d'impact de porte (côté droit)
- Capteur d'impact de porte (côté gauche)
- Module de l'airbags latéral (côté conducteur)
- Module de l'airbag latéral (côté passager avant)
- Capteur des airbags rideaux (côté droit de la roue arrière)
- Capteur des airbags rideaux (côté gauche de la roue arrière)
- Module des airbags rideaux (côté droit)
- Module des airbags rideaux (côté gauche)
- Capteur satellite de sécurité (sous le siège arrière du milieu)
- Prétensionneur de ceinture de sécurité (côté conducteur)
- Prétensionneur de ceinture de sécurité (côté passager avant)
- Bouton de boucle de ceinture de sécurité (côté passager avant)
- Capteur du système de détection de l'occupant passager avant
- Module de commande de détection de l'occupant passager avant
- Témoin indicateur MARCHE et ARRÊT de l'airbag frontal du passager avant
- Tous les câblages connexes

 **DANGER**

■ **Témoin d'alerte SRS**

Si le témoin lumineux montre une des conditions suivants, il peut y avoir un dysfonctionnement avec les prétensionneurs des ceintures de sécurité et/ou le système d'airbags SRS. Amenez immédiatement votre véhicule au concessionnaire SUBARU le plus proche pour une vérification du système. Sans vérification ou réparation adaptée, les prétensionneurs des ceintures de sécurité et/ou des airbags SRS ne fonctionneront pas correctement en cas de collision, ce qui pourrait augmenter les risques de blessures.

- Clignotement du témoin lumineux
- Le témoin lumineux ne s'allume pas quand le contacteur de démarrage est d'abord mis en position "ON".
- Éclairage continu du témoin lumineux
- Éclairage du témoin lumineux pendant la conduite



## Index

Abbreviation list .....	470
Alphabetical index.....	471
What to do if... .....	481

## Abbreviation list

# Abbreviation/Acronym list

ABBREVIATIONS	MEANING
ABS	Anti-lock Brake System
ACC	Accessory
ALR	Automatic Locking Retractor
CRS	Child Restraint System
DISP	Display
ECU	Electronic Control Unit
EDR	Event Data Recorder
ELR	Emergency Locking Retractor
GAWR	Gross Axle Weight Ratings
GVWR	Gross Vehicle Weight Rating
I/M	Emission inspection and maintenance
LATCH	Lower Anchors and Tethers for Children
LED	Light Emitting Diode
LSD	Limited Slip Differential
M + S	Mud and Snow
MMT	Methylcyclopentadienyl Manganese Tricarbonyl
MTBE	Methyl Tertiary Butyl Ether
OBD	On Board Diagnostics
SRS	Supplemental Restraint System
TIN	Tire Identification Number
TPMS	Tire Pressure Monitoring System
TRAC	Traction Control
VIN	Vehicle Identification Number
VSC	Vehicle Stability Control

# Alphabetical index

<b>A</b>	<b>A/C</b> .....	<b>234, 241</b>
	<b>ABS</b> .....	<b>215</b>
	<b>Access key</b>	
	If the access key does not operate properly.....	394
	<b>Air conditioning filter</b> .....	<b>322</b>
	<b>Air conditioning system</b>	
	Air conditioning filter.....	322
	Automatic air conditioning system.....	241
	Manual air conditioning system.....	234
	<b>Airbags</b>	
	Airbag operating conditions.....	102, 110
	Airbag precautions for your child.....	116
	Airbag warning light.....	365
	Curtain airbag operating conditions.....	110
	Curtain airbag precautions.....	116
	Front passenger occupant detection system.....	122
	General airbag precautions.....	116
	Locations of airbags.....	87
	Modification and disposal of airbags.....	119
	Proper driving posture.....	85, 116
	Side airbag operating conditions.....	110
	Side airbag precautions.....	116
	Side and curtain airbags operating conditions.....	110
	Side and curtain airbags precautions.....	116
	SRS airbags.....	87
	<b>Alarm</b> .....	<b>81</b>
	<b>Antenna</b> .....	<b>275</b>

<b>Anti-lock brake system</b> .....	<b>215</b>
<b>Audio input</b> .....	<b>252</b>
<b>Audio system</b>	
Antenna.....	275
Audio input.....	252
AUX port.....	252
iPod.....	252
Portable music player.....	252
USB memory.....	252
USB port.....	252
<b>Automatic air conditioning system</b> .....	<b>241</b>
<b>Automatic light control system</b> .....	<b>200</b>
<b>Automatic transmission</b>	
Automatic transmission.....	172
If the select lever cannot be shifted from P.....	392
Manual mode.....	175
Mode select switch.....	174
<b>AUX port</b> .....	<b>252</b>

**B**

**Back-up lights**  
 Replacing light bulbs ..... 337  
 Wattage ..... 421

**Battery**  
 Checking ..... 302  
 If the vehicle has a  
 discharged battery ..... 398  
 Preparing and checking  
 before winter ..... 226

**Bottle holders** ..... 257

**Brake**  
 Fluid ..... 300  
 Parking brake ..... 183

**Brake assist** ..... 215

**Break-in tips** ..... 149

**Brightness control**  
 Instrument panel light  
 control ..... 189

**C**

**Care**  
 Alcantara® ..... 280  
 Exterior ..... 272  
 Interior ..... 276  
 Seatbelts ..... 277

**Cargo capacity** ..... 221

**Chains** ..... 228

**Child restraint system**  
 Booster seats,  
 definition ..... 132  
 Booster seats,  
 installation ..... 136  
 Convertible seats,  
 definition ..... 132  
 Convertible seats,  
 installation ..... 136  
 Front passenger occupant  
 detection system ..... 122  
 Infant seats,  
 definition ..... 132  
 Infant seats,  
 installation ..... 136

Installing CRS with  
 LATCH anchors ..... 137  
 Installing CRS with  
 seatbelts ..... 139  
 Installing CRS with  
 top tether straps ..... 142

**Child safety**

Airbag precautions ..... 116  
 Battery precautions ..... 305, 401  
 Child restraint system ..... 132  
 How your child should  
 wear the seatbelt ..... 60  
 Installing child restraints ..... 136  
 Power window lock switch ..... 70  
 Power window  
 precautions ..... 72  
 Removed key battery  
 precautions ..... 328  
 Seat heater precautions ..... 267  
 Seatbelt guide ..... 59  
 Seatbelt precautions ..... 62  
 Trunk precautions ..... 48

**Cleaning**

Alcantara® ..... 280  
 Exterior ..... 272  
 Interior ..... 276  
 Seatbelts ..... 277

**Clock** ..... 262

**Condenser** ..... 300

**Console tray** ..... 258

**Cooling system**

Engine overheating ..... 403

**Cruise control** ..... 210

**Cup holders** ..... 258

**Customizable features** ..... 439

**D**

- Daytime running light system** ..... 203
- Defogger**
  - Rear window..... 250
  - Side mirror..... 250
- Dimension**..... 410
- Dinghy towing** ..... 231
- Display**
  - Multi-information display..... 195
  - Trip information ..... 196
- Do-it-yourself maintenance**.... 289
- Door courtesy lights**
  - Door courtesy lights..... 253
  - Wattage..... 421
- Doors**
  - Door lock ..... 23, 37, 42
  - Door windows..... 70
  - Side mirrors..... 67
- Driver's seatbelt reminder light**..... 367
- Driving**
  - Break-in tips ..... 149
  - Correct posture..... 85
  - Procedures..... 146
  - Winter drive tips..... 226

**E**

- Electric power steering** .....215
- Emergency, in case of**
  - If the access key does not operate properly.....394
  - If the engine will not start .....389
  - If the select lever cannot be shifted from P.....392
  - If the vehicle has a discharged battery .....398
  - If the warning buzzer sounds .....364
  - If the warning light turns on.....364
  - If you have a flat tire .....378
  - If you lose your keys .....393
  - If you think something is wrong .....362
  - If your vehicle becomes stuck .....406
  - If your vehicle needs to be towed .....355
  - If your vehicle overheats .....403

**Engine**  
 Compartment .....294  
 Engine hood .....292  
 Engine switch ..... 160, 169  
 How to start the  
   engine .....160, 169  
 Identification number .....411  
 If the engine will not start .....389  
 Ignition switch.....160, 169  
 Overheating.....403  
**Engine coolant**  
 Capacity .....416  
 Checking .....298  
**Engine coolant temperature**  
   **gauge** .....185  
**Engine hood** .....292  
**Engine immobilizer system**.....77  
**Engine oil**  
 Capacity .....414  
 Checking .....295  
 Preparing and checking  
   before winter .....226  
**Engine switch**..... 160, 169  
**Engine switch light** .....253  
**Event data recorder** .....16

**F** **Floor mat** .....268  
**Fluid**  
   Brake.....300  
   Washer.....306  
**Fog lights**  
   Replacing light bulbs.....337  
   Switch .....206  
   Wattage.....421  
**Front fog lights**  
   Replacing light bulbs.....337  
   Switch .....206  
   Wattage.....421  
**Front passenger occupant**  
   **detection system** .....122  
**Front passenger's seatbelt**  
   **reminder light** .....367  
**Front seats**  
   Adjustment.....51  
**Front side marker light**  
   Replacing light bulbs.....337  
   Wattage.....421  
**Front turn signal lights**  
   Replacing light bulbs.....337  
   Switch .....182  
   Wattage.....421

**Fuel**  
 Capacity ..... 413  
 Fuel gauge ..... 185  
 Fuel pump shut off system ... 363  
 Gas station information ..... 484  
 Information ..... 422  
 Refueling ..... 73  
**Fuel door**..... 73  
**Fuel filler lid**..... 73  
**Fuel pump shut off system** .... 363  
**Fuses**..... 329

**G** **Gauges** ..... 185  
**Glove box**..... 256

**H** **Hazard lights**  
 Switch ..... 354  
**Hazard warning flashers**  
 Switch ..... 354  
**Head restraints**  
 Adjusting ..... 56  
**Headlights**  
 Discharge headlight  
     precautions ..... 351  
 Replacing light bulbs ..... 337  
 Switch ..... 200  
 Wattage ..... 421  
**Heaters**  
 Seat heaters ..... 266  
 Side mirror ..... 250  
**Horn**..... 184

**I** **I/M test**.....288  
**Identification**  
 Engine .....411  
 Vehicle .....411  
**Ignition switch**..... 160, 169  
**Ignition switch light**  
 Ignition switch light .....253  
**Illuminated entry system**.....253  
**Immobilizer system**.....77  
**Indicator lights** ..... 190  
**Inside rear view mirror** .....66  
**Interior light**  
 Interior light .....254  
 Switch .....254  
 Wattage .....421

**J** **Jack**  
 Vehicle-equipped  
     jack .....378  
**Jack handle** .....378

<b>K</b>	<b>Keyless entry.....37</b>
	<b>Keys</b>
	Access key .....20
	Engine switch ..... 160, 169
	If you lose your keys .....393
	If your access key
	battery is discharged.....394
	Key number.....20
	Keyless entry.....37
	Keys .....20
	Mechanical key .....21
	Transmitter.....37
<b>L</b>	<b>License plate lights</b>
	Replacing light bulbs .....337
	Wattage.....421
	<b>Light bulbs</b>
	Replacing .....337
	Wattage.....421
	<b>Lights</b>
	Door courtesy lights .....253
	Engine switch light .....253
	Fog light switch .....206
	Hazard light switch .....354
	Hazard warning flasher
	switch .....354
	Headlights switch .....200
	Interior light switch .....254
	Replacing light bulbs .....337
	Turn signal lever.....182
	Vanity lights.....261
	Wattage.....421
	<b>Load capacity .....225</b>

<b>M</b>	<b>Maintenance</b>
	Do-it-yourself
	maintenance .....289
	General maintenance.....285
	Maintenance data .....410
	Maintenance requirements ...282
	<b>Manual air conditioning</b>
	<b>system .....234</b>
	<b>Manual transmission .....179</b>
	<b>Meter</b>
	Instrument panel
	light control .....189
	Meters .....185
	<b>Mirrors</b>
	Inside rear view mirror .....66
	Side mirror heater .....250
	Side mirrors.....67
	Vanity mirrors.....261
	<b>Multi-information display .....195</b>
<b>N</b>	<b>Noise from under vehicle.....14</b>
<b>O</b>	<b>Odometer.....185</b>
	<b>Oil</b>
	Engine oil .....295
	<b>Opener</b>
	Engine hood.....292
	Fuel filler lid.....73
	Trunk lid .....45
	<b>Outside rear view mirrors</b>
	Adjusting and folding.....67
	<b>Outside temperature</b>
	display .....263
	<b>Overheating, Engine .....403</b>



**P**

**Parking brake** ..... 183

**Parking lights**

    Switch ..... 200

**Power outlets**..... 264

**Power windows** ..... 70

**R**

**Radiator**..... 300

**Rear seats** ..... 54

**Rear side marker lights**

    Replacing light bulbs ..... 337

    Switch ..... 200

    Wattage ..... 421

**Rear turn signal lights**

    Replacing light bulbs ..... 337

    Switch ..... 182

    Wattage ..... 421

**Rear window defogger**..... 250

**Replacing**

    Fuses..... 329

    Key battery ..... 325

    Light bulbs ..... 337

    Tires ..... 378

**Reporting safety defects**

    for U.S. owners ..... 445

**REV indicator**..... 150

**S**

**Seatbelts**

    Adjusting the seatbelt.....58

    Automatic Locking

        Retractor (ALR).....60

    Child restraint system

        installation ..... 136

    Cleaning and maintaining

        the seatbelts .....277

    Emergency Locking

        Retractor (ELR).....60

    How to wear your seatbelt.....58

    How your child should

        wear the seatbelt .....60

    Pregnant women,

        proper seatbelt use .....62

    Reminder light .....367

    Seatbelt guide .....59

    Seatbelt pretensioners .....59

**Seat heaters**.....266

**Seating capacity**.....225

**Seats**

- Adjustment .....51
- Adjustment precautions.....52
- Child seats/child restraint  
system installation ..... 136
- Cleaning.....276
- Head restraint.....56
- Properly sitting in the seat.....85
- Seat heaters.....266

**Service reminder**

- indicators .....190**

**Shift lever**

- Automatic transmission..... 172
- If the select lever cannot  
be shifted from P.....392
- Manual transmission ..... 179

**Shift lock system .....392**

**Side airbags.....87**

**Side marker lights**

- Replacing light bulbs.....337
- Switch.....200
- Wattage.....421

**Side mirror**

- Adjusting and folding.....67

**Keyless access with**

**push button start system**

- Antenna location .....25
- “Keyless access” entry  
function .....23
- Starting the engine ..... 160

**Spare tire**

- Inflation pressure .....420
- Storage location ..... 378

**Spark plug .....416**

**Specifications .....410**

**Speedometer**

- Speedometer ..... 185

**Steering**

- Column lock release ..... 65

**Steering wheel**

- Adjustment.....65

**Storage feature .....255**

**Stuck**

- If your vehicle becomes  
stuck .....406

**Sun visors .....260**

**Switch**

- Driving mode selector  
switch..... 174
- Engine switch..... 160, 169
- Fog light switch .....206
- Hazard light switch..... 354
- Hazard warning flasher  
switch..... 354
- Ignition switch ..... 160, 169
- Light switches .....200
- “ODO/TRIP” switch ..... 187
- Power door lock  
switch.....43
- Power window switch.....70
- Transmission shift  
switches..... 175, 177
- Window lock switch.....70
- Wiper and washer  
switch.....207

**T**

**Tachometer**  
 Tachometer ..... 185

**Tail lights**  
 Switch ..... 200

**Theft deterrent system**  
 Alarm ..... 81  
 Engine immobilizer system..... 77

**Theft prevention labels**..... 80

**Tire inflation pressure** ..... 420

**Tire information**  
 Glossary ..... 432  
 Size ..... 429  
 Tire identification number ..... 428  
 Uniform tire quality  
 grading ..... 430

**Tires**  
 Chains ..... 228  
 Checking ..... 308  
 Compact spare tire ..... 378  
 If you have a flat tire ..... 378  
 Inflation pressure ..... 315  
 Inflation pressure sensor ..... 308  
 Information ..... 426  
 Replacing ..... 378  
 Rotating tires ..... 308  
 Size ..... 420  
 Snow tires ..... 226  
 Spare tire ..... 378  
 Tire pressure monitoring  
 system ..... 367

**Tools** .....378

**Towing**  
 Dinghy towing.....231  
 Emergency towing.....355

**TRAC** .....215

**Traction control**.....215

**Transmission shift  
 switches** .....175, 177

**Transmitter**  
 Locking/Unlocking .....37  
 Replacing the battery .....325  
 Transmitter .....37

**Trip meter** ..... 185

**Trunk lid**  
 Opener .....45

**Trunk light**  
 Wattage .....421

**Turn signal lights**  
 Replacing light bulbs .....337  
 Switch ..... 182  
 Wattage .....421

**U**

**USB port** .....252

**V**

**Vanity lights**  
 Vanity lights .....261  
 Wattage .....421

**Vanity mirrors**.....261

**Vehicle identification  
 number** .....411

**Vehicle stability control  
 (VSC)**.....215

**Vehicle stability control  
 (VSC) SPORT mode**.....217

**W**

**Warning buzzers**  
 Electric power steering.....365  
 Seatbelt reminder.....367

**Warning lights**  
 Automatic transmission  
   fluid temperature  
   warning light.....367  
 Anti-lock brake  
   system .....365  
 Brake assist system .....365  
 Brake system .....364  
 Charging system .....364  
 Cruise control  
   indicator light.....365  
 Electric power steering  
   system warning light .....365  
 Electronic engine control  
   system .....365  
 Engine oil pressure .....364  
 Keyless access with  
   push button start  
   system .....365, 374  
 Low fuel level .....367  
 Low tire pressure.....367  
 Malfunction indicator  
   lamp.....365  
 Open door .....367  
 Pretensioners .....365  
 Seatbelt reminder  
   light .....367  
 Slip indicator light.....365  
 SRS airbags.....365  
 Tire pressure monitoring  
   system .....367

**Washer**  
 Checking .....306  
 Preparing and checking  
   before winter .....226  
 Switch.....207

**Washing and waxing .....272**

**Weight**  
 Cargo capacity .....221  
 Load limits.....225  
 Weight.....410

**Wheels .....319**

**Window glasses .....70**

**Window lock switch.....70**

**Windows**  
 Power windows .....70  
 Rear window defogger .....250  
 Washer.....207

**Windshield wipers .....207**

## What to do if...

## What to do if...

A tire punctures	P. 378	If you have a flat tire
The engine does not start	P. 389	If the engine will not start
	P. 77	Engine immobilizer system
	P. 398	If the battery is discharged
The select lever cannot be moved out	P. 392	If the select lever cannot be shifted from P
The engine coolant temperature gauge enters the red	P. 403	If your vehicle overheats
Steam can be seen coming from under the engine hood		
The key is lost	P. 393	If you lose your keys
The battery runs out	P. 398	If the battery is discharged
The doors cannot be locked	P. 42	Doors
The trunk cannot be opened	P. 45	Trunk lid
The vehicle is stuck in mud or sand	P. 406	If the vehicle becomes stuck
A warning light or indicator light comes on	P. 364	If a warning light turns on or a warning buzzer sounds...

What to do if...

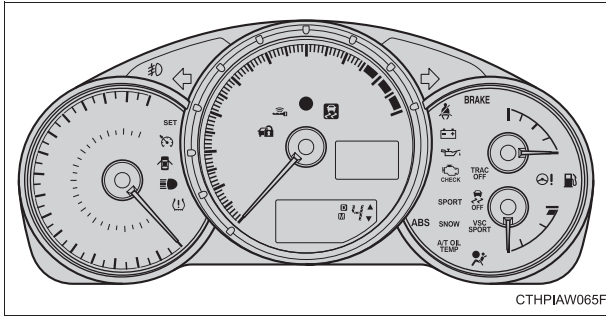

■ Warning lights

**BRAKE** Brake system warning light

or



P. 364



Charging system warning light P. 364



Low engine oil pressure warning light P. 364



Malfunction indicator lamp

or



P. 365



SRS airbag system warning light P. 365



ABS warning light

or



P. 365



Electric power steering warning light P. 365



Keyless access with push button start system indicator light P. 365, 374



Slip indicator

P. 365



Cruise control indicator light\* P. 365



Open door warning light P. 367



Low fuel level warning light P. 367



Driver's seatbelt reminder light P. 367



Front passenger's seatbelt reminder light P. 367



Tire pressure warning light P. 367



Automatic transmission fluid temperature warning light P. 367

\*: The light comes on in yellow to indicate a malfunction.

