

1 Before driving

1-1. Key information
 Keys 28

1-2. Opening, closing and locking the doors
 Wireless remote control 29
 Side doors 33
 Back door 38

1-3. Adjustable components (seats, mirrors, steering wheel)
 Front seats 41
 Rear seats 44
 Driving position memory system 58
 Head restraints 60
 Seat belts 63
 Steering wheel 69
 Anti-glare inside rear view mirror 70
 Outside rear view mirrors 73

1-4. Opening and closing the windows and moon roof
 Power windows 76
 Power back window 79
 Moon roof 82

1-5. Refueling
 Opening the fuel tank cap 85

1-6. Theft deterrent system

Engine immobilizer system... 88
 Alarm 90
 Theft prevention labels (U.S.A.) 92

1-7. Safety information

Correct driving posture 93
 SRS airbags 95
 Front passenger occupant classification system 108
 Child restraint systems 113
 Installing child restraints 117

2 When driving

2-1. Driving procedures

Driving the vehicle 132
 Engine (ignition) switch 140
 Automatic Transmission 143
 Turn signal lever 145
 Parking brake 146
 Horn 147

2-2. Instrument cluster

Gauges and meters 148
 Indicators and warning lights 151
 Accessory meter 155

2-3. Operating the lights and wipers

Headlight switch 158
 Fog light switch 162
 Windshield wipers and washer 163

Rear window wiper and washer 165

2-4. Using other driving systems

Cruise control..... 166

Electronically modulated air suspension..... 169

AUTO LSD system (2WD models and Multi-mode 4WD models) 175

Four-wheel drive system (4WD models)..... 177

Active traction control system (L4 mode on 4WD models) 182

Rear differential lock system 184

Downhill Assist Control 186

Driving assist systems 188

2-5. Driving information

Off-road precautions 198

Cargo and luggage 203

Vehicle load limits 211

Winter driving tips 213

Trailer towing 216

Dinghy towing 228

3 Interior features

3-1. Using the air conditioning system and defogger

Air conditioning system 230

Rear window and outside rear view mirror defoggers 240

3-2. Using the audio system

Audio system (without navigation system)..... 241

Using the radio 244

Using the CD player 250

Playing back MP3 and WMA discs 257

Optimal use of the audio system..... 266

Using the AUX adapter..... 269

Using the steering wheel audio switches..... 271

3-3. Using the rear audio/video system

Rear seat entertainment system..... 274

Using the DVD player (DVD video)..... 280

Using the DVD player (video CD)..... 288

Using the DVD player (audio CD/CD text)..... 291

Using the DVD player (MP3 discs) 292

Using the video mode..... 294

Changing the Setup Menu settings..... 297

3-4. Using the interior lights

Interior lights list 305

• Personal lights..... 306

• Personal/interior lights..... 307

• Interior light 307

3-5. Using the storage features

List of storage features..... 309

• Glove box 310

• Coin holder..... 311

- Console box 312
- Tissue pocket 313
- Trash holder 314
- Overhead console 316
- Cup holders 316
- Bottle holders 321
- Auxiliary boxes 322

3-6. Other interior features

- Sun visors 323
- Vanity mirrors 324
- Clock 325
- Outside temperature display 326
- Rear side-view mirrors 328
- Power outlets 329
- Seat heaters 334
- Armrest 336
- Floor mat 337
- Luggage compartment features 338
- Garage door opener 345
- Compass 350

4 Maintenance and care

4-1. Maintenance and care

- Cleaning and protecting the vehicle exterior 356
- Cleaning and protecting the vehicle interior 359

4-2. Maintenance

- Maintenance requirements 362
- General maintenance 364
- Emission inspection and maintenance (I/M) programs 367

4-3. Do-it-yourself maintenance

- Do-it-yourself service precautions 368
- Hood 372
- Engine compartment 373
- Tires 389
- Tire inflation pressure 395
- Wheels 398
- Air conditioning filter 400
- Wireless remote control battery 402
- Checking and replacing fuses 404
- Light bulbs 415

5 When trouble arises

5-1. Essential information

Emergency flashers	426
If your vehicle needs to be towed	427
If you think something is wrong	432
Fuel pump shut off system	433
Event data recorder	434

5-2. Steps to take in an emergency

If a warning light turns on or a warning buzzer sounds.....	436
If you have a flat tire.....	445
If the engine will not start	456
If the shift lever cannot be shifted from P.....	457
If you lose your keys	458
If the vehicle battery is discharged	459
If your vehicle overheats	463
If the vehicle becomes stuck	466

6 Vehicle specifications

6-1. Specifications

Maintenance data (fuel, oil level, etc.)	470
Fuel information	481
Tire information.....	484

6-2. Customization

Customizable features.....	495
Items to initialize.....	498

7 For owners

Reporting safety defects for U.S. owners.....	500
Seat belt instructions for Canadian owners (in French).....	501

Index

Abbreviation list.....	504
Alphabetical index	506
What to do if... ..	515

1

2

3

4

5

6

7



Customer Experience Center
1-800-331-4331

4Runner

2009 Quick Reference Guide

2009 4Runner

This *Quick Reference Guide* is a summary of basic vehicle operations. It contains brief descriptions of fundamental operations so you can locate and use the vehicle's main equipment quickly and easily.

The *Quick Reference Guide* is not intended as a substitute for the *Owner's Manual* located in the vehicle's glove box. We strongly encourage you to review the *Owner's Manual* and supplementary manuals so you will have a better understanding of the vehicle's capabilities and limitations.

Your dealership and the entire staff of Toyota Motor Sales, U.S.A., Inc. wish you many years of satisfied driving in your new 4Runner.

! A word about safe vehicle operations

This *Quick Reference Guide* is not a full description of 4Runner operations. Every 4Runner owner should review the *Owner's Manual* that accompanies this vehicle.

Pay special attention to the boxed information highlighted in color throughout the *Owner's Manual*. Each box contains safe operating instructions to help you avoid injury or equipment malfunction.

All information in this *Quick Reference Guide* is current at the time of printing. Toyota reserves the right to make changes at any time without notice.

Spare tire & tools

Tool location

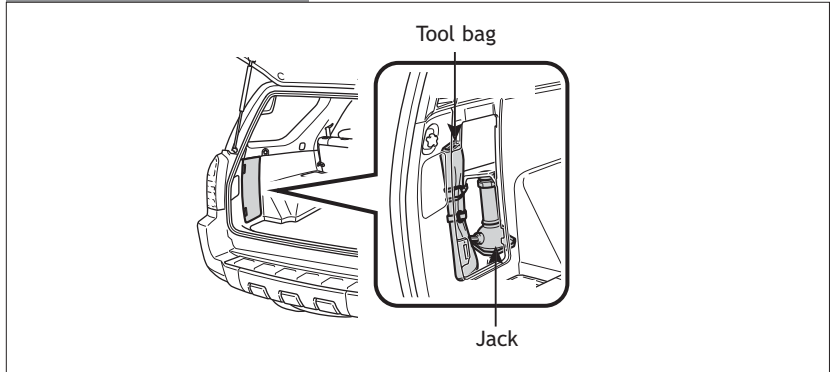

Removing the spare tire

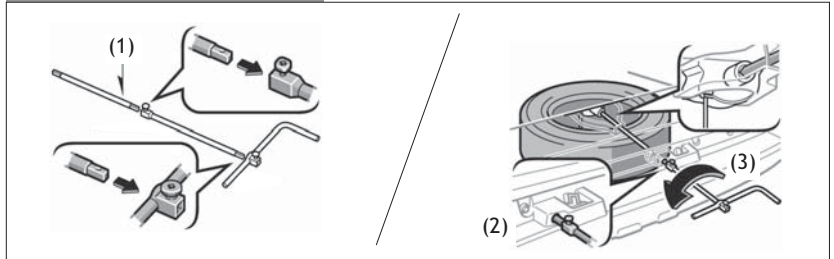

- (1) Assemble the jack handle.
- (2) Insert the jack handle end through the opening in the bumper, and into the lowering screw.
- (3) Turn the jack handle counterclockwise.

Refer to the *Owner's Manual* for tire changing and jack positioning procedures.

INDEX

OVERVIEW

Engine maintenance	7
Fuel tank door release and cap	6
Hood release	7
Indicator symbols	4-5
Instrument cluster	4
Instrument panel	2-3
Keyless entry¹	6

FEATURES/OPERATIONS

Air Conditioning/Heating	17
Audio	18-19
Auto lock functions^{1,2}	8
Automatic Transmission	8
Bottle holders	23
Clock	13
Cruise control	16
Cup holders	22
Door locks	20
Four-wheel drive	9
Garage door opener (HomeLink [®]) ³	21
Light control-Instrument panel	13
Lights¹ & turn signals	14
Moonroof¹	22
Parking brake	12
Power outlets-12V DC	23
Power outlets-115V AC	23
Rear seat entertainment system	20
Seat adjustments-Front	10
Seat adjustments-Rear	11
Seat heaters	16
Seats-Head restraints	12
Tilt and telescopic steering wheel	10
VSC OFF button	21
Windows¹	15
Window-Rear hatch¹	15
Windshield wipers & washers	13

SAFETY AND

EMERGENCY FEATURES

Doors-Child safety locks	24
Seat belts	24
Seat belts-Shoulder belt anchor	24
Spare tire & tools	25
Tire Pressure Monitoring (warning) System	24

¹ Visit your Toyota dealer for information on customizing this feature.

² Programmable by customer. Refer to the Owner's Manual for instructions and more information.

³ HomeLink[®] is a registered trademark of Johnson Controls, Inc.

OVERVIEW

Instrument panel

Steering wheel controls

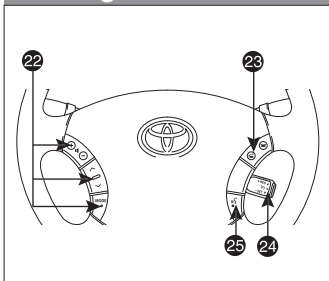

Rear console box

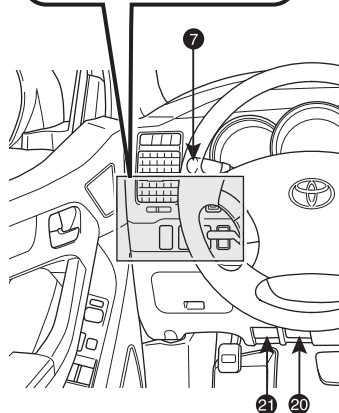
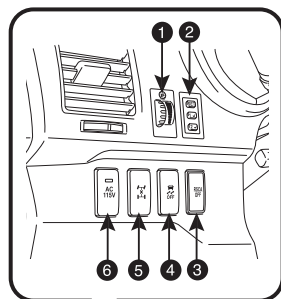
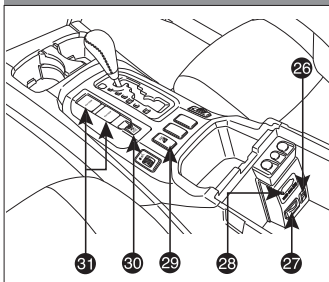

- 1 Instrument panel light control
- 2 Driving position memory switches¹
- 3 "RSCA OFF" (Roll Sensing of Curtain shield Airbags "OFF") switch¹
- 4 VSC OFF switch¹
- 5 Center differential lock switch¹
- 6 115V AC Power outlet ON/OFF switch¹
- 7 Headlight, turn signal and front fog light¹ control
- 8 Wiper and washer controls
- 9 Engine switch
- 10 Four-wheel drive selector¹ (full-time 4WD models) or two wheel/ four-wheel drive selector¹ (part-time 4WD models)
- 11 Multi-information display
- 12 Audio system or navigation system²
- 13 Front passenger seat belt reminder light
- 14 Emergency flasher switch
- 15 Front passenger occupant classification indicator
- 16 Engine immobilizer/Theft deterrent system indicator¹

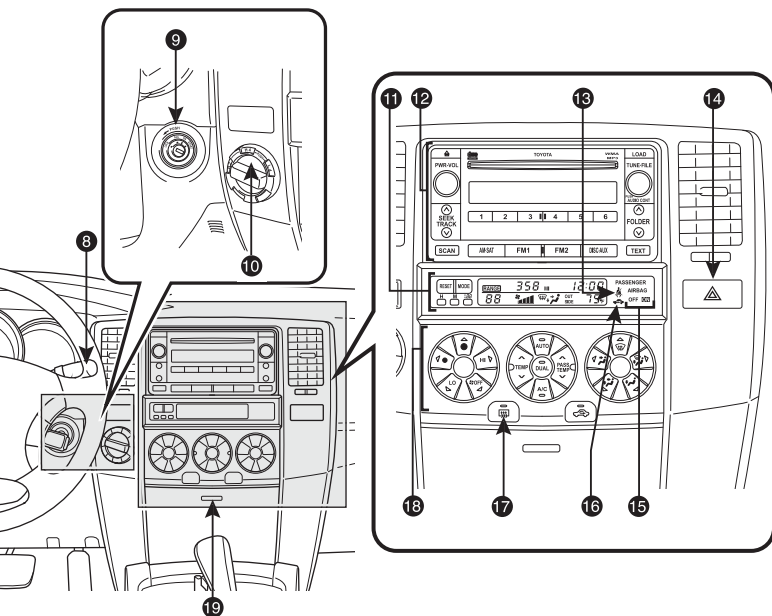

- 17 Back window and outside rearview mirror defogger¹ switch
- 18 Air Conditioning controls
- 19 Auxiliary boxes
- 20 Hood release
- 21 Fuel tank door opener
- 22 Steering wheel audio controls^{1,2}
- 23 Telephone switches^{1,2}
- 24 Cruise control
- 25 Navigation voice command button^{1,2}
- 26 AUX adapter
- 27 115V AC Power outlet¹
- 28 A/V input adapter¹
- 29 Downhill Assist Control switch¹
- 30 Power back window switch
- 31 12V DC Power outlet/Cigarette lighter

¹ If equipped

² For vehicles with a navigation system, refer to the “Navigation System Owner’s Manual.”

Instrument cluster

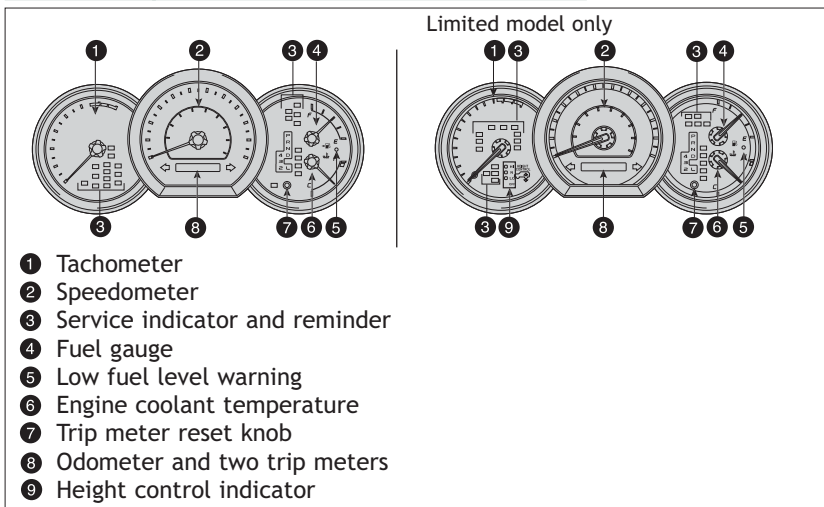

















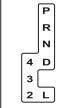



Indicator symbols

	Brake system warning ¹
	Driver/Front passenger seat belt reminder ¹
	Charging system warning ¹
	Low engine oil pressure warning ¹
	Malfunction/Check Engine indicator ¹
	Engine oil replacement reminder ¹
	Open door warning ¹
	Airbag SRS warning ¹
	Automatic Transmission fluid temperature warning ¹
	Low Tire Pressure Warning ¹
	Engine immobilizer/Theft deterrent system indicator

¹ For details, refer to “If a warning light turns on or warning buzzer sounds...” Section 5-2, 2009 Owner’s Manual.

² For details, see “SRS airbags” Section 1-7, 2009 Owner’s Manual.

³ If this light flashes, refer to “Four-wheel drive system,” Section 2-4, 2009 Owner’s Manual.

	Roll Sensing of Curtain shield Airbag OFF indicator ²
	AIR BAG ON indicator
	AIR BAG OFF indicator
	Headlight high beam indicator
	Turn signal indicator
	Front fog light indicator
	Automatic Transmission indicator
	Low speed four-wheel drive indicator ³
	Center differential lock indicator ³
	Vehicle Stability Control "OFF" indicator ¹
	Four-wheel drive indicator ³
	Slip indicator
	AUTO Limited Slip Differential indicator
	Downhill Assist Control indicator
	Height control indicator ⁴
	Cruise control indicator ⁵
	Anti-lock Brake System warning ¹
	Low fuel level warning ¹
	Active traction control indicator
	Rear differential lock indicator

⁴ If "OFF" indicator flashes, refer to "Electronically modulated air suspension" Section 2-4, 2009 Owner's Manual.

⁵ If this light flashes, refer to "Cruise control," Section 2-4, 2009 Owner's Manual.

Fuel tank door release and cap

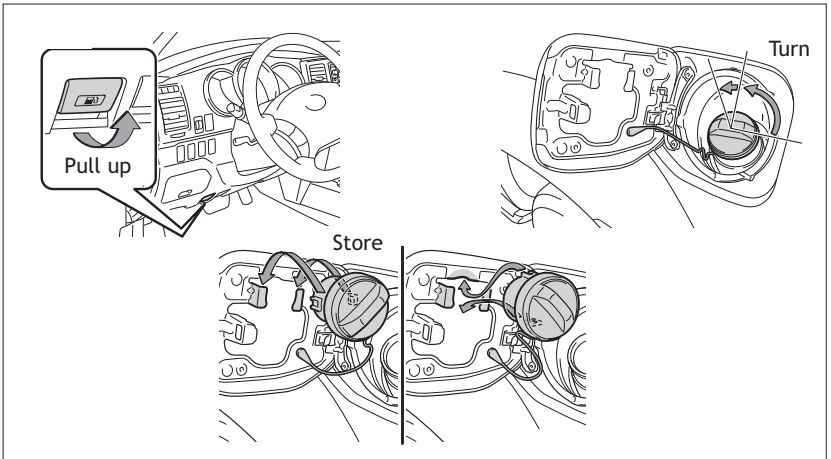

NOTE: Tighten until one click is heard. If the cap is not tightened enough, Check Engine “” indicator may illuminate.

Keyless entry (if equipped)

Beep sound can be switched ON or OFF. Refer to the *Owner's Manual* for more details.

Locking operation



Push



Unlocking operation



Push ONCE: Driver door
TWICE: All doors



NOTE: After unlocking, if a door is not opened within 30 seconds, all doors will relock for safety.

Back window operation



Push and hold



Panic button



Push and hold



Hood release

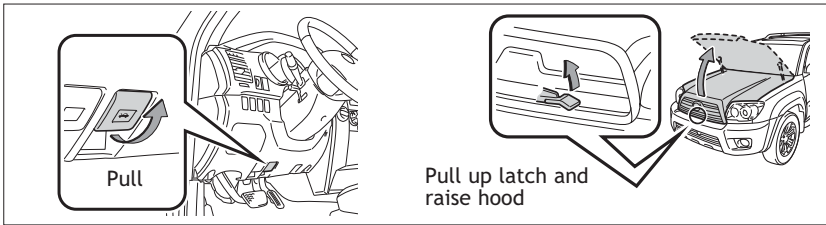

Engine maintenance

6 cylinder (1GR-FE) engine

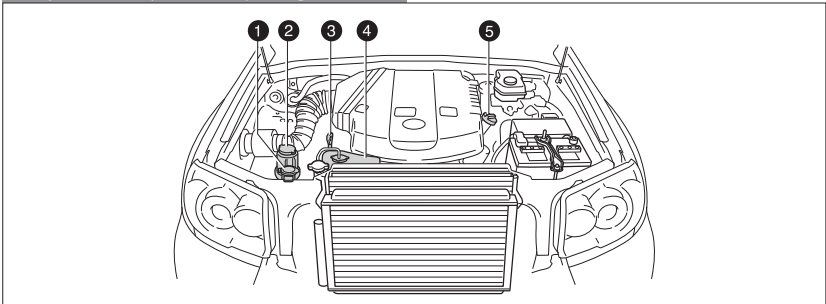

8 cylinder (2UZ-FE) engine

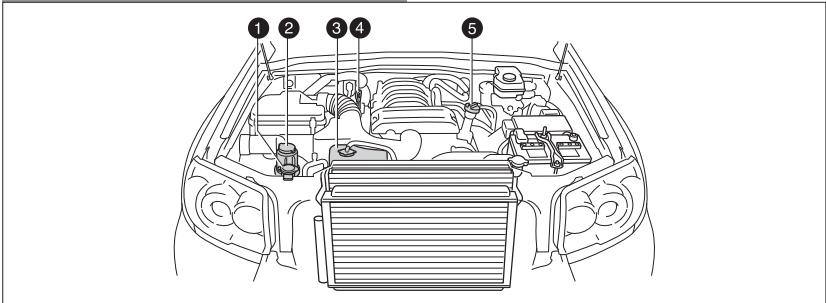

- ❶ Windshield and back window washer fluid tank
- ❷ Power steering fluid reservoir
- ❸ Engine oil level dipstick
- ❹ Engine coolant reservoir
- ❺ Engine oil filler cap

Note: Regularly scheduled maintenance, including oil changes, will help extend the life of your vehicle and maintain performance. Please refer to the “Owner’s Warranty Information Booklet,” “Scheduled Maintenance Guide” or “Owner’s Manual Supplement.”

FEATURES/OPERATIONS

Auto lock functions

Automatic door locks can be programmed to operate in four different modes, or turned OFF.

- Doors lock when shifting from Park.
- Doors lock when the vehicle speed goes above approximately 12 mph.
- Doors unlock when shifting into Park.
- Doors unlock when the engine switch is set from "ON" to "ACC" or "LOCK" and driver's door is opened.

Refer to the *Owner's Manual* for more details.

Automatic Transmission

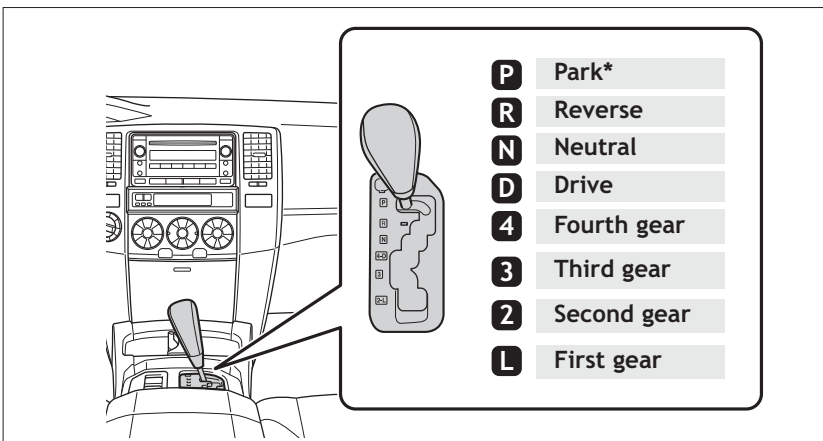

* The engine switch must be "ON" and the brake pedal depressed to shift from Park.

Downshifting increases power going uphill, or provides engine braking downhill. For best fuel economy during normal driving conditions, always drive with the shift lever in the "D" position.

Four-wheel drive (if equipped)

Part-time four-wheel drive models

- H2** High speed (2WD)
- H4** High speed (4WD)
Turn to "H4" with speed below 62 mph.
- L4** Low speed (4WD)
Shift to "N" position, then push and turn to "L4."

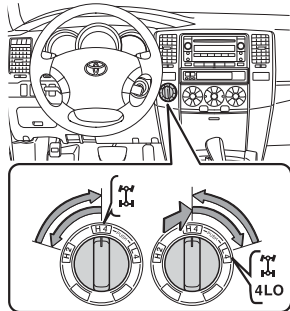

Full-time four-wheel drive models

- H4** High speed
Turn to "H4" with speed below 62 mph.
- L4** Low speed
Shift to "N" position, then push and turn to "L4."

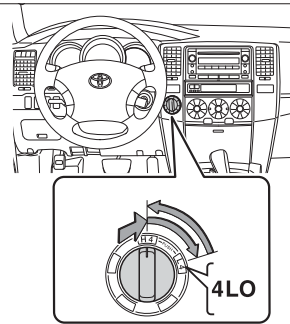

Center differential lock button

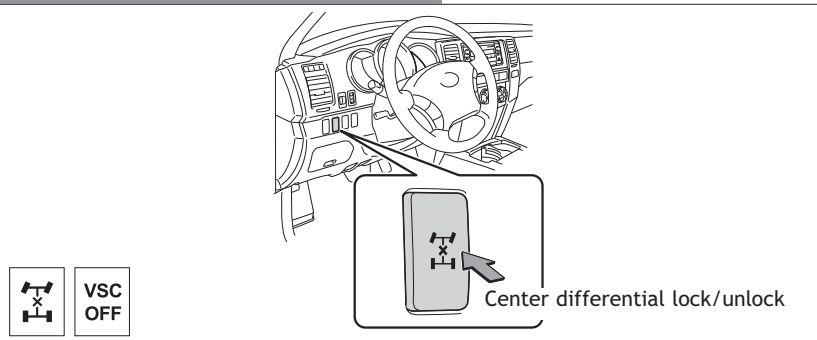

For best fuel economy and performance under normal driving conditions:

- "H2" position (part-time four-wheel drive models)
- "H4" position (full-time four-wheel drive models), center differential unlocked (center differential lock indicator and "VSC OFF" indicator are not illuminated).

Tilt and telescopic (if equipped) steering wheel

(1) Angle

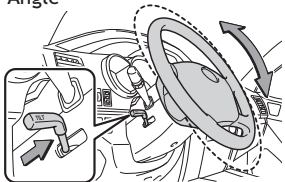

(2) Column length

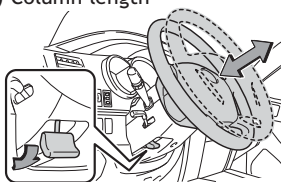

- (1) **To change the angle** Hold the steering wheel, pull the lock release lever, tilt to the desired angle, and release the lever.
- (2) **To change the column length** Push the lock release lever down, set the desired length, and return the lever to its locked position.

Note: Do not attempt to adjust while the vehicle is in motion.

Seat adjustments-Front

Manual seat

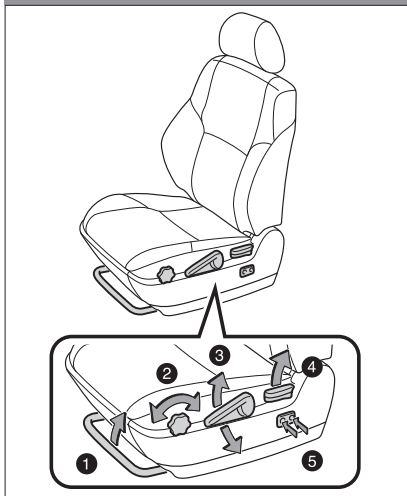

Power seat

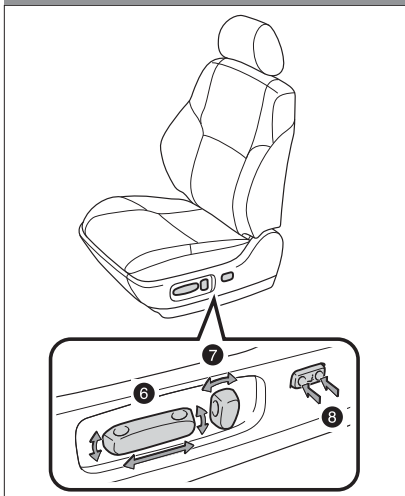

- ① Seat position (forward/backward)
- ② Cushion angle (driver side only)
- ③ Height crank (driver side only)
- ④ Seatback angle
- ⑤ Lumbar support (driver side only)
- ⑥ Driver seat: position, cushion angle and height
Passenger seat: position
- ⑦ Seatback angle
- ⑧ Lumbar support (driver side only)

Seat adjustments-Rear (vehicles with third row seats)

Second row seats

Seatback angle

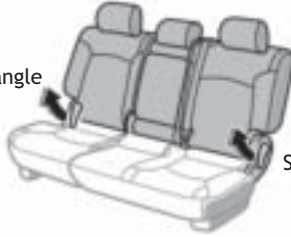

Seatback angle

Third row seats

Seatback angle



Seatback angle

Seat adjustments-Rear (vehicles without third row seats)

(2) Lower

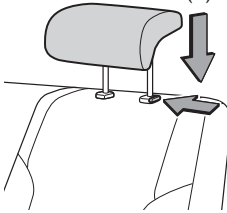

(1) Push

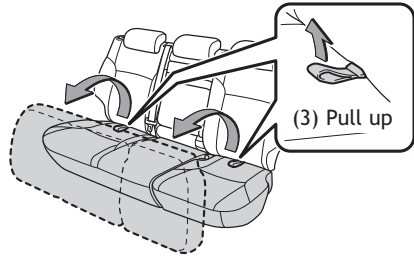

(3) Pull up

(4) Push down

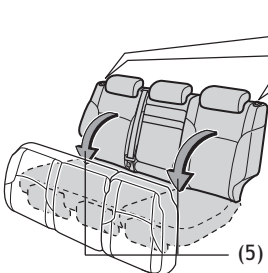

(5) Fold down

Parking brake

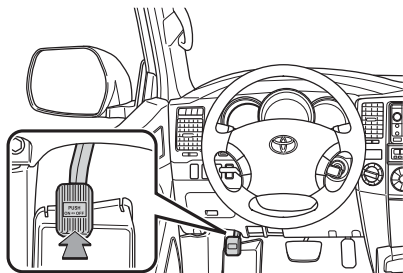

Set: Depress
Release: Depress again

Seats-Head restraints

Front

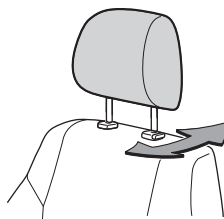
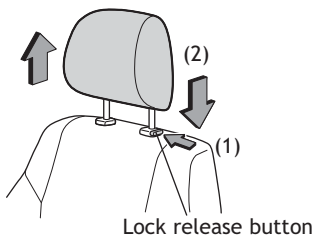

Second row

With third seat

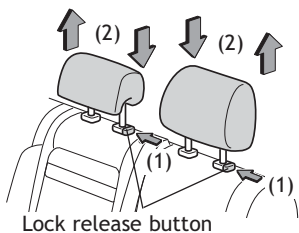

Without third seat

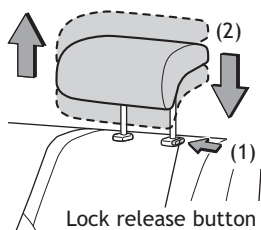

Third row

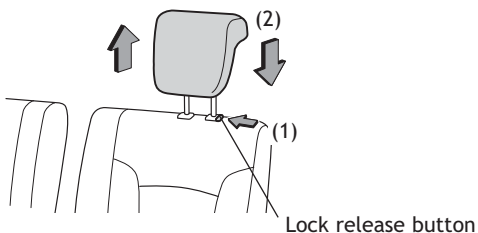

Windshield wipers & washers

Front

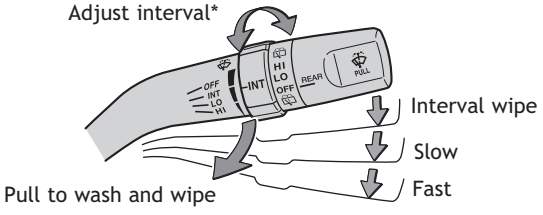

* Intermittent windshield wiper interval adjustment
 Rotate to increase/decrease wipe frequency.

Rear

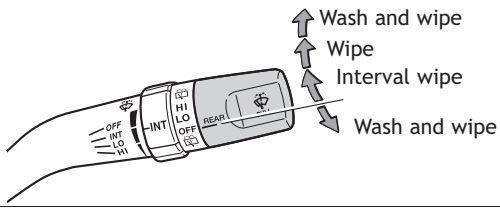

NOTE: Rear wiper and washer operate only when rear window is fully closed. If battery is disconnected, rear washer will not function until rear window is reinitialized by being fully opened and then closed.

Light control-Instrument panel

Brightness control

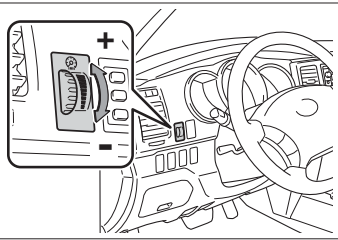

Clock

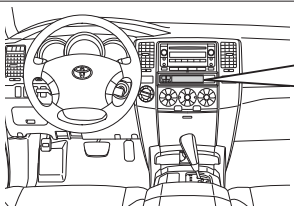

H- Hour set
 M- Minute set
 :00- Round off minutes

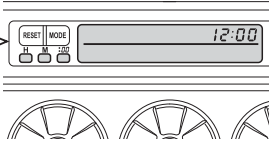

Lights & turn signals

Headlights

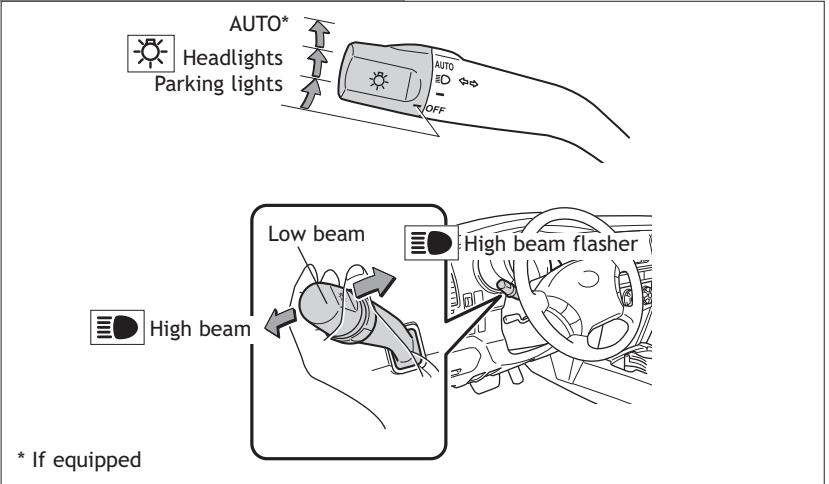

-Daytime Running Light system (if equipped)

Automatically turns on the headlights at a reduced intensity.

-Automatic light cut off system Will automatically turn lights off after a delay of 30 seconds, or the lock switch on remote may be pushed after locking.

Turn signals

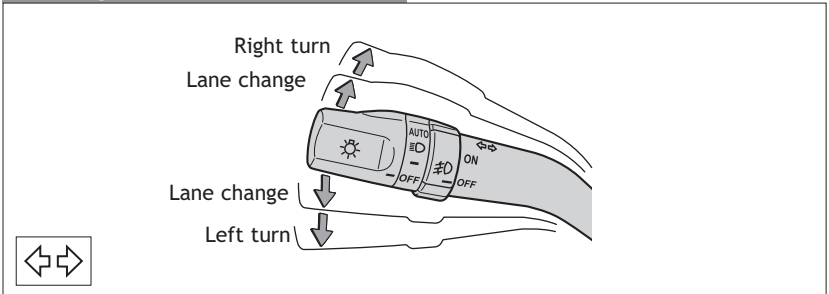

Front fog lights (if equipped)

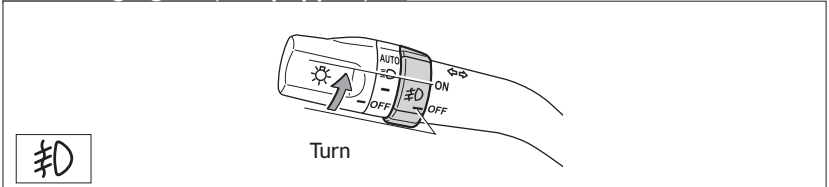

Front fog lights come on only when the headlights are on low beam.

Windows

Driver side

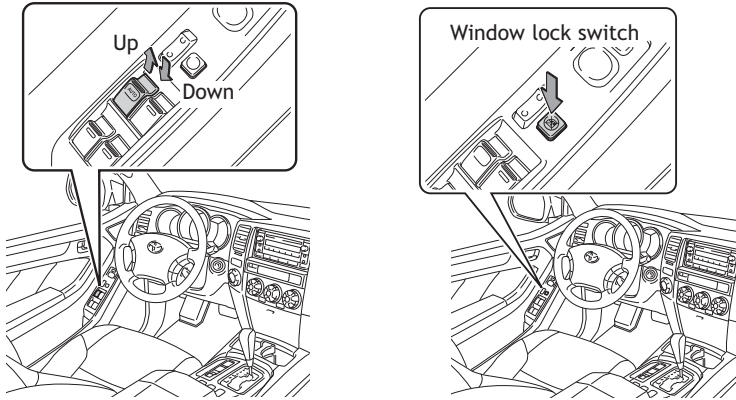

Automatic operation (driver side only) Push the switch completely down or pull it completely up and release to fully open or close. To stop window midway, lightly push the switch in the opposite direction.

Window lock switch Deactivates all passenger windows. Driver's window remains operable.

NOTE: If the battery is disconnected, the window will need to be reinitialized. Refer to the *Owner's Manual* for more details.

Window-Rear hatch

Operating from inside

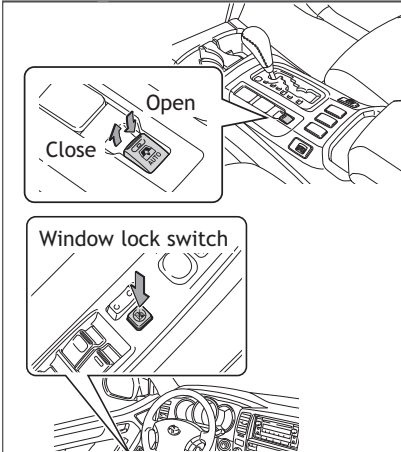

Operating from outside

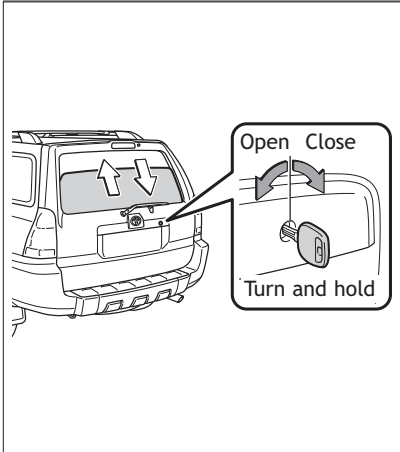

NOTE: If the battery is disconnected, the rear hatch window will need to be reinitialized. Refer to the *Owner's Manual* for more details.

Cruise control

Turning system ON/OFF

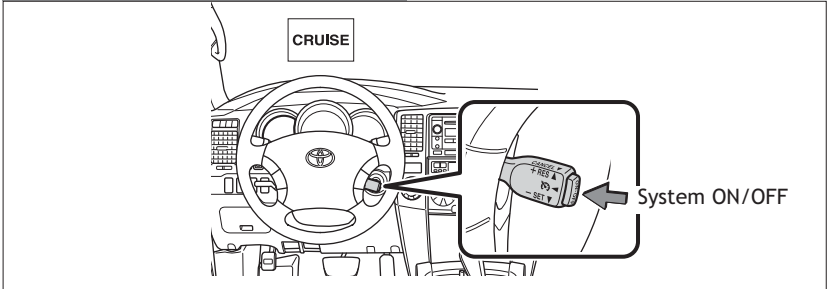

Functions

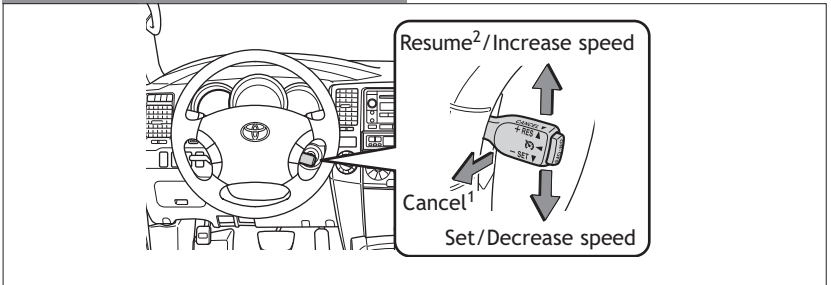

¹ The set speed may also be cancelled by depressing the brake pedal.

² The set speed may be resumed once vehicle speed exceeds 25 mph.

Refer to the *Owner's Manual* for more details.

Seat heaters (if equipped)

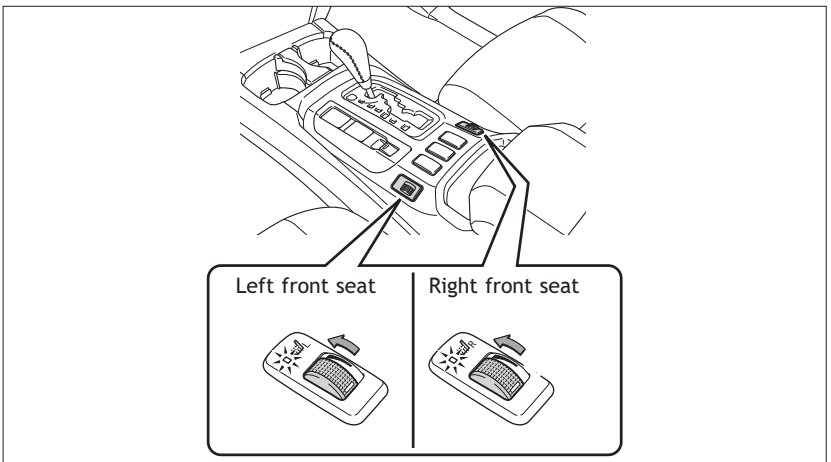

Air Conditioning/Heating

With “DUAL” button

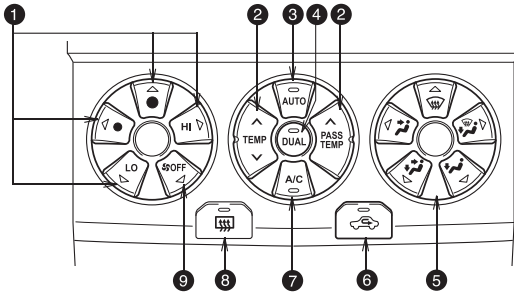

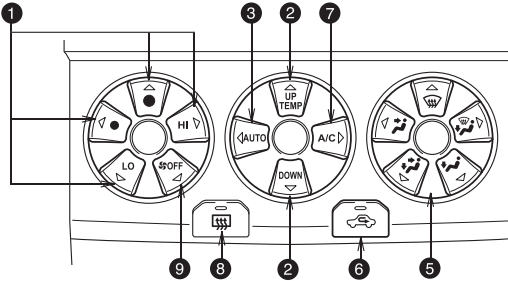

Without “DUAL” button



- ❶ Fan speed
- ❷ Temperature selector
- ❸ Automatic climate control ON/OFF
- ❹ “DUAL” button

Indicator ON: Separate temperature settings for driver and passenger.

Indicator OFF: Synchronize temperature settings for driver and passenger.

- ❺ Airflow vent
In “” mode, use fresh air (“” indicator OFF) to reduce window fogging. “” mode uses fresh air only.
- ❻ Fresh or recirculated cabin air
- ❼ Air Conditioning ON/OFF
- ❽ Rear defogger
- ❾ Climate control OFF

Audio

Type 1

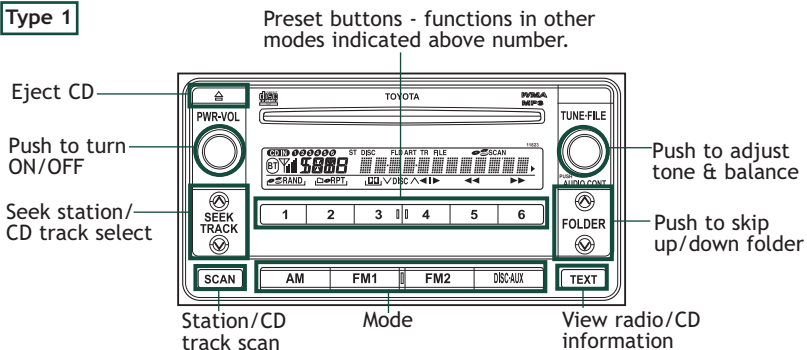

Type 2 additional functions

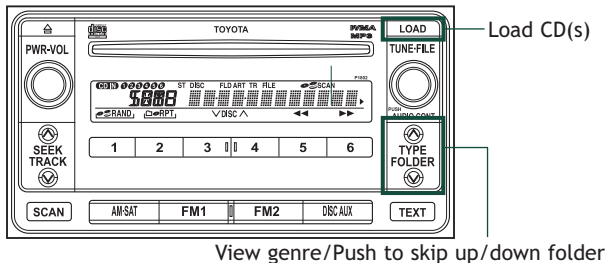

Type 3 additional functions

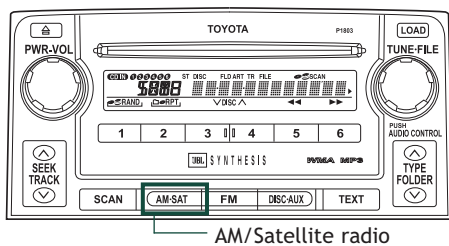

CD PLAYER

To scan tracks on a disc Push “SCAN.” Push again to hold selection.

CD Changer (Types 2 and 3)

- To load one disc Push “LOAD” and insert one disc.
- To load multiple discs Push and hold “LOAD” until you hear a beep. Insert one disc. Shutter will close and then re-open for next disc.

To select a file (MP3/WMA only) Turn “TUNE-FILE.”

To select a folder (MP3/WMA only) Push either side of “FOLDER” or “TYPE/FOLDER.”

RADIO

To preset stations Tune in the desired station and hold down a preset button (1-6) until you hear a beep. Push desired preset button (1-6) to select.

To scan stations Push “SCAN.” Push and hold to scan preset stations. Push again to hold selection.

Steering wheel controls (if equipped)

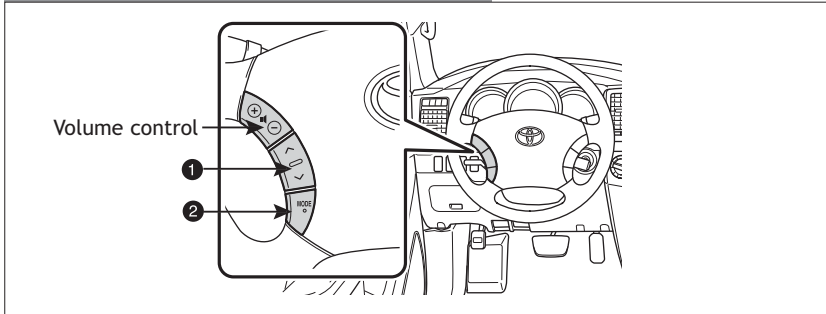

1 “▲▼”

-In radio mode Push to select a preset station; push and hold to seek the next strong station.

-In CD mode Push to skip up or down to next/previous track.

2 “MODE”

Push to turn audio ON and select an audio mode. Push and hold to turn audio system OFF.

AUX adapter

Center console

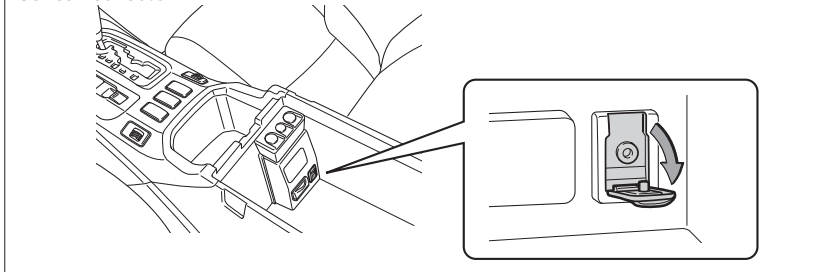

By inserting a mini plug into the AUX audio jack, you can listen to music from a portable audio device through the vehicle’s speaker system while in AUX mode.

Door locks

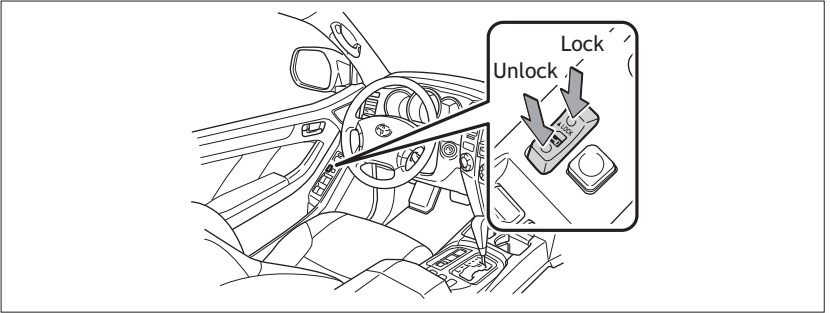

Rear seat entertainment system (if equipped)

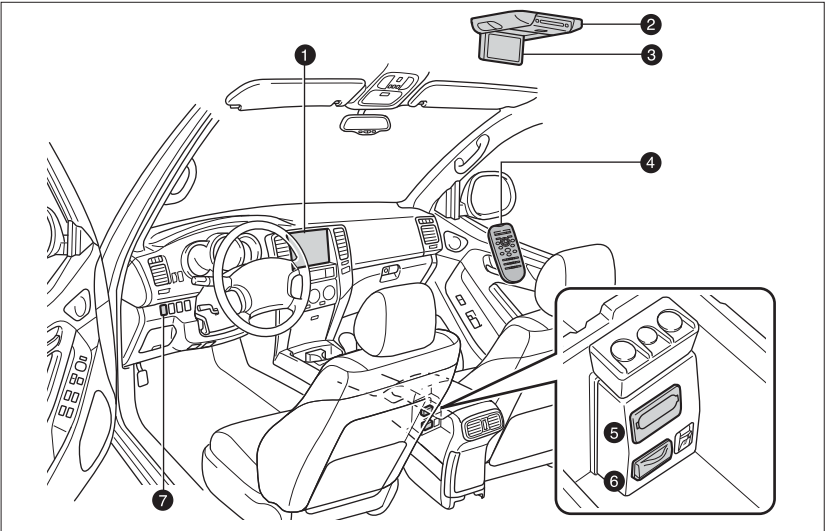

- ① Front audio system
- ② DVD player
- ③ DVD screen
- ④ Remote control
- ⑤ A/V input adapter
- ⑥ 115V AC Power outlet
- ⑦ 115V AC Power outlet ON/OFF switch

Garage door opener (HomeLink®)* (if equipped)

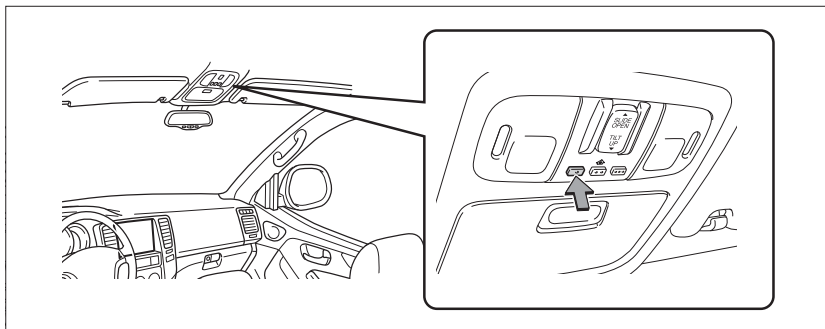

Garage door openers manufactured under license from HomeLink®* can be programmed to operate garage doors, estate gates, security lighting, etc.

Refer to the *Owner's Manual* for more details.

For programming assistance, contact the Toyota Customer Experience Center at 1-800-331-4331, or visit <http://www.homelink.com>.

* HomeLink® is a registered trademark of Johnson Controls, Inc.

VSC OFF button

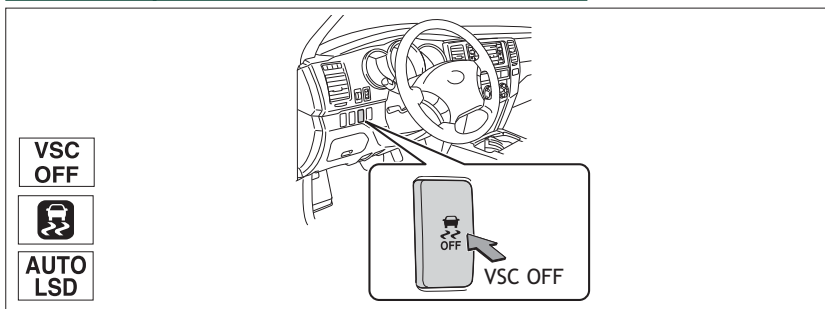

The VSC OFF button is used to switch between modes related to the TRAC, VSC and Auto LSD functions.

Refer to Section 2-4 of the *Owner's Manual* for more information.

Moonroof (if equipped)

Sliding operation

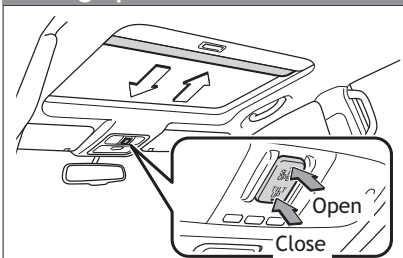

Push once to open/close completely. To stop partway, press switch lightly.

Tilting operation

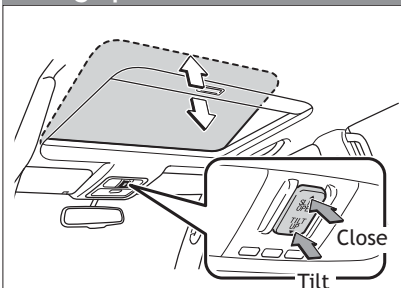

NOTE: If battery is disconnected, the moonroof will need to be reinitialized. Refer to the *Owner's Manual* for more details.

Cup holders

Center console

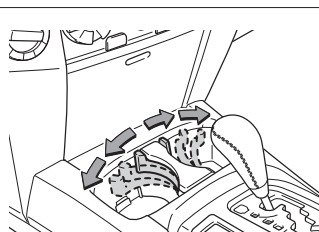
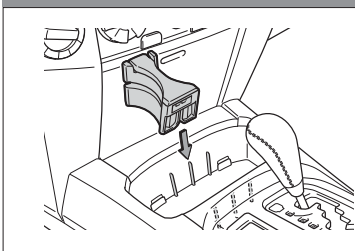

Rear (without third seats)

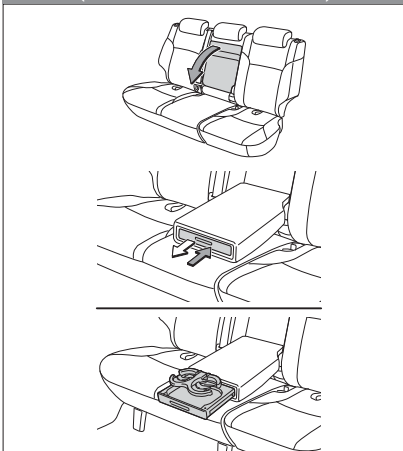

Rear (with third seats)

Second row seat

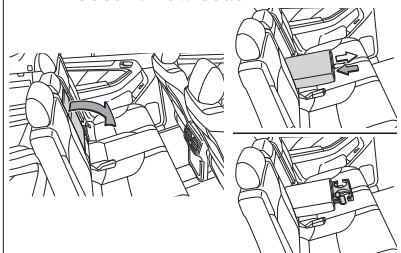

Third row side trim

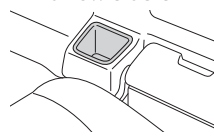

Bottle holders

Front doors

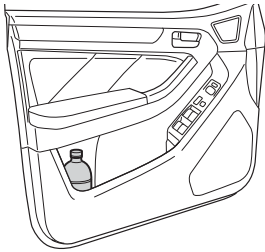

Rear doors

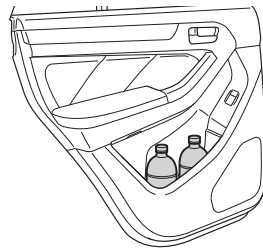

Power outlets-12V DC

Auxiliary box

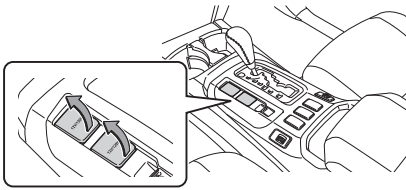

Luggage compartment

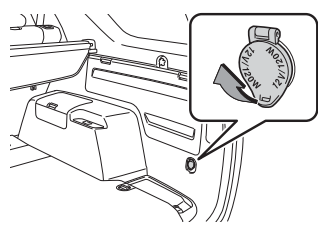

NOTE: Designed for car accessories. Engine switch must be in the “ACC” or “ON” position to be used.

Power outlets-115V AC (if equipped)

ON/OFF switch

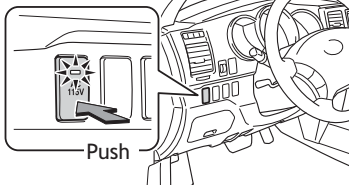

Inside center console

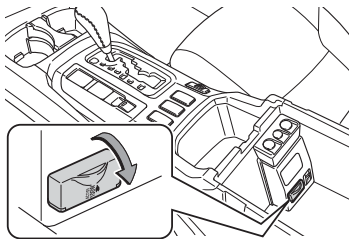

NOTE: Engine switch must be in the “ON” position to be used.

SAFETY AND EMERGENCY FEATURES

Doors-Child safety locks

Rear door

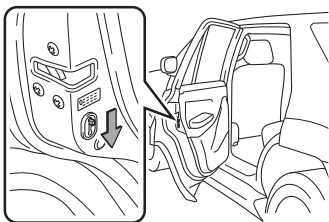

Moving the lever to “LOCK” will allow the door to be opened only from the outside.

Seat belts



If belt is fully extended, then retracted even slightly, it cannot be re-extended beyond that point, unless fully retracted again. This feature is used to help hold child restraint systems securely.

To find more information about seat belts, and how to install a child restraint system, refer to the *Owner's Manual*.

Seat belts-Shoulder belt anchor

Push up or squeeze lock release to lower

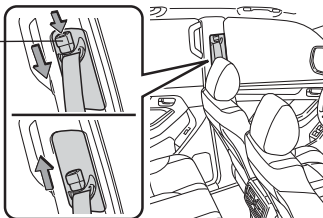

Tire Pressure Monitoring (warning) System

If tire pressure becomes critically low on any of the tires (including the spare), indicator light will come on. Correctly adjusting tire inflation will turn off the light after a few minutes. If the light does not turn off, have the system checked by your Toyota dealer.

Refer to the *Owner's Manual* for more details.

Abbreviation/Acronym list

ABBREVIATIONS	MEANING
2WD	Two Wheel Drive
4WD	Four Wheel Drive
ABS	Anti-Lock Brake System
ACC	Accessory
ALR	Automatic Locking Retractor
A-TRAC	Active Traction Control
AUTO LSD	Automatic Limited Slip Differential
CRS	Child Restraint System
DAC	Downhill assist control
ECU	Electronic Control Unit
EDR	Event Data Recorder
ELR	Emergency Locking Retractor
GAWR	Gross Axle Weight Rating
GCWR	Gross Combination Weight Rating
GVWR	Gross Vehicle Weight Rating
I/M	Emission inspection and maintenance
INT	Intermittent
LATCH	Lower Anchors and Tethers for Children
LED	Light Emitting Diode
LT	Light truck
M + S	Mud + Snow
MMT	Methylcy clopentadienyl Manganese Tricarbonyl
MTBE	Methyl Tertiary Butyl Ether
OBD	On Board Diagnostics
RES	Resume
RR DIFF LOCK	Rear differential lock
RSCA	Roll sensing of curtain shield airbag

ABBREVIATIONS	MEANING
SRS	Supplemental Restraint System
TIN	Tire Identification Number
TPMS	Tire Pressure Warning System
TRAC	Traction Control
TWI	Treadwear indicators
VIN	Vehicle Identification Number
VSC	Vehicle Stability Control

For your information

Main Owners Manual

Please note that this manual applies to all models explains and all equipment, including options. Therefore, you may find some explanations for equipment not installed on your vehicle.

All specifications provided in this manual are current at the time of printing. However, because of the Toyota policy of continual product improvement, we reserve the right to make changes at any time without notice.

Depending on specifications, the vehicle shown in the illustrations may differ from your vehicle in terms of equipment.

Accessories, spare parts and modification of your Toyota

A wide variety of non-genuine spare parts and accessories for Toyota vehicles are currently available in the market. You should know that Toyota does not warrant these products and is not responsible for their performance, repair, or replacement, or for any damage they may cause to, or adverse effect they may have on, your Toyota vehicle.

This vehicle should not be modified with non-genuine Toyota products. Modification with non-genuine Toyota products could affect its performance, safety or durability, and may even violate governmental regulations. In addition, damage or performance problems resulting from the modification may not be covered under warranty.

Installation of a mobile two-way radio system

As the installation of a mobile two-way radio system in your vehicle could affect electronic systems such as the multiport fuel injection system/sequential multiport fuel injection system, cruise control system, anti-lock brake system, SRS airbag system and seat belt pretensioner system, be sure to check with your Toyota dealer for precautionary measures or special instructions regarding installation.

Scrapping your Toyota

The SRS airbag and seat belt pretensioner devices in your Toyota contain explosive chemicals. If the vehicle is scrapped with the airbags and seat belt pretensioners left as they are, this may cause an accident such as fire. Be sure to have the systems of the SRS airbag and seat belt pretensioner removed and disposed of by a qualified service shop or by your Toyota dealer before you scrap your vehicle.

Perchlorate Material

Special handling may apply,
See www.dtsc.ca.gov/hazardouswaste/perchlorate.

Your vehicle has components that may contain perchlorate. These components may include airbag, seat belt pretensioners, and wireless remote control batteries.

CAUTION

n General precautions while driving

Driving under the influence: Never drive your vehicle when under the influence of alcohol or drugs that have impaired your ability to operate your vehicle. Alcohol and certain drugs delay reaction time, impair judgment and reduce coordination, which could lead to an accident that will hurt or kill you, your occupants or others.

Defensive driving: Always drive defensively. Anticipate mistakes that other drivers or pedestrians might make and be ready to avoid accidents.

Driver distraction: Always give your full attention to driving. Anything that distracts the driver, such as adjusting controls, talking on a cellular phone or reading can result in a collision with resulting death or serious injury to you, your occupants or others.

 CAUTION

n General precaution regarding children's safety

Never leave children unattended in the vehicle, and never allow children to have or use the key.

Children may be able to start the vehicle or shift the vehicle into neutral. There is also a danger that children may injure themselves by playing with the cigarette lighter, the windows, or other features of the vehicle. In addition, heat build-up or extremely cold temperatures inside the vehicle can be fatal to children.

Symbols used throughout this manual

Cautions & Notices

CAUTION

This is a warning against anything which may cause injury to people if the warning is ignored. You are informed about what you must or must not do in order to reduce the risk of injury to yourself and others.

NOTICE

This is a warning against anything which may cause damage to the vehicle or its equipment if the warning is ignored. You are informed about what you must or must not do in order to avoid or reduce the risk of damage to your Toyota and its equipment.

Symbols used in illustrations



Safety symbol

The symbol of a circle with a slash through it means “Do not”, “Do not do this”, or “Do not let this happen”.

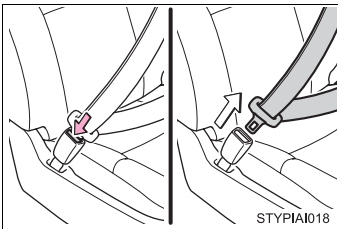

Arrows indicating operations



-  Indicates the action (pushing, turning, etc.) used to operate switches and other devices.
-  Indicates the outcome of an operation (e.g. a lid opens).

TABLE OF CONTENTS

1	Before driving	Adjusting and operating features such as door locks, mirrors, and steering column.
2	When driving	Driving, stopping and safe-driving information.
3	Interior features	Air conditioning and audio systems, as well as other interior features for a comfortable driving experience.
4	Maintenance and care	Cleaning and protecting your vehicle, performing do-it-yourself maintenance, and maintenance information.
5	When trouble arises	What to do if the vehicle needs to be towed, gets a flat tire, or is involved in an accident.
6	Vehicle specifications	Detailed vehicle information.
7	For owners	Reporting safety defects for U.S. owners and seat belt instructions for Canadian owners
	Index	Alphabetical listing of information contained in this manual.

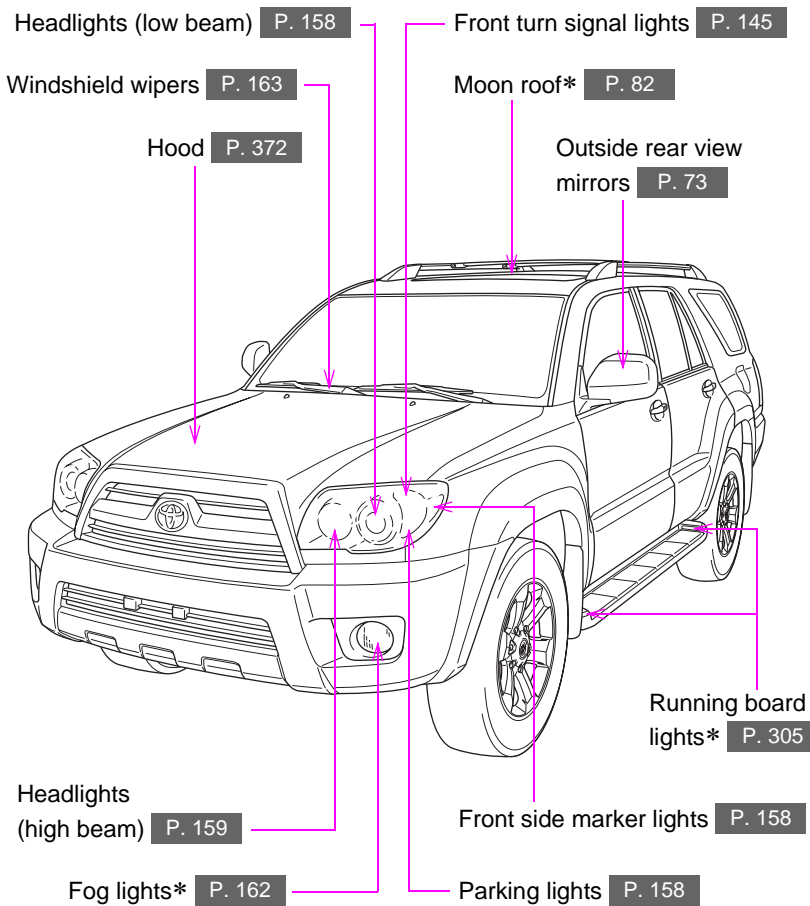

Roof luggage carrier* P. 203

Rear turn signal lights P. 145

Fuel filler door P. 85

Rear window defogger P. 240

Back window P. 79

Side doors P. 33

Rear window wiper P. 165

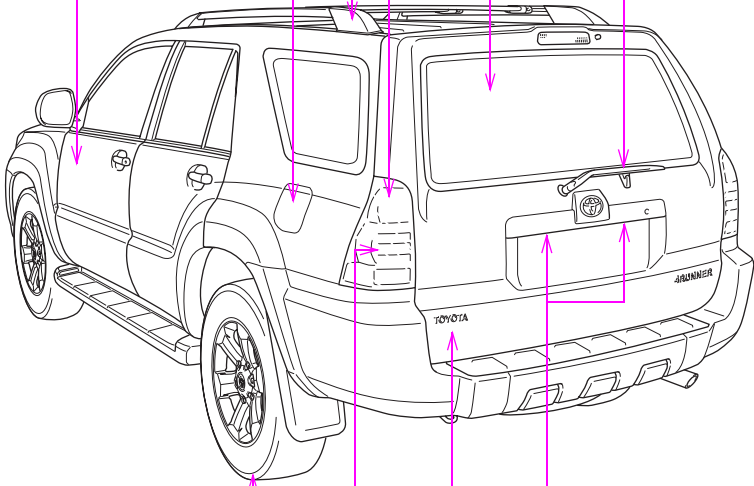

Tires P. 389

1 Rotation P. 445

1 Replacement P. 395

1 Inflation pressure P. 484

1 Information

License plate lights P. 158

Back door P. 38

Stop/tail and rear side marker lights P. 158

*: If equipped

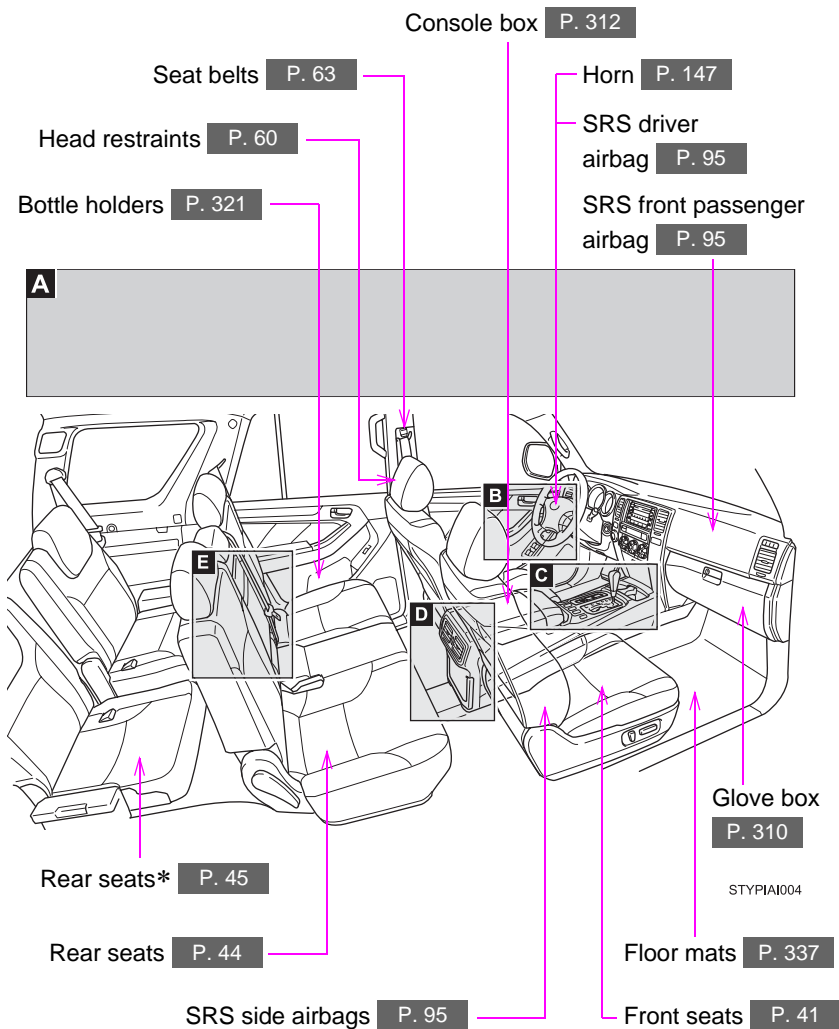

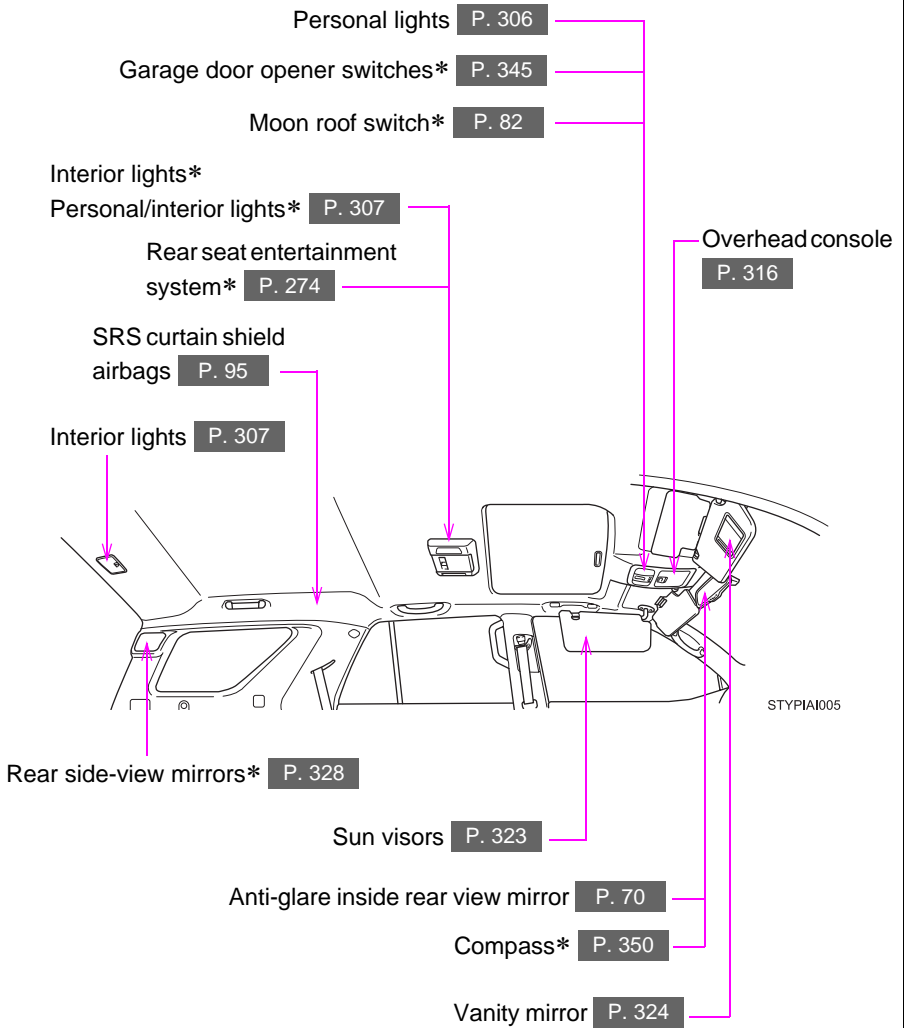
A

*: If equipped

B

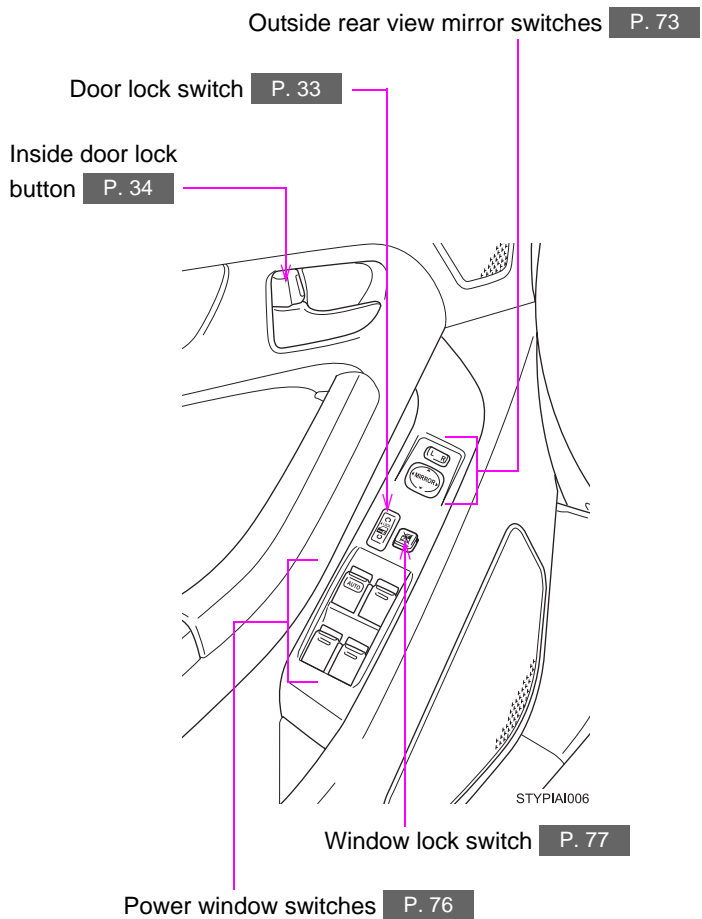

C

Height control switch* P. 169

A-TRAC switch* P. 182

Shift lever P. 143

Shift lock override button P. 457

Cup holders P. 316

HEIGHT CONTROL OFF switch* P. 169

RR DIFF LOCK switch* P. 184

Coin holder P. 311

AUX adapter P. 269

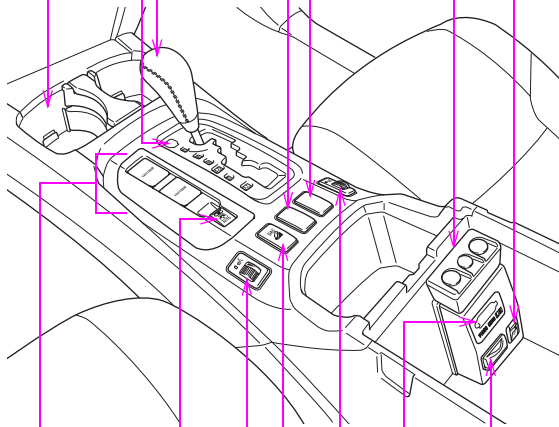

STYPIA1007

Power outlets P. 329

Power back window switch P. 79

Seat heater switch* P. 334

DAC switch* P. 186

Power outlet* P. 329

A/V input adapter* P. 294

Seat heater switch* P. 334

*: If equipped

D

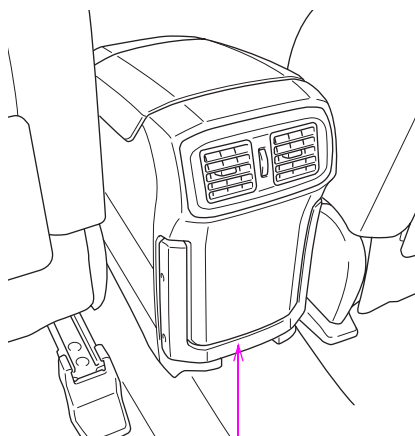

STYPIAI008

Trash holder **P. 314**

E

Armrest **P. 336**

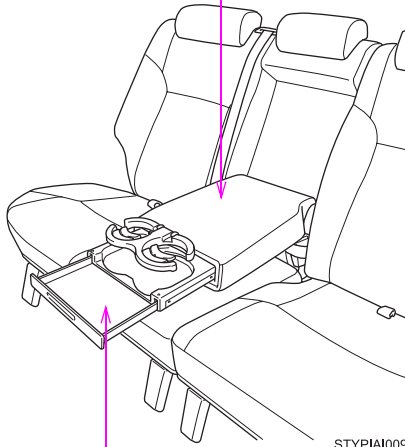

Rear cup holders* **P. 316**

Rear cup holders and tray* **P. 316**

*: If equipped

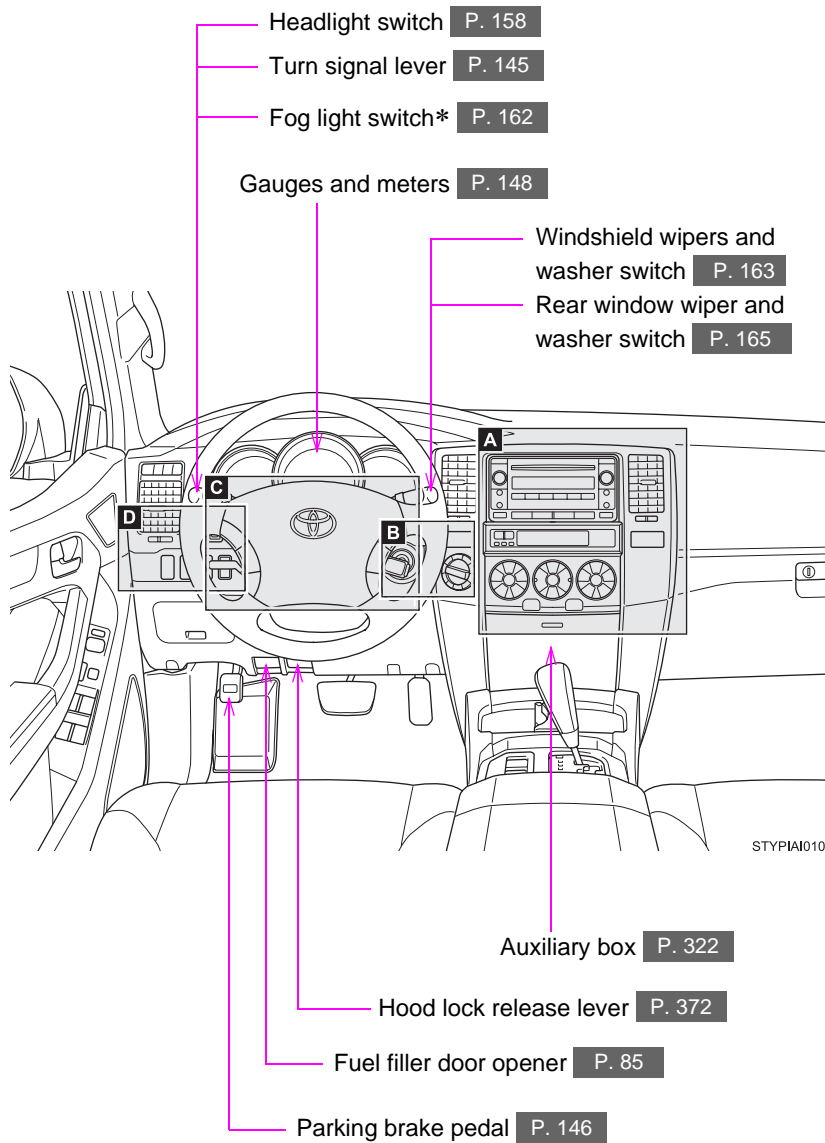

A

Accessory meter P. 155

Clock P. 325

Emergency flasher switch P. 426

Audio system P. 241

Navigation system*

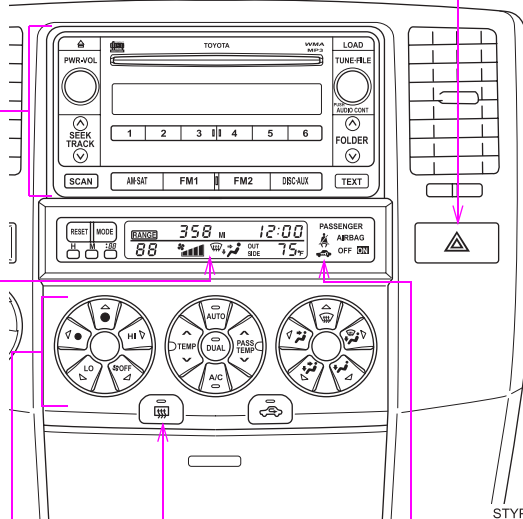

STYPIA1011

Security indicator P. 88

Back window defogger/
Back window and outside rear
view mirror defoggers* P. 240

Air conditioning system P. 230

*: If equipped

*: Refer to "Navigation System Owner's Manual"

B

Engine (ignition) switch **P. 140**

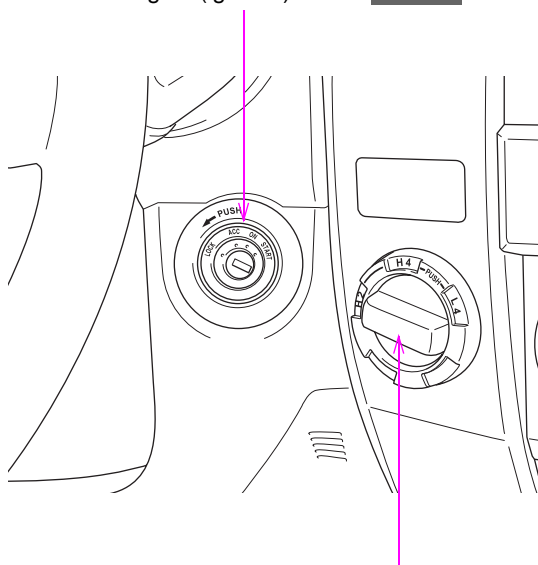

STYPIA012

Four-wheel drive control switch* **P. 177**

C

Audio remote control switches* P. 271

Telephone switches*

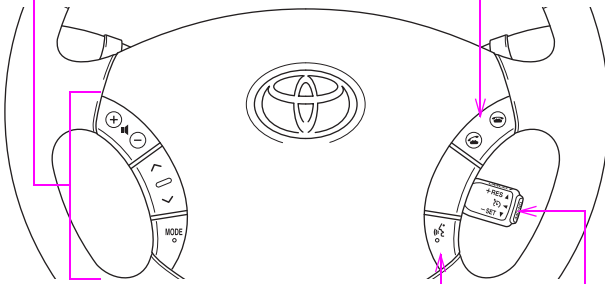

STYPIA1013

Talk switch*

Cruise control switch P. 166

*: If equipped

*: Refer to "Navigation System Owner's Manual"

D

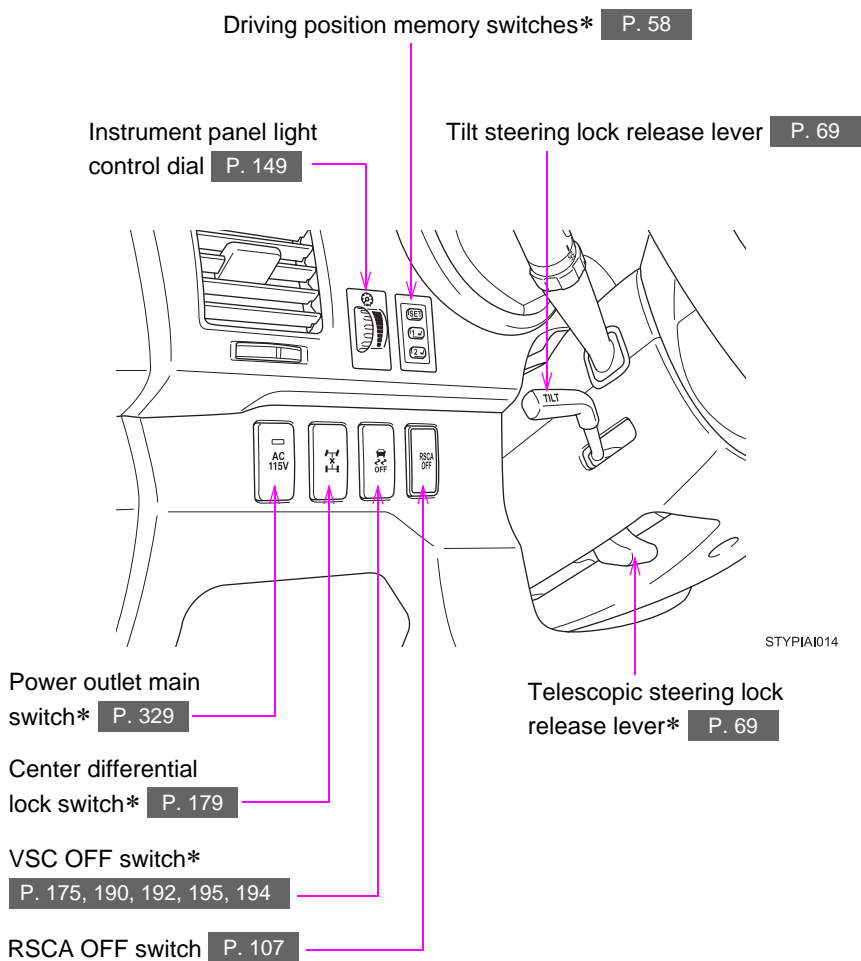

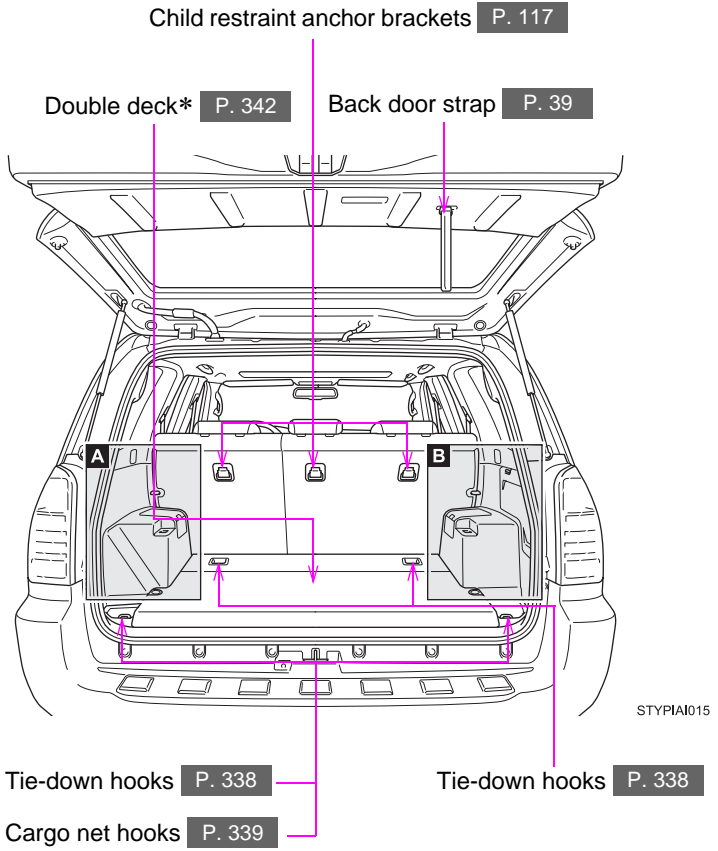

*: If equipped

A

Cargo net hooks P. 339

Luggage cover* P. 341

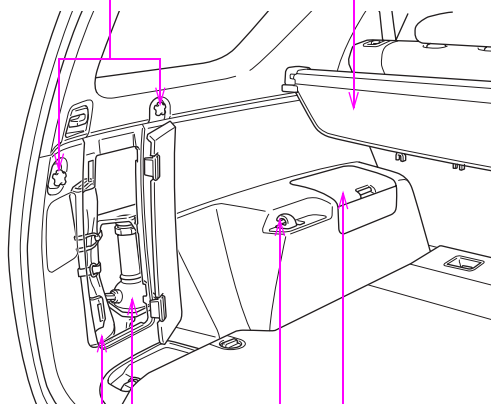

Auxiliary box* P. 322

Shopping bag hooks* P. 340

Jack P. 445

Tools P. 445

STYPIA016

B

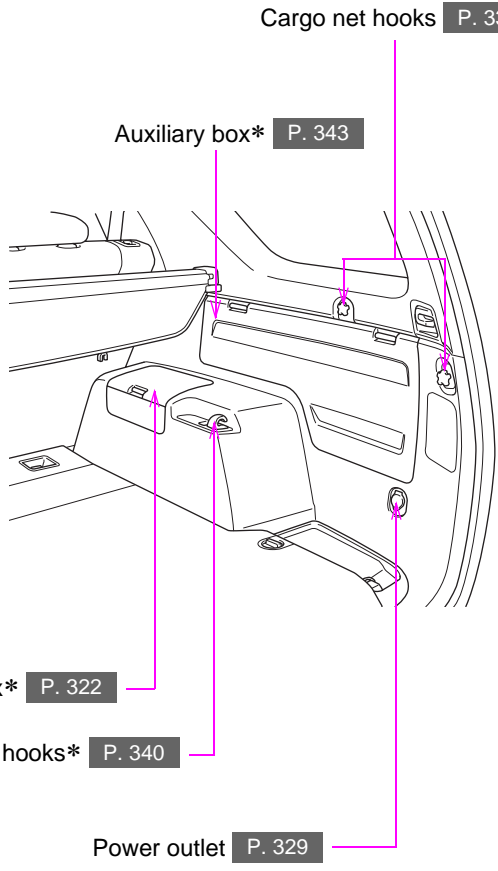

STYPIA017

*: If equipped

Keys

The following keys are provided with the vehicle.

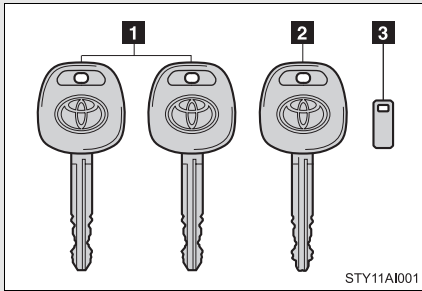

- 1** Master keys
- 2** Valet key
- 3** Key number plate

n When required to leave a key to the vehicle with a parking attendant

Lock the glove box as circumstances demand. (→P. 310)

Carry the master key for your own use and leave the valet key only with the attendant.

n Key number plate

Keep the plate in a safe place such as your wallet, not in the vehicle. In the event that a key is lost, a new key can be made by your Toyota dealer using the key number plate. (→P. 458)

⚠ NOTICE

n To prevent key damage

- I** Do not subject the keys to strong shocks, expose them to high temperatures by placing them in direct sunlight, or get them wet.
- I** Do not expose the keys to electromagnetic materials or attach any material that blocks electromagnetic waves to the key surface.

1-2. Opening, closing and locking the doors Wireless remote control

The wireless remote control can be used to lock and unlock the vehicle from outside the vehicle.

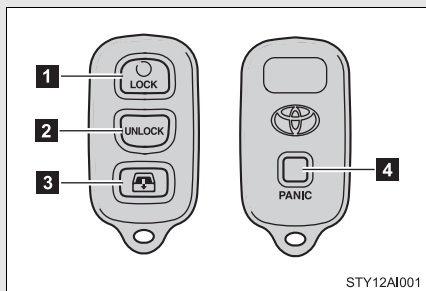

- 1 Locks all doors
- 2 Unlocks all doors

Pressing the button unlocks the driver's door. Pressing the button again within 3 seconds unlocks the other doors.

- 3 Open the back window (push and hold)
- 4 Sounds alarm (push and hold)

1

Before driving

n Operation signals

Doors: A buzzer sounds and the emergency flashers flash to indicate that the doors have been locked/unlocked. (Locked: Once; Unlocked: Twice)

Back window: A buzzer sounds to indicate that the back window has been opened.

n Panic mode

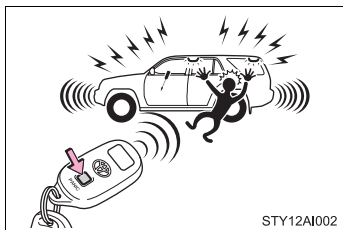

When PANIC switch is pushed for longer than about one second, an alarm will sound for about 60 seconds and the vehicle lights will flash to deter any person from trying to break into or damage your vehicle.

To stop the alarm, push any button on the wireless remote control.

▫ **Door lock buzzer**

If a door is not fully closed, a buzzer sounds continuously if an attempt to lock the door is made. Fully close the door to stop the buzzer, and lock the vehicle once more.

▫ **Wireless remote control battery depletion**

The standard battery life is 1 to 2 years. (The battery becomes depleted even if the wireless remote control is not used.) If the wireless remote control function does not operate, the battery may be depleted. Replace the battery when necessary. (→P. 402)

▫ **If the wireless remote control does not operate**

Locking and unlocking the doors: Use the key. (→P. 33)

▫ **Security feature**

If a door is not opened within approximately 30 seconds after the vehicle is unlocked, the security feature automatically locks the vehicle again.

▫ **Alarm**

Using the wireless remote control to lock the door will set the alarm system. (→P. 90)

▫ **Conditions affecting operation**

The wireless remote control function may not operate normally in the following situations.

- Near a TV tower, radio station, electric power plant, airport or other facility that generates strong radio waves
- When carrying a portable radio, cellular phone or other wireless communication device
- When multiple wireless keys are in the vicinity
- When the wireless key has come into contact with, or is covered by a metallic object
- When a wireless key (that emits radio waves) is being used nearby
- When the wireless key has been left near an electrical appliance such as a personal computer

n Customization that can be configured at Toyota dealer

Settings (e.g. wireless remote control) can be changed.
(Customizable features →P. 495)

n Certification for wireless remote control

► For vehicles sold in U.S.A.

NOTE:

This device complies with Part 15 of the FCC Rules. Operation is subject to the following two conditions:

(1) This device may not cause harmful interference, and (2) this device must accept any interference received, including interference that may cause undesired operation.

NOTICE:

This equipment has been tested and found to comply with the limits for a Class B digital device, pursuant to Part 15 of the FCC Rules. These limits are designed to provide reasonable protection against harmful interference in a residential installation. This equipment generates, uses and can radiate radio frequency energy and, if not installed and used in accordance with the instructions, may cause harmful interference to radio communications. However, there is no guarantee that interference will not occur in a particular installation. If this equipment does cause harmful interference to radio or television reception, which can be determined by turning the equipment off and on, the user is encouraged to try to correct the interference by one or more of the following measures:

- 1 Reorient or relocate the receiving antenna.
- 1 Increase the separation between the equipment and receiver.
- 1 Connect the equipment into an outlet on a circuit different from that to which the receiver is connected.
- 1 Consult the dealer or an experienced radio/TV technician for help.

FCC WARNING:

Changes or modifications not expressly approved by the party responsible for compliance could void the user's authority to operate the equipment.

► For vehicles sold in Canada

NOTE:

Operation is subject to the following two conditions:

(1) this device may not cause interference, and (2) this device must accept any interference, including interference that may cause undesired operation of the device.

1-2. Opening, closing and locking the doors

Side doors

The vehicle can be locked and unlocked using the wireless remote control, key or door lock switch.

n **Wireless remote control**

→P. 29

n **Key**

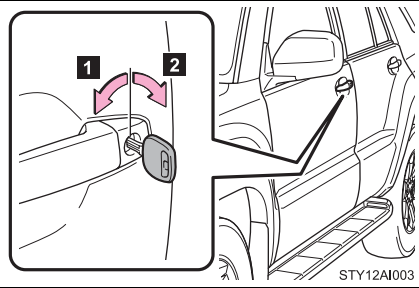

1 Locks all doors

2 Unlocks all doors

Turning the key a single time in the driver's door unlocks the driver's door and turning the key again unlocks the other doors.

n **Door lock switch**

► **Driver's door lock switch**

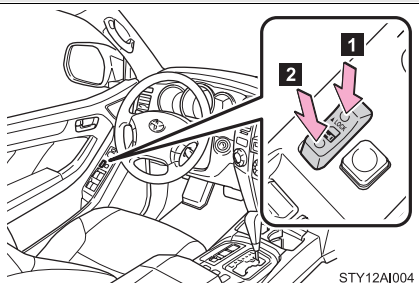

1 Locks all doors

2 Unlocks all doors

► Passenger's door lock switch

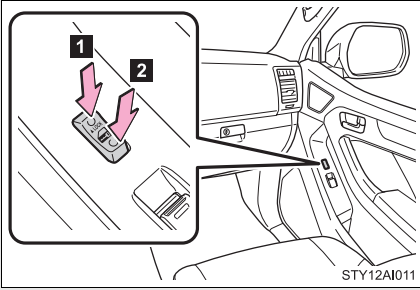

- 1 Locks all doors
- 2 Unlocks all doors

n Inside lock button

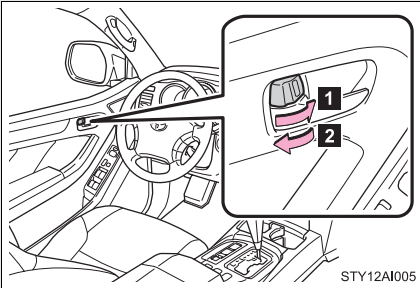

- 1 Locks the door
- 2 Unlocks the door

Pulling the inside handle can open the front door even if the inside door lock button is in the lock position.

Locking the front doors from the outside without a key

STEP 1 Move the inside door lock button to the lock position.

STEP 2 Close the door.

The front door cannot be locked if a front door is open and the key is in the engine switch.

Rear door child-protector lock

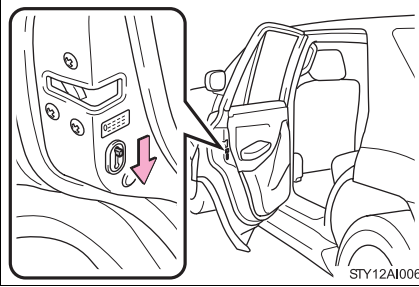

The door cannot be opened from inside the vehicle when the lock is set.

These locks can be set to prevent children from opening the rear doors. Push down on each rear door switch to lock both rear doors.

1

Before driving

Automatic door locking and unlocking systems

The following functions can be set or canceled:

Function	Operation
Shift position linked door locking function	Shifting the shift lever out of P locks all doors.
Shift position linked door unlocking function	Shifting the shift lever to P unlocks all doors.
Speed linked door locking function	All doors are locked when the vehicle speed is approximately 12 mph (20 km/h) or higher.
Engine switch linked door unlocking function	All doors are unlocked when the driver's door is opened within 10 seconds after turning the engine switch to the ACC or LOCK position or the key is removed.

n Setting and canceling the functions

To switch between setting and canceling, follow the procedure below:

STEP 1 Close all the doors and turn the engine switch to the ON position. (Perform step 2 within 10 seconds.)

STEP 2 Set the parking brake.

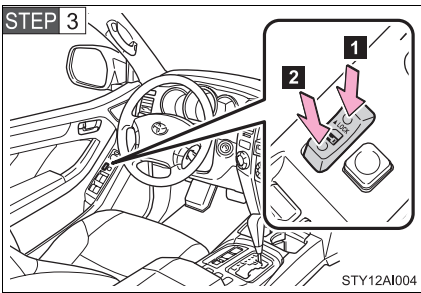

Shift the shift lever to P or N, press and hold the driver's door lock switch (**1** or **2**) for approximately 5 seconds and then release.

The shift lever and switch positions corresponding to the desired function to be set or canceled are shown as follows.

Function	Shift lever position	Switch position
Shift position linked door locking function	P	1
Shift position linked door unlocking function		2
Speed linked door locking function	N	1
Engine switch linked door unlocking function		2

When the setting or canceling operation is complete, all doors are locked and then unlocked.

n When locking the doors using the key

The door cannot be locked if the key is in the engine switch.

n Key reminder buzzer

A buzzer sounds if the driver's door is opened, while the engine switch is in the ACC or LOCK position to remind you to remove the key.

n Customization that can be configured at Toyota dealer

Settings (e.g. unlocking function using a key) can be changed.
(Customizable features →P. 495)

⚠ CAUTION**n To prevent an accident**

Observe the following precautions while driving the vehicle.

Failing to do so may result in a door opening and an occupant falling out, resulting in death or serious injury.

! Always use a seat belt.

! Always lock the doors.

! Ensure that all doors are properly closed.

! Do not pull the inside handle of the doors while driving.

The doors may be opened and the passengers are thrown out of the vehicle and it may result in serious injury or death.

! Be especially careful for the front doors, the doors may be opened even if the inside lock buttons are in locked position.

! Set the rear door child protector locks when children are seated in the rear seats.

1-2. Opening, closing and locking the doors

Back door

The back door can be opened using the back door opener. The back door can be locked/unlocked using a key, wireless remote control or door lock switch.

n Back door opener

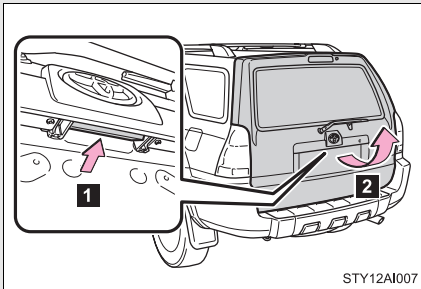

1 Push up

2 Raise

n Wireless remote control

→P. 29

n Key

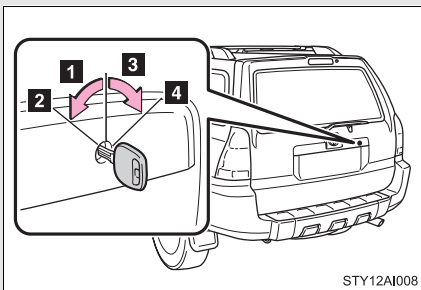

1 Unlocks all doors

2 Opens the back window
(turn and hold) (→P. 79)

3 Locks all doors

4 Closes the back window
(turn and hold) (→P. 79)

n Door lock switches

→P. 33

Rear step bumper

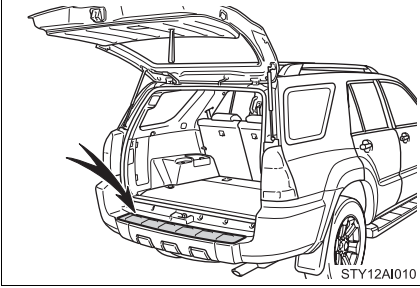

For rear end protection and easier step-up loading.

To get on the rear step bumper, use the shaded area in the illustration.

1

Before driving

n Back door strap

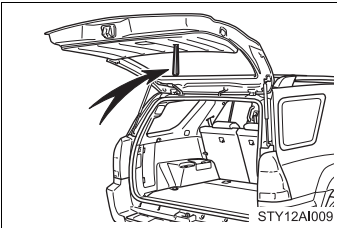

Use the strap when closing.

n Back door easy closer

In the event that the back door is left slightly open, the back door easy closer will automatically close it to the fully closed position.

n When the battery is disconnected

The back door must be initialized. To initialize the back door, unlock it with the key, wireless remote control or power door lock switch.

n If the battery is disconnected or reconnected

The back door will be automatically locked. Be careful not to lock your keys in the vehicle.

 CAUTION

Observe the following precautions.

Failing to do so may result in death or serious injury.

n Caution while driving

- l** Keep the back door and back window closed.
If the back door and back window are open, the luggage will be thrown out and exhaust gases will enter the vehicle.
- l** Do not get on the rear step bumper.

n Back door easy closer

When the back door is not completely closed, the back door easy closer will automatically close it. Be careful not to catch fingers or anything else in the back door. Failure to do so may result in serious injury.

n Closing the back door

- l** Do not allow children to close the back door.
Closing the back door on someone can cause serious injury, and in some instances, even death.

 NOTICE

n To prevent damage to the back door components

- l** Do not apply any force, paint or let any other foreign matter on the damper.
- l** Do not apply excessive force when the back door closer is operating.
- l** Make sure there is nothing in the doorway before closing.
- l** Do not allow more than one person to get on the rear step bumper at a time.

1-3. Adjustable components (seats, mirrors, steering wheel)

Front seats

► Manual seat

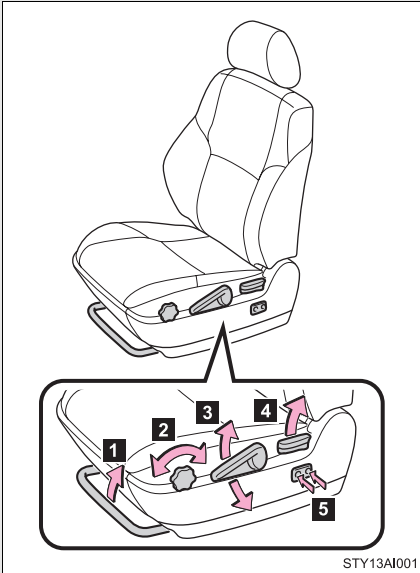

- 1 Seat position adjustment lever
- 2 Seat cushion angle adjustment knob (driver's side only)
- 3 Seat height adjustment lever (driver's side only)
- 4 Seatback angle adjustment lever
- 5 Seat lumbar support adjustment switch (driver's side only)

► Power seat

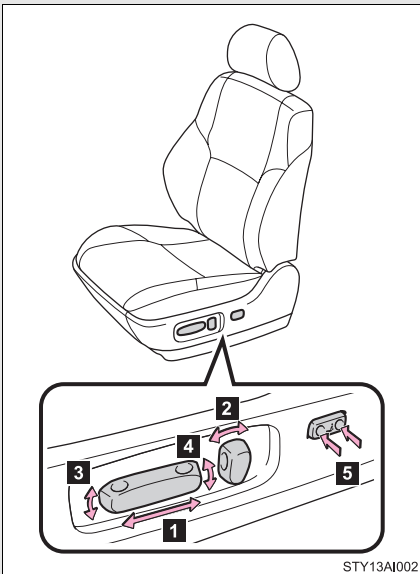

- 1 Seat position adjustment switch
- 2 Seatback angle adjustment switch
- 3 Seat cushion angle adjustment switch (driver's side only)
- 4 Seat height adjustment switch (driver's side only)
- 5 Seat lumbar support adjustment switch (driver's side only)

Flattening seatback

n When flattening the seatbacks (vehicles with manual seat)

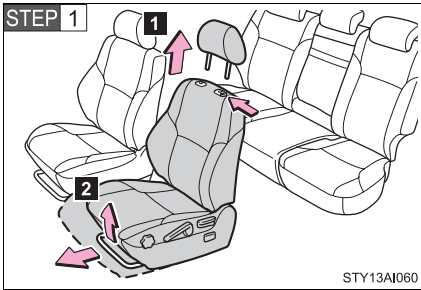

1 Remove the head restraint.
(→P. 61)

2 Move the seat to the front-most lock position.

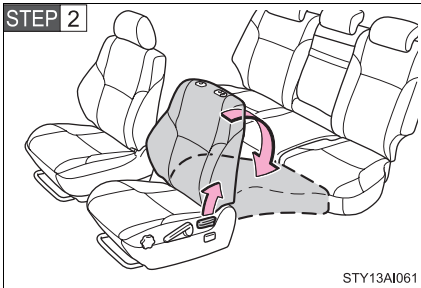

Pull the seatback angle adjustment lever to unlock the seatback and then push down the seatback.

n When flattening the seatbacks (vehicles with power seat)

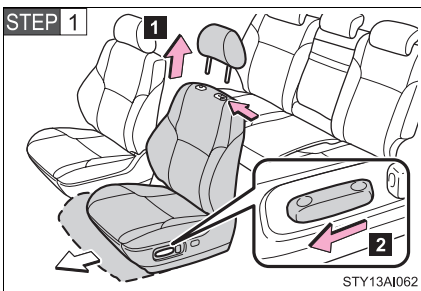

1 Remove the head restraint.
(→P. 61)

2 Move the seat to the front-most lock position.

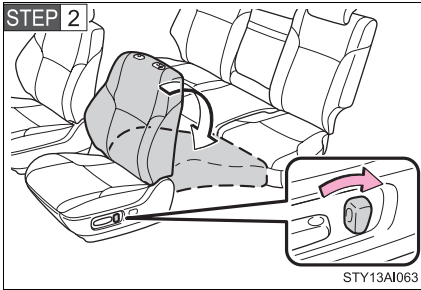

Move the seatback angle adjustment switch backward to flatten the seatback.

- n **Waterproof and water-repellent seats (vehicles with off-road package)**
Waterproof and water-repellent seats are installed in your vehicle; however, the water-repellent effect does not last forever.
- n **When returning the seatback upright (vehicles with manual seat)**
Be careful not to make yourself hit by the seatback which will bound with considerable spring force.

⚠ CAUTION

n Seat adjustment

- l Be careful that the seat does not hit passengers or luggage.
- l Do not recline the seat more than necessary when the vehicle is in motion to reduce the risk of sliding under the lap belt.
If the seat is too reclined, the lap belt may slide past the hips and apply restraint forces directly to the abdomen or your neck may contact the shoulder belt, increasing the risk of death or serious injury in the event of an accident.
- l Manual seat only: After adjusting the seat, make sure that the seat is locked in position.

n While driving

- l Do not allow passengers to ride on the flattened seat.
- l Do not drive with the head restraints removed.

Rear seats

n **Second seats (vehicles without third seats)**

The second seats do not have a seat adjustment function.

n **Second seats (vehicles with third seats)**

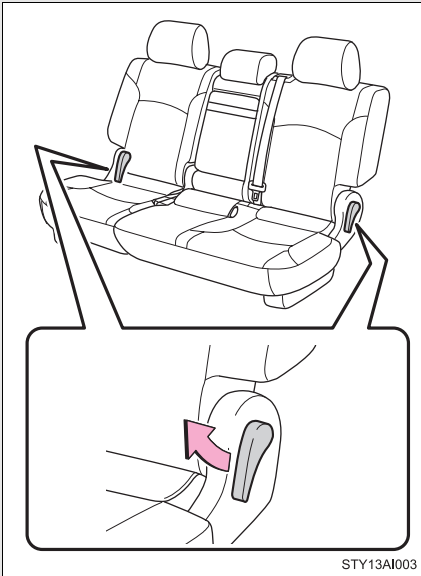

Seatback angle adjustment lever

n **Third seats (if equipped)**

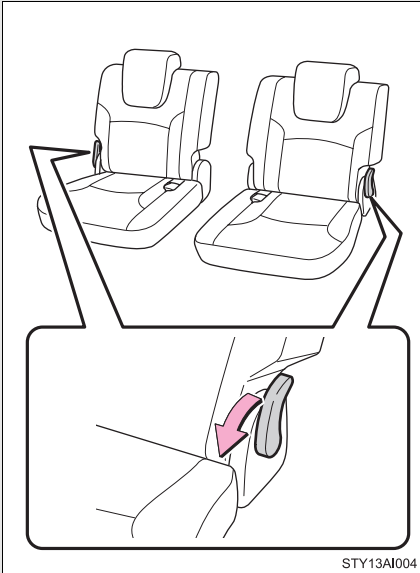

Seatback angle adjustment lever

STY13AI004

Folding down the second seats (vehicles without third seats)

n **Before folding down the second seats**

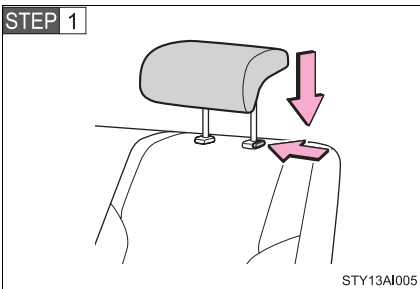

Adjust the head restraint to the downmost position.

STY13AI005

1-3. Adjustable components (seats, mirrors, steering wheel)

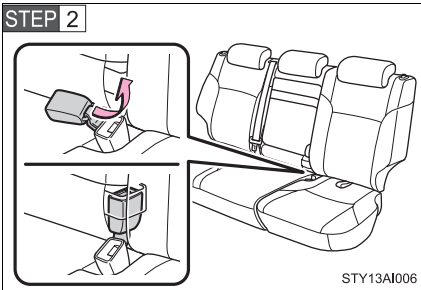

Stow the second seat belt buckle.

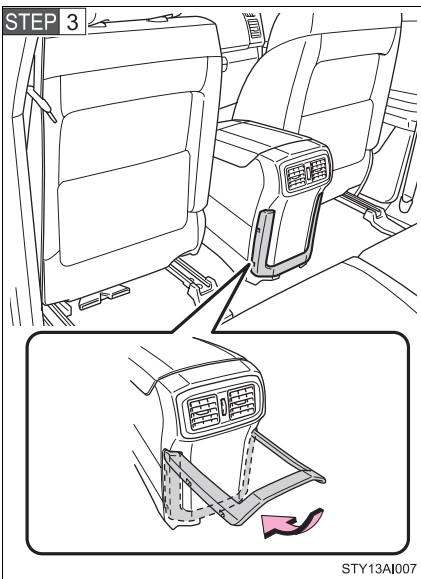

Lower the trash holder.

n Folding down the second seats

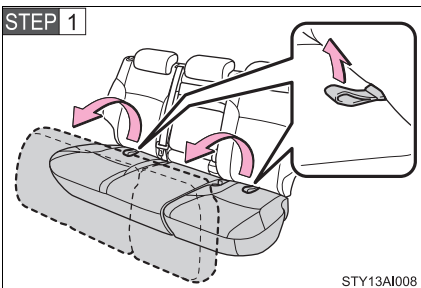

Swing the bottom cushion up by pulling the lock release strap.

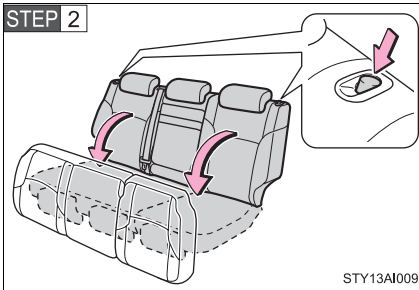

Push the lock release button and fold down the seatback.

Tumbling the second seats (vehicles with third seats)

n Before tumbling second seats

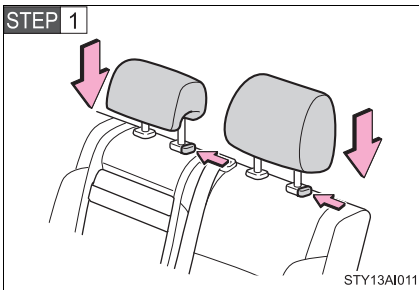

Adjust the head restraint to the downmost position.

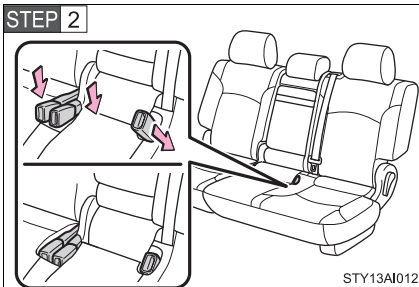

Stow the second seat belt buckles.

n **Tumbling the second seats**

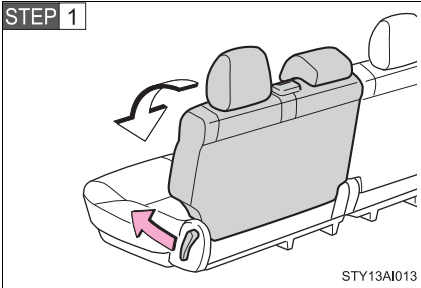

Pull the lever to unlock the seat-back and then fold the seatback down.

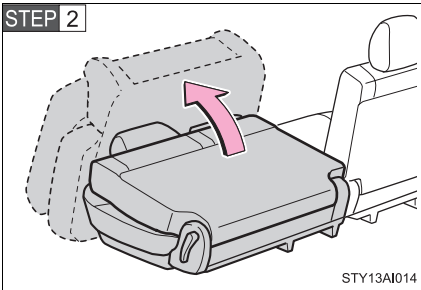

Swing the whole seat up and forward until they are locked.

n **When returning the second seats**

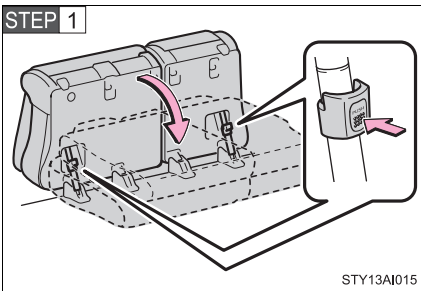

Push the knob to unlock the seat and swing the whole seat down.

STEP 2

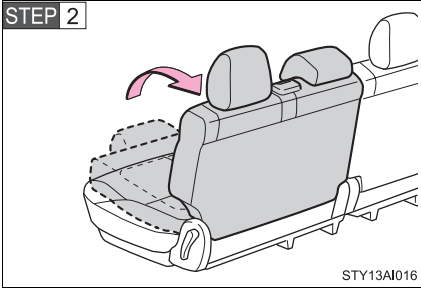

Swing the seatback up.

Folding up the third seats (vehicles with third seats)

n Before folding up the third seats

STEP 1

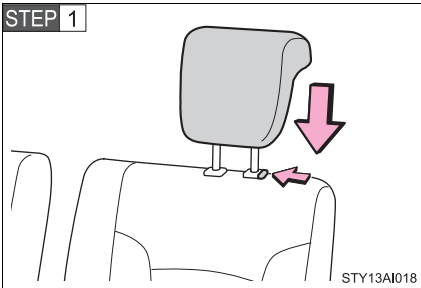

Adjust the head restraint to the downmost position.

STEP 2

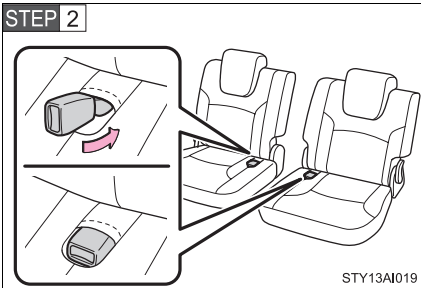

Stow the third seat belt buckles.

1-3. Adjustable components (seats, mirrors, steering wheel)

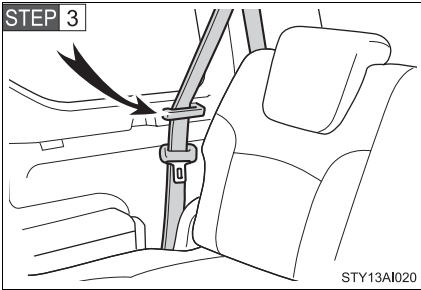

Pass the seat belts through the seat belt hangers.

This prevents the shoulder belt from being damaged.

Make sure that the seat belts are removed from the hangers before using them.

n Folding up the third seats

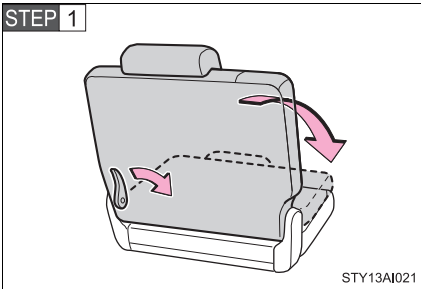

Fold down third seat by pushing the lock release lever forward.

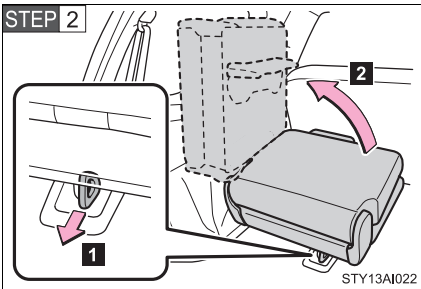

1 Unlock the seat leg by pulling the handle.

2 Swing the whole seat up and sideward.

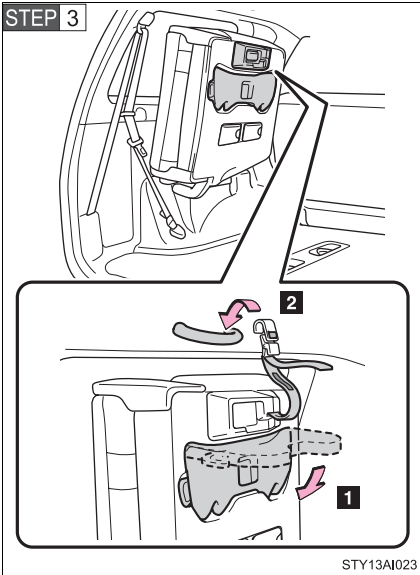

1 Retract the seat leg.

2 Take the holding strap out and attach the strap to the assist grip.

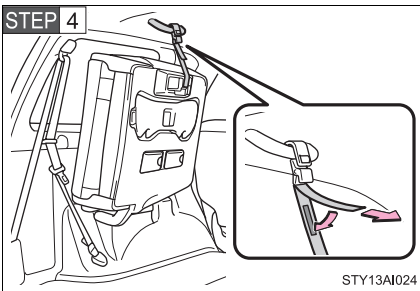

Pull the free end of the strap then fix it with the hook-and-loop fastener.

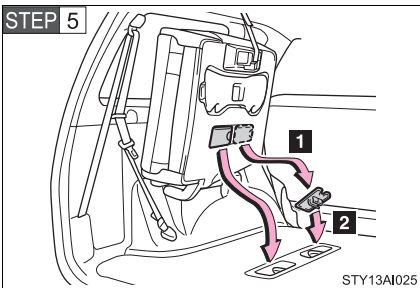

1 Remove the seat anchor covers from the back of the seat cushion.

2 Install the seat anchor covers over the seat anchors.

n Returning the third seats

Reverse the steps of folding up the third seats. (→P. 49)

Removing the third seats (vehicles with third seats)

n Before removing the third seats

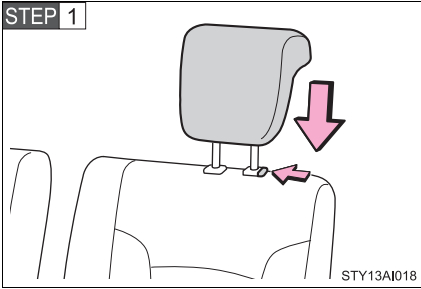

Adjust the head restraint to the downmost position.

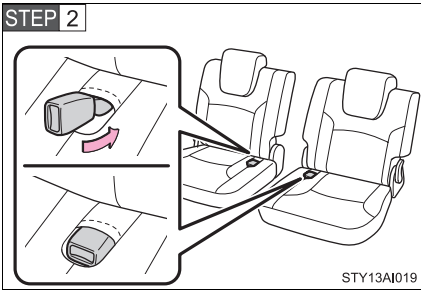

Stow the third seat belt buckles.

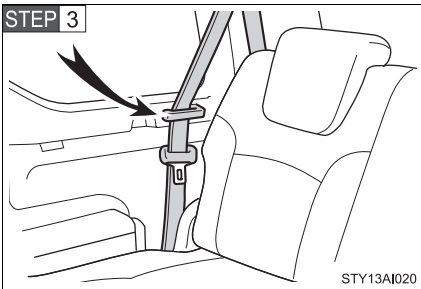

Pass the seat belts through the seat belt hangers.

This prevents the shoulder belt from being damaged.

Make sure that the seat belts are removed from the hangers before using them.

n Removing the third seats

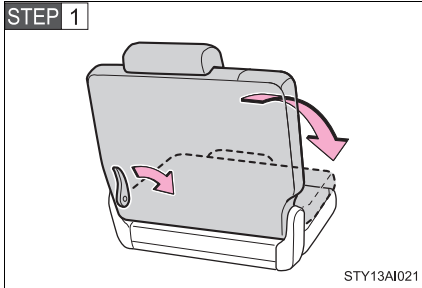

Fold down the third seat by pushing the lock release lever forward.

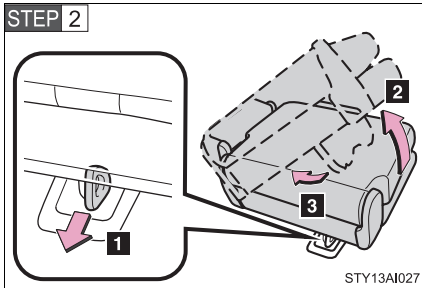

- 1** Unlock the seat leg by pulling the handle.
- 2** Lift the whole seat up.
- 3** Retract the seat leg, then place the seat on the floor.

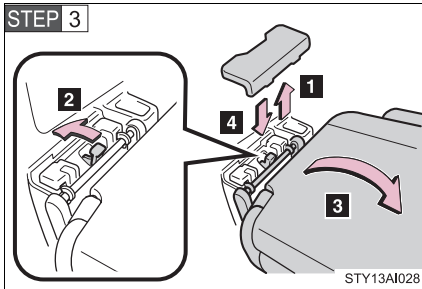

- 1** Remove the seat lock cover.
- 2** Push the seat lock release lever outward to unlock the seat lock.
- 3** Pull up the whole seat and remove it.
- 4** Reinstall the seat lock cover.

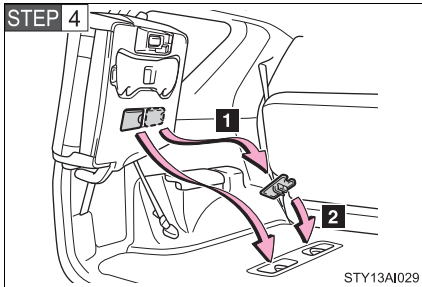

- 1** Remove the seat anchor covers from the back of the seat cushion.
- 2** Install the seat anchor covers over the seat anchors.

n Reinstalling the third seat (vehicles with third seat)

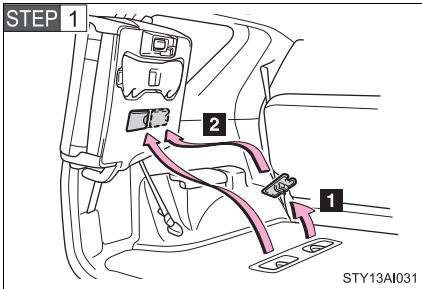

1 Remove the seat anchor covers.

2 Install the seat anchor covers in the back of the seat cushion.

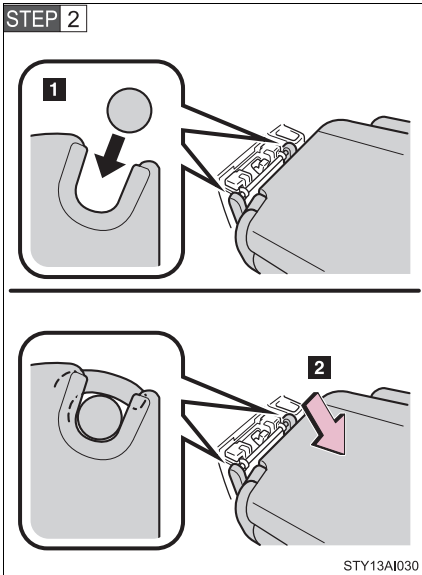

1 Hold the seat and engage the seat striker to the seat lock, then place the seat on the floor.

2 Press down the seatback to securely lock the seat to the body.

STEP 3 Reinstall the seat lock cover.

STEP 4 Reverse STEP1 and STEP2 of removing the third seat.
(→P. 53)

n If you cannot raise the seatback (second seats)

► Vehicles without third seats

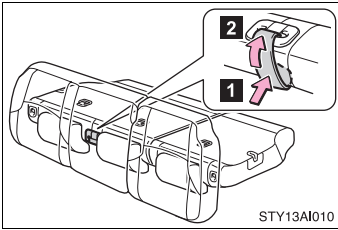

Release the seat belt lock by:

- 1** Pushing on the lower front edge of the seatback to slacken the seat belt.
- 2** Let the seat belt retract a little.

► Vehicles with third seats

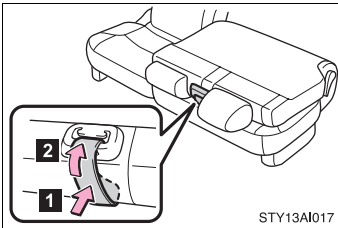

Release the seat belt lock by:

- 1** Pushing on the lower front edge of the seatback to slacken the seat belt.
- 2** Let the seat belt retract a little.

n Waterproof and water-repellent seats (vehicles with off-road package)

Waterproof and water-repellent seats are installed in your vehicle; however, the water-repellent effect does not last forever.

⚠ CAUTION

n Reclining adjustment (vehicles with third seats)

Do not recline the seat more than necessary when the vehicle is in motion, to reduce the risk of sliding under the lap belt.

If the seat is too reclined during an accident, the lap belt may slide past the hips and apply restraint forces directly to the abdomen or your neck may contact the shoulder belt, increasing the risk of death or serious injury.

n Before folding down or tumbling a rear seats

Do not fold down a rear seat when there are passengers sitting in the rear seats or when there is luggage placed on/under the rear seats.

 **CAUTION**

n When the seatback is folded

Do not sit on or place anything on the seatback while driving.

n When folding down, tumbling, folding up or removing the seats

I Do not fold down, tumble, fold up or remove the seat while the vehicle is moving.

I Be careful not to get your hands or feet pinched in the seat.

I Make sure the seats are securely locked. Failure to do so will prevent the seat belt from operating properly.

When removing the third seats:

I Do not leave the removed seat loose in the vehicle.

I Be careful not to hit a person with the removed seat or drop it on yourself.

I Do not sit on or place anything on the removed seat.

n When returning or reinstalling the seats

I Do not return or reinstall the seat while the vehicle is moving.

I Be careful not to get your hands or feet pinched in the seat.

I Make sure the seats are securely locked. Failure to do so will prevent the seat belt from operating properly.

I Check that the seat belts are not twisted or caught under the seat.

I Arrange the seat belts in the proper positions for ready use.

When reinstalling the third seats:

I Install each seat in the same position from which it was removed. Failure to do so will prevent third seat occupants from using the seat belts properly.

n When removing or folding up the third seats

Be sure to install the seat anchor covers on the seat anchors, or you may get burned when they become hot.

n When folding up the third seats

Fix the seats securely by adjusting the length of the holding strap. Failure to do so may cause death or serious injury in the event of an accident or sudden braking.



NOTICE

n Before tumbling, folding up or removing the seats

The seat belts and buckles must be stowed.

n Removed third seats (vehicles with third seats)

Avoid putting heavy loads on the seat. The metallic tips of the seat leg may be damaged, and you may be unable to correctly reinstall the seat.

1-3. Adjustable components (seats, mirrors, steering wheel) Driving position memory system (if equipped)

Your preferred driving position (the position of the driver's seat) can be entered into the computer's memory and recalled with the touch of a button.

Two different driving positions can be entered into memory.

n Entering a position into memory

Check that the shift lever is set in P.

STEP 1 Turn the engine switch to the ON position.

STEP 2 Adjust the driver's seat to the desired positions.

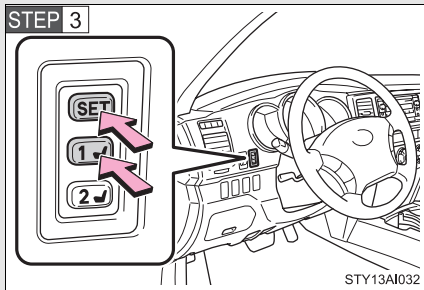

While pushing the SET button, push button "1" or "2" until the signal beeps.

If the selected button has already been preset, the previously recorded position will be overwritten.

n Recalling the memorized position

Check that the shift lever is set in P.

STEP 1 Turn the engine switch to the ON position.

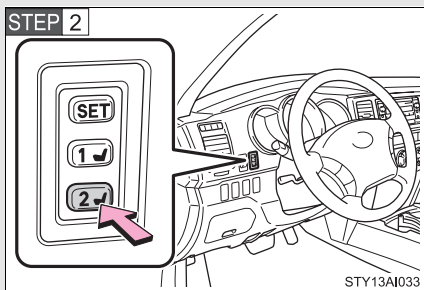

Push button "1" or "2" to recall the desired position.

n **Retained accessory power**

Each memorized position can be activated within 30 seconds after the driver's door is opened, even if the key is not in the engine switch.

n **If any position memory button is pushed while the adjustments are being made**

The operation will stop. To reactivate the system, push the button ("1" or "2") again.

n **If the battery is disconnected**

The memorized positions must be reset because the computer's memory is erased when the battery is disconnected.

 **CAUTION**

n **Seat adjustment caution**

Take care during seat adjustment that the seat does not strike the rear passenger or squeeze your body against the steering wheel.

If this happens, you can stop the movement by pressing another seat position memory button.

1-3. Adjustable components (seats, mirrors, steering wheel)

Head restraints

n Adjusting the head restraints

► Front seats

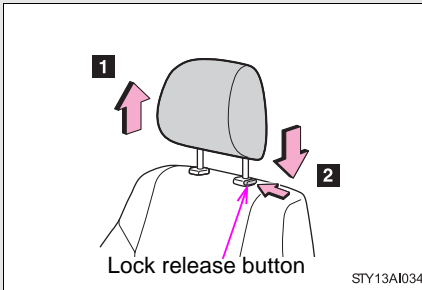

Vertical adjustment

- 1 Up
- 2 Down

Push and hold the lock release button when lowering the head restraint.

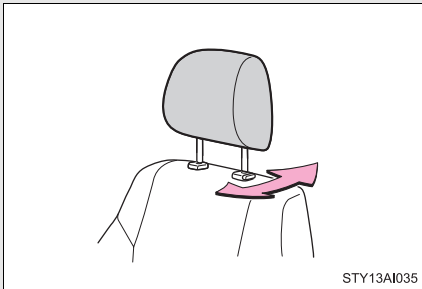

Angle adjustment

► Second seats (vehicles without third seats)

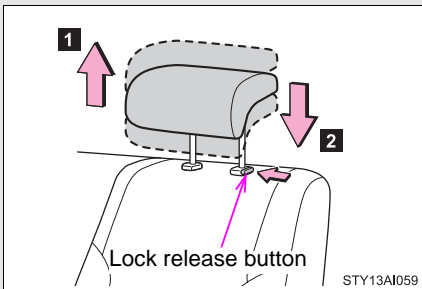

Vertical adjustment

- 1 Up
- 2 Down

Push and hold the lock release button when lowering the head restraint.

► Second seats (vehicles with third seats)

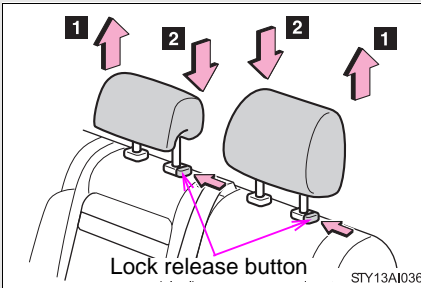

Vertical adjustment

- 1 Up
- 2 Down

Push and hold the lock release button when lowering the head restraint.

► Third seats

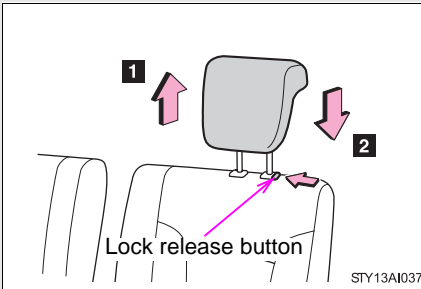

Vertical adjustment

- 1 Up
- 2 Down

Push and hold the lock release button when lowering the head restraint.

n Removing the head restraints

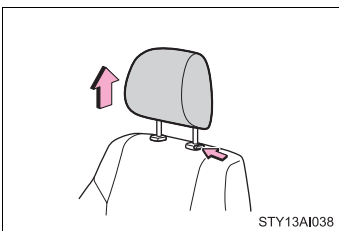

Pull the head restraint up while pushing the lock release button.

n Adjusting the height of the head restraints

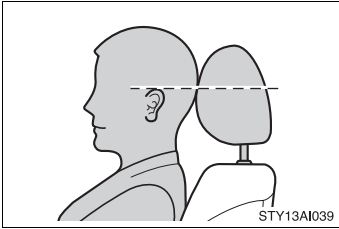

Make sure that the head restraints are adjusted so that the center of the head restraint is closest to the top of your ears.

n Adjusting the rear seat head restraints (vehicles without third seats) or center second seat head restraint and third seat head restraints (vehicles with third seats)

Always raise the head restraint one level from the stowed position when using.

⚠ CAUTION

n Head restraint precautions

Observe the following precautions regarding the head restraints. Failure to do so may result in death or serious injury.

- I** Use the head restraints designed for each respective seat.
- I** Adjust the head restraints to the correct position at all times.
- I** Do not drive with the head restraints removed.

1-3. Adjustable components (seats, mirrors, steering wheel)

Seat belts

Make sure that all occupants are wearing their seat belts before driving the vehicle.

n Correct use of the seat belts

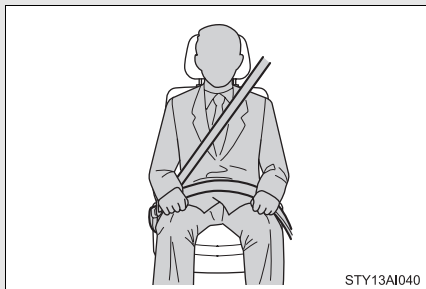

- 1 Extend the shoulder belt so that it comes fully over the shoulder, but does not come into contact with the neck or slide off the shoulder.
- 1 Position the lap belt as low as possible over the hips.
- 1 Adjust the position of the seatback. Sit up straight and well back in the seat.
- 1 Do not twist the seat belt.

n Fastening and releasing the seat belt

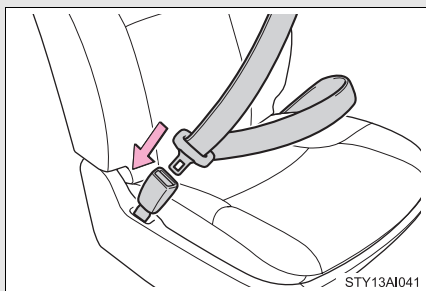

Fastening the belt

Push the tab into the buckle until a clicking sound is heard.

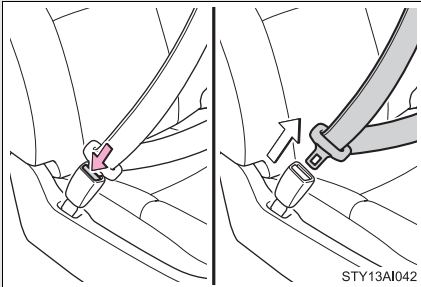

Releasing the belt

Press the release button.

n Adjusting the height of the belt

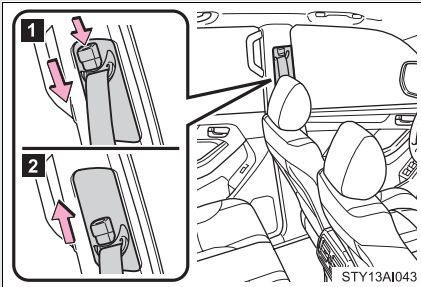

1 Down

Push the lock release knob and slide the height adjuster down.

2 Up

Move the height adjuster up as needed until you hear a click.

Seat belt pretensioners (front seats)

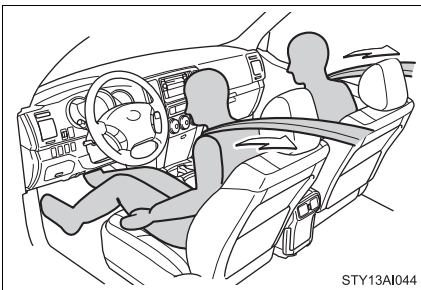

The pretensioner helps the seat belt to quickly restrain the occupant by retracting the seat belt when the vehicle is subjected to certain types of severe frontal collision or a vehicle rollover.

The pretensioner may not activate in the event of a minor frontal impact, a side impact or a rear impact.

n **Emergency locking retractor (ELR)**

The retractor will lock the belt during a sudden stop or on impact. It may also lock if you lean forward too quickly. A slow, easy motion will allow the belt to extend so that you can move around fully.

n **Automatic locking retractor (ALR)**

When a passenger's shoulder belt is completely extended and then retracted even slightly, the belt is locked in that position and cannot be extended. This feature is used to hold the child restraint system (CRS) firmly. To free the belt again, fully retract the belt and then pull the belt out once more. (→P. 117)

n **Pregnant women**

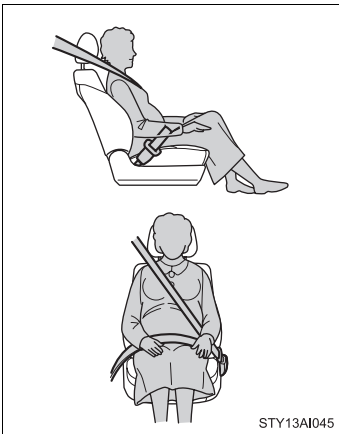

Obtain medical advice and wear the seat belt in the proper way. (→P. 63)

Women who are pregnant should position the lap belt as low as possible over the hips in the same manner as other occupants. Extend the shoulder belt completely over the shoulder and position the belt across the chest. Avoid belt contact over the rounding of the abdominal area.

If the seat belt is not worn properly, not only a pregnant woman, but also the fetus could suffer death or serious injury as a result of sudden braking or a collision.

n **People suffering illness**

Obtain medical advice and wear the seat belt in the proper way.

■ **Child seat belt usage**

The seat belts of your vehicle were principally designed for persons of adult size.

- 1 Use a child restraint system appropriate for the child, until the child become large enough to properly wear the vehicle's seat belt. (→P. 113)
- 1 When the child becomes large enough to properly wear the vehicle's seat belt, follow the instructions on P. 63 regarding seat belt usage.

■ **Replacing the belt after the pretensioner has been activated**

If the vehicle is involved in multiple collisions, the pretensioner will activate for the first collision, but will not activate for the second or subsequent collisions.

■ **Seat belt extender**

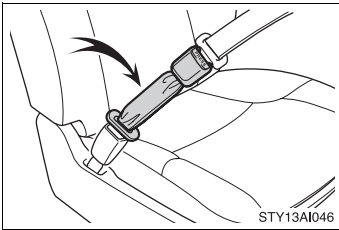

If your seat belts cannot be fastened securely because they are not long enough, a personalized seat belt extender is available from your Toyota dealer free of charge.

⚠ CAUTION

Observe the following precautions to reduce the risk of injury in the event of sudden braking or an accident.

Failing to do so may cause death or severe injury.

■ **Wearing a seat belt**

- 1 Ensure that all passengers wear a seat belt.
- 1 Always wear a seat belt properly.
- 1 Each seat belt should be used by one person only. Do not use a seat belt for more than one person at once, including children.
- 1 Toyota recommends that children be seated in the rear seat and always use a seat belt and/or an appropriate child restraint system.

 **CAUTION****n Wearing a seat belt**

- l Do not recline the seat any more than necessary to achieve a proper seating position. The seat belt is most effective when the occupants are sitting up straight and well back in the seats.
- l Do not wear the shoulder belt under your arm.
- l Always wear your seat belt low and snug across your hips.

n Adjustable shoulder anchor

Always make sure the shoulder belt is positioned across the center of your shoulder. The belt should be kept away from your neck, but not falling off your shoulder. Failure to do so could reduce the amount of protection in an accident and cause death or serious injuries in a collision. (→P. 64)

n Seat belt pretensioners

- l Do not place anything, such as a cushion, on the front passenger's seat. Doing so will disperse the passenger's weight, which prevents the sensor from detecting the passenger's weight properly. As a result, the seat belt pretensioner for the front passenger's seat may not activate in the event of a collision.
- l If the pretensioner has activated, the seat belt becomes locked: it cannot be further extended, nor will it return to the stowed position. The seat belt cannot be used again and must be replaced at your Toyota dealer.

n Child restraint lock function belt precaution

Do not allow children to play with the child restraint lock function belt. If the belt becomes twisted around a child's neck, it will not be possible to pull the belt out leading to choking or other serious injuries that could result in death. If this occurs and the buckle cannot be unfastened, scissors should be used to cut the belt.

n Seat belt damage and wear

- l Do not damage the seat belts by allowing the belt, plate, or buckle to be jammed in the door.
- l Inspect the seat belt system periodically. Check for cuts, fraying, and loose parts. Do not use a damaged seat belt until it is replaced. Damaged seat belt cannot protect an occupant from death or serious injury.

 CAUTION

n Seat belt damage and wear

- l** Ensure that the belt and tab are locked and the belt is not twisted.
If the seat belt does not function correctly, immediately contact your Toyota dealer.
- l** Replace the seat assembly, including the belts, if your vehicle has been involved in a serious accident, even if there is no obvious damage.
- l** Do not attempt to install, remove, modify, disassemble or dispose of the seat belts. Have any necessary repairs carried out by your Toyota dealer. Inappropriate handling of the pretensioner may prevent it from operating properly resulting in death or serious injury.

n Using a seat belt extender

- l** Do not wear the seat belt extender if you can fasten the seat belt without the extender.
- l** Do not use the seat belt extender when installing a child restraint system because the belt will not securely hold the child restraint system, increasing the risk of death or serious injury in the event of an accident.
- l** The personalized extender may not be safe on another vehicle, when used by another person, or at a different seating position other than the one originally intended.

 NOTICE

n When using a seat belt extender

- When releasing the seat belt, press on the buckle release button on the extender, not on the seat belt.
This helps prevent damage to the vehicle interior and the extender itself.

1-3. Adjustable components (seats, mirrors, steering wheel)

Steering wheel

1

Before driving

The steering wheel can be adjusted to a comfortable position.

n Tilt steering wheel

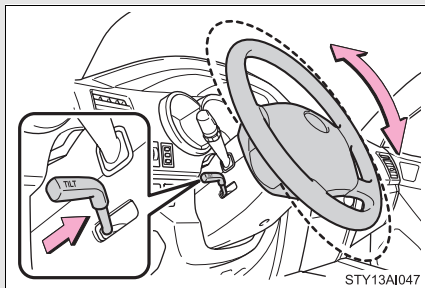

STEP 1 Hold the steering wheel and pull the lever.

STEP 2 Adjust to the ideal position by moving the steering wheel vertically.

STEP 3 Release the lever.

n Telescopic steering wheel (if equipped)

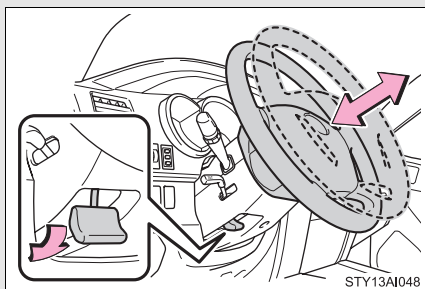

STEP 1 Hold the steering wheel and press the lever down.

STEP 2 Adjust to the ideal position by moving the steering wheel horizontally.

STEP 3 Pull the lever up.

⚠ CAUTION

n Caution while driving

Do not adjust the steering wheel while driving. Doing so may cause the driver to mishandle the vehicle and an accident, resulting in death or serious injury.

n After adjusting the steering wheel

Make sure that the steering wheel is securely locked. Otherwise, the steering wheel may move suddenly, possibly causing an accident and resulting in death or serious injury.

1-3. Adjustable components (seats, mirrors, steering wheel) Anti-glare inside rear view mirror

Glare from the headlights of vehicles behind can be reduced by using the following functions.

► Manual anti-glare inside rear view mirror

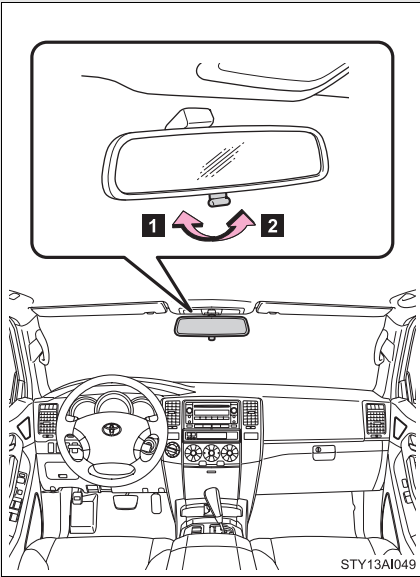

- 1 Normal position
- 2 Anti-glare position

STY13AI049

► Auto anti-glare inside rear view mirror

In automatic mode, sensors are used to detect the headlights of vehicles behind and automatically reduces the reflected light.

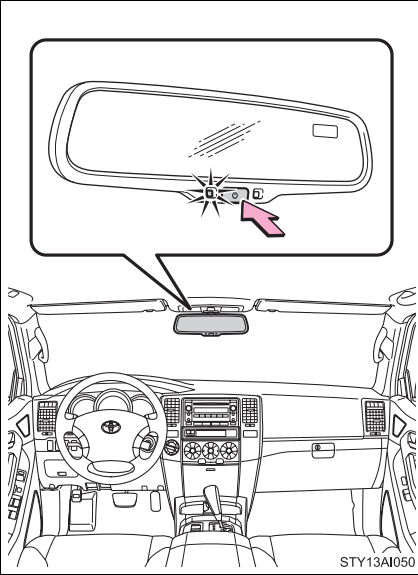

Press the button for longer than 3 seconds to turn auto mode ON/OFF.

The indicator comes on when automatic mode is turned on.

The mirror will revert to the automatic mode each time the engine switch is turned on.

■ To prevent sensor error (vehicles with auto anti-glare inside rear view mirror)

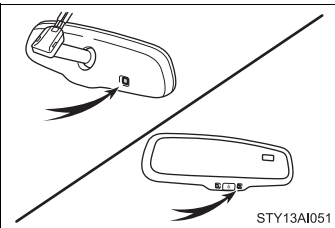

To ensure that the sensors operate properly, do not touch or cover them.

 CAUTION

n Caution while driving

Do not adjust the position of the mirror while driving.

Doing so may lead to mishandling of the vehicle and an accident, resulting in death or serious injury.

1-3. Adjustable components (seats, mirrors, steering wheel)

Outside rear view mirrors

Mirror angle can be adjusted.

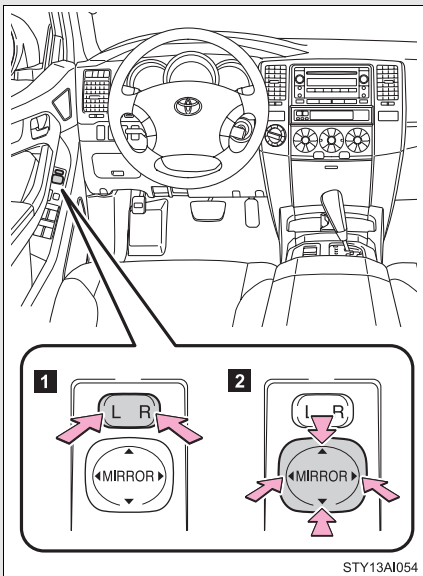

- 1 Select a mirror to adjust.
(L: left or R: right)
- 2 Adjust the mirror up, down, in or out using the switch.

1
Before driving

Folding back the mirrors

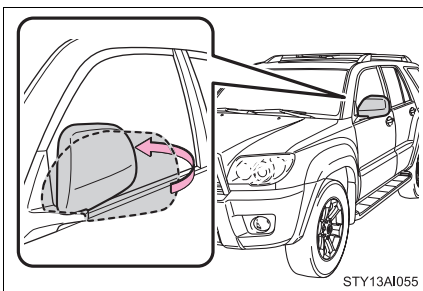

Push backward to fold the mirrors.

▮ **Mirror operating conditions**

The engine switch is in the ACC or ON position.

▮ **When the mirrors are fogged up (vehicles with outside rear view mirror defoggers)**

Turn on the mirror defoggers to defog the mirrors. (→P. 240)

▮ **Rain clearing mirrors**

The rain clearing mirrors have been coated to spread the raindrops evenly into a thin film (hydrophilic effect) when they adhere to the mirror surface, clearing the driver's rear view.

▮ **In the following cases, the rain clearing effect will be reduced temporarily, but will recover by exposing the mirrors to bright direct sunlight for 1 or 2 days**

┆ After wiping dirt off the mirrors

┆ When the mirrors fog up

┆ After waxing your vehicle in an automatic car wash

┆ After your vehicle has been parked for a long period in a place with no direct sunlight, such as under ground parking lots

 **CAUTION**

▮ **When driving the vehicle**

Observe the following precautions while driving.

Failing to do so may result in loss of control of the vehicle and cause an accident, resulting in death or serious injury.

┆ Do not adjust the mirrors while driving.

┆ Do not drive with the mirrors folded back.

┆ Both the driver and passenger side mirrors must be extended and properly adjusted before driving.

▮ **When a mirror is moving**

To avoid personal injury and mirror malfunction, be careful not to get your hand caught by the moving mirror.

 CAUTION

n When the mirror defoggers are operating (vehicles with outside rear view mirror defoggers)

Do not touch the rear view mirror surfaces, as they can become very hot and burn you.

 NOTICE

n If ice should jam the mirror

Do not operate the control or scrape the mirror face. Use a spray de-icer to free the mirror.

n When the mirror surfaces freeze (vehicles with mirror defoggers)

To maintain the rain clearing effect, do not scrape any ice off the mirrors using any objects such as a piece of plastic but instead pour warm water or operate the mirror defoggers to melt the ice.

1-4. Opening and closing the windows and moon roof Power windows

The power windows can be opened and closed using the following switches.

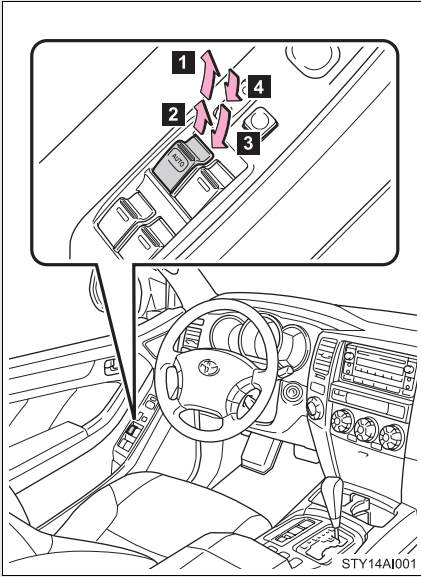

- 1** One-touch closing*
(driver's window only)
- 2** Closing
- 3** One-touch opening*
(driver's window only)
- 4** Opening

*: Pressing the switch in the opposite direction will stop window travel partway.

Lock switch

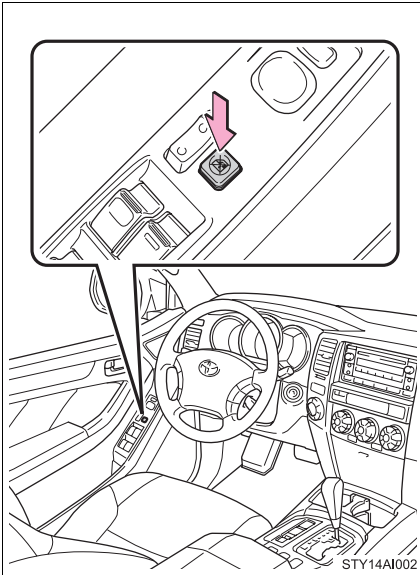

Press the switch down to lock passenger window switches and back window switch.

Use this switch to prevent children from accidentally opening or closing a passenger window and back window.

1

Before driving

n **The power windows can be operated when**

The engine switch is in the ON position.

n **Operating the power windows after turning the engine switch off**

The power windows can be operated for approximately 43 seconds even after the engine switch is turned off. They cannot, however, be operated once either front door is opened.

n **Jam protection function (driver's window only)**

If an object becomes caught between the window and the window frame, window travel is stopped and the window is opened slightly.

n When the battery is disconnected

The power windows must be initialized in order to ensure proper operation.
(driver's window only)

STEP 1 Open the window halfway.

STEP 2 Fully close the window by pulling the switch up and continue holding the switch for 1 second.

⚠ CAUTION

n Closing the windows

Observe the following precautions.

Failing to do so may result in death or serious injury.

I Check to make sure that all passengers do not have any part of their body in a position where it could be caught when a window is being operated.

I Do not allow children to operate the power windows.

Closing a power window on someone can cause serious injury, and in some instances, even death.

n Jam protection function

I Never try jamming any part of your body to activate the jam protection function intentionally.

I The jam protection function may not work if something gets caught just before the window fully closes.

1-4. Opening and closing the windows and moon roof

Power back window

The power back window can be opened and closed using the switch and key.

► From inside

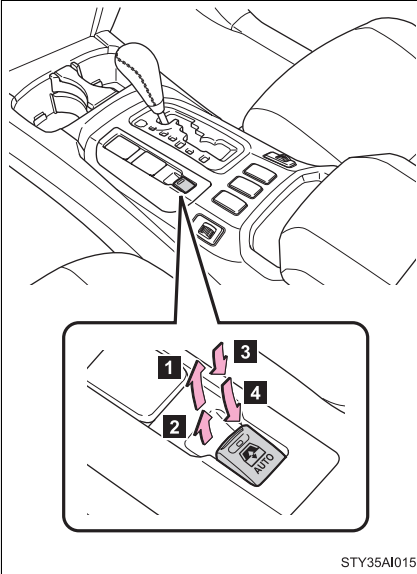

- 1 One-touch closing*
- 2 Closing
- 3 Opening
- 4 One-touch opening*

*: Pressing the switch in the opposite direction will stop window travel partway.

► From outside

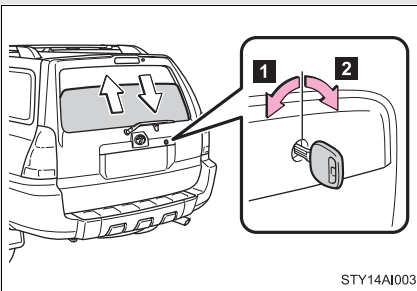

- 1 Opening
- 2 Closing

Turn the key fully and hold it.

■ **The power back window can be operated when**

- ┆ The engine switch is in the ON position.
- ┆ The power back window can be opened when the rear window wiper is working. At that time, the wiper stops working until the window is closed again.
If the rear window is not fully closed, the rear window wiper, washer, and defogger will not work.

■ **Operating the power back window after turning the engine switch off**

The power back window can be operated for approximately 43 seconds even after the engine switch is turned off. It cannot, however, be operated once either front door is opened.

■ **Jam protection function**

If an object becomes caught between the window and the window frame, window travel is stopped and the window is opened slightly.

■ **When the battery is disconnected**

The power windows must be initialized in order to ensure proper operation.

STEP 1 Open the window halfway.

STEP 2 Fully close the window by pulling the switch up and continue holding the switch for 1 second.

■ **Customization that can be configured at Toyota dealer**

Settings (e.g. wireless remote control linked operation) can be changed.
(Customizable features →P. 495)

 **CAUTION****n Caution while driving**

Keep the back door and back window closed.

This not only keeps the luggage from being thrown out but also prevents exhaust gases from entering the vehicle.

n Closing the power back window

Observe the following precautions.

Failing to do so may result in death or serious injury.

I Check to make sure that all passengers do not have any part of their body in a position where it could be caught when a window is being operated.

I Do not allow children to operate the power back window.

Closing a power back window on someone can cause serious injury, and in some instances, even death.

n Jam protection function

I Never try jamming any part of your body to activate the jam protection function intentionally.

I The jam protection function may not work if something gets caught just before the window fully closes.

1-4. Opening and closing the windows and moon roof Moon roof (if equipped)

Use the overhead switches to open, close, and tilt the moon roof up and down.

n Opening and closing

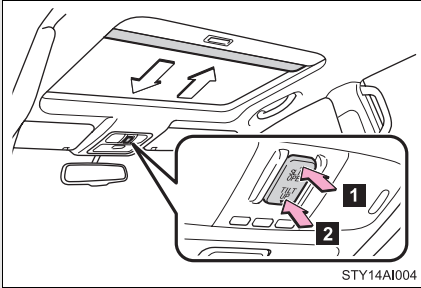

1 Open

2 Close

To stop partway, press the switch lightly.

n Tilt up and down

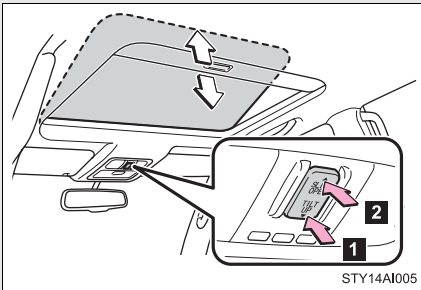

1 Tilt up

2 Tilt down

To stop partway, press the switch lightly.

n **The moon roof can be operated when**

The engine switch is in the ON position.

n **Operating the moon roof after turning the engine switch off**

The moon roof can be operated for approximately 43 seconds even after the engine switch is turned off. It cannot, however, be operated once either front door is opened.

n **Jam protection function**

l If an object is detected between the moon roof and the frame while closing, travel is stopped and the moon roof opens slightly.

l If an object is detected between the moon roof and the frame while tilting down, travel is stopped and the moon roof opens fully.

n **Sunshade**

The sunshade can be opened and closed manually. However, the sunshade will open automatically when the moon roof is opened.

n **When the battery is disconnected**

The moon roof must be initialized in order to ensure proper operation

STEP 1 Push and hold the switch on the TILT UP side until the moon roof tilts all the way up and then tilts down a little automatically.

STEP 2 To ensure the initialization is complete, make sure automatic opening and closing functions work properly.

 **CAUTION**

n Opening the moon roof

Observe the following precautions.

Failing to do so may cause death or serious injury.

- I** Do not allow any passengers to put their hands or heads outside the vehicle while it is moving.
- I** Do not sit on top of the moon roof.

n Closing the moon roof

Observe the following precautions.

Failing to do so may result in death or serious injury.

- I** Check to make sure that all passengers do not have any part of their bodies in a position where they could be caught when the moon roof is being operated.
- I** Do not allow children to operate the moon roof.
Closing the moon roof on someone can cause death or serious injury.

n Jam protection function

- I** Never try jamming any part of your body to activate the jam protection function intentionally.
- I** The jam protection function may not work if something gets caught just before the moon roof fully closes.

Opening the fuel tank cap

Perform the following steps to open the fuel tank cap.

n Before refueling the vehicle

Turn the engine switch off and ensure that all the doors and windows are closed.

n Opening the fuel tank cap

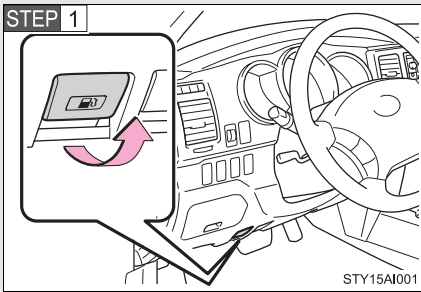

Pull the fuel filler door lever.

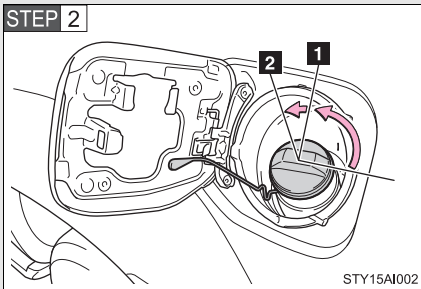

To remove the fuel tank cap, turn the cap counterclockwise by 90 degrees (**1**), and then turn it an additional 30 degrees (**2**). Pause slightly before removing it.

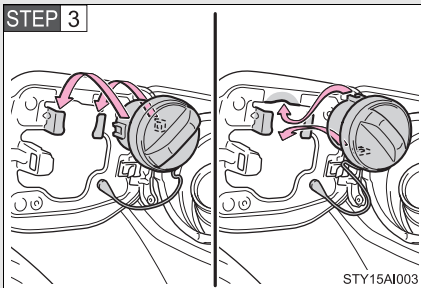

Hang the fuel tank cap on the back of the fuel filler door.

Closing the fuel tank cap

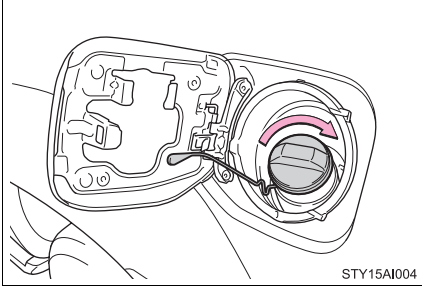

When replacing the fuel tank cap, turn it until a clicking sound is heard.

n Fuel types

Use unleaded gasoline. (Octane rating 87 [Research Octane Number 91] or higher)

n Fuel tank capacity

Approximately 23.0 gal. (87.0 L, 19.1 Imp. gal.)

⚠ CAUTION

n Refueling the vehicle

Observe the following precautions while refueling the vehicle. Failure to do so may result in death or serious injury.

- I Touch the vehicle or some other metal surface to discharge any static electricity.
Sparks resulting from discharging static electricity may cause the fuel vapors to ignite.
- I Always hold the grips on the fuel tank cap and turn it slowly to remove it. A whooshing sound may be heard when the fuel tank cap is loosened. Wait until the sound cannot be heard before fully removing the cap. In hot weather, pressurized fuel may spray out of the filler neck and cause injury.
- I Do not allow anyone that has not discharged static electricity from their bodies to come close to an open fuel tank.

 **CAUTION****n Refueling the vehicle**

- i** Do not inhale vaporized fuel.
Fuel contains substances that are harmful if inhaled.
- i** Do not smoke while refueling the vehicle.
Doing so may cause the fuel to ignite and cause a fire.
- i** Do not return to the vehicle or touch any person or object that is statically charged.
This may cause static electricity to build up, resulting in a possible ignition hazard.

n When replacing the fuel cap

Do not use anything but a genuine Toyota fuel tank cap designed for your vehicle. Doing so may cause a fire or other incident which may result in death or serious injury.

 **NOTICE****n Refueling**

Do not spill fuel during refueling.
Doing so may damage the vehicle, such as causing the exhaust systems to operate abnormally or damaging fuel system components or the vehicle's painted surface.

n To prevent damage to the fuel filler door

Do not apply excessive force.

Engine immobilizer system

The vehicle's keys have built-in transponder chips that prevent the engine from starting if the key has not been previously registered in the vehicle's on-board computer.

Never leave the keys inside the vehicle when you leave the vehicle.

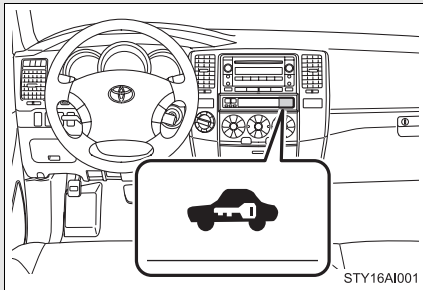

The indicator flashes after the key has been removed from the engine switch to indicate that the system is operating.

▮ System maintenance

The vehicle has a maintenance-free type of engine immobilizer system.

▮ Conditions that may cause the system to malfunction

- ▮ If the key is in contact with a metallic object
- ▮ If the key is in close proximity to or touching a key to the security system (key with a built-in transponder chip) of another vehicle

▮ Certifications for the engine immobilizer system

► For vehicles sold in U.S.A.

This device complies with Part 15 of the FCC Rules. Operation is subject to the following two conditions: (1) this device may not cause harmful interference, and (2) this device must accept any interference received, including interference that may cause undesired operation.

FCC WARNING:

Changes or modifications not expressly approved by the party responsible for compliance could void the user's authority to operate the equipment.

► For vehicles sold in Canada

This device complies with RSS-210 of Industry Canada.

Operation is subject to the following two conditions: (1) this device may not cause interference, and (2) this device must accept any interference, including interference that may cause undesired operation of the device.

 NOTICE

n To prevent damage to the key

Do not modify, remove or disable the engine immobilizer system. If any unauthorized changes or modifications are made, the proper operation of the system cannot be guaranteed.

1-6. Theft deterrent system Alarm (if equipped)

The system sounds the alarm and flashes lights when forcible entry is detected.

n Triggering of the alarm

The alarm is triggered in the following situations.

- 1 A locked door is unlocked or opened in any way other than using the wireless remote control door lock function or key. The doors will lock again automatically.
- 1 The hood is opened while the vehicle is locked.
- 1 The battery is reconnected.

n Setting the alarm system

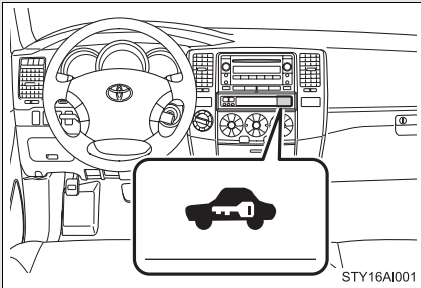

Close the doors and hood, and lock all doors using the wireless remote control or key. The system will be set automatically after 30 seconds.

The indicator changes from being on to flashing when the system is set.

n Deactivating or stopping the alarm

- 1 Unlock the doors using the wireless remote control or key.
- 1 Turn the engine switch to the ON position.
(The alarm will be deactivated or stopped after a few seconds.)

n **Items to check before locking the vehicle**

To prevent unexpected triggering of the alarm and vehicle theft, make sure of the following.

- l Nobody is in the vehicle.
- l The windows and moon roof are closed before the alarm is set.
- l No valuables or other personal items are left in the vehicle.

n **Triggering of the alarm**

The alarm may be triggered in the following situations.
(Stopping the alarm deactivates the system.)

- l A person inside the vehicle opens a door or hood.
- l The battery is recharged or replaced when the vehicle is locked.

n **Panic mode**

→P. 29

n **When the battery is disconnected**

Be sure to cancel the alarm system.

If the battery is discharged before canceling the alarm, the system may be triggered when the battery is reconnected.

1-6. Theft deterrent system

Theft prevention labels (U.S.A.)

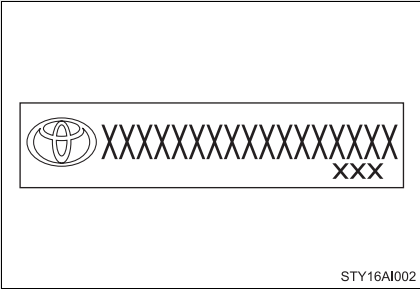

These labels are attached to the vehicle to reduce vehicle theft by facilitating the tracing and recovery of parts from stolen vehicles. Do not remove under penalty of law.

1-7. Safety information

Correct driving posture

Drive in a good posture as follows:

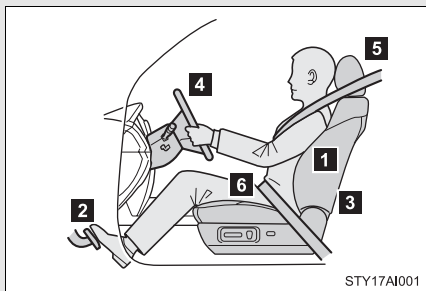

- 1 Sit upright and well back in the seat. (→P. 41)
- 2 Adjust the position of the seat forward or backward to ensure the pedals can be reached and easily depressed to the extent required. (→P. 41)
- 3 Adjust the seatback so that the controls are easily operable.
- 4 Adjust the tilt and telescopic positions of the steering wheel downward so the air-bag is facing your chest. (→P. 69)
- 5 Lock the head restraint in place with the center of the head restraint closest to the top of your ears. (→P. 60)
- 6 Wear the seat belt correctly. (→P. 63)

1

Before driving

 **CAUTION**

n While driving

- i** Do not adjust the position of the driver's seat while driving. Doing so could cause the driver to lose control of the vehicle.
- i** Do not place a cushion between the driver or passenger and the seatback. A cushion may prevent correct posture from being achieved, and reduce the effectiveness of the seat belt and head restraint, increasing the risk of death or serious injury to the driver or passenger.
- i** Do not place anything under the front seats. Objects placed under the front seats may become jammed in the seat tracks and stop the seat from locking in place. This may lead to an accident. The adjustment mechanism may also be damaged.

n Adjusting the seat position

- i** Take care when adjusting the seat position to ensure that other passengers are not injured by the moving seat.
- i** Do not put your hands under the seat or near the moving parts to avoid injury. Fingers or hands may become jammed in the seat mechanism.

SRS airbags

The SRS airbags inflate when the vehicle is subjected to certain types of severe impacts that may cause significant injury to the occupants. They work together with the seat belts to help reduce the risk of death or serious injury.

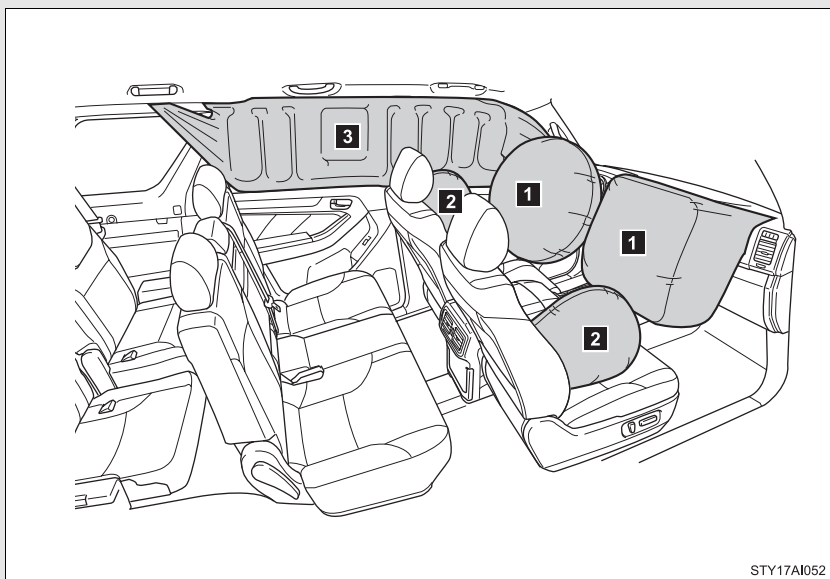

► Front airbags

1 Driver airbag/front passenger airbag

Can help protect the head and chest of the driver and front passenger from impact with interior components.

► Side and curtain shield airbags

2 Side airbags

Can help protect the torso of the front seat occupants.

3 Curtain shield airbags

Can help protect primarily the head of front seat occupants and second seat occupants.

Airbag system components

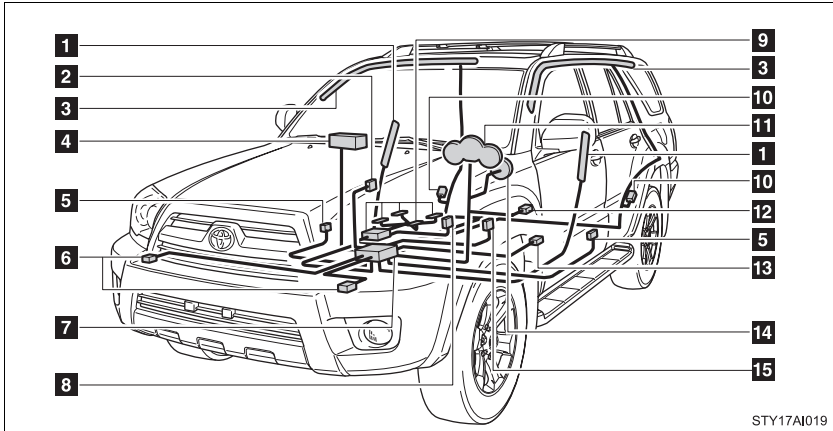

STY17AI019

- | | |
|--|--|
| 1 Side airbags | 9 Occupant detection system (ECU and sensors) |
| 2 AIR BAG ON and AIR BAG OFF indicator lights | 10 Curtain shield airbag sensors |
| 3 Curtain shield airbags | 11 SRS warning light and RSCA OFF indicator light |
| 4 Front passenger airbag | 12 RSCA OFF switch |
| 5 Side and curtain shield airbag sensors | 13 Driver's seat position sensor |
| 6 Front airbag sensors | 14 Driver airbag |
| 7 Airbag sensor assembly | 15 Driver's seat belt buckle switch |
| 8 Front passenger's seat belt buckle switch | |

Your vehicle is equipped with ADVANCED AIRBAGS designed based on US motor vehicle safety standards (FMVSS208). The airbag system controls airbag deployment power for the driver and front passenger. The driver airbag system consists of the driver seat's position sensor etc. The front passenger's airbag system consists of the front passenger occupant classification sensor etc.

The main SRS airbag system components are shown above. The SRS airbag system is controlled by the airbag sensor assembly. The airbag sensor assembly consists of a safing sensor and an airbag sensor.

In certain types of severe frontal or side impacts, the SRS airbag system triggers the airbag inflators. A chemical reaction in the inflators quickly fills the airbags with non-toxic gas to help restrain the motion of the occupants.

1

Before driving

n **SRS warning light**

This warning light system monitors the airbag sensor assembly, front airbag sensors, side and curtain shield airbag sensor assemblies, curtain shield airbag sensor assemblies, driver's seat position sensor, driver's seat belt buckle switch, front passenger occupant classification system, AIR BAG ON and AIR BAG OFF indicator lights, front passenger's seat belt buckle switch, front seat belt pretensioner assemblies, RSCA OFF indicator light, inflators, interconnecting wiring and power sources. (→P. 437)

n **If the SRS airbags deploy (inflate)**

- l Bruising and slight abrasions may result from contact with a deploying (inflating) SRS airbag.
- l A loud noise and white powder will be emitted.
- l Parts of the airbag module (steering wheel hub, airbag cover and inflator) as well as the front seats, and parts of the front and rear pillars and roof side rail, may be hot for several minutes. The airbag itself may also be hot.
- l The front windshield may crack.

n Operating conditions (front airbags)

- l The SRS front airbags will deploy if the severity of the frontal impact is above the designed threshold level, comparable to an approximate 15 mph (25 km/h) collision when the vehicle impacts straight into a fixed barrier that does not move or deform.

However, this threshold velocity will be considerably higher if the vehicle strikes an object, such as a parked vehicle or sign pole, which can move or deform on impact, or if the vehicle is involved in an underride collision (e.g. a collision in which the front of the vehicle “underrides”, or goes under, the bed of a truck, etc.).

- l It is possible that in some collisions where the forward deceleration of the vehicle is very close to the designed threshold level, the SRS front airbags and the seat belt pretensioners may not activate together.
- l The SRS front passenger airbag will not activate if there is no passenger sitting in the front passenger seat. However, the front passenger airbag may deploy if luggage is put in the seat, or the seat belt is fastened, even if the seat is unoccupied. (→P. 108)

n Operating conditions (side airbags)

- l The SRS side airbags are designed to inflate when the passenger compartment is subjected to a severe impact from the side.
- l The SRS side airbag on the passenger seat will not activate if there is no passenger sitting in the front passenger seat. However, the side airbag on the passenger seat may deploy if luggage is put in the seat, even if the seat is unoccupied. (→P. 108)

n Operating conditions (curtain shield airbags)

The SRS curtain shield airbags are designed to inflate when the passenger compartment is subjected to a severe impact from the side or vehicle roll-over. Depending on the conditions and type of accident, there are times when the curtain shield airbags may deploy (inflate) in a front impact.

11 Conditions under which the SRS airbags may deploy (inflate), other than a collision

The SRS front airbags may also deploy if a serious impact occurs to the underside of your vehicle. Some examples are shown in the illustration.

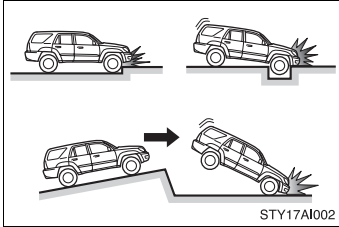

- 1 Hitting a curb, edge of pavement or hard surface
- 1 Falling into or jumping over a deep hole
- 1 Landing hard or vehicle falling

The SRS curtain shield airbags may also deploy under the situation shown in the illustration.

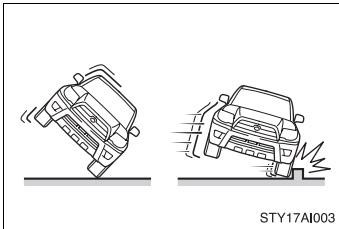

- 1 The angle of vehicle tip-up is marginal.
- 1 The vehicle skids and hits a curb stone.

11 Types of collisions that may not deploy the SRS airbag (front airbags)

The SRS front airbags are generally not designed to inflate if the vehicle is involved in a side or rear collision, if it rolls over, or if it is involved in a low-speed frontal collision. But, whenever a collision of any type causes sufficient forward deceleration of the vehicle, deployment of the SRS front airbags may occur.

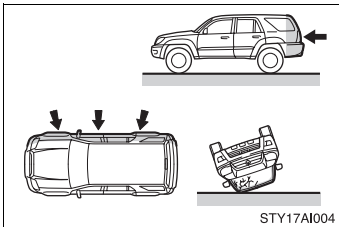

- 1 Collision from the side
- 1 Collision from the rear
- 1 Vehicle rollover

▮ **Types of collisions that may not deploy the SRS airbag (side airbags and curtain shield airbags)**

The SRS side airbag and curtain shield airbag system may not activate if the vehicle is subjected to a collision from the side at certain angles, or a collision to the side of the vehicle body other than the passenger compartment.

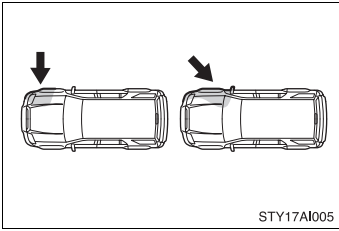

- | Collision from the side to the vehicle body other than the passenger compartment
- | Collision from the side at an angle

The SRS side airbags are not generally designed to inflate if the vehicle is involved in a frontal or rear collision, if it rolls over, or if it is involved in a low-speed side collision.

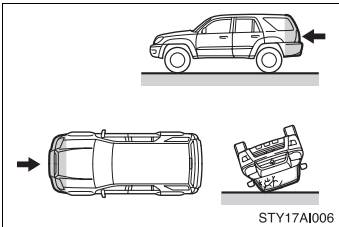

- | Collision from the front
- | Collision from the rear
- | Vehicle rollover

The SRS curtain shield airbags are not generally designed to inflate if the vehicle is involved in a frontal or rear collision, if it pitches end over end, or if it is involved in a low-speed side collision.

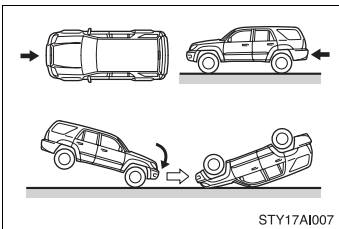

- | Collision from the front
- | Collision from the rear
- | Pitching end over end

11 When to contact your Toyota dealer

In the following cases, contact your Toyota dealer as soon as possible. Do not disconnect the battery cables before contacting your Toyota dealer.

1 Any of the SRS airbags have been inflated.

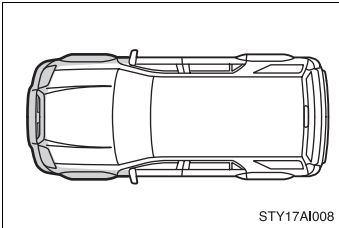

- 1 The front of the vehicle is damaged or deformed, or was involved in an accident that was not severe enough to cause the SRS airbags to inflate.

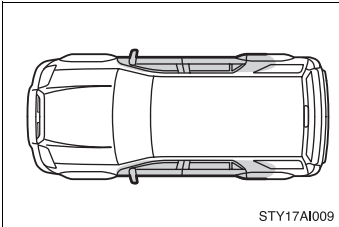

- 1 A portion of a door is damaged or deformed, or the vehicle was involved in an accident that was not severe enough to cause the SRS side airbags and curtain shield airbags to inflate.

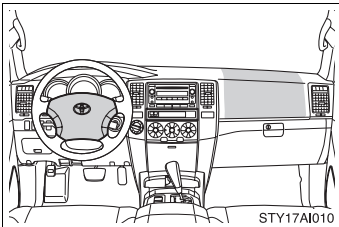

- 1 The pad section of the steering wheel or dashboard near the front passenger airbag is scratched, cracked, or otherwise damaged.

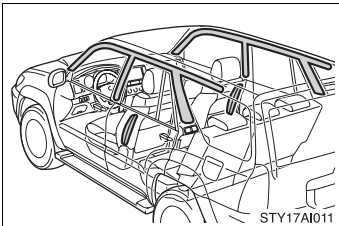

- 1 The surface of the seats with the side airbag is scratched, cracked or otherwise damaged.
- 1 The portion of the front, center and rear pillars or roof side rail garnishes (padding) containing the curtain shield airbags inside is scratched, cracked or otherwise damaged.

 CAUTION

n SRS airbag precautions

Observe the following precautions regarding the airbags.
Failure to do so may cause death or serious injury.

I The driver and all passengers in the vehicle must wear their seat belts properly.

The SRS airbags are supplemental devices to be used with the seat belts.

I The SRS driver airbag deploys with considerable force, and can cause death or serious injury especially if the driver is very close to the airbag. The National Highway Traffic Safety Administration (“NHTSA”) advises:

Since the risk zone for the driver’s airbag is the first 2 - 3 in. (50 - 75 mm) of inflation, placing yourself 10 in. (250 mm) from your driver airbag provides you with a clear margin of safety. This distance is measured from the center of the steering wheel to your breastbone. If you now sit less than 10 in. (250 mm) away, you can change your driving position in several ways:

- Move your seat to the rear as far as you can while still reaching the pedals comfortably.
- Slightly recline the back of the seat.
Although vehicle designs vary, many drivers can achieve the 10 in. (250 mm) distance, even with the driver seat all the way forward, simply by reclining the back of the seat somewhat. If reclining the back of your seat makes it hard to see the road, raise yourself by using a firm, non-slippery cushion, or raise the seat if your vehicle has that feature.
- If your steering wheel is adjustable, tilt it downward. This points the airbag toward your chest instead of your head and neck.

The seat should be adjusted as recommended by NHTSA above, while still maintaining control of the foot pedals and steering wheel, and your view of the instrument panel controls.

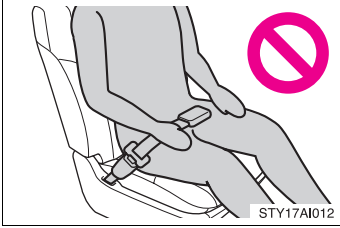
⚠ CAUTION**n SRS airbag precautions**

I If the seat belt extender has been connected to the driver's seat belt buckle but the seat belt extender has not also been fastened to the latch plate of the driver's seat belt, the SRS driver's airbag system will judge that the driver is wearing the seat belt even though the seat belt has not been connected. In this case, the driver's airbag may not activate correctly in a collision, resulting in death or serious injury in the event of collision. Be sure to wear the seat belt with the seat belt extender.

I The SRS front passenger airbag also deploys with considerable force, and can cause death or serious injury especially if the front passenger is very close to the airbag. The front passenger seat should be as far from the airbag as possible with the seatback adjusted, so the front passenger sits upright.

I Improperly seated and/or restrained infants and children can be killed or seriously injured by a deploying airbag. An infant or child who is too small to use a seat belt should be properly secured using a child restraint system. Toyota strongly recommends that all infants and children be placed in the rear seats of the vehicle and properly restrained. The rear seats are the safest for infants and children. (→P. 113)

! CAUTION

n SRS airbag precautions

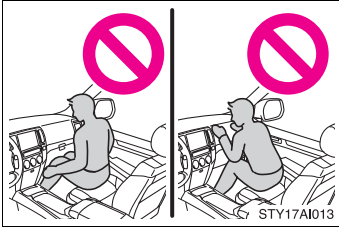

I Do not sit on the edge of the seat or lean against the dashboard.

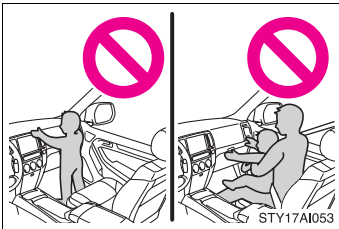

I Do not allow a child to stand in front of the SRS front passenger airbag unit or sit on the knees of a front passenger.

I Do not drive the vehicle while the driver or passenger has items resting on their knees.



I Do not lean against the door, the roof side rail or the front, side and rear pillars.

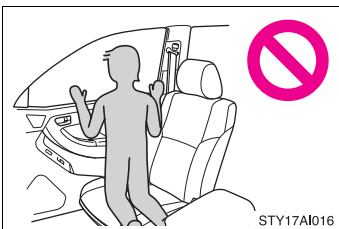

I Do not allow anyone to kneel on the passenger seat toward the door or put their head or hands outside the vehicle.

⚠ CAUTION

n SRS airbag precautions

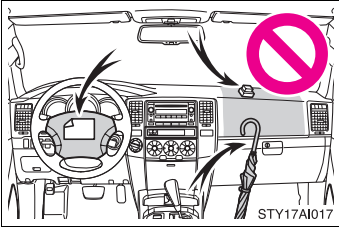

- Do not attach anything to or lean anything against areas such as the dashboard or steering wheel pad.

These items can become projectiles when SRS driver and front passenger airbags deploy.

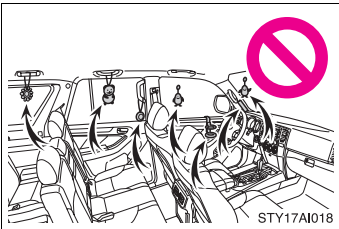

- Do not attach anything to areas such as the door, windshield glass, side door glass, front and rear pillars, roof side rail or assist grip.

- Do not hang coat hangers or other hard objects on the coat hooks. All of these items could become projectiles and seriously injure or kill you, should the SRS curtain shield airbag deploy.

- Do not use seat accessories which cover the parts where the SRS side airbags inflate as they may interfere with inflation of the airbags.
- Do not strike or apply significant levels of force to the area of the SRS airbag components (→P. 96). Doing so can cause the SRS airbags to malfunction.
- Do not touch any of the component parts immediately after the SRS airbags have deployed (inflated) as they may be hot.
- If breathing becomes difficult after the SRS airbag has deployed, open a door or window to allow fresh air in, or leave the vehicle if it is safe to do so. Wash off any residue as soon as possible to prevent skin irritation.
- If the areas where the SRS airbags are stored, such as the steering wheel pad, front, center and rear pillars and roof side rail garnishes, are damaged or cracked, have them replaced by your Toyota dealer.

 CAUTION

n Modification and disposal of SRS airbag system components

Do not dispose of your vehicle or perform any of the following modifications without consulting your Toyota dealer.

The SRS airbags may malfunction or deploy (inflate) accidentally, causing death or serious injury.

- I Installation, removal, disassembly and repair of the SRS airbags.
- I Repairs, modifications, removal or replacement of the steering wheel, instrument panel, dashboard, seats or seat upholstery, front, side and rear pillars or roof side rails.
- I Repairs or modifications of the front fender, front bumper, or side of the occupant compartment.
- I Installation of snow plows, winches, etc. to the front grille (bull bars, kangaroo bar etc.).
- I Modifications to the vehicle's suspension system.
- I Installation of electronic devices such as mobile two-way radios or CD players.
- I Modifications to your vehicle for a person with a physical disability.

Deactivating the curtain shield airbags in a vehicle rollover

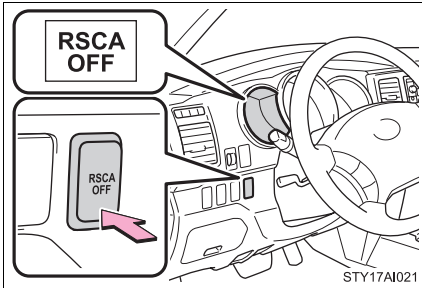

ON/OFF (hold for a few seconds)

The RSCA OFF indicator turns on. (only when the engine switch is in the ON position.)

The roll sensing function for the curtain shield airbags and seat belt pretensioners will turn back on automatically each time the engine switch is turned on.

1

Before driving

n **The switch only should be used**

In a situation where inflation is not desired (such as during extreme off-road driving).

n **Operating conditions when the RSCA OFF indicator is on**

- l The curtain shield airbag and seat belt pretensioner will not activate in a vehicle rollover.
- l The curtain shield airbag will activate in a severe side impact.

⚠ CAUTION

n **For normal driving**

Make sure the RSCA OFF indicator is not turned on. If it is left on, the curtain shield airbag will not activate in the event of an accident, which may result in death or serious injury.

Front passenger occupant classification system

Your vehicle is equipped with a front passenger occupant classification system. This system detects the conditions of the front passenger seat and activates or deactivates the devices for the front passenger.

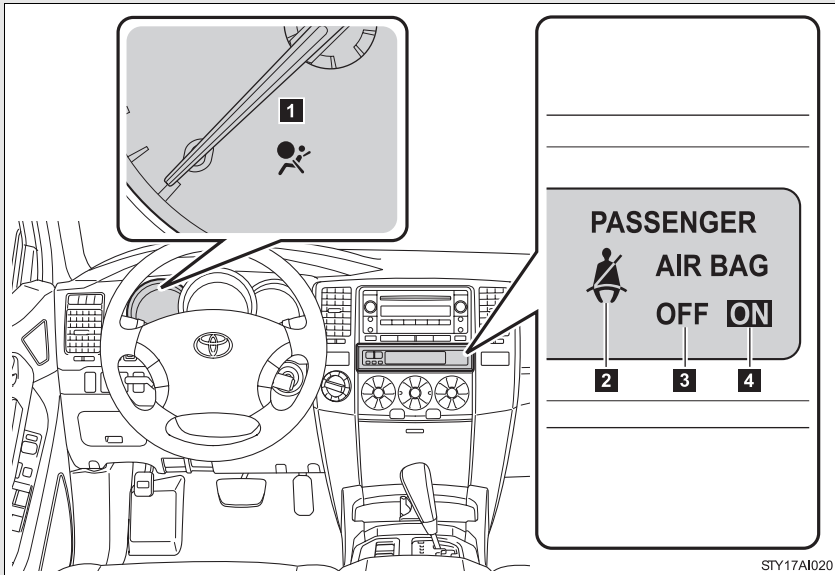

- 1** SRS warning light
- 2** Front passenger's seat belt reminder light
- 3** AIR BAG OFF indicator light
- 4** AIR BAG ON indicator light

Conditions and operation of the front passenger occupant classification system

n Adult*¹

Indicator/ warning light	AIR BAG ON and AIR BAG OFF indicator lights	AIR BAG ON
	SRS warning light	Off
	Front passenger's seat belt reminder light	Flashing* ²
Devices	Front passenger airbag	Activated
	Side airbag on the front passenger seat	
	Curtain shield airbag in the front passenger side	
	Front passenger's seat belt pretensioner	

n Child*³ or child restraint system*⁴

Indicator/ warning light	AIR BAG ON and AIR BAG OFF indicator lights	AIR BAG OFF* ⁵
	SRS warning light	Off
	Front passenger's seat belt reminder light	Flashing* ²
Devices	Front passenger airbag	Deactivated
	Side airbag on the front passenger seat	
	Curtain shield airbag in the front passenger side	Activated
	Front passenger's seat belt pretensioner	

n Unoccupied

Indicator/ warning light	AIR BAG ON and AIR BAG OFF indicator lights	Not illuminated
	SRS warning light	Off
	Front passenger's seat belt reminder light	
Devices	Front passenger airbag	Deactivated
	Side airbag on the front passenger seat	
	Curtain shield airbag in the front passenger side	Activated
	Front passenger's seat belt pretensioner	Deactivated

n There is a malfunction in the system

Indicator/ warning light	AIR BAG ON and AIR BAG OFF indicator lights	AIR BAG OFF
	SRS warning light	On
	Front passenger's seat belt reminder light	Off
Devices	Front passenger airbag	Deactivated
	Side airbag on the front passenger seat	
	Curtain shield airbag in the front passenger side	Activated
	Front passenger's seat belt pretensioner	

*1: The system judges a person of adult size as an adult. When a smaller adult sits in the front passenger seat, the system may recognize him/her as a child depending on his/her physique and posture.

*2: In the event the front passenger does not wear a seat belt.

*3: When a larger child who has outgrown a child restraint system sits in the front passenger seat, the system may recognize him/her as an adult depending on his/her physique or posture.

*4: Never install a rear-facing child restraint system on the front passenger seat. A forward-facing child restraint system should only be installed on the front passenger seat when it is unavoidable.

(→P. 113)

*5: In case the indicator is not illuminated, consult this manual for installing the child restraint system properly. (→P. 117)

CAUTION

n Front passenger occupant classification system precautions

Observe the following precautions regarding front passenger occupant classification system.

Failure to do so may cause death or serious injury.

- I Wear the seat belt properly.
- I Make sure the front passenger's seat belt tab has not been left inserted into the buckle before someone sits in the front passenger seat.
- I Make sure the AIR BAG OFF indicator light is not illuminated when using the seat belt extender for the front passenger seat. If the AIR BAG OFF indicator light is illuminated, disconnect the extender tongue from the seat belt buckle, then reconnect the seat belt. Reconnect the seat belt extender after making sure the AIR BAG ON indicator light is illuminated. If you use the seat belt extender while the AIR BAG OFF indicator light is illuminated, the front passenger airbag may not activate correctly, which could cause death or serious injury in the event of collision.
- I Do not apply a heavy load to the front passenger seat or equipment.
- I Do not put weight on the front passenger seat by putting your hands or feet on the front passenger seat seatback from the rear passenger seat.
- I Do not let a rear passenger lift the front passenger seat with their feet or press on the seatback with their legs.
- I Do not put objects under the front passenger seat.

 CAUTION

n Front passenger occupant classification system precautions

- I** Do not recline the front passenger seatback so far that it touches a rear seat. This may cause the AIR BAG OFF indicator light to be illuminated, which indicates that the passenger's airbags will not deploy in the event of a severe accident. If the seatback touches the rear seat, return the seatback to a position where it does not touch the rear seat. Keep the front passenger seatback as upright as possible when the vehicle is moving. Reclining the seatback excessively may lessen the effectiveness of the seat belt system.
- I** If an adult sits in the front passenger seat, the AIR BAG ON indicator light is illuminated. If the AIR BAG OFF indicator is illuminated, ask the passenger to sit up straight, well back in the seat, feet on the floor, and with the seat belt worn correctly. If the AIR BAG OFF indicator still remains illuminated, either ask the passenger to move to the rear seat, or if that is not possible, move the front passenger seat fully rearward.
- I** When it is unavoidable to install the forward-facing child restraint system on the front passenger seat, install the child restraint system on the front passenger seat in the proper order. (→P. 117)
- I** Do not modify or remove the front seats.
- I** Do not kick the front passenger seat or subject it to severe impact. Otherwise, the SRS warning light may come on to indicate a malfunction of the detection system. In this case, contact your Toyota dealer immediately.
- I** Child restraint systems installed on the rear seat should not contact the front seatbacks.

1-7. Safety information

Child restraint systems

A child restraint system for a small child or baby must itself be properly restrained on the seat with the lap portion of the lap/shoulder belt.

The laws of all 50 states of the U.S.A. and Canada now require the use of child restraint systems.

1

Before driving

Points to remember

Studies have shown that installing a child restraint on a rear seat is much safer than installing one to the front passenger seat.

1 Choose a child restraint system that suits your vehicle and is appropriate to the age and size of the child.

1 For installation details, follow the instructions provided with the child restraint system.

General installation instructions are provided in this manual.

(→P. 117)

Types of child restraint

Child restraint systems are classified into the following 3 types according to the age and size of the child.

► Rear facing — Infant seat/convertible seat



► Forward facing — Convertible seat

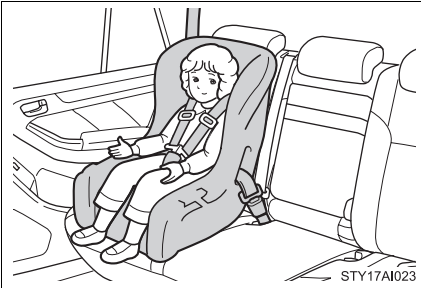

► Booster seat

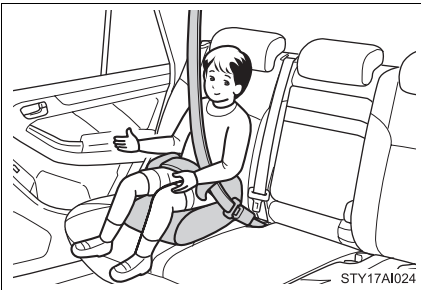

n **Selecting an appropriate child restraint system**

- l Use a child restraint system appropriate for the child until the child becomes large enough to properly wear the vehicle's seat belts.
- l If a child is too large for a child restraint system, sit the child on a rear seat and use the vehicle's seat belt. (→P. 63)

 CAUTION**n Child restraint precautions**

- I** For effective protection in automobile accidents and sudden stops, a child must be properly restrained, using a seat belt or child restraint system depending on the age and size of the child. Holding a child in your arms is not a substitute for a child restraint system. In an accident, the child can be crushed against the windshield, or between you and the vehicle's interior.
- I** Toyota strongly urges the use of a proper child restraint system that conforms to the size of the child, installed on the rear seat. According to accident statistics, the child is safer when properly restrained in the rear seat than in the front seat.
- I** Never install a rear-facing child restraint system on the front passenger seat even if the AIR BAG OFF indicator light is illuminated.
In the event of an accident, the force of the rapid inflation of the front passenger airbag can cause death or serious injury to the child if the rear-facing child restraint system is installed on the front passenger seat.
- I** A forward-facing child restraint system may be installed on the front passenger seat only when it is unavoidable. A child restraint system that requires a top tether strap should not be used in the front passenger seat since there is no top tether strap anchor for the front passenger seat. Adjust the seatback as upright as possible and always move the seat as far back as possible even if the AIR BAG OFF indicator light is illuminated, because the front passenger airbag could inflate with considerable speed and force. Otherwise, the child may be killed or seriously injured.
- I** Do not use the seat belt extender when installing a child restraint system on the front or rear passenger seat. If installing a child restraint system with the seat belt extender connected to the seat belt, the seat belt will not securely hold the child restraint system, which could cause death or serious injury to the child or other passengers in the event of an accident.
- I** Do not allow the child to lean his/her head or any part of his/her body against the door or the area of the seat, front and rear pillars or roof side rail from which the side airbags or curtain shield airbags deploy even if the child is seated in the child restraint system. It is dangerous if the side airbags and curtain shield airbags inflate, and the impact could cause death or serious injury to the child.

 **CAUTION**

n Child restraint precautions

- I** Make sure you have complied with all installation instructions provided by the child restraint manufacturer and that the system is properly secured. If it is not secured properly, it may cause death or serious injury to the child in the event of a sudden stop or an accident.

n Child restraint lock function belt precaution

Do not allow children to play with the child restraint lock function belt. If the belt becomes twisted around a child's neck, it will not be possible to pull the belt out leading to choking or other serious injuries that could result in death. If this occurs and the buckle cannot be unfastened, scissors should be used to cut the belt.

n When the child restraint system is not in use

- I** Keep the child restraint system properly secured on the seat even if it is not in use. Do not store the restraint unsecured in the passenger compartment.
- I** If it is necessary to detach the child restraint system, remove it from the vehicle or store it securely in the luggage compartment. This will prevent it from injuring passengers in the event of a sudden stop or accident.

Installing child restraints

Follow the child restraint system manufacturer's instructions. Firmly secure child restraints to the rear seats using the LATCH anchors or a seat belt. Attach the top tether strap when installing a child restraint.

The lap/shoulder belt can be used if your child restraint system is not compatible with the LATCH (Lower Anchors and Tethers for Children) system.

► Vehicles without third seats

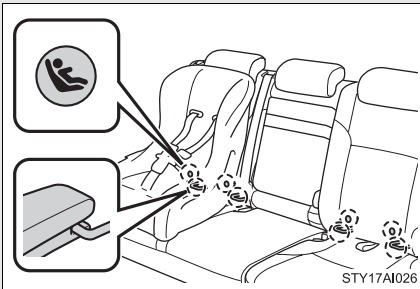

Child restraint LATCH anchors

LATCH anchors are provided for the outside rear seats. (Buttons displaying the location of the anchors are attached to the seats.)

► Vehicles with third seats

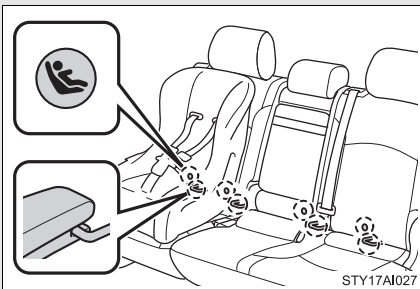

Second seat: Child restraint LATCH anchors

LATCH anchors are provided for the right side seat and between the center and left side seats. (Buttons displaying the location of the anchors are attached to the seats.)

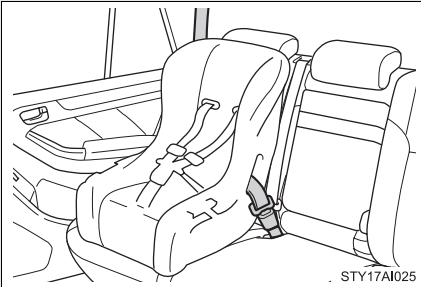

Seat belts equipped with a child restraint locking mechanism (ALR/ELR belts except driver's seat belt) (→P. 63)

► Vehicles without third seats

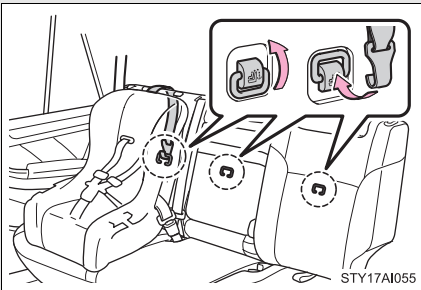

Anchor brackets (for top tether strap)

Anchor brackets are provided for all rear seats.

► Vehicles with third seats

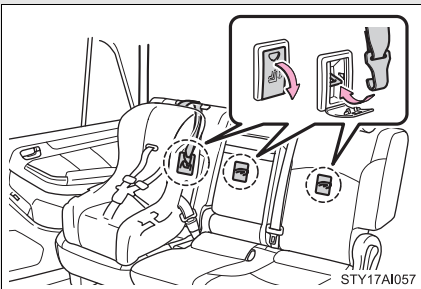

Anchor brackets (for top tether strap)

Anchor brackets are provided for all second seats.

Installation with LATCH system (rear/second seat only)

n Installing on the rear seats (vehicles without third seats)

► Type A

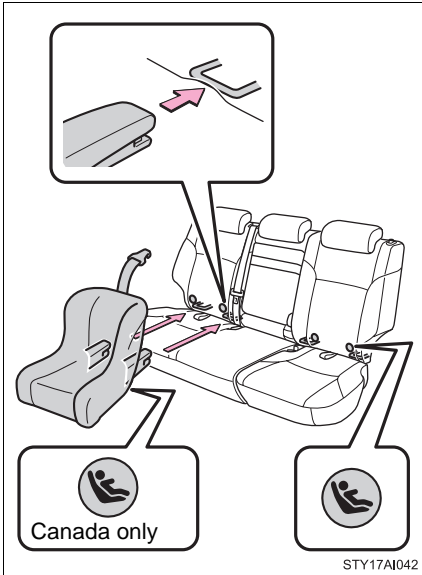

STEP 1 Widen the gap between the seat cushion and seatback slightly.

STEP 2 Latch the buckles onto the LATCH anchors.

STEP 3 If the child restraint has a top tether strap, the top tether strap should be latched onto the top tether strap anchor. (→P. 126)

For owners in Canada:
The symbol on a child restraint system indicates the presence of a lower connector system.

► Type B

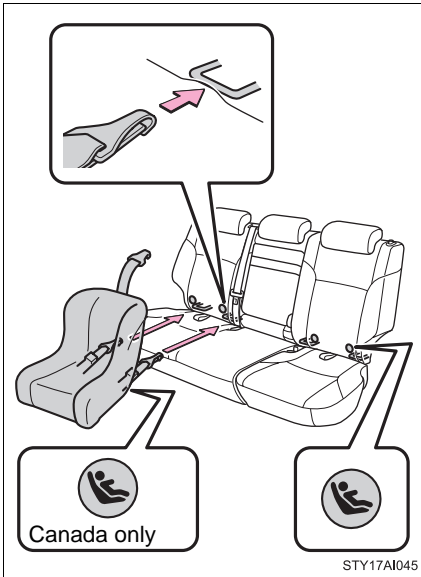

STEP 1 Widen the gap between the seat cushion and seatback slightly.

STEP 2 Latch the hooks of the lower straps onto the LATCH anchors and tighten the lower straps.

STEP 3 If the child restraint has a top tether strap, the top tether strap should be latched onto the top tether strap anchor. (→P. 126)

For owners in Canada:

The symbol on a child restraint system indicates the presence of a lower connector system.

n Installing on the second seats (vehicles with third seats)

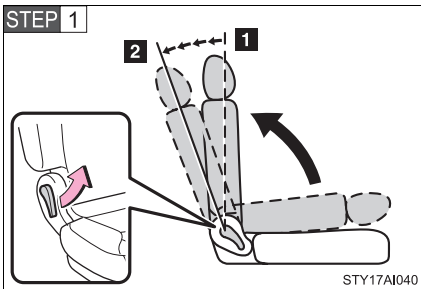

Fold the seatback while pulling the lever. Return the seatback and secure it at the 1st lock position (most upright position). Adjust the seatback to the 5th lock position. (→P. 44)

1 1st lock position

2 5th lock position

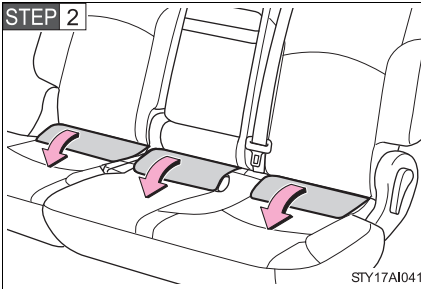

► Type A

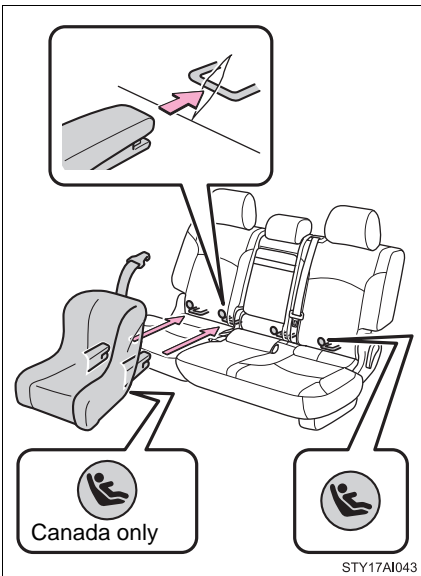

Take off the cover on the seat cushion.

STEP 3 Widen the slits of the seat cushion slightly.

STEP 4 Latch the buckles onto the LATCH anchors.

STEP 5 If the child restraint has a top tether strap, the top tether strap should be latched onto the top tether strap anchor. (→P. 126)

For owners in Canada:
The symbol on a child restraint system indicates the presence of a lower connector system.

► Type B

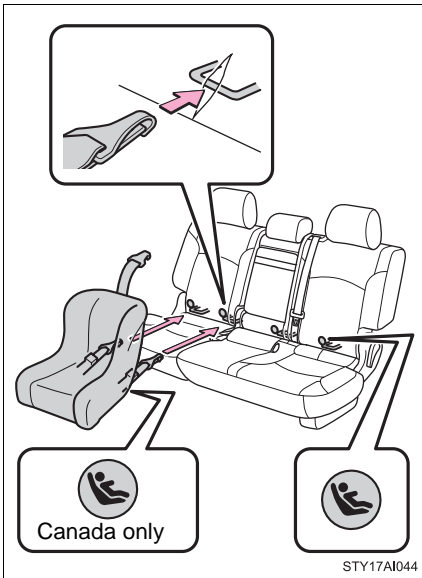

STEP 3 Widen the slits of the seat cushion slightly.

STEP 4 Latch the hooks of the lower straps onto the LATCH anchors and tighten the lower straps.

STEP 5 If the child restraint has a top tether strap, the top tether strap should be latched onto the top tether strap anchor. (→P. 126)

For owners in Canada:
The symbol on a child restraint system indicates the presence of a lower connector system.

Installing child restraints using a seat belt (child restraint lock function belt)

n Rear facing — Infant seat/convertible seat

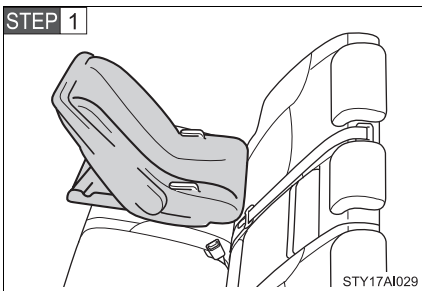

Place the child seat on the rear seat facing the rear of the vehicle.

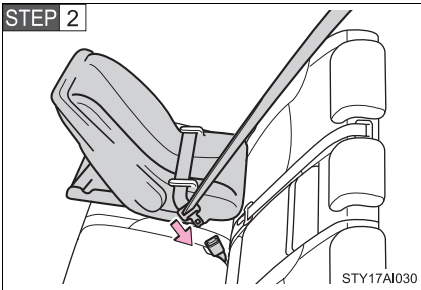

Run the seat belt through the child seat and insert the plate into the buckle. Make sure that the belt is not twisted.

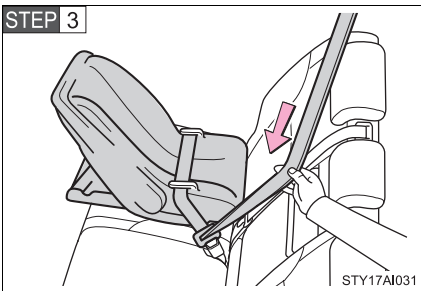

Fully extend the shoulder belt and then allow it to retract slightly in order to activate the ALR lock mode.

Lock mode allows the seat belt to retract only.

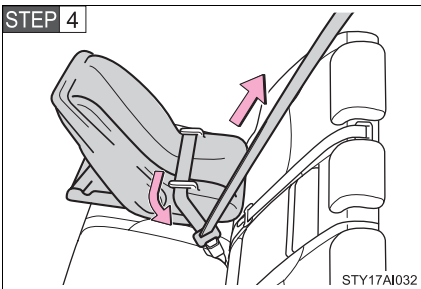

While pushing the child seat down into the rear seat, allow the shoulder belt to retract until the child seat is securely in place.

After the shoulder belt has retracted to a point where there is no slack in the belt, pull the belt to check that it cannot be extended.

n Forward facing — Convertible seat

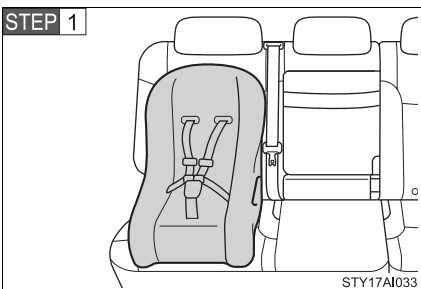

Place the child seat on the seat facing the front of the vehicle.

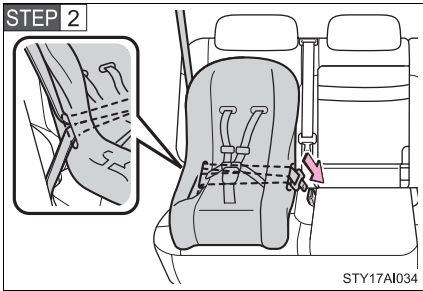

Run the seat belt through the child seat and insert the plate into the buckle. Make sure that the belt is not twisted.

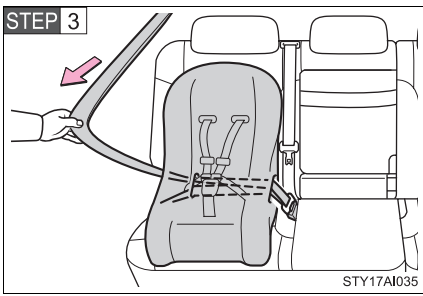

Fully extend the shoulder belt and then allow it to retract slightly in order to activate the ALR lock mode.

Lock mode allows the seat belt to retract only.

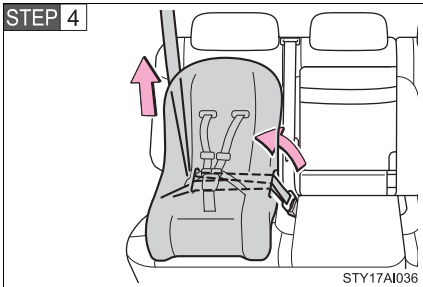

While pushing the child seat into the rear seat, allow the shoulder belt to retract until the child seat is securely in place.

After the shoulder belt has retracted to a point where there is no slack in the belt, pull the belt to check that it cannot be extended.

STEP 5 If the child restraint has a top tether strap, the top tether strap should be latched onto the top tether strap anchor. (→P. 126)

n Booster seat

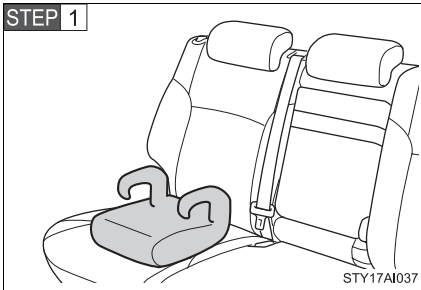

Place the booster seat on the seat facing the front of the vehicle.



Sit the child in the booster seat. Fit the seat belt to the booster seat according to the manufacturer's instructions and insert the plate into the buckle. Make sure that the belt is not twisted.

Check that the shoulder belt is correctly positioned over the child's shoulder, and that the lap belt is as low as possible.
(→P. 63)

Removing a child restraint installed with a seat belt

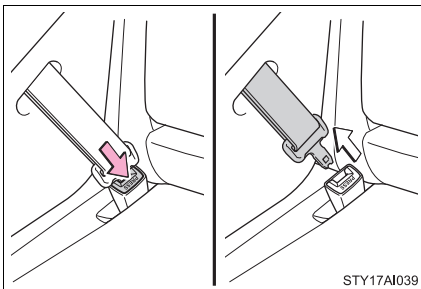

Push the buckle release button and fully retract the seat belt.

Child restraint systems with a top tether strap

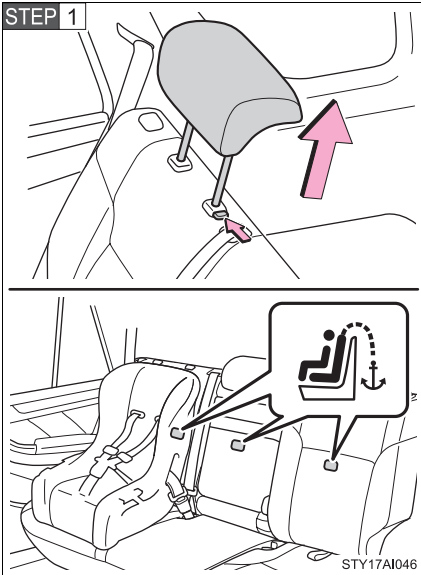

Secure the child restraint using the LATCH anchors or seat belt, and remove the head restraint.

► Vehicles without third seats

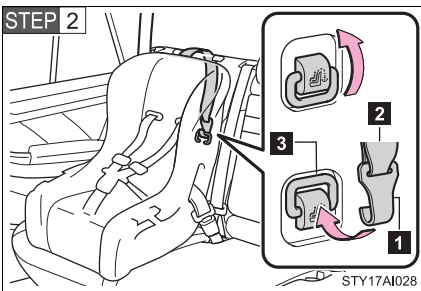

Raise the anchor bracket, latch the hook onto the anchor bracket and tighten the top tether strap.

Make sure the top tether strap is securely latched.

- 1** Hook
- 2** Top tether strap
- 3** Anchor bracket

► Vehicles with third seats

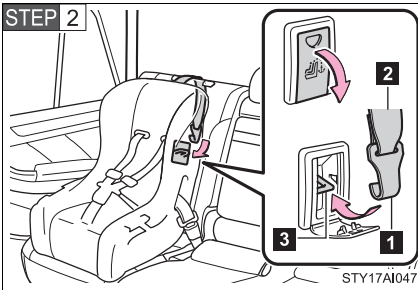

Open the anchor bracket cover, latch the hook onto the anchor bracket and tighten the top tether strap.

Make sure the top tether strap is securely latched.

- 1 Hook
- 2 Top tether strap
- 3 Anchor bracket

Reinstall the head restraint.

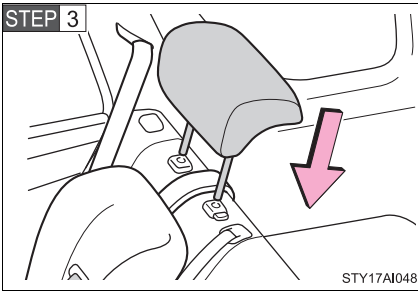

▣ **Laws and regulations pertaining to anchorages**

The LATCH system conforms to FMVSS225 or CMVSS210.2.

Child restraint systems conforming to FMVSS213 or CMVSS213 specifications can be used.

This vehicle is designed to conform to the SAE J1819.

▣ **When the anchor bracket is not in use (vehicles without third seats)**

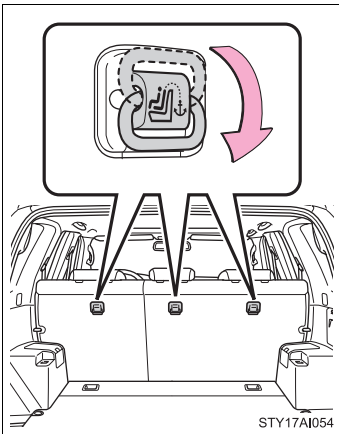

Lower the anchor bracket.

The anchor bracket is only designed to secure the top tether strap. Do not use the anchor bracket for any other purpose.

⚠ CAUTION

n When installing a booster seat

Do not fully extend the shoulder belt to prevent the belt from going to ALR lock mode. (→P. 65)

ALR mode causes the belt to tighten only which could cause injury or discomfort to the child.

n When installing a child restraint system

Follow the directions given in the child restraint system installation manual and fix the child restraint system securely in place.

If the child restraint system is not correctly fixed in place, the child or other passengers may be seriously injured or even killed in the event of sudden braking or an accident.

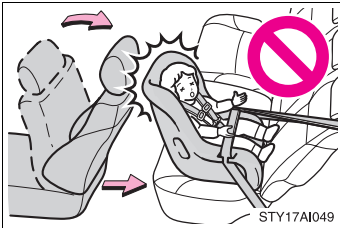

! If the driver's seat interferes with the child restraint system and prevents it from being attached correctly, attach the child restraint system to the right-hand rear seat.

! Adjust the front passenger seat so that it does not interfere with the child restraint system.

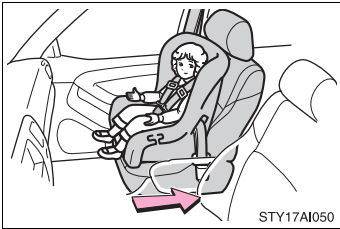

! Only put a forward-facing or booster child seat on the front seat when unavoidable. When installing a forward-facing or booster child seat on the front passenger seat, move the seat as far back as possible even if the AIR BAG OFF indicator light is illuminated. Failing to do so may result in death or serious injury if the airbags deploy (inflate).

! Vehicles with third seats: When installing a child restraint system in the second center position, adjust both seatbacks at the same angle. Otherwise, the child restraint system cannot be securely restrained and this may cause death or serious injuries in an accident.

⚠ CAUTION

n When installing a child restraint system

- l When a booster seat is installed, always ensure that the shoulder belt is positioned across the center of the child's shoulder. The belt should be kept away from the child's neck, but not so that it could fall off the child's shoulder. Failing to do so may result in death or serious injury in the event of an accident or sudden braking.
- l Ensure that the belt and tab are securely locked and the seat belt is not twisted.
- l Push and pull the child restraint system from side to side and forward to be sure it is secure.
- l After securing a child restraint system, never adjust the seat.
- l Follow all installation instructions provided by the child restraint system manufacturer.

n Do not use a seat belt extender

If a seat belt extender is used when installing a child restraint system, the seat belt will not securely hold the child restraint system, which could cause death or serious injury to the child or other passengers in the event of an accident.

n To correctly attach a child restraint system to the anchors

- l When using the LATCH anchors, be sure that there are no foreign objects around the anchors and that the seat belt is not caught behind the child restraint. Make sure the child restraint system is securely attached, or it may cause death or serious injury to the child or other passengers in the event of a sudden stop or accident.

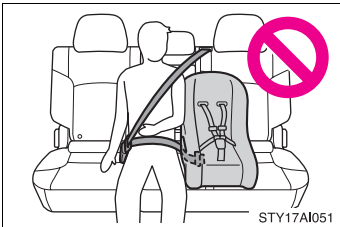

- l Vehicles with third seats: When using the left side LATCH anchors for the child restraint system, do not sit in the center seat. Seat belt function may be impaired, such as being positioned overly high or loose-fitting, which may result in death or serious injury in the event of sudden braking or an accident.

2-1. Driving procedures

Driving the vehicle

The following procedures should be observed to ensure safe driving.

n Starting the engine (→P. 140)

n Driving

STEP 1 With the brake pedal depressed, shift the shift lever to D. (→P. 143)

STEP 2 Release the parking brake. (→P. 146)

STEP 3 Gradually release the brake pedal and gently depress the accelerator pedal to accelerate the vehicle.

n Stopping

STEP 1 With the shift lever in D, depress the brake pedal.

STEP 2 If necessary, set the parking brake.

When the vehicle is stopped for an extended period of time, shift the shift lever to P or N. (→P. 143)

n Parking the vehicle

STEP 1 With the shift lever in D, depress the brake pedal.

STEP 2 Set the parking brake. (→P. 146)

STEP 3 Shift the shift lever to P. (→P. 143)

When parking on a hill, if necessary, block the wheels.

STEP 4 Turn the engine switch off to stop the engine.

STEP 5 Lock the door, making sure that you have the key on your person.

Starting on a steep uphill

STEP 1 With the brake pedal depressed, firmly set the parking brake and shift the shift lever to D.

STEP 2 Gently depress the accelerator pedal.

STEP 3 Release the parking brake.

n **Driving in the rain**

- l Drive carefully when it is raining, because visibility will be reduced, the windows may become fogged-up, and the road will be slippery.
- l Drive carefully when it starts to rain, because the road surface will be especially slippery.
- l Refrain from high speeds when driving on an expressway in the rain, because there may be a layer of water between the tires and the road surface, preventing the steering and brakes from operating properly.

n **Breaking in your new Toyota**

To extend the life of the vehicle, the following precautions are recommended to observe:

- l For the first 200 miles (300 km):
Avoid sudden stops.
- l For the first 500 miles (800 km):
Do not tow a trailer.
- l For the first 1000 miles (1600 km):
 - Do not drive at extremely high speeds.
 - Avoid sudden acceleration.
 - Do not drive continuously in the low gears.
 - Do not drive at a constant speed for extended periods.

n **Drum-in disc type parking brake system**

Your vehicle has a drum-in-disc type parking brake system. This type of brake system needs bedding-down of the brake shoes periodically or whenever the parking brake shoes and/or drum are replaced. Have your Toyota dealer perform the bedding down.

n **Operating your vehicle in a foreign country**

Comply with the relevant vehicle registration laws and confirm the availability of the correct fuel. (→P. 473)

n **Normal characteristics after turning off the engine**

Approximately five hours after the engine is turned off, you may hear sound coming from under the vehicle for several minutes. This is the sound of a fuel evaporation leakage check and, it does not indicate a malfunction.

 **CAUTION**

n When starting the vehicle

Always keep your foot on the brake pedal while stopped with the engine running. This prevents the vehicle from creeping.

n When driving the vehicle

I Do not drive if you are unfamiliar with the location of the brake and accelerator pedals to avoid depressing the wrong pedal.

- Accidentally depressing the accelerator pedal instead of the brake pedal will result in sudden acceleration that may lead to an accident that could result in death or serious injury.
- When backing up, you may twist your body around, leading to a difficulty in operating the pedals. Make sure to operate the pedals properly.
- Make sure to keep a correct driving posture even when moving the vehicle only slightly, allowing you to depress the brake and accelerator pedals properly.
- Depress the brake pedal using your right foot. Depressing the brake pedal using your left foot may delay response in an emergency, resulting in an accident.

I Do not drive the vehicle over or stop the vehicle near flammable materials. The exhaust system and exhaust gases can be extremely hot. This may cause a fire if there is any flammable material nearby.

I Do not let the vehicle roll backwards while the shift lever is in a driving position, or roll forward while the shift lever is in R. Doing so may cause the engine to stall or lead to poor brake and steering performance, resulting in an accident or damage to the vehicle.

I If the smell of exhaust is noticed inside the vehicle, open the windows and check that the back door and back window are closed. Large amounts of exhaust in the vehicle can cause driver drowsiness and an accident, resulting in death or a serious health hazard. Have the vehicle inspected by your Toyota dealer immediately.

I Do not under any circumstances shift the shift lever to P, R or N while the vehicle is moving. Doing so can cause significant damage to the transmission system and may result in a loss of vehicle control.

 **CAUTION**
n When driving the vehicle

- I** Do not shift the shift lever to N while the vehicle is moving.
Doing so may cause the engine brake to not operate properly and lead to an accident.
- I** Do not turn the engine off while driving.
The power steering and brake booster systems will not operate properly if the engine is not running.
- I** Use engine braking (downshift) to maintain a safe speed when driving down a steep hill.
Using the brakes continuously may cause the brakes to overheat and lose effectiveness. (→P. 144)
- I** When stopped on an inclined surface, use the brake pedal and parking brake to prevent the vehicle from rolling backward or forward and causing an accident.
- I** Do not adjust the position of the steering wheel, the seat, or the inside or outside rear view mirrors while driving.
Doing so may result in a loss of vehicle control that can cause accidents that may result in death or serious injury.
- I** Always check that all passengers' arms, heads or other parts of their bodies are not outside the vehicle, as this may result in death or serious injury.
- I** Do not drive in excess of the speed limit. Even if the legal speed limit permits it, do not drive over 85 mph (140 km/h) unless your vehicle has high-speed capability tires. Driving over 85 mph (140 km/h) may result in tire failure, loss of control and possible injury. Be sure to consult a tire dealer to determine whether the tires on your vehicle are high-speed capability tires or not before driving at such speeds.

n When driving on slippery road surfaces

- I** Sudden braking, acceleration and steering may cause tire slippage and reduce your ability to control the vehicle, resulting in an accident.
- I** Sudden changes in engine speed, such as engine braking caused by up-shifting or down-shifting, may cause the vehicle to skid, resulting in an accident.

 CAUTION

n When driving on slippery road surfaces

- I** After driving through a puddle, lightly depress the brake pedal to make sure that the brakes are functioning properly. Wet brake pads may prevent the brakes from functioning properly. If the brakes on only one side are wet and not functioning properly, steering control may be affected, resulting in an accident.

n When shifting the shift lever

- Be careful not to shift the shift lever with the accelerator pedal depressed. This may lead to unexpected rapid acceleration of the vehicle that may cause an accident and result in death or serious injury.

n When the vehicle is stopped

- I** Do not race the engine.
If the vehicle is in any gear other than P or N, the vehicle may accelerate suddenly and unexpectedly, and may cause an accident.
- I** Do not leave the vehicle with the engine running for a long time.
If such a situation cannot be avoided, park the vehicle in an open space and check that exhaust fumes do not enter the vehicle interior.
- I** Always keep a foot on the brake pedal while the engine is running to prevent an accident caused by the vehicle moving.

n When the vehicle is parked

- I** Do not leave glasses, cigarette lighters, spray cans, or soft drink cans in the vehicle when it is in the sun.
Doing so may result in the following.
 - Gas may leak from a cigarette lighter or spray can, and may lead to a fire.
 - The temperature inside the vehicle may cause the plastic lenses and plastic material of eye glasses to deform or crack.
 - Soft drink cans may fracture, causing the contents to spray over the interior of the vehicle, and may also cause a short circuit in the vehicle's electrical components.
- I** Always apply the parking brake, shift the shift lever to P, stop the engine and lock the vehicle.
Do not leave the vehicle unattended while the engine is running.

 **CAUTION****n When the vehicle is parked**

- I** Do not touch the exhaust pipe while the engine is running or immediately after turning the engine off.
Doing so may cause burns.
- I** Do not leave the engine running in an area with snow build-up, or where it is snowing. If snowbanks build up around the vehicle while the engine is running, exhaust gases may collect and enter the vehicle. This may lead to death or a serious health hazard.

n Exhaust gases

Exhaust gases include harmful carbon monoxide (CO) that is colorless and odorless. Inhaling exhaust gases may lead to death or a serious health hazard.

- I** If the vehicle is in a poorly ventilated area, stop the engine. In a closed area, such as a garage, exhaust gases may collect and enter the vehicle. This may lead to death or a serious health hazard.
- I** The exhaust should be checked occasionally. If there is a hole or crack caused by corrosion, damage to a joint or abnormal exhaust noise, be sure to have the vehicle inspected and repaired by your Toyota dealer. Failure to do so may allow exhaust gases to enter the vehicle, resulting in death or a serious health hazard.

n When taking a nap in the vehicle

Always turn the engine off. Otherwise, you may accidentally move the shift lever or depress the accelerator pedal, which could cause an accident or fire due to engine overheating. Additionally, if the vehicle is parked in a poorly ventilated area, exhaust gases may collect and enter the vehicle, leading to death or a serious health hazard.

n When braking the vehicle

- I** When the brakes are wet, drive more cautiously.
Braking distance increases when the brakes are wet, and may cause one side of the vehicle to brake differently than the other side. Also the parking brake may not securely hold the vehicle.

 **CAUTION**

n When braking the vehicle

- i** If the power brake assist function does not operate, do not follow other vehicles closely and avoid downhills or sharp turns that require braking. In this case, braking is still possible, but it will require more force on the pedal than usual. Braking distance may also increase.
- i** Do not pump the brake pedal if the engine stalls. Each push on the brake pedal uses up the reserve for the power-assisted brakes.
- i** The brake system consists of 2 individual hydraulic systems: If one of the systems fails, the other will still operate. In this case, the brake pedal should be depressed more firmly than usual and braking distance becomes longer. Do not drive your vehicle with only a single brake system. Have your brakes fixed immediately.

 **NOTICE**

n When driving the vehicle

Do not use the accelerator pedal or depress accelerator and brake pedals together to hold the vehicle on a hill.

n When parking the vehicle

Always put the shift lever in P.

Failure to do so may cause the vehicle to move or the vehicle may accelerate suddenly if the accelerator pedal is accidentally depressed.

n Avoiding damage to vehicle parts

- i** Do not turn the steering wheel fully in either direction and hold it there for a long time. Doing so may damage the power steering pump.
- i** When driving over bumps in the road, drive as slowly as possible to avoid damaging the wheels, underside of the vehicle, etc.

 NOTICE

n If you hear a squealing or scraping noise while driving (brake pad wear limit indicators)

Have the brake pads checked and replaced by your Toyota dealer as soon as possible.

The rotor damage can result if the pads are not replaced when needed.

It is dangerous to drive the vehicle when the wear limits of the brake pads and/or that of the brake discs are exceeded.

n If you get a flat tire while driving

A flat or damaged tire may cause the following situations. Hold the steering wheel firmly and gradually press the brake pedal to slow down the vehicle.

- ! It may be difficult to control your vehicle.
- ! The vehicle will make abnormal sounds.
- ! The vehicle will behave abnormally.

Replace a flat tire with a new one. (→P. 448)

n When encountering flooded roads

Do not drive on a road that has flooded after heavy rain etc. Doing so may cause the following serious damage to the vehicle.

- ! Engine stalling
- ! Short in electrical components
- ! Engine damage caused by water immersion

In the event that you drive on a flooded road and the vehicle is flooded, be sure to have your Toyota dealer check the following.

- ! Brake function
- ! Changes in quantity and quality of oil and fluid used for the engine, transmission, transfer (4WD models), differentials, etc.
- ! Lubricant condition for the propeller shaft, bearings and suspension joints (where possible) and the function of all joints, bearings, etc.

Engine (ignition) switch

n Engine switch

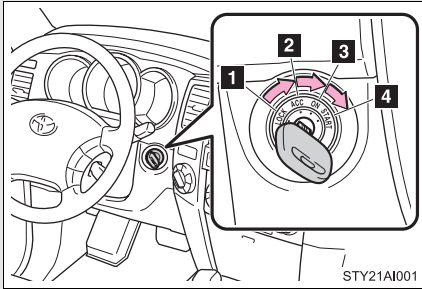

1 LOCK

The steering wheel is locked and the key can be removed. (The key can be removed only when the shift lever is in P.)

2 ACC

Some electrical components such as the audio system can be used.

3 ON

All electrical components can be used.

4 START

For starting the engine.

n Starting the engine

STEP 1 Check that the parking brake is set.

STEP 2 Check that the shift lever is set in P.

STEP 3 Sit in the driver's seat and firmly depress the brake pedal.

STEP 4 Turn the engine switch to the START position and start the engine.

The engine will crank until it starts or for up to 25 seconds, whichever is less. If you turn the engine switch, the engine will keep cranking for about 30 seconds maximum.

Continue depressing the brake pedal until the engine is completely started.

n Turning the key from ACC to LOCK

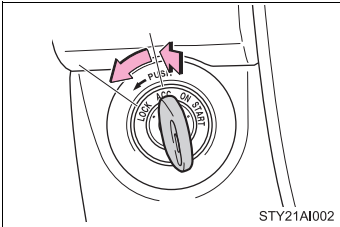

STEP 1 Shift the shift lever to P.
(→P. 143)

STEP 2 Push in the key and turn to the LOCK position.

n Steering lock release

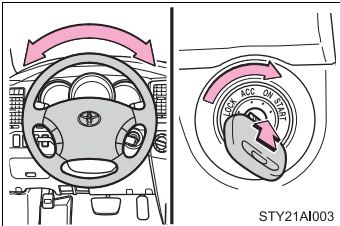

When starting the engine, the engine switch may seem stuck in the LOCK position. To free it, turn the key while turning the steering wheel slightly in either direction.

n If the engine does not start

The engine immobilizer system may not have been deactivated. (→P. 88)

n Key reminder function

A buzzer sounds if the driver's door is opened, while the engine switch is in the ACC or LOCK position to remind you to remove the key.

⚠ CAUTION

n When starting the engine

Always start the engine while sitting in the driver's seat. Do not depress the accelerator while starting the engine under any circumstances. Doing so may cause an accident resulting in death or serious injury.

 CAUTION

n Caution while driving

Do not turn the engine switch to the LOCK position.

If in an emergency, you must turn the engine off while the vehicle is moving, turn the engine switch only to the ACC position.

 NOTICE

n To prevent battery discharge

Do not leave the engine switch in the ACC or ON position for long periods if the engine is not running.

n When starting the engine

I Do not crank for more than 30 seconds at a time. This may overheat the starter and wiring systems.

I Do not race a cold engine.

I If the engine becomes difficult to start or stalls frequently, have the engine checked immediately.

2-1. Driving procedures

Automatic Transmission

Select a shift position appropriate for the driving conditions.

n Shifting the shift lever

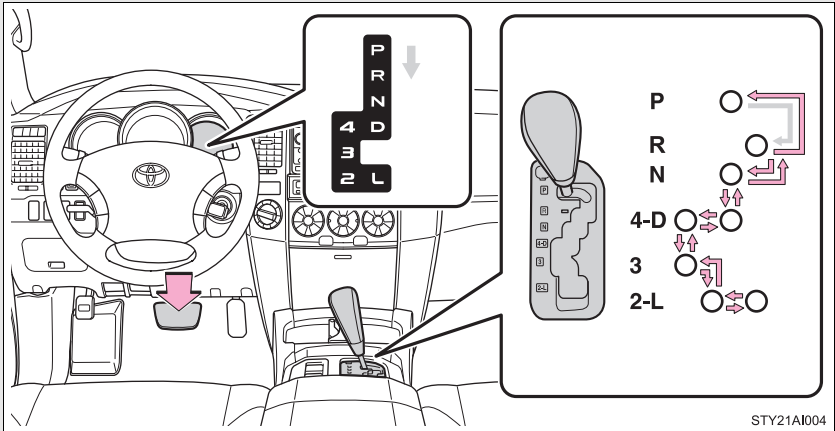

← While the engine switch is on, depress the brake pedal and move the shift lever.

n Shift position uses

Shift position	Function
P	Parking the vehicle or starting the engine
R	Reversing
N	Neutral
D	Normal driving*
4	Position for engine braking
3, 2	Position for more powerful engine braking
L	Position for maximum engine braking

*: To improve fuel consumption and reduce noises, set the shift lever in D for normal driving.

▮ Downshifting restrictions

The shift lever cannot be downshifted if the following speeds are exceeded.

▶ 2WD models

mph (km/h)

Downshifting	Maximum speed	
	4.0 L V6 (1GR-FE) engine	4.7 L V8 (2UZ-FE) engine
4 → 3	82 (133)	86 (139)
3 → 2	55 (90)	58 (94)
2 → L	24 (39)	25 (40)

▶ 4WD models

mph (km/h)

Downshifting	Transfer position	Maximum speed	
		4.0 L V6 (1GR-FE) engine	4.7 L V8 (2UZ-FE) engine
4 → 3	H2 and H4	82 (133)	86 (139)
	L4	31 (51)	34 (54)
3 → 2	H2 and H4	55 (90)	58 (94)
	L4	21 (35)	22 (36)
2 → L	H2 and H4	24 (39)	25 (40)
	L4	9 (15)	9 (15)

▮ When driving with the cruise control system

The engine brake will not operate when downshifting from D to 4.(→P. 166)

▮ If the shift lever cannot be shifted from P (→P. 457)

Turn signal lever

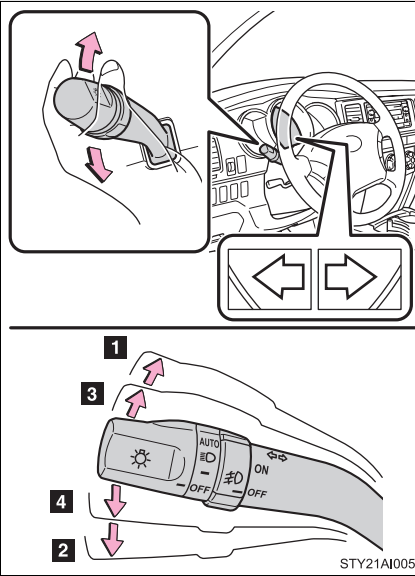

1 Right turn

2 Left turn

3 Move and hold the lever partway to signal a lane change.

The right hand signal will flash until you release the lever.

4 Move and hold the lever partway to signal a lane change.

The left hand signal will flash until you release the lever.

n Turn signals can be operated when

The engine switch is in the ON position.

n If the indicators flash faster than usual

Check that a light bulb in the front or rear turn signal lights has not burned out.

Parking brake

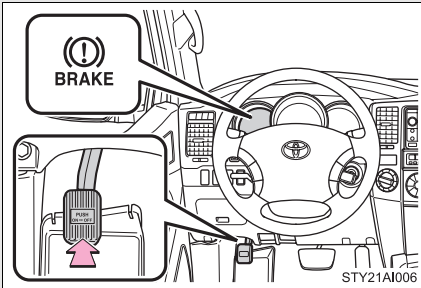

Set the parking brake*.
(Depressing the pedal again releases the parking brake.)

At this time, the indicator will come on.

*: Fully depress the parking brake pedal with your left foot while depressing the brake pedal with your right foot.

n Parking brake engaged warning buzzer

The buzzer sounds to indicate that parking brake is still engaged (with the vehicle having reached a speed of 3 mph [5 km/h]).

NOTICE

n Before driving

Fully release the parking brake.

Driving the vehicle with the parking brake set will lead to brake components overheating, which may affect braking performance and increase brake wear.

Horn

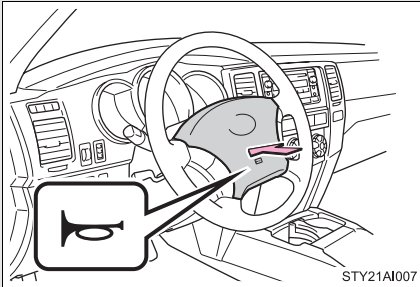

To sound the horn, press on or close to the  mark.

n **After adjusting the steering wheel**

Make sure that the steering wheel is securely locked.

The horn may not sound if the steering wheel is not securely locked.

(→P. 69)

2-2. Instrument cluster

Gauges and meters

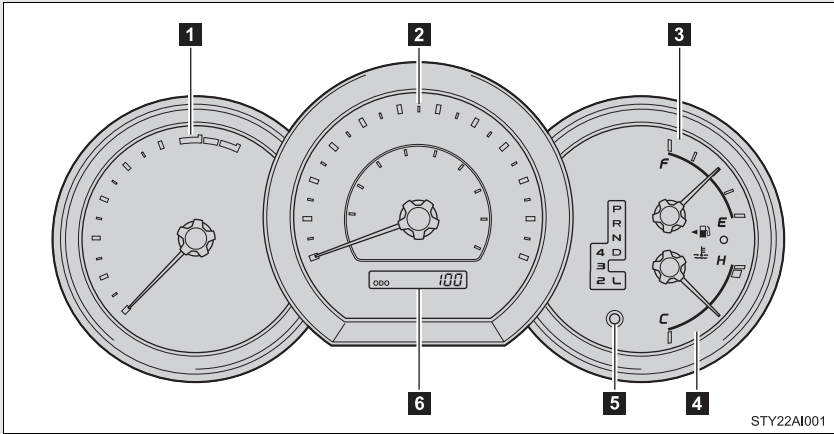

STY22AI001

The following gauges, meters and displays illuminate when the engine switch is in the ON position.

1 Tachometer

Displays the engine speed in revolutions per minute.

2 Speedometer

Displays the vehicle speed.

3 Fuel gauge

Displays the quantity of fuel remaining in the tank.

4 Engine coolant temperature gauge

Displays the engine coolant temperature.

5 Odometer/trip meter switching and trip meter resetting button

Switches between odometer and trip meter displays. Pushing and holding the button will reset the trip meter when the trip meter is being displayed.

6 Odometer/trip meter

Odometer:

Displays the total distance the vehicle has been driven.

Trip meter:

Displays the distance the vehicle has been driven since the meter was last reset. Trip meters A and B can be used to record and display different distances independently.

Odometer and trip meter display button

Pressing this button switches between odometer and trip meter displays.

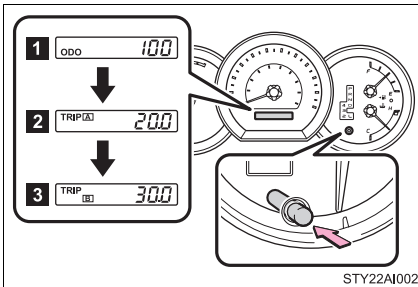

1 Odometer

2 Trip meter A*

3 Trip meter B*

*:Pushing and holding the button will reset the trip meter.

Instrument panel light control

The brightness of the instrument panel lights can be adjusted.

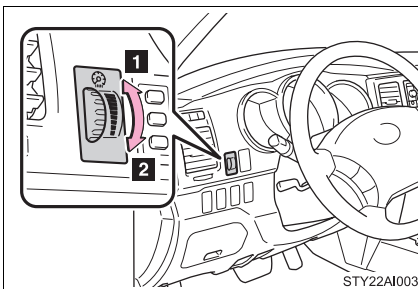

1 Brighter

2 Darker

 NOTICE

n To prevent damage to the engine and its components

- l** Do not let the indicator needle of the tachometer enter the red zone, which indicates the maximum engine speed.
- l** The engine may be overheating if the temperature gauge is in the red zone (H). In this case, immediately stop the vehicle in a safe place, and check the engine after it has cooled completely. (→P. 463)

Indicators and warning lights

The indicator and warning lights on the instrument cluster and center panel inform the driver of the status of the vehicle's various systems.

► Instrument cluster (type A)

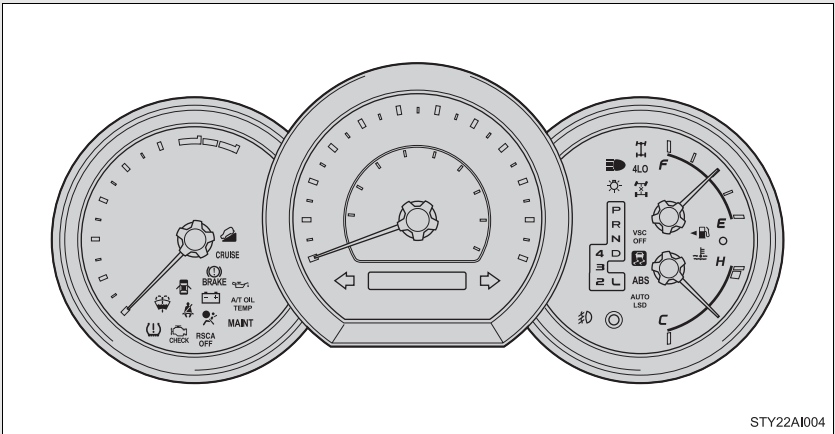

► Instrument cluster (type B)

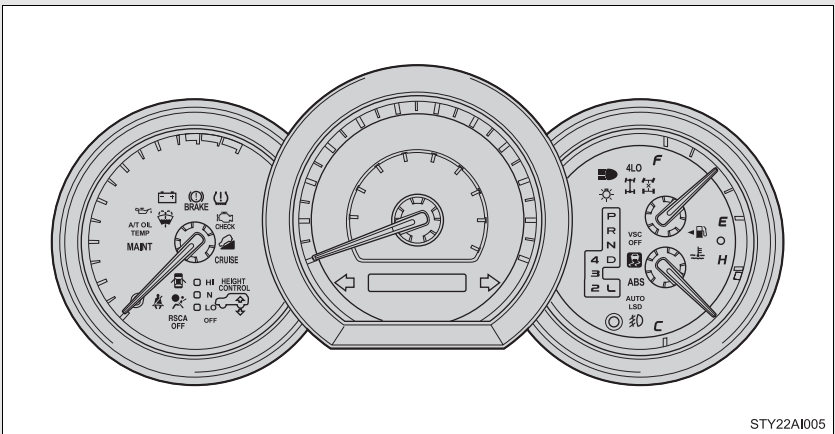

► Instrument cluster (type C)

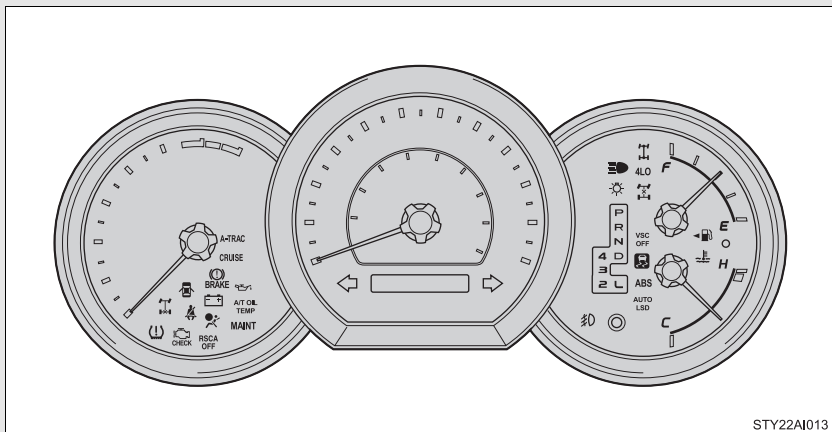

► Center panel

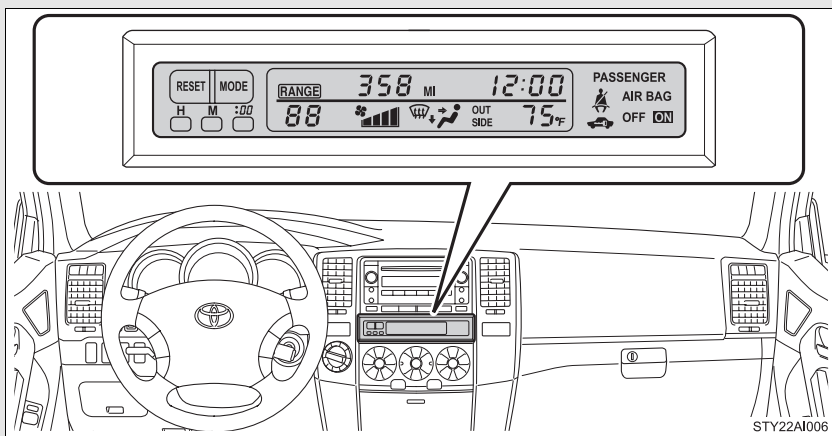

n Indicators

The indicators inform the driver of the operating state of the vehicle's various systems.



Turn signal indicator
(→P. 145)



Headlight high beam indicator (→P. 159)



(U.S.A.)

Headlight indicator
(→P. 158)



(Canada)

Tail light indicator
(→P. 158)



(if equipped)

Front fog light indicator
(→P. 162)



Security indicator
(→P. 88)

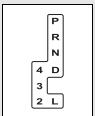

Shift position and shift range indicators
(→P. 143)



Cruise control indicator
(→P. 166)



*

Slip indicator
(→P. 175, 183, 189)



*

VSC OFF indicator
(→P. 179, 191)



(if equipped)

Active traction control indicator (→P. 182)



*

AUTO LSD indicator
(→P. 175, 190)



(if equipped)

Four-wheel drive indicator (→P. 177)



(4WD models)

Center differential lock indicator (→P. 179)



(4WD models)

4LO indicator (→P. 177)



(if equipped)

Rear differential lock indicator (→P. 184)



*

(if equipped)

Downhill assist control indicator (→P. 186)

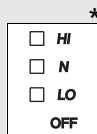

Height control indicators
(→P. 169)



AIR BAG ON indicator
(→P. 108)



RSCA OFF indicator
(→P. 107)



AIR BAG OFF indicator
(→P. 108)

n Warning lights

Warning lights inform the driver of malfunctions in any of the vehicle's systems. (→P. 436)

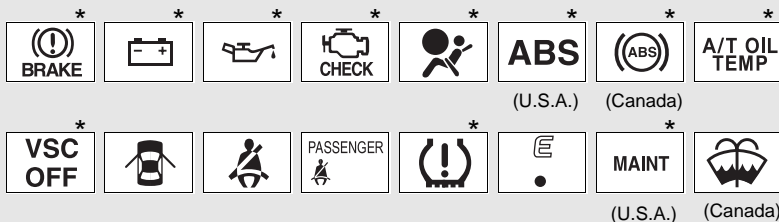

*: These lights turn on when the engine switch is turned to the ON position to indicate that a system check is being performed. They will turn off after the engine is started, or after a few seconds. There may be a malfunction in a system if a light does not come on, or if the lights do not turn off. Have the vehicle inspected by your Toyota dealer.

⚠ CAUTION

n If a safety system warning light does not come on

Should a safety system light such as ABS and the SRS airbag warning light not come on when you start the engine, this could mean that these systems are not available to help protect you in an accident, which could result in death or serious injury. Have the vehicle inspected by your Toyota dealer immediately if this occurs.

2-2. Instrument cluster Accessory meter

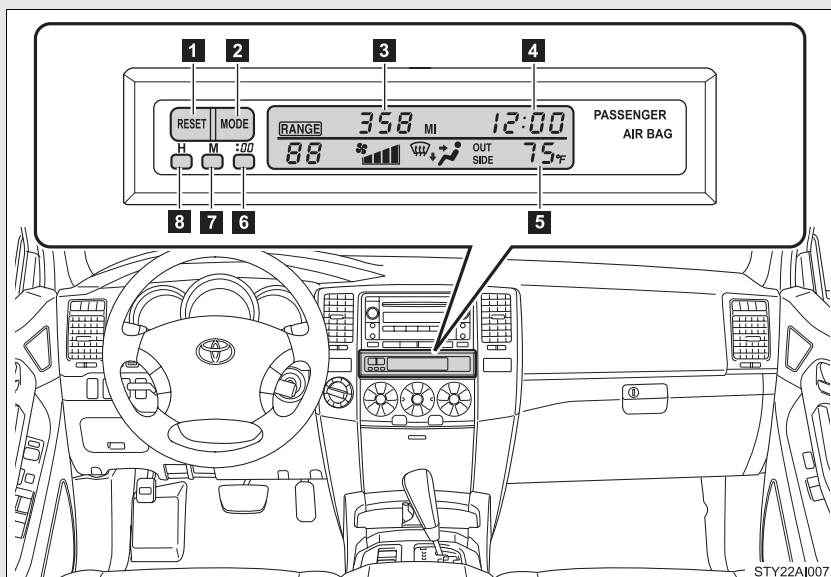

- 1** RESET button
- 2** MODE button
- 3** Trip information display (air conditioning system without DUAL button)
Displays the trip information. (→P. 156)
Outside temperature and trip information display (air conditioning system with DUAL button)
Displays the outside temperature and trip information. (→P. 156, 326)
- 4** Clock
(→P. 325)
- 5** Outside temperature display (air conditioning system without DUAL button)
Displays the outside air temperature. (→P. 326)
- 6** :00 button (→P. 325)
- 7** M (Minute) button (→P. 325)
- 8** H (Hour) button (→P. 325)

Outside temperature and trip information display (if equipped)

Every time the MODE button is pushed, the display toggles through these information.

1 OUTSIDE (outside temperature display)

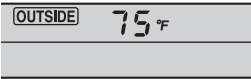

Displays the outside air temperature.

The temperature range that can be displayed is from -22°F (-30°C) to 122 °F (50°C).

1 RANGE (driving range)

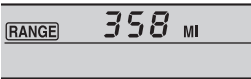

Displays the estimated maximum distance that can be driven with the quantity of fuel remaining.

- The distance is computed based on your average fuel consumption. As a result, the actual distance that can be driven may differ from that displayed.
- When only a small amount of fuel is added to the tank, the display may not be updated.

1 AVG. (average fuel consumption)



Displays the average fuel consumption since the engine was started or since the function was reset.

The function can be reset by pressing the RESET button for longer than 1 second when the average fuel consumption is displayed.

1 AVG. (average vehicle speed)

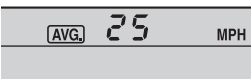

Displays the average vehicle speed since the engine was started or since the function was reset.

The function can be reset by pressing the RESET button for longer than 1 second when the average vehicle speed is displayed.

1 Display off

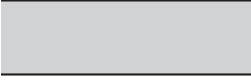

CAUTION

n Caution while driving

Do not adjust the display.

Doing so may cause the driver to mishandle the vehicle and cause an accident, resulting in death or serious injury.

2-3. Operating the lights and wipers

Headlight switch

The headlights can be operated manually or automatically.

► Vehicles without automatic light control system

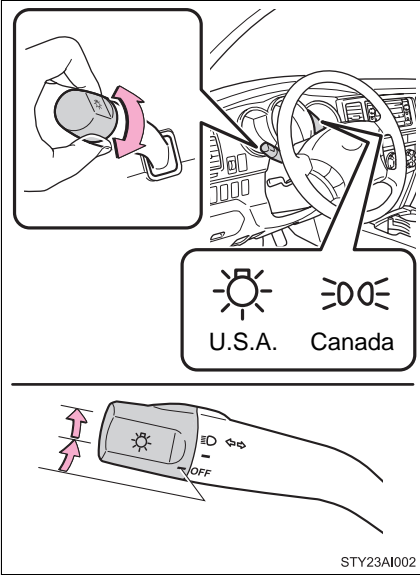

— The side marker, parking, tail, license plate and instrument panel lights turn on.

☰ The headlights and all lights listed above turn on.

► Vehicles with automatic light control system

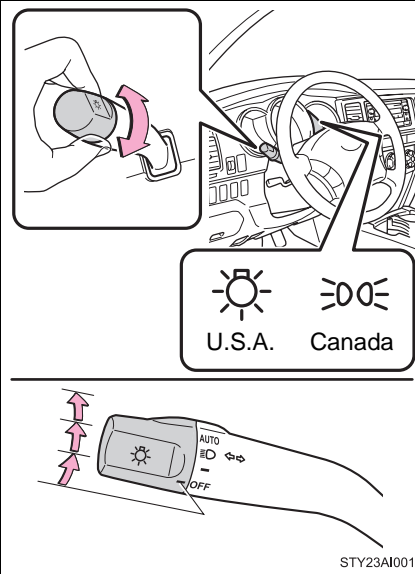

— The side marker, parking, tail, license plate and instrument panel lights turn on.

☰ The headlights and all lights listed above turn on.

AUTO The headlights and all lights listed above turn on and off automatically. (When the engine switch is in the ON position)

Turning on the high beam headlights

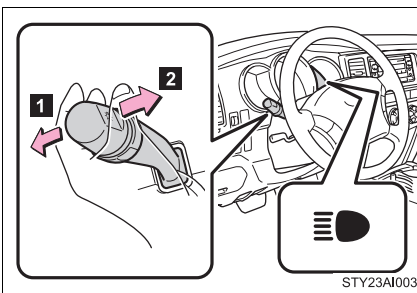

1 With the headlights on, push the lever forward to turn on the high beams.

Pull the lever back to the center position to turn the high beams off.

2 Pull the lever toward you to turn on the high beams.

Release the lever to turn them off. You can flash the high beams with the headlights on or off.

■ **Daytime running light system (if equipped)**

To make your vehicle more visible to other drivers, the headlights turn on automatically (at a reduced intensity) whenever the engine is started and the parking brake is released. Daytime running lights are not designed for use at night.

■ **Headlight control sensor**

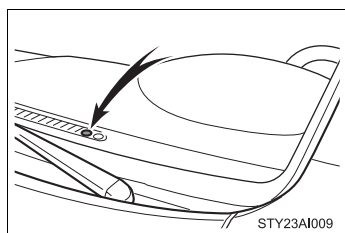

The sensor may not function properly if an object is placed on the sensor, or anything that blocks the sensor is affixed to the windshield.



Doing so interferes with the sensor detecting the level of ambient light and may cause the automatic headlight system to malfunction.

■ **Automatic light off system**

ℓ When the headlights come on: The headlights and tail lights turn off 30 seconds after all doors are closed with the engine switch turned to the ACC or LOCK position. (The lights turn off immediately if the LOCK button on the wireless remote control is pressed twice after all doors are locked.)

ℓ When only the tail lights come on: The tail lights turn off automatically with the engine switch turned to the ACC or LOCK position and the driver's door is opened.

If the driver's door is kept open, the lights automatically turn off after 30 minutes.

To turn the lights on again, turn the engine switch to the ON position, or turn the headlight switch off once and then back to the  or  position.

■ **Customization that can be configured at Toyota dealer**

Settings (e.g. light sensor sensitivity) can be changed.
(Customizable features →P. 495)



NOTICE

n To prevent battery discharge

Do not leave the lights on longer than necessary when the engine is not running.

2-3. Operating the lights and wipers

Fog light switch (if equipped)

The fog lights improve visibility in difficult driving conditions, such as in rain or fog. They can be turned on only when the headlights are on low beam.

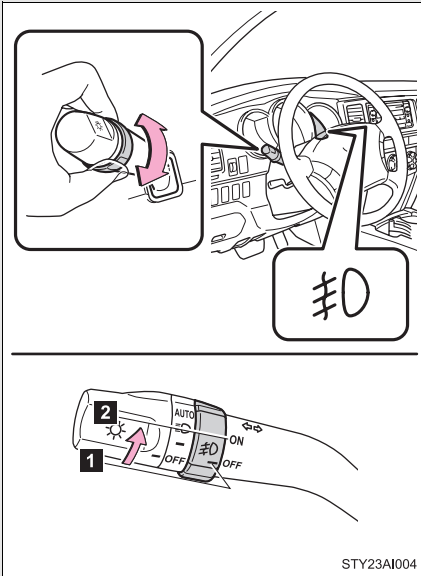

- 1 OFF
- 2 Front fog lights ON

2-3. Operating the lights and wipers Windshield wipers and washer

Wiper intervals can be adjusted for intermittent operation (when INT is selected.)

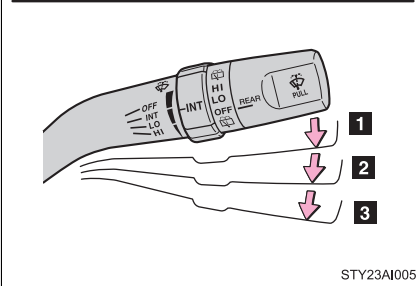
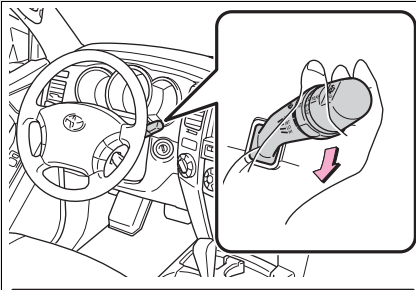

STY23AI005

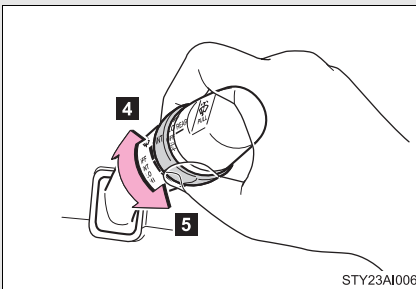

STY23AI006

1 Intermittent windshield wiper operation

2 Low speed windshield wiper operation

3 High speed windshield wiper operation

4 Decreases the intermittent windshield wiper frequency

5 Increases the intermittent windshield wiper frequency

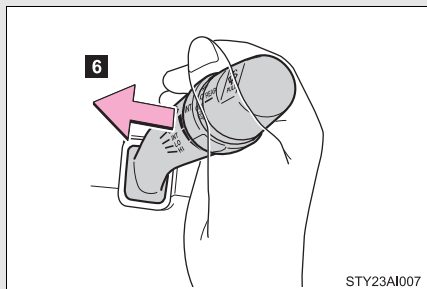

6 Washer/wiper dual operation

Wipers will automatically operate a couple of times after the washer squirts.

n The windshield wiper and washer can be operated when

The engine switch must be in the ON position.

n If no windshield washer fluid sprays

Check that the washer nozzles are not blocked and if there is washer fluid in the windshield washer fluid reservoir.

⚠ NOTICE

n When the windshield is dry

Do not use the wipers, as they may damage the windshield.

n When there is no washer fluid spray from the nozzle

Damage to the washer fluid pump may be caused if the lever is pulled toward you and held continually.

n When a nozzle becomes block

Do not try to clear it with a pin or other object. The nozzle will be damaged.

Rear window wiper and washer

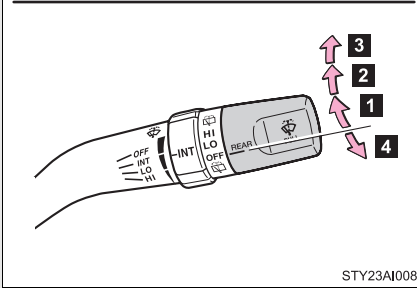
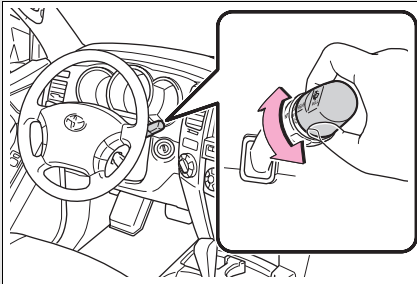

- 1 Intermittent window wiper operation.
- 2 Normal window wiper operation
- 3 Washer/wiper dual operation
- 4 Washer/wiper dual operation

The rear window wiper operates while the washer squirts.

n The rear window wiper and washer can be operated when

- 1 The engine switch must be in the ON position.
- 1 The back window is fully closed.

⚠ NOTICE

n When the rear window is dry

Do not use the wipers, as they may damage the rear window.

n When there is no washer fluid spray from the nozzle

Damage to the washer fluid pump may be caused if the knob is continuously twisted upward or downward as far as it will go.

2-4. Using other driving systems

Cruise control

Use cruise control to maintain a set speed without using the accelerator.

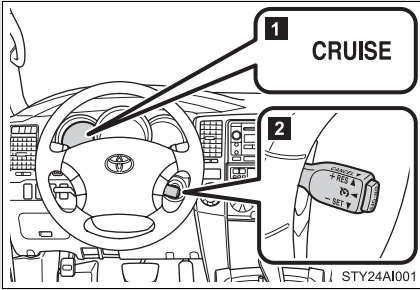

- 1 Indicator
- 2 Cruise control switch

n Set the vehicle speed

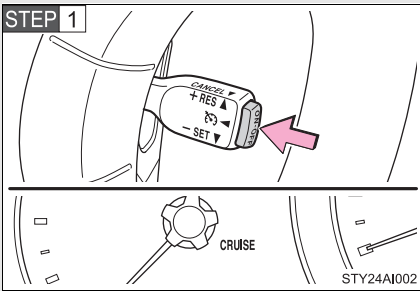

Press the ON-OFF button to turn the cruise control on.

At this time, the cruise control indicator will come on.

Press the button once more to deactivate the cruise control.

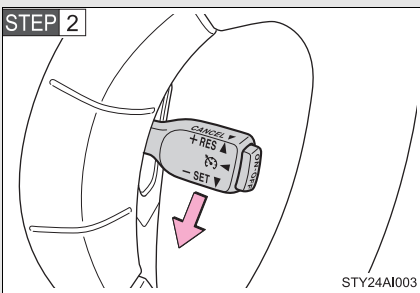

Accelerate or decelerate to the desired speed and push the lever down to set the cruise control speed.

n Adjusting the speed setting

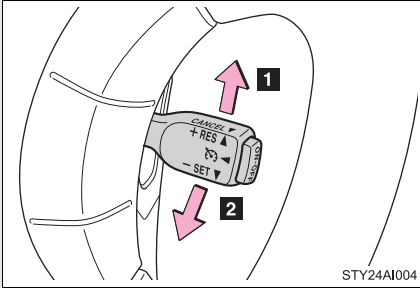

- 1** Increase speed
- 2** Decrease speed

Hold the lever until the desired speed setting is obtained.

Fine adjustment of the set speed (approximately 1.0 mph [1.6 km/h]) can be made by lightly pushing the lever up or down and releasing it.

n Canceling and resuming regular acceleration

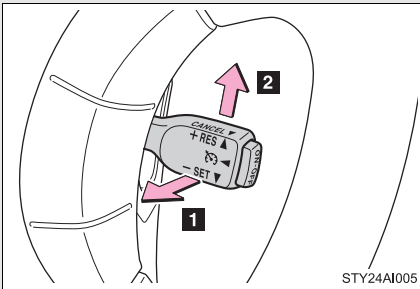

- 1** Cancel

Pull the lever towards you to cancel cruise control.

The speed setting is also canceled when the brakes are applied.

- 2** Resume

To resume cruise control and return to the set speed, push the lever up.

n Cruise control can be set when

- l The shift lever is in D or 4.
- l Vehicle speed is more than approximately 25 mph (40 km/h).

n Accelerating

The vehicle can be accelerated normally.

n Automatic cruise control cancellation

The set speed is automatically canceled in any of the following situations.

- l Actual vehicle speed falls more than 10 mph (16 km/h) below the preset vehicle speed.
At this time, the memorized set speed is not retained.
- l Actual vehicle speed is below 25 mph (40 km/h).
- l VSC is activated.

n If the cruise control indicator flashes

Press the ON-OFF button to turn the cruise control off, and then reactivate the system.

If the cruise control speed cannot be set or if the cruise control cancels immediately after being activated, there may be a malfunction in the cruise control system. Have the vehicle inspected by your Toyota dealer.

⚠ CAUTION

n To avoid operating the cruise control by mistake

Keep the ON-OFF button off when not in use.

n Situations unsuitable for cruise control

Do not use cruise control in any of the following situations.

Doing so may result in control of the vehicle being lost and could cause an accident resulting in death or serious injury.

- l In heavy traffic
- l On roads with sharp bends
- l On winding roads
- l On slippery roads, such as those covered with rain, ice or snow
- l On steep hills
- l When towing a trailer

The electronically modulated air suspension allows the driver to control the vehicle's height in order to adjust for driving conditions. Select the desired height with the height control switch.

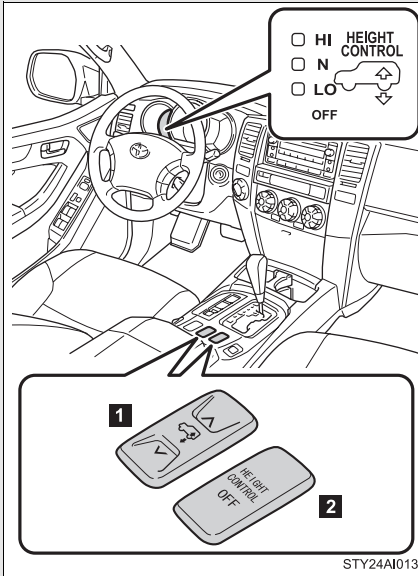

- 1 Height control switch
- 2 HEIGHT CONTROL OFF switch

Selecting vehicle height

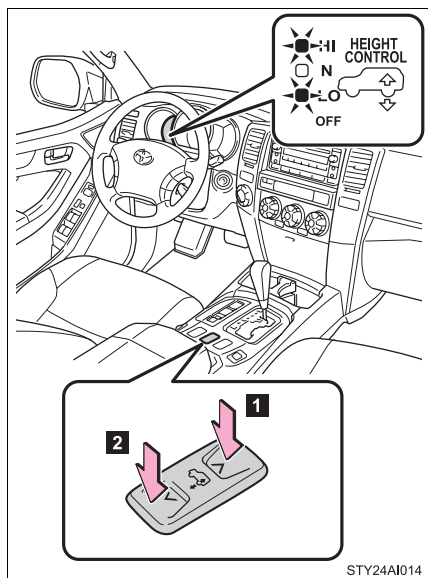

1 Higher

2 Lower

Vehicle height can be adjusted only when the engine is running. The height control indicator stops blinking, and comes on continuously to indicate that the mode shift is completed.

n Height modes

1 N mode (normal mode): For ordinary driving

Normal height

1 HI mode (high mode): For driving on bumpy roads and through water

1.6 in. (40 mm) higher than the normal height

The HI mode is unavailable when the vehicle's speed exceeds 18 mph (30 km/h).

When the vehicle's speed exceeds 18 mph (30 km/h), the height will be adjusted to the normal height automatically.

- 1 LO mode (low mode): For the ease of egress/ingress and loading luggage

0.8 in. (20 mm) lower than the normal height

The LO mode is unavailable when the vehicle's speed exceeds 8 mph (12 km/h).

When the vehicle's speed exceeds 8 mph (12 km/h), the height will be adjusted to the normal height automatically.

Disabling the height control

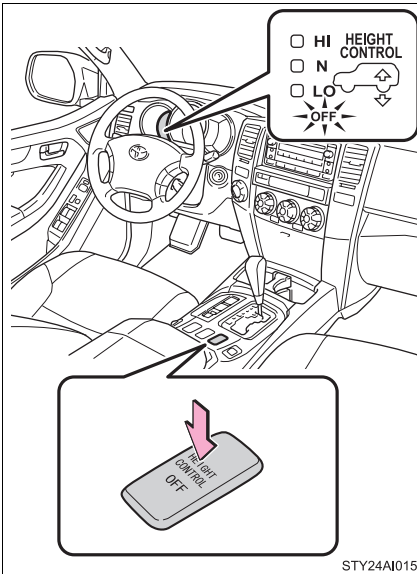

STY24AI015

When the HEIGHT CONTROL OFF switch is pressed, the vehicle height is fixed at the current height.

The height can be adjusted by pressing the HEIGHT CONTROL OFF switch again.

When the vehicle's speed exceeds 18 mph (30 km/h), the height will be adjusted to the normal height automatically.

■ **Automatic leveling function**

Regardless of the number of occupants or the luggage load, vehicle height in any mode is always adjusted to a fixed height by the automatic leveling function.

■ **When HI mode is selected**

The vehicle height will change to N mode when driving at the speeds of 18 mph (30 km/h).

■ **When LO mode is selected**

l The vehicle height will change to N mode when vehicle speed exceeds 7 mph (12 km/h).

l This mode allows for easy access to the vehicle (getting in and out) and easy loading and unloading.

■ **The electronically modulated air suspension will not operate in the following cases:**

l The underbody of the vehicle is touching the surface of the road.

l The area around the suspension is covered with ice.

The height control indicators will blink, turn off and then turn on continuously to indicate that the electronically modulated air suspension is not operational.

To re-enable operation, turn off the engine and then restart it.

■ **Even if you hear an operating noise**

This does not indicate a problem in the electronically modulated air suspension.

■ **If there is a problem somewhere in the electronically modulated air suspension**

The height control OFF indicator will behave as follows:

l The indicator will not come on when the engine switch is turned on.

l The indicator will blink.

Although the vehicle may be driven, have the vehicle inspected by your Toyota dealer.

 **CAUTION**

n The electronically modulated air suspension must be turned off in the following circumstances:

Otherwise, the automatic leveling function may cause the vehicle's height to change, resulting in an unexpected accident.

- I When driving through water such as shallow streams (Put the vehicle height in HI mode and turn off the electronically modulated air suspension. Drive at 18 mph [30 km/h] or slower.)
- I When jacking up the vehicle, installing tire chains or tying the vehicle with chains/wires for transportation via flat bed truck (Turn the system off and stop the engine.)
- I When the vehicle must be towed (Put the vehicle height in N mode and turn the system off.)
- I When the vehicle gets stuck (Turn the system off.)
- I When disconnecting a trailer (Put the vehicle height in LO mode and turn the system off.)

n Selecting the correct height mode

Observe the following precautions to prevent accidents.

Failure to do so may cause damage to parts of the vehicle, as well as dangerous handling characteristics, which may lead to fatal or injury accidents.

- I Before you lower the vehicle's height, check under the vehicle to make sure that no one is there.
- I The HI mode should be used for off-road driving conditions. As the vehicle's center of gravity is higher in this setting, the vehicle may become unstable when turning abruptly.
- I Do not select HI mode when you load cargo on the roof luggage carrier. This may result in a loss of control or vehicle rollover.

 NOTICE

n Be careful in any place where overhead space is limited.

When changing to a higher mode or after unloading, the vehicle height will rise. This may cause damage to the vehicle.

n Do not select LO mode when driving on bumpy roads.

If the underbody of the vehicle touches a rugged road surface, the vehicle may be damaged.

n Do not change the vehicle height frequently.

The compressor might overheat and cause the operation to stop.

n When on the extremely uneven roads with rocks

Sometimes the vehicle height is not adjusted because it is judged as uneven road driving.

The AUTO LSD system aids traction by using the traction control system to control engine performance and braking when one of the rear wheels begins to spin.

The system should be used only when one of the rear wheels spinning occurs in a ditch or rough surface.

n System operation

The system can be used on 2WD models and in 2WD mode on 4WD models.

The system is activated when driving at a speed under 62 mph (100 km/h).

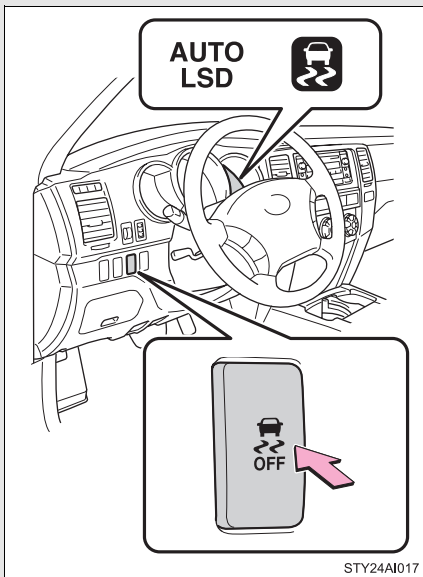

Press the VSC OFF switch to turn on the system.

At this time, the AUTO LSD and slip indicators will come on.

To turn off the system, push the switch again.

If the engine is turned off while the AUTO LSD and slip indicators are on and then restarted, the indicator will turn off automatically.

When the AUTO LSD system is operating

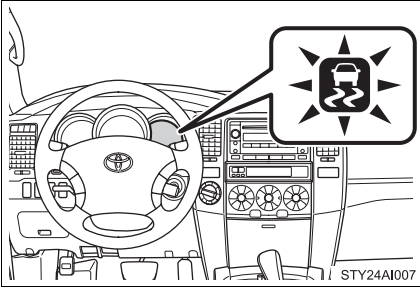

If the rear wheels spin, the slip indicator flashes to indicate that the AUTO LSD system has been controlled the spinning of the rear wheels.

n If the brake system overheats

The system will cease operation and a buzzer will sound to alert the driver. Stop the vehicle in a safe place. (There is no problem with continuing normal driving.)

⚠ CAUTION

n To avoid an accident

- ! Do not use the AUTO LSD system in conditions other than the above. A much greater steering effort and more careful cornering control will be required.
- ! Do not drive with the AUTO LSD system continuously turned on.

Four-wheel drive system (4WD models)

Use the four-wheel drive control switch and center differential lock switch to select the following transfer and center differential modes.

n Four-wheel drive control switch

► Multi-mode 4WD models

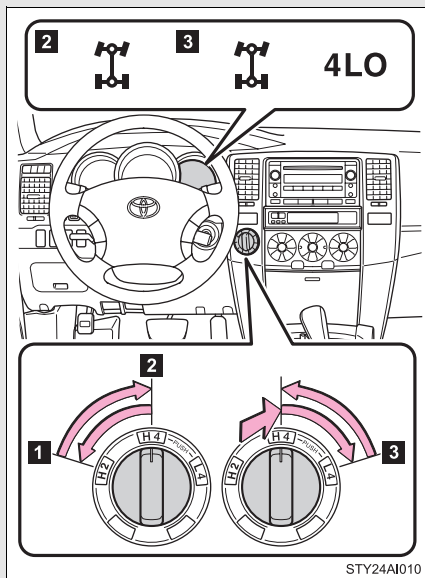

1 H2 (high speed position, two-wheel drive)

Normal driving

2 H4 (high speed position, four-wheel drive)

Greater traction than two wheel drive.

When you experience a loss of power, such as wheel slipping.

The four-wheel drive indicator will come on.

3 L4 (low speed position, four-wheel drive)

Driving requiring maximum power and traction such as climbing or descending steep hills, off-road driving, and hard pulling in sand or mud, etc.

The four-wheel drive and 4LO indicators will come on.

► Full-time 4WD models

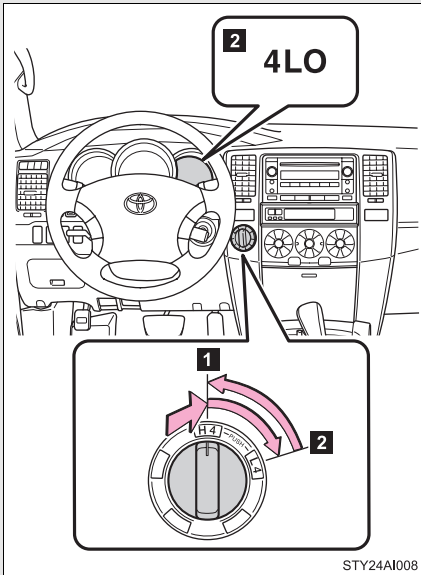

1 H4 (high speed position)

Normal driving on all types of roads.

2 L4 (low speed position)

Driving requiring maximum power and traction such as climbing or descending steep hills, off-road driving, and hard pulling in sand or mud, etc.

The 4LO indicator will come on.

n Center differential lock switch

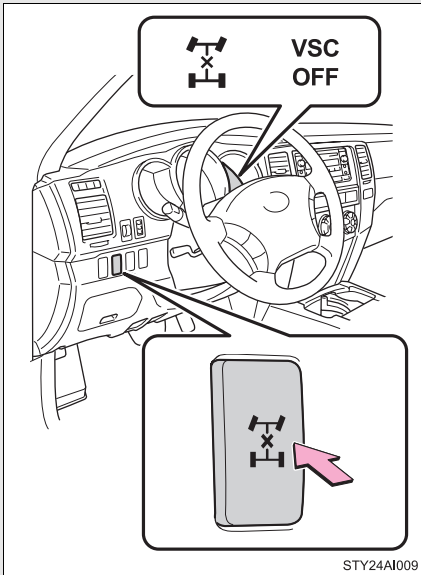

Use the center differential lock system when the wheels get stuck in a ditch, or when driving on a slippery or bumpy surface.

Unlock the center differential after the wheels have been freed, or after moving to a flat, non-slippery surface.

To unlock the center differential, push the switch again.

Shifting between H4 and L4

n Shifting from H4 to L4

STEP 1 Stop the vehicle completely.

STEP 2 Shift the shift lever to N.

STEP 3 Push and turn the four-wheel drive control switch fully clockwise.

Maintain this condition until the 4LO indicator turns on.

n Shifting from L4 to H4

STEP 1 Stop the vehicle completely.

STEP 2 Shift the shift lever to N.

STEP 3 Turn the four-wheel drive control switch counterclockwise.

Maintain this condition until the 4LO indicator turns off.

n Shifting between H2 and H4

l Shifting from H2 to H4

Reduce the vehicle speed to less than 62 mph (100 km/h) and turn the four-wheel drive control switch fully clockwise.

l Shifting from H4 to H2

Turn the four-wheel drive control switch fully counterclockwise. This can be done at any speed.

n If the four-wheel drive indicator or the 4LO indicator blinks

l Shifting from H2 to H4

- If the four-wheel drive indicator continues to blink, drive straight ahead while accelerating or decelerating.
- If the four-wheel drive indicator continues to blink and the buzzer sounds, stop the vehicle or reduce the vehicle speed to less than 62 mph (100 km/h). Operate the switch again.

l Shifting from H4 to H2

- If the four-wheel drive indicator continues to blink, drive straight ahead while accelerating or decelerating, or drive forward or backward in a short distance.

l Shifting to H4 or L4

If the 4LO indicator continues to blink when you operate the four-wheel drive control switch to the H4 or L4 position, drive forward or backward in a short distance, then stop the vehicle completely, shift the shift lever securely into N and operate the switch again.

If the indicators continue to blink even if doing so, contact your Toyota dealer as soon as possible. There may be a trouble in the four-wheel drive system.

n Four-wheel drive usage frequency (Multi-mode 4WD models)

You should drive in four-wheel drive for at least 10 miles (16 km) each month.

This will assure that the front drive components are lubricated.

n **Limited slip center differential**

If one wheel begins to spin, the limited slip center differential (transfer) is designed to aid traction by automatically transmitting driving force to the wheels on the other drive axle. It transmits driving force to the front wheels if a rear wheel spins, and to the rear wheels if a front wheel spins.

n **The center differential lock switch can be operated when**

The four-wheel drive control switch is in the H4 or L4 position.

n **Center differential lock system**

- l When the center differential is locked, the VSC system is automatically turned off and the center differential lock and VSC OFF indicators come on.
- l When the four-wheel drive control switch is turned to the H2 position, the center differential is automatically unlocked.
- l If the operation is not completed, the center differential lock indicator blinks. If the indicator does not go off when unlocking the center differential, drive straight ahead while accelerating or decelerating, or drive in reverse.



NOTICE

n **When shifting the four-wheel drive control switch**

Never operate the four-wheel drive control switch if the wheels are slipping. Stop the slipping or spinning before shifting.

n **To prevent damage to the center differential**

- l For normal driving on dry and hard surface roads, unlock the center differential.
- l Unlock the center differential after the wheels are out of the ditch or off the loose or bumpy surface.
- l Do not push the center differential lock switch when the vehicle is cornering or when its wheels are spinning freely off the ground.

The active traction control system automatically helps prevent the spinning of 4 wheels when the vehicle is started or accelerated on slippery road surfaces.

n System operation

▶ Vehicles without the A-TRAC switch

Stop the vehicle, shift the shift lever to N and turn the four-wheel drive control switch to the L4 position. Then the system will automatically activate.

▶ Vehicles with the A-TRAC switch

1 When activating the system with the center differential lock unlocked

Stop the vehicle, shift the shift lever to N and turn the four-wheel drive control switch to the L4 position. Then the system will automatically activate.

1 When activating the system with the center differential lock locked

STEP 1 Stop the vehicle, shift the shift lever to N and turn the four-wheel drive control switch to the L4 position. Then press the center differential lock switch.

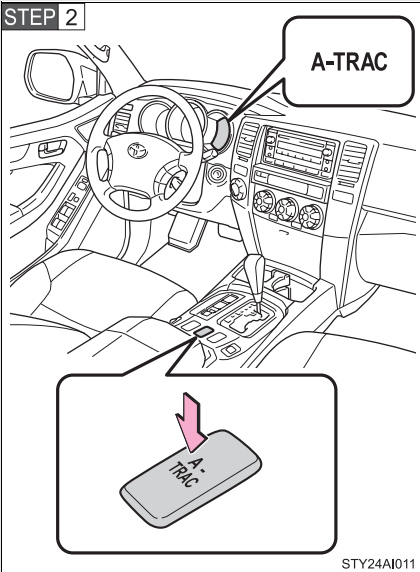

Press the A-TRAC switch to activate the system.

At this time, the active traction control indicator will come on.

To cancel the system, push the switch again.

When the active traction control system is operating

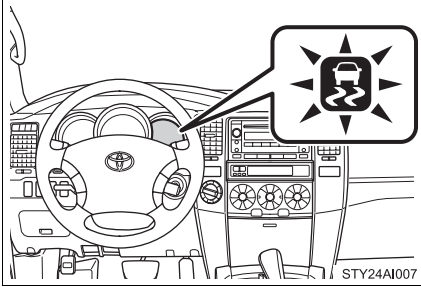

If all wheels spin, the slip indicator flashes to indicate that the active traction control system have been engaged.

n **When the rear differential is locked (vehicles with the rear differential lock system)**

The active traction control system is activated only when the vehicle speed is less than 4 mph (6 km/h).

n **Sounds and vibrations caused by the active traction control system**

l A sound may be heard from the engine compartment when the engine is started or just after the vehicle begins to move. This sound does not indicate that a malfunction has occurred in the system.

l Vibrations may be felt through the vehicle body and steering. It may occur when the system is operating.

n **If the brake system overheats**

The system will cease operation and a buzzer will sound to alert the driver. Stop the vehicle in a safe place. (There is no problem with continuing normal driving.)

CAUTION

n **The active traction control system may not operate effectively when**

Directional control and power may not be achievable while driving on slippery road surfaces, even if the active traction control system is operating.

Do not drive the vehicle in conditions where stability and power may be lost.

2-4. Using other driving systems

Rear differential lock system (if equipped)

The rear differential lock system is provided for use only when wheel spinning occurs in a ditch or on a slippery or rugged surface.

The rear differential lock system is effective in case one of the rear wheels is spinning.

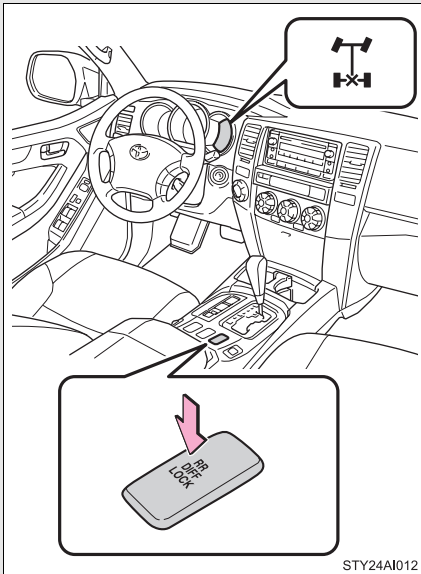

Press the RR DIFF LOCK switch to lock the rear differential.

At this time, the rear differential lock indicator will blink. Wait a few seconds for the system to complete operation. After the rear differential is locked, the indicator will stop blinking and remain on.

To unlock the rear differential, push the switch again.

Using the rear differential lock system

STEP 1 Before using the rear differential lock system.

Stop the vehicle, shift the shift lever to N and turn the four-wheel drive control switch to the L4 position to see if this is sufficient. If this has no effect, additionally use the rear differential lock system.

STEP 2 Be sure to stop the wheels.

STEP 3 Press the RR DIFF LOCK switch.

After the rear differential is locked, the rear differential lock indicator will come on.

STEP 4 Gently depress the accelerator pedal.

Unlock the rear differential as soon as the vehicle moves out.
To unlock the rear differential, push the switch again.

n **Locking the rear differential**

- l When the rear differential is locked, VSC is automatically turned off. (The rear differential lock and VSC OFF indicators come on.)
- l The following systems do not operate when the rear differential is locked. It is normal operation for the ABS warning light, VSC OFF indicator and slip indicator to be on at this time.
 - ABS
 - Brake assist system
 - VSC
 - TRAC

n **The rear differential lock is disengaged when**

- l Turn the four-wheel drive control switch to the H2 or H4 position.
Never forget to turn off the switch after using this feature.

n **After unlocking the rear differential**

- l Check that the indicator goes off.

CAUTION

n **To avoid an accident**

- l Do not use the rear differential lock system except when wheel spinning occurs in a ditch or on a slippery or ragged surface. Large steering effort and careful cornering control will be required.
- l Do not lock the rear differential until the wheels have stopped spinning. Otherwise, the vehicle may move in an unexpected direction when the differential lock is engaged, resulting in an accident. This may also lead to possible damage to rear differential lock component parts.
- l Do not drive over 5 mph (8 km/h) when the rear differential is locked.
- l Do not keep driving with the RR DIFF LOCK switch on.

Downhill Assist Control (if equipped)

The downhill assist control system helps to prevent excessive speed on steep downhill descents.

n System operation

The system will operate when the vehicle is traveling under 15 mph (25 km/h) and the four-wheel drive control switch is in the L4 position.

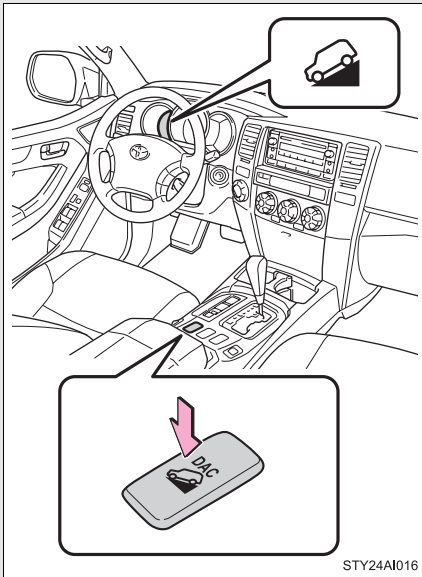

Press the DAC switch. The downhill assist control indicator will come on, and the system will operate.

With the vehicle traveling at a speed of 15 mph (25 km/h) or less, release your foot from the accelerator or brake pedal to activate the system.

When the system is in operation, the slip indicator will flash, and the stop lights/high mounted stop light will come on. A sound may also occur during the operation. This does not indicate a malfunction.

n Turning off the system

Press the DAC switch while the system is in operation. The downhill assist control indicator will flash as the system gradually ceases operation, and will turn off when the system is fully off.

Pressing the DAC switch while the downhill assist control indicator is flashing will start the system again.

n **Operating tips**

The system will operate when the shift lever is in a position other than P. However, to make effective use of the system it is recommended that the shift lever be shifted to 2 or L.

n **The system will not operate when**

The four-wheel drive control switch is in the H2 or H4 position.

n **The downhill assist control indicator flashes when**

l The shift lever is in N.

l The four-wheel drive control switch is in the H2 or H4 position.

n **If the brake system overheats**

The system will cease operation and a buzzer will sound to alert the driver. Stop the vehicle in a safe place. (There is no problem with continuing normal driving.)

n **System malfunction**

l The downhill assist control indicator does not come on when the engine switch is turned to the ON position.

l The downhill assist control indicator does not come on when the DAC switch is pressed.

In the above cases have your vehicle checked by your Toyota dealer.

CAUTION

n **Do not rely excessively on the downhill assist control system**

It may not be able to maintain a low speed over road surfaces on which sliding can easily occur, such as extremely steep slopes or icy or muddy roads.

Driving assist systems

To help enhance driving safety and performance, the following systems operate automatically in response to various driving situations. Be aware, however, that these systems are supplementary and should not be relied upon too heavily when operating the vehicle.

n ABS (Anti-lock Brake System)

Helps to prevent wheel lock when the brakes are applied suddenly, or if the brakes are applied while driving on a slippery road surface.

n Brake Assist

Generates an increased level of braking force after the brake pedal is depressed, when the system detects a panic stop situation.

n VSC (Vehicle Stability Control)

Helps the driver to control skidding when swerving suddenly or turning on slippery road surfaces.

n TRAC (Traction Control)

Maintains drive power and prevents the rear wheels (2WD models and H2 mode on Multi-mode 4WD models) or all wheels (4WD models except on L4 mode) from spinning when starting the vehicle or accelerating on slippery roads.

n A-TRAC (Active Traction Control) for L4 mode on 4WD models (vehicles with the A-TRAC switch except when the center differential lock is locked)

Maintains drive power and prevents the all wheels from spinning when starting the vehicle or accelerating on slippery roads.

n Hill-start assist control (if equipped)

Helps prevent the vehicle from rolling backwards when starting on an incline or slippery slope. It operates for approximately 5 seconds at maximum.

When the VSC/TRAC/A-TRAC/hill-start assist control system are operating

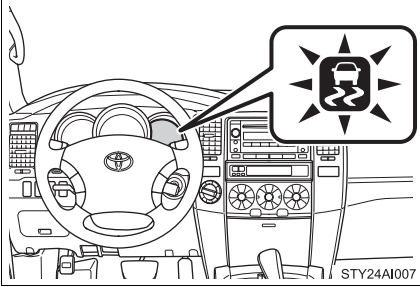

If the vehicle is in danger of slipping, the rear wheels (2WD models) or four wheels (4WD models) spin, the vehicle starts to roll backwards when starting on an incline, the slip indicator flashes to indicate that the VSC/TRAC/A-TRAC/hill-start assist control have been engaged.

A buzzer (intermittent) sounds to indicate that VSC/hill-start assist control is operating.

The stop lights and high mounted stoplight turn on when the hill-start assist control system is operating.

To disable TRAC, AUTO LSD and/or VSC (2WD models and H2 mode on Multi-mode 4WD models)

If the vehicle gets stuck in fresh snow or mud, TRAC or VSC may reduce power from the engine to the wheels. You may need to turn the system off to enable you to rock the vehicle in order to free it.

n TRAC OFF mode

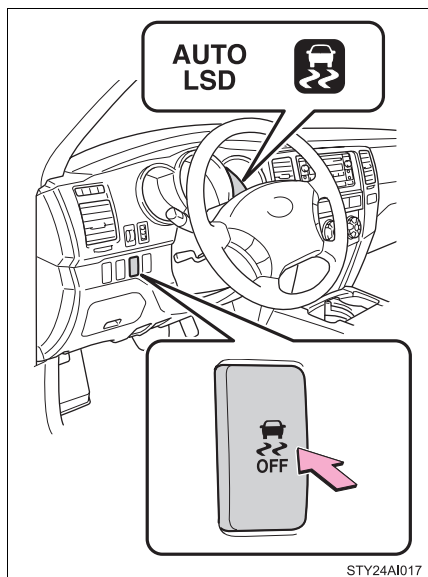

Press the VSC OFF switch briefly.

The slip and AUTO LSD indicators will come on.

The system is in TRAC off, AUTO LSD on and VSC on mode.

Push the switch again to turn the system back on.

n VSC OFF mode

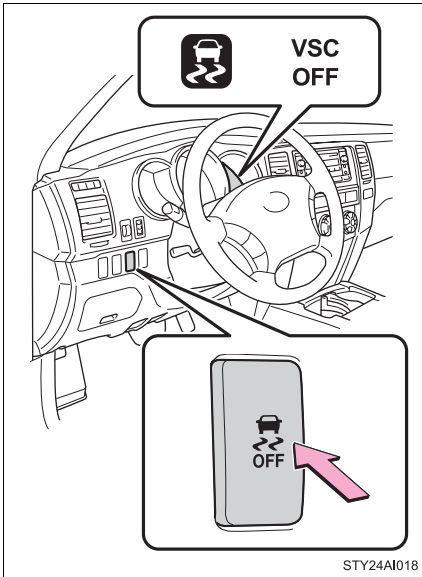

Stop the vehicle completely, and press the VSC OFF switch for more than 3 seconds.

The slip and VSC OFF indicators will come on.

The system is in TRAC off, AUTO LSD off and VSC off mode.

To disable TRAC and/or VSC (H4 mode on 4WD models)

If the vehicle gets stuck in fresh snow or mud, TRAC or VSC may reduce power from the engine to the wheels. You may need to turn the system off to enable you to rock the vehicle in order to free it.

n TRAC OFF mode

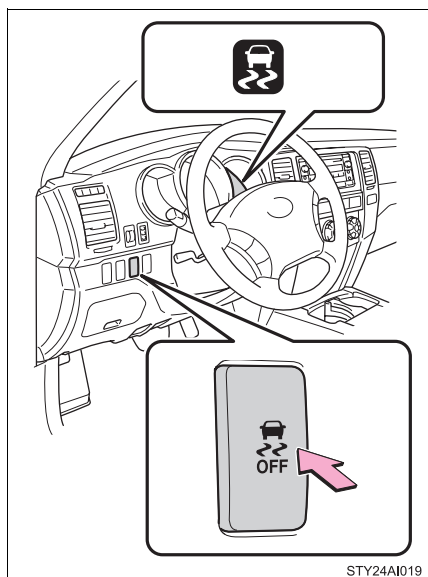

STY24A1019

Press the VSC OFF switch briefly.

The slip indicator will come on.

The system is in TRAC off and VSC on mode.

Push the switch again to turn the system back on.

n VSC OFF mode

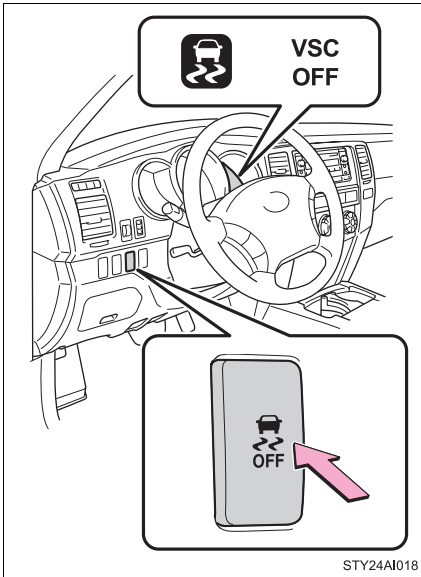

Stop the vehicle completely, and press the VSC OFF switch for more than 3 seconds.

The slip and VSC OFF indicators will come on.

The system is in TRAC off and VSC off mode.

To disable TRAC (four-wheel drive control switch is in H4 mode and center differential lock is locked on 4WD models)

If the vehicle gets stuck in fresh snow or mud, TRAC may reduce power from the engine to the wheels. You may need to turn the system off to enable you to rock the vehicle in order to free it.

n VSC OFF mode

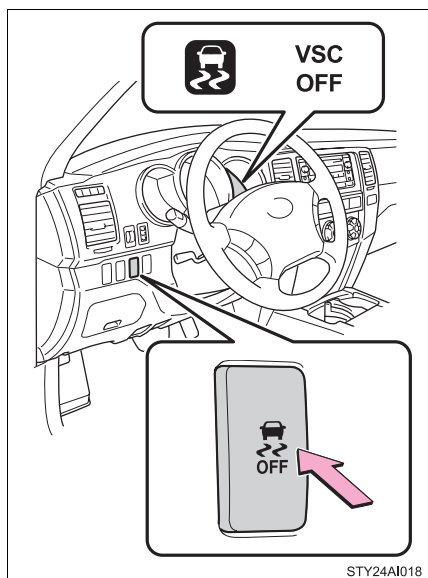

Stop the vehicle completely, and press the VSC OFF switch for more than 3 seconds.

The slip indicator will come on.

The system is in TRAC off mode.

To disable A-TRAC and VSC (L4 mode on 4WD models)

If the vehicle gets stuck in fresh snow or mud, A-TRAC or VSC may reduce power from the engine to the wheels. You may need to turn the system off to enable you to rock the vehicle in order to free it.

n VSC OFF mode

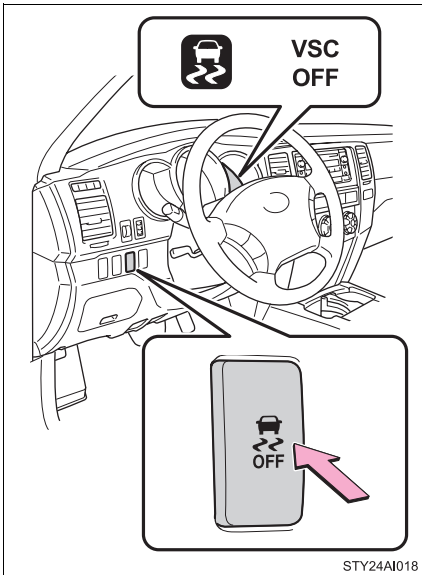

Stop the vehicle completely, and press the VSC OFF switch for more than 3 seconds.

The slip and VSC OFF indicators will come on.

The system is in A-TRAC off and VSC off mode.

n Sounds and vibrations caused by the ABS, TRAC, A-TRAC, VSC and brake assist system

- | A sound may be heard from the engine compartment when the engine is started or just after the vehicle begins to move. This sound does not indicate that a malfunction has occurred in any of these systems.
- | Any of the following conditions may occur when the above systems are operating. None of these indicates that a malfunction has occurred.
 - Vibrations may be felt through the vehicle body and steering.
 - A motor sound may be heard after the vehicle comes to a stop.
 - The brake pedal may pulsate slightly after the ABS is activated.
 - The brake pedal may move down slightly after the ABS is activated.

n If the brake system overheats

TRAC will cease operation and a buzzer will sound to alert the driver. Stop the vehicle in a safe place. (There is no problem with continuing normal driving.)

 **CAUTION**
n The ABS does not operate effectively when

- l The limits of the gripping performance have been exceeded.
- l The vehicle hydroplanes while driving at high speed on the wet or slick road.

n Stopping distance when the ABS is operating will exceed that of normal conditions

The ABS is not designed to shorten the vehicle's stopping distance. Always maintain a safe distance from the vehicle in front of you in the following situations.

- l When driving on dirt, gravel or snow-covered roads
- l When driving with tire chains
- l When driving over bumps in the road
- l When driving over roads with potholes or roads with uneven roads

n When VSC is activated

The slip indicator flashes and a warning buzzer sounds. Always drive carefully. Reckless driving may cause an accident. Exercise particular care when the indicator flashes and a buzzer sounds.

n TRAC/A-TRAC may not operate effectively when

Directional control and power may not be achievable while driving on slippery road surfaces, even if TRAC/A-TRAC is operating. Do not drive the vehicle in conditions where stability and power may be lost.

n Replacing tires

Make sure that all tires are of the same size, brand, tread pattern and total load capacity. In addition, make sure that the tires are inflated to the appropriate tire pressure level.

The ABS and VSC will not function correctly if different tires are fitted on the vehicle.

Contact your Toyota dealer for further information when replacing tires or wheels.

n Handling of tires and suspension

Using tires with any kind of problem or modifying the suspension will affect the driving assist systems, and may cause the system to malfunction.

Off-road precautions

This vehicle belongs to the utility vehicle class, which has higher ground clearance and narrower tread in relation to the height of its center of gravity to make it capable of performing in a wide variety of off-road applications.

Off-road vehicle feature

- 1 Specific design characteristics give it a higher center of gravity than ordinary passenger cars. This vehicle design feature causes this type of vehicle to be more likely to rollover. And, utility vehicles have a significantly higher rollover rate than other types of vehicles.
- 1 An advantage of the higher ground clearance is a better view of the road allowing you to anticipate problems.
- 1 It is not designed for cornering at the same speeds as ordinary passenger cars any more than low-slung sports cars designed to perform satisfactorily under off-road conditions. Therefore, sharp turns at excessive speeds may cause rollover.

 CAUTION**n Off-road vehicle precautions**

Always observe the following precautions to minimize the risk of serious personal injury or damage to your vehicle:

- I** In a rollover crash, an unbelted person is significantly more likely to die than a person wearing a seat belt. Therefore, the driver and all passengers should fasten their seat belts whenever the vehicle is moving.
- I** Avoid sharp turns or abrupt maneuvers, if at all possible. Failure to operate this vehicle correctly may result in loss of control or vehicle rollover causing death or serious injury.
- I** Loading cargo on the roof luggage carrier will make the center of the vehicle gravity higher. Avoid high speeds, sudden starts, sharp turns, sudden braking or abrupt maneuvers, otherwise it may result in loss of control or vehicle rollover due to failure to operate this vehicle correctly.
- I** Always slow down in gusty crosswinds. Because of its profile and higher center of gravity, your vehicle is more sensitive to side winds than an ordinary passenger car. Slowing down will allow you to have better control.
- I** When driving off-road or in rugged terrain, do not drive at excessive speeds, jump, make sharp turns, strike objects, etc. This may cause loss of control or vehicle rollover causing death or serious injury. You are also risking expensive damage to your vehicle's suspension and chassis.
- I** Do not drive horizontally across steep slopes. Driving straight up or straight down is preferred. Your vehicle (or any similar off-road vehicle) can tip over sideways much more easily than forward or backward.

Off-road driving

When driving your vehicle off-road, please observe the following precautions to ensure your driving enjoyment and to help prevent the closure of areas to off-road vehicles.

- 1 Drive your vehicle only in areas where off-road vehicles are permitted to travel.
- 1 Respect private property. Get owner's permission before entering private property.
- 1 Do not enter areas that are closed. Honor gates, barriers and signs that restrict travel.
- 1 Stay on established roads. When conditions are wet, driving techniques should be changed or travel delayed to prevent damage to roads.

n **Additional information for off-road driving**

► For owners in U.S. mainland, Hawaii and Puerto Rico:

To obtain additional information pertaining to driving your vehicle off-road, consult the following organizations.

- 1 State and Local Parks and Recreation Departments
- 1 State Motor Vehicle Bureau
- 1 Recreational Vehicle Clubs
- 1 U.S. Forest Service and Bureau of Land Management

 **CAUTION****n Off-road driving precautions**

Always observe the following precautions to minimize the risk of serious personal injury or damage to your vehicle:

- I** Drive carefully when off the road. Do not take unnecessary risks by driving in dangerous places.
- I** Do not grip the steering wheel spokes when driving off-road. A bad bump could jerk the wheel and injure your hands. Keep both hands and especially your thumbs on the outside of the rim.
- I** Always check your brakes for effectiveness immediately after driving in sand, mud, water or snow.
- I** After driving through tall grass, mud, rock, sand, rivers, etc., check that there is no grass, bush, paper, rags, stone, sand, etc. adhering or trapped on the underbody. Clear off any such matter from the underbody. If the vehicle is used with these materials trapped or adhering to the underbody, a breakdown or fire could occur.
- I** In a rollover crash, an unbelted person is significantly more likely to die than a person wearing a seat belt. Therefore, the driver and all passengers should fasten their seat belts whenever the vehicle is moving.
- I** When driving off-road or in rugged terrain, do not drive at excessive speeds, jump, make sharp turns, strike objects, etc. This may cause loss of control or vehicle rollover causing death or serious injury. You are also risking expensive damage to your vehicle's suspension and chassis.

 NOTICE

n To prevent the water damage

- i** Take all necessary safety measures to ensure that water damage to the engine or other components does not occur.
- i** Water entering the engine air intake will cause severe engine damage.
- i** Water entering the automatic transmission will cause deterioration in shift quality, locking up of your transmission accompanied by vibration, and ultimately damage.
- i** Water can wash the grease from wheel bearings, causing rusting and premature failure, and may also enter the differentials, transmission and transfer case, reducing the gear oil's lubricating qualities.

n When you drive through water

If driving through water, such as when crossing shallow streams, first check the depth of the water and the bottom of the river bed for firmness. Drive slowly and avoid deep water.

n Inspection after off-road driving

- i** Sand and mud that has accumulated in brake drums and around brake discs may affect braking efficiency and may damage brake system components.
- i** Always perform a maintenance inspection after each day of off-road driving that has taken you through rough terrain, sand, mud, or water. For scheduled maintenance information, refer to the "Scheduled Maintenance Guide" or "Owner's Manual Supplement".

2-5. Driving information

Cargo and luggage

Take notice of the following information about storage precautions, cargo capacity and load.

- 1 Stow cargo and luggage in the luggage compartment whenever possible.
- 1 Be sure all items are secured in place.
- 1 Be careful to keep the vehicle level. Placing the weight as far forward as possible helps maintain vehicle balance.
- 1 For better fuel economy, do not carry unnecessary weight.

n **Roof luggage carrier (if equipped)**

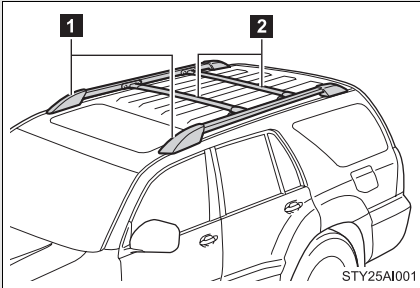

- 1 Roof rails
- 2 Cross rails

Adjustment the position of cross rails

STEP 1

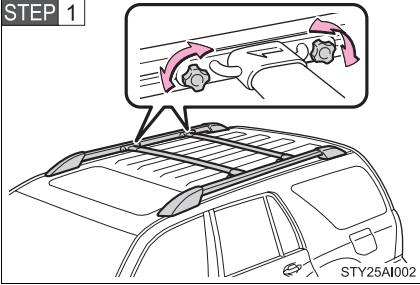

Turn the knobs counterclockwise to loosen the cross rails.

STEP 2

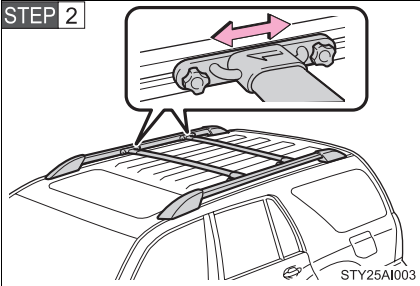

Slide the cross rails to the appropriate position for loading luggage.

After adjusting, be sure to tighten the cross rails by turning knobs clockwise.

Capacity and distribution

Cargo capacity depends on the total weight of the occupants.

(Cargo capacity) = (Total load capacity) – (Total weight of occupants)

Steps for Determining Correct Load Limit—

- (1) Locate the statement “The combined weight of occupants and cargo should never exceed XXX kg or XXX lbs.” on your vehicle’s placard.
- (2) Determine the combined weight of the driver and passengers that will be riding in your vehicle.
- (3) Subtract the combined weight of the driver and passengers from XXX kg or XXX lbs.
- (4) The resulting figure equals the available amount of cargo and luggage load capacity.
For example, if the “XXX” amount equals 1400 lbs. and there will be five 150 lb passengers in your vehicle, the amount of available cargo and luggage load capacity is 650 lbs. (1400 – 750 (5 × 150) = 650 lbs.)
- (5) Determine the combined weight of luggage and cargo being loaded on the vehicle. That weight may not safely exceed the available cargo and luggage load capacity calculated in Step 4.
- (6) If your vehicle will be towing a trailer, load from your trailer will be transferred to your vehicle. Consult this manual to determine how this reduces the available cargo and luggage load capacity of your vehicle.

Example on your vehicle

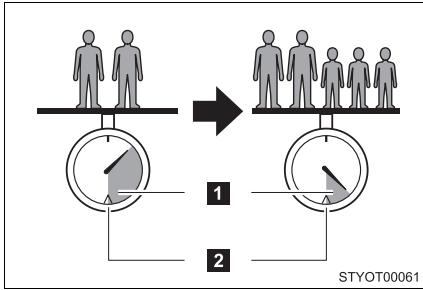

- 1** Cargo capacity
- 2** Total load capacity

When 2 people with the combined weight of 366 lb. (166 kg) are riding in your vehicle, the available amount of cargo and luggage load capacity will be as follows:

- ▶ Without third seats — total load capacity: 950 lb. (431 kg)
 $950 \text{ lb.} - 366 \text{ lb.} = 584 \text{ lb.}$ ($431 \text{ kg} - 166 \text{ kg} = 265 \text{ kg}$)
- ▶ With third seats — total load capacity: 1050 lb. (477 kg)
 $1050 \text{ lb.} - 366 \text{ lb.} = 684 \text{ lb.}$ ($477 \text{ kg} - 166 \text{ kg} = 311 \text{ kg}$)

In this condition, if 3 more passengers with the combined weight of 388 lb. (176 kg) get on, the available cargo and luggage load will be reduced as follows:

- ▶ Without third seats
 $584 \text{ lb.} - 388 \text{ lb.} = 196 \text{ lb.}$ ($265 \text{ kg} - 176 \text{ kg} = 89 \text{ kg}$)
- ▶ With third seats
 $684 \text{ lb.} - 388 \text{ lb.} = 296 \text{ lb.}$ ($311 \text{ kg} - 176 \text{ kg} = 135 \text{ kg}$)

As shown in the above example, if the number of occupants increases, the cargo and luggage load will be reduced by an amount that equals the increased weight due to the additional occupants. In other words, if an increase in the number of occupants causes an excess of the total load capacity (combined weight of occupants plus cargo and luggage load), you must reduce the cargo and luggage on your vehicle.

Seating configuration variation

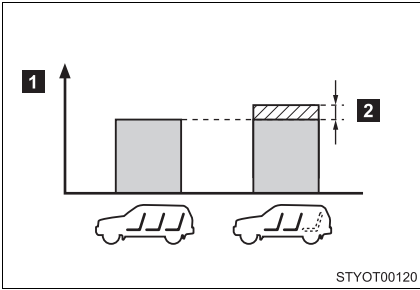

1 Cargo capacity

2 Weight of removed third seat

If removing the third seat, it is possible to load extra cargo equal to the weight of the removed seats.

(Cargo capacity) = (Total load capacity) – (Total weight of occupants)
+ (Weight of the removed third seats)

Third seat weight:

Each seat 24 lb. (11 kg)

 **CAUTION**

n Things that must not be carried in the luggage compartment

The following things may cause a fire if loaded in the luggage compartment.

- I Receptacles containing gasoline
- I Aerosol cans

n Storage precautions

I Do not stack anything in the luggage compartment higher than the seatbacks.

Such items may be thrown about and possibly injure people in the vehicle during sudden braking or in an accident.

I Do not drive with objects on top of the instrument panel.

They may interfere with the driver's field of view or move during sharp acceleration or turning, thus impairing the driver's control of the vehicle. In an accident they may injure the vehicle occupants.

I Secure all items in the occupant compartment, as they may shift and injure someone during an accident or sudden braking.

I Never allow anyone to ride in the luggage compartment. It is not designed for passengers. They should ride in their seats with their seat belts properly fastened. Otherwise, they are much more likely to suffer death or serious bodily injury, in the event of sudden braking or an accident.

n Capacity and distribution

I Do not exceed the maximum axle weight rating or the total vehicle weight rating.

I Even if the total load of occupant's weight and the cargo load is less than the total load capacity, do not apply the load unevenly. Improper loading may cause deterioration of steering or braking control which may cause death or serious injury.

⚠ CAUTION

n Roof luggage carrier precautions

To use the roof rails as a roof luggage carrier, you must fit the roof rails with two or more genuine Toyota cross rails or their equivalent.

When you load cargo on the roof luggage carrier, observe the following:

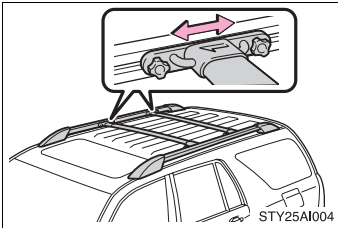

- l Place the cargo so that its weight is distributed evenly between the front and rear axles.
- l If loading long or wide cargo never exceed the vehicle overall length or width.
(→P. 470)

- l Before driving, make sure the cargo is securely fastened on the roof luggage carrier.
- l Loading cargo on the roof luggage carrier will make the center of the vehicle gravity higher. Avoid high speeds, sudden starts, sharp turns, sudden braking or abrupt maneuvers, otherwise it may result in loss of control or vehicle rollover due to failure to operate this vehicle correctly and result in death or serious injury.
- l If driving for a long distance, on rough roads, or at high speeds, stop the vehicle now and then during the trip to make sure the cargo remains in its place.
- l Do not exceed 120 lb. (54 kg) cargo weight on the roof luggage carrier.

n Cross rail adjustment

Make sure the cross rails are locked securely by pushing forward and rearward them.

Failure to do so may cause an unexpected accident or severe injury in the event of emergency braking or a collision.

 NOTICE

n Cross rail adjustment

Do not remove the cross rail stoppers, or the moon roof may be damaged when it is tilted.

n When loading the luggage

Be careful not to scratch the surface of the moon roof.

Vehicle load limits include total load capacity, seating capacity, towing capacity and cargo capacity.

n Total load capacity:

- ▶ Without third seats — 950 lb. (431 kg)
- ▶ With third seats — 1050 lb. (477 kg)

Total load capacity means the combined weight of occupants, cargo and luggage.

n Seating capacity:

- ▶ Without third seats — 5 occupants (Front 2, Rear 3)
- ▶ With third seats — 7 occupants (Front 2, Rear 5)

Seating capacity means the maximum number of occupants whose estimated average weight is 150 lb. (68 kg) per person.

Even if the number of occupants are within the seating capacity, do not exceed the total load capacity.

n Towing capacity:

- ▶ For weight carrying hitch
5000 lb. (2268 kg)
- ▶ For weight distributing hitch
(4.7 L V8 [2UZ-FE] engine only)
2WD models — 7300 lb. (3311 kg)
4WD models — 7000 lb. (3175 kg)

Towing capacity means the maximum gross trailer weight (trailer weight plus its cargo weight) that your vehicle is able to tow.

n Cargo capacity

Cargo capacity may increase or decrease depending on the weight and the number of occupants.

n Total load capacity and seating capacity

These details are also described on the tire and loading information label.(→P. 395)

 **CAUTION**

n Overloading the vehicle

Do not overload the vehicle.

It may not only cause damage to the tires, but also degrade steering and braking ability, resulting in an accident.

Carry out the necessary preparations and inspections before driving the vehicle in winter. Always drive the vehicle in a manner appropriate to the prevailing weather conditions.

n Pre-winter preparations

- 1 Use fluids that are appropriate to the prevailing outside temperatures.
 - Engine oil
 - Engine coolant
 - Washer fluid
- 1 Have a service technician inspect the level and specific gravity of battery electrolyte.
- 1 Have the vehicle fitted with four snow tires or purchase a set of tire chains for the rear tires.

Ensure that all tires are the same size and brand, and that chains match the size of the tires.

n Before driving the vehicle

Perform the following according to the driving conditions.

- 1 Do not try to forcibly open a window, scrape an outside rear view mirror surface or move a wiper or outside rear view mirror that is frozen. Pour warm water over the frozen area to melt the ice. Wipe away the water immediately to prevent it from freezing.
- 1 To ensure proper operation of the climate control system fan, remove any snow that has accumulated on the air inlet vents in front of the windshield.
- 1 Remove any ice that has accumulated on the vehicle chassis.
- 1 Periodically check for and remove any excess ice or snow that may have accumulated in the wheel well or on the brakes.

n **When driving the vehicle**

Accelerate the vehicle slowly and drive at a reduced speed suitable to road conditions.

n **When parking the vehicle**

Park the vehicle and move the shift lever to P without setting the parking brake. The parking brake may freeze up, preventing it from being released.

Regulations on the use of snow chains

- 1 Regulations regarding the use of tire chains vary according to location and type of road. Always check local regulations before installing chains.
- 1 Install the chains on the rear tires.
- 1 Retighten the chains after driving 1/4 - 1/2 mile (0.5 - 1.0 km).

n **Snow chain installation**

Observe the following precautions when installing and removing chains.

- 1 Install and remove tire chains in a safe location.
- 1 Install tire chains on the rear tires only. Do not install tire chains on the front tires.
- 1 Install tire chains following the instructions provided in the accompanying instructions.

 **CAUTION**
n Driving with snow tires

Observe the following precautions to reduce the risk of accidents. Failing to do so may result in a loss of vehicle control and cause death or serious injury.

- I Use tires of the size specified for your vehicle.
- I Maintain the recommended level of air pressure.
- I Do not drive in excess of 75 mph (120 km/h) regardless of the type of snow tires being used.
- I Snow tires should be installed on all wheels.
- I 4WD models:
Do not mix tires of different makes, models, tread patterns or treadwear.

n Driving with snow chains

Observe the following precautions to reduce the risk of accidents. Failing to do so may result in the vehicle being unable to be driven safely, and may cause death or serious injury.

- I Do not drive in excess of the speed limit specified for the tire chains being used or 30 mph (50 km/h), whichever is lower.
- I Avoid driving on bumpy road surfaces or over potholes.
- I Avoid sudden turns and braking.
- I Slow down sufficiently before entering a curve to ensure that vehicle control is maintained.

 **NOTICE**
n Repairing or replacing snow tires

Request repairs of and obtain replacement snow tires from Toyota dealers or legitimate tire retailers.

This is because the removal and attachment of snow tires affects the operation of the tire pressure warning valves and transmitters.

n Fitting tire chains

The tire pressure warning valves and transmitters may not function correctly when tire chains are fitted.

Trailer towing

Your vehicle is designed primarily as a passenger-and-load carrying vehicle. Towing a trailer will have an adverse effect on handling, performance, braking, durability, and fuel consumption. For your safety and the safety of others, do not overload the vehicle or trailer.

To tow a trailer safely, use extreme care and drive the vehicle in accordance with the trailer's characteristics and operating conditions.

The vehicle stability and braking performance are affected by trailer stability, brake setting and performance, and the hitch.

Toyota warranties do not apply to damage or malfunction caused by towing a trailer for commercial purposes.

Contact your Toyota dealer for further information about additional requirements such as a towing kits, etc.

Weight limits

Confirm that the gross trailer weight, gross combination weight, gross vehicle weight, gross axle weight and trailer tongue load are all within the limits.

n **Towing capacity**

- ▶ For weight carrying hitch
5000 lb. (2268 kg)
- ▶ For weight distributing hitch
(4.7 L V8 [2UZ-FE] engine only)
2WD models — 7300 lb. (3311 kg)
4WD models — 7000 lb. (3175 kg)

1 The gross trailer weight must never exceed towing capacity described above.

n GCWR

- ▶ For weight carrying hitch
 - 4.0 L V6 (1GR-FE) engine — 9600 lb. (4354 kg)
 - 4.7 L V8 (2UZ-FE) engine — 9750 lb. (4422 kg)
- ▶ For weight distributing hitch
 - (4.7 L V8 [2UZ-FE] engine only)
 - 12000 lb. (5443 kg)

- 1 The gross combination weight must never exceed the GCWR above.

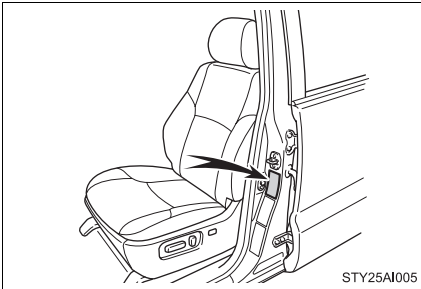

- 1 The gross vehicle weight must never exceed the GVWR indicated the Certification Label.
- 1 The gross axle weight on each axle must never exceed the GAWR indicated the Certification Label.

Towing related term

Towing related term	Meaning
GVWR (Gross Vehicle Weight Rating)	The maximum allowable gross vehicle weight. The gross vehicle weight is the total weight of the vehicle. When towing a trailer, it is the sum of the vehicle weight (including the occupants, cargo and any optional equipment installed on the vehicle) and the tongue load.
GAWR (Gross Axle Weight Rating)	The maximum allowable gross axle weight. The gross axle weight is the load placed on each axle (front and rear).
GCWR (Gross Combination Weight Rating)	The maximum allowable gross combination weight. The gross combination weight is the sum of the total vehicle weight (including the occupants, cargo and any optional equipment installed on the vehicle) and the weight of the trailer being towed (including the cargo in the trailer).
Gross trailer weight	The sum of the trailer weight and the weight of the cargo in the trailer.
Towing capacity	The maximum allowable gross trailer weight. Towing capacity is calculated considering base vehicle with necessary vehicle equipment and 150 pound driver. Additional optional equipment, passengers and cargo in the vehicle will reduce the towing capacity, gross trailer weight includes the trailer, cargo and necessary equipment for towing.
Tongue load	The load placed on the trailer hitch ball.

Trailer tongue load

- 1 A recommended tongue load varies in accordance with the types of trailers or towing as described below.
- 1 In order to ensure the recommended values shown below, the trailer must be loaded by referring to the following instructions. The trailer cargo load should be distributed so that the tongue load is 10% of the gross trailer weight, not exceeding the following.

(Tongue load /Gross trailer weight x 100 = 10%)

If the gross trailer weight is over 2000 lbs. (907 kg), it is necessary to use a sway control device with sufficient capacity.

If the gross trailer weight is over 5000 lbs. (2268 kg), it is necessary to use a weight distributing hitch with sufficient capacity.

If using a weight distributing hitch when towing, keep your vehicle level with the ground.

The gross trailer weight and tongue load can be measured with platform scales found at a highway weighing station, building supply company, trucking company, junk yard, etc.

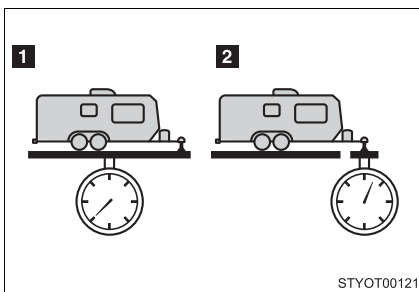

1 Gross trailer weight

2 Tongue load

Hitch

Trailer hitch assemblies have different weight capacities established by the hitch manufacturer. Even though the vehicle may be rated for towing a higher weight, the operator must never exceed the maximum weight rating specified for the trailer hitch.

Selecting trailer ball

Use the correct trailer ball for your application.

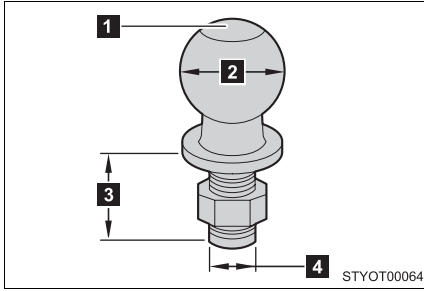

1 Trailer ball load rating

Matches or exceeds the gross trailer weight rating of the trailer.

2 Ball diameter

Matches the size of the trailer coupler. Most couplers are stamped with the required trailer ball size.

Trailer class	Typical trailer ball size
IV	2 5/16 in.
II and III	2 in.
I	1 7/8 in.

3 Shank length

Protrudes beyond the bottom of the lock washer and nut at least 2 threads.

4 Shank diameter

Matches the ball mount hole diameter size.

Connecting trailer lights

Use the wire harness stored in the rear end under body.

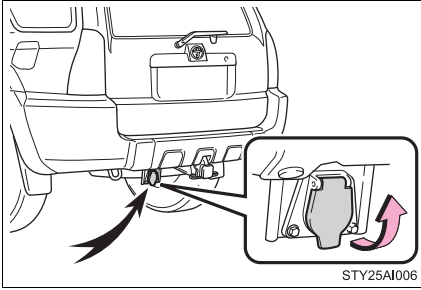

Trailer towing tips

Your vehicle will handle differently when towing a trailer. The three main causes of vehicle-trailer accidents are driver error, excessive speed and improper trailer loading. Keep the following in mind when towing.

- 1 Before starting out, check the trailer's light and the vehicle-trailer connections. Recheck after driving a short distance.
- 1 Practice turning, stopping and reversing with the trailer attached in an area away from traffic until you become accustomed to the feel of the vehicle.
- 1 Reversing with a trailer attached is difficult and requires practice. Grip the bottom of the steering wheel and move your hand to the left to move the trailer to the left. Move your hand to the right to move the trailer to the right. (This is generally opposite to reversing without a trailer attached.) Avoid sharp or prolonged turning. Have someone guide you when reversing to reduce the risk of an accident.
- 1 As stopping distance is increased when towing a trailer, vehicle-to-vehicle distance should be increased. For each 10 mph (16 km/h) of speed, allow at least one vehicle and trailer length.

- 1 Avoid sudden braking as you may skid, resulting in jackknifing and loss of control. This is especially true on wet or slippery surfaces.
- 1 Avoid jerky starts or sudden acceleration.
- 1 Avoid jerky steering and sharp turns, and slow down before making a turn.
- 1 Note that when making a turn, the trailer wheels will be closer than the vehicle wheels to the inside of the turn. Compensate by making a larger than normal turning radius.
- 1 Crosswinds and rough roads will adversely affect handling of your vehicle and trailer, causing sway. Periodically check the rear to prepare for being passed by large trucks or buses, which may cause your vehicle and trailer to sway. If swaying occurs, firmly grip the steering wheel, reduce speed immediately but gradually, and steer straight ahead. Never increase speed. If you make no extreme correction with the steering or brakes, your vehicle and trailer will stabilize.
- 1 Take care when passing other vehicles. Passing requires considerable distance. After passing a vehicle, do not forget the length of your trailer, and be sure you have plenty of room before changing lanes.
- 1 In order to maintain engine braking efficiency when driving on a long steep downgrade, do not use the transmission in D. Transmission shift position must be in 4.
- 1 Due to the added load of the trailer, your vehicle's engine may overheat on hot days (at temperatures over 85°F [30°C]) when driving up a long or steep grade. If the engine coolant temperature gauge indicates overheating, immediately turn off the air conditioning (if in use), pull your vehicle off the road and stop in a safe spot. (→P. 463)

1 Always place wheel blocks under both the vehicle and the trailer wheels when parking. Apply the parking brake firmly, and put the transmission in P. Avoid parking on a slope, but if unavoidable, do so only after performing the following:

STEP 1 Apply the brakes and keep them applied.

STEP 2 Have someone place wheel blocks under both the vehicle and trailer wheels.

STEP 3 When the wheel blocks are in place, release the brakes slowly until the blocks absorb the load.

STEP 4 Apply the parking brake firmly.

STEP 5 Shift into P and turn off the engine.

1 When restarting after parking on a slope:

STEP 1 With the transmission in P, start the engine. Be sure to keep the brake pedal pressed.

STEP 2 Shift into a forward gear. If reversing, shift into R.

STEP 3 Release the parking brake and brake pedal, and slowly pull or back away from the wheel blocks. Stop and apply the brakes.

STEP 4 Have someone retrieve the blocks.

n Service connector for towing brake controller (if equipped)

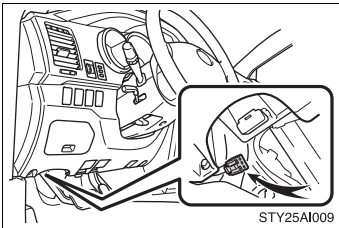

Your vehicle is equipped with a service connector for the trailer brake controller as shown.

■ Matching trailer ball height to trailer coupler height

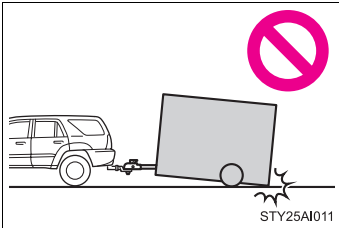

No matter which class of tow hitch applies, for a safe trailer hookup, the trailer ball setup on must be the proper height for the coupler on the trailer.

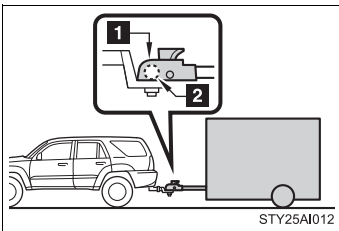

1 Coupler

2 Trailer ball

■ Before towing

Check that the following conditions are met:

- 1 Ensure that your vehicle's tires are properly inflated. (→P. 479)
- 1 Trailer tires should be inflated according to the trailer manufacturer's recommendation.
- 1 All trailer lights work to be legal.
- 1 All lights work each time you connect them.
- 1 The trailer ball is set up at the proper height for the coupler on the trailer.
- 1 The vehicle remains level when a loaded or unloaded trailer is hitched. Do not drive if the vehicle is not level, and check for improper tongue load, overloading, worn suspension, or other possible causes.
- 1 The trailer cargo is securely loaded.
- 1 The rear view mirrors conform to all applicable federal, state/provincial or local regulations. If they do not, install rear view mirrors appropriate for towing purposes.

n **When connecting and disconnecting a trailer**

Set the electronically modulated air suspension system to LO mode and push the HEIGHT CONTROL OFF switch to turn off the rear height control air suspension. (if equipped)

n **Break-in schedule**

If your vehicle is new or equipped with any new power train components (such as an engine, transmission, differential and wheel bearing), Toyota recommends that you do not tow a trailer until it has been driven for over 500 miles (800 km).

However, avoid full throttle acceleration.

n **Maintenance**

- l If you tow a trailer, your vehicle will require more frequent maintenance due to the additional load. (See “Scheduled Maintenance Guide” or “Owner’s Manual Supplement”.)
- l Retighten the fixing bolts of the towing ball and bracket after approximately 600 miles (1000 km).

CAUTION

n **Trailer towing precautions**

- l Follow all the instructions described in this section. Failure to do so could cause an accident resulting in death or serious injury.
- l Exceeding the towing capacity, GVWR, GCWR or GAWR can cause an accident resulting in death or serious injuries.

n **To avoid accident or injury**

- l Do not exceed the trailer hitch assembly weight, gross vehicle weight, gross axle weight and trailer tongue load capacities.
- l Do not exceed 45 mph (72 km/h) or the posted towing speed limit, whichever is lower. As instability (swaying) of the towing vehicle-trailer combination increases as speed increases, exceeding 45 mph (72 km/h) may cause loss of control.
- l Do not use cruise control when you are towing.
- l Slow down and downshift before descending steep or long downhill grades. Do not make sudden downshifts.

 **CAUTION**

n To avoid accident or injury

- ! Avoid holding the brake pedal down too long or applying the brakes too frequently. This could cause the brakes to overheat and result in reduced braking efficiency.

n Hitches

- ! If you wish to install a trailer hitch, contact your Toyota dealer.
- ! Use only a hitch that conforms to the gross trailer weight requirement.
- ! Follow the directions supplied by the hitch manufacturer.
- ! Lubricate the hitch ball with a light coat of grease.
- ! Remove the trailer hitch whenever you are not towing a trailer. After removing the hitch, seal any mounting hole in the vehicle body to prevent entry of any substances into the vehicle.

n When towing a trailer

- ! If the gross trailer weight exceeds 1000 lb. (453 kg), trailer brakes are required. Toyota recommends trailers with brakes that conform to all applicable federal and state/provincial regulations.
- ! Never tap into your vehicle's hydraulic system, as this will lower the vehicle's braking effectiveness.
- ! Never tow a trailer without using a safety chain securely attached to both the trailer and the vehicle. If damage occurs to the coupling unit or hitch ball, there is danger of the trailer wandering into another lane.

**NOTICE****n When installing a trailer hitch**

- I** Use only the position recommended by your Toyota dealer. Do not install the trailer hitch on the bumper; this may cause body damage.
- I** Do not use axle-mounted hitches, as they can cause damage to the axle housing, wheel bearing, wheels or tires.

n Safety chain

A safety chain must always be used between the towing vehicle and the trailer. Leave sufficient slack in the chain for turns. The chain should cross under the trailer tongue to prevent the tongue from dropping to the ground in the case that it becomes damaged or separated. For the correct safety chain installation procedure, ask your Toyota dealer.

n Do not directly splice trailer lights

Directly splicing trailer lights may damage your vehicle's electrical system and cause a malfunction.

2-5. Driving information

Dinghy towing

Your vehicle is not designed to be dinghy towed (with 4 wheels on the ground) behind a motor home.

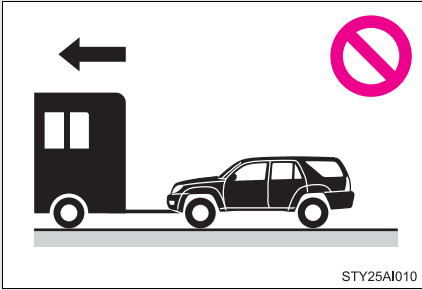

NOTICE

n To avoid serious damage to your vehicle

Do not tow your vehicle with four wheels on the ground.

3-1. Using the air conditioning system and defogger

Air conditioning system

Airflow and outlets are automatically adjusted according to the temperature setting.

► **Control panel (vehicles without DUAL button)**

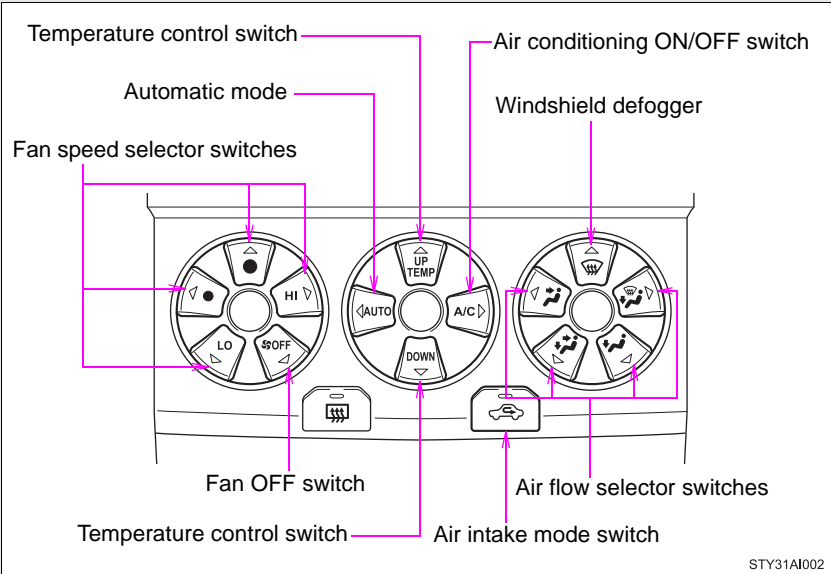

► Control panel (vehicles with DUAL button)

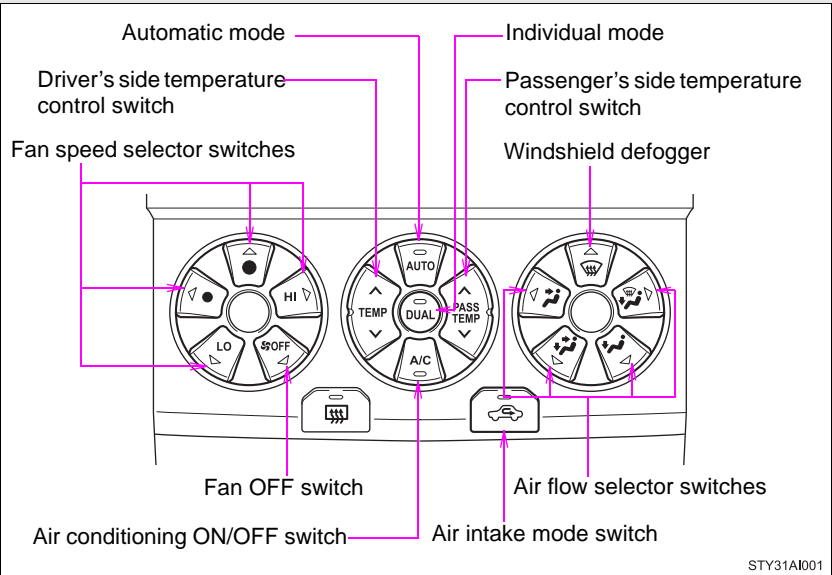



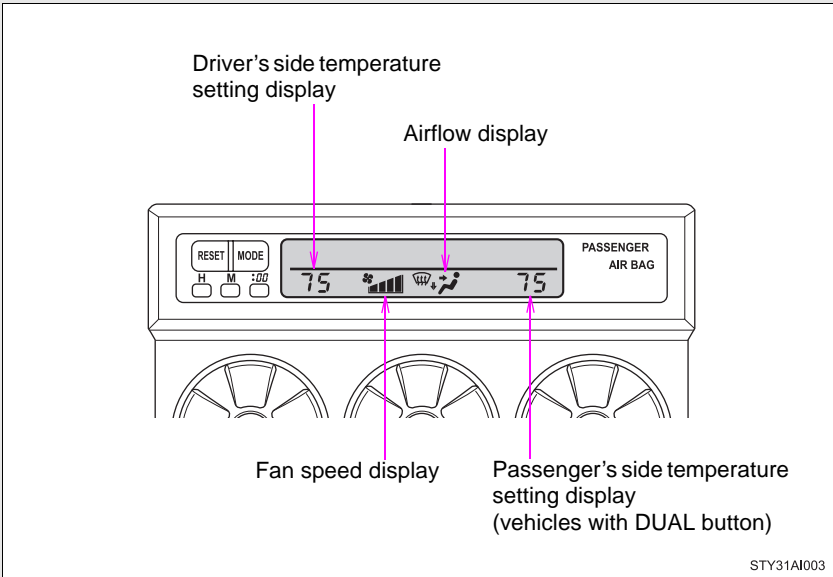

► Display



Using the automatic mode

STEP 1 Press  or .

The air conditioning system will begin to operate. Air outlets and fan speed are automatically adjusted according to the temperature setting.

STEP 2 Press  or  to increase the temperature and 
or  to decrease the temperature.



Vehicles with DUAL button:

The temperature for the driver and passenger seat can be set separately.



Adjusting the settings



n Adjusting the temperature setting

▶ Vehicles without DUAL button

Press  to increase the temperature and  to decrease the temperature.

▶ Vehicles with DUAL button

Driver's side: Press  to increase the temperature and  to decrease the temperature.

Passenger's side: Press  to increase the temperature and  to decrease the temperature.

The air conditioning system switches between individual and simultaneous modes each time  is pressed.





1 Simultaneous mode (the indicator on  is off)

The driver's side temperature control switch can be used to adjust the temperature for all seats.

1 Individual mode (the indicator on  is on)

The temperature for the driver's and passenger's seat can be adjusted separately. Operate the passenger's side temperature controls to enter individual mode.

n **Adjusting the fan speed**

Touch any switch of    
(decrease ↔ increase).

The fan speed is shown on the display. (4 levels)

Press  to turn the fan off.

n **Changing the air outlets**

Push the air flow selector switch.

The air outlets switch each time any of the air flow selector switch is pushed. The air flow shown on the display indicates the following.

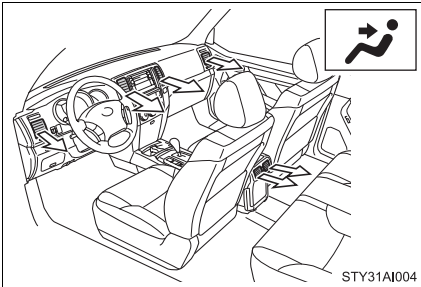

When  is pushed, air flows to the upper body.

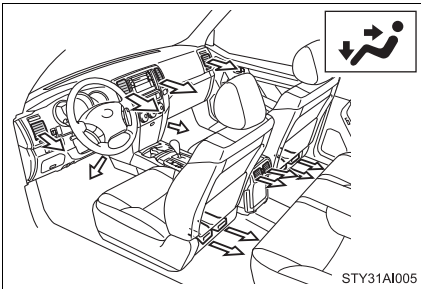

When  is pushed, air flows to the upper body and feet.

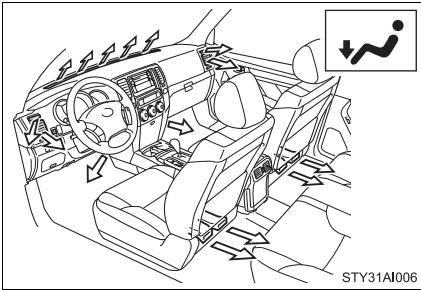

When  is pushed, air flows to the feet.

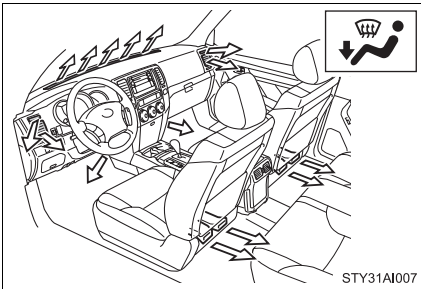

When  is pushed, air flows to the feet and the windshield defogger operates.

Recirculated air mode will automatically switch to outside air mode.

To return the recirculated air mode, press .

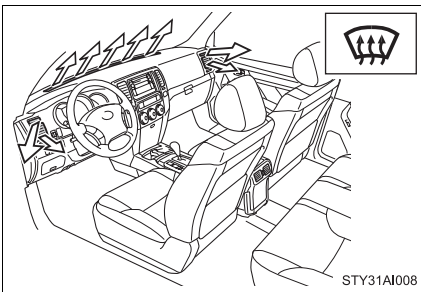



When  is pushed, windshield defogger operates.

Recirculated air mode will automatically switch to outside air mode.

In this mode, the air intake mode cannot be changed to the recirculated air mode.

n **Switching between outside air and recirculated air modes**

Press .

The mode switches between  (outside air mode) and  (recirculated air mode) each time the switch is pressed.

Adjusting the position and opening and closing the air outlets

► **Front center outlets**

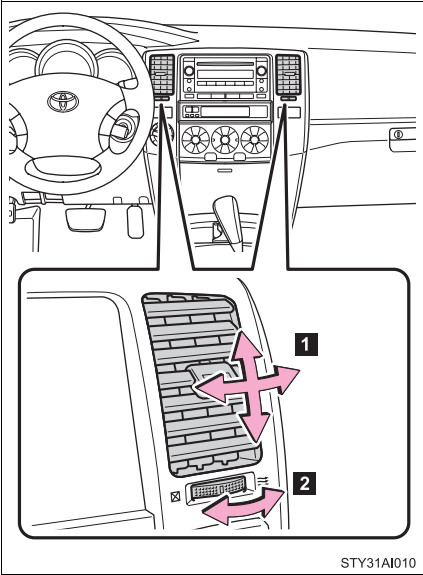

- 1** Direct air flow to the left or right, up or down.
- 2** Turn the knob to open or close the vent.

► Front side outlets

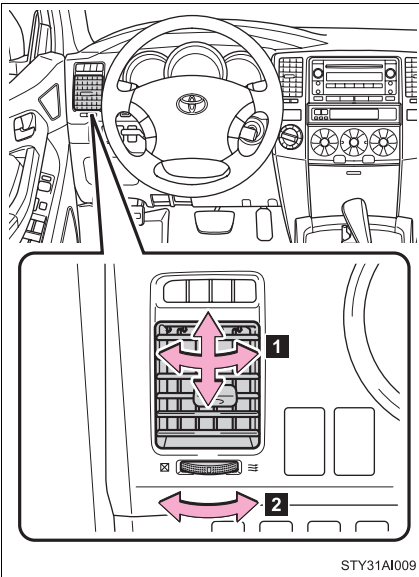

STY31AI009

- 1 Direct air flow to the left or right, up or down.
- 2 Turn the knob to open or close the vent.

► Rear center outlets

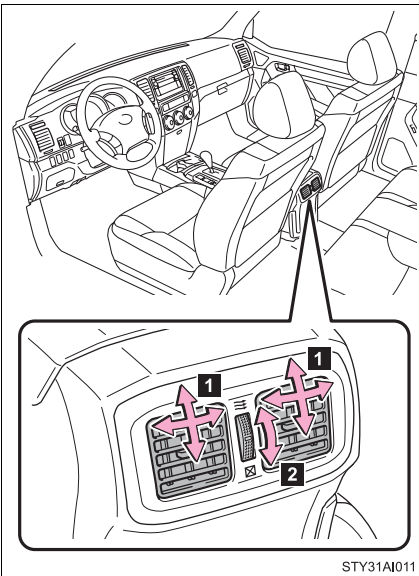

STY31AI011

- 1 Direct air flow to the left or right, up or down.
- 2 Turn the knob to open or close the vent.

■ **Using the automatic mode**

Fan speed is adjusted automatically in accordance with the temperature setting and ambient conditions. As a result, the following may occur.

- 1 The system may switch automatically to recirculated mode when the coolest temperature setting is selected in summer.
- 1 Immediately after the switch is pressed, the fan may stop for a while until warm or cool air is ready to flow.
- 1 Cool air may flow to the area around the upper body when the heater is on.



■ **Using the system in recirculated air mode**

The windows will fog up more easily if the recirculated air mode is used for an extended period.



■ **Window defogger feature**

Recirculated air mode may automatically switch to outside air mode in situations where the windows need to be defogged.

■ **When outside temperature approaches 32°F (0°C)**

The air conditioning system may not operate even when  or  is pressed.

■ **When the indicator on  or  flashes**

Press  or  and turn off the air conditioning system before turning it on once more. There may be a problem in the air conditioning system if the indicator continues to flash. Turn the air conditioning system off and have it inspected by your Toyota dealer.

 CAUTION

n To prevent the windshield from fogging up

Do not use  during cool air operation in extremely humid weather. The difference between the temperature of the outside air and that of the windshield can cause the outer surface of the windshield to fog up, blocking your vision.

 NOTICE

n To prevent battery discharge

Do not leave the air conditioning system on longer than necessary when the engine is stopped.

3-1. Using the air conditioning system and defogger Rear window and outside rear view mirror defoggers (if equipped)

Clear the rear window using the defogger.

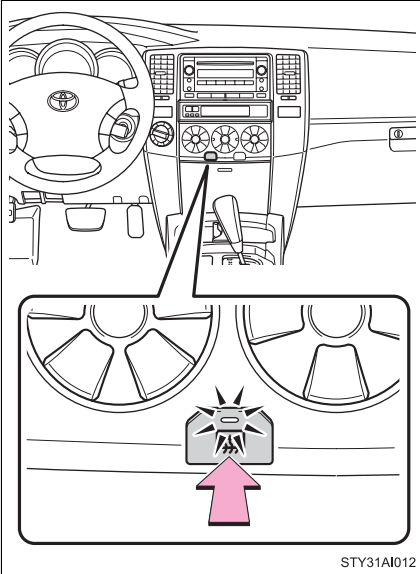

On/off

Press the button to turn on the rear window defogger. The indicator will come on. The defoggers will automatically turn off after approximately 15 minutes. Pressing the button again also turns the defoggers off.

n **The rear window and outside rear view mirror defoggers can be operated when**

The engine switch is in the ON position.

n **Outside rear view mirror defoggers (vehicles with outside rear view mirror defoggers)**

Turning the rear window defogger on will turn the outside rear view mirror defoggers on.

⚠ CAUTION

n **When the outside rear view mirror defoggers are on (vehicles with outside rear view mirror defoggers)**

Do not touch the rear view mirror surfaces, as they can become very hot and burn you.

3-2. Using the audio system

Audio system (without navigation system)

Owners of models equipped with a navigation system should refer to the “Navigation System Owner’s Manual”.

Type A: CD player with external CD changer controller and AM/FM radio

Type B and C: CD player with changer and AM/FM radio

► Type A

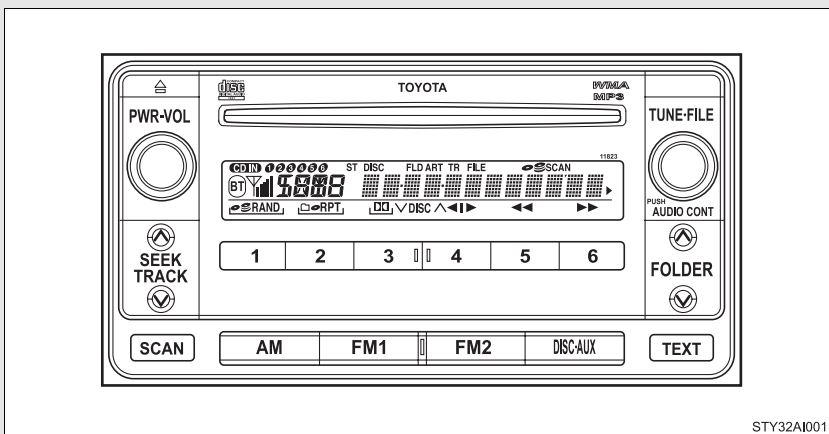

► Type B

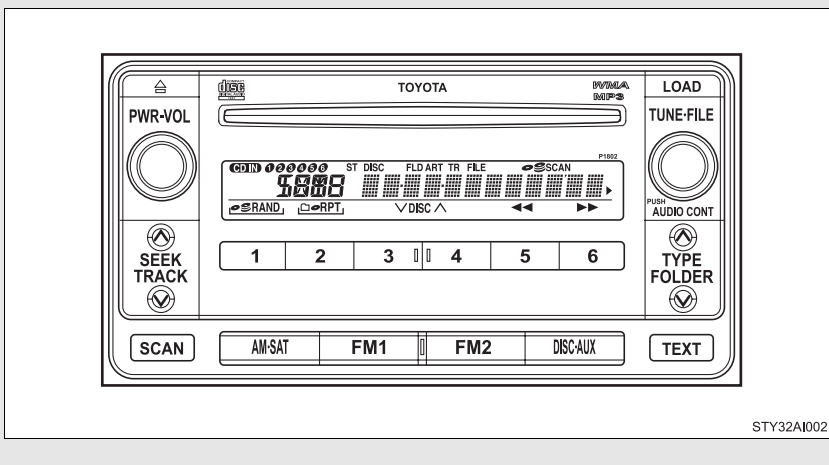

► Type C

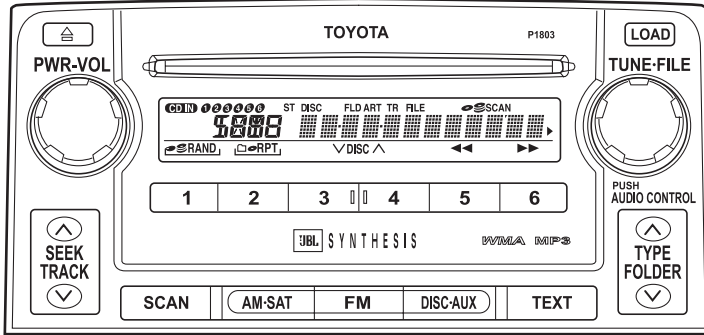

STY32AI003

Title	Page
Using the radio	P. 244
Using the CD player	P. 250
Playing back MP3 and WMA discs	P. 257
Optimal use of the audio system	P. 266
Using the AUX adapter	P. 269
Using the steering wheel audio switches	P. 271

n **Using cellular phones**

Interference may be heard through the audio system's speakers if a cellular phone is being used inside or close to the vehicle while the audio system is operating.

 **CAUTION**
n For vehicles sold in U.S.A. and Canada
I Part 15 of the FCC Rules

FCC Warning:

Any unauthorized changes or modifications to this equipment will void the user's authority to operate this device.

I Laser products

- Do not take this unit apart or attempt to make any changes yourself. This is an intricate unit that uses a laser pickup to retrieve information from the surface of compact discs. The laser is carefully shielded so that its rays remain inside the cabinet. Therefore, never try to disassemble the player or alter any of its parts since you may be exposed to laser rays and dangerous voltages.
- This product utilizes a laser. Use of controls or adjustments or performance of procedures other than those specified herein may result in hazardous radiation exposure.

 **NOTICE**
n To prevent battery discharge

Do not leave the audio system on longer than necessary with the engine is off.

n To avoid damaging the audio system

Take care not to spill drinks or other fluids over the audio system.

3-2. Using the audio system Using the radio

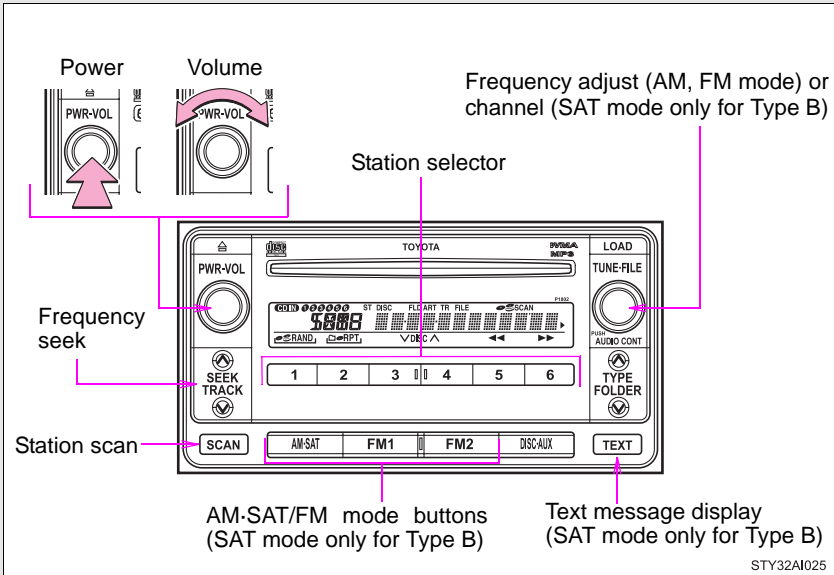

► Type A and B



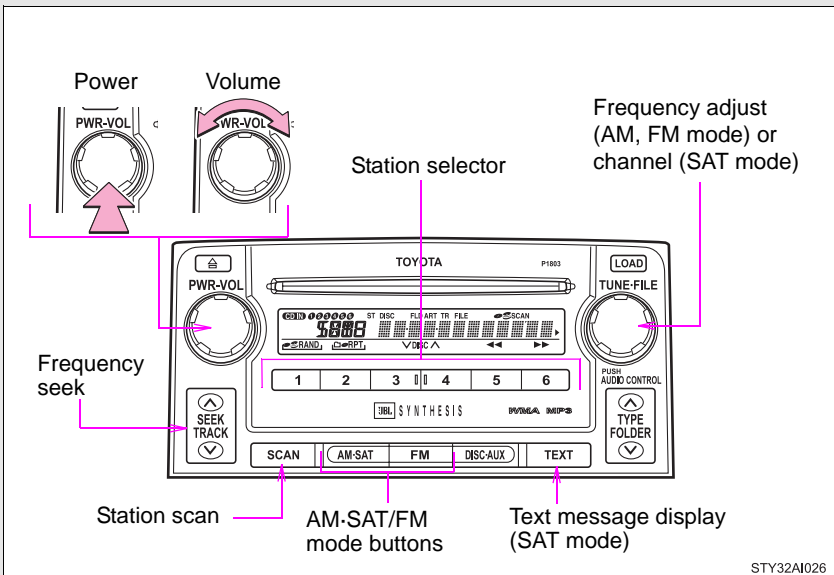

► Type C



Setting station presets (excluding XM[®] Satellite Radio)

STEP 1 Search for desired stations by turning  or  , or

pressing “^” or “v” on  or  .

STEP 2 Press and hold the button (from to) that the station is to be set to until you hear a beep.

Scanning radio stations (excluding XM[®] Satellite Radio)

n Scanning the preset radio stations

STEP 1 Press and hold or until you hear a beep.

Preset stations will be played for 5 seconds each.

STEP 2 When the desired station is reached, press the button once again to stop scanning.

n Scanning all radio stations within range

STEP 1 Press or .

All stations with reception will be played for 5 seconds each.

STEP 2 When the desired station is reached, press the button once again to stop scanning.





XM[®] Satellite Radio (type B and C)

n Receiving XM[®] Satellite Radio

STEP 1 Press or and select the XM[®] band.

The display changes as follows each time or is pressed.



AM → SAT1 → SAT2 → SAT3

STEP 2 Turn  or  to select the desired channel in all categories or press “^” or “v” on  or  to select the desired channel in the current category.

n **Setting XM[®] Satellite Radio channel presets**

Select the desired channel. Press and hold the button (from to) that the channel is to be set to until you hear a beep.

n **Changing the channel category**

Press “^” or “v” on the  or .

n **Scanning XM[®] Satellite Radio channels**

1 Scanning channels in the current category

STEP 1 Press or .

STEP 2 When the desired channel is reached, press or again to stop scanning.

1 Scanning preset channels

STEP 1 Press and hold or until you hear a beep.

STEP 2 When the desired channel is reached, press or again to stop scanning.

n **Displaying text information**

Press or .

The display will show up to 10 characters.

The display changes as follows each time the button is pressed.

1 CH NAME

1 TITLE (SONG/PROGRAM TITLE)

- 1 NAME (ARTIST NAME/FEATURE)
 - 1 CH NUMBER
-

n **When the battery is disconnected**

Stations presets are erased.

n **Reception sensitivity**

- l Cargo loaded on the roof luggage carrier, especially metal objects, may adversely affect the reception of XM[®] Satellite Radio.
- l Maintaining stable radio reception at all times is difficult due to the continually changing position of the antenna and differences in signal strength and surrounding objects, such as trains, transmitters, etc.
- l The radio antenna is mounted inside the quarter windows. To maintain clear radio reception, do not attach metallic window tinting or other metallic objects to the antenna wire mounted inside the quarter windows.

n **XM[®] Satellite Radio (type B and C)**

An XM[®] Satellite Radio is a tuner designed exclusively to receive broadcasts provided under a separate subscription. Availability is limited to the 48 contiguous U.S. states and 10 Canadian provinces.

l XM[®] subscriptions

For detailed information about XM[®] Satellite Radio or to subscribe:



U.S.A.—

Visit on the web at www.xmradio.com or call 1-800-967-2346.

Canada—

Visit on the web at www.xmradio.ca or call 1-877-438-9677.

1 Radio ID

You will need the radio ID when activating XM[®] service or reporting a problem. Select “CH000” using  or , and the receiver’s 8-character ID number will appear.

1 Satellite tuner

The tuner supports only Audio Services (Music and Talk) and the accompanying Text Information of XM[®] Satellite Radio.

1 If the satellite radio does not operate normally (type B and C)

If a problem occurs with the XM[®] tuner, a message will appear on the display. Refer to the table below to identify the problem, and take the suggested corrective action.

ANTENNA	The XM [®] antenna is not connected. Check whether the XM [®] antenna cable is attached securely.
	There is a short-circuit in the antenna or the surrounding antenna cable. See a Toyota certified dealer.
UPDATING	You have not subscribed to the XM [®] Satellite Radio. The radio is being updated with the latest encryption code. Contact the XM [®] Satellite Radio for subscription information. When a contract is canceled, you can choose the “CH000” and all free-to-air channels.
	The premium channel you selected is not authorized. Wait for about 2 seconds until the radio returns to the previous channel or “CH001”. If it does not change automatically, select another channel. If you want to listen to the premium channel, contact the XM [®] Satellite Radio.
NO SIGNAL	The XM [®] signal is too weak at the current location. Wait until your vehicle reaches a location with a stronger signal.

LOADING	The unit is acquiring audio or program information. Wait until the unit has received the information.
OFF AIR	The channel you selected is not broadcasting any programming. Select another channel.
-----	There is no song/program title or artist name/feature associated with the channel at that time. No action needed.
---	The channel you selected is no longer available. Wait for about 2 seconds until the radio returns to the previous channel or "CH001". If it does not change automatically, select another channel.

Contact the XM[®] Listener Care Center at 1-800-967-2346 (U.S.A.) or 1-877-438-9677 (Canada).

n **Certifications for the radio tuner**

This equipment has been tested and found to comply with the limits for a class B digital device, pursuant to Part 15 of the FCC Rules. These limits are designed to provide reasonable protection against harmful interference in a residential installation. This equipment generates, uses and can radiate radio frequency energy and, if not installed and used in accordance with the instructions, may cause harmful interference to radio communications. However, there is no guarantee that interference will not occur in a particular installation.

If this equipment does cause harmful interference to radio or television reception, which can be determined by turning the equipment off and on, the user is encouraged to try to correct the interference by trying one or more of the following:

- l Reorienting or relocating the receiving antenna.
- l Increasing the separation between the equipment and receiver.
- l Connecting the equipment into an outlet on a circuit different from that to which the receiver is connected.
- l Consulting the dealer or an experienced radio/TV technician for help.

3-2. Using the audio system Using the CD player

▶ Type A and B

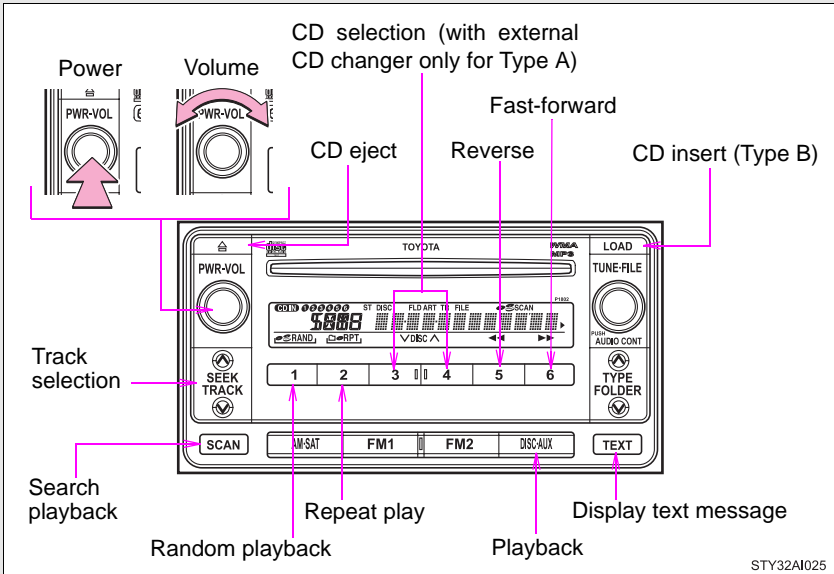

▶ Type C

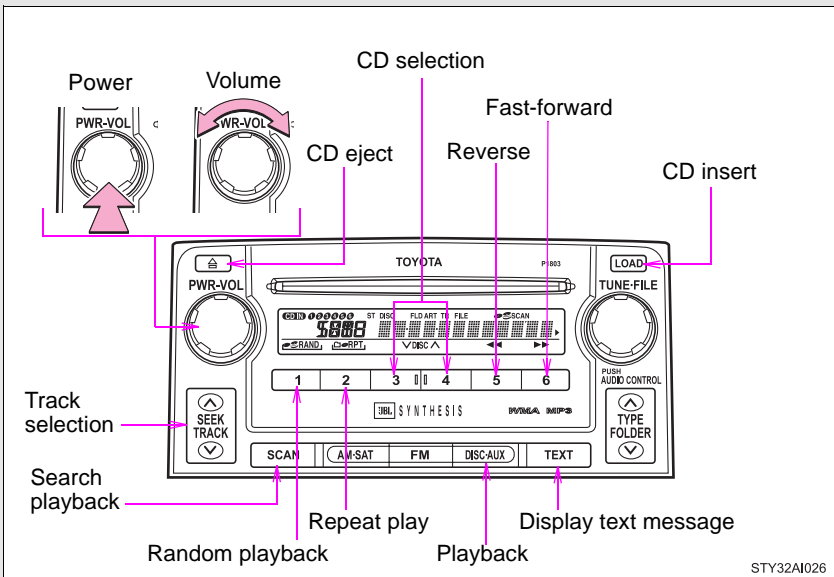

Loading CDs

n Loading a CD (type A)

Insert a CD.

n Loading a CD (type B and C)



STEP 1 Press  or .

WAIT is shown on the display.

STEP 2 Insert a CD when the indicator on the slot turns from amber to green.

The display changes from WAIT to LOAD.

n Loading multiple CDs (type B and C)

STEP 1 Press and hold  or  until you hear a beep.

WAIT is shown on the display.



STEP 2 Insert a CD when the indicator on the slot turns from amber to green.

The display changes from WAIT to LOAD.

The indicator on the slot turns to amber when the CD is inserted.

STEP 3 Insert the next CD when the indicator on the slot turns from amber to green again.

Repeat the procedure for the remaining CDs.

To stop the operation, press  or .

Ejecting CDs

n Ejecting a CD (type A)

Press  and remove the CD.

n **Ejecting a CD (type B and C)**



STEP 1 To select the CD to be ejected.

Press  or .

The number of the CD selected is shown on the display.

STEP 2 Press  or  and remove the CD.

n **Ejecting all the CDs (type B and C)**



Press and hold  or  until you hear a beep, and then remove the CDs.

Selecting and scanning CDs (with CD changer only)

n **Selecting the desired CD**

Press  or .

n **Scanning loaded CDs**



STEP 1 Press and hold  or  until you hear a beep.

The first 10 seconds of the first track on each CD will be played.

STEP 2 Press the button again when the desired CD is reached.

Selecting and scanning tracks

n **Selecting a track**

Press “^” to move up or “v” to move down using  or  until the desired track number is displayed.

n **Scanning tracks**

STEP 1 Press  or .

The first 10 seconds of each track will be played.

STEP 2 Press the button again when the desired track is reached.

Fast-forwarding and reversing tracks

To fast-forward or reverse.

Press and hold or .

Repeat play

n Repeating a track

Press .

n Repeating all of the tracks on a CD (with CD changer only)

Press and hold until you hear a beep.

Random playback

n Current CD

Press .

Tracks are played in random order until the button is pressed once more.

n All CDs (with CD changer only)

Press and hold until you hear a beep.

Tracks on all loaded CDs are played in random order until the button is pressed once more.

Switching the display

Press or .

Each time the button is pressed, the display changes in the order of Track no./Elapsed time→CD title→Track name.

▮ **Display**

Up to 12 characters can be displayed at a time.

If there are 13 characters or more, pressing and holding or for 1 second or more will display the remaining characters.

A maximum of 24 characters can be displayed.

If or is pressed for 1 second or more again or has not been pressed for 6 seconds or more, the display will return to the first 12 characters.

Depending on the contents recorded, the characters may not be displayed properly or may not be displayed at all.

▮ **Canceling random playback**

Press again.

▮ **Canceling repeat play**

Press again.

▮ **Error messages**

ERROR: This indicates a problem either with the CD or inside the player. The CD may be dirty, damaged or inserted up-side down.

WAIT: Operation has stopped due to a high temperature inside the player. Wait for a while and then press or . Contact your Toyota dealer if the CD still cannot be played back.

▮ **Discs that can be used**

Discs with the marks shown below can be used.

Playback may not be possible depending on recording format or disc features, or due to scratches, dirt or deterioration.



CDs with copy-protect features may not playback.

▮ **CD player protection feature**

To protect the internal components, playback is automatically stopped when a problem is detected while the CD player is being used.

▮ **If CDs are left inside the CD player or in the ejected position for extended periods**

CDs may be damaged and may not play properly.

n Lens cleaners

Do not use lens cleaners. Doing so may damage the CD player.

n When inserting the CDs

This player can store up to six discs.

NOTICE

n CDs and adapters that cannot be used

Do not use the following types of CDs, 3 in. (8 cm) CD adapters or Dual Disc.

Doing so may damage the CD player and/or the CD insert/eject function.

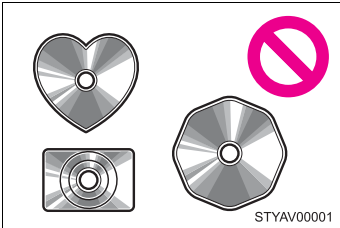

1 CD player with external CD changer controller and AM/FM radio:
CDs that have a diameter that is not 3 in. (8 cm) or 4.7 in. (12 cm)

1 CD player with changer and AM/FM radio:
CDs that have a diameter that is not 4.7 in. (12 cm)

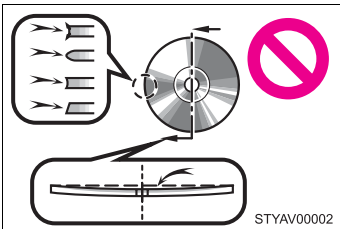

1 Low-quality and deformed CDs

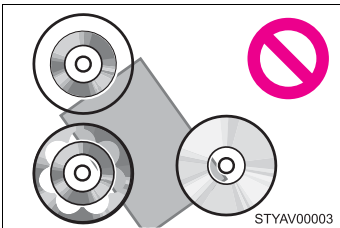

1 CDs with a transparent or translucent recording area

 NOTICE

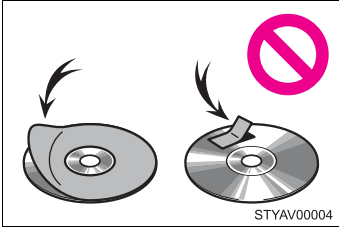

- ! CDs that have had tape, stickers or CD-R labels attached to them, or that have had the label peeled off

n CD player precautions

Failure to follow the precautions below may result in serious damage to the CDs or the player itself.

- ! Do not insert anything other than CDs into the CD slot.
- ! Do not apply oil to the CD player.
- ! Store CDs away from direct sunlight.
- ! Never try to disassemble any part of the CD player.

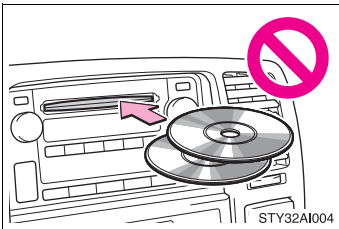

- ! Do not insert more than one CD at a time

3-2. Using the audio system

Playing back MP3 and WMA discs

▶ Type A and B

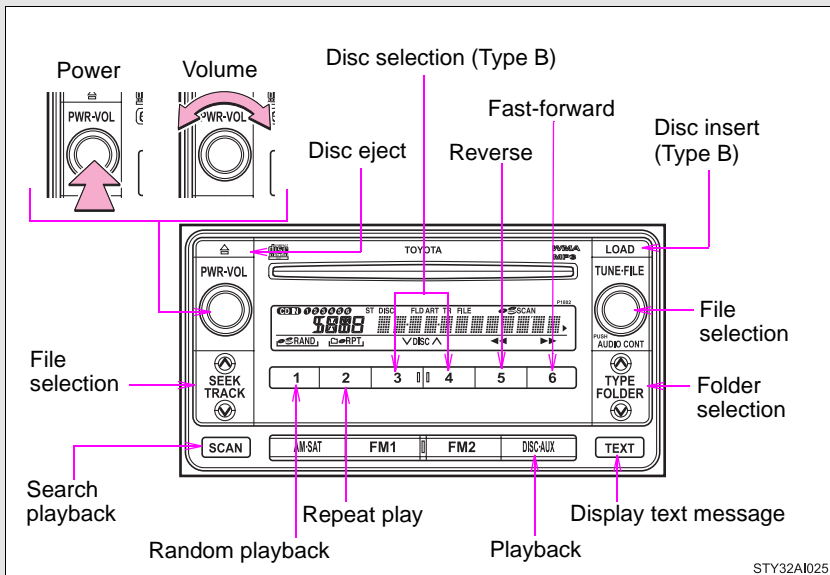

▶ Type C

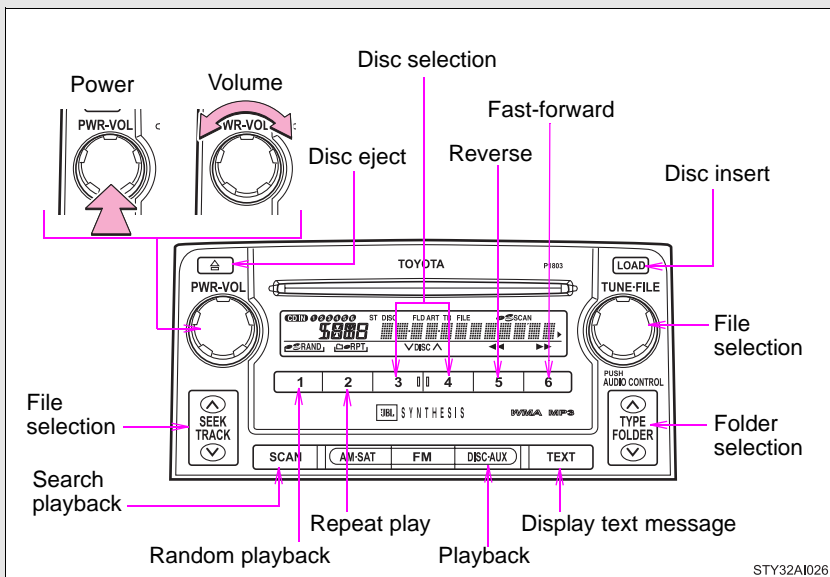

Loading MP3 and WMA discs

n Loading a disc (type A)

Insert a disc.

n Loading a disc (type B and C)



STEP 1 Press  or .

WAIT is shown on the display.

STEP 2 Insert a disc when the indicator on the slot turns from amber to green.

The display changes from WAIT to LOAD.

n Loading multiple discs (type B and C)

STEP 1 Press and hold  or  until you hear a beep.

WAIT is shown on the display.



STEP 2 Insert a disc when the indicator on the slot turns from amber to green.

The display changes from WAIT to LOAD.

The indicator on the slot turns to amber when the disc is inserted.

STEP 3 Insert the next disc when the indicator on the slot turns from amber to green again.

Repeat the procedure for the remaining discs.

To stop the operation, press  or .

Ejecting MP3 and WMA discs

n Ejecting a disc (type A)

Press  and remove the disc.

n **Ejecting a disc (type B and C)**



STEP 1 To select the disc to be ejected.

Press  or .

The number of the disc selected is shown on the display.

STEP 2 Press  or  and remove the disc.

n **Ejecting all the discs (type B and C)**

Press and hold  or  until you hear a beep, and then remove the discs.

Selecting a disc (type B and C)

n **Selecting the desired disc**



Press  or .

Selecting and scanning folders

n **Selecting folders one at a time**

To select the desired folder, press “^” or “v” on  or .



n **Scanning the desired folder by cueing the first file of each folder**

Press and hold  or  until you hear a beep.

The first 10 seconds of the first file in the each folder will be played.

When the desired folder is reached, press the button once again.

n **Returning to the first folder**

Press and hold “v” on  or  until you hear a beep.

Selecting and scanning files

n Selecting one file at a time

To select the desired file, turn the  or , or press “^” or

“v” on  or .

n Scanning the desired file by cueing the files in the folder

Press  or .

The first 10 seconds of all files in the folder will be played.

When the desired file is reached, press the button once again.

Fast-forwarding and reversing files

To fast-forward or reverse.

Press and hold  or .

Repeat play

n Repeating a file

Press .

n Repeating all of the files in the folder

Press and hold  until you hear a beep.

Random playback

n Playing files from a particular folder in random order

Press .

n Playing all of the files on a disc in random order

Press and hold  until you hear a beep.

Switching the display

Press or .

Each time the button is pressed, the display changes in the order of Folder no./File no./Elapsed time→Folder name→File name→Album title (MP3 only)→Track title→Artist name.

Display

Up to 12 characters can be displayed at a time.

If there are 13 characters or more, pressing and holding or for 1 second or more will display the remaining characters.

A maximum of 24 characters can be displayed.

If or is pressed for 1 second or more again or has not been pressed for 6 seconds or more, the display will return to the first 12 characters.

Depending on the contents recorded, the characters may not be displayed properly or may not be displayed at all.

Canceling random playback

Press again.

Canceling repeat play

Press again.

Error messages

ERROR: This indicates a problem either with the CD or inside the player. The CD may be dirty, damaged or inserted up-side down.

WAIT: Operation has stopped due to a high temperature inside the player. Wait for a while and then press or . Contact your Toyota dealer if the CD still cannot be played.

NO MUSIC: This indicates that the MP3/WMA file is not included in the CD.

▮ **Discs that can be used**

Discs with the marks shown below can be used.

Playback may not be possible depending on recording format or disc features, or due to scratches, dirt or deterioration.



▮ **MP3 and WMA player protection feature**

To protect the internal components, playback is automatically stopped when a problem is detected while the MP3 and WMA player is being used.

▮ **If discs are left inside the MP3 and WMA player or in the ejected position for extended periods**

Discs may be damaged and may not play properly.

▮ **Lens cleaners**

Do not use lens cleaners. Doing so may damage the MP3 and WMA player.

▮ **When inserting the MP3 and WMA discs**

This player can store up to six discs.

▮ **MP3 and WMA files**

MP3 (MPEG Audio LAYER3) is a standard audio compression format.

Files can be compressed to approximately 1/10 of their original size by using MP3 compression.

WMA (Windows Media[®] Audio) is a Microsoft[®] audio compression format.

This format compresses audio data to a size smaller than that of the MP3 format.

There is a limit to the MP3 and WMA file standards and to the media/formats recorded by them that can be used.

1 MP3 file compatibility

- Compatible standards
MP3 (MPEG1 LAYER3, MPEG2 LSF LAYER3)
- Compatible sampling frequencies
MPEG1 LAYER3: 32, 44.1, 48 (kHz)
MPEG2 LSF LAYER3: 16, 22.05, 24 (kHz)
- Compatible bit rates (compatible with VBR)
MPEG1 LAYER3: 64, 80, 96, 112, 128, 160, 192, 224, 256, 320 (kbps)
MPEG2 LSF LAYER3: 64, 80, 96, 112, 128, 144, 160 (kbps)
- Compatible channel modes: stereo, joint stereo, dual channel and monaural

1 WMA file compatibility

- Compatible standards
WMA Ver. 7, 8, 9
- Compatible sampling frequencies
32, 44.1, 48 (kHz)
- Compatible bit rates (only compatible with 2-channel playback)
Ver. 7, 8: CBR 48, 64, 80, 96, 128, 160, 192 (kbps)
Ver. 9: CBR 48, 64, 80, 96, 128, 160, 192, 256, 320 (kbps)

1 Compatible media

Media that can be used for MP3 and WMA playback are CD-Rs and CD-RWs.

Playback in some instances may not be possible, depending on the status of the CD-R or CD-RW. Playback may not be possible or the audio may jump if the disc is scratched or marked with fingerprints.

1 Compatible disc formats

The following disc formats can be used.

- Disc formats: CD-ROM Mode 1 and Mode 2
CD-ROM XA Mode 2, Form 1 and Form 2
- File formats: ISO9660 Level 1, Level 2, (Romeo, Joliet)
MP3 and WMA files written in any format other than those listed above may not play correctly, and their file names and folder names may not be displayed correctly.

Items related to standards and limitations are as follows.

- Maximum directory hierarchy: 8 levels
- Maximum length of folder names/file names: 32 characters
- Maximum number of folders: 192 (including the root)
- Maximum number of files per disc: 255

I File names

The only files that can be recognized as MP3/WMA and played are those with the extension .mp3 or .wma.

I Multi-sessions

As the audio system is compatible with multi-sessions, it is possible to play discs that contain MP3 and WMA files. However, only the first session can be played.

I ID3 and WMA tags

ID3 tags can be added to MP3 files, making it possible to record the track title and artist name, etc.

The system is compatible with ID3 Ver. 1.0, 1.1, and Ver. 2.2, 2.3 ID3 tags. (The number of characters is based on ID3 Ver. 1.0 and 1.1.)

WMA tags can be added to WMA files, making it possible to record the track title and artist name in the same way as with ID3 tags.

I MP3 and WMA playback

When a disc containing MP3 or WMA files is inserted, all files on the disc are first checked. Once the file check is finished, the first MP3 or WMA file is played. To make the file check finish more quickly, we recommend that you do not save any files other than MP3 or WMA files or create any unnecessary folders.

If the discs contain a mixture of music data and MP3 or WMA format data, only music data can be played.

I Extensions

If the file extensions .mp3 and .wma are used for files other than MP3 and WMA files, they will be mistakenly recognized and played as MP3 and WMA files. This may result in large amounts of interference and damage to the speakers.

1 Playback

- To play MP3 files with steady sound quality, we recommend a fixed bit rate of 128 kbps and a sampling frequency of 44.1 kHz.
- CD-R or CD-RW playback may not be possible in some instances, depending on the characteristics of the disc.
- There is a wide variety of freeware and other encoding software for MP3 and WMA files on the market, and depending on the status of the encoding and the file format, poor sound quality or noise at the start of playback may result. In some cases, playback may not be possible at all.
- When files other than MP3 or WMA files are recorded on a disc, it may take more time to recognize the disc and in some cases, playback may not be possible at all.
- Microsoft[®], Windows[®], and Windows Media[®] are registered trademarks of Microsoft Corporation in the U.S. and other countries.



NOTICE

- n **CDs and adapters that cannot be used (→P. 255)**
- n **CD player precautions (→P. 256)**

3-2. Using the audio system

Optimal use of the audio system

► Type A and B

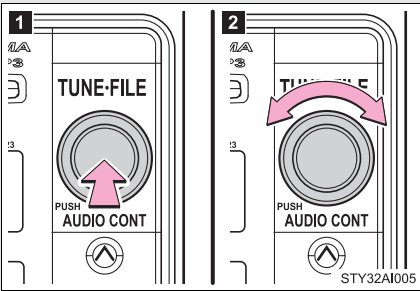

- 1 Displays the current mode
- 2 Changes the following settings

- 1 Sound quality and volume balance

The sound quality and balance settings can be changed to produce the best sound.

► Type C

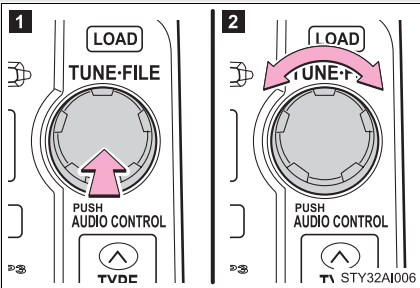



- 1 Automatic Sound Levelizer on/off (→P. 267)

- 1 Rear seat entertainment system lock on/off (→P. 268)

Using the audio control function

n Changing sound quality modes

Pressing  or  selects the mode to be changed in the following order.

BAS → MID*¹ → TRE → FAD → BAL → ASL → RSE*²

*1: Type C only

*2: Vehicles with rear seat entertainment system

n Adjusting sound quality

Turning  or  adjusts the level.

Mode displayed	Sound quality mode	Level	Turn to the left	Turn to the right
BAS	Bass*	-5 to 5	Low	High
MID	Mid-range* (type C only)	-5 to 5		
TRE	Treble*	-5 to 5		
FAD	Front/rear volume balance	R7 to F7	Shifts to rear	Shifts to front
BAL	Left/right volume balance	L7 to R7	Shifts to left	Shifts to right

*: The sound quality level is adjusted individually in each radio mode or CD mode.

n Adjusting the Automatic Sound Levelizer (ASL)

► Type A and B

When ASL is selected, turning  to the right changes the amount of ASL in the order of LOW, MID and HIGH.

Turning  to the left turns ASL off.

ASL automatically adjusts the volume and tone quality according to vehicle speed.

► Type C

When ASL is selected, turning  to the right turns ASL on, and

turning  to the left turns ASL off.

ASL automatically adjusts the volume and tone quality according to the noise level as you drive your vehicle.

n Setting the rear seat entertainment system lock (if equipped)

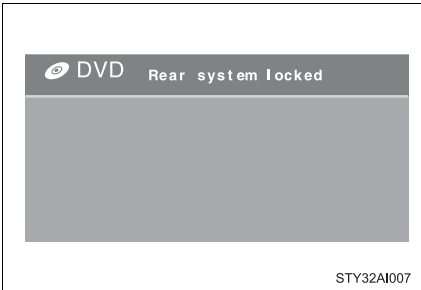

When RSE is selected, turn



until ON/OFF is displayed.

The rear seat entertainment system lock remains on, even when the engine switch is turned off.

n Trademark owned by SRS Labs, Inc. (type A and B)



The audio systems utilize SRS FOCUS[®] and SRS TruBass[®] audio enhancement technologies, under license from SRS Labs, Inc., in all modes except AM radio mode.

FOCUS, TruBass, SRS and  symbols are trademarks of SRS Labs, Inc.

FOCUS and TruBass technologies are incorporated under license from SRS Labs, Inc.

3-2. Using the audio system Using the AUX adapter

This adapter can be used to connect a portable audio device and listen to it through the vehicle's speakers.

STEP 1

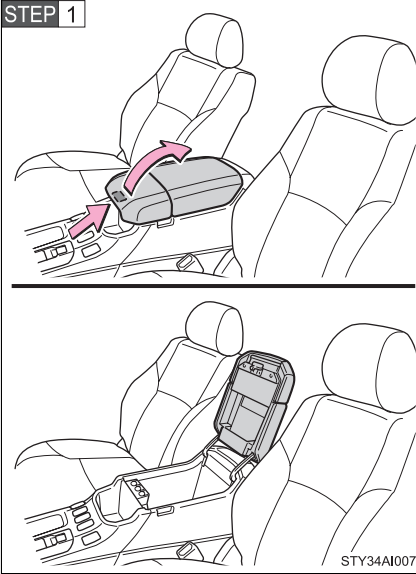

Pull up the console box lid while pushing the lock release button.

STEP 2

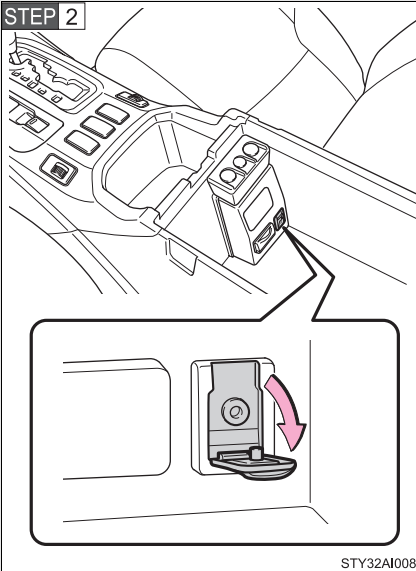

Connect the portable audio device.

► Type A and B

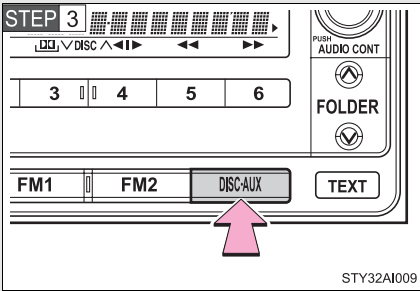

Press .

► Type C

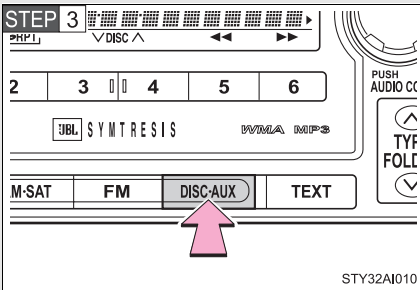

Press .

■ **Operating portable audio devices connected to the audio system**

The volume can be adjusted using the vehicle's audio controls. All other adjustments must be made on the portable audio device itself.

■ **When using a portable audio device connected to the power outlet**

Noise may occur during playback. Use the battery power source of the portable audio device to reduce noise.

3-2. Using the audio system

Using the steering wheel audio switches (if equipped)

Some audio features can be controlled using the switches on the steering wheel.

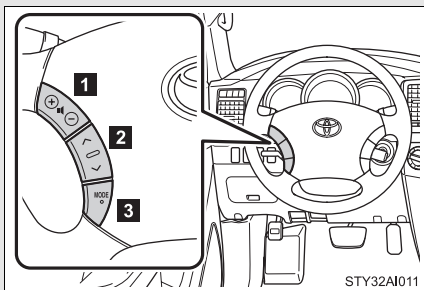



- 1 Volume
- 2 Radio: Select radio stations
CD: Select tracks, files (MP3 and WMA) and discs
DVD: Select tracks and chapters
- 3 Power on, select audio source

Turning on the power

Press  when the audio system is turned off.

The audio system can be turned off by holding the switch down until the system turns off.

Changing the audio source

Press  when the audio system is turned on. The audio source changes as follows, each time  is pressed.

CD player without changer:

FM1 → FM2 → CD → AUX → AM

CD player with changer:

FM1 → FM2 → CD changer → AUX → AM → SAT1* → SAT2* → SAT3*

*: Type B and C

Adjusting the volume

Press “+” on  to increase the volume and “-” to decrease the volume.

Press and hold “+” or “-” on  to continue increasing or decreasing the volume.

Selecting a radio station

STEP 1 Press  to select the radio mode.

STEP 2 Press “^” or “v” on  to select a preset station.

To scan for receivable stations, press and hold the switch until you hear a beep.

Selecting a track/file

STEP 1 Press  to select the CD mode.

STEP 2 Press “^” or “v” on  to select the desired track/file.

Selecting a disc in the CD player (CD player with changer only)

STEP 1 Press  to select the CD mode.

STEP 2 Press and hold “^” or “v” on  until you want to listen to is set.

 CAUTION

n To reduce the risk of an accident

Exercise care when operating the audio switches on the steering wheel.

3-3. Using the rear audio/video system

Rear seat entertainment system (if equipped)

The rear seat entertainment system is designed for the rear passengers to enjoy audio and DVD video separately from the front audio system.

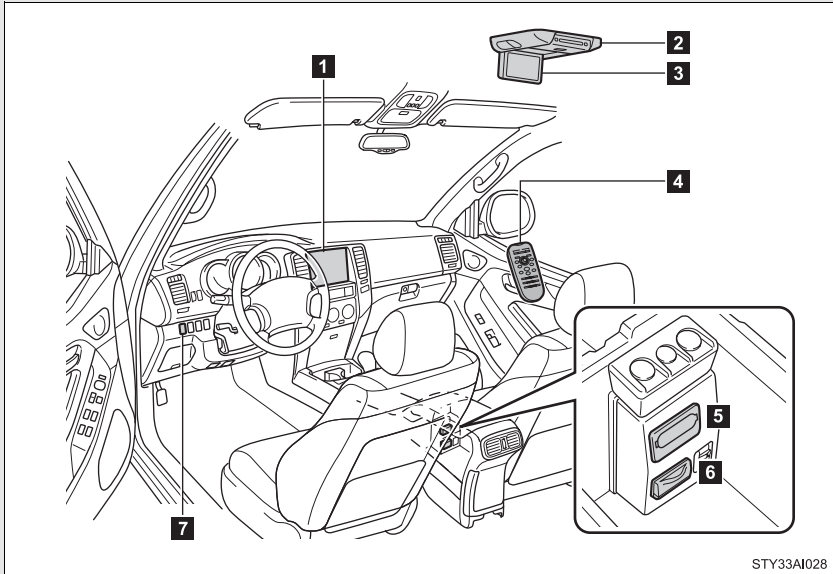

STY33AI028

- 1** Front audio system
- 2** DVD player
- 3** Display
- 4** Rear seat entertainment system remote controller
- 5** A/V input adapter (→P. 294)
- 6** Power outlet (→P. 329)
- 7** Power outlet main switch (→P. 329)

Opening and closing the display

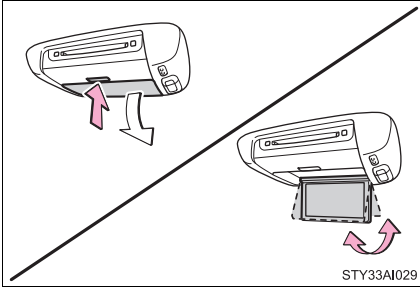

Press the lock release button to open the display.

Pull the display down to an easily viewable angle (between 90° and 125°).

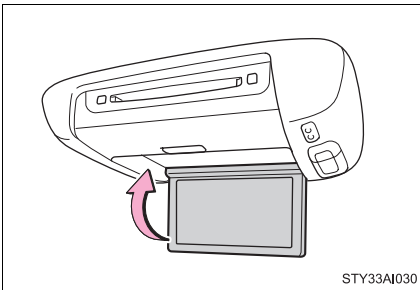

To close the display, push the display up until a click is heard.

The illumination of the screen is automatically turned off when the display is closed. However, the rear seat entertainment system is not turned off.

Loading a disc

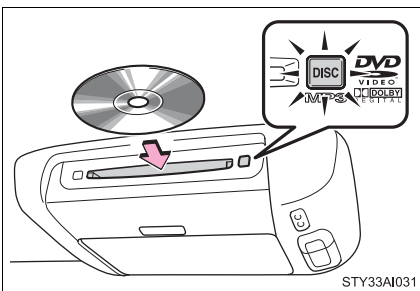



Insert the disc into the slot with the label side up.

The DISC indicator light turns on while the disc is loaded.

The player will play the track or chapter, and will repeat it after it reaches the end.

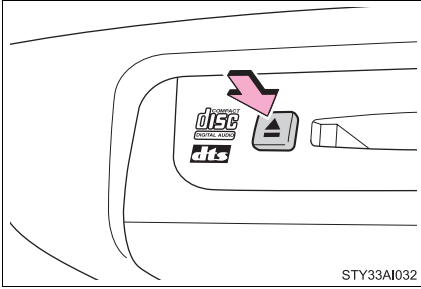
Ejecting a disc



Press  and remove the disc.

■ The rear seat entertainment system can be used when

The engine switch is in the ACC or ON position.

■ Discs that can be used

Discs with the marks shown below can be used.

Playback may not be possible depending on recording format or disc features, or due to scratches, dirt or deterioration.



■ When appears on the screen

It indicates that the selected switch cannot work.

■ Rear seat entertainment system lock

→P. 268

■ Error messages

DISC CHECK: Indicates that the disc is dirty, damaged or was inserted upside down. Clean the disc or insert it correctly.

REGION CODE ERROR: Indicates that the DVD region code is not set properly.

DVD ERROR: Indicates that there is a problem inside the player. Eject the disc. Set the disc again. If the malfunction still exists, take the vehicle to your Toyota dealer.

■ Before using the remote controller (for new vehicle owners)

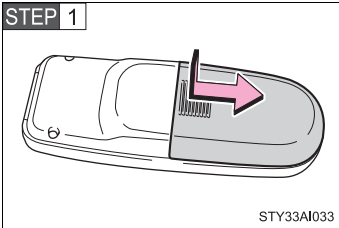

Remove the cover.

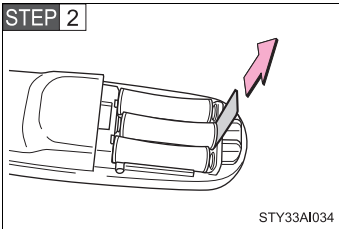

Remove the insulating sheet.

■ When the remote controller battery is fully depleted

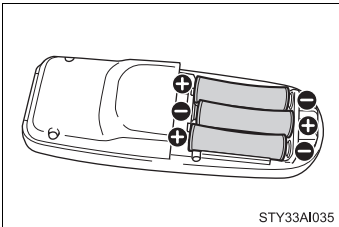

Remove the depleted batteries and install 3 new AA batteries.

n **If the remote controller batteries are discharged**

The following symptoms may occur.

- l The rear seat entertainment system control will not function properly.
- l The operational range is reduced.

n **When replacing the AA batteries**

Batteries can be purchased at your Toyota dealer, electric appliance shop, or camera stores.

Replace only with the same or equivalent type recommended by a Toyota dealer.

Dispose of used batteries according to local laws.

n **Headphones**

With some headphones generally available in the market, sound quality may be poor. Toyota recommends the use of Toyota genuine wireless headphones.

Please contact your Toyota dealer for further details.

n **Volume**

Conversational speech on some DVDs is recorded at a low volume to emphasize the impact of sound effects. If you adjust the volume assuming that the conversations represent the maximum volume level that the DVD will play, you may be startled by louder sound effects or when you change to a different audio source. Be sure to adjust the volume with this in mind.

⚠ CAUTION**n While driving**

Do not use headphones.

Doing so may cause an accident, resulting in death or serious injury.

n When the rear seat entertainment system is not used

Keep the display closed.

In the event of an accident or sudden braking, the opened display may hit an occupant's body, resulting in injury.

n To prevent accidents and electric shock

Do not disassemble or modify the remote controller.

n When the remote controller is not used

Stow the remote controller.

Injuries may result in the event of an accident or sudden braking.

n Removed batteries and other parts

Keep away from children.

These parts are small and if swallowed by a child they can cause choking.

⚠ NOTICE**n For normal operation after replacing the batteries**

Observe the following precautions to prevent accidents.

1 Always work with dry hands.

Moisture may cause the battery to rust.

1 Do not touch or move any other components inside the remote controller.

1 Do not bend any of the battery terminals.

3-3. Using the rear audio/video system

Using the DVD player (DVD video)

n Remote controller

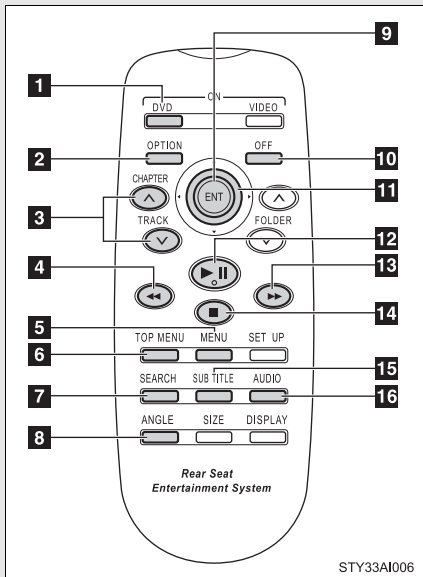

- 1** Turning on the DVD mode
- 2** Turning on/off the control icon screen
- 3** Selecting a chapter
- 4** Reversing a disc
- 5** Turning on the menu screen
- 6** Turning on the title selection screen
- 7** Searching the title
- 8** Changing the screen angle
- 9** Inputting the selected control icon
- 10** Turning off the screen
- 11** Selecting a control icon
- 12** Playing/pausing a disc
- 13** Fast-forwarding a disc
- 14** Stopping a disc
- 15** Changing the subtitle language
- 16** Changing the audio language

n Control icon screen (Page1)

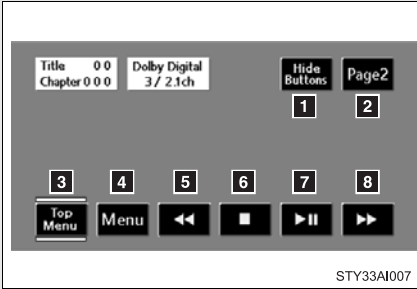

STY33AI007

- 1 Turning off the control icon screen on the screen
- 2 Displaying control icon screen page 2
- 3 Turning on/off the title selection screen for the disc
- 4 Turning on/off the menu screen for the disc
- 5 Reversing a disc
- 6 Stopping a disc
- 7 Playing/pausing a disc
- 8 Fast-forwarding a disc

n Control icon screen (Page2)

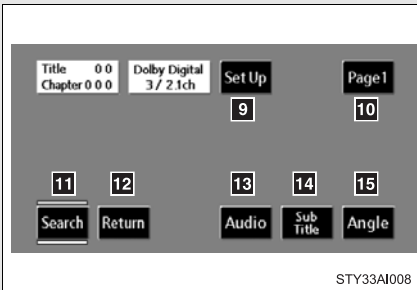

STY33AI008

- 9 Displaying the initial setting screen
- 10 Displaying control icon screen page 1
- 11 Searching the title
- 12 Returning to the previous screen
- 13 Changing the audio language
- 14 Changing the subtitle language
- 15 Changing the angle

 NOTICE

n Cleaning the screen

Wipe the screen with a dry soft cloth.

If the screen is wiped with a rough cloth, the surface of the screen may be scratched.

n To prevent damage to the remote controller

I Keep the remote controller away from direct sunlight, heat and high humidity.

I Do not drop or knock the remote controller against hard objects.

I Do not sit on or place heavy objects on the remote controller.

n DVD player



Never try to disassemble or oil any part of the DVD player. Do not insert anything other than a disc into the slot.

Turning on/off the control icon screen



Press  to turn on the control icon screen.

Press  once again or select  to turn off the control icon screen.

Turning on the title selection screen

Press  or select  to turn on the title selection screen. For the operation of the title selection screen, see the separate manual for the DVD disc.

Turning on the menu screen

Press  or select  to turn on the menu screen. For the operation of the menu screen, see the separate manual for the DVD disc.

Returning to the previous screen

Select **Return** to return to the previous screen. For the operation of the menu screen, see the separate manual for the DVD disc.

Searching for a title

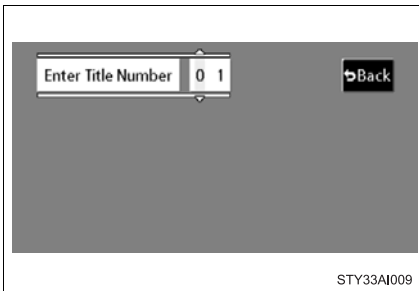

Press **SEARCH** or select **Search** to display the screen to search for a title.

Select the title number, and press



to input it.

Select **Back** to return to the previous screen.

Changing the subtitle language

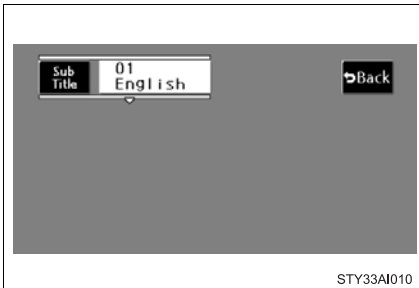



Press **SUB TITLE** or select **Sub Title** to display the subtitle language screen.

Each time **SUB TITLE** is pressed or **Sub Title** is selected, another language stored on the disc is selected.

Select **Back** to return to the previous screen.

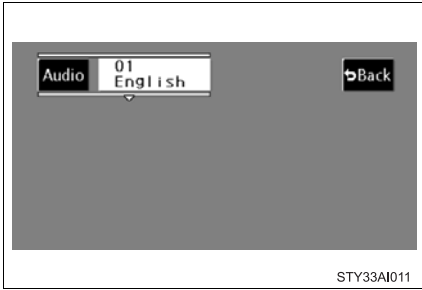
Changing the audio language



Press  or select **Audio** to display the audio language screen.

Each time  is pressed or **Audio** is selected, another language stored on the disc is selected.

Select **Back** to return to the previous screen.

Changing the angle



Press  or select **Angle** to display the screen to change the angle.

Each time  is pressed or **Angle** is selected, the angle changes.

Select **Back** to return to the previous screen.





■ DVD player and DVD video discs

This DVD player is compatible with NTSC color TV formats. DVD video discs conforming to other formats such as PAL or SECAM cannot be used.

■ Region codes

Some DVD video discs have a region code indicating where you can use them. If the DVD video disc is not labeled “ALL” or “1”, you cannot use it in this DVD player. If you attempt to play an inappropriate DVD video disc in this player, “REGION CODE ERROR” appears on the screen. Even if the DVD video disc does not have a region code, in some cases you cannot use it.

■ Marks shown on DVD video discs

NTSC	Indicates NTSC format of color TV.
	Indicates the number of audio tracks.
	Indicates the number of language subtitles.
	Indicates the number of angles.
	Indicates the screen to be selected. Wide screen: 16:9 Standard: 4:3
	Indicates regions in which this video disc can be played. All: all countries Number: region code

■ DVD video disc glossary

- 1 DVD video discs: Digital Versatile Discs that hold world's standard video. DVD video discs have adopted "MPEG2", one of the world standards of digital compression technologies. The picture data is compressed by 1/40 on average and stored. Variable rate encoded technology has been adopted in which the volume of data assigned to the picture is changed depending on the picture format. Audio data is stored using PCM and Dolby digital, which enables higher sound. Furthermore, multi-angle and multi-language features will also help you enjoy the more advanced technology of DVD video.
- 1 Viewer restrictions: This feature limits what can be viewed in conformity with the level of restrictions of the country. The level of restrictions varies depending on the DVD video disc. Some DVD video discs cannot be played at all, or violent scenes are skipped or replaced with other scenes.
 - Level 1: DVD video discs for children can be played.
 - Level 2 - 7: DVD video discs for children and G-rated movies can be played.
 - Level 8: All types of DVD video discs can be played.
- 1 Multi-angle feature: Allows you to enjoy the same scene at different angles.
- 1 Multi-language feature: Allows you to select the language of the subtitles and audio.
- 1 Region codes: Region codes are provided on DVD players and DVD discs. If the DVD video disc does not have the same region code as the DVD player, you cannot play the disc on the DVD player.
- 1 Audio: This DVD player can play linear PCM, Dolby digital, dts and MPEG audio format DVD. Other decoded type cannot be played.
- 1 Title and chapter: Video and audio programs stored on DVD video discs are divided into sections by title and chapter.
- 1 Title: The largest unit of the video and audio programs stored on DVD video discs. Usually, one piece of a movie, one album, or one audio program is assigned as a title.
- 1 Chapter: A unit smaller than a title. A title comprises multiple chapters.

n Audio

Manufactured under license from Dolby Laboratories. “Dolby”, “Pro Logic”, and the double-D symbol are trademarks of Dolby Laboratories.

Confidential unpublished works.

©1992-1997 Dolby Laboratories. All rights reserved.

This product incorporates copyright protection technology that is protected by method claims of certain U.S. patents and other intellectual property rights owned by Macrovision Corporation and other rights owners. Use of this copyright protection technology must be authorized by Macrovision Corporation, and is intended for home and other limited viewing uses only unless otherwise authorized by Macrovision Corporation. Reverse engineering or disassembly is prohibited.

“dts” is a trademark of Digital Theater Systems, Inc.

3-3. Using the rear audio/video system

Using the DVD player (video CD)

n Remote controller

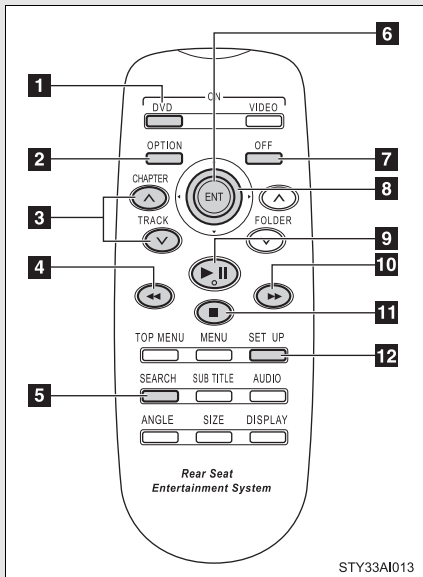

- 1 Turning on the DVD mode
- 2 Turning on/off the control icon screen
- 3 Selecting a chapter
- 4 Reversing a disc
- 5 Display operation switches
- 6 Inputting the selected control icon
- 7 Turning off the screen
- 8 Selecting a control icon
- 9 Playing/pausing a disc
- 10 Fast-forwarding a disc
- 11 Stopping a disc
- 12 Changing the initial setting

n Control icon screen (Page1)

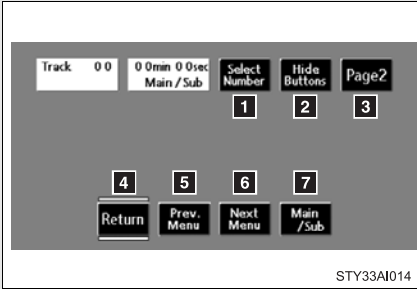

STY33AI014

- 1 Selecting a disc menu number
- 2 Turning off the menu screen
- 3 Displaying control icon screen page 2
- 4 Turning on the disc menu
- 5 Returning to the previous page screen (with the disc menu displayed)
- 6 Proceeding to the next page screen (with the disc menu displayed)
- 7 Changing to a multiplex transmission

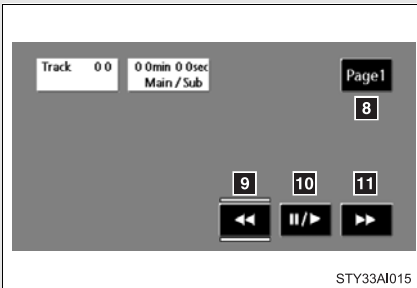

n Control icon screen (Page2)





STY33AI015

- 8 Displaying control icon screen page 1
- 9 Reversing a disc
- 10 Playing/pausing a disc
- 11 Fast-forwarding a disc

Selecting a disc menu number

Press  or select  to display the disc menu number search screen.

Select the disc menu number, and press  to input it.

Select  to return to the previous screen.

Using the DVD player (audio CD/CD text)

n Control screen

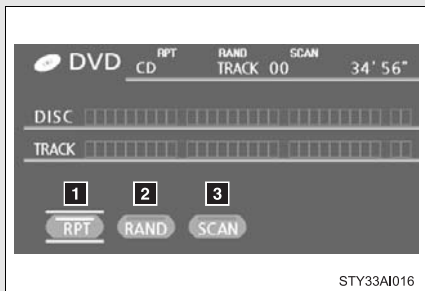

Press  to display the control screen.

- 1** Repeat play
- 2** Random playback
- 3** Search playback

Repeat play

n Repeating a track

Select .

Random playback

n Playing all of the tracks on a CD in random order

Select .

Search playback

n Scanning tracks

STEP 1 Select .

The first 10 seconds of each track will be played.

STEP 2 Select  again when the desired track is reached.

n Canceling repeat play and random playback

Select  or  once again.

3-3. Using the rear audio/video system

Using the DVD player (MP3 discs)

n Control screen

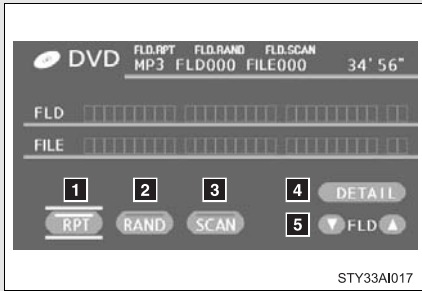

Press  to display the control screen.



- 1 Repeat play
- 2 Random playback
- 3 Search playback
- 4 Displaying file information
- 5 Selecting a folder

Repeat play

n Repeating a file

Select .

n Repeating all of the files in the folder



Select , and press and hold .

Random playback

n Playing files from a particular folder in random order

Select .

n Playing all of the files on a disc in random order



Select , and press and hold .

Selecting and scanning folders

n Selecting folders one at a time

To select the desired folder, select  or .

n Scanning the desired folder by cueing the first file of each folder

STEP 1 Select , and press and hold .

The first 10 seconds of the first file in the each folder will be played.

STEP 2 When the desired folder is reached, select  once again.

Scanning files

n Scanning the desired file by cueing the files in the folder

STEP 1 Select .

The first 10 seconds of all files in the folder will be played.

STEP 2 When the desired file is reached, select  once again.

Displaying file information.

Select .

n Canceling repeat play and random playback

Select  or  once again.

3-3. Using the rear audio/video system

Using the video mode

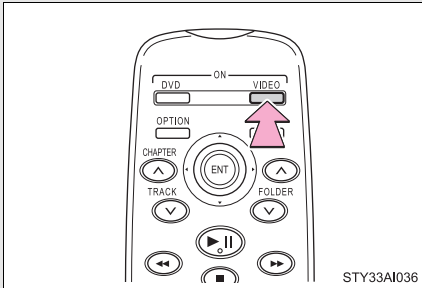

Press  to select the video mode.

Before switching to the video mode, connect the audio source to the A/V input adapter.

Using the A/V input adapter

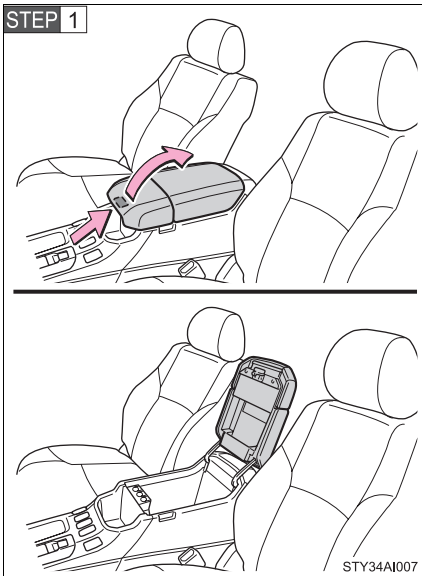

Pull up the console box lid while pushing the lock release button.

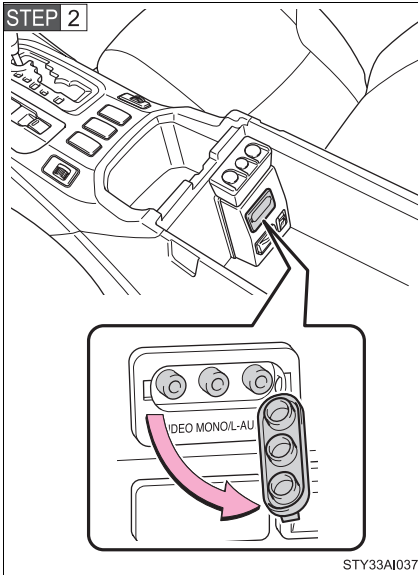

Open the cover.

The A/V input adapter is composed of 3 input adapters.

Yellow: Image input adapter

White: Left channel audio input adapter

Red: Right channel audio input adapter

n After plugging the cord into the adapter

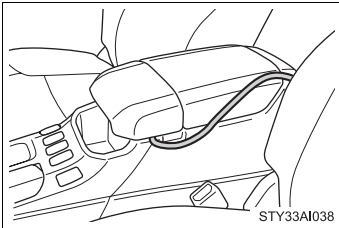

Let it go through the gap between the console box and the tray. Use a cord which is thin enough to go through the gap. Close the console box lid.

n A/V input adapter

The rear seat entertainment system plays videos and sound when audio-visual equipment is connected to the A/V input adapter. For details, refer to the manufacturer's instructions.

n Power outlet

The power outlet can be used to connect the audio-visual device. (→P. 329)

 NOTICE

n When the A/V input adapter is not in use

Keep the A/V input adapter cover closed.

Inserting anything other than an appropriate plug may cause electrical failure or a short circuit.

Changing the Setup Menu settings

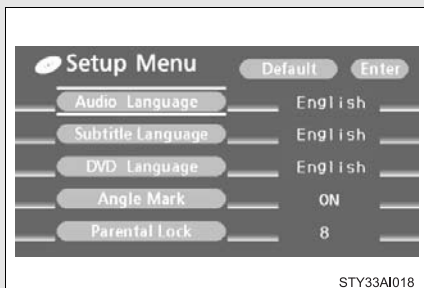

Press  or select **Set Up** to display the initial setting screen.

The following settings can be customized here.

- 1 Audio language
- 1 Subtitle language
- 1 DVD language
- 1 Angle mark
- 1 Parental lock

Changing the audio language

STEP 1 Select  .



Select the language you want to hear, and press  to input it.

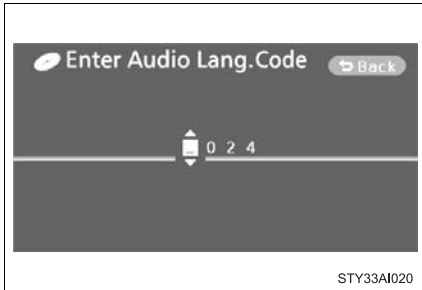

Select **Others** if you cannot find the language you would like to hear.

Enter the appropriate 4-digit language code. (→P. 302)

Select a number, and press

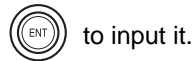



to input it.

If a code that is not in the list is entered, "Incorrect Code" will appear on the screen.

Changing the subtitle language

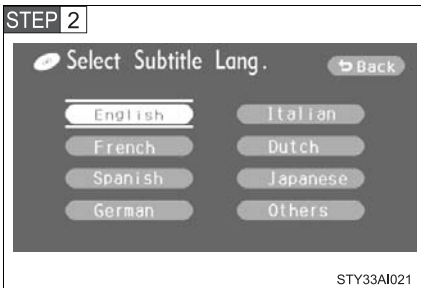
STEP 1 Select **Subtitle Language**.



Select the language you would like to read, and press  to input it.

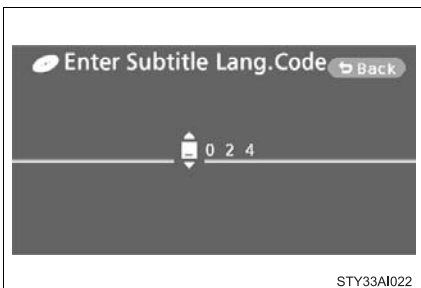

Select **Others** if you cannot find the language you would like to read.

Enter the appropriate 4-digit language code. (→P. 302)

Select a number, and press

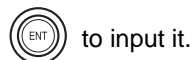

to input it.

If a code that is not in the list is entered, "Incorrect Code" will appear on the screen.

Changing the DVD language

STEP 1 Select **DVD Language**.



Select the language you would like to hear and press  to input it.



Select **Others** if you cannot find the language you would like to hear.

Enter the appropriate 4-digit language code. (→P. 302)

Select a number, and press

 to input it.

If a code that is not in the list is entered, "Incorrect Code" will appear on the screen.

Turning on/off the angle mark

The angle mark can be turned on for discs that are multi-angle compatible.

Each time you press  when **Angle Mark** is selected, the angle mark turns on or off.

Setting viewer restriction levels

Setting a personal code allows the viewer restriction to be used.

STEP 1 Select **Parental Lock** .

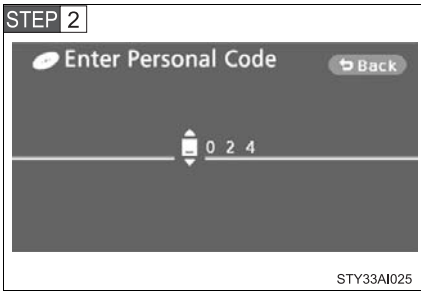

Enter a personal code and press



The setting cannot be changed unless a personal code is entered.

When you forget a personal code, initialize a personal code. (→P. 302)

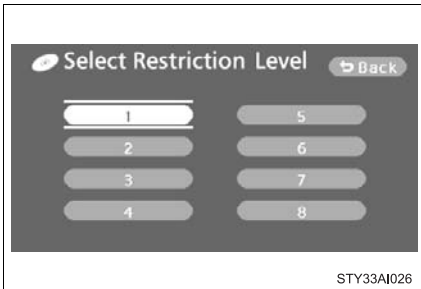

Select a restriction level (1-8),

and press  . The smaller the level number, the stricter the restrictions.

Initializing all menus

Select **Default** .

Turning off the Setup Menu screen

Select **Enter** .

Setting the display mode

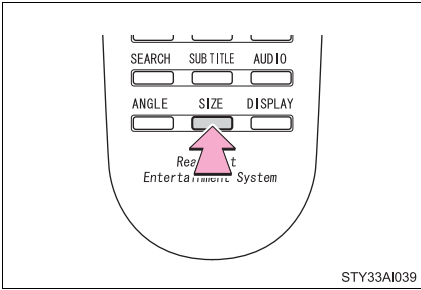

Pressing  changes the display mode sequentially as follows:

Normal → Wide 1 → Wide 2

Returning to the previous screen

Select  to return to the previous screen.

n To initialize the password

Press ◀ on the remote controller or unit ten times when the Enter Personal Code screen is displayed.

n Language code list

Code	Language
0514	English
0618	French
0405	German
0920	Italian
0519	Spanish
2608	Chinese
1412	Dutch
1620	Portuguese
1922	Swedish
1821	Russian
1115	Korean
0512	Greek
0101	Afar
0102	Abkhazian
0106	Afrikaans
0113	Amharic
0118	Arabic
0119	Assamese
0125	Aymara
0126	Azerbaijani
0201	Bashkir
0205	Byelorussian
0207	Bulgarian

Code	Language
0208	Bihari
0209	Bislama
0214	Bengali
0215	Tibetan
0218	Breton
0301	Catalan
0315	Corsican
0319	Czech
0325	Welsh
0401	Danish
0426	Bhutani
0515	Esperanto
0520	Estonian
0521	Basque
0601	Persian
0609	Finnish
0610	Fiji
0615	Faroese
0625	Frisian
0701	Irish
0704	Scots-Gaelic
0712	Galician
0714	Guarani

Code	Language
0721	Gujarati
0801	Hausa
0809	Hindi
0818	Croatian
0821	Hungarian
0825	Armenian
0901	Interlingua
0905	Interlingue
0911	Inupiak
0914	Indonesian
0919	Icelandic
0923	Hebrew
1001	Japanese
1009	Yiddish
1023	Javanese
1101	Georgian
1111	Kazakh
1112	Greenlandic
1113	Cambodian
1114	Kannada
1119	Kashmiri
1121	Kurdish
1125	Kirghiz
1201	Latin
1214	Lingala
1215	Laothian
1220	Lithuanian
1222	Latvian
1307	Malagasy
1309	Maori

Code	Language
1311	Macedonian
1312	Malayalam
1314	Mongolian
1315	Moldavian
1318	Marathi
1319	Malay
1320	Maltese
1325	Burmese
1401	Nauru
1405	Nepali
1415	Norwegian
1503	Occitan
1513	(Afan) Oromo
1518	Oriya
1601	Punjabi
1612	Polish
1619	Pashto, Pushto
1721	Quechua
1813	Rhaeto-Romance
1814	Kirundi
1815	Romanian
1823	Kinyarwanda
1901	Sanskrit
1904	Sindhi
1907	Sangho
1908	Serbo-Croatian
1909	Sinhalese
1911	Slovak
1912	Slovenian
1913	Samoan

Code	Language
1914	Shona
1915	Somali
1917	Albanian
1918	Serbian
1919	Siswati
1920	Sesotho
1921	Sundanese
1923	Swahili
2001	Tamil
2005	Telugu
2007	Tajik
2008	Thai
2009	Tigrinya
2011	Turkmen
2012	Tagalog

Code	Language
2014	Setswana
2015	Tonga
2018	Turkish
2019	Tsonga
2020	Tatar
2023	Twi
2111	Ukrainian
2118	Urdu
2126	Uzbek
2209	Vietnamese
2215	Volapük
2315	Wolof
2408	Xhosa
2515	Yoruba
2621	Zulu

n Adjusting the screen

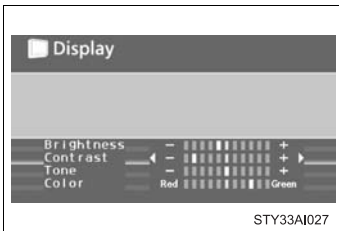

Press  .

Select the brightness, contrast, tone or color, and make adjustments. Press

 or  to input it.

	“-” or “Red”	“+” or “Green”
Brightness	Darkens	Brightens
Contrast	Weakens the contrast	Strengthens the contrast
Tone*	Weakens the tone	Strengthens the tone
Color*	Strengthens the red color	Strengthens the green color

* : The screen tone and color can be adjusted in DVD or video mode.

Interior lights list

Your Toyota is equipped with an illuminated entry system to assist in entering the vehicle. Due to the function of the system, the lights shown in the following illustration automatically turn on/off according to whether the doors are locked/unlocked, whether the doors are opened/closed, the engine switch position and the vehicle's speed.

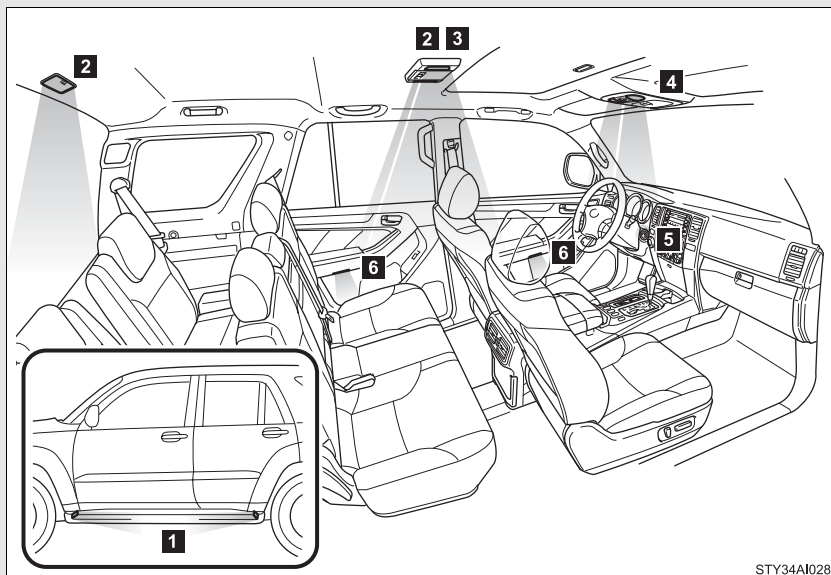

- 1** Running board lights (if equipped)
- 2** Interior lights (→P. 307)
- 3** Personal/interior lights (→P. 307)
- 4** Personal lights (→P. 306)
- 5** Engine switch light
- 6** Door courtesy lights

STY34Al028

n To prevent the battery from being discharged

All of the lights will automatically turn off when the key is removed and the door is left open for more than 30 minutes.

n Customization that can be configured at Toyota dealer

Settings (e.g. The time elapsed before lights turn off) can be changed.
(Customizable features →P. 495)

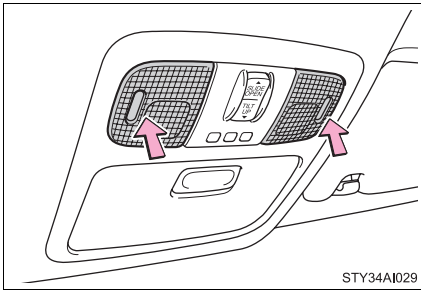
Personal lights

On/off

Personal/interior lights

n Center (vehicles with rear seat entertainment system)

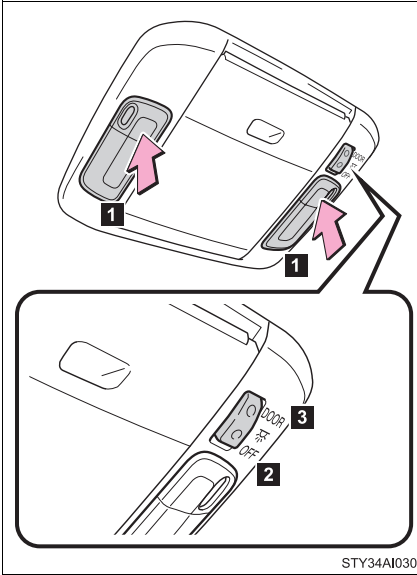

1 On/off

2 OFF

3 DOOR position

Interior light

► Center (vehicles without rear seat entertainment system)

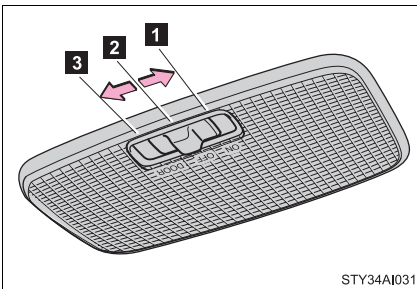

1 ON

2 OFF

3 DOOR position

► Rear

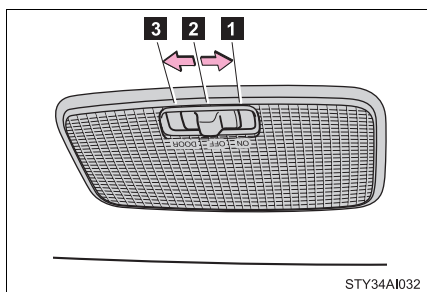

- 1** ON
- 2** OFF
- 3** DOOR position

3-5. Using the storage features

List of storage features

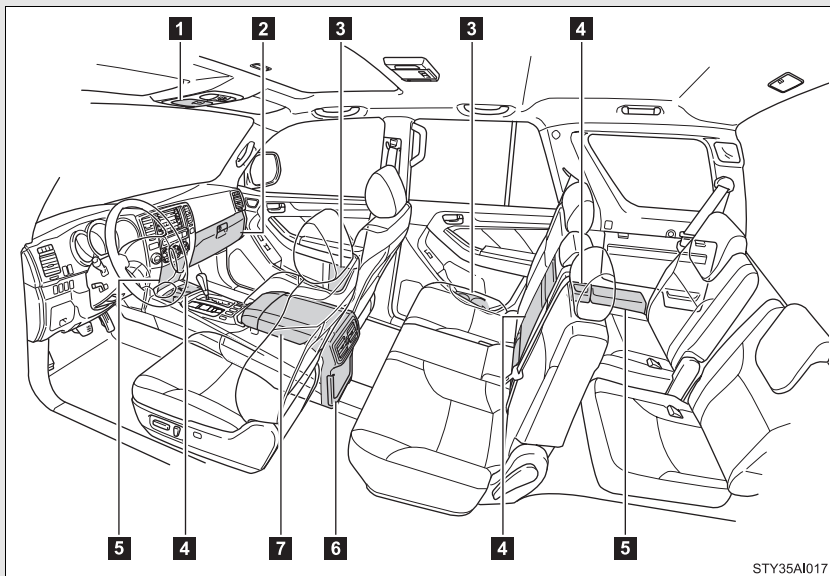

1 Overhead console

2 Glove box

3 Bottle holders

4 Cup holders

5 Auxiliary boxes

6 Trash holder

7 Console box

Coin holder

Tissue pocket

Glove box

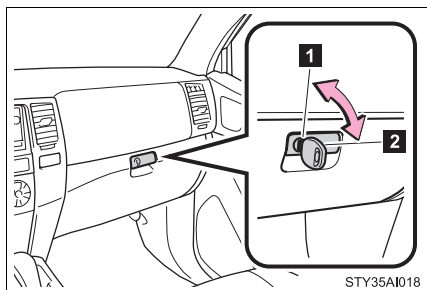

- 1 Unlock with the master key
- 2 Lock with the master key

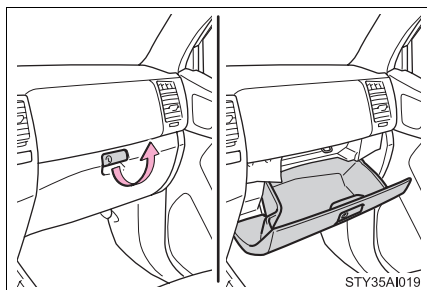

Pull the lever up.

n Auxiliary box in the glove box (if equipped)

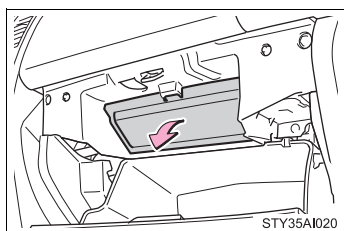

Open the lid.

⚠ CAUTION

n Caution while driving

Keep the glove box closed.

Injuries may result in the event of an accident or sudden braking.

Coin holder

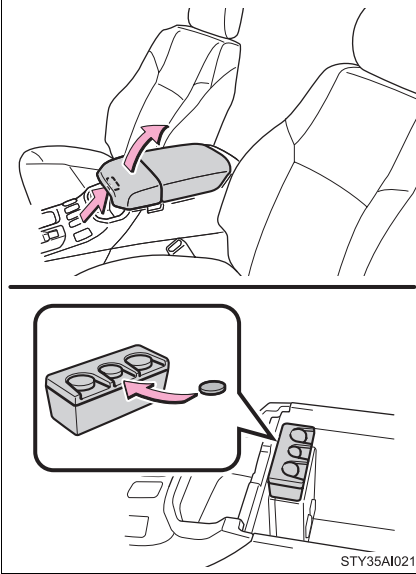

Pull up the console box lid while pushing the lock release button.

n The coin holder can be removed

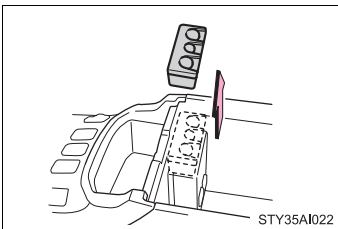

Pull the coin holder up.

Console box

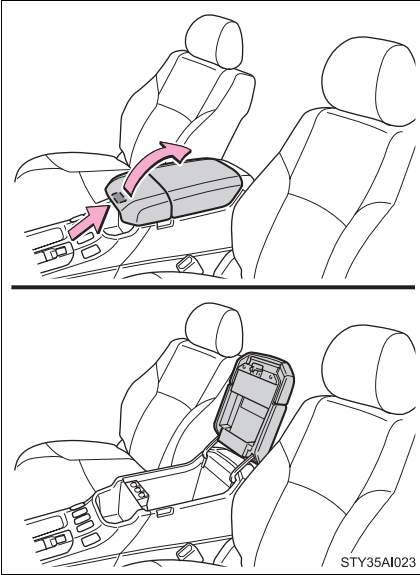

Pull up the console box lid while pushing the lock release button.

n When using the console box as a table

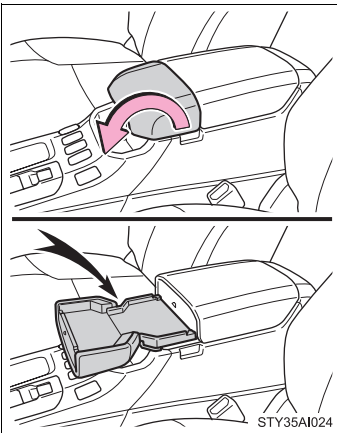

Lift the lid.

⚠ CAUTION**n Caution while driving**

Keep the console box closed.
Injuries may result in the event of an accident or sudden braking.

⚠ NOTICE**n Console box table weight capacity**

Do not place any object heavier than 2.2 lb. (1 kg) on console box table.

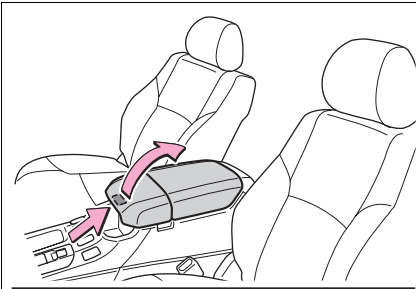
Tissue pocket

Pull up the console box lid while pushing the lock release button.

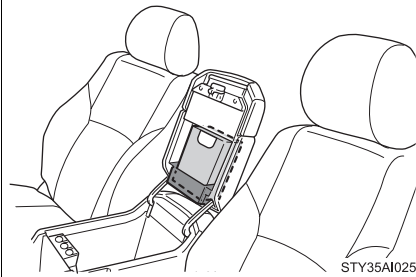

⚠ CAUTION

n Caution while driving

Keep the console box closed.

Injuries may result in the event of an accident or sudden braking.

Trash holder

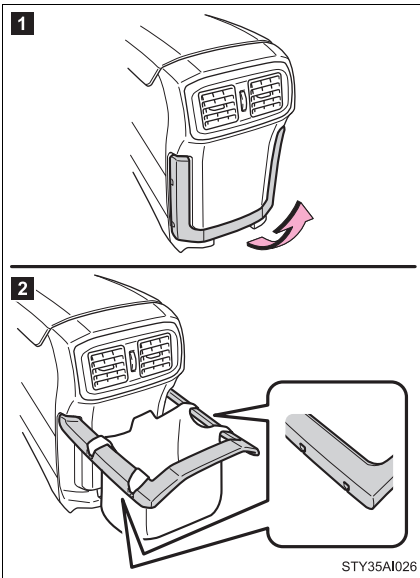

1 Raise the trash holder.

2 Fit the grocery bag onto the holder by hanging its handles on the two hooks indicated at the left and right.

The trash holder can support to 2.2 lb. (1 kg).

n If the trash holder is pulled strongly or stepped on

Trash holder will detach from the console box.

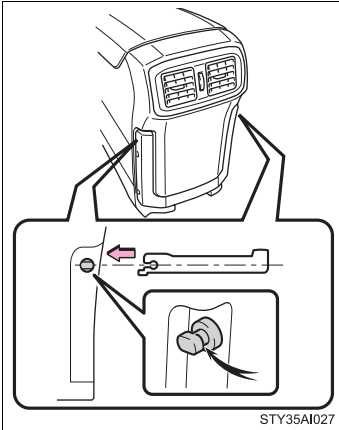

Reinstall it in a horizontal direction as indicated in the illustration. It cannot be installed in any other direction.

⚠ NOTICE

n To prevent damage to the trash holder

Do not deliberately pull or step on the trash holder, as it may be damaged or broken.

Overhead console

The overhead console is useful for temporarily storing sunglasses and similar small items.

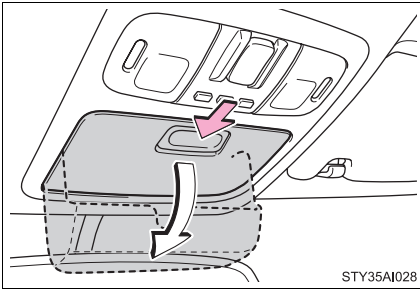

Push the knob forward.

⚠ CAUTION

■ Items that should not be left in the overhead console

Do not leave glasses or lighters in the console.

If the interior of the vehicle become hot, lighters may explode and glasses may warp or becomes cracked.

■ Caution while driving

Do not leave the overhead console open while driving.

Items stored in it may fall out and cause injury.

Cup holders

► Front

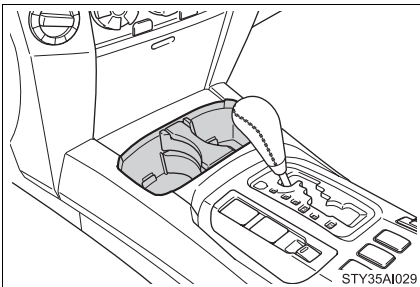

► Center (vehicles without third seats)

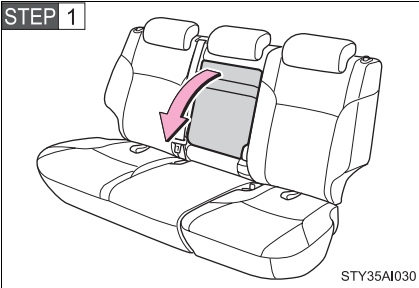

Pull the armrest down.

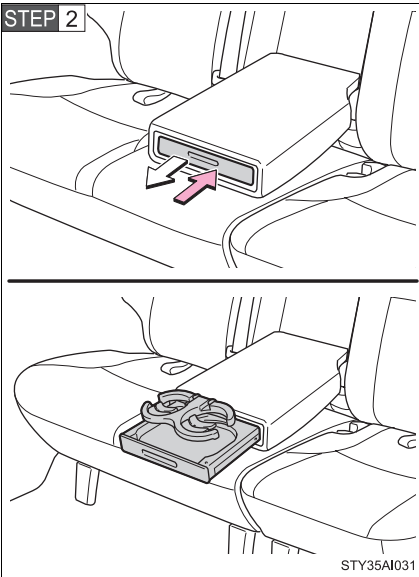

To open, press in and release the cup holder on the armrest.

► Center (vehicles with third seats)

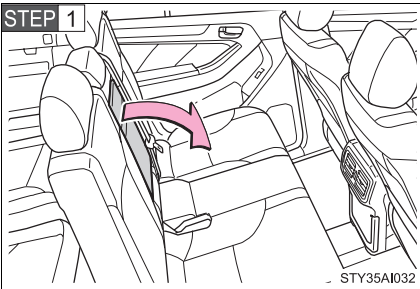

Pull the armrest down.

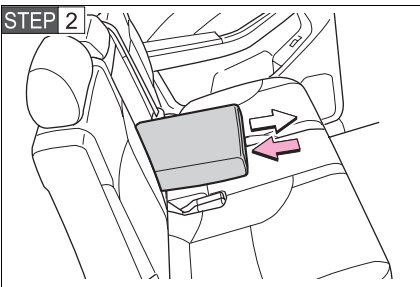

To open, press in and release the cup holder on the armrest.

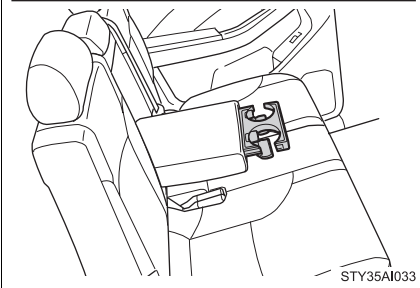

► Rear (vehicles with third seats)

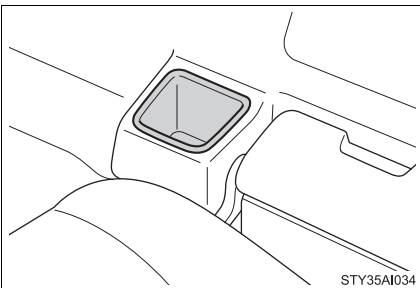

n Removing the holder (front)

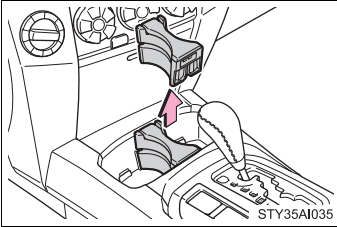

Pull the holder up.

n The position of the holder can be changed (front)

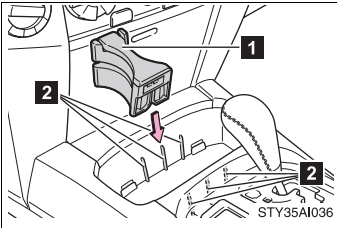

1 Holder

2 Tab

Change the position of the holder.

n The holder can be adjusted (front)

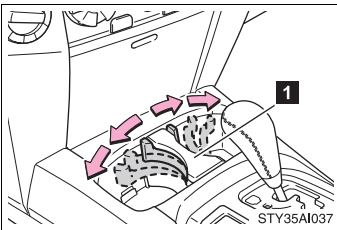

1 Holder

Adjust the holder.

■ **Tray in the cup holder (vehicles without third seats)**

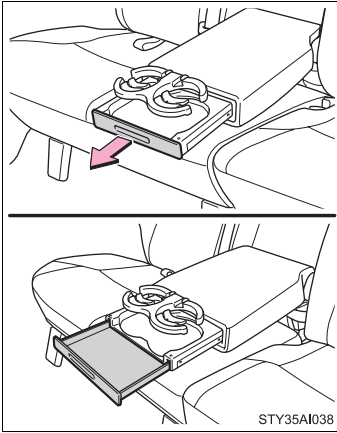

Pull the lid.

⚠ CAUTION

■ **Items unsuitable for the cup holder**

Do not place anything other than cups or aluminum cans in the cup holders. Other items may be thrown out of the holders in the event of an accident or sudden braking and cause injury. If possible, cover hot drinks to prevent burns.

■ **When not in use**

Second seat cup holder: Keep the cup holders closed. Injuries may result in the event of an accident or sudden braking.

Bottle holders

► Front

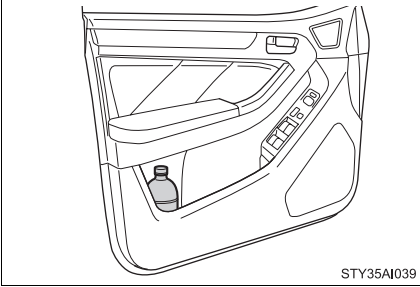

► Rear

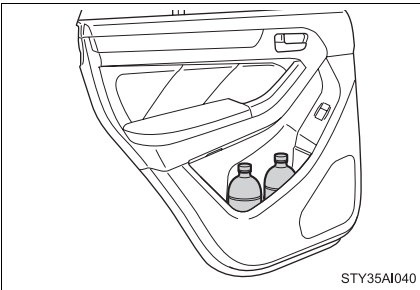

NOTICE

n Items that should not be stowed in the bottle holders

Put the cap on before stowing a bottle. Do not place open bottles in the bottle holders, or glasses and paper cups containing liquid. The contents may spill and glasses may break.

Auxiliary boxes

► Instrument panel

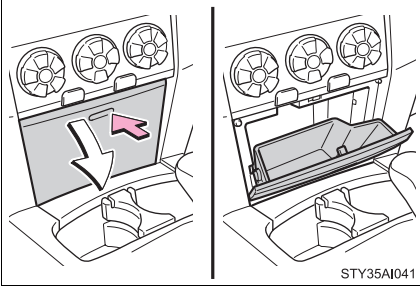

Push on the lid.

► Rear

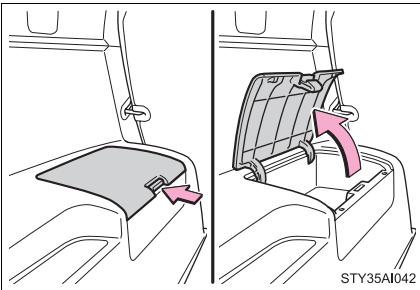

Push the knob to release the lock. Lift the lid.

⚠ CAUTION

■ Caution while driving

Keep the auxiliary boxes closed.

Injuries may result in the event of an accident or sudden braking.

3-6. Other interior features

Sun visors

n Main visor

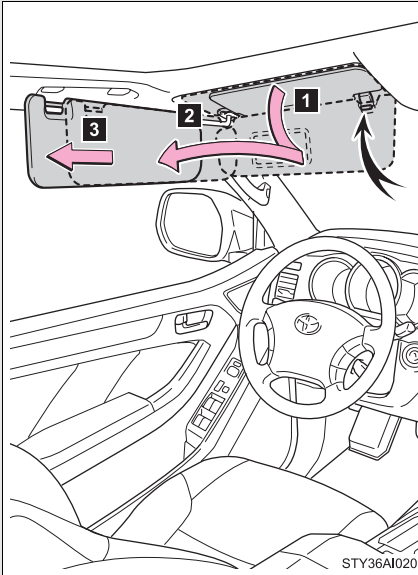

1 Forward position:

Flip down.

2 Side position:

Flip down, unhook, and swing to the side.

3 Side extender:

Place in side position then slide backwards.

n Sub visor

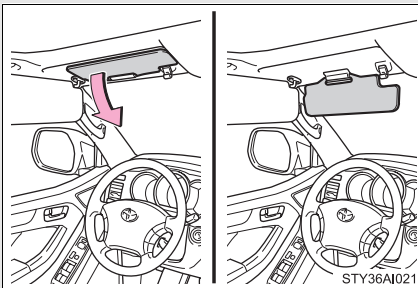

Flip down.

3-6. Other interior features

Vanity mirrors

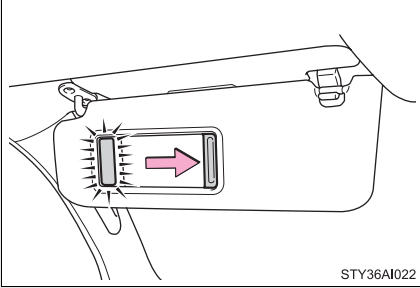

Slide the cover.

The light turns on when the cover is opened.

Clock

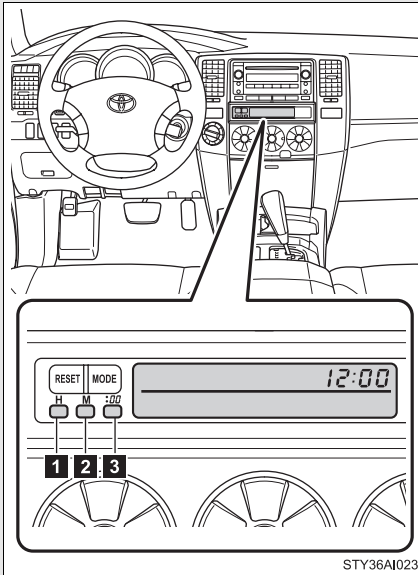

- 1** Adjusts the hours.
- 2** Adjusts the minutes.
- 3** Rounds to the nearest hour.*

*: e.g. 1:00 to 1:29 → 1:00
1:30 to 1:59 → 2:00

n For quicker adjustment of the clock

Push the :00 button.

n The clock is displayed when

The engine switch is in the ACC or ON position.

n When disconnecting and reconnecting battery terminals

The time display will automatically be set to 1:00.

Outside temperature display

► Air conditioning system with DUAL button

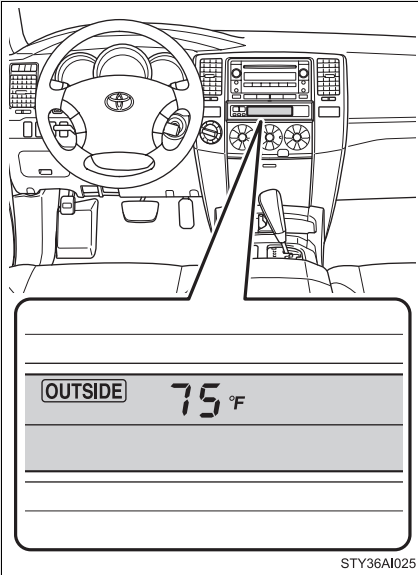

Displays the outside air temperature.

The temperature range that can be displayed is from -22°F (-30°C) to 122°F (50°C).

► Air conditioning system without DUAL button

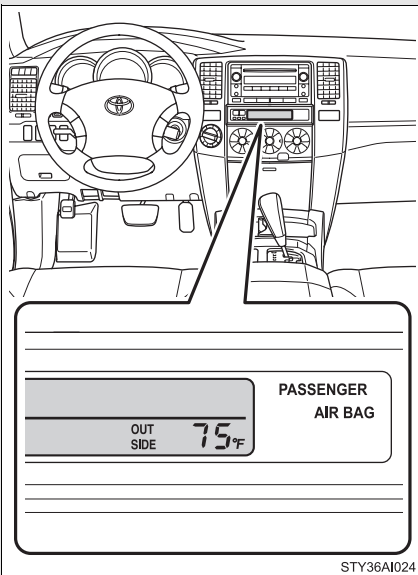

Displays the outside air temperature.

The temperature range that can be displayed is from -22°F (-30°C) to 122°F (50°C).

n **When --°C or --°F is displayed**

The system may be malfunctioning. Take your vehicle to your Toyota dealer.

n **The outside air temperature is displayed when**

The engine switch is in the ON position.

n **Display**

In the following situations, the correct outside temperature may not be displayed, or the display may take longer than normal to change.

- l When stopped, or driving at low speeds (less than 12 mph [20 km/h])
- l When the outside temperature has changed suddenly (at the entrance/exit of a garage, tunnel, etc.)

3-6. Other interior features

Rear side-view mirrors (if equipped)

Rear side-view mirrors are useful as a secondary means of checking the area to the rear of the vehicle.

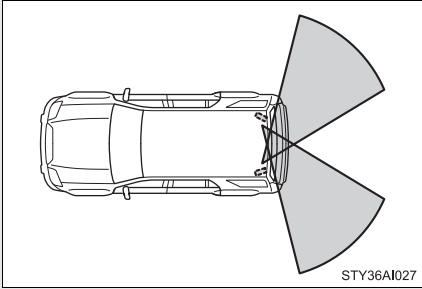
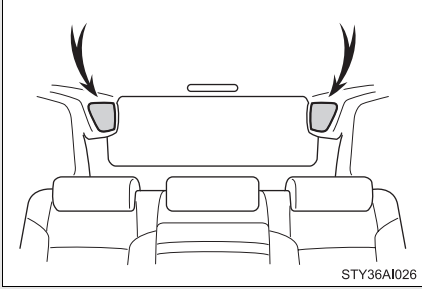

Carefully check the area to the rear of the vehicle by either looking directly or using both outside and inside rear view mirrors.

Power outlets

The power outlet can be used for a following component.

12 V: Accessories that run on less than 10 A.

115V AC: Accessories that use less than 100 W.

► Instrument panel (12 V)

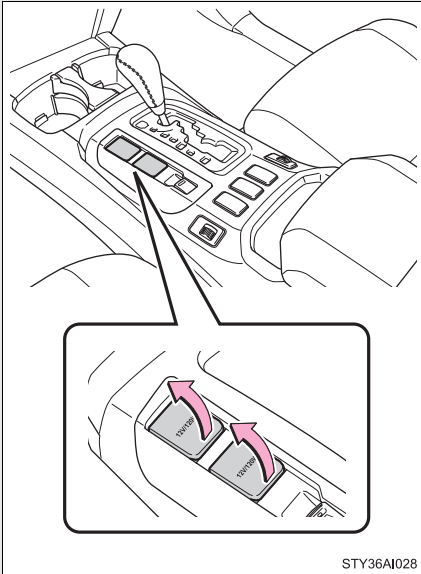

► Inside the console box (115 V AC)*

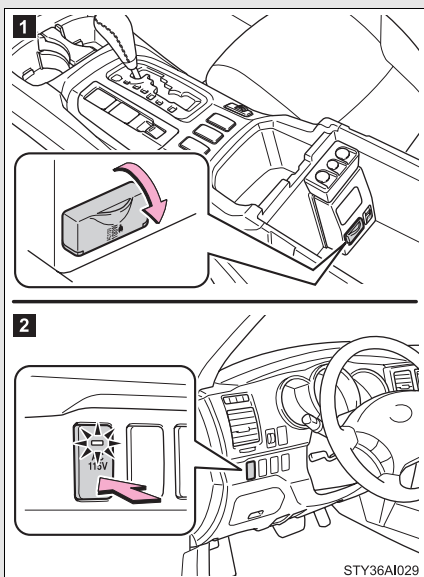

1 Power outlet socket

Open the console box.
(→P. 312)

2 Main switch

To use the power outlet, turn
on the main switch.

The indicator comes on.

► Luggage compartment (12V)

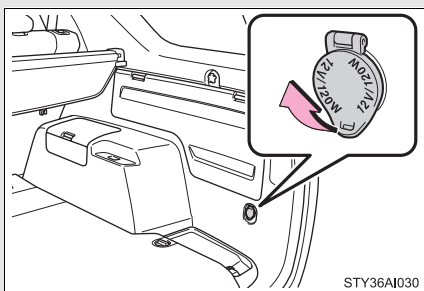

*: If equipped

n The power outlet can be used when

▶ **12V**

The engine switch is in the ACC or ON position.

▶ **115V AC**

The engine switch is in the ON position.

⚠ CAUTION

n Using a power outlet

Observe the following precautions to reduce the risk of injury.

- l Use of the power outlet when it is wet with drinking water or snow may result in electrical shocks and is extremely dangerous. The power outlet must be thoroughly dried before use.
- l Do not allow children to use or play with the power outlet.
- l Be careful not to get any part of your body caught in the power outlet lid.
- l When using electrical appliances, strictly follow any cautions and notices written on their labels and in the manufacturers' instruction manuals.
- l Do not modify, disassemble or repair the power outlet or its inverter, in any way. Doing so may result in unexpected malfunctions or accidents, which could cause serious damage or injuries. Contact a Toyota dealer for any necessary repairs.

n To prevent injuries and accidents, securely fix all electric appliances before use and do not use any appliances that may do any of the following:

- l Distract the driver while driving, or hamper safe driving.
- l Result in a fire or burn injuries due to the appliance rolling, falling or overheating while driving.
- l Emit steam, while the windows of the cabin are closed.

 CAUTION

n To prevent unexpected accidents, such as electric shocks, do not perform any of the following.

- l Using the power outlet for electric heaters while sleeping.
- l Contaminating the power outlet with liquid substances or mud.
- l Handling electrical appliance plugs at the power outlet with wet hands or feet.
- l Inserting foreign objects into the power outlet.
- l Using malfunctioning electric appliances.
- l Inserting inappropriate or badly fitting plugs into the power outlet.

 NOTICE

n To avoid damaging the power outlet and the plug

- l Close the power outlet lid when not in use.
- l Foreign objects or liquids that enter the power outlet may cause a short circuit.
- l Do not use plug adaptors to connect too many plugs to the power outlet.
- l After inserting a plug, gently close the power outlet lid.

n To prevent the fuse from being blown

▶ **12V**

Do not use an accessory that uses more than 12 V 10 A.

▶ **115V AC**

Do not use a 115V AC appliance that requires more than 100 W.

If a 115V AC appliance that consumes more than 100 W is used, the protection circuit will cut the power supply.

 NOTICE**n Appliances that may not operate properly (115V AC)**

The following 115V AC appliances may not operate even if their power consumption is under 100 W.

- l Appliances with high initial peak wattage
- l Measuring devices that process precise data
- l Other appliances that require an extremely stable power supply

n To prevent the battery from being discharged

Turn off all the vehicle's electronic equipment and accessories, such as the headlights and air conditioning, when electrical appliances that consume in excess of 100W are used continuously for long periods of time.

n To prevent any damage caused by heat

- l Do not use any electrical appliances that give off intense heat such as toasters, in any locations including the internal or external trim, seats and deck.
- l Do not use any electrical appliances, which are easily affected by vibration or heat, inside the vehicle.
Vibration while driving, or the heat of the sun while parking, may result in damage to those electrical appliances.

n If any electrical appliances are to be used while driving

Securely fasten both the appliances and their cables to prevent them from falling or getting caught any of the power train components.

n If the power outlet is loose when an electrical appliance plug is connected

Replace the outlet.
Contact a Toyota dealer for any necessary replacements.

n If the power outlet gets dirty

Turn the main switch off and use a soft, clean cloth to wipe it gently.
Do not use any cleansing materials, such as organic solvents, wax, or compound cleaners, as these may damage the power outlet or cause it to malfunction.

3-6. Other interior features

Seat heaters (if equipped)

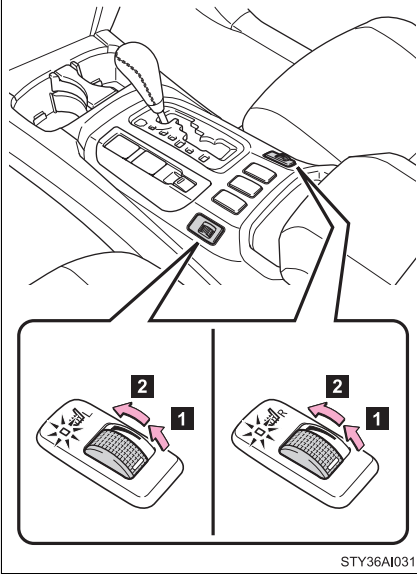

1 On

The indicator comes on.

2 Adjusts the seat temperature.

The further you turn the dial upward, the warmer the seat becomes.

■ The seat heaters can be used when

The engine switch is in the ON position.

■ When not in use

Turn the dial fully downward. The indicator turns off.

 **CAUTION****n Burns**

- I** Use caution when seating the following persons in a seat with the seat heater on to avoid the possibility of burns:
- Babies, small children, the elderly, the sick and the disabled
 - Persons with sensitive skin
 - Persons who are fatigued
 - Persons who have taken alcohol or drugs that induce sleep (sleeping drugs, cold remedies, etc.)
- I** Do not cover the seat with anything when using the seat heater. Using the seat heater with a blanket or cushion increases the temperature of the seat and may lead to overheating.

 **NOTICE****n To prevent seat heater damage**

Do not put unevenly weighted objects on the seat and do not stick sharp objects (needles, nails, etc.) into the seat.

n To prevent battery discharge

Turn the switches off when the engine is not running.

3-6. Other interior features

Armrest

▶ Vehicles without third seats

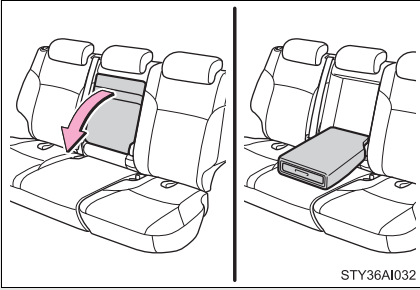

Pull the armrest down for use.

▶ Vehicles with third seats

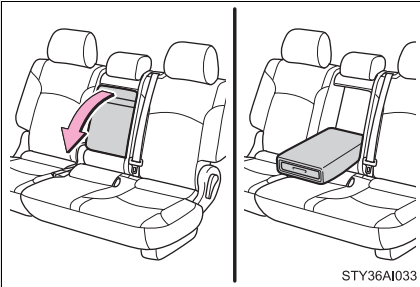

Pull the armrest down for use.

NOTICE

n To prevent damage to the armrest

- !** Do not place too much strain on the armrest.
- !** Do not sit on the armrest.

3-6. Other interior features

Floor mat

Securely place a mat that matches the size of the space on the carpet.

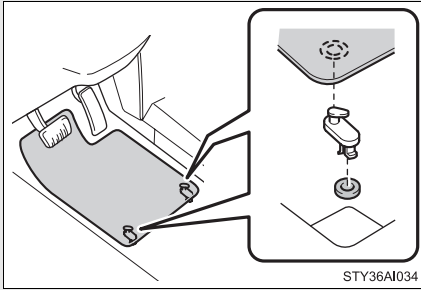

Secure the driver's floor mat using the hooks provided.

⚠ CAUTION

n When inserting the floor mat

Observe the following precautions.

Failure to do so may result in the floor mat slipping and interfering with the movement of the pedals during driving, resulting in an accident.

- I** Make sure the floor mat is properly placed on the vehicle carpet and the correct side faces upward.
- I** Do not place floor mats on top of existing mats.

3-6. Other interior features

Luggage compartment features

n Tie-down hooks

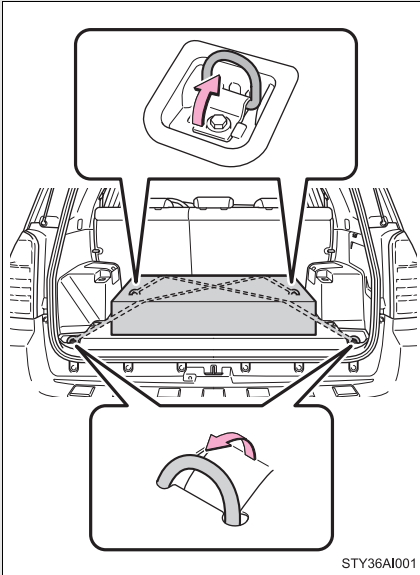

Tie-down hooks are provided for securing loose items.

n Cargo net hooks

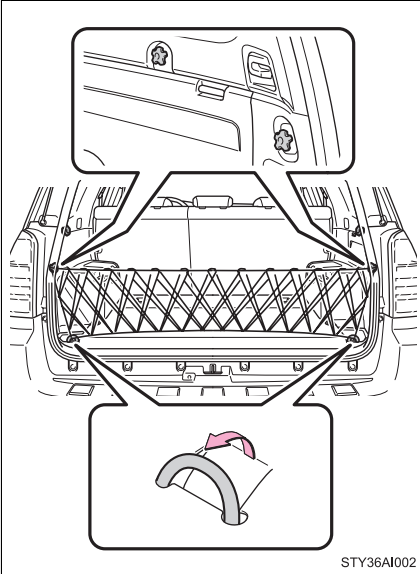

To hang the cargo net, use the cargo net hooks.

The cargo net itself is not included as original equipment.

n **Shopping bag hooks (if equipped)**

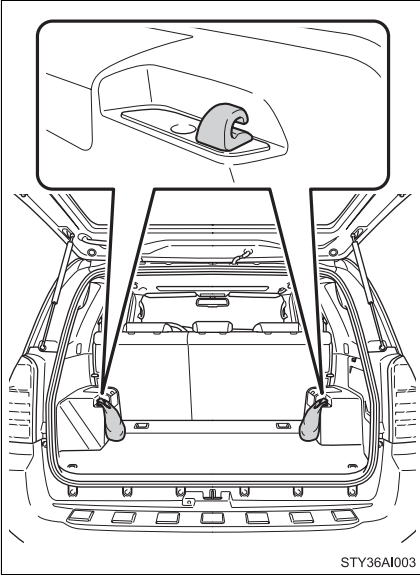

To hang shopping bags, use the shopping bag hooks.

n Luggage cover (if equipped)

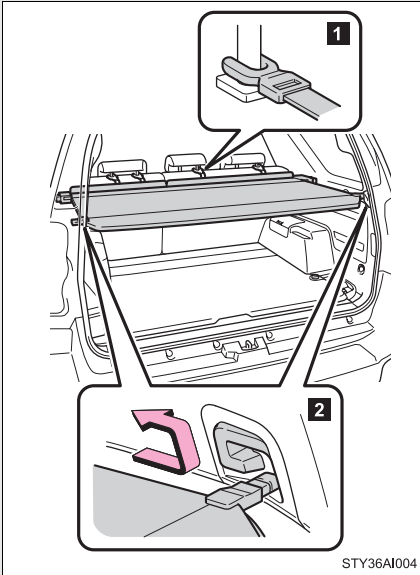

- 1** Attach the front hooks of the luggage cover to the head restraint.
- 2** Pull out the rear luggage cover and hook it on the anchors.

n Double deck (if equipped)

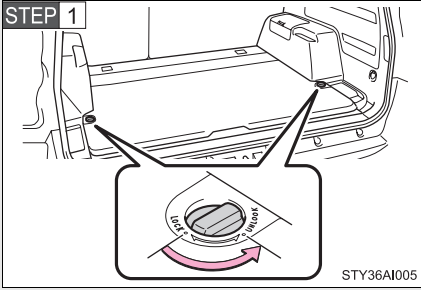

Turn the knobs to the UNLOCK position.

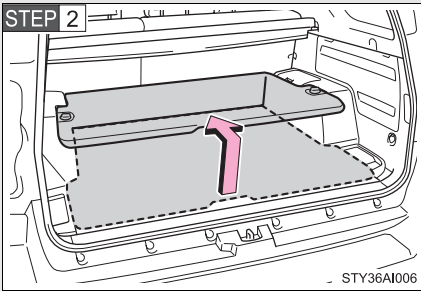

Lift the deck.

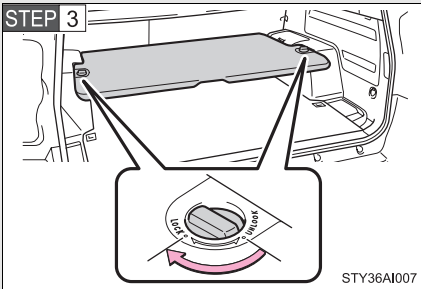

Turn the knobs to the LOCK position.

n Auxiliary box

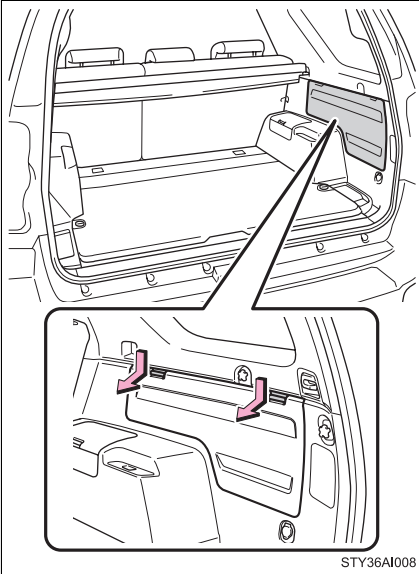

Open the cover.

n When using the holding belts (auxiliary box)

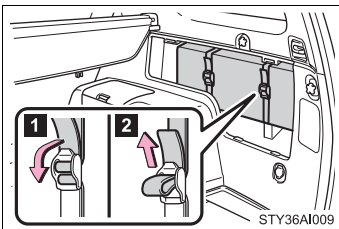

1 To loosen: Pull the buckle forward.

2 To tighten: Pull on the belt.

⚠ CAUTION

n When the tie-down hooks are not in use

To avoid injury, always return the tie-down hooks to their retracted positions when they are not in use.

n Caution while driving

Keep the double deck locked. Injuries may result in the event of an accident or sudden braking.

⚠ NOTICE

n Shopping bag hooks weight capacity

Do not hang any object heavier than 2.2 lb. (1 kg) on shopping bag hooks.

n Double deck weight capacity

Do not place any object heavier than 66 lb. (30 kg) on double deck.

Removing luggage cover (if equipped)

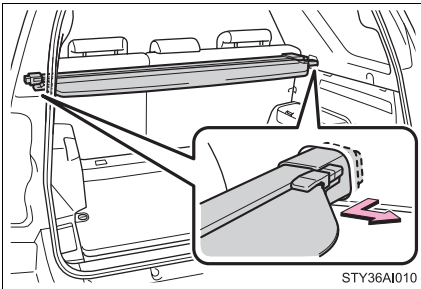

Retract the cover and release both ends, then lift it out.

After removing the luggage cover, place it somewhere other than the passenger compartment.

⚠ CAUTION

n Caution while driving

Do not place anything on the luggage cover. Such items may be thrown about and possibly injure people in the vehicle during sudden braking or an accident.

Garage door opener (if equipped)

The garage door opener can be programmed to operate garage doors, gates, entry doors, door locks, home lighting systems, security systems, and other devices.

The garage door opener (HomeLink[®] Universal Transceiver) is manufactured under license from HomeLink[®].

Programming the HomeLink[®] (for U.S.A. owners)

The HomeLink[®] compatible transceiver in your vehicle has 3 buttons which can be programmed to operate 3 different devices. Refer to the programming method below appropriate for the device.

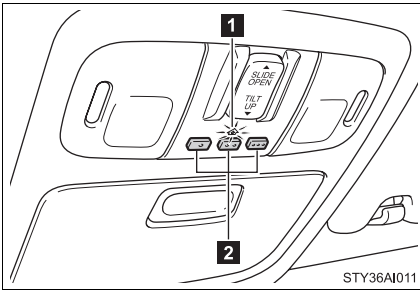

1 Indicator

2 Buttons

n Programming the HomeLink[®]

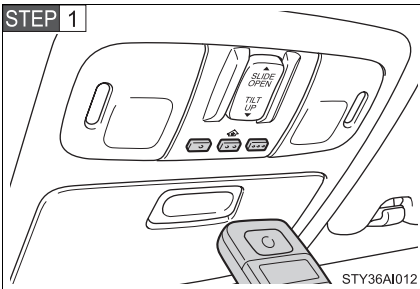

Point the remote control transmitter for the device 1 to 3 in. (25 to 75 mm) from the HomeLink[®] control buttons.

Keep the indicator on the HomeLink[®] in view while programming.

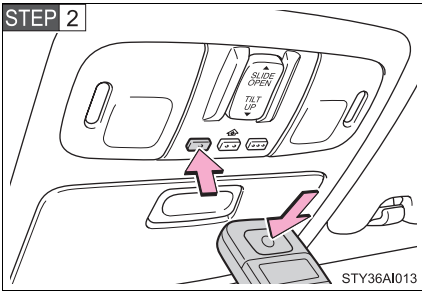

Press and hold down one of the buttons on the HomeLink[®] and the button on the transmitter. When the indicator on the HomeLink[®] changes from a slow to a rapid flash after 20 seconds, you can release both buttons.

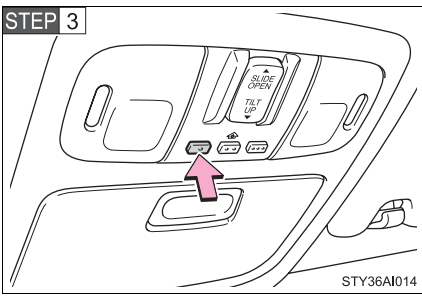

Test the operation of the HomeLink[®] by pressing the newly programmed button.

If programming a garage door opener, check to see if the garage door opens and closes. If the garage door does not operate, see if your garage transmitter is of the Rolling Code type. Press and hold the programmed HomeLink[®] button. The garage door has the rolling code feature if the indicator (on the HomeLink[®]) flashes rapidly for 2 seconds and then remains lit. If your transmitter is the Rolling Code type, proceed to the heading "Programming a rolling code system".

STEP 4 Repeat the steps above to program another device for each of the remaining HomeLink[®] buttons.

n **Programming a Rolling Code system (for U.S.A. owners)**

If your device is Rolling Code equipped, follow the steps under the heading “Programming the HomeLink®” before proceeding with the steps listed below.

STEP 1 Locate the training button on the ceiling mounted garage door opener motor. The exact location and color of the button may vary by brand of garage door opener.

Refer to the operation manual supplied with the garage door opener for the location of the training button.

STEP 2 Press the training button.

Following this step, you have 30 seconds in which to initiate step 3 below.

STEP 3 Press and release the vehicle’s programmed HomeLink® button twice. The garage door may open.

If the garage door opens, the programming process is complete. If the door does not open, press and release the button a third time. This third press and release will complete the programming process by opening the garage door.

The ceiling mounted garage door opener motor should now recognize the HomeLink® transceiver and operate the garage door.

STEP 4 Repeat the steps above to program another rolling code system for any of the remaining HomeLink® buttons.

n **Programming an entry gate (for U.S.A. owners)/Programming all devices in the Canadian market**

STEP 1 Place your transmitter 1 to 3 in. (25 to 75 mm) away from the surface of the HomeLink®.

Keep the indicator on the HomeLink® in view while programming.

STEP 2 Press and hold the selected HomeLink® button.

STEP 3 Repeatedly press and release (cycle) the device’s remote control button for two seconds each until step 4 is complete.

STEP 4 When the indicator on the HomeLink® compatible transceiver start to flashing rapidly, release the buttons.

STEP 5 Test the operation of the HomeLink[®] by pressing the newly programmed button. Check to see if the gate/device operates correctly.

STEP 6 Repeat the steps above to program another device for each of the remaining HomeLink[®] buttons.

n Programming other devices

To program other devices such as home security systems, home door locks or lighting, contact your authorized Toyota dealer for assistance.

n Reprogramming a button

The individual HomeLink[®] buttons cannot be erased but can be reprogrammed. To reprogram a button, follow the programming instructions.

Operating the HomeLink[®]

Press the appropriate HomeLink[®] button. The HomeLink[®] indicator on the HomeLink[®] transceiver should turn on.

The HomeLink[®] continues to send a signal for a maximum of 20 seconds if the button is held in.

Erasing the entire HomeLink[®] memory (all three programs)

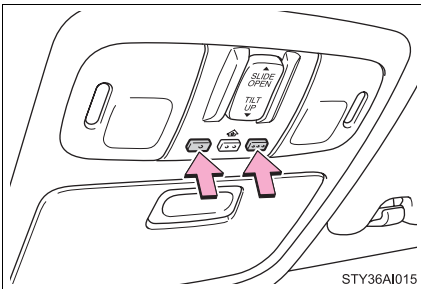

Press and hold down the 2 outside buttons for 20 seconds until the indicator flashes.

If you sell your vehicle, be sure to erase the programs stored in the HomeLink[®] memory.

n Before programming

- l Install a new battery in the remote control transmitter.
- l The battery side of the remote control transmitter must be pointed away from the HomeLink®.

n Certification for the garage door opener

This device complies with Part 15 of the FCC Rules and with RSS-210 of the IC Rules.

Operation is subject to the following two conditions: (1) This device may not cause harmful interference, and (2) this device must accept any interference received, including interference that may cause undesired operation.

WARNING: This transmitter has been tested and complies with FCC and IC rules. Changes or modifications not expressly approved by the party responsible for compliance could void the user's authority to operate the device.

⚠ CAUTION**n When programming a garage door or other remote control device**

The garage door may operate, so ensure that people and objects are out of danger to prevent potential harm.

n Conforming to federal safety standards

Do not use the HomeLink® Compatible Transceiver with any garage door opener or device that lacks safety stop and reverse features as required by federal safety standards.

This includes any garage door that cannot detect an obstruction object. A door or device without these features increases the risk of death or serious injury.

3-6. Other interior features

Compass (if equipped)

The compass on the inside rear view mirror indicates the direction in which the vehicle is heading.

n Operation

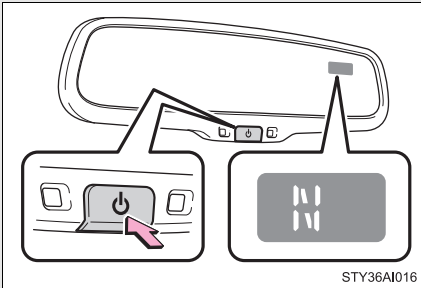

To turn the compass on or off, press the switch.

n Displays and directions

Display	Direction
N	North
NE	Northeast
E	East
SE	Southeast
S	South
SW	Southwest
W	West
NW	Northwest

Calibrating the compass

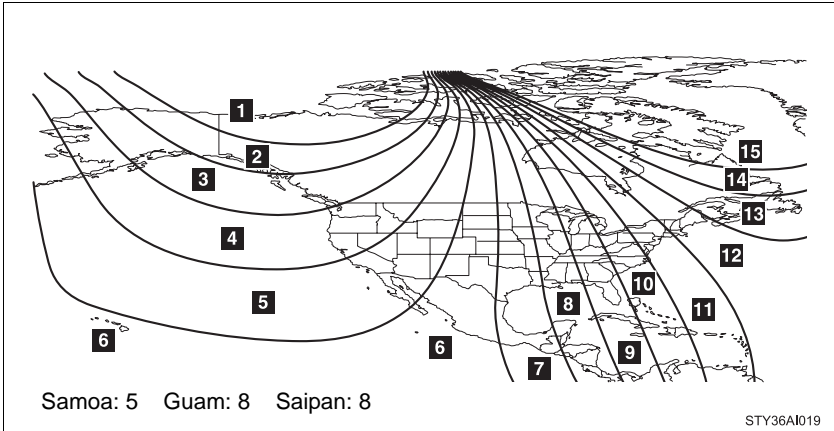

The direction display deviates from the true direction determined by the earth's magnetic field. The amount of deviation varies according to the geographic position of the vehicle.

If you cross over a map boundary shown in illustration, the compass will deviate.

To obtain higher precision or accurate calibration, refer to the following.

n Deviation calibration

STEP 1 Stop the vehicle where it is safe to drive in a circle.

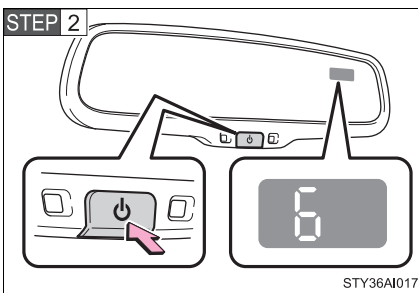

Press the switch until a number (1 to 15) appears on the compass display.

STEP 3 Press the switch, and referring to the map above, select the number of the zone where you are.

If the direction is displayed several seconds after adjustment, the calibration is complete.

n Circling calibration

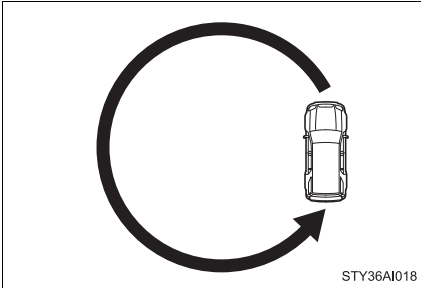

When “C” appears on the display, drive the vehicle at 5 mph (8 km/h) or less in a circle until a direction is displayed.

If there is not enough space to drive in a circle, drive around the block until the direction is displayed.

n Conditions unfavorable to correct operation

The compass may not show the correct direction in the following conditions:

- l The vehicle is stopped immediately after turning.
- l The vehicle is on an inclined surface.
- l The vehicle is in a place where the earth’s magnetic field is subject to interference by artificial magnetic fields (underground car park/parking lot, under a steel tower, between buildings, roof car park/parking lot, near an intersection, near a large vehicle, etc.).
- l The vehicle has become magnetized.
(There is a magnet or metal object near the inside rear view mirror.)
- l The battery has been disconnected.
- l A door is open.

⚠ CAUTION

n While driving the vehicle

Do not adjust the display. Be sure to adjust the display only when the vehicle is stopped.

n When doing the circling calibration

Be sure to secure a wide space, and watch out for people and vehicles in the neighborhood. Do not violate any local traffic rules while performing circling calibration.

 NOTICE**n To avoid the compass malfunctions**

Do not place magnets or any metal objects near the inside rear view mirror. Doing this may cause a malfunction of the compass sensor.

n To ensure normal operation of the compass

- l** Do not perform circling calibration of the compass in a place where the earth's magnetic field is subject to interference by artificial magnetic fields.
- l** During calibration, do not operate electric systems (moon roof, power windows, etc.) as they may interfere with the calibration.

Cleaning and protecting the vehicle exterior

Perform the following to protect the vehicle and maintain it in prime condition.

- 1 Working from top to bottom, liberally apply water to the vehicle body, wheel wells and underside of the vehicle to remove any dirt and dust.

Wash the vehicle body using a sponge or soft cloth, such as a chamois.

- 1 For hard-to-remove marks, use car wash soap and rinse thoroughly with water.

- 1 Wipe away any water.

- 1 Wax the vehicle when the waterproof coating deteriorates.

If water does not bead on a clean surface, apply wax when the vehicle body is cool.

n **Automatic car washes**

- 1 Fold the mirrors back before washing the vehicle.
- 1 Brushes used in automatic car washes may scratch the vehicle surface and harm your vehicle's paint.

n **High pressure car washes**

Do not allow the nozzles of the car wash to come within close proximity of the windows. Before entering an automatic car wash, check that the fuel filler door on your vehicle is closed properly.

n **Aluminum wheels (if equipped)**

Remove any dirt immediately by using a neutral detergent. Do not use hard brushes or abrasive cleaners. Do not use strong or harsh chemical cleaners. Use the same mild detergent and wax as used on the point.

n **Bumpers and side moldings**

Do not scrub with abrasive cleaners.

n **Rear height control air suspension (if equipped)**

Do not spray a jet of high-pressure water at the air suspension unit, especially the air spring, at an extremely close range. This may damage the air suspension.

n **Coating of rain clearing mirrors**

To maintain the rain clearing ability, observe the following instructions.

- l Clean the mirror with car shampoo or glass cleaner that does not contain any silicon or abrasive, and then rinse it thoroughly with water.
- l Expose the mirror to the sunlight 1 or 2 days.

n **To prevent deterioration and body corrosion**

- l Wash the vehicle immediately in the following cases:
 - After driving near the sea coast
 - After driving on salted roads
 - If you see coal tar or tree sap on the paint surface
 - If you see dead insects or insect droppings on the paint
 - After driving in an area contaminated with soot, oily smoke, mine dust, iron powder or chemical substances
 - If the vehicle becomes heavily soiled in dust or mud
 - If liquids such as benzene and gasoline are spilled on the paint surface
- l If the paint is chipped or scratched, have it repaired immediately.

CAUTION

n **Caution about the exhaust pipe**

Exhaust gasses cause the exhaust pipe to become quite hot.

When washing the vehicle, be careful not to touch the pipe until it has cooled sufficiently, as touching a hot exhaust pipe can cause burns.



NOTICE

n To protect your vehicle's painted surfaces

Do not use organic cleaners such as benzene or gasoline.

n Cleaning the exterior lights

I Wash carefully. Do not use organic substances or scrub with a hard brush. This may damage the surfaces of the lights.

I Do not apply wax on the surfaces of the lights. Wax may cause damage to the lenses.

The following procedures will help protect your vehicle's interior and keep it in top condition:

n Protecting the vehicle interior

Remove dirt and dust using a vacuum cleaner. Wipe dirty surfaces with a cloth dampened with lukewarm water.

n Cleaning the leather areas

1 Remove dirt and dust using a vacuum cleaner.

1 Wipe any excess dirt and dust with a soft cloth dampened with diluted detergent.

Use a diluted water solution of approximately 5% neutral wool detergent.

1 Wring out any excess water from the cloth and thoroughly wipe off all remaining traces of detergent.

1 Wipe the surface with a dry, soft cloth to remove any remaining moisture. Allow the leather to dry in a shaded and ventilated area.

n Synthetic leather areas

1 Remove loose dirt using a vacuum cleaner.

1 Apply a mild soap solution to the synthetic leather using a sponge or soft cloth.

1 Allow the solution to soak in for a few minutes. Remove the dirt and wipe off the solution with a clean, damp cloth.

n Cleaning the inside of the back window and the rear quarter windows

Do not use glass cleaner to clean the back window and the rear quarter windows, as this may cause damage to the rear window defogger heater wires or antennas. Use a cloth dampened with lukewarm water to gently wipe the window clean. Wipe the window in strokes running parallel to the heater wires.

n Caring for leather areas

Toyota recommends cleaning the interior of the vehicle at least twice a year to maintain the quality of the vehicle's interior.

n Shampooing the carpets

There are several commercial foaming-type cleaners available. Use a sponge or brush to apply the foam. Rub in overlapping circles. Do not apply water. The excellent results are obtained when keeping the carpet as dry as possible.

n Seat belts

Clean with mild soap and lukewarm water using a cloth or sponge. Also check the belts periodically for excessive wear, fraying or cuts.

⚠ CAUTION

n Water in the vehicle

I Do not splash or spill liquid in the vehicle.
Doing so may cause the electrical components etc. to malfunction or catch fire.

I Do not get any of the SRS components or wiring in the vehicle interior wet.
(→P. 95)

Electrical malfunction may cause the airbags to deploy or not function properly, resulting in death or severe injury.

 NOTICE**n Cleaning detergents**

Do not use organic substances such as benzene or gasoline, acidic or alkaline solutions, dye, bleach or other detergent. Doing so may discolor the vehicle interior or cause streaks or damage to painted surfaces.

n Preventing damage to leather surfaces

Observe the following precautions to avoid damage to and deterioration of leather surfaces.

- I Remove any dust or dirt on leather surfaces immediately.
- I Do not expose the vehicle to direct sunlight for extended periods of time. Park the vehicle in the shade, especially during summer.
- I Do not place items made of vinyl, plastic, or that contain wax on the upholstery, as they may stick to the leather surface if the vehicle interior heats up significantly.

n Water on the floor

Do not wash the vehicle floor with water.

Vehicle systems such as the audio system may be damaged if water comes into contact with electrical components under the floor of the vehicle, and may also cause the body to rust.

n Cleaning the inside of the back window and the rear quarter windows

Be careful not to scratch or damage the heater wires or antennas.

Maintenance requirements

To ensure safe and economical driving, day-to-day care and regular maintenance is essential. It is the owner's responsibility to perform regular checks. Toyota recommends the following maintenance.

n General maintenance

Should be performed on a daily basis. This can be done by yourself or by a Toyota dealer.

n Scheduled maintenance

Should be performed at specified intervals according to the maintenance schedule.

For details about maintenance items and schedules, refer to the "Scheduled Maintenance Guide" or "Owner's Manual Supplement".

n Do-it-yourself maintenance

You can perform some maintenance procedures yourself. Please be aware that do-it-yourself maintenance may affect warranty coverage.

The use of Toyota Repair Manuals is recommended.

For details about warranty coverage, see the separate "Owner's Warranty Information Booklet", "Owner's Manual Supplement".

n Repair and replacement

It is recommended that genuine Toyota parts be used for repair to ensure performance of each system. If non-Toyota parts are used in replacement or if a repair shop other than Toyota dealer performs repairs, confirm the warranty coverage.

n Allow inspection and repairs to be performed by a Toyota dealer

- l Toyota technicians are well-trained specialists and are kept up to date with the latest service information. They are well informed about the operations of all systems on your vehicle.
- l Keep a copy of the repair order. It proves that the maintenance that has been performed is under warranty coverage. If any problem should arise while your vehicle is under warranty, your Toyota dealer will promptly take care of it.

⚠ CAUTION**n Warning in handling of battery**

- l Engine exhaust, some of its constituents, and a wide variety of automobile components contain or emit chemicals known to the State of California to cause cancer and birth defects and other reproductive harm. Work in a well ventilated area.
- l Oils, fuels and fluids contained in vehicles as well as waste produced by component wear contain or emit chemicals known to the State of California to cause cancer and birth defects or other reproductive harm. Avoid exposure and wash any affected area immediately.
- l Battery posts, terminals and related accessories contain lead and lead compounds which are known to cause brain damage. Wash your hands after handling. (→P. 384)

General maintenance

Listed below are the general maintenance items that should be performed at the intervals specified in the “Scheduled Maintenance Guide” or “Owner’s Manual Supplement”. It is recommended that any problem you notice should be brought to the attention of your Toyota dealer or qualified service shop for advice.

Engine compartment

Items	Check points
Battery	Maintenance-free. (→P. 384)
Brake fluid	At the correct level? (→P. 381)
Engine coolant	At the correct level? (→P. 380)
Engine oil	At the correct level? (→P. 375)
Exhaust system	No fumes or strange sounds?
Power steering fluid	At the correct level? (→P. 383)
Radiator/condenser/hoses	Not blocked with foreign matter? (→P. 381)
Washer fluid	At the correct level? (→P. 387)

Vehicle interior

Items	Check points
Accelerator pedal	<ul style="list-style-type: none"> • Moves smoothly (without uneven pedal effort or catching)?
Automatic transmission “Park” mechanism	<ul style="list-style-type: none"> • Can the vehicle be hold securely on an incline with the shift lever in P?
Brake pedal	<ul style="list-style-type: none"> • Moves smoothly? • Does it have appropriate clearance and correct amount of free play?
Brakes	<ul style="list-style-type: none"> • Not pull to one side when applied? • Loss of brake effectiveness? • Spongy feeling brake pedal? • Pedal almost touches floor?
Head restraints	<ul style="list-style-type: none"> • Move smoothly and lock securely?
Indicators/buzzers	<ul style="list-style-type: none"> • Function properly?
Lights	<ul style="list-style-type: none"> • Do all the lights come on? • Headlights aimed correctly?
Parking brake	<ul style="list-style-type: none"> • Moves smoothly? • Can hold the vehicle securely on an incline?
Seat belts	<ul style="list-style-type: none"> • Does the seat belt system operate smoothly? • Are the belts undamaged?
Seats	<ul style="list-style-type: none"> • Do the seat controls operate properly?
Steering wheel	<ul style="list-style-type: none"> • Moves smoothly? • Has correct free play? • No strange noises?

Vehicle exterior

Items	Check points
Door	<ul style="list-style-type: none"> • Operate smoothly?
Engine hood	<ul style="list-style-type: none"> • The lock system works properly?
Fluid leaks	<ul style="list-style-type: none"> • Is there any leakage after parking?
Tire	<ul style="list-style-type: none"> • Inflation pressure is correct? • Tire surfaces not worn or damaged? • Tires rotated according to the maintenance schedule? • Wheel nuts are not loose?

⚠ CAUTION

■ If the engine is running

Turn the engine off and ensure that there is adequate ventilation before performing maintenance checks.

Some states have vehicle emission inspection programs which include OBD (On Board Diagnostics) checks. The OBD system monitors the operation of the emission control system.

n If the malfunction indicator lamp comes on

The OBD system determines that a problem exists somewhere in the emission control system. Your vehicle may not pass the I/M test and may need to be repaired. Contact your Toyota dealer to service the vehicle.

n Your vehicle may not pass the I/M test:

l When the battery is disconnected or discharged

Readiness codes that are set during ordinary driving are erased.

Also, depending on your driving habits, the readiness codes may not be completely set.

l When the fuel tank cap is loose

The malfunction indicator lamp comes on as a temporary malfunction and your vehicle may not pass the I/M test.

n When the malfunction indicator lamp goes off after several driving trips

The error code in the OBD system will not be cleared unless the vehicle is driven 40 or more times.

n If your vehicle does not pass the I/M test

Contact your Toyota dealer to prepare the vehicle for re-testing.

Do-it-yourself service precautions

If you perform maintenance yourself, be sure to follow the correct procedures as given in these sections.

Items	Parts and tools
Battery condition (→P. 384)	<ul style="list-style-type: none"> • Warm water • Baking soda • Grease • Conventional wrench (for terminal clamp bolts)
Brake fluid level (→P. 381)	<ul style="list-style-type: none"> • FMVSS No.116 DOT 3 or SAE J1703 brake fluid • Rag or paper towel
Engine coolant level (→P. 380)	<ul style="list-style-type: none"> • “Toyota Super Long Life Coolant” or similar high quality ethylene glycol based non-silicate, non-amine, non-nitrite and non-borate coolant with long-life hybrid organic acid technology. U.S.A.: “Toyota Super Long Life Coolant” is pre-mixed with 50% coolant and 50% deionized water. Canada: “Toyota Super Long Life Coolant” is pre-mixed with 55% coolant and 45% deionized water.
Engine oil level (→P. 375)	<ul style="list-style-type: none"> • Toyota Genuine Motor Oil or equivalent • Rag or paper towel • Funnel (used only for adding oil)
Fuses (→P. 404)	<ul style="list-style-type: none"> • Fuse with same amperage rating as original

Items	Parts and tools
Light bulbs (→P. 415)	<ul style="list-style-type: none"> • Bulb with same number and wattage rating as original • Phillips-head screwdriver • Flathead screwdriver
Power steering fluid level (→P. 383)	<ul style="list-style-type: none"> • Automatic transmission fluid DEXRON® II or III • Rag or paper towel • Funnel (used only for adding power steering fluid)
Radiator and condenser (→P. 381)	—
Tire inflation pressure (→P. 395)	<ul style="list-style-type: none"> • Tire pressure gauge • Compressed air source
Washer fluid (→P. 387)	<ul style="list-style-type: none"> • Water • Washer fluid containing antifreeze (for winter use) • Funnel (used only for adding washer fluid)

 **CAUTION**

The engine compartment contains many mechanisms and fluids that may move suddenly, become hot, or become electrically energized. To avoid death or serious injury observe the following precautions.

n When working on the engine compartment

- I** Keep hands, clothing, and tools away from the moving fan and engine drive belt.
- I** Be careful not to touch the engine, radiator, exhaust manifold, etc. right after driving as they may be hot. Oil and other fluids may also be hot.
- I** Do not leave anything that may burn easily, such as paper or rags, in the engine compartment.
- I** Do not smoke, cause sparks or expose an open flame to fuel or the battery. Fuel and battery fumes are flammable.
- I** Be extremely cautious when working on the battery. It contains poisonous and corrosive sulfuric acid.
- I** Take care because brake fluid can harm your hands or eyes and damage painted surfaces.
If fluid gets on your hands or in your eyes, flush the affected area with clean water immediately.
If you still experience discomfort, see a doctor.

n When working near the cooling fan or radiator grille

Be sure the engine switch is off.

With the engine switch on, the cooling fan may automatically start to run if the air conditioning is on and/or the coolant temperature is high.

n Safety glasses

Wear safety glasses to prevent flying or falling material, fluid spray, etc. from getting in the eyes.

**NOTICE****n If you remove the air cleaner**

Driving with the air cleaner removed may cause excessive engine wear due to dirt in the air. Also a backfire could cause a fire in the engine compartment.

n If the fluid level is low or high

It is normal for the brake fluid level to go down slightly as the brake pads wear or when the fluid level in the accumulator is high.

If the reservoir needs frequent refilling, it may indicate a serious problem.

4-3. Do-it-yourself maintenance

Hood

Release the lock from the inside of the vehicle to open the hood.

STEP 1

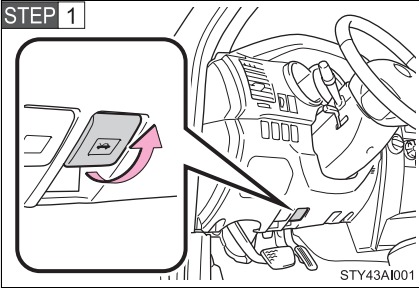

Pull the hood release lever.

The hood will pop up slightly.

STEP 2

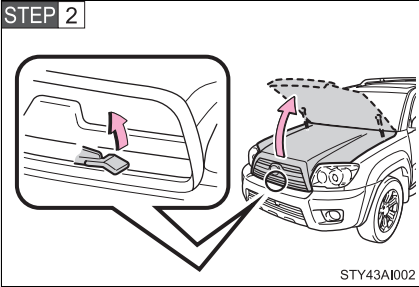

Pull up the hood catch lever and lift the hood.

⚠ CAUTION

n Pre-driving check

Check that the hood is fully closed and locked.

If the hood is not locked properly, it may open while the vehicle is in motion and cause an accident, which may result in death or serious injury.

4-3. Do-it-yourself maintenance

Engine compartment

► 4.0 L V6 (1GR-FE) engine

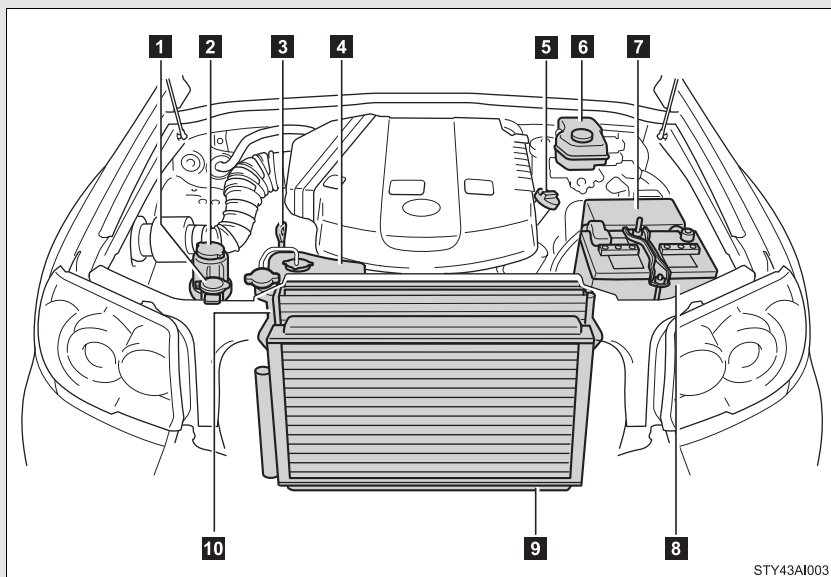

STY43AI003

- | | |
|---|--|
| 1 Washer fluid tank (→P. 387) | 6 Brake fluid reservoir (→P. 381) |
| 2 Power steering fluid reservoir (→P. 383) | 7 Fuse box (→P. 404) |
| 3 Engine oil level dipstick (→P. 375) | 8 Battery (→P. 384) |
| 4 Engine coolant reservoir (→P. 380) | 9 Condenser (→P. 381) |
| 5 Engine oil filler cap (→P. 376) | 10 Radiator (→P. 381) |

► 4.7 L V8 (2UZ-FE) engine

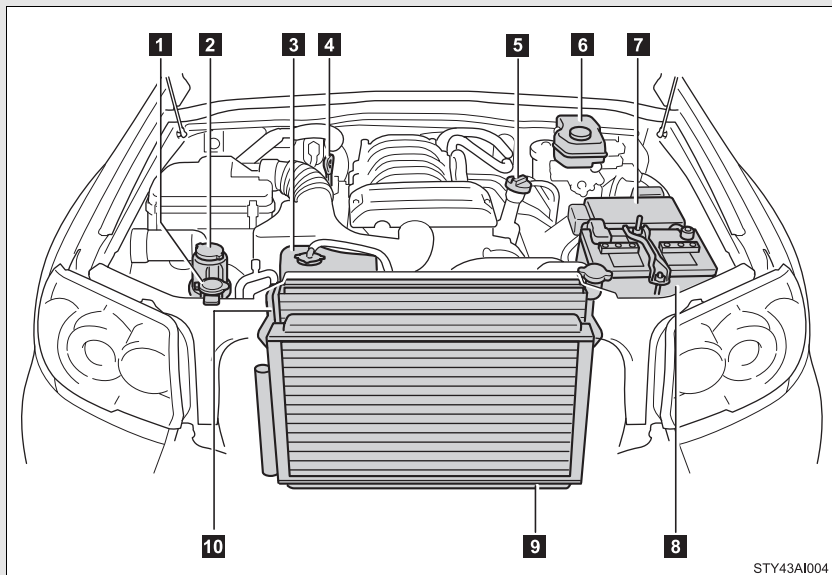

- | | |
|---|--|
| 1 Washer fluid tank (→P. 387) | 6 Brake fluid reservoir (→P. 381) |
| 2 Power steering fluid reservoir (→P. 383) | 7 Fuse box (→P. 404) |
| 3 Engine coolant reservoir (→P. 380) | 8 Battery (→P. 384) |
| 4 Engine oil level dipstick (→P. 375) | 9 Condenser (→P. 381) |
| 5 Engine oil filler cap (→P. 376) | 10 Radiator (→P. 381) |

Engine oil

With the engine at operating temperature and turned off, check the oil level on the dipstick.

n Checking the engine oil

STEP 1 Park the vehicle on level ground. After turning off the engine, wait more than 5 minutes for the oil to drain back into the bottom of the engine.

STEP 2 Hold a rag under the end and pull the dipstick out.

► 4.0 L V6 (1GR-FE) engine

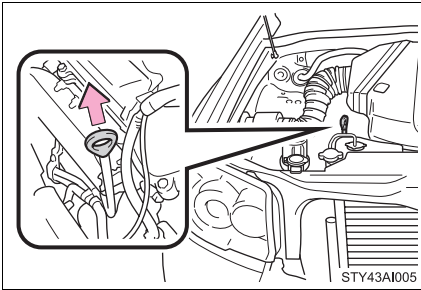

► 4.7 L V8 (2UZ-FE) engine

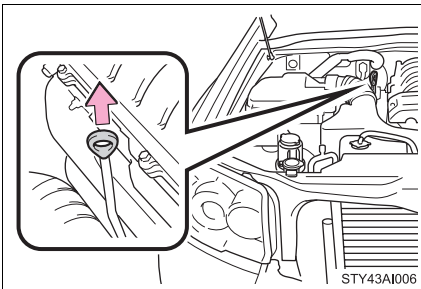

STEP 3 Wipe the dipstick clean.

STEP 4 Reinsert the dipstick fully.

STEP 5 Holding a rag under the end, pull the dipstick out and check the oil level.

STEP 6 Wipe the dipstick and reinsert it fully.

► 4.0 L V6 (1GR-FE) engine

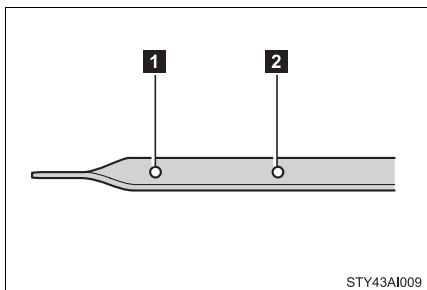

1 Low

2 Full

► 4.7 L V8 (2UZ-FE) engine

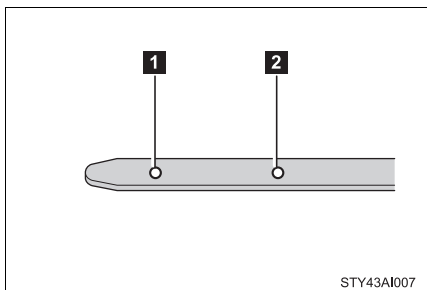

1 Low

2 Full

n Adding engine oil

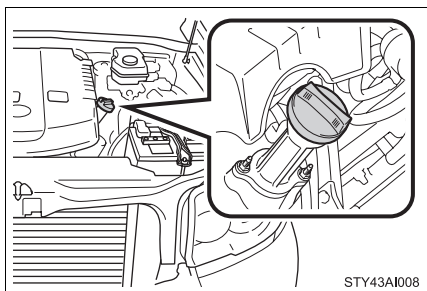

If the oil level is below or near the low level mark, add engine oil of the same type as already in the engine.

Make sure to check the oil type and prepare the items needed before adding oil.

Oil grade	ILSAC multigrade engine oil
Items	Clean funnel

STEP 1 Remove the oil filler cap, turning it counterclockwise.

STEP 2 Add engine oil slowly.

STEP 3 Checking the dipstick.

STEP 4 Reinstall the filler cap, turning it clockwise.

The approximate quantity of oil needed to raise the level between low and full on the dipstick is indicated as follows:

1.6 qt. (1.5 L, 1.3 Imp. qt.)

n Recommended viscosity

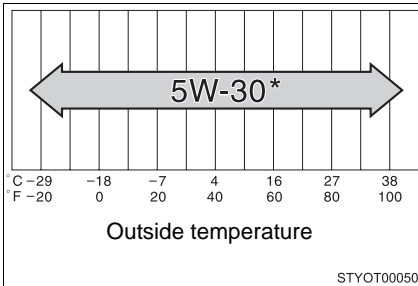

SAE 5W-30 is the best choice for good fuel economy, and good starting in cold weather.

*: If SAE 5W-30 oil is not available, SAE 10W-30 oil may be used. However, it should be replaced with SAE 5W-30 at the next oil change.

n How to read oil container labels

The ILSAC (International Lubricant Standardization and Approval Committee) Certification Mark is added to some oil containers to help you select the oil you should use.



▮ **Engine oil consumption**

- | The amount of engine oil consumed depends on the oil viscosity, the quality of the oil and the way the vehicle is driven.
- | More oil is consumed under driving conditions such as high speeds and frequent acceleration and deceleration.
- | A new engine consumes more oil.
- | When judging the amount of oil consumption, keep in mind that the oil may have become diluted, making it difficult to judge the true level accurately.
- | Oil consumption: Max. 1.1 qt./600 miles, 0.9 Imp.qt./600 miles (1.0 L per 1000 km)
- | If you consume more than 1.1 qt. (1.0 L, 0.9 Imp.qt.) every 600 miles (1000 km), contact your Toyota dealer.

▮ **After changing the engine oil (U.S.A. only)**

The oil change system should be reset. Perform the following procedures:

- STEP 1** Turn the engine switch to the ACC or LOCK position with the odometer reading shown.(→P. 148)
- STEP 2** Turn the engine switch to the ON position while holding down the trip meter reset button.
- STEP 3** Hold down the button until the light goes off. Before the light goes off, it illuminates for 3 seconds, flashes for 2 seconds and illuminates for 1 second.

If the system fails to reset, the light will remain flashing.

 **CAUTION****n Used engine oil**

- I** Used engine oil contains potentially harmful contaminants which may cause skin disorders such as inflammation or skin cancer, so care should be taken to avoid prolonged and repeated contact. To remove used engine oil from your skin, wash thoroughly with soap and water.
- I** Dispose of used oil and filters only in a safe and acceptable manner. Do not dispose of used oil and filters in household trash, in sewers or onto the ground. Call your Toyota dealer, service station or auto parts store for information concerning recycling or disposal.
- I** Do not leave used engine oil within the reach of children.

 **NOTICE****n To prevent serious engine damage**

Check the oil level on regular basis.

n When replacing the engine oil

- I** Be careful not to spill engine oil on the vehicle components.
- I** Avoid overfilling, as the engine could be damaged.
- I** Check the oil level on the dipstick every time you refill the vehicle.
- I** Be sure the engine oil filler cap is properly tightened.

Engine coolant

The coolant level is satisfactory if it is between the F (Full) and L (Low) lines on the reservoir when the engine is cold.

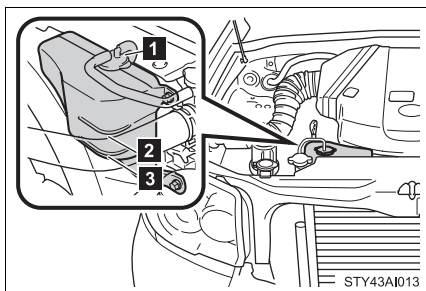

1 Reservoir cap

2 F

3 L

If the level is on or below the L line, add coolant up to the F line.

n If the coolant level drops within a short time after replenishing

Visually check the radiator, hoses, reservoir cap, radiator cap, drain cock and water pump.

If you cannot find a leak, have your Toyota dealer pressure test the cap and check for leaks in the cooling system.

n Coolant selection

Only use “Toyota Super Long Life Coolant” or similar high quality ethylene glycol based non-silicate, non-amine, non-nitrite and non-borate coolant with long-life hybrid organic acid technology.

U.S.A.: “Toyota Super Long Life Coolant” is a mixture of 50% coolant and 50% deionized water. (Enabled: -31°F [-35°C])

Canada: “Toyota Super Long Life Coolant” is a mixture of 55% coolant and 45% deionized water. (Enabled: -44°F [-42°C])

For more details about engine coolant, contact your Toyota dealer.

⚠ CAUTION

n When the engine is hot

Do not remove the radiator cap.

The cooling system may be under pressure and may spray hot coolant if the cap is removed, causing burns or other injuries.

 NOTICE

n When adding engine coolant

Coolant is neither plain water nor straight antifreeze. The correct mixture of water and antifreeze must be used to provide proper lubrication, corrosion protection and cooling. Be sure to read the antifreeze or coolant label.

n If you spill coolant

Be sure to wash it off with water to prevent damage to parts or paint.

Radiator and condenser

Check the radiator and condenser and clear any foreign objects. If either of the above parts are extremely dirty or you are not sure of their condition, have your vehicle checked by your Toyota dealer.

 CAUTION

n When the engine is hot

Do not touch the radiator or condenser as they may be hot and may cause burns.

Brake fluid

n Checking fluid level

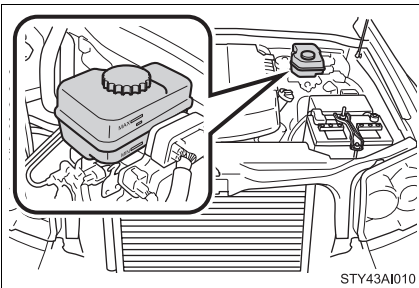

STY43A1010

The brake fluid level should be between the MAX and MIN lines on the reservoir.

n Adding fluid

Make sure to check the fluid type and prepare the necessary items.

Fluid type	FMVSS No.116 DOT 3 or SAE J1703 brake fluid
Items	Rag or paper towel

STEP 1 Turn the engine switch off.

STEP 2 Depress the brake pedal 20 times or more.

STEP 3 Remove the reservoir cap.

STEP 4 Add newly opened brake fluid up to the MAX line.

n Brake fluid can absorb moisture from the air

Excess moisture in the fluid can cause a dangerous loss of braking efficiency. Use only newly opened brake fluid.

CAUTION

n When filling the reservoir

Take care because brake fluid can harm your hands or eyes and damage painted surfaces.

If fluid gets on your hands or in your eyes, flush the affected area with clean water immediately.

If you still experience discomfort, see a doctor.

NOTICE

n If the fluid level is low or high

It is normal for the brake fluid level to go down slightly as the brake pads wear or when the fluid level in the accumulator is high.

If the reservoir needs frequent refilling, it may indicate a serious problem.

n If you spill fluid

Be sure to wash it off with water to prevent damage to parts or paint.

Power steering fluid

n Fluid level

The fluid level should be within the appropriate range.

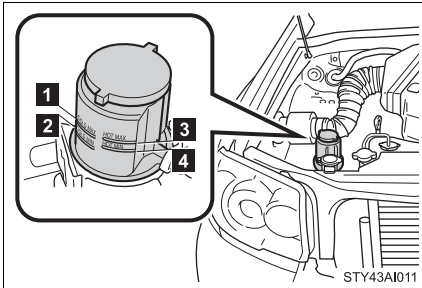

- 1 Full (when cold)
- 2 Add fluid (when cold)
- 3 Full (when hot)
- 4 Add fluid (when hot)

Hot: Vehicle has been driven around 50 mph (80 km/h) for 20 minutes, or slightly longer in frigid temperatures. (Fluid temperature, 140°F - 175°F [60°C - 80°C])

Cold: Engine has not been run for about 5 hours. (Room temperature, 50°F - 85°F [10°C - 30°C])

n Checking the fluid level

Make sure to check the fluid type and prepare the necessary items.

Fluid type	Automatic transmission fluid DEXRON® II or III
Items	Rag or paper towel

STEP 1 Clean all dirt off the reservoir.

STEP 2 Remove the cap by turning it counterclockwise.

STEP 3 Wipe the dipstick clean.

STEP 4 Reinstall and remove the reservoir cap again.

STEP 5 Check the fluid level.

⚠ CAUTION

n Checking the fluid level

Take care, as the reservoir may be hot.

⚠ NOTICE

n When adding fluid

Avoid overfilling, or the power steering may be damaged.

n After replacing the reservoir cap

Check the steering box case, vane pump and hose connections for leaks or damage.

Battery

n Battery exterior

Make sure that the battery terminals are not corroded and that there are no loose connections, cracks, or loose clamps.

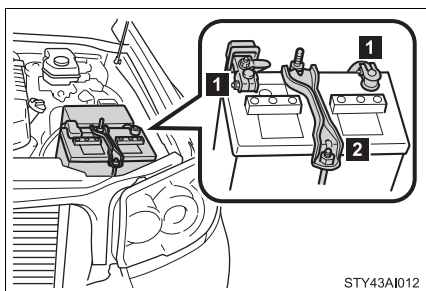

1 Terminals

2 Hold-down clamp

STY43AI012

n Checking battery condition

Check the battery condition using the indicator color.

► Type A

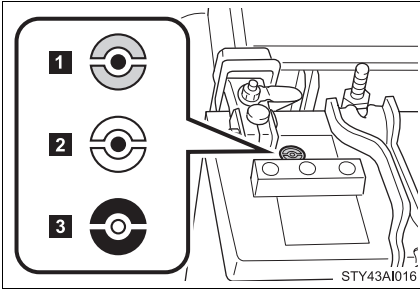

- 1 Blue: Good condition
- 2 White: Charging is necessary. Have the vehicle inspected by your Toyota dealer.
- 3 Red: Not working properly, have the battery checked by your Toyota dealer.

► Type B

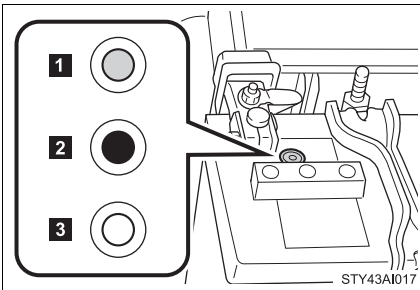

- 1 Green: Good condition
- 2 Dark: Charging is necessary. Have the vehicle inspected by your Toyota dealer.
- 3 Clear or light yellow: Not working properly, have the battery checked by your Toyota dealer.

n Before recharging

When recharging, the battery produces hydrogen gas which is flammable and explosive. Therefore, before recharging:

- 1 If recharging with the battery installed on the vehicle, be sure to disconnect the ground cable.
- 1 Make sure the power switch on the charger is off when connecting and disconnecting the charger cables to the battery.

 **CAUTION**

n Chemicals in the battery

A battery contains poisonous and corrosive sulfuric acid and may produce hydrogen gas which is flammable and explosive. To reduce the risk of death or serious injury, take the following precautions while working on or near battery:

- I Do not cause sparks by touching the battery terminals with tools.
- I Do not smoke or light a match near the battery.
- I Avoid contact with eyes, skin and clothes.
- I Never inhale or swallow electrolyte.
- I Wear protective safety glasses when working near the battery.
- I Keep children away from the battery.

n Where to safety charge the battery

Always charge the battery in an open area. Do not charge the battery in a garage or closed room where there is not sufficient ventilation.

n How to recharge the battery

Only perform a slow charge (5A or less).

The battery may explode if charged at a quicker rate.

n Emergency measures regarding electrolyte

- I If electrolyte gets in your eyes

Flush your eyes with clean water for at least 15 minutes and get immediate medical attention. If possible, continue to apply water with a sponge or cloth while traveling to the nearest medical facility.

- I If electrolyte gets on your skin

Wash the affected area thoroughly. If you feel pain or burning, get medical attention immediately.

- I If electrolyte gets on your clothes

It can soak through clothing on to your skin. Immediately take off the clothing and follow the procedure above if necessary.

- I If you accidentally swallow electrolyte

Drink a large quantity of water or milk. Follow with milk of magnesia, beaten raw egg or vegetable oil. Get emergency medical attention immediately.

 NOTICE

n When recharging the battery

Never recharge the battery while the engine is running. Also, be sure all accessories are turned off.

Washer fluid

Add washer fluid in the following situations.

- 1 Any washer does not work.
- 1 The low washer fluid warning light comes on. (Canada only)

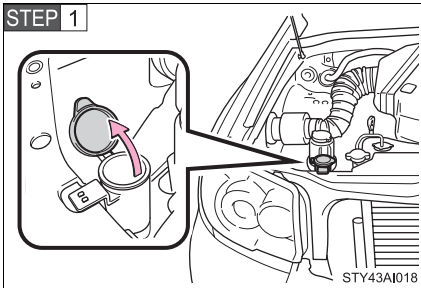

Open the lid.

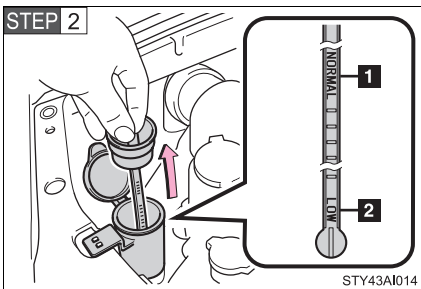

Check the washer fluid level on the level gauge.

1 NORMAL

2 LOW

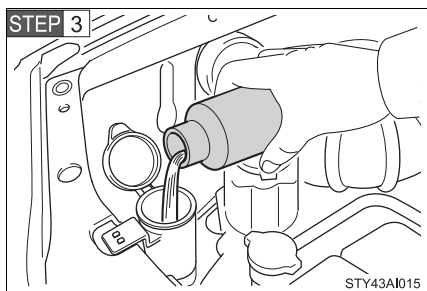

If the washer fluid level is at LOW, add washer fluid.

⚠ CAUTION

n When refilling the washer fluid

Do not refill the washer fluid when the engine is hot or running, as the washer fluid contains alcohol and may catch fire if spilled on the engine etc.

⚠ NOTICE

n Do not use any fluid other than washer fluid

Do not use soapy water or engine antifreeze instead of washer fluid. Doing so may cause streaking on the vehicle's painted surfaces.

n Diluting washer fluid

Dilute washer fluid with water as necessary. Refer to the freezing temperatures listed on the washer fluid tank.

Tires

Replace or rotate tires in accordance with maintenance schedules and treadwear.

n Checking tires

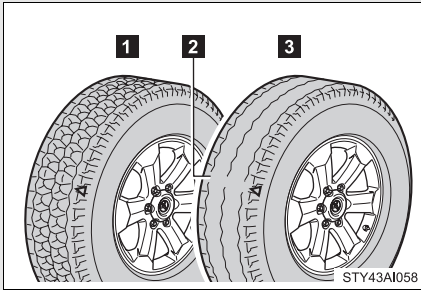

- 1 New tread
- 2 Treadwear indicator
- 3 Worn tread

The location of treadwear indicators is shown by the “TWI” or “△” marks, etc., molded on the sidewall of each tire.

Check spare tire condition and inflation pressure if not rotated.

n Tire rotation

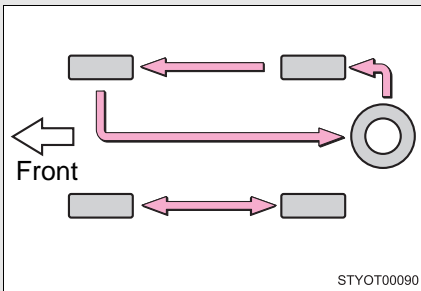

Rotate the tires in the order shown.

To equalize tire wear and extend tire life, Toyota recommends that tire rotation is carried out at the same interval as tire inspection.

n The tire pressure warning system

Your Toyota is equipped with a tire pressure warning system that uses tire pressure warning valves and transmitters to detect low tire inflation pressure before serious problems arise. (→P. 439)

Installing tire pressure warning valves and transmitters

When replacing tires or wheels, tire pressure warning valves and transmitters must also be installed.

When new tire pressure warning valves and transmitters are installed, new tire pressure warning valve and transmitter ID codes must be registered in the tire pressure warning computer and tire pressure warning system must be initialized. Have tire pressure warning valve and transmitter ID codes registered by your Toyota dealer. (→P. 390)

Registering ID codes

The tire pressure warning valve and transmitter is equipped with a unique ID code. When replacing a tire pressure warning valve and transmitter, it is necessary to register the ID code of tire pressure warning valve and transmitter. Have the ID code registered by your Toyota dealer.

n When to replace your vehicle's tires

Tires should be replaced if:

- l You have tire damage such as cuts, splits, cracks deep enough to expose the fabric or bulges indicating internal damage
- l A tire goes flat repeatedly or cannot be properly repaired due to the size or location of a cut or other damage

If you are not sure, consult with your Toyota dealer.

n Replacing tires and wheels

If the ID code of the tire pressure warning valve and transmitter is not registered, the tire pressure warning system will not work properly. After driving for about 20 minutes, the tire pressure warning light comes on after blinking for 1 minute to indicate a system malfunction.

n Tire life

Any tire over 6 years old must be checked by a qualified technician even if they have seldom or never been used or damage is not obvious.

n **If the tread wears down below 0.16 in. (4 mm) on snow tires**

The effectiveness of snow tires is lost.

n **Maximum load of tire**

Check that the maximum load of the replaced tire is greater than 1/2 of the Gross Axle Weight Ratings (GAWR) of either the front axle or the rear axle, whichever is greater.

As for the maximum load of the tire, see the load limit at maximum cold tire inflation pressure mentioned on the sidewall of the tire, and as for the Gross Axle Weight Ratings (GAWR), see the Certification Label. (→P. 395, 471, 484).

n **Tire types**

1 Summer tires

Summer tires are high-speed performance tires best suited to highway driving under dry conditions. Since summer tires do not have the same traction performance as snow tires, summer tires are inadequate for driving on snow-covered or icy roads. For driving on snow-covered roads or icy roads, the use of snow tires is recommended. When installing snow tires, be sure to replace all four tires.

2 All season tires

All season tires are designed to provide better traction in snow and to be adequate for driving in most winter conditions, as well as for use year round. All season tires, however, do not have adequate traction performance compared with snow tires in heavy or loose snow. Also, all season tires fall short in acceleration and handling performance compared with summer tires in highway driving.

3 Snow tires

For driving on snow-covered roads or icy roads, we recommend using snow tires. If you need snow tires, select tires of the same size, construction and load capacity as the originally installed tires. Since your vehicle has radial tires as original equipment, make sure your snow tires also have radial construction. Do not install studded tires without first checking local regulations for possible restriction. Snow tires should be installed on all wheels. (→P. 213)

■ **Routine tire inflation pressure checks**

The tire pressure warning system does not replace routine tire inflation pressure checks. Make sure to check tire inflation pressure as part of your routine of daily vehicle checks.

■ **Tire pressure warning system certification**

MODEL/FCC IDs:

Transmitter: PAXPMV107J

Receiver: HYQ13BCG

IC (Canada) IDs:

Transmitter: 3729A-PMV107J

Receiver:1551A-13BCG

► For vehicles sold in U.S.A.

NOTE:

This device complies with Part 15 of the FCC Rules. Operation is subject to the following two conditions: (1) This device may not cause harmful interference, and (2) this device must accept any interference received, including interference that may cause undesired operation.

FCC WARNING:

Changes or modifications not expressly approved by the party responsible for compliance could void the user's authority to operate the equipment.

► For vehicles sold in Canada

NOTE:

Operation is subject to the following two conditions: (1) this device may not cause interference, and (2) this device must accept any interference, including interference that may cause undesired operation of the device.

 **CAUTION**
n When inspecting or replacing tires

Observe the following precautions to prevent accidents. Failure to do so may cause damage to parts of the drive train, as well as dangerous handling characteristics, which may lead to an accident resulting in death or serious injury.

- I Do not mix tires of different makes, models, tread patterns or tread-wear.
- I Do not use tire sizes other than those recommended by Toyota.
- I Do not mix radial, bias-belted, or bias-ply tires.
- I Do not mix summer, all season and winter tires.
- I Do not use tires that have been used on another vehicle.
- I Do not use tires if you do not know how they were used previously.

 **NOTICE**
n Repairing or replacing tires, wheels and tire pressure warning valves and transmitters

When removing or fitting the wheels, tires or the tire pressure warning valve and transmitter, contact your Toyota dealer as the tire pressure warning valve and transmitter may be damaged if not handled correctly.

n To avoid damaging the tire pressure warning valves and transmitters

Do not use liquid sealants on flat tires.

 NOTICE

n Driving on rough roads

Take particular care when driving on roads with loose surfaces or pot-holes.

These conditions may cause losses in tire inflation pressure, reducing the cushioning ability of the tires. In addition driving on rough roads may cause damage to the tires themselves, as well as the vehicle's wheels and body.

n If tire inflation pressures become low while driving

Do not continue driving, or your tires and/or wheels may be ruined.

4-3. Do-it-yourself maintenance

Tire inflation pressure

n Tire inflation pressure

The recommended cold tire inflation pressure and tire size is displayed on the tire and loading information label. (→P. 479)

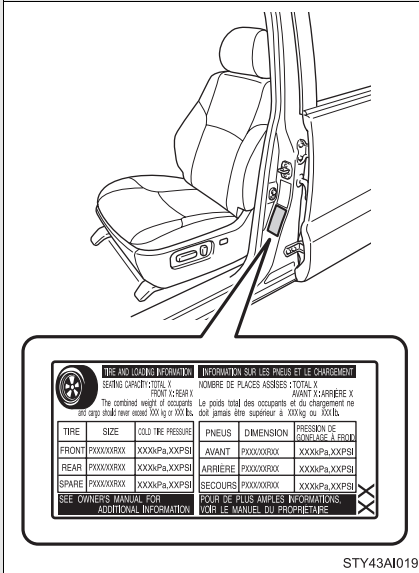

n Inspection and adjustment procedure

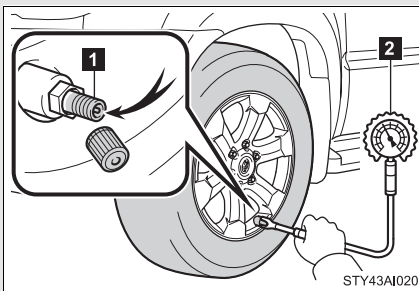

- 1 Tire valve
- 2 Tire pressure gauge

STEP 1 Remove the tire valve cap.

STEP 2 Press the tip of the tire pressure gauge onto the tire valve.

STEP 3 Read the pressure using the graduations of the gauge.

STEP 4 If the tire inflation pressure is not within the recommended levels, adjust inflate the tire.

If you add too much air, press the center of the valve to lower.

STEP 5 After completing the tire inflation pressure measurement and adjustment, apply soapy water to the valve and check for leakage.

STEP 6 Reinstall the tire valve cap.

n Tire inflation pressure check interval

You should check tire pressure every two weeks, or at least once a month.

Do not forget to check the spare.

n Effects of incorrect tire inflation pressure

Driving with incorrect tire inflation pressure may result in the following:

- l Reduced fuel efficiency
- l Reduced driving comfort and tire life
- l Reduced safety
- l Damage to the drive train

If a tire needs frequent refilling, have it checked by your Toyota dealer.

n Instructions for checking tire inflation pressure

When checking tire inflation pressure, observe the following:

- l Check only when the tires are cold.

If your vehicle has been parked for at least 3 hours and has not been driven for more than 1 mile or 1.5 km, you will get an accurate cold tire inflation pressure reading.

- l Always use a tire pressure gauge.

The appearance of the tire can be misleading. In addition, tire inflation pressures that are even just a few pounds off can degrade ride and handling.

- 1 Do not bleed or reduce tire inflation pressure after driving. It is normal for the tire inflation pressure to be higher after driving.
- 1 Never exceed the vehicle capacity weight. Passengers and luggage weight should be placed so that the vehicle is balanced.

CAUTION

n Proper inflation is critical to save tire performance

Keep your tires properly inflated.

Otherwise, the following conditions may occur and result in an accident causing death or serious injury.

- 1 Excessive wear
- 1 Uneven wear
- 1 Poor handling
- 1 Possibility of blowouts resulting from overheated tires
- 1 Poor sealing of the tire bead
- 1 Wheel deformation and/or tire separation
- 1 A greater possibility of tire damage from road hazards

NOTICE

n When inspecting and adjusting tire inflation pressure

Be sure to reinstall the tire valve caps.

Without the valve caps, dirt or moisture could get into the valve and cause air leakage, which could result in an accident. If the caps have been lost, replace them as soon as possible.

Wheels

If a wheel is bent, cracked or heavily corroded, it should be replaced.

Otherwise, the tire may separate from the wheel or cause loss of handling control.

n Wheel selection

When replacing wheels, care should be taken to ensure that they are equivalent to those removed in load capacity, diameter, rim width, and offset.

Replacement wheels are available at your Toyota dealer.

Toyota does not recommend using:

- 1 Wheels of different sizes or types
- 1 Used wheels
- 1 Bent wheels that have been straightened

n Aluminum wheel precautions (if equipped)

- 1 Use only Toyota wheel nuts and wrench designed for use with your aluminum wheels.
- 1 When rotating, repairing or changing your tires, check that the wheel nuts are still tight after driving 1000 miles (1600 km).
- 1 Be careful not to damage the aluminum wheels when using tire chains.
- 1 Use only Toyota genuine balance weights or equivalent and a plastic or rubber hammer when balancing your wheels.

n When replacing wheels

The wheels of your Toyota are equipped with tire pressure warning valves and transmitters that allow the tire pressure warning system to provide advanced warning in the event of a loss in tire inflation pressure. Whenever wheels are replaced, the tire pressure warning valves and transmitters must be installed. (→P. 390)

 CAUTION**n When replacing wheels**

- i** Do not use wheels that are a different size from those recommended in the Owner's Manual, as this may result in loss of handling control.
- i** Never use an inner tube in a leaking wheel which is designed for a tubeless tire. Doing so may result in an accident, causing death or serious injury.

 NOTICE**n Replacing tire pressure warning valves and transmitters**

- i** Because tire repair or replacement may affect the tire pressure warning valves and transmitters, make sure to have tires serviced by your Toyota dealer or other qualified service shop. In addition, make sure to purchase your tire pressure warning valves and transmitters at your Toyota dealer.
- i** Ensure that only Genuine Toyota wheels are used on your vehicle. Tire pressure warning valves and transmitters may not work properly with non-genuine wheels.

4-3. Do-it-yourself maintenance

Air conditioning filter

The air conditioning filter must be changed regularly to maintain air conditioning efficiency.

n Removal method

STEP 1 Turn the engine switch off.

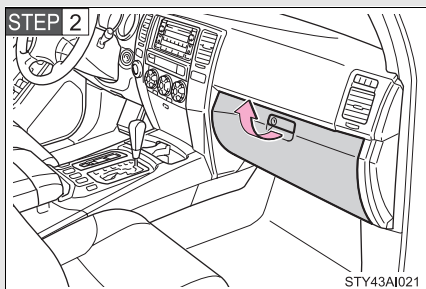

Open the glove box.

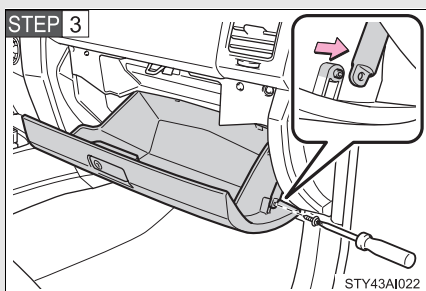

Remove the screw with a Phillips-head screwdriver and slide off the damper.

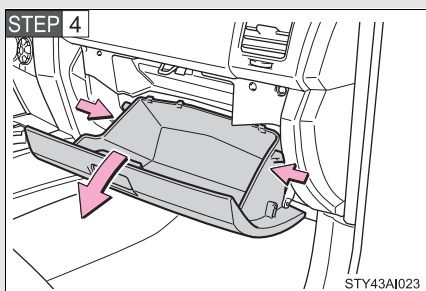

Push in each side of the glove box to disconnect the claws.

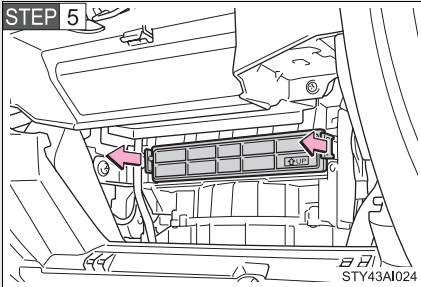

Remove the filter case.

n Replacement method

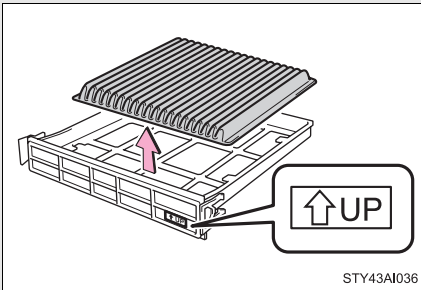

Remove the air conditioning filter and replace it with a new one.

The “↑UP” marks shown on the filter should be pointing up.

n Checking interval

Inspect and replace the air conditioning filter according to the maintenance schedule. In dusty areas or areas with heavy traffic flow, early replacement may be required. (For scheduled maintenance information, please refer to the “Scheduled Maintenance Guide” or “Owner’s Manual Supplement”.)

n If air flow from the vents decreases dramatically

The filter may be clogged. Check the filter and replace if necessary.

⚠ NOTICE

n When using the air conditioning system

Make sure that a filter is always installed.

Using the air conditioning system without a filter may cause damage to the system.

Wireless remote control battery

Replace the battery with a new one if it is discharged.

n **You will need the following items:**

- 1 A coin or equivalent
- 1 Lithium battery CR2016

n **Replacing the battery**

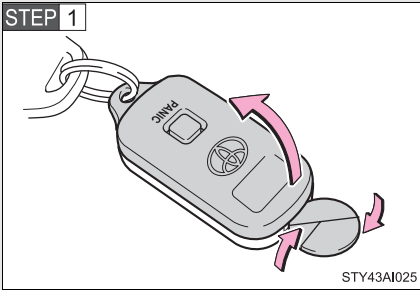

Remove the cover using a coin protected with tape etc.

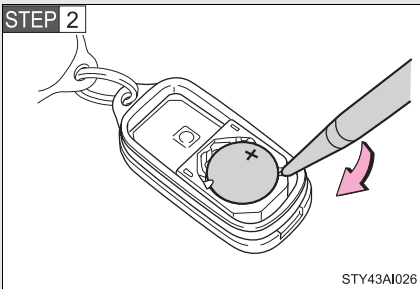

Remove the depleted battery.

Insert a new battery with the "+" terminal facing up.

n If the wireless remote control battery is discharged

The following symptoms may occur.

- l The wireless remote control will not function properly.
- l The operational range is reduced.

n Use a CR2016 lithium battery

- l Batteries can be purchased at your Toyota dealer, jewelers, or camera stores.
- l Replace only with the same or equivalent type recommended by your Toyota dealer.
- l Dispose of used batteries according to the local laws.

⚠ CAUTION**n Removed battery and other parts**

Keep away from children.

These parts are small and if swallowed by a child they can cause choking.

⚠ NOTICE**n For normal operation after replacing the battery**

Observe the following precautions to prevent accidents.

- l Always work with dry hands.
Moisture may cause the battery to rust.
- l Do not touch or move any other components inside the remote control.
- l Do not bend either of the battery terminals.

4-3. Do-it-yourself maintenance

Checking and replacing fuses

If any of the electrical components do not operate, a fuse may have blown. If this happens, check and replace the fuses as necessary.

STEP 1 Turn the engine switch off.

STEP 2 The fuses are located in the following places. To check the fuses, follow the instructions below.

► Engine compartment

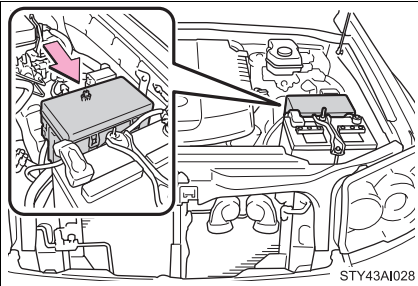

Push the tab in and lift the lid off.

► Under the instrument panel

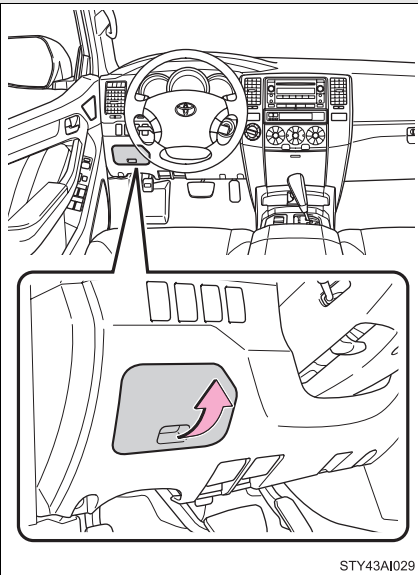

Remove the lid.

STEP 3 After a system failure, see “Fuse layout and amperage ratings” (→P. 407) for details about which fuse to check.

STEP 4

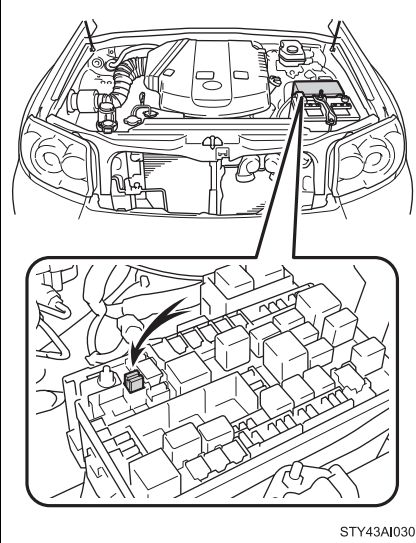

STY43AI030

Remove the fuse with the pull-out tool.

STEP 5 Check if the fuse has blown.

► Type A

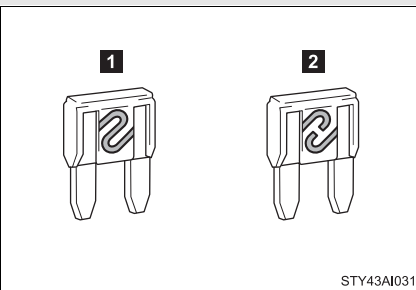

STY43AI031

1 Normal fuse

2 Blown fuse

Replace it with one of an appropriate amperage rating. The amperage rating can be found on the fuse box lid.

► Type B

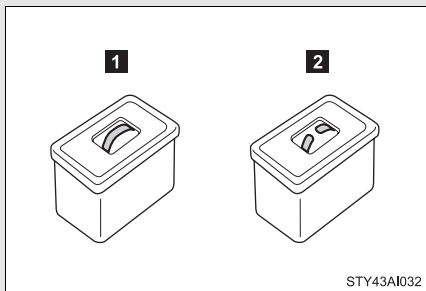

1 Normal fuse

2 Blown fuse

Replace it with one of an appropriate amperage rating. The amperage rating can be found on the fuse box lid.

► Type C

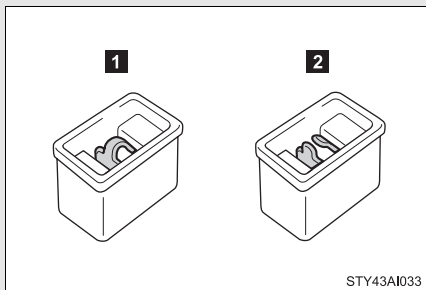

1 Normal fuse

2 Blown fuse

Replace it with one of an appropriate amperage rating. The amperage rating can be found on the fuse box lid

Fuse layout and amperage ratings

n Engine compartment

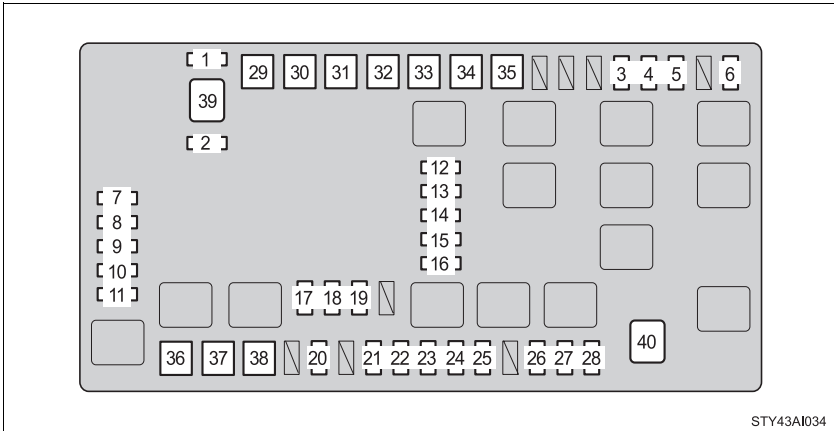

Fuse		Ampere	Circuit
1	SPARE	10 A	Spare fuse
2	SPARE	15 A	Spare fuse
3	STOP	10 A	Stop/tail lights, high mounted stop-light, shift lock control system, anti-lock brake system, traction control system (2WD models), active traction control system (4WD models), vehicle stability control system, rear height control air suspension, multiport fuel injection system/ sequential multiport fuel injection system, trailer brake controller, trailer lights (tail lights)
4	AC 115V INV	15 A	AC inverter
5	FR FOG	15 A	Front fog lights
6	OBD	7.5 A	On-board diagnosis system
7	HEAD (LO RH)	10 A	Right-hand headlight (low beam)
8	HEAD (LO LH)	10 A	Left-hand headlight (low beam)

4-3. Do-it-yourself maintenance

Fuse		Ampere	Circuit
9	HEAD (HI RH)	10 A	Right-hand headlight (high beam)
10	HEAD (HI LH)	10 A	Left-hand headlight (high beam)
11	EFI NO.2	10 A	Multiport fuel injection system/ sequential multiport fuel injection system
12	HEATER NO.2	7.5 A	Air conditioning system
13	AIRSUS NO.2	10 A	Rear height control air suspension
14	SEAT HEATER	25 A	Seat heaters
15	DEFOG	30 A	Back window defogger, multiport fuel injection system/sequential multiport fuel infection system
16	MIR HEATER	10 A	Outside rear view mirror heater
17	DOME	10 A	Interior light, personal lights, wire- less remote control system, door courtesy lights, gauge and meter, vanity lights, instrument panel lights, running board lights, multi- plex communication system
18	RADIO NO.1	20 A	Audio system, navigation system, rear seat entertainment system
19	ECU-B	10 A	Anti-lock brake system, traction control system (2WD models), active traction control system (4WD models), vehicle stability control system, air conditioning system, multiplex communication system, theft deterrent system, driving posi- tion memory system, front passen- ger occupant classification system
20	ALT-S	7.5 A	Charging system
21	HORN	10 A	Horns
22	A/F HEATER	15 A	A/F sensor

Fuse		Ampere	Circuit
23	TRN-HAZ	15 A	Turn signal lights, emergency flashers
24	ETCS	10 A	Multiport fuel injection system/ sequential multiport fuel injection system
25	EFI	20 A	Multiport fuel injection system/ sequential multiport fuel injection system
26	DR/LCK	20 A	Power door lock system
27	TOWING	30 A	Towing converter
28	RADIO NO.2	20 A	Audio system
29	A/PUMP	50 A	Multiport fuel injection system/ sequential multiport fuel injection system
30	AIRSUS	50 A	Rear height control air suspension
31	AM1	50 A	ACC, CIG, IG1, ECU-IG, FR WIP- WSH, RR-WSH, 4WD, and STA fuses
32	TOWING BRK	30 A	Trailer brake controller
33	J/B	50 A	PWR OUTLET, D P/SEAT, P P/ SEAT, POWER, TAIL, SECU/ HORN fuses
34	BATT CHG	30 A	Trailer sub battery
35	TOWING	40 A	Trailer lights (tail lights)
36	ABS MTR	40 A	Anti-lock brake system, traction control system (2WD models), active traction control system (4WD models), vehicle stability control system
37	AM2	30 A	Starter system, IGN, GAUGE, STA NO.2, SRS fuses

Fuse		Ampere	Circuit
38	ABS SOL	30 A	Anti-lock brake system, traction control system (2WD models), active traction control system (4WD models), vehicle stability control system
39	ALT	140 A	A/PUMP, AIRSUS, AM1, TOWING BRK, J/B, BATT CHG, TOWING, TAIL, STOP, AC 115V INV, FR FOG, OBD, DEFOG, MIR HEATER fuses
40	HEATER	60 A	Air conditioning system

n Under the instrument panel

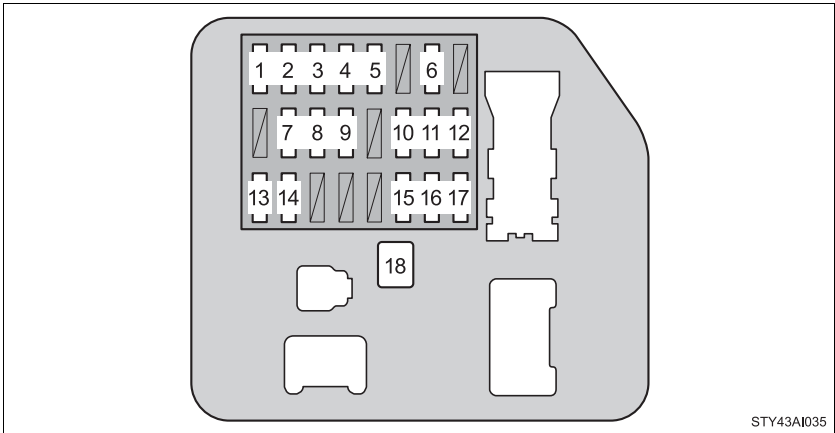

Fuse		Ampere	Circuit
1	IGN	10 A	Multipoint fuel injection system/ sequential multipoint fuel injection system, anti-lock brake system, traction control system (2WD mod- els), active traction control system (4WD models), vehicle stability control system, meter and gauge, front passenger occupant classifi- cation system
2	SRS	10 A	SRS airbag system
3	GAUGE	7.5 A	Meter and gauge
4	STA NO.2	7.5 A	Starting system, multipoint fuel injection system/sequential multi- port fuel injection system
5	FR WIP-WSH	30 A	Windshield wipers and washer
6	4WD	20 A	4WD control system
7	D P/SEAT	30 A	Driver's power seat
8	P P/SEAT	30 A	Front passenger's power seat
9	PWR OUTLET	15 A	Power outlets

Fuse		Ampere	Circuit
10	RR WSH	15 A	Back window washer, multiplex communication system
11	ECU-IG	10 A	Shift lock control system, power windows, anti-lock brake system, traction control system (2WD models), active traction control system (4WD models), vehicle stability control system, electric moon roof, multiplex communication system, theft deterrent system, rear height control air suspension, tire pressure warning system, driving position memory system
12	IG1	15 A	Anti-lock brake system, traction control system (2WD models), active traction control system (4WD models), vehicle stability control system, air conditioning system, charging system, back window defogger, back-up lights, emergency flashers, seat heaters, AC inverter, instrument panel light control, auto anti-glare inside rear view mirror, seat belt tension reducer
13	STA	7.5 A	No circuit
14	SECU/HORN	10 A	Theft deterrent system
15	TAIL	10 A	Tail lights, license plate lights, parking lights, instrument panel light control, multiport fuel injection system/sequential multiport fuel injection system, instrument panel lights, meter and gauge, glove box light

Fuse		Ampere	Circuit
16	ACC	7.5 A	Power outlets, outside rear view mirrors, audio system, navigation system, shift lock control system, instrument panel lights, rear seat entertainment system
17	CIG	10 A	No circuit
18	POWER	30 A	Power windows, electric moon roof

n After a fuse is replaced

- l If the lights do not turn on even after the fuse has been replaced, a bulb may need replacement. (→P. 415)
- l If the replaced fuse blows again, have the vehicle inspected by your Toyota dealer.

n If there is an overload in the circuits

The fuses are designed to blow before the entire wiring harness is damaged.

CAUTION

n To prevent system breakdowns and vehicle fire

Observe the following precautions.

Failing to do so may cause damage, and possibly a fire or injury.

- l Never use a fuse of a higher amperage rating than indicated, or use any other object in place of a fuse.
- l Always use a genuine Toyota fuse or equivalent.
Never replace a fuse with a wire, even as a temporary fix.
This can cause extensive damage or even fire.
- l Do not modify the fuse or the fuse box.

 NOTICE

n Before replacing fuses

Have the cause of electrical overload determined and repaired by your Toyota dealer as soon as possible.

Light bulbs

You may replace the following bulbs yourself. The difficulty level of replacement varies depending on the bulb. If necessary bulb replacement seems difficult to perform, contact your Toyota dealer.

For more information about replacing other light bulbs, contact your Toyota dealer.

1 **Prepare a replacement light bulb.**

Check the wattage of the light bulb being replaced. (→P. 480)

1 **Front bulb locations**

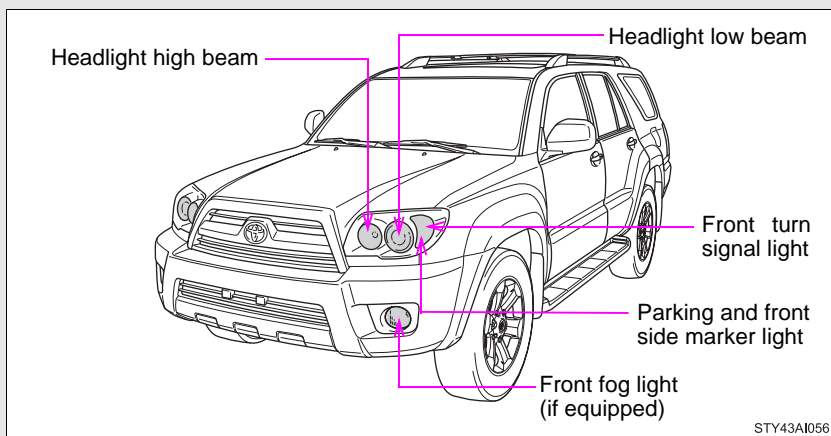

n Rear bulb locations

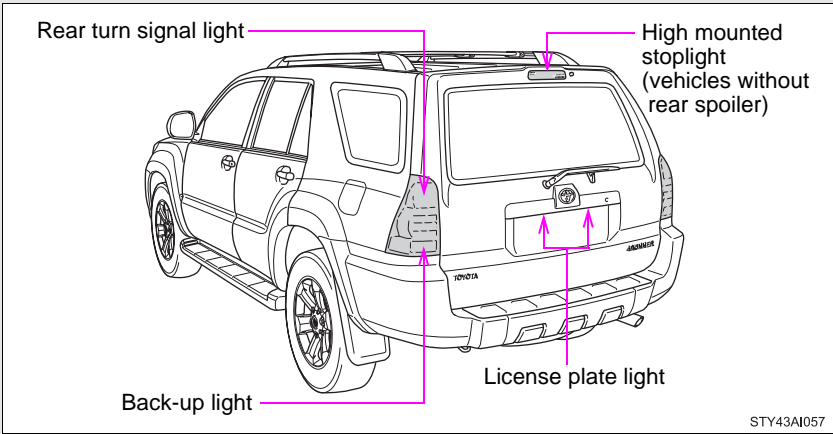

Replacing light bulbs

n Headlights

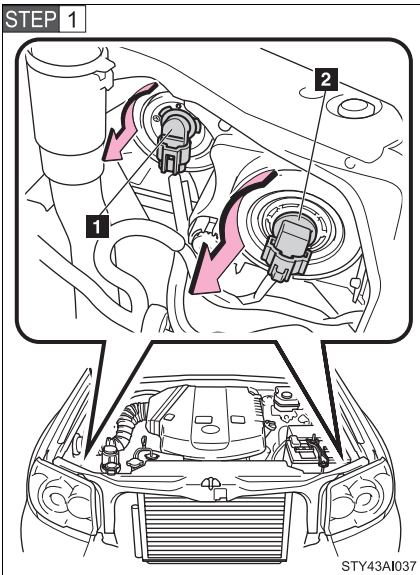

Turn the bulb base counterclockwise.

- 1 High beam (inside)
- 2 Low beam (outside)

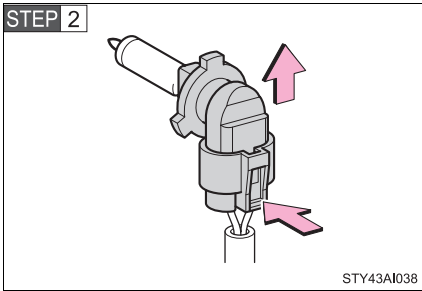

Unplug the connector while depressing the lock release.

n Front fog light (if equipped)

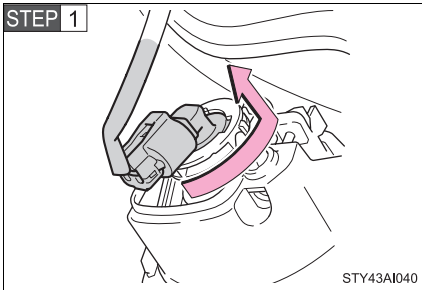

Turn the bulb base counterclockwise.

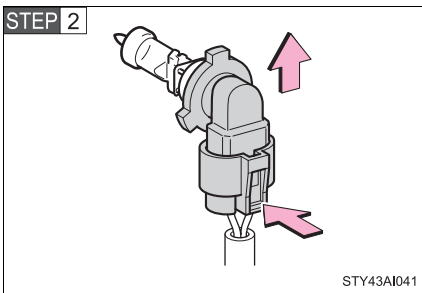

Unplug the connector while depressing the lock release.

n Parking and front side marker lights

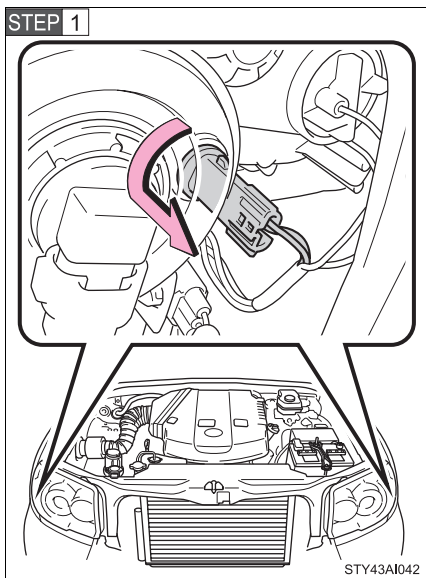

Turn the bulb base counterclockwise.

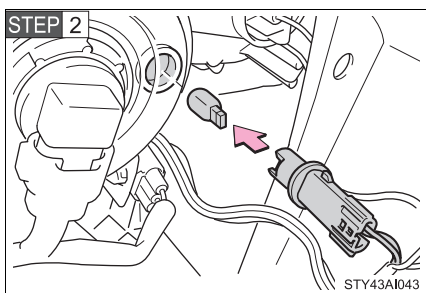

Remove the light bulb.

n Front turn signal lights

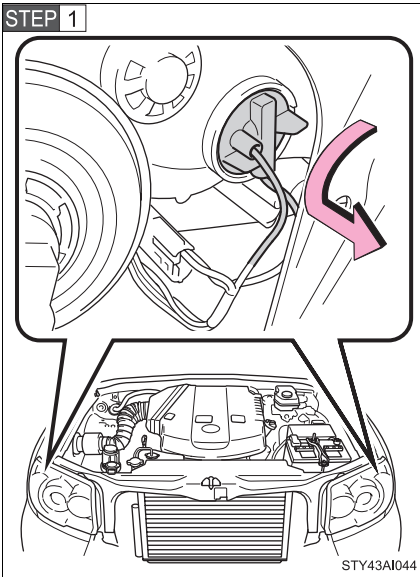

Turn the bulb base counterclockwise.

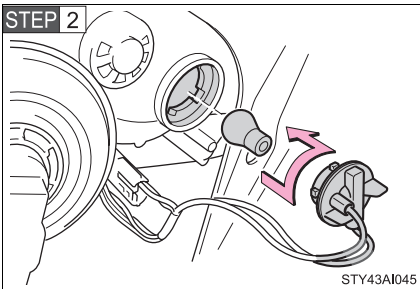

Remove the light bulb.

n Rear turn signal and back-up lights

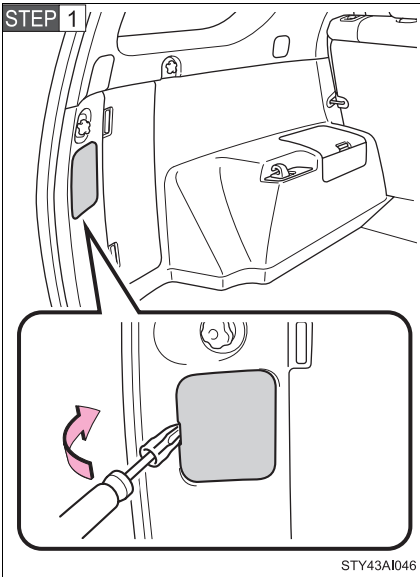

Open the back door and remove the cover.

Using a flathead screwdriver or equivalent which is wrapped with a cloth.

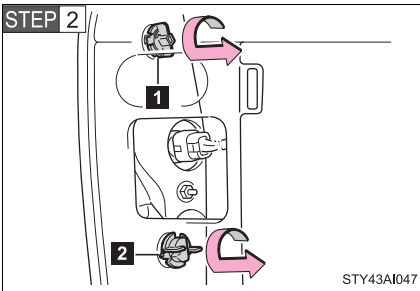

Turn the bulb bases counter-clockwise.

- 1** Rear turn signal light
- 2** Back-up light

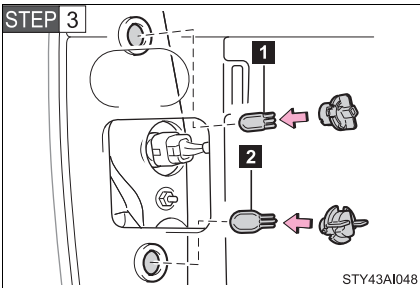

Remove the light bulb.

- 1** Rear turn signal light
- 2** Back-up light

n License plate lights

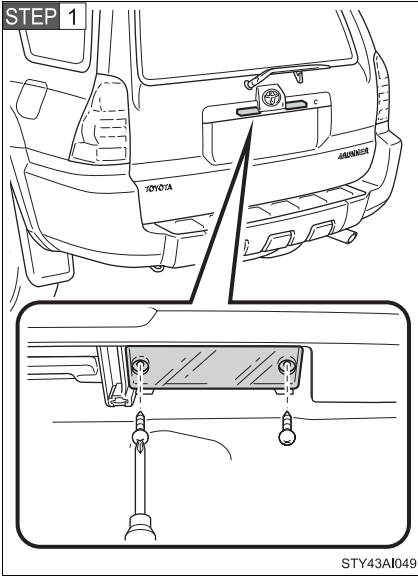

Remove the screws and cover.

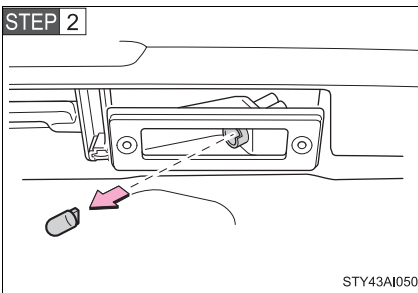

Remove the light bulb.

n High mounted stoplight (vehicles without rear spoiler)

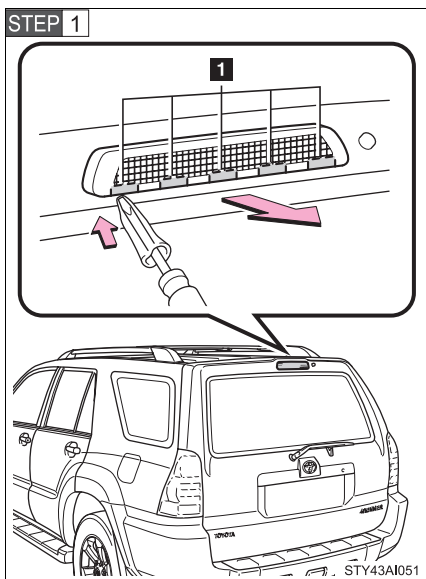

Disconnect the clips by using a flathead screwdriver which is wrapped with a cloth.

1 Clips

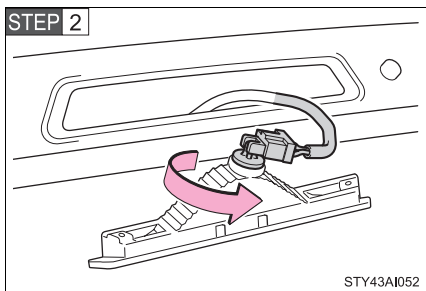

Turn the bulb base counterclockwise.

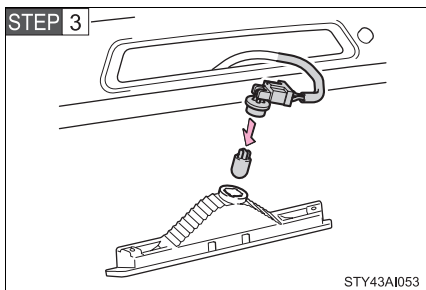

Remove the light bulb.

n **Lights other than the above**

If any of the lights listed below has burnt out, have it replaced by your Toyota dealer.

- Stop/tail and rear side marker lights
- High mounted stoplight (vehicles with rear spoiler)

n **Condensation build-up on the inside of the lens**

Contact your Toyota dealer for more information in the following situations. Temporary condensation build-up on the inside of the headlight lens does not indicate a malfunction.

- l Large drops of water are built up on the inside of the lens.
- l Water has built up inside the headlight.

n **LED lights**

The stop/tail and rear side marker lights, and high mounted stoplight (vehicles with the rear spoiler) consist of a number of LEDs. If any of the LEDs burn out, take your vehicle to your Toyota dealer to have the light replaced.

If two or more LEDs in a stop light burn out, your vehicle may not conform to local laws (SAE).

CAUTION

n **Replacing light bulbs**

- l Turn off the headlights. Do not attempt to replace the bulb immediately after turning off the headlights.
The bulbs become very hot and may cause burns.
- l Halogen bulbs have pressurized gas inside and require special handling. Do not touch the glass portion of the light bulb with bare hands. Hold the bulb by the plastic or metal portion.
If the bulb is scratched or dropped it may blow out or crack.
- l Fully install light bulbs and any parts used to secure them. Failing to do so may result in heat damage, fire, or water entering the headlight unit. This may damage the headlights or cause condensation to build up on the lens.

n **To prevent damage or fire**

Make sure bulbs are fully seated and locked.

5-1. Essential information

Emergency flashers

Use the emergency flashers if the vehicle malfunctions or is involved in an accident.

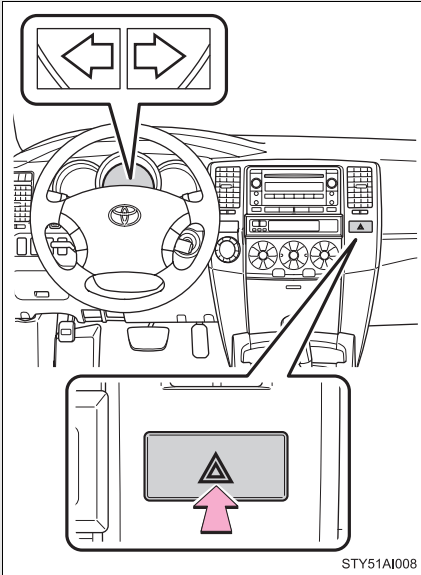

Press the switch to flash all the turn signal lights. To turn them off, press the switch once again.

NOTICE

n To prevent battery discharge

Do not leave the emergency flashers on longer than necessary when the engine is not running.

If your vehicle needs to be towed

If towing is necessary, we recommend having your vehicle towed by your Toyota dealer or a commercial towing service, using a lift-type truck or a flat bed truck.

Use a safety chain system for all towing, and abide by all state/provincial and local laws.

The wheels and axle on the ground must be in good condition.

If they are damaged, use a towing dolly or flat bed truck.

Before towing

The following may indicate a problem with your transmission. Contact your Toyota dealer before towing.

- 1 The engine is running, but the vehicle will not move.
- 1 The vehicle makes an abnormal sound.

Emergency towing

If a tow truck is not available, in an emergency your vehicle may be temporarily towed using a cable or chain secured to the emergency towing eyelet. This should only be attempted on hard, surfaced roads for short distances at low speeds.

A driver must be in the vehicle to steer and operate the brakes. The vehicle's wheels, drive train, axles, steering and brakes must be in good condition.

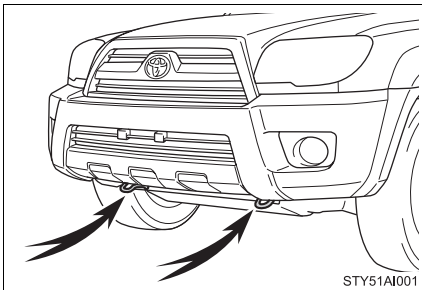

Towing eyelet

n Emergency towing procedure

STEP 1 The engine switch must be in the ACC (engine off) or the ON (engine running) position.

STEP 2 4WD models:
On multi-mode 4WD models, put the four-wheel drive control switch in H2.
On full-time 4WD models, unlock the center differential.

STEP 3 Put the shift lever in N.

STEP 4 Release the parking brake.

 **CAUTION**

n Caution while towing

- I** Use extreme caution when towing the vehicle.
Avoid sudden starts or erratic driving maneuvers which place excessive stress on the emergency towing eyelet and the cables or chains.
- I** If the engine is not running, the power assist for the brakes and steering will not function, making steering and braking more difficult.

 **NOTICE**

n To prevent causing serious damage to the transmission

Never tow this vehicle from the rear with the four wheels on the ground. This may cause serious damage to the transmission.

n Emergency towing eyelet precautions

- I** Before emergency towing, check that the eyelet is not broken or damaged.
- I** Fasten the towing cable or chain securely to the eyelet.
- I** Do not jerk the eyelet. Apply steady and even force.
- I** To avoid damaging the eyelet, do not pull from the side or at a vertical angle. Always pull straight ahead.

Towing with a sling-type truck

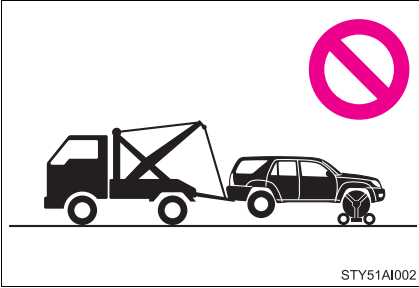

NOTICE

n To prevent body damage

Do not tow with a sling-type truck, either from the front or rear.

Towing with a wheel lift-type truck from the front

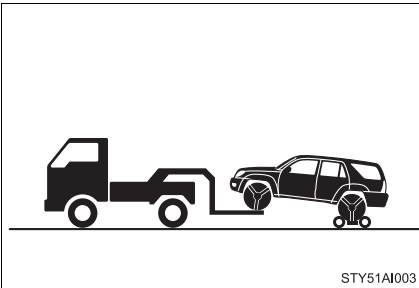

Use a towing dolly under the rear wheels.

NOTICE

n To prevent causing serious damage to the transmission

Never tow this vehicle wheels on the ground.

Towing with a wheel lift-type truck from the rear

► 2WD models

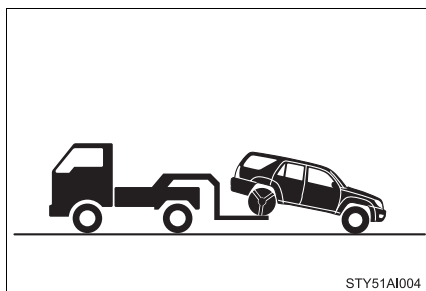

Turn the engine switch to the ACC position.

► 4WD models

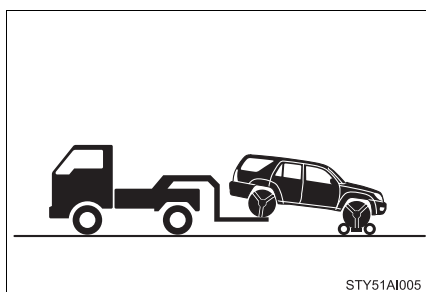

Full-time 4WD models: Use a towing dolly under the front wheels.

Multi-mode 4WD models: When not using a towing dolly, turn the engine switch to the ACC position, shift the shift lever to N and put the four-wheel drive control switch in H2.

NOTICE

n To prevent causing serious damage to the transmission (4WD models)

Never tow this vehicle wheels on the ground.

n To prevent damaging the vehicle

- I** Do not tow the vehicle with the key removed or in the LOCK position. The steering lock mechanism is not strong enough to hold the front wheel straight.
- I** When raising the vehicle, ensure adequate ground clearance for towing at the opposite end of the raised vehicle. Without adequate clearance, the vehicle could be damaged while being towed.

Using a flat bed truck

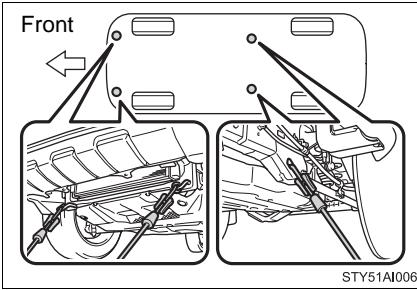

If your Toyota is transported by a flat bed truck, it should be tied down at the locations shown in the illustration.

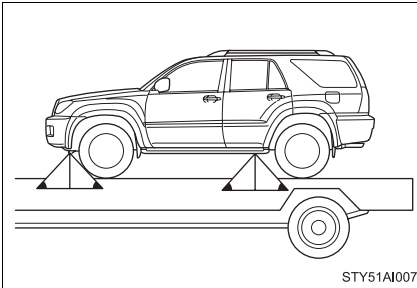

If you use chains or cables to tie down your vehicle, the angles shaded in black must be 45°.

Do not overly tighten the tie downs or the vehicle may be damaged.

Apply the parking brake firmly.

If you think something is wrong

If you notice any of the following symptoms, your vehicle probably needs adjustment or repair. Contact your Toyota dealer as soon as possible.

n Visible symptoms

- 1 Fluid leaks under the vehicle
(Water dripping from the air conditioning after use is normal.)
- 1 Flat-looking tires or uneven tire wear
- 1 Engine coolant temperature gauge needle continually points higher than normal

n Audible symptoms

- 1 Changes in exhaust sound
- 1 Excessive tire squeal when cornering
- 1 Strange noises related to the suspension system
- 1 Pinging or other noises related to the engine

n Operational symptoms

- 1 Engine missing, stumbling or running rough
- 1 Appreciable loss of power
- 1 Vehicle pulls heavily to one side when braking
- 1 Vehicle pulls heavily to one side when driving on a level road
- 1 Loss of brake effectiveness, spongy feeling, pedal almost touches the floor

Fuel pump shut off system

To minimize the risk of fuel leakage when the engine stalls or an air-bag inflates upon collision, the fuel pump shut off system stops supplying fuel to the engine.

Follow the procedure below to restart the engine after the system is activated.

STEP 1 Turn the engine switch to the ACC or LOCK position.

STEP 2 Restart the engine.



NOTICE

n Before starting the engine

Inspect the ground under the vehicle.

If you find that fuel has leaked onto the ground, the fuel system has been damaged and is in need of repair. Do not restart the engine.

5-1. Essential information

Event data recorder

Your vehicle has computers that monitor and control certain aspects of your vehicle. These computers assist in driving and maintaining optimal vehicle performance.

Besides storing data useful for troubleshooting, there is an event data recorder (EDR) that records data in a crash or a near car crash event.

In a crash or a near car crash event

The SRS airbag sensor assembly contains the EDR. In a crash or a near car crash event, this device may record some or all of the following information:

- 1 Engine speed
- 1 Whether the brake pedal was applied or not
- 1 Vehicle speed
- 1 To what extent the accelerator pedal was depressed
- 1 Position of the transmission shift lever
- 1 Whether the driver and front passenger wore seat belts or not
- 1 Driver's seat position
- 1 SRS airbag deployment data
- 1 SRS airbag system diagnostic data
- 1 Front passenger's occupant classification

The information above is intended to be used for the purpose of improving vehicle safety performance. Unlike general data recorders, the EDR does not record sound data such as conversation between passengers.

Disclosure of the data

Toyota will not disclose the data recorded in an EDR to a third party except when:

- 1 An agreement from the vehicle's owner (or the leasing company for a leased vehicle) is obtained
- 1 Officially requested by the police or other authorities
- 1 Used as a defense for Toyota in a law suit
- 1 Ordered by a court of law

However, if necessary Toyota will:

- 1 Use the data for research on Toyota vehicle safety performance
- 1 Disclose the data to a third party for research purposes without disclosing details of the vehicle owner, and only when it is deemed necessary
- 1 Disclose summarized data cleared of vehicle identification information to a non-Toyota organization for research purposes

5-2. Steps to take in an emergency

If a warning light turns on or a warning buzzer sounds...

Calmly perform the following actions if any of the warning lights turn on or flash. If a light turns on or flashes, but then turns off, this does not necessarily indicate a malfunction in the system.

Stop the vehicle immediately. Continuing to drive the vehicle may be dangerous.

The following warning indicates a possible problem in the brake system. Immediately stop the vehicle in a safe place and contact your Toyota dealer.



Warning light	Warning light/Details
	Brake system warning light (warning buzzer)* <ul style="list-style-type: none">• Low brake fluid• Malfunction in the brake system This light also comes on when the parking brake is not released. If the light turns off after the parking brake is fully released, the system is operating normally.

*: Parking brake engaged warning buzzer:

The buzzer sounds to indicate that parking brake is still engaged (with the vehicle having reached a speed of 3 mph [5 km/h])

Stop the vehicle immediately.



The following warnings indicate the possibility of damage to the vehicle that may lead to an accident. Immediately stop the vehicle in a safe place and contact your Toyota dealer.





Warning light	Warning light/Details
	<p>Charging system warning light Indicates a malfunction in the vehicle's charging system.</p>
	<p>Low engine oil pressure warning light Indicates that the engine oil pressure is too low*.</p>

*: The light may come on when the oil level is extremely low. It is not designed to indicate low oil level, and the oil level must be checked using the engine oil level dipstick.

Have the vehicle inspected immediately.





Failing to investigate the cause of the following warnings may lead to the system operating abnormally and possibly cause an accident. Have the vehicle inspected by your Toyota dealer immediately.



Warning light	Warning light/Details
	<p>Malfunction indicator lamp Indicates a malfunction in:</p> <ul style="list-style-type: none"> • The electronic engine control system; • The electronic throttle control system; • The electronic automatic transmission control system; or • The emission control system.
	<p>SRS warning light Indicates a malfunction in:</p> <ul style="list-style-type: none"> • The SRS airbag system; • The front passenger occupant classification system; or • The seat belt pretensioner system.

Warning light	Warning light/Details
 (U.S.A.)  (Canada)	<p>ABS warning light Indicates a malfunction in:</p> <ul style="list-style-type: none"> • The ABS; or • The brake assist system.
	<p>Automatic transmission fluid temperature warning light Indicates that the automatic transmission fluid temperature is too high.</p>
 (Flashing)	<p>VSC OFF warning light Indicates a malfunction in:</p> <ul style="list-style-type: none"> • The VSC; • The TRAC; • The AUTO LSD system; • The active traction control system (4WD models); • The downhill assist control system (if equipped); or • The hill-start assist control system (if equipped).

Follow the correction procedures.

After taking the specified steps to correct the suspected problem, check that the warning light turns off.

Warning light	Warning light/Details	Correction procedure
	<p>Open door warning light Indicates that a door is not fully closed.</p>	Check that all doors are closed.
 (On the instrument cluster)	<p>Driver's seat belt reminder light (warning buzzer)^{*1} Warns the driver to fasten his/her seat belt.</p>	Fasten the seat belt.
 (On the center panel)	<p>Front passenger's seat belt reminder light (warning buzzer)^{*2} Warns the front passenger to fasten his/her seat belt.</p>	Fasten the seat belt.
	<p>Tire pressure warning light</p> <ul style="list-style-type: none"> • When the light comes on: Indicates low tire inflation pressure. • When the light stays on after blinking for 1 minute: Indicates a malfunction in the tire pressure warning system. 	<p>Adjust the tire inflation pressure. (including spare tire)</p> <p>Have the system checked by your Toyota dealer.</p>
	<p>Low fuel level warning light Low level of fuel.</p>	Refuel the vehicle.

Warning light	Warning light/Details	Correction procedure
 <p>MAINT (U.S.A.)</p>	<p>Engine oil replacement reminder light</p> <ul style="list-style-type: none"> • Illuminates for about 3 seconds and then flashes for about 12 seconds: Indicates that the engine oil is scheduled to be changed. • Comes on and remains: Indicates that the engine oil should be changed. 	<p>Check the engine oil, and change if necessary.</p> <p>Check and change the engine oil.</p>
 <p>(if equipped)</p>	<p>Low washer fluid warning light</p> <p>Low level of washer fluid.</p>	<p>Fill the tank.</p>

*1: Driver's seat belt reminder:

The driver's seat belt reminder sounds to alert the driver that his or her seat belt is not fastened. Once the engine switch is turned to the ON or START position, the buzzer sounds for about 4 to 8 seconds. If the vehicle has reached a speed of at least 12 mph (20 km/h), the buzzer sounds for about 10 seconds. Then, if the seat belt is still unfastened, the buzzer will sound in a different tone for about 20 seconds.

*2: Front passenger's seat belt reminder:

The front passenger's seat belt reminder sounds to alert the front passenger that his or her seat belt is not fastened. The buzzer sounds for about 10 seconds after the vehicle has reached a speed of at least 12 mph (20 km/h). Then, if the seat belt is still unfastened, the buzzer will sound in a different tone for about 20 seconds.

n Key reminder buzzer

The buzzer indicates that the key has not been removed (with the engine switch in the ACC or LOCK position and the driver's door opened).

n If the malfunction indicator lamp comes on while driving

First check the following:

- l Is your vehicle low on gas?
If it is, refuel the vehicle immediately.
- l Is the fuel tank cap loose?
If it is, tighten it securely.

The light will go off after taking several driving trips.

If the light does not go off even after several trips, contact your Toyota dealer as soon as possible.

n Front passenger detection sensor and passenger seat belt reminder

If luggage or other load is placed on the front passenger seat, depending on its weight, the reminder light to flash and buzzer to sound.

n When the tire pressure warning light comes on

Check the tire inflation pressure and adjust to the appropriate level.

n The tire pressure warning light may turn on due to natural causes

The tire pressure warning light may turn on due to natural causes such as natural air leaks or tire inflation pressure changes caused by temperature. In this case, adjusting the tire inflation pressure will turn off the warning light (after a few minutes).

n When a tire is replaced with a spare tire

The spare tire is also equipped with the tire pressure warning valve and transmitter. The tire pressure warning light will turn on if the tire inflation pressure of the spare tire is low. If a tire goes flat, even though the flat tire is replaced with the spare tire, the tire pressure warning light does not turn off. Replace the spare tire with the repaired tire and adjust the proper tire inflation pressure. The tire pressure warning light will turn off after a few minutes.

n If the tire pressure warning system is inoperative

The tire pressure warning system will be disabled in the following conditions:

(When the condition becomes normal, the system will work properly.)

- l If tires not equipped with tire pressure warning valves and transmitters are used.
- l If the ID code on the tire pressure warning valves and transmitters is not registered in the tire pressure warning computer.
- l If the tire inflation pressure is 73 psi (500 kPa, 5.1 kgf/cm² or bar) or higher.

The tire pressure warning system may be disabled in the following conditions:

(When the condition becomes normal, the system will work properly.)

- l If electronic devices or facilities using similar radio wave frequencies are nearby.
 - l If a radio set at similar frequencies is in use in the vehicle.
 - l If a window tint that affects the radio wave signals is installed.
 - l If there is a lot of snow or ice on the vehicle, in particular around the wheels or wheel housings.
 - l If non-genuine Toyota wheels are used. (Even if you use Toyota wheels, the tire pressure warning system may not work properly with some types of tires.)
 - l If tire chains are used.
- n If the tire pressure warning light comes on after blinking for 1 minute frequently**

If the tire pressure warning light comes on after blinking for 1 minute frequently when the engine switch is turned to the ON position, have it checked by your Toyota dealer.

n After changing the engine oil (U.S.A. only)

Make sure to reset the oil maintenance data. (→P. 378)

n Customization that can be configured at Toyota dealer

The vehicle speed linked seat belt reminder buzzer can be disabled. (Customizable features →P. 495)

 **CAUTION****n If the tire pressure warning light comes on**

Be sure to observe the following precautions. Failure to do so could cause loss of vehicle control and result in death or serious injury.

- 1** Stop your vehicle in a safe place as soon as possible. Adjust the tire inflation pressure immediately.
- 1** If the tire pressure warning light comes on even after tire inflation pressure adjustment, it is probable that you have a flat tire. Check the tires. If the tire is flat, change to the spare tire and have the flat tire repaired by the nearest Toyota dealer.
- 1** Avoid abrupt maneuvering and braking. If the vehicle tires deteriorate, you could lose control of the steering wheel or the brakes.

n If a blowout or sudden air leakage should occur

The tire pressure warning system may not activate immediately.

n Maintenance of the tire

Each tire, including the spare (if provided), should be checked monthly when cold and inflated to the inflation pressure recommended by the vehicle manufacturer on the vehicle placard or tire inflation pressure label (tire and load information label). (If your vehicle has tires of a different size than the size indicated on the vehicle placard or tire inflation pressure label [tire and load information label], you should determine the proper tire inflation pressure for those tires.)

As an added safety feature, your vehicle has been equipped with a tire pressure monitoring system (TPMS-tire pressure warning system) that illuminates a low tire pressure telltale (tire pressure warning light) when one or more of your tires is significantly under-inflated. Accordingly, when the low tire pressure telltale (tire pressure warning light) illuminates, you should stop and check your tires as soon as possible, and inflate them to the proper pressure. Driving on a significantly under-inflated tire causes the tire to overheat and can lead to tire failure. Under-inflation also reduces fuel efficiency and tire tread life, and may affect the vehicle's handling and stopping ability.

 CAUTION

Please note that the TPMS (tire pressure warning system) is not a substitute for proper tire maintenance, and it is the driver's responsibility to maintain correct tire pressure, even if under-inflation has not reached the level to trigger illumination of the TPMS low tire pressure telltale (tire pressure warning light).

Your vehicle has also been equipped with a TPMS (tire pressure warning system) malfunction indicator to indicate when the system is not operating properly. The TPMS (tire pressure warning system) malfunction indicator is combined with the low tire pressure telltale (tire pressure warning light). When the system detects a malfunction, the telltale will flash for approximately one minute and then remain continuously illuminated. This sequence will continue upon subsequent vehicle start-ups as long as the malfunction exists. When the malfunction indicator is illuminated, the system may not be able to detect or signal low tire pressure as intended.

TPMS (tire pressure warning system) malfunctions may occur for a variety of reasons, including the installation of replacement or alternate tires or wheels on the vehicle that prevent the TPMS (tire pressure warning system) from functioning properly. Always check the TPMS (tire pressure warning system) malfunction telltale after replacing one or more tires or wheels on your vehicle to ensure that the replacement or alternate tires and wheels allow the TPMS (tire pressure warning system) to continue to function properly.

 NOTICE

n Precaution when installing a different tire

When a tire of a different specification or maker is installed, the tire pressure warning system may not operate properly.

5-2. Steps to take in an emergency If you have a flat tire

Remove the flat tire and replace it with the spare provided.

n Before jacking up the vehicle

- 1 Stop the vehicle on a hard, flat surface.
- 1 Set the parking brake.
- 1 Shift the shift lever to P.
- 1 Stop the engine.
- 1 Turn on the emergency flashers.

n Location of the spare tire

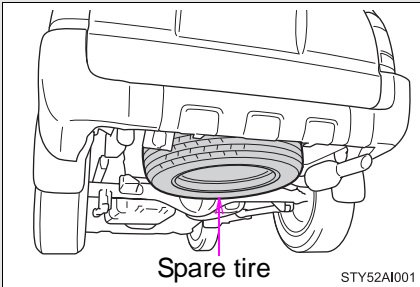

n Location of the jack and tools

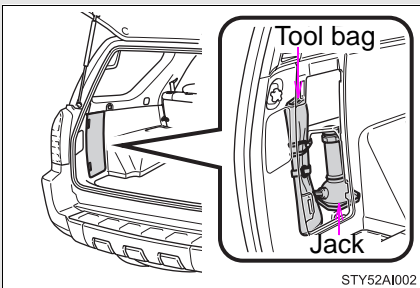

Taking out the jack and tool bag

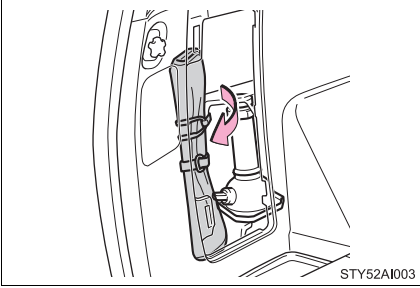

Remove the cover and loosen the strap.

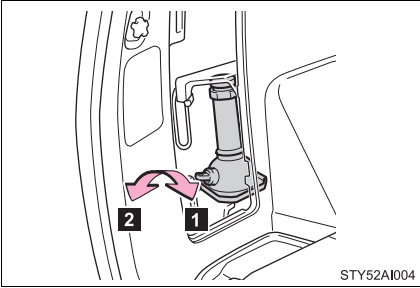

- 1 Tighten
- 2 Loosen

Taking out the spare tire

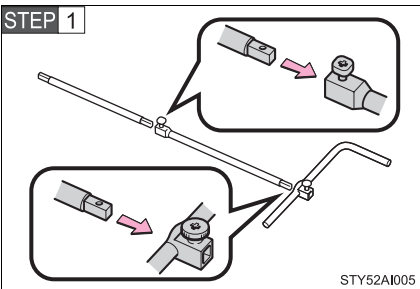

Assemble the jack handle extension as shown. Be sure to tighten each bolt securely.

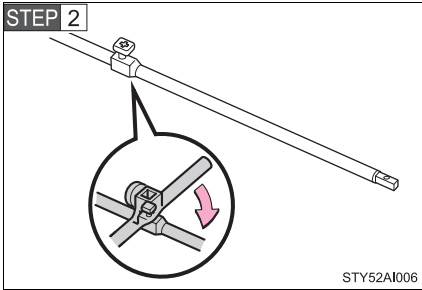

When connecting the jack handle extensions, use the jack handle to tighten the square head bolt. Make sure that the bolt fits into the depression on the joint.

When connecting the jack handle extension with the jack handle, tighten the round head bolt by hand.

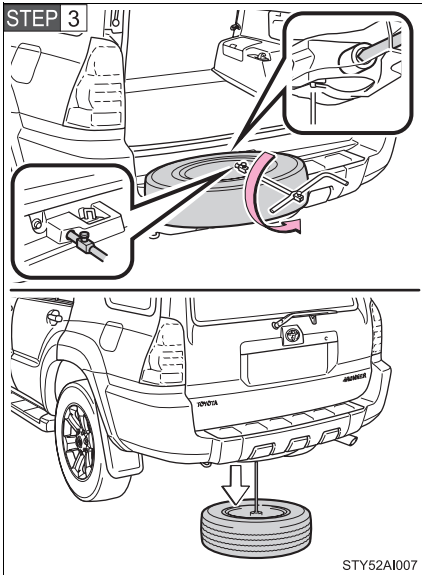

Insert the end of the jack handle extension into the lowering screw and turn it counterclockwise.

After the tire is lowered completely to the ground, remove the holding bracket.

Replacing a flat tire

STEP 1

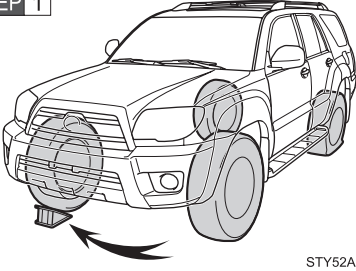

STY52AI008

Chock the tires.

Flat tire		Wheel chock positions
Front	Left-hand side	Behind the rear right-hand side tire
	Right-hand side	Behind the rear left-hand side tire
Rear	Left-hand side	In front of the front right-hand side tire
	Right-hand side	In front of the front left-hand side tire

STEP 2 Remove the wheel ornament using the wheel nut wrench as shown.

To protect the wheel and wheel ornament, place a rag between the wrench and the wheel ornament, as shown in the illustration.

► Steel wheel

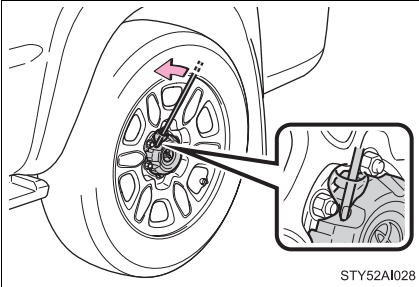

► Aluminum wheel

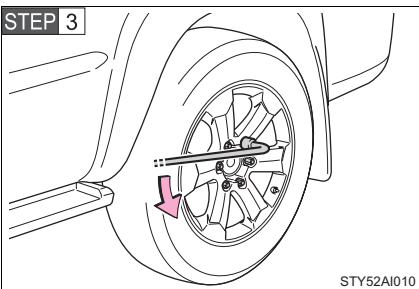
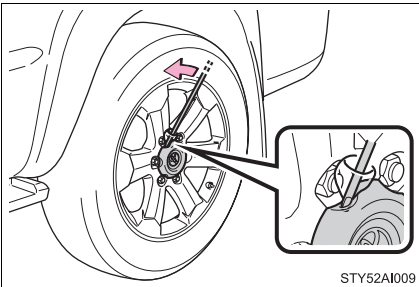

Slightly loosen the wheel nuts (one turn).

5-2. Steps to take in an emergency

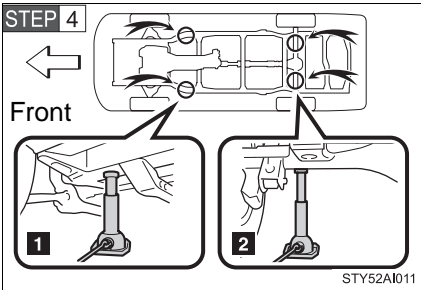

Position the jack at the correct jack point as shown.

- 1** Front
- 2** Rear

Make sure the jack is positioned on a level and solid place.

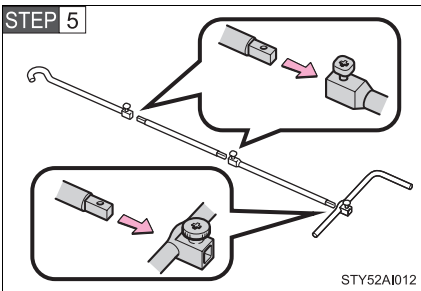

Assemble the jack handle extension as shown. Be sure to tighten each bolt securely.

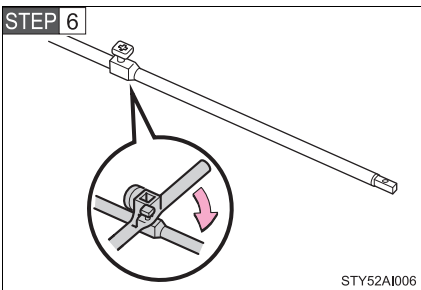

When connecting the jack handle extension(s) and jack handle end, use the jack handle to tighten the square head bolt. Make sure that the bolt fits into the depression on the joint.

When connecting the jack handle extension with the jack handle, tighten the round head bolt by hand.

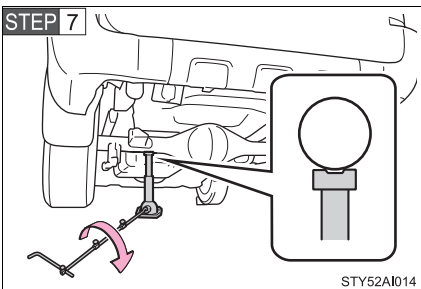

Raise the vehicle until the tire is slightly raised off the ground.

When positioning the jack under the rear axle housing, make sure the groove on the top of the jack fits with the rear axle housing.

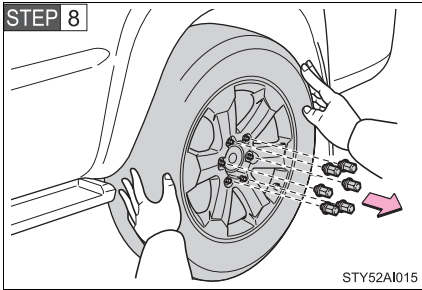

Remove all the wheel nuts and the tire.

When resting the tire on the ground, place the tire so that the wheel design faces up to avoid scratching the wheel surface.

Installing the tire

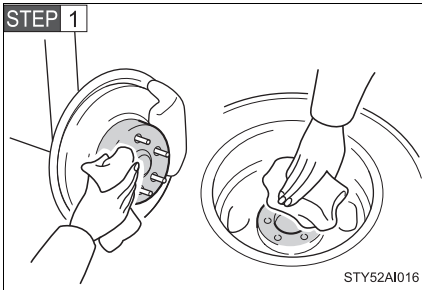

Remove any dirt or foreign matter from the wheel contact surface.

If foreign matter is on the wheel contact surface, the wheel nuts may loosen while the vehicle is in motion, and the tire may come off the vehicle.

STEP 2 Install the tire and loosely tighten each wheel nut by hand by approximately the same amount.

► Replacing a steel wheel

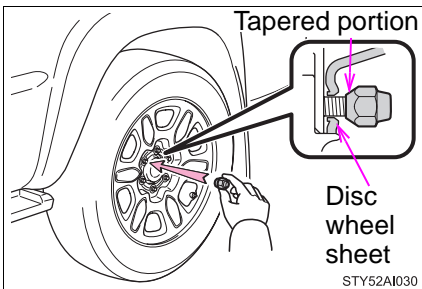

Tighten the nuts until the tapered portion comes into loose contact with the disc wheel sheet.

5-2. Steps to take in an emergency

► Replacing an aluminum wheel

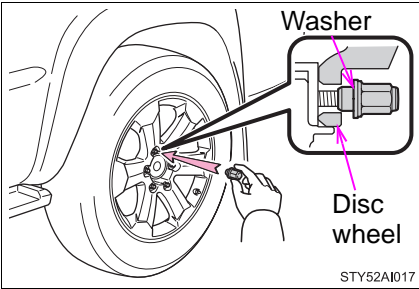

Tighten the nuts until the washer of the nut comes into loose contact with the disc wheel.

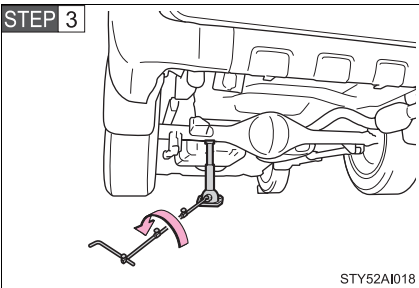

Lower the vehicle.

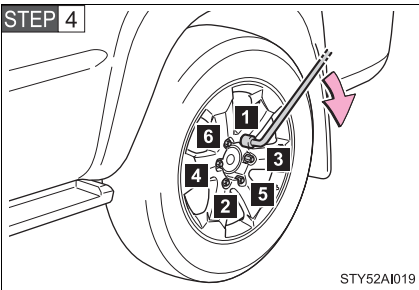

Firmly tighten each nut two or three times in the order shown in the illustration.

Tightening torque:
83 ft·lbf (110 N·m, 11.5 kgf·m)

STEP 5 Reinstall the wheel ornament.

▶ Steel wheel

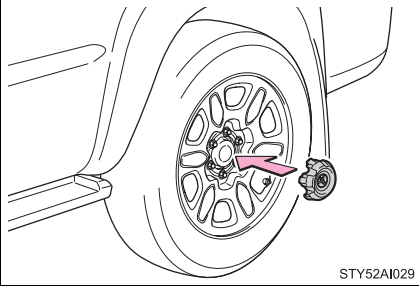

▶ Aluminum wheel

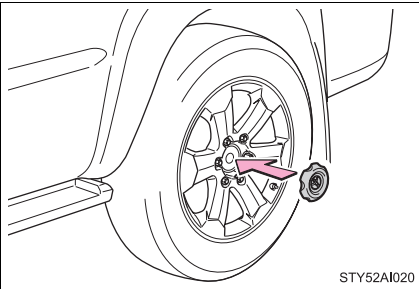

Stowing the flat tire, jack and all tools

STEP 1 Lay down the tire with the outer side facing up, and install the holding bracket.

Then secure the tire, taking care that the tire goes straight up without catching on any other part, to prevent it from flying forward during a collision or sudden braking.

STEP 2 Stow the tools and jack securely.

11 After completing the tire change

The tire pressure warning system must be reset. (→P. 390)

 CAUTION

n Using the jack

Improper use of the jack may lead to death or serious injuries due to the vehicle suddenly falling off the jack.

- I Do not use the jack for any purpose other than replacing tires or installing and removing tire chains.
- I Only use the jack that comes with this vehicle for replacing a flat tire. Do not use it on other vehicles, and do not use other jacks for replacing tires on this vehicle.
- I Always check that the jack is securely set to the jack point.
- I Do not put any part of your body under the vehicle supported by a jack.
- I Do not start or run the engine while your vehicle is supported by the jack.
- I Do not raise the vehicle while someone is in it.
- I When raising the vehicle, do not put an object on or under the jack.
- I Do not raise the vehicle to a height greater than that required to replace the tire.
- I Use a jack stand if it is necessary to get under the vehicle.

Take particular care when lowering the vehicle to ensure that no one working on or near the vehicle will be injured.

n Using the jack handle

Tighten all the square head bolts securely to prevent the extension parts from coming apart unexpectedly.

n Replacing a flat tire

Observe the following precautions to reduce the risk of death or serious injury.

- I Lower the spare tire completely to the ground before removing it from under the vehicle.
- I Do not try to remove the wheel ornament by hand. Take due care in handling the ornament to avoid unexpected personal injury.

 **CAUTION**
n Replacing a flat tire

- I** Never use oil or grease on the wheel bolts or wheel nuts.
 The oil or grease can cause the wheel nuts to loosen, causing a serious accident. Remove any oil or grease on the wheel bolts or wheel nuts.
- I** Have the wheel nuts tightened with a torque wrench to 83 ft-lbf (110 N-m, 11.5 kgf-m) as soon as possible after changing wheels.
 Failure to follow these precautions could cause the nuts to loosen and the wheels may fall off, which could lead to an accident causing death or serious injury.
- I** Do not attach a heavily damaged wheel ornament, as it may fly off the wheel while the vehicle is moving.

 **NOTICE**
n Do not drive the vehicle with a flat tire.

Do not continue driving with a flat tire.
 Driving even a short distance with a flat tire can damage the tire and the wheel beyond repair.

n When stowing the flat tire

Ensure that there is no object caught between the tire and the vehicle underbody.

n When replacing the tires

- I** When removing or fitting the wheels, tires or the tire pressure warning valve and transmitter, contact your Toyota dealer as the tire pressure warning valve and transmitter may be damaged if not handled correctly.
- I** Replace the grommets for the tire pressure warning valves and transmitters as well.

n To avoid damaging the tire pressure warning valves and transmitters

Do not use liquid sealants on flat tires.

5-2. Steps to take in an emergency If the engine will not start

If the engine still does not start after following the correct starting procedure (→P. 140) or releasing the steering lock (→P. 141), confirm the following points.

n The engine will not start even when the starter motor operates normally.

One of the following may be the cause of the problem.

- 1 There may not be sufficient fuel in the vehicle's tank.
Refuel the vehicle.
- 1 The engine may be flooded.
Try to restart the engine once more following correct starting procedures.
- 1 There may be a malfunction in the engine immobilizer system.
(→P. 88)

n The starter motor turns over slowly, the interior lights and headlights are dim, or the horn does not sound or sounds at a low volume.

One of the following may be the cause of the problem.

- 1 The battery may be discharged. (→P. 459)
- 1 The battery terminal connections may be loose or corroded.

n The starter motor does not turn over, the interior lights and headlights do not turn on, or the horn does not sound.

One of the following may be the cause of the problem.

- 1 One or both of the battery terminals may be disconnected.
- 1 The battery may be discharged. (→P. 459)

Contact your Toyota dealer if the problem cannot be repaired, or if repair procedures are unknown.

5-2. Steps to take in an emergency

If the shift lever cannot be shifted from P

If the shift lever cannot be shifted with your foot on the brake, there may be a problem with the shift lock system (a system to prevent accidental operation of the shift lever). Have the vehicle inspected by your Toyota dealer immediately.

The following steps may be used as an emergency measure to ensure that the shift lever can be shifted.

STEP 1 Set the parking brake.

STEP 2 Turn the engine switch to the ACC or ON position.

STEP 3 Depress the brake pedal.

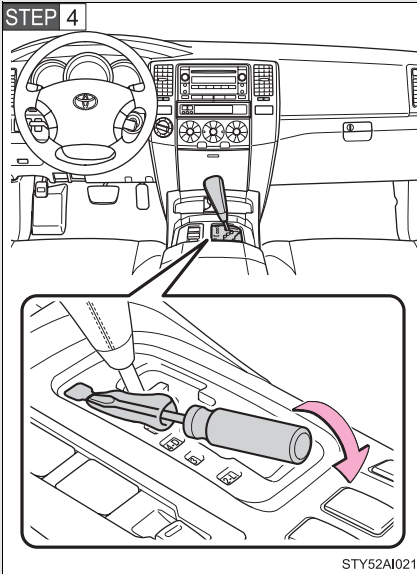

Pry the cover up with a flat-head screwdriver or equivalent.

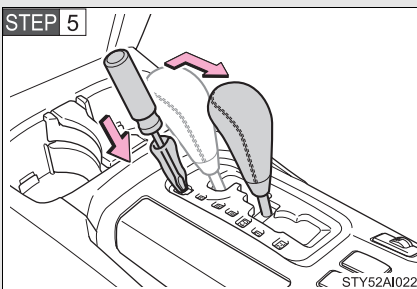

Press the shift lock override button.

The shift lever can be shifted while the button is pressed.

If you lose your keys

New genuine Toyota keys can be made by your Toyota dealer using one of the master keys and the key number stamped on your key number plate. (→P. 28)

n If you lose all your master keys.

You cannot make new keys; the whole engine immobilizer system must be replaced.

5-2. Steps to take in an emergency If the vehicle battery is discharged

The following procedures may be used to start the engine if the vehicle's battery is discharged.

You can call your Toyota dealer or qualified repair shop.

If you have a set of jumper (or booster) cables and a second vehicle with a 12-volt battery, you can jump start your Toyota following the steps below.

STEP 1 Connect the jumper cables.

► 4.0 L V6 (1GR-FE) engine

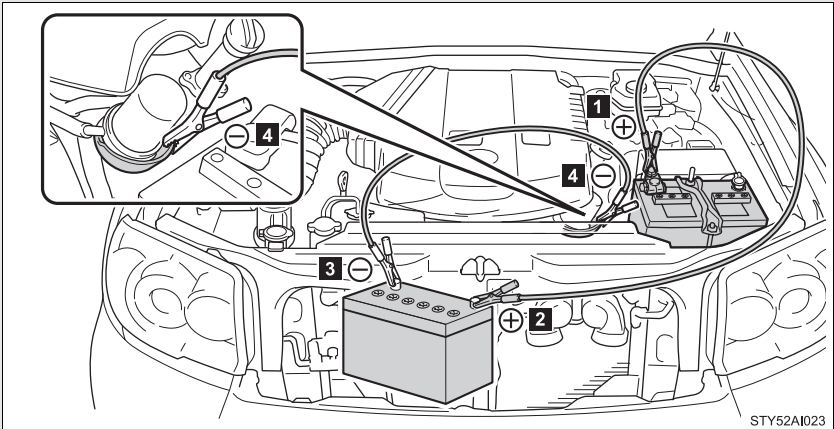

► 4.7 L V8 (2UZ-FE) engine

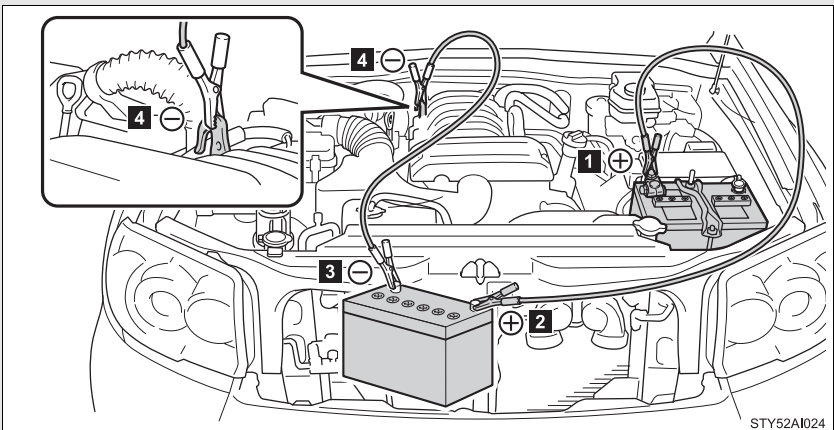

- 1** Positive (+) battery terminal on your vehicle
 - 2** Positive (+) battery terminal on the second vehicle
 - 3** Negative (-) battery terminal on the second vehicle
 - 4** Connect the jumper cable to ground on your vehicle as shown in the illustration.
- STEP 2** Start the engine of the second vehicle. Increase the engine speed slightly and maintain at that level for approximately 5 minutes to recharge the battery of your vehicle.
- STEP 3** Maintain the engine speed of the second vehicle and start the vehicle's engine.
- STEP 4** Once the vehicle's engine has started, remove the jumper cables in the exact reverse order in which they were connected.

Once the engine starts, have the vehicle checked at your Toyota dealer as soon as possible.

n Starting the engine when the battery is discharged

The engine cannot be started by push-starting.

n Avoiding a discharged battery

- 1 Turn off the headlights and the audio system while the engine is turned off.
- 1 Turn off any unnecessary electrical components when the vehicle is running at a low speed for an extended period, such as in heavy traffic, etc.

n When the battery is removed or discharged

The power windows, power back window, back door and moon roof must be initialized. (→P. 498)

 **CAUTION****n Avoiding battery fires or explosions**

Observe the following precautions to prevent accidentally igniting the flammable gas that may be emitted from the battery.

- I Make sure the jumper cable is connected to the correct terminal and that it is not unintentionally in contact with any part other than the intended terminal.
- I Do not allow the jumper cables to come into contact with the “+” and “-” terminals.
- I Do not smoke, use matches, cigarette lighters or allow open flame near the battery.

n Battery precautions

The battery contains poisonous and corrosive acidic electrolyte, while related parts contain lead and lead compounds. Observe the following precautions when handling the battery.

- I When working with the battery, always wear safety glasses and take care not to allow any battery fluids (acid) to come into contact with skin, clothing or the vehicle body.
- I Do not lean over the battery.
- I In the event that battery fluid comes into contact with the skin or eyes, immediately wash the affected area with water and seek medical attention. Place a wet sponge or cloth over the affected area until medical attention can be received.
- I Always wash your hands after handling the battery support, terminals, and other battery-related parts.
- I Do not allow children near the battery.



NOTICE

n When handling jumper cables

Be careful that the jumper cables do not become tangled in the cooling fan or any of the belts when connecting or disconnecting them.

5-2. Steps to take in an emergency If your vehicle overheats

If your engine overheats:

STEP 1 Stop the vehicle in a safe place and turn off the air conditioning system.

STEP 2 Check to see if steam is coming out from under the hood.

If you see steam:

Stop the engine. Carefully lift the hood after the steam subsides and then restart the engine.

If you do not see steam:

Leave the engine running and carefully lift the hood.

STEP 3 Check to see if the cooling fan is operating.

If the fan is operating:

Wait until the temperature of the engine (shown on the instrument cluster) begins to fall and then stop the engine.

If the fan is not operating:

Stop the engine immediately and call your local Toyota dealer.

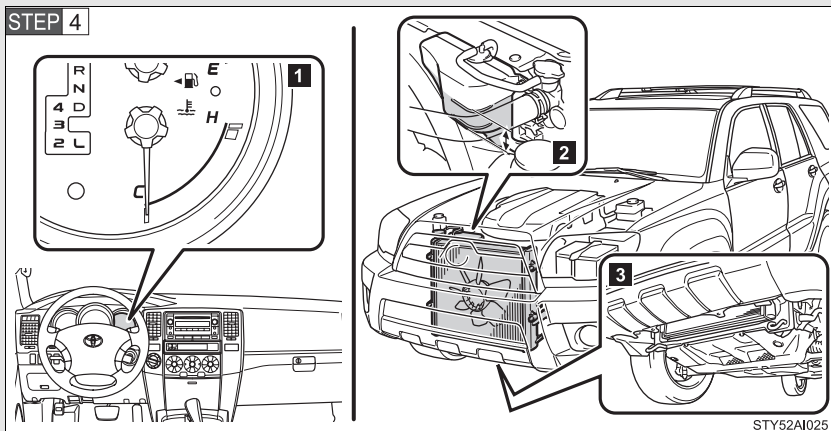

1 The engine has cooled down sufficiently.

The engine coolant temperature gauge indicates C.

2 Check the engine coolant level.

3 Look for obvious coolant leaks from the radiator, hoses and under the vehicle.

Note that water draining from the air conditioning is normal if it has been used.

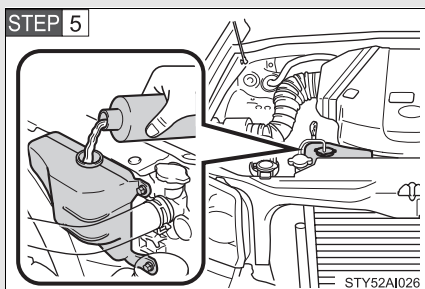

Add engine coolant if required.

Water can be used in an emergency if engine coolant is unavailable. (→P. 475)

Have the vehicle checked at your nearest Toyota dealer as soon as possible.

n **Overheating**

If you observe the following, your vehicle may be overheating.

- l The engine coolant temperature gauge enters the red zone or a loss of power is experienced.
- l Steam is coming from under the hood.

CAUTION

n **To prevent an accident or injury when inspecting under the hood of your vehicle**

- l If steam is seen coming from under the hood, do not open the hood until the steam has subsided. The engine compartment may be very hot, causing serious injury such as burns.
- l Keep hands and clothing away from the fan and other belts while the engine is running.
- l Do not loosen the radiator cap while the engine and radiator are hot. Serious injury, such as burns, may result from hot coolant and steam released under pressure.

NOTICE

n **When adding engine coolant**

Wait until the engine has cooled down before adding engine coolant. When adding coolant, do so slowly. Adding cool coolant to a hot engine too quickly can cause damage to the engine.

5-2. Steps to take in an emergency

If the vehicle becomes stuck

Carry out the following procedures if the tires spin or the vehicle becomes stuck in mud, dirt, or snow.

STEP 1 Stop the engine. Set the parking brake and put the shift lever in P.

STEP 2 Remove the mud, snow, or sand from around the stuck tire.

STEP 3 Place wood, stones or some other material to help provide traction under the tires.

STEP 4 Restart the engine.

STEP 5 Turn off the VSC. (→P. 190)

STEP 6 Shift the shift lever to D or R position and carefully apply the accelerator to free the vehicle.

CAUTION

n When attempting to free a stuck vehicle

If you choose to rock the vehicle back and forth to free it, make sure the surrounding area is clear, to avoid striking other vehicles, objects or persons. The vehicle may also lunge forward or lunge back suddenly as it becomes free. Use extreme caution.

n When shifting the shift lever

Be careful not to shift the shift lever with the accelerator pedal depressed. This may lead to unexpected rapid acceleration of the vehicle that may cause an accident and result in death or serious injury.



NOTICE

n To avoid damaging the transmission and other components

- l** Avoid spinning the wheels and do not rev the engine.
- l** If the vehicle remains stuck after trying these procedures, the vehicle may require towing to be freed.

6-1. Specifications

Maintenance data (fuel, oil level, etc.)

Dimensions and weight

Overall length	189.2 in. (4805 mm)
Overall width	75.2 in. (1910 mm)
Overall height* ¹	71.7 in. (1820 mm) ^{*2 or 3,4} 70.9 in. (1800 mm) ^{*2,3,5} 69.1 in. (1755 mm) ^{*2,3} 71.1 in. (1805 mm) ^{*2 or 3,4,6} 70.3 in. (1785 mm) ^{*2 or 3,5,6} 68.5 in. (1740 mm) ^{*2 or 3,6}
Wheelbase	109.8 in. (2790 mm)
Front tread	62.0 in. (1575 mm)
Rear tread	62.0 in. (1575 mm)
Vehicle capacity weight (Occupants + luggage)	950 lb. (431 kg) ^{*7} 1050 lb. (477 kg) ^{*8}
Towing capacity (Trailer weight + cargo)	► For weight carrying hitch 5000 lb. (2268 kg) ► For weight distributing hitch (4.7 L V8 [2UZ-FE] engine only) 2WD models: 7300 lb. (3311kg) 4WD models: 7000 lb. (3175 kg)
Luggage compartment load capacity	200 lb. (91 kg) ^{*7} 0 lb. (0 kg) ^{*8}

*1. Unladen vehicle

*2. 2WD models

*3. 4WD models

*4. With roof rails

*5. With rear spoiler

*6. With rear height control air suspension

*7. With 5 occupants

*8. With 7 occupants

Vehicle identification

n Vehicle identification number

The vehicle identification number (VIN) is the legal identifier for your vehicle. This is the primary identification number for your Toyota. It is used in registering the ownership of your vehicle.

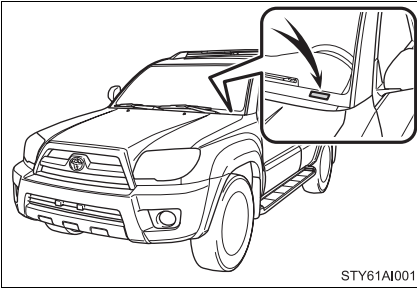

This number is stamped on the top left of the instrument panel.

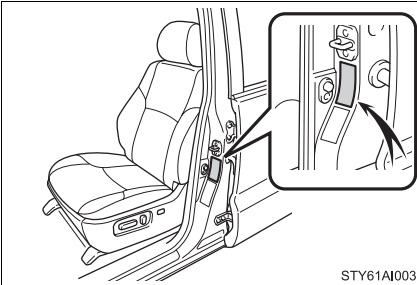

This number is also on the Certification Label.

n Engine number

▶ 4.0 L V6 (1GR-FE) engine

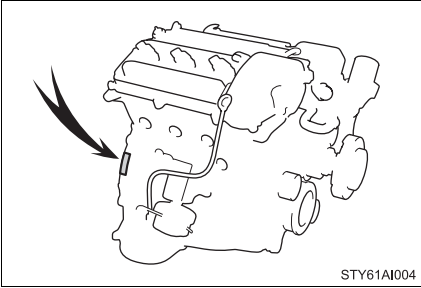

The engine number is stamped on the engine block as shown.

▶ 4.7 L V8 (2UZ-FE) engine



Engine

► 4.0 L V6 (1GR-FE) engine

Model	1GR-FE
Type	6-cylinder V type, 4-cycle, gasoline
Bore and stroke	3.70 × 3.74 in. (94.0 × 95.0 mm)
Displacement	241.4 cu.in. (3956 cm ³)
Drive belt tension	Automatic adjustment
Valve clearance (engine cold)	
Intake	0.006—0.010 in. (0.15—0.25 mm)
Exhaust	0.011—0.015 in. (0.29—0.39 mm)

► 4.7 L V8 (2UZ-FE) engine

Model	2UZ-FE
Type	8-cylinder V type, 4-cycle, gasoline
Bore and stroke	3.70 × 3.31 in. (94.0 × 84.0 mm)
Displacement	284.5 cu.in. (4664 cm ³)
Drive belt tension	Automatic adjustment
Valve clearance (engine cold)	
Intake	0.006—0.010 in. (0.15—0.25 mm)
Exhaust	0.010—0.014 in. (0.25—0.35 mm)

Fuel

Fuel type	Unleaded gasoline only
Octane rating	87 (Research octane number 91) or higher
Fuel tank capacity (Reference)	23.0 gal. (87.0 L, 19.1 Imp.gal.)

Lubrication system

<p>Oil capacity drain and refill (Reference)</p> <ul style="list-style-type: none"> ▶ 4.0 L V6 (1GR-FE) engine ▶ 4.7 L V8 (2UZ-FE) engine 	<ul style="list-style-type: none"> ▶ With filter 5.5 qt. (5.2 L, 4.6 Imp.qt.) ▶ Without filter 5.2 qt. (4.9 L, 4.3 Imp.qt.) ▶ With filter 6.5 qt. (6.2 L, 5.5 Imp.qt.) ▶ Without filter 6.0 qt. (5.7 L, 5.0 Imp.qt.)
<p>Oil grade</p>	<p>ILSAC multigrade engine oil</p>
<p>Recommended oil viscosity</p>	<p>Use Toyota approved "Toyota Genuine Motor Oil" or equivalent to satisfy the grade and viscosity shown below.</p> <div data-bbox="484 815 912 1101" style="border: 1px solid black; padding: 10px; text-align: center;"> <p style="text-align: center;">Outside temperature</p> <p style="text-align: right; font-size: small;">STYOT00050</p> </div>

*: 5W-30 is an oil that provides optimal levels of fuel efficiency.

Oil viscosity

- I The 5W portion of the oil viscosity rating indicates the characteristic of the oil which allows cold startability. Oils with a lower value before the W allow for easier starting of the engine in cold weather.
- I The 30 in 5W-30 indicates the oil viscosity when the oil is at its operating temperature. An oil with a higher viscosity may be better suited if the vehicle is operated at high speeds, or under extreme load condition.

Cooling system

Capacity	<ul style="list-style-type: none"> ▶ 4.0 L V6 (1GR-FE) engine 10.4 qt. (9.8 L, 8.6 Imp.qt.) ▶ 4.7 L V8 (2UZ-FE) engine 13.0 qt. (12.3 L, 10.8 Imp. qt.)
Coolant type	<p>Use either of the following.</p> <ul style="list-style-type: none"> • “Toyota Super Long Life Coolant” • Similar high-quality ethylene glycol-based non-silicate, non-amine, non-nitrite, and non-borate coolant with long-life hybrid organic acid technology <p>Do not use plain water alone.</p>

Ignition system

Spark plug	
▶ 4.0 L V6 (1GR-FE) engine	
Make	DENSO K20HR-U11
	NGK LFR6C11
Gap	0.043 in. (1.1 mm)
▶ 4.7 L V8 (2UZ-FE) engine	
Make	DENSO SK20R11
	NGK IFR6A11
Gap	0.043 in. (1.1 mm)

NOTICE

n Iridium-tipped spark plugs

Use only iridium-tipped spark plugs. Do not adjust gap when tuning engine.

Electrical system

Battery	
Open voltage at 68°F (20°C):	12.6 — 12.8 V Fully charged 12.2 — 12.4 V Half charged 11.8 — 12.0 V Discharged (Voltage checked 20 minutes after the key is removed with all the lights turned off)
Charging rates	5 A max.

Differential

Oil capacity	Front (4WD models)	<ul style="list-style-type: none"> ▶ Vehicles with an automatic disconnecting differential 1.6 qt. (1.55 L, 1.4 Imp.qt.) ▶ Vehicles without an automatic disconnecting differential 1.5 qt. (1.4 L, 1.2 Imp.qt.)
	Rear	<ul style="list-style-type: none"> ▶ Vehicles with a rear differential lock 3.1 qt. (2.95 L, 2.6 Imp.qt.) ▶ Vehicles without a rear differential lock 3.2 qt. (3.05 L, 2.7 Imp.qt.)
Oil type and viscosity		<p>Toyota Genuine Differential Gear Oil LT 75W-85 GL-5 or equivalent</p> <p>“Toyota Genuine Differential Gear Oil” is filled in your Toyota vehicle at factory fill. Use Toyota approved “Toyota Genuine Differential Gear Oil” or an equivalent of matching quality to satisfy the above specification. Please contact your Toyota dealer for further details.</p>

Automatic transmission

Fluid capacity *	<ul style="list-style-type: none"> ▶ 4.0 L V6 (1GR-FE) engine 10.9 qt. (10.4 L, 9.1 Imp.qt.) ▶ 4.7 L V8 (2UZ-FE) engine 10.9 qt. (10.4 L, 9.1 Imp.qt.)
Fluid type	Toyota Genuine ATF WS

*: The fluid capacity is the quantity of reference. If replacement is necessary, contact your Toyota dealer.

NOTICE

n Automatic transmission fluid type

Using automatic transmission fluid other than “Toyota Genuine ATF WS” may cause deterioration in shift quality, locking up of your transmission accompanied by vibration, and ultimately damage the automatic transmission of your vehicle.

Transfer (4WD models)

Oil capacity	1.5 qt. (1.4 L, 1.2 Imp.qt.)
Oil type	Hypoid gear oil API GL-5
Recommended oil viscosity	SAE 75W-90

Brakes

Pedal clearance *1	2.1 in. (54 mm) Min.
Pedal free play	0.04 — 0.24 in. (1 — 6 mm)
Brake pad wear limit	0.04 in. (1.0 mm)
Parking brake lining wear limit	0.04 in. (1.0 mm)
Parking brake pedal travel *2	5 — 7 clicks
Fluid type	FMVSS No. 116 DOT 3 or SAE J1703

*1: Minimum pedal clearance when depressed with a force of 110 lbf (490 N, 50 kgf) with the engine running.

*2: Parking brake pedal travel when depressed with a force of 66.1 lbf (294 N, 30 kgf).

Chassis lubrication

Propeller shafts	Spider	Lithium base chassis grease, NLGI No.2
	Slide yoke	Molybdenum — disulfide lithium base chassis grease, NLGI No.2 or lithium base multipurpose grease, NLGI No.2

Steering

Free play	Less than 1.2 in. (30 mm)
Power steering fluid type	Automatic transmission fluid DEXRON® II or III

Tires and wheels

Tire size	P265/70R16 111S, P265/65R17 110S, P265/60R18 109H
Tire inflation pressure (Recommended cold tire inflation pressure)	Front tires: 32 psi (220 kPa, 2.2 kgf/cm ² or bar) Rear tires: 32 psi (220 kPa, 2.2 kgf/cm ² or bar) Spare tire: 32 psi (220 kPa, 2.2 kgf/cm ² or bar)
Wheel size	16 × 7 J, 16 × 7 JJ, 17 × 7 1/2 JJ, 18 × 7 1/2 J
Wheel nut torque	83 ft·lbf (110 N·m, 11.5 kgf·m)

Light bulbs

	Light Bulbs	Bulb No.	W	Type
Exterior	Headlights (high beam)	9005	60	A
	Headlights (low beam)	—	55	B
	Front fog lights	9006	51	C
	Parking and front side marker lights	2827	5	D
	Front turn signal lights	1156NA	27	E
	Rear turn signal lights	—	21	D
	Back-up lights	921	16	F
	License plate lights	168	5	F
	High mounted stoplight	921	16	F
Interior	Interior light	—	8	G
	Personal lights	—	5	F
	Vanity lights	—	3	G
	Door courtesy lights	—	3.8	F
	Glove box light	—	1.2	F
	Luggage compartment light	—	8	G
	Running board lights	—	3.8	F

A: HB3 halogen bulbs

B: H11 halogen bulbs

C: HB4 halogen bulbs

D: Wedge base bulbs (amber)

E: Single end bulbs

F: Wedge base bulbs (clear)

G: Double end bulbs

6-1. Specifications

Fuel information

Your vehicle must use only unleaded gasoline.

Select octane rating 87 (Research Octane Number 91) or higher. Use of unleaded gasoline with an octane rating lower than 87 may result in engine knocking. Persistent knocking can lead to engine damage.

At minimum, the gasoline you use should meet the specifications of ASTM D4814 in the U.S.A. and CGSB3.5-M93 in Canada.

n **Fuel tank opening for unleaded gasoline**

To help prevent incorrect fueling, your Toyota has a fuel tank opening that only accommodates the special nozzle on unleaded fuel pumps.

n **If your engine knocks**

l Consult your Toyota dealer.

l You may occasionally notice light knocking for a short time while accelerating or driving uphill. This is normal and there is no need for concern.

n **Gasoline quality**

In very few cases, driveability problems may be caused by the brand of gasoline you are using. If driveability problems persist, try changing the brand of gasoline. If this does not correct the problem, consult your Toyota dealer.

n **Gasoline quality standards**

l Automotive manufacturers in the US, Europe and Japan have developed a specification for fuel quality called World-Wide Fuel Charter (WWFC) that is expected to be applied worldwide.

l The WWFC consists of four categories that are based on required emission levels. In the US, category 3 or 4 has been adopted.

l The WWFC improves air quality by lowering emissions in vehicle fleets, and customer satisfaction through better performance.

▮ **Toyota recommends the use of gasoline containing detergent additives**

- | Toyota recommends the use of gasoline that contains detergent additives to avoid build-up of engine deposits.
- | All gasoline sold in the US contains detergent additives to clean and/or keep clean intake systems.

▮ **Toyota recommends the use of cleaner burning gasoline**

Cleaner burning gasoline, including reformulated gasoline that contains oxygenates such as ethanol or MTBE (Methyl Tertiary Butyl Ether) is available in many areas.

Toyota recommends the use of cleaner burning gasoline and appropriately blended reformulated gasoline. These types of gasoline provide excellent vehicle performance, reduce vehicle emissions and improve air quality.

▮ **Toyota does not recommend blended gasoline**

- | Toyota allows the use of oxygenate blended gasoline where the oxygenate content is up to 10% ethanol or 15% MTBE.
- | If you use gasohol in your Toyota, be sure that it has an octane rating no lower than 87.
- | Toyota does not recommend the use of gasoline containing methanol.

▮ **Toyota does not recommend gasoline containing MMT**

Some gasoline contains octane enhancing additive called MMT (Methylcyclopentadienyl Manganese Tricarbonyl).

Toyota does not recommend the use of gasoline that contains MMT. If fuel containing MMT is used, your emission control system may be adversely affected.

The malfunction indicator lamp on the instrument cluster may come on. If this happens, contact your Toyota dealer for service.

 **NOTICE****n Notice on fuel quality**

- I** Do not use improper fuels. If improper fuels are used the engine will be damaged.
- I** Do not use leaded gasoline.
Leaded gasoline can cause damage to your vehicle's three-way catalytic converters causing the emission control system to malfunction.
- I** Do not use gasohol other than that stated here.
Other gasohol may cause fuel system damage or vehicle performance problems.
- I** Use of unleaded gasoline with an octane rating lower than 87 may result in engine knocking. Persistent knocking can lead to engine damage and should be corrected by refueling with higher octane unleaded gasoline.

n Fuel-related poor driveability

If after using a different type of fuel, poor driveability is encountered (poor hot starting, vaporization, engine knocking, etc.), discontinue the use of that type of fuel.

n When refueling with gasohol

Take care not to spill gasohol.
It can damage your vehicle's paint.

6-1. Specifications

Tire information

Typical tire symbols

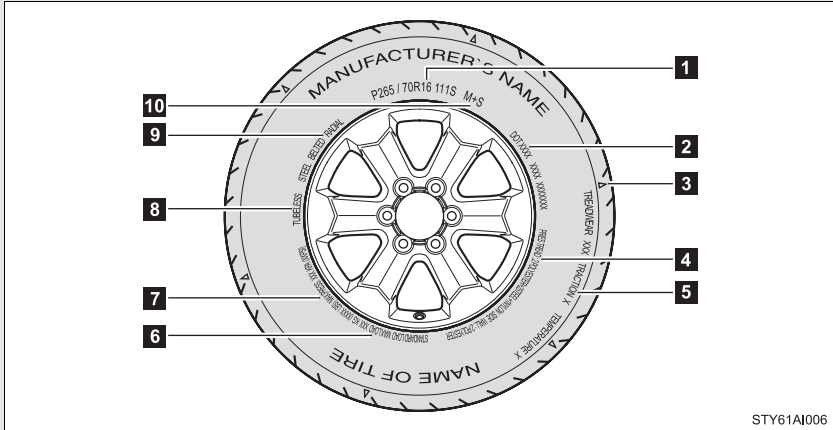

STY61AI006

1 Tire size (→P. 486)

2 DOT and Tire Identification Number (TIN) (→P. 485)

3 Location of treadwear indicators (→P. 487)

4 Tire ply composition and materials

Ply is layers of rubber-coated parallel cords. Cords are the strands which form the plies in a tire.

5 Uniform tire quality grading

For details, see “Uniform Tire Quality Grading” that follows.

6 Load limit at maximum cold tire inflation pressure (→P. 489)

7 Maximum cold tire inflation pressure (→P. 489)

This means the pressure to which a tire may be inflated.

8 TUBELESS or TUBE TYPE

A tubeless tire does not have a tube and air is directly filled in the tire. A tube type tire has a tube inside the tire and the tube maintains the air pressure.

9 Radial tires or bias-ply tires

A radial tire has RADIAL on the sidewall. A tire not marked RADIAL is a bias-ply tire.

10 Summer tire or all season tire (→P. 391)

An all season tire has M+S on the sidewall. A tire not marked M+S is a summer tire.

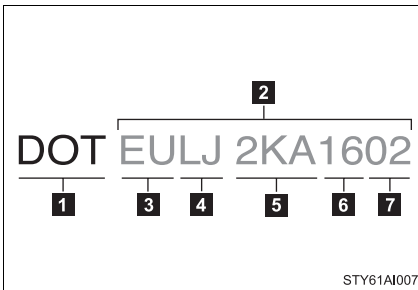
Typical DOT and tire identification number (TIN)**1** DOT symbol***2** Tire Identification Number (TIN)**3** Tire manufacturer's identification mark**4** Tire size code**5** Manufacturer's optional tire type code (3 or 4 letters)**6** Manufacturing week**7** Manufacturing year

*:The DOT symbol certifies that the tire conforms to applicable Federal Motor Vehicle Safety Standards.

Tire size

n Typical tire size information

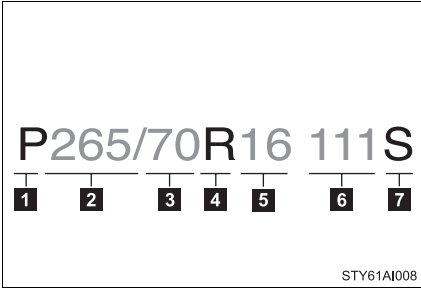

The illustration indicates typical tire size.

- 1** Tire use
(P = Passenger car,
T = Temporary use)
- 2** Section width (millimeters)
- 3** Aspect ratio
(tire height to section width)
- 4** Tire construction code
(R = Radial, D = Diagonal)
- 5** Wheel diameter (inches)
- 6** Load index (2 digits or 3 digits)
- 7** Speed symbol
(alphabet with one letter)

n Tire dimensions

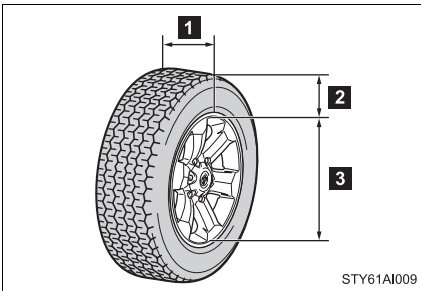

- 1** Section width
- 2** Tire height
- 3** Wheel diameter

Tire section names

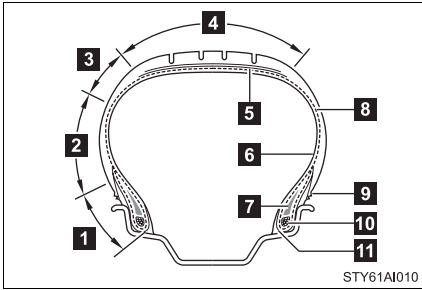

- 1** Bead
- 2** Sidewall
- 3** Shoulder
- 4** Tread
- 5** Belt
- 6** Inner liner
- 7** Reinforcing rubber
- 8** Carcass
- 9** Rim lines
- 10** Bead wires
- 11** Chafer

Uniform Tire Quality Grading

This information has been prepared in accordance with regulations issued by the National Highway Traffic Safety Administration of the U.S.A. Department of Transportation.

It provides the purchasers and/or prospective purchasers of Toyota vehicles with information on uniform tire quality grading.

Your Toyota dealer will help answer any questions you may have as you read this information.

n DOT quality grades

All passenger vehicle tires must conform to Federal Safety Requirements in addition to these grades. Quality grades can be found where applicable on the tire sidewall between tread shoulder and maximum section width.

For example: Treadwear 200 Traction AA Temperature A

n **Treadwear**

The treadwear grade is a comparative rating based on the wear rate of the tire when tested under controlled conditions on a specified government test course.

For example, a tire graded 150 would wear one and a half (1 - 1/2) times as well on the government course as a tire graded 100.

The relative performance of tires depends upon the actual conditions of their use, however, and may depart significantly from the norm due to variations in driving habits, service practices and differences in road characteristics and climate.

n **Traction AA, A, B, C**

The traction grades, from highest to lowest, are AA, A, B and C, and they represent the tire's ability to stop on wet pavement as measured under controlled conditions on specified government test surfaces of asphalt and concrete.

A tire marked C may have poor traction performance.

Warning: The traction grade assigned to this tire is based on braking (straight ahead) traction tests and does not include cornering (turning) traction.

n **Temperature A, B, C**

The temperature grades are A (the highest), B, and C, representing the tire's resistance to the generation of heat and its ability to dissipate heat when tested under controlled conditions on a specified indoor laboratory test wheel.

Sustained high temperature can cause the material of the tire to degenerate and reduce tire life, and excessive temperature can lead to sudden tire failure.

The grade C corresponds to a level of performance which all passenger car tires must meet under the Federal Motor Vehicle Safety Standard No. 109.

Grades B and A represent higher levels of performance on the laboratory test wheel than the minimum required by law.

Warning: The temperature grades for this tire are established for a tire that is properly inflated and not overloaded.

Excessive speed, underinflation, or excessive loading, either separately or in combination, can cause heat buildup and possible tire failure.

Glossary of tire terminology

Tire related term	Meaning
Cold tire inflation pressure	Tire pressure when the vehicle has been parked for three hours or more, or has not been driven more than 1 mile or 1.5 km under that condition
Maximum inflation pressure	The maximum cold inflated pressure to which a tire may be inflated, shown on the sidewall of the tire
Recommended inflation pressure	Cold tire inflation pressure recommended by a manufacturer
Accessory weight	The combined weight (in excess of those standard items which may be replaced) of transmission, power steering, power brakes, power windows, power seats, radio and heater, to the extent that these items are available as factory-installed equipment (whether installed or not)
Curb weight	The weight of a motor vehicle with standard equipment, including the maximum capacity of fuel, oil and coolant, and if so equipped, air conditioning and additional weight optional engine
Maximum loaded vehicle weight	The sum of: (a) Curb weight (b) Accessory weight (c) Vehicle capacity weight (d) Production options weight

Tire related term	Meaning
Normal occupant weight	150 lb. (68 kg) times the number of occupants specified in the second column of Table 1* that follows
Occupant distribution	Distribution of occupants in a vehicle as specified in the third column of Table 1* below
Production options weight	The combined weight of installed regular production options weighing over 5 lb. (2.3 kg) in excess of the standard items which they replace, not previously considered in curb weight or accessory weight, including heavy duty brakes, ride levelers, roof rack, heavy duty battery, and special trim
Rim	A metal support for a tire or a tire and tube assembly upon which the tire beads are seated
Rim diameter (Wheel diameter)	Nominal diameter of the bead seat
Rim size designation	Rim diameter and width
Rim type designation	The industry manufacturer's designation for a rim by style or code
Rim width	Nominal distance between rim flanges
Vehicle capacity weight (Total load capacity)	The rated cargo and luggage load plus 150 lb. (68 kg) times the vehicle's designated seating capacity
Vehicle maximum load on the tire	The load on an individual tire that is determined by distributing to each axle its share of the maximum loaded vehicle weight, and dividing by two
Vehicle normal load on the tire	The load on an individual tire that is determined by distributing to each axle its share of curb weight, accessory weight, and normal occupant weight (distributed in accordance with Table 1* below), and dividing it by two

Tire related term	Meaning
Weather side	The surface area of the rim not covered by the inflated tire
Bead	The part of the tire that is made of steel wires, wrapped or reinforced by ply cords and that is shaped to fit the rim
Bead separation	A breakdown of the bond between components in the bead
Bias ply tire	A pneumatic tire in which the ply cords that extend to the beads are laid at alternate angles substantially less than 90 degrees to the centerline of the tread
Carcass	The tire structure, except tread and sidewall rubber which, when inflated, bears the load
Chunking	The breaking away of pieces of the tread or sidewall
Cord	The strands forming the plies in the tire
Cord separation	The parting of cords from adjacent rubber compounds
Cracking	Any parting within the tread, sidewall, or innerliner of the tire extending to cord material
CT	A pneumatic tire with an inverted flange tire and rim system in which the rim is designed with rim flanges pointed radially inward and the tire is designed to fit on the underside of the rim in a manner that encloses the rim flanges inside the air cavity of the tire
Extra load tire	A tire designed to operate at higher loads and at higher inflation pressures than the corresponding standard tire
Groove	The space between two adjacent tread ribs
Innerliner	The layer(s) forming the inside surface of a tubeless tire that contains the inflating medium within the tire

Tire related term	Meaning
Innerliner separation	The parting of the innerliner from cord material in the carcass
Intended outboard sidewall	(a)The sidewall that contains a whitewall, bears white lettering, or bears manufacturer, brand, and/or model name molding that is higher or deeper than the same molding on the other sidewall of the tire, or (b)The outward facing sidewall of asymmetrical tire that has a particular side that must always face outward when mounted on a vehicle
Light truck (LT) tire	A tire designated by its manufacturer as primarily intended for use on lightweight trucks or multipurpose passenger vehicles
Load rating	The maximum load that a tire is rated to carry for a given inflation pressure
Maximum load rating	The load rating for a tire at the maximum permissible inflation pressure for that tire
Maximum permissible inflation pressure	The maximum cold inflation pressure to which a tire may be inflated
Measuring rim	The rim on which a tire is fitted for physical dimension requirements
Open splice	Any parting at any junction of tread, sidewall, or innerliner that extends to cord material
Outer diameter	The overall diameter of an inflated new tire
Overall width	The linear distance between the exteriors of the sidewalls of an inflated tire, including elevations due to labeling, decorations, or protective bands or ribs
Passenger car tire	A tire intended for use on passenger cars, multipurpose passenger vehicles, and trucks, that have a gross vehicle weight rating (GVWR) of 10,000 lb. or less

Tire related term	Meaning
Ply	A layer of rubber-coated parallel cords
Ply separation	A parting of rubber compound between adjacent plies
Pneumatic tire	A mechanical device made of rubber, chemicals, fabric and steel or other materials, that, when mounted on an automotive wheel, provides the traction and contains the gas or fluid that sustains the load
Radial ply tire	A pneumatic tire in which the ply cords that extend to the beads are laid at substantially 90 degrees to the centerline of the tread
Reinforced tire	A tire designed to operate at higher loads and at higher inflation pressures than the corresponding standard tire
Section width	The linear distance between the exteriors of the sidewalls of an inflated tire, excluding elevations due to labeling, decoration, or protective bands
Sidewall	That portion of a tire between the tread and bead
Sidewall separation	The parting of the rubber compound from the cord material in the sidewall
Snow tire	A tire that attains a traction index equal to or greater than 110, compared to the ASTM E-1136 Standard Reference Test Tire, when using the snow traction test as described in ASTM F-1805-00, Standard Test Method for Single Wheel Driving Traction in a Straight Line on Snow-and Ice-Covered Surfaces, and which is marked with an Alpine Symbol () on at least one sidewall
Test rim	The rim on which a tire is fitted for testing, and may be any rim listed as appropriate for use with that tire

Tire related term	Meaning
Tread	That portion of a tire that comes into contact with the road
Tread rib	A tread section running circumferentially around a tire
Tread separation	Pulling away of the tread from the tire carcass
Treadwear indicators(TWI)	The projections within the principal grooves designed to give a visual indication of the degrees of wear of the tread
Wheel-holding fixture	The fixture used to hold the wheel and tire assembly securely during testing

*:Table 1 — Occupant loading and distribution for vehicle normal load for various designated seating capacities

Designated seating capacity, Number of occupants	Vehicle normal load, Number of occupants	Occupant distribution in a normally loaded vehicle
2 through 4	2	2 in front
5 through 10	3	2 in front, 1 in second seat
11 through 15	5	2 in front, 1 in second seat, 1 in third seat, 1 in fourth seat
16 through 20	7	2 in front, 2 in second seat, 2 in third seat, 1 in fourth seat

Customizable features

Your vehicle includes a variety of electronic features that can be personalized to your preferences. Programming these preferences requires specialized equipment and may be performed by an authorized Toyota dealership.

Some function settings are changed simultaneously with other functions being customized. Contact your Toyota dealer for further details.

Item	Function	Default setting	Customized setting
Wireless remote control (→P. 29)	Wireless remote control	ON	OFF
	Unlocking operation	Driver's door unlocked in one step, all doors unlocked in two steps	All doors unlocked in one step
	Time elapsed before automatic door lock function is activated if door is not opened after being unlocked	30 seconds	0 seconds
			60 seconds
			120 seconds
	Operation signal (Emergency flashers)	ON	OFF
	Door lock buzzer	ON	OFF
	Panic function	ON	OFF
Buzzer sounds when pushing LOCK with any door not closed	ON	OFF	

Item	Function	Default setting	Customized setting
Door lock (→P. 33)	Speed-detecting auto- matic door lock function	OFF	ON
	Opening driver's door unlocks all doors.	OFF	ON
	Shifting gears to "P" unlocks all doors.	OFF	ON
	Shifting gears to posi- tion other than "P" locks all doors.	ON	OFF
	Unlocking using a key	Driver's door unlocked in one step, all doors unlocked in two steps	All doors unlocked in one step
Power back window (→P. 79)	Mechanical key linked operation (close)	ON	OFF
	Mechanical key linked operation (open)	ON	OFF
	Wireless remote control linked operation (open)	Push and hold	Push twice
			One short push
OFF			
Automatic light control system (→P. 158)	Light sensor sensitivity	Level 3	Level 1 to 5
	Daytime running light system	ON	OFF
	Time elapsed before headlights automati- cally turn off after doors are closed	30 seconds	0 seconds
			60 seconds
			90 seconds
Time period until lights turn on	0.1 seconds	1.0 second	

Item	Function	Default setting	Customized setting
Illumination (→P. 305)	Time elapsed before lights turn off	15 seconds	7.5 seconds
			30 seconds
	Operation after the engine switch is turned to the LOCK position	ON	OFF
	Operation when the doors are unlocked	ON	OFF
Seat Belt Reminder Buzzer (→P. 439)	Vehicle speed linked seat belt reminder buzzer	ON	OFF

Items to initialize

The following items must be initialized for normal system operation in cases such as after the battery is reconnected, or maintenance is performed on the vehicle.

Item	When to initialize	Reference
Power windows	<ul style="list-style-type: none"> • After reconnecting or changing the battery • After changing a fuse 	P. 76
Power back window		P. 79
Back door		P. 38
Moon roof		P. 82
Engine oil maintenance data	After changing engine oil	P. 378

Reporting safety defects for U.S. owners

If you believe that your vehicle has a defect which could cause a crash or could cause injury or death, you should immediately inform the National Highway Traffic Safety Administration (NHTSA) in addition to notifying Toyota Motor Sales, U.S.A., Inc. (Toll-free: 1-800-331-4331).

If NHTSA receives similar complaints, it may open an investigation, and if it finds that a safety defect exists in a group of vehicles, it may order a recall and remedy campaign. However, NHTSA cannot become involved in individual problems between you, your dealer, or Toyota Motor Sales, U.S.A., Inc.

To contact NHTSA, you may call the Vehicle Safety Hotline toll-free at 1-888-327-4236 (TTY: 1-800-424-9153); go to <http://www.safercar.gov>; or write to: Administrator, NHTSA, 1200 New Jersey Ave, S.E., Washington, DC 20590. You can also obtain other information about motor vehicle safety from <http://www.safercar.gov>.

Seat belt instructions for Canadian owners (in French)

The following is a French explanation of seat belt instructions extracted from the seat belt section in this manual.

See the seat belt section for more detailed seat belt instructions in English.

Utilisation correcte des ceintures de sécurité

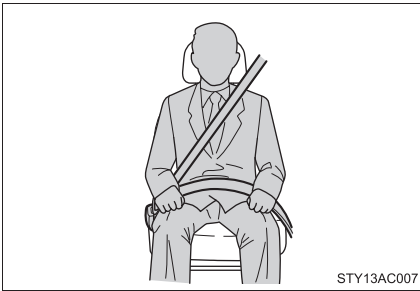

- Tirez sur la ceinture épaulière jusqu'à ce qu'elle recouvre entièrement l'épaule, mais elle ne doit pas toucher le cou ni glisser de l'épaule.
- Placez la sangle abdominale de la ceinture de sécurité le plus bas possible sur les hanches.
- Réglez la position du dossier du siège. Tenez-vous assis dans le fond du siège, le dos droit.
- Ne tournez pas la ceinture de sécurité.

Entretien et soins

■ Ceintures de sécurité

Avec un tissu ou une éponge, nettoyez à l'aide d'un savon doux et de l'eau tiède. Vérifiez aussi les ceintures régulièrement pour vous assurer qu'elles ne présentent pas d'usure excessive, d'effilochage ou de coupures.

ATTENTION

■ Dommages et usure de la ceinture de sécurité

Vérifiez périodiquement le système de ceintures de sécurité. Assurez-vous qu'il n'y a pas de coupures, d'effilochures ni de pièces desserrées. N'utilisez pas une ceinture de sécurité endommagée avant qu'elle soit remplacée. Une ceinture de sécurité endommagée ne peut pas protéger les occupants contre les blessures.

A	A/C	230
	ABS	188
	Accessory meter	155
	Active traction control system	182
	Air conditioning filter	400
	Air conditioning system	
	Air conditioning filter.....	400
	Air conditioning system	230
	Airbags	
	Airbag operating conditions.....	98
	Airbag precautions for your child	102
	Airbag warning light.....	437
	Curtain shield airbag operating conditions.....	98
	Curtain shield airbag precautions	102
	Front passenger occupant classification system	108
	General airbag precautions...	102
	Locations of airbags	95
	Modification and disposal of airbags	106
	Proper driving posture.....	93, 102
	Side airbag operating conditions.....	98
	Side airbag precautions	104
	SRS airbags	95
	Alarm	90
	Antenna	248
	Anti-lock brake system	
	ABS warning light.....	438
	Anti-lock brake system	188
	Armrest	336
	Audio input	269
	Audio remote controls	271
	Audio system	
	Antenna.....	247
	Audio input	269
	Audio visual input.....	269
	AUX adapter.....	269
	CD player	250

	DVD player.....	280
	MP3/WMA disc	257
	Optimal use.....	266
	Portable music player	269
	Radio.....	244
	Rear seat entertainment system	274
	Type	241
	Audio visual input	294
	AUTO LSD system	175
	Automatic light off system	160
	Automatic transmission	
	Automatic transmission.....	143
	If the shift lever cannot be shifted from P	457
	AUX adapter	269
	Auxiliary box	309, 322, 343
	A/V input adapter	294

B	Back door	
	Back door.....	38
	Wireless remote control	29
	Back window	79
	Back-up lights	
	Replacing light bulbs.....	416
	Wattage.....	480
	Back window	79
	Battery	
	Charging system warning light	437
	Checking	385
	If the vehicle battery is discharged	459
	Preparing and checking before winter	213
	Bottle holders	309, 321
	Brake assist	188
	Brakes	
	Brake system warning light	436
	Fluid	381
	Parking brake.....	146

Break-in tips 133

C Care

Exterior 356
 Interior 359
 Seat belts 360

Cargo capacity 203

Cargo net hook..... 339

CD changer 250

CD player 250

Center differential lock 179

Certification label 217, 471

Chains 214

Child restraint system

Booster seats, definition 114
 Booster seats, installation 125
 Convertible seats,
 definition..... 114
 Convertible seats,
 installation 123
 Front passenger occupant
 classification system 108
 Infant seats, definition 113
 Infant seats, installation..... 122
 Installing CRS with LATCH
 system..... 119
 Installing CRS with seat
 belts 117
 Installing CRS with top tether
 straps 126

Child safety

Airbag precautions 102
 Battery precautions 386, 461
 Child restraint system..... 113
 Child-protectors 35
 How your child should wear
 the seat belt 66
 Installing child restraints 117
 Moon roof precautions..... 84
 Power window lock switch..... 77
 Power window precautions..... 78
 Removed key battery
 precautions 403

Seat belt extender
 precautions 68
 Seat belt precautions 66
 Seat heater precautions 335

Child-protectors 35

Cleaning

Exterior 356
 Interior 359
 Seat belts 360

Clock 325

Coin holder 311

Compass..... 350

Condenser 381

Console box 312

Cooling system

Engine overheating 463

CRS 113

Cruise control..... 166

Cup holders 305, 316

Curtain shield airbags 95

Customizable features..... 495

D Daytime running light

system 160

DAC 186

Defogger

Rear window 240
 Side mirrors..... 240

Dimension..... 470

Dinghy towing 228

Do-it-yourself maintenance..... 368

Door courtesy lights

Door courtesy lights 305
 Wattage 480

Doors

Door glasses 76
 Door lock 29, 33
 Open door warning light 439
 Side doors 33
 Side mirrors 73

Downhill Assist Control 186
Driver's seat belt reminder
 buzzer 439
Driver's seat belt reminder
 light 439
Driving
 Break-in tips 133
 Correct posture 93
 Driving assist systems 188
 Procedures 140
 Winter driving tips 213
Driving position memory 58
DVD player 280

E

Electronically modulated air suspension 169
Emergency, in case of
 If a warning buzzer sounds 436
 If a warning light turns on 436
 If the engine will not start 456
 If the shift lever cannot be shifted from P 457
 If the vehicle battery is discharged 459
 If the vehicle becomes stuck 466
 If you have a flat tire 445
 If you lose your keys 458
 If you think something is wrong 432
 If your vehicle needs to be towed 427
 If your vehicle overheats 463
Emergency flashers
 Switch 426
Engine
 Compartment 373
 Engine switch 140
 Hood 372
 How to start the engine 140
 Identification number 472
 If the engine will not start 456

Ignition switch 140
Immobilizer system 88
Overheating 463
Engine coolant
 Capacity 475
 Checking 380
 Preparing and checking before winter 213
 Temperature gauge 148
Engine coolant temperature gauge 148
Engine immobilizer system 88
Engine oil
 Capacity 474
 Checking 375
 Preparing and checking before winter 213
 Warning light 437, 439
Engine oil maintenance data 378
Engine switch 140
Event data recorder 434

F

Floor mat 337
Fluid
 Brake 381
 Washer 387
Fog lights
 Replacing light bulbs 417
 Switch 162
 Wattage 480
Four-wheel drive system
 Four-wheel drive control switch 177
Front passenger occupant classification system 108
Front passenger's seat belt reminder light 439
Front passenger's seat belt warning buzzer 439
Front seats
 Adjustment 41

Front side marker lights
 Replacing light bulbs 418
 Switch 158
 Wattage 480

Front turn signal lights
 Replacing light bulbs 419
 Switch 145
 Wattage 480

Fuel
 Capacity 473
 Fuel gauge 148
 Fuel pump shut off system ... 433
 Gas station information 520
 Information 481
 Refueling 85
 Type 473
 Warning light 439

Fuel door 85

Fuel filler door 85

Fuel pump shut off system ... 433

Fuses
 Fuses 404
 Locations 407

G **Garage door opener** 345

Gas station information 520

Gauges 148

Glove box 310

H **Hazard lights**
 Switch 426

Head restraints
 Adjusting 60

Headlights
 Replacing light bulbs 416
 Switch 158
 Wattage 480

Heaters
 Seat heaters 334
 Side mirror 240

Height control
 Electronically modulated
 air suspension 169

Hill-start assist control 188

Hood 372

Hooks
 Cargo net 339
 Shopping bag 340

Horn 147

I **I/M test** 367

Identification
 Engine 472
 Tire 485
 Vehicle 471

Ignition switch 140

Illuminated entry system 305

Immobilizer system 88

Indicator lights 151

Initialization
 Items to initialize 498

Inside rear view mirror 70

Instrument panel light control 149

Interior lights
 Interior lights 305
 Switch 307
 Wattage 480

J **Jack**
 Positioning the jack 448
 Vehicle-equipped jack 445

Jack handle 448

K **Keyless entry** 29

Keys
 Engine switch 140
 If you lose your keys 458
 Ignition switch 140
 Key battery 402
 Keyless entry 29
 Key number 28

Keys	28
Reminder buzzer	441
Wireless remote control key	28, 29

L License plate lights

Replacing light bulbs	421
Switch	158
Wattage	480

Light bulbs

Replacing	415
Wattage	480

Lights

Automatic light off system	160
Emergency flasher switch	426
Hazard light switch	426
Headlight switch	158
Instrument panel light control dial	149
Interior light switch	307
Personal light switch	306
Replacing light bulbs	415
Running board lights	305
Turn signal lights switch	145
Wattage	480

Load capacity211, 470

Lock steering column.....69

Luggage compartment features.....338

M Maintenance

Do-it-yourself maintenance ...	368
General maintenance	364
Maintenance data	470
Maintenance requirements...	362
Vehicle exterior	356
Vehicle interior	359

Malfunction indicator lamp437

Meter

Accessory meter	155
Instrument panel light control	149
Meters	148

Mirrors

Inside rear view mirror	70
Rear side-view mirrors	328
Side mirrors	73
Vanity mirrors	324

Moon roof 82

MP3 disc 257

O Odometer..... 148

Off-road precautions 198

Oil

Engine oil	375
Warning light	437, 439

Opener

Fuel door	85
Fuel filler door	85
Hood	372

Outside rear view mirrors

Adjusting and folding	73
-----------------------------	----

Outside temperature

display	326
---------------	-----

Overhead console..... 316

Overheating, Engine..... 463

P Parking brake 146

Parking lights

Replacing light bulbs	418
Switch	158
Wattage	480

Personal lights 306

Switch	306
Wattage	480

Power back windows..... 79

Power outlet 329

Power steering

Fluid	383
-------------	-----

Power windows..... 76

R	Radiator	373, 381
	Radio	244
	Rear seat	
	Folding down the second seats	45
	Folding up the third seats	49
	Removing the third seats.....	52
	Tumbling the second seats	47
	Rear seat entertainment system	274
	Rear seat entertainment system controller battery	277
	Rear side-view mirrors	240
	Rear turn signal lights	
	Replacing light bulbs	420
	Switch.....	145
	Wattage.....	480
	Rear window	38
	Rear window defogger	240
	Replacing	
	Fuses.....	404
	Key battery	402
	Light bulbs	415
	Tires	389,445
	Wheels	398
	Rear differential lock system	184
	Rear step bumper	39
	Rear window wiper	165
	Reporting safety defects for U.S. owners	500
	Roll sensing of curtain shield airbags off switch	107
	Running board lights	305

S	Seat belts	
	Adjustment	64
	ALR	65
	Automatic Locking Retractor ...	65
	Child restraint system installation.....	117
	Cleaning and maintaining.....	360
	ELR	65
	Emergency Locking Retractor	65
	How to wear your seat belt.....	63
	How your child should wear the seat belt	66
	Pregnant women, proper seat belt use	65
	Reminder buzzer.....	436
	Reminder light.....	436
	Seat belt extenders	66
	Seat belt pretensioners	64
	Seat heaters	334
	Seating capacity	211
	Seats	
	Adjustment	41
	Adjustment precautions.....	43
	Child seats/child restraint system installation	117
	Cleaning.....	359
	Driver's seat position memory.....	58
	Folding down the second seats	45
	Folding up the third seats.....	49
	Front seat adjustment	41
	Front seat adjustment precautions	43
	Head restraint.....	60
	Properly sitting in the seat.....	93
	Rear seats adjustment precautions	55
	Removing the third seats	52
	Seat heaters.....	334
	Tumbling the second seats	47

Service reminder indicators 151

Shift lever

- Automatic transmission 143
- If the shift lever cannot be shifted from P 457

Shift lock system 457

Shopping bag hooks 340

Side airbags 95

Side doors 33

Side marker lights

- Replacing light bulbs 418
- Switch 158
- Wattage 480

Side mirror

- Adjusting and folding 73

Spare tire

- Inflation pressure 479
- Replacing 445
- Storage location 445

Spark plug 475

Specifications 470

Speedometer 148

SRS airbags

- Curtain shield airbags 95
- Front airbags 95
- Precautions 102
- Side airbags 95

Steering wheel

- Adjustment 69
- Audio switches 271

Stop lights

- Replacing light bulbs 423
- Wattage 480

Storage feature 309

Storage precautions 208

Stuck

- If the vehicle becomes stuck 466

Sun visors 323

Switch

- Active traction control switch 182

- AUTO LSD switch 175
- Cruise control switch 166
- Downhill Assist control switch 186
- Emergency flasher switch 426
- Engine switch 140
- Fog light switch 162
- Four-wheel drive control switch 177
- Hazard light switch 426
- Ignition switch 140
- Light switch 158
- Power back window switch 79
- Power door lock switch 33
- Power window switch 76
- Rear differential lock switch 184
- Rear window wiper and washer switch 165
- Turn signal lights 145
- Window lock switch 77
- Wiper and washer 163, 165

T

Tachometer 148

Tail lights

- Replacing light bulbs 423
- Switch 158
- Wattage 480

Theft deterrent system

- Alarm 90
- Engine immobilizer system 88
- Theft prevention labels 92

Theft prevention labels 92

Tire inflation pressure 479

Tire information

- Glossary 489
- Size 486
- Tire identification number 485
- Uniform tire quality grading ... 487

Tires

- Chains 214
- Checking 389
- Identification number 485

	If you have a flat tire	445
	Inflation pressure	479
	Information	484
	Replacing	389, 445
	Rotating tires	389
	Size	479
	Spare tire	445
	Tire pressure warning system.....	389, 441
	Warning light	439
	Tissue pocket	313
	Tools.....	445
	Total load capacity.....	211
	Towing	
	Dinghy towing.....	228
	Emergency towing.....	427
	Trailer towing.....	216
	Traction control system	188
	TRAC	188
	Trash holder	314
	Trip meter.....	148
	Turn signal lights	
	Replacing light bulbs	419, 420
	Switch.....	145
	Wattage.....	480
V	Valet key.....	28
	Vanity lights	
	Vanity lights	324
	Wattage.....	480
	Vanity mirrors.....	324
	Vehicle identification	
	number.....	471
	Vehicle stability control.....	188
	VSC.....	188

W	Warning buzzers	
	Brake system	436
	Key reminder.....	441
	Seat belt reminder.....	439
	Warning lights	
	ABS.....	437
	Airbag system	437
	Anti-lock brake system	437
	Automatic transmission fluid temperature	437
	Brake system	436
	Charging system	437
	Driver's seat belt	439
	Engine oil replacement.....	439
	Front passenger occupant classification system	437
	Front passenger's seat belt...	439
	Low engine oil pressure	437
	Low fuel level	439
	Low washer fluid	439
	Malfunction indicator lamp	437
	Open door	439
	SRS.....	437
	Tire pressure	439
	VSC OFF.....	437
	Washer	
	Checking	387
	Preparing and checking before winter	213
	Switch.....	163, 165
	Washing and waxing	356
	Weight	
	Cargo capacity	203
	Load limits	211
	Weight.....	470
	Wheels	398
	Window glasses	76, 79
	Window lock switch.....	77
	Windows	
	Power back window	79
	Power windows	76
	Rear window defogger	240
	Washer.....	163, 165

Windshield wipers	163, 165
Wireless remote control key	
Replacing the battery	402
Wireless remote control	29
Winter driving tips	213
WMA disc	257

What to do if...

What to do if...

A tire punctures

P. 445 If you have a flat tire

The engine does not start

P. 456 If the engine will not start

P. 88 Engine immobilizer system

P. 459 If the vehicle battery is discharged

The shift lever cannot be moved out

P. 457 If the shift lever cannot be shifted from P

The engine coolant temperature gauge enters the red zone

P. 463 If your vehicle overheats

Steam can be seen coming from under the hood

The key is lost

P. 458 If you lose your keys

The battery runs out

P. 459 If the vehicle battery is discharged

The doors cannot be locked

P. 33 Side doors

P. 38 Back door

The horn begins to sound.

P. 90 Alarm

The vehicle is stuck in mud or sand

P. 466 If the vehicle becomes stuck

The warning light or indicator light comes on

P. 436 If a warning light turns on

n Instrument cluster

► Type A

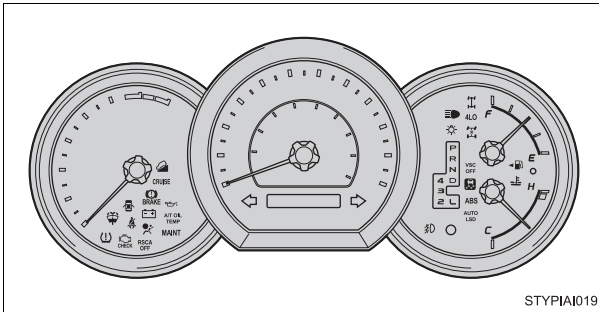

► Type B

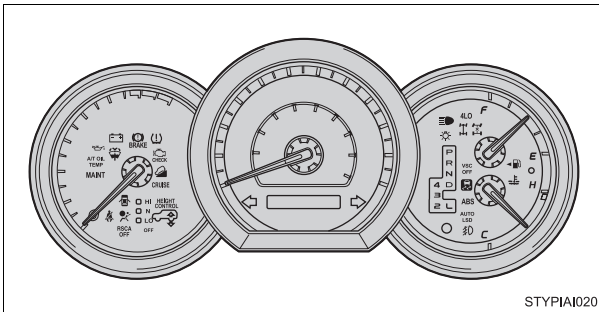

► Type C

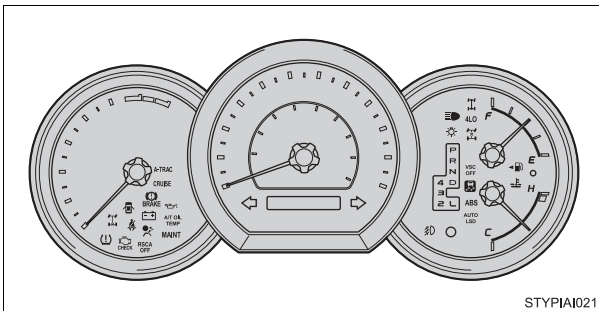

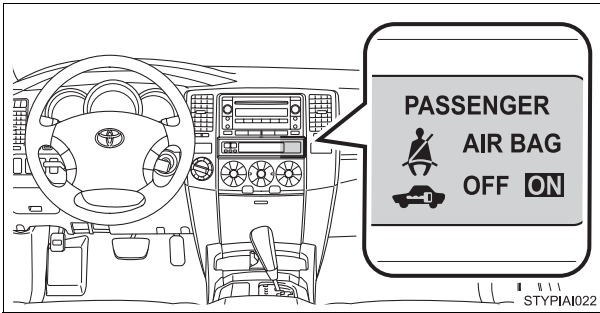

n Center panel





nWarning lights

 Brake system warning light P. 436

 VSC OFF warning light P. 437

 Charging system warning light P. 437

 Open door warning light P. 439

 Low engine oil pressure warning light P. 437

 Driver's seat belt reminder light P. 439

 Malfunction indicator lamp P. 437

 Front passenger's seat belt reminder light P. 439

 SRS warning light P. 437

 Tire pressure warning light P. 439

 ABS warning light

 Low fuel level warning light P. 439

or

 P. 437

 Engine oil replacement reminder light P. 439

 Automatic transmission fluid temperature warning light P. 437

 Low washer fluid warning light P. 439

GAS STATION INFORMATION

Auxiliary catch lever

P. 372

Fuel filler door

P. 85

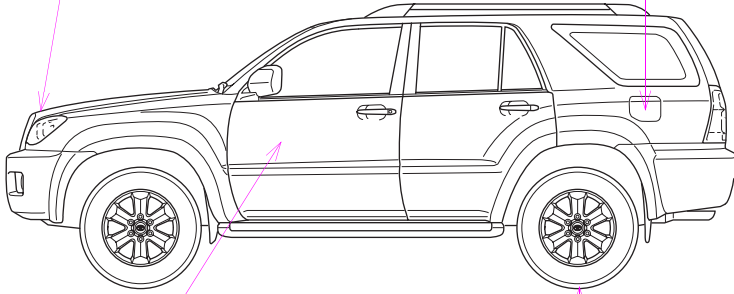

Hood lock release lever

P. 372

Tire inflation pressure

P. 479

STYPIAI003

Fuel tank capacity		23.0 gal. (87.0 L, 19.1 Imp.gal.)	
Fuel type		Unleaded gasoline, Octane Rating 87 (Research Octane Number 91) or higher	
Cold tire inflation pressure		P. 479	
Engine oil capacity (Drain and refill)	4.0 L V6 (1GR-FE) engine	With filter	qt. (L, Imp.qt.) 5.5 (5.2, 4.6)
		Without filter	5.2 (4.9, 4.3)
	4.7 L V8 (2UZ-FE) engine	With filter	qt. (L, Imp.qt.) 6.5 (6.2, 5.5)
		Without filter	6.0 (5.7, 5.0)
Engine oil type		Toyota Genuine Motor Oil or equivalent Oil grade: P. 474 ILSAC multigrade engine oil Recommended oil viscosity: SAE 5W-30	