



ToyotaOwnersOnline.com

CUSTOMER EXPERIENCE CENTER

1-800-331-4331

SIENNA

2 0 1 0

QUICK REFERENCE GUIDE



2010 Sienna

This *Quick Reference Guide* is a summary of basic vehicle operations. It contains brief descriptions of fundamental operations so you can locate and use the vehicle's main equipment quickly and easily.

The *Quick Reference Guide* is not intended as a substitute for the *Owner's Manual* located in the vehicle's glove box. We strongly encourage you to review the *Owner's Manual* and supplementary manuals so you will have a better understanding of the vehicle's capabilities and limitations.

Your dealership and the entire staff of Toyota Motor Sales, U.S.A., Inc. wish you many years of satisfied driving in your new Sienna.

! A word about safe vehicle operations

This *Quick Reference Guide* is not a full description of Sienna operations. Every Sienna owner should review the *Owner's Manual* that accompanies this vehicle.

Pay special attention to the boxed information highlighted in color throughout the *Owner's Manual*. Each box contains safe operating instructions to help you avoid injury or equipment malfunction.

All information in this *Quick Reference Guide* is current at the time of printing. Toyota reserves the right to make changes at any time without notice.

Spare tire & tools

All-wheel drive models are equipped with run-flat tires. Refer to the *Owner's Manual* for more detail.

Tool and spare tire location

Two-wheel drive models

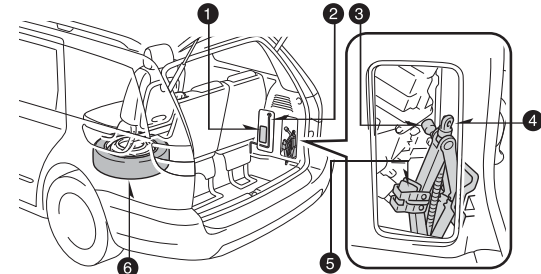

Four-wheel drive models

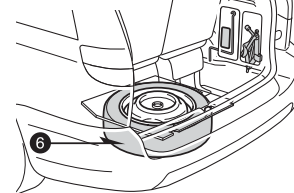

- 1 Tire bag
- 2 Jack handle
- 3 Wheel nut wrench
- 4 Jack
- 5 Adapter
- 6 Spare tire

Removing the spare tire

Two-wheel drive models

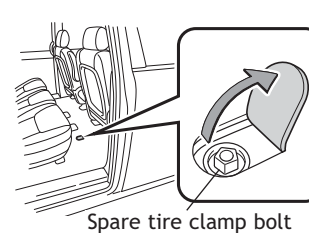

Spare tire clamp bolt

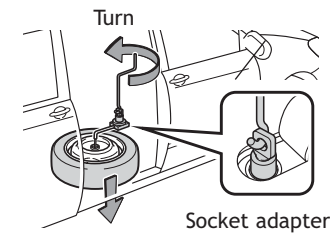

Socket adapter

Four-wheel drive models

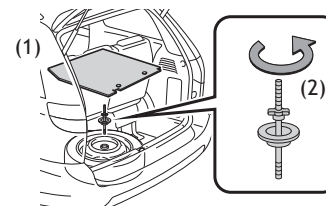

- (1) Remove the lid.
- (2) Loosen and remove the bolt.

Refer to the *Owner's Manual* for jack positioning and tire changing procedures.

INDEX

OVERVIEW

Engine maintenance	7
Fuel tank door release and cap	7
Hood release	6
Indicator symbols	4-5
Instrument cluster	4
Instrument panel	2-3
Keyless entry¹	6

FEATURES/OPERATIONS

Air Conditioning/Heating	22-23
Audio	20-21
Auto lock functions²	8
Automatic Transmission	8
Bottle holders	25
Clock	13
Console box	13
Cruise control	18
Cup holders	26
Door-Power back	12
Doors-Sliding	12
Dynamic Laser Cruise Control	18-19
Front seat console table	13
Light control-Instrument panel	19
Lights¹ & turn signals	9
Moonroof	11
Multi-information display (HomeLink [®]) ³	24
Parking brake	10
Power outlets-12V DC	25
Power outlets-115V AC	25
Rear seat entertainment system	24
Seat adjustments-Front	14
Seat adjustments-Rear	14
Seat arrangements	15
Seat heaters	11
Seats-Head restraints	15
Seats-Stowing third row seats	16-17
Seats-Tumble/Remove second row seats	16
Sunshade-Side	17
Telephone controls (Bluetooth [®])	21
Tilt and telescopic steering wheel	8
Windows	11
Windows-Power quarter	10
Windshield wipers & washers	10

SAFETY AND EMERGENCY FEATURES

Door locks	27
Doors-Child safety locks	27
Seatbelt comfort guide	27
Seatbelts	28
Seatbelts-Shoulder belt anchor	27
Spare tire & tools	29
Tire Pressure Monitoring (warning) System	28

¹ Visit your Toyota dealer for information on customizing this feature.

² Programmable by customer. Refer to the Owner's Manual for instructions and more information.

³ HomeLink[®] is a registered trademark of Johnson Controls, Inc.

OVERVIEW

Instrument panel

Overhead console

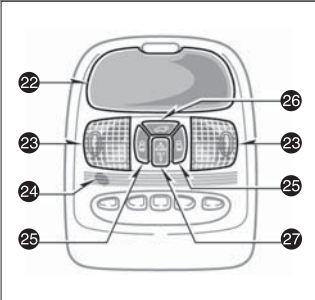

Steering wheel switches

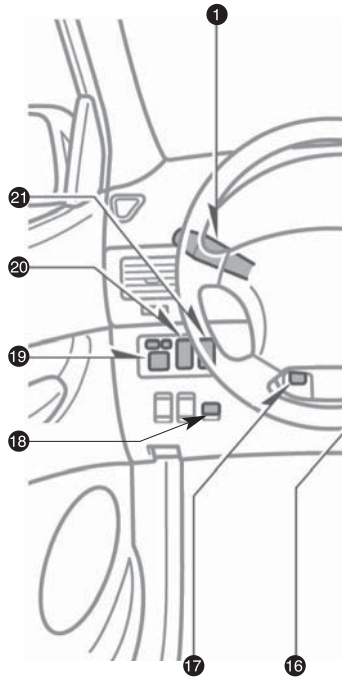
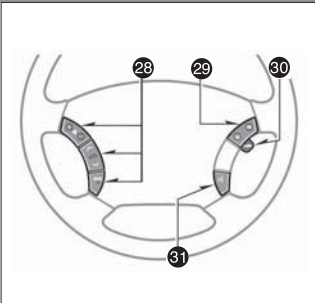

- 1 Headlight, turn signal and front fog light¹ controls
- 2 Wiper and washer controls
- 3 Rear window and outside rearview mirror defogger¹ and windshield wiper de-icer¹ switch
- 4 Emergency flasher button
- 5 Audio system or navigation system²
- 6 115V AC Power outlet ON/OFF button¹
- 7 AUX adapter
- 8 Intuitive parking assist switch and indicator¹
- 9 Front Air Conditioning controls
- 10 Front passenger occupant classification indicator
- 11 Seat heater switches¹
- 12 12V DC Power outlets
- 13 Interior lights main switch
- 14 Ignition switch
- 15 "TRAC OFF" (Traction Control "OFF")¹
- 16 Cruise control or Dynamic Laser Cruise Control¹

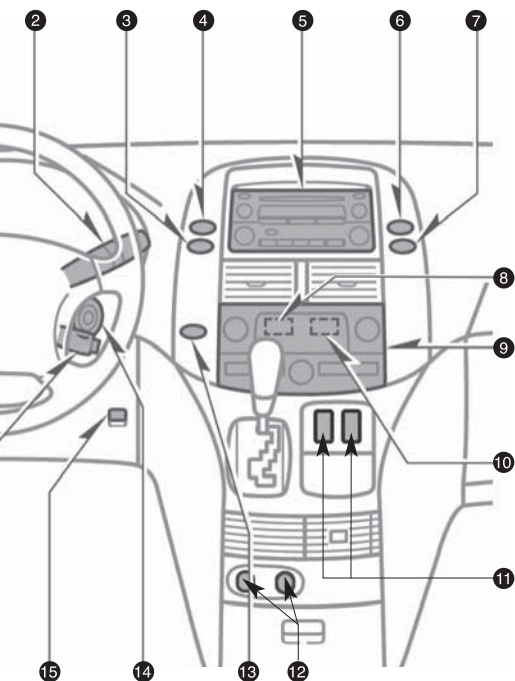

- 17 Tilt and telescopic steering lock release
- 18 Tire Pressure Monitoring (warning) System reset
- 19 Power rearview mirror controls
- 20 Power quarter window switch¹
- 21 Headlight beam level control dial¹
- 22 Conversation mirror
- 23 Front personal lights
- 24 Microphone^{1,2}
- 25 Power sliding door button¹
- 26 Power back door button¹
- 27 Electric moonroof switch¹
- 28 Steering wheel audio controls^{1,2}
- 29 Telephone controls^{1,2}
- 30 Dynamic Laser Cruise Control distance switch¹
- 31 Speech command button^{1,2}

¹ If equipped

² For vehicles with a navigation system, refer to the "Navigation System Owner's Manual."

Instrument cluster

Non-optitron type meters

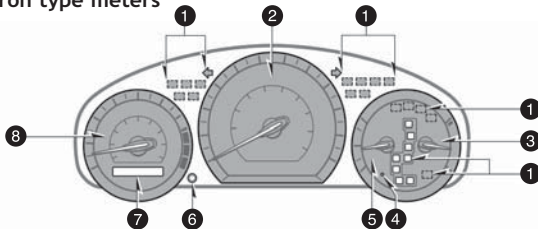

Optitron type meters

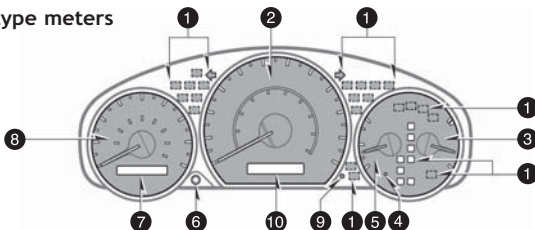

- ① Service indicator and reminder
- ② Speedometer
- ③ Engine coolant temperature
- ④ Low fuel level warning
- ⑤ Fuel gauge
- ⑥ Trip meter reset knob
- ⑦ Odometer and two trip meters
- ⑧ Tachometer
- ⑨ Dynamic Laser Cruise Control master warning
- ⑩ Dynamic Laser Cruise Control display











Indicator symbols

For details, refer to "Indicators and warning lights," Section 2-2, 2010 Owner's Manual.

	Brake system warning ^{1,2}
	Driver seatbelt reminder ² (alarm will sound if speed is over 12 mph)
	Front passenger seatbelt reminder ² (alarm will sound if speed is over 12 mph)
	Charging system warning ^{1,2}
	Malfunction/Check Engine indicator ^{1,2}

¹ If indicator does not turn off within a few seconds of starting engine, there may be a malfunction. Have vehicle inspected by your Toyota dealer.

² For details, refer to "If a warning light turns on or a warning buzzer sounds..." Section 5-2, 2010 Owner's Manual.

	Low engine oil pressure warning ^{1,2}
	Open door warning ²
	Airbag SRS warning ^{1,2}
VSC	Vehicle Stability Control/Traction Control warning ^{1,2}
	Low Tire Pressure Warning ^{1,2}
	Low windshield washer fluid level warning ²
MAINT REQD	Engine oil replacement reminder ^{1,2}
3RD SEAT	Third seat fold incomplete warning ²
	Theft deterrent/Engine immobilizer system indicator
AIR BAG ON	AIR BAG ON indicator ¹
AIR BAG OFF	AIR BAG OFF indicator ¹
	Headlight low beam indicator
	Headlight high beam indicator
	Turn signal indicator
	Automatic Transmission indicator
	Slip indicator ¹
TRAC OFF	Traction Control OFF indicator ¹
CRUISE	Cruise control indicator ³ or Dynamic Laser Cruise Control indicator ⁴
READY	Dynamic Laser Cruise Control ready mode indicator ¹
NORM.	Conventional cruise control mode indicator
ABS	Anti-lock Brake System warning ^{1,2}

³ If this light flashes, refer to "Cruise control," Section 2-4, 2010 Owner's Manual.

⁴ If this light flashes, refer to "Dynamic laser cruise control," Section 2-4, 2010 Owner's Manual.

Keyless entry

Locking operation

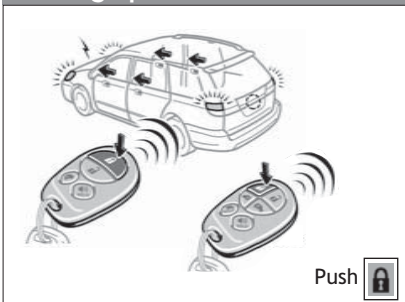

Unlocking operation

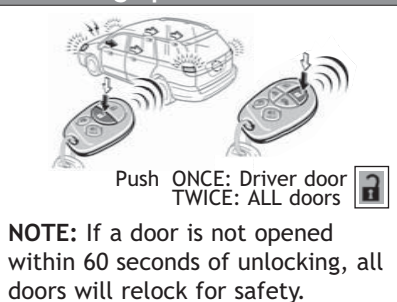

Power sliding door operation (if equipped)

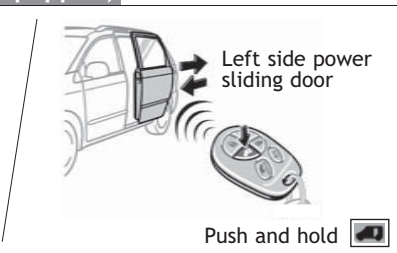
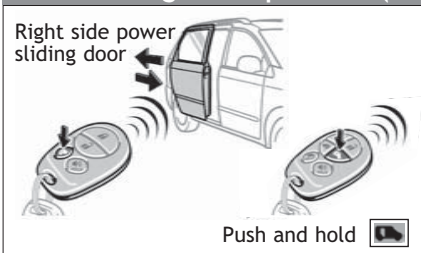

Power back door operation (if equipped)



Panic button

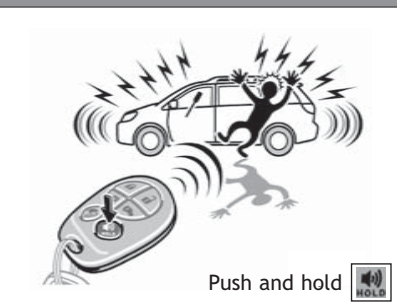

Hood release

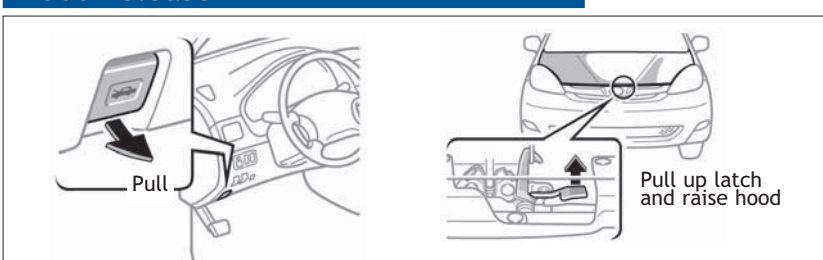

Fuel tank door release and cap

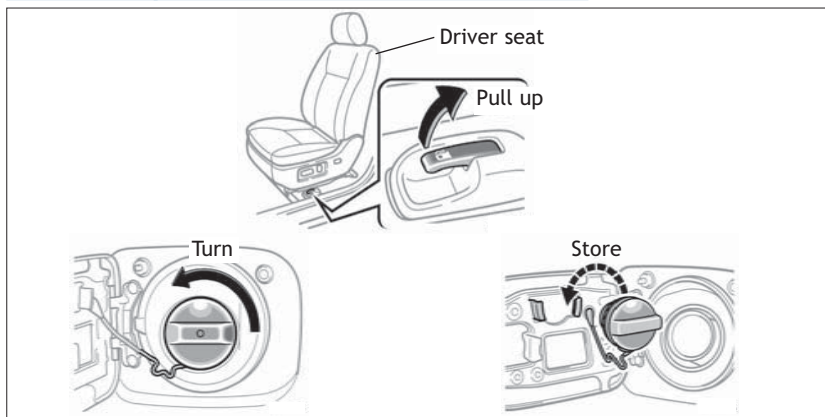

NOTE: Tighten until one click is heard. If the cap is not tightened enough, Check Engine "  " indicator may illuminate.

Engine maintenance

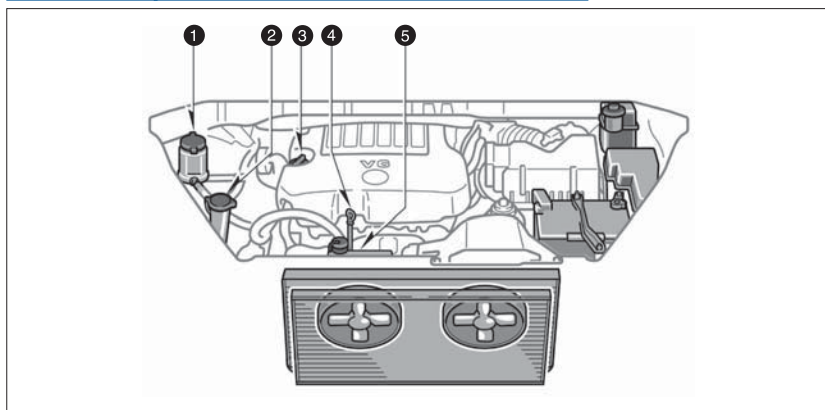

- 1 Power steering fluid reservoir
- 2 Windshield and rear window washer fluid tank
- 3 Engine oil filler cap
- 4 Engine oil level dipstick
- 5 Engine coolant reservoir

Note: Regularly scheduled maintenance, including oil changes, will help extend the life of your vehicle and maintain performance. Please refer to the "Warranty Maintenance Guide."

FEATURES/OPERATIONS

Auto lock functions

Automatic door locks can be programmed to operate in four different modes, or turned OFF.

- Doors lock when shifting from Park.
- Doors lock when the vehicle speed goes above approximately 12 mph.
- Doors unlock when the engine key is turned to the "ACC" or "LOCK" position and driver's door is opened.
- Doors unlock when shifting into Park.

Automatic Transmission

P	Park*
R	Reverse
N	Neutral
D	Drive
4	Fourth gear
3	Third gear
2	Second gear
L	First gear

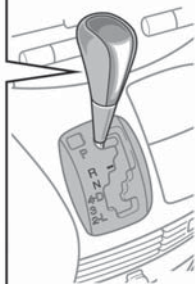

* The engine switch must be "ON" and the brake pedal depressed to shift from Park.

Downshifting increases power going uphill, or provides engine braking downhill. For best fuel economy during normal driving conditions, always drive with the shift lever in the "D" position.

Tilt and telescopic steering wheel

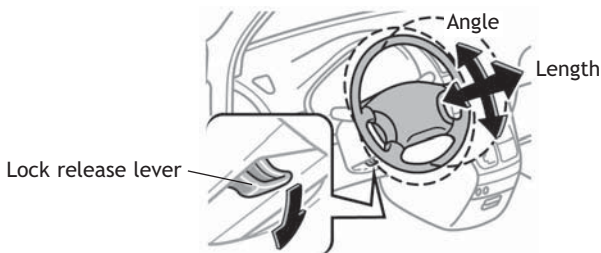

Hold wheel, push lever down, set angle and length, and return lever.

Note: Do not attempt to adjust while the vehicle is in motion.

Lights & turn signals

Headlights

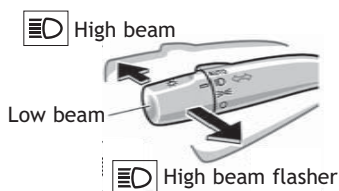

* If equipped

-**Daytime Running Light system (if equipped)** Automatically turns on the headlights at a reduced intensity.

-**Automatic light cut off system** Automatically turns lights off after 30 seconds when any of the doors are opened and closed with the engine off. Lights may also be turned off by pushing lock button on remote once more after locking.

Turn signals

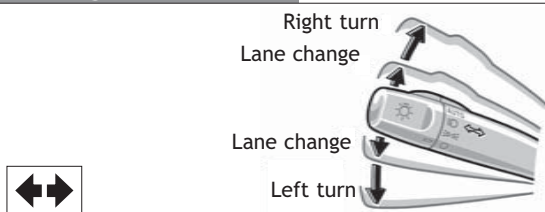

Front fog lights (if equipped)

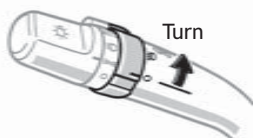

Front fog lights come on only when the headlights are on low beam.

Headlight beam level control (if equipped)

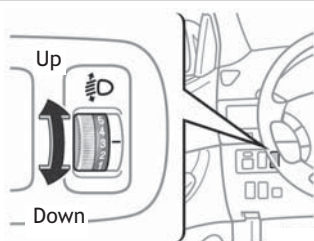
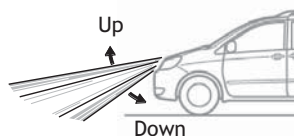

Higher number will lower the beam.

Windshield wipers & washers

Front

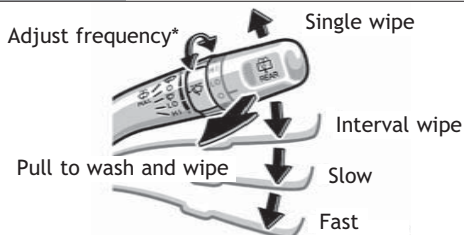

* Intermittent windshield wiper frequency adjustment
Rotate to increase/decrease wipe frequency.

Rear

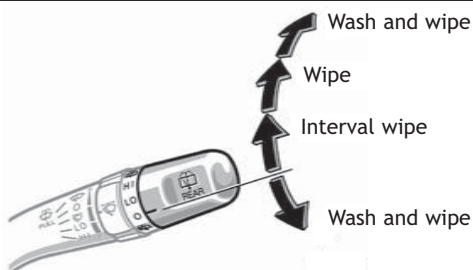

Parking brake

BRAKE

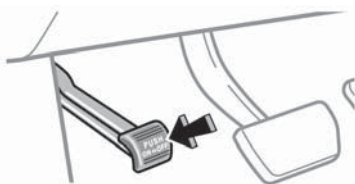

Set: Depress
Release: Depress again

Windows-Power quarter (if equipped)

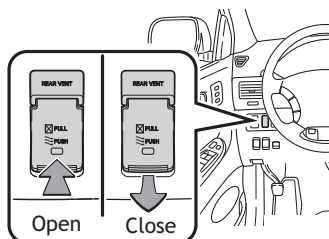

Windows

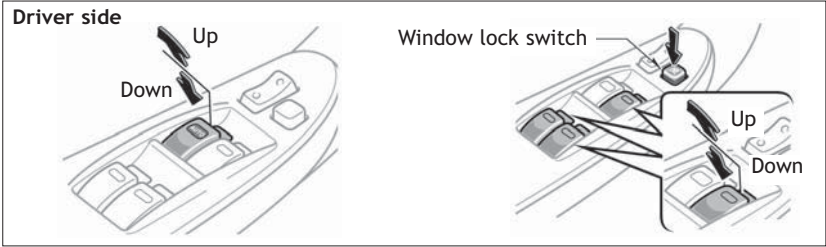

Automatic operation (driver side only) (If equipped) Push the switch completely down or pull it completely up and release to fully open or close. To stop window midway, lightly push the switch in the opposite direction.

Window lock switch Deactivates all passenger windows. Driver's window remains operable.

NOTE: If battery is disconnected, the windows need to be reinitialized. Refer to the *Owner's Manual* for more details.

Moonroof (if equipped)

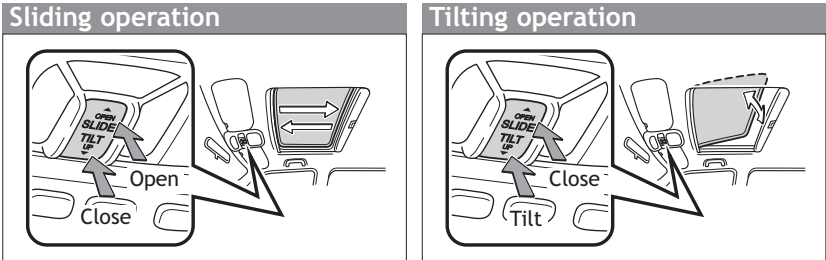

NOTE: If battery is disconnected, the moonroof needs to be reinitialized. Refer to the *Owner's Manual* for more details.

Seat heaters (if equipped)

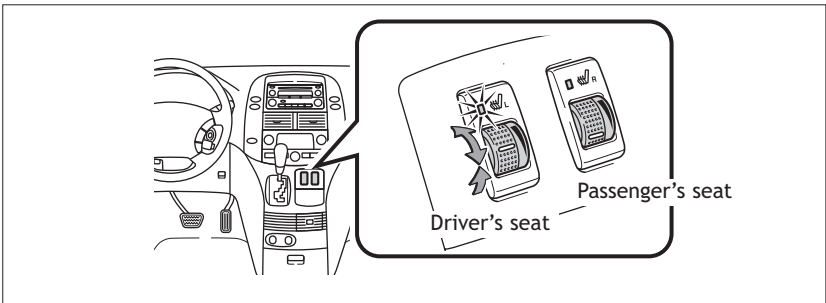

Doors-Sliding

ON/OFF switch

Instrument panel

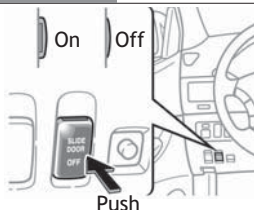

Opening/Closing

Front overhead console

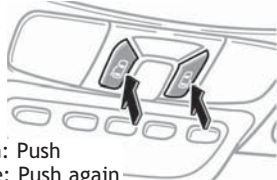

Open: Push
Close: Push again

Center pillar

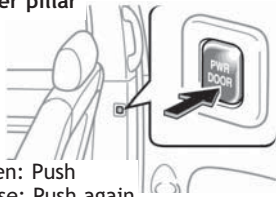

Open: Push
Close: Push again

Power

- Sliding doors will not fully open if the sliding door window is open.
- When the engine switch is in the "ON" position, power sliding doors will open only when gear selector is in the "P" (Park) position, and doors are unlocked. Refer to the *Owner's Manual* for more details.
- An alarm will sound if a sliding door is open and the vehicle is shifted out of Park.
- If battery is disconnected, the power sliding doors need to be reinitialized. Refer to the *Owner's Manual* for more details.

Manual

- Sliding doors will not lock into the open position if the sliding door window is open.

Door-Power back (if equipped)

ON/OFF switch

Instrument panel

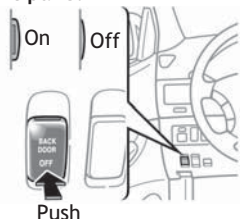

Opening/Closing

Front overhead console

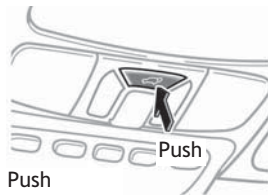

Open: Push
Close: Push again

NOTE: If battery is disconnected, the power back door needs to be reinitialized. Refer to the *Owner's Manual* for more details.

Console box (if equipped)

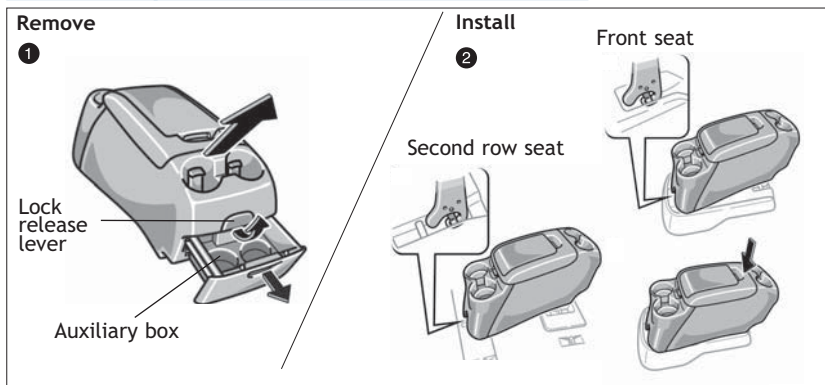

The console box can be removed and installed between the front or second row seats.

- To remove** Open the auxiliary box on the rear side, and pull the lock release lever. Lift the box from the rear to release it from the hook.
- To install** Place the hook into the striker. Lower box and push down to engage the rear lock.

Front seat console table (if equipped)



Clock

**With manual
Air Conditioning system**

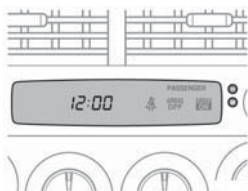

**With automatic
Air Conditioning system**

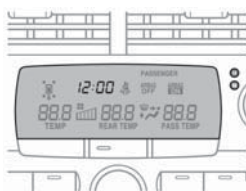

H- Hour set
M- Minute set

Seat adjustments-Front

Manual seat



Power seat



- ① Seat position (forward/backward)
- ② Height crank (driver side only)
- ③ Seatback angle
- ④ Lumbar support (driver side only)(If equipped)
- ⑤ Seat position, cushion angle and height
- ⑥ Seatback angle

Seat adjustments-Rear

Second row seat



Third row seat

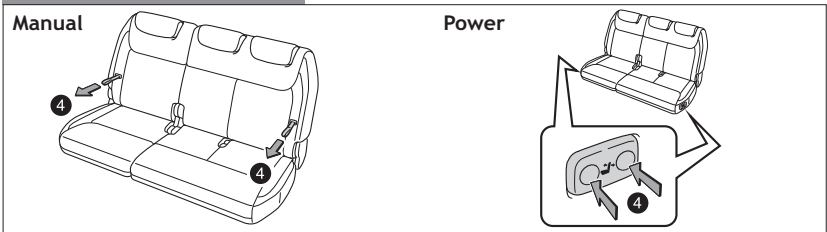

- ① Seatback release (from third row seat)
- ② Seatback release (from second row seat)
- ③ Seat position (forward/backward)
- ④ Seatback angle

Refer to the *Owner's Manual* for more details.

Seats-Head restraints

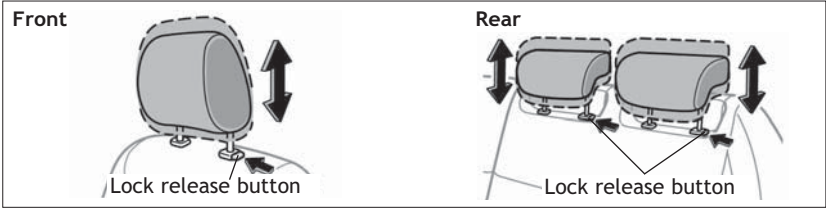

Seat arrangements (examples)

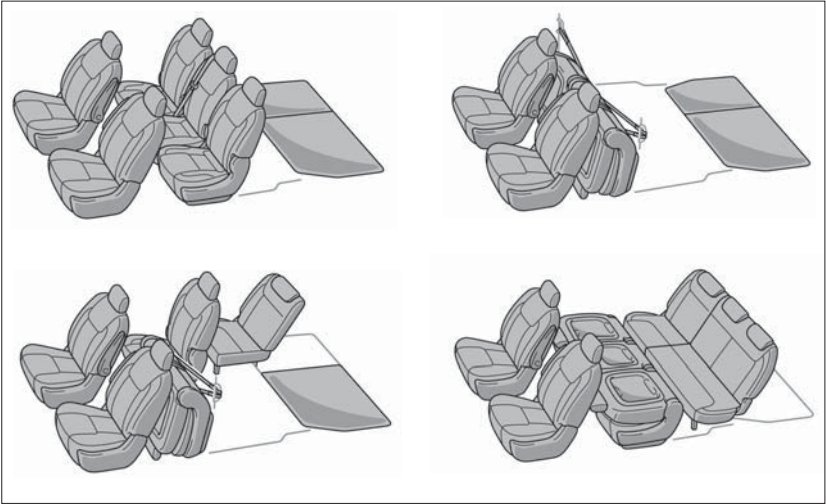

These are some possible seat arrangements. Please read the following section and refer to the *Owner's Manual* for more information about seat positions.

7-passenger models

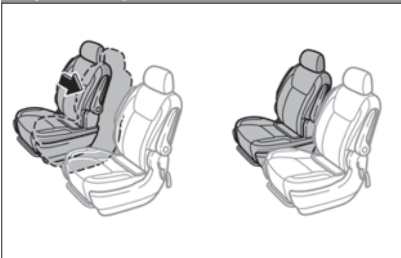

7-passenger models The right seat can be placed in the inside or outboard position.

8-passenger models The center seat can be placed in the forward position or even with the other seats.

8-passenger models



Seats-Tumble/Remove second row seats

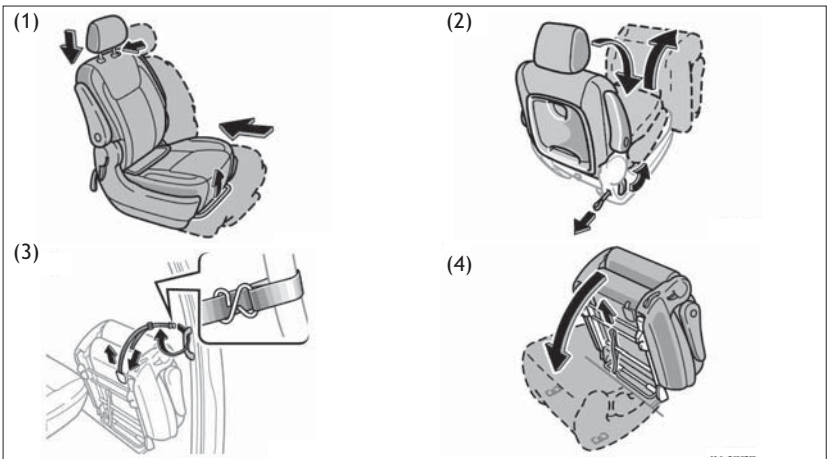

- (1) Lower the head restraint and slide the seat to the rear-most locked position.
- (2) Pull the strap or lever and tumble the seat.
- (3) Pass the strap through the assist grip.
- (4) Pull and hold the strap, then fold down the seat to disengage from front hooks.

Seats-Stowing third row seats (manual)

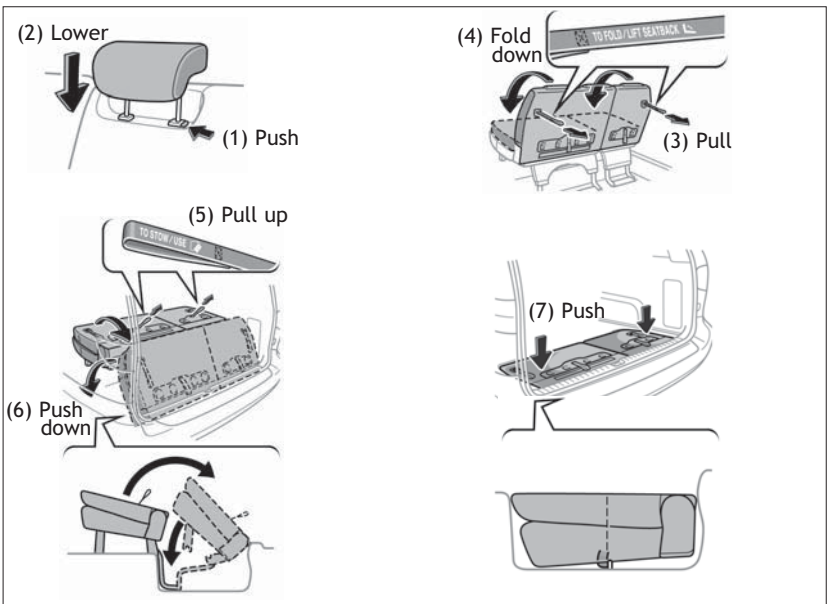

Seats-Stowing third row seats (power)(if equipped)

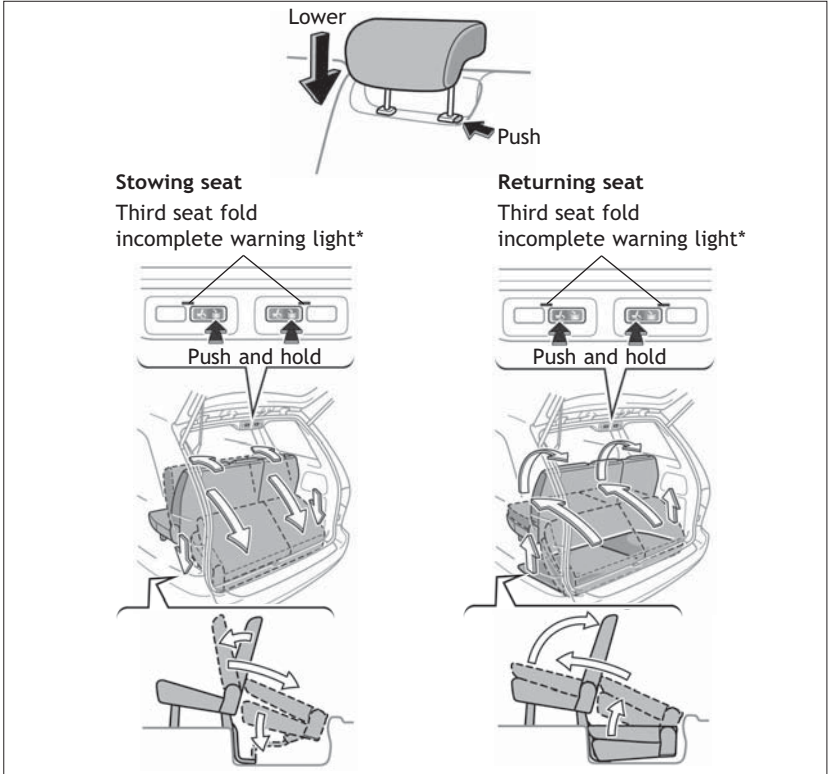

* This light will remain ON until the seat is fully open or stowed.

An alarm will also sound for 10 seconds, and the **3RD SEAT** indicator will light up on the instrument panel.

Refer to the *Owner's Manual* for more details.

Sunshade-Side (if equipped)

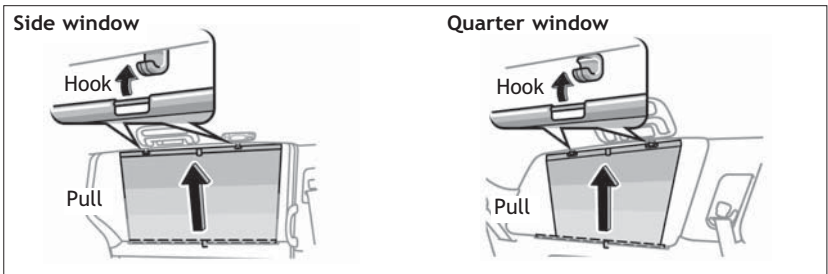

Cruise control (if equipped)

Turning system ON/OFF

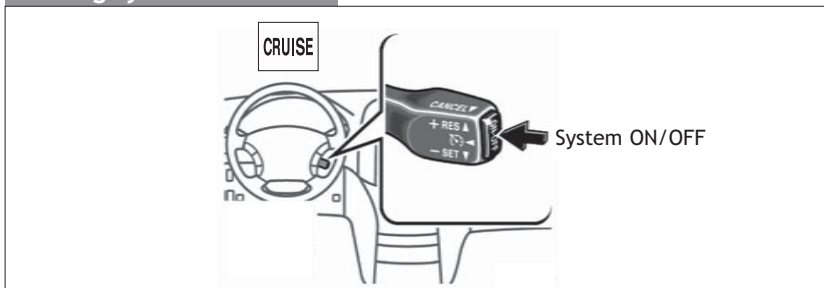

Functions

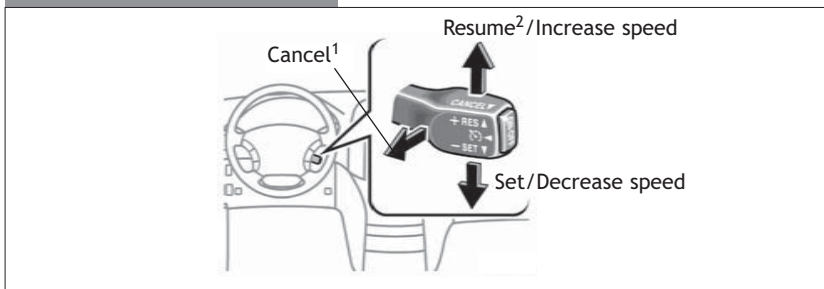

¹ The set speed may also be cancelled by depressing the brake pedal.

² The set speed may be resumed once vehicle speed reaches 25 mph.

Dynamic Laser Cruise Control (if equipped)

Refer to the *Owner's Manual* for more details and complete safety precautions before attempting to use the "Dynamic Laser Cruise Control."

Fixed speed mode

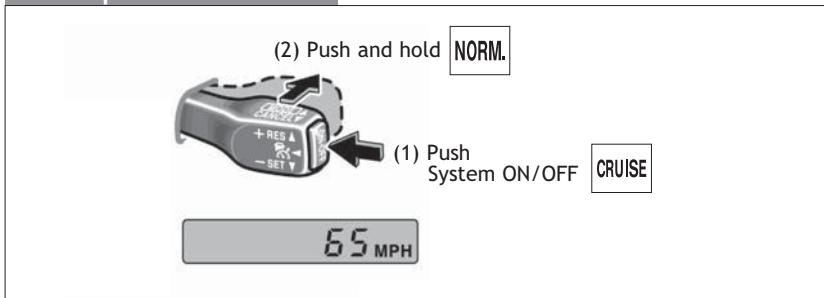

To set, cancel and resume a speed Refer to "Functions" in the *Cruise Control* section above, and to the *Owner's Manual* for more details.

Distance control mode



The distance control mode will cruise at a set speed, decelerate to maintain a selected distance from a slower vehicle traveling in front of you, and accelerate back up to the selected speed if the vehicle in front changes lanes or speeds up.

To set, cancel and resume a speed Refer to “Functions” in the *Cruise Control* section at left, and your *Owner’s Manual* for more details.

NOTE: Once vehicle speed is set, pushing lever up toward “+ RES” will increase speed to the nearest 5 mph, and then in 5 mph increments. Pushing lever down toward “- SET” will reduce speed in the same way.

Changing vehicle-to-vehicle distance

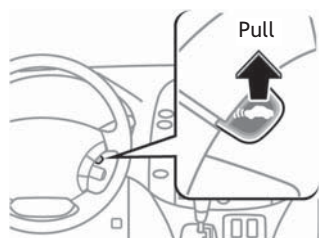

LONG  65 MPH

MIDDLE  65 MPH

SHORT  65 MPH

Light control-Instrument panel

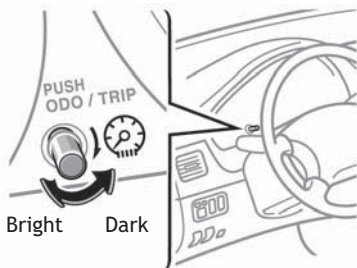

Audio

Type 1

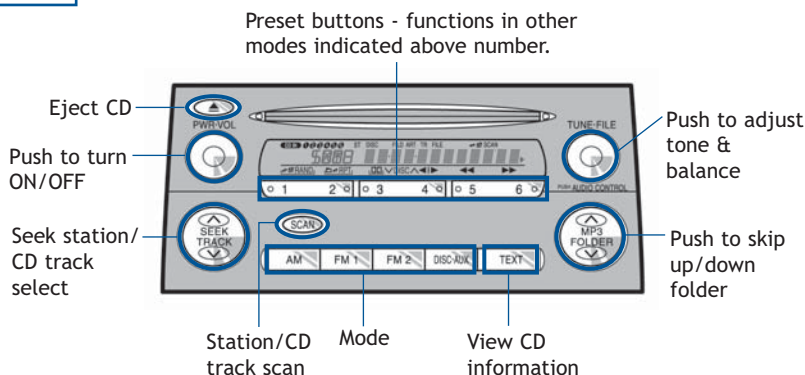

Type 2 additional functions

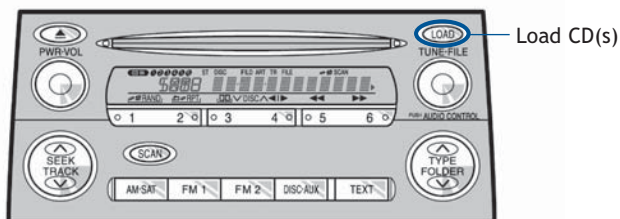

CD PLAYER

To scan tracks on a disc Push "SCAN." Push again to hold selection.
CD Changer (Type 2 only)

-To load one disc Push "LOAD" and insert one disc.

-To load multiple discs Push and hold "LOAD" until you hear a beep. Insert one disc. Shutter will close and then re-open for next disc.

To select a file (MP3/WMA only) Turn "TUNE-FILE."

To select a folder (MP3/WMA only) Push either side of "MP3/FOLDER."

RADIO

To preset stations Tune in the desired station and hold down a preset button (1-6) until you hear a beep. Push desired preset button (1-6) to select.

To scan stations Push "SCAN." Push and hold to scan preset stations. Push again to hold selection.

Steering wheel switches (if equipped)

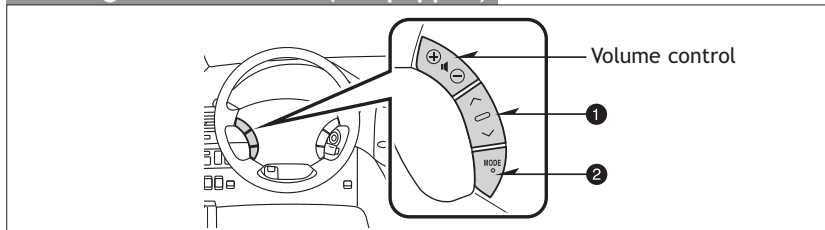

1 "▲ ▼"

-In radio mode Push to select a preset station; push and hold to seek the next strong station.

-In CD mode Push to skip up or down to next/previous track.

2 "MODE"

Push to turn audio ON and select an audio mode. Push and hold to turn the audio system OFF.

AUX adapter

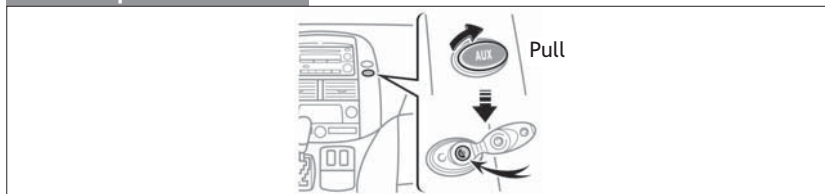

By inserting a mini plug into the AUX audio jack, you can listen to music from a portable audio device through the vehicle's speaker system while in AUX mode.

Telephone controls (Bluetooth®) (if equipped)

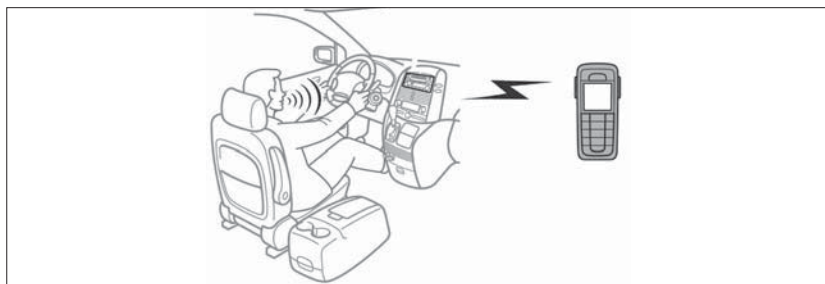

Bluetooth® technology allows dialing or receipt of calls without taking hands from the steering wheel or using a cable to connect the telephone and the system.

Refer to "Using the hands-free phone system (for cellular phone)," Section 3-4 in the *Owner's Manual* for more details.

Air Conditioning/Heating

Front manual Air Conditioning

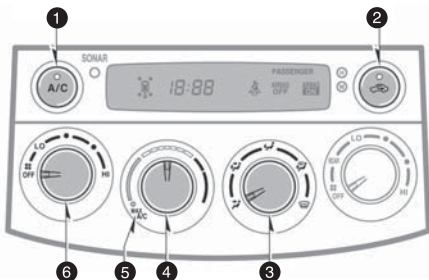

- ① Air Conditioning ON/OFF
- ② Fresh or recirculated cabin air
- ③ Airflow vent
In “” or “” mode, use fresh air (“” indicator OFF) to reduce window fogging.
- ④ Temperature selector
- ⑤ Use for quick cooling. MAX A/C changes air intake to recirculate. It is not possible to change intake to fresh.
- ⑥ Fan speed

Rear manual Air Conditioning

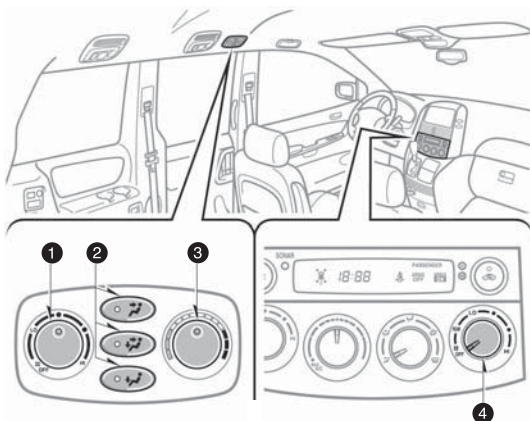

- ① Fan speed
- ② Airflow vent
- ③ Temperature selector
- ④ Fan speed

Front automatic Air Conditioning

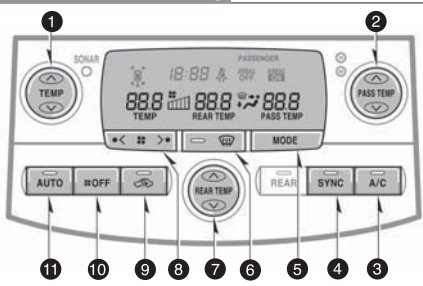

- 1 Temperature selector (driver side)
- 2 Temperature selector (front passenger side)
- 3 Air Conditioning ON/OFF
- 4 Synchronizes front and rear temperature settings
- 5 Airflow vent
In "Fresh" or "Recirculated" mode, use fresh air ("Fresh" indicator OFF) to reduce window fogging.
- 6 Windshield airflow/defogger
- 7 Temperature selector (rear passenger side)
- 8 Fan speed
- 9 Fresh or recirculated cabin air
- 10 Climate control OFF
- 11 Automatic climate control ON/OFF

Rear automatic Air Conditioning

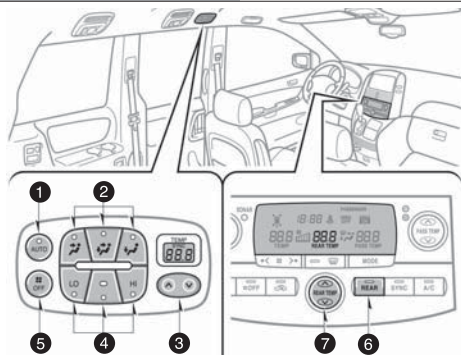

- 1 Automatic climate control ON/OFF
- 2 Airflow vent
- 3 Temperature selector
- 4 Fan speed
- 5 Climate control OFF
- 6 ON/OFF switch
- 7 Temperature selector

Rear seat entertainment system (if equipped)

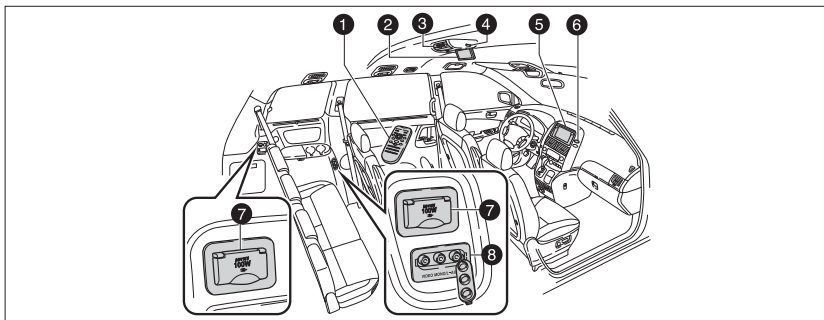

- ① Remote control
- ② DVD screen
- ③ DVD player
- ④ Headphone jacks and headphone volume control
- ⑤ Front audio
- ⑥ 115V AC Power outlet ON/OFF switch
- ⑦ 115V AC Power outlets
- ⑧ AV input adapter

Multi-information display (HomeLink®)* (if equipped)

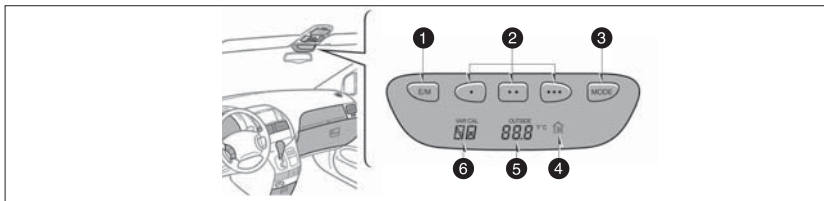

- ① Select standard or metric
- ② **Garage door opener buttons** Garage door openers manufactured under license from HomeLink®* can be programmed to operate garage doors, estate gates, security lighting, etc.

Refer to "Garage door openers," Section 3-7 in the *Owner's Manual* for more details.

For programming assistance, contact the Toyota Customer Experience Center at 1-800-331-4331, or visit <http://www.homelink.com>.

- ③ Change display information
- ④ Garage door opener indicator
- ⑤ Information display
- ⑥ Compass

* HomeLink® is a registered trademark of Johnson Controls, Inc.

Power outlets-12V DC

Instrument panel

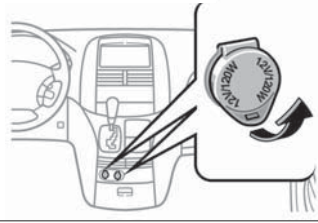

Luggage compartment

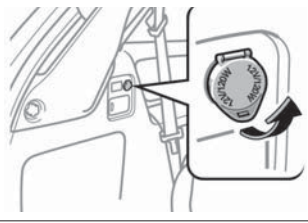

Power outlets-115V AC (if equipped)

ON/OFF switch

Instrument panel

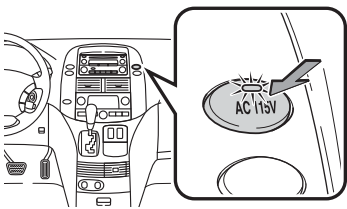

Power outlets

Beside third row seat

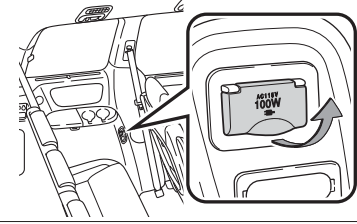

Luggage compartment

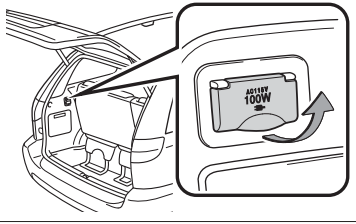

Designed for car accessories. Engine switch must be in the "ACC" or "ON" position to be used.

Bottle holders

Front doors

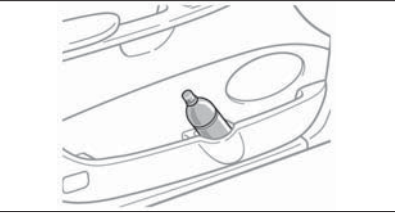

Sliding doors

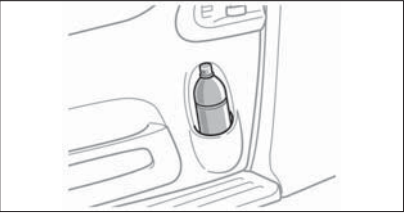

Note: Do not place open containers in the sliding door bottle holders.

Cup holders

Instrument panel

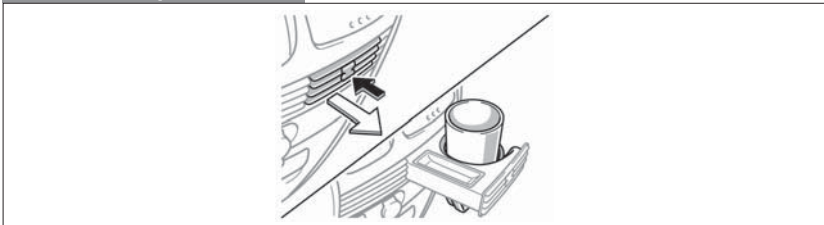

Front side table

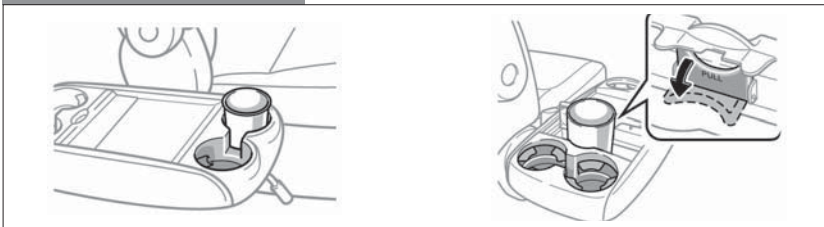

Third row area



Console box

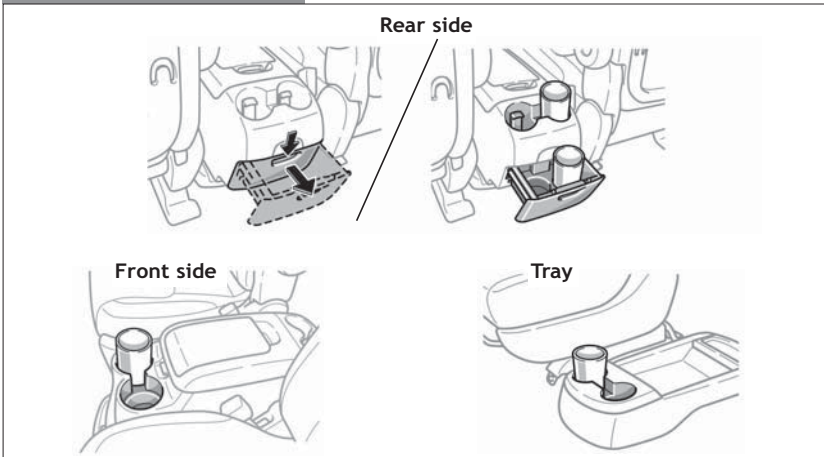

SAFETY AND EMERGENCY FEATURES

Door locks

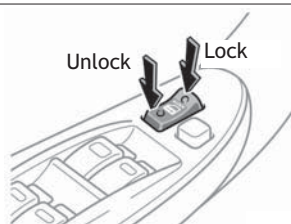

Doors-Child safety locks

Rear door

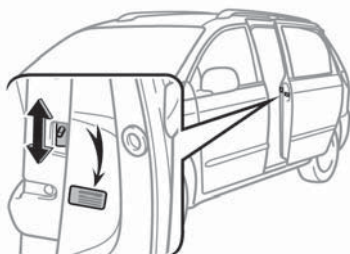

Moving the lever to "LOCK" will allow the door to be opened only from the outside.

Seatbelts-Shoulder belt anchor

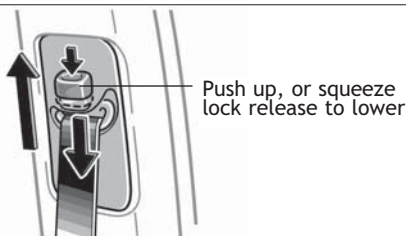

Seatbelt comfort guide



Seatbelts

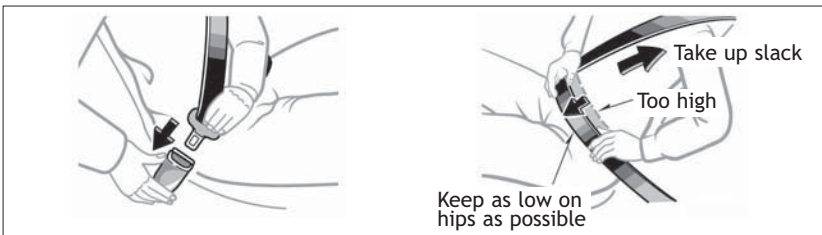

If belt is fully extended, then retracted even slightly, it cannot be re-extended beyond that point, unless fully retracted again. This feature is used to help hold child restraint systems securely.

To find more information about seatbelts, and how to install a child restraint system, refer to the *Owner's Manual*.

Tire Pressure Monitoring (warning) System

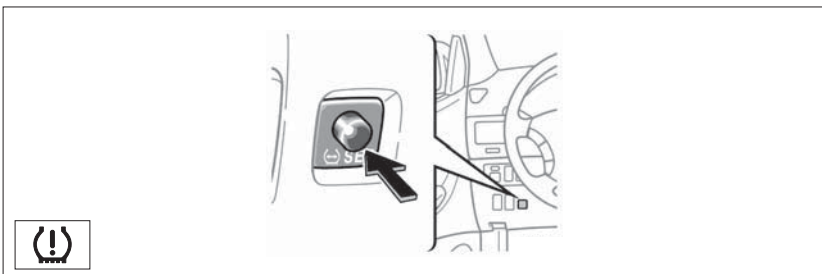

After adjusting tire pressures, or after tires have been rotated or replaced, turn the ignition switch to "ON" and press and hold the "SET" button until indicator blinks three times. Let the vehicle sit for a few minutes to allow initialization to complete.

Refer to the load label on the door jamb or the *Owner's Manual* for tire inflation specifications.

If the tire pressure indicator flashes for more than 60 seconds and then remains on, take the vehicle to your local Toyota dealer.

Note: The warning light may come on due to temperature changes or changes in tire pressure from natural air leakage. If the system has not been initialized recently, setting the tire pressures to factory specifications should turn off the light.

Abbreviation/Acronym list

ABBREVIATIONS	MEANING
2WD	2 Wheel Drive
AWD	All Wheel Drive
ABS	Anti-lock Brake System
ACC	Accessory
ALR	Automatic Locking Retractor
AVG	Average
CAL	Calibration
CRS	Child Restraint System
ECU	Electronic Control Unit
EDR	Event Data Recorder
ELR	Emergency Locking Retractor
E/M	English/U.S. customary system/Metric
GAWR	Gross Axle Weight Rating
GVWR	Gross Vehicle Weight Rating
I/M	Emission inspection and maintenance
LATCH	Lower Anchors and Tethers for Children
LED	Light Emitting Diode
MAX	Maximum
MIN	Minimum
MMT	Methylcyclopentadienyl Manganese Tricarbonyl
M + S	Mud and Snow
MTBE	Methyl Tertiary Butyl Ether
OBD	On Board Diagnostics
RFT	Run-Flat Tire
SRS	Supplemental Restraint System
TIN	Tire Identification Number
TPMS	Tire Pressure Warning System

ABBREVIATIONS	MEANING
TRAC	Traction Control
VAR	Variation
VIN	Vehicle Identification Number
VSC	Vehicle Stability Control

For your information

Main Owner's Manual

Please note that this manual covers all models and all equipment, including options. Therefore, you may find some explanations for equipment not installed on your vehicle.

All specifications provided in this manual are current at the time of printing. However, because of the Toyota policy of continual product improvement, we reserve the right to make changes at any time without notice.

Depending on specifications, the vehicle shown in the illustrations may differ from your vehicle in terms of equipment.

Noise from under vehicle after turning off the engine

Approximately five hours after the engine is turned off, you may hear sound coming from under the vehicle for several minutes. This is the sound of a fuel evaporation leakage check and, it does not indicate a malfunction.

Accessories, spare parts and modification of your Toyota

A wide variety of non-genuine spare parts and accessories for Toyota vehicles are currently available on the market. You should know that these parts are not covered by Toyota warranty and that Toyota is not responsible for their performance, repair, or replacement, or for any damage they may cause to, or adverse effect they may have on, your Toyota vehicle.

This vehicle should not be modified with non-genuine Toyota products. Modification with non-genuine Toyota products could affect its performance, safety or durability, and may even violate governmental regulations. In addition, damage or performance problems resulting from the modification may not be covered under warranty.

Installation of a mobile two-way radio system

As the installation of a mobile two-way radio system in your vehicle may affect electronic systems such as the multi-port fuel injection system/sequential multi-port fuel injection system, cruise control system, anti-lock brake system, SRS airbag system or seat belt pretensioner system, be sure to check with your Toyota dealer for precautionary measures or special instructions regarding installation.

Scrapping of your Toyota

The SRS airbag and seat belt pretensioner devices in your Toyota contain explosive chemicals. If the vehicle is scrapped with the airbags and seat belt pretensioners left as they are, this may cause an accident such as fire. Be sure to have the systems of the SRS airbag and seat belt pretensioner removed and disposed of by a qualified service shop or by your Toyota dealer before you scrap your vehicle.

Perchlorate Material

Special handling may apply, See www.dtsc.ca.gov/hazardouswaste/perchlorate.

Your vehicle has components that may contain perchlorate. These components may include airbags, seat belt pretensioners, and wireless remote control batteries.



CAUTION

■ **General precautions while driving**

Driving under the influence: Never drive your vehicle when under the influence of alcohol or drugs that have impaired your ability to operate your vehicle. Alcohol and certain drugs delay reaction time, impair judgment and reduce coordination, which could lead to an accident that could result in death or serious injury.

Defensive driving: Always drive defensively. Anticipate mistakes that other drivers or pedestrians might make and be ready to avoid accidents.

Driver distraction: Always give your full attention to driving. Anything that distracts the driver, such as adjusting controls, talking on a cellular phone or reading can result in a collision with resulting death or serious injury to you, your occupants or others.

■ **General precaution regarding children's safety**

Never leave children unattended in the vehicle, and never allow children to have or use the key.

Children may be able to start the vehicle or shift the vehicle into neutral. There is also a danger that children may injure themselves by playing with the cigarette lighter, the windows, or other features of the vehicle. In addition, heat build-up or extremely cold temperatures inside the vehicle can be fatal to children.

Symbols used throughout this manual

Cautions & Notices

CAUTION

This is a warning against anything which may cause death or injury to people if the warning is ignored. You are informed about what you must or must not do in order to reduce the risk of injury to yourself and others.

NOTICE

This is a warning against anything which may cause damage to the vehicle or its equipment if the warning is ignored. You are informed about what you must or must not do in order to avoid or reduce the risk of damage to your Toyota and its equipment.

Symbols used in illustrations



Safety symbol

The symbol of a circle with a slash through it means “Do not”, “Do not do this”, or “Do not let this happen”.

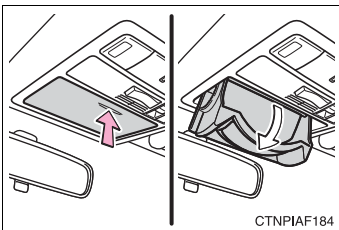

Arrows indicating operations



-  Indicates the action (pushing, turning, etc.) used to operate switches and other devices.
-  Indicates the outcome of an operation (e.g. a lid opens).

TABLE OF CONTENTS

1	Before driving	Adjusting and operating features such as door locks, mirrors, and steering column.
2	When driving	Driving, stopping and safe-driving information.
3	Interior features	Air conditioning and audio systems, as well as other interior features for a comfortable driving experience.
4	Maintenance and care	Cleaning and protecting your vehicle, performing do-it-yourself maintenance, and maintenance information.
5	When trouble arises	What to do if the vehicle needs to be towed, gets a flat tire, or is involved in an accident.
6	Vehicle specifications	Detailed vehicle information.
7	For owners	Reporting safety defects for U.S. owners and seat belt instructions for Canadian owners
	Index	Alphabetical listing of information contained in this manual.



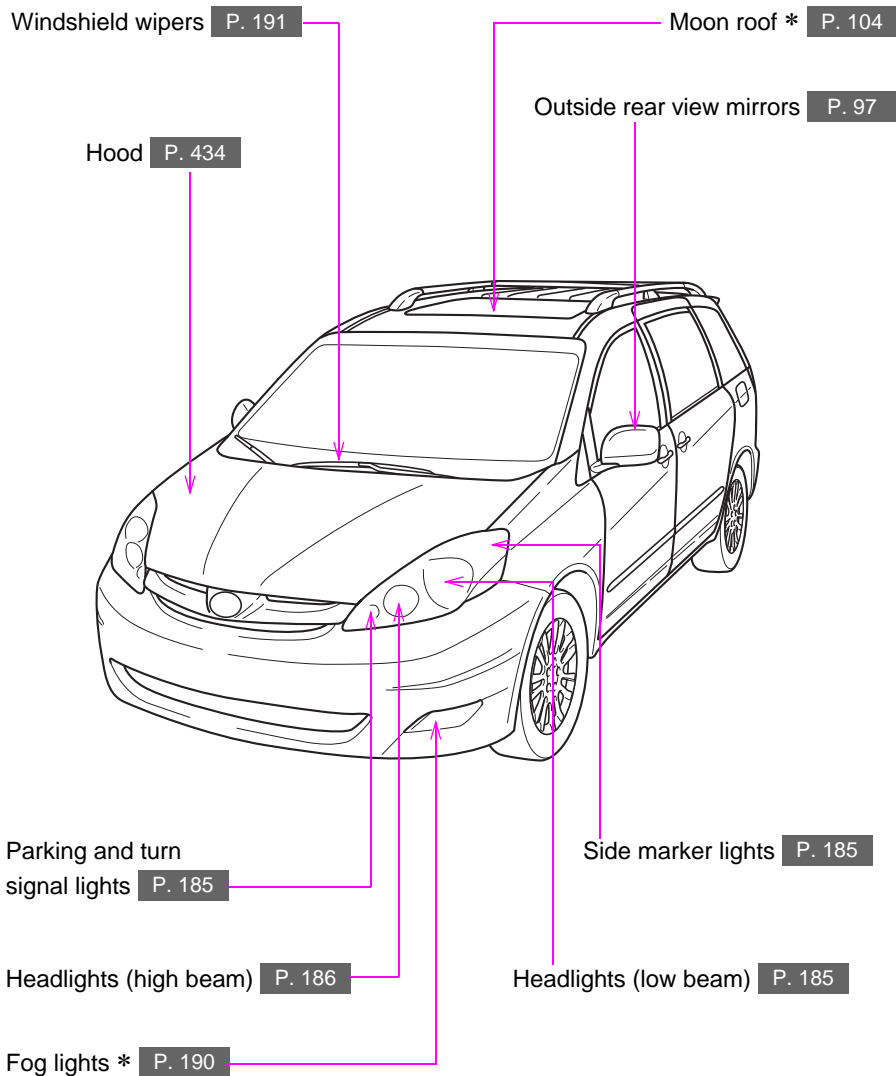
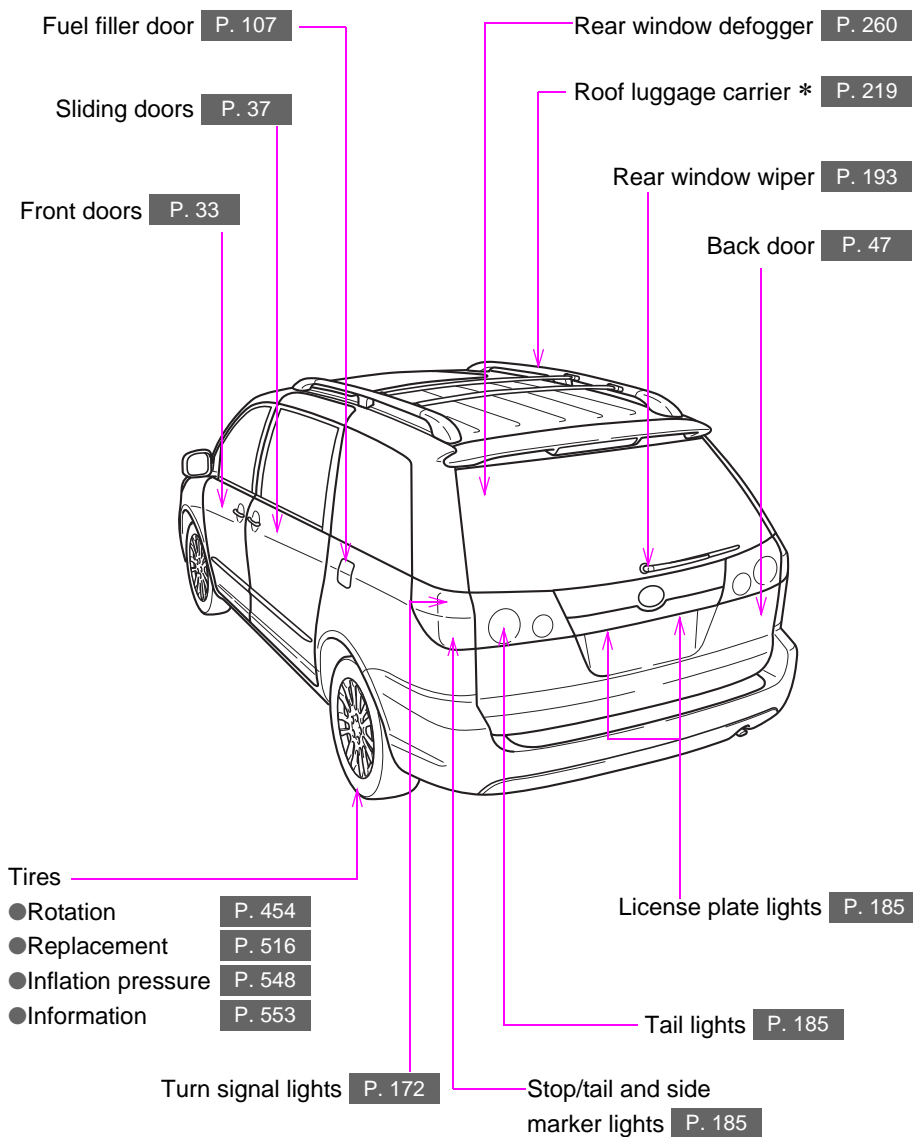

*: If equipped

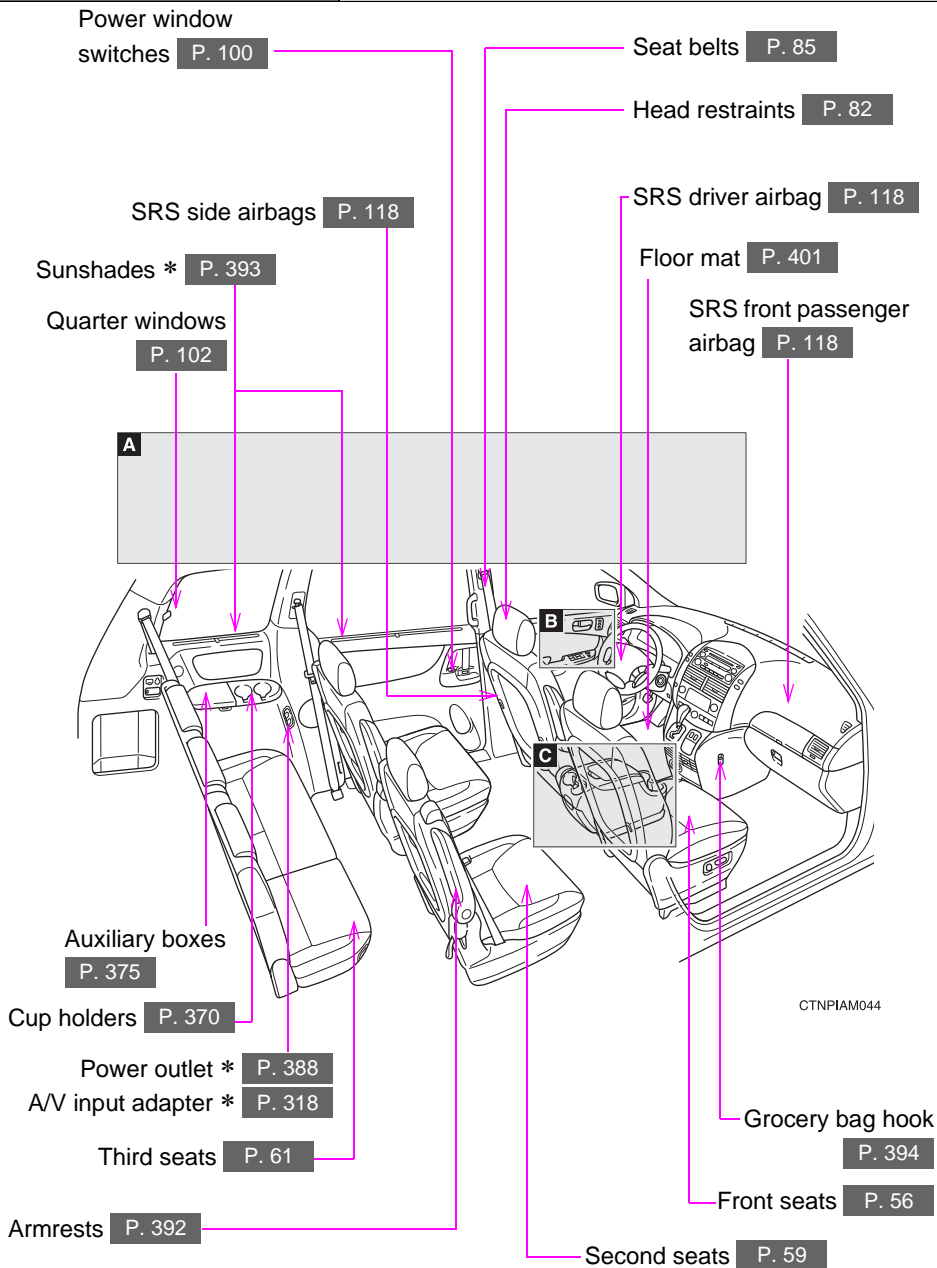

A

► **With garage door opener**

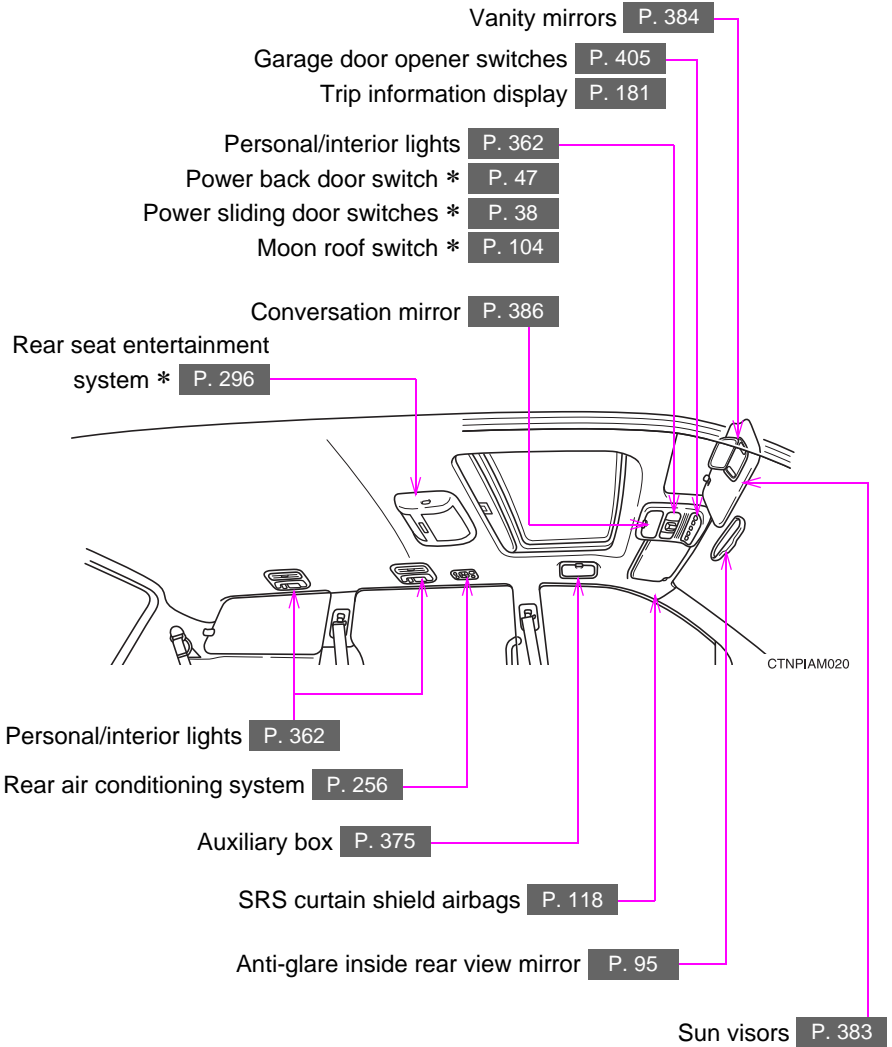

*: If equipped

A

► Without garage door opener

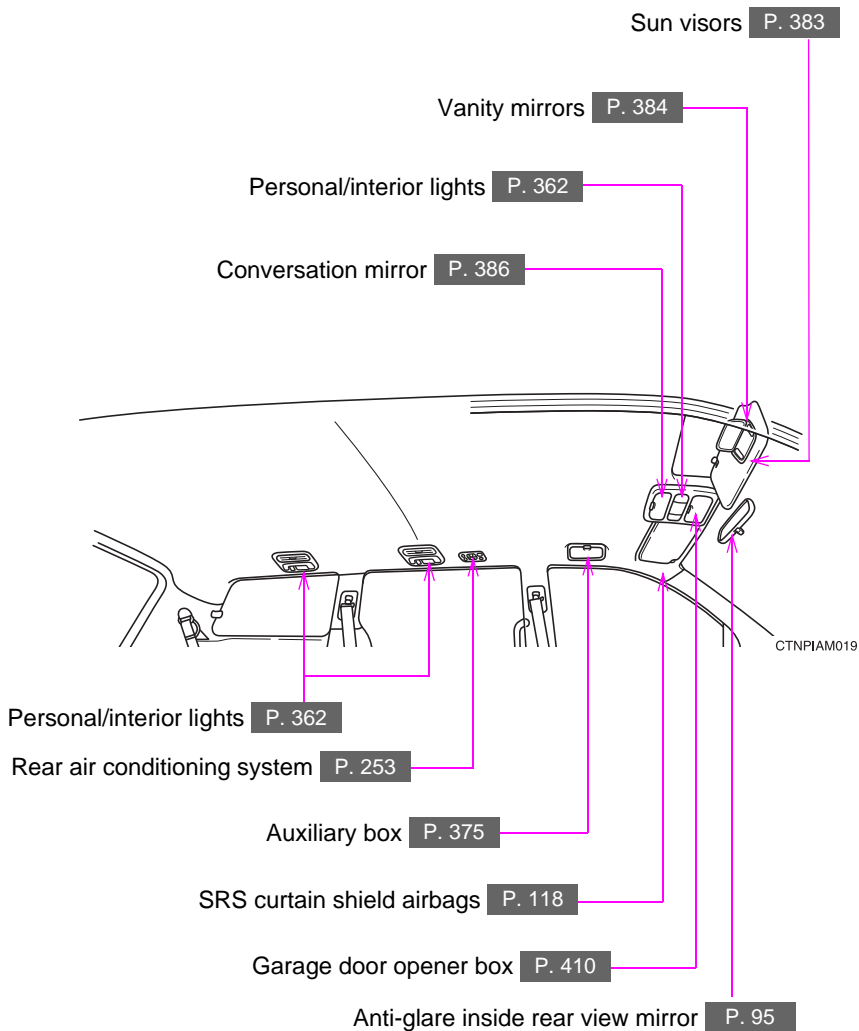

B

Inside door lock buttons P. 33

Driving position memory switches * P. 80

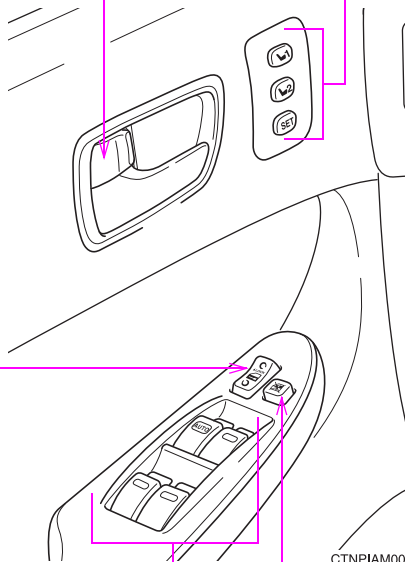

Door lock switches P. 33

Window lock switch P. 100

Power window switches P. 100

*: If equipped

C

► With console box

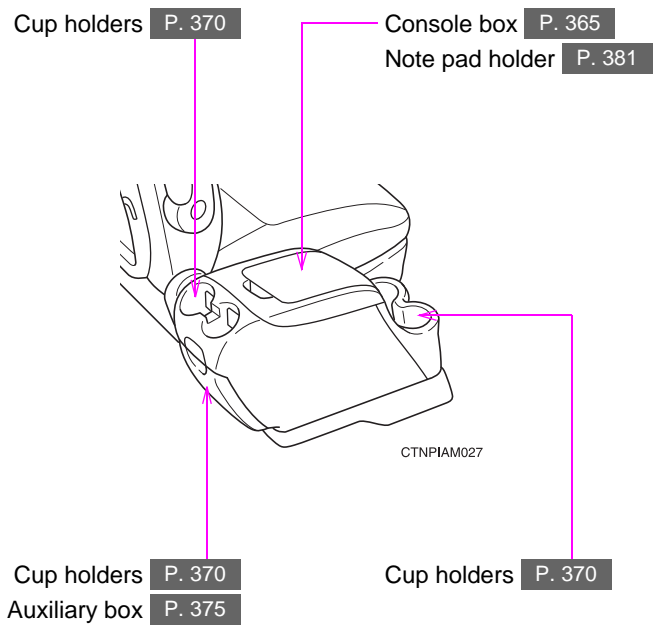

C**► With front seat side table**

Cup holders **P. 370**

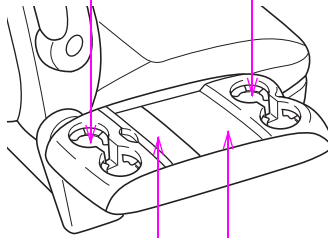

CTNPIAM026

Cup holder **P. 370**

Auxiliary box **P. 375**

Front seat side table **P. 399**

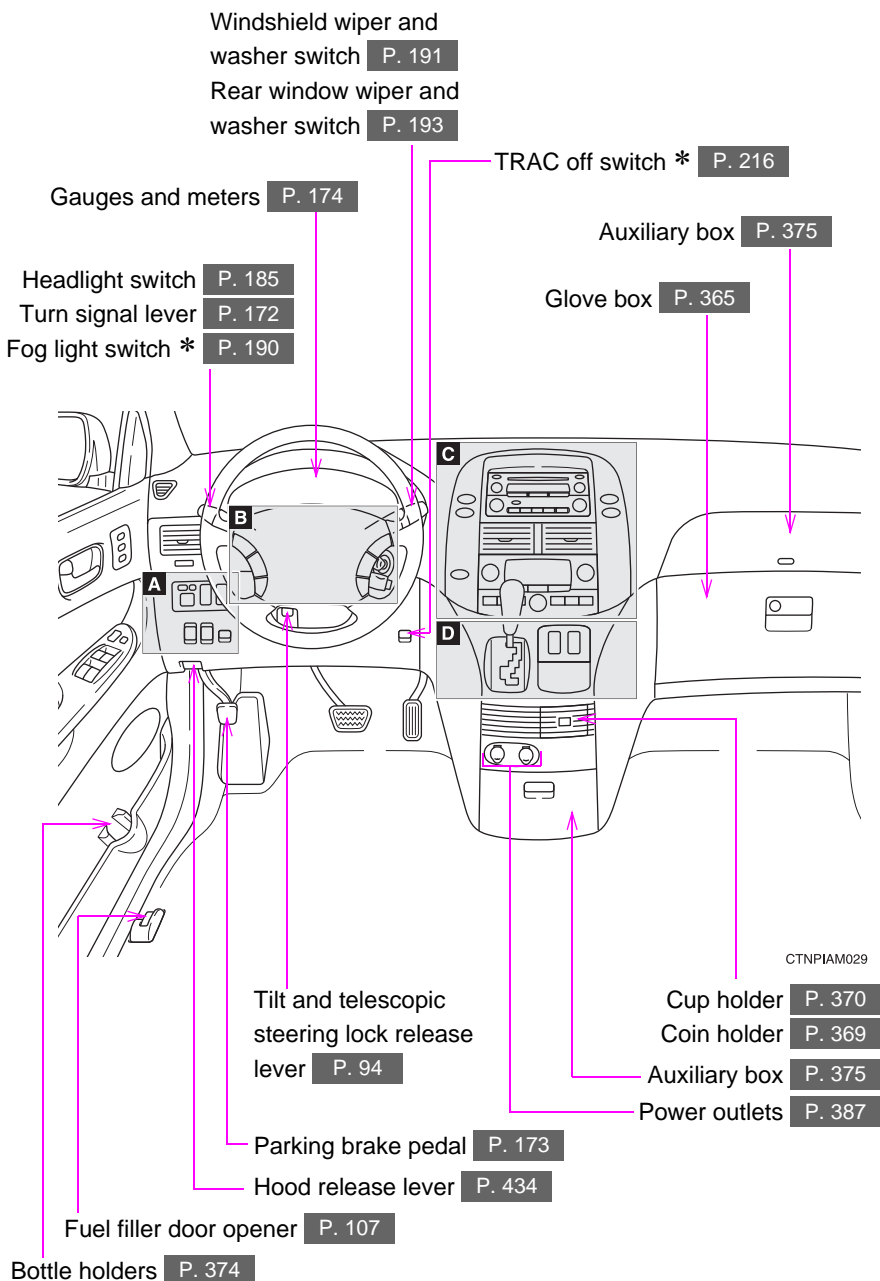

A

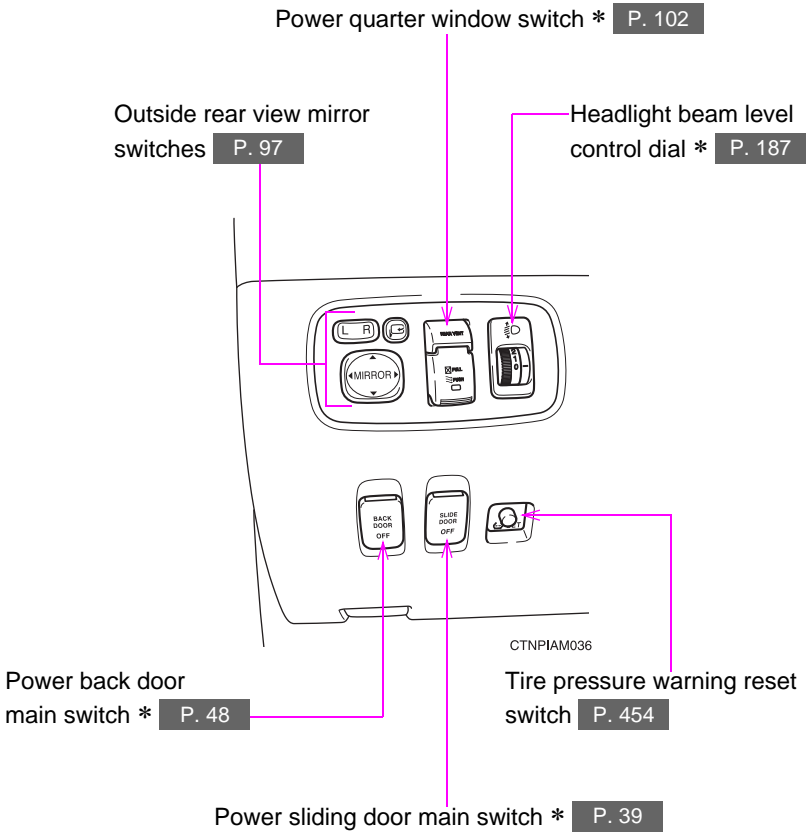

*: If equipped

B

Audio remote control switches * P. 292

Engine (ignition) switch P. 167

Telephone switch *, * P. 332

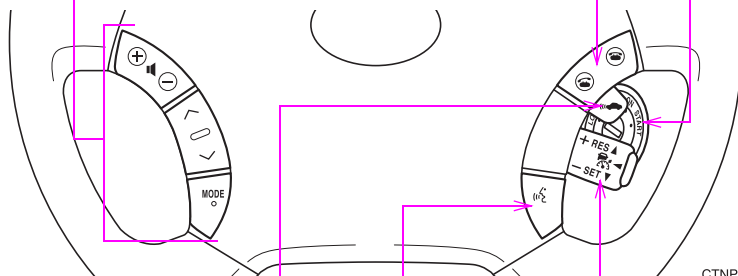

CTNPIAM023

Cruise control switch P. 194, 197

Talk switch *, * P. 332

Distance switch * P. 197

C

Rear window defogger switch P. 260

Outside rear view mirror defogger switch * P. 260

Windshield wiper de-icer switch * P. 260

AUX adapter P. 291

Power outlet main switch * P. 388

Emergency flasher switch

Audio system P. 262

Rear view monitor/navigation system *

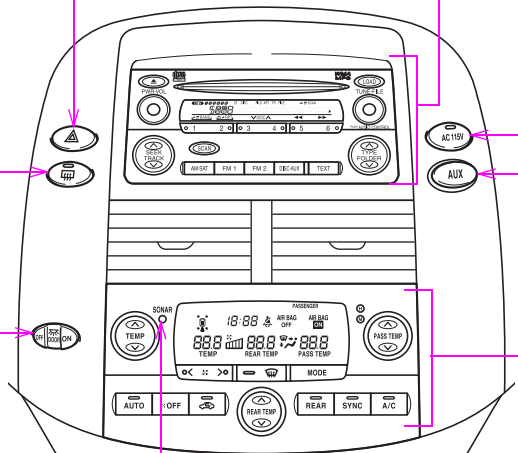

CTNPIAM012

Intuitive parking assist switch * P. 209

Personal/interior light main switch P. 362

Front air conditioning system
P. 240, 246

*: If equipped
: Refer to "Navigation System Owner's Manual".

D

► **With seat heater**

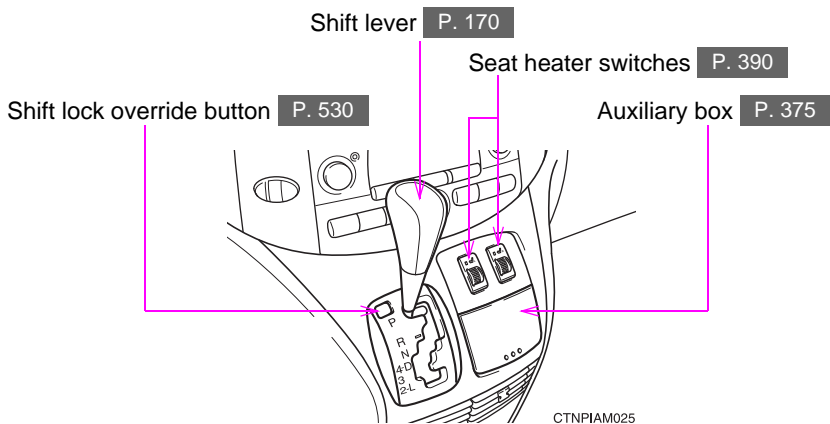

► **Without seat heater**

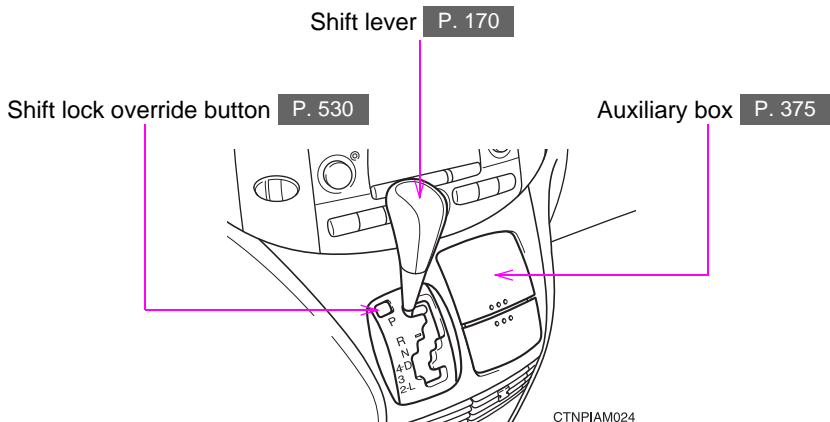

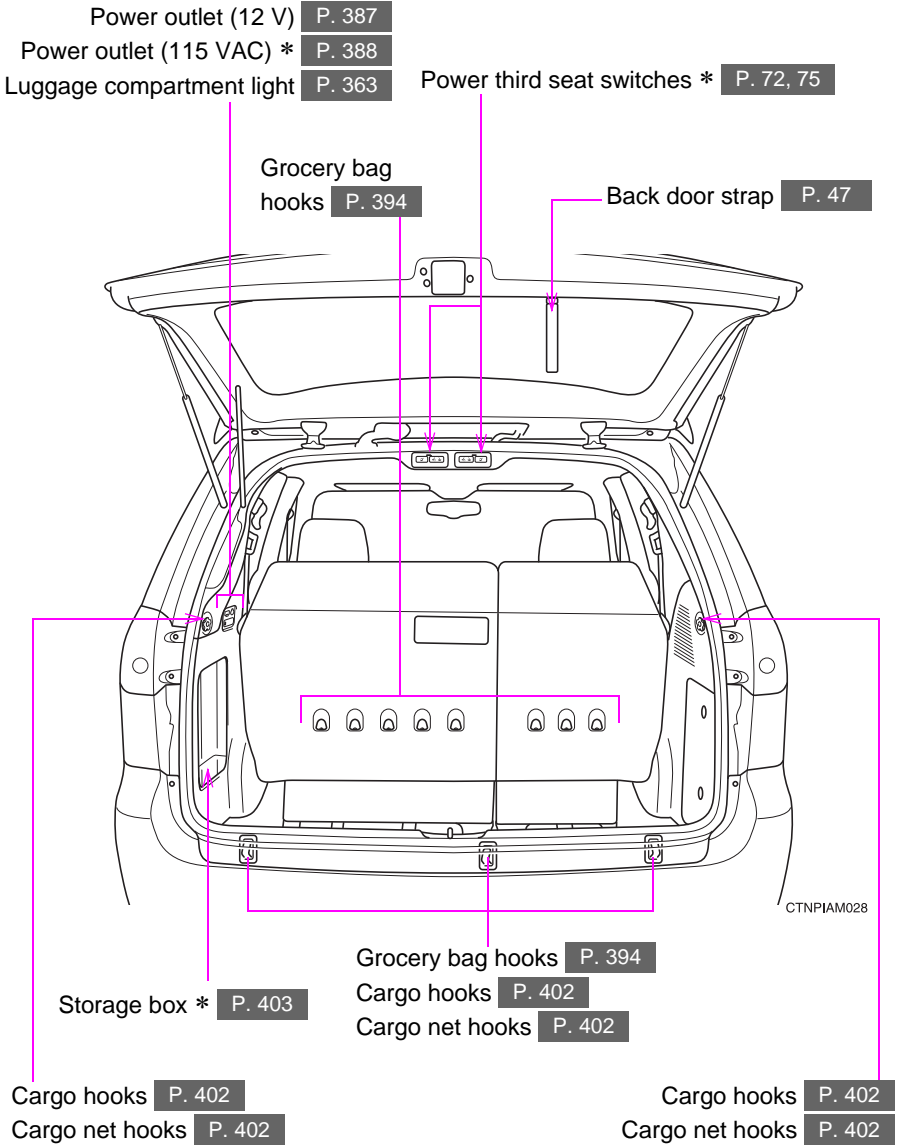

*: If equipped

Keys

The following keys are provided with the vehicle.

► **Vehicles without engine immobilizer system**

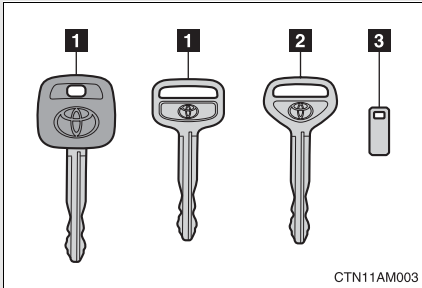

- 1** Master keys
- 2** Valet key
- 3** Key number plate

► **Vehicles with engine immobilizer system**

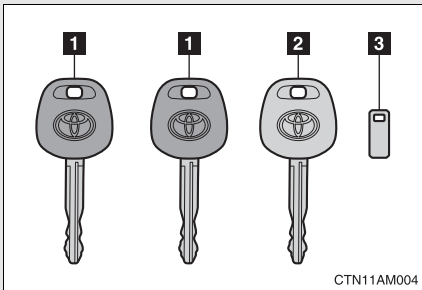

- 1** Master keys (black)
- 2** Valet key (gray)
- 3** Key number plate

■ **When required to leave a key to the vehicle with a parking attendant**

Lock the glove box as circumstances demand. (→P. 365)

Carry the master key for your own use and leave the valet key only with the attendant.

■ **Key number plate**

Keep the plate in a safe place such as your wallet, not in the vehicle. In the event that a key is lost, a new key can be made by your Toyota dealer using the key number plate. (→P. 531)

1-2. Opening, closing and locking the doors Wireless remote control

The wireless remote control can be used to lock and unlock the vehicle from outside the vehicle.

► Type A

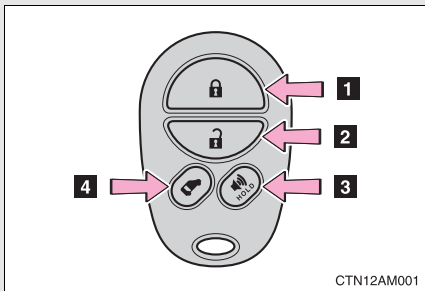

1 Locks all doors

2 Unlocks all doors

Pressing the button unlocks the driver's door. Pressing the button again within 3 seconds unlocks the other doors.

3 Pushing and holding:
Sounds alarm

4 Pushing and holding:
Opens and closes the right side power sliding door (if equipped)

► Type B

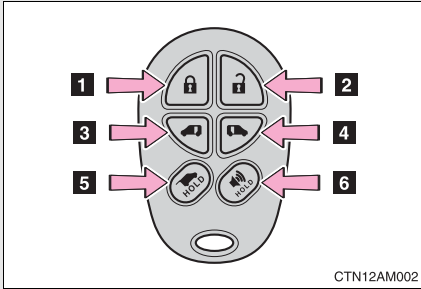

1 Locks all doors

2 Unlocks all doors

Pressing the button unlocks the driver's door. Pressing the button again within 3 seconds unlocks the other doors.

3 Pushing and holding:
Opens and closes the left side power sliding door (if equipped)

4 Pushing and holding:
Opens and closes the right side power sliding door (if equipped)

5 Pushing and holding:
Opens and closes the power back door (if equipped)

6 Pushing and holding:
Sounds alarm

■ Operation signals

Doors: A buzzer sounds and the emergency flashers flash to indicate that the doors have been locked/unlocked. (Locked: Once; Unlocked: Twice)

Back door (type B only): A buzzer sounds and the emergency flashers flash twice to indicate that the back door has been opened/closed.

■ Door lock buzzer

If a door is not fully closed, a buzzer sounds continuously for 10 seconds if an attempt to lock the door is made. Fully close the door to stop the buzzer, and lock the vehicle once more.

■ Panic mode

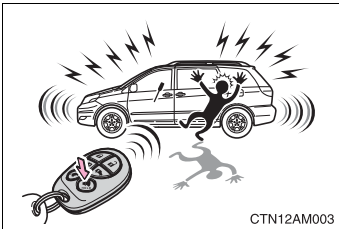

When  is pressed for longer than about one second, an alarm will sound intermittently and the vehicle lights will flash to deter any person from trying to break into or damage your vehicle.

To stop the alarm, press any button on the wireless remote control.

■ Wireless remote control battery depletion

If the wireless remote control function does not operate, the battery may be depleted. Replace the battery when necessary. (→P. 472)

■ Security feature

If a door is not opened within approximately 60 seconds after the vehicle is unlocked, the security feature automatically locks the vehicle again.

■ **Conditions affecting operation**

The wireless remote control function may not operate normally in the following situations.

- Near a TV tower, radio station, electric power plant, airport or other facility that generates strong radio waves
- When carrying a portable radio, cellular phone or other wireless communication devices
- When multiple wireless remote control are in the vicinity
- When the wireless remote control is in contact with, or is covered by, a metallic object
- When a wireless remote control (that emits radio waves) is being used nearby
- When the wireless remote control has been left near an electrical appliance such as a personal computer
- If window tint with a metallic content or metallic objects is attached to the rear window

■ **Customization that can be configured at Toyota dealer**

Settings (e.g. operation signal) can be changed.
(Customizable features →P. 565)

■ Certification for wireless remote control

► For vehicles sold in the U.S.A.

NOTE:

This device complies with Part 15 of the FCC Rules. Operation is subject to the following two conditions: (1) this device may not cause harmful interference, and (2) this device must accept any interference received, including interference that may cause undesired operation.

NOTICE:

This equipment has been tested and found to comply with the limits for a Class B digital device, pursuant to Part 15 of the FCC Rules. These limits are designed to provide reasonable protection against harmful interference in a residential installation. This equipment generates, uses and can radiate radio frequency energy and, if not installed and used in accordance with the instructions, may cause harmful interference to radio communications. However, there is no guarantee that interference will not occur in a particular installation. If this equipment does cause harmful interference to radio or television reception, which can be determined by turning the equipment off and on, the user is encouraged to try to correct the interference by one or more of the following measures:

- Reorient or relocate the receiving antenna.
- Increase the separation between the equipment and receiver.
- Connect the equipment into an outlet on a circuit different from that to which the receiver is connected.
- Consult the dealer or an experienced radio/TV technician for help.

FCC WARNING:

Changes or modifications not expressly approved by the party responsible for compliance could void the user's authority to operate the equipment.

► For vehicles sold in Canada

NOTE:

Operation is subject to the following two conditions: (1) this device may not cause interference, and (2) this device must accept any interference, including interference that may cause undesired operation of the device.

■ When riding in an aircraft

When bringing a wireless remote control onto an aircraft, make sure you do not press any buttons on the wireless remote control while inside the aircraft cabin. If you are carrying a wireless remote control in your bag etc, ensure that the buttons are not likely to be pressed accidentally. Pressing a button may cause the wireless remote control to emit radio waves that could interfere with the operation of the aircraft.



NOTICE

■ To prevent wireless remote control damage

- Do not subject the wireless remote control to strong shocks, expose them to high temperatures by placing them in direct sunlight, or get them wet.
- Do not expose the wireless remote control to electromagnetic materials or attach any material that blocks electromagnetic waves to the wireless remote control surface.
- Do not disassemble the wireless remote control.

1-2. Opening, closing and locking the doors

Front doors

The vehicle can be locked and unlocked using the wireless remote control, key, door lock switch or inside lock button.

■ Wireless remote control

→P. 27

■ Key

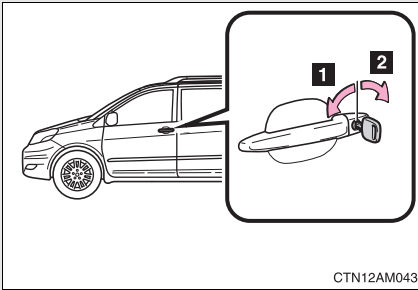

- 1** Locks the door
- 2** Unlocks the door

Turning the key unlocks the driver's door. Turning the key again within 3 seconds unlocks the other doors.

■ Door lock switch

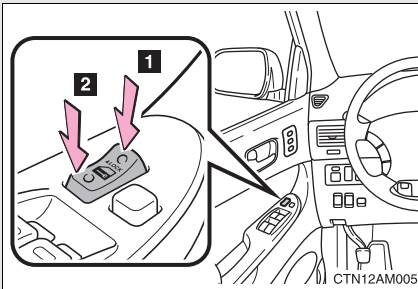

- 1** Locks all doors
- 2** Unlocks all doors

■ Inside lock button

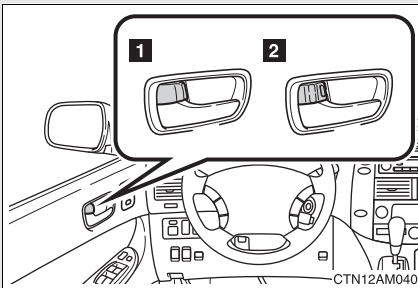

- 1** Locks the door
- 2** Unlocks the door

The front doors can be opened by pulling the inside handle even if the lock buttons are in the lock position.

Locking the front doors from the outside without the wireless remote control or key

STEP 1 Move the inside door lock button to the lock position.

STEP 2 Close the door.

The doors cannot be locked when the key is in the engine switch and either of the front door is open.

Automatic door locking and unlocking systems

The following functions can be set or cancelled:

Function	Operation
Shift position linked door locking function	Shifting the shift lever out of P locks all doors.
Shift position linked door unlocking function	Shifting the shift lever to P unlocks all doors.
Speed linked door locking function	All doors are locked when the vehicle speed is approximately 12 mph (20 km/h) or higher.
Driver's door linked door unlocking function	All doors are unlocked when the driver's door is opened within 10 seconds after turning the engine switch to "ACC" or "LOCK".

The shift position linked door locking function works when all doors are closed.

■ Setting and canceling the functions

To switch between set and canceled, follow the procedure below:

STEP 1 Close all the doors and turn the engine switch to the “ON” position. (Perform step 2 within 10 seconds.)

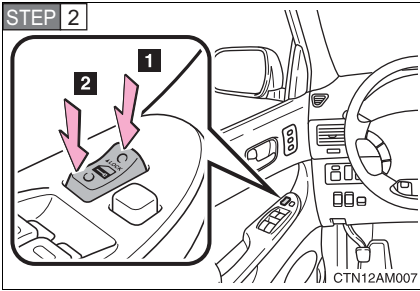

Shift the shift lever to P or N, and press and hold the driver's door lock switch (**1** or **2**) for approximately 5 seconds and then release.

The shift lever and switch positions corresponding to the desired function to be set are shown as follows.

Use the same procedure to cancel the function.

Function	Shift lever position	Door lock switch position
Shift position linked door locking function	P	1
Shift position linked door unlocking function		2
Speed linked door locking function	N	1
Driver's door linked door unlocking function		2

When the setting or canceling operation is complete, all doors are locked and then unlocked.

■ **When all the doors are locked with the wireless remote control or key**

The doors cannot be unlocked with the door lock switch.

The door lock switch can be reset by unlocking all the doors with the wireless remote control or key.

■ **Customization that can be configured at Toyota dealer**

Settings (e.g. unlocking function using a key) can be changed.

(Customizable features →P. 565)

 **CAUTION**

■ **To prevent an accident**

Observe the following precautions while driving the vehicle.

Failing to do so may result in a door opening and an occupant falling out, resulting in death or serious injury.

- Always use a seat belt.
- Always lock the doors.
- Ensure that all doors are properly closed.
- Do not pull the inside handle of the doors while driving.

The doors may be opened and the passengers are thrown out of the vehicle and it may result in serious injury or death.

Be especially careful for the front doors, the doors may be opened even if the inside lock buttons are in locked position.

1-2. Opening, closing and locking the doors

Sliding doors

► Vehicles without power sliding doors

The sliding doors can be opened and closed using the sliding door handle. The sliding door can be locked and unlocked using the inside lock knob or wireless remote control.

► Vehicles with power sliding doors

The power sliding doors can be opened and closed using the sliding door handle, power sliding door switches or wireless remote control. The power sliding doors can be locked and unlocked using the inside lock knob or wireless remote control.

■ Wireless remote control

→P. 27

■ Sliding door handle

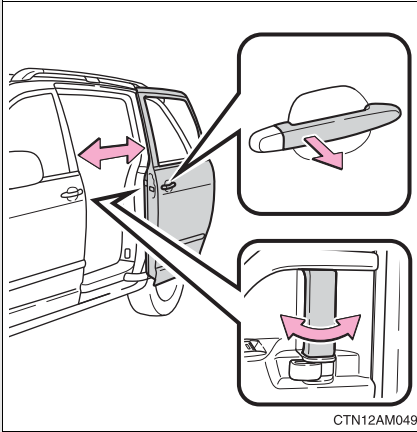

Open/close

Vehicles with power sliding doors: The sliding door will be automatically and completely opened and closed by the following.

- Pull the outside handle.
- Slide the inside handle forward to open or backward to close.

■ Inside lock knobs

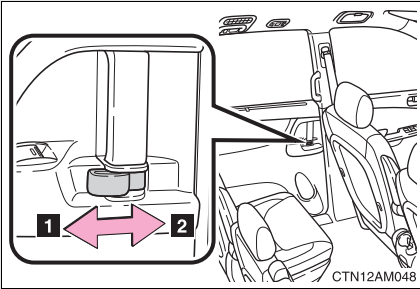

1 Unlocks

2 Locks

■ Power sliding door switches (vehicles with power sliding doors)

► From front seats (type A)

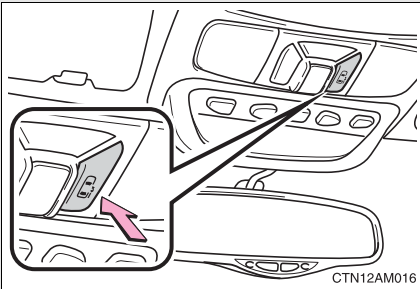

Push and hold the switch to open and close the right side sliding door.

► From front seats (type B)

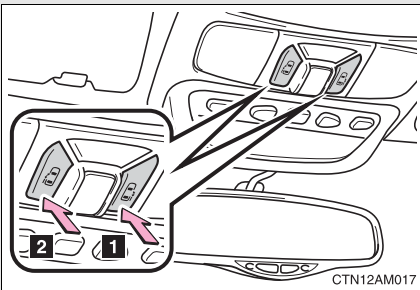

Push and hold the switch to open and close the following door.

1 The right side sliding door

2 The left side sliding door

► From rear seats

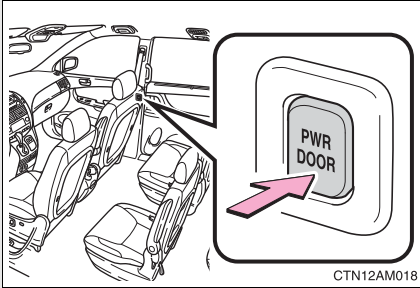

Push the switch to open and close each sliding door.

Canceling the power sliding door system (if equipped)

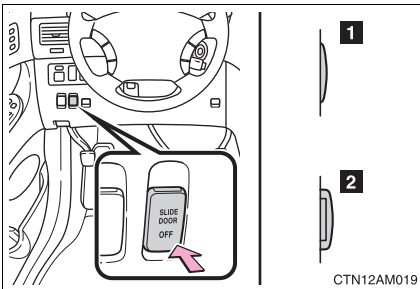

Turn the main switch off to disable the power sliding door system.

1 Off

The sliding doors can be opened and closed manually.

2 On

The power sliding door can be opened and closed with the power sliding door switches for the front occupants or wireless remote control even if the sliding door child-protectors are locked.

Locking the sliding doors from the outside without the wireless remote control

STEP 1 Move the inside lock knob to the lock position.

STEP 2 Close the sliding door.

Sliding door child-protector locks

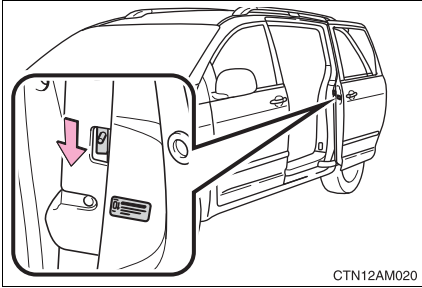

The sliding door cannot be opened from inside the vehicle when the child-protector lock is set.

These locks can be set to prevent children from opening the sliding doors. Push down on each sliding door switch to lock both sliding doors.

■ The power sliding door can be operated when (vehicles with power sliding doors)

- The engine switch is in the “ON” position and the shift lever is in P.
- The power sliding door is unlocked.
- The sliding door child-protector lock is not set. (However, the switch for the front occupants still operates the power sliding door.)

■ The situations in which the sliding door does not open completely

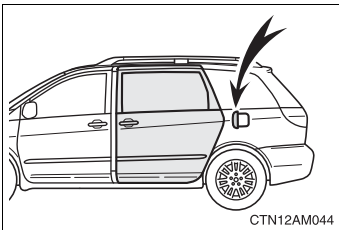

The left side sliding door (if equipped) does not open when the fuel filler door is opened.

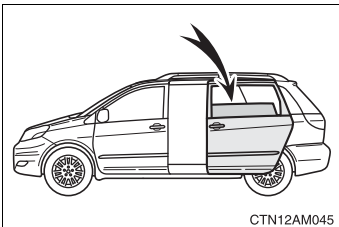

The sliding door will stop at half-opened position when the sliding door window is opened more than approximately 6 in. (15 cm).

■ When the power sliding door system is on (vehicles with power sliding doors)

A buzzer sounds if you put the shift lever out of P with the engine switch in the "ON" position and the sliding door not completely closed.

■ Jam protection function (vehicles with power sliding doors)

- If anything obstructs the power sliding door while it is closing or opening, the power sliding door will automatically operate in the opposite direction.
- If the jam protection function operates during two consecutive closing operations, the power sliding door will be stopped at that position and the power sliding door system will be canceled.

■ Sliding door closer (if equipped)

In the event that the sliding door is left slightly open, the sliding door closer will automatically close it to the fully closed position.

■ When the battery is disconnected (vehicles with power sliding doors)

The power sliding door system must be initialized in order to ensure proper operation. To initialize it, close the sliding doors completely by hand.

■ Customization that can be configured at Toyota dealer

Settings (e.g. opening and closing operation) can be changed.
(Customizable features →P. 565)

 CAUTION

■ **Caution while driving**

Observe the following precautions while driving.

Failure to do so may cause a door to open unexpectedly and an occupant to fall out of the vehicle, resulting in death or serious injury.

- Always use a seat belt.
- Always lock the doors.
- Ensure that all doors are properly closed.
- Do not slide the inside handle of the doors while driving.
- Set the sliding door child protector locks when children are seated in the vehicle.

■ **When children are in the vehicle**

Observe the following precautions.

Failure to do so may result in death or serious injury.

- Do not leave children alone in the vehicle.
If a child is accidentally locked in the vehicle, they could overheat.
- Do not allow a child to open or close the sliding door.
Doing so may cause the sliding door to operate unexpectedly, or cause the child's hands, head, or neck to be caught by the closing sliding door.

! CAUTION**■ Operating the sliding doors**

Observe the following precautions.

Failure to do so may cause parts of the body to be caught, resulting in serious injury.

- When opening or closing a sliding door, thoroughly check to make sure the surrounding area is safe.
- If anyone is in the vicinity, make sure they are safe and let them know that the sliding door is about to open or close.
- Do not leave the sliding door at half-opened position because the sliding door is not latched at this position. If the vehicle is stopped on a downward slope, the sliding door may move and cause an unexpected injury.

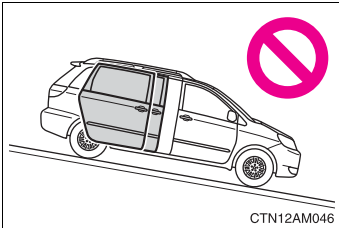

- When the vehicle is stopped on a slope, the door will slide faster when opening or closing, so be especially careful that the passengers do not get hit or pinched by the door.

- When stopping on a downward slope, open the door fully while passengers are getting on or off. Do not pull the outside handle or inside handle while the door is open as the door could suddenly close by itself causing injury.

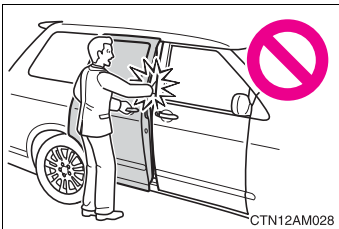

- When closing the sliding door, take extra care to prevent your fingers etc. from being caught.

! CAUTION

■ Sliding door closer (if equipped)

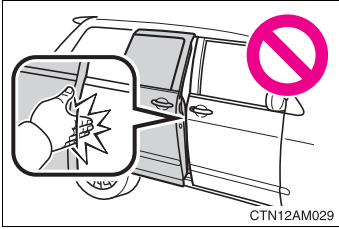

- In the event that the sliding door is left slightly open, the sliding door closer will automatically close it to the fully closed position. It takes several seconds before the sliding door closer begins to operate. Be careful not to catch fingers or anything else in the sliding door, as this may cause bone fractures or other serious injuries.

- Use caution when using the sliding door closer. The sliding door closer still operates when the power sliding door system is canceled.

■ Power sliding doors (vehicles with power sliding doors)

Observe the following precautions when the power sliding door system is on. Failure to do so may cause serious injury.

- Check the safety of the surrounding area to make sure there are no obstacles or anything that could cause any of your belongings to get caught.
- If anyone is in the vicinity, make sure they are safe and let them know that the sliding door is about to open or close.
- If the power sliding door switch is pressed while the sliding door is opening during automatic operation, the sliding door stops opening. Take extra care when on an incline, as the sliding door may open or close suddenly.
- Do not leave the sliding door at half-opened position because the door will unlock after 30 minutes. If the vehicle is stopped on a downward slope, the sliding door may move and cause an unexpected injury.

 **CAUTION**

- In the following situations, the power sliding door may detect an abnormality and automatic operation may be stopped. In this case, the sliding door has to be operated manually. Take extra care in this situation, as the stopped sliding door may suddenly close, causing an accident.
 - When the sliding door contacts an obstacle
 - When the battery voltage suddenly drops, such as when the engine switch is turned to the “ON” position or the engine is started during automatic operation
- Do not attach any accessories other than genuine Toyota parts to the power sliding door. The power sliding door may not operate, causing itself to malfunction, or the power sliding door may close again after it is opened.
- In cases such as when replacing tires, make sure to turn off the power sliding door main switch. Failure to do so may cause the sliding door to operate unintentionally if the power sliding door switch is accidentally touched, resulting in hands and fingers being caught and injured.
- When the child-protector locks are set, make sure to turn off the power sliding door system with the main switch in order to totally disable the system.

■ Jam protection function (vehicles with power sliding doors)

Observe the following precautions.

Failure to do so may cause serious injury.

- Never use any part of your body to intentionally activate the jam protection function.
- The jam protection function may not work if something gets caught just before the power sliding door fully closes. Be careful not to catch fingers or anything else.

 NOTICE

■ **To prevent damage to your vehicle**

- Do not apply excessive force when the sliding door closer (if equipped) is operating.
- Make sure there is nothing in the doorway before closing.
- Do not close the sliding door by applying the brakes. Doing so could cause the sliding door to be damaged.
- Avoid forcibly opening the left side sliding door (if equipped) fully when the fuel filler door is opened. Otherwise, the fuel filler door may be damaged.

■ **To prevent battery discharge (vehicles with power sliding doors)**

Do not leave the power sliding door at half-opened position while the power sliding door system is on.

1-2. Opening, closing and locking the doors

Back door

▶ Vehicles without power back door

The back door can be opened using the back door opener. The back door can be locked and unlocked using the wireless remote control or door lock switch.

▶ Vehicles with power back door

The power back door can be opened and closed using the power back door switch or wireless remote control. The back door can be locked and unlocked using the wireless remote control or door lock switch.

■ Back door opener

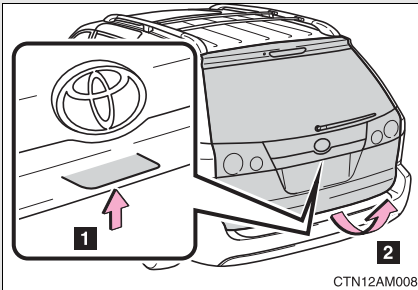

1 Push up

2 Raise

■ Power back door switch (vehicles with power back door)

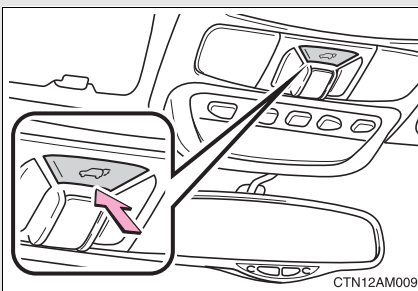

Open (press and hold)/close

Pressing the switch again while the power back door is operating will reverse the operation.

As the power back door starts to open or close automatically, two beeps sound and the turn signal lights flash twice.

■ **Wireless remote control (vehicles with power back door)**

→P. 27

Canceling the power back door system (vehicles with power back door)

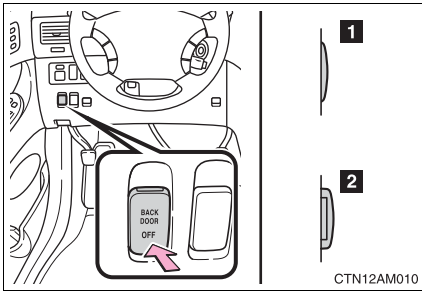

Turn the main switch off to disable the power back door system.

- 1** Off
- 2** On

■ **Back door strap**

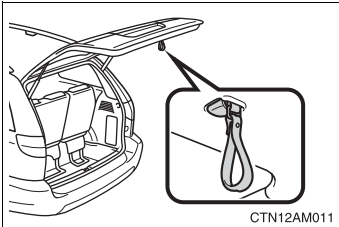

Use the strap when closing the back door.

■ **If the back door opener is inoperative**

The back door can be operated from the inside.

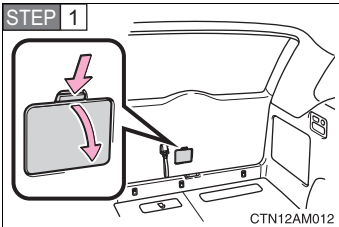

Remove the cover.

▶ **Vehicles without power back door**

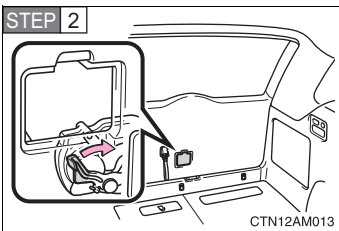

Pull the lever.

▶ **Vehicles with power back door**

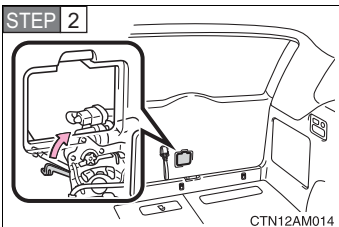

Pull the lever.

■ **The power back door can be operated when (vehicles with power back door)**

- The engine switch is in the “ON” position and the shift lever is in P.
- The back door is unlocked.

■ **Jam protection function (vehicles with power back door)**

- If anything obstructs the power back door while it is closing or opening, the back door will automatically operate in the opposite direction.
- If the jam protection function operates during two consecutive closing operations, the back door will be stopped at that position.

■ **Back door closer (if equipped)**

In the event that the back door is left slightly open, the back door closer will automatically close it to the fully closed position.

■ **Assist operation (vehicles with power back door)**

If the back door is closed approximately 4 - 6 in. (10 - 15 cm) from its fully-opened position with the power back door main switch on, the back door closer will automatically close it to the fully closed position. If the door is closed slowly, assist operation may not be performed.

■ **When the battery is disconnected**

- The back door will be automatically locked after the battery is reconnected.
- The power back door (if equipped) must be initialized in order to ensure proper operation.

STEP 1 Unlock the back door with the wireless remote control or door lock switch.

STEP 2 Close the back door completely by hand.

 **CAUTION****■ Caution while driving**

- Keep the back door closed while driving.

If the back door is left open, it may hit near-by objects while driving or luggage may be unexpectedly thrown out, causing an accident.

In addition, exhaust gases may enter the vehicle, causing death or a serious health hazard. Make sure to close the back door before driving.

- Before driving the vehicle, make sure that the back door is fully closed. If the back door is not fully closed, it may open unexpectedly while driving, causing an accident.
- Never let anyone sit in the luggage compartment. In the event of sudden braking or a collision, they are susceptible to death or serious injury.

■ When children are in the vehicle

Observe the following precautions.

Failure to do so may result in death or serious injury.

- Do not leave children alone in the luggage compartment.

If a child is accidentally locked in the luggage compartment, they could overheat.

- Do not allow a child to open or close the back door.

Doing so may cause the back door to operate unexpectedly, or cause the child's hands, head, or neck to be caught by the closing back door.

! CAUTION

■ Operating the back door

Observe the following precautions.

Failure to do so may cause parts of the body to be caught, resulting in serious injury.

- When opening or closing the back door, thoroughly check to make sure the surrounding area is safe.
- If anyone is in the vicinity, make sure they are safe and let them know that the back door is about to open or close.
- Use caution when opening or closing the back door in windy weather as it may move abruptly in strong wind.

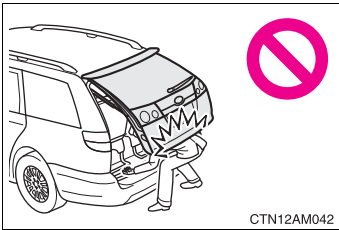

- The back door may fall if it is not opened fully. It is more difficult to open or close the back door on an incline than on a level surface, so beware of the back door unexpectedly opening or closing by itself. Make sure that the back door is fully open and secure before using the luggage compartment.

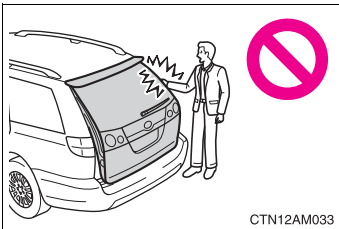

- When closing the back door, take extra care to prevent your fingers etc. from being caught.
- When closing the back door, make sure to press it lightly on its outer surface. If the back door strap is used to fully close the back door, it may result in hands or arms being caught.

- Do not pull on the back door damper stay to close the back door, and do not hang on the back door damper stay. Doing so may cause hands to be caught or the back door damper stay to break, causing an accident.
- Do not attach any accessories other than genuine Toyota parts to the back door. Such additional weight on the back door may cause the back door to fall closed again after it is opened.

! CAUTION

■ Back door closer (if equipped)

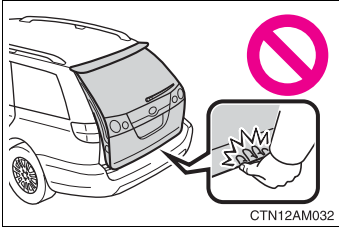

- In the event that the back door is left slightly open, the back door closer will automatically close it to the fully closed position. It takes several seconds before the back door closer begins to operate. Be careful not to catch fingers or anything else in the back door, as this may cause bone fractures or other serious injuries.

- Use caution when using the back door closer as it still operates when the power back door system is canceled.

■ Power back door

Observe the following precautions when operating the power back door. Failure to do so may cause serious injury.

- Check the safety of the surrounding area to make sure there are no obstacles or anything that could cause any of your belongings to get caught.
- If anyone is in the vicinity, make sure they are safe and let them know that the back door is about to open or close.

 CAUTION

- In the following situations, the power back door may detect an abnormality and automatic operation may be stopped. In this case, the back door has to be operated manually. Take extra care in this situation, as the stopped back door may suddenly fall, causing an accident.
 - When the back door contacts an obstacle
 - When the battery voltage suddenly drops, such as when the engine switch is turned to the “ON” position or the engine is started during automatic operation
- Do not attach any accessories other than genuine Toyota parts to the back door. The power back door may not operate, causing itself to malfunction, or the back door may fall closed again after it is opened.
- In cases such as when replacing tires, make sure to turn off the power back door main switch. Failure to do so may cause the back door to operate unintentionally if the power back door switch is accidentally touched, resulting in hands and fingers being caught and injured.

■ **Jam protection function (vehicles with power back door)**

Observe the following precautions.

Failure to do so may cause serious injury.

- Although the back door stops closing when the jam protection function detects an object, take extra care as you may still be injured if part of your body is already caught.
- Never use any part of your body to intentionally activate the jam protection function.
- The jam protection function may not work if something gets caught just before the back door fully closes. Be careful not to catch fingers or anything else.
- Sensors installed on the right and left edges of the power back door detect an object to prevent it from being caught. Depending on its shape, however, the sensors may not detect the object.
When opening or closing the back door, take extra care to prevent your fingers etc. from being caught.

 NOTICE

■ **To prevent damage to the back door components**

- Do not apply any force, paint or let any other foreign matter on the damper.
- Do not apply excessive force when the back door closer is operating.
- Make sure there is nothing in the doorway before closing.

1-3. Adjustable components (seats, mirrors, steering wheel)

Front seats

► Manual seat

Passenger's seat

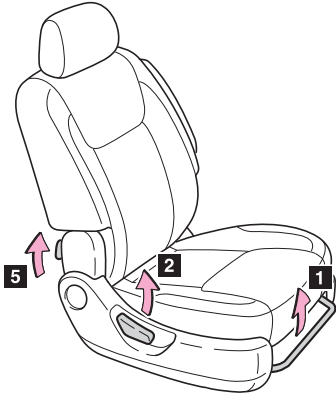

Driver's seat

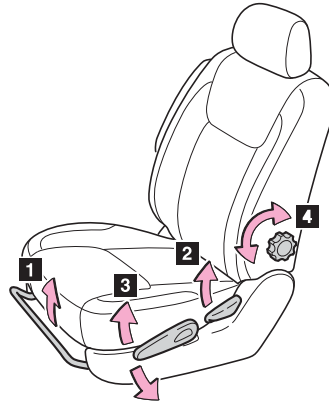

CTN13AM104

- 1** Seat position adjustment lever
- 2** Seatback angle adjustment lever
- 3** Vertical height adjustment lever
- 4** Lumbar support adjustment knob
- 5** Seatback folding lever (if equipped)

► Power seat

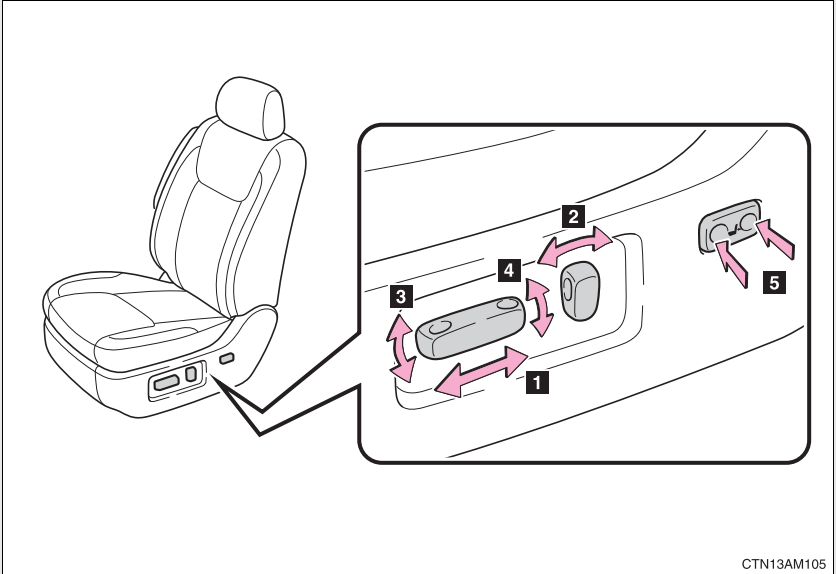

- 1 Seat position adjustment switch
- 2 Seatback angle adjustment switch
- 3 Seat cushion (front) angle adjustment switch (driver's side only)
- 4 Vertical height adjustment switch (driver's side only)
- 5 Lumbar support switch (driver's side only)

■ Seatback table (if equipped on manual seat)

The folded seat can be used as a temporary table. (→P. 397)

 CAUTION

■ **Seat adjustment**

- Be careful that the seat does not hit passengers or luggage.
- Do not recline the seat more than necessary when the vehicle is in motion to reduce the risk of sliding under the lap belt.
If the seat is too reclined, the lap belt may slide past the hips and apply restraint forces directly to the abdomen or your neck may contact the shoulder belt, increasing the risk of death or serious injury in the event of an accident.
- Manual seat: After adjusting the seat, make sure that the seat is locked in position.

1-3. Adjustable components (seats, mirrors, steering wheel)

Second seats

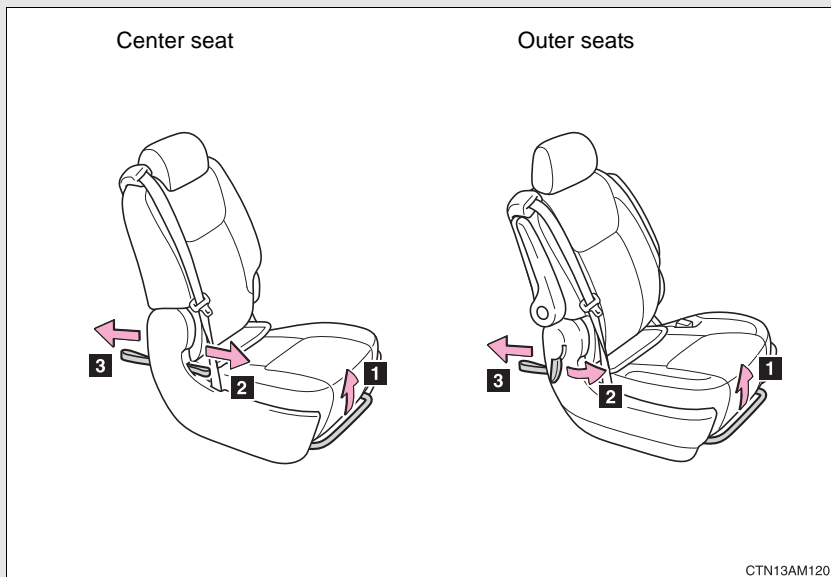

- 1** Seat position adjustment lever
- 2** Seatback angle adjustment lever/strap (from front)
The seatback can be folded down by this lever/strap.
- 3** Seatback angle adjustment strap (from rear)
The seatback can be folded down by this strap.

■ **Tumbling the seat for third seat entry**

The second seats can be tumbled for access to the third seat.
(To tumble the seats: →P. 63)

■ **Seatback table**

The folded seats can be used as a temporary table. (→P. 397)

 CAUTION

■ **Seat adjustment**

- Be careful that the seat does not hit passengers or luggage.
- Do not recline the seat more than necessary when the vehicle is in motion to reduce the risk of sliding under the lap belt.
If the seat is too reclined, the lap belt may slide past the hips and apply restraint forces directly to the abdomen or your neck may contact the shoulder belt, increasing the risk of death or serious injury in the event of an accident.
- After adjusting the seat, make sure that the seat is locked in position.

■ **After access to the third seat**

Return the seat and make sure that the seat is locked in position.

Third seats

► Manual seat

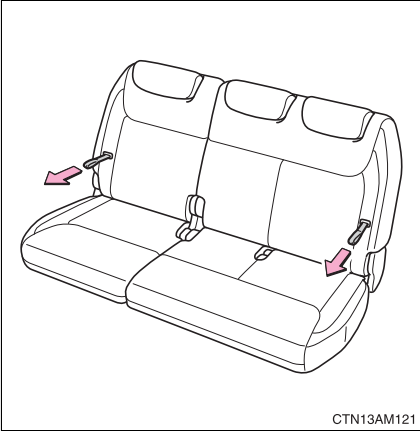

Seatback angle adjustment strap

► Power seat

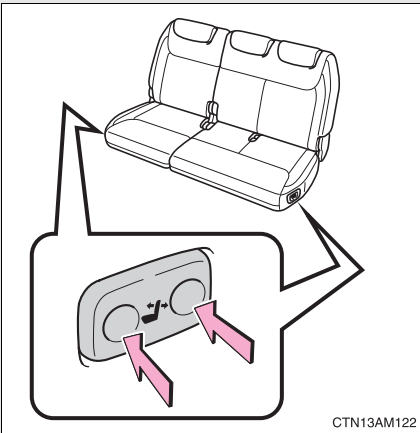

Seatback angle adjustment switch

 CAUTION

■ **Seat adjustment**

- Be careful that the seat does not hit passengers or luggage.
- Do not recline the seat more than necessary when the vehicle is in motion to reduce the risk of sliding under the lap belt.
If the seat is too reclined, the lap belt may slide past the hips and apply restraint forces directly to the abdomen or your neck may contact the shoulder belt, increasing the risk of death or serious injury in the event of an accident.
- Align both seatbacks at the same angle when a person sits in the center position.
- Manual seat: After adjusting the seat, make sure that the seat is locked in position.

1-3. Adjustable components (seats, mirrors, steering wheel)

Seating configurations

Tumbling the second seats

■ Before tumbling the second seats

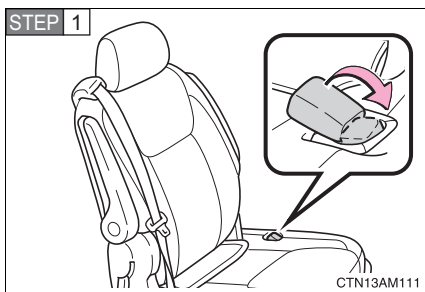

Stow the seat belt buckles.

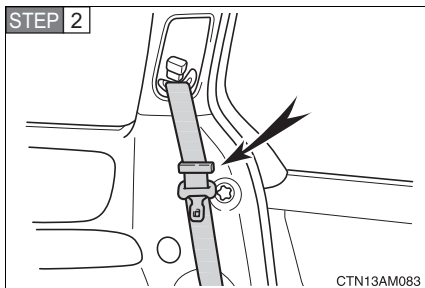

Outer seats: Use the seat belt hangers to prevent the belts from being tangled.

■ Tumbling the second seats

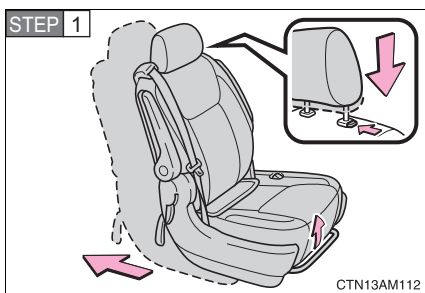

Lower the head restraints to the lowest position and slide the seat to the rear-most lock position.

1-3. Adjustable components (seats, mirrors, steering wheel)

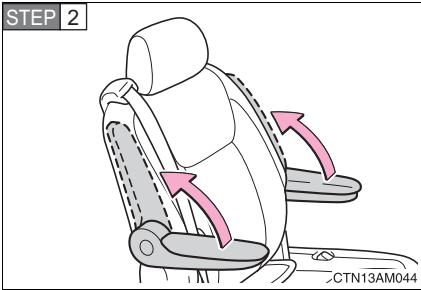

7-passenger models: Pull the armrests up.

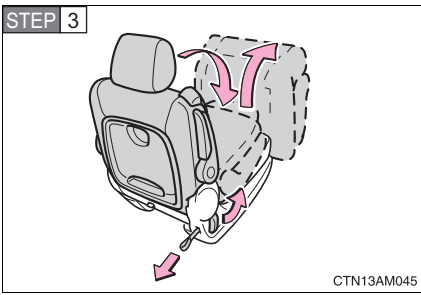

Outer seats: Fold down the seatback while pulling the seatback angle adjustment lever or strap and swing up the seat.

If the front seat is in the way, adjust it so it will not interfere.

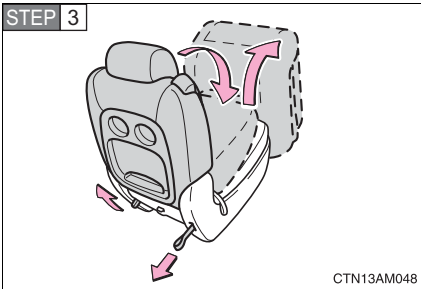

Center seat: Fold down the seatback while pulling the seatback angle adjustment strap.

Pull up the seat lock release lever (red) and swing up the seat.

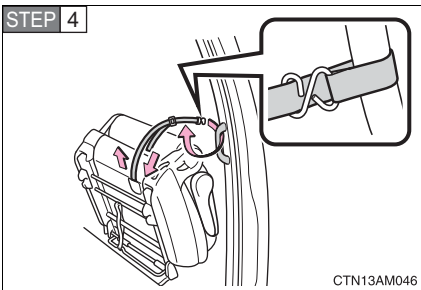

Take the holding strap out of the pocket.

Pass the strap through the assist grip, and hook it.

To secure the seat, pull the strap until it is taut.

Removing the second seats

The seats can be removed after tumbling the second seats.

■ Before removing the second seats

Tumble the second seats. (→P. 63)

■ Removing the second seats

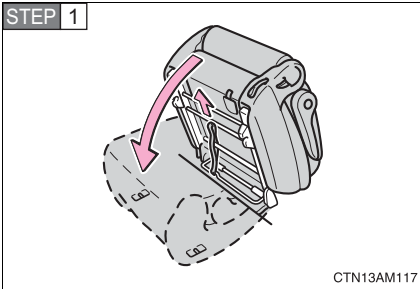

Pull and hold the front leg release strap and fold down the seat.

STEP 2 The front leg locks will disengage and remove the seat.

Installing the second seats

When you install the second seats, be sure to place them where the seats are originally positioned because the second seats are not interchangeable.

► Outer seats

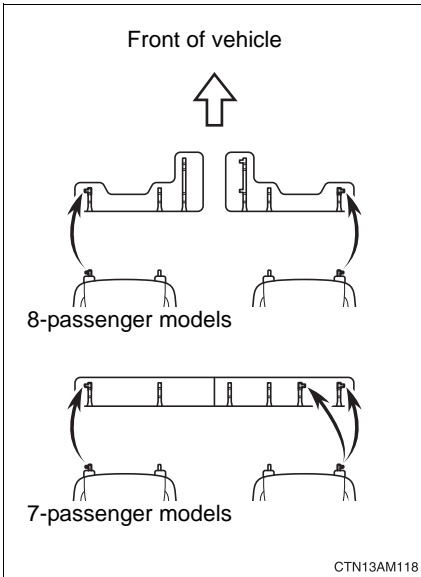

You can distinguish the original seat position by the position of the front leg pins and the shape of the seat striker bezels in the floor.

► Center seat (8-passenger models)

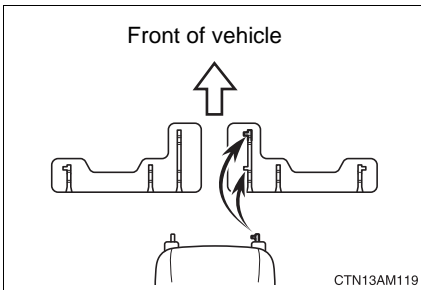

■ Installing the second seats

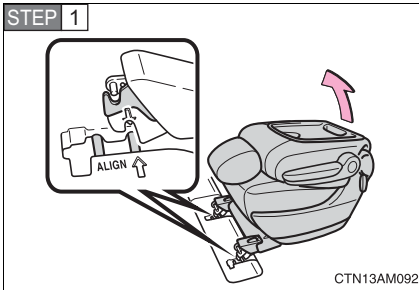

Align the front leg hooks with the rear strikers, then swing up the seat.

Make sure the front legs align with the strikers before swinging up the seat.

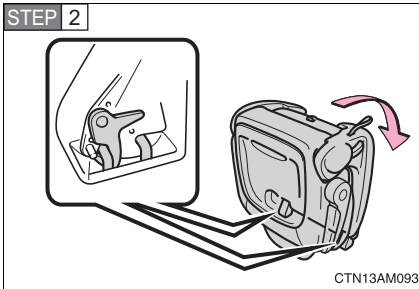

Fold down the seat and engage the rear leg locks.

Make sure the front legs are locked securely.

If you locked the rear legs unintentionally before the front legs are locked securely, do the following:

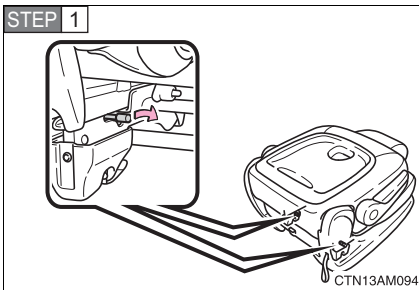

Outer seats: Disengage the rear leg locks by pushing the pins (red) inside each rear leg.

1-3. Adjustable components (seats, mirrors, steering wheel)

STEP 1

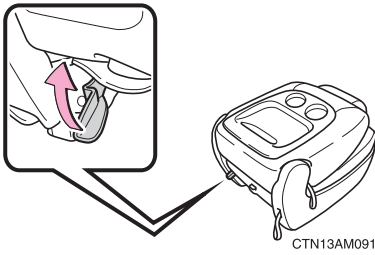

Center seat: Disengage the rear leg locks by pulling the rear leg release lever.

STEP 2 Reinstall the seat following the correct procedure.

■ Changing the installed position

► Outer seat (7-passenger models)

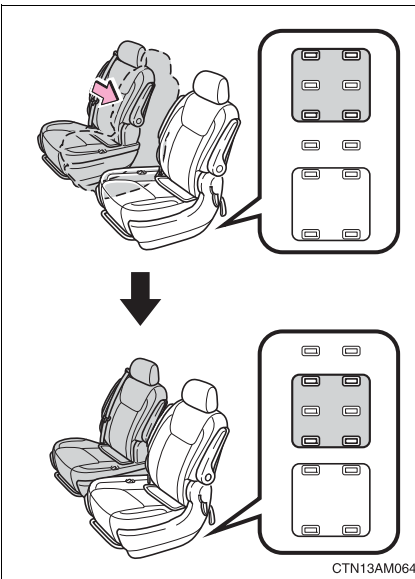

The right side second seat can be moved to the inside when the console box (if equipped) is not installed between the second seats.

► Center seat (8-passenger models)

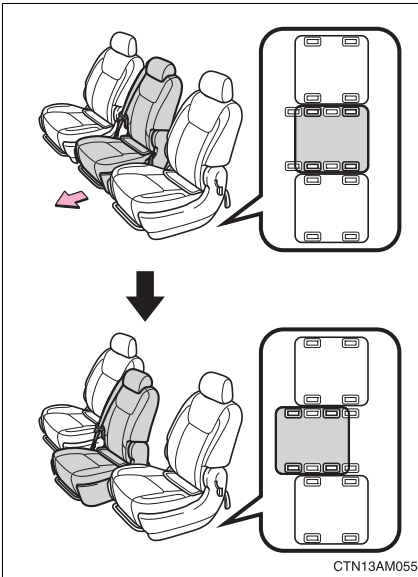

The second center seat can be used in the forward position.

To use the second center seat in the forward position, install it according to the following procedure:

STEP 1 Slide the front seats forward and stand the seatbacks in the upright position.

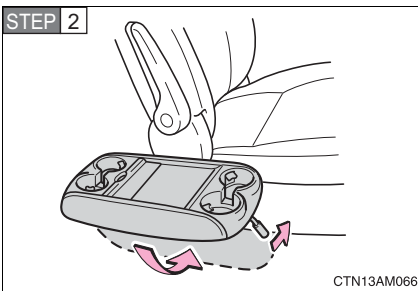

Fold the front seat side table (if equipped) down.

STEP 3 Remove the second center seat from the normal position. (→P. 65)

1-3. Adjustable components (seats, mirrors, steering wheel)

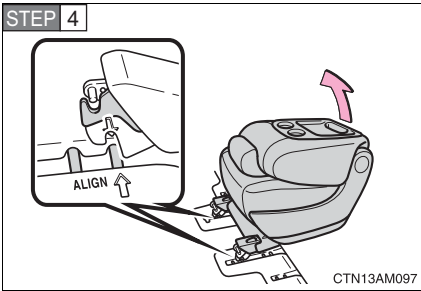

Align the front leg hooks with the rear strikers of the foremost pair. Then swing up the seat.

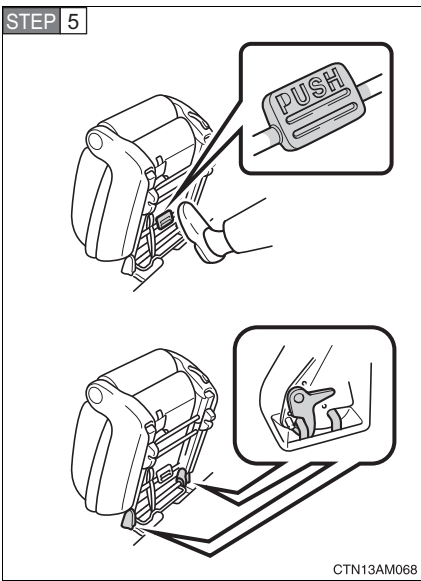

Push the foot pedal forward to securely latch the front leg locks.

Make sure the front legs are locked securely, fold down the seat and engage the rear leg locks.

Folding the third seats (manual seats)

■ Before folding the third seats

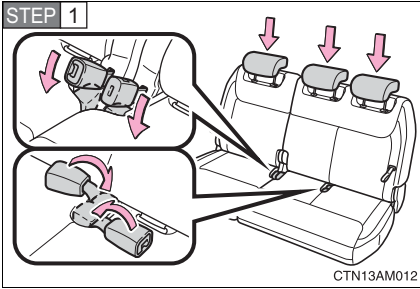

Lower the head restraints to the lowest position and stow the seat belt buckles.

STEP 2 Stow the center seat belt. (→P. 87)

■ Folding the third seats

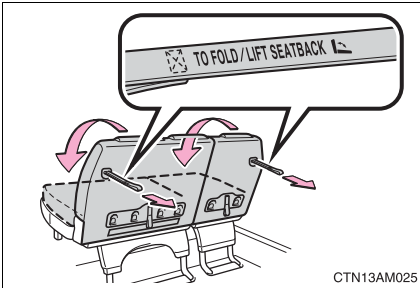

Pull the "TO FOLD/LIFT SEATBACK" strap and fold down the seatback.

■ Raising the third seats

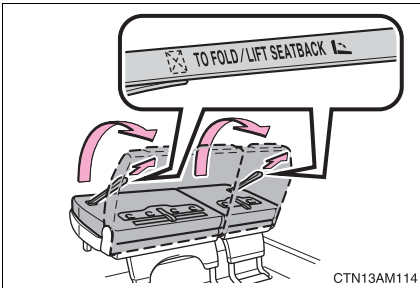

Pull the "TO FOLD/LIFT SEATBACK" strap and raise the seatback.

Folding the third seats (power seats)

You can operate the power third seats when the engine switch is in the “ACC” or “LOCK” position, and/or the shift lever is in P.

■ Before folding the third seats

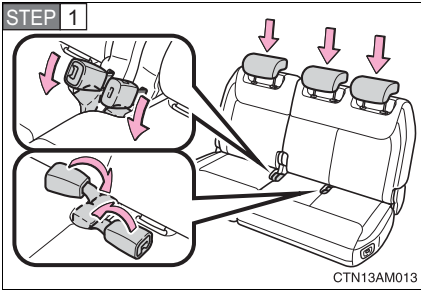

Lower the head restraints to the lowest position and stow the seat belt buckles.

STEP 2 Stow the center seat belt. (→P. 87)

■ Folding the third seats

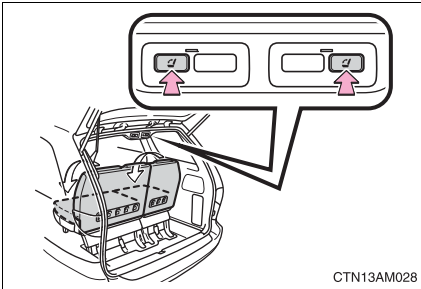

Press the folding/returning switch.

■ Raising the third seats

Press the folding/returning switch, returning switch (→P. 76) or seatback angle adjustment switch (→P. 61).

Stowing the third seats (manual seats)

■ Before stowing the third seats

Fold down the seatbacks. (→P. 71)

■ Stowing the third seats

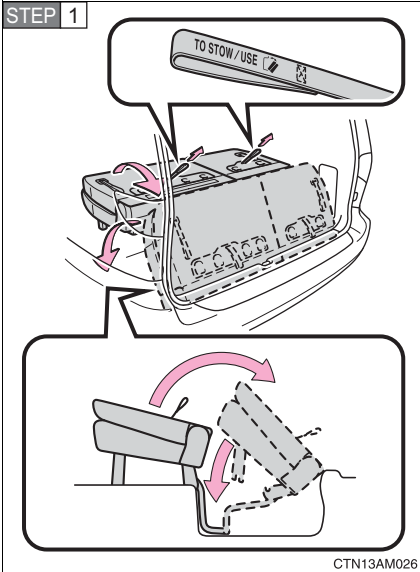

Pull and hold the “TO STOW/USE” strap and lift up the seat rearward. Then push the seat down.

If the seat does not lift up when the “TO STOW/USE” strap is pulled, lift the seatback by pulling on the “TO FOLD/LIFT SEAT-BACK” strap. Then push the seatback down again.

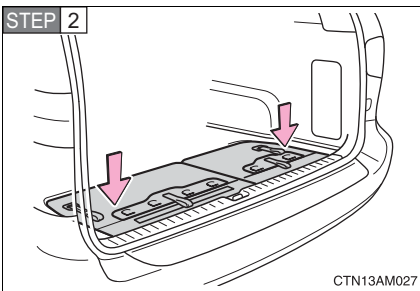

Push the seat against the floor and make sure it is locked securely.

■ Returning the third seats

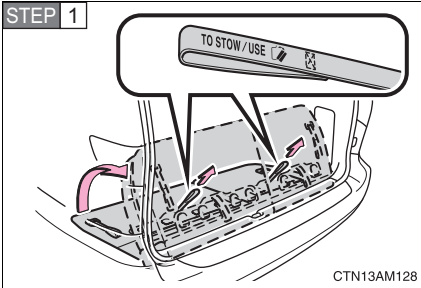

Pull and hold the “TO STOW/USE” strap and lift up the seat rearward.

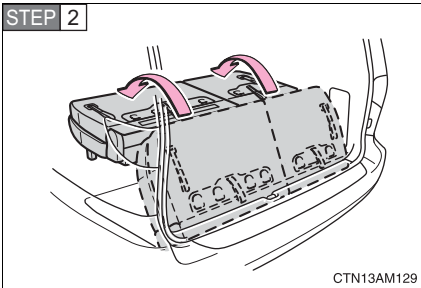

Push the seat forward and then engage the front leg locks.

Make sure the front legs are locked securely.

STEP 3 Raise the seatback. (→P. 71)

Stowing the third seats (power seats)

You can operate the power third seats when the engine switch is in the “ACC” or “LOCK” position, and/or the shift lever is in P.

■ **Before stowing the third seats**

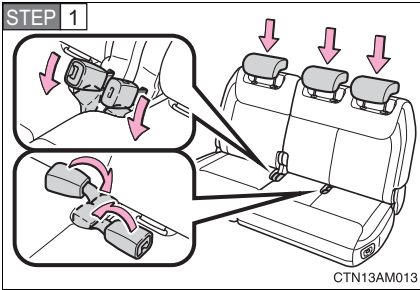

Lower the head restraints to the lowest position and stow the seat belt buckles.

STEP 2 Stow the center seat belt. (→P. 87)

■ **Stowing the third seats**

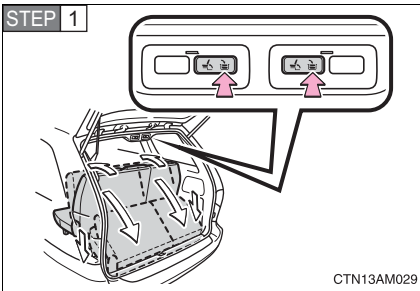

Push and hold the stowing switch.

A beep sounds twice to indicate the start of the operation. The beep sounds again twice when the operation is completed.

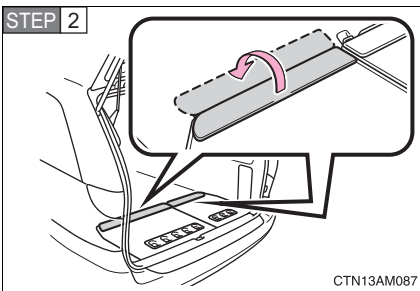

Open the flaps.

■ Returning the third seats

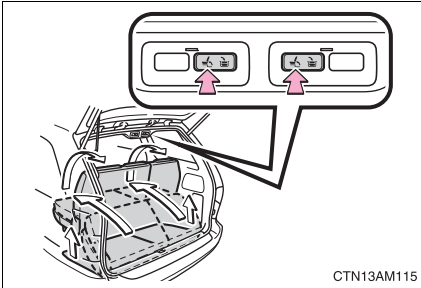

Push and hold the returning switch until the seat cushion is locked.

A beep sounds twice to indicate the start of the operation. The beep sounds again twice when operation is completed.

■ When returning the tumbled second seat

Once the seat is moved from the tumbled position to the folded-down position, it cannot be directly returned to the tumbled position again. Raise the seatback once if it is folded.

■ Power third seat

- If the indicator light above the switches flashes three times when the folding/returning switch is pushed, the folding operation will not start. Make sure the engine switch is in the “LOCK” or “ACC” position and/or the automatic transmission shift lever is in P.
- If any of the following conditions occur while the seat is operating, the seat operation will stop. The indicator light above the switches will flash three times and a beep will sound for about 10 seconds:
 - An object is caught between the seatback and seat cushion.
 - The stowing switch is released.
 - Other power third seat switch is pushed while operating the stowing switch.
 - The shift lever is moved from P when the engine switch is in the “ON” position.
 - The engine switch is turned to the “ON” position when the shift lever is in N.

If the engine is started during operating, the seat operation may also be stopped.

To continue the folding operation, the seatback must be returned to its original position first.

■ “3RD SEAT” warning light (power third seat)

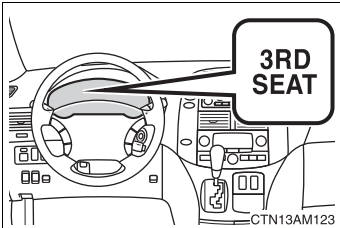

The warning light comes on if the third seat operation is not yet complete when the engine switch is in the “ON” position.

⚠ CAUTION

■ When seats are moved

Observe the following precautions.

Failure to do so may result in death or serious injuries.

- When seats are to be moved, stop the vehicle on level ground, set the parking brake and put the shift lever in P.
- Do not fold, adjust or otherwise move the seats while the vehicle is moving.
- When a seat is folded, adjusted, moved or removed, be careful that it does not hit passengers or luggage.
- Be careful not to get your hands or feet pinched by any part of a seat.
- After a seat is folded, adjusted, moved or reinstalled, push it forward and backward to make sure that it is properly locked in position.
- When returning or installing a seat, make sure the seat belts are not twisted or caught in the seat.
- The seat belts for the second seats must be removed from their hangers when the seat belts are in use.

■ Folding seats

- Do not sit on a folded seatback.
- Do not use a seat as a temporary table while the vehicle is moving.
- When a seat is used as a temporary table, make sure the seat is securely locked in position.

 CAUTION

■ **Tumbling the second seats**

- In order to prevent personal injury in a collision or sudden stop, do not allow passengers to sit in the third seats when a second seat is tumbled.
- When tumbling the second seats, fix the seats securely by adjusting the length of the seat's holding strap.
- Do not attach the holding strap to anything other than the assist grip to hold the second seat.
- The holding strap must be stowed into the pocket when it is not in use.

■ **Removing the second seats**

- Do not leave a seat in the vehicle if it has been disengaged from the floor.
- Do not sit on or place anything on a seat that has been removed from the vehicle.

■ **Stowing the third seats**

- Make sure that the seat path is clear before moving the seat. Otherwise, injury may result from contact with, or by being pinched by parts of the seat.
- Manual third seats: Do not sit on the third seat when it is in the stowed position with the seatback upright.
- Power third seats: Do not continue the stowing operation when the indicator above the stowing switch and returning switch comes on or flashes. An object or a person may be caught in the seat.
- Power third seats: During the stowing operation, to prevent the vehicle from moving, do not shift the shift lever out of P with the engine switch in the "ON" position.

 NOTICE**■ To prevent damage to the seat**

- Avoid putting heavy loads on a folded seat that is being used as a temporary table.
- Before folding a second seat as preparation for removal or tumbling the seat, the seat belt buckles must be stowed.
- Do not sit on or put heavy loads on a second seat that has been removed from the vehicle. The metal tips of the seat leg may be damaged, preventing reinstallation of the seat.
- The second seats must be reinstalled in their original positions. If they are installed in the wrong position, the seat locks or bezels will be damaged.
- When installing a second seat, make sure to align the front leg hooks with the rearmost of the two bars in each of the front strikers in the floor. If you align the legs with the front strikers, the bezel in the floor will be damaged.
- Do not use the seat position adjustment lever to lift or carry a seat that has been disengaged from the floor or removed from the vehicle. Otherwise, during reinstallation, part of the seat may slide preventing proper reinstallation of the seat. If this happens, return the seat to the rearmost position before reinstalling it.
- Make sure that the path the seat will move through is clear before stowing or returning the third seat.

1-3. Adjustable components (seats, mirrors, steering wheel) Driving position memory (if equipped)

Your preferred driving position (the position of the driver's seat and outside rear view mirrors) can be memorized and recalled with the touch of a button.

Two different driving positions can be entered into memory.

■ Entering a position to memory

Check that the shift lever is set in P.

STEP 1 Turn the engine switch to the "ON" position.

STEP 2 Adjust the driver's seat and outside rear view mirrors to the desired positions.

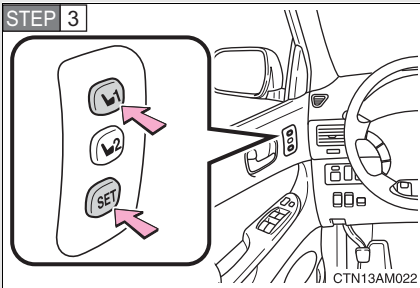

While pushing the "SET" button, push button "1" or "2" until the signal beeps.

If the selected button has already been preset, the previously recorded position will be overwritten.

■ Recalling the memorized position

Check that the shift lever is set in P.

STEP 1 Turn the engine switch to the "ON" position.

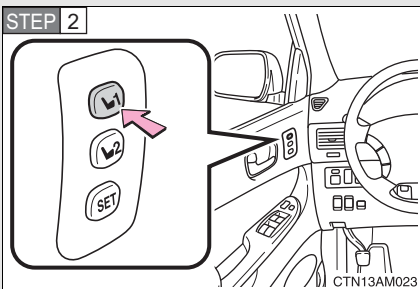

Push button "1" or "2" to recall the memorized position.

■ **Operating the driving position memory after turning the engine switch to the “LOCK” position**

Memorized positions can be activated up to 30 seconds after the driver's door is opened, even after turning the engine switch to the “LOCK” position.

■ **To cancel memorized position recall**

Perform any of the following operations.

- Push the “SET” button.
- Push button “1” or “2”.
- Adjust the seat using the switches (using the switches only cancels seat position recall).

■ **If the battery is disconnected**

The memorized positions are erased when the battery is disconnected.

 **CAUTION**

■ **Seat adjustment caution**

Take care during seat adjustment that the seat does not strike the rear passenger or squeeze your body against the steering wheel.

1-3. Adjustable components (seats, mirrors, steering wheel)

Head restraints

Head restraints are provided for all seats.

► Front seats

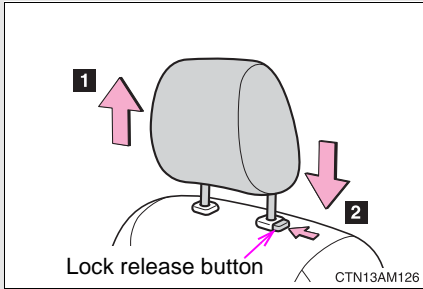

Vertical adjustment

1 Up

Pull the head restraints up.

2 Down

Push the head restraint down while pushing the lock release button.

► Second seats

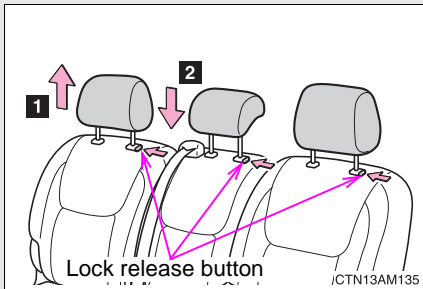

Vertical adjustment

1 Up

Pull the head restraints up.

2 Down

Push the head restraint down while pushing the lock release button.

► Third seats

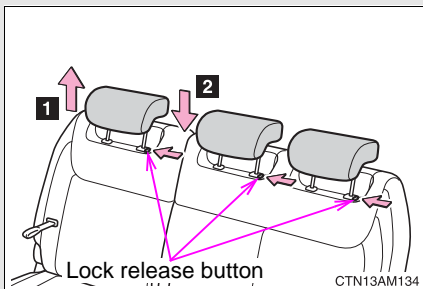

Vertical adjustment

1 Up

Pull the head restraints up.

2 Down

Push the head restraint down while pushing the lock release button.

■ Removing the head restraints

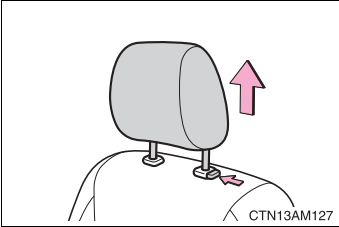

Pull the head restraint up while pressing the lock release button.

■ Installing the head restraints

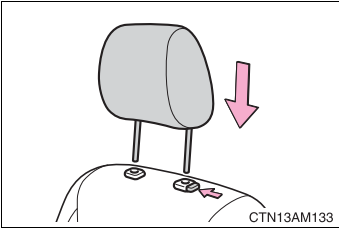

Align the head restraint with the installation holes and push it down to the lock position.

Press and hold the lock release button when lowering the head restraint.

■ Adjusting the height of the head restraints

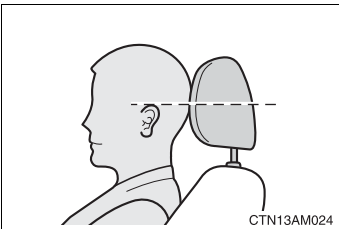

Make sure that the head restraints are adjusted so that the center of the head restraint is closest to the top of your ears.

 CAUTION

■ **Head restraint precautions**

Observe the following precautions regarding the head restraints. Failure to do so may result in death or serious injury.

- Use the head restraints designed for each respective seat.
- Adjust the head restraints to the correct position at all times.
- After adjusting the head restraints, push down on them and make sure they are locked in position.
- Do not drive with the head restraints removed.

Make sure that all occupants are wearing their seat belts before driving the vehicle.

■ **Correct use of the seat belts**

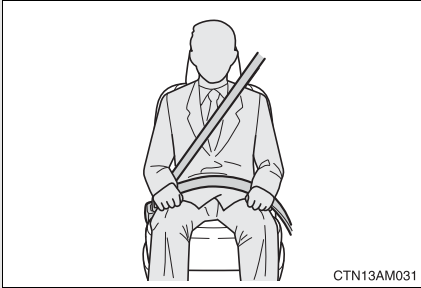

- Extend the shoulder belt so that it comes fully over the shoulder, but does not come into contact with the neck or slide off the shoulder.
- Position the lap belt as low as possible over the hips.
- Adjust the position of the seatback. Sit up straight and well back in the seat.
- Do not twist the seat belt.

■ **Fastening and releasing the seat belt**

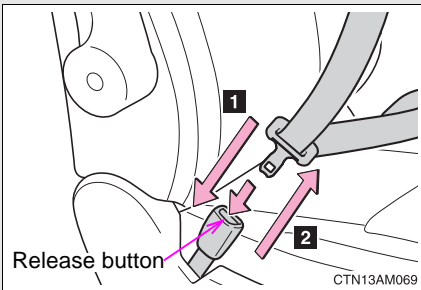

1 Fastening the belt

Push the tab into the buckle until a clicking sound is heard.

2 Releasing the belt

Press the release button.

■ Adjusting the height of the belt (front seats)

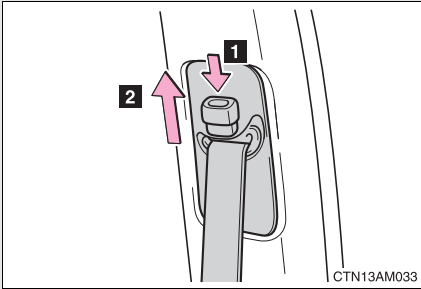

1 Down

2 Up

Move the height adjuster up and down as needed until you hear a click.

Center third seat belt

The center third seat belt is a 3-point type restraint with 2 buckles. Both seat belt buckles must be correctly located and securely latched for proper operation.

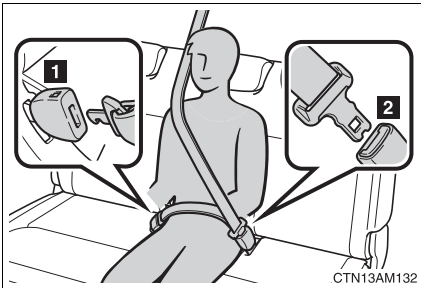

Make sure that the buckle **1** is securely latched for ready use of the center seat belt.

1 Matches the tab with the hooked end.

2 Matches the tab with the concave end.

■ Release method

The belt can be completely released when not required, such as when folding down the third seat.

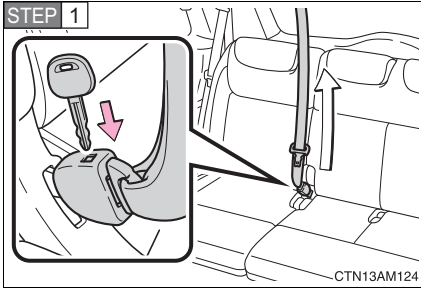

Insert the key into the hole on the center seat belt buckle to release the tab (with the hooked end), and allow the belt to retract.

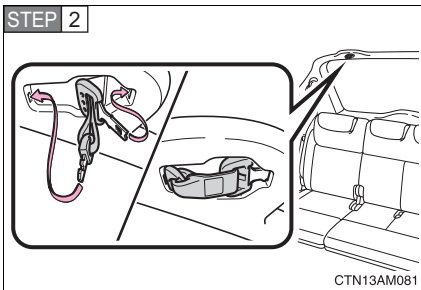

Stow the seat belt tabs in the cover set in the roof as shown.

■ Extracting the belt

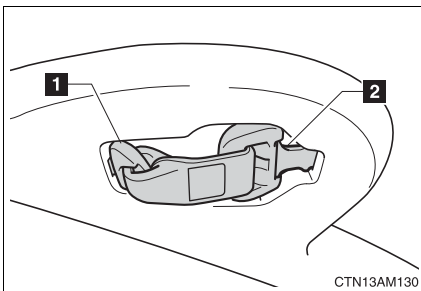

Pull tab **1** out and pull the belt out a little. Then pull tab **2** out.

Seat belt comfort guide (outer third seat)

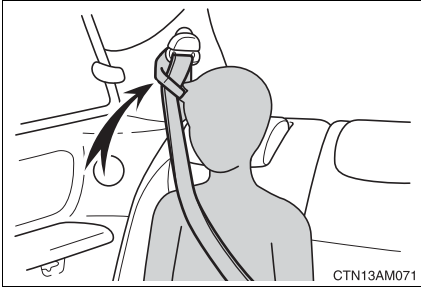

If the shoulder belt sits close to a person's neck, use the seat belt comfort guide.

Seat belt pretensioners (front seats)

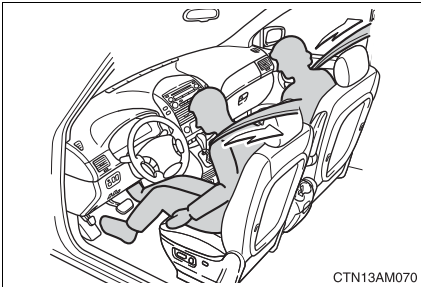

The pretensioner helps the seat belt to quickly restrain the occupant by retracting the seat belt when the vehicle is subjected to certain types of severe frontal collision.

The pretensioner may not activate in the event of a minor frontal impact, a side impact or a rear impact.

■ Emergency locking retractor (ELR)

The retractor will lock the belt during a sudden stop or on impact. It may also lock if you lean forward too quickly. A slow, easy motion will allow the belt to extend so that you can move around fully.

■ Automatic locking retractor (ALR)

When a passenger's shoulder belt is completely extended and then retracted even slightly, the belt is locked in that position and cannot be extended. This feature is used to hold the child restraint system (CRS) firmly. To free the belt again, fully retract the belt and then pull the belt out once more. (→P. 140)

■ Pregnant women

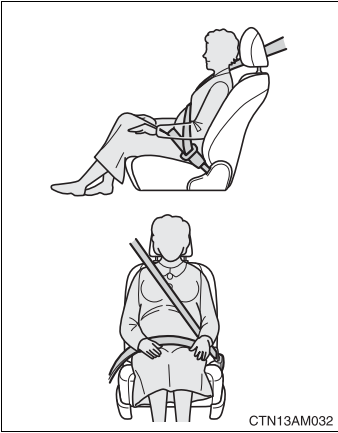

Obtain medical advice and wear the seat belt in the proper way. (→P. 85)

Women who are pregnant should position the lap belt as low as possible over the hips in the same manner as other occupants. Extend the shoulder belt completely over the shoulder and position the belt across the chest. Avoid belt contact over the rounding of the abdominal area.

If the seat belt is not worn properly, not only a pregnant woman, but also the fetus could suffer death or serious injury as a result of sudden braking or a collision.

■ People suffering illness

Obtain medical advice and wear the seat belt in the proper way.

■ When not using the second seat belts

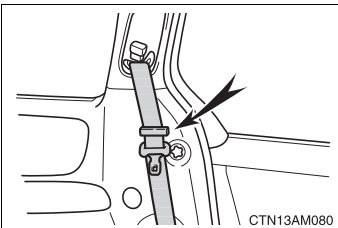

Pass the outer seat belts through the seat belt hangers and secure the seat belt plates to prevent the shoulder belts from being damaged.

■ Child seat belt usage

The seat belts of your vehicle were principally designed for persons of adult size.

- Use a child restraint system appropriate for the child, until the child becomes large enough to properly wear the vehicle's seat belt. (→P. 136)
- When the child becomes large enough to properly wear the vehicle's seat belt, follow the instructions on P. 85 regarding seat belt usage.

■ Replacing the belt after the pretensioner has been activated

If the vehicle is involved in multiple collisions, the pretensioner will activate for the first collision, but will not activate for the second or subsequent collisions.

■ Seat belt extender

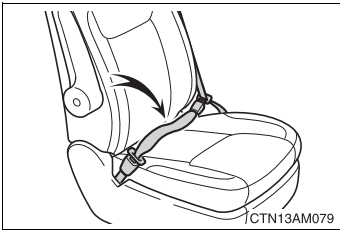

If your seat belts cannot be fastened securely because they are not long enough, a personalized seat belt extender is available from your Toyota dealer free of charge.

! CAUTION

Observe the following precautions to reduce the risk of injury in the event of sudden braking or an accident.

Failing to do so may cause death or severe injury.

■ Wearing a seat belt

- Ensure that all passengers wear a seat belt.
- Always wear a seat belt properly.
- Each seat belt should be used by one person only. Do not use a seat belt for more than one person at once, including children.
- Toyota recommends that children be seated in the rear seat and always use a seat belt and/or an appropriate child restraint system.
- Do not recline the seat any more than necessary to achieve a proper seating position. The seat belt is most effective when the occupants are sitting up straight and well back in the seats.
- Do not wear the shoulder belt under your arm.
- Always wear your seat belt low and snug across your hips.
- Always wear the belt with the shoulder portion over the outside armrest and the lap portion under the outside armrest.

■ Adjustable shoulder anchor

Always make sure the shoulder belt is positioned across the center of your shoulder. The belt should be kept away from your neck, but not falling off your shoulder. Failure to do so could reduce the amount of protection in an accident and cause death or serious injuries in a collision. (→P. 86)

■ Seat belt pretensioners

- Do not place anything, such as a cushion, on the front passenger's seat. Doing so will disperse the passenger's weight, which prevents the sensor from detecting the passenger's weight properly. As a result, the seat belt pretensioner for the front passenger's seat may not activate in the event of a collision.
- If the pretensioner has activated, the seat belt becomes locked: it cannot be further extended, nor will it return to the stowed position. The seat belt cannot be used again and must be replaced at your Toyota dealer.

! CAUTION

■ Child restraint lock function belt precaution

Do not allow children to play with the child restraint lock function belt. If the belt becomes twisted around a child's neck, it will not be possible to pull the belt out leading to choking or other serious injuries that could result in death. If this occurs and the buckle cannot be unfastened, scissors should be used to cut the belt.

■ Seat belt damage and wear

- Do not damage the seat belts by allowing the belt, plate, or buckle to be jammed in the door or under the seats.
- Inspect the seat belt system periodically. Check for cuts, fraying, and loose parts. Do not use a damaged seat belt until it is replaced. Damaged seat belts cannot protect an occupant from death or serious injury.
- Ensure that the belt and tab are locked and the belt is not twisted. If the seat belt does not function correctly, immediately contact your Toyota dealer.
- Replace the seat assembly, including the belts, if your vehicle has been involved in a serious accident, even if there is no obvious damage.
- Do not attempt to install, remove, modify, disassemble or dispose of the seat belts. Have any necessary repairs carried out by your Toyota dealer. Inappropriate handling of the pretensioner may prevent it from operating properly resulting in death or serious injury.

■ When using the center third seat belt

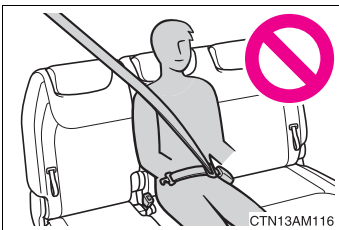

Do not use the center third seat belt with either buckle released. Fastening only one of the buckles may result in death or serious injury in case of sudden braking or a collision.

 **CAUTION****■ Using a seat belt comfort guide**

- Make sure the belt is not twisted and that it lies flat.
- Always make sure the shoulder belt is positioned across the center of the shoulder. The belt should be kept away from the neck, and should not fall off the shoulder.

Failure to observe these precautions could reduce the effectiveness of the seat belt in an accident, causing death or serious injury.

■ Using a seat belt extender

- Do not wear the seat belt extender if you can fasten the seat belt without the extender.
- Do not use the seat belt extender when installing a child restraint system because the belt will not securely hold the child restraint system, increasing the risk of death or serious injury in the event of an accident.
- The personalized extender may not be safe on another vehicle, when used by another person, or at a different seating position other than the one originally intended.

 **NOTICE****■ When using a seat belt extender**

When releasing the seat belt, press on the buckle release button on the extender, not on the seat belt.

This helps prevent damage to the vehicle interior and the extender itself.

1-3. Adjustable components (seats, mirrors, steering wheel)

Steering wheel

The steering wheel can be adjusted to a comfortable position.

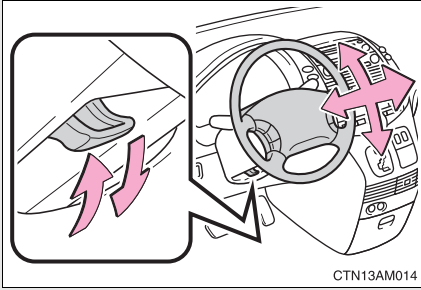

STEP 1 Hold the steering wheel and press the lever down.

STEP 2 Adjust to the ideal position by moving the steering wheel horizontally and vertically.

STEP 3 Pull the lever up.

CAUTION

■ Caution while driving

Do not adjust the steering wheel while driving.

Doing so may cause the driver to mishandle the vehicle and cause an accident, resulting in death or serious injury.

■ After adjusting the steering wheel

Make sure that the steering wheel is securely locked.

Otherwise, the steering wheel may move suddenly, possibly causing an accident and resulting in death or serious injury.

1-3. Adjustable components (seats, mirrors, steering wheel)

Anti-glare inside rear view mirror

Glare from the headlights of vehicles behind can be reduced using the following functions.

► Manual anti-glare inside rear view mirror

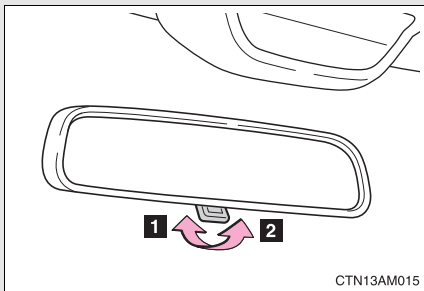

- 1 Normal position
- 2 Anti-glare position

► Auto anti-glare inside rear view mirror

In automatic mode, sensors are used to detect the headlights of vehicles behind and the reflected light is automatically reduced.

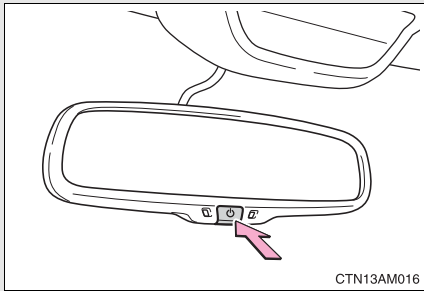

Turns automatic mode on/off

The indicator comes on when automatic mode is turned on.

The mirror will revert to the automatic mode each time the engine switch is turned to the "ON" position.

■ **To prevent sensor error (vehicles with auto anti-glare inside rear view mirror)**

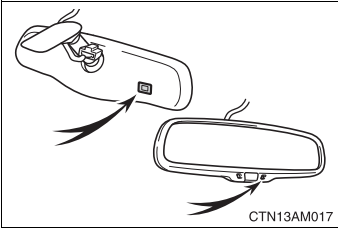

To ensure that the sensors operate properly, do not touch or cover them.

! CAUTION

■ **Caution while driving**

Do not adjust the position of the mirror while driving.

Doing so may lead to mishandling of the vehicle and an accident, resulting in death or serious injury.

1-3. Adjustable components (seats, mirrors, steering wheel)

Outside rear view mirrors

Mirror angle can be adjusted using the switch.

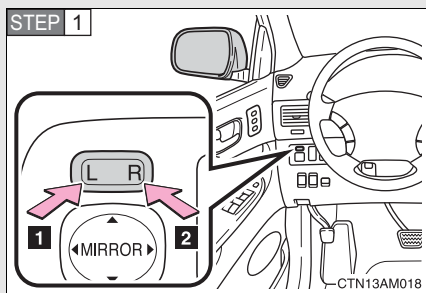

Select a mirror to adjust.

- 1** Left
- 2** Right

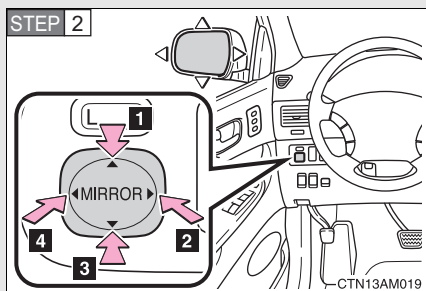

Adjust the mirror.

- 1** Up
- 2** Right
- 3** Down
- 4** Left

Folding back the mirrors

► Manual folding type

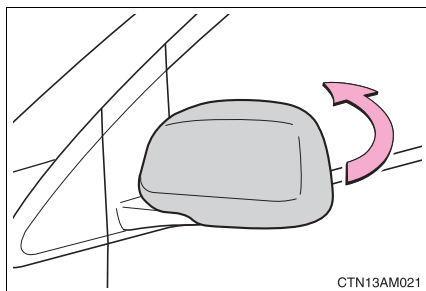

Push backward to fold the mirrors.

▶ Power folding type

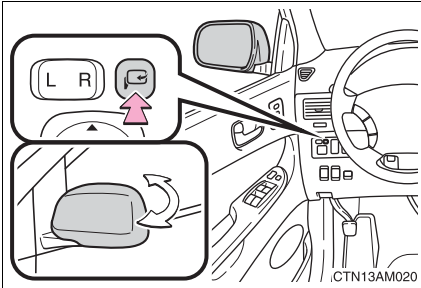

Press the switch.

Pressing again will extend the mirror.

■ **Mirror can be adjusted when**

The engine switch is in the “ACC” or “ON” position.

■ **When the mirrors are fogged up (vehicles with outside rear view mirror defoggers)**

Turn on the mirror defoggers to defog the mirrors. (→P. 260)

■ **One-touch adjustment of the mirror angle (vehicles with driving position memory)**

A desired mirror face angle can be entered to memory and adjusted with the touch of a button. (→P. 80)

■ **Auto anti-glare function (vehicles with auto anti-glare inside rear view mirror)**

When the anti-glare inside rear view mirror is set to automatic mode, the outside rear view mirrors will activate in conjunction with the anti-glare inside rear view mirror to reduce reflected light. (→P. 95)

 CAUTION

■ **When driving the vehicle**

Observe the following precautions while driving.

Failing to do so may result in loss of control of the vehicle and cause an accident, resulting in death or serious injury.

- Do not adjust the mirrors while driving.
- Do not drive with the mirrors folded back.
- Both the driver and passenger side mirrors must be extended and properly adjusted before driving.

■ **When a mirror is moving**

To avoid personal injury and mirror malfunction, be careful not to get your hand caught by the moving mirror.

■ **When the mirror defoggers are operating (vehicles with outside rear view mirror defoggers)**

Do not touch the rear view mirror surfaces, as they can become very hot and burn you.

1-4. Opening and closing the windows

Power windows

The power windows can be opened and closed using the following switches.

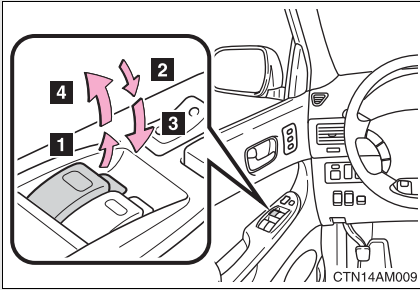

Type A

- 1 Closing
- 2 Opening
- 3 One-touch opening (driver's window only)*

Type B

- 1 Closing
- 2 Opening
- 3 One-touch opening (driver's window only)*
- 4 One-touch closing (driver's window only)*

*: Pressing the switch in the opposite direction will stop window travel partway.

Lock switch

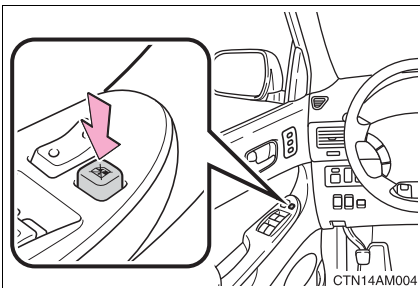

Press the switch down to lock the passenger window switches.

Use this switch to prevent children from accidentally opening or closing a passenger window.

■ The power windows can be operated when

The engine switch is in the “ON” position.

■ Operating the power windows after turning the engine off

The power windows can be operated for approximately 45 seconds after the engine switch is turned to the “ACC” or “LOCK” position. They cannot, however, be operated once either front door is opened.

■ Jam protection function (driver’s window on type B only)

If an object becomes caught between the window and the window frame, window travel is stopped and the window is opened slightly.

■ When the battery is disconnected

The power windows must be initialized in order to ensure proper operation. (Perform for each window with the switch for each seat.)

STEP 1 Open the window halfway.

STEP 2 Fully close the window by pulling the switch up and continue holding the switch for one second.

CAUTION

■ Closing the windows

Observe the following precautions.

Failing to do so may result in death or serious injury.

- Check to make sure that all passengers do not have any part of their body in a position where it could be caught when a window is being operated.
- Do not allow children to operate the power windows.
Closing a power window on someone can cause serious injury, and in some instances, even death.

■ Jam protection function

- Never try jamming any part of your body to activate the jam protection function intentionally.
- The jam protection function may not work if something gets caught just before the window fully closes.

1-4. Opening and closing the windows

Quarter windows

The quarter windows can be opened to bring in fresh outside air for additional ventilation.

■ Manual type

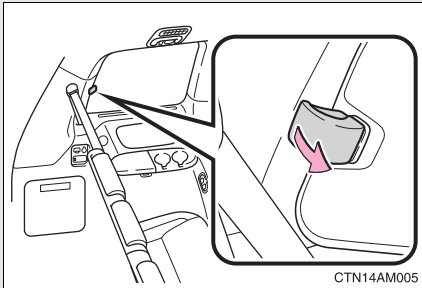

Pull the handle and swing the window fully out to open.

■ Power type

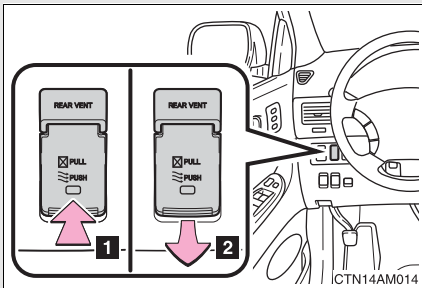

1 Opening

2 Closing

Both the left and right rear quarter windows move.

■ The windows can be operated when (power type)

The engine switch is in the "ON" position.

■ Operating the windows after turning the engine off (power type)

The power type windows can be operated for approximately 45 seconds after the engine switch is turned to the "ACC" or "LOCK" position. They cannot, however, be operated once either front door is opened.

 **CAUTION****■ Closing the windows**

Observe the following precautions.

Failing to do so may result in death or serious injury.

- Check to make sure that all passengers do not have any part of their body in a position where it could be caught when a window is being operated.
- Do not allow children to operate the power windows.
Closing a power window on someone can cause serious injury, and in some instances, even death.

1-4. Opening and closing the windows Moon roof (if equipped)

Use the overhead switches to open, close, and tilt the moon roof up and down.

■ Opening and closing

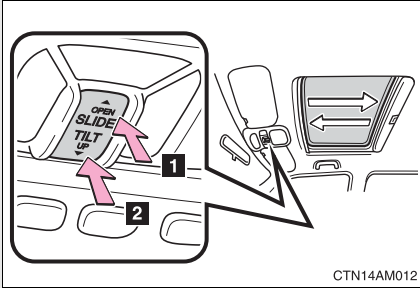

1 Opening

2 Closing

Push the switch in either direction to stop the moon roof part-way.

■ Tilting up and down

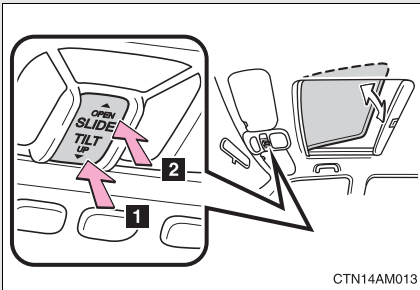

1 Tilt up

2 Tilt down

Push the switch in either direction to stop the moon roof part-way.

■ The moon roof can be operated when

The engine switch is in the “ON” position.

■ Operating the moon roof after turning the engine off

The moon roof can be operated for approximately 45 seconds after the engine switch is turned to the “ACC” or “LOCK” position. It cannot, however, be operated once either front door is opened.

■ Jam protection function

If an object is detected between the moon roof and the frame while closing or tilting down, travel is stopped and the moon roof opens slightly.

■ Sunshade

The sunshade can be opened and closed manually. However, the sunshade will open automatically when the moon roof is opened.

■ Opening the moon roof by small degrees

Quickly push and release the switch.

■ When the battery is disconnected

The moon roof must be initialized in order to ensure proper operation.

Press and hold the “TILT UP” side of the switch until the moon roof tilts up completely.

 **CAUTION**

■ **Opening the moon roof**

Observe the following precautions.

Failing to do so may cause death or serious injury.

- Do not allow any passengers to put their hands or heads outside the vehicle while it is moving.
- Do not sit on top of the moon roof.

■ **Closing the moon roof**

Observe the following precautions.

Failing to do so may result in death or serious injury.

- Check to make sure that all passengers do not have any part of their bodies in a position where it could be caught when the moon roof is being operated.
- Do not allow children to operate the moon roof.
Closing the moon roof on someone can cause death or serious injury.

■ **Jam protection function**

- Never try jamming any part of your body to activate the jam protection function intentionally.
- The jam protection function may not work if something gets caught just before the moon roof fully closes.

Opening the fuel tank cap

Perform the following steps to open the fuel tank cap.

■ **Before refueling the vehicle**

Turn the engine off and ensure that all the doors and windows are closed.

■ **Opening the fuel tank cap**

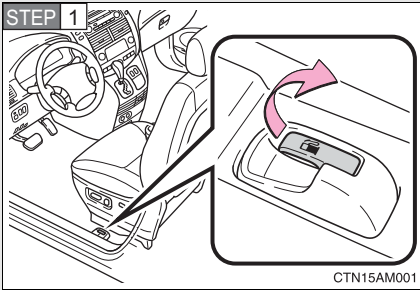

Pull up the fuel filler door opener.

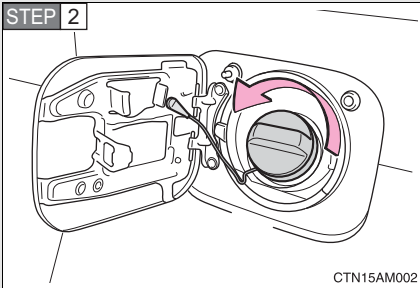

Turn the fuel tank cap slowly to open.

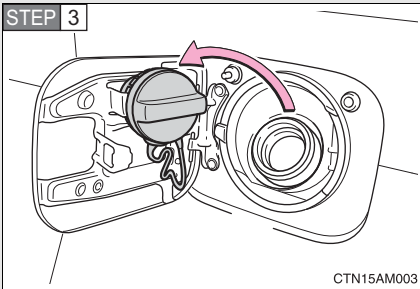

Hang the fuel tank cap on the back of the fuel filler door.

Closing the fuel tank cap

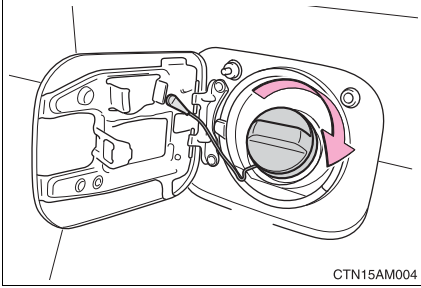

When replacing the fuel tank cap, turn it until a clicking sound is heard.

After releasing your hand, the cap will turn slightly to the opposite direction.

■ Fuel type

Unleaded gasoline (Octane rating 87 [Research Octane Number 91] or higher)

■ Fuel tank capacity (reference)

20.9 gal. (79 L, 17.5 Imp. gal.)

 **CAUTION****■ Refueling the vehicle**

Observe the following precautions while refueling the vehicle.
Failure to do so may result in death or serious injury.

- Touch the vehicle or some other metal surface to discharge any static electricity.
Sparks resulting from discharging static electricity may cause the fuel vapors to ignite.
- Always hold the grips on the fuel tank cap and turn it slowly to remove it.
A whooshing sound may be heard when the fuel tank cap is loosened.
Wait until the sound cannot be heard before fully removing the cap.
In hot weather, pressurized fuel may spray out of the filler neck and cause injury.
- Do not allow anyone that has not discharged static electricity from their bodies to come close to an open fuel tank.
- Do not inhale vaporized fuel.
Fuel contains substances that are harmful if inhaled.
- Do not smoke while refueling the vehicle.
Doing so may cause the fuel to ignite and cause a fire.
- Do not return to the vehicle or touch any person or object that is statically charged.
This may cause static electricity to build up, resulting in a possible ignition hazard.

■ When replacing the fuel cap

Do not use anything but a genuine Toyota fuel tank cap designed for your vehicle. Doing so may cause a fire or other incident which may result in death or serious injury.



NOTICE

■ Refueling

Do not spill fuel during refueling.

Doing so may damage the vehicle, such as causing the exhaust systems to operate abnormally or damaging fuel system components or the vehicle's painted surface.

The vehicle's keys have built-in transponder chips that prevent the engine from starting if the key has not been previously registered in the vehicle's on-board computer.

Never leave the keys inside the vehicle when you leave the vehicle.

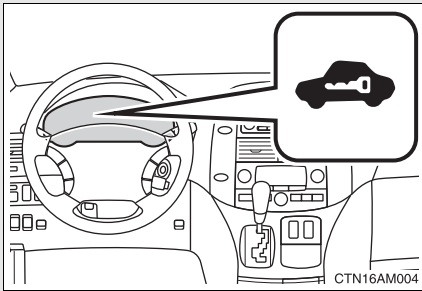

On some models: The indicator light flashes after the key has been removed from the engine switch to indicate that the system is operating.

■ System maintenance

The vehicle has a maintenance-free type of engine immobilizer system.

■ Conditions that may cause the system to malfunction

- If the key is in contact with a metallic object
- If the key is in close proximity to or touching a key to the security system (key with a built-in transponder chip) of another vehicle

■ Certifications for the engine immobilizer system

► U.S.A.

FCC ID: MOZ RI-21BTY

This device complies with Part 15 of the FCC Rules. Operation is subject to the following two conditions: (1) This device may not cause harmful interference, and (2) this device must accept any interference received, including interference that may cause undesired operation.

► Canada

This device complies with RSS-210 of Industry Canada. Operation is subject to the following two conditions: (1) This device may not cause interference, and (2) this device must accept any interference, including interference that may cause undesired operation of the device.

 CAUTION

Changes or modifications not expressly approved by the party responsible for compliance could void the user's authority to operate the equipment.

 NOTICE

■ **To prevent damage to the key**

Do not modify, remove or disable the engine immobilizer system. If any unauthorized changes or modifications are made, the proper operation of the system cannot be guaranteed.

1-6. Theft deterrent system Alarm (if equipped)

The system sounds the alarm and flashes the lights when forcible entry is detected.

■ Triggering of the alarm

The alarm is triggered in the following situations.

- A locked door is unlocked or opened without the key or wireless remote control.
- The hood is opened while the vehicle is locked.
- The battery is reconnected.

■ Setting the alarm system

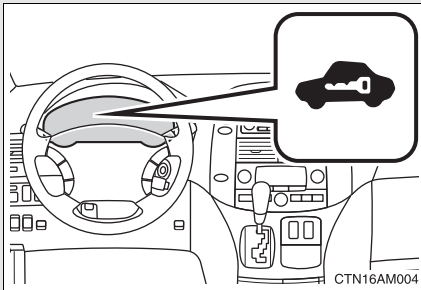

Close the doors and hood, and lock all doors. The system will be set automatically after 30 seconds.

The indicator light changes from being on to flashing when the system is set.

■ Deactivating or stopping the alarm

Do one of the following to deactivate or stop the alarm.

- Unlock the doors using the wireless remote control or key.
- Turn the engine switch to the "ON" position.

■ **Items to check before locking the vehicle**

To prevent unexpected triggering of the alarm and vehicle theft, make sure of the following.

- Nobody is in the vehicle.
- The windows and moon roof are closed before the alarm is set.
- No valuables or other personal items are left in the vehicle.

■ **Triggering of the alarm**

The alarm may be triggered in the following situations.
(Stopping the alarm deactivates the system.)

- A person inside the vehicle opens a door or hood.
- The battery is recharged or replaced when the vehicle is locked.

■ **When the battery is disconnected**

Be sure to deactivate the alarm system.

If the battery is disconnected before deactivating the alarm system, the alarm may be triggered when the battery is reconnected.

1-6. Theft deterrent system

Theft prevention labels (for U.S.A.)

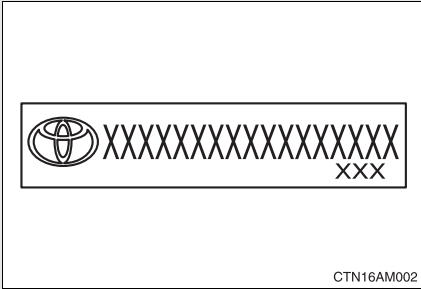

These labels are attached to the vehicle to reduce vehicle theft by facilitating the tracing and recovery of parts from stolen vehicles. Do not remove under penalty of law.

Correct driving posture

Drive in a good posture as follows:

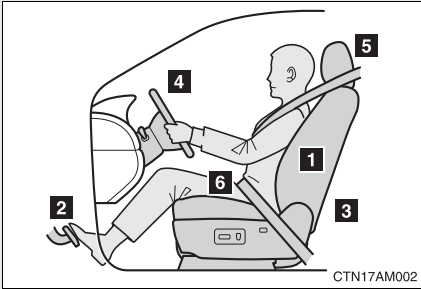

- 1** Sit upright and well back in the seat. (→P. 56)
- 2** Adjust the position of the seat forward or backward to ensure the pedals can be reached and easily depressed to the extent required. (→P. 56)
- 3** Adjust the seatback so that the controls are easily operable.
- 4** Adjust the tilt and telescopic positions of the steering wheel downward so the air-bag is facing your chest. (→P. 94)
- 5** Lock the head restraint in place with the center of the head restraint closest to the top of your ears. (→P. 82)
- 6** Wear the seat belt correctly. (→P. 85)

 **CAUTION****■ While driving**

- Do not adjust the position of the driver's seat while driving.
Doing so could cause the driver to lose control of the vehicle.
- Do not place a cushion between the driver or passenger and the seatback.
A cushion may prevent correct posture from being achieved, and reduce the effectiveness of the seat belt and head restraint, increasing the risk of death or serious injury to the driver or passenger.
- Do not place anything under the front seats except for putting them in the tray.
Objects placed under the front seats may become jammed in the seat tracks and stop the seat from locking in place. This may lead to an accident. The adjustment mechanism may also be damaged.

■ Adjusting the seat position

- Take care when adjusting the seat position to ensure that other passengers are not injured by the moving seat.
- Do not put your hands under the seat or near the moving parts to avoid injury.
Fingers or hands may become jammed in the seat mechanism.

SRS airbags

The SRS airbags inflate when the vehicle is subjected to certain types of severe impacts that may cause significant injury to the occupants. They work together with the seat belts to help reduce the risk of death or serious injury.

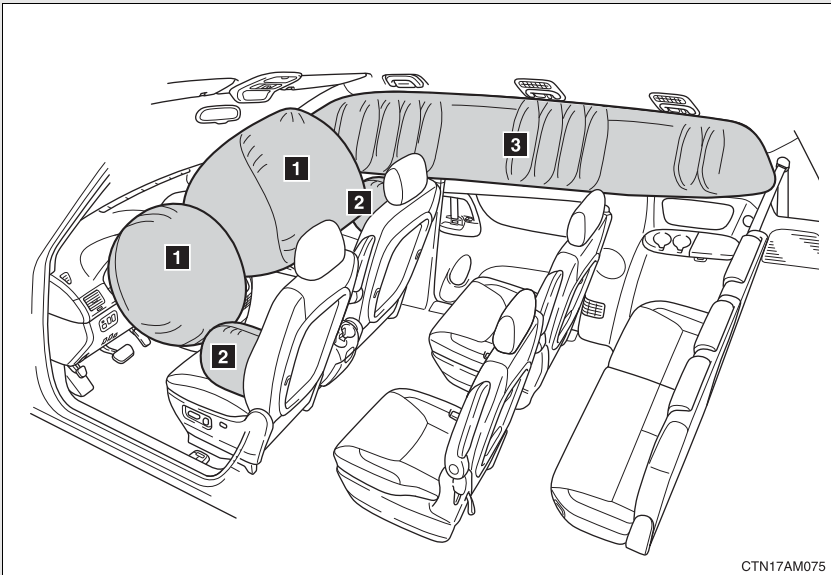

CTN17AM075

► Front airbags

1 Driver airbag/front passenger airbag

Can help protect the head and chest of the driver and front passenger from impact with interior components.

► Side and curtain shield airbags

2 Side airbags

Can help protect the torso of the front seat occupants.

3 Curtain shield airbags

Can help protect primarily the head of occupants in the outer seats.

Airbag system components

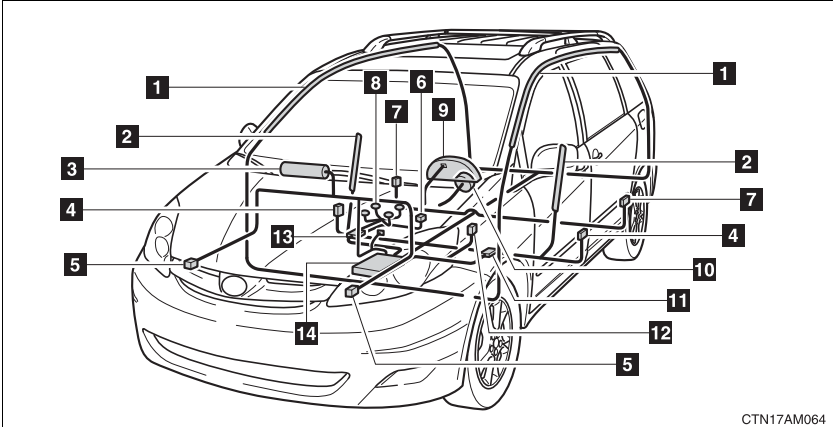

CTN17AM064

- | | |
|---|---|
| 1 Curtain shield airbags | 9 SRS warning light |
| 2 Side airbags | 10 Driver airbag |
| 3 Front passenger airbag | 11 Driver's seat position sensor |
| 4 Side and curtain shield airbag sensors | 12 Driver's seat belt buckle switch |
| 5 Front airbag sensors | 13 "AIR BAG ON" and "AIR BAG OFF" indicator lights |
| 6 Front passenger's seat belt buckle switch | 14 Airbag sensor assembly |
| 7 Curtain shield airbag sensors | |
| 8 Front passenger occupant classification system (ECU and sensors) | |

Your vehicle is equipped with ADVANCED AIRBAGS designed based on US motor vehicle safety standards (FMVSS208). The airbag system controls airbag deployment power for the driver and front passenger. The driver airbag system consists of the driver seat's position sensor etc. The front passenger's airbag system consists of the front passenger occupant classification sensor etc.

The main SRS airbag system components are shown above. The SRS airbag system is controlled by the airbag sensor assembly. The airbag sensor assembly consists of a safing sensor and an airbag sensor.

In certain types of severe frontal or side impacts, the SRS airbag system triggers the airbag inflators. A chemical reaction in the inflators quickly fills the airbags with non-toxic gas to help restrain the motion of the occupants.

■ SRS warning light

This warning light system monitors the airbag sensor assembly, front airbag sensors, side and curtain shield airbag sensor assemblies, curtain shield airbag sensor assemblies, driver's seat position sensor, driver's seat belt buckle switch, front passenger occupant classification system, "AIR BAG ON" and "AIR BAG OFF" indicator lights, front passenger's seat belt buckle switch, front seat belt pretensioner assemblies, inflators, interconnecting wiring and power sources. (→P. 505)

■ If the SRS airbags deploy (inflate)

- Bruising and slight abrasions may result from contact with a deploying (inflating) SRS airbag.
- A loud noise and white powder will be emitted.
- Parts of the airbag module (steering wheel hub, airbag cover and inflator) as well as the front seats, and parts of the front and rear pillars and roof side rail, may be hot for several minutes. The airbag itself may also be hot.
- The windshield may crack.

■ Operating conditions (front airbags)

- The SRS front airbags will deploy if the severity of the frontal impact is above the designed threshold level, comparable to an approximate 15 mph (25 km/h) collision when the vehicle impacts straight into a fixed barrier that does not move or deform.

However, this threshold velocity will be considerably higher if the vehicle strikes an object, such as a parked vehicle or sign pole, which can move or deform on impact, or if the vehicle is involved in an underride collision (e.g. a collision in which the front of the vehicle “underrides”, or goes under, the bed of a truck, etc.).

- It is possible that in some collisions where the forward deceleration of the vehicle is very close to the designed threshold level, the SRS front airbags and the seat belt pretensioners may not activate together.
- The SRS front passenger airbag will not activate if there is no passenger sitting in the front passenger seat. However, the front passenger airbag may deploy if luggage is put in the seat, or the seat belt is fastened, even if the seat is unoccupied. (→P. 130)

■ Operating conditions (side airbags and curtain shield airbags)

- The SRS side airbags and curtain shield airbags are designed to inflate when the passenger compartment is subjected to a severe impact from the side.
- The SRS side airbag on the passenger seat will not activate if there is no passenger sitting in the front passenger seat. However, the side airbag on the passenger seat may deploy if luggage is put in the seat, even if the seat is unoccupied. (→P. 130)

■ **Conditions under which the SRS airbags may deploy (inflate), other than a collision**

The SRS front airbags may also deploy if a serious impact occurs to the underside of your vehicle. Some examples are shown in the illustration.

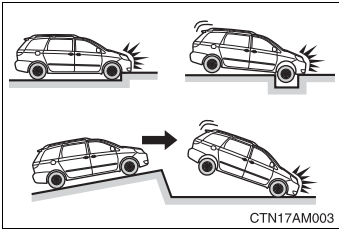

- Hitting a curb, edge of pavement or hard surface
- Falling into or jumping over a deep hole
- Landing hard or vehicle falling

■ **Types of collisions that may not deploy the SRS front airbag**

The SRS front airbags are generally not designed to inflate if the vehicle is involved in a side or rear collision, if it rolls over, or if it is involved in a low-speed frontal collision. But, whenever a collision of any type causes sufficient forward deceleration of the vehicle, deployment of the SRS front airbags may occur.

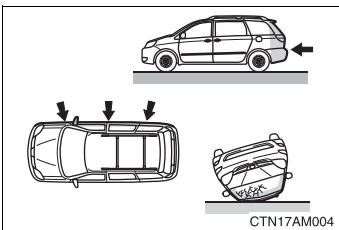

- Collision from the side
- Collision from the rear
- Vehicle rollover

■ Types of collisions that may not deploy the SRS side airbags and curtain shield airbags

The SRS side airbag and curtain shield airbag system may not activate if the vehicle is subjected to a collision from the side at certain angles, or a collision to the side of the vehicle body other than the passenger compartment.

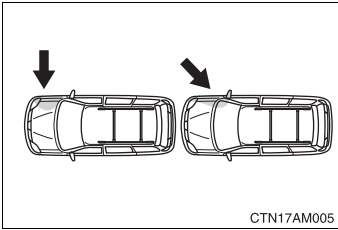

- Collision from the side to the vehicle body other than the passenger compartment
- Collision from the side at an angle

The SRS side airbags and curtain shield airbags are not generally designed to inflate if the vehicle is involved in a frontal or rear collision, if it rolls over, or if it is involved in a low-speed side collision.

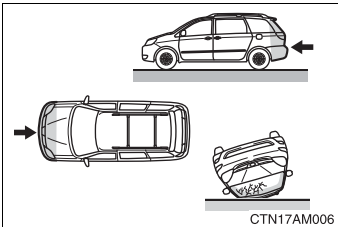

- Collision from the front
- Collision from the rear
- Vehicle rollover

■ When to contact your Toyota dealer

In the following cases, contact your Toyota dealer as soon as possible. Do not disconnect the battery cables before contacting your Toyota dealer.

- Any of the SRS airbags have been inflated.

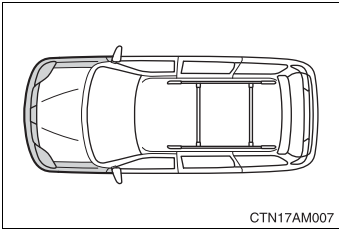

- The front of the vehicle is damaged or deformed, or was involved in an accident that was not severe enough to cause the SRS airbags to inflate.

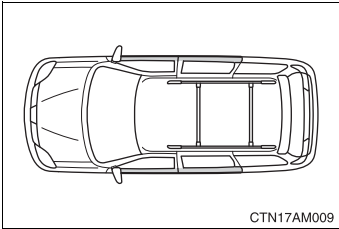

- A portion of a door is damaged or deformed, or the vehicle was involved in an accident that was not severe enough to cause the SRS side airbags and curtain shield airbags to inflate.

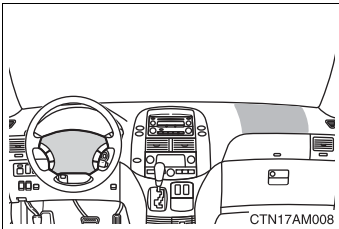

- The pad section of the steering wheel or dashboard is scratched, cracked, or otherwise damaged.

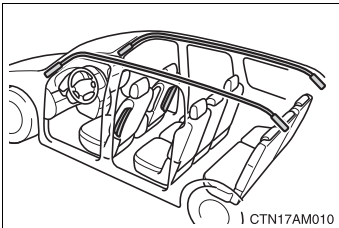

- The surface of the seats with the side airbag is scratched, cracked or otherwise damaged.
- The portion of the front pillars, rear pillars or roof side rail garnishes (padding) containing the curtain shield airbags inside is scratched, cracked or otherwise damaged.

 **CAUTION****■ SRS airbag precautions**

Observe the following precautions regarding the airbags.
Failure to do so may cause death or serious injury.

- The driver and all passengers in the vehicle must wear their seat belts properly.

The SRS airbags are supplemental devices to be used with the seat belts.

- The SRS driver airbag deploys with considerable force, and can cause death or serious injury especially if the driver is very close to the airbag. The National Highway Traffic Safety Administration (“NHTSA”) advises:

Since the risk zone for the driver’s airbag is the first 2 - 3 in. (50 - 75 mm) of inflation, placing yourself 10 in. (250 mm) from your driver airbag provides you with a clear margin of safety. This distance is measured from the center of the steering wheel to your breastbone. If you sit less than 10 in. (250 mm) away now, you can change your driving position in several ways:

- Move your seat to the rear as far as you can while still reaching the pedals comfortably.
- Slightly recline the back of the seat.
Although vehicle designs vary, many drivers can achieve the 10 in. (250 mm) distance, even with the driver seat all the way forward, simply by reclining the back of the seat somewhat. If reclining the back of your seat makes it hard to see the road, raise yourself using a firm, non-slippery cushion, or raise the seat if your vehicle has that feature.
- If your steering wheel is adjustable, tilt it downward. This points the airbag toward your chest instead of your head and neck.

The seat should be adjusted as recommended by NHTSA above, while still maintaining control of the foot pedals, steering wheel, and your view of the instrument panel controls.

! CAUTION

■ SRS airbag precautions

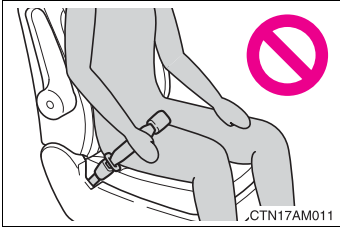

● If the seat belt extender has been connected to the driver's seat belt buckle but the seat belt extender has not also been fastened to the latch plate of the driver's seat belt, the SRS driver's airbag system will judge that the driver is wearing the seat belt even though the seat belt has not been connected. In this case, the driver's airbag may not activate correctly in a collision, resulting in death or serious injury in the event of collision. Be sure to wear the seat belt with the seat belt extender.

- The SRS front passenger airbag also deploys with considerable force, and can cause death or serious injury especially if the front passenger is very close to the airbag. The front passenger seat should be as far from the airbag as possible with the seatback adjusted, so the front passenger sits upright.
- Improperly seated and/or restrained infants and children can be killed or seriously injured by a deploying airbag. An infant or child who is too small to use a seat belt should be properly secured using a child restraint system. Toyota strongly recommends that all infants and children be placed in the rear seats of the vehicle and properly restrained. The rear seats are the safest for infants and children. (→P. 136)

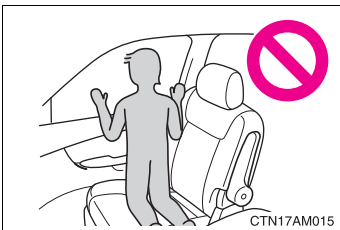
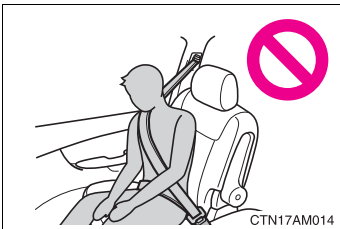
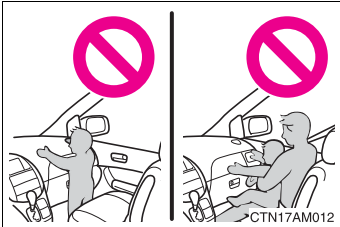
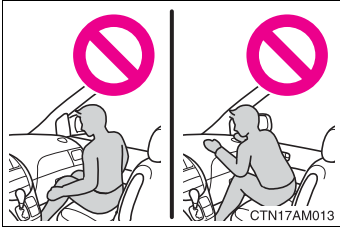
! CAUTION**■ SRS airbag precautions**

- Do not sit on the edge of the seat or lean against the dashboard.
- Do not allow a child to stand in front of the SRS front passenger airbag unit or sit on the knees of a front passenger.
- Do not drive the vehicle while the driver or passenger has items resting on their knees.
- Do not lean against the door, the roof side rail or the front, side and rear pillars.
- Do not allow anyone to kneel on the passenger seat toward the door or put their head or hands outside the vehicle.

! CAUTION

■ SRS airbag precautions

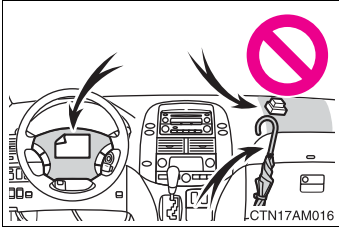

- Do not attach anything to or lean anything against areas such as the dashboard or steering wheel pad.

These items can become projectiles when SRS driver and front passenger airbags deploy.



- Do not attach anything to areas such as the door, windshield glass, side door glass, front or side pillars, roof side rail or assist grip.

- Do not hang coat hangers or other hard objects on the coat hooks. All of these items could become projectiles and seriously injure or kill you, should the SRS curtain shield airbag deploy.

- Do not use seat accessories which cover the parts where the SRS side airbags inflate as they may interfere with inflation of the airbags.
- Do not strike or apply significant levels of force to the area of the SRS airbag components (→P. 119).
Doing so can cause the SRS airbags to malfunction.

⚠ CAUTION**■ SRS airbag precautions**

- Do not touch any of the component parts immediately after the SRS airbags have deployed (inflated) as they may be hot.
- If breathing becomes difficult after the SRS airbag has deployed, open a door or window to allow fresh air in, or leave the vehicle if it is safe to do so. Wash off any residue as soon as possible to prevent skin irritation.
- If the areas where the SRS airbags are stored, such as the steering wheel pad and front and rear pillar garnishes, are damaged or cracked, have them replaced by your Toyota dealer.

■ Modification and disposal of SRS airbag system components

Do not dispose of your vehicle or perform any of the following modifications without consulting your Toyota dealer.

The SRS airbags may malfunction or deploy (inflate) accidentally, causing death or serious injury.

- Installation, removal, disassembly and repair of the SRS airbags.
- Repairs, modifications, removal or replacement of the steering wheel, instrument panel, dashboard, seats or seat upholstery, front, side and rear pillars or roof side rails.
- Repairs or modifications of the front fender, front bumper, or side of the occupant compartment.
- Installation of snow plows, winches, etc. to the front grille (bull bars, kangaroo bar etc.).
- Modifications to the vehicle's suspension system.
- Installation of electronic devices such as mobile two-way radios or CD players.
- Modifications to your vehicle for a person with a physical disability.

Front passenger occupant classification system

Your vehicle is equipped with a front passenger occupant classification system. This system detects the conditions of the front passenger seat and activates or deactivates the devices for front passenger.

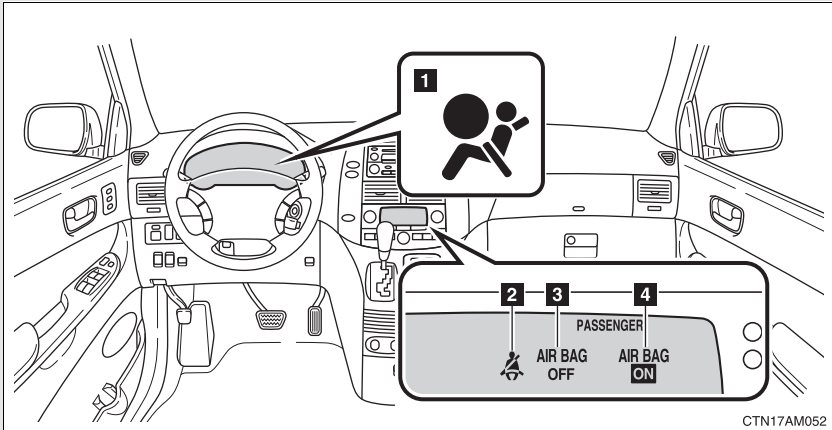

- 1** SRS warning light
- 2** Front passenger's seat belt reminder light
- 3** "AIR BAG OFF" indicator light
- 4** "AIR BAG ON" indicator light

Conditions and operation of the front passenger occupant classification system

■ Adult*¹

Indicator/ warning light	“AIR BAG ON” and “AIR BAG OFF” indicator lights	“AIR BAG ON”
	SRS warning light	Off
	Front passenger's seat belt reminder light	Flashing* ²
Devices	Front passenger airbag	Activated
	Side airbag on the front passenger seat	
	Curtain shield airbag in the front passenger side	
	Front passenger's seat belt pretensioner	

■ Child*³ or child restraint system*⁴

Indicator/ warning light	“AIR BAG ON” and “AIR BAG OFF” indicator lights	“AIR BAG OFF”* ⁵
	SRS warning light	Off
	Front passenger's seat belt reminder light	Flashing* ²
Devices	Front passenger airbag	Deactivated
	Side airbag on the front passenger seat	
	Curtain shield airbag in the front passenger side	Activated
	Front passenger's seat belt pretensioner	

■ Unoccupied

Indicator/ warning light	“AIR BAG ON” and “AIR BAG OFF” indicator lights	Not illuminated
	SRS warning light	Off
	Front passenger's seat belt reminder light	
Devices	Front passenger airbag	Deactivated
	Side airbag on the front passenger seat	
	Curtain shield airbag in the front passenger side	Activated
	Front passenger's seat belt pretensioner	Deactivated

■ There is a malfunction in the system

Indicator/ warning light	“AIR BAG ON” and “AIR BAG OFF” indicator lights	“AIR BAG OFF”
	SRS warning light	On
	Front passenger's seat belt reminder light	Off
Devices	Front passenger airbag	Deactivated
	Side airbag on the front passenger seat	
	Curtain shield airbag in the front passenger side	Activated
	Front passenger's seat belt pretensioner	

- *1: The system judges a person of adult size as an adult. When a smaller adult sits in the front passenger seat, the system may recognize him/her as a child depending on his/her physique and posture.
- *2: In the event the front passenger does not wear a seat belt.
- *3: When a larger child who has outgrown a child restraint system sits in the front passenger seat, the system may recognize him/her as an adult depending on his/her physique or posture.

- *4: Never install a rear-facing child restraint system on the front passenger seat. A forward-facing child restraint system should only be installed on the front passenger seat when it is unavoidable. (→P. 137)
- *5: In case the indicator is not illuminated, consult this manual as for installing the child restraint system properly. (→P. 140)

 CAUTION

■ Front passenger occupant classification system precautions

Observe the following precautions regarding front passenger occupant classification system.

Failure to do so may cause death or serious injury.

- Wear the seat belt properly.
- Make sure the front passenger's seat belt tab has not been left inserted into the buckle before someone sits in the front passenger seat.
- Make sure the "AIR BAG OFF" indicator light is not illuminated when using the seat belt extender for the front passenger seat. If the "AIR BAG OFF" indicator light is illuminated, disconnect the extender tongue from the seat belt buckle, then reconnect the seat belt. Reconnect the seat belt extender after making sure the "AIR BAG ON" indicator light is illuminated. If you use the seat belt extender while the "AIR BAG OFF" indicator light is illuminated, the front passenger airbag, side airbag on the front passenger side may not activate correctly, which could cause death or serious injury in the event of collision.
- Do not apply a heavy load to the front passenger seat or equipment (e.g. seatback pocket).
- Do not put weight on the front passenger seat by putting your hands or feet on the front passenger seat seatback from the rear passenger seat.
- Do not let a rear passenger lift the front passenger seat with their feet or press on the seatback with their legs.
- Do not put objects under the front passenger seat except for putting them in the tray.
- Do not recline the front passenger seatback so far that it touches a rear seat. This may cause the "AIR BAG OFF" indicator light to be illuminated, which indicates that the passenger's airbags will not deploy in the event of a severe accident. If the seatback touches the rear seat, return the seatback to a position where it does not touch the rear seat. Keep the front passenger seatback as upright as possible when the vehicle is moving. Reclining the seatback excessively may lessen the effectiveness of the seat belt system.

 CAUTION**■ Front passenger occupant classification system precautions**

- If an adult sits in the front passenger seat, the “AIR BAG ON” indicator light is illuminated. If the “AIR BAG OFF” indicator is illuminated, ask the passenger to sit up straight, well back in the seat, feet on the floor, and with the seat belt worn correctly. If the “AIR BAG OFF” indicator still remains illuminated, either ask the passenger to move to the rear seat, or if that is not possible, move the front passenger seat fully rearward.
- When it is unavoidable to install the forward-facing child restraint system on the front passenger seat, install the child restraint system on the front passenger seat in the proper order. (→P. 140)
- Do not modify or remove the front seats.
- Do not kick the front passenger seat or subject it to severe impact. Otherwise, the SRS warning light may come on to indicate a malfunction of the detection system. In this case, contact your Toyota dealer immediately.
- Child restraint systems installed on the rear seat should not contact the front seatbacks.
- Do not use a seat accessory, such as a cushion or seat cover, that covers the seat cushion surface.
- Do not modify or replace the upholstery of the front seat.

Child restraint systems

A child restraint system for a small child or baby must be properly restrained on the seat with the lap portion of the lap/shoulder belt.

The laws of all 50 states of U.S.A. and Canada now require the use of child restraint systems.

Points to remember

Studies have shown that installing a child restraint system on a rear seat is much safer than installing one to the front passenger seat.

- Choose a child restraint system that suits your vehicle and appropriate to the age and size of the child.
- For installation details, follow the instructions provided with the child restraint system.

General installation instructions are provided in this manual.

(→P. 140)

Types of child restraints

Child restraint systems are classified into the following 3 types according to the age and size of the child.

▶ Rear facing — Infant seat/convertible seat

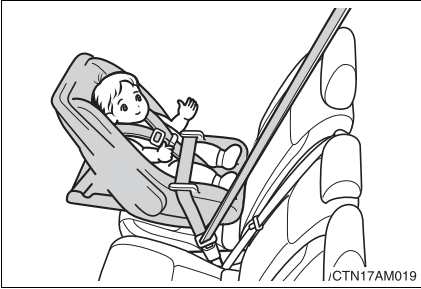

▶ Forward facing — Convertible seat

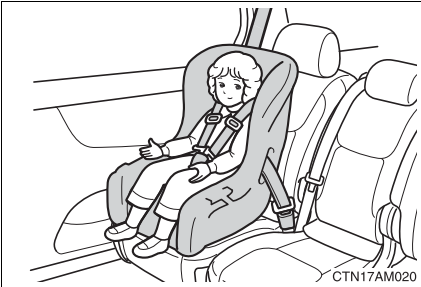

▶ Booster seat

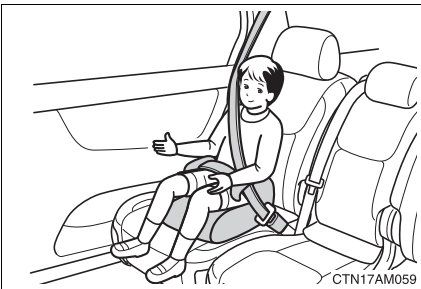

■ Selecting an appropriate child restraint system

- Use a child restraint system appropriate for the child until the child becomes large enough to properly wear the vehicle's seat belt.
- If a child is too large for a child restraint system, sit the child on a rear seat and use the vehicle's seat belt. (→P. 85)

CAUTION

■ Child restraint precautions

- For effective protection in automobile accidents and sudden stops, a child must be properly restrained, using a seat belt or child restraint system depending on the age and size of the child. Holding a child in your arms is not a substitute for a child restraint system. In an accident, the child can be crushed against the windshield, or between you and the vehicle's interior.
- Toyota strongly urges the use of a proper child restraint system that conforms to the size of the child, installed on the rear seat. According to accident statistics, the child is safer when properly restrained in the rear seat than in the front seat.
- Never install a rear-facing child restraint system on the front passenger seat even if the "AIR BAG OFF" indicator light is illuminated. In the event of an accident, the force of the rapid inflation of the front passenger airbag can cause death or serious injury to the child if the rear-facing child restraint system is installed on the front passenger seat.
- A forward-facing child restraint system may be installed on the front passenger seat only when it is unavoidable. A child restraint system that requires a top tether strap should not be used in the front passenger seat since there is no top tether strap anchor for the front passenger seat. Adjust the seatback as uprights as possible and always move the seat as far back as possible even if the "AIR BAG OFF" indicator light is illuminated, because the front passenger airbag could inflate with considerable speed and force. Otherwise, the child may be killed or seriously injured.

 **CAUTION****■ Child restraint precautions**

- Do not use the seat belt extender when installing a child restraint system on the front or rear passenger seat. If installing a child restraint system with the seat belt extender connected to the seat belt, the seat belt will not securely hold the child restraint system, which could cause death or serious injury to the child or other passengers in the event of an accident.
- Do not allow the child to lean his/her head or any part of his/her body against the side window or the area of the seat, front or side pillars or roof side rail from which the side airbags or curtain shield airbags deploy even if the child is seated in the child restraint system. It is dangerous if the side airbags and curtain shield airbags inflate, and the impact could cause death or serious injury to the child.
- Make sure you have complied with all installation instructions provided by the child restraint manufacturer and that the system is properly secured. If it is not secured properly, it may cause death or serious injury to the child in the event of a sudden stop or an accident.

■ Child restraint lock function belt precaution

Do not allow children to play with the child restraint lock function belt. If the belt becomes twisted around a child's neck, it will not be possible to pull the belt out leading to choking or other serious injuries that could result in death. If this occurs and the buckle cannot be unfastened, scissors should be used to cut the belt.

■ When the child restraint system is not in use

- Keep the child restraint system properly secured on the seat even if it is not in use.
Do not store the restraint unsecured in the passenger compartment.
- If it is necessary to detach the child restraint system, remove it from the vehicle or store it securely in the luggage compartment. This will prevent it from injuring passengers in the event of a sudden stop or an accident.

Installing child restraints

Follow the child restraint system manufacturer's instructions. Firmly secure child restraints to the rear seats using the LATCH anchors or a seat belt. Attach the top tether strap when installing a child restraint.

The lap/shoulder belt can be used if your child restraint system is not compatible with the LATCH (Lower Anchors and Tethers for Children) system.

■ Using the LATCH anchors

► Second seats (8-passenger models)

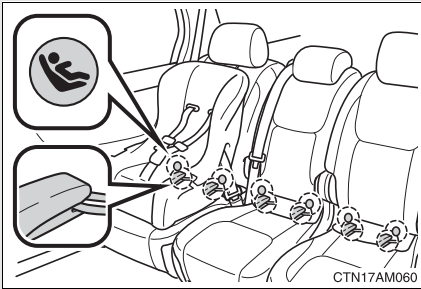

Child restraint LATCH anchors

LATCH anchors are provided for all second seats. (Buttons displaying the location of the anchors are attached to the seats.)

► Second seats (7-passenger models)

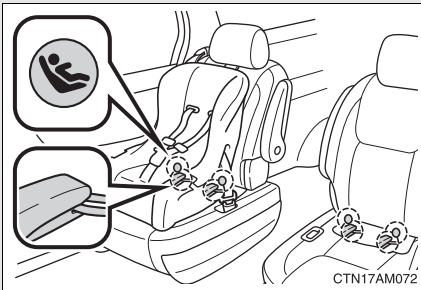

Child restraint LATCH anchors

LATCH anchors are provided for both second seats. (Buttons displaying the location of the anchors are attached to the seats.)

▶ Third seats

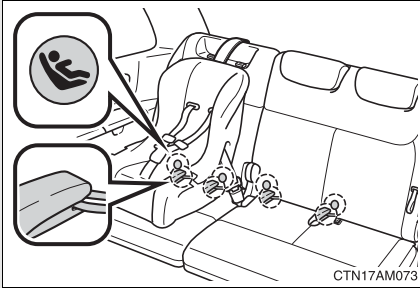

Child restraint LATCH anchors

LATCH anchors are provided for right and center seats. (Buttons displaying the location of the anchors are attached to the seats.)

■ Using the seat belts

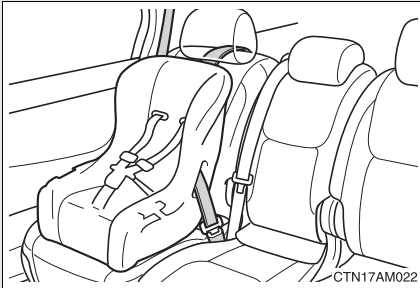

Seat belts equipped with a child restraint locking mechanism (ALR/ELR belts except driver's seat belt)

■ Using the top tether strap



Anchor brackets (for top tether strap)

► Second seats (8-passenger models)

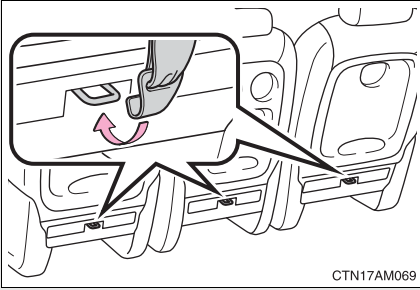

Anchor brackets are provided for all second seats.

► Second seats (7-passenger models)

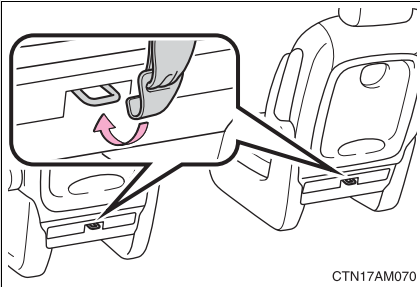

Anchor brackets are provided for both second seats.

► Third seats

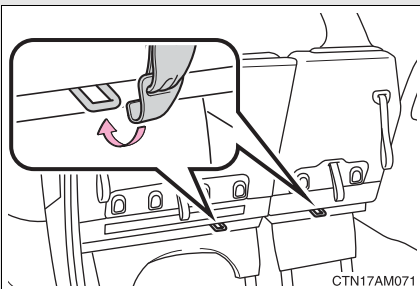

Anchor brackets are provided for right and center seats.

Installation with LATCH system (second seat)

■ Outer seats

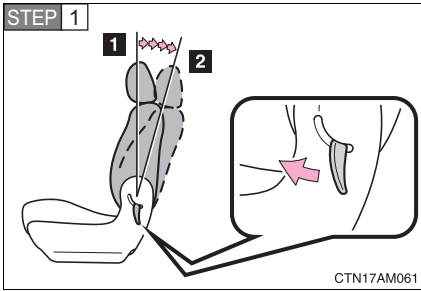

Fold the seatback while pulling the lever. Return the seatback and secure it at the 1st lock position (most upright position). Adjust the seatback to the 5th lock position. (→P. 59)

1 1st lock position

2 5th lock position

■ Center seat (if equipped)

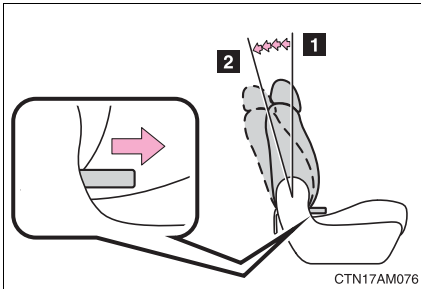

Fold the seatback while pulling the strap. Return the seatback and secure it at the 1st lock position (most upright position). Adjust the seatback to the 5th lock position. (→P. 59)

1 1st lock position

2 5th lock position

1

Before driving

► Type A

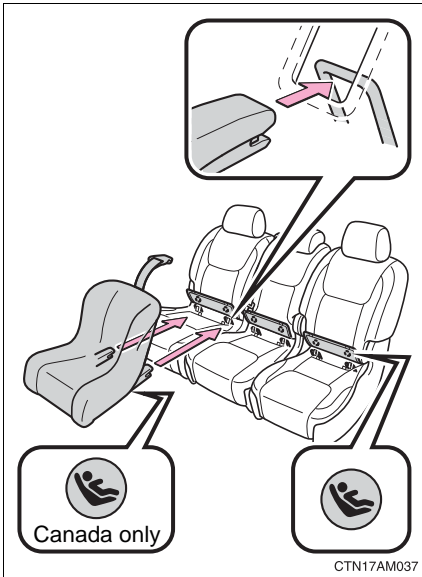

STEP 2 LATCH anchors are behind the button. Open the cover and confirm the position of the LATCH anchors.

STEP 3 Latch the buckles onto the LATCH anchors.

STEP 4 If the child restraint has a top tether strap, the top tether strap should be latched onto the top tether strap anchor. (→P. 152, 153)

For owners in Canada:

The symbol on a child restraint system indicates the presence of a lower connector system.

► Type B

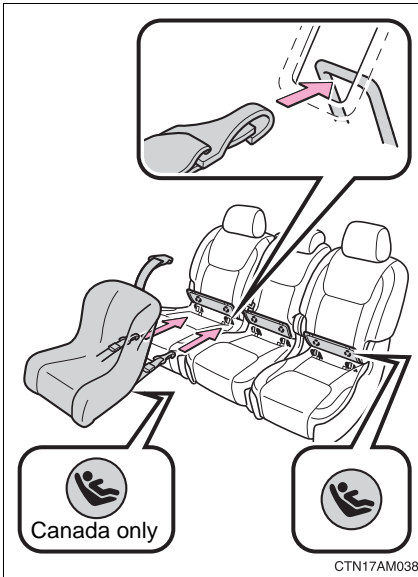

STEP 2 LATCH anchors are behind the button. Open the cover and confirm the position of the LATCH anchors.

STEP 3 Latch the hooks of the lower straps onto the LATCH anchors.

STEP 4 If the child restraint has a top tether strap, the top tether strap should be latched onto the top tether strap anchor.
(→P. 152, 153)

For owners in Canada:

The symbol on a child restraint system indicates the presence of a lower connector system.

Installation with LATCH system (third seat)

► Manual seat

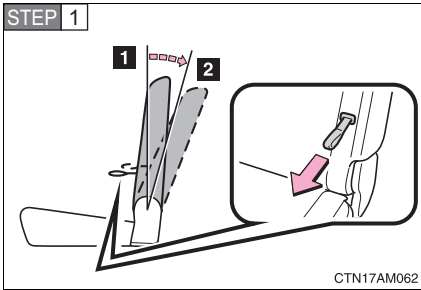

Fold the seatback while pulling the lever. Return the seatback and secure it at the 1st lock position (most upright position). Adjust the seatback to the 11th lock position. (→P. 61)

1 1st lock position

2 11th lock position

► Power seat

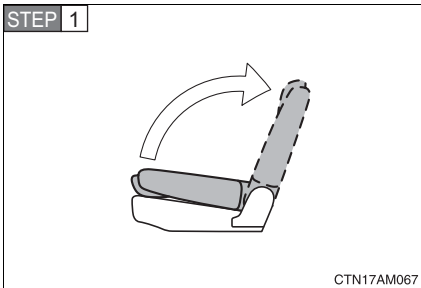

Fold down the seatback by pressing the folding/returning switch (→P. 72). Raise the seatback by pressing the same switch, the returning switch (→P. 76) or the seatback angle adjustment switch (→P. 61). (The seatback will automatically stop.) Do not touch the switch while the seatback is moving, because the operation will stop.

► Type A

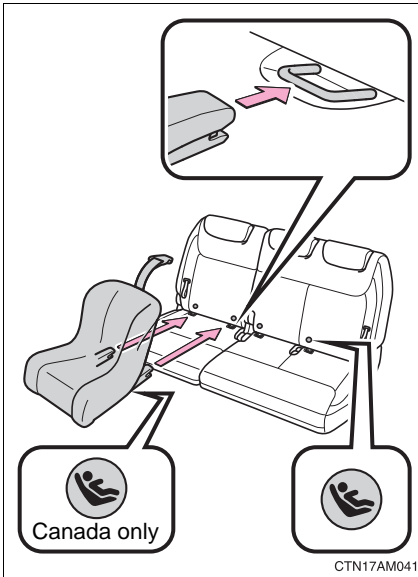

STEP 2 Widen the gap between the seat cushion and seatback slightly and confirm the position of the LATCH anchors near the button on the seatback.

STEP 3 Latch the buckles onto the LATCH anchors.

STEP 4 If the child restraint has a top tether strap, the top tether strap should be latched onto the top tether strap anchor.
(→P. 152, 153)

For owners in Canada:

The symbol on a child restraint system indicates the presence of a lower connector system.

► Type B

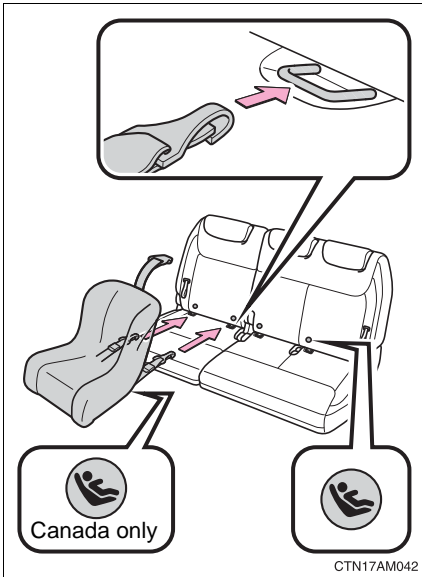

STEP 2 Widen the gap between the seat cushion and seatback slightly and confirm the position of the LATCH anchors near the button on the seatback.

STEP 3 Latch the hooks of the lower straps onto the LATCH anchors.

STEP 4 If the child restraint has a top tether strap, the top tether strap should be latched onto the top tether strap anchor. (→P. 152, 153)

For owners in Canada:

The symbol on a child restraint system indicates the presence of a lower connector system.

Installing child restraints using a seat belt (child restraint lock function belt)

■ Rear facing — Infant seat/convertible seat

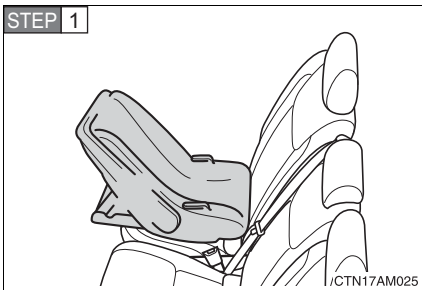

Place the child seat on the rear seat facing the rear of the vehicle.

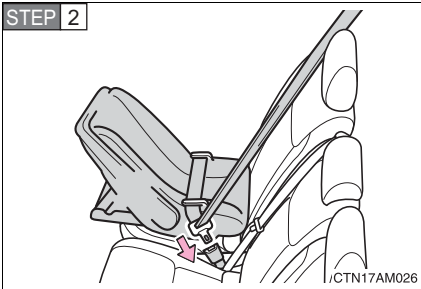

Run the seat belt through the child seat and insert the plate into the buckle. Make sure that the belt is not twisted.

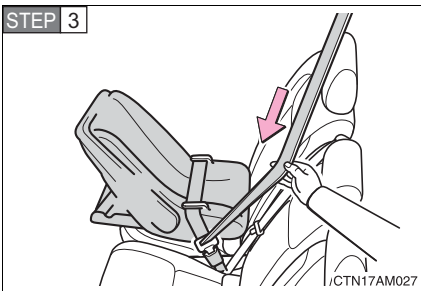

Fully extend the shoulder belt and then allow it to retract slightly in order to activate the ALR lock mode.

Lock mode allows the seat belt to retract only.

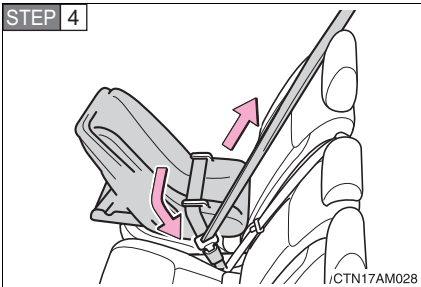

While pushing the child seat down into the rear seat, allow the shoulder belt to retract until the child seat is securely in place.

After the shoulder belt has retracted to a point where there is no slack in the belt, pull the belt to check that it cannot be extended.

■ Forward facing — Convertible seat

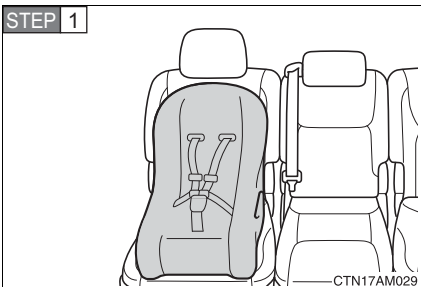

Place the child seat on the seat facing the front of the vehicle.

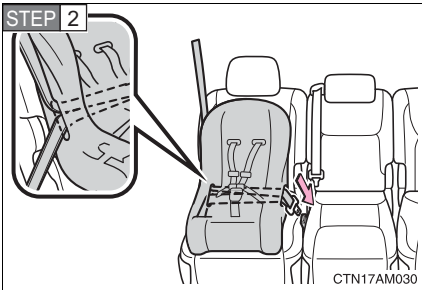

Run the seat belt through the child seat and insert the plate into the buckle. Make sure that the belt is not twisted.

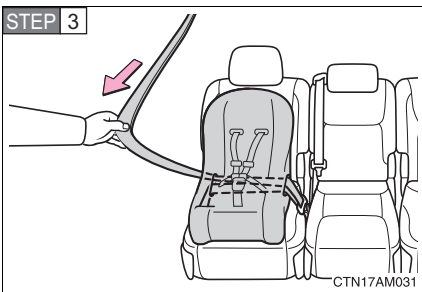

Fully extend the shoulder strap and then allow it to retract slightly into the ALR lock mode.

Lock mode allows the seat belt to retract only.

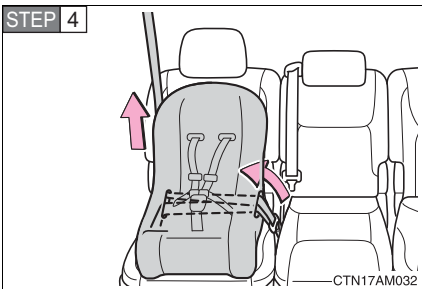

While pushing the child seat into the rear seat, allow the shoulder belt to retract until the child seat is securely in place.

After the shoulder belt has retracted to a point where there is no slack in the belt, pull the belt to check that it cannot be extended.

STEP 5 If the child restraint has a top tether strap, the top tether strap should be latched onto the top tether strap anchor.
(→P. 152, 153)

■ Booster seat

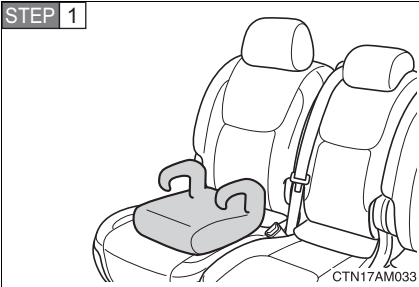

Place the booster seat on the seat facing the front of the vehicle.

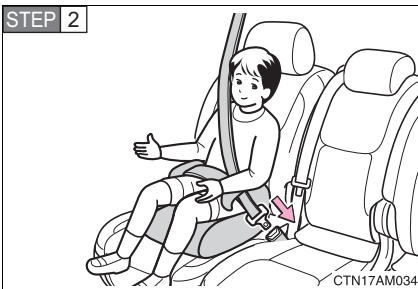

Sit the child in the booster seat. Fit the seat belt to the booster seat according to the manufacturer's instructions and insert the plate into the buckle. Make sure that the belt is not twisted.

Check that the shoulder belt is correctly positioned over the child's shoulder, and that the lap belt is as low as possible. (→P. 85)

Removing a child restraint installed with a seat belt

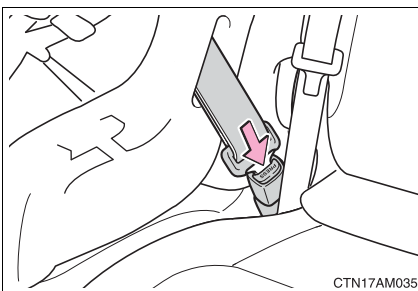

Push the buckle release button and fully retract the seat belt.

Child restraint systems with a top tether strap (second seat)

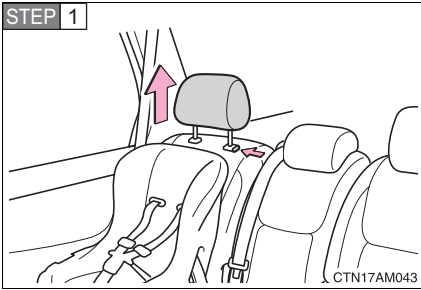

Secure the child restraint using the seat belt or LATCH anchors. Remove the head restraint.

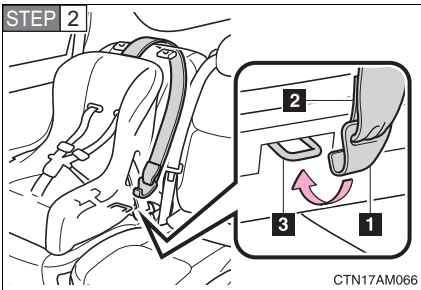

Latch the hook onto the anchor bracket and tighten the top tether strap.

Make sure the top tether strap is securely latched.

- 1** Hook
- 2** Top tether strap
- 3** Anchor bracket

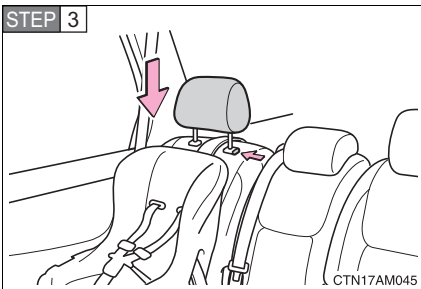

Replace the head restraint.

Child restraint systems with a top tether strap (third seat)

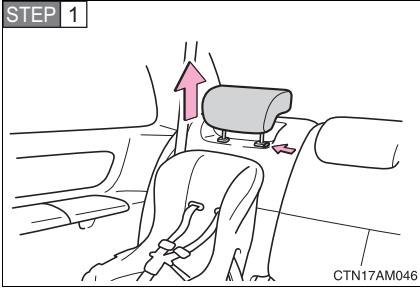

Secure the child restraint using the seat belt or LATCH anchors. Remove and safely stow the head restraint.

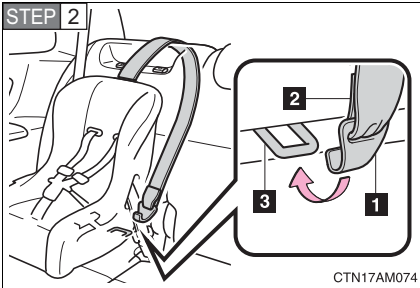

Latch the hook onto the anchor bracket and tighten the top tether strap.

Make sure the top tether strap is securely latched.

- 1** Hook
- 2** Top tether strap
- 3** Anchor bracket

■ Laws and regulations pertaining to anchorages

The LATCH system conforms to FMVSS225 or CMVSS210.2.

Child restraint systems conforming to FMVSS213 or CMVSS213 specifications can be used.

This vehicle is designed to conform to the SAE J1819.

! CAUTION

■ When installing a booster seat

Do not fully extend the shoulder belt to prevent the belt from going to ALR lock mode: (→P. 88)

ALR mode causes the belt to tighten only which could cause injury or discomfort to the child.

■ When installing a child restraint system

Follow the directions given in the child restraint system installation manual and fix the child restraint system securely in place.

If the child restraint system is not correctly fixed in place, the child or other passengers may be seriously injured or even killed in the event of sudden braking or an accident.

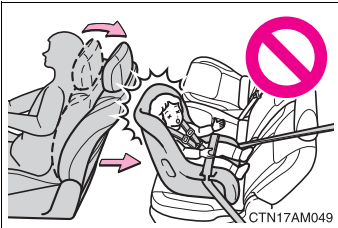

● If the driver's seat interferes with the child restraint system and prevents it from being attached correctly, attach the child restraint system to the right-hand rear seat.

● Adjust the front passenger seat or second seats so that it does not interfere with the child restraint system.

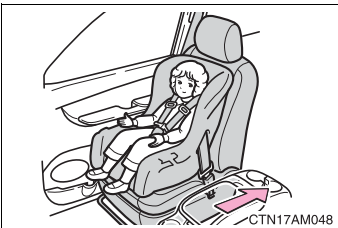

● Only put a forward-facing or booster child seat on the front seat when unavoidable. When installing a forward-facing or booster child seat on the front passenger seat, move the seat as far back as possible even if "AIR BAG OFF" indicator light is illuminated. Failing to do so may result in death or serious injury if the airbags deploy (inflate).

 **CAUTION****■ When installing a child restraint system**

- When installing a child restraint system in the third center seat, adjust both seatbacks at the same angle. Otherwise, the child restraint system cannot be securely restrained and this may cause death or serious injuries in an accident.
- When using the LATCH anchors for a child restraint system, move the seat as far back as possible (second seat only), with the seatback close to the child restraint system.
- When a booster seat is installed, always ensure that the shoulder belt is positioned across the center of the child's shoulder. The belt should be kept away from the child's neck, but not so that it could fall off the child's shoulder. Failing to do so may result in death or serious injury in the event of an accident or sudden braking.
- Ensure that the belt and tab are securely locked and the seat belt is not twisted.
- Push and pull the child seat in different directions to be sure it is secure.
- After securing a child restraint system, never adjust the seat.
- Follow all installation instructions provided by the child restraint system manufacturer.
- Third seats: When a child restraint system with a top tether strap is installed, do not install the head restraint. The head restraint may interfere with the top tether strap preventing secure installation of the child restraint system.
- Make sure to properly store the removed head restraint in a secure place when you use the child restraint system on the third seat.

■ Do not use a seat belt extender

If a seat belt extender is used when installing a child restraint system, the seat belt will not securely hold the child restraint system, which could cause death or serious injury to the child or other passengers in the event of an accident.



CAUTION

■ **To correctly attach a child restraint system to the anchors**

When using the LATCH anchors, be sure that there are no foreign objects around the anchors and that the seat belt is not caught behind the child restraint. Make sure the child restraint system is securely attached, or it may cause death or serious injury to the child or other passengers in the event of a sudden stop or an accident.

2-1. Driving procedures

Driving the vehicle

The following procedures should be observed to ensure safe driving.

■ Starting the engine

→P. 167

■ Driving

STEP 1 With the brake pedal depressed, shift the shift lever to D. (→P. 170)

STEP 2 Release the parking brake. (→P. 173)

STEP 3 Gradually release the brake pedal and gently depress the accelerator pedal to accelerate the vehicle.

■ Stopping

STEP 1 With the shift lever in D, depress the brake pedal.

STEP 2 If necessary, set the parking brake.

When the vehicle is stopped for an extended period of time, shift the shift lever to P or N. (→P. 170)

■ Parking the vehicle

STEP 1 With the shift lever in D, depress the brake pedal.

STEP 2 Set the parking brake. (→P. 173)

STEP 3 Shift the shift lever to P. (→P. 170)

When parking on a hill, if necessary, block the wheels.

STEP 4 Turn the engine switch to the “LOCK” position and stop the engine.

STEP 5 Lock the door, making sure that you have the key on your person.

Starting on a steep uphill

- STEP 1** Firmly set the parking brake and shift the shift lever to D.
- STEP 2** Gently depress the accelerator pedal.
- STEP 3** Release the parking brake.

■ Driving in the rain

- Drive carefully when it is raining, because visibility will be reduced, the windows may become fogged-up, and the road will be slippery.
- Drive carefully when it starts to rain, because the road surface will be especially slippery.
- Refrain from high speeds when driving on an expressway in the rain, because there may be a layer of water between the tires and the road surface, preventing the steering and brakes from operating properly.

■ Breaking in your new Toyota

To extend the life of the vehicle, the following precautions are recommended to observe:

- For the first 200 miles (300 km):
Avoid sudden stops.
- For the first 500 miles (800 km):
Do not tow a trailer.
- For the first 1000 miles (1600 km):
 - Do not drive at extremely high speeds.
 - Avoid sudden acceleration.
 - Do not drive continuously in the low gears.
 - Do not drive at a constant speed for extended periods.

■ Drum-in-disc type parking brake system

Your vehicle has a drum-in-disc type parking brake system. This type of brake system needs bedding-down of the brake shoes periodically or whenever the parking brake shoes and/or drum are replaced. Have your Toyota dealer perform the bedding down.

■ Operating your vehicle in a foreign country

Comply with the relevant vehicle registration laws and confirm the availability of the correct fuel. (→P. 544)

CAUTION

■ When starting the vehicle

Always keep your foot on the brake pedal while stopped with the engine running. This prevents the vehicle from creeping.

■ When driving the vehicle

- Do not drive if you are unfamiliar with the location of the brake and accelerator pedals to avoid depressing the wrong pedal.
 - Accidentally depressing the accelerator pedal instead of the brake pedal will result in sudden acceleration that may lead to an accident that could result in death or serious injury.
 - When backing up, you may twist your body around, leading to a difficulty in operating the pedals. Make sure to operate the pedals properly.
 - Make sure to keep a correct driving posture even when moving the vehicle only slightly, allowing you to depress the brake and accelerator pedals properly.
 - Depress the brake pedal using your right foot. Depressing the brake pedal using your left foot may delay response in an emergency, resulting in an accident.
- Do not drive the vehicle over or stop the vehicle near flammable materials. The exhaust system and exhaust gases can be extremely hot. This may cause a fire if there is any flammable material nearby.
- Do not let the vehicle roll backwards while the shift lever is in a driving position, or roll forward while the shift lever is in R. Doing so may cause the engine to stall or lead to poor brake and steering performance, resulting in an accident or damage to the vehicle.

 CAUTION

- If the smell of exhaust is noticed inside the vehicle, open the windows and check that the back door is closed. Large amounts of exhaust in the vehicle can cause driver drowsiness and an accident, resulting in death or a serious health hazard. Have the vehicle inspected by your Toyota dealer immediately.
- Do not shift the shift lever to P while the vehicle is moving. Doing so can damage the transmission and may result in a loss of vehicle control.
- Do not shift the shift lever to R while the vehicle is moving forward. Doing so can damage the transmission and may result in a loss of vehicle control.
- Do not shift the shift lever to D while the vehicle is moving backward. Doing so can damage the transmission and may result in a loss of vehicle control.
- Moving the shift lever to N while the vehicle is moving will disengage the engine from the transmission. Engine braking is not available when N is selected.
- During normal driving, do not turn off the engine. Turning the engine off while driving will not cause loss of steering or braking control, but the power assist to these systems will be lost. This will make it more difficult to steer and brake, so you should pull over and stop the vehicle as soon as it is safe to do so.
However, in the event of an emergency, such as if it becomes impossible to stop the vehicle in the normal way: →P. 504
- Use engine braking (downshift) to maintain a safe speed when driving down a steep hill. Using the brakes continuously may cause the brakes to overheat and lose effectiveness. (→P. 170)
- When stopped on an inclined surface, use the brake pedal and parking brake to prevent the vehicle from rolling backward or forward and causing an accident.
- Do not adjust the position of the steering wheel, the seat, or the inside or outside rear view mirrors while driving. Doing so may result in a loss of vehicle control that can cause accidents that may result in death or serious injury.

 **CAUTION**

- Always check that all passengers' arms, heads or other parts of their bodies are not outside the vehicle, as this may result in death or serious injury.
- Do not drive the vehicle off-road.
This is not a AWD vehicle designed for real off-road driving. Proceed with all due caution if it becomes unavoidable to drive off-road.
- Do not drive across a river or through other bodies of water.
This may cause electric/electronic components to short circuit, damage the engine or cause other serious damage to the vehicle.
- Do not drive in excess of the speed limit. Even if the legal speed limit permits it, do not drive over 85 mph (140 km/h) unless your vehicle has high-speed capability tires. Driving over 85 mph (140 km/h) may result in tire failure, loss of control and possible injury. Be sure to consult a tire dealer to determine whether the tires on your vehicle are high-speed capability tires or not before driving at such speeds.

■ **When driving on slippery road surfaces**

- Sudden braking, acceleration and steering may cause tire slippage and reduce your ability to control the vehicle, resulting in an accident.
- Sudden changes in engine speed, such as engine braking caused by up-shifting or down-shifting, may cause the vehicle to skid, resulting in an accident.
- After driving through a puddle, lightly depress the brake pedal to make sure that the brakes are functioning properly. Wet brake pads may prevent the brakes from functioning properly. If the brakes on only one side are wet and not functioning properly, steering control may be affected, resulting in an accident.

■ **When shifting the shift lever**

Be careful not to shift the shift lever with the accelerator pedal depressed. This may lead to unexpected rapid acceleration of the vehicle that may cause an accident and result in death or serious injury.

■ **When the vehicle is stopped**

- Do not race the engine. If the vehicle is in any gear other than P or N, the vehicle may accelerate suddenly and unexpectedly, and may cause an accident.

 **CAUTION**

- Do not leave the vehicle with the engine running for a long time. If such a situation cannot be avoided, park the vehicle in an open space and check that exhaust fumes do not enter the vehicle interior.
- Always keep a foot on the brake pedal while the engine is running to prevent an accident caused by the vehicle moving.

■ When the vehicle is parked

- Do not leave glasses, cigarette lighters, spray cans, or soft drink cans in the vehicle when it is in the sun. Doing so may result in the following.
 - Gas may leak from a cigarette lighter or spray can, and may lead to a fire.
 - The temperature inside the vehicle may cause the plastic lenses and plastic material of eye glasses to deform or crack.
 - Soft drink cans may fracture, causing the contents to spray over the interior of the vehicle, and may also cause a short circuit in the vehicle's electrical components.
- Always apply the parking brake, shift the shift lever to P, stop the engine and lock the vehicle.
Do not leave the vehicle unattended while the engine is running.
- Do not touch the exhaust pipe while the engine is running or immediately after turning the engine off. Doing so may cause burns.
- Do not leave the engine running in an area with snow build-up, or where it is snowing. If snowbanks build up around the vehicle while the engine is running, exhaust gases may collect and enter the vehicle. This may lead to death or a serious health hazard.

■ Exhaust gases

Exhaust gases include harmful carbon monoxide (CO) that is colorless and odorless. Inhaling exhaust gases may lead to death or a serious health hazard.

- If the vehicle is in a poorly ventilated area, stop the engine. In a closed area, such as a garage, exhaust gases may collect and enter the vehicle. This may lead to death or a serious health hazard.

 **CAUTION**

- The exhaust should be checked occasionally. If there is a hole or crack caused by corrosion, damage to a joint or abnormal exhaust noise, be sure to have the vehicle inspected and repaired by your Toyota dealer. Failure to do so may allow exhaust gases to enter the vehicle, resulting in death or a serious health hazard.

■ **When taking a nap in the vehicle**

Always turn the engine off. Otherwise, you may accidentally move the shift lever or depress the accelerator pedal, which could cause an accident or fire due to engine overheating. Additionally, if the vehicle is parked in a poorly ventilated area, exhaust gases may collect and enter the vehicle, leading to death or a serious health hazard.

■ **When braking the vehicle**

- When the brakes are wet, drive more cautiously.
Braking distance increases when the brakes are wet, and may cause one side of the vehicle to brake differently than the other side. Also the parking brake may not securely hold the vehicle.
- If the power brake assist function does not operate, do not follow other vehicles closely and avoid downhills or sharp turns that require braking. In this case, braking is still possible, but it will require more force on the pedal than usual. Braking distance may also increase.
- Do not pump the brake pedal if the engine stalls.
Each push on the brake pedal uses up the reserve for the power-assisted brakes.
- The brake system consists of 2 individual hydraulic systems: If one of the systems fails, the other will still operate. In this case, the brake pedal should be depressed more firmly than usual and braking distance becomes longer.
Do not drive your vehicle with only a single brake system. Have your brakes fixed immediately.

■ **If the vehicle becomes stuck or bogged (AWD models)**

Do not spin the wheels recklessly when any of the tires is up in the air, or stuck in sand or mud, etc. This may damage the drive system components or propel the vehicle forward (or in another direction) and cause an accident.

 NOTICE**■ When driving the vehicle**

Do not use the accelerator pedal or depress the accelerator and brake pedals together to hold the vehicle on a hill.

■ When parking the vehicle

Always put the shift lever in P. Failure to do so may cause the vehicle to move or the vehicle may accelerate suddenly if the accelerator pedal is accidentally depressed.

■ Avoiding damage to vehicle parts

- Do not turn the steering wheel fully in either direction and hold it there for a long time. Doing so may damage the power steering pump.
- When driving over bumps in the road, drive as slowly as possible to avoid damaging the wheels, underside of the vehicle, etc.

■ If you hear a squealing or scraping noise (brake pad wear limit indicators)

Have the brake pads checked and replaced by your Toyota dealer as soon as possible.

Rotor damage can result if the pads are not replaced when needed.

It is dangerous to drive the vehicle when the wear limits of the brake pads and/or those of the brake discs are exceeded.

 NOTICE

■ **If you get a flat tire while driving**

A flat or damaged tire may cause the following situations. Hold the steering wheel firmly and gradually press the brake pedal to slow down the vehicle.

- It may be difficult to control your vehicle.
- The vehicle will make abnormal sounds.
- The vehicle will behave abnormally.

Replace a flat tire with a new one. (→P. 520)

■ **When encountering flooded roads**

Do not drive on a road that has flooded after heavy rain etc. Doing so may cause the following serious damage to the vehicle.

- Engine stalling
- Short in electrical components
- Engine damage caused by water immersion

In the event that you drive on a flooded road and the vehicle is flooded, be sure to have your Toyota dealer check the following.

- Brake function
- Changes in quantity and quality of oil and fluid used for the engine, transaxle, transfer (AWD models), differential, etc.
- Lubricant condition for the propeller shaft (AWD models), bearings and suspension joints (where possible) and the function of all joints, bearings, etc.

2-1. Driving procedures

Engine (ignition) switch

■ Starting the engine

- STEP 1** Check that the parking brake is set.
- STEP 2** Check that the shift lever is set in P.
- STEP 3** Sit in the driver's seat and firmly depress the brake pedal.
- STEP 4** Turn the engine switch to the "START" position and start the engine.

The engine will crank until it starts or for up to 25 seconds, whichever is less. If you turn the engine switch, the engine will keep cranking for about 30 seconds maximum.

Continue depressing the brake pedal until the engine is completely started.

■ Engine (ignition) switch

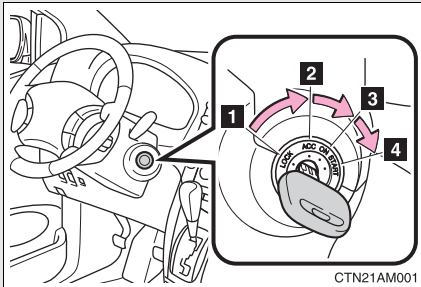

1 "LOCK"

The steering wheel is locked and the key can be removed. (The key can be removed only when the shift lever is in "P".)

2 "ACC"

Some electrical components such as the audio system can be used.

3 "ON"

All electrical components can be used.

4 "START"

For starting the engine.

■ Steering lock release

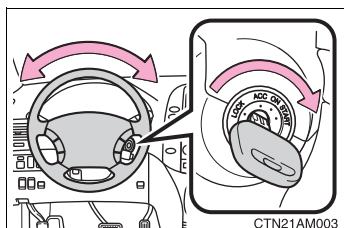

When starting the engine, the engine switch may seem stuck in the “LOCK” position. To free it, turn the key while turning the steering wheel slightly in either direction.

■ If the engine does not start (vehicles with engine immobilizer system)

The engine immobilizer system may not have been deactivated. (→P. 111)

■ Key reminder buzzer

A buzzer sounds if the driver's door is opened while the engine switch is in the “LOCK” or “ACC” position to remind you to remove the key.

⚠ CAUTION

■ When starting the engine

Always start the engine while sitting in the driver's seat. Do not depress the accelerator while starting the engine under any circumstances.

Doing so may cause an accident resulting in death or serious injury.

■ Caution when driving

Do not turn the engine switch to the “LOCK” position while driving. If, in an emergency, you must turn the engine off while the vehicle is moving, turn the engine switch only to the “ACC” position.

 NOTICE**■ To prevent battery discharge**

Do not leave the key in the “ACC” or “ON” position for long periods if the engine is not running.

■ When starting the engine

- Do not race a cold engine.
- If the engine becomes difficult to start or stalls frequently, have the engine checked immediately.

2-1. Driving procedures

Automatic transmission

Select a shift position appropriate for the driving conditions.

■ Shifting the shift lever

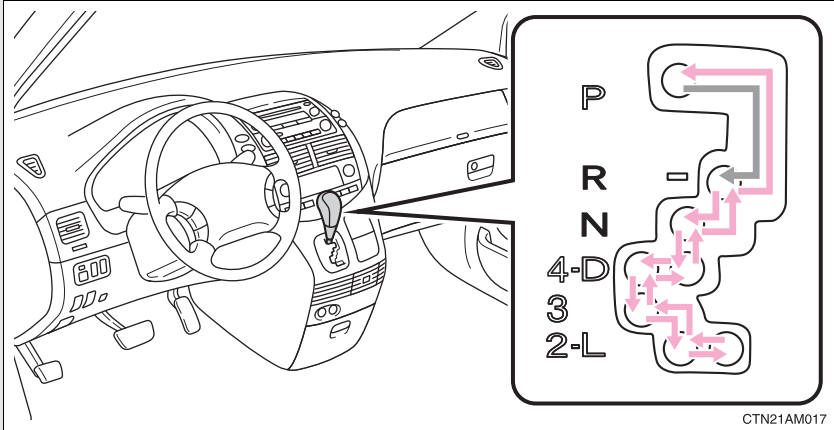

← While the engine switch is in the “ON” position, depress the brake pedal and move the shift lever.

■ Shift position uses

Shift position	Function
P	Parking the vehicle or starting the engine
R	Reversing
N	Neutral
D	Normal driving*
4	Position for engine braking
3, 2	Position for more powerful engine braking
L	Position for maximum engine braking

*: To improve fuel efficiency and reduce noises, set the shift lever in the D position for normal driving.

■ Downshifting restrictions

The shift lever cannot be downshifted if the following speeds are exceeded.

▶ 2WD models

mph (km/h)

Downshifting	Maximum speed
4→3	100 (162)
3→2	64 (104)
2→L	36 (58)

▶ AWD models

mph (km/h)

Downshifting	Maximum speed
4→3	95 (154)
3→2	61 (99)
2→L	34 (55)

■ When driving with the cruise control system

Engine braking will not occur when downshifting from D to 4. (→P. 194, 197)

■ If the shift lever cannot be shifted from P

→P. 530

2-1. Driving procedures

Turn signal lever

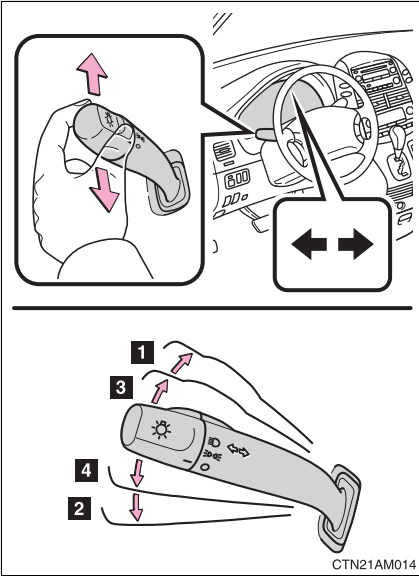

- 1 Right turn
- 2 Left turn
- 3 Move and hold the lever partway to signal a lane change.

The right hand signal will flash until you release the lever.

- 4 Move and hold the lever partway to signal a lane change.

The left hand signal will flash until you release the lever.

■ Turn signals can be operated when

The engine switch is in the "ON" position.

■ If the indicators flash faster than usual

Check that a light bulb in the front or rear turn signal lights has not burned out.

Parking brake

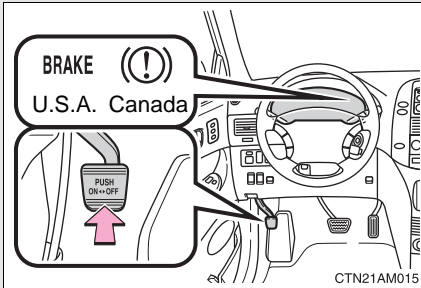

Sets the parking brake*

(Depressing the pedal again releases the parking brake.)

*: Fully depress the parking brake pedal with your left foot while depressing the brake pedal with your right foot.

 NOTICE

Before driving

Fully release the parking brake.

Driving the vehicle with the parking brake set will lead to brake components overheating, which may affect braking performance and increase brake wear.

2-2. Instrument cluster and information display

Gauges and meters

► Optriton type meters

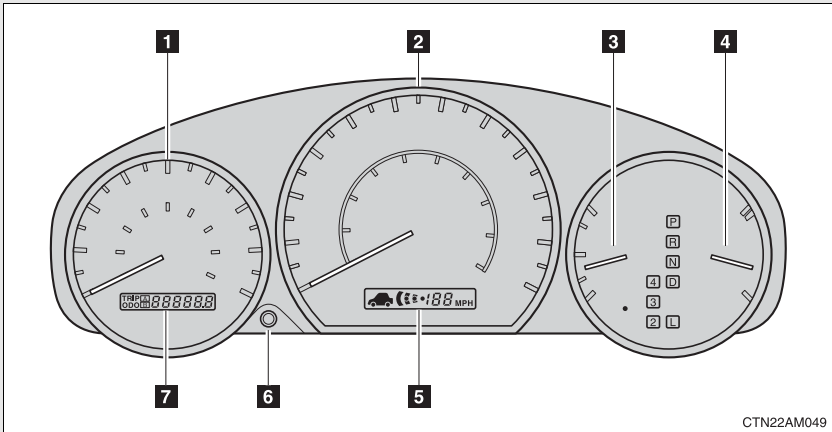

► Non-Optriton type meters

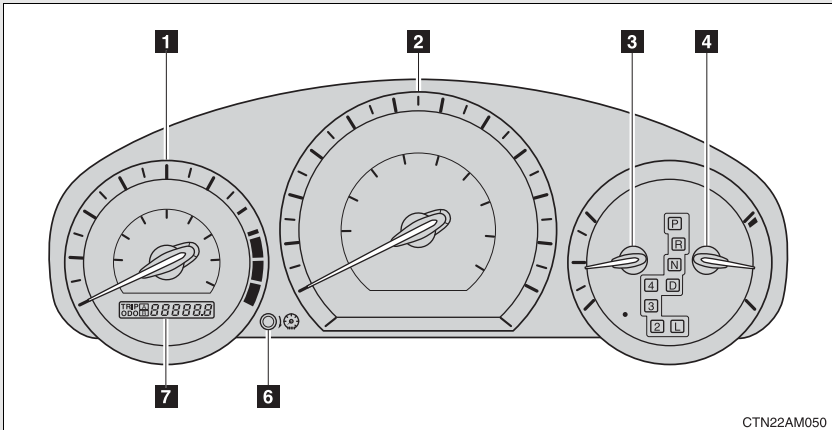

Optriton type meters only — The following gauges, meters and displays illuminate when the engine switch is in the “ON” position.

1 Tachometer

Displays the engine speed in revolutions per minute.

2 Speedometer

Displays the vehicle speed.

3 Fuel gauge

Displays the quantity of fuel remaining in the tank.

4 Engine coolant temperature gauge

Displays the engine coolant temperature.

5 Dynamic laser cruise control display (if equipped)

→P. 197

6 Odometer/trip meter/instrument panel light control and trip meter reset button

Switches between odometer and trip meter displays. Pressing and holding the button will reset the trip meter when the trip meter is being displayed.

To adjust the brightness of the instrument panel light, turn the button. (→P. 176)

7 Odometer and trip meter

Odometer: Displays the total distance the vehicle has been driven.

Trip meter: Displays the distance the vehicle has been driven since the meter was last reset. Trip meters "A" and "B" can be used to record and display different distances independently.

Instrument panel light control

The brightness of the instrument panel lights can be adjusted.

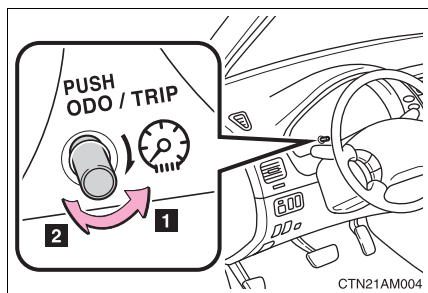

1 Darker

2 Brighter

Optitron type meters only:
When the headlight switch is turned on, the brightness will be reduced slightly unless the control button is turned fully clockwise.

NOTICE

■ To prevent damage to the engine and its components

- Do not let the indicator needle of the tachometer enter the red zone, which indicates the maximum engine speed.
- The engine may be overheating if the engine coolant temperature gauge is in the red zone (H). In this case, immediately stop the vehicle in a safe place, and check the engine after it has cooled completely. (→P. 536)

2-2. Instrument cluster and information display Indicators and warning lights

The indicator and warning lights on the instrument cluster and center panel inform the driver of the status of the vehicle's various systems.

■ Instrument cluster

▶ Optitron type meters

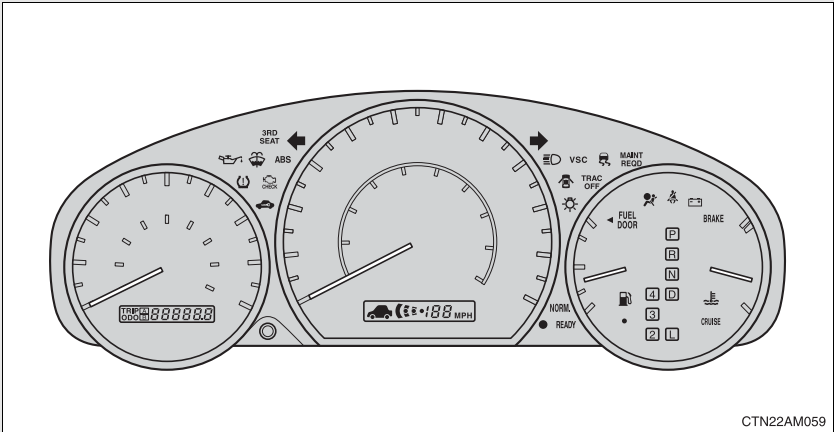

▶ Non-Optitron type meters

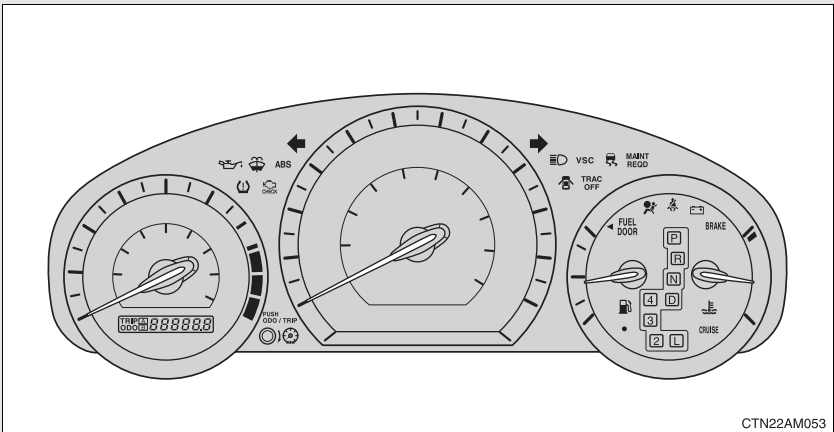



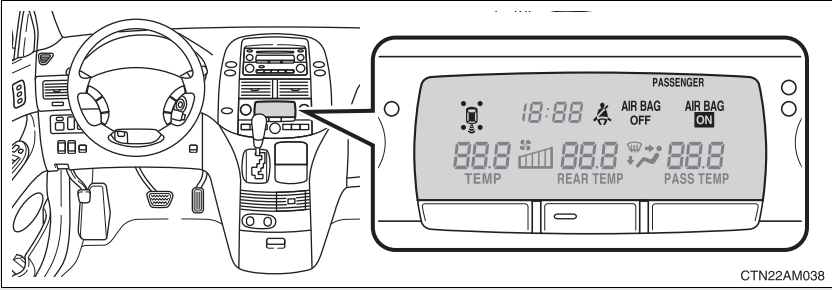









■ Center panel

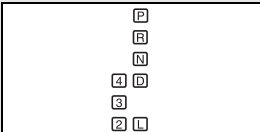

■ Indicators

The indicators inform the driver of the operating state of the vehicle's various systems.

	Turn signal indicator (→P. 172)		Headlight indicator (→P. 185)
		(if equipped)	
	Headlight high beam indicator (→P. 186)		Tail light indicator (→P. 185)
		(if equipped)	
	Slip indicator (→P. 215)		Engine immobilizer/theft deterrent system indicator (→P. 111, 113)
		(if equipped)	
	Cruise control indicator/ dynamic laser cruise control indicator (→P. 194, 197)		Shift position indicators (→P. 170)
	Conventional cruise control mode indicator (→P. 197)		Intuitive parking assist indicator (→P. 209)
(if equipped)		(if equipped)	
	Dynamic laser cruise control ready mode indicator (→P. 197)		"TRAC OFF" indicator (→P. 216)
(if equipped)		(if equipped)	
	"AIR BAG ON" and "AIR BAG OFF" indicator (→P. 130)		

*1: These lights turn on when the engine switch is turned to the "ON" position to indicate that a system check is being performed. They will turn off after the engine is started, or after a few seconds. There may be a malfunction in a system if a light does not come on, or if the lights do not turn off. Have the vehicle inspected by your Toyota dealer for details.

*2: For vehicles sold in U.S.A. *3: For vehicles sold in Canada

■ Warning lights

Warning lights inform the driver of malfunctions in any of the vehicle's systems. (→P. 504)

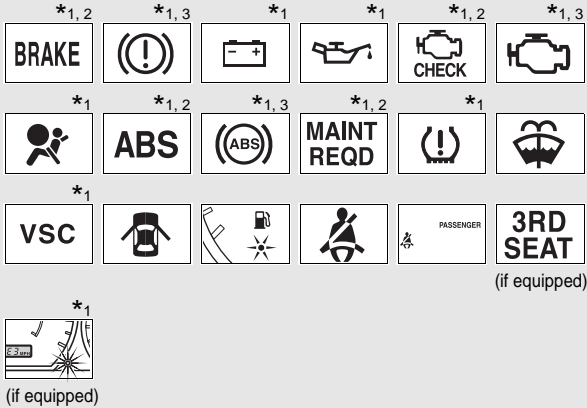

*1: These lights turn on when the engine switch is turned to the “ON” position to indicate that a system check is being performed. They will turn off after the engine is started, or after a few seconds. There may be a malfunction in a system if a light does not come on, or if the lights do not turn off. Have the vehicle inspected by your Toyota dealer for details.

*2: For vehicles sold in U.S.A.

*3: For vehicles sold in Canada

⚠ CAUTION

■ If a safety system warning light does not come on

Should a safety system light such as the ABS or SRS airbag warning light not come on when you start the engine, this could mean that these systems are not available to help protect you in an accident, which could result in death or serious injury. Have the vehicle inspected by your Toyota dealer immediately if this occurs.

2-2. Instrument cluster and information display

Trip information display (if equipped)

The trip information display presents the driver with a variety of driving-related data, including the current outside temperature.

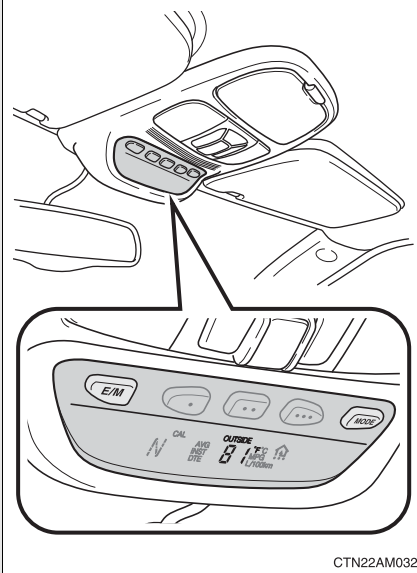

Trip information (→P. 182)

Displays outside temperature, fuel consumption and cruising range.

“E/M” button is used to switch between English/U.S. Customary System and metric units. (→P. 183)

Trip information

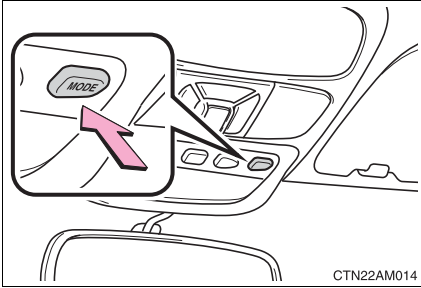

Push the “MODE” button to display trip information.

Display items can be switched by pressing the “MODE” button.

■ Outside temperature



Displays the outside temperature.

The temperature range that can be displayed is from -40°F (-40°C) to 140°F (60°C).

■ Average fuel consumption



Displays the average fuel consumption since the function was reset.

To reset the calculations, return the mode to “AVG” and push and hold the “MODE” and “E/M” buttons simultaneously for 2 seconds.

■ Instantaneous fuel consumption



Displays the instantaneous fuel consumption.

■ Cruising range



Displays the estimated maximum distance that can be driven with the quantity of fuel remaining.

- This distance is computed based on your average fuel consumption. As a result, the actual distance that can be driven may differ from that displayed.
- When only a small amount of fuel is added to the tank, the display may not be updated.

E/M button

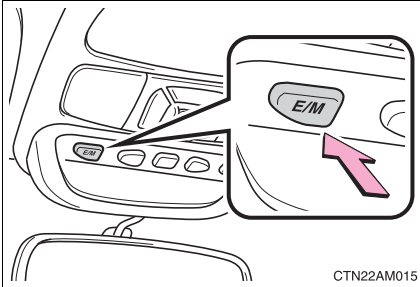

Each time you push the “E/M” button, the display switches (as shown in the following table).

This is also linked to the front and rear air conditioning displays.

2

When driving

Indication	Outside temperature	Average fuel consumption/ Instantaneous fuel consumption	Distance to empty
English/U.S. Customary System (E)	°F	MPG	MI
Metric (M)	°C	L/100 km	km

■ Outside temperature display

In the following situations, the correct outside temperature may not be displayed, or the display may take longer than normal to change.

- When stopped, or driving at low speeds (less than 12 mph [20 km/h])
- When the outside temperature has changed suddenly (at the entrance/exit of a garage, tunnel, etc.)

2-3. Operating the lights and wipers

Headlight switch

The headlights can be operated manually or automatically.

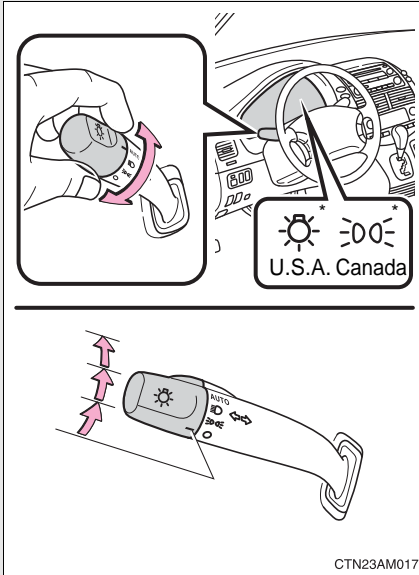

The side marker, parking, tail, license plate and instrument panel lights turn on.



The headlights and all lights listed above turn on.

AUTO

(if equipped) The headlights, side marker, parking, tail, license plate and instrument panel lights turn on and off automatically.

(When the engine switch is in the "ON" position)

*: if equipped

Turning on the high beam headlights

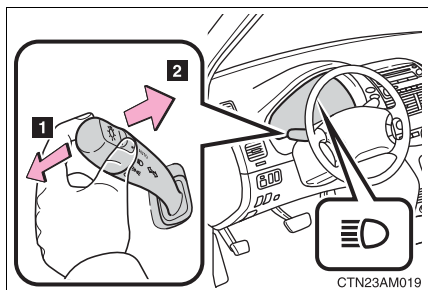

1 With the headlights on, push the lever forward to turn on the high beams.

Pull the lever back to the center position to turn the high beams off.

2 Pull the lever toward you to turn on the high beams.

Release the lever to turn them off. You can flash the high beams with the headlights on or off.

Manual headlight leveling dial (vehicles with discharge headlights)

The level of the headlights can be adjusted according to the number of passengers and the loading condition of the vehicle.

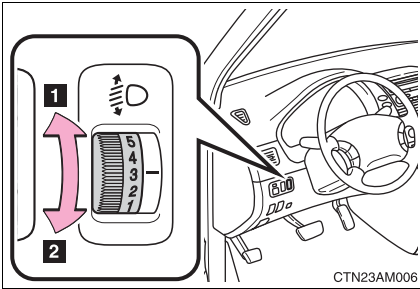

- 1** Raises the level of the headlights
- 2** Lowers the level of the headlights

■ Guide to dial settings

Occupancy and luggage load conditions		Dial position	
Occupants	Luggage load	7-passenger models	8-passenger models
Driver	None	0	0
Driver and front passenger	None	0	0
Driver, front passenger and all passengers in the second seat	None	1	1
All seats occupied	None	1	1
All seats occupied	Full luggage loading	1	2
Driver	Full luggage loading	1	2

■ Daytime running light system (if equipped)

To make your vehicle more visible to other drivers, the headlights turn on automatically (at a reduced intensity) whenever the engine is started and the parking brake is released. Daytime running lights are not designed for use at night.

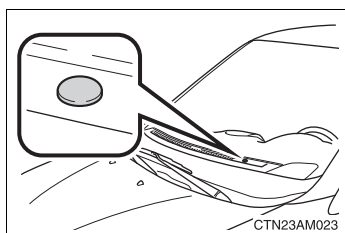

■ Headlight control sensor (if equipped)





The sensor may not function properly if an object is placed on the sensor, or anything that blocks the sensor is affixed to the windshield.

Doing so interferes with the sensor detecting the level of ambient light and may cause the automatic headlight system to malfunction.

■ Automatic light off system

- When the light switch is in the  or **AUTO** position with the tail lights on: The tail lights turn off after driver's door is opened if the engine switch has been turned to the "ACC" or "LOCK" position.
- When the light switch is in the  or **AUTO** position with the headlights on: The headlights and all lights turn off 30 seconds after all the side doors and back door are closed if the engine switch has been turned to the "ACC" or "LOCK" position. (The lights turn off immediately if the  on the wireless remote control is pressed after all doors are locked.)

To turn the lights on again, turn the engine switch to the "ON" position, or turn the light switch off once and then back to the  or  position.

■ Customization that can be configured at Toyota dealer

Settings (e.g. light sensor sensitivity) can be changed.
(Customizable features →P. 565)



NOTICE

■ **To prevent battery discharge**

Do not leave the lights on longer than necessary when the engine is not running.

Fog light switch (if equipped)

The fog lights improve visibility in difficult driving conditions, such as in rain or fog. They can be turned on only when the headlights are on low beam.

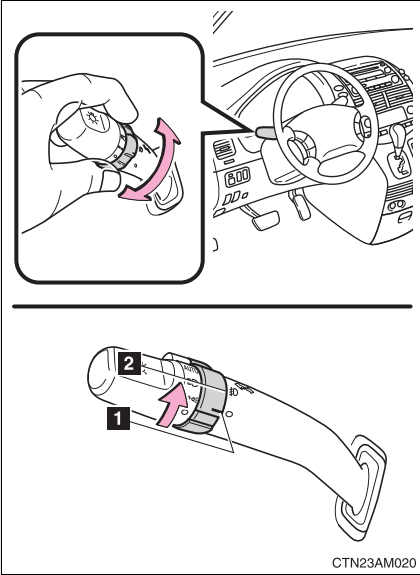

- 1** To turn the front fog lights off
- 2** To turn the front fog lights on

2-3. Operating the lights and wipers Windshield wipers and washer

Wiper intervals can be adjusted for intermittent operation (when intermittent wiper operation is selected).

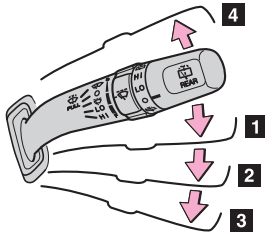
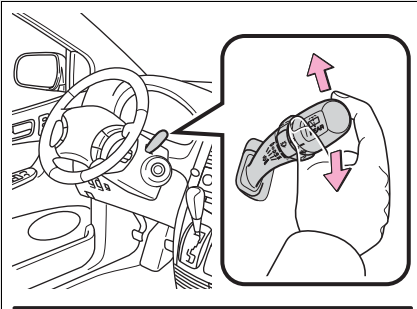

CTN23AM022

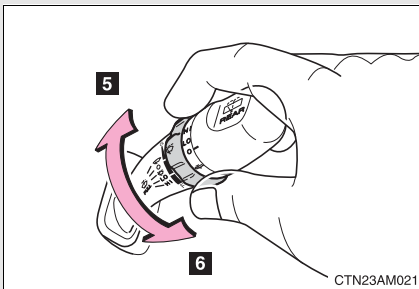

CTN23AM021

- 1** Intermittent windshield wiper operation
- 2** Low speed windshield wiper operation
- 3** High speed windshield wiper operation
- 4** Temporary operation

- 5** Decreases the intermittent windshield wiper frequency
- 6** Increases the intermittent windshield wiper frequency

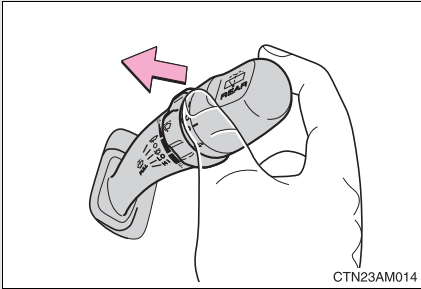

Washer/wiper dual operation

Wipers operate automatically.

■ **The windshield wipers and washer can be operated when**

The engine switch is in the “ON” position.

■ **If no windshield washer fluid sprays**

Check that the washer nozzles are not blocked if there is washer fluid in the windshield washer fluid reservoir.

 **NOTICE**

■ **When the windshield is dry**

Do not use the wipers, as they may damage the windshield.

■ **When there is no washer fluid spray from the nozzle**

Damage to the washer fluid pump may be caused if the lever is pulled toward you and held continually.

■ **When a nozzle is blocked**

Do not try to clear it with a pin or other object. The nozzle will be damaged.

Rear window wiper and washer

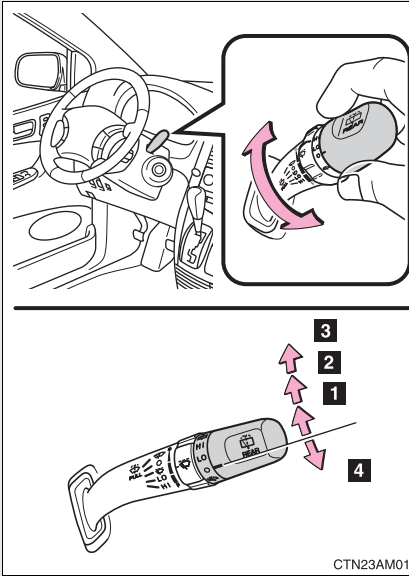

- 1 Intermittent window wiper operation
- 2 Normal window wiper operation
- 3 Washer/wiper dual operation
- 4 Washer/wiper dual operation

Wiper operates automatically.

■ **The rear window wiper and washer can be operated when**

The engine switch is in the "ON" position.

 **NOTICE**

■ **When the rear window is dry**

Do not use the wipers, as they may damage the rear window.

■ **When there is no washer fluid spray from the nozzle**

Damage to the washer fluid pump may be caused if the lever is pulled toward you and held continually.

■ **When a nozzle is blocked**

Do not try to clear it with a pin or other object. The nozzle will be damaged.

2-4. Using other driving systems Cruise control (if equipped)

Use cruise control to maintain a set speed without using the accelerator.

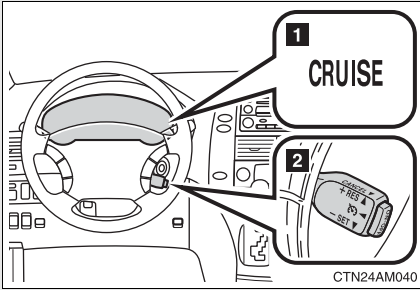

- 1 Indicator
- 2 Cruise control switch

■ Setting the vehicle speed

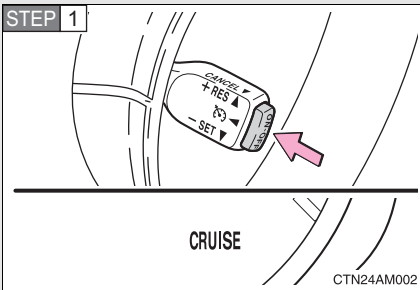

Turn the "ON-OFF" button on.

Press the button once more to deactivate the cruise control.

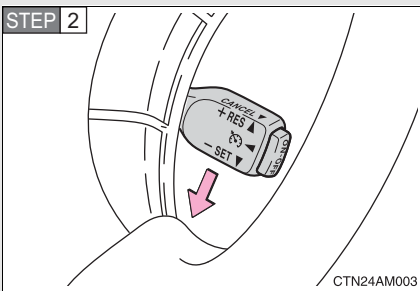

Accelerate or decelerate to the desired speed and push the lever down to set the cruise control speed.

■ Adjusting the speed setting

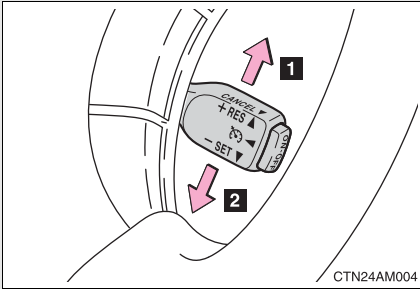

- 1** Increase speed
- 2** Decrease speed

Hold the lever until the desired speed setting is obtained.

Fine adjustment of the set speed (approximately 1.0 mph [1.6 km/h]) can be made by lightly pushing the lever up or down and releasing it.

■ Canceling and resuming regular acceleration

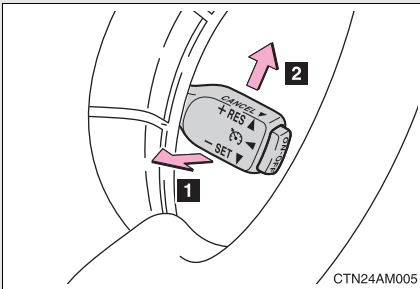

- 1** Cancel

Push the lever towards you to cancel cruise control.

The speed setting is also canceled when the brakes are applied.

- 2** Resume

To resume cruise control and return to the set speed, push the lever up.

■ Cruise control can be set when

- The shift lever is in D or 4.
- Vehicle speed is between approximately 25 mph (40 km/h) and 125 mph (200 km/h).

■ Accelerating

The vehicle can be accelerated normally. After acceleration, the set speed resumes.

■ Automatic cruise control cancellation

The set speed is automatically canceled in any of the following situations.

- Actual vehicle speed falls more than 10 mph (16 km/h) below the preset vehicle speed.
At this time, the memorized set speed is not retained.
- Actual vehicle speed is below 25 mph (40 km/h).
- VSC is activated.

■ If the cruise control indicator light flashes

Turn the “ON-OFF” button off once, and then reactivate the system.

If the cruise control speed cannot be set or if the cruise control cancels immediately after being activated, there may be a malfunction in the cruise control system. Have the vehicle inspected by your Toyota dealer.

CAUTION

■ To avoid operating the cruise control by mistake

Keep the “ON-OFF” button off when not in use.

■ Situations unsuitable for cruise control

Do not use cruise control in any of the following situations.

Doing so may result in control of the vehicle being lost and could cause an accident resulting in death or serious injury.

- In heavy traffic
- On roads with sharp bends
- On winding roads
- On slippery roads, such as those covered with rain, ice or snow
- On steep hills

Dynamic laser cruise control (if equipped)

Dynamic laser cruise control supplements conventional cruise control with a vehicle-to-vehicle distance control. In the vehicle-to-vehicle distance control mode, the vehicle automatically accelerates or decelerates in order to maintain a set following distance from vehicles ahead.

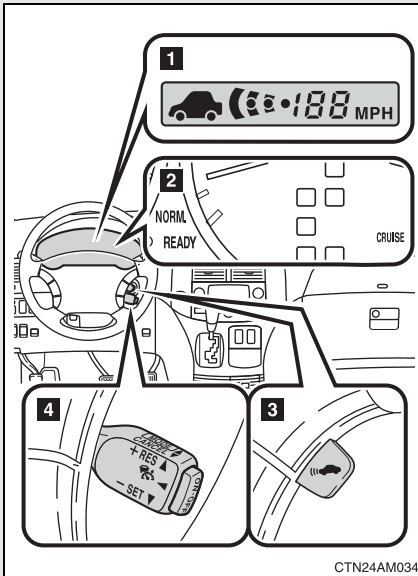

- 1** Display
- 2** Indicator
- 3** Distance switch
- 4** Cruise control switch

■ Selecting cruise mode

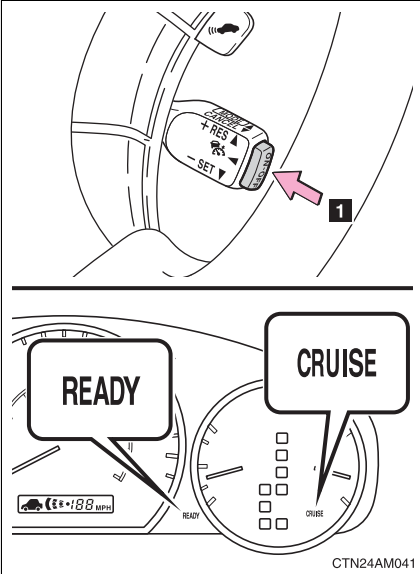

Selecting vehicle-to-vehicle distance control mode

1 Turn the “ON-OFF” button on.

Push the button once more to deactivate.

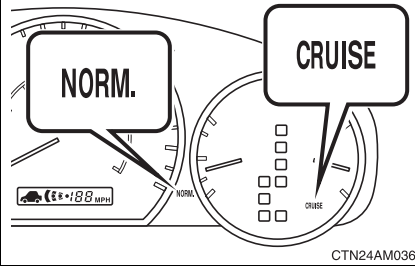
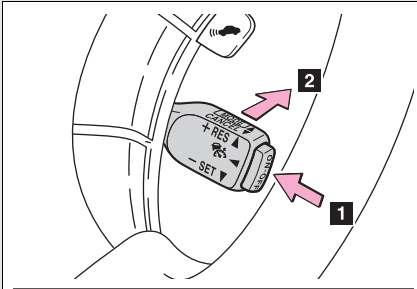

CTN24AM036

Selecting conventional fixed speed control mode

- 1 Turn the “ON-OFF” button on.

Push the button once more to deactivate.

Vehicle-to-vehicle distance control mode is always reset when the engine switch is turned to the “ON” position.

- 2 Switch to fixed speed control mode.
(push and hold for approximately one second)

■ Driving in the selected cruise control mode

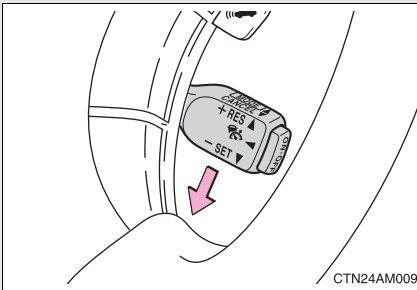

CTN24AM009

Accelerate or decelerate to the desired speed and press the lever down to set.

■ Adjusting the speed setting

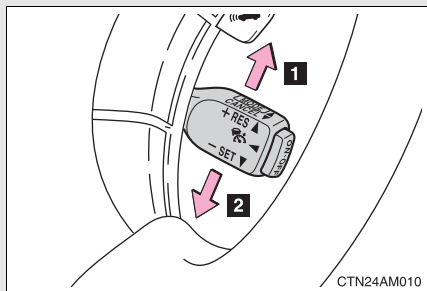

- 1** Increase speed
- 2** Decrease speed

Hold the lever until the desired speed setting is displayed.

■ Canceling and resuming the speed setting

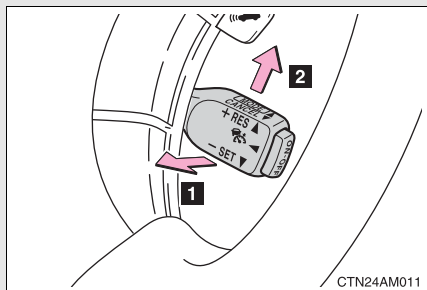

- 1** Cancel

Push the lever towards you to cancel cruise control.

The setting is also canceled when the brakes are applied.

- 2** Resume

To resume cruise control and return to the set speed, push the lever up.

■ Changing the vehicle-to-vehicle distance

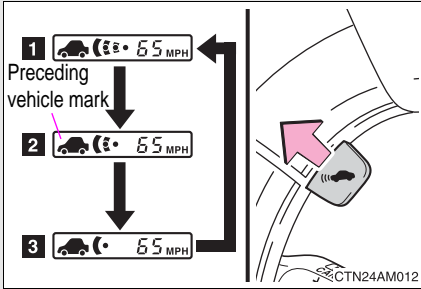

Each pull of the switch toward you changes the vehicle-to-vehicle distance.

- 1** Long
- 2** Medium
- 3** Short

The vehicle-to-vehicle distance is automatically set to the long mode when the engine switch is turned to the “ON” position.

A mark will be displayed to indicate the presence of the vehicle if a vehicle is running ahead of you.

Driving in vehicle-to-vehicle distance control mode

This mode employs a laser radar sensor to detect the presence of vehicles within 400 ft. (120 m) ahead and to judge the distance between your vehicle and those vehicles.

Note that vehicle-to-vehicle distance will close when traveling on long downhill slopes.

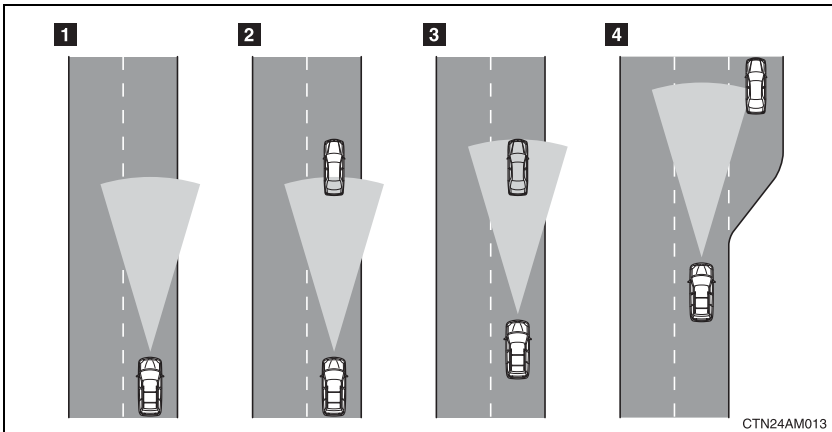

CTN24AM013

- 1** Example of constant speed cruising (when there are no vehicles ahead):

When set to 62 mph (100 km/h)

The vehicle travels at the speed set by the driver. The desired vehicle-to-vehicle distance can also be set by operating the vehicle-to-vehicle distance switch.

- 2** Example of deceleration cruising (when the vehicle ahead is driving slower than the set speed):

When fixed speed cruising is set at 62 mph (100 km/h) and the vehicle ahead is driving at 50 mph (80 km/h)

When a vehicle is detected running ahead of you, in the same lane, the system automatically decelerates your vehicle. When a greater reduction in vehicle speed is necessary, the system applies the brakes. A warning tone warns you when the system cannot decelerate sufficiently to prevent your vehicle from closing on the vehicle ahead.

- 3** Example of follow-up cruising (when following a vehicle driving slower than the set speed):

When the speed is set to 62 mph (100 km/h) and the vehicle ahead is driving at 50 mph (80 km/h)

The system continues follow-up cruising while adjusting for changes in the speed of the vehicle ahead in order to maintain the vehicle-to-vehicle distance set by the driver.

- 4** Example of acceleration (when there are no longer vehicles driving slower than the set speed in the lane ahead):

When the speed is set to 62 mph (100 km/h) and the vehicle ahead driving at 50 mph (80 km/h) is out of the lane

When the vehicle ahead of you executes a lane change, the system slowly accelerates until the set vehicle speed is reached. The system then returns to fixed speed cruising.

■ Fine adjustment of the set speed

Adjustment of the set speed by the following speed can be made by lightly pressing the lever up or down and releasing it.

In the constant speed control mode: Approximately 1.0 mph (1.6 km/h)

In the vehicle-to-vehicle distance control mode:

U.S.A.: Approximately 5 mph (8 km/h)

Canada and Mexico: Approximately 5 km/h (3 mph)

■ Dynamic laser cruise control warnings

If a system malfunction is detected, dynamic laser cruise control master warning light comes on, the “CRUISE” indicator light flashes, the buzzer sounds, and a warning code appears on the display to alert you to the need for caution while driving.

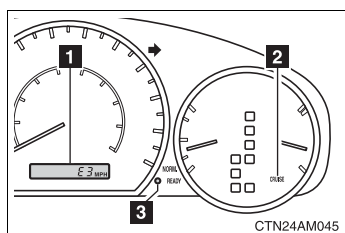

- 1** Warning code
- 2** “CRUISE” indicator light
- 3** Dynamic laser cruise control master warning light

The warning codes indicate the following.

Warning code	Details	Correction procedures
E1	Indicates that the laser radar sensor is dirty or covered with ice.	Clean the sensor.
E2	Indicates that the system is unable to judge the vehicle-to-vehicle distance.	<ul style="list-style-type: none"> • Stop the wipers or switch the wiper switch to intermittent operation. • Avoid direct sunlight. • Wait until the weather becomes clear.
E3 CRUISE (Flashing)	Indicates that a system malfunction has been detected.	Turn off the engine and restart it.

If the same code appears again after implementing the correction procedure, or if the cruise control cannot be set, contact your Toyota dealer.

■ The dynamic laser cruise can be set when

- The shift lever is in D or 4.
- Vehicle speed is between the following speed.

U.S.A.: Approximately 28 mph (45 km/h) - 85 mph (137 km/h)

Canada: Approximately 45 km/h (28 mph) - 139 km/h (86 mph)

■ Accelerating

The vehicle can be accelerated normally.

■ Automatically canceling vehicle-to-vehicle distance control

Vehicle-to-vehicle distance control driving is automatically canceled in the following situations.

- Vehicle speed falls below 25 mph (40 km/h).
- VSC is activated.
- The sensor cannot operate correctly because it is covered in some way.*
- The windshield wipers are operating at high or low speed.*

*: Vehicle-to-vehicle distance control driving must be reset by turning the "ON-OFF" button on again.

If vehicle-to-vehicle distance control driving is automatically canceled for any other reason, there may be a malfunction in the system. Contact your Toyota dealer.

■ Automatically cancelling fixed speed control

The set speed is automatically canceled in the following situations.

- Actual vehicle speed is more than 10 mph (16 km/h) below the preset vehicle speed.
At this time, the memorized set speed is not retained.
- Vehicle speed falls below 25 mph (40 km/h).
- VSC is activated.

■ **Vehicle-to-vehicle distance settings**

Select a distance from the table below. Note that the distances shown correspond to a vehicle speed of 55 mph (88 km/h). Vehicle-to-vehicle distance increases/decreases in accordance with vehicle speed.

Distance options	Vehicle-to-vehicle distance
Long	Approximately 245 ft. (75 m)
Medium	Approximately 165 ft. (50 m)
Short	Approximately 100 ft. (30 m)

■ **Laser radar sensor**

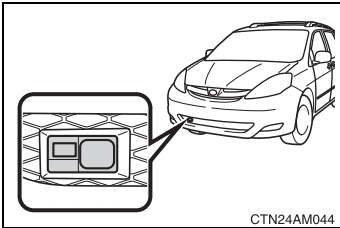

Always keep the sensor clean to ensure that the vehicle-to-vehicle distance control operates properly. (Some obstructions, such as snow, ice or plastic objects, cannot be detected by the obstruction sensor.)

Dynamic laser cruise control is canceled if an obstruction is detected.

■ **Certification**

This product is a class I laser product complied with 21 C.F.R part 1040. 10 and 1040. 11.

 **CAUTION****■ Before using dynamic laser cruise control**

Do not overly rely on vehicle-to-vehicle distance control.

Be aware of the set vehicle speed. If automatic deceleration/acceleration is not appropriate, adjust the vehicle speed, as well as the distance between your vehicle and vehicles ahead by applying the brakes, etc.

■ To avoid inadvertent cruise control activation

Keep the "ON-OFF" button off when not in use.

■ Situations unsuitable for dynamic laser cruise control

Do not use dynamic laser cruise control in any of the following situations. Doing so may result in inappropriate control of speed and could cause serious or fatal accident.

- In heavy traffic
- On roads with sharp bends
- On winding roads
- On slippery roads, such as those covered with rain, ice or snow
- Where there are sudden changes between sharp up and down gradients
- At entrances to expressways
- When weather conditions are bad enough that they may prevent the sensors from functioning correctly (fog, snow, sandstorm, etc.)
- Where buzzer can be heard often

 **CAUTION**

■ When the laser radar sensor may not be correctly detecting the vehicle ahead

Apply the brakes as necessary when any of the following types of vehicles are in front of you.

As the sensor may not be able to correctly detect these types of vehicles, the proximity alarm (→P. 204) will not be activated, and an accident may result.

- Vehicles that cut in suddenly
- Vehicles traveling at low speeds
- Vehicles that are not moving
- Vehicles with small rear ends (trailers with no load on board etc.)
- Motorcycles traveling in the same lane

■ Conditions under which the vehicle-to-vehicle distance control may not function correctly

Apply the brakes as necessary in the following conditions as the laser radar sensor may not be able to correctly detect vehicles ahead, and an accident may result.

- When water or snow thrown up by the surrounding vehicles hinders the functioning of the sensor
- When your vehicle is pointing upwards (caused by a heavy load in the luggage compartment, etc.)
- When the road curves or when the lanes are narrow
- When steering wheel operation or your position in the lane is unstable

■ To ensure the laser radar sensor functions correctly

Do not do the following to the sensor as doing so may cause the sensor not to function correctly and could result in an accident.

- Stick or attach anything to it
- Leave it dirty
- Disassemble, subject it to strong shocks
- Modify or paint it
- Replace it with non-genuine parts

Intuitive parking assist (if equipped)

The distance to obstacles measured by the sensors is communicated via the indicator and a buzzer when parallel parking or maneuvering into a garage. Always check the surrounding area when using this system.

■ Types of sensors

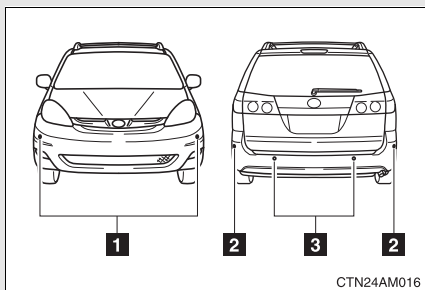

- 1** Front corner sensors (if equipped)
- 2** Rear corner sensors
- 3** Back sensors

■ Intuitive parking assist indicator and switch

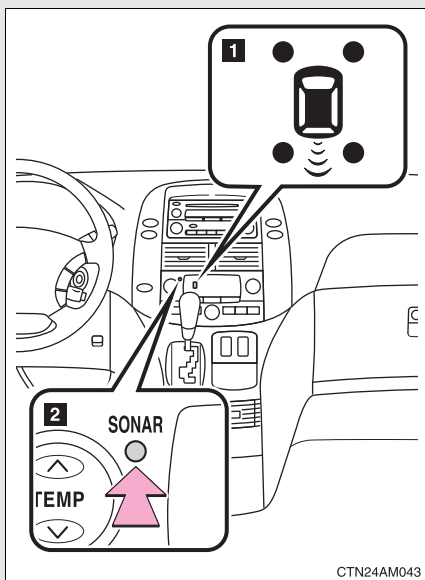

- 1** Intuitive parking assist indicator
- 2** Intuitive parking assist switch
On/off

When on, the indicator is displayed and the buzzer sounds to inform the driver that the function is operational.

The indicator and buzzer system

■ Corner sensor operation and distance to an obstacle

The system operates when the vehicle approaches within following distance to an obstacle. The indicator flashes and the buzzer sounds when the system is operating.

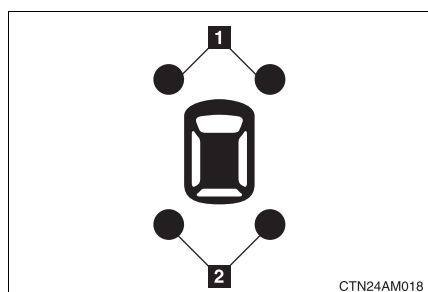

1 Front (if equipped)

ft. (cm)

Distance to an obstacle	Indicator and buzzer
Approximately 2.0 - 1.3 (60 - 40)	Intermittent
Approximately 1.3 - 0.8 (40 - 25)	Fast intermittent
Approximately 0.8 or less (25 or less)	Continuously

2 Rear

ft. (cm)

Distance to an obstacle	Indicator and buzzer
Approximately 2.8 - 1.7 (85 - 52)	Intermittent
Approximately 1.7 - 0.8 (52 - 25)	Fast intermittent
Approximately 0.8 or less (25 or less)	Continuously

■ Back sensor operation and distance to an obstacle

The system operates when the vehicle approaches within following distance to an obstacle. The indicator flashes and the buzzer sounds when the system is operating.

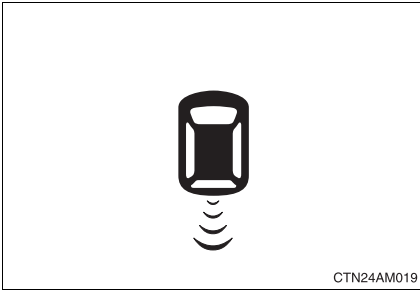

ft. (cm)

Distance to an obstacle	Indicator and buzzer
Approximately 5.9 - 3.0 (180 - 90)	Intermittent
Approximately 3.0 - 1.8 (90 - 55)	Fast intermittent
Approximately 1.8 or less (55 or less)	Continuously

Detection range of the sensors

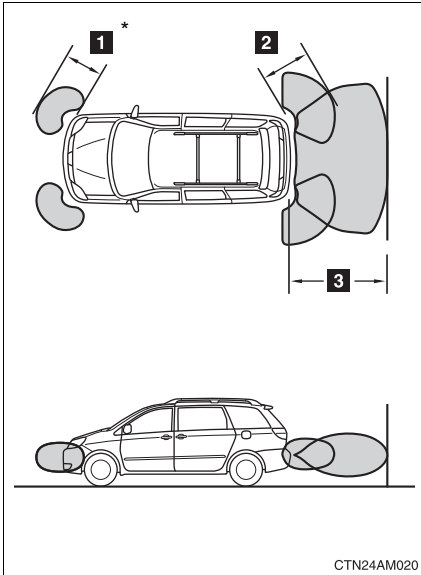

- 1 Approximately 2.0 ft. (60 cm)
- 2 Approximately 2.8 ft. (85 cm)
- 3 Approximately 5.9 ft. (180 cm)

The diagram shows the detection range of the sensors. Note that the sensors cannot detect obstacles that are extremely close to the vehicle.

The range of the sensors may change depending on the shape of the object etc.

*: if equipped

■ Intuitive parking assist can be operated when

The engine switch is in the “ON” position and the shift lever is not in P.

■ Rear corner and back sensors can be operated only when

The shift lever is in R.

■ Front corner sensors can be operated when

- The shift lever is in R.
- The shift lever is not in P or R and vehicle speed is approximately 6 mph (10 km/h) or less.

■ Sensor detection information

- Certain vehicle conditions and the surrounding environment may affect the ability of the sensor to correctly detect obstacles. Particular instances where this may occur are listed below.
 - There is dirt, snow or ice on the sensor.
 - The sensor is frozen.
 - The sensor is covered in any way.
 - The vehicle is leaning considerably to one side.
 - On an extremely bumpy road, on an incline, on gravel, or on grass
 - The vicinity of the vehicle is noisy due to vehicle horns, motorcycle engines, air brakes of large vehicles, or other loud noises producing ultrasonic waves.
 - There is another vehicle equipped with parking assist sensors in the vicinity.
 - The sensor is coated with a sheet of spray or heavy rain.
 - The vehicle is equipped with a fender pole or wireless antenna.
 - The bumper or sensor receives a strong impact.
 - The vehicle is approaching a tall or curved curb.
 - In harsh sunlight or intense cold weather

In addition to the examples above, there are instances in which, because of their shapes, signs and other objects may be judged by the sensor to be closer than they are.

- The shape of the obstacle may prevent the sensor from detecting it. Pay particular attention to the following obstacles:
 - Wires, fences, ropes etc.
 - Cotton, snow and other materials that absorb radio waves
 - Sharply-angled objects
 - Low obstacles
 - Tall obstacles with upper sections projecting outwards in the direction of your vehicle
 - Objects just under the bumper
 - Objects very close to your vehicle
 - A person near the vehicle (depending on the type of clothes worn)

■ **When to contact your Toyota dealer**

In the following cases, have your Toyota dealer check the system.

- When the bumper is damaged.
- When the indicator is continuously on.

■ **Certification (Canada only)**

This ISM device complies with Canadian ICES-001.

 **CAUTION**

■ **Caution when using the Intuitive parking assist**

- The Intuitive parking assist is intended as an aid to assist you to park and is not a substitute for your personal judgment. Make your driving decisions based on your observations.
- Do not attach accessories or other objects to the vehicle within the sensor perceptible area. Doing so may cause the system to malfunction, which might result in an accident.
- In certain situations, the system will not function properly and when the vehicle approaches certain objects, the system will not detect those objects. Therefore, always observe the area around the vehicle and do not rely solely on the system.

 **NOTICE**

■ **Notes when washing the vehicle**

Do not apply intensive bursts of water or steam to the sensor area. Doing so may result in the sensor malfunctioning.

2-4. Using other driving systems

Driving assist systems

To help enhance driving safety and performance, the following systems operate automatically in response to various driving situations. Be aware, however, that these systems are supplementary and should not be relied upon too heavily when operating the vehicle.

■ ABS (Anti-lock Brake System)

Helps to prevent wheel lock when the brakes are applied suddenly, or if the brakes are applied while driving on a slippery road surface.

■ Brake assist

Generates an increased level of braking force after the brake pedal is depressed, when the system detects a panic stop situation.

■ VSC (Vehicle Stability Control)

Helps the driver to control skidding when swerving suddenly or turning on slippery road surfaces.

■ TRAC (Traction Control)

Maintains drive power and prevents the front wheels (2WD models) or 4 wheels (AWD models) from spinning when starting the vehicle or accelerating on slippery roads.

When VSC and TRAC are operating

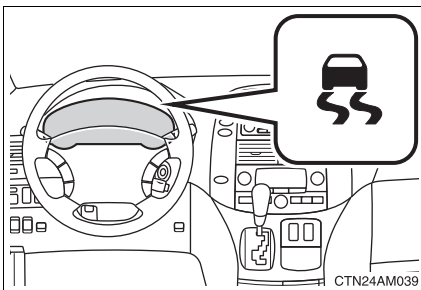

If the vehicle is in danger of slipping or the front wheels (2WD models), or 4 wheels (AWD models) spin, the indicator flashes to indicate that VSC/TRAC system have been engaged.

A buzzer (intermittent) sounds to indicate that VSC is operating.

To disable TRAC (2WD models only)

If the vehicle gets stuck in fresh snow or mud, TRAC may reduce power from the engine to the wheels. You may need to turn the system off to enable you to rock the vehicle in order to free it.

■ Turning off TRAC

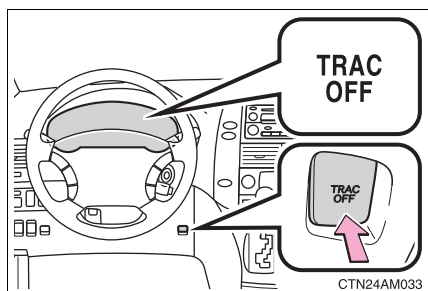

Push the button to turn off TRAC.

The "TRAC OFF" indicator light should come on.

Push the button again to turn the system back on.

■ Automatic reactivation of TRAC (2WD models only)

Turning the engine switch off after turning off the TRAC system will automatically re-enable it.

■ Sounds and vibrations caused by ABS, brake assist, VSC and TRAC

- A sound may be heard from the engine compartment when the engine is started or just after the vehicle begins to move. This sound does not indicate that a malfunction has occurred in any of these systems.
- Any of the following conditions may occur when the above systems are operating. None of these indicates that a malfunction has occurred.
 - Vibrations may be felt through the vehicle body and steering.
 - A motor sound may be heard after the vehicle comes to a stop.
 - The brake pedal may pulsate slightly after ABS is activated.
 - The brake pedal may move down slightly after ABS is activated.

■ **Another situation in which the “TRAC OFF” indicator light comes on (2WD models only)**

When the “VSC” warning light comes on, the “TRAC OFF” indicator light comes on even if the “TRAC OFF” switch is not pushed.

 **CAUTION**

■ **ABS does not operate effectively when**

- Tires with inadequate gripping ability are used (such as excessively worn tires on a snow covered road).
- The vehicle hydroplanes while driving at high speed on the wet or slick road.

■ **Stopping distance when ABS is operating on the wet or slick roads**

ABS is not designed to shorten the vehicle's stopping distance. Always maintain a safe distance from the vehicle in front of you in the following situations.

- When driving on dirt, gravel or snow-covered roads
- When driving with tire chains
- When driving over bumps in the road
- When driving over roads with potholes or uneven roads

■ **TRAC may not operate effectively when**

Directional control and power may not be achievable while driving on slippery road surfaces, even if the TRAC system is operating. Do not drive the vehicle in conditions where stability and power may be lost.

 **CAUTION**

■ **When VSC is activated**

The slip indicator light flashes and a warning buzzer sounds. Always drive carefully. Reckless driving may cause an accident. Exercise particular care when the indicator light flashes and a buzzer sounds.

■ **When TRAC is off (2WD models only)**

Be especially careful and drive at a speed appropriate to the road conditions. As this is a system to ensure vehicle stability and driving force, do not turn off TRAC unless necessary.

■ **Replacing tires**

Make sure that all tires are of the same size, brand, tread pattern and total load capacity. In addition, make sure that the tires are inflated to the recommended tire pressure level.

The ABS and VSC systems will not function correctly if different tires are fitted on the vehicle.

Contact your Toyota dealer for further information when replacing tires or wheels.

■ **Handling of tires and suspension**

Using tires with any kind of problem or modifying the suspension will affect the driving assist systems, and may cause the system to malfunction.

2-5. Driving information

Cargo and luggage

Take notice of the following information about storage precautions, cargo capacity and load.

- Stow cargo and luggage in the luggage compartment whenever possible. Be sure all items are secured in place.
- Be careful to keep the vehicle level. Placing the weight as far forward as possible helps maintain vehicle balance.
- For better fuel economy, do not carry unnecessary weight.

■ Roof luggage carrier (if equipped)

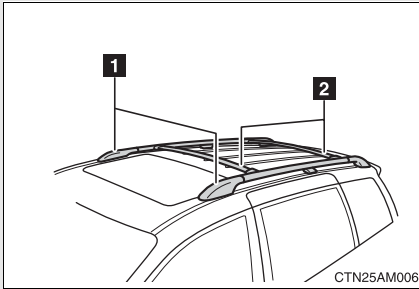

- 1 Roof rails
- 2 Cross rails

Adjusting the position of cross rails (if equipped)

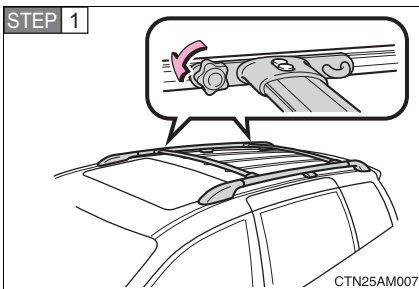

Turn the knobs counterclockwise to release the cross rails.

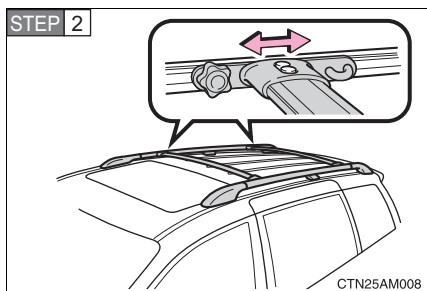

Slide the cross rails to the appropriate position for loading luggage and turn the knobs clockwise to tighten the cross rails securely.

Capacity and distribution

Cargo capacity depends on the total weight of the occupants.

(Cargo capacity) = (Total load capacity) - (Total weight of occupants)

Steps for Determining Correct Load Limit —

- (1) Locate the statement “The combined weight of occupants and cargo should never exceed XXX kg or XXX lbs.” on your vehicle’s placard.
- (2) Determine the combined weight of the driver and passengers that will be riding in your vehicle.
- (3) Subtract the combined weight of the driver and passengers from XXX kg or XXX lbs.
- (4) The resulting figure equals the available amount of cargo and luggage load capacity.

For example, if the “XXX” amount equals 1400 lbs. and there will be five 150 lb passengers in your vehicle, the amount of available cargo and luggage load capacity is 650 lbs. $(1400 - 750 (5 \times 150) = 650 \text{ lbs.})$

- (5) Determine the combined weight of luggage and cargo being loaded on the vehicle. That weight may not safely exceed the available cargo and luggage load capacity calculated in Step 4.

- (6) If your vehicle will be towing a trailer, load from your trailer will be transferred to your vehicle. Consult this manual to determine how this reduces the available cargo and luggage load capacity of your vehicle. (→P. 542)

Example on your vehicle

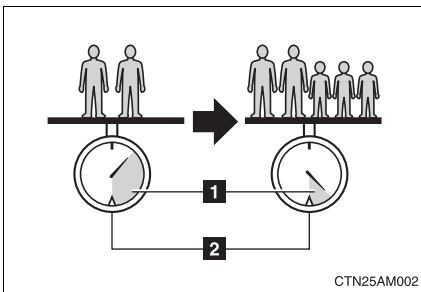

- 1** Cargo capacity
- 2** Total load capacity

When 2 people with the combined weight of 366 lb. (166 kg) are riding in your vehicle, which has a total load capacity of 850 lb. (385 kg), the available amount of cargo and luggage load capacity will be as follows:

$$850 \text{ lb.} - 366 \text{ lb.} = 484 \text{ lb.} \quad (385 \text{ kg} - 166 \text{ kg} = 219 \text{ kg})$$

In this condition, if 3 more passengers with the combined weight of 388 lb. (176 kg) get on, the available cargo and luggage load will be reduced as follows:

$$484 \text{ lb.} - 388 \text{ lb.} = 96 \text{ lb.} \quad (219 \text{ kg} - 176 \text{ kg} = 43 \text{ kg})$$

As shown in the above example, if the number of occupants increases, the cargo and luggage load will be reduced by an amount that equals the increased weight due to the additional occupants. In other words, if an increase in the number of occupants causes an excess of the total load capacity (combined weight of occupants plus cargo and luggage load), you must reduce the cargo and luggage on your vehicle.

Seating configuration variation

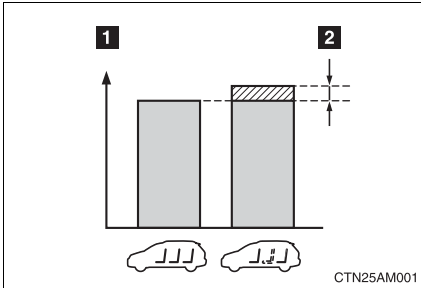

1 Cargo capacity

2 Weight of the removed second seat

If removing the second seats, it is possible to load extra cargo equal to the weight of the removed seats.

(Cargo capacity) = (Total load capacity) - (Total weight of occupants) + (Weight of the removed second seats)

Second seats weight:



7-passenger models — Right side 61 lb. (28 kg)
Left side 55 lb. (25 kg)

8-passenger models — Right side 48 lb. (22 kg)
Left side 48 lb. (22 kg)
Center 52 lb. (24 kg)

CAUTION

Things that must not be carried in the luggage compartment

The following things may cause a fire if loaded in the luggage compartment.

-  Receptacles containing gasoline
-  Aerosol cans

 **CAUTION****■ Storage precautions**

Observe the following precautions.

Failing to do so may result in death or serious injury.

● Do not place cargo or luggage in or on the following locations as the item may get under the brake or accelerator pedal and prevent the pedals from being depressed properly, block the driver's vision, or hit the driver or passengers, causing an accident.

- Driver's feet
- Front passenger or rear seats (when stacking items)
- Instrument panel
- Dashboard

● Secure all items in the occupant compartment, as they may shift and injure someone during an accident or sudden braking.

● Never allow anyone to ride in the luggage compartment. It is not designed for passengers. They should ride in their seats with their seat belts properly fastened. Otherwise, they are much more likely to suffer death or serious bodily injury, in the event of sudden braking or an accident.

■ Capacity and distribution

● Do not exceed the maximum axle weight rating or the total vehicle weight rating.

● Even if the total load of occupant's weight and the cargo load is less than the total load capacity, do not apply the load unevenly.

Improper loading may cause deterioration of steering or braking control which may cause death or serious injury.

 CAUTION

■ **Roof luggage carrier precautions**

When you load cargo on the roof luggage carrier, observe the following:

- Place the cargo so that its weight is distributed evenly between the front and rear axles.
- If loading long or wide cargo, never exceed the vehicle overall length or width. (→P. 542)
- Before driving, make sure the cargo is securely fastened on the roof luggage carrier.
- Loading cargo on the roof luggage carrier will make the center of the vehicle gravity higher. Avoid high speeds, sudden starts, sharp turns, sudden braking or abrupt maneuvers, otherwise it may result in loss of control or vehicle rollover due to failure to operate this vehicle correctly and result in death or serious injury.
- If driving for a long distance, on rough roads, or at high speeds, stop the vehicle now and then during the trip to make sure the cargo remains in its place.
- Do not exceed 150 lb. (68 kg) cargo weight on the roof luggage carrier.

■ **Cross rail adjustment**

Make sure the cross rails are locked securely by pushing forward and rearward them.

Failure to do so may cause an unexpected accident or severe injury in the event of emergency braking or a collision.

 NOTICE

■ **When loading the luggage**

Be careful not to scratch the surface of the moon roof.

Vehicle load limits include total load capacity, seating capacity, towing capacity and cargo capacity.

■ **Total load capacity: (→P. 542)**

Total load capacity means the combined weight of occupants, cargo and luggage.

■ **Seating capacity:**

▶ 7-passenger models

Total 7 (Front 2, Rear 5)

▶ 8-passenger models

Total 8 (Front 2, Rear 6)

Seating capacity means the maximum number of occupants whose estimated average weight is 150 lb. (68 kg) per person.

■ **Towing capacity**

Without towing package: 1200 lb. (544 kg)

With towing package: 3500 lb. (1585 kg)

Towing capacity means the maximum gross trailer weight (trailer weight plus its cargo weight) that your vehicle is able to tow.

■ **Cargo capacity**

Cargo capacity may increase or decrease depending on the weight and the number of occupants.

■ **Total load capacity and seating capacity**

These details are also described on the tire and loading information label. (→P. 463)

 **CAUTION**

■ **Overloading the vehicle**

Do not overload the vehicle.

It may not only cause damage to the tires, but also degrade steering and braking ability, resulting in an accident.

2-5. Driving information

Winter driving tips

Carry out the necessary preparations and inspections before driving the vehicle in winter. Always drive the vehicle in a manner appropriate to the prevailing weather conditions.

■ Pre-winter preparations

- Use fluids that are appropriate to the prevailing outside temperatures.
 - Engine oil
 - Engine coolant
 - Washer fluid
- Have a service technician inspect the level and specific gravity of battery electrolyte.
- Have the vehicle fitted with four snow tires or purchase a set of tire chains for the front tires.

Ensure that all tires are the same size and brand, and that chains match the size of the tires.

■ Before driving the vehicle

Perform the following according to the driving conditions.

- Do not try to forcibly open a window or move a wiper that is frozen. Pour warm water over the frozen area to melt the ice. Wipe away the water immediately to prevent it from freezing.
- To ensure proper operation of the climate control system fan, remove any snow that has accumulated on the air inlet vents in front of the windshield.
- Remove any ice that has accumulated on the vehicle chassis.
- Periodically check for and remove any excess ice or snow that may have accumulated in the wheel well or on the brakes.

■ When driving the vehicle

Accelerate the vehicle slowly and drive at a reduced speed suitable to road conditions.

■ When parking the vehicle

Park the vehicle and move the shift lever to P without setting the parking brake. The parking brake may freeze up, preventing it from being released.

Selecting tire chains

Use the tire chains of correct size and type.

Use SAE Class "S" type radial tire chains, with the exception of radial cable chains or V-bar type chains.

Regulations on the use of snow chains

- Regulations regarding the use of tire chains vary according to location and type of road. Always check local regulations before installing chains.
- Install the chains on the front tires.
- Retighten the chains after driving 1/4 - 1/2 mile (0.5 - 1.0 km).

■ Snow chain installation

Observe the following precautions when installing and removing chains.

- Install and remove tire chains in a safe location.
- Install tire chains on the front tires only. Do not install tire chains on rear tires.
- Install tire chains following the instructions provided in the accompanying manual.

 **CAUTION**

■ **Driving with snow tires**

Observe the following precautions to reduce the risk of accidents. Failing to do so may result in a loss of vehicle control and cause death or serious injury.

- Use tires of the size specified for your vehicle.
- Maintain the recommended level of air pressure.
- Do not drive in excess of 75 mph (120 km/h), regardless of the type of snow tires being used.
- Snow tires should be installed on all wheels.

■ **Driving with tire chains**

Observe the following precautions to reduce the risk of accidents. Failing to do so may result in the vehicle being unable to be driven safely, and may cause death or serious injury.

- Do not drive in excess of the speed limit specified for the tire chains being used or 30 mph (50 km/h), whichever is lower.
- Avoid driving on bumpy road surfaces or over potholes.
- Avoid sudden turns and braking, as use of chains may adversely affect vehicle handling.
- Slow down sufficiently before entering a curve to ensure that vehicle control is maintained.

 **NOTICE**

■ **Repairing or replacing snow tires**

Request repairs of and obtain replacement snow tires from Toyota dealers or legitimate tire retailers.

This is because the removal and attachment of snow tires affects the operation of the tire pressure warning valves and transmitters.

■ **Fitting tire chains**

The tire pressure warning valves and transmitters may not function correctly when tire chains are fitted.

Trailer towing

Your vehicle is designed primarily as a passenger-carrying vehicle. Towing a trailer will have an adverse effect on handling, performance, braking, durability, and fuel consumption. For your safety and the safety of others, do not overload the vehicle or trailer.

Toyota warranties do not apply to damage or malfunction caused by towing a trailer for commercial purposes.

■ Weight limits

Confirm that the total trailer weight, gross vehicle weight, gross axle weight and trailer tongue load are all within the limits.

■ Gross vehicle weight

The gross vehicle weight must not exceed the Gross Vehicle Weight Rating (GVWR) indicated on the Certification Label. The gross vehicle weight is the sum weight of the unloaded vehicle, driver, passengers, luggage, hitch and trailer tongue load. Also included is the weight of any special equipment installed on your vehicle.

■ Gross axle weight

The load on either the front or rear axle resulting from distribution of the gross vehicle weight on both axles must not exceed the Gross Axle Weight Rating (GAWR) listed on the Certification Label.

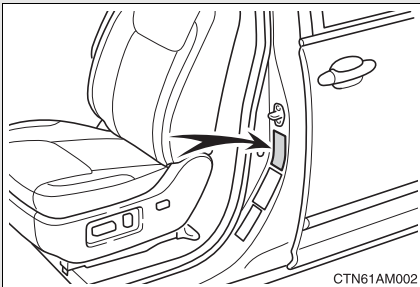

Certification label

■ Trailer tongue load

The trailer cargo load should be distributed so that the tongue load is 9 to 11% for weight carrying hitch or 15% for weight distributing hitch of the total trailer weight, not exceeding the maximum load of the following. (Tongue load / Total trailer weight x 100 = 9 to 11% or 15%)

Without towing package: 120 lb. (54 kg)

With towing package: 350 lb. (158 kg)

The total trailer weight and tongue load can be measured with platform scales found at highway weighing stations, building supply companies, trucking companies, junk yards, etc.

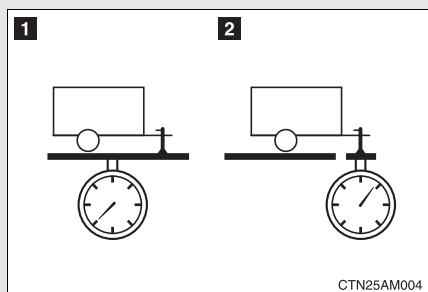

1 Total trailer weight

2 Tongue load

Towing a trailer

Contact your Toyota dealer for further information about additional requirements such as a towing kit, etc.

Hitch

Trailer hitch assemblies have different weight capacities established by the hitch manufacturer. Even though the vehicle may be rated for towing a higher weight, the operator must never exceed the maximum weight rating specified for the trailer hitch.

■ Before towing

- Ensure that your vehicle's tires are properly inflated. (→P. 463)
- Trailer tires should be inflated according to the trailer manufacturer's recommendation.
- All trailer lights must work in order to be legal.
- Confirm all lights work each time you connect them.
- Check that your vehicle remains level when a loaded or unloaded trailer is hitched. Do not drive if the vehicle is not level, and check for improper tongue load, overloading, worn suspension, or other possible causes.
- Make sure the trailer cargo is securely loaded.
- Check that your rear view mirrors conform to any federal, state/provincial or local regulations. If they do not, install rear view mirrors appropriate for towing purposes.

■ Break-in schedule

Toyota recommends that you do not use a new vehicle or a vehicle with any new power train components (engine, transmission, differential, wheel bearings, etc.) to tow a trailer for the first 500 miles (800 km) of driving.

■ Maintenance

- If you tow a trailer, your vehicle will require more frequent maintenance due to the additional load. (See "Scheduled Maintenance Guide" or "Owner's Manual Supplement".)
- Retighten the fixing bolts of the towing ball and bracket after approximately 600 miles (1000 km) of trailer towing.

 **CAUTION**

■ **To avoid accident or injury**

- Do not exceed the trailer hitch assembly weight, gross vehicle weight, gross axle weight and trailer tongue load capacities.
- Never load more weight in the back than in the front of the trailer. About 60% of the load should be in the front half of the trailer, and the remaining 40% in the rear.
- Do not use cruise control when you are towing.
- Do not tow the vehicle with the compact spare tire installed.

■ **Hitches**

- Use only a hitch that conforms to the total trailer weight requirement.
- Follow the directions supplied by the hitch manufacturer.
- Lubricate the hitch ball with a light coat of grease.
- Remove the trailer hitch whenever you are not towing a trailer. After removing the hitch, seal any mounting hole in the vehicle body to prevent entry of any substances into the vehicle.

■ **When towing a trailer**

- If the gross trailer weight exceeds 1000 lb. (453 kg), trailer brakes are required. Toyota recommends trailers with brakes that conform to all applicable federal and state/provincial regulations.
- Never tap into your vehicle's hydraulic system, as this will lower the vehicle's braking effectiveness.
- Never tow a trailer without using a safety chain securely attached to both the trailer and the vehicle. If damage occurs to the coupling unit or hitch ball, there is danger of the trailer wandering into another lane.

 NOTICE**■ When installing a trailer hitch**

- Use only the position recommended by your Toyota dealer. Do not install the trailer hitch on the bumper; this may cause body damage.
- Do not use axle-mounted hitches, as they can cause damage to the axle housing, wheel bearings, wheels or tires.

■ Brakes

Toyota recommends trailers with brakes that conform to all applicable federal and state/provincial regulations.

■ Safety chain

A safety chain must always be used between the towing vehicle and the trailer. Leave sufficient slack in the chain for turns. The chain should cross under the trailer tongue to prevent the tongue from dropping to the ground in the case that it becomes damaged or separated. For the correct safety chain installation procedure, ask your Toyota dealer.

■ Do not directly splice trailer lights

Directly splicing trailer lights may damage your vehicle's electrical system and cause a malfunction.

Trailer towing tips

Your vehicle will handle differently when towing a trailer. The 3 main causes of vehicle-trailer accidents are driver error, excessive speed and improper trailer loading. Keep the following in mind when towing.

- Before starting out, check the trailer lights and the vehicle-trailer connections. Recheck after driving a short distance.
- Practice turning, stopping and reversing with the trailer attached in an area away from traffic until you become accustomed to the feel of the vehicle.

- Reversing with a trailer attached is difficult and requires practice. Grip the bottom of the steering wheel and move your hand to the left to move the trailer to the left. Move your hand to the right to move the trailer to right. (This is generally opposite to reversing without a trailer attached.) Avoid sharp or prolonged turning. Have someone guide you when reversing to reduce the risk of an accident.
- As stopping distance is increased when towing a trailer, vehicle-to-vehicle distance should be increased. For each 10 mph (16 km/h) of speed, allow at least one vehicle and trailer length.
- Avoid sudden braking as you may skid, resulting in jackknifing and loss of control. This is especially true on wet or slippery surfaces.
- Avoid jerky starts or sudden acceleration.
- Avoid jerky steering and sharp turns, and slow down before making turns.
- Note that when making a turn, the trailer wheels will be closer than the vehicle wheels to the inside of the turn. Compensate by making a larger than normal turning radius.
- Crosswinds and rough roads will adversely affect handling of your vehicle and trailer, causing sway. Periodically check the rear to prepare for being passed by large trucks or buses, which may cause your vehicle and trailer to sway. If swaying occurs, firmly grip the steering wheel, reduce speed immediately but gradually, and steer straight ahead. Never increase speed. If you make no extreme correction with the steering or brakes, your vehicle and trailer will stabilize.
- Take care when passing other vehicles. Passing requires considerable distance. After passing a vehicle, do not forget the length of your trailer, and be sure you have plenty of room before changing lanes.
- In order to maintain efficient engine braking and electrical charging performance, do not use overdrive.

- Due to the added load of the trailer, your vehicle's engine may overheat on hot days (at temperatures over 85°F [30°C]) when driving up a long or steep grade. If the engine coolant temperature gauge indicates overheating, immediately turn off the air conditioning (if in use), pull your vehicle off the road and stop in a safe spot. (→P. 536)

- Always place wheel blocks under both the vehicle and the trailer wheels when parking. Apply the parking brake firmly, and put the transmission in P. Avoid parking on a slope, but if unavoidable, do so only after performing the following:

STEP 1 Apply the brakes and keep them applied.

STEP 2 Have someone place wheel blocks under both the vehicle and trailer wheels.

STEP 3 When the wheel blocks are in place, release the brakes slowly until the blocks absorb the load.

STEP 4 Apply the parking brake firmly.

STEP 5 Shift into P and turn off the engine.

- When restarting after parking on a slope:

STEP 1 With the transmission in P, start the engine. Be sure to keep the brake pedal pressed.

STEP 2 Shift into a forward gear. If reversing, shift into R.

STEP 3 Release the parking brake and brake pedal, and slowly pull or back away from the wheel blocks. Stop and apply the brakes.

STEP 4 Have someone retrieve the blocks.

 CAUTION

■ **To avoid an accident**

- Do not exceed 45 mph (72 km/h) or posted towing speed limit, whichever is lower. As instability (swaying) of the towing vehicle-trailer combination increases as speed increases, exceeding 45 mph (72 km/h) may cause loss of control.
- Slow down and downshift before descending steep or long downhill grades. Do not make sudden downshifts.
- Avoid holding the brake pedal down too long or applying the brakes too frequently. This could cause the brakes to overheat and result in reduced braking efficiency.

2-5. Driving information

Dinghy towing

Your vehicle is not designed to be dinghy towed (with 4 wheels on the ground) behind a motor home.

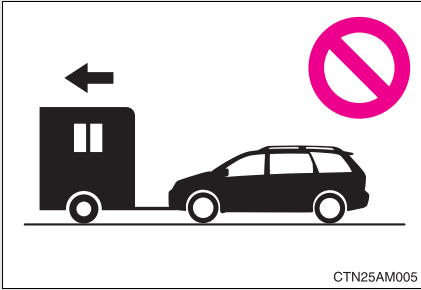

NOTICE

■ To avoid serious damage to your vehicle

Do not tow your vehicle with four wheels on the ground.

3-1. Using the air conditioning system and defogger Front manual air conditioning system (if equipped)

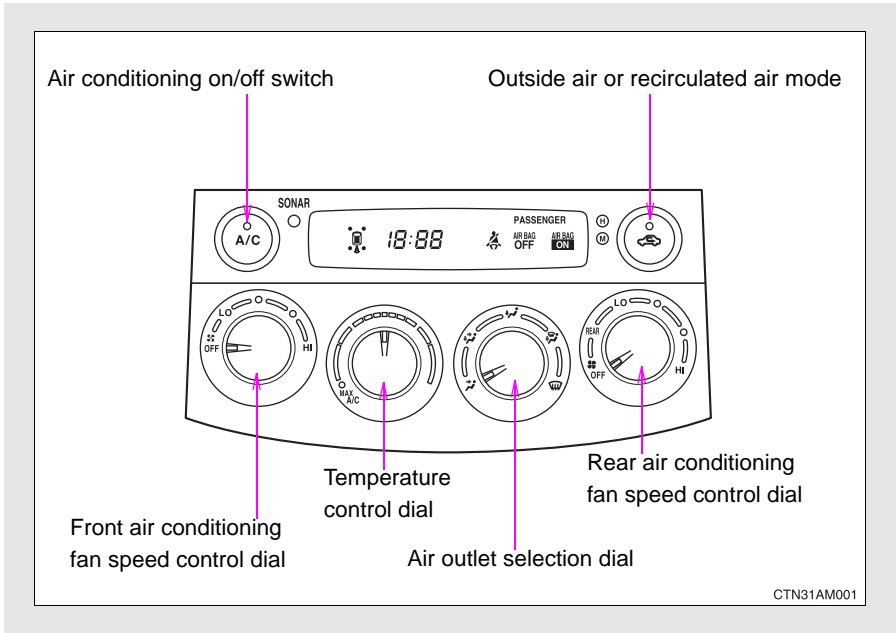

Adjusting the settings

■ Adjusting the temperature setting

Turn the temperature control dial clockwise (warm) or counter-clockwise (cool).

If  is not pressed, the system will blow ambient temperature air or heated air.

For quick cooling, turn the temperature control dial to the "MAX A/C" position. The air conditioning will automatically turn on and the air circulation mode will be set to recirculated air mode.

When the dial is in the "MAX A/C" position, the air conditioning system cannot be turned off even if  is pressed.

■ **Adjusting the fan speed**

Turn the fan speed control dial clockwise (increase) or counter-clockwise (decrease).

Set the dial to "OFF" to turn the fan off.

■ **Changing the air outlets**

Set the air outlet selection dial to an appropriate position.

The positions between the air outlet selections shown below can also be selected for more detailed adjustment.

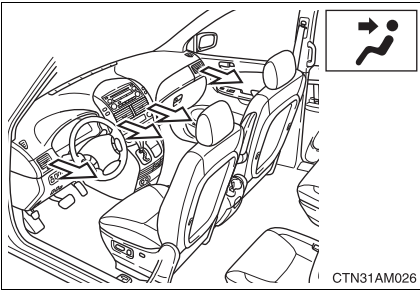

Upper body

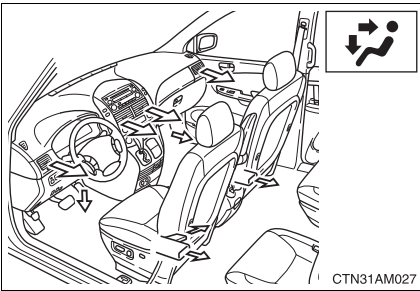

Upper body and feet

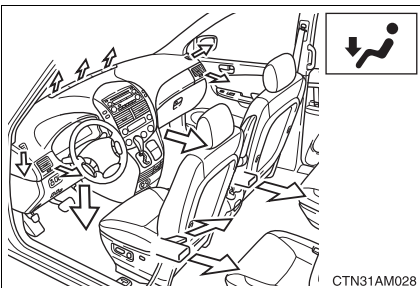

Feet

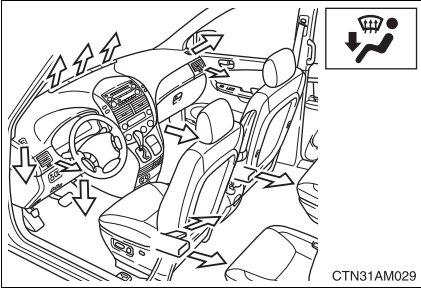

Feet and windshield

The air conditioning system operates automatically.

Recirculated air mode will automatically switch to outside air mode.

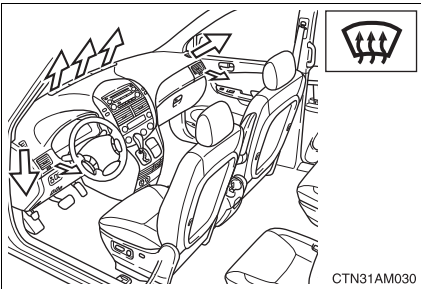

Windshield and side windows

The air conditioning system operates automatically.

Recirculated air mode will automatically switch to outside air mode. It is not possible to return to recirculated air mode when the switch is in this position.

■ Switching between outside air and recirculated air modes

Press  .

The mode switches between outside air mode (indicator off) and recirculated air mode (indicator on) each time  is pressed.

Changing the rear setting

■ Adjusting the fan speed

Turn the rear fan speed control dial clockwise (increase) or counter-clockwise (decrease).

When the rear fan speed control dial is turned to “REAR”, rear fan speed can be operated from the rear air conditioning control panel. (→P. 253)

When the front or rear fan speed control dial is turned to “OFF”, the rear air conditioning system is turned off.

Adjusting the position of and opening and closing the air outlets

► Center outlets

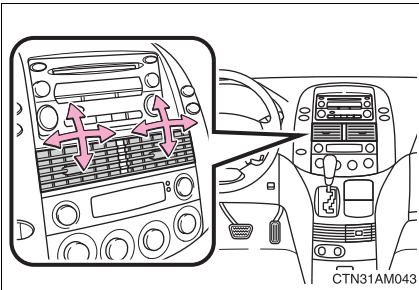

Direct air flow to the left or right, up or down.

► Right and left side outlets

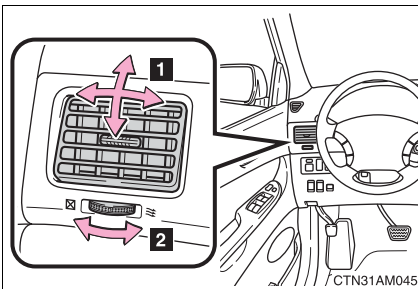

1 Direct air flow to the left or right, up or down.

2 Turn the knob to open or close the vent.

■ **Using the system in recirculated air mode**

The windows will fog up more easily if the recirculated air mode is used for an extended period.

■ **Window defogger feature**

In order to prevent the windows from fogging up, recirculated air mode may automatically switch to outside air mode if the ambient temperature drops. This feature can be cancelled by pushing and holding the air circulation mode switch for longer than 2 seconds. The feature will be reactivated when the engine switch is turned to the “ACC” or “LOCK” position.

■ **When outside air temperature approaches 32°F (0°C)**

The air conditioning system may not operate even when  is pressed.

■ **When  is selected for the air outlets used**

For your driving comfort, air flowing to the feet may be warmer than air flowing to the upper body depending on the temperature setting.

■ **When the indicator light on  flashes**

Press  and turn off the air conditioning system before turning it on once more. There may be a problem in the air conditioning system if the indicator light continues to flash. Turn the air conditioning system off and have it inspected by your Toyota dealer.

■ **Air conditioning odors**

- During use, various odors from inside and outside the vehicle may enter into and accumulate in the air conditioning system. This may then cause odor to be emitted from the vents.
- To reduce potential odors from occurring:
It is recommended that the air conditioning system be set to outside air mode prior to turning the vehicle off.

 CAUTION

■ **To prevent the windshield from fogging up**

Do not set the air outlet selection dial to  during cool air operation in extremely humid weather. The difference between the temperature of the outside air and that of the windshield can cause the outer surface of the windshield to fog up, blocking your vision.

 NOTICE

■ **To prevent battery discharge**

Do not leave the air conditioning system on longer than necessary when the engine is off.

3-1. Using the air conditioning system and defogger Front automatic air conditioning system (if equipped)

Airflow and outlets are automatically adjusted according to the temperature setting.

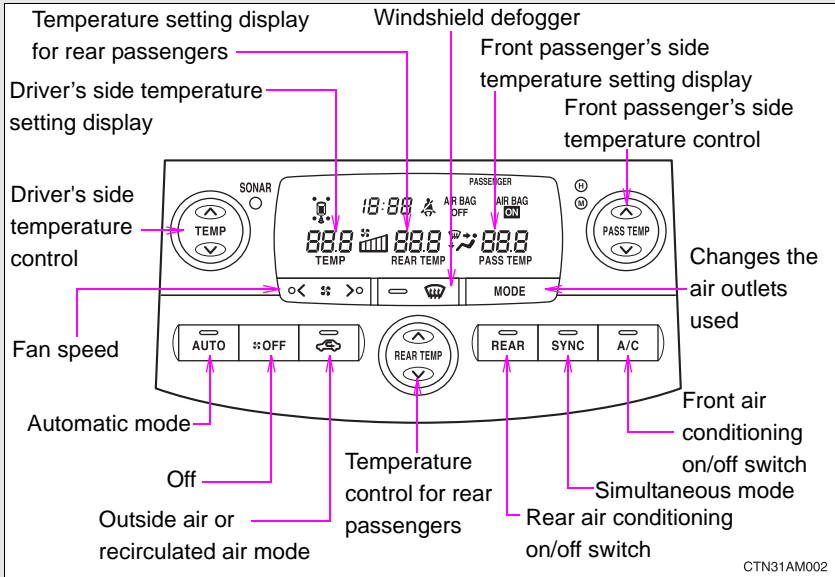

Using the automatic mode

STEP 1 Press  .

The air conditioning system begins to operate. Air outlets and fan speed are automatically adjusted according to the temperature setting.

STEP 2 Press “^” on  to increase the temperature and “v” to decrease the temperature.



Air outlets and fan speed for the driver and passenger seats may be set separately depending on the temperature setting.

Adjusting the settings

■ Adjusting the temperature setting

Press “^” on  to increase the temperature and “v” to decrease the temperature.

The air conditioning system switches between individual and simultaneous modes each time  is pressed.

Simultaneous mode (the indicator on  is on): Only  (driver’s side) can be used to adjust the temperature for all seats.

Individual mode (the indicator on  is off): The temperature for the driver’s, front passenger’s and rear seats (→P. 256) can be adjusted separately. Operating the passenger’s side or rear temperature control will enter individual mode.

■ Adjusting the fan speed

Press “>” (increase) or “<” (decrease) on  .

The fan speed is shown on the display. (5 levels)

Press  to turn the fan off.

■ Changing the air outlets

Press **MODE** .

The air outlets switch each time **MODE** is pressed. The air flow shown on the display indicates the following.

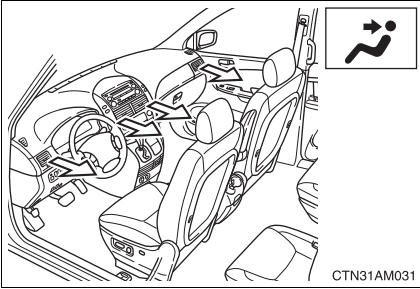

Upper body

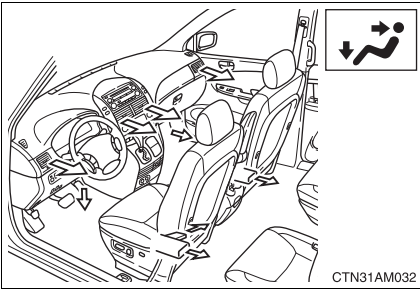

Upper body and feet

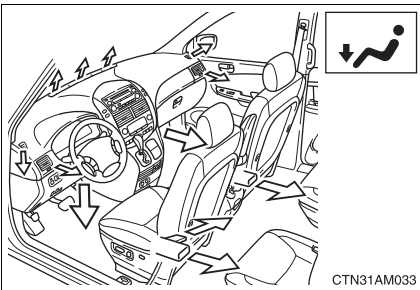

Feet

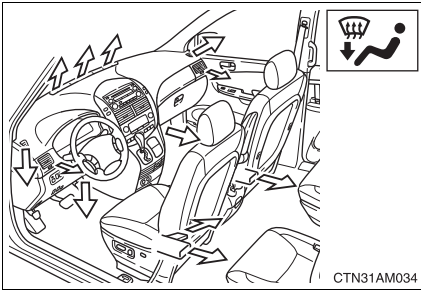

Feet and windshield

■ **Switching between outside air and recirculated air modes**

Press .

The mode switches between outside air mode (indicator off) and recirculated air mode (indicator on) each time is pressed.

Defogging the windshield

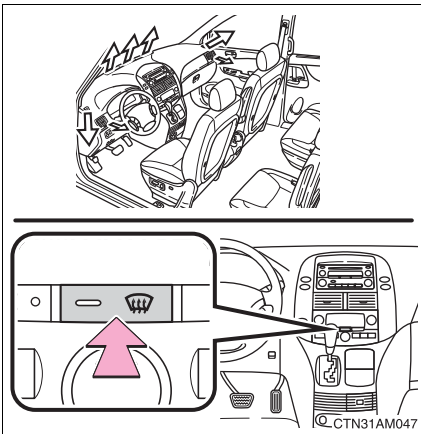

Press .

The air conditioning system operates automatically.

Recirculated air mode will automatically switch to outside air mode. It is not possible to return to recirculated air mode when the switch is on.

3 Interior features

Changing the rear setting

■ Adjusting the temperature setting

STEP 1 Press  (indicator on).

STEP 2 Press “^” on  to increase the temperature and “v” to decrease the temperature.

The air conditioning system switches between individual and simultaneous modes each time  is pressed.

When  is pressed on the front air conditioning system to turn it off, the rear air conditioning system is also turned off.

Adjusting the position of the air outlets

► Center outlets

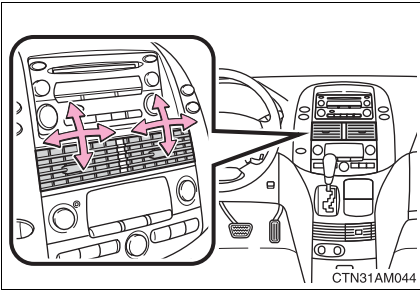

Direct air flow to the left or right, up or down.

► Right and left side outlets

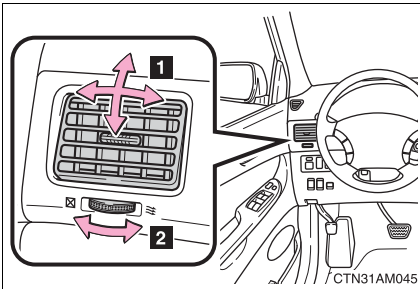

- 1 Direct air flow to the left or right, up or down.
- 2 Turn the knob to open or close the vent.

■ Using the automatic mode

Fan speed is adjusted automatically in accordance with the temperature setting and ambient conditions. As a result, the following may occur.

- Immediately after  is pressed, the fan may stop for a while until warm or cool air is ready to flow.
- Cool air may flow to the area around the upper body when the heater is on.

■ Using the system in recirculated air mode

The windows will fog up more easily if the recirculated air mode is used for an extended period.

■ Window defogger feature

In order to prevent the windows from fogging up, recirculated air mode may automatically switch to outside air mode if the ambient temperature drops.

■ Temperature display

The temperature display (English/U.S. Customary System and metric units) on the trip information display can be changed. (→P. 183)

■ When outside temperature approaches 32°F (0°C)

The air conditioning system may not operate even when  is pressed.

■ **When  is selected for the air outlets used**

For your driving comfort, air flowing to the feet may be warmer than air flowing to the upper body depending on the temperature setting.

■ **When the indicator light on  flashes**

Press  and turn off the air conditioning system before turning it on once more. There may be a problem in the air conditioning system if the indicator light continues to flash. Turn the air conditioning system off and have it inspected by your Toyota dealer.

■ **Air conditioning odors**

- During use, various odors from inside and outside the vehicle may enter into and accumulate in the air conditioning system. This may then cause odor to be emitted from the vents.
- To reduce potential odors from occurring:
 - It is recommended that the air conditioning system be set to outside air mode prior to turning the vehicle off.
 - The start timing of the blower may be delayed for a short period of time immediately after the air conditioning system is started in automatic mode.

 **CAUTION**

■ **To prevent the windshield from fogging up**

Do not use  during cool air operation in extremely humid weather. The difference between the temperature of the outside air and that of the windshield can cause the outer surface of the windshield to fog up, blocking your vision.

 **NOTICE**

■ **To prevent battery discharge**

Do not leave the air conditioning system on longer than necessary when the engine is off.

3-1. Using the air conditioning system and defogger Rear manual air conditioning system (if equipped)

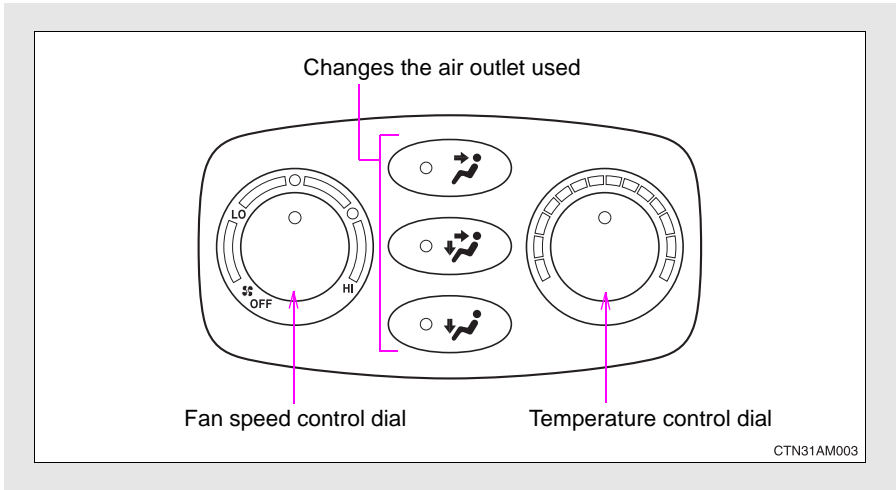

Adjusting the settings

■ Adjusting the temperature setting

Turn the temperature control dial clockwise (warm) or counter-clockwise (cool).

■ Adjusting the fan speed

Turn the fan speed control dial clockwise (increase) or counter-clockwise (decrease).

■ Changing the air outlets

Press the desired  ,  or  .

Air flows as shown below according to the mode selected.

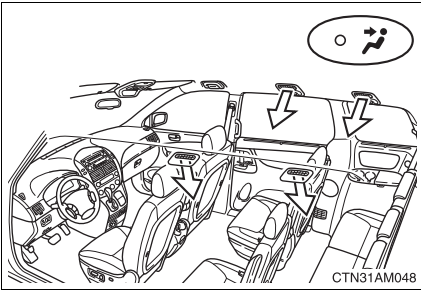

Upper body

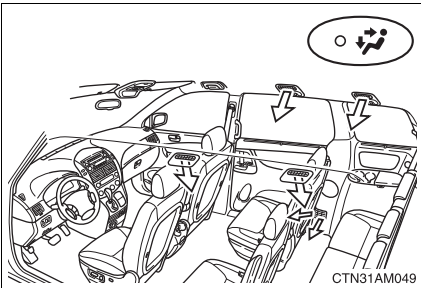

Upper body and feet

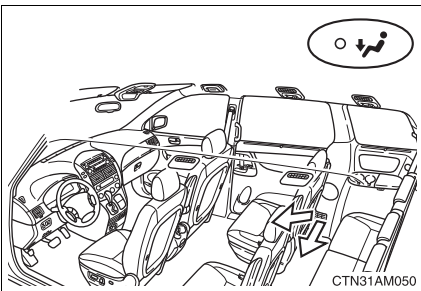

Feet

Adjusting the position of and opening and closing the air outlets

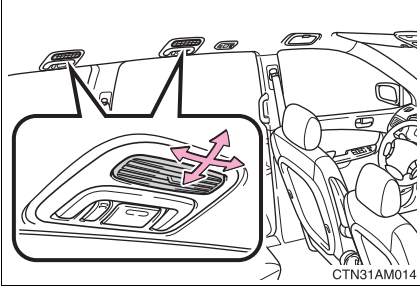

Direct air flow to the front or rear, up or down.

 **NOTICE**

 **To prevent battery discharge**

Do not leave the air conditioning system on longer than necessary when the engine is off.

3-1. Using the air conditioning system and defogger Rear automatic air conditioning system (if equipped)

Airflow and outlets are automatically adjusted according to the temperature setting.

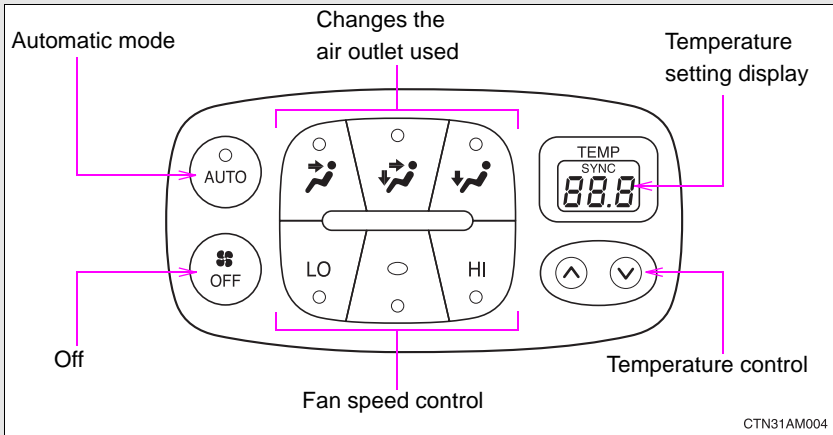

Using the automatic mode

STEP 1 Press  .

The air conditioning system begins to operate. Air outlets and fan speed are automatically adjusted according to the temperature setting.

STEP 2 Press “^” on  to increase the temperature and “v” to decrease the temperature.

Adjusting the settings

■ Adjusting the temperature setting

Press “^” on  to increase the temperature and “v” to decrease the temperature.

■ Changing the air outlets

Press the desired ,  or  .

Air flows as shown below according to the mode selected.

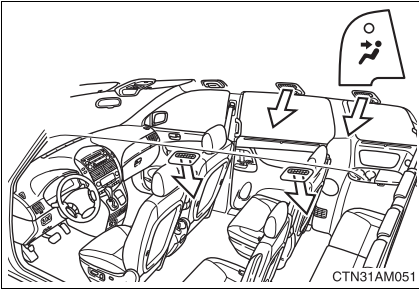

Upper body

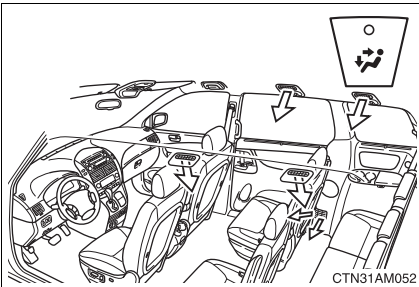

Upper body and feet

3-1. Using the air conditioning system and defogger

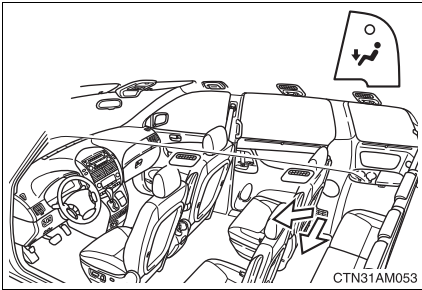

Feet

■ Adjusting the fan speed

Press  (decrease ↔ increase).

Press  to turn the fan off.

Adjusting the position of the air outlets

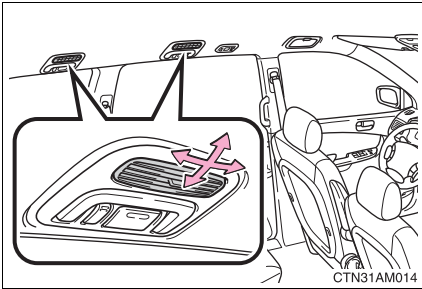

Direct air flow to the front or rear, up or down.

■ **Temperature display**

The temperature display (English/U.S. Customary System and metric units) on the trip information display can be changed. (→P. 183)

■ **When the front air conditioning system is in simultaneous mode**

“SYNC” is shown on the display. The rear air conditioning system controls will not function. (→P. 247)



NOTICE

■ **To prevent battery discharge**

Do not leave the air conditioning system on longer than necessary when the engine is off.

3-1. Using the air conditioning system and defogger Rear window and outside rear view mirror defoggers, and windshield wiper de-icer

The rear window defogger is used to defog the rear window. The outside rear view mirror defoggers^{*1} are used to remove frost, dew or raindrops from the outside rear view mirrors. The windshield wiper de-icer^{*2} is used to prevent ice from building up on the windshield and wiper blades.

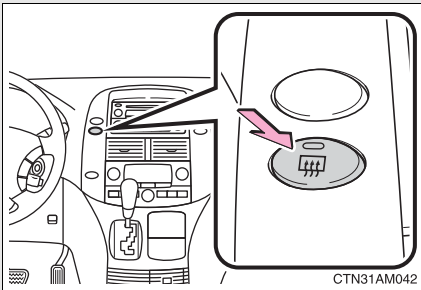

On/off

The defoggers and de-icer will automatically turn off after approximately 15 minutes.

*1: Vehicles with outside rear view mirror defoggers

*2: Vehicles with windshield wiper de-icer

■ The defogger can be operated when

The engine switch is in the "ON" position.

■ Outside rear view mirror defoggers (vehicles with outside rear view mirror defoggers)

Turning the rear window defogger on will turn the outside rear view mirror defoggers on.

■ Windshield wiper de-icer (vehicles with windshield wiper de-icer)

Turning the rear window defogger on will turn the windshield wiper de-icer on.

 CAUTION

■ **Outside rear view mirror defoggers (vehicles with outside rear view mirror defoggers)**

The surfaces of the outside rear view mirrors become hot. Do not touch them to prevent from burning yourself.

■ **When the windshield wiper de-icer is on (vehicles with windshield wiper de-icer)**

Do not touch the glass at the lower part of the windshield or to the side of the front pillars as the surfaces can become very hot and burn you.

3-2. Using the audio system

Audio system types

▶ With navigation system

Owners of models equipped with a navigation system should refer to the “Navigation System Owner’s Manual”.

▶ Without navigation system (type A)

CD player with changer controller and AM/FM radio

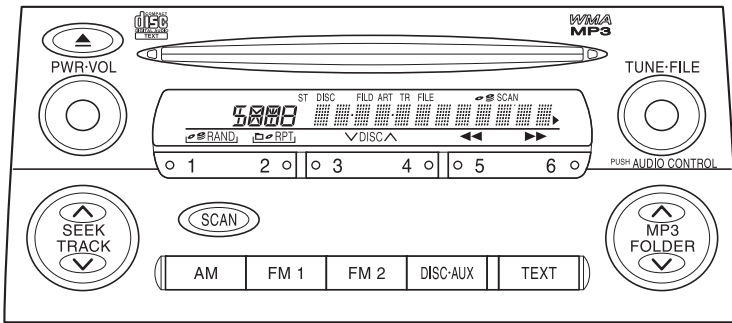

CTN32AM014

▶ Without navigation system (type B)

CD player with changer and AM/FM radio

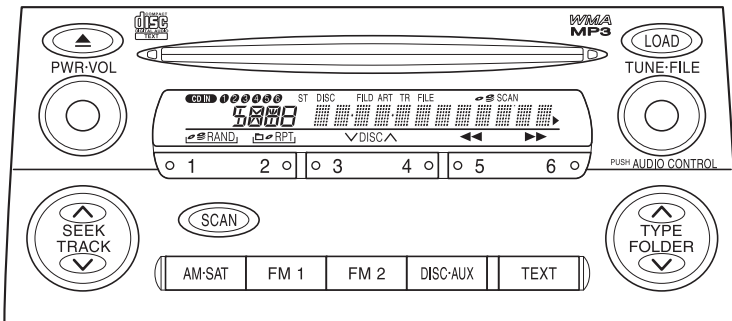

CTN32AM002

► Without navigation system (type C)
CD player with changer and AM/FM radio

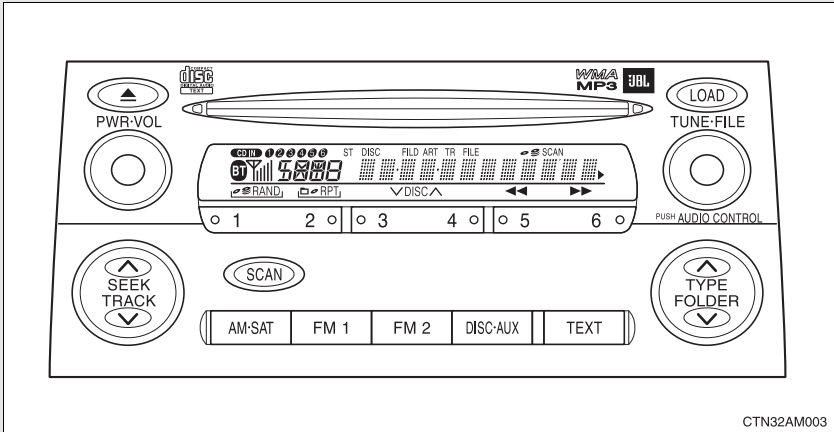

CTN32AM003

Title	Page
Using the radio	P. 265
Using the CD player	P. 271
Playing back MP3 and WMA discs	P. 279
Optimal use of the audio system	P. 287
Using the AUX adapter	P. 291
Using the steering wheel audio switches	P. 292

■ Using cellular phones

Interference may be heard through the audio system's speakers if a cellular phone is being used inside or close to the vehicle while the audio system is operating.

 **CAUTION**

■ **For vehicles sold in U.S.A. and Canada**

● Part 15 of the FCC Rules

FCC Warning:

Any unauthorized changes or modifications to this equipment will void the user's authority to operate this device.

● Laser products

- Do not take this unit apart or attempt to make any changes yourself.

This is an intricate unit that uses a laser pickup to retrieve information from the surface of compact discs. The laser is carefully shielded so that its rays remain inside the cabinet. Therefore, never try to disassemble the player or alter any of its parts since you may be exposed to laser rays and dangerous voltages.

- This product utilizes a laser.

Use of controls or adjustments or performance of procedures other than those specified herein may result in hazardous radiation exposure.

 **NOTICE**

■ **To prevent battery discharge**

Do not leave the audio system on longer than necessary when the engine is off.

■ **To avoid damaging the audio system**

Take care not to spill drinks or other fluids over the audio system.

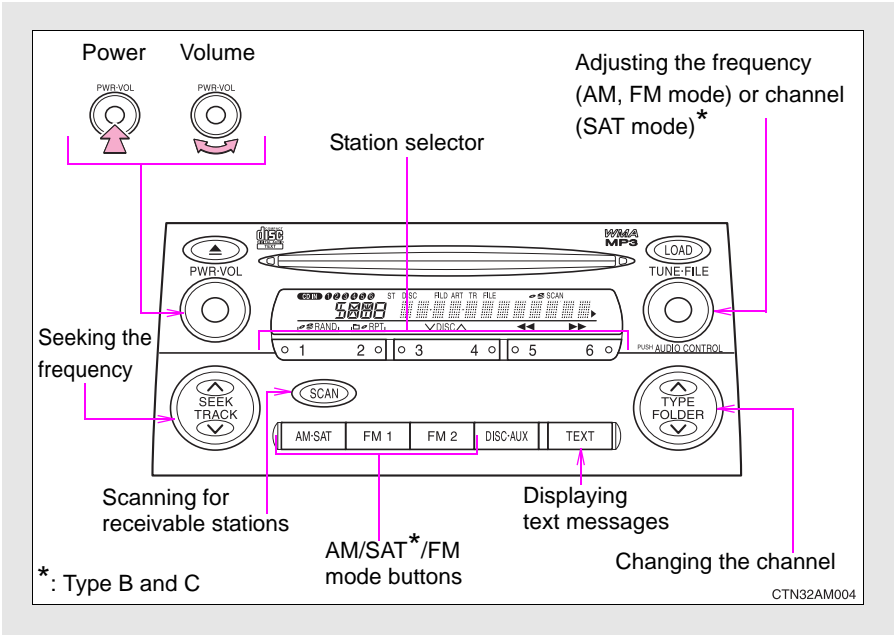

3-2. Using the audio system Using the radio



Setting station presets (excluding XM[®] Satellite Radio)

STEP 1 Search for desired stations by turning  or pressing “^”

or “v” on  .

STEP 2 Press and hold the button (from  to ) the station is to be set to until you hear a beep.

Scanning radio stations (excluding XM[®] Satellite Radio)

■ Scanning the preset radio stations

STEP 1 Press and hold  until you hear a beep.

Preset stations will be played for 5 seconds each.

STEP 2 When the desired station is reached, press  once again.

■ Scanning all radio stations within range

STEP 1 Press  .

All stations with reception will be played for 5 seconds each.

STEP 2 When the desired station is reached, press  once again.

XM[®] Satellite Radio (type B and C)

■ Receiving XM[®] Satellite Radio

STEP 1 Press  .

The display changes as follows each time  is pressed.



AM → SAT1 → SAT2 → SAT3



STEP 2 Turn  to select the desired channel from all categories

or press “^” or “v” on  to select the desired channel in the current category.

■ Setting XM[®] Satellite Radio channel presets

Select the desired channel. Press and hold the button (from  to ) the channel is to be set to until you hear a beep.

■ Changing the channel category

Press “^” or “v” on  .

■ Scanning XM[®] Satellite Radio channels

- Scanning channels in the current category

STEP 1 Press  .

STEP 2 When the desired channel is reached, press  again.

- Scanning preset channels

STEP 1 Press and hold  until you hear a beep.

STEP 2 When the desired channel is reached, press  again.

■ Displaying text information

Press  .

The display will show up to 10 characters.

The display changes as follows each time  is pressed.

- Channel name
- Title (song/program title)
- Name (artist name/feature)
- Channel number

■ **When the battery is disconnected**

Station presets are erased.

■ **Reception sensitivity**

- Type B and C — Cargo loaded on the roof luggage carrier, especially metal objects, may adversely affect the reception of XM[®] Satellite Radio.
- Maintaining perfect radio reception at all times is difficult due to the continually changing position of the antenna, differences in signal strength and surrounding objects, such as trains, transmitters, etc.
- Mast type antenna — The radio antenna is mounted on the roof. The antenna can be removed from the base by turning it.
- Print type antenna — The radio antenna is mounted inside the rear quarter window. To maintain clear radio reception, do not attach metallic window tinting or other metallic objects to the antenna wire mounted inside the rear quarter window.

■ **XM[®] Satellite Radio (type B and C)**

An XM[®] Satellite Radio is a tuner designed exclusively to receive broadcasts provided under a separate subscription. Availability is limited to the 48 contiguous states and 10 Canadian provinces.

● XM[®] subscriptions

For detailed information about XM[®] Satellite Radio or to subscribe:

U.S.A. —

Visit on the web at www.xmradio.com or call 1-800-967-2346.

Canada —

Visit on the web at www.xmradio.ca or call 1-877-438-9677.

● Radio ID

You will need the radio ID when activating XM[®] service or reporting a

problem. Select “CH000” using



, and the receiver's 8-character ID

number will appear.

● Satellite tuner

The tuner supports only Audio Services (Music and Talk) and the accompanying Text Information of XM[®] Satellite Radio.

■ **If the satellite radio does not operate normally (type B and C)**

If a problem occurs with the XM[®] tuner, a message will appear on the display. Refer to the table below to identify the problem, and take the suggested corrective action.

ANTENNA	The XM [®] antenna is not connected. Check whether the XM [®] antenna cable is attached securely.
	There is a short-circuit in the antenna or the surrounding antenna cable. See a Toyota certified dealer.
UPDATING	You have not subscribed to XM [®] Satellite Radio. The radio is being updated with the latest encryption code. Contact XM [®] Satellite Radio for subscription information. When a contract is canceled, you can choose the "CH000" and all free-to-air channels.
	The premium channel you selected is not authorized. Wait for about 2 seconds until the radio returns to the previous channel or "CH001". If it does not change automatically, select another channel. If you want to listen to the premium channel, contact XM [®] Satellite Radio.
NO SIGNAL	The XM [®] signal is too weak at the current location. Wait until your vehicle reaches a location with a stronger signal.
LOADING	The unit is acquiring audio or program information. Wait until the unit has received the information.
OFF AIR	The channel you selected is not broadcasting any programming. Select another channel.
-----	There is no song/program title or artist name/feature associated with the channel at that time. No action needed.

The channel you selected is no longer available. Wait for about 2 seconds until the radio returns to the previous channel or "CH001". If it does not change automatically, select another channel.

Contact the XM[®] Listener Care Center at 1-800-967-2346 (U.S.A.) or 1-877-438-9677 (Canada).

■ Certifications for the radio tuner

This equipment has been tested and found to comply with the limits for a class B digital device, pursuant to Part 15 of the FCC Rules. These limits are designed to provide reasonable protection against harmful interference in a residential installation. This equipment generates, uses and can radiate radio frequency energy and, if not installed and used in accordance with the instructions, may cause harmful interference to radio communications. However, there is no guarantee that interference will not occur in a particular installation.

If this equipment does cause harmful interference to radio or television reception, which can be determined by turning the equipment off and on, the user is encouraged to try to correct the interference by trying one or more of the following:

- Reorienting or relocating the receiving antenna.
- Increasing the separation between the equipment and receiver.
- Connecting the equipment into an outlet on a circuit different from that to which the receiver is connected.
- Consulting the dealer or an experienced radio/TV technician for help.



NOTICE

■ To prevent damage, remove the antenna in the following cases. (Mast type antenna)

- The antenna will touch the ceiling of a garage.
- A cover will be put on the vehicle.

3-2. Using the audio system Using the CD player

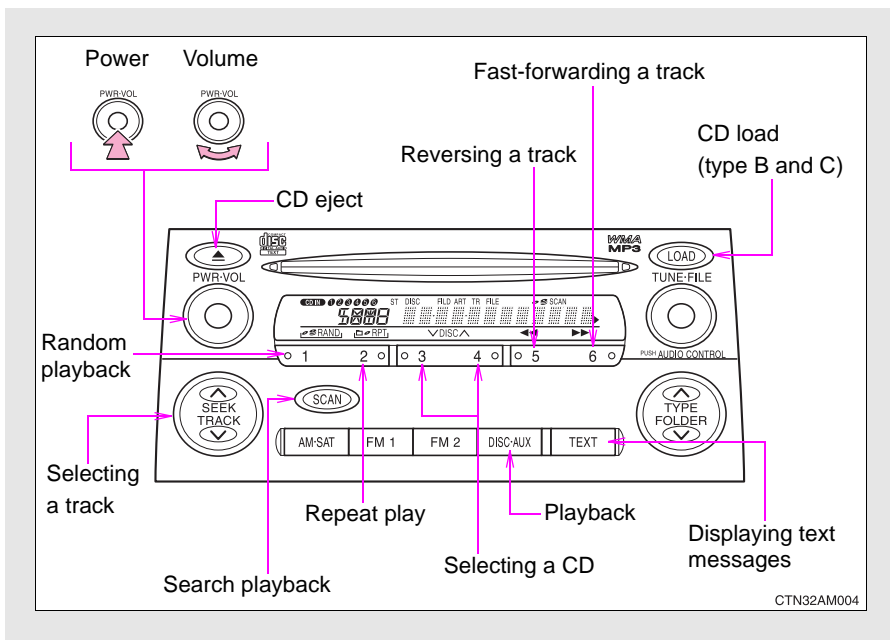

Loading CDs

■ Loading a CD

► Type A

Insert a CD.

► Type B and C

STEP 1 Press **LOAD**.

“WAIT” is shown on the display.

STEP 2 Insert a CD when the indicator on the slot turns from amber to green.

The display changes from “WAIT” to “LOAD”.

■ Loading multiple CDs (type B and C)

STEP 1 Press and hold  until you hear a beep.
“WAIT” is shown on the display.

STEP 2 Insert a CD when the indicator on the slot turns from amber to green.

The display changes from “WAIT” to “LOAD”.

The indicator on the slot turns to amber when the CD is inserted.

STEP 3 Insert the next CD when the indicator on the slot turns from amber to green again.

Repeat the procedure for the remaining CDs.

To stop the operation, press  .



Ejecting CDs

■ Ejecting a CD

▶ Type A

Press  and remove the CD.

▶ Type B and C

STEP 1 To select the CD to be ejected, press  (∨) or  (∧).

The number of the CD selected is shown on the display.

STEP 2 Press  and remove the CD.

■ Ejecting all the CDs (type B and C)

Press and hold  until you hear a beep, and then remove the CDs.

Selecting a track



■ To select one track at a time

Press “^” to move up or “v” to move down using  until the desired track number is displayed.

■ To return to the beginning of the current track

Press “v” on .

Fast-forwarding and reversing tracks

To fast-forward or reverse, press  (reverse) or  (fast-forward).

Scanning tracks

STEP 1 Press .

The first 10 seconds of each track will be played.

STEP 2 Press  again when the desired track is reached.

Selecting a CD (type A with a CD changer, type B and type C)

■ To select a CD to play

To select the desired CD, press  (v) or  (^).

■ To scan loaded CDs

STEP 1 Press and hold  until you hear a beep.

The first 10 seconds of the first track on each CD will be played.

STEP 2 Press  again when the desired CD is reached.

Repeat play

■ To repeat a track

Press (RPT).

■ To repeat all of the tracks on a CD (type A with a CD changer, type B and type C)

Press and hold (RPT) until you hear a beep.

Random playback

■ Current CD

Press (RAND).

Tracks are played in a random order until is pressed once more.

■ All CDs (type A with a CD changer, type B and type C)

Press and hold (RAND) until you hear a beep.

Tracks on all loaded CDs are played in a random order until is pressed once more.

Switching the display

Press .

Each time is pressed, the display changes in the order of "Track no./Elapsed time"→"CD title"→"Track name".

■ Display

Up to 12 characters can be displayed at a time.

If there are 13 characters or more, pressing and holding  for 1 second or more will display the remaining characters.

A maximum of 24 characters can be displayed.

If  is pressed for 1 second or more again or has not been pressed for 6 seconds or more, the display will return to the first 12 characters.

Depending on the contents recorded, the characters may not be displayed properly or may not be displayed at all.

■ Canceling random and repeat playback

Press  (RAND),  (RPT) or  again.

■ Error messages

“ERROR 1”: The disc may be dirty, damaged or inserted upside down.

“ERROR 3”: There is a problem inside the player.

“ERROR 4”: Over-current. Ask your Toyota dealer.

“WAIT”: Operation has stopped due to a high temperature inside the player. Wait for a while and then press . Contact your Toyota dealer if the CD still cannot be played back.

■ Discs that can be used

Discs with the marks shown below can be used.

Playback may not be possible depending on recording format or disc features, or due to scratches, dirt or deterioration.



CDs with copy-protect features may not be used.

■ CD player protection feature

To protect the internal components, playback is automatically stopped when a problem is detected while the CD player is being used.

■ If CDs are left inside the CD player or in the ejected position for extended periods

CDs may be damaged and may not play properly.

■ Lens cleaners

Do not use lens cleaners. Doing so may damage the CD player.

 NOTICE

■ CDs and adapters that cannot be used

Do not use the following types of CDs, 3 in. (8 cm) CD adapters (type A only) or Dual Discs.

Doing so may damage the CD player and/or the CD insert/eject function.

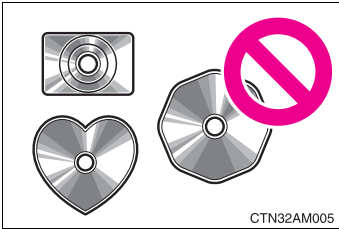

- Type A: CDs that have a diameter other than 4.7 in. (12 cm) or 3 in. (8 cm)
- Type B and C: CDs that have a diameter that is not 4.7 in. (12 cm)

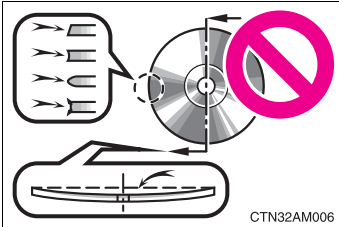

- Low-quality and deformed CDs

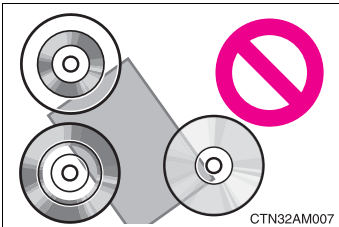

- CDs with a transparent or translucent recording area

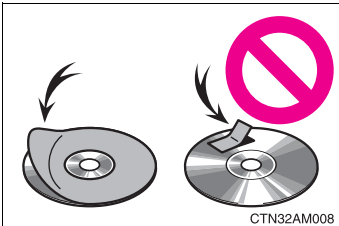

- CDs that have had tape, stickers or CD-R labels attached to them, or that have had the label peeled off

 NOTICE

■ **CD player precautions**

Failure to follow the precautions below may result in serious damage to the CDs or the player itself.

- Do not insert anything other than CDs into the CD slot.
- Do not apply oil to the CD player.
- Store CDs away from direct sunlight.
- Never try to disassemble any part of the CD player.

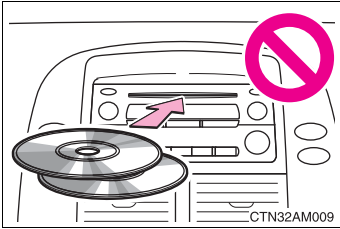

- Do not insert more than one CD at a time.

3-2. Using the audio system

Playing back MP3 and WMA discs

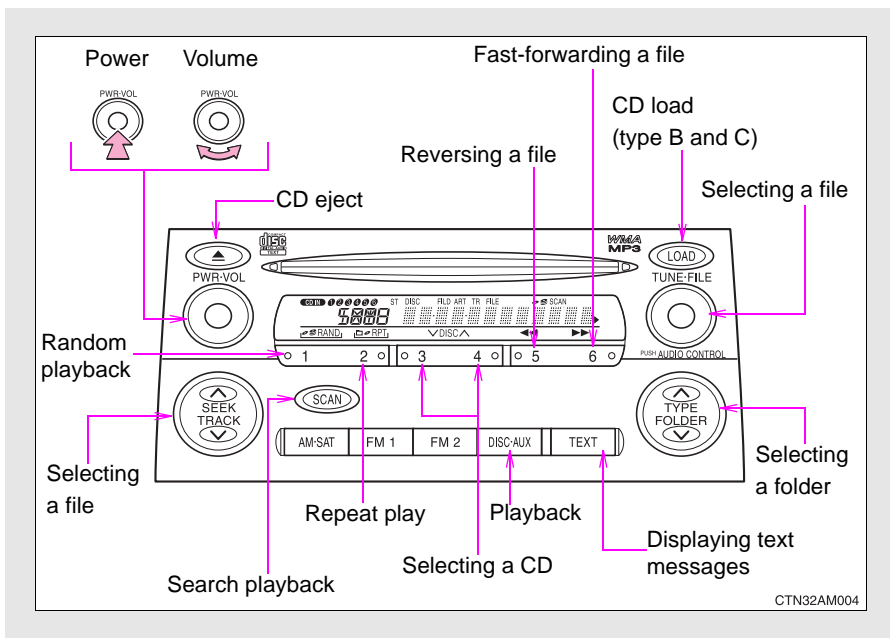

Loading and ejecting MP3 and WMA discs

→P. 271, 272

Selecting a MP3 and WMA disc (type A with a CD changer, type B and type C)



→P. 273

Selecting and scanning a folder



■ Selecting folders one at a time

Press “^” or “v” on  or  to select the desired folder.

■ Selecting the desired folder by cueing the first file of each folder



Press and hold  until you hear a beep. When the desired folder is reached, press  once again.

■ Returning to the first folder

Press and hold “v” on  or  until you hear a beep.

Selecting and scanning files

■ Selecting one file at a time

Turn  or press “^” or “v” on  to select the desired file.

■ Selecting the desired file by cueing the files in the folder

Press  .

When the desired file is reached, press  once again.

■ To return to the beginning of the current file

Press “v” on  .

Fast-forwarding and reversing files

To fast-forward or reverse, press (reverse) or (fast-forward).

Repeat play

■ To repeat a file

Press (RPT).

■ To repeat all of the files in a folder

Press and hold (RPT) until you hear a beep.

Random playback

■ To play files from a particular folder in random order

Press (RAND).

■ To play all of the files on a disc in random order

Press and hold (RAND) until you hear a beep.

Switching the display

Press .

Each time is pressed, the display changes in the order of “Folder no./File no./Elapsed time”→“Folder name”→“File name”→“Album title” (MP3 only)→“Track title”→“Artist name”.

■ Display

→P. 275

■ Canceling random and repeat playback

→P. 275

■ Error messages

“ERROR 1”: The disc may be dirty, damaged or inserted upside down.

“ERROR 3”: There is a problem inside the player.

“ERROR 4”: Over-current. Ask your Toyota dealer.

“WAIT”:
Operation has stopped due to a high temperature inside the player. Wait for a while and then press  . Contact your Toyota dealer if the CD still cannot be played back.

“NO MUSIC”:
This indicates that the MP3/WMA file is not included in the CD.

■ Discs that can be used

Discs with the marks shown below can be used.

Playback may not be possible depending on recording format or disc features, or due to scratches, dirt or deterioration.



■ CD player protection feature

→P. 276

■ If CDs are left inside the CD player or in the ejected position for extended periods

→P. 276

■ Lens cleaners

→P. 276

■ MP3 and WMA files

MP3 (MPEG Audio LAYER3) is a standard audio compression format.

Files can be compressed to approximately 1/10 of their original size using MP3 compression.

WMA (Windows Media TM Audio) is a Microsoft audio compression format.

This format compresses audio data to a size smaller than that of the MP3 format.

There is a limit to the MP3 and WMA file standards and to the media/formats recorded by them that can be used.

● MP3 file compatibility

- Compatible standards
MP3 (MPEG1 LAYER3, MPEG2 LSF LAYER3)
- Compatible sampling frequencies
MPEG1 LAYER3: 32, 44.1, 48 (kHz)
MPEG2 LSF LAYER3: 16, 22.05, 24 (kHz)
- Compatible bit rates (compatible with VBR)
MPEG1 LAYER3: 64, 80, 96, 112, 128, 160, 192, 224, 256, 320 (kbps)
MPEG2 LSF LAYER3: 64, 80, 96, 112, 128, 144, 160 (kbps)
- Compatible channel modes: stereo, joint stereo, dual channel and monaural

● WMA file compatibility

- Compatible standards
WMA Ver. 7, 8, 9
- Compatible sampling frequencies
32, 44.1, 48 (kHz)
- Compatible bit rates (only compatible with 2-channel playback)
Ver. 7, 8: CBR 48, 64, 80, 96, 128, 160, 192 (kbps)
Ver. 9: CBR 48, 64, 80, 96, 128, 160, 192, 256, 320 (kbps)

● Compatible media

Media that can be used for MP3 and WMA playback are CD-Rs and CD-RWs.

Playback in some instances may not be possible, depending on the status of the CD-R or CD-RW. Playback may not be possible or the audio may jump if the disc is scratched or marked with fingerprints.

● Compatible disc formats

The following disc formats can be used.

- Disc formats: CD-ROM Mode 1 and Mode 2
CD-ROM XA Mode 2, Form 1 and Form 2
- File formats: ISO9660 Level 1, Level 2, (Romeo, Joliet)
MP3 and WMA files written in any format other than those listed above may not play correctly, and their file names and folder names may not be displayed correctly.

Items related to standards and limitations are as follows.

- Maximum directory hierarchy: 8 levels
- Maximum length of folder names/file names: 32 characters
- Maximum number of folders: 192 (including the root)
- Maximum number of files per disc: 255

● File names

The only files that can be recognized as MP3/WMA and played are those with the extension .mp3 or .wma.

● Multi-sessions

As the audio system is compatible with multi-sessions, it is possible to play discs that contain MP3 and WMA files. However, only the first session can be played.

● ID3 and WMA tags

ID3 tags can be added to MP3 files, making it possible to record the track title, artist name, etc.

The system is compatible with ID3 Ver. 1.0, 1.1, and Ver. 2.2, 2.3 ID3 tags. (The number of characters is based on ID3 Ver. 1.0 and 1.1.)

WMA tags can be added to WMA files, making it possible to record the track title and artist name in the same way as with ID3 tags.

● MP3 and WMA playback

When a disc containing MP3 or WMA files is inserted, all files on the disc are first checked. Once the file check is finished, the first MP3 or WMA file is played. To make the file check finish more quickly, we recommend you do not write in any files other than MP3 or WMA files or create any unnecessary folders.

If the discs contain a mixture of music data and MP3 or WMA format data, only music data can be played.

● Extensions

If the file extensions .mp3 and .wma are used for files other than MP3 and WMA files, they will be mistakenly recognized and played as MP3 and WMA files. This may result in large amounts of interference and damage to the speakers.

● Playback

- To play MP3 file with steady sound quality, we recommend a fixed bit rate of 128 kbps and a sampling frequency of 44.1 kHz.
- CD-R or CD-RW playback may not be possible in some instances, depending on the characteristics of the disc.
- There is a wide variety of freeware and other encoding software for MP3 and WMA files on the market, and depending on the status of the encoding and the file format, poor sound quality or noise at the start of playback may result. In some cases, playback may not be possible at all.
- When files other than MP3 or WMA files are recorded on a disc, it may take more time to recognize the disc and in some cases, playback may not be possible at all.
- Microsoft, Windows, and Windows Media are the registered trademarks of Microsoft Corporation in the U.S. and other countries.

 NOTICE

■ **CDs and adapters that cannot be used**

→P. 277

■ **CD player precautions**

→P. 278

Optimal use of the audio system

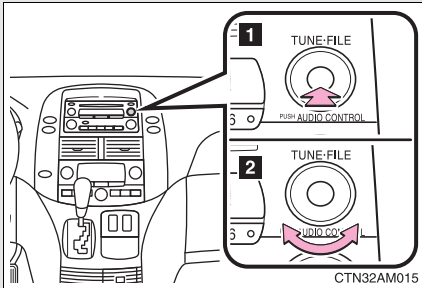

- 1 Displays the current mode
- 2 Changes the following setting

- Sound quality and volume balance (→P. 288)

The sound quality and balance setting can be changed to produce the best sound.

- Volume and tone quality level (Automatic Sound Levelizer) (→P. 289)
- Rear seat entertainment system lock on/off (→P. 289)

Using the audio control function

■ Changing sound quality modes

Pressing  selects the mode to be changed in the following order.

“BAS”→“MID*1”→“TRE”→“FAD”→“BAL”→“SURROUND*1”→“ASL”→“RSE*2”



*1: Type C only

*2: Vehicles with rear seat entertainment system

■ Adjusting sound quality and volume balance

Turning  adjusts the level.

Mode displayed	Sound quality mode	Level	Turn to the left	Turn to the right
BAS*	Bass	-5 to 5	Low	High
MID* (type C only)	Mid-range	-5 to 5		
TRE*	Treble	-5 to 5		
FAD	Front/rear volume balance	R7 to F7	Shifts to rear	Shifts to front
BAL	Left/right volume balance	L7 to R7	Shifts to left	Shifts to right
SURROUND (type C only)	Surround	ON/OFF	OFF	ON

*: The sound quality level is adjusted individually in each radio mode or CD mode.

■ Adjusting the Automatic Sound Levelizer (ASL)

ASL automatically adjusts the volume and tone quality to compensate for varying noise levels while driving.

▶ Type A and B

When “ASL” is selected, turning  to the right changes the “ASL” level in the order of “LOW”, “MID” and “HIGH”.

Turning  to the left turns “ASL” off.

▶ Type C

When “ASL” is selected, turning  to the right turns “ASL” on,

and turning  to the left turns “ASL” off.

■ Setting the rear seat entertainment system lock (vehicles with rear seat entertainment system)

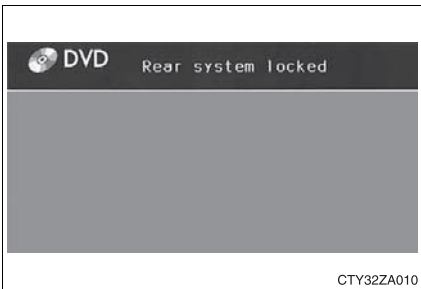

When “RSE” is selected, turn  until “RSE ON” or “RSE OFF” is displayed.

The rear seat entertainment system lock remains on, even when the engine switch is turned off.

■ **Trademark owned by SRS Labs, Inc. (type A and B)**



The audio systems utilize SRS FOCUS[®] and SRS TruBass[®] audio enhancement technologies, under license from SRS Labs, Inc., in all modes except AM radio mode.

FOCUS, TruBass, SRS and  symbols are trademarks of SRS Labs, Inc.

FOCUS and TruBass technologies are incorporated under license from SRS Labs, Inc.

3-2. Using the audio system Using the AUX adapter

This adapter can be used to connect a portable audio device and listen to it through the vehicle's speakers.

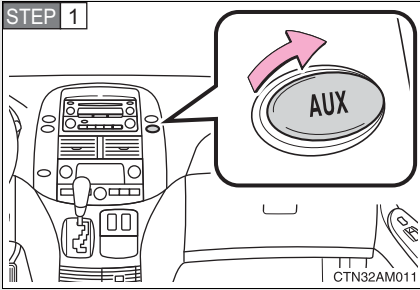

Open the cover and connect the portable audio device.

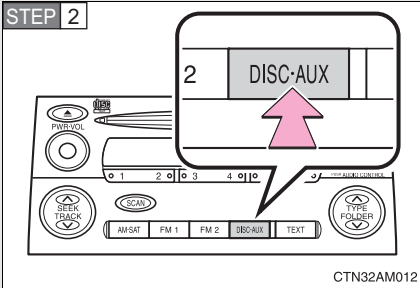

Press **DISC:AUX**.

■ Operating portable audio devices connected to the audio system

The volume can be adjusted using the vehicle's audio controls. All other adjustments must be made on the portable audio device itself.

■ When using a portable audio device connected to the power outlet

Noise may occur during playback. Use the power source of the portable audio device.

3-2. Using the audio system

Using the steering wheel audio switches (if equipped)

Some audio features can be controlled using the switches on the steering wheel.

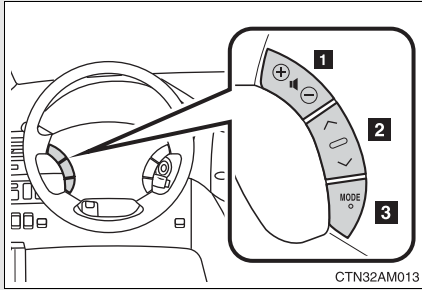



- 1** Volume
- 2** Radio: Select radio stations
CD: Select tracks, files (MP3 and WMA) and discs
RSE: Select tracks and chapters
- 3** Power on/off, select audio source

Turning on the power

Press  when the audio system is turned off.

The audio system can be turned off by holding  down until you hear a beep.

Changing the audio source

Press  when the audio system is turned on. The audio source changes as follows each time  is pressed.

Type A:

FM1→FM2→CD→CD changer*¹→AUX→AM

Type B:

FM1→FM2→CD changer→AUX→AM→SAT1→SAT2→SAT3



Type C:

FM1→FM2→CD changer→RSE*²→AUX→AM→SAT1→SAT2→SAT3

*¹: If installed with a CD changer

*²: Vehicles with rear seat entertainment system

Adjusting the volume

Press “+” on  to increase the volume and “-” to decrease the volume.

Press and hold  to continue increasing or decreasing the volume.

Selecting a radio station/channel

■ To select a preset station/channel

STEP 1 Press  to select the radio mode.

STEP 2 Press “^” or “v” on  to select a preset station/channel.

■ To scan for receivable stations

STEP 1 Press  to select the radio mode.

STEP 2 Press and hold  until you hear a beep.

Selecting a track/file

■ To select one track/file at a time

STEP 1 Press  to select the CD mode.

STEP 2 Press “^” or “v” on  to select the desired track/file.

■ To return to the beginning of the current track/file

STEP 1 Press  to select the CD mode.

STEP 2 Press “v” on  .

Selecting a folder (type A)

STEP 1 Press  to select the CD mode.

STEP 2 Press and hold  until you hear a beep.

Selecting a disc (type A with a CD changer, type B and type C)

STEP 1 Press  to select the CD mode.

STEP 2 Press and hold  until you hear a beep.

Selecting a track/chapter (type C — rear seat entertainment system)

STEP 1 Press  to select the RSE mode.

STEP 2 Press “^” or “v” on  to select the desired track/chapter.

CAUTION

■ To reduce the risk of an accident

Exercise care when operating the audio switches on the steering wheel.

3-3. Using the rear audio system

Rear seat entertainment system features (if equipped)

The rear seat entertainment system is designed for the rear passengers to enjoy audio and DVD video separately from the front audio system.

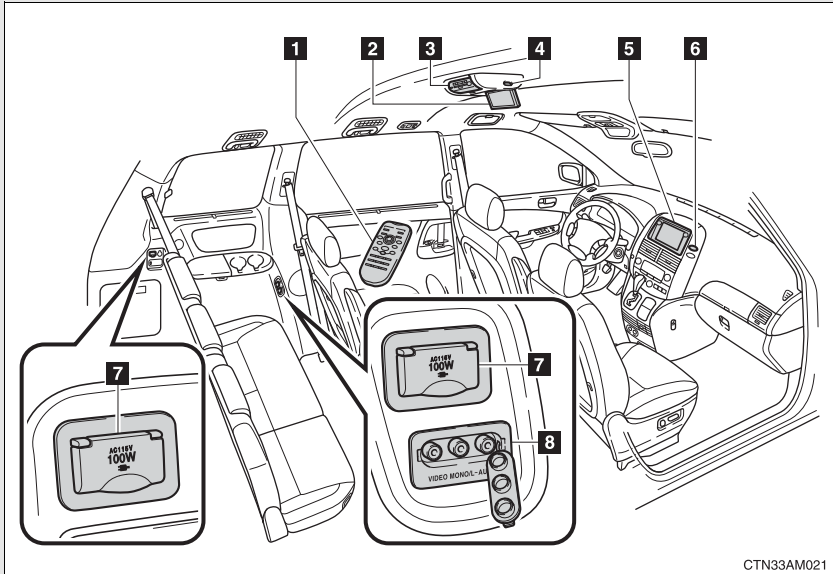

CTN33AM021

- 1** Rear seat entertainment system controller
- 2** Display
- 3** DVD player
- 4** Headphone volume control dials and headphone jacks
- 5** Front audio system
- 6** Power outlet main switch
- 7** Power outlets
- 8** A/V input adapter

Opening and closing the display

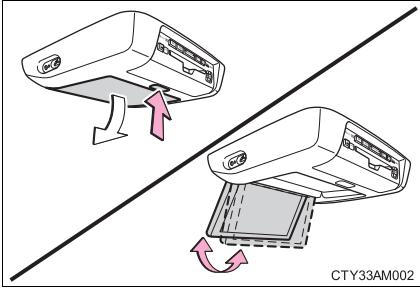

Press the lock release button to open the display.

Pull the display down to an easily viewable angle (between 90° and 125°).

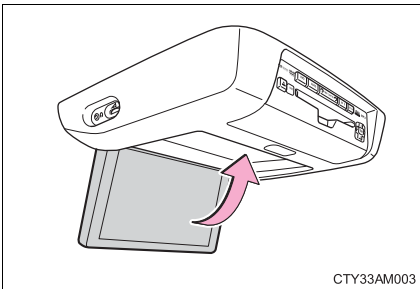

To close the display, push the display up until a click is heard.

The illumination of the screen is automatically turned off when the display is closed. However, the rear seat entertainment system is not turned off.

Loading a disc

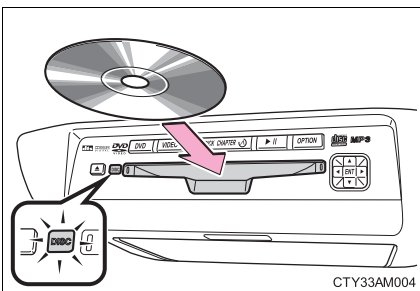



Insert the disc into the slot with the label side up.

The “DISC” indicator light turns on while the disc is loaded.

The player will play the track or chapter, and will repeat it after it reaches the end.

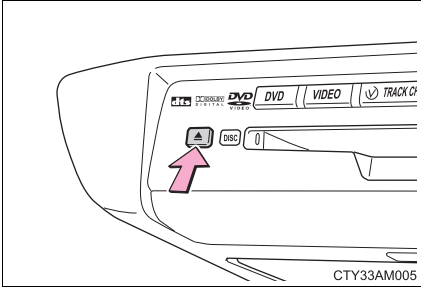
Ejecting a disc



Press  and remove the disc.

Headphone jacks

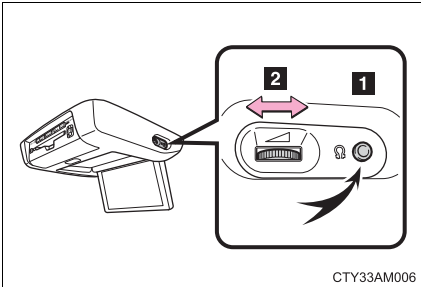

1 To use the headphones, connect them to the jack.

2 To adjust the volume

Right side dial: Turn it toward the front of the vehicle to increase the volume. Turn it toward the rear of the vehicle to decrease the volume.

Left side dial: Turn it toward the rear of the vehicle to increase the volume. Turn it toward the front of the vehicle to decrease the volume.

■ The rear seat entertainment system can be used when

The engine switch is in the “ACC” or “ON” position.

■ Discs that can be used

Discs with the marks shown below can be used.

Playback may not be possible depending on recording format or disc features, or due to scratches, dirt or deterioration.



■ When appears on the screen

It indicates that the selected switch cannot work.

■ Rear system lock

→P. 289

■ Error messages

“DISC CHECK”: Indicates that the disc is dirty, damaged or was inserted upside down. Clean the disc or insert it correctly.

“REGION ERROR”: Indicates that the DVD region code is not set properly.

“DVD ERROR”: Indicates that there is a problem inside the player. Eject the disc. Set the disc again.
If the malfunction still exists, take the vehicle to your Toyota dealer.

■ **Before using the remote controller (for new vehicle owners)**

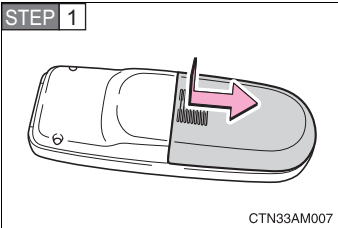

Remove the cover.

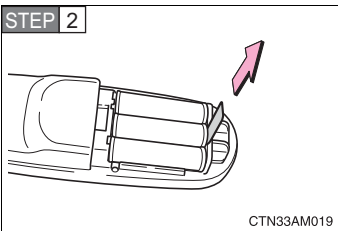

Remove the insulating sheet.

■ **When the remote controller battery is fully depleted**

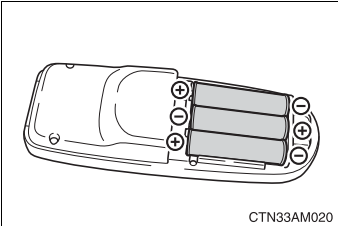

Remove the depleted batteries and install new 3 AA batteries.

■ **If the remote controller batteries are discharged**

The following symptoms may occur.

- The rear seat entertainment system control will not function properly.
- The operational range is reduced.

■ **When using 3 AA batteries**

Batteries can be purchased at your Toyota dealer, electric appliance shops, or camera stores.

Replace only with the same or equivalent type recommended by a Toyota dealer.

Dispose of used batteries according to the local laws.

■ Headphones

With some headphones generally available in the market, it may be difficult to catch signals properly. Toyota recommends the use of Toyota genuine wireless headphones.

Please contact your Toyota dealer for further details.

■ Volume

- Adjust the volume when you connect the headphones to the jack. Loud sounds may have a significant impact on the human body.
- Conversational speech on some DVDs is recorded at a low volume to emphasize the impact of sound effects. If you adjust the volume assuming that the conversations represent the maximum volume level that the DVD will play, you may be startled by louder sound effects or when you change to a different audio source. Be sure to adjust the volume with this in mind.

CAUTION

■ While driving

Do not use headphones.

Doing so may cause an accident, resulting in death or serious injury.

■ When the rear seat entertainment system is not used

Keep the display closed.

In the event of an accident or sudden braking, the opened display may hit an occupant's body, resulting in injury.

■ To prevent accidents and electric shock

Do not disassemble or modify the remote controller.

■ When the remote controller is not used

Stow the remote controller.

Injuries may result in the event of an accident or sudden braking.

■ Removed battery and other parts

Keep away from children.

These parts are small and if swallowed by a child they can cause choking.

 NOTICE

■ **For normal operation after replacing the battery**

Observe the following precautions to prevent accidents.

- Always work with dry hands.
Moisture may cause the battery to rust.
- Do not touch or move any other components inside the remote controller.
- Do not bend either of the battery terminals.

Using the DVD player (DVD video)

■ Remote controller

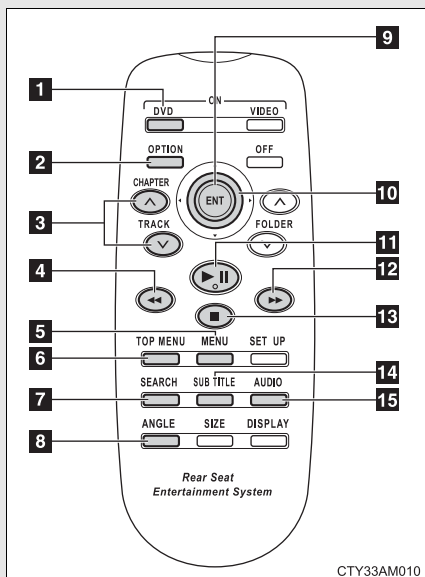

- 1 Turning on the DVD mode
- 2 Turning on or off the operation switches (icon) on the display
- 3 Selecting a chapter
- 4 Reversing a disc
- 5 Turning on the menu screen
- 6 Turning on the title selection screen
- 7 Searching the title
- 8 Changing the screen angle
- 9 Inputting the selected switch (icon)
- 10 Selecting a switch (icon)
- 11 Playing/pausing a disc
- 12 Fast forwarding a disc
- 13 Stopping a disc
- 14 Changing the subtitle language
- 15 Changing the audio language

■ Unit

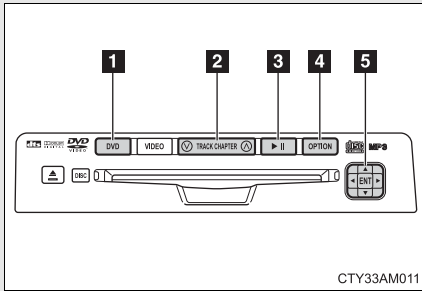

- 1 Turning on the DVD mode
- 2 Skipping to the desired chapter
- 3 Playing/pausing a disc
- 4 Turning on or off the operation switches (icon) on the display
- 5 Selecting a switch (icon)/inputting the selected switch (icon)

■ Display (Page 1)

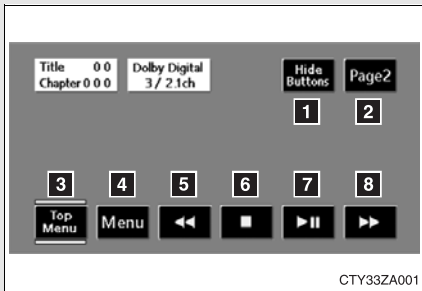

- 1 Turning off the operation switches (icon) on the display
- 2 Displaying page 2
- 3 Turning on the title selection screen for the disc
- 4 Turning on the menu screen for the disc
- 5 Reversing a disc
- 6 Stopping a disc
- 7 Pausing the disc/canceling the pause
- 8 Fast forwarding a disc

■ Display (Page 2)

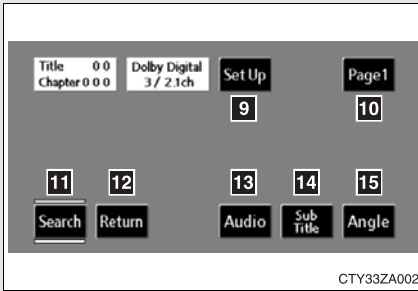

- 9 Displaying the initial setting screen
- 10 Displaying page 1
- 11 Search for a title
- 12 Returning to the previous screen
- 13 Changing the audio language
- 14 Changing the subtitle language
- 15 Changing the angle

■ Front audio system

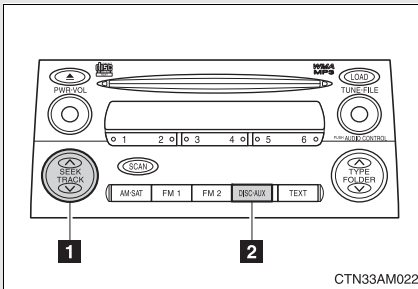

- 1 Selecting a chapter
- 2 Selecting either the front audio system or DVD player audio for the speakers

⚠ NOTICE

■ Cleaning the display

Wipe the display with a dry soft cloth.

If the screen is wiped with a rough cloth, the surface of the screen may be scratched.

 NOTICE

■ **To prevent damage to the remote controller**



- Keep the remote control away from direct sunlight, temperature heat and high humidity.
- Do not drop or knock the remote controller against hard objects.
- Do not sit on or place heavy objects on the remote controller.

■ **DVD player**



Never try to disassemble or oil any part of the DVD player. Do not insert anything other than a disc into the slot.

Turning on or off the operation switches



Press  or  to turn on the operation switches.

Press  or  once again or select  to turn off the operation switches.









Turning on the title selection screen

Press  or select  to turn on the title selection screen. For the operation of the title selection screen, see the separate manual for the DVD disc.

Turning on the menu screen

Press  or select  to turn on the menu screen. For the operation of the menu screen, see the separate manual for the DVD disc.

Slow playback

Press  or select  and then press  or select . Video is played slowly when you press  or select  by pressing and holding  or .

Returning to the previous screen

Select **Return** to return to the previous screen. For the operation of the menu screen, see the separate manual for the DVD disc.

Searching for a title

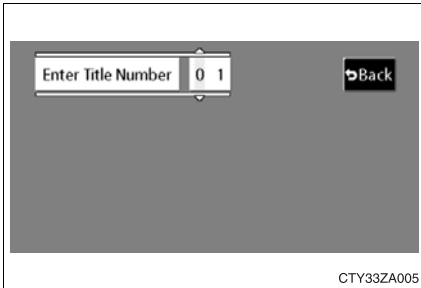

Press  or select **Search** to display the screen to search for a title.



Select the title number, and press

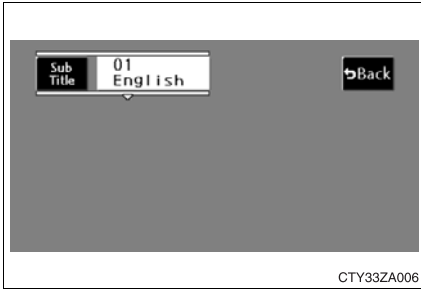

 or  to input it.

Select **Back** to return to the previous screen.

Changing the subtitle language





Press  or select  to display the subtitle language screen.

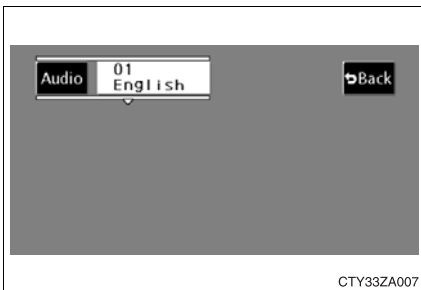

Each time  is pressed or  is selected, another language stored on the disc is selected.

Select  to return to the previous screen.

Changing the audio language





Press  or select  to display the audio language screen.

Each time  is pressed or  is selected, another language stored on the disc is selected.

Select  to return to the previous screen.

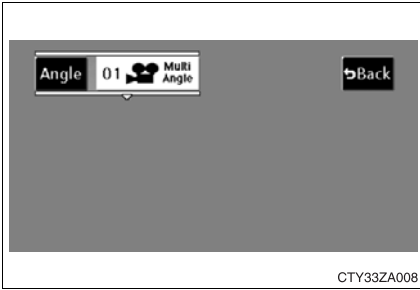
Changing the angle



Press  or select **Angle** to display the screen to change the angle.

Each time  is pressed or **Angle** is selected, the angle changes.

Select **Back** to return to the previous screen.





■ DVD player and DVD video discs

This DVD player is compatible NTSC color TV formats. DVD video discs conforming to other formats such as PAL or SECAM cannot be used.

■ Region codes

Some DVD video discs have a region code indicating where you can use them. If the DVD video disc is not labeled "ALL" or "1", you cannot use it in this DVD player. If you attempt to play an inappropriate DVD video disc in this player, "REGION CODE ERROR" appears on the screen. Even if the DVD video disc does not have a region code, in some cases you cannot use it.

■ Marks shown on DVD video discs

NTSC	Indicates NTSC format of color TV.
	Indicates the number of audio tracks.
	Indicates the number of language subtitles.
	Indicates the number of angles.
	Indicates the screen to be selected. Wide screen: 16:9 Standard: 4:3
	Indicates regions in which this video disc can be played. ALL: all countries Number: region code

■ DVD video disc glossary

- **DVD video discs:** Digital Versatile Discs that hold world's standard video. DVD video discs have adopted "MPEG2", one of the world standards of digital compression technologies. The picture data is compressed by 1/40 on average and stored. Variable rate encoded technology has been adopted in which the volume of data assigned to the picture is changed depending on the picture format. Audio data is stored using PCM and Dolby digital, which enables higher quality of sound. Furthermore, multi-angle and multi-language features will also help you enjoy the more advanced technology of DVD video.
- **Viewer restrictions:** This feature limits what can be viewed in conformity with the level of restrictions of the country. The level of restrictions varies depending on the DVD video disc. Some DVD video discs cannot be played at all, or violent scenes are skipped or replaced with other scenes.
 - Level 1: DVD video discs for children can be played.
 - Level 2 - 7: DVD video discs for children and G-rated movies can be played.
 - Level 8: All types of DVD video discs can be played.

- Multi-angle feature: Allows you to enjoy the same scene at different angles.
- Multi-language feature: Allows you to select the language of the subtitles and audio.
- Region codes: Region codes are provided on DVD players and DVD discs. If the DVD video disc does not have the same region code as the DVD player, you cannot play the disc on the DVD player.
- Audio: This DVD player can play liner PCM, Dolby digital, dts and MPEG audio format DVD. Other decoded type cannot be played.
- Title and chapter: Video and audio programs stored on DVD video discs are divided into sections by title and chapter.
- Title: The largest unit of the video and audio programs stored on DVD video discs. Usually, one piece of a movie, one album, or one audio program is assigned as a title.
- Chapter: A unit smaller than a title. A title comprises multiple chapters.

■ Audio

Manufactured under license from Dolby Laboratories. “Dolby”, “Pro Logic”, and  are trademarks of Dolby[®] Laboratories. Confidential unpublished works.

1992-1997 Dolby[®] Laboratories. All rights reserved.

“dts” is a trademark of Digital Theater Systems, Inc.

3-3. Using the rear audio system Using the DVD player (video CD)

■ Remote controller

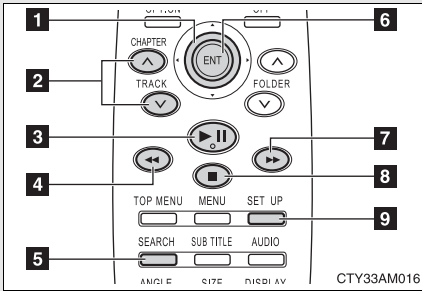

- 1 Selecting a switch (icon)
- 2 Selecting a chapter
- 3 Playing/pausing a disc
- 4 Reversing a disc
- 5 Displaying operation switches (icon)
- 6 Inputting the selected switch (icon)
- 7 Fast forwarding a disc
- 8 Stopping a disc
- 9 Changing the initial setting

■ Unit

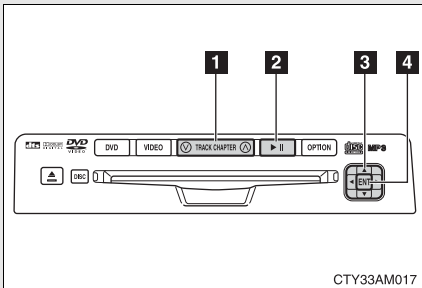

- 1 Skipping to the desired chapter
- 2 Playing/pausing a disc
- 3 Selecting a switch (icon)
- 4 Inputting the selected switch (icon)

■ Display (page 1)

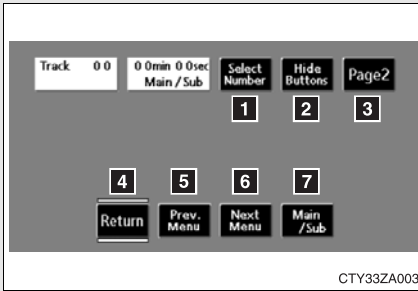

- 1 Selecting a disc menu number
- 2 Turning off the menu screen
- 3 Displaying page 2
- 4 Turning on the disc menu
- 5 Returning to the previous page screen (with the disc menu displayed)
- 6 Proceeding to the next page screen (with the disc menu displayed)
- 7 Changing to a multiplex transmission

■ Display (page 2)

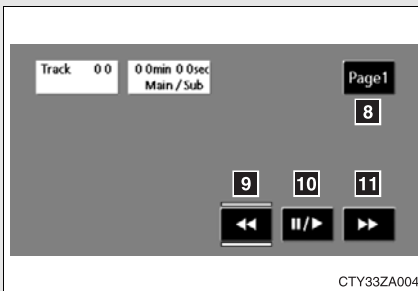

- 8 Displaying page 1
- 9 Reversing a disc
- 10 Pausing the disc/canceling the pause
- 11 Fast forwarding a disc

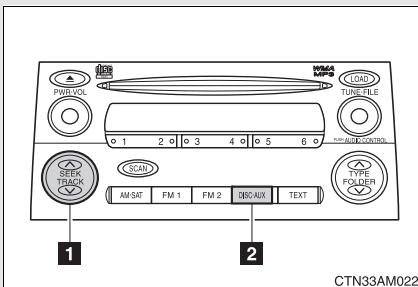

■ Front audio system



- 1 Selecting a chapter
- 2 Selecting either the front audio system or DVD player audio for the speakers







Selecting a disc menu number

Select  to display the disc menu number search screen.

Select the disc menu number, and press  or  to input it.

Select  to return to the previous screen.

Slow playback



Press  or select  and then press  or select . Video is played slowly when you press  or select  by pressing and

holding  or .

3-3. Using the rear audio system

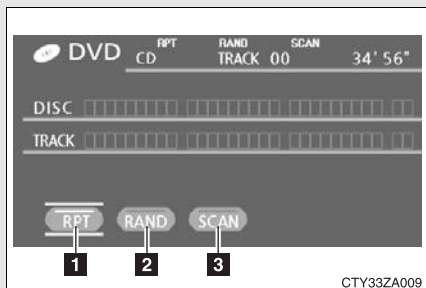
Using the DVD player (audio CD/CD text)



Using the control screen, press  or  to display the control screen.

- 1** Repeat play
- 2** Random playback
- 3** Search playback

■ Front audio system

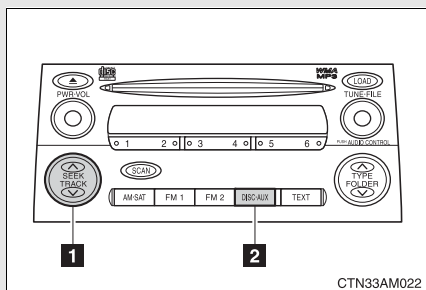

- 1** Selecting a track
- 2** Selecting either the front audio system or DVD player audio for the speakers

■ Canceling random, repeat and scan play



Select ,  or  again.

3-3. Using the rear audio system

Using the DVD player (MP3 discs)

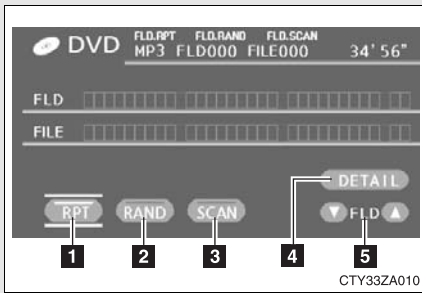
■ Using the control screen



Press  or  to display the control screen.

- 1 Repeat play
- 2 Random playback
- 3 Search playback
- 4 Displaying file information
- 5 Selecting a folder

■ Front audio system

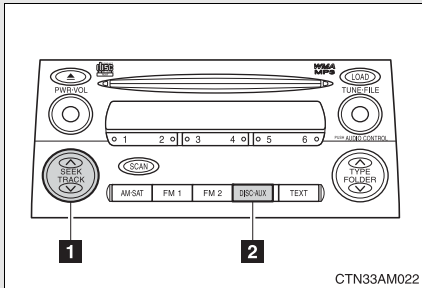



- 1 Selecting a file
- 2 Selecting either the front audio system or DVD player audio for the speakers

Repeat play

■ Repeating a file

Select  .

■ Repeating all of files in a folder



Select  , and press and hold  or  .

Random playback

■ Playing files from a particular folder in random order

Select **RAND** .

■ Playing all of the files on a disc in random order

Select **RAND** , and press and hold  or .



Search playback

■ Selecting the desired file by cueing the files in the folder

Select **SCAN** .

The player will scan all the files in the folder. Each file will be played for 10 seconds.

■ Selecting the desired file by cueing the folders on the disc

Select **SCAN** , and press and hold  or .

The player will scan all the folders on the disc. The first file in each folder will be played for 10 seconds.

■ Canceling random, repeat and play back

Select **RPT** , **RAND** or **SCAN** again.

3-3. Using the rear audio system

Using the video mode

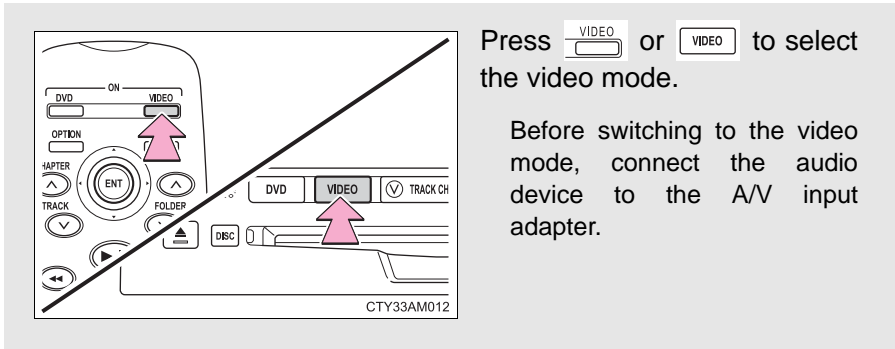

Using the adapter

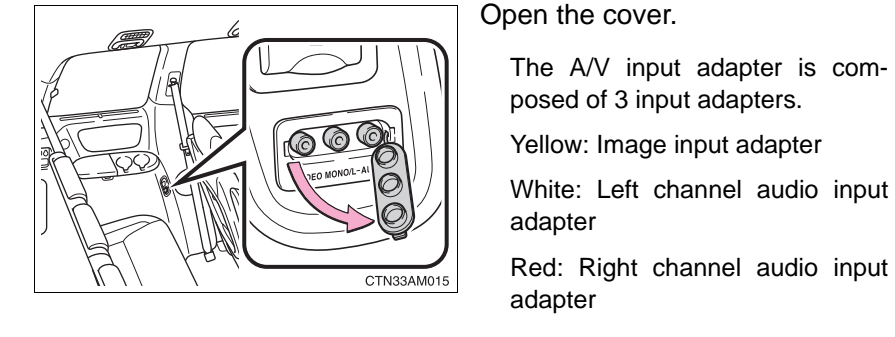

■ A/V input adapter

The rear seat entertainment system plays videos and sounds when audio-video device is connected to the A/V input adapter. For details, refer to the manufacturer's instructions.

■ Power outlet

The power outlet is used to connect the audio device. (→P. 387)

 NOTICE**■ When the A/V input adapter is not in use**

Keep the A/V input adapter cover closed.

Inserting anything other than an appropriate plug may cause electrical failure or short circuit.

3-3. Using the rear audio system

Changing the initial setting

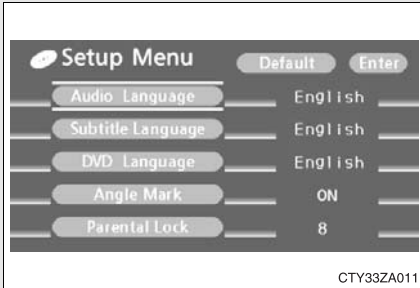

Press  or select **Set Up** to display the initial setting screen.



The following initialization can be changed here.

- Audio language
- Subtitle language
- DVD language
- Angle mark
- Parental lock

Changing the audio language



Select "Audio Language".

Select the language you want to hear, and press  or  to input it.

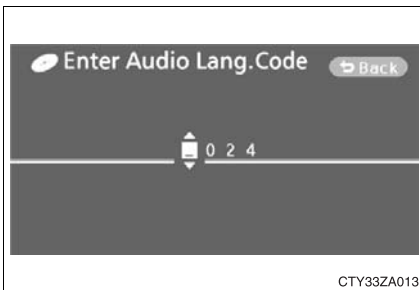

Select "Others" if you cannot find the language you want to hear.

Enter the appropriate 4-digit language code. (→P. 324)

Select a number, and press



 or  to input it.

If a code that is not in the list is entered, "Incorrect Code" will appear on the screen.

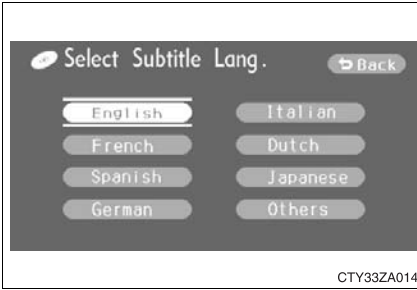
Changing the subtitle language



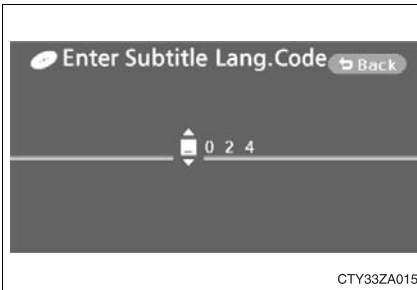

Select “Subtitle Language”.

Select the language you want to read, and press  or  to input it.



Select “Others” if you cannot find the language you want to read. Enter the appropriate 4-digit language code. (→P. 324)



Select a number, and press  or  to input it.

If a code that is not in the list is entered, “Incorrect Code” will appear on the screen.

Changing the DVD language



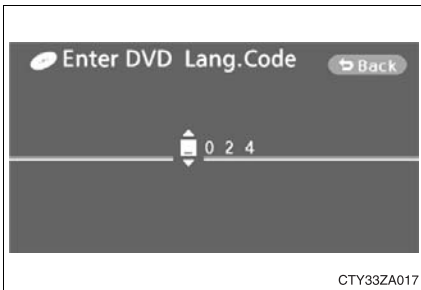

Select “DVD Language”.

Select the language you want to read, and press  or  to input it.



Select “Others” if you cannot find the language you want to read. Enter the appropriate 4-digit language code. (→P. 324)

Select a number, and press  or  to input it.

If a code that is not in the list is entered, “Incorrect Code” will appear on the screen.

Turning on or off the angle mark

The angle mark can be turned on for discs that are multi-angle compatible.

Each time you press  or  when “Angle Mark” is selected, the angle mark turns on or off alternately.

Setting viewer restriction levels

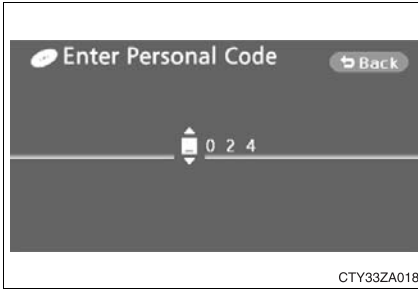

Setting a password allows the viewer restriction to be effective.

Select "Parental Lock".

Enter the password and press

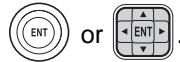

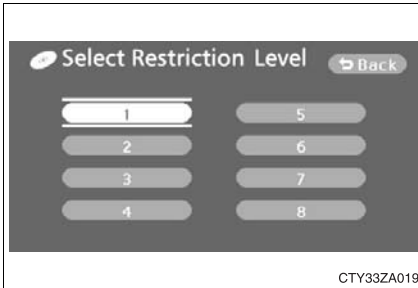

The setting cannot be changed unless the password is entered.

When you forget the password, initialize the password. (→P. 324)



Select a restriction level (1-8),

and press  or . The smaller the level number, the stricter the age limit.

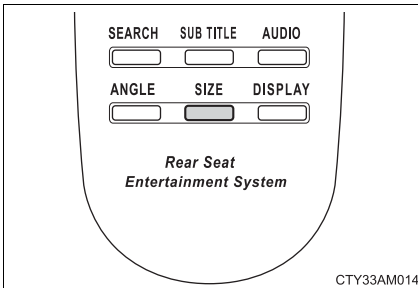

Setting the display mode



Pressing  changes the display modes sequentially as follows:

Normal → Wide 1 → Wide 2

■ Returning to the previous screen

Select  and press  or .

■ To initialize the password

Press  on the remote controller or unit ten times when the screen to enter the personal code is displayed.

■ Language code list

Code	Language
0514	English
0618	French
0405	German
0920	Italian
0519	Spanish
2608	Chinese
1412	Dutch
1620	Portuguese
1922	Swedish
1821	Russian
1115	Korean
0512	Greek
0101	Afar
0102	Abkhazian
0106	Afrikaans
0113	Amharic
0118	Arabic
0119	Assamese
0125	Aymara
0126	Azerbaijani
0201	Bashkir
0205	Byelorussian
0207	Bulgarian

Code	Language
0208	Bihari
0209	Bislama
0214	Bengali
0215	Tibetan
0218	Breton
0301	Catalan
0315	Corsican
0319	Czech
0325	Welsh
0401	Danish
0426	Bhutani
0515	Esperanto
0520	Estonian
0521	Basque
0601	Persian
0609	Finnish
0610	Fiji
0615	Faroese
0625	Frisian
0701	Irish
0704	Scots-Gaelic
0712	Galician
0714	Guarani

Code	Language
0721	Gujarati
0801	Hausa
0809	Hindi
0818	Croatian
0821	Hungarian
0825	Armenian
0901	Interlingua
0905	Interlingue
0911	Inupiak
0914	Indonesian
0919	Icelandic
0923	Hebrew
1001	Japanese
1009	Yiddish
1023	Javanese
1101	Georgian
1111	Kazakh
1112	Greenlandic
1113	Cambodian
1114	Kannada
1119	Kashmiri
1121	Kurdish
1125	Kirghiz
1201	Latin
1214	Lingala
1215	Laothian
1220	Lithuanian
1222	Latvian
1307	Malagasy
1309	Maori

Code	Language
1311	Macedonian
1312	Malayalam
1314	Mongolian
1315	Moldavian
1318	Marathi
1319	Malay
1320	Maltese
1325	Burmese
1401	Nauru
1405	Nepali
1415	Norwegian
1503	Occitan
1513	(Afan) Oromo
1518	Oriya
1601	Punjabi
1612	Polish
1619	Pashto, Pushto
1721	Quechua
1813	Rhaeto-Romance
1814	Kirundi
1815	Romanian
1823	Kinyarwanda
1901	Sanskrit
1904	Sindhi
1907	Sangho
1908	Serbo-Croatian
1909	Sinhalese
1911	Slovak
1912	Slovenian
1913	Samoan

Code	Language
1914	Shona
1915	Somali
1917	Albanian
1918	Serbian
1919	Siswati
1920	Sesotho
1921	Sundanese
1923	Swahili
2001	Tamil
2005	Telugu
2007	Tajik
2008	Thai
2009	Tigrinya
2011	Turkmen
2012	Tagalog

Code	Language
2014	Setswana
2015	Tonga
2018	Turkish
2019	Tsonga
2020	Tatar
2023	Twi
2111	Ukrainian
2118	Urdu
2126	Uzbek
2209	Vietnamese
2215	Volapük
2315	Wolof
2408	Xhosa
2515	Yoruba
2621	Zulu

■ **Adjusting the screen**

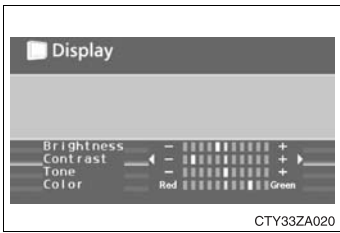

Press  .

Select the brightness, contrast, tone or color, and make adjustments. Press

 ,  or  to input it.

	“-” or “Red”	“+” or “Green”
“Brightness”	Darkens	Brightens
“Contrast”	Weakens the contrast	Strengthens the contrast
“Tone” (if displayed)	Weakens the tone	Strengthens the tone
“Color” (if displayed)	Strengthens the red color	Strengthens the green color

3-4. Using the hands-free phone system (for cellular phone) Hands-free phone system (for cellular phone) features (if equipped)

Owners of models equipped with a navigation system should refer to the “Navigation System Owner's Manual”.

This system supports Bluetooth®, which allows you to make or receive calls without using cables to connect a cellular phone and the system, and without operating the cellular phone.

Title	Page
Using the hands-free phone system (for cellular phone)	P. 331
Making a phone call	P. 339
Setting a cellular phone	P. 345
Security and system setup	P. 350
Using the phone book	P. 353

■ Conditions affecting operation

The hands-free phone system may not operate normally in the following situations:

- The cellular phone is turned off, or located outside the service area.
- The cellular phone has a low battery.
- The cellular phone is not connected to the system.
- The cellular phone is behind the seat or in the glove box, or metal material covers or touches the phone.

■ When transferring ownership of the vehicle

Be sure to initialize the system to prevent personal data from being improperly accessed.

■ Required profiles for the cellular phone

- HFP (Hands Free Profile) Ver. 1.0
- OPP (Object Push Profile) Ver. 1.1

If your cellular phone does not support HFP, you cannot enter the Bluetooth® phone, and take OPP service individually.

■ **Trademark owned by Bluetooth SIG. Inc.**



■ **Certification for the hands-free phone system**

FCC ID: HYQBTAU01A
IC ID: 1551A-BTAU01A
MADE IN JAPAN

NOTE:

This device complies with Part 15 of the FCC Rules and RSS-210 of industry Canada. Operation is subject to the following two conditions: (1) This device may not cause harmful interference, and (2) This device must accept any interference received, including interference that may cause undesired operation.

NOTICE:

This equipment has been tested and found to comply with the limits for a Class B digital device, pursuant to Part 15 of the FCC Rules. These limits are designed to provide reasonable protection against harmful interference in a residential installation. This equipment generates, uses and can radiate radio frequency energy and, if not installed and used in accordance with the instructions, may cause harmful interference to radio communications. However, there is no guarantee that interference will not occur in a particular installation. If this equipment does cause harmful interference to radio or television reception, which can be determined by turning the equipment off and on, the user is encouraged to try to correct the interference by one or more of the following measures:

- Reorient or relocate the receiving antenna.
- Increase the separation between the equipment and receiver.
- Connect the equipment into an outlet on a circuit different from that to which the receiver is connected.
- Consult the dealer or an experienced radio/TV technician for help.

FCC WARNING:

Changes or modifications in construction not expressly approved by the party responsible for compliance could void the user's authority to operate the equipment.

CAUTION:**Radio Frequency Radiation Exposure**

This equipment complies with FCC radiation exposure limits set forth for uncontrolled equipment and meets the FCC radio frequency (RF) Exposure Guidelines in Supplement C to OET65. This equipment has very low levels of RF energy that it deemed to comply without maximum permissive exposure evaluation (MPE). But it is desirable that it should be installed and operated with at least 20 cm and more between the radiator and person's body (excluding extremities: hands, wrists, feet and legs).

Co-location:

This transmitter must not be co-located or operated in conjunction with any other antenna or transmitter.

 **CAUTION**

■ **Caution while driving**

Do not use a cellular phone, or connect the Bluetooth[®] phone.

 **NOTICE**

■ **To prevent damage to a cellular phone**

Do not leave a cellular phone in the vehicle. The temperature inside may become high resulting in damage to the phone.

3-4. Using the hands-free phone system (for cellular phone) Using the hands-free phone system (for cellular phone) (if equipped)

■ Audio unit

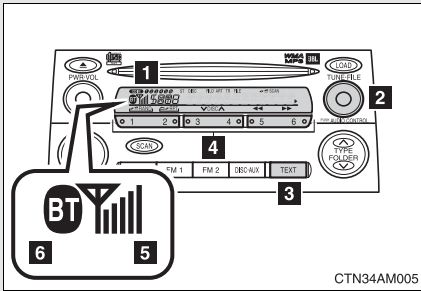

- 1** Displays such items as messages, name, and phone number

Lower-case characters and special characters, such as an umlaut, cannot be displayed.

- 2** Selects items such as menu or number

Turn: Selects an item

Press: Inputs the selected item

- 3** Press and hold: Displays information that is too long to be displayed at one time on the screen

- 4** Selects speed dials

- 5** Displays the reception level

- 6** Displays Bluetooth® connection condition

If “BT” is not displayed, the hands-free phone system cannot be used.

■ Steering wheel telephone switches

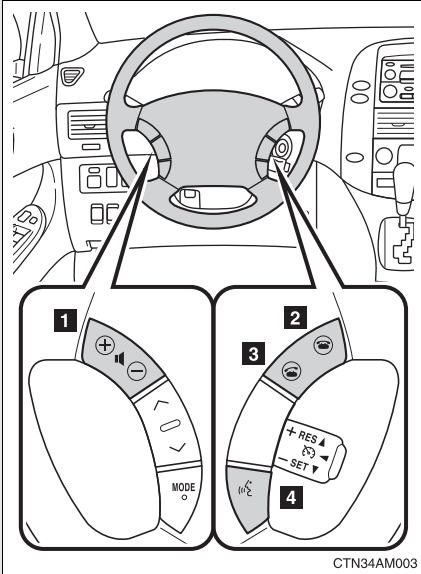

1 Volume

The voice guidance volume cannot be adjusted using this button.

2 Hands-free phone system off/ends a call/refuses a call

3 Hands-free phone system on/starts a call

4 Press: Voice command system on

Press and hold: Voice command system off

■ Microphone

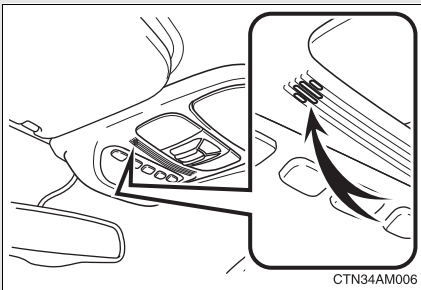

Operating the system using a voice command

By following voice guidance instructions output from the speaker, voice commands can be given to allow for operation of the hands-free phone system without checking the display or operating



■ Operation procedure when using a voice command

Press  and say a command for a desired function.
(→P. 335)

■ Auxiliary commands when using a voice command

The following auxiliary commands can be used when operating the system using a voice command:

- Cancel: Exits the hands-free phone system
- Repeat: Repeats the previous voice guidance instruction
- Go back: Returns to the previous procedure
- Help: Reads aloud the function summary if a help comment is registered for the selected function

Using the hands-free phone system for the first time

Before using the hands-free phone system, it is necessary to register a cellular phone in the system. The phone registration mode will be entered automatically when starting the system with no cellular phone registered. Follow the procedure below to register a cellular phone:

STEP 1 Press  or  .

The introductory guidance and phone name registration instructions are heard.

STEP 2 Register a phone name by either of the following methods.

a. Select “Record Name” using  , and say a name to be registered.

b. Press  and say a name to be registered.

A voice guidance instruction to confirm the input is heard.

STEP 3 Select “Confirm” using a voice command or  .

A passkey is displayed and heard, and a voice guidance instruction for inputting the passkey into the cellular phone is heard.

STEP 4 Input the passkey into the cellular phone.

Refer to the manual that comes with the cellular phone for the operation of the phone.

Guidance for registration completion is heard.

Menu list of the hands-free phone system

■ Normal operation

First menu	Second menu	Third menu	Operation detail
Callback	-	-	Dialing a number stored in the incoming call history memory
Redial	-	-	Dialing a number stored in the outgoing call history memory
Dial by number	-	-	Dialing by inputting a number
Dial by name	-	-	Dialing by inputting a name registered in the phone book
Phonebook	Add Entry	-	Adding a new number
	Change Name	-	Changing a name in the phone book
	Delete Entry	-	Deleting the phone book data
	Delete Speed Dial (Del Spd Dial)	-	Deleting a registered speed dial
	List Names	-	Listing the phone book data
	Set Speed Dial (Speed Dial)	-	Registering a speed dial

3-4. Using the hands-free phone system (for cellular phone)

First menu	Second menu	Third menu	Operation detail
Setup	Security	Set PIN	Setting a PIN code
		Phonebook Lock	Locking the phone book
		Phonebook Unlock	Unlocking the phone book
	Phone Setup	Pair Phone	Registering the cellular phone to be used
		Change Name	Changing a registered name of a cellular phone
		Delete	Deleting a registered cellular phone
		List Phones	Listing the registered cellular phones
		Select Phone	Selecting a cellular phone to be used
		Set Passkey	Changing the passkey
	System Setup	Guidance Volume (Guidance Vol)	Setting voice guidance volume
Initialize		Initialization	

■ Using a short cut key

First menu	Second menu	Operation detail
Dial "XXX (name)"	-	Dialing a number registered in the phone book
Phone book add entry	-	Adding a new number
Phone book change name	-	Changing the name of a phone number in the phone book
Phone book delete entry	-	Deleting phone book data
Phone book list names	-	Listing the phone book data
Phone book set speed dial	-	Registering a speed dial
Phone book delete speed dial	-	Deleting a speed dial
Phonebook	Phonebook Unlock	Unlocking the phone book
	Phonebook Lock	Locking the phone book

■ **Automatic adjustment of volume**

When vehicle speed is 50 mph (80 km/h) or more, the volume automatically increases. The volume returns to the previous volume setting when vehicle speed drops to 43 mph (70 km/h) or less.

■ **When using a voice command**

- For numbers, say a combination of single digits from zero to nine, # (pound), * (star), and + (plus).
- Say a command correctly and clearly.

■ **The system may not recognize your voice in the following situations:**

- When driving on a rough road
- When driving at high speeds
- When air is blowing out of the vents onto the microphone
- When the air conditioning fan emits a loud noise

■ **The following cannot be performed while driving:**

- Operating the system with  TUNE FILE
FM-AGED CONTROL
- Registering a cellular phone to the system

■ **Changing the passkey**

→P. 348

Making a phone call

■ Making a phone call

- Dialing by inputting a number
“Dial by number”
- Dialing by inputting a name
“Dial by name”
- Speed dialing
- Dialing a number stored in the outgoing history memory
“Redial”
- Dialing a number stored in the incoming history memory
“Call back”

■ Receiving a phone call

- Answering the phone
- Refusing the call

■ Transferring a call

■ Using the call history memory

- Dialing
- Storing data in the phone book
- Deleting

Dialing by inputting a number

STEP 1 Press  and say "Dial by number".

STEP 2 Press  and say the phone number.

STEP 3 Dial by one of the following methods:

a. Press  .

b. Press  and say "Dial".



c. Select "Dial" using  .

Dialing by inputting a name

STEP 1 Press  and say "Dial by name".

STEP 2 Select a registered name to be input by either of the following methods:

a. Press  and say a registered name.

b. Press  and say "List names". Press  while the desired name is being read aloud.

STEP 3 Dial by one of the following methods:

a. Press  .

b. Press  and say "Dial".

c. Select "Dial" using  .

Speed dialing

STEP 1 Press  .

STEP 2 Press the preset button in which the desired number is registered.

STEP 3 Press  .

When receiving a phone call

■ Answering the phone

Press  .

■ Refusing the call

Press  .

Transferring a call

A call can be transferred between the cellular phone and system while dialing or receiving a call, or during a call. Use one of the following methods:

- a. Operate the cellular phone.

Refer to the manual that comes with the cellular phone for the operation of the phone.

- b. Press  *1.

- c. Press  and say "Call Transfer" *2.

*1: This operation can be performed only when transferring a call from the cellular phone to the system during a call.

*2: While the vehicle is in motion, a call cannot be transferred from the system to the cellular phone.

Using the call history memory

Follow the procedure below to use a number stored in the call history memory:

STEP 1 Press  and say “Redial” (when using a number stored in the outgoing call history memory) or “Call back” (when using a number stored in the incoming call history memory).

STEP 2 Select the number by either of the following methods:
 a. Say “Previous” or “Go back” until the desired number is displayed.

b. Select the desired number using  .

The following operations can be performed:

Dialing: Press  or select “Dial” using a voice command or

 .

Storing the number in the phone book: Select “Store” using a voice command or  .

Deleting: Select “Delete” using a voice command or  .

■ **Call history**

Up to 5 phone numbers can be stored in each of the outgoing and incoming call history memories.

■ **When talking on the phone**

- Do not talk simultaneously with the other party.
- Keep the volume of the received voice down. Otherwise, voice echo will increase.

3-4. Using the hands-free phone system (for cellular phone) Setting a cellular phone

Registering a cellular phone in the hands-free phone system allows the system to function. The following functions can be used for registered cellular phones:

■ Functions and operation procedures

To enter the menu for each function, follow the steps below using a

voice command or  :

- Registering a cellular phone
 1. "Setup" → 2. "Phone Setup" → 3. "Pair Phone"
- Selecting the cellular phone to be used
 1. "Setup" → 2. "Phone Setup" → 3. "Select Phone"
- Changing a registered name
 1. "Setup" → 2. "Phone Setup" → 3. "Change Name"
- Listing the registered cellular phones
 1. "Setup" → 2. "Phone Setup" → 3. "List Phones"
- Deleting a cellular phone
 1. "Setup" → 2. "Phone Setup" → 3. "Delete"
- Changing the passkey
 1. "Setup" → 2. "Phone Setup" → 3. "Set Passkey"

Registering a cellular phone

Select "Pair Phone" using a voice command or  , and do the procedure for registering a cellular phone. (→P. 334)

Selecting the cellular phone to be used



STEP 1 Select “Select Phone” using a voice command or  .

► Pattern A

STEP 2 Select the cellular phone to be used by either of the following methods, and select “Confirm” using a voice command or



a. Press  and say the desired phone name.

b. Press  and say “List phones”. While the name of the desired cellular phone is being read aloud, press  .

► Pattern B

STEP 2 Select the cellular phone to be used using  .



Changing a registered name

STEP 1 Select “Change Name” using a voice command or  .

STEP 2 Select the name of the cellular phone to be changed by one of the following methods:

a. Press  and say the desired phone name, and select

“Confirm” using a voice command or  .

b. Press  and say “List phones”. While the desired phone name is being read aloud, press  .

c. Select the desired phone name using  .

STEP 3 Press  or select “Record Name” using  , and say a new name.

STEP 4 Select “Confirm” using a voice command or  .

Listing the registered cellular phones

Selecting “List Phones” using a voice command or  causes the list of registered cellular phones to be read aloud. When listing is complete, the system returns to “Phone Setup”.

Pressing  while the name of a cellular phone is being read selects the cellular phone, and the following functions will be available:

- Selecting a cellular phone: “Select Phone”
- Changing a registered name: “Change Name”
- Deleting a cellular phone: “Delete”

Deleting a cellular phone



STEP 1 Select “Delete” using a voice command or  .

► Pattern A

STEP 2 Select the cellular phone to be deleted by either of the following methods and select “Confirm” using a voice command or



a. Press  and say the name of the desired cellular phone.

b. Press  and say “List phones”. While the name of the desired cellular phone is being read aloud, press  .

► Pattern B

STEP 2 Select the desired cellular phone to be deleted using  .

Changing the passkey

STEP 1 Select “Set Passkey” using a voice command or  .

► Pattern A

STEP 2 Press  , say a 4 to 8-digit number, and select “Confirm”

using a voice command or  .

► Pattern B

STEP 2 Select a 4 to 8-digit number using  .

The number should be input 1 digit at a time.

STEP 3 When the entire number to be registered as a passkey has

been input, press  once again.

■ **The number of cellular phones that can be registered**

Up to 6 cellular phones can be registered in the system.

3-4. Using the hands-free phone system (for cellular phone) Security and system setup

To enter the menu of each setting, follow the steps below:

■ Security setting items and operation procedure

- Setting or changing the PIN (Personal Identification Number)
 1. "Setup" → 2. "Security" → 3. "Set PIN"
- Locking the phone book
 1. "Setup" → 2. "Security" → 3. "Phonebook Lock"
- Unlocking the phone book
 1. "Setup" → 2. "Security" → 3. "Phonebook Unlock"

■ System setup items and operation procedure

- Setting voice guidance volume
 1. "Setup" → 2. "System Setup" → 3. "Guidance Vol"
- Initialization
 1. "Setup" → 2. "System Setup" → 3. "Initialize"





can only be used for system setup operation.

Setting or changing the PIN

■ Setting a PIN

STEP 1 Select "Set PIN" using a voice command or  .

STEP 2 Enter a PIN using a voice command or  .

When using  , input the code 1 digit at a time.

■ Changing the PIN

STEP 1 Select "Set PIN" using a voice command or  .

STEP 2 Enter the registered PIN using a voice command or  .

STEP 3 Enter a new PIN using a voice command or  .

When using  , input the code 1 digit at a time.

Locking or unlocking the phone book

STEP 1 Select “Phonebook lock (Phbk Lock)” or “Phonebook unlock (Phbk Unlock)” using a voice command or  .

STEP 2 Input the PIN by either of the following methods and select “Confirm” using a voice command or  :

a. Press  and say the registered PIN.

b. Input a registered PIN using  .

Setting voice guidance volume

STEP 1 Select “Guidance Vol” using  .

STEP 2 Change the voice guidance volume.

To decrease the volume: Turn  counterclockwise.

To increase the volume: Turn  clockwise.

Initialization

STEP 1 Select “Initialize” and then “Confirm” using



.

STEP 2 Select “Confirm” using



.

■ Initialization

● The following data in the system can be initialized:

- Phone book
- Outgoing and incoming call history
- Speed dials
- Registered cellular phone data
- Security code

● Once the initialization has been completed, the data cannot be restored to its original state.

■ When the phone book is locked

The following functions cannot be used:

- Dialing by inputting a name
- Speed dialing
- Dialing a number stored in the call history memory
- Using the phone book

3-4. Using the hands-free phone system (for cellular phone) Using the phone book

To enter the menu of each setting, follow the steps below:

- Adding a new phone number
 1. "Phonebook" → 2. "Add Entry"
- Setting speed dial
 1. "Phonebook" → 2. "Set Speed Dial (Speed Dial)"
- Changing a registered name
 1. "Phonebook" → 2. "Change Name"
- Deleting registered data
 1. "Phonebook" → 2. "Delete Entry"
- Deleting speed dial
 1. "Phonebook" → 2. "Delete Speed Dial (Del Spd Dial)"
- Listing the registered data
 1. "Phonebook" → 2. "List Names"

Adding a new phone number

The following methods can be used to add a new phone number:

- Inputting a phone number using a voice command
- Transferring data from the cellular phone
- Inputting a phone number using  TUNE FILE
RPM AUDIO CONTROL
- Selecting a phone number from outgoing or incoming call history

■ Adding procedure

STEP 1 Select “Add Entry” using a voice command or  .

STEP 2 Use one of the following methods to input a phone number:

▶ Inputting a phone number using a voice command

STEP2-1:Select “By Voice” using a voice command or  .

STEP2-2:Press  , say the desired number, and select “Confirm” using a voice command.

▶ Transferring data from the cellular phone

STEP2-1:Select “By Phone” and then “Confirm” using a voice

command or  .

STEP2-2:Transfer the data from the cellular phone.

Refer to the manual that comes with the cellular phone for the details of transferring data.

STEP2-3:Select the data to be registered by either of the following methods:

a. Say “Previous” or “Next” until the desired data is displayed, and select “Confirm” using a voice command.

b. Select the desired data using  .

► Inputting a phone number using 

STEP2-1: Select “Manual Input” using  .

STEP2-2: Input a phone number using  .

Input the phone number 1 digit at a time.

STEP2-3: When the entire number has been input, press

 once again.

► Selecting a phone number from outgoing or incoming call history

STEP2-1: Select “Call History” using a voice command or

 .

STEP2-2: Select “Outgoing” or “Incoming” using a voice com-

mand or  .

STEP2-3: Select the data to be registered by either of the following methods:

a. Say “Previous” or “Go back” until the desired data is displayed, and select “Confirm” using a voice command.

b. Select the desired data using  .

3-4. Using the hands-free phone system (for cellular phone)

STEP 3 Select the name to be registered by either of the following methods, and select “Confirm” using a voice command or



a. Press  and say the desired name.

b. Select “Record Name” using , and say the desired name.

STEP 4 Select “Confirm” using a voice command or .

In **STEP 3**, selecting “Set Speed Dial (Speed Dial)” instead of “Confirm” registers the newly added phone number as a speed dial.

Setting speed dials



STEP 1 Select “Set Speed Dial (Speed Dial)” using a voice command



STEP 2 Select the data to be registered as a speed dial by one of the following methods:

a. Press , say desired name, and select “Confirm”

using a voice command or .

b. Press , and say “List names”. While the desired name is being read aloud, press , and select “Confirm” using a voice command or  .

c. Select the desired data using  .

STEP 3 Select the desired preset button, and register the data into speed dial by either of the following methods:

a. Press the desired preset button, and select “Confirm” using

a voice command or  .

b. Press and hold the desired preset button.

Changing a registered name



STEP 1 Select “Change Name” using a voice command or  .

STEP 2 Select the name to be changed by one of the following methods.



a. Press , say desired name, and select “Confirm”

using a voice command or  .

3-4. Using the hands-free phone system (for cellular phone)

b. Press , and say “List names”. While the desired name is being read aloud, press , and select “Confirm” using a voice command or  .

c. Select the desired name using  .

STEP 3 Press  or select “Record Name” using , and say a new name.

STEP 4 Select “Confirm” using a voice command or  .



Deleting registered data

STEP 1 Select “Delete Entry” using a voice command or  .

► Pattern A

STEP 2 Select the data to be deleted by either of the following methods, and select “Confirm” using a voice command or  :

a. Press , and say the name of the desired phone number to be deleted.

- b. Press  , say “List phones”. While the name of the desired phone number is being read aloud, press  .

► Pattern B

STEP 2 Select the data to be deleted using  .

Deleting speed dials

STEP 1 Select “Delete Speed Dial (Del Spd Dial)” using a voice com-

mand or  .

STEP 2 Press the preset button in which the desired speed dial is registered, and select “Confirm” using a voice command or



Listing the registered data

Selecting “List names” using a voice command causes a list of the registered data to be read aloud.

When listing is complete, the system returns to “Phonebook”.

Pressing  while the desired data is being read aloud selects the data, and the following function will be available.

- Dialing: “Dial”
- Changing a registered name: “Change Name”
- Deleting an entry: “Delete Entry”
- Setting a speed dial: “Set Speed Dial (Speed Dial)”

■ **Limitation of number of digits**

A phone number that exceeds 24 digits cannot be registered.

3-5. Using the interior lights

Interior lights list

Your Toyota is equipped with the illuminated entry system to assist in entering the vehicle. Owing to the function of the system, the lights shown in the following illustration automatically turn on/off according to whether the doors are locked/unlocked, whether the doors are opened/closed, and the engine switch position.

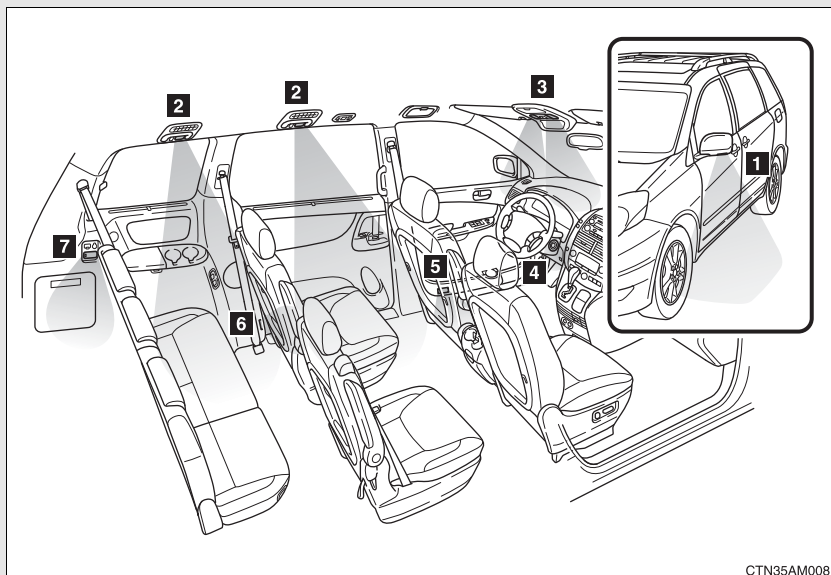

- 1** Outer foot lights (if equipped)
- 2** Rear personal/interior lights (→P. 363)
- 3** Front personal/interior lights (→P. 362)
- 4** Engine switch light
- 5** Front door courtesy lights
- 6** Sliding door courtesy lights
- 7** Luggage compartment light (→P. 363)

Personal/interior light main switch

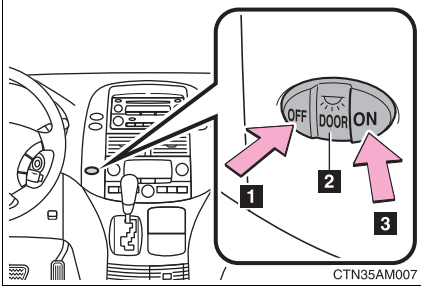

1 Off

The front personal light function can still be turned on and off.

2 Door position

The personal/interior lights and luggage compartment light come on when a door is opened. They turn off when the doors are closed.

3 On

The personal/interior lights cannot be individually turned off.

Personal/interior lights

► Front

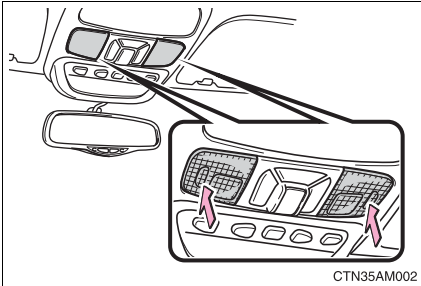

On/off

► Rear

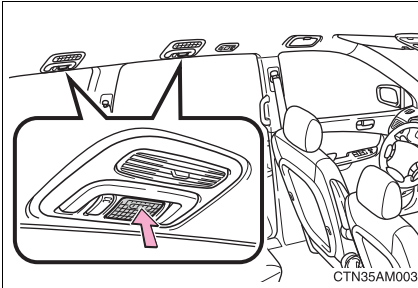

On/off

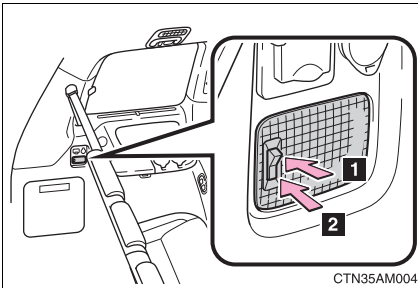
Luggage compartment light

- 1** On
- 2** Off

■ **To prevent the battery from being discharged**

If the lights remain on when a door is not fully closed and the personal/interior light main switch is in door position, the lights will go off automatically after 20 minutes.

■ **Customization that can be configured at Toyota dealer**

Settings (e.g. the time elapsed before lights turn off) can be changed.
(Customizable features →P. 565)

3-6. Using the storage features

List of storage features

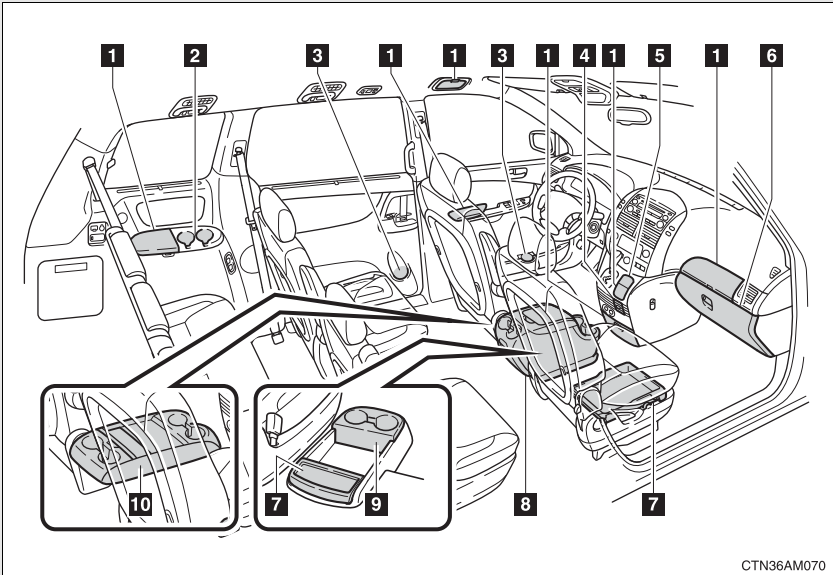

CTN36AM070

- 1** Auxiliary boxes
- 2** Cup holders
- 3** Bottle holders
- 4** Coin holder and cup holder
- 5** Auxiliary box (if equipped)
- 6** Glove box
- 7** Trays (if equipped)
- 8** Console box, cup holders and note pad holder (if equipped)
- 9** Cup holder (if equipped)
- 10** Auxiliary box and cup holders (if equipped)

Glove box

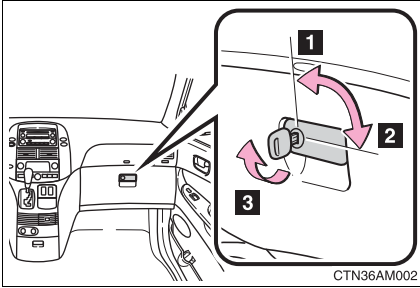

- 1 Unlock with the master key
- 2 Lock with the master key
- 3 Open (pull the lever)

⚠ CAUTION

■ Caution while driving

Keep the glove box closed.
Injuries may result in the event of an accident or sudden braking.

Console box (if equipped)

■ Using the console box

▶ Upper console box

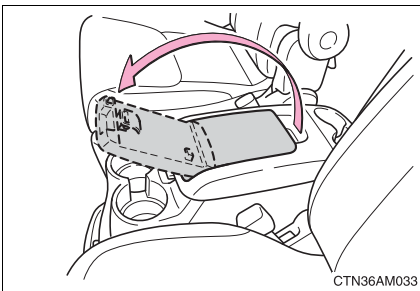

Lift the lid.

► Lower console box

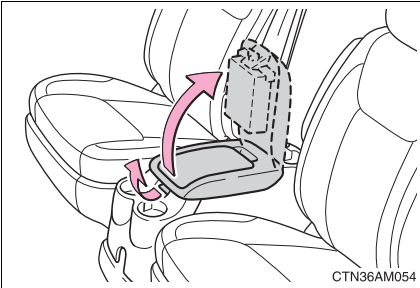

Pull up the knob to release the lock and lift the lid.

■ Removing the console box (7-passenger models)

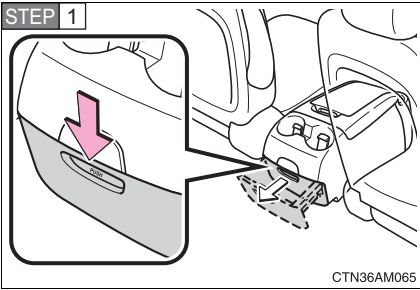

Press down the lever.

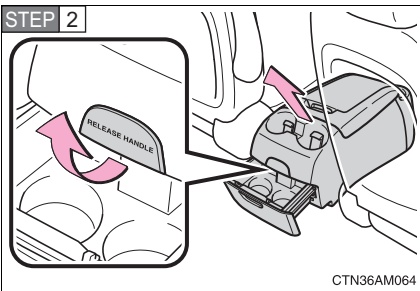

Pull up the lever to disengage the rear lock. Then lift the console box and release the front hook.

■ Installing the console box (7-passenger models)

► Between the front seats

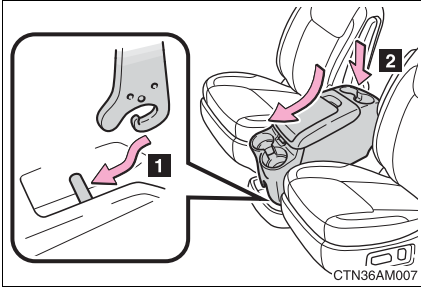

1 Install the front hook in the front striker of the console box installation base.

2 Push down on the back to engage the rear lock.

► Between the second seats

STEP 1 If the right side second seat is in the inside position: Return the seat to its original position. (The striker for the right side second seat is also used as the console box lock striker.) (→P. 66)

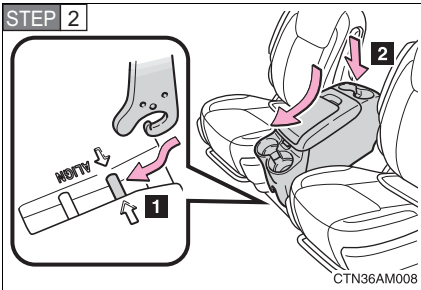

1 Install the front hook in the rear striker of the double striker set.

2 Push down on the back to engage the rear lock.

 **CAUTION****■ Caution while driving**

Keep the console box closed.

Injuries may result in the event of an accident or sudden braking.

■ When installing the console box (7-passenger models)

- Be careful not to catch hands or feet in or under the console box.
- Make sure that the console box is securely installed by pushing it back and forth, upward and sideways. Failure to do so may result in serious injury in the event of sudden braking or a collision.

■ When installing the console box between the second seats (7-passenger models)

Do not install the console box by any means other than the center striker between the second seats. Doing so may result in serious injury in the event of sudden braking or a collision, which may lead to an accident.

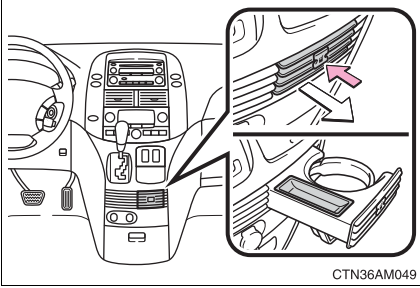
Coin holder

Push the button.

⚠ CAUTION**■ Caution while driving**

Keep the coin holder closed.
Injuries may result in the event of an accident or sudden braking.

Cup holders

► Type A

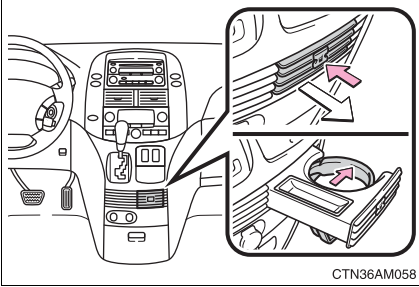

Push the button.

► Type B

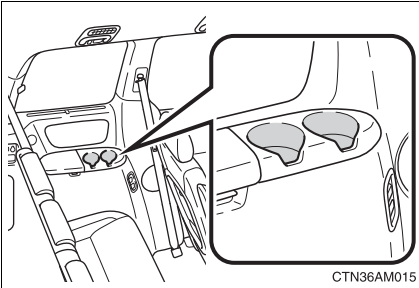

► Type C (if equipped)

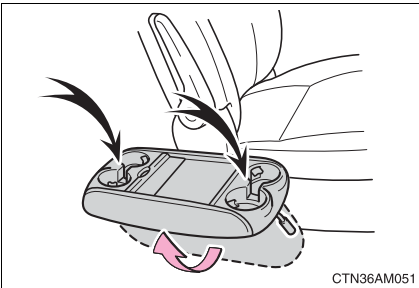

Raise the table if it is folded down.

▶ Type D (if equipped)

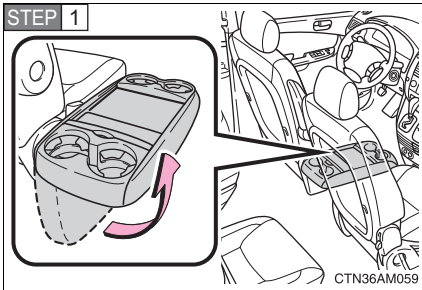

Raise the table if it is folded down.

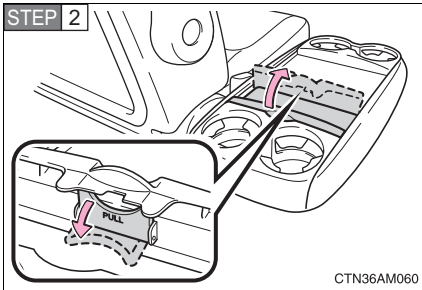

Open the lid and pull down the tab on the back of the lid.

▶ Type E (if equipped)

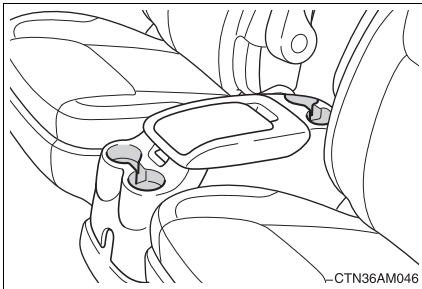

► Type F (if equipped)

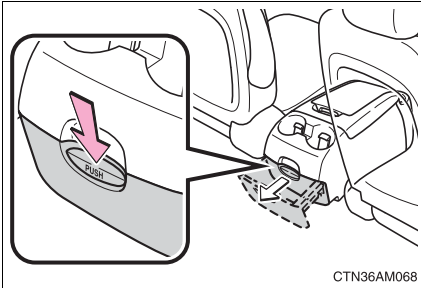

Press down the lever.

► Type G (if equipped)

STEP 1 Remove the console box. (→P. 366)

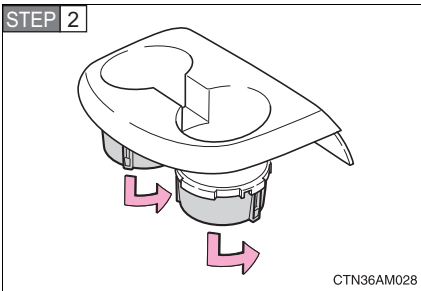

Pull down the cup bottom to extend them (the cup holder is stored in the console box). Turn them clockwise to lock.

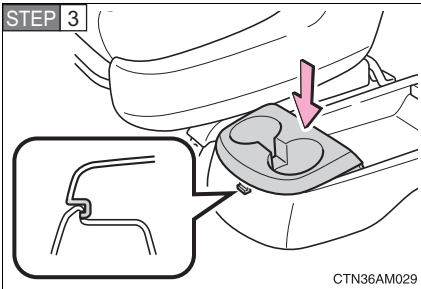

To install the cup holder, hook it onto the outer edge of the console box installation base, then push down on the opposite end to secure it.

■ **When the cup holders of type C and D are not in use (if equipped)**

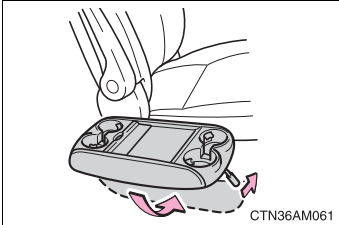

Pull up the lever and push against the driver's seat side.

! CAUTION

■ **When installing the cup holder of type G (if equipped)**

Make sure that the cup holder is securely installed by pushing it back and forth, upward and sideways. Failure to do so may result in serious injury in the event of sudden braking or a collision.

■ **Items unsuitable for the cup holder**

Do not place anything other than cups or aluminum cans in the cup holders. Other items may be thrown out of the holders in the event of an accident or sudden braking and cause injury. If possible, cover hot drinks to prevent burns.

■ **When not in use**

Type A, type D (if equipped) and type F (if equipped): Keep the cup holders closed.

Type C and D (if equipped): Make sure the table is folded down and locked securely.

Type G (if equipped): Keep the cup holders stowed.

Injuries may result in the event of an accident or sudden braking.

Bottle holders

► Front

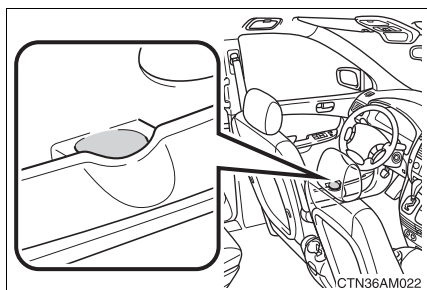

► Rear

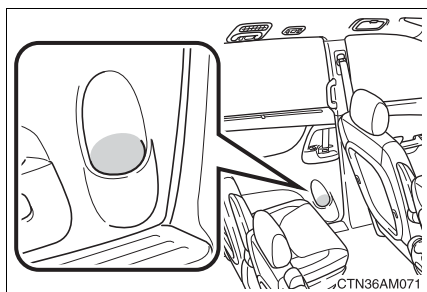
**! CAUTION****■ Items unsuitable for the bottle holder**

Do not place anything other than a bottle in the bottle holders. Other items may be thrown out of the holders in the event of an accident or sudden braking and cause injury.

! NOTICE**■ When stowing a bottle**

Put the cap on before stowing a bottle. Do not place open bottles in the bottle holders. The contents may spill.

Auxiliary boxes

► Type A

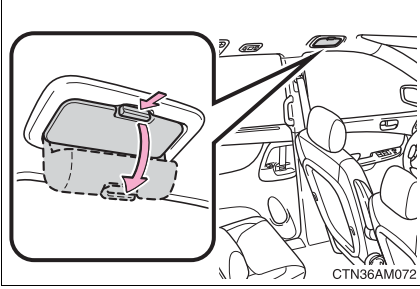

Push the button and pull down the box.

► Type B

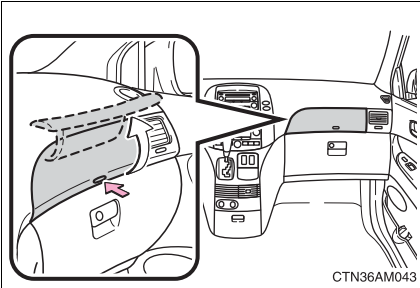

Push the button.

► Type C

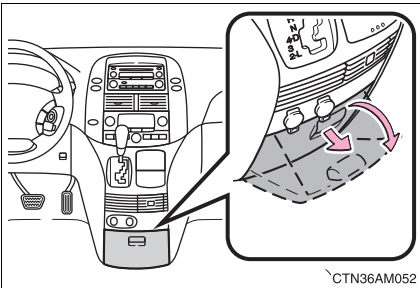

Pull up the lever and open the box.

► Type D

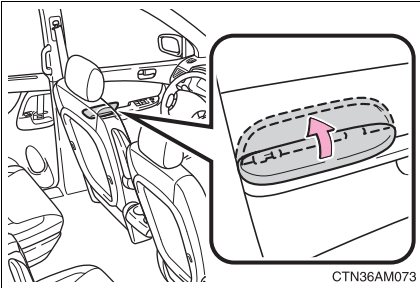

Lift the lid.

► Type E

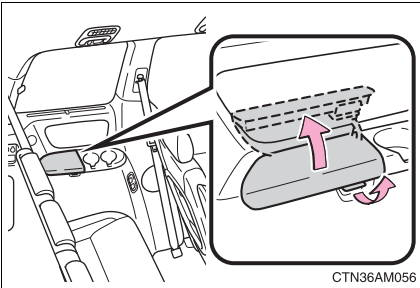

Pull up the lever and lift the lid.

► Type F (if equipped)

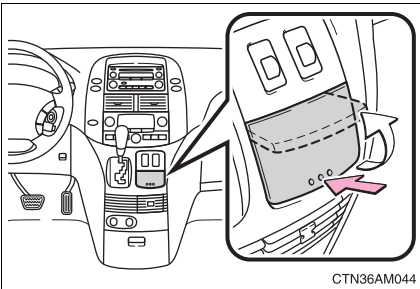

Press in and release the lid to open.

► Type G (if equipped)

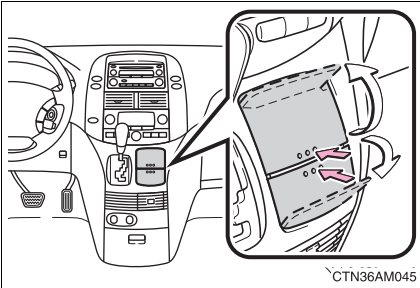

Press in and release the lid to open.

► Type H (if equipped)

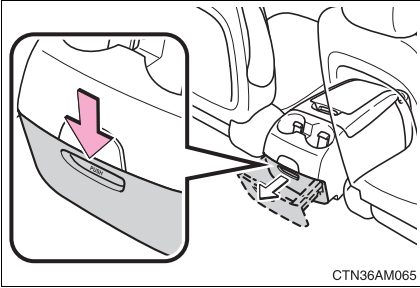

Press down the lever.

► Type I (if equipped)

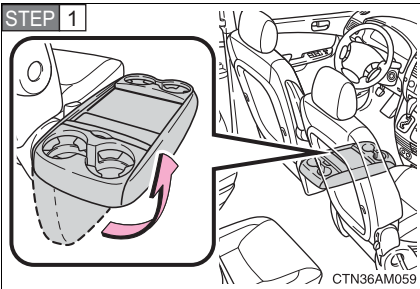

Raise the table if it is folded down.

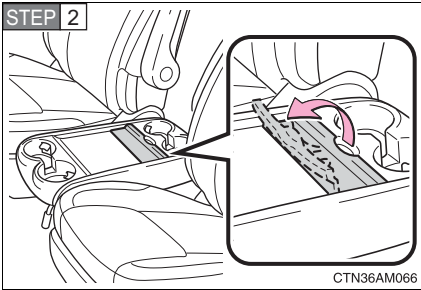

Open the lid.

■ **Changing the position of the partition in the auxiliary box of type G (if equipped)**

The partition can be moved as shown in the illustration.

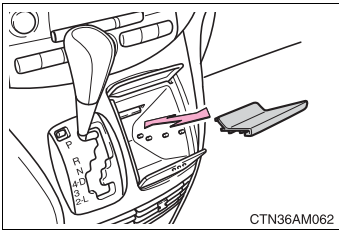

Pull out the partition and place it in the desired position as following illustration.

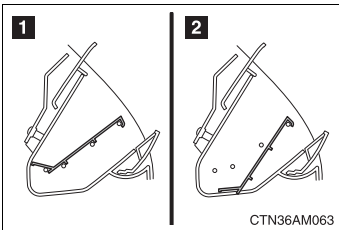

1 Pattern A

2 Pattern B

■ **When the auxiliary box of type I is not in use (if equipped)**

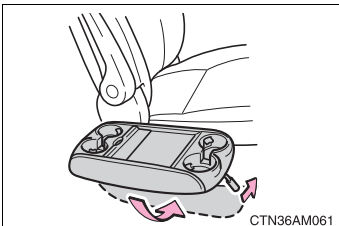

Pull up the lever and push against the driver's seat side.

 **CAUTION****■ Items that should not be left in the auxiliary box (type A)**

Do not leave glasses or lighters in the auxiliary box.

If the interior of the vehicle becomes hot, lighters may explode and glasses may warp or become cracked.

■ Items unsuitable for storing (type A)

Do not place any heavy objects in them.

Doing so may cause the auxiliary box to open and the items inside may fall out, resulting in an accident.

■ Caution while driving

Keep the auxiliary boxes closed.

Injuries may result in the event of an accident or sudden braking.

■ When not in use

Type I (if equipped): Make sure the table is folded down and locked securely. Injuries may result in the event of an accident or sudden braking.

Trays (if equipped)

► Under the front passenger's seat

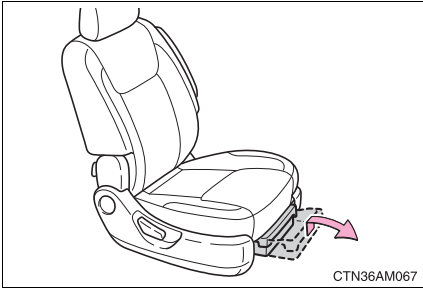

Lift the tray and pull it forward.

► Between the front seats

STEP 1 Remove the console box. (→P. 366)

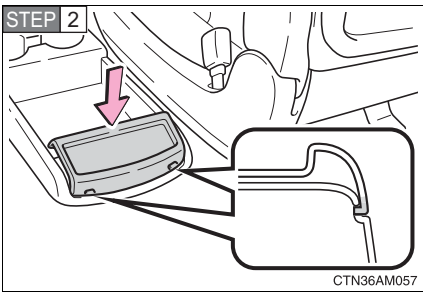

To install the tray (the tray is stored in the console box), hook it onto the outer edge of the console box installation base, then push down on the opposite end to secure it.

! CAUTION**■ When the tray between the front seats is not in use**

Keep the tray stowed.

Injuries may result in the event of an accident or sudden braking.

■ When installing the tray between the front seats

Make sure that the tray is securely installed by pushing it back and forth, upward and sideways. Failure to do so may result in serious injury in the event of sudden braking or a collision.

■ Caution while driving (the tray under the front passenger's seat)

Keep the tray closed.

Injuries may result in the event of an accident or sudden braking.

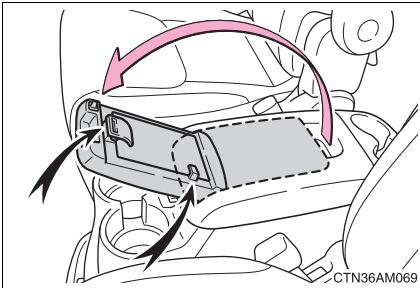
Note pad holder (if equipped)

Raise the upper console box lid.

 **CAUTION**

■ **Caution while driving**

Keep the upper console box lid closed.

Injuries may result in the event of an accident or sudden braking.

Sun visors

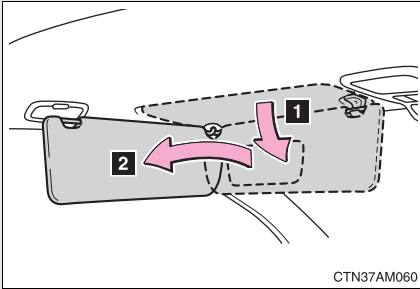

1 Forward position:
Flip down.

2 Side position:
Flip down, unhook, and
swing to the side.

Vanity mirrors

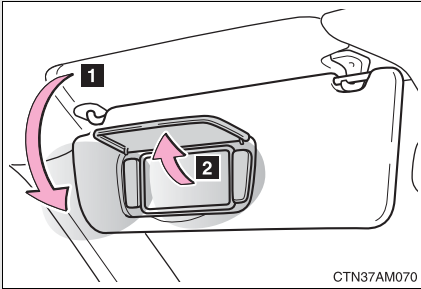

1 Flip down.

2 Open the cover.

The light turns on when the cover is opened.

Clock

► With a manual air conditioning system

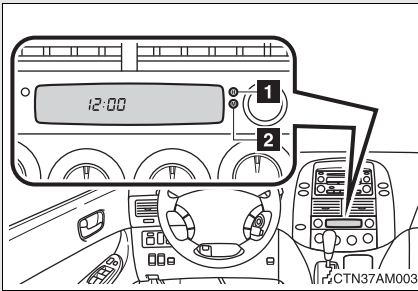

- 1 Adjusts the hours.
- 2 Adjusts the minutes.

► With an automatic air conditioning system

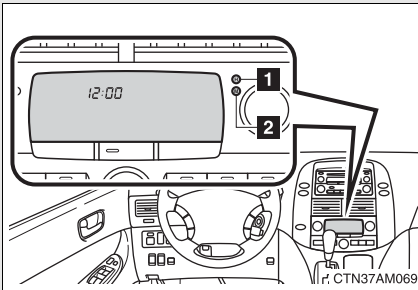

- 1 Adjusts the hours.
- 2 Adjusts the minutes.

■ **The clock is displayed when**

The engine switch is in the “ACC” or “ON” position.

■ **When disconnecting and reconnecting battery terminals**

The time display will automatically be set to 1:00.

3-7. Other interior features

Conversation mirror

The conversation mirror can provide the driver and the front passenger with a view of the rear seat area without the need to turn around.

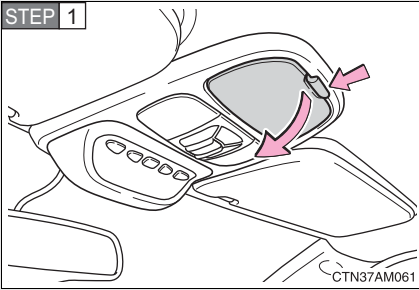

Push the tab and flip down the lid.

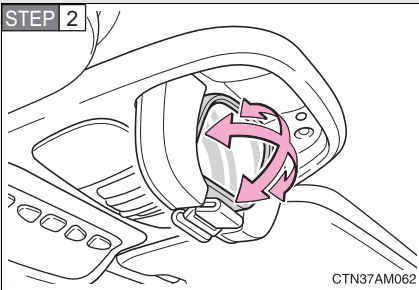

The mirror can be adjusted by pushing its edge.

CAUTION

Caution while driving

Do not adjust the position of the mirror while driving.

Doing so may lead to mishandling of the vehicle and an accident, resulting in death or serious injury.

Power outlets

The following power outlets can be used for:

12 V: Accessories that use a combined total of less than 120 W (10 A at 12 V).

115 VAC: Accessories that use a combined total of less than 100 W.

■ 12 V

► Center panel

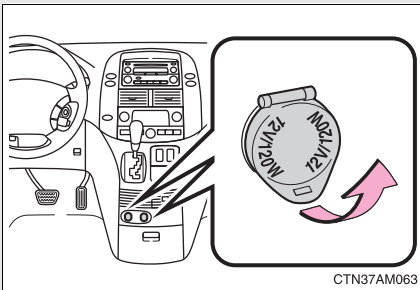

► Luggage compartment

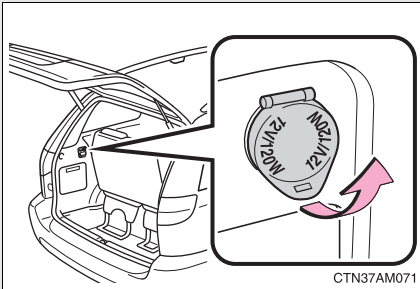

■ **115 VAC (if equipped)**

▶ **Main switch**

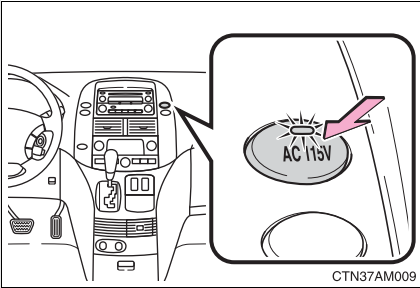

To use the power outlet, turn on the main switch.

The indicator light comes on.

▶ **Power outlet socket (beside third seat)**

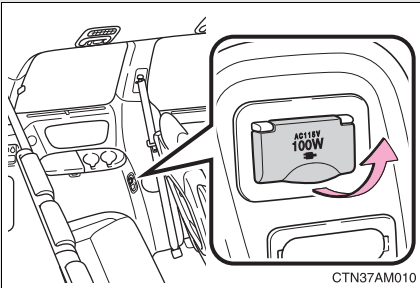

▶ **Power outlet socket (luggage compartment)**

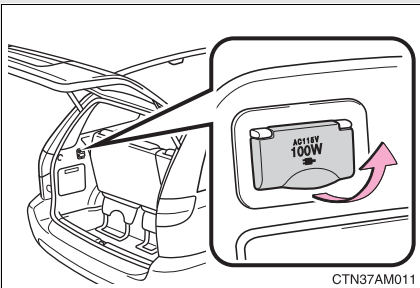

■ **The power outlet can be used when**

▶ **12 V**

The engine switch is in the “ACC” or “ON” position.

▶ **115 VAC**

The engine switch is in the “ON” position.



NOTICE

■ **To avoid damaging the power outlet**

Close the power outlet lid when the power outlet is not in use.

Foreign objects or liquids that enter the power outlet may cause a short circuit.

■ **To prevent the fuse from being blown**

▶ **12 V**

Do not use accessories that require a combined total of more than 120 W (10 A at 12 V).

▶ **115 VAC**

Do not use 115 VAC appliances that require a combined total of more than 100 W.

If a 115 VAC appliance that consumes more than 100 W is used, the protection circuit will cut the power supply.

■ **To prevent the battery from being discharged**

Do not use the power outlet longer than necessary when the engine is off.

■ **Appliances that may not operate properly (115 VAC)**

The following 115 VAC appliances may not operate properly even if their power consumption is under 100 W.

- Appliances with high initial peak wattage
- Measuring devices that process precise data
- Other appliances that require an extremely stable power supply

3-7. Other interior features

Seat heaters (if equipped)

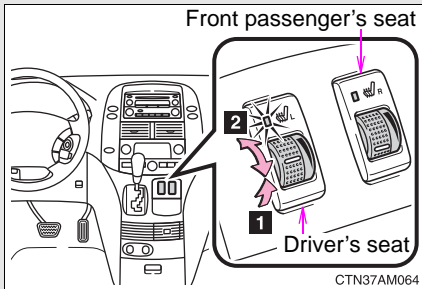

1 On

The indicator light comes on.

2 Adjusts the seat temperature

The further you move the dial upward, the warmer the seat becomes.

■ The seat heaters can be used when

The engine switch is in the "ON" position.

■ When not in use

Move the dial fully downward. The indicator light turns off.

⚠ CAUTION

■ Burns

- Use caution when seating the following persons in a seat with the seat heater on to avoid the possibility of burns:
 - Babies, small children, the elderly, the sick and the disabled
 - Persons with sensitive skin
 - Persons who are fatigued
 - Persons who have taken alcohol or drugs that induce sleep (sleeping drugs, cold remedies, etc.)
- Do not cover the seat with anything when using the seat heater. Using the seat heater with a blanket or cushion increases the temperature of the seat and may lead to overheating.

 NOTICE**■ To prevent seat heater damage**

Do not put unevenly weighted objects on the seat and do not stick sharp objects (needles, nails, etc.) into the seat.

■ To prevent battery discharge

Turn the switches off when the engine is not running.

3-7. Other interior features

Armrests

▶ Front seat

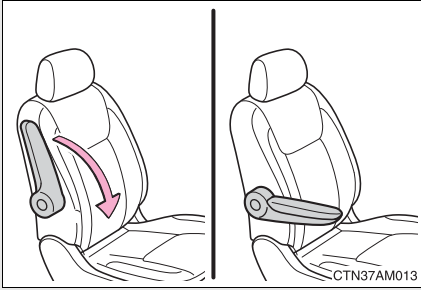

Pull the armrest down for use.

▶ Second seat (if equipped)

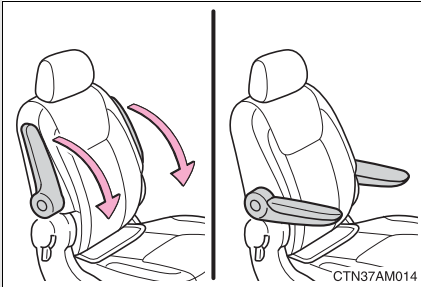

Pull the armrest down for use.

NOTICE

To prevent damage to the armrest

Do not place too much strain on the armrest.

Rear side sunshades (if equipped)

► Rear door window

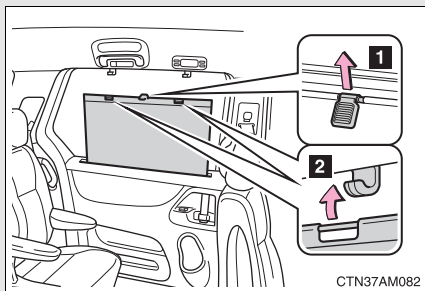

- 1 Pull the tab up.
- 2 Secure the sunshade using the hooks.

To retract the sunshade, pull the tab up slightly to unhook the sunshade, and lower the sunshade slowly.

► Rear quarter window

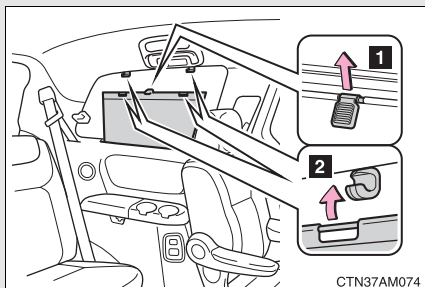

- 1 Pull the tab up.
- 2 Secure the sunshade using the hooks.

To retract the sunshade, pull the tab up slightly to unhook the sunshade, and lower the sunshade slowly.

⚠ NOTICE

■ To ensure normal operation of the sunshade

Observe the following precautions.

- Do not place anything where it may hinder the opening/closing of the sunshade.
- Do not place anything on the sunshade.

3-7. Other interior features

Grocery bag hooks

The hooks are designed to hang things like a grocery bag.

► Type A (instrument panel)

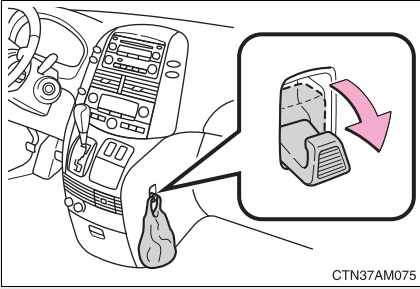

Pull the hook down.

► Type B (front seatback)

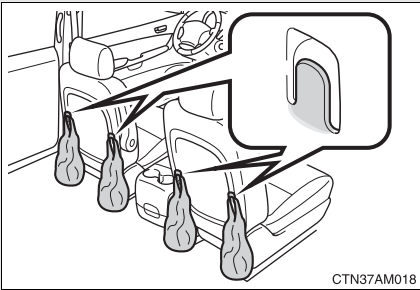

► Type C (manual third seat)

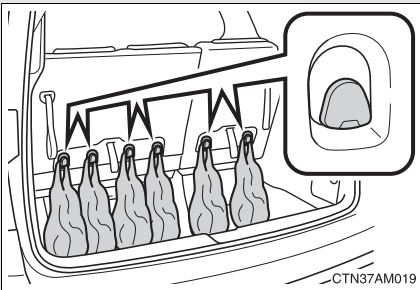

▶ Type C (power third seat)

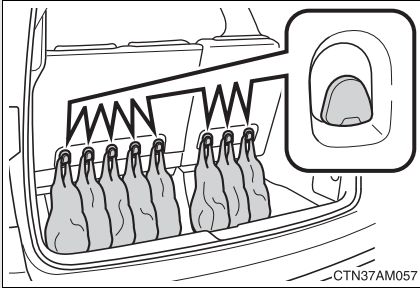

▶ Type D (luggage compartment)



Pull the hook up.

⚠ CAUTION

■ **When not in use (Type A and D)**

Keep the grocery bag hook stowed.
Injuries may result in the event of an accident or sudden braking.

⚠ NOTICE

■ **Grocery bag hook weight capacity (Type A, B and C)**

Do not hang any object heavier than 8.8 lb. (4 kg) on the grocery bag hook.

3-7. Other interior features

Coat hooks

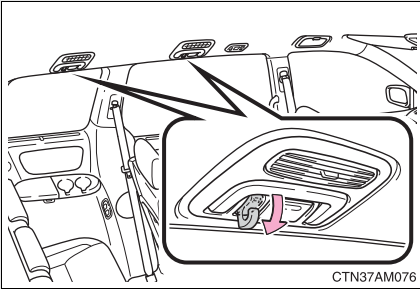

To use the coat hook, pull it down.

! CAUTION

■ Items that must not be hung on the hook

Do not hang a coat hanger or other hard or sharp objects on the hook. If the SRS curtain shield airbags deploy, these items may become projectiles that cause death or serious injury.

Seatback tables

Following seatbacks can be used as a temporary table only when the vehicle is stopped.

▶ **Front passenger's seatback table (if equipped)**

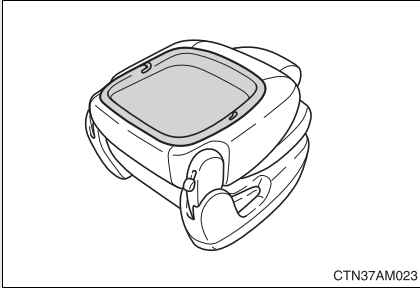

Fold down the seatback.
(→P. 56)

▶ **Second outside seatback table**

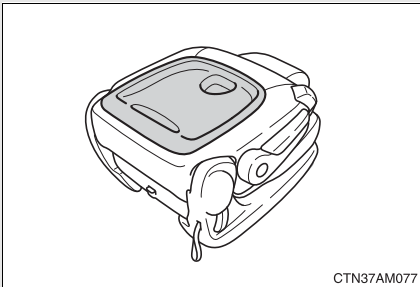

Fold down the seatback.
(→P. 59)

▶ **Second center seatback table (if equipped)**

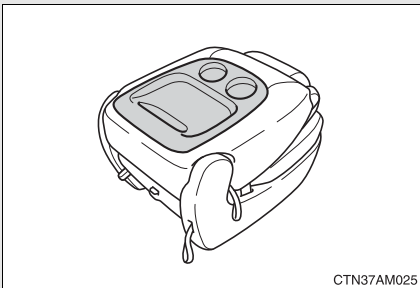

Fold down the seatback.
(→P. 59)

 CAUTION

■ **Caution while driving**

Observe the following precautions to avoid death or serious injury.

- Do not set up the seatback table.
- Do not sit on or place anything on the seatback table.

 NOTICE

■ **To prevent damage to the seatback table**

Do not put heavy loads on the table.

Front seat side table (if equipped)

Front seat side table can be used as a temporary table only when the vehicle is stopped.

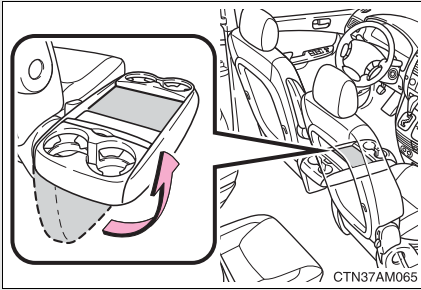

Raise the table if it is folded down.

■ Folding down the front seat side table

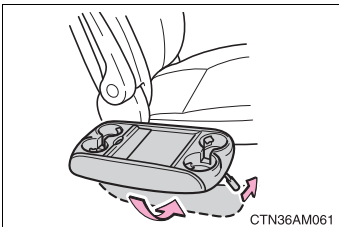

Pull up the lever and push against the driver's seat side.

 **CAUTION**

■ **Caution while driving**

Do not place anything on the front seat side table to avoid death or serious injury.

■ **When not in use**

Keep the front seat side table folded down and securely locked. Injuries may result in the event of an accident or sudden braking.

 **NOTICE**

■ **To prevent damage to the front seat side table**

Do not put heavy loads on the table.

Floor mat

Securely place a mat that matches the size of the space on the carpet.

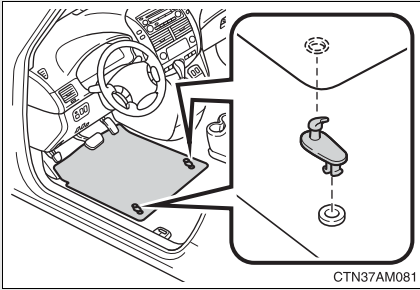

Secure the driver's floor mat using the hooks provided.

CAUTION

■ When inserting the floor mat

Observe the following precautions.

Failure to do so may result in the floor mat slipping and interfering with the movement of the pedals during driving, resulting in an accident.

- Make sure the floor mat is properly placed on the vehicle carpet and the correct side faces upward.
- Do not place floor mats on top of existing mats.

3-7. Other interior features

Luggage compartment features

■ Cargo hooks

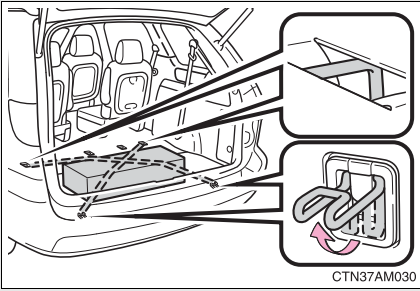

Cargo hooks are provided for securing loose items.

■ Cargo net hooks

► Pattern 1

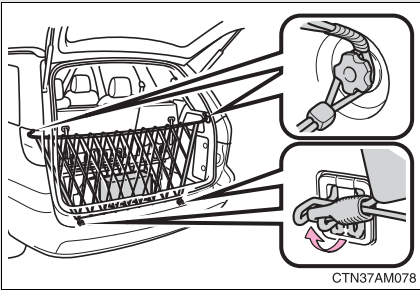

► Pattern 2

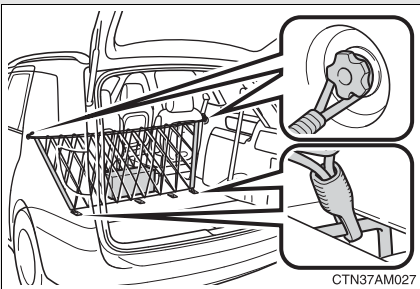

► Pattern 3

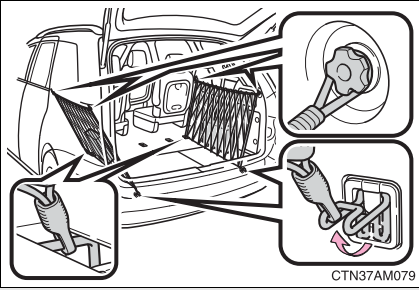

► Pattern 4

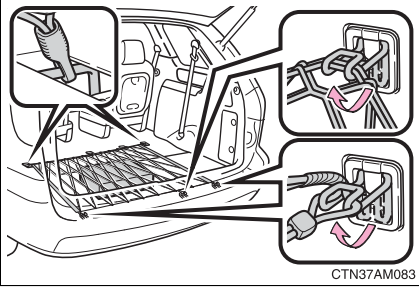

■ Storage box (if equipped)

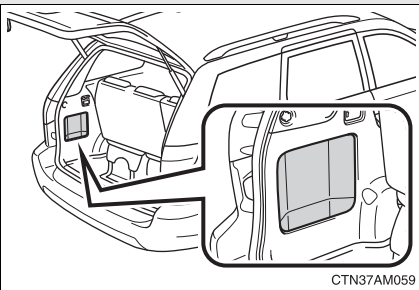

 CAUTION

■ **When the cargo hooks are not in use**

To avoid injury, always return the cargo hooks to their positions when they are not in use.

 NOTICE

■ **To prevent damage to the cargo net hooks**

Avoid hanging things other than a cargo net on them.

Garage door opener (if equipped)

The garage door opener can be programmed to operate garage doors, gates, entry doors, door locks, home lighting systems, security systems, and other devices.

The garage door opener (HomeLink[®] Universal Transceiver) is manufactured under license from HomeLink[®].

Programming the HomeLink[®] (for U.S.A. owners)

The HomeLink[®] compatible transceiver in your vehicle has 3 buttons which can be programmed to operate 3 different devices. Refer to the programming method below appropriate for the device.

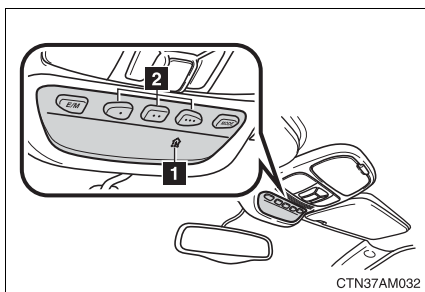

1 Indicator

2 Buttons

■ Programming the HomeLink[®]

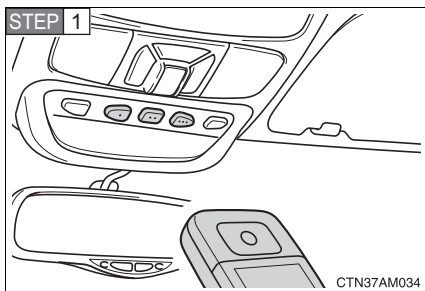

Point the remote control for the device 1 to 3 in. (25 to 75 mm) from the HomeLink[®] control buttons.

Keep the indicator light on the HomeLink[®] in view while programming.

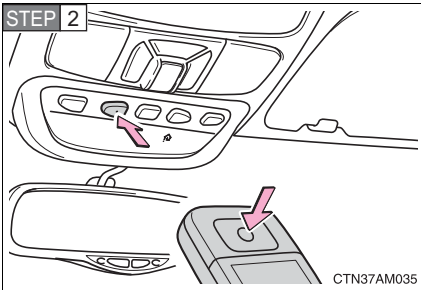

Press and hold down one of the buttons on the HomeLink[®] and the button on the transmitter. When the indicator light on the HomeLink[®] changes from a slow to a rapid flash after 20 seconds, you can release both buttons.

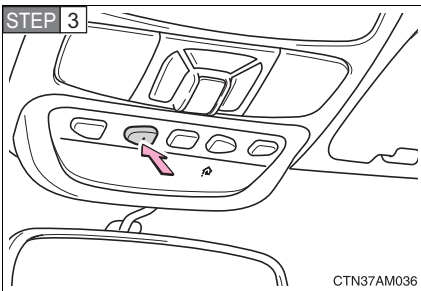

Test the operation of the HomeLink[®] by pressing the newly programmed button.

If programming a garage door opener, check to see if the garage door opens and closes. If the garage door does not operate, see if your garage transmitter is of the Rolling Code type. Press and hold the programmed HomeLink[®] button. The garage door has the rolling code feature if the indicator light (on the HomeLink[®]) flashes rapidly for 2 seconds and then remains lit. If your transmitter is the Rolling Code type, proceed to the heading "Programming a rolling code system".

STEP 4 Repeat the steps above to program another device for each of the remaining HomeLink[®] buttons.

■ Programming a Rolling Code system (for U.S.A. owners)

If your device is Rolling Code equipped, follow the steps under the heading “Programming the HomeLink®” before proceeding with the steps listed below.

STEP 1 Locate the training button on the ceiling mounted garage door opener motor. The exact location and color of the button may vary by brand of garage door opener.

Refer to the operation manual supplied with the garage door opener for the location of the training button.

STEP 2 Press the training button.

STEP 3 Press and release the vehicle’s programmed HomeLink® button twice. The garage door may open.

If the garage door opens, the programming process is complete. If the door does not open, press and release the button a third time. This third press and release will complete the programming process by opening the garage door.

The ceiling mounted garage door opener motor should now recognize the HomeLink® transceiver and operate the garage door.

STEP 4 Repeat the steps above to program another rolling code system for any of the remaining HomeLink® buttons.

■ Programming an entry gate (for U.S.A. owners)/Programming all devices in the Canadian market

STEP 1 Place your transmitter 1 to 3 in. (25 to 75 mm) away from the surface of the HomeLink®.

Keep the indicator light on the HomeLink® in view while programming.

STEP 2 Press and hold the selected HomeLink® button.

STEP 3 Repeatedly press and release (cycle) the device’s remote control button for two seconds each until step 4 is complete.

STEP 4 When the indicator light on the HomeLink® compatible transceiver starts to flashing rapidly, release the buttons.

STEP 5 Test the operation of the HomeLink[®] by pressing the newly programmed button. Check to see if the gate/device operates correctly.

STEP 6 Repeat the steps above to program another device for each of the remaining HomeLink[®] buttons.

■ Programming other devices

To program other devices such as home security systems, home door locks or lighting, contact your authorized Toyota dealer for assistance.

■ Reprogramming a button

The individual HomeLink[®] buttons cannot be erased but can be reprogrammed. To reprogram a button, follow the programming instructions.

Operating the HomeLink[®]

Press the appropriate HomeLink[®] button. The HomeLink[®] indicator light on the HomeLink[®] transceiver should turn on.

The HomeLink[®] continues to send a signal for up to 20 seconds as long as the button is pressed.

Erasing the entire HomeLink[®] memory (all three programs)

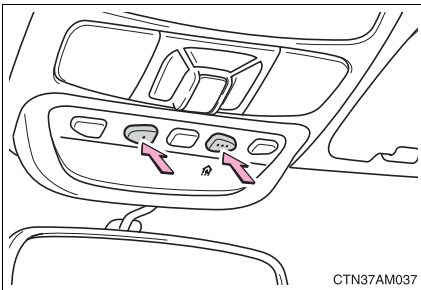

Press and hold down the 2 outside buttons for 20 seconds until the indicator light flashes.

If you sell your vehicle, be sure to erase the programs stored in the HomeLink[®] memory.

■ Before programming

- Install a new battery in the transmitter.
- The battery side of the transmitter must be pointed away from the HomeLink®.

■ Certification for the garage door opener

This device complies with Part 15 of the FCC Rules and with RSS-210 of the IC Rules.

Operation is subject to the following two conditions: (1) This device may not cause harmful interference, and (2) this device must accept any interference received, including interference that may cause undesired operation.

WARNING: This transmitter has been tested and complies with FCC and IC rules. Changes or modifications not expressly approved by the party responsible for compliance could void the user's authority to operate the device.

■ For additional programming assistance with your HomeLink® Universal Transceiver

Refer to HomeLink® on the internet at WWW.HOMELINK.COM.

CAUTION

■ When programming a garage door or other remote control device

The garage door may operate, so ensure people and objects are out of danger to prevent potential harm.

■ Conforming to federal safety standards

Do not use the HomeLink® Compatible Transceiver with any garage door opener or device that lacks safety stop and reverse features as required by federal safety standards.

This includes any garage door that cannot detect an obstruction object. A door or device without these features increases the risk of death or serious injury.

Garage door opener box (if equipped)

The box is designed to store a garage door opener transmitter.

■ Setting the transmitter

STEP 1

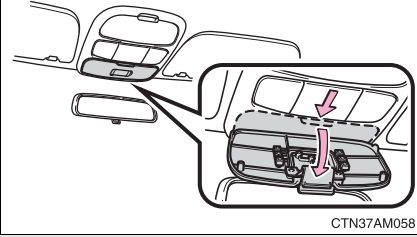

Push the button and flip down the lid.

STEP 2

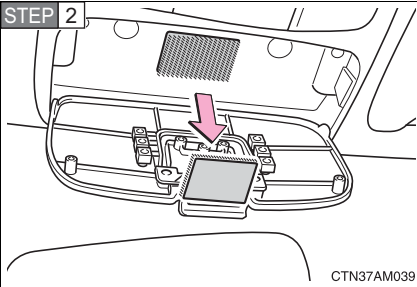

Remove the hook-and-loop fastener.

STEP 3

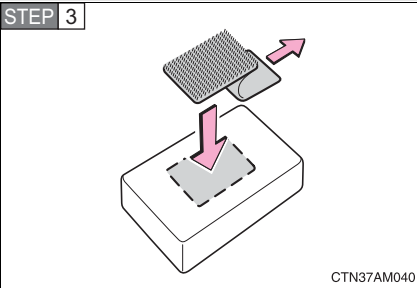

Remove the paper strip covering the adhesive on backside of loop and adhere loop to back side of the transmitter near its center.

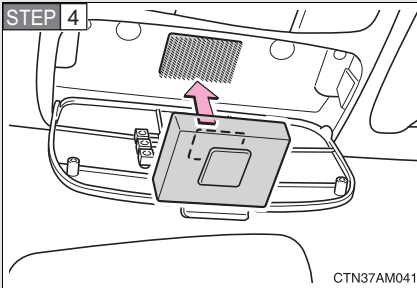

Place the transmitter with the fastener facing inside of box into the box.

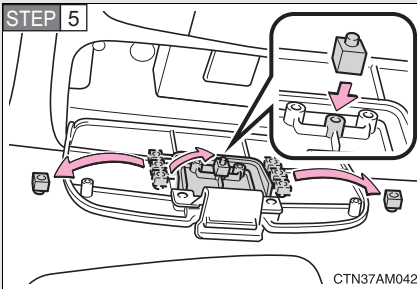

Remove spacers from the center panel.

Place one spacer on the pin that would be below the transmitter button when the cover is closed.

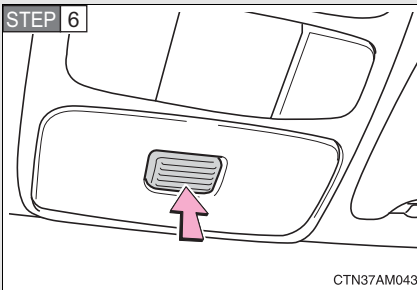

Test the operation of the transmitter by pressing the button.

■ **When the spacer does not contact your transmitter button**

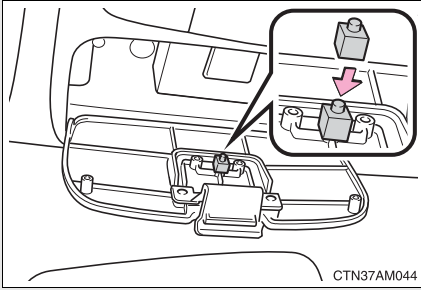

Check to see if the spacer is on the correct pin.

If the spacer is on the correct pin, attach another spacer on top of the original spacer. Recheck transmitter operation. If required, add spacers until contact is achieved.

■ **If the transmitter rattles during driving**

Stuffing the box with a piece of felt or pad will stop the noise.

⚠ CAUTION

■ **Caution while driving**

Keep the garage door opener box closed.
Injuries may result in the event of an accident or sudden braking.

■ **Removed spacers**

Keep away from children.
These parts are small and if swallowed by a child they can cause choking.

3-7. Other interior features

Compass (if equipped)

The compass on the trip information display indicates the direction in which the vehicle is heading.

■ Operation

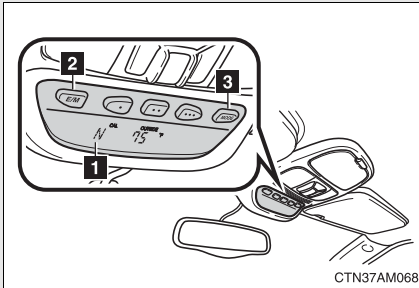

1 Direction display

2 “E/M” button

3 “MODE” button

■ Displays and directions

Display	Direction
N	North
NE	Northeast
E	East
SE	Southeast
S	South
SW	Southwest
W	West
NW	Northwest

Calibrating the compass

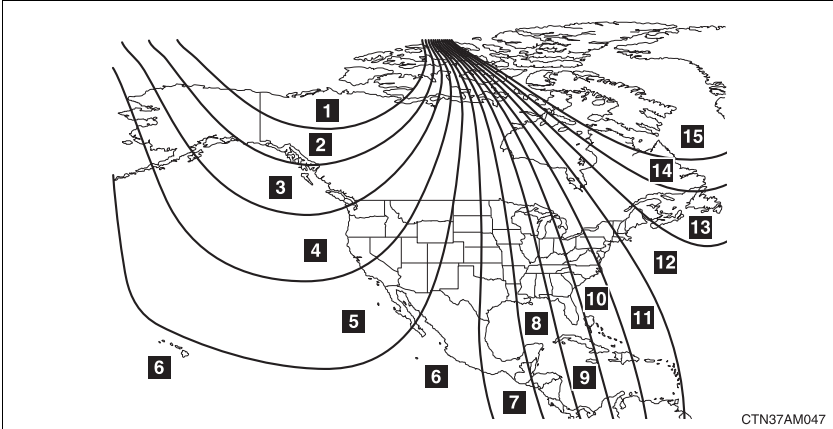

The direction display deviates from the true direction determined by the earth's magnetic field. The amount of deviation varies according to the geographic position of the vehicle.

If you cross over a map boundary shown in illustration, the compass will deviate.

To obtain higher precision or perfect calibration, refer to the following.

■ Deviation calibration

STEP 1 Stop the vehicle in a level place.

STEP 2 Switch the trip information display to the outside temperature.
(→P. 182)

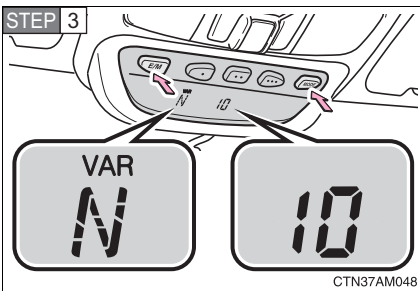

Press and hold both the "MODE" and "E/M" buttons simultaneously for 5 seconds until the "VAR" indication and a number (1 to 15) appears on the compass display.

STEP 4 Press the “E/M” button, and referring to the map above, select the number of the zone where you are.

If the direction is displayed several seconds after adjustment, the calibration is complete.

■ Circling calibration

When the direction display may not change after a turn, the compass needs to be calibrated.

STEP 1 Stop the vehicle in a level place where it is safe to drive in a circle.

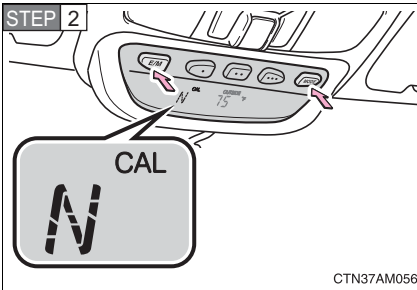

Press and hold both the “MODE” and “E/M” buttons simultaneously for 10 seconds until the “CAL” indication appears on the compass display. (At this time, the compass display is locked in “N”.)

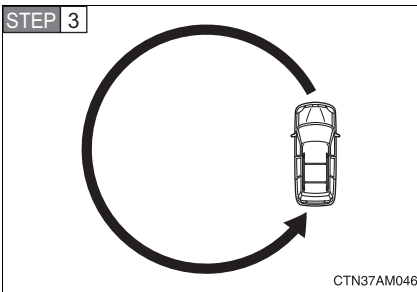

Drive the vehicle at 5 mph (8 km/h) or less in a circle until “CAL” indicator goes off and the compass returns to the normal mode.

If there is not enough space to drive in a circle, drive around the block until “CAL” indicator goes off and the compass returns to the normal mode.

■ **Conditions unfavorable to correct operation**

The compass may not show the correct direction in the following conditions:

- The vehicle is stopped immediately after turning.
- The vehicle is on an inclined surface.
- The vehicle is in a place where the earth's magnetic field is subject to interference by artificial magnetic fields (underground car park/parking lot, under a steel tower, between buildings, roof car park/parking lot, near an intersection, near a large vehicle, etc.).
- The vehicle has become magnetized.
(There is a magnet or metal object near the trip information display.)
- The battery has been disconnected.
- A door is open.

CAUTION

■ **While driving the vehicle**

Do not adjust the display. Be sure to adjust the display only when the vehicle is stopped.

■ **When doing the circling calibration**

Be sure to secure a wide space, and watch out for people and vehicles in the neighborhood. Do not violate any local traffic rules while performing circling calibration.

NOTICE

■ **To avoid a compass malfunctions**

Do not place magnets or any metal objects near the roof of the vehicle. Doing this may cause a malfunction of the compass sensor.

■ **To ensure normal operation of the compass**

- Do not perform circling calibration of the compass in a place where the earth's magnetic field is subject to interference by artificial magnetic fields.
- During calibration, do not operate electric systems (moon roof, power windows, etc.) as they may interfere with the calibration.

Cleaning and protecting the vehicle exterior

Perform the following to protect the vehicle and maintain it in prime condition.

- Working from top to bottom, liberally apply water to the vehicle body, wheel wells and underside of the vehicle to remove any dirt and dust.
Wash the vehicle body using a sponge or soft cloth, such as a chamois.
- For hard-to-remove marks, use car wash soap and rinse thoroughly with water.
- Wipe away any water.
- Wax the vehicle when the waterproof coating deteriorates.

If water does not bead on a clean surface, apply wax when the vehicle body is cool.

■ Automatic car washes

- Before washing the vehicle, do the following.
 - Fold the mirrors back.
 - Remove the antenna. (Mast type only)
 - Turn the power back door system off. (If equipped)
 - Turn the power sliding door system off. (If equipped)
- Brushes used in automatic car washes may scratch the vehicle surface and harm your vehicle's paint.

■ High pressure car washes

- Do not allow the nozzles of the car wash to come within close proximity of the windows.
- Before car wash, check that the fuel filler door on your vehicle is closed properly.

■ Aluminum wheels

Remove any dirt immediately using a neutral detergent. Do not use hard brushes or abrasive cleaners. Do not use strong or harsh chemical cleaners. Use the same mild detergent and wax as used on the paint.

■ Bumpers and side moldings

Do not scrub with abrasive cleaners.

■ To prevent deterioration and body corrosion

- Wash the vehicle immediately in the following cases:
 - After driving near the sea coast
 - After driving on salted roads
 - If you see coal tar or tree sap on the paint surface
 - If you see dead insects or bird droppings on the paint
 - After driving in an area contaminated with soot, oily smoke, mine dust, iron powder or chemical substances
 - If the vehicle becomes heavily soiled in dust or mud
 - If liquids such as benzene and gasoline are spilled on the paint surface
- If the paint is chipped or scratched, have it repaired immediately.

 CAUTION**■ Caution about the exhaust pipe**

Exhaust gasses cause the exhaust pipe to become quite hot.

When washing the vehicle, be careful not to touch the pipe until it has cooled sufficiently, as touching a hot exhaust pipe can cause burns.

 NOTICE

■ **To protect your vehicle's painted surfaces**

Do not use organic cleaners such as benzene or gasoline.

■ **If the windshield washer nozzle or rear window washer nozzle becomes blocked**

Contact your Toyota dealer. Do not try to clear it with a pin or other object. This may damage the nozzle.

■ **Cleaning the exterior lights**

● Wash carefully. Do not use organic substances or scrub with a hard brush. This may damage the surfaces of the lights.

● Do not apply wax on the surfaces of the lights. Wax may cause damage to the lenses.

The following procedures will help protect your vehicle's interior and keep it in top condition:

■ **Protecting the vehicle interior**

Remove dirt and dust using a vacuum cleaner. Wipe dirty surfaces with a cloth dampened with lukewarm water.

■ **Cleaning the leather areas**

- Remove dirt and dust using a vacuum cleaner.
- Wipe any excess dirt and dust with a soft cloth dampened with diluted detergent.

Use a diluted water solution of approximately 5% neutral wool detergent.

- Wring out any excess water from the cloth and thoroughly wipe off all remaining traces of detergent.
- Wipe the surface with a dry, soft cloth to remove any remaining moisture. Allow the leather to dry in a shaded ventilated area.

■ **Cleaning the synthetic leather areas**

- Remove loose dirt using a vacuum cleaner.
- Apply a mild soap solution to the synthetic leather using a sponge or soft cloth.
- Allow the solution to soak in for a few minutes. Remove the dirt and wipe off the solution with a clean, damp cloth.

■ Caring for leather areas

Toyota recommends cleaning the interior of the vehicle at least twice a year to maintain the quality of the vehicle's interior.

■ Shampooing the carpets

There are several commercial foaming-type cleaners available. Use a sponge or brush to apply the foam. Rub in overlapping circles. Do not apply water. The excellent results are obtained when keeping the carpet as dry as possible.

■ Seat belts

Clean with mild soap and lukewarm water using a cloth or sponge. Also check the belts periodically for excessive wear, fraying or cuts.

CAUTION

■ Water in the vehicle

- Do not splash or spill liquid in the vehicle.
Doing so may cause electrical components etc. to malfunction or catch fire.
- Do not get any of the SRS components or wiring in the vehicle interior wet.
(→P. 119)
Electrical malfunction may cause the airbags to deploy or not function properly, resulting in death or severe injury.

 NOTICE**■ Cleaning detergents**

Do not use organic substances such as benzene or gasoline, acidic or alkaline solutions, dye, bleach or other detergent. Doing so may discolor the vehicle interior or cause streaks or damage to painted surfaces.

■ Preventing damage to leather surfaces

Observe the following precautions to avoid damage to and deterioration of leather surfaces.

- Remove any dust or dirt on leather surfaces immediately.
- Do not expose the vehicle to direct sunlight for extended periods of time. Park the vehicle in the shade, especially during summer.
- Do not place items made of vinyl, plastic, or that contain wax on the upholstery, as they may stick to the leather surface if the vehicle interior heats up significantly.

■ Water on the floor

Do not wash the vehicle floor with water.

Vehicle systems such as the audio system may be damaged if water comes into contact with electrical components under the floor of the vehicle, and may also cause the body to rust.

■ Cleaning the inside of the rear window and the rear quarter windows

- Do not use glass cleaner to clean the rear window and the rear quarter windows, as this may cause damage to the rear window defogger heater wires or print type antenna (if equipped). Use a cloth dampened with lukewarm water to gently wipe the windows clean. Wipe the windows in strokes running parallel to the heater wires or print type antenna (if equipped).
- Be careful not to scratch or damage the heater wires or print type antenna (if equipped).

Maintenance requirements

To ensure safe and economical driving, day-to-day care and regular maintenance is essential. It is the owner's responsibility to perform regular checks. Toyota recommends the following maintenance.

■ General maintenance

Should be performed on a daily basis. This can be done by yourself or by a Toyota dealer.

■ Scheduled maintenance

Should be performed at specified intervals according to the maintenance schedule.

For details about maintenance items and schedules, refer to the "Scheduled Maintenance Guide" or "Owner's Manual Supplement".

■ Do-it-yourself maintenance

You can perform some maintenance procedures yourself. Please be aware that do-it-yourself maintenance may affect warranty coverage.

The use of Toyota Repair Manuals is recommended.

For details about warranty coverage, see the separate "Owner's Warranty Information Booklet" or "Owner's Manual Supplement".

■ Repair and replacement

It is recommended that genuine Toyota parts be used for repair to ensure performance of each system. If non-Toyota parts are used in replacement or if a repair shop other than a Toyota dealer performs repairs, confirm the warranty coverage.

■ Allow inspection and repairs to be performed by a Toyota dealer

- Toyota technicians are well-trained specialists and are kept up to date with the latest service information. They are well informed about the operations of all systems on your vehicle.
- Keep a copy of the repair order. It proves that the maintenance that has been performed is under warranty coverage. If any problem should arise while your vehicle is under warranty, your Toyota dealer will promptly take care of it.

⚠ CAUTION**■ Warning in handling of battery**

- Engine exhaust, some of its constituents, and a wide variety of automobile components contain or emit chemicals known to the State of California to cause cancer and birth defects and other reproductive harm. Work in a well ventilated area.
- Oils, fuels and fluids contained in vehicles as well as waste produced by component wear contain or emit chemicals known to the State of California to cause cancer and birth defects or other reproductive harm. Avoid exposure and wash any affected area immediately.
- Battery posts, terminals and related accessories contain lead and lead compounds which are known to cause brain damage. Wash your hands after handling. (→P. 450)

General maintenance

Listed below are the general maintenance items that should be performed at the intervals specified in the “Scheduled Maintenance Guide” or “Owner’s Manual Supplement”. It is recommended that any problem you notice should be brought to the attention of your Toyota dealer or qualified service shop for advice.

Engine compartment

Items	Check points
Battery	Maintenance-free. (→P. 450)
Brake fluid	At the correct level? (→P. 446)
Engine coolant	At the correct level? (→P. 444)
Engine oil	At the correct level? (→P. 439)
Exhaust system	No fumes or strange sounds?
Power steering fluid	At the correct level? (→P. 448)
Radiator/condenser/hoses	Not blocked with foreign matter? (→P. 446)
Washer fluid	Is there sufficient washer fluid? (→P. 453)

Vehicle interior

Items	Check points
Accelerator pedal	<ul style="list-style-type: none"> • Moves smoothly (without uneven pedal effort or catching)?
Automatic transmission “Park” mechanism	<ul style="list-style-type: none"> • Can the vehicle be held securely on an incline with the shift lever in P?
Brake pedal	<ul style="list-style-type: none"> • Moves smoothly? • Does it have appropriate clearance and correct amount of free play?
Brakes	<ul style="list-style-type: none"> • Not pull to one side when applied? • Loss of brake effectiveness? • Spongy feeling brake pedal? • Pedal almost touches floor?
Head restraints	<ul style="list-style-type: none"> • Move smoothly and lock securely?
Indicators/buzzers	<ul style="list-style-type: none"> • Function properly?
Lights	<ul style="list-style-type: none"> • Do all the lights come on? • Headlights aimed correctly?
Parking brake	<ul style="list-style-type: none"> • Moves smoothly? • Can hold the vehicle securely on an incline?
Seat belts	<ul style="list-style-type: none"> • Does the seat belt system operate smoothly? • Are the belts undamaged?
Seats	<ul style="list-style-type: none"> • Do the seat controls operate properly?
Steering wheel	<ul style="list-style-type: none"> • Moves smoothly? • Has correct free play? • No strange noises?

Vehicle exterior

Items	Check points
Doors	<ul style="list-style-type: none"> • Operate smoothly?
Engine hood	<ul style="list-style-type: none"> • The lock system works properly?
Fluid leaks	<ul style="list-style-type: none"> • Is there any leakage after parking?
Tires	<ul style="list-style-type: none"> • Inflation pressure is correct? • Tire surfaces not worn or damaged? • Tires rotated according to the maintenance schedule? • Wheel nuts are not loose?

CAUTION

■ If the engine is running

Turn the engine off and ensure that there is adequate ventilation before performing maintenance checks.

Some states have vehicle emission inspection programs which include OBD (On Board Diagnostics) checks. The OBD system monitors the operation of the emission control system.

■ **If the malfunction indicator lamp comes on**

The OBD system determines that a problem exists somewhere in the emission control system. Your vehicle may not pass the I/M test and may need to be repaired. Contact your Toyota dealer to service the vehicle.

■ **Your vehicle may not pass the I/M test:**

- When the battery is disconnected or discharged

Readiness codes that are set during ordinary driving are erased.

Also, depending on your driving habits, the readiness codes may not be completely set.

- When the fuel tank cap is loose

The malfunction indicator lamp comes on as a temporary malfunction and your vehicle may not pass the I/M test.

■ **When the malfunction indicator lamp goes off after several driving trips**

The error code in the OBD system will not be cleared unless the vehicle is driven 40 or more times.

■ **If your vehicle does not pass the I/M test**

Contact your Toyota dealer to prepare the vehicle for re-testing.

Do-it-yourself service precautions

If you perform maintenance yourself, be sure to follow the correct procedures as given in these sections.

Items	Parts and tools
Battery condition (→P. 450)	<ul style="list-style-type: none"> • Warm water • Baking soda • Grease • Conventional wrench (for terminal clamp bolts)
Brake fluid level (→P. 446)	<ul style="list-style-type: none"> • FMVSS No.116 DOT 3 or SAE J1703 brake fluid • Rag or paper towel • Funnel (used only for adding brake fluid)
Engine coolant level (→P. 444)	<ul style="list-style-type: none"> • “Toyota Super Long Life Coolant” or similar high quality ethylene glycol based non-silicate, non-amine, non-nitrite and non-borate coolant with long-life hybrid organic acid technology. For the U.S.A.: “Toyota Super Long Life Coolant” is pre-mixed with 50% coolant and 50% deionized water. For Canada: “Toyota Super Long Life Coolant” is pre-mixed with 55% coolant and 45% deionized water. • Funnel (used only for adding engine coolant)
Engine oil level (→P. 439)	<ul style="list-style-type: none"> • “Toyota Genuine Motor Oil” or equivalent • Rag or paper towel, funnel (used only for adding oil)

Items	Parts and tools
Fuses (→P. 474)	<ul style="list-style-type: none"> • Fuse with same amperage rating as original
Light bulbs (→P. 486)	<ul style="list-style-type: none"> • Bulb with same number and wattage rating as original • Phillips-head screwdriver • Flathead screwdriver • Wrench
Power steering fluid level (→P. 448)	<ul style="list-style-type: none"> • Automatic transmission fluid DEXRON® II or III • Rag or paper towel • Funnel (used only for adding power steering fluid)
Radiator and condenser (→P. 446)	—
Tire inflation pressure (→P. 463)	<ul style="list-style-type: none"> • Tire pressure gauge • Compressed air source
Washer fluid (→P. 453)	<ul style="list-style-type: none"> • Water washer fluid containing antifreeze (for winter use) • Funnel

 **CAUTION**

The engine compartment contains many mechanisms and fluids that may move suddenly, become hot, or become electrically energized. To avoid death or serious injury, observe the following precautions.

■ **When working on the engine compartment**

- Keep hands, clothing, and tools away from the moving fan and engine drive belt.
- Be careful not to touch the engine, radiator, exhaust manifold, etc. right after driving as they may be hot. Oil and other fluids may also be hot.
- Do not leave anything that may burn easily, such as paper or rags, in the engine compartment.
- Do not smoke, cause sparks or expose an open flame to fuel or the battery. Fuel and battery fumes are flammable.
- Be extremely cautious when working on the battery. It contains poisonous and corrosive sulfuric acid.
- Take care because brake fluid can harm your hands or eyes and damage painted surfaces.

If fluid gets on your hands or in your eyes, flush the affected area with clean water immediately.

If you still experience discomfort, see a doctor.

- Do not touch the engine compartment when the electric cooling fan is operating.

The electric cooling fan may keep rotating for about 3 minutes even after the engine switch is turned to the "LOCK" position.

With the engine switch in the "ON" position, the electric cooling fan may automatically start to run if the air conditioning is on and/or the coolant temperature is high. Be sure the engine switch is in the "LOCK" position and that the electric cooling fan is completely stopped when working near the electric cooling fan or radiator grille.

■ **Safety glasses**

Wear safety glasses to prevent flying or falling material, fluid spray, etc. from getting in the eyes.

 NOTICE**■ If you remove the air cleaner**

Driving with the air cleaner removed may cause excessive engine wear due to dirt in the air. Also a backfire could cause a fire in the engine compartment.

4-3. Do-it-yourself maintenance

Hood

Release the lock from the inside of the vehicle to open the hood.

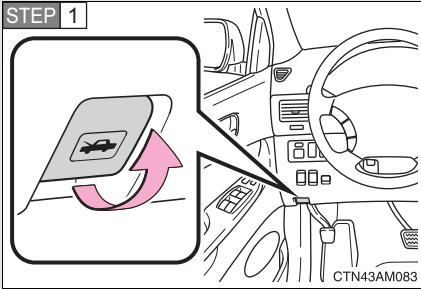

Pull the hood release lever.

The hood will pop up slightly.

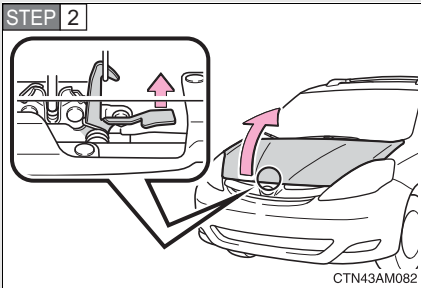

Lift the auxiliary catch lever and lift the hood.

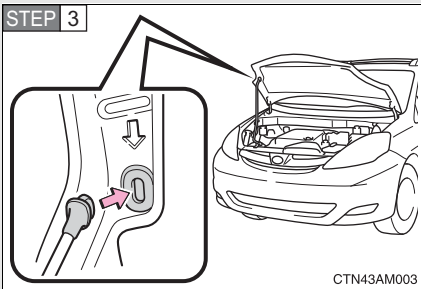

Hold the hood open by inserting the supporting rod into the slot.

 **CAUTION****■ Pre-driving check**

Check that the hood is fully closed and locked.

If the hood is not locked properly, it may open while the vehicle is in motion and cause an accident, which may result in death or serious injury.

■ After installing the support rod into the slot

Make sure the rod supports the hood securely from falling down on to your head or body.

 **NOTICE****■ When closing the hood**

Be sure to return the support rod to its clip before closing the hood. Closing the hood with the support rod up could cause the hood to bend.

4-3. Do-it-yourself maintenance

Positioning a floor jack

When raising your vehicle with a floor jack, position the jack correctly. Improper placement may damage your vehicle or cause injury.

■ Front

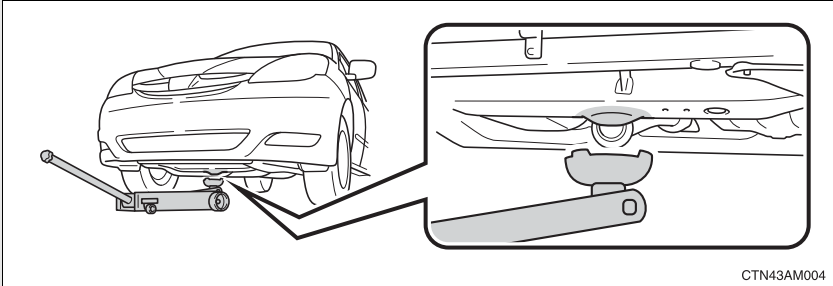

■ Rear

► 2WD models

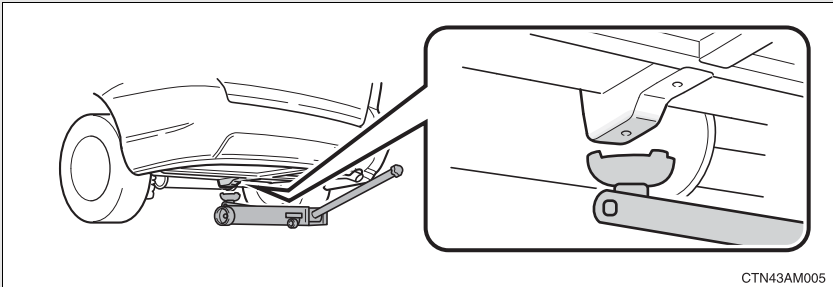

► AWD models

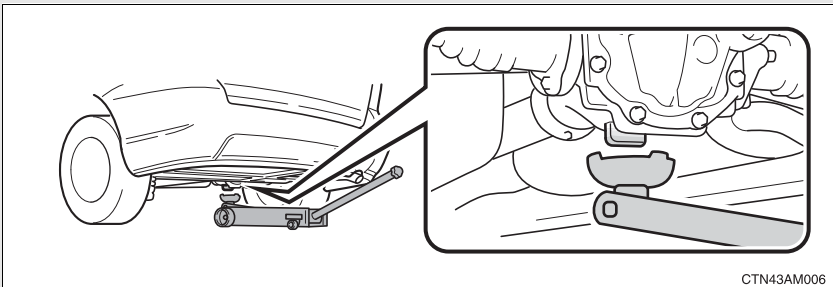

⚠ CAUTION

■ When raising your vehicle

Make sure to observe the following to reduce the possibility of death or serious injury.

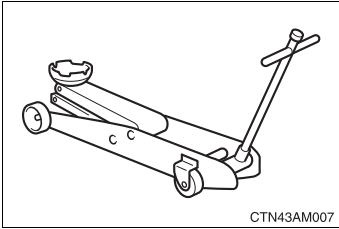

- Lift up the vehicle using a floor jack such as the one shown in the illustration.

- Do not use the jack that was supplied with your vehicle.
- Do not put any part of your body or get underneath the vehicle supported only by the floor jack.
Always use automotive jack stands on a solid, level surface.
- Do not start the engine while the vehicle is supported by the floor jack.
- Stop the vehicle on level firm ground, firmly set the parking brake and shift the shift lever in P.
- Make sure to set the floor jack properly at the jack point.
Raising the vehicle with an improperly positioned floor jack will damage the vehicle and may cause the vehicle to fall off the floor jack.
- Do not raise the vehicle while someone is in the vehicle.
- When raising the vehicle, do not place any objects on top of or underneath the floor jack.

4-3. Do-it-yourself maintenance

Engine compartment

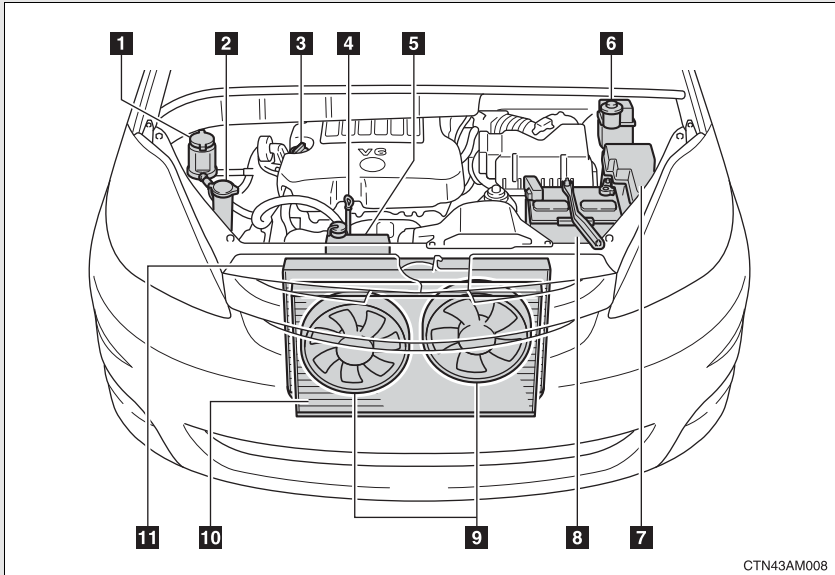

- | | |
|--|--|
| 1 Power steering fluid reservoir
(→P. 448) | 5 Engine coolant reservoir
(→P. 444) |
| 2 Windshield and rear window
washer fluid tank (→P. 453) | 6 Brake fluid reservoir
(→P. 446) |
| 3 Engine oil filler cap
(→P. 440) | 7 Fuse box
(→P. 474) |
| 4 Engine oil level dipstick
(→P. 439) | 8 Battery
(→P. 450) |
| | 9 Electric cooling fans |
| | 10 Condenser
(→P. 446) |
| | 11 Radiator
(→P. 446) |

Engine oil

With the engine at operating temperature and turned off, check the oil level on the dipstick.

■ Checking the engine oil

STEP 1 Park the vehicle on level ground. After turning off the engine, wait more than five minutes for the oil to drain back into the bottom of the engine.

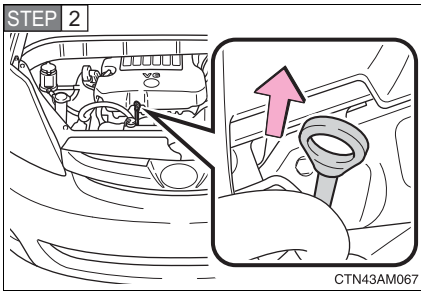

Hold a rag under the end and pull the dipstick out.

STEP 3 Wipe the dipstick clean.

STEP 4 Reinsert the dipstick fully.

STEP 5 Holding a rag under the end, pull the dipstick out and check the oil level.

STEP 6 Wipe the dipstick and reinsert it fully.

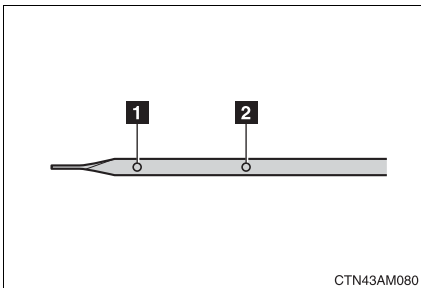

1 Low

2 Full

■ Adding engine oil

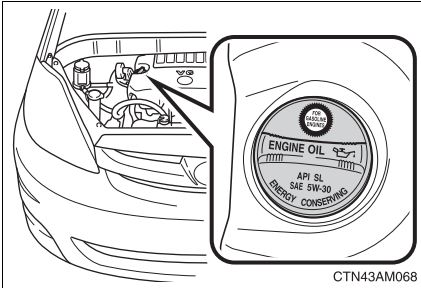

If the oil level is below or near the low level mark, add engine oil of the same type as already in the engine.

Make sure to check the oil type and prepare the items needed before adding oil.

Oil grade	ILSAC multi-grade engine oil
Items	Clean funnel

STEP 1 Remove the oil filler cap by turning it counterclockwise.

STEP 2 Add engine oil slowly, checking the dipstick.

STEP 3 Install the oil filler cap by turning it clockwise.

The approximate quantity of oil needed to raise the level from low to full on the dipstick is indicated as follows:

1.6 qt. (1.5 L, 1.3 Imp. qt.)

■ Recommended viscosity

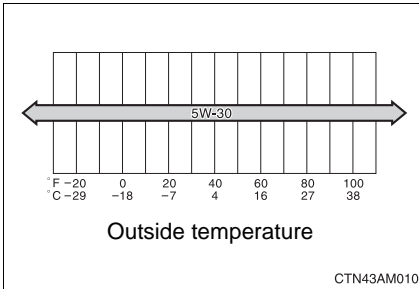

SAE 5W-30 is the best choice for good fuel economy, and good starting in cold weather.

If SAE 5W-30 oil is not available, SAE 10W-30 oil may be used. However, it should be replaced with SAE 5W-30 at the next oil change.

■ How to read oil container labels

Some oil containers are labeled with ILSAC certification marks that help you to select the proper oil.

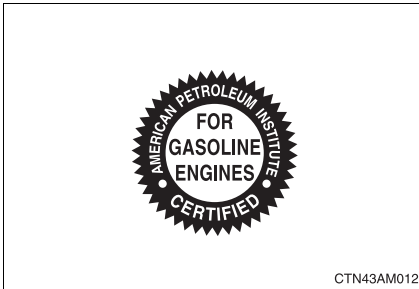

■ Engine oil consumption

- The amount of engine oil consumed depends on the oil viscosity, the quality of the oil and the way the vehicle is driven.
- More oil is consumed under driving conditions such as high speeds and frequent acceleration and deceleration.
- A new engine consumes more oil.
- When judging the amount of oil consumption, keep in mind that the oil may have become diluted, making it difficult to judge the true level accurately.
- Oil consumption: Max. 1.1 qt./600 miles, 0.9 Imp.qt./600 miles (1.0 L per 1000 km)
- If your vehicle consumes more than 1.1 qt. (1.0 L, 0.9 Imp.qt.) every 600 miles (1000 km), contact your Toyota dealer.

■ Changing the engine oil (U.S.A. only)

To reset the oil change system, follow the procedure below:

- STEP 1** Turn the engine switch to the “ACC” or “LOCK” position with the odometer reading shown. (→P. 174)
- STEP 2** While pressing the trip meter reset button, turn the engine switch to the “ON” position.
- STEP 3** Continue to press and hold the button until the trip meter displays “000000”.

CAUTION

■ Used engine oil

- Used engine oil contains potentially harmful contaminants which may cause skin disorders such as inflammation or skin cancer, so care should be taken to avoid prolonged and repeated contact. To remove used engine oil from your skin, wash thoroughly with soap and water.
- Dispose of used oil and filters only in a safe and acceptable manner. Do not dispose of used oil and filters in household trash, in sewers or onto the ground. Call your Toyota dealer, service station or auto parts store for information concerning recycling or disposal.
- Do not leave used engine oil within the reach of children.

**NOTICE****■ To prevent serious engine damage**

Check the oil level on a regular basis.

■ When replacing the engine oil

- Be careful not to spill engine oil on the vehicle components.
- Avoid overfilling, as the engine could be damaged.
- Check the oil level on the dipstick every time you refill the vehicle.
- Be sure the engine oil filler cap is properly tightened.

Engine coolant

The coolant level is satisfactory if it is between the “FULL” and “LOW” lines on the reservoir when the engine is cold.

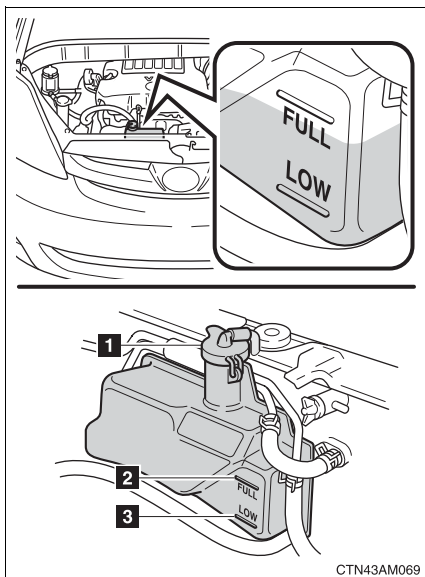

1 Reservoir cap

2 “FULL”

3 “LOW”

If the level is on or below the “LOW” line, add coolant up to the “FULL” line.

■ If the coolant level drops within a short time after replenishing

Visually check the radiator, hoses, engine coolant reservoir cap, radiator cap, drain cock and water pump.

If you cannot find a leak, have your Toyota dealer test the cap and check for leaks in the cooling system.

■ Coolant selection

Only use “Toyota Super Long Life Coolant” or similar high quality ethylene glycol based non-silicate, non-amine, non-nitrite, and non-borate coolant with long-life hybrid organic acid technology.

U.S.A.: “Toyota Super Long Life Coolant” is a mixture of 50% coolant and 50% deionized water. (Enabled: -31°F [-35°C])

Canada: “Toyota Super Long Life Coolant” is a mixture of 55% coolant and 45% deionized water. (Enabled: -44°F [-42°C])

For more details about engine coolant, contact your Toyota dealer.

CAUTION

■ When the engine is hot

Do not remove the coolant reservoir cap.

The cooling system may be under pressure and may spray hot coolant if the cap is removed, causing burns or other injuries.

NOTICE

■ When adding engine coolant

Coolant is neither plain water nor straight antifreeze. The correct mixture of water and antifreeze must be used to provide proper lubrication, corrosion protection and cooling. Be sure to read the antifreeze or coolant label.

■ If you spill coolant

Be sure to wash it off with water to prevent damage to parts or paint.

Radiator and condenser

Check the radiator and condenser, and clear any foreign objects. If either of the above parts are extremely dirty or you are not sure of their condition, have your vehicle checked by your Toyota dealer.

⚠ CAUTION

■ When the engine is hot

Do not touch the radiator or condenser as they may be hot and may cause burns.

■ When the electric cooling fan is operating

Do not touch the engine compartment.

The electric cooling fan may keep rotating for about 3 minutes after the engine switch is turned to the "LOCK" position.

With the engine switch in the "ON" position, the electric cooling fan may automatically start to run if the air conditioning is on and/or the coolant temperature is high. Be sure the engine switch is in the "LOCK" position and that the electric cooling fan is completely stopped when working near the electric cooling fan or radiator grille.

Brake fluid

■ Checking fluid level

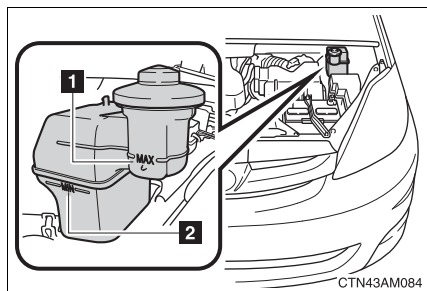

The brake fluid level should be between the "MAX" and "MIN" lines on the tank.

1 "MAX"

2 "MIN"

■ Adding fluid

Make sure to check the fluid type and prepare the necessary items.

Fluid type	FMVSS No.116 DOT 3 or SAE J1703 brake fluid
Items	Clean funnel

■ Brake fluid can absorb moisture from the air

Excess moisture in the fluid can cause a dangerous loss of braking efficiency. Use only newly opened brake fluid.

CAUTION

■ When filling the reservoir

Take care because brake fluid can harm your hands or eyes and damage painted surfaces.

If fluid gets on your hands or in your eyes, flush the affected area with clean water immediately.

If you still experience discomfort, see a doctor.

NOTICE

■ If the fluid level is low or high

It is normal for the brake fluid level to go down slightly as the brake pads wear or when the fluid level in the accumulator is high.

If the reservoir needs frequent refilling, it may indicate a serious problem.

Power steering fluid

■ Fluid level

The fluid level should be within the appropriate range.

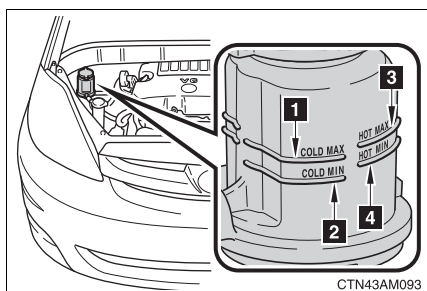

- 1 Full (when cold)
- 2 Add fluid (when cold)
- 3 Full (when hot)
- 4 Add fluid (when hot)

Hot: Vehicle has been driven around 50 mph (80 km/h) for 20 minutes, or slightly longer in cold temperatures. (Fluid temperature, 140°F - 175°F [60°C - 80°C])

Cold: Engine has not been run for about 5 hours. (Room temperature, 50°F - 85°F [10°C - 30°C])

■ Checking the fluid level

Make sure to check the fluid type and prepare the necessary items.

Fluid type	Automatic transmission fluid DEXRON® II or III
Items	<ul style="list-style-type: none"> • Rag or paper towel • Funnel (used only for adding power steering fluid)

STEP 1 Clean all dirt off the reservoir.

STEP 2 Remove the reservoir cap by turning it counterclockwise and wipe the dipstick clean.

STEP 3 Reinstall the reservoir cap.

STEP 4 Remove the reservoir cap again and look at the fluid level.

 **CAUTION****■ Checking the fluid level**

Take care, as the reservoir may be hot.

 **NOTICE****■ When adding fluid**

Avoid overfilling, or the power steering may be damaged.

■ After replacing the reservoir cap

Check the steering box case, vane pump and hose connections for leaks or damage.

Battery

■ Battery exterior

Make sure that the battery terminals are not corroded and that there are no loose connections, cracks, or loose clamps.

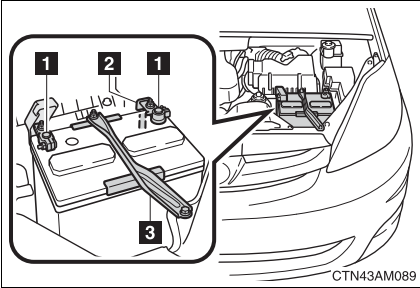

- 1 Terminals
- 2 Ground cable
- 3 Hold-down clamp

■ Checking battery condition

Check the battery condition using the indicator color.

► Type A

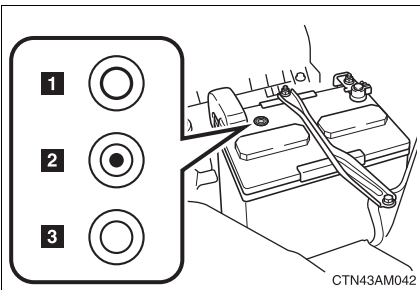

- 1 Green: Good condition
- 2 Dark: Charging is necessary. Have the vehicle inspected by your Toyota dealer.
- 3 Clear or light yellow: Not working properly. Have the battery checked by your Toyota dealer.

► Type B

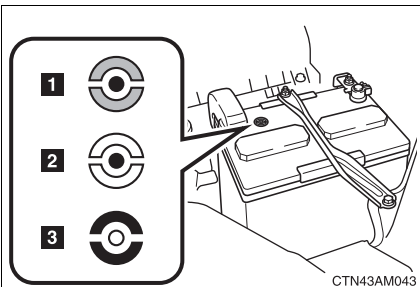

- 1 Blue: Good condition
- 2 White: Charging is necessary. Have the vehicle inspected by your Toyota dealer.
- 3 Red: Not working properly. Have the battery checked by your Toyota dealer.

■ Before recharging

When recharging, the battery produces hydrogen gas which is flammable and explosive. Therefore, before recharging:

- If recharging with the battery installed on the vehicle, be sure to disconnect the ground cable.
- Make sure the power switch on the charger is off when connecting and disconnecting the charger cables to the battery.

 **CAUTION**

■ **Chemicals in the battery**

A battery contains poisonous and corrosive sulfuric acid and may produce hydrogen gas which is flammable and explosive. To reduce the risk of death or serious injury, take the following precautions while working on or near the battery:

- Do not cause sparks by touching the battery terminals with tools.
- Do not smoke or light a match near the battery.
- Avoid contact with eyes, skin and clothes.
- Never inhale or swallow electrolyte.
- Wear protective safety glasses when working near the battery.
- Keep children away from the battery.

■ **Where to safely charge the battery**

Always charge the battery in an open area. Do not charge the battery in a garage or closed room where there is not sufficient ventilation.

■ **How to recharge the battery**

Only perform a slow charge (5 A or less). The battery may explode if charged at a quicker rate.

■ **Emergency measures regarding electrolyte**

- If electrolyte gets in your eyes
Flush your eyes with clean water for at least 15 minutes and get immediate medical attention. If possible, continue to apply water with a sponge or cloth while traveling to the nearest medical facility.
- If electrolyte gets on your skin
Wash the affected area thoroughly. If you feel pain or burning, get medical attention immediately.
- If electrolyte gets on your clothes
It can soak through clothing on to your skin. Immediately take off the clothing and follow the procedure above if necessary.
- If you accidentally swallow electrolyte
Drink a large quantity of water or milk. Get emergency medical attention immediately.

 NOTICE

■ **When recharging the battery**

Never recharge the battery while the engine is running. Also, be sure all accessories are turned off.

Washer fluid

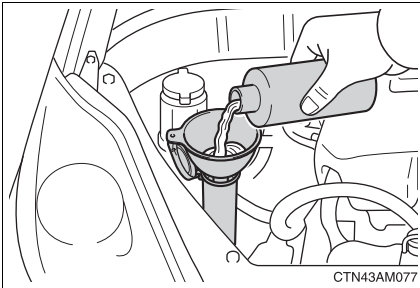

Add washer fluid in the following situations.

- Any washer does not work.
- The low washer fluid warning light comes on.

 CAUTION

■ **When refilling washer fluid**

Do not refill washer fluid when the engine is hot or running, as washer fluid contains alcohol and may catch fire if spilled on the engine etc.

 NOTICE

■ **Do not use any fluid other than washer fluid**

Do not use soapy water or engine antifreeze instead of washer fluid. Doing so may cause streaking on the vehicle's painted surfaces.

■ **Diluting washer fluid**

Dilute washer fluid with water as necessary. Refer to the freezing temperatures listed on the washer fluid tank.

Tires

Replace or rotate tires in accordance with maintenance schedules and treadwear.

■ Checking tires

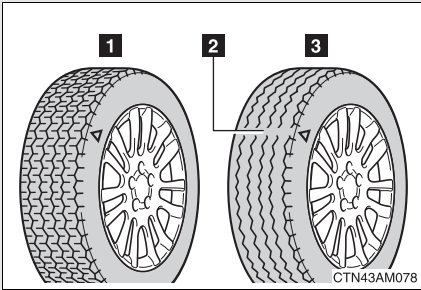

- 1 New tread
- 2 Treadwear indicator
- 3 Worn tread

The location of treadwear indicators is shown by the “TWI” or “△” marks, etc., molded on the sidewall of each tire.

Vehicles with compact spare tire: check spare tire condition and inflation pressure.

■ Tire rotation

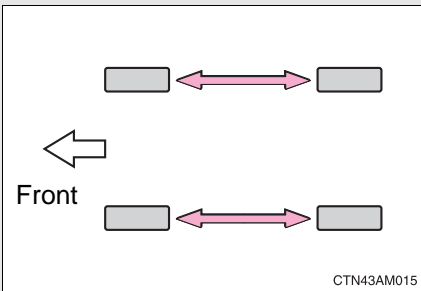

Rotate the tires in the order shown.

To equalize tire wear and extend tire life, Toyota recommends that tire rotation is carried out at the same interval as tire inspection.

■ The tire pressure warning system

Your Toyota is equipped with a tire pressure warning system that uses tire pressure warning valves and transmitters to detect low tire inflation pressure before serious problems arise. (→P. 507)

Vehicles with compact spare tire: The compact spare tire is not equipped with the tire pressure warning valve and transmitters.

Installing tire pressure warning valves and transmitters

When replacing tires or wheels, tire pressure warning valves and transmitters must also be installed.

When new tire pressure warning valves and transmitters are installed, new tire pressure warning valve and transmitter ID codes must be registered in the tire pressure warning computer and tire pressure warning system must be initialized. Have tire pressure warning valve and transmitter ID codes registered by your Toyota dealer. (→P. 456)

Initializing the tire pressure warning system

■ The tire pressure warning system must be initialized when the tire size is changed

When the tire pressure warning system is initialized, the current tire inflation pressure is set as the pressure benchmark.

■ How to initialize the tire pressure warning system

STEP 1 Park the vehicle in a safe place and turn the engine switch to the “ACC” or “LOCK” position.

While the vehicle is moving, initialization is not performed.

STEP 2 Adjust the tire inflation pressure to the specified cold tire inflation pressure level. (→P. 548)

Make sure to adjust the tire pressure to the specified cold tire inflation pressure level. The tire pressure warning system will operate based on this pressure level.

STEP 3 Turn the engine switch to the “ON” position.

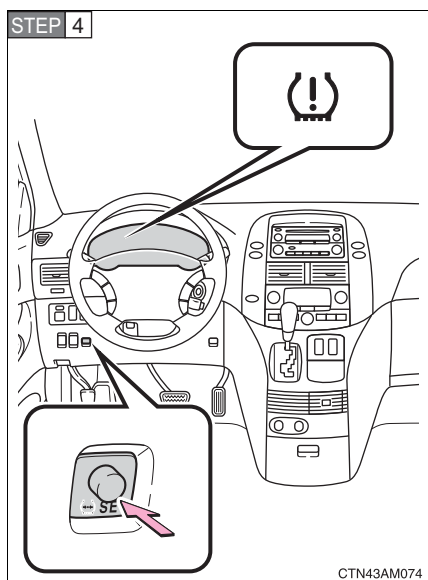

Push and hold the tire pressure warning reset switch until the tire pressure warning light blinks slowly three times.

STEP 5 Wait for several minutes with the engine switch in the “ON” position, and then turn the engine switch to the “ACC” or “LOCK” position.

Registering ID codes

The tire pressure warning valve and transmitter is equipped with a unique ID code. When replacing a tire pressure warning valve and transmitter, it is necessary to register the ID code of tire pressure warning valve and transmitter. Have the ID code registered by your Toyota dealer.

■ When to replace your vehicle's tires

Tires should be replaced if:

- You have tire damage such as cuts, splits, cracks deep enough to expose the fabric or bulges indicating internal damage
- A tire goes flat repeatedly or cannot be properly repaired due to the size or location of a cut or other damage

If you are not sure, consult with your Toyota dealer.

■ Replacing tires and wheels

If the ID code of the tire pressure warning valve and transmitter is not registered, the tire pressure warning system will not work properly. After driving for about 20 minutes, the tire pressure warning light comes on after blinking for 1 minute to indicate a system malfunction.

■ Tire life

Any tire over 6 years old must be checked by a qualified technician even if they have seldom or never been used or damage is not obvious.

■ If the tread wears down below 0.16 in. (4 mm) on snow tires

The effectiveness of snow tires is lost.

■ Maximum load of tire

Check that the number given by dividing the maximum load by 1.10 of the replacement tire is greater than 1/2 of the Gross Axle Weight Ratings (GAWR) of either the front axle or the rear axle, whichever is greater.

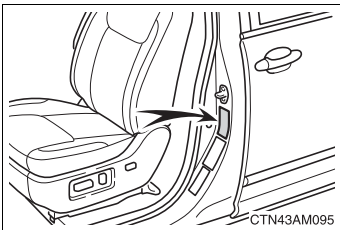

For the GAWR, see the Certification Label. For the maximum load of the tire, see the load limit at maximum cold tire inflation pressure mentioned on the sidewall of the tire. (→P. 553)

■ Tire types

1 Summer tires

Summer tires are high-speed performance tires best suited to highway driving under dry conditions. Since summer tires do not have the same traction performance as snow tires, summer tires are inadequate for driving on snow-covered or icy roads. For driving on snow-covered roads or icy roads, the use of snow tires is recommended. When installing snow tires, be sure to replace all four tires.

2 All season tires

All season tires are designed to provide better traction in snow and to be adequate for driving in most winter conditions, as well as for use year round. All season tires, however, do not have adequate traction performance compared with snow tires in heavy or loose snow. Also, all season tires fall short in acceleration and handling performance compared with summer tires in highway driving.

3 Snow tires

For driving on snow-covered roads or icy roads, we recommend using snow tires. If you need snow tires, select tires of the same size, construction and load capacity as the originally installed tires. Since your vehicle has radial tires as original equipment, make sure your snow tires also have radial construction. Do not install studded tires without first checking local regulations for possible restriction. Snow tires should be installed on all wheels. (→P. 226)

■ Initializing the tire pressure warning system

Initialize the tire pressure warning system with the tire inflation pressure adjusted to the specified level.

■ If you push the tire pressure warning reset switch accidentally

If initialization is performed, adjust the tire inflation pressure to the specified level and initialize the tire pressure warning system again.

■ When the initialization of the tire pressure warning system has failed

Initialization can be completed in several minutes. However, in the following cases, the settings have not been recorded and the system will not operate properly. If repeated attempts to record tire inflation pressure settings are unsuccessful, have the vehicle inspected by your Toyota dealer.

- When operating the tire pressure warning reset switch, the tire pressure warning light does not flash 3 times.
- After carrying out the initialization procedure, the tire pressure warning light blinks for 1 minute then stays on after driving for about 20 minutes.

■ Routine tire inflation pressure checks

The tire pressure warning system does not replace routine tire inflation pressure checks. Make sure to check tire inflation pressure as part of your routine of daily vehicle checks.

■ **Tire pressure warning system certification**

MODEL/FCC IDs:

Transmitter: GQ4-32T

Receiver: GQ4-37R

IC (Canada) IDs:

Transmitter: 1470A-13T

Receiver: 1470A-9R

► For vehicles sold in the U.S.A.

This device complies with Part 15 of the FCC Rules. Operation is subject to the following two conditions: (1) This device may not cause harmful interference, and (2) this device must accept any interference received, including interference that may cause undesired operation.

FCC WARNING:

Changes or modifications not expressly approved by the party responsible for compliance could void the user's authority to operate the equipment.

► For vehicles sold in Canada

Operation is subject to the following two conditions: (1) this device may not cause interference, and (2) this device must accept any interference, including interference that may cause undesired operation of the device.

 **CAUTION****■ When inspecting or replacing tires**

Observe the following precautions to prevent accidents. Failure to do so may cause damage to parts of the drive train, as well as dangerous handling characteristics, which may lead to an accident resulting in death or serious injury.

- Do not mix tires of different makes, models or tread patterns. Also, do not mix tires of remarkably different treadwear.
- Do not use tire sizes other than those recommended by Toyota.
- Do not mix differently constructed tires (radial, bias-belted or bias-ply tires).
- Do not mix summer, all season and snow tires.
- Do not tow if your vehicle has a compact spare tire installed.

■ When initializing the tire pressure warning system

Do not push the tire pressure warning reset switch without first adjusting the tire inflation pressure to the specified level. Otherwise, the tire pressure warning light may not come on even if the tire inflation pressure is low, or it may come on when the tire inflation pressure is actually normal.

 NOTICE

■ **Repairing or replacing tires, wheels and tire pressure warning valves and transmitters**

When removing or fitting the wheels, tires or the tire pressure warning valve and transmitter, contact your Toyota dealer as the tire pressure warning valve and transmitter may be damaged if not handled correctly.

■ **To avoid damaging the tire pressure warning valves and transmitters**

Do not use liquid sealants on flat tires.

■ **Do not use puncture sealant sprays to repair flats**

Puncture sealant sprays may damage tire pressure warning valves and transmitters.

■ **Driving on rough roads**

Take particular care when driving on roads with loose surfaces or potholes.

These conditions may cause losses in tire inflation pressure, reducing the cushioning ability of the tires. In addition driving on rough roads may cause damage to the tires themselves, as well as the vehicle's wheels and body.

■ **If tire inflation pressures become low while driving**

Do not continue driving, or your tires and/or wheels may be ruined.

4-3. Do-it-yourself maintenance

Tire inflation pressure

■ Tire inflation pressure

The recommended cold tire inflation pressure and tire size is displayed on the tire and loading information label. (→P. 548)

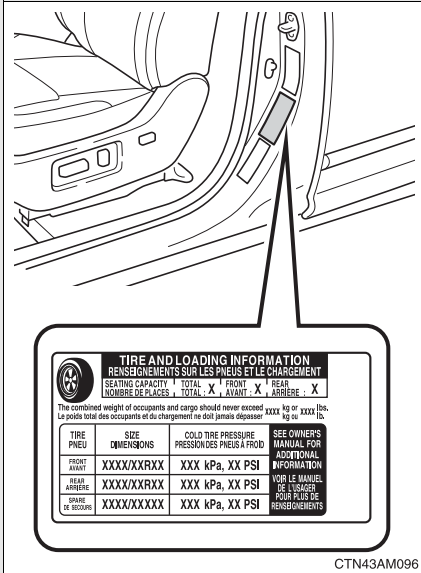

■ Inspection and adjustment procedure

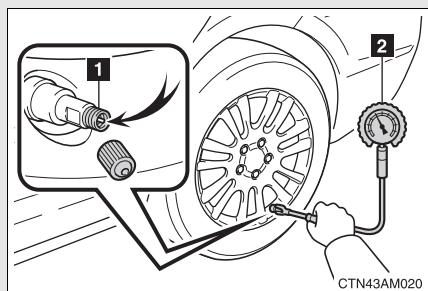

- 1 Tire valve
- 2 Tire pressure gauge

STEP 1 Remove the tire valve cap.

STEP 2 Press the tip of the tire pressure gauge onto the tire valve.

STEP 3 Read the pressure using the graduations of the gauge.

STEP 4 If the tire inflation pressure is not within the recommended levels, adjust the pressure.

If you add too much air, press the center of the valve to lower.

STEP 5 After completing the tire inflation pressure measurement and adjustment, apply soapy water to the valve and check for leakage.

STEP 6 Reinstall the tire valve cap.

■ Tire inflation pressure check interval

You should check tire inflation pressure every two weeks, or at least once a month.

Do not forget to check the spare.

■ Effects of incorrect tire inflation pressure

Driving with incorrect tire inflation pressure may result in the following:

- Reduced fuel efficiency
- Reduced driving comfort and tire life
- Reduced safety
- Damage to the drive train

If a tire needs frequent refilling, have it checked by your Toyota dealer.

■ Instructions for checking tire inflation pressure

When checking tire inflation pressure, observe the following:

- Check only when the tires are cold.
If your vehicle has been parked for at least 3 hours and has not been driven for more than 1 mile or 1.5 km, you will get an accurate cold tire inflation pressure reading.
- Always use a tire pressure gauge.
The appearance of the tire can be misleading. In addition, tire inflation pressures that are even just a few pounds off can degrade ride and handling.
- Do not bleed or reduce tire inflation pressure after driving. It is normal for the tire inflation pressure to be higher after driving.
- Never exceed the vehicle capacity weight.
Passengers and luggage weight should be placed so that the vehicle is balanced.

 CAUTION

■ **Proper inflation is critical to save tire performance**

Keep your tires properly inflated.

Otherwise, the following conditions may occur and result in an accident causing death or serious injury.

- Excessive wear
- Uneven wear
- Poor handling
- Possibility of blowouts resulting from overheated tires
- Poor sealing of the tire bead
- Wheel deformation and/or tire separation
- A greater possibility of tire damage from road hazards

 NOTICE

■ **When inspecting and adjusting tire inflation pressure**

Be sure to reinstall the tire valve caps.

Without the valve caps, dirt or moisture could get into the valve and cause air leakage, which could result in an accident. If the caps have been lost, replace them as soon as possible.

Wheels

If a wheel is bent, cracked or heavily corroded, it should be replaced.

Otherwise, the tire may separate from the wheel or cause loss of handling control.

■ Wheel selection

When replacing wheels, care should be taken to ensure that they are equivalent to those removed in load capacity, diameter, rim width, and offset.

Replacement wheels are available at your Toyota dealer.

Toyota does not recommend using:

- Wheels of different sizes or types
- Used wheels
- Bent wheels that have been straightened

■ Aluminum wheel precautions

- Use only Toyota wheel nuts and wrenches designed for use with your aluminum wheels.
- When rotating, repairing or changing your tires, check that the wheel nuts are still tight after driving 1000 miles (1600 km).
- Be careful not to damage the aluminum wheels when using tire chains.
- Use only Toyota genuine balance weights or equivalent and a plastic or rubber hammer when balancing your wheels.

■ When replacing wheels

The wheels of your Toyota are equipped with tire pressure warning valves and transmitters that allow the tire pressure warning system to provide advanced warning in the event of a loss in tire inflation pressure. Whenever wheels are replaced, the tire pressure warning valves and transmitters must be installed. (→P. 455)

 **CAUTION**

■ **When replacing wheels**

- Do not use wheels that are a different size from those recommended in the Owner's Manual, as this may result in loss of handling control.
- Never use an inner tube in a leaking wheel which is designed for a tubeless tire. Doing so may result in an accident, causing serious injury or death.

 **NOTICE**

■ **Replacing tire pressure warning valves and transmitters**

- Because tire repair or replacement may affect the tire pressure warning valves and transmitters, make sure to have tires serviced by your Toyota dealer or other qualified service shop. In addition, make sure to purchase your tire pressure warning valves and transmitters at your Toyota dealer.
- Ensure that only genuine Toyota wheels are used on your vehicle. Tire pressure warning valves and transmitters may not work properly with non-genuine wheels.

4-3. Do-it-yourself maintenance

Air conditioning filter

The air conditioning filter must be cleaned or changed regularly to maintain air conditioning efficiency.

■ Removal method

STEP 1 Turn the engine switch to the “LOCK” position.

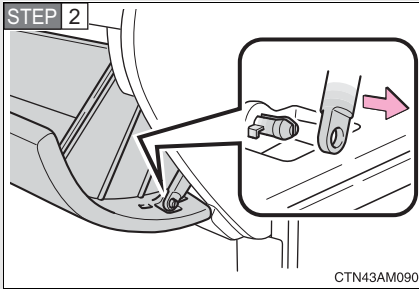

Open the glove box. Slide off the damper.

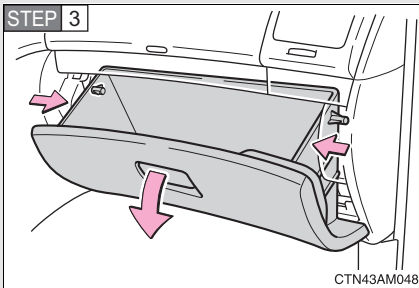

Push in each side of the glove box to disconnect the claws.

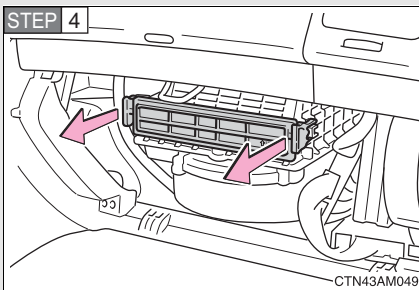

Remove the filter case.

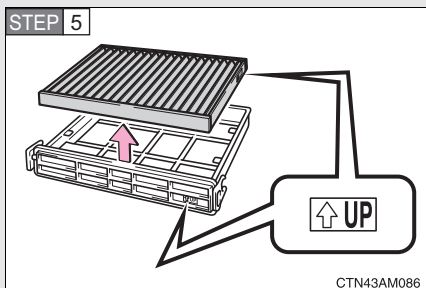

Remove the filter from the filter case.

■ Cleaning method

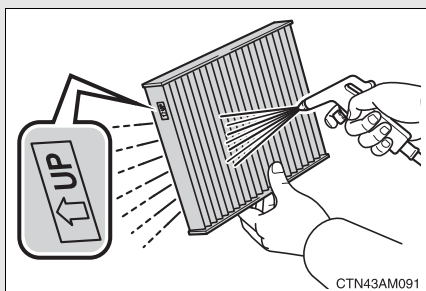

If the filter is dirty, clean by blowing compressed air through the filter from the downward side.

Hold the air gun 2 in. (5 cm) from the filter and blow for approximately 2 minutes at 72 psi (500 kPa, 5.0 kgf/cm² or bar).

If it is not available, have the filter cleaned by your Toyota dealer.

■ Replacement method

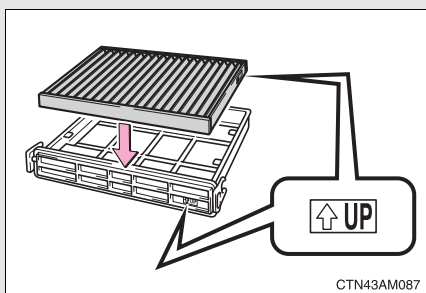

Install a new filter to the filter case.

The "↑UP" marks shown on the filter should be pointing up.

■ Checking interval

Inspect, clean and replace the air conditioning filter according to the maintenance schedule. In dusty areas or areas with heavy traffic flow, more frequent cleaning or early replacement may be required. (For scheduled maintenance information, please refer to the “Scheduled Maintenance Guide” or “Owner’s Manual Supplement”.)

■ If air flow from the vents decreases dramatically

The filter may be clogged. Check the filter and replace it if necessary.

 **NOTICE****■ To prevent damage to the system**

- When using the air conditioning system, make sure that a filter is always installed.
- When cleaning the filter, do not clean the filter with water.

Wireless remote control battery

Replace the battery with a new one if it is discharged.

■ **You will need the following:**

Lithium battery (CR2032)

■ **Replacing the battery**

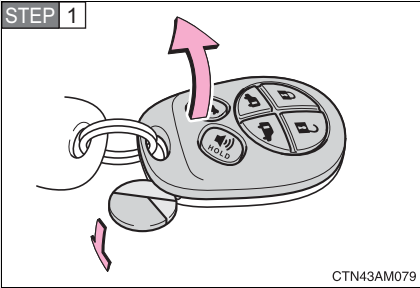

Remove the cover using a coin protected with tape etc.

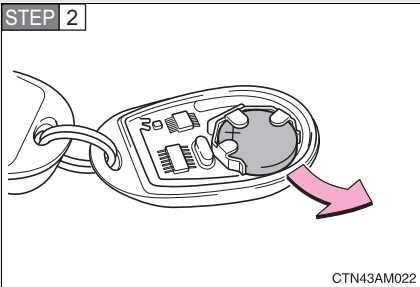

Remove the discharged transmitter battery.

Insert a new battery with the "+" terminal facing up.

■ If the wireless remote control battery is discharged

The following symptoms may occur.

- The wireless remote control will not function properly.
- The operational range is reduced.

■ Use a CR2032 lithium battery

- Batteries can be purchased at your Toyota dealer, jewelers, or camera stores.
- Replace only with the same or equivalent type recommended by your Toyota dealer.
- Dispose of used batteries according to the local laws.

CAUTION

■ Removed battery and other parts

Keep away from children.

These parts are small and if swallowed by a child they can cause choking.

NOTICE

■ For normal operation after replacing the battery

Observe the following precautions to prevent accidents.

- Always work with dry hands.
Moisture may cause the battery to rust.
- Do not touch or move any other components inside the remote control.
- Do not bend either of the battery terminals.

4-3. Do-it-yourself maintenance

Checking and replacing fuses

If any of the electrical components do not operate, a fuse may have blown. If this happens, check and replace the fuses as necessary.

STEP 1 Turn the engine switch to the “LOCK” position.

STEP 2 The fuses are located in the following places. To check the fuses, follow the instructions below.

► Engine compartment

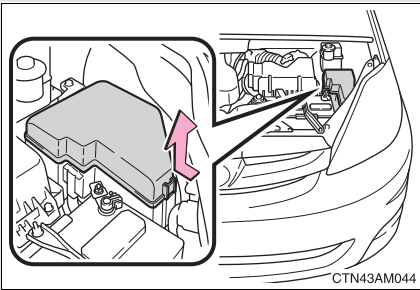

Push the tab in and lift the lid off.

► Driver's side instrument panel

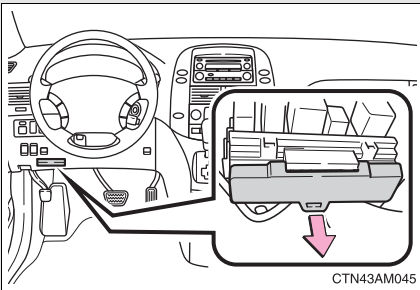

Remove the lid.

▶ Passenger's side instrument panel

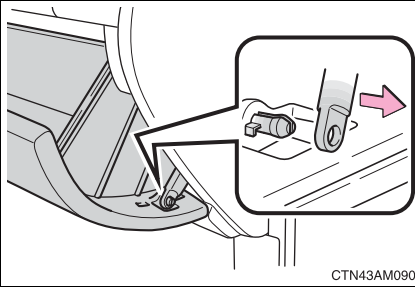

1. Open the glove box. Slide off the damper.

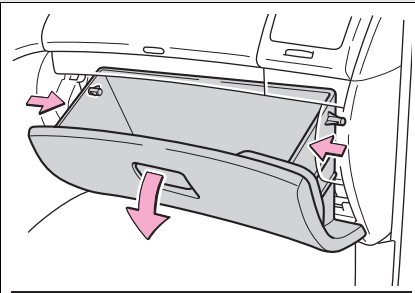

2. Push in each side of the glove box to disconnect the claws.

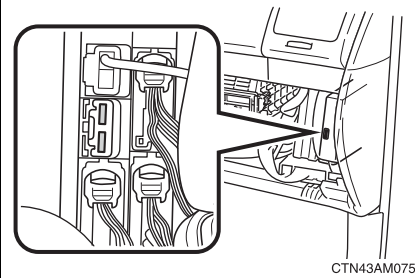

STEP 3 After a system failure, see “Fuse layout and amperage ratings” (→P. 478) for details about which fuse to check.

STEP 4



Take out the pullout tool.

Only type A fuse can be removed using the pullout tool.

STEP 5 Check if the fuse has blown.

► Type A

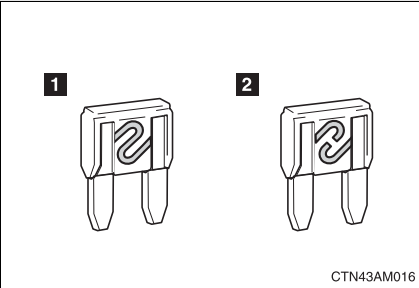

1 Normal fuse

2 Blown fuse

Replace it with one of an appropriate amperage rating. The amperage rating can be found on the fuse box lid.

► Type B

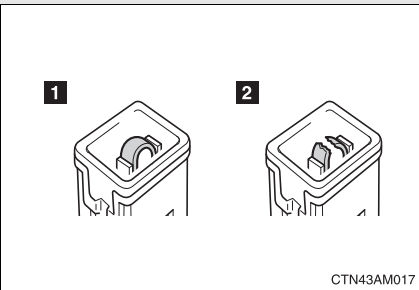

1 Normal fuse

2 Blown fuse

Replace it with one of an appropriate amperage rating. The amperage rating can be found on the fuse box lid.

► Type C

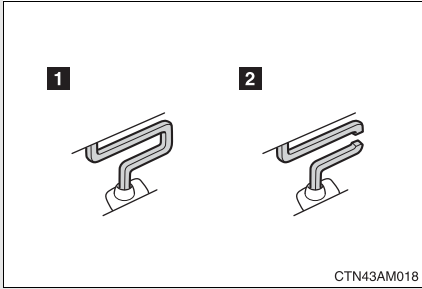

1 Normal fuse

2 Blown fuse

Contact your Toyota dealer.

► Type D

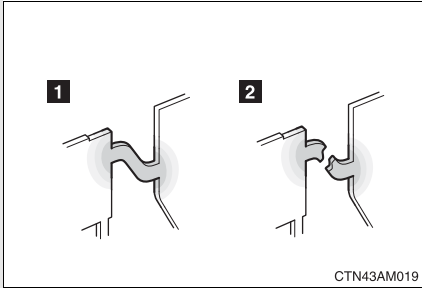

1 Normal fuse

2 Blown fuse

Contact your Toyota dealer.

Fuse layout and amperage ratings

■ Engine compartment

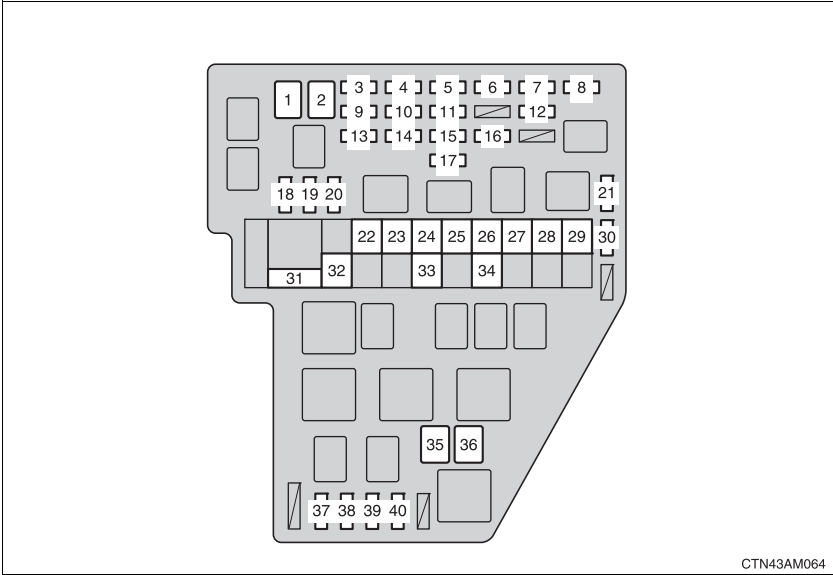

CTN43AM064

Fuse		Ampere	Circuit
1	MAIN	30 A	Headlights, daytime running light system, H-LP RL, H-LP LL
2	AM2	30 A	INJ, IGN, GAUGE 2
3	ETCS	10 A	Multiport fuel injection system/ sequential multiport fuel injection system
4	DRL	20 A	Daytime running light system, H-LP RH, H-LP LH
5	DOOR NO.2	25 A	Power door lock system
6	HORN	10 A	Horns
7	DOME	10 A	Personal/interior lights, vanity lights, door courtesy lights, luggage compartment light, engine switch light, trip information display

Fuse		Ampere	Circuit
8	RAD NO.1	15 A	Audio system
9	EFI NO.1	20 A	Multiport fuel injection system/ sequential multiport fuel injection system, EFI NO.2
10	ALT-S	7.5 A	Charging system
11	HAZ	15 A	Turn signal lights, emergency flashers
12	ECU-B	10 A	Power sliding door, air conditioning system, power windows, multiplex communication system, meter and gauge, wireless remote control sys- tem
13	H-LP RH	15 A	Right-hand headlight
14	H-LP LH	15 A	Left-hand headlight
15	RAD NO.3	30 A	Audio system
16	EFI NO.2	10 A	Multiport fuel injection system/ sequential multiport fuel injection system
17	A/F	25 A	Multiport fuel injection system/ sequential multiport fuel injection system
18	SPARE	15 A	Spare fuse
19	SPARE	20 A	Spare fuse
20	SPARE	30 A	Spare fuse
21	SPARE	30 A	Spare fuse
22	RR2 SEAT	50 A	Power third seat
23	HTR	50 A	Air conditioning system, A/C
24	FAN	50 A	Electric cooling fans
25	PBD	30 A	Power back door
26	R-PSD	30 A	Right side power sliding door

Fuse		Ampere	Circuit
27	L-PSD	30 A	Left side power sliding door
28	RR A/C	40 A	Rear air conditioning system
29	DEF	40 A	Rear window defogger, MIR HTR
30	SPARE	7.5 A	Spare fuse
31	ALT	140 A	Charging system, RR A/C, HTR, FAN, PBD, R-PSD, L-PSD, DEF
32	ABS1	50 A	Anti-lock brake system, traction control system, vehicle stability control system
33	ABS2	30 A	Anti-lock brake system, traction control system, vehicle stability control system
34	ST	30 A	Starting system
35	L-RR2 SEAT	30 A	Power third seat
36	R-RR2 SEAT	30 A	Power third seat
37	H-LP RL	10 A	Right-hand headlight (low beam)
38	H-LP LL	10 A	Left-hand headlight (low beam), front fog lights
39	RSE	7.5 A	Rear seat entertainment system
40	INJ	10 A	Multiport fuel injection system/ sequential multiport fuel injection system

■ Under the driver's side instrument panel

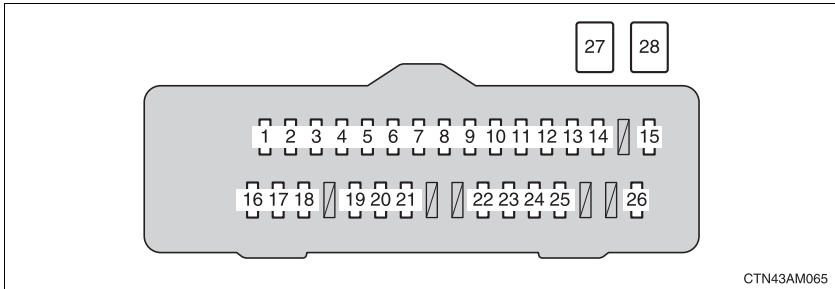

Fuse		Ampere	Circuit
1	MIR HTR	10 A	Outside rear view mirror defoggers
2	RAD2	7.5 A	Audio system, navigation system, rear seat entertainment system
3	PWR OUTLET	15 A	Power outlets
4	CIG	15 A	Cigarette lighter
5	ECU ACC	7.5 A	Shift lock control system, air conditioning system, power rear view mirror control
6	GAUGE2	7.5 A	Meter and gauge
7	IGN	7.5 A	Multipoint fuel injection system/ sequential multipoint fuel injection system, SRS airbag system, multiplex communication system
8	IG2	7.5 A	Multipoint fuel injection system/ sequential multipoint fuel injection system
9	RR WIP	15 A	Rear window wiper
10	WIP	30 A	Windshield wiper and rear window wiper
11	GAUGE1	10 A	Back-up lights, turn signal lights, emergency flashers
12	S-HTR	15 A	Seat heaters

Fuse		Ampere	Circuit
13	WSH	20 A	Windshield washer and rear window washer
14	HTR	10 A	Air conditioning system
15	ECU-IG	10 A	Intuitive parking assist system, rear view monitor system, multiplex communication system, multiport fuel injection system/sequential multiport fuel injection system, anti-lock brake system, traction control system, vehicle stability control system, shift lock control system, dynamic laser cruise control system, seat heaters, power back door, moon roof, multi-information display, auto anti-glare inside rear view mirror, power windows, power outlets (115 V), power third seat, driving position memory system
16	PANEL	10 A	Air conditioning system, seat heaters, audio system, navigation system, power sliding door, power back door, trip information display, rear window defogger, emergency flashers, instrument panel lights, steering switch lights
17	TAIL	10 A	Stop/tail lights, license plate lights, parking lights, side maker lights
18	S/ROOF	25 A	Moon roof
19	AC INV	15 A	Power outlets (115 V)
20	FR DEF	15 A	Windshield wiper de-icer
21	AM1	7.5 A	Multiport fuel injection system/sequential multiport fuel injection system, starter system

Fuse		Ampere	Circuit
22	STOP	10 A	Stop/tail lights, high mounted stop-light, shift lock control system, anti-lock brake system, traction control system, vehicle stability control system, multiport fuel injection system/sequential multiport fuel injection system, multiplex communication system
23	P/W	25 A	Power windows, power rear view mirror
24	OBD	7.5 A	On-board diagnosis system
25	FOG	15 A	Front fog lights
26	P/VENT	15 A	Power quarter windows
27	P/SEAT	30 A	Power front seats
28	PWR	30 A	Power windows

■ Under the passenger's side instrument panel

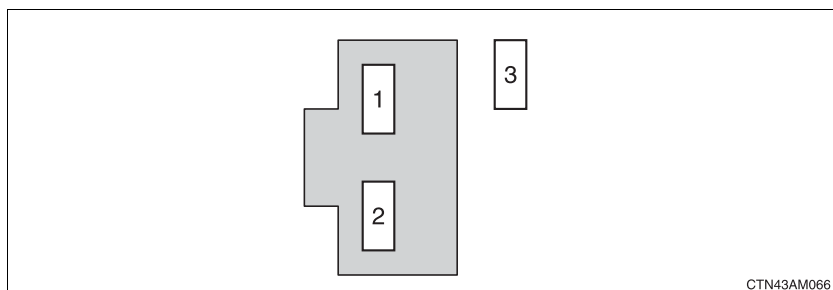

Fuse		Ampere	Circuit
1	ST	7.5 A	Multiport fuel injection system/ sequential multiport fuel injection system
2	A/C	7.5 A	Manual air conditioning system
3	SFT	5 A	Shift lock control system

■ After a fuse is replaced

- If the lights do not turn on even after the fuse has been replaced, a bulb may need replacement. (→P. 486)
- If the replaced fuse blows again, have the vehicle inspected by your Toyota dealer.

■ If there is an overload in the circuits

The fuses are designed to blow before the entire wiring harness is damaged.

 **CAUTION****■ To prevent system breakdowns and vehicle fire**

Observe the following precautions.

Failing to do so may cause damage, and possibly a fire or injury.

- Never use a fuse of a higher amperage rating than indicated, or use any other object in place of a fuse.
- Always use a genuine Toyota fuse or equivalent.
Never replace a fuse with a wire, even as a temporary fix.
This can cause extensive damage or even fire.
- Do not modify fuses or the fuse box.

 **NOTICE****■ Before replacing fuses**

Have the cause of electrical overload determined and repaired by your Toyota dealer as soon as possible.

Light bulbs

You may replace the following bulbs yourself. The difficulty level of replacement varies depending on the bulb. If necessary bulb replacement seems difficult to perform, contact your Toyota dealer.

For more information about replacing other light bulbs, contact your Toyota dealer.

■ Preparing a replacement light bulb

Check the wattage of the light bulb being replaced. (→P. 549)

■ Turning the power back door main switch off

→P. 48

■ Front bulb locations

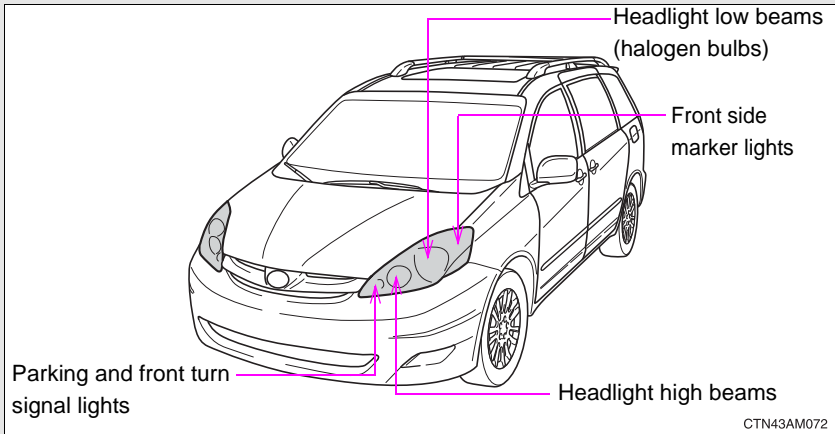

■ Rear bulb locations

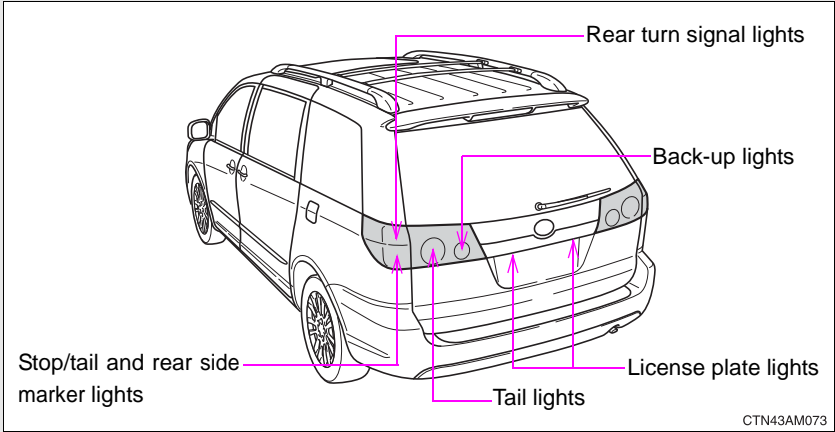

CTN43AM073

Replacing light bulbs

■ Headlight (halogen bulbs)

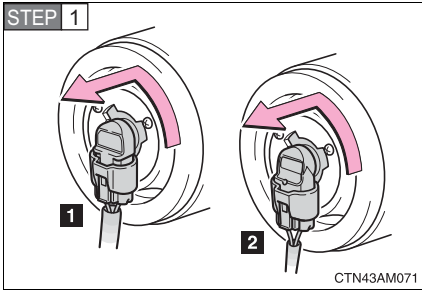

Turn the bulb base counterclockwise.

- 1** Headlight (high beam)
- 2** Headlight (low beam)

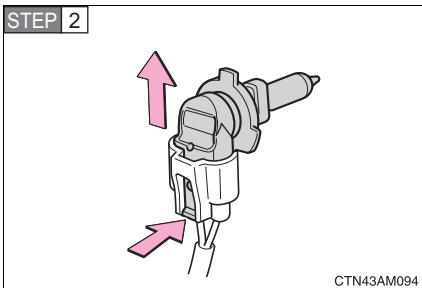

Pull out the light bulb while depressing the lock release.

■ Front side marker light

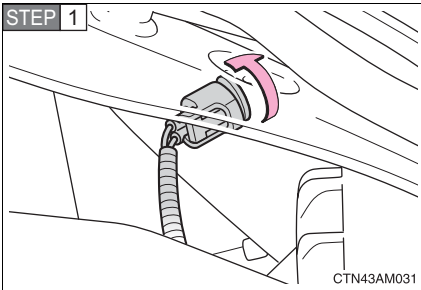

Turn the bulb base counterclockwise.

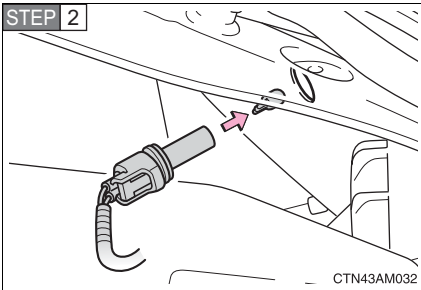

Remove the light bulb.

■ Parking and front turn signal lights

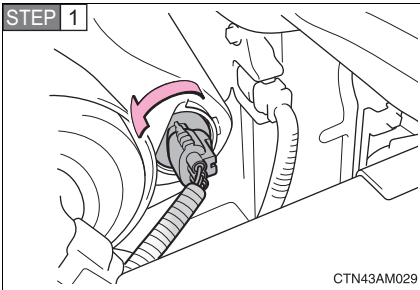

Turn the bulb base counterclockwise.

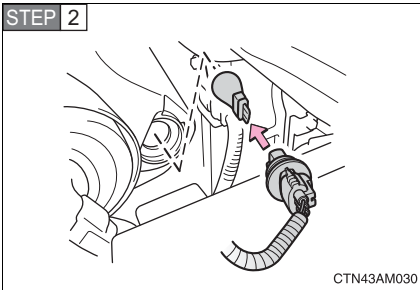

Remove the light bulb.

■ Rear turn signal, stop/tail and rear side marker lights

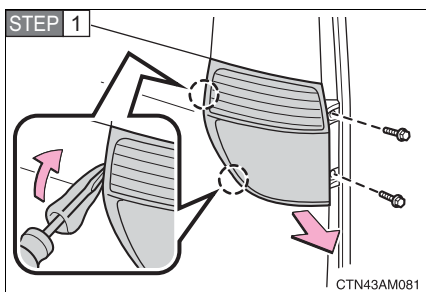

Remove the securing bolts and remove the unit.

To protect the cover, place a rag between the flathead screwdriver and cover as shown in the illustration.

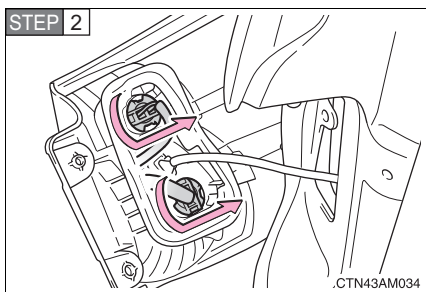

Turn the bulb bases counter-clockwise.

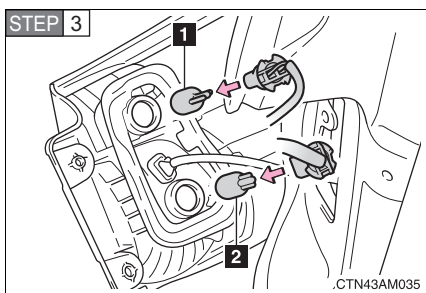

Remove the light bulbs.

- 1 Rear turn signal light
- 2 Stop/tail and rear side marker light

■ Tail and back-up lights

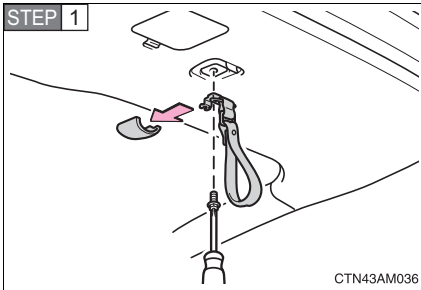

Open the back door and remove the strap.

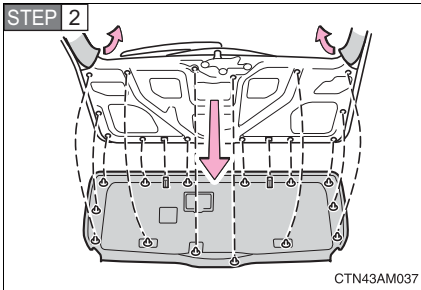

Remove the back door trim board.

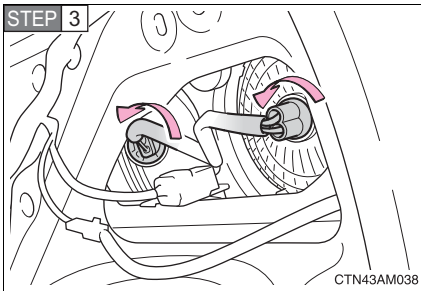

Turn the bulb bases counter-clockwise.

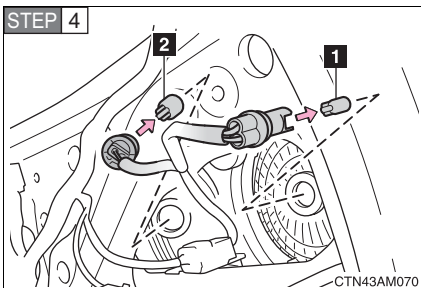

Remove the light bulbs.

- 1** Tail light
- 2** Back-up light

■ License plate lights

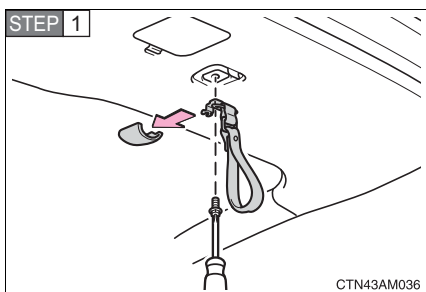

Open the back door and remove the strap.

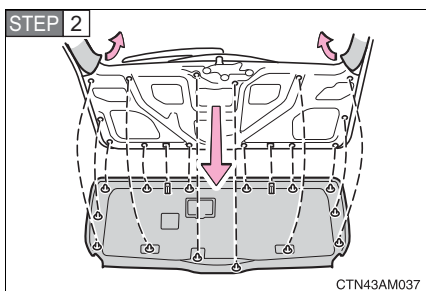

Remove the back door trim board.

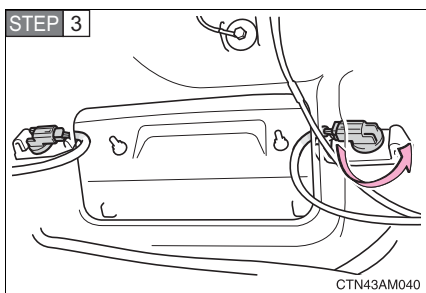

Turn the bulb bases counter-clockwise.

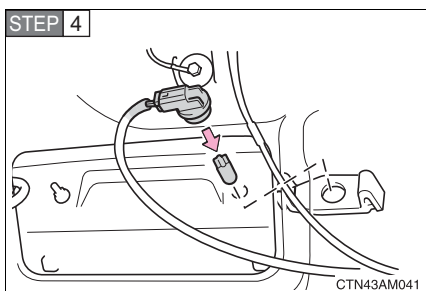

Remove the light bulb.

■ Lights other than the above

If any of the lights listed below has burnt out, have it replaced by your Toyota dealer.

- Headlight low beams (discharge bulbs)
 - High mounted stoplight
 - Front fog lights (if equipped)
 - Outer foot lights (if equipped)
-

■ Condensation build-up on the inside of the lens

Contact your Toyota dealer for more information in the following situations. Temporary condensation build-up on the inside of the headlight lens does not indicate a malfunction.

- Large drops of water are built up on the inside of the lens.
- Water has built up inside the headlight.

■ Discharge headlights

If voltage to the discharge bulbs is insufficient, the bulbs may not come on, or may go out temporarily. The discharge bulbs will come on when normal power is restored.

■ LED high mounted stoplight

The high mounted stoplight consists of a number of LEDs. If any of the LEDs burn out, take your vehicle to your Toyota dealer to have the light replaced.

 CAUTION

■ **Replacing light bulbs**

- Turn off the headlights. Do not attempt to replace the bulb immediately after turning off the headlights.
The bulbs become very hot and may cause burns.
- Do not touch the glass portion of the light bulb with bare hands. Hold the bulb by the plastic or metal portion.
If the bulb is scratched or dropped it may blow out or crack.
- Fully install light bulbs and any parts used to secure them. Failing to do so may result in heat damage, fire, or water entering the headlight unit. This may damage the headlights or cause condensation to build up on the lens.
- Do not attempt to take apart or repair the low beam headlight bulbs, connectors, power supply circuits, or related components.
Doing so could result in electric shock and serious injury or death.

■ **Discharge headlights**

- Contact your Toyota dealer before replacing discharge headlights (including light bulbs).
- Do not touch the high-intensity discharge headlight's high voltage socket when the headlights are turned on.
An extremely high voltage of 20000 V will be discharged and could result in serious injury or death by electric shock.

■ **To prevent damage or fire**

Make sure bulbs are fully seated and locked.

 NOTICE

■ **When installing the back door trim**

To prevent damage, be careful not to pinch any of the wire harnesses or connectors with the back door trim.

If your vehicle needs to be towed

If towing is necessary, we recommend having your vehicle towed by your Toyota dealer or a commercial towing service, using a lift-type truck or a flat bed truck.

Use a safety chain system for all towing, and abide by all state/provincial and local laws.

2WD models only: If towing from the front, the vehicle's rear wheels and axles must be in good condition. (→P. 497)

If they are damaged, use a towing dolly or flat bed truck.

Before towing

The following may indicate a problem with your transmission. Contact your Toyota dealer before towing.

- The engine is running, but the vehicle will not move.
- The vehicle makes an abnormal sound.

Towing with a sling-type truck

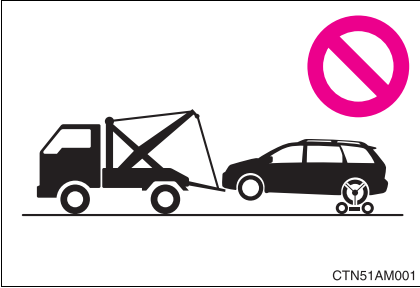

NOTICE

■ To prevent body damage

Do not tow with a sling-type truck, either from the front or rear.

Towing with a wheel-lift type truck from the front

▶ 2WD models

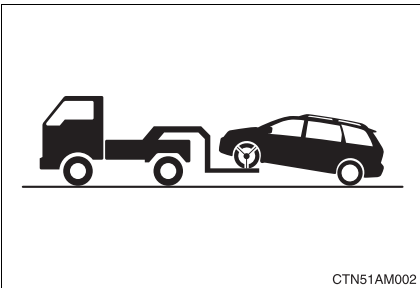

Release the parking brake.

► AWD models

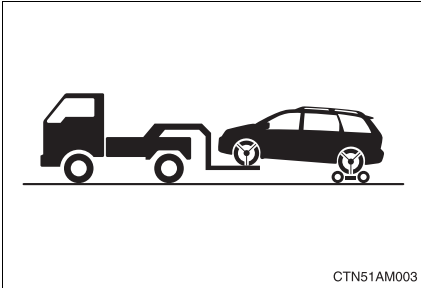

Use a towing dolly under the rear wheels.

 NOTICE

■ **To prevent damaging the vehicle**

When raising the vehicle, ensure adequate ground clearance for towing at the opposite end of the raised vehicle. Without adequate clearance, the vehicle could be damaged while being towed.

■ **To prevent causing serious damage to the transmission (AWD models)**

Never tow this vehicle from the front with the rear wheels on the ground.

Towing with a wheel-lift type truck from the rear

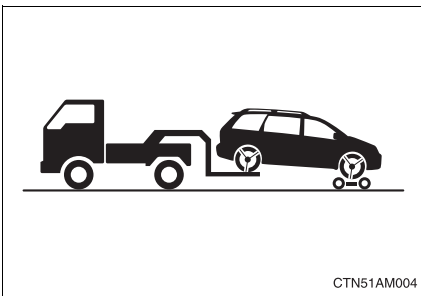

Use a towing dolly under the front wheels.

 NOTICE

■ **To prevent causing serious damage to the transmission**

Never tow this vehicle from the rear with the front wheels on the ground.

Using a flat bed truck

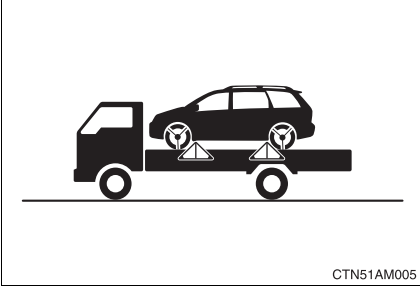

If you use chains or cables to tie down your vehicle, the angles shaded in black must be 45°.

Do not overly tighten the tie downs or the vehicle may be damaged.

If you think something is wrong

If you notice any of the following symptoms, your vehicle probably needs adjustment or repair. Contact your Toyota dealer as soon as possible.

■ Visible symptoms

- Fluid leaks under the vehicle
(Water dripping from the air conditioning after use is normal.)
- Flat-looking tires or uneven tire wear
- Engine coolant temperature gauge needle continually points higher than normal

■ Audible symptoms

- Changes in exhaust sound
- Excessive tire squeal when cornering
- Strange noises related to the suspension system
- Pinging or other noises related to the engine

■ Operational symptoms

- Engine missing, stumbling or running rough
- Appreciable loss of power
- Vehicle pulls heavily to one side when braking
- Vehicle pulls heavily to one side when driving on a level road
- Loss of brake effectiveness, spongy feeling, pedal almost touches the floor

5-1. Essential information

Fuel pump shut off system

To minimize the risk of fuel leakage when the engine stalls or an air-bag inflates upon collision, the fuel pump shut off system stops supplying fuel to the engine.

Follow the procedure below to restart the engine after the system is activated.

STEP 1 Turn the engine switch to the “ACC” or “LOCK” position.

STEP 2 Restart the engine.

NOTICE

■ Before starting the engine

Inspect the ground under the vehicle.

If you find that fuel has leaked on to the ground, the fuel system has been damaged and is in need of repair. Do not restart the engine.

Your vehicle has computers that monitor and control certain aspects of your vehicle. These computers assist in driving and maintaining optimal vehicle performance.

Besides storing data useful for troubleshooting, there is an event data recorder (EDR) that records data in a crash or a near car crash event.

In a crash or a near car crash event

The SRS airbag sensor assembly contains the EDR. In a crash or a near car crash event, this device may record some or all of the following information:

- Engine speed
- Whether the brake pedal was applied or not
- Vehicle speed
- To what extent the accelerator pedal was depressed
- Position of the transmission shift lever
- Whether the driver and front passenger wore seat belts or not
- Driver's seat position
- SRS airbag deployment data
- SRS airbag system diagnostic data
- Front passenger's occupant classification

The information above is intended to be used for the purpose of improving vehicle safety performance. Unlike general data recorders, the EDR does not record sound data such as conversation between passengers.

Disclosure of the data

Toyota will not disclose the data recorded in an EDR to a third party except when:

- An agreement from the vehicle's owner (or the leasing company for a leased vehicle) is obtained
- Officially requested by the police or other authorities
- Used as a defense for Toyota in a law suit
- Ordered by a court law

However, if necessary Toyota will:

- Use the data for research on Toyota vehicle safety performance
- Disclose the data to a third party for research purposes without disclosing details of the vehicle owner, and only when it is deemed necessary
- Disclose summarized data cleared of vehicle identification information to a non-Toyota organization for research purposes



5-2. Steps to take in an emergency

If a warning light turns on or a warning buzzer sounds...

Calmly perform the following actions if any of the warning lights turn on or flash. If a light turns on or flashes, but then turns off, this does not necessarily indicate a malfunction in the system.

Stop the vehicle immediately. Continuing to drive the vehicle may be dangerous.



The following warning indicates a possible problem in the brake system. Immediately stop the vehicle in a safe place and contact your Toyota dealer.

Warning light	Warning light/Details
 (U.S.A.)	Brake system warning light (warning buzzer)* <ul style="list-style-type: none">• Low brake fluid• Malfunction in the brake system This light also comes on when the parking brake is not released. If the light turns off after the parking brake is fully released, the system is operating normally.
 (Canada)	

*: Parking brake engaged warning buzzer: The buzzer sounds to indicate that the parking brake is still engaged (with the vehicle having reached a speed of 3 mph [5 km/h]).



Stop the vehicle immediately.

The following warning indicates the possibility of damage to the vehicle that may lead to an accident. Immediately stop the vehicle in a safe place and contact your Toyota dealer.

Warning light	Warning light/Details
	Charging system warning light Indicates a malfunction in the vehicle's charging system.
	Low engine oil pressure warning light Indicates that the engine oil pressure is too low.

Have the vehicle inspected immediately.

Failing to investigate the cause of the following warnings may lead to the system operating abnormally and possibly cause an accident. Have the vehicle inspected by your Toyota dealer immediately.

Warning light	Warning light/Details
 (U.S.A.)	Malfunction indicator lamp Indicates a malfunction in: <ul style="list-style-type: none"> • The emission control system; • The electronic engine control system; • The electronic throttle control system; or • The electronic automatic transmission control system.
 (Canada)	
	SRS warning light Indicates a malfunction in: <ul style="list-style-type: none"> • The SRS airbag system; • The front passenger occupant classification system; • The seat belt pretensioner system.

Warning light	Warning light/Details
<div style="border: 1px solid black; padding: 5px; display: inline-block; margin-bottom: 5px;">ABS</div> (U.S.A.) <div style="border: 1px solid black; border-radius: 50%; padding: 5px; display: inline-block; margin-bottom: 5px; width: 30px; height: 30px; text-align: center; vertical-align: middle;">(ABS)</div> (Canada)	<p>“ABS” warning light</p> <p>Indicates a malfunction in:</p> <ul style="list-style-type: none"> • ABS; or • The brake assist system.
<div style="border: 1px solid black; padding: 5px; display: inline-block;">VSC</div>	<p>“VSC” warning light</p> <p>Indicates a malfunction in the VSC system or TRAC system.</p>

■ If the malfunction indicator lamp comes on while driving





First check the following:



- Is the fuel tank empty?
If it is, fill the fuel tank immediately.
- Is the fuel tank cap loose?
If it is, tighten it securely.

The malfunction indicator lamp will go off after taking several driving trips. If the malfunction indicator lamp does not go off even after several trips, contact your Toyota dealer as soon as possible.

Follow the correction procedures.

After taking the specified steps to correct the suspected problem, check that the warning light turns off.

Warning light	Warning light/Details	Correction procedure
	Open door warning light Indicates that a door is not fully closed.	Check that all doors are closed.
	Low fuel level warning light Indicates that remaining fuel is about 3.0 gal. (11.4 L, 2.5 Imp. gal.) or less	Refuel the vehicle.
	Driver's seat belt reminder light (warning buzzer)*1 Warns the driver to fasten his/her seat belt.	Fasten the seat belt.
 (on the center panel)	Front passenger's seat belt reminder light (warning buzzer)*1 Warns the front passenger to fasten his or her seat belt.	Fasten the seat belt.
	Low washer fluid warning light Low level of washer fluid	Fill the tank.

Warning light	Warning light/Details	Correction procedure
 <p>MAINT REQD (U.S.A.)</p>	<p>Engine oil replacement reminder light</p>	
	<p>Illuminates for about 3 seconds and then flashes for about 12 seconds approximately 4500 miles (7200 km) after the engine oil is changed: Indicates that the engine oil is scheduled to be changed.</p>	<p>Check the engine oil, and change if necessary.</p>
	<p>Comes on and remains on if the distance driven exceeds 5000 miles (8000 km): Indicates that the engine oil should be changed.</p>	<p>Check and change the engine oil.</p>
	<p>Tire pressure warning light</p>	
	<p>When the light comes on: Low tire inflation pressure</p>	<p>Adjust the tire inflation pressure.</p>
<p>When the light comes on after blinking for 1 minute: Malfunction in the tire pressure warning system</p>	<p>Have the system checked by your Toyota dealer.</p>	
	<p>Third seat warning light^{*2} Indicates that the third seat operation is not yet complete.</p>	<p>Complete the third seat operation.</p>

Warning light	Warning light/Details	Correction procedure
	<p>Dynamic laser cruise control master warning light^{*2}</p> <p>Indicates a malfunction in the dynamic laser cruise control system. When the light comes on, the alarm sounds and the warning code will appear on the display.</p>	<p>→P. 204</p>

^{*1}: Driver's and front passenger's seat belt warning buzzers:

The driver's and front passenger's seat belt warning buzzers sound to alert the driver and front passenger that his or her seat belt is not fastened. The buzzer sounds intermittently for 10 seconds after the vehicle has reached a speed of 12 mph (20 km/h). Then, if the seat belt is still unfastened, the buzzer will sound at a different tone for 20 more seconds.

^{*2}: If equipped

■ **Front passenger detection sensor and passenger seat belt reminder**

- If luggage is placed on the front passenger seat, the front passenger detection sensor may cause the warning light to flash, even if a passenger is not sitting in the seat.
- If a cushion is placed on the seat, the sensor may not detect a passenger, and the warning light may not operate properly.

■ **Changing the engine oil (U.S.A. only)**

Make sure to reset the oil change system. (→P. 442)

■ **When the tire pressure warning light comes on**

Check the tire inflation pressure and adjust to the appropriate level. Pushing the tire pressure warning reset switch does not turn off the tire pressure warning light.

■ **The tire pressure warning light may turn on due to natural causes**

The tire pressure warning light may turn on due to natural causes such as natural air leaks or tire inflation pressure changes caused by temperature. In this case, adjusting the tire inflation pressure will turn off the warning light (after several minutes).

■ **When a tire is replaced with a spare tire (vehicles without run-flat tires)**

The compact spare tire is not equipped with the tire pressure warning valve and transmitter. If a tire goes flat, the tire pressure warning light will not turn off even though the flat tire is replaced with the spare tire. Replace the spare tire with the repaired tire and adjust the proper tire inflation pressure. The tire pressure warning light will turn off after several minutes.

■ If the tire pressure warning system is inoperative

The tire pressure warning system will be disabled in the following conditions:

(When the condition becomes normal, the system will work properly.)

- If tires not equipped with tire pressure warning valves and transmitters are used.
- If the ID code on the tire pressure warning valves and transmitters is not registered in the tire pressure warning computer.

The tire pressure warning system may be disabled in the following conditions:

(When the condition becomes normal, the system will work properly.)

- If electronic devices or facilities using similar radio wave frequencies are nearby.
- If a radio set at similar frequencies is in use in the vehicle.
- If there is a lot of snow or ice on the vehicle, in particular around the wheels or wheel housings.
- If non-genuine Toyota wheels are used. (Even if you use Toyota wheels, the tire pressure warning system may not work properly with some types of tires.)
- If tire chains are used.

■ If the tire pressure warning light comes on after blinking for 1 minute frequently

If the tire pressure warning light comes on after blinking for 1 minute frequently when the engine switch is turned to the "ON" position, have it checked by your Toyota dealer.

■ Customization that can be configured at Toyota dealer

The vehicle speed linked seat belt reminder buzzer can be disabled.

(Customizable features →P. 565) However, Toyota recommends that the seat belt reminder buzzer be operational to alert the driver and front passenger that the seat belts are not fastened.

 CAUTION

■ **If the tire pressure warning light comes on**

Be sure to observe the following precautions. Failure to do so could cause loss of vehicle control and result in death or serious injury.

● Vehicles with run-flat tires:

- Decelerate to the lowest appropriate speed as soon as possible. Do not drive over 55 mph (90 km/h).
- Check and adjust the tire inflation pressure immediately.
- If the tire pressure warning light comes on even after tire inflation pressure adjustment, it is probable that you have a flat tire. Have the tire replaced by the nearest Toyota dealer.
- Avoid abrupt maneuvering and braking. If the vehicle tires deteriorate, you could lose control of the steering wheel or the brakes.

● Vehicles with standard tires:

- Stop your vehicle in a safe place as soon as possible. Adjust the tire inflation pressure immediately.
- If the tire pressure warning light comes on even after tire inflation pressure adjustment, it is probable that you have a flat tire. Check the tires. If the tire is flat, change to the spare tire and have the flat tire repaired by the nearest Toyota dealer.
- Avoid abrupt maneuvering and braking. If the vehicle tires deteriorate, you could lose control of the steering wheel or the brakes.

■ **If a blowout or sudden air leakage should occur**

The tire pressure warning system may not activate immediately.

 **CAUTION****■ Maintenance of the tires**

Each tire, including the spare (if provided), should be checked monthly when cold and inflated to the inflation pressure recommended by the vehicle manufacturer on the vehicle placard or tire inflation pressure label (tire and load information label). (If your vehicle has tires of a different size than the size indicated on the vehicle placard or tire inflation pressure label [tire and load information label], you should determine the proper tire inflation pressure for those tires.)

As an added safety feature, your vehicle has been equipped with a tire pressure monitoring system (TPMS-tire pressure warning system) that illuminates a low tire pressure telltale (tire pressure warning light) when one or more of your tires is significantly under-inflated. Accordingly, when the low tire pressure telltale (tire pressure warning light) illuminates, you should stop and check your tires as soon as possible, and inflate them to the proper pressure. Driving on a significantly under-inflated tire causes the tire to overheat and can lead to tire failure. Under-inflation also reduces fuel efficiency and tire tread life, and may affect the vehicle's handling and stopping ability.

Please note that the TPMS (tire pressure warning system) is not a substitute for proper tire maintenance, and it is the driver's responsibility to maintain correct tire pressure, even if under-inflation has not reached the level to trigger illumination of the TPMS low tire pressure telltale (tire pressure warning light).

 CAUTION

Your vehicle has also been equipped with a TPMS (tire pressure warning system) malfunction indicator to indicate when the system is not operating properly. The TPMS (tire pressure warning system) malfunction indicator is combined with the low tire pressure telltale (tire pressure warning light). When the system detects a malfunction, the telltale will flash for approximately one minute and then remain continuously illuminated. This sequence will continue upon subsequent vehicle start-ups as long as the malfunction exists. When the malfunction indicator is illuminated, the system may not be able to detect or signal low tire pressure as intended.

TPMS (tire pressure warning system) malfunctions may occur for a variety of reasons, including the installation of replacement or alternate tires or wheels on the vehicle that prevent the TPMS (tire pressure warning system) from functioning properly. Always check the TPMS (tire pressure warning system) malfunction telltale after replacing one or more tires or wheels on your vehicle to ensure that the replacement or alternate tires and wheels allow the TPMS (tire pressure warning system) to continue to function properly.

 NOTICE

■ **Precaution when installing a different tire**

When a tire of a different specification or maker is installed, the tire pressure warning system may not operate properly.

Take your vehicle to the nearest Toyota dealer or authorized tire dealer as soon as possible.

- **Run-flat tires (A “RFT” or “DSST” mark is molded on the sidewall)**



You can continue driving a vehicle with run-flat tires even if any tire goes flat.

It is able to run for a maximum of 100 miles (160 km) at a speed below 55 mph (90 km/h) after the tire pressure warning light comes on. (→P. 507)

- **In some condition (such as at high temperatures)**

You cannot continue driving for up to 100 miles (160 km).

- **If you cannot distinguish between the standard tires and run-flat tires**

Consult your Toyota dealer.

- **For the detailed information on run-flat tires**

See the tire warranty book.

 **NOTICE**

- **When replacing the tires**

When removing or fitting the wheels, tires or the tire pressure warning valve and transmitter, contact your Toyota dealer as the tire pressure warning valve and transmitter may be damaged if not handled correctly.

- **To avoid damaging the tire pressure warning valves and transmitters**

Do not use liquid sealants on flat tires.

5-2. Steps to take in an emergency

If you have a flat tire (vehicles with standard tires)

Remove the flat tire and replace it with the spare provided.

■ **Before jacking up the vehicle**

- Stop the vehicle on a hard, flat surface.
- Set the parking brake.
- Shift the shift lever to P.
- Stop the engine.
- Turn on the emergency flashers.

■ **Location of the spare tire, jack and tools**

► **Type A**

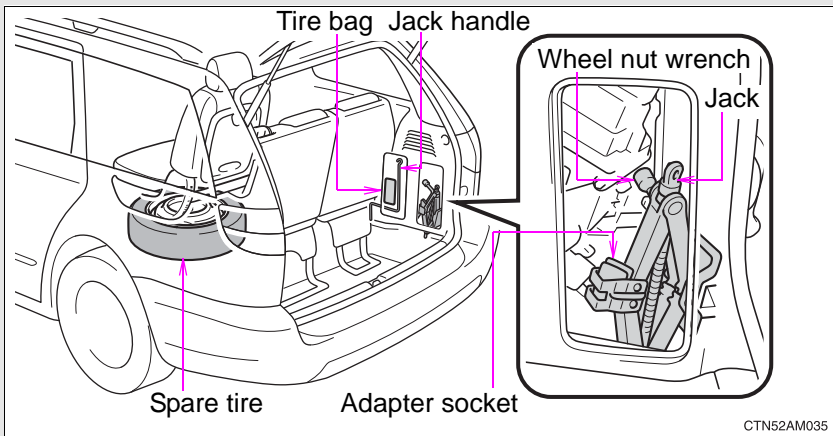

► Type B

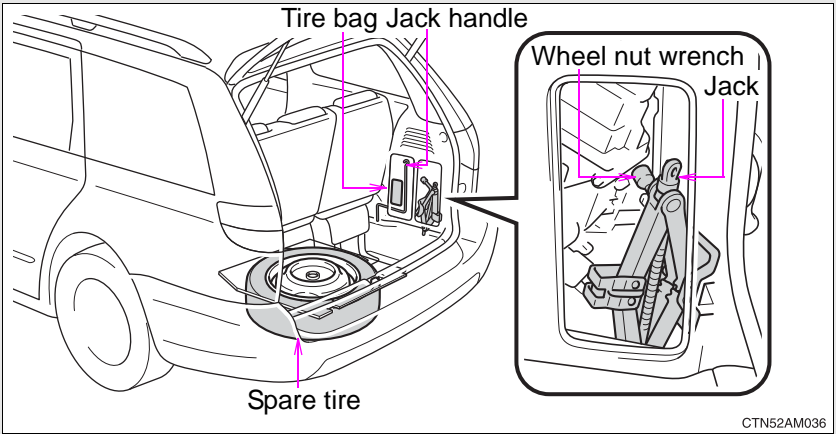

Taking out the jack and tools

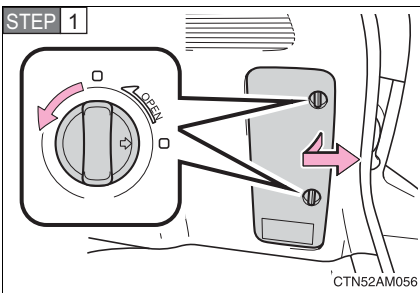

Turn the knobs to the "OPEN" position and remove the cover.

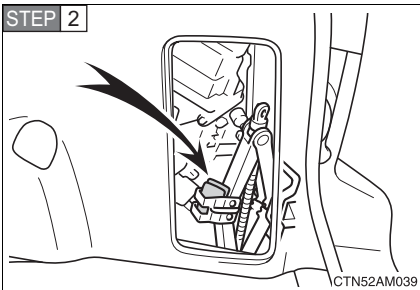

Remove the adapter socket. (Type A only)

The adapter socket is in a bag.

5-2. Steps to take in an emergency

STEP 3



Remove the jack.

STEP 4

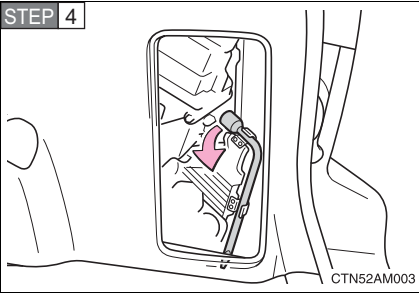

Remove the wheel nut wrench.

Taking out the spare tire (type A)

STEP 1 Slide the front passenger's seat to the front-most lock position and the right side second seat to the rear-most lock position so they will not interfere with the jack handle.

STEP 2

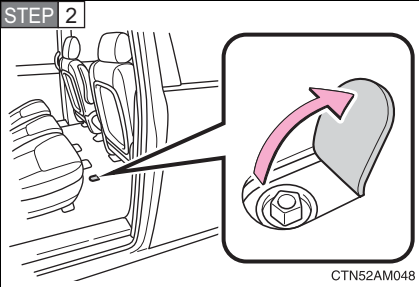

Open the right side sliding door and you will find the flap on the floor. Pull back the flap to find the spare tire clamp bolt.

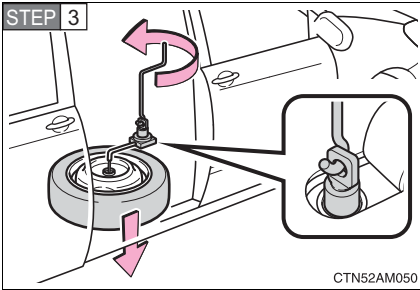

Attach the adapter socket over the spare tire clamp bolt.

Connect the jack handle and the adapter socket. Turn the jack handle.

The tire will be lowered completely to the ground.

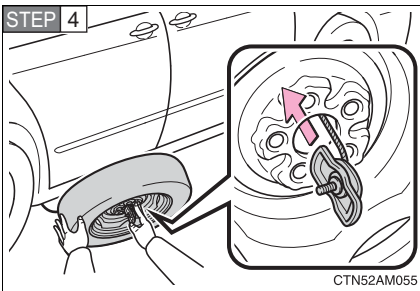

Take the spare tire out from underneath the vehicle and remove the holding bracket.

Taking out the spare tire (type B)

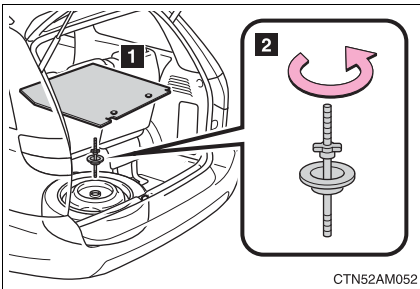

1 Remove the lid.

2 Loosen the bolt, then remove the bolt and spacer.

Replacing a flat tire

STEP 1

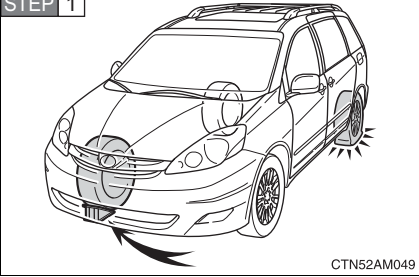

Chock the tires.

Flat tire		Wheel chock positions
Front	Left-hand side	Behind the rear right-hand side tire
	Right-hand side	Behind the rear left-hand side tire
Rear	Left-hand side	In front of the front right-hand side tire
	Right-hand side	In front of the front left-hand side tire

STEP 2

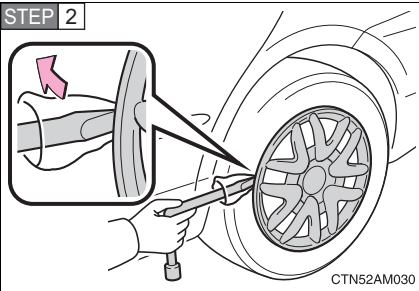

Vehicles with a steel wheel, remove the wheel ornament using the wheel nut wrench.

To protect the wheel ornament, place a rag between the wheel nut wrench and the wheel ornament, as shown in the illustration.

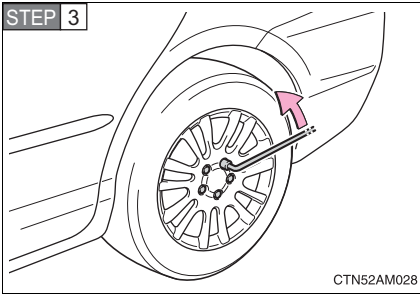

Slightly loosen the wheel nuts (one turn).

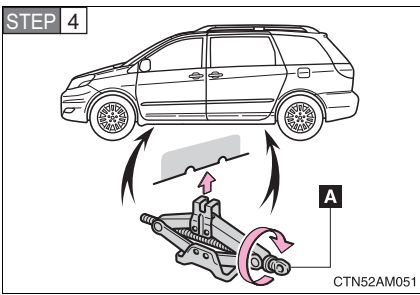

Turn the tire jack portion "A" by hand until the notch of the jack is in contact with the jack point.

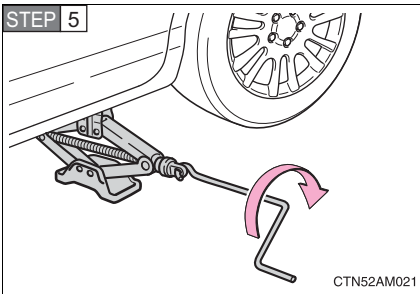

Raise the vehicle until the tire is slightly raised off the ground.

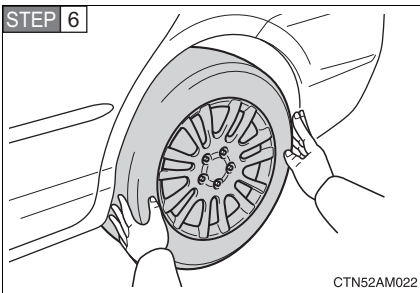

Remove all the wheel nuts and the tire.

When resting the tire on the ground, place the tire so that the wheel design faces up to avoid scratching the wheel surface.

Installing the spare tire

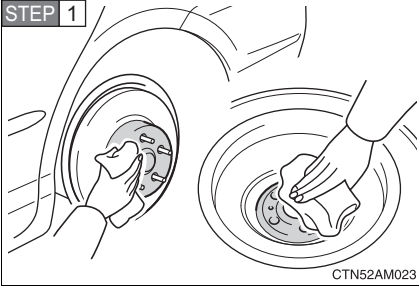

Remove any dirt or foreign matter from the wheel contact surface.

If foreign matter is on the wheel contact surface, the wheel nuts may loosen while the vehicle is in motion, and the tire may come off the vehicle.

STEP 2 Install the tire and loosely tighten each wheel nut by hand by approximately the same amount.

► Replacing a steel wheel with a compact spare tire

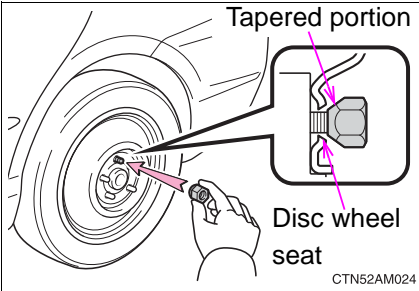

Tighten the nuts until the tapered portion comes into loose contact with the disc wheel seat.

► Replacing an aluminum wheel with a compact spare tire

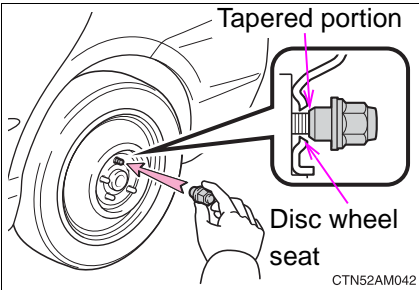

Tighten the nuts until the tapered portion comes into loose contact with the disc wheel seat.

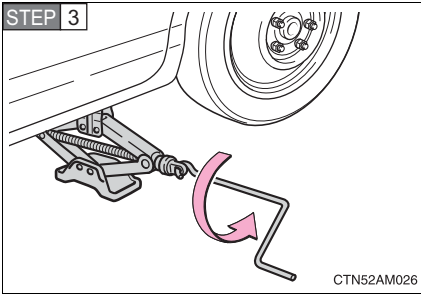

Lower the vehicle.

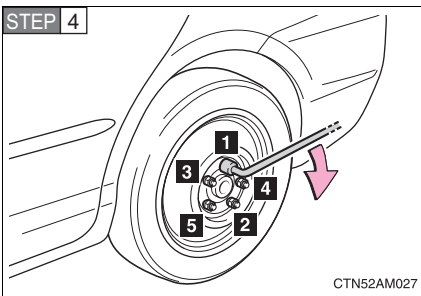

Firmly tighten each nut two or three times in the order shown in the illustration.

Tightening torque:
76 ft•lbf (103 N•m, 10.5 kgf•m)

STEP 5 Stow the flat tire, tire jack and all tools.

Stowing the flat tire

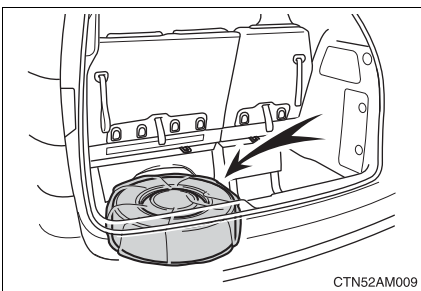

Wrap the flat tire in the tire bag and stow temporarily in the luggage compartment.

■ **When reinstalling the wheel ornament (vehicles with a steel wheel)**

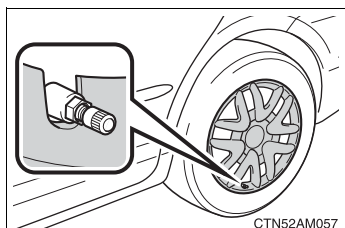

Align the cutout of the wheel ornament with the valve stem as shown.

■ **When stowing the adapter socket (Type A only)**

Insert the bag with the fold portion facing downward.

■ **The compact spare tire**

- The compact spare tire is identified by the label “TEMPORARY USE ONLY” on the tire sidewall.

Use the compact spare tire temporarily only in an emergency.

- Make sure to check the tire pressure of the compact spare tire. (→P. 548)

■ **If you have a flat front tire on a road covered with snow or ice**

Install the compact spare tire on the rear of the vehicle. Perform the following steps and fit tire chains to the front tires.

STEP 1 Replace a rear tire with the compact spare tire.

STEP 2 Replace the flat front tire with the tire removed from the rear of the vehicle.

STEP 3 Fit tire chains to the front tires.

■ **After completing the tire change**

The tire pressure warning system must be reset. (→P. 455)

■ **When using the compact spare tire**

As the compact spare tire is not equipped with the tire pressure warning valve and transmitter, low inflation pressure of the spare tire will not be warned. Also, if you replace the compact spare tire after the tire pressure warning light comes on, the light remains on.

 CAUTION**■ Using the tire jack**

Improper use of the tire jack may lead to death or serious injuries due to the vehicle suddenly falling off the jack.

- Do not use the tire jack for any purpose other than replacing tires or installing and removing tire chains.
- Only use the tire jack that comes with this vehicle for replacing a flat tire.
Do not use it on other vehicles, and do not use other tire jacks for replacing tires on this vehicle.
- Always check that the tire jack is securely set to the jack point.
- Do not put any part of your body under the vehicle while it is supported by the jack.
- Do not start or run the engine while your vehicle is supported by the jack.
- Do not raise the vehicle while someone is in it.
- When raising the vehicle, do not put an object on or under the jack.
- Do not raise the vehicle to a height greater than that required to replace the tire.
- Use a jack stand if it is necessary to get under the vehicle.

Take particular care when lowering the vehicle to ensure that no one working on or near the vehicle will be injured.

 **CAUTION**

■ **Replacing a flat tire**

Observe the following precautions to reduce the risk of death or serious injury:

- Remove the spare tire before jacking up the vehicle. If the spare tire is removed after jacking up the vehicle, the tire carrier and the spare tire may interfere with the jack and cause a serious accident.
- Never use oil or grease on the wheel bolts or wheel nuts. Oil and grease may cause the wheel nuts to be excessively tightened, leading to bolt or disc wheel damage. In addition, the oil or grease can cause the wheel nuts to loosen and the wheel may fall off, causing a serious accident. Remove any oil or grease from the wheel bolts or wheel nuts.
- Have the wheel nuts tightened with a torque wrench to 76 ft•lbf (103 N•m, 10.5 kgf•m) as soon as possible after changing wheels. Failure to follow these precautions could cause the nuts to loosen and the wheel may fall off, which could lead to an accident causing death or serious injury.

■ **When using the compact spare tire**

- Remember that your compact spare tire is specifically designed for use with your vehicle. Do not use your compact spare tire on another vehicle.
- Do not use more than one compact spare tire simultaneously.
- Replace the compact spare tire with a standard tire as soon as possible.
- Avoid sudden acceleration, deceleration and braking, as well as sharp cornering.

■ **Speed limit when using the compact spare tire**

Do not drive at speeds in excess of 50 mph (80 km/h) when a compact spare tire is installed on the vehicle.

The compact spare tire is not designed for driving at high speeds. Failing to observe this precaution may lead to an accident causing death or serious injury.

 CAUTION**■ When the spare tire is installed**

The vehicle speed may not be correctly detected, and the following systems may not operate correctly:

- ABS & Brake assist
- VSC
- TRAC
- Navigation system (if equipped)

 NOTICE

■ **When loosening or tightening the spare tire clamp bolt (type A only)**

Do not use an impact wrench. Use the adapter socket and jack handle.

■ **Do not drive the vehicle with a flat tire**

Do not continue driving with a flat tire.

Driving even a short distance with a flat tire can damage the tire and the wheel beyond repair.

■ **Be careful when driving over bumps with the compact spare tire installed on the vehicle**

The vehicle becomes lower when driving with the compact spare tire compared to when driving with standard tires. Be careful when driving over uneven road surfaces.

■ **Driving with tire chains and the compact spare tire**

Do not fit tire chains to the compact spare tire.

Tire chains may damage the vehicle body and adversely affect driving performance.

■ **When replacing the tires**

When removing or fitting the wheels, tires or the tire pressure warning valve and transmitter, contact your Toyota dealer as the tire pressure warning valve and transmitter may be damaged if not handled correctly.

■ **To avoid damaging the tire pressure warning valves and transmitters**

Do not use liquid sealants on flat tires.

■ **After taking out or stowing the spare tire (type A only)**

Make sure to secure the tire carrier by tightening the clamp bolt to prevent the holding bracket from hitting the under body of the vehicle during driving.

■ **Using the tire carrier**

● As the tire carrier is designed for use with the compact spare tire, it cannot be used with standard tires.

● If the spare tire is flat, do not use the tire carrier, as the tire may not be held securely.

5-2. Steps to take in an emergency If the engine will not start

If the engine still does not start after following the correct starting procedure (→P. 167) or releasing the steering lock (→P. 168), confirm the following points.

■ The engine will not start even when the starter motor operates normally.

One of the following may be the cause of the problem.

- There may not be sufficient fuel in the vehicle's tank.
Refuel the vehicle.
- The engine may be flooded.
Try to restart the engine once more following correct starting procedures. (→P. 167)
- There may be a malfunction in the engine immobilizer system (if equipped). (→P. 111)

■ The starter motor turns over slowly, the interior lights and headlights are dim, or the horn does not sound or sounds at a low volume.

One of the following may be the cause of the problem.

- The battery may be discharged. (→P. 532)
- The battery terminal connections may be loose or corroded.

■ The starter motor does not turn over, the interior lights and headlights do not turn on, or the horn does not sound.

One of the following may be the cause of the problem.

- One or both of the battery terminals may be disconnected.
- The battery may be discharged. (→P. 532)

Contact your Toyota dealer if the problem cannot be repaired, or if repair procedures are unknown.

5-2. Steps to take in an emergency

If the shift lever cannot be shifted from P

If the shift lever cannot be shifted with your foot on the brake, there may be a problem with the shift lock system (a system to prevent accidental operation of the shift lever). Have the vehicle inspected by your Toyota dealer.

The following steps may be used as an emergency measure to ensure that the shift lever can be shifted.

STEP 1 Set the parking brake.

STEP 2 Turn the engine switch to the "LOCK" position.

STEP 3 Depress the brake pedal.

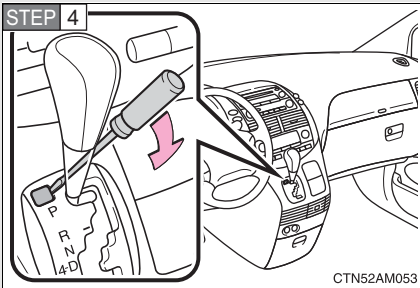

Pry the cover up with a flat-head screwdriver or equivalent.

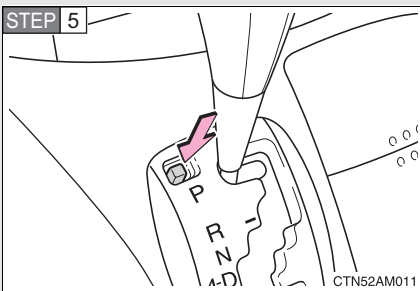

Press the shift lock override button.

The shift lever can be shifted while the button is pressed.

■ **Keys**

New genuine keys can be made by your Toyota dealer. Bring a master key and the key number stamped on the key number plate.

■ **Wireless remote control transmitter**

New genuine wireless remote control transmitters can be purchased and programmed by your Toyota dealer. If a wireless remote control transmitter has been lost, bring the other wireless remote control transmitter when going to pick up the new transmitter.

5-2. Steps to take in an emergency If the battery is discharged

The following procedures may be used to start the engine if the vehicle's battery is discharged.

You can call your Toyota dealer or qualified repair shop.

If you have a set of jumper (or booster) cables and a second vehicle with a 12-volt battery, you can jump start your Toyota following the steps below.

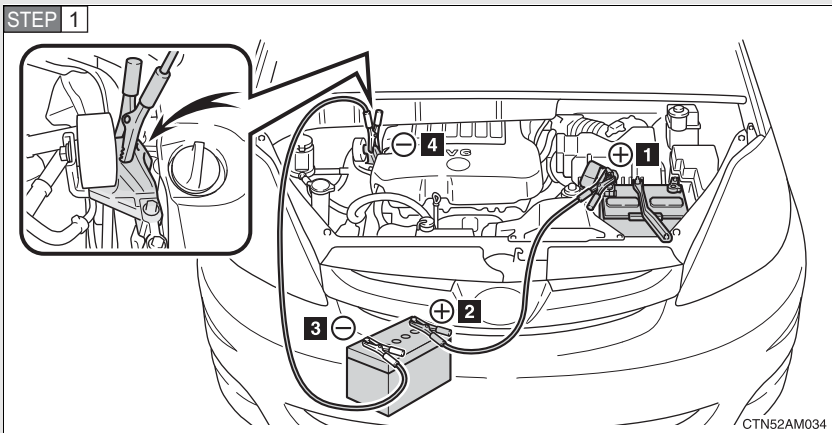

Connecting the jumper cables

- 1** Positive (+) battery terminal on your vehicle
- 2** Positive (+) battery terminal on the second vehicle
- 3** Negative (-) battery terminal on the second vehicle
- 4** Connect the jumper cable to ground on your vehicle as shown in the illustration.

STEP 2 Start the engine of the second vehicle. Increase the engine speed slightly and maintain at that level for approximately 5 minutes to recharge the battery of your vehicle.

STEP 3 Maintain the engine speed of the second vehicle and turn the engine switch to the "ON" position, then start the vehicle's engine.

STEP 4 Once the vehicle's engine has started, remove the jumper cables in the exact reverse order in which they were connected.

Once the engine starts, have the vehicle checked at your Toyota dealer as soon as possible.

■ **Starting the engine when the battery is discharged**

The engine cannot be started by push-starting.

■ **Avoiding a discharged battery**

- Turn off the headlights and the audio system while the engine is turned off.
- Turn off any unnecessary electrical components when the vehicle is running at a low speed for an extended period, such as in heavy traffic, etc.

■ **When the battery is removed or discharged**

- The power sliding door (if equipped) must be initialized. (→P. 37)
- The power back door (if equipped) must be initialized. (→P. 47)
- The power window must be initialized. (→P. 100)
- The moon roof (if equipped) must be initialized. (→P. 104)

 **CAUTION**

■ **Avoiding battery fires or explosions**

Observe the following precautions to prevent accidentally igniting the flammable gas that may be emitted from the battery.

- Make sure the jumper cable is connected to the correct terminal and that it is not unintentionally in contact with any part other than the intended terminal.
- Do not allow the jumper cables to come into contact with the “+” and “-” terminals.
- Do not smoke, use matches, cigarette lighters or allow open flame near the battery.

■ **Battery precautions**

The battery contains poisonous and corrosive acidic electrolyte, while related parts contain lead and lead compounds. Observe the following precautions when handling the battery.

- When working with the battery, always wear safety glasses and take care not to allow any battery fluids (acid) to come into contact with skin, clothing or the vehicle body.
- Do not lean over the battery.
- In the event that battery fluid comes into contact with the skin or eyes, immediately wash the affected area with water and seek medical attention. Place a wet sponge or cloth over the affected area until medical attention can be received.
- Always wash your hands after handling the battery support, terminals, and other battery-related parts.
- Do not allow children near the battery.



NOTICE

■ **When handling jumper cables**

Be careful that the jumper cables do not become tangled in the cooling fans or any of the belts when connecting or disconnecting them.

5-2. Steps to take in an emergency If your vehicle overheats

If your engine overheats:

STEP 1 Stop the vehicle in a safe place and turn off the air conditioning system.

STEP 2 Check to see if steam is coming out from under the hood.

If you see steam:

Stop the engine. Carefully lift the hood after the steam subsides and then restart the engine.

If you do not see steam:

Leave the engine running and carefully lift the hood.

STEP 3 Check to see if the cooling fans are operating.

If the fans are operating:

Wait until the temperature of the engine (shown on the instrument cluster) begins to fall and then stop the engine.

If the fans are not operating:

Stop the engine and call your Toyota dealer.

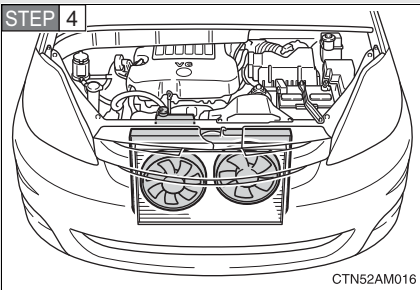

After the engine has cooled down sufficiently, check the engine coolant level and inspect the radiator core (radiator) for any leaks.

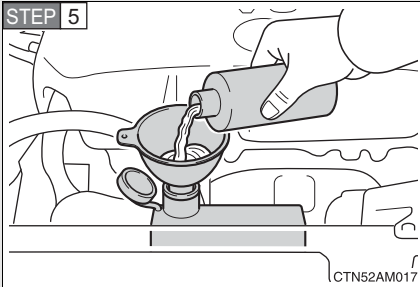

Add engine coolant if necessary.

Water can be used in an emergency if engine coolant is unavailable. (→P. 546)

Have the vehicle checked at the nearest Toyota dealer as soon as possible.

■ Overheating

If you observe the following, your vehicle may be overheating.

- The engine coolant temperature gauge enters the red zone or a loss of power is experienced.
- Steam is coming from under the hood.

⚠ CAUTION

■ To prevent an accident or injury when inspecting under the hood of your vehicle

- If steam is seen coming from under the hood, do not open the hood until the steam has subsided. The engine compartment may be very hot, causing serious injury such as burns.
- Keep hands and clothing away from the fan and other belts while the engine is running.
- Do not loosen the coolant reservoir cap while the engine and radiator are hot.
Serious injury, such as burns, may result from hot coolant and steam released under pressure.

 NOTICE

■ **When adding engine coolant**

Wait until the engine has cooled down before adding engine coolant.

When adding coolant, do so slowly. Adding cool coolant to a hot engine too quickly can cause damage to the engine.

5-2. Steps to take in an emergency If the vehicle becomes stuck

Carry out the following procedures if the tires spin or the vehicle becomes stuck in mud, dirt, or snow.

STEP 1 Stop the engine. Set the parking brake and put the shift lever in P.

STEP 2 Remove the mud, snow, or sand from around the stuck tire.

STEP 3 Place wood, stones or some other material to help provide traction under the tires.

STEP 4 Restart the engine.

STEP 5 Shift the shift lever to the D or R position and carefully apply the accelerator to free the vehicle.

2WD models only: Turn off TRAC if this function is hampering your attempts to free the vehicle. (→P. 216)

CAUTION

■ When attempting to free a stuck vehicle

If you choose to rock the vehicle back and forth to free it, make sure the surrounding area is clear, to avoid striking other vehicles, objects or persons. The vehicle may also lunge forward or lunge back suddenly as it becomes free. Use extreme caution.

■ When shifting the shift lever

Be careful not to shift the shift lever with the accelerator pedal depressed. This may lead to unexpected rapid acceleration of the vehicle that may cause an accident and result in death or serious injury.

NOTICE

■ To avoid damaging the transmission and other components

- Avoid spinning the wheels and do not rev the engine.
- If the vehicle remains stuck after trying these procedures, the vehicle may require towing to be freed.

6-1. Specifications

Maintenance data (fuel, oil level, etc.)

Dimensions and weights

Overall length		201.0 in. (5105 mm)
Overall width		77.4 in (1965 mm)
Overall height* ¹		68.9 in (1750 mm)
Wheelbase		119.3 in (3030 mm)
Tread	Front	65.6 in (1665 mm) ^{*2} 65.9 in (1675 mm) ^{*3}
	Rear	66.9 in (1700 mm) ^{*2} 67.3 in (1710 mm) ^{*3}
Vehicle capacity weight (Occupants + luggage)	Wagon	2WD models ▶ LE or CE grade 1210 lb. (550 kg) ^{*4} 1150 lb. (520 kg) ^{*5} ▶ XLE or Limited grade 1210 lb. (550 kg) ^{*4} 1120 lb. (510 kg) ^{*5}
		AWD models ▶ LE or CE grade 1100 lb. (500 kg) ▶ XLE or Limited grade 1050 lb. (480 kg)
	Van	1210 lb. (550 kg)
Towing capacity (Trailer weight + cargo weight)	Vehicle without towing package	1200 lb. (544 kg)
	Vehicle with towing package	3500 lb. (1587 kg)

*1: Unladen vehicle

*2: With P215/65R16 tires

*3: With P225/60R17 tires

*4: 8-passenger models

*5: 7-passenger models

Vehicle identification

■ Vehicle identification number

The vehicle identification number (VIN) is the legal identifier for your vehicle. This is the primary identification number for your Toyota. It is used in registering the ownership of your vehicle.

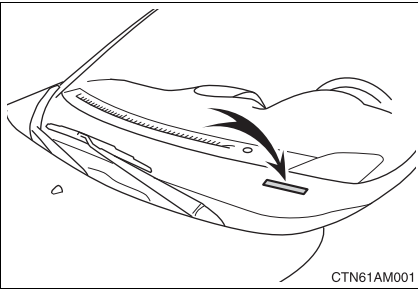

This number is stamped on the top left of the instrument panel.

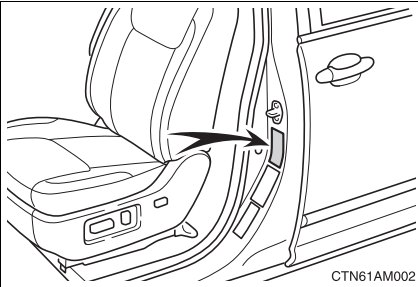

This number is also on the Certification Label on the driver's side center pillar.

■ Engine number

The engine number is stamped on the engine block as shown.

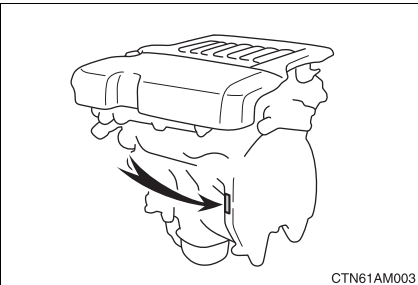

Engine

Model	2GR-FE engine
Type	6 cylinder V type, 4 cycle, gasoline
Bore and stroke	3.70 × 3.27 in. (94.0 × 83.0 mm)
Displacement	210.9 cu.in. (3456 cm ³)
Drive belt tension	Automatic adjustment
Valve clearance	

Fuel

Fuel type	Unleaded gasoline only
Octane rating	87 (Research Octane Number 91) or higher
Fuel tank capacity	20.9 gal. (79 L, 17.5 Imp.gal.)

Lubrication system

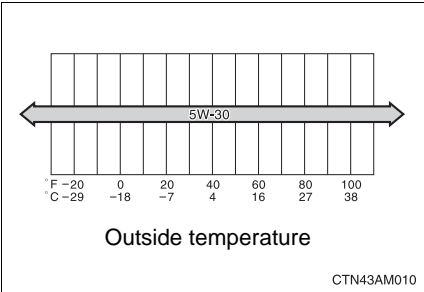
<p>Oil capacity (drain and refill)</p> <p>With filter</p> <p>Without filter</p>	<p>6.4 qt. (6.1 L, 5.4 Imp.qt.)</p> <p>6.0 qt. (5.7 L, 5.0 Imp.qt.)</p>
<p>Oil grade</p>	<p>ILSAC multigrade engine oil</p>
<p>Recommended oil viscosity</p>	<p>Use Toyota approved "Toyota Genuine Motor Oil" or equivalent to satisfy the grade and viscosity shown below.</p> <div data-bbox="483 583 910 873" style="border: 1px solid black; padding: 10px; text-align: center;">  <p>Outside temperature</p> <p>CTN43AM010</p> </div> <p>5W-30 is the oil that provides the optimal level of fuel efficiency.</p>

Oil viscosity

- The 5W portion of the oil viscosity rating indicates the characteristic of the oil which allows cold startability. Oils with a lower value before the W allow for easier starting of the engine in cold weather.
- The 30 in 5W-30 indicates the oil viscosity when the oil is at its operating temperature. An oil with a higher viscosity may be better suited if the vehicle is operated at high speeds, or under extreme load condition.

Cooling system

Capacity (Reference)	12.0 qt. (11.3 L, 10.0 Imp.qt.)
Coolant type	<p>Use either of the following.</p> <ul style="list-style-type: none"> • “Toyota Super Long Life Coolant” • Similar high-quality ethylene glycol-based non-silicate, non-amine, non-nitrite, and non-borate coolant with long-life hybrid organic acid technology <p>Do not use plain water alone.</p>

Ignition system

Spark plug	
Make	DENSO FK20HR11
Gap	0.043 in. (1.1 mm)

NOTICE

Iridium-tipped spark plugs

Use only iridium-tipped spark plugs. Do not adjust spark plug gap.

Electrical system

Battery	
Open voltage at 68°F (20°C):	<p>12.6 — 12.8 V Fully charged</p> <p>12.2 — 12.4 V Half charged</p> <p>11.8 — 12.0 V Discharged</p> <p>(Voltage checked 20 minutes after the engine and all the lights turned off)</p>
Charging rates	5 A max.

Automatic transaxle

Fluid capacity (drain and refill)	3.7 qt. (3.5 L, 3.1 Imp.qt.)
Fluid type	Toyota Genuine ATF WS

 **NOTICE****Automatic transmission fluid type**

Using automatic transmission fluid other than “Toyota Genuine ATF WS” may cause deterioration in shift quality, locking up of your transmission accompanied by vibration, and ultimately damage the transmission of your vehicle.

Rear differential (AWD models)

Oil capacity	1.0 qt. (0.9 L, 0.8 Imp.qt.)
Oil type	Hypoid gear oil API GL-5
Recommended oil viscosity	Above 0°F (-18°C): SAE 90 Below 0°F (-18°C): SAE 80W or 80W-90

Transfer (AWD models)

Oil capacity	1.0 qt. (0.9 L, 0.8 Imp.qt.)
Oil type	Hypoid gear oil API GL-5
Recommended oil viscosity	Above 0°F (-18°C): SAE 90 Below 0°F (-18°C): SAE 80W or 80W-90

Brakes

Pedal clearance ^{*1}	2.0 in. (52 mm)
Pedal free play	0.04 — 0.24 in. (1 — 6 mm)
Brake pad wear limit	0.04 in. (1.0 mm)
Parking brake lining wear limit	0.04 in. (1.0 mm)
Parking brake pedal travel ^{*2}	3 — 5 clicks
Fluid type	SAE J1703 or FMVSS No.116 DOT 3

*1: Minimum pedal clearance when depressed with a force of 110 lbf (490 N, 50 kgf) while the engine is running

*2: Parking brake pedal travel when depressed with a force of 66 lbf (294 N, 30 kgf)

Steering

Free play	Less than 1.2 in. (30 mm)
Power steering fluid type	Automatic transmission fluid DEXRON [®] II or III

Tires and wheels

Tire size	P215/65R16 96T, P225/60R17 98T T155/80R17 101M (compact spare)
Tire inflation pressure (Recommended cold tire inflation pressure)	Front: 35 psi (240 kPa, 2.4 kgf/cm ² or bar) Rear: 35 psi (240 kPa, 2.4 kgf/cm ² or bar) Spare: 60 psi (420 kPa, 4.2 kgf/cm ² or bar)
Wheel size	16 × 6 1/2 JJ (P215/65R16 96T) 17 × 6 1/2J (P225/60R17 98T) 17 × 4T (compact spare)
Wheel nut torque	76 ft•lbf (103 N•m, 10.5 kgf•m)

Light bulbs

	Light Bulbs	Bulb No.	W	Type
Exterior	Headlights (low beam)	—	35	A
	With discharge headlights	9006	51	B
	Without discharge headlights	9005	60	C
	Headlights (high beam)	9006	51	B
	Front fog lights	3457A	27/7	E
	Front turn signal and parking lights	—	5	E
	Front side marker lights	7440	21	D
	Rear turn signal lights	7443	21/5	D
	Stop/tail and rear side marker lights	194	3.8	D
	Tail lights	921	16	D
	Back-up lights	—	5	D
License plate lights	—	6	D	
Outer foot lights	—	4.9	D	
Interior	Front personal/interior lights	—	5.0	D
	Rear personal/interior lights	—	5	F
	Luggage compartment light	—	3	F
	Vanity lights	—	6	F
	Front door courtesy lights	—	3.8	D
	Sliding door courtesy lights	—		

A: D2R discharge bulbs

B: HB4 halogen bulbs

C: HB3 halogen bulbs

D: Wedge base bulbs (clear)

E: Wedge base bulbs (amber)

F: Double end bulbs

6-1. Specifications

Fuel information

You must only use unleaded gasoline in your vehicle.

Select octane rating 87 (Research Octane Number 91) or higher. Use of unleaded gasoline with an octane rating lower than 87 may result in engine knocking. Persistent knocking can lead to engine damage.

At minimum, the gasoline you use should meet the specifications of ASTM D4814 in the U.S.A. and CGSB3.5-M93 in Canada.

■ Fuel tank opening for unleaded gasoline

To help prevent incorrect fueling, your Toyota has a fuel tank opening that only accommodates the special nozzle on unleaded fuel pumps.

■ If your engine knocks

- Consult your Toyota dealer.
- You may occasionally notice light knocking for a short time while accelerating or driving uphill. This is normal and there is no need for concern.

■ Gasoline quality

In very few cases, driveability problems may be caused by the brand of gasoline you are using. If driveability problems persist, try changing the brand of gasoline. If this does not correct the problem, consult your Toyota dealer.

■ Gasoline quality standards

- Automotive manufacturers in the U.S., the Europe and Japan have developed a specification for fuel quality called World-Wide Fuel Charter (WWFC) that is expected to be applied worldwide.
- The WWFC consists of four categories that are based on required emission levels. In the U.S., category 4 has been adopted.
- The WWFC improves air quality by lowering emissions in vehicle fleets, and improves customer satisfaction through better performance.

■ Toyota recommends the use of gasoline containing detergent additives

- Toyota recommends the use of gasoline that contains detergent additives to avoid build-up of engine deposits.
- All gasoline sold in the U.S. contains detergent additives to clean and/or keep clean intake systems.

■ Toyota recommends the use of cleaner burning gasoline

Cleaner burning gasoline, including reformulated gasoline that contains oxygenates such as ethanol or MTBE (Methyl Tertiary Butyl Ether) is available in many areas.

Toyota recommends the use of cleaner burning gasoline and appropriately blended reformulated gasoline. These types of gasoline provide excellent vehicle performance, reduce vehicle emissions and improve air quality.

■ Toyota does not recommend blended gasoline

- Toyota allows the use of oxygenate blended gasoline where the oxygenate content is up to 10% ethanol or 15% MTBE.
- If you use gasohol in your Toyota, be sure that it has an octane rating no lower than 87.
- Toyota does not recommend the use of gasoline containing methanol.

■ Toyota does not recommend gasoline containing MMT

Some gasoline contains octane enhancing additive called MMT (Methylcyclopentadienyl Manganese Tricarbonyl).

Toyota does not recommend the use of gasoline that contains MMT. If fuel containing MMT is used, your emission control system may be adversely affected.

The malfunction indicator lamp on the instrument cluster may come on. If this happens, contact your Toyota dealer for service.

 NOTICE

■ **Notice on gasoline quality**

- Do not use leaded gasoline.

Leaded gasoline can cause damage to your vehicle's catalytic converters causing the emission control system to malfunction.

- Do not use gasohol other than that stated here.

Other gasohol may cause fuel system damage or vehicle performance problems.

- Using unleaded gasoline with an octane number or rating lower than that stated here will cause persistent heavy knocking.

At worst, this will lead to engine damage.

■ **Fuel-related poor driveability**

If after using a different type of fuel, poor driveability is encountered (poor hot starting, vaporization, engine knocking, etc.), discontinue the use of that type of fuel.

■ **When refueling with gasohol**

Take care not to spill gasohol. It can damage your vehicle's paint.

6-1. Specifications

Tire information

Typical tire symbols

► Run-flat tire or standard tire

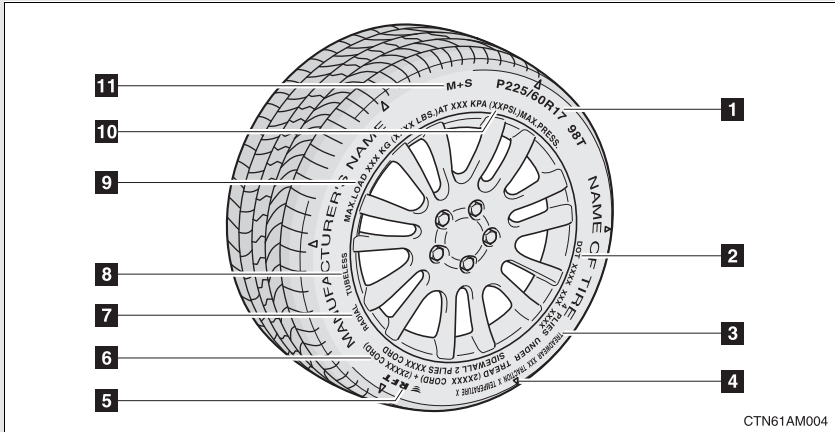

► Compact spare tire

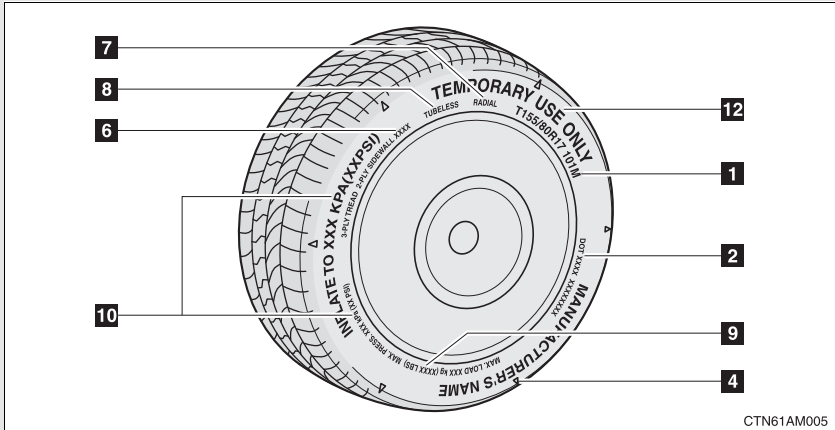

- 1** Tire size (→P. 556)
- 2** DOT and Tire Identification Number (TIN) (→P. 555)
- 3** Uniform tire quality grading
For details, see “Uniform Tire Quality Grading” that follows.
- 4** Location of treadwear indicators (→P. 454)

5 Run-flat tire (RFT) or standard tire (→P. 515)

This vehicle can be equipped with either run-flat tires (RFT) or standard tires. A “RFT” or “DSST” mark is molded on the sidewall of the run-flat tire.

6 Tire ply composition and materials

Plies are layers of rubber-coated parallel cords. Cords are the strands which form the plies in a tire.

7 Radial tires or bias-ply tires

A radial tire has “RADIAL” on the sidewall. A tire not marked “RADIAL” is a bias-ply tire.

8 TUBELESS or TUBE TYPE

A tubeless tire does not have a tube and air is directly filled in the tire. A tube type tire has a tube inside the tire and the tube maintains the air pressure.

9 Load limit at maximum cold tire inflation pressure (→P. 457)

10 Maximum cold tire inflation pressure (→P. 548)

This means the pressure to which a tire may be inflated.

11 Summer tires or all season tires (→P. 458)

An all season tire has “M+S” on the sidewall. A tire not marked “M+S” is a summer tire.

12 “TEMPORARY USE ONLY” (→P. 524)

A compact spare tire is identified by the phrase “TEMPORARY USE ONLY” molded into its sidewall. This tire is designed for temporary emergency use only.

Typical DOT and Tire Identification Number (TIN)

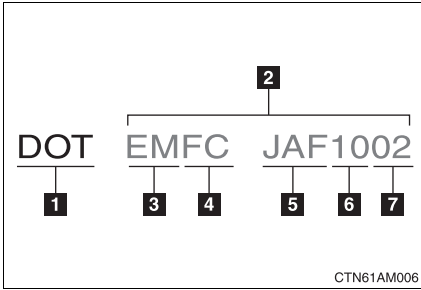

- 1** DOT symbol*
- 2** Tire Identification Number (TIN)
- 3** Tire manufacturer's identification mark
- 4** Tire size code
- 5** Manufacturer's optional tire type code (3 or 4 letters)
- 6** Manufacturing week
- 7** Manufacturing year

*: The DOT symbol certifies that the tire conforms to applicable Federal Motor Vehicle Safety Standards.

Tire size

■ Typical tire size information

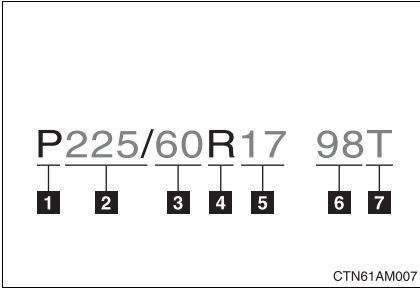

The illustration indicates typical tire size.

- 1 Tire use
(P = Passenger car,
T = Temporary use)
- 2 Section width (millimeters)
- 3 Aspect ratio
(tire height to section width)
- 4 Tire construction code
(R = Radial, D = Diagonal)
- 5 Wheel diameter (inches)
- 6 Load index (2 or 3 digits)
- 7 Speed symbol
(alphabet with one letter)

■ Tire dimensions

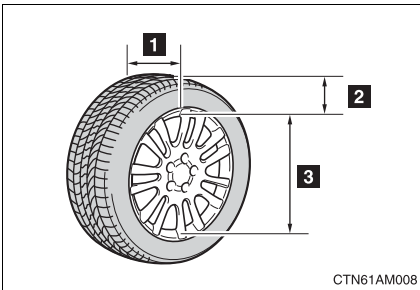

- 1 Section width
- 2 Tire height
- 3 Wheel diameter

Tire section names

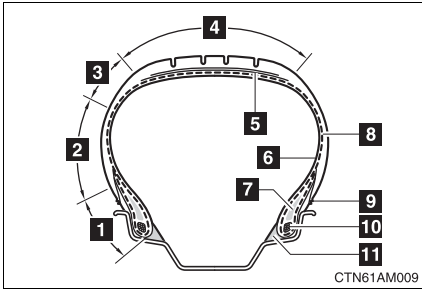

- 1** Bead
- 2** Sidewall
- 3** Shoulder
- 4** Tread
- 5** Belt
- 6** Inner liner
- 7** Reinforcing rubber
- 8** Carcass
- 9** Rim lines
- 10** Bead wires
- 11** Chafer

Uniform Tire Quality Grading

This information has been prepared in accordance with regulations issued by the National Highway Traffic Safety Administration of the U.S. Department of Transportation.

It provides the purchasers and/or prospective purchasers of Toyota vehicles with information on uniform tire quality grading.

Your Toyota dealer will help answer any questions you may have as you read this information.

■ DOT quality grades

All passenger vehicle tires must conform to Federal Safety Requirements in addition to these grades. Quality grades can be found where applicable on the tire sidewall between tread shoulder and maximum section width.

For example: Treadwear 200 Traction AA Temperature A

■ Treadwear

The treadwear grade is a comparative rating based on the wear rate of the tire when tested under controlled conditions on a specified government test course.

For example, a tire graded 150 would wear one and a half (1-1/2) times as well on the government course as a tire graded 100.

The relative performance of tires depends upon the actual conditions of their use, however, and may depart significantly from the norm due to variations in driving habits, service practices and differences in road characteristics and climate.

■ Traction AA, A, B, C

The traction grades, from highest to lowest, are AA, A, B and C, and they represent the tire's ability to stop on wet pavement as measured under controlled conditions on specified government test surfaces of asphalt and concrete.

A tire marked C may have poor traction performance.

Warning: The traction grade assigned to this tire is based on braking (straight ahead) traction tests and does not include cornering (turning) traction.

■ Temperature A, B, C

The temperature grades are A (the highest), B, and C, representing the tire's resistance to the generation of heat and its ability to dissipate heat when tested under controlled conditions on a specified indoor laboratory test wheel.

Sustained high temperature can cause the material of the tire to degenerate and reduce tire life, and excessive temperature can lead to sudden tire failure.

The grade C corresponds to a level of performance which all passenger car tires must meet under the Federal Motor Vehicle Safety Standard No. 109.

Grades B and A represent higher levels of performance on the laboratory test wheel than the minimum required by law.

Warning: The temperature grades for this tire are established for a tire that is properly inflated and not overloaded.

Excessive speed, underinflation, or excessive loading, either separately or in combination, can cause heat buildup and possible tire failure.

Glossary of tire terminology

Tire related term	Meaning
Cold tire inflation pressure	Tire pressure when the vehicle has been parked for three hours or more, or has not been driven more than 1 mile or 1.5 km under that condition
Maximum inflation pressure	The maximum cold inflated pressure to which a tire may be inflated, shown on the sidewall of the tire
Recommended inflation pressure	Cold tire inflation pressure recommended by a manufacturer
Accessory weight	The combined weight (in excess of those standard items which may be replaced) of automatic transmission, power steering, power brakes, power windows, power seats, radio and heater, to the extent that these items are available as factory-installed equipment (whether installed or not)
Curb weight	The weight of a motor vehicle with standard equipment, including the maximum capacity of fuel, oil and coolant, and if so equipped, air conditioning and additional weight optional engine
Maximum loaded vehicle weight	The sum of: (a) Curb weight (b) Accessory weight (c) Vehicle capacity weight (d) Production options weight

Tire related term	Meaning
Normal occupant weight	150 lb. (68 kg) times the number of occupants specified in the second column of Table 1* that follows
Occupant distribution	Distribution of occupants in a vehicle as specified in the third column of Table 1* below
Production options weight	The combined weight of installed regular production options weighing over 5 lb. (2.3 kg) in excess of the standard items which they replace, not previously considered in curb weight or accessory weight, including heavy duty brakes, ride levelers, roof rack, heavy duty battery, and special trim
Rim	A metal support for a tire or a tire and tube assembly upon which the tire beads are seated
Rim diameter (Wheel diameter)	Nominal diameter of the bead seat
Rim size designation	Rim diameter and width
Rim type designation	The industry manufacturer's designation for a rim by style or code
Rim width	Nominal distance between rim flanges
Vehicle capacity weight (Total load capacity)	The rated cargo and luggage load plus 150 lb. (68 kg) times the vehicle's designated seating capacity
Vehicle maximum load on the tire	The load on an individual tire that is determined by distributing to each axle its share of the maximum loaded vehicle weight, and dividing by two
Vehicle normal load on the tire	The load on an individual tire that is determined by distributing to each axle its share of curb weight, accessory weight, and normal occupant weight (distributed in accordance with Table 1* below), and dividing by two

Tire related term	Meaning
Weather side	The surface area of the rim not covered by the inflated tire
Bead	The part of the tire that is made of steel wires, wrapped or reinforced by ply cords and that is shaped to fit the rim
Bead separation	A breakdown of the bond between components in the bead
Bias ply tire	A pneumatic tire in which the ply cords that extend to the beads are laid at alternate angles substantially less than 90 degrees to the centerline of the tread
Carcass	The tire structure, except tread and sidewall rubber which, when inflated, bears the load
Chunking	The breaking away of pieces of the tread or sidewall
Cord	The strands forming the plies in the tire
Cord separation	The parting of cords from adjacent rubber compounds
Cracking	Any parting within the tread, sidewall, or innerliner of the tire extending to cord material
CT	A pneumatic tire with an inverted flange tire and rim system in which the rim is designed with rim flanges pointed radially inward and the tire is designed to fit on the underside of the rim in a manner that encloses the rim flanges inside the air cavity of the tire
Extra load tire	A tire designed to operate at higher loads and at higher inflation pressures than the corresponding standard tire
Groove	The space between two adjacent tread ribs
Innerliner	The layer(s) forming the inside surface of a tubeless tire that contains the inflating medium within the tire

Tire related term	Meaning
Innerliner separation	The parting of the innerliner from cord material in the carcass
Intended outboard sidewall	<p>(a) The sidewall that contains a whitewall, bears white lettering, or bears manufacturer, brand, and/or model name molding that is higher or deeper than the same molding on the other sidewall of the tire, or</p> <p>(b) The outward facing sidewall of an asymmetrical tire that has a particular side that must always face outward when mounted on a vehicle</p>
Light truck (LT) tire	A tire designated by its manufacturer as primarily intended for use on lightweight trucks or multipurpose passenger vehicles
Load rating	The maximum load that a tire is rated to carry for a given inflation pressure
Maximum load rating	The load rating for a tire at the maximum permissible inflation pressure for that tire
Maximum permissible inflation pressure	The maximum cold inflation pressure to which a tire may be inflated
Measuring rim	The rim on which a tire is fitted for physical dimension requirements
Open splice	Any parting at any junction of tread, sidewall, or innerliner that extends to cord material
Outer diameter	The overall diameter of an inflated new tire
Overall width	The linear distance between the exteriors of the sidewalls of an inflated tire, including elevations due to labeling, decorations, or protective bands or ribs
Passenger car tire	A tire intended for use on passenger cars, multipurpose passenger vehicles, and trucks, that have a gross vehicle weight rating (GVWR) of 10,000 lb. or less

Tire related term	Meaning
Ply	A layer of rubber-coated parallel cords
Ply separation	A parting of rubber compound between adjacent plies
Pneumatic tire	A mechanical device made of rubber, chemicals, fabric and steel or other materials, that, when mounted on an automotive wheel, provides the traction and contains the gas or fluid that sustains the load
Radial ply tire	A pneumatic tire in which the ply cords that extend to the beads are laid at substantially 90 degrees to the centerline of the tread
Reinforced tire	A tire designed to operate at higher loads and at higher inflation pressures than the corresponding standard tire
Section width	The linear distance between the exteriors of the sidewalls of an inflated tire, excluding elevations due to labeling, decoration, or protective bands
Sidewall	That portion of a tire between the tread and bead
Sidewall separation	The parting of the rubber compound from the cord material in the sidewall
Snow tire	A tire that attains a traction index equal to or greater than 110, compared to the ASTM E-1136 Standard Reference Test Tire, when using the snow traction test as described in ASTM F-1805-00, Standard Test Method for Single Wheel Driving Traction in a Straight Line on Snow-and Ice-Covered Surfaces, and which is marked with an Alpine Symbol () on at least one sidewall
Test rim	The rim on which a tire is fitted for testing, and may be any rim listed as appropriate for use with that tire

Tire related term	Meaning
Tread	That portion of a tire that comes into contact with the road
Tread rib	A tread section running circumferentially around a tire
Tread separation	Pulling away of the tread from the tire carcass
Treadwear indicators (TWI)	The projections within the principal grooves designed to give a visual indication of the degrees of wear of the tread
Wheel-holding fixture	The fixture used to hold the wheel and tire assembly securely during testing

*: Table 1 — Occupant loading and distribution for vehicle normal load for various designated seating capacities

Designated seating capacity, Number of occupants	Vehicle normal load, Number of occupants	Occupant distribution in a normally loaded vehicle
2 through 4	2	2 in front
5 through 10	3	2 in front, 1 in second seat
11 through 15	5	2 in front, 1 in second seat, 1 in third seat, 1 in fourth seat
16 through 20	7	2 in front, 2 in second seat, 2 in third seat, 1 in fourth seat

Customizable features

Your vehicle includes a variety of electronic features that can be personalized to your preferences. Programming these preferences requires specialized equipment and may be performed by your Toyota dealer.

Some function settings are changed simultaneously with other functions being customized. Contact your Toyota dealer.

Item	Function	Default setting	Customized setting
Wireless remote control (→P. 27)	Wireless remote control	On	Off
	Unlocking operation	Driver's door unlocked in one step, all doors unlocked in two steps	All doors unlocked in one step
	Automatic door lock function to be activated if door is not opened after being unlocked	On	Off
	Time elapsed before automatic door lock function is activated if door is not opened after being unlocked	60 seconds	30 seconds
			120 seconds
	Operation signal (Emergency flashers)	On	Off
	Operation signal (Buzzer)	On	Off
	Door lock buzzer	On	Off
Panic function	On	Off	

Item	Function	Default setting	Customized setting
Wireless remote control (→P. 27)	Power sliding door operation	On	Off
		Press and hold	Press twice
	Power back door operation		On
		Press and hold	Press twice
Door lock (→P. 33)	Unlocking using a key	Driver's door unlocked in one step, all doors unlocked in two steps	All doors unlocked in one step
	Speed-detecting automatic door lock function	Off	On
	Opening driver's door unlocks all doors	Off	On
	Shifting gears to P unlocks all doors	On	Off
	Shifting gears to position other than P locks all doors	On	Off
Power sliding door (if equipped) (→P. 37)	Operation signal (buzzer)	Off	Loud sound
			Low sound
	Opening and closing operation	Push and hold	One short push
Automatic light control system (→P. 185)	Time elapsed before headlights automatically turn off after doors are closed	30 seconds	0 second
			60 seconds
			90 seconds
	Light sensor sensitivity	Level 3	Level 1 to 5

Item	Function	Default setting	Customized setting
Illumination (→P. 361)	Time elapsed before lights turn off	15 seconds	7.5 seconds
			30 seconds
	Operation when the doors are unlocked	On	Off
	Operation after the engine switch is turned to the "LOCK" position	On	Off
	Outer foot lights	On	Off
Seat belt reminder (→P. 507)	Vehicle speed linked seat belt reminder buzzer	On	Off

Items to initialize

The following items must be initialized for normal system operation in cases such as after maintenance is performed on the vehicle.

Item	When to initialize	Reference
Power sliding door (if equipped)	After reconnecting or changing the battery	P. 37
Power back door (if equipped)	After reconnecting or changing the battery	P. 47
Power window	After reconnecting or changing the battery	P. 100
Moon roof (if equipped)	After reconnecting or changing the battery	P. 104
Engine oil maintenance data (U.S.A. only)	After changing engine oil	P. 442
Tire pressure warning system	When changing the tire size	P. 454

Reporting safety defects for U.S. owners

If you believe that your vehicle has a defect which could cause a crash or could cause injury or death, you should immediately inform the National Highway Traffic Safety Administration (NHTSA) in addition to notifying Toyota Motor Sales, U.S.A., Inc. (Toll-free: 1-800-331-4331).

If NHTSA receives similar complaints, it may open an investigation, and if it finds that a safety defect exists in a group of vehicles, it may order a recall and remedy campaign. However, NHTSA cannot become involved in individual problems between you, your dealer, or Toyota Motor Sales, U.S.A., Inc.

To contact NHTSA, you may call the Vehicle Safety Hotline toll-free at 1-888-327-4236 (TTY: 1-800-424-9153); go to <http://www.safercar.gov>; or write to: Administrator, NHTSA, 1200 New Jersey Ave, S.E., Washington, DC 20590. You can also obtain other information about motor vehicle safety from <http://www.safercar.gov>.

Seat belt instructions for Canadian owners (in French)

The following is a French explanation of seat belt instructions extracted from the seat belt section in this manual.

See the seat belt section for more detailed seat belt instructions in English.

Utilisation correcte des ceintures de sécurité



- Tendez la sangle diagonale de sorte qu'elle couvre complètement l'épaule, sans entrer en contact avec le cou ou glisser de l'épaule.
- Placez la sangle abdominale le plus bas possible sur les hanches.
- Réglez la position du dossier de siège. Asseyez-vous le dos le plus droit possible et caliez-vous bien dans le siège.
- Ne vrillez pas la ceinture de sécurité.

ATTENTION

■ Lorsque vous utilisez la ceinture de sécurité du siège central de la troisième rangée

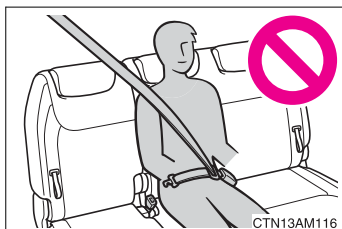

N'utilisez pas la ceinture de sécurité du siège central de la troisième rangée avec l'une ou l'autre des boucles déverrouillées. Si une seule des boucles est verrouillée, ceci peut entraîner des blessures graves, voire mortelles en cas de freinage brusque ou de collision.

Guide confort de ceinture de sécurité (siège extérieur de la troisième rangée)

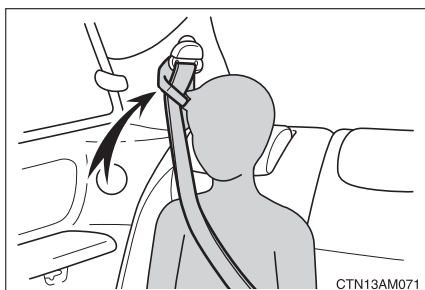

Si la sangle diagonale gêne la personne au niveau du cou, utilisez le guide confort de la ceinture de sécurité.

Entretien et soin

■ Ceintures de sécurité

Nettoyez avec un chiffon ou une éponge humectée d'eau savonneuse tiède. Profitez de l'occasion pour vérifier régulièrement que les ceintures ne sont pas effilochées, entaillées, ou ne paraissent pas exagérément usées.

ATTENTION

■ Détérioration et usure des ceintures de sécurité

Inspectez les ceintures de sécurité périodiquement. Contrôlez qu'elles ne sont pas entaillées, effilochées, et que leurs ancrages ne sont pas desserrés. N'utilisez pas une ceinture de sécurité défectueuse avant qu'elle ne soit remplacée. Une ceinture de sécurité défectueuse n'apporte aucune garantie de protection de l'occupant en cas d'accident.

A	<p>A/C.....240, 246, 256, 253</p> <p>ABS215</p> <p>Air conditioning filter.....469</p> <p>Air conditioning system</p> <ul style="list-style-type: none"> Air conditioning filter.....469 Front automatic air conditioning system246 Front manual air conditioning system240 Rear automatic air conditioning system256 Rear manual air conditioning system253 <p>Airbags</p> <ul style="list-style-type: none"> Airbag operating conditions.....121 Airbag precautions for your child125 Airbag warning light.....505 Curtain shield airbag operating conditions.....121 Curtain shield airbag precautions125 Front passenger occupant classification system130 General airbag precautions125 Locations of airbags118 Modification and disposal of airbags129 Proper driving posture.....116, 125 Side airbag operating conditions121 Side airbag precautions125 SRS airbags.....118 <p>Alarm.....113</p> <p>Antenna268</p> <p>Anti-lock brake system215</p> <p>Armrest.....392</p> <p>Audio input.....291</p> <p>Audio system</p> <ul style="list-style-type: none"> A/V input adapter318 Antenna.....268 Audio input291 Audio visual input.....318 AUX adapter291 CD player/changer271 DVD player....303, 312, 315, 316 MP3/WMA disc279 Optimal use.....287 Portable music player291 Radio.....265 Rear seat entertainment system296 Steering wheel audio switch.....292 Type262 <p>Audio visual input.....318</p> <p>Automatic light control system185</p> <p>Automatic transmission.....170</p> <p>AUX adapter291</p> <p>Auxiliary box375</p> <p>A/V input adapter318</p>
----------	---

B

Back-up lights

- Replacing light bulbs 486
- Wattage 549

Back door

- Back door 47
- Wireless remote control..... 27

Battery

- Checking 450
- If the vehicle has discharged battery 532
- Preparing and checking before winter 226

Bluetooth® 331

Bottle holder 374

Brakes

- Fluid..... 446
- Parking brake 173

Brake assist..... 215

Break-in tips 159

C

Care

- Exterior 418
- Interior 421
- Seat belts 422

Cargo capacity 225

Cargo hooks 402

CD changer 271

CD player 271

Chains 226

Child restraint system

- Booster seats, definition 136
- Booster seats, installation 140
- Convertible seats, definition 136
- Convertible seats, installation..... 140
- Front passenger occupant classification system 130
- Infant seats, definition 136
- Infant seats, installation..... 140
- Installing CRS with LATCH anchors 143, 146
- Installing CRS with seat belts 148
- Installing CRS with top tether strap..... 152, 153

Child safety

- Airbag precautions 125
- Battery precautions 452, 534
- Child restraint system..... 136
- Child-protectors..... 40
- How your child should wear the seat belt 90
- Installing child restraints..... 140
- Moon roof precautions 106
- Power window lock switch..... 100
- Power window precautions ... 101
- Removed key battery precautions 473
- Seat belt comfort guide 88
- Seat belt extender precautions 93
- Seat belt precautions 91
- Seat heater precautions 390

Child-protectors 40

Cleaning
 Exterior 418
 Interior 421
 Seat belts 422
Clock 385
Coat hooks 396
Coin holder 369
Compass 413
Condenser 446
Console box 365
Conversation mirror 386
Cooling system
 Engine overheating 536
Cornering assist sensors 209
Cruise control
 Cruise control 194
 Dynamic laser cruise
 control 197
Cup holders 370
Curtain shield airbags 118
Customizable features 565

D **Daytime running light
 system** 188
Defogger
 Rear window 260
 Side mirrors 260
Dimension 542
Dinghy towing 237
Display
 Dynamic laser cruise
 control 197
 Trip information 181
Do-it-yourself maintenance 430
Door courtesy lights
 Door courtesy lights 361
 Wattage 549
Doors
 Back door 47
 Door glasses 100
 Door lock 27, 33, 38
 Front doors 33
 Side mirrors 97
 Sliding doors 37
**Driver's seat belt reminder
 light** 507
Driving
 Break-in tips 159
 Correct posture 116
 Procedures 158
 Winter driving tips 226
Driving position memory 80
DVD player 303, 312, 315, 316

E

Emergency, in case of

- If the back door opener is inoperative 49
- If the engine will not start..... 529
- If the shift lever cannot be shifted 530
- If the vehicle has discharged battery 532
- If the warning buzzer sounds... 504
- If the warning light turns on 504
- If you have a flat tire 515, 516
- If you lose your keys/ wireless remote control transmitter 531
- If you think something is wrong 500
- If your vehicle becomes stuck..... 539
- If your vehicle needs to be towed 496
- If your vehicle overheats 536

Engine

- Compartment..... 438
- Engine switch 167
- Hood..... 434
- How to start the engine 167
- Identification number 543
- If the engine will not start..... 529
- Ignition switch..... 167
- Overheating..... 536

Engine coolant

- Capacity 546
- Checking 444
- Preparing and checking before winter 226

Engine coolant temperature

- gauge 174**

Engine immobilizer system..... 111

Engine oil

- Capacity 545
- Checking 439
- Preparing and checking before winter 226

Engine oil maintenance

- data 442**

Event data recorder 502

F

Floor mat..... 401

Fluid

- Brake 446
- Power steering 448
- Washer..... 453

Fog lights

- Replacing light bulbs 486
- Switch..... 190
- Wattage..... 549

Front automatic air

- conditioning system..... 246**

Front fog lights
 Replacing light bulbs 486
 Switch..... 190
 Wattage..... 549

Front manual air conditioning system 240

Front passenger occupant classification system 130

Front passenger's seat belt reminder light..... 507

Front seats
 Adjustment 56

Front side marker lights
 Replacing light bulbs 486
 Switch..... 185
 Wattage..... 549

Front turn signal lights
 Replacing light bulbs 486
 Wattage..... 549

Fuel
 Capacity 544
 Fuel gauge 174
 Fuel pump shut off system 501
 Gas station information 592
 Information 550
 Refueling 107
 Type 544

Fuel door..... 107

Fuel filler door 107

Fuel pump shut off system 501

Fuses..... 474

G **Garage door opener** 405

Garage door opener box 410

Gas station information 592

Gauges..... 174

Glove box 365

Grocery bag hooks 394

H **Hands-free system (for cellular phone)**..... 327

Head restraints
 Adjusting 82

Headlights
 Manual headlight leveling dial 187
 Replacing light bulbs 486
 Switch 185
 Wattage..... 549

Heaters
 Seat heaters..... 390
 Side mirror 260

Hood..... 434

Hooks
 Cargo hooks..... 402
 Grocery bag hooks..... 394

I	I/M test	429
	Identification	
	Engine	543
	Vehicle.....	543
	Ignition switch	167
	Illuminated entry system	361
	Indicator lights	177
	Initialization	
	Items to initialize.....	568
	Inside rear view mirror	95
	Interior lights	
	Interior lights.....	361
	Switch.....	362
	Wattage.....	549
	Intuitive parking assist	209
J	Jack	
	Positioning a floor jack	436
	Replacing the wheel	516
	Jack handle	516
K	Keyless entry	27
	Keys	
	Engine switch	167
	If you lose your keys/ wireless remote control transmitter	531
	Ignition switch.....	167
	Keyless entry.....	27
	Key number	26
	Keys	26
	Wireless remote control.....	27

L	License plate lights	
	Replacing light bulbs	486
	Wattage.....	549
	Light bulbs	
	Replacing	486
	Wattage.....	549
	Lights	
	Door courtesy lights	361
	Engine switch light	361
	Fog light switch	190
	Headlight switch	185
	Interior light switch	362
	Luggage compartment light	363
	Outer foot lights.....	361
	Personal light switch	362
	Replacing light bulbs	486
	Turn signal lever.....	172
	Vanity lights.....	384
	Wattage.....	549
	Load capacity	225
	Lock steering column	167
	Luggage compartment light	
	Switch.....	363
	Wattage.....	549

M	Maintenance	
	Do-it-yourself	
	maintenance	430
	General maintenance.....	426
	Maintenance data.....	542
	Maintenance requirements....	424
	Meter	
	Instrument panel light	
	control.....	176
	Meters	174
	Mirrors	
	Conversation mirror.....	386
	Inside rear view mirror.....	95
	Side mirror heaters.....	260
	Side mirrors.....	97
	Vanity mirrors	384
	Moon roof	104
	MP3 disc	279
N	Noise from under vehicle	20
	Note pad holder	381
O	Odometer	174
	Oil	
	Engine oil	439
	Opener	
	Back door	47
	Fuel filler door	107
	Hood.....	434
	Outer foot lights	
	Outer foot lights.....	361
	Replacing light bulbs	486
	Wattage.....	549
	Outside rear view mirrors	
	Adjusting and folding.....	97
	Driving position memory.....	80
	Overheating, Engine	536

P	Parking assist sensors	209
	Parking brake	173
	Parking lights	
	Replacing light bulbs.....	486
	Switch	185
	Wattage.....	549
	Personal lights	
	Switch	362
	Wattage.....	549
	Power outlets	387
	Power windows	100, 102
Q	Quarter windows	102
R	Radiator	446
	Radio	265
	Rear automatic air conditioning system	256
	Rear manual air conditioning system	253
	Rear seat	
	Adjustment	59, 61
	Folding third seats.....	71, 72
	Installing second seats.....	66
	Removing second seats.....	65
	Seating configurations	63
	Stowing third seats.....	73, 75
	Tumbling second seats	63
	Rear seat entertainment system	
	Initial setting	320
	Rear seat entertainment system	296
	Rear side marker lights	
	Replacing light bulbs.....	486
	Wattage.....	549

Rear turn signal lights
 Replacing light bulbs 486
 Wattage 549
Rear window defogger..... 260
Rear window wiper..... 193
Replacing
 Fuses..... 474
 Light bulbs 486
 Tires 516
 Wireless remote control
 battery 472
Reporting safety defects for
U.S. owners 570
Roof luggage carrier 219

S **Seat belts**
 Adjusting the seat belt 85
 Automatic Locking
 Retractor 88
 Child restraint system
 installation 140
 Cleaning and maintaining
 the seat belts..... 422
 Emergency Locking
 Retractor 88
 How to wear your seat belt..... 85
 How your child should wear
 the seat belt 90
 Pregnant women, proper seat
 belt use 89
 Reminder light 507
 Seat belt extenders 90
 Seat belt pretensioners 88
Seat heaters..... 390
Seating capacity..... 225

Seats
 Adjustment56, 59, 61
 Adjustment
 precaution58, 60, 62
 Child seats/child restraint
 system installation140
 Cleaning421
 Driver's seat position
 memory80
 Head restraint.....82
 Properly sitting in the seat..... 116
 Seat heaters390
Second seats.....59
Service reminder
indicators177
Shift lever
 Automatic transmission170
 If the shift lever cannot
 be shifted from P.....530
Shift lock system530
Side airbags.....118
Side marker lights
 Replacing486
 Switch.....185
 Wattage549
Side mirrors
 Adjusting and folding.....97
 Mirror position memory80
Sliding doors
 Sliding doors37
 Wireless remote control27

Spare tire
 Inflation pressure.....548
 Spare tire.....516
Spark plug546
Specifications.....542
Speech command switch332
Speedometer 174
Steering
 Column lock release..... 167
Steering wheel
 Adjustment94
 Audio switches292
Stop lights
 Replacing light bulbs486
 Wattage.....549
Storage feature.....364
Storage precautions223
Stuck
 If your vehicle becomes
 stuck539
Sunshades
 Rear door393
 Roof..... 105
Sun visors.....383
Switch
 Engine switch 167
 Fog light switch 190
 Ignition switch..... 167
 Light switches..... 185
 Power door lock switch33
 Power window switch100, 102
 Window lock switch..... 100
 Wiper and washer
 switch.....191, 193

T

Tables
 Front seat side table 399
 Seatback tables 397
Tachometer 174
Tail lights
 Replacing light bulbs.....486
 Switch 185
 Wattage.....549
Talk switch 332
Telephone switch..... 332
Theft deterrent system
 Alarm..... 113
 Engine immobilizer system ... 111
Theft prevention labels 115
Third seats.....61
Tire inflation pressure463
Tire information
 Glossary.....559
 Size548
 Tire identification number.....555
 Uniform tire quality
 grading.....557
Tires
 Chains.....226
 Checking454
 If you have a flat tire.....515, 516
 Inflation pressure463
 Information553
 Replacing.....516
 Rotating tires.....454
 Size548
 Snow tires226
 Tire pressure warning
 system454, 507
Tools516
Total load capacity225

Towing
 Dinghy towing..... 237
 Trailer towing..... 229
Traction control..... 215
TRAC..... 215
Trays..... 380
Trip information display..... 181
Trip meter..... 174
Turn signal lights
 Replacing light bulbs 486
 Switch..... 172
 Wattage..... 549

V **Valet key..... 26**
Vanity lights
 Vanity lights..... 384
 Wattage..... 549
Vanity mirrors..... 384
Vehicle identification
 number..... 543
Vehicle stability control..... 215
VSC..... 215

W **Warning buzzers**
 Brake system504
 Seat belt reminder.....507
Warning lights
 Anti-lock brake system505
 Brake assist system505
 Brake system504
 Charging system505
 Dynamic laser cruise control
 master warning light.....507
 Engine oil pressure505
 Low fuel level507
 Low washer fluid507
 Malfunction indicator lamp505
 Master warning light507
 Open door507
 Pretensioners505
 Seat belt reminder light507
 SRS airbags505
 Third seat warning light507
 Tire pressure warning light.....507
 Vehicle stability control
 system505
Washer
 Checking453
 Preparing and checking
 before winter226
 Switch.....191, 193
Washing and waxing418

Weight	
Cargo capacity	219
Load limits	225
Weight	542
Wheels	467
Window glasses	100
Window lock switch.....	100
Windows	
Power windows	100, 102
Rear window defogger	260
Washer.....	191, 193
Windshield wiper de-icer.....	260
Windshield wipers	191
Wireless remote control	
Replacing the battery	472
Wireless remote control	27
WMA disc.....	279

What to do if...

What to do if...

A tire punctures	P. 515/ P. 516	If you have a flat tire
The engine does not start	P. 529	If the engine will not start
	P. 111	Engine immobilizer system
	P. 532	If the battery is discharged
The shift lever cannot be moved out	P. 530	If the shift lever cannot be shifted from P
The engine coolant temperature gauge enters the red zone	P. 536	If your vehicle overheats
Steam can be seen coming from under the hood		
The key is lost	P. 531	If you lose your keys/wireless remote control transmitter
The battery runs out	P. 532	If the battery is discharged
The doors cannot be locked	P. 33	Front doors
	P. 37	Siding doors
	P. 47	Back door
The horn begins to sound	P. 113	Alarm
The vehicle is stuck in mud or sand	P. 539	If the vehicle becomes stuck

A warning light or indicator light comes on

P. 504

If a warning light turns on or a warning buzzer sounds...

► Optitron type meters

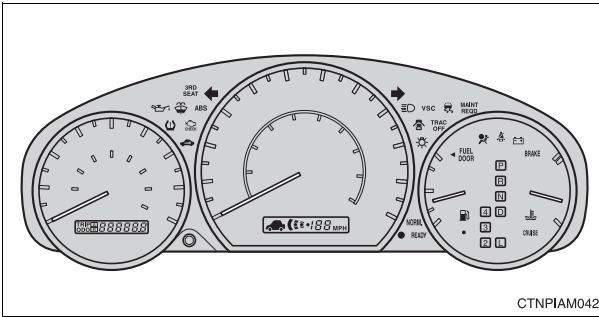

► Non-Optitron type meters

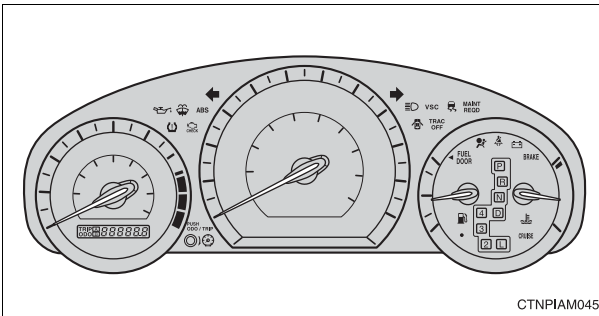



■ Warning lights

BRAKE Brake system warning light

or

 P. 504

 Charging system warning light P. 505

 Low engine oil pressure warning light P. 505

 **CHECK** Malfunction indicator lamp

or

 P. 505

 SRS warning light P. 505

 Open door warning light P. 507

ABS "ABS" warning light

or

 P. 505

VSC "VSC" warning light P. 505

 Low fuel level warning light P. 507

 Driver's seat belt reminder light P. 507

 **PASSENGER** Front passenger's seat belt reminder light P. 507

MAINT REQD Engine oil replacement reminder light P. 507

 Low washer fluid warning light P. 507

 Tire pressure warning light P. 507

3RD SEAT Third seat warning light P. 507

 Dynamic laser cruise control master warning light P. 507

GAS STATION INFORMATION

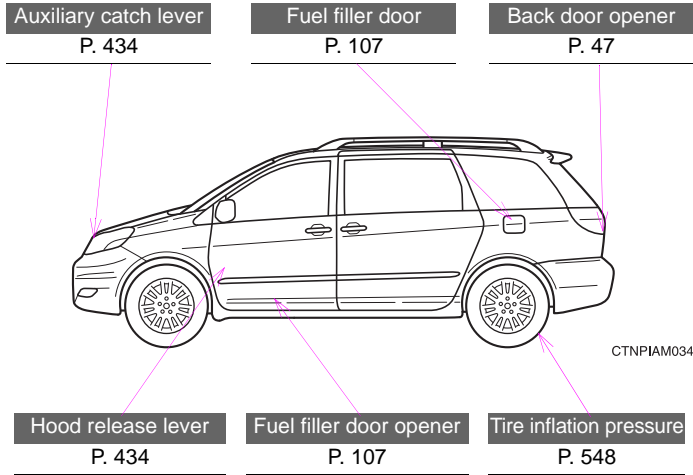

Fuel tank capacity (Reference)	20.9 gal. (79 L, 17.5 Imp.gal.)	
Fuel type	Unleaded gasoline with an Octane Rating of 87 (Research Octane Number 91)	
Cold tire inflation pressure	P. 548	
Engine oil capacity Drain and refill (Reference)	Without filter	qt. (L, Imp.qt.) 6.0 (5.7, 5.0)
	With filter	6.4 (6.1, 5.4)
Engine oil type	Toyota Genuine Motor Oil or equivalent Oil grade: P. 545 ILSAC multigrade engine oil Recommended oil viscosity: SAE 5W-30	

1 Before driving

1-1. Key information
 Keys 26

1-2. Opening, closing and locking the doors
 Wireless remote control 27
 Front doors 33
 Sliding doors 37
 Back door 47

1-3. Adjustable components (seats, mirrors, steering wheel)
 Front seats 56
 Second seats 59
 Third seats 61
 Seating configurations..... 63
 Driving position memory..... 80
 Head restraints 82
 Seat belts 85
 Steering wheel 94
 Anti-glare inside rear view mirror..... 95
 Outside rear view mirrors 97

1-4. Opening and closing the windows
 Power windows 100
 Quarter windows 102
 Moon roof 104

1-5. Refueling
 Opening the fuel tank cap 107

1-6. Theft deterrent system
 Engine immobilizer system 111
 Alarm 113
 Theft prevention labels (for U.S.A.) 115

1-7. Safety information
 Correct driving posture 116
 SRS airbags 118
 Front passenger occupant classification system..... 130
 Child restraint systems 136
 Installing child restraints 140

2 When driving

2-1. Driving procedures
 Driving the vehicle 158
 Engine (ignition) switch..... 167
 Automatic transmission 170
 Turn signal lever 172
 Parking brake 173

2-2. Instrument cluster and information display
 Gauges and meters 174
 Indicators and warning lights 177
 Trip information display 181

2-3. Operating the lights and wipers
 Headlight switch 185
 Fog light switch 190

Windshield wipers and washer	191
Rear window wiper and washer	193

2-4. Using other driving systems

Cruise control.....	194
Dynamic laser cruise control.....	197
Intuitive parking assist.....	209
Driving assist systems	215

2-5. Driving information

Cargo and luggage	219
Vehicle load limits	225
Winter driving tips	226
Trailer towing	229
Dinghy towing	237

3 Interior features

3-1. Using the air conditioning system and defogger

Front manual air conditioning system	240
Front automatic air conditioning system	246
Rear manual air conditioning system	253
Rear automatic air conditioning system	256
Rear window and outside rear view mirror defoggers, and windshield wiper de-icer.....	260

3-2. Using the audio system

Audio system types	262
Using the radio	265
Using the CD player	271
Playing back MP3 and WMA discs	279
Optimal use of the audio system.....	287
Using the AUX adapter.....	291
Using the steering wheel audio switches.....	292

3-3. Using the rear audio system

Rear seat entertainment system features.....	296
Using the DVD player (DVD video).....	303
Using the DVD player (video CD).....	312
Using the DVD player (audio CD/CD text).....	315
Using the DVD player (MP3 discs)	316
Using the video mode.....	318
Changing the initial setting.....	320

3-4. Using the hands-free phone system (for cellular phone)

Hands-free phone system (for cellular phone) features	327
Using the hands-free phone system (for cellular phone)	331
Making a phone call	339
Setting a cellular phone.....	345

Security and system
 setup 350
 Using the phone book 353

3-5. Using the interior lights

Interior lights list 361
 • Personal/interior light main
 switch 362
 • Personal/interior lights..... 362
 • Luggage compartment
 light 363

3-6. Using the storage features

List of storage features..... 364
 • Glove box 365
 • Console box 365
 • Coin holder..... 369
 • Cup holders..... 370
 • Bottle holders 374
 • Auxiliary boxes 375
 • Trays 380
 • Note pad holder 381

3-7. Other interior features

Sun visors 383
 Vanity mirrors 384
 Clock 385
 Conversation mirror..... 386
 Power outlets 387
 Seat heaters 390
 Armrests 392
 Rear side sunshades 393
 Grocery bag hooks 394
 Coat hooks 396
 Seatback tables..... 397
 Front seat side table..... 399
 Floor mat 401
 Luggage compartment
 features 402

Garage door opener 405
 Garage door opener box 410
 Compass 413

4 Maintenance and care

4-1. Maintenance and care

Cleaning and protecting
 the vehicle exterior 418
 Cleaning and protecting
 the vehicle interior 421

4-2. Maintenance

Maintenance
 requirements 424
 General maintenance 426
 Emission inspection and
 maintenance (I/M)
 programs 429

4-3. Do-it-yourself maintenance

Do-it-yourself service
 precautions 430
 Hood 434
 Positioning a floor jack..... 436
 Engine compartment 438
 Tires..... 454
 Tire inflation pressure 463
 Wheels..... 467
 Air conditioning filter 469
 Wireless remote control
 battery 472
 Checking and replacing
 fuses 474
 Light bulbs 486

5 When trouble arises

5-1. Essential information

If your vehicle needs to be towed	496
If you think something is wrong	500
Fuel pump shut off system	501
Event data recorder	502

5-2. Steps to take in an emergency

If a warning light turns on or a warning buzzer sounds... ..	504
If you have a flat tire (vehicles with run-flat tires).....	515
If you have a flat tire (vehicles with standard tires).....	516
If the engine will not start	529
If the shift lever cannot be shifted from P.....	530
If you lose your keys/wireless remote control transmitter	531
If the battery is discharged	532
If your vehicle overheats	536
If the vehicle becomes stuck	539

6 Vehicle specifications

6-1. Specifications

Maintenance data (fuel, oil level, etc.)	542
Fuel information.....	550
Tire information	553

6-2. Customization

Customizable features.....	565
----------------------------	-----

6-3. Initialization

Items to initialize	568
---------------------------	-----

7 For owners

Reporting safety defects for U.S. owners	570
Seat belt instructions for Canadian owners (in French).....	571

Index

Abbreviation list.....	576
Alphabetical index	578
What to do if... ..	589