

Abbreviation/Acronym list

ABBREVIATIONS	MEANING
2WD	Two Wheel Drive
4WD	Four Wheel Drive
ABS	Anti-Lock Brake System
ACC	Accessory
AI-SHIFT	Artificial Intelligence shifting
ALR	Automatic Locking Retractor
A-TRAC	Active Traction Control
AUTO LSD	Automatic Limited Slip Differential
CRS	Child Restraint System
E/M	English/U.S. Customary System and metric
ECU	Electronic Control Unit
EDR	Event Data Recorder
ELR	Emergency Locking Retractor
GAWR	Gross Axle Weight Rating
GVWR	Gross Vehicle Weight Rating
I/M	Emission inspection and maintenance
INT	Intermittent
LATCH	Lower Anchors and Tethers for Children
LED	Light Emitting Diode
LT	Light truck
M + S	Mud + Snow
MMT	Methylcy clopentadienyl Manganese Tricarbonyl
MTBE	Methyl Tertiary Butyl Ether
OBD	On Board Diagnostics
RES	Resume
RR DIFF LOCK	Rear differential lock
SRS	Supplemental Restraint System

ABBREVIATIONS	MEANING
TIN	Tire Identification Number
TPMS	Tire Pressure Warning System
TRAC/TRC	Traction Control
TWI	Treadwear indicators
VIN	Vehicle Identification Number
VSC	Vehicle Stability Control

For your information

Main Owners Manual

Please note that this manual applies to all models explains and all equipment, including options. Therefore, you may find some explanations for equipment not installed on your vehicle.

All specifications provided in this manual are current at the time of printing. However, because of the Toyota policy of continual product improvement, we reserve the right to make changes at any time without notice.

Depending on specifications, the vehicle shown in the illustrations may differ from your vehicle in terms of equipment.

Noise from under vehicle after turning off the engine

Approximately five hours after the engine is turned off, you may hear sound coming from under the vehicle for several minutes. This is the sound of a fuel evaporation leakage check and, it does not indicate a malfunction.

Accessories, spare parts and modification of your Toyota

A wide variety of non-genuine spare parts and accessories for Toyota vehicles are currently available in the market. You should know that Toyota does not warrant these products and is not responsible for their performance, repair, or replacement, or for any damage they may cause to, or adverse effect they may have on, your Toyota vehicle.

This vehicle should not be modified with non-genuine Toyota products. Modification with non-genuine Toyota products could affect its performance, safety or durability, and may even violate governmental regulations. In addition, damage or performance problems resulting from the modification may not be covered under warranty.

Installation of a mobile two-way radio system

As the installation of a mobile two-way radio system in your vehicle could affect electronic systems such as the multiport fuel injection system/sequential multiport fuel injection system, cruise control system, anti-lock brake system, SRS airbag system and seat belt pretensioner system, be sure to check with your Toyota dealer for precautionary measures or special instructions regarding installation.

Scrapping your Toyota

The SRS airbag and seat belt pretensioner devices in your Toyota contain explosive chemicals. If the vehicle is scrapped with the airbags and seat belt pretensioners left as they are, this may cause an accident such as fire. Be sure to have the systems of the SRS airbag and seat belt pretensioner removed and disposed of by a qualified service shop or by your Toyota dealer before you scrap your vehicle.

Perchlorate Material

Special handling may apply,
See www.dtsc.ca.gov/hazardouswaste/perchlorate.

Your vehicle has components that may contain perchlorate. These components may include airbag, seat belt pretensioners, and wireless remote control batteries.

 **CAUTION**

n General precautions while driving

Driving under the influence: Never drive your vehicle when under the influence of alcohol or drugs that have impaired your ability to operate your vehicle. Alcohol and certain drugs delay reaction time, impair judgment and reduce coordination, which could lead to an accident that could result in death or serious injury.

Defensive driving: Always drive defensively. Anticipate mistakes that other drivers or pedestrians might make and be ready to avoid accidents.

Driver distraction: Always give your full attention to driving. Anything that distracts the driver, such as adjusting controls, talking on a cellular phone or reading can result in a collision with resulting death or serious injury to you, your occupants or others.

n General precaution regarding children's safety

Never leave children unattended in the vehicle, and never allow children to have or use the key.

Children may be able to start the vehicle or shift the vehicle into neutral. There is also a danger that children may injure themselves by playing with the cigarette lighter, the windows, or other features of the vehicle. In addition, heat build-up or extremely cold temperatures inside the vehicle can be fatal to children.

Symbols used throughout this manual

Cautions & Notices

⚠ CAUTION

This is a warning against anything which may cause injury to people if the warning is ignored. You are informed about what you must or must not do in order to reduce the risk of injury to yourself and others.

⚠ NOTICE

This is a warning against anything which may cause damage to the vehicle or its equipment if the warning is ignored. You are informed about what you must or must not do in order to avoid or reduce the risk of damage to your Toyota and its equipment.

Symbols used in illustrations



Safety symbol

The symbol of a circle with a slash through it means “Do not”, “Do not do this”, or “Do not let this happen”.

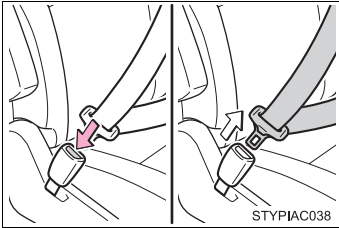

Arrows indicating operations



-  Indicates the action (pushing, turning, etc.) used to operate switches and other devices.
-  Indicates the outcome of an operation (e.g. a lid opens).

TABLE OF CONTENTS

1	Before driving	Adjusting and operating features such as door locks, mirrors, and steering column.
2	When driving	Driving, stopping and safe-driving information.
3	Interior features	Air conditioning and audio systems, as well as other interior features for a comfortable driving experience.
4	Maintenance and care	Cleaning and protecting your vehicle, performing do-it-yourself maintenance, and maintenance information.
5	When trouble arises	What to do if the vehicle needs to be towed, gets a flat tire, or is involved in an accident.
6	Vehicle specifications	Detailed vehicle information.
7	For owners	Reporting safety defects for U.S. owners, and seat belt and SRS airbag instructions for Canadian owners
	Index	Alphabetical listing of information contained in this manual.

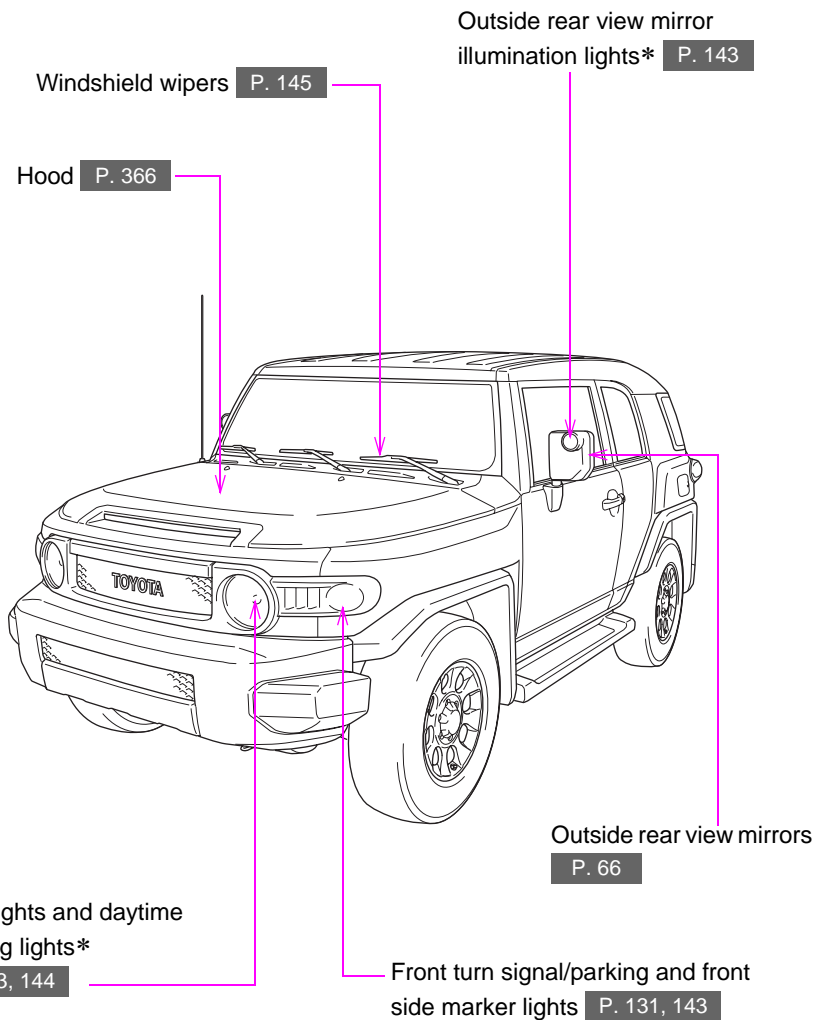

Stop/tail and rear side
marker lights P. 143

Fuel filler door P. 71

Access doors P. 34

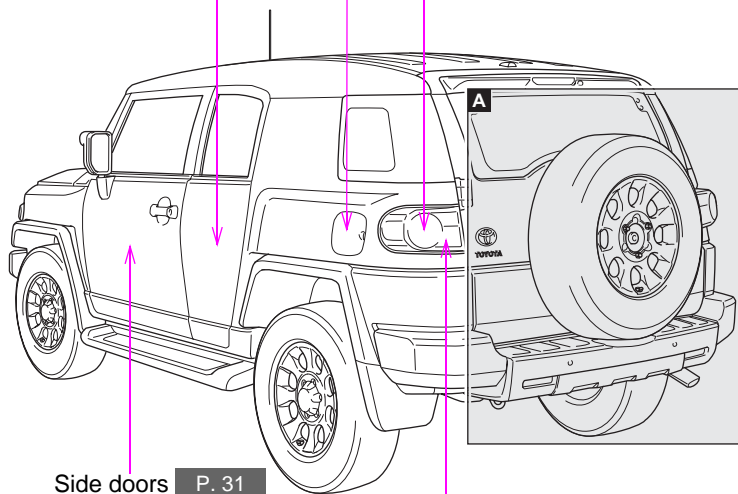

Side doors P. 31

Tires

- | Rotation P. 381
- | Replacement P. 440
- | Inflation pressure P. 387
- | Information P. 482

Rear turn signal lights P. 131

*: If equipped

A

Glass hatch **P. 41**

Rear window
defogger **P. 213**

Rear window wiper*
P. 147

Back door **P. 36**

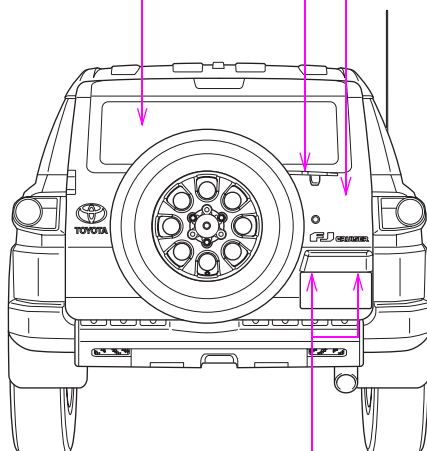

License plate lights **P. 143**

*: If equipped

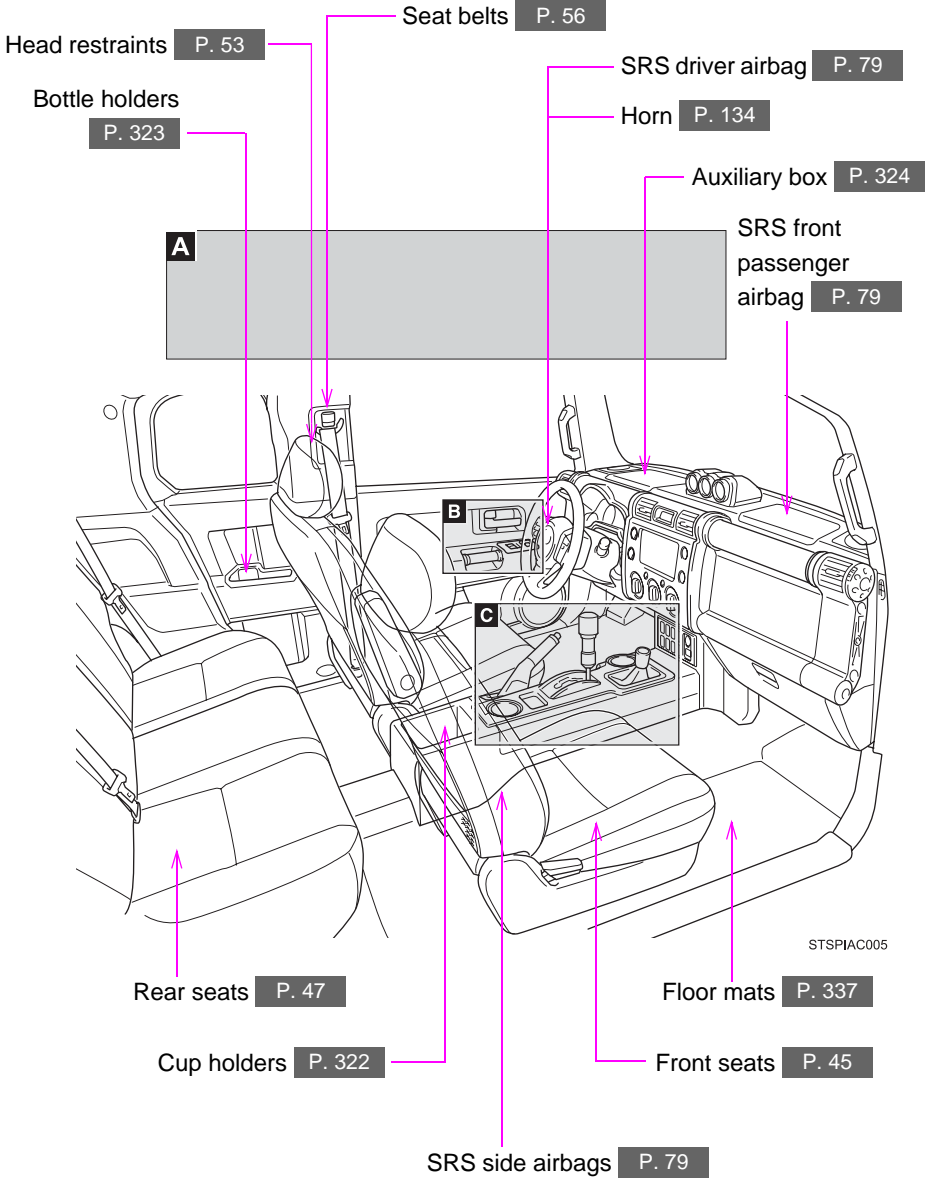

A

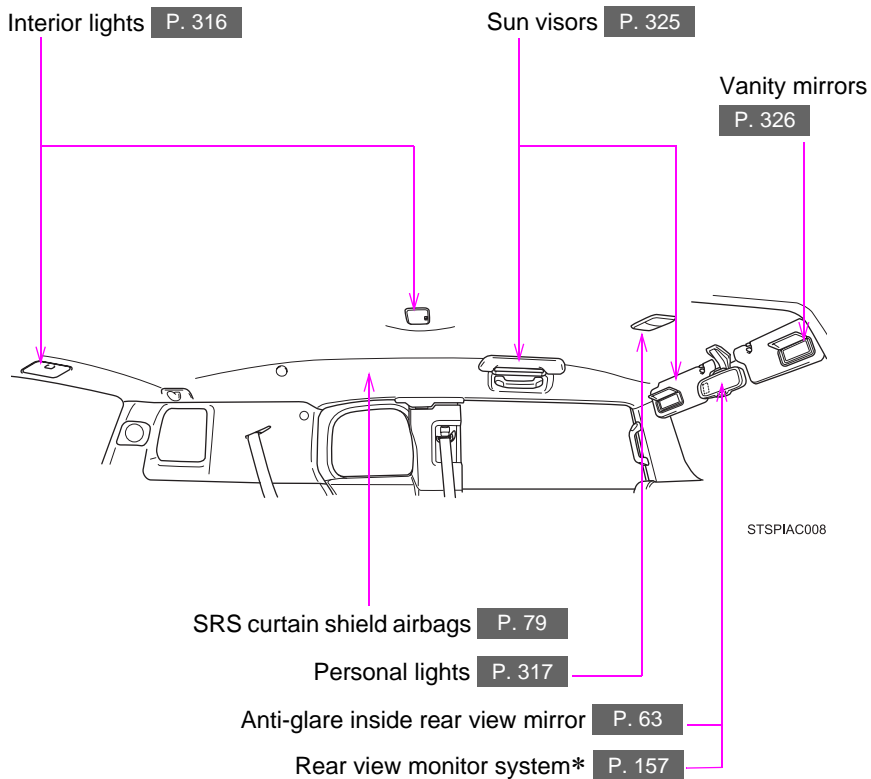

B

Inside door lock button P. 32

Door lock switch P. 31

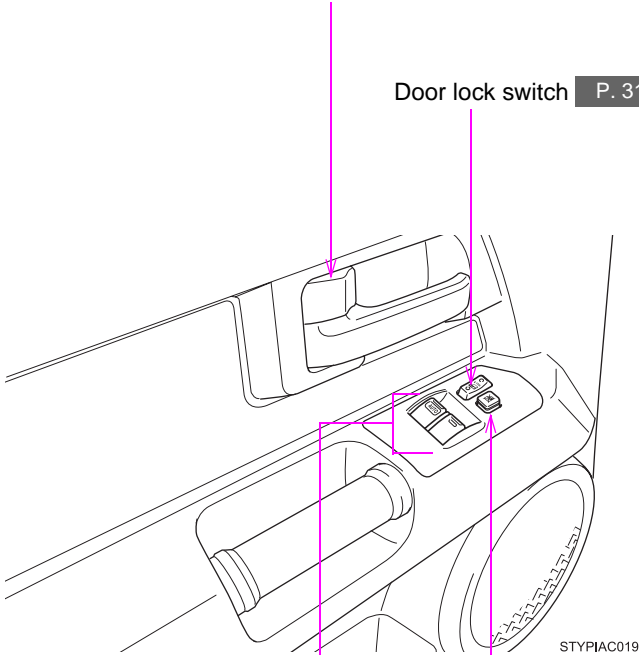

STYPIAC019

Window lock switch P. 69

Power window switches P. 69

*: If equipped

C

► **Automatic transmission**

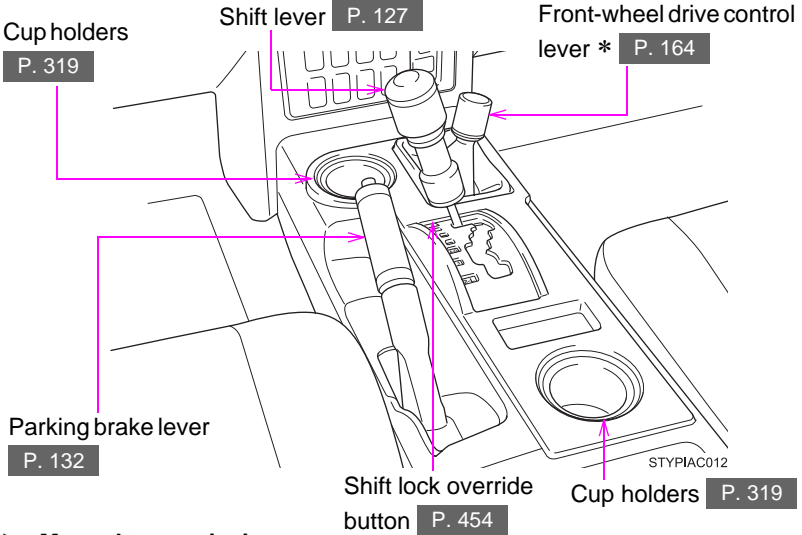

► **Manual transmission**

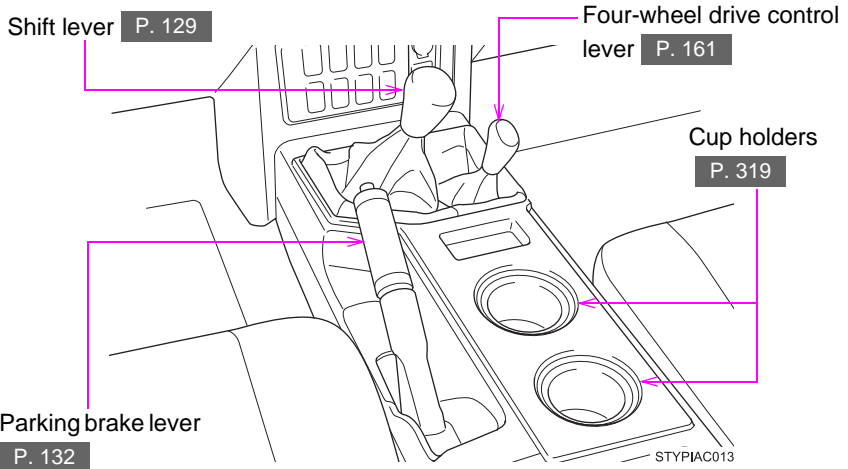

*: If equipped

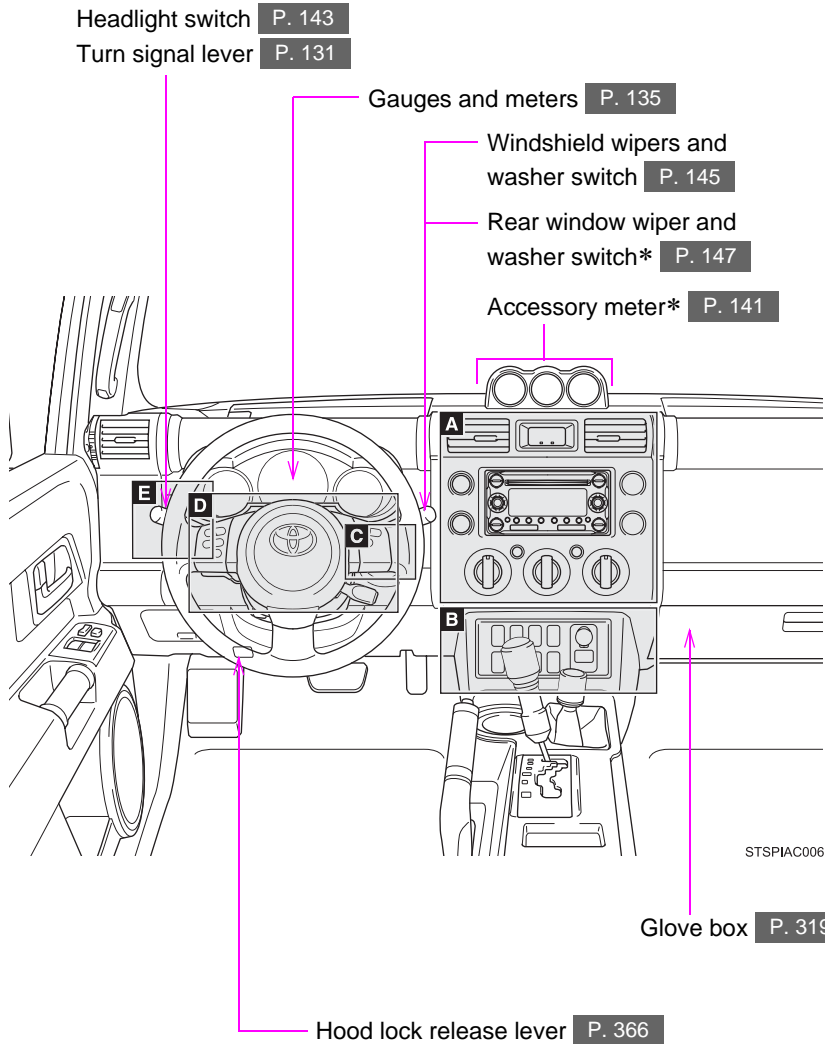

*: If equipped

A

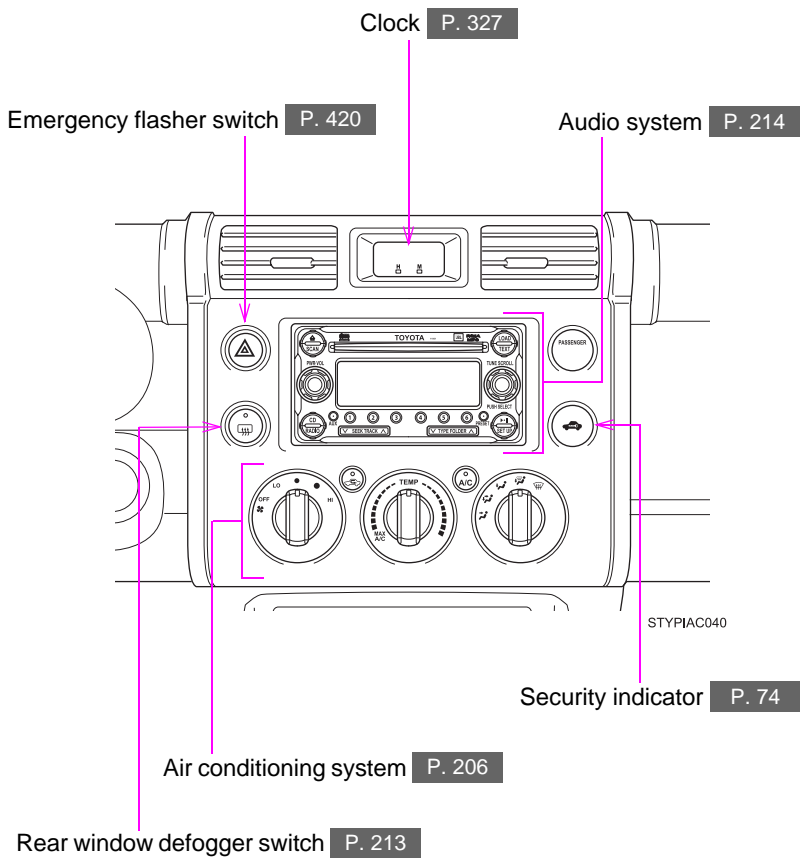

B

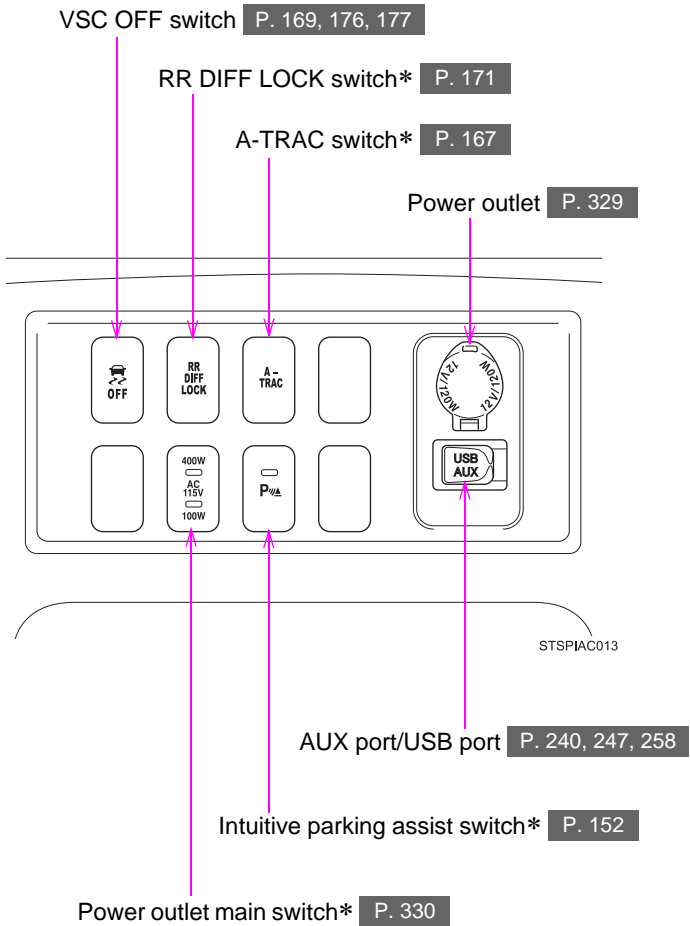

*: If equipped

C

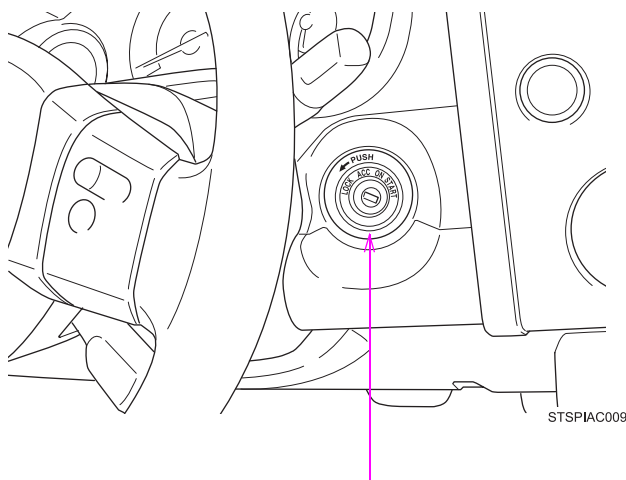

STSPIAC009

Engine (ignition) switch P. 124

D

Audio remote control switches P. 259

Telephone switch P. 283

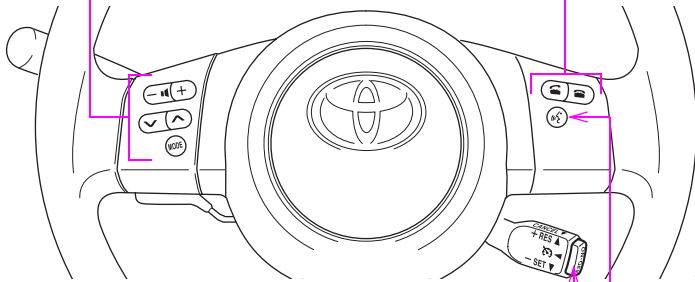

STSPIAC007

Talk switch P. 283

Cruise control switch* P. 148

*: If equipped

E

Instrument panel light control dial P. 136

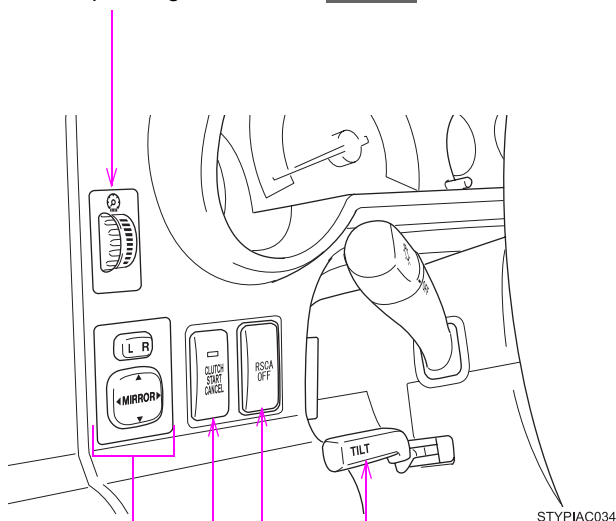

Tilt steering lock
release lever P. 62

RSCA OFF switch P. 90

CLUTCH START CANCEL switch* P. 174

Outside rear view mirror switches* P. 66

*: If equipped

Child restraint anchor brackets P. 101

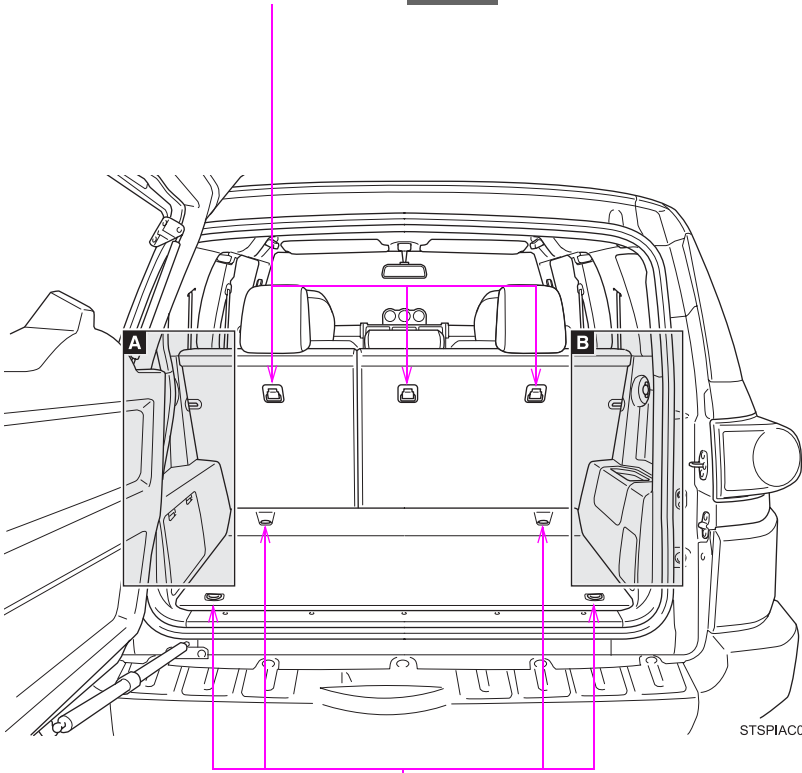

Tie-down hooks P. 340

A

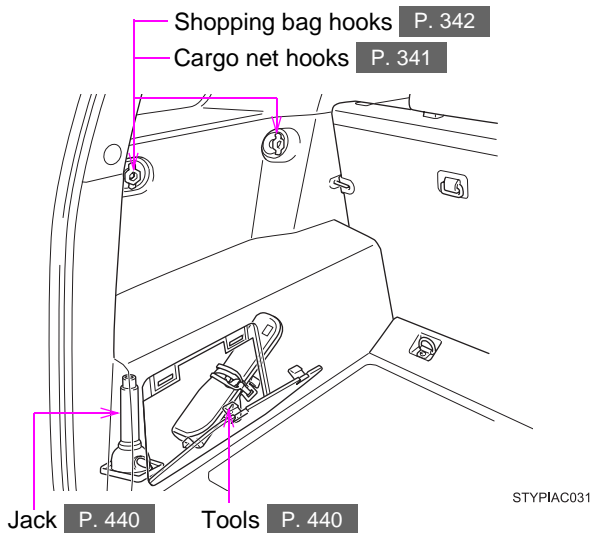

B

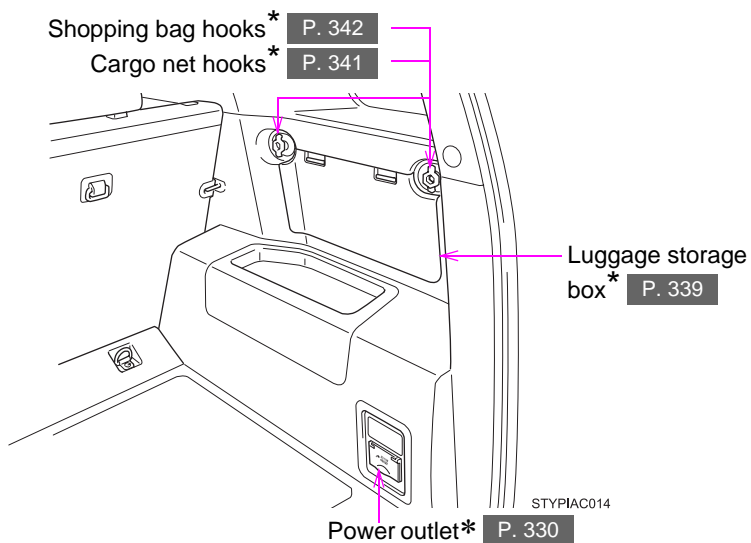

*: If equipped

*: Vehicles without sub woofer



FJ CRUISER

2 0 1 1

QUICK REFERENCE
GUIDE



TOYOTA

2011 FJ Cruiser

This *Quick Reference Guide* is a summary of basic vehicle operations. It contains brief descriptions of fundamental operations so you can locate and use the vehicle's main equipment quickly and easily.

The *Quick Reference Guide* is not intended as a substitute for the *Owner's Manual* located in your vehicle's glove box. We strongly encourage you to review the *Owner's Manual* and supplementary manuals so you will have a better understanding of your vehicle's capabilities and limitations.

Your dealership and the entire staff of Toyota Motor Sales, U.S.A., Inc. wish you many years of satisfied driving in your new FJ Cruiser.

! A word about safe vehicle operations

This *Quick Reference Guide* is not a full description of FJ Cruiser operations. Every FJ Cruiser owner should review the *Owner's Manual* that accompanies this vehicle.

Pay special attention to the boxed information highlighted in color throughout the *Owner's Manual*. Each box contains safe operating instructions to help you avoid injury or equipment malfunction.

All information in this *Quick Reference Guide* is current at the time of printing. Toyota reserves the right to make changes at any time without notice.

INDEX

OVERVIEW

Engine maintenance	7
Fuel tank door release and cap	6
Hood release	7
Indicator symbols	4-5
Instrument cluster	4
Instrument panel	2-3
Keyless entry¹	6

FEATURES/OPERATIONS

Accessory meter	13
Air Conditioning/Heating	16
Audio	14-15
Automatic Transmission	8
Bottle holders-Rear seat	19
Clock	15
Cruise control	17
Cup holders	19
Door-Back	13
Four-wheel drive	9
Intuitive parking assist	16
Light control-Instrument panel	19
Lights¹ & turn signals	12
Parking brake	10
Power outlet-12V DC	18
Power outlet-115V AC	18
Seat adjustments-Front	10
Seats-Folding rear seats	11
Seats-Head restraints	10
Seats-Removing rear seats	11
Telephone controls (Bluetooth®)	17
Tilt steering wheel	8
VSC OFF button	18
Windows	13
Windshield wipers & washers	12

SAFETY AND

EMERGENCY FEATURES

Door locks	20
Seat belts	20
Seat belts-Shoulder belt anchor	20
Spare tire & tools	21
Tire Pressure Monitoring (warning) System	20

¹ Visit your Toyota dealer for information on this and other customizable options.

OVERVIEW

Instrument panel

Steering wheel controls

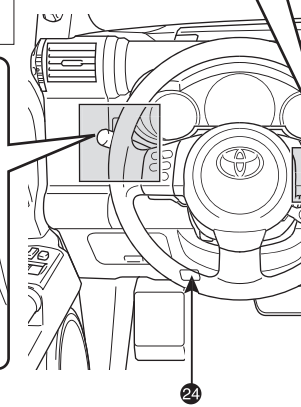
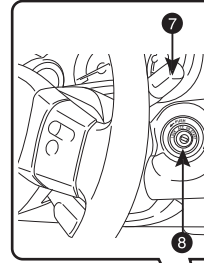
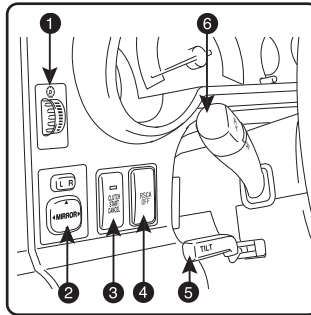
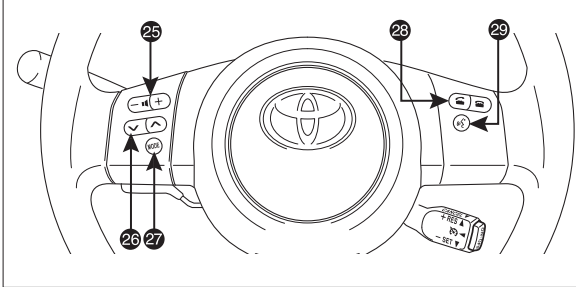

- 1 Instrument panel light control
- 2 Power outside rearview mirror controls¹
- 3 Clutch start cancel switch¹
- 4 Roll Sensing of Curtain shield Airbag OFF switch
- 5 Tilt steering lock release
- 6 Headlight and turn signal control
- 7 Wiper and washer controls
- 8 Ignition switch
- 9 Emergency flasher button
- 10 Clock
- 11 Front passenger seat belt reminder light
- 12 Audio system
- 13 Engine immobilizer indicator
- 14 Air Conditioning controls
- 15 Rear window defogger button
- 16 VSC OFF switch¹

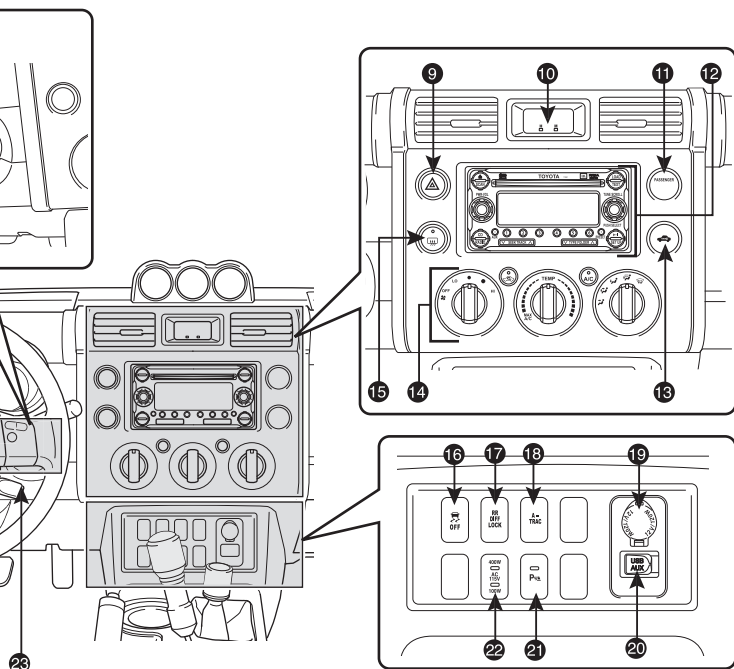

- 17 Rear differential lock button¹
- 18 Active traction control switch¹
- 19 Power outlet
- 20 AUX or USB/AUX port
- 21 Intuitive parking assist switch¹
- 22 Power outlet main switch¹
- 23 Cruise control¹
- 24 Hood release
- 25 Volume control switch (for audio)
- 26 "V ▲" button (for audio)
- 27 "MODE" button (for audio)
- 28 Telephone controls
- 29 Voice command button

¹ If equipped





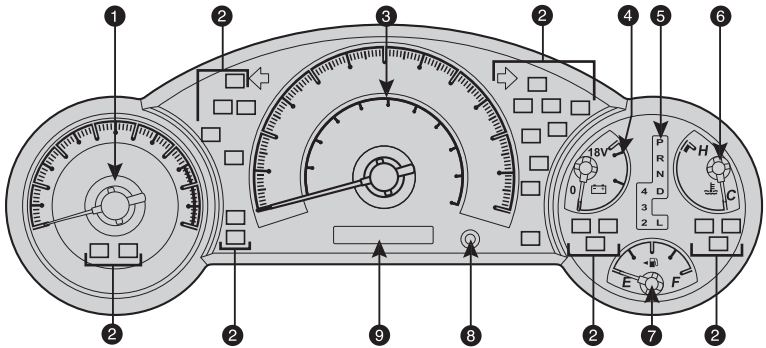

² For details, refer to the "Navigation System Owner's Manual."

Instrument cluster























- ❶ Tachometer
- ❷ Service indicators
- ❸ Speedometer
- ❹ Voltmeter
- ❺ Automatic Transmission indicator
- ❻ Engine coolant temperature
- ❼ Fuel gauge
- ❽ Trip meter reset knob
- ❾ Odometer and two trip meters

Indicator symbols

BRAKE	Brake system warning ¹
	PASSENGER  Driver/Front passenger seat belt reminder ¹ (alarm will sound if speed is over 12 mph)
	Battery warning ¹
	Low engine oil pressure warning ¹
	Malfunction/Check Engine indicator ¹
MAINT REQD	Maintenance/Service required indicator ¹
	Low fuel level warning ¹
	Open door warning ¹

¹ For details, refer to "If a warning light turns on or a warning buzzer sounds" Section 5-2, 2011 Owner's Manual.

² For details, see "Rear differential lock system," Section 2-4, 2011 Owner's Manual.

	Airbag SRS warning ¹
	Automatic Transmission fluid temperature warning ¹
	Unengaged Park warning ¹
	Low Tire Pressure Warning ¹
	Engine immobilizer system indicator
	Front passenger occupant classification indicator
	Headlight high beam indicator
	Turn signal indicator
	Automatic Transmission indicator
	Rear differential lock indicator ²
	Center differential lock indicator ³
	Vehicle Stability Control OFF indicator
	Four-wheel drive indicator ³
	Slip indicator ¹
	AUTO Limited Slip Differential indicator
	Active traction control system indicator
	Roll Sensing of Curtain shield Airbag OFF indicator
	Traction Control/OFF indicator
	Cruise control indicator ⁴
	Anti-lock Brake System warning ¹

³ If this light flashes, refer to "Four-wheel drive system," Section 2-4, 2011 Owner's Manual.

⁴ If this light flashes, refer to "Cruise control," Section 2-4, 2011 Owner's Manual.

Fuel tank door release and cap

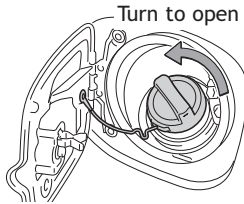
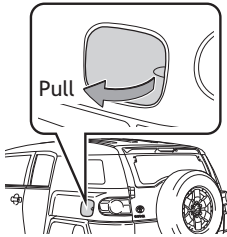

NOTE: Tighten until one click is heard. If the cap is not tightened enough, Check Engine "CHECK" indicator may illuminate.

Keyless entry (if equipped)

Beep sound can be switched ON or OFF. Refer to the *Owner's Manual* for more details.

Locking operation

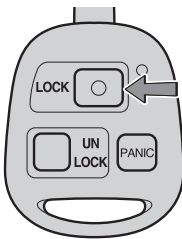

Push 

Unlocking operation

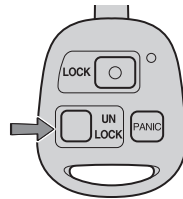

Push ONCE: Driver door
TWICE: All doors



NOTE: If a door is not opened within 60 seconds of unlocking, all doors will relock for safety.

Panic button



Push and hold 

Hood release

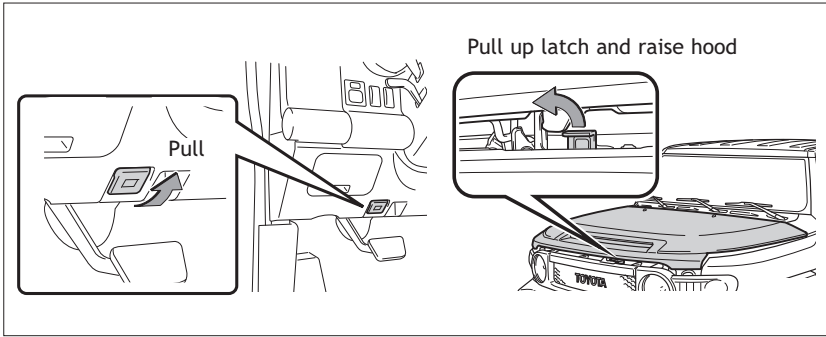

Engine maintenance

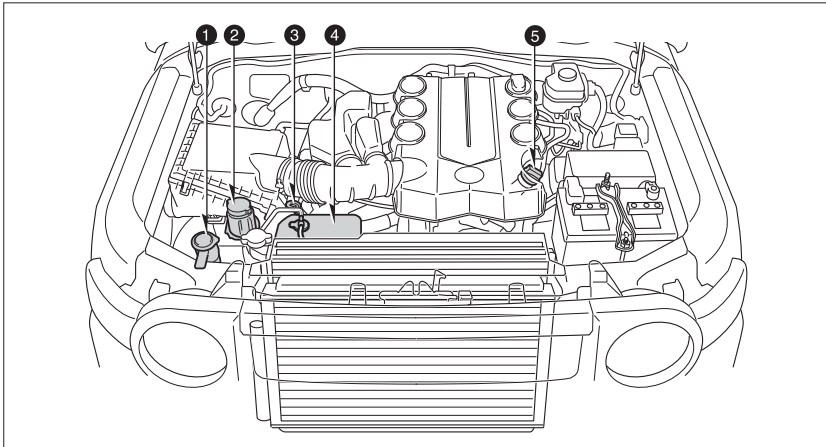

- 1 Windshield washer fluid tank
- 2 Power steering fluid reservoir
- 3 Engine oil level dipstick
- 4 Engine coolant reservoir
- 5 Engine oil filler cap

NOTE: Regularly scheduled maintenance, including oil changes, will help extend the life of your vehicle and maintain performance. Please refer to the "Warranty Maintenance Guide."

FEATURES/OPERATIONS

Automatic Transmission (if equipped)

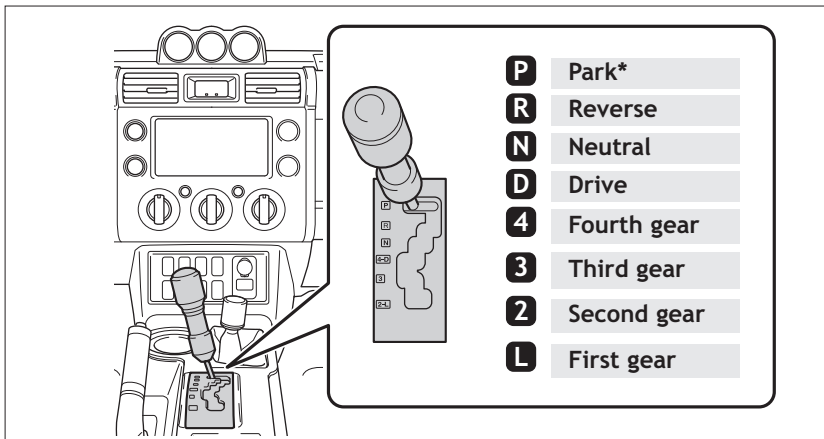

* The key must be in the "ON" position and the brake pedal depressed to shift from Park.

Downshifting increases power going uphill, or provides engine braking downhill. For best fuel economy during normal driving conditions, always drive with the shift lever in the "D" position.

Tilt steering wheel

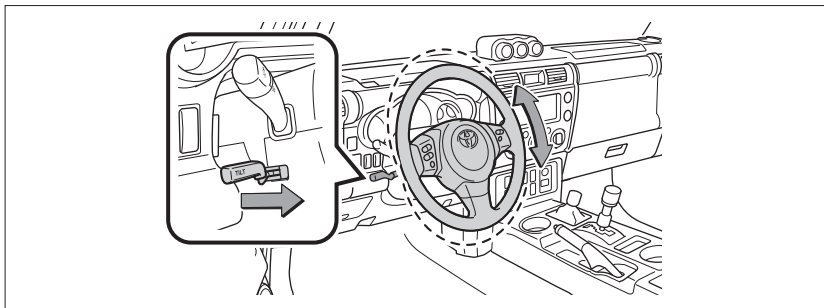

Hold the steering wheel, pull the lock release lever, tilt to the desired angle and release the lever.

NOTE: Do not attempt to adjust while the vehicle is in motion.

Four-wheel drive (if equipped)

Part-time four-wheel drive models (Automatic Transmission)

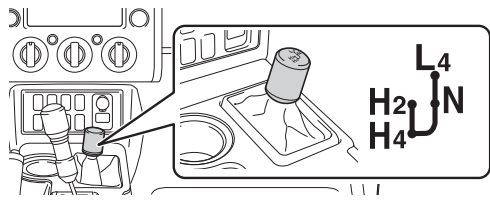

- H2** High speed (2WD)
- H4** High speed (4WD)
Shift to "H4" with speed below 50 mph.
- L4** Low speed (4WD)
Stop vehicle, shift to "N" position, then move the lever to "L4."

NOTE: For best fuel economy and performance under normal driving conditions, shift vehicle into "H2" position.

Full-time four-wheel drive models (Manual Transmission)

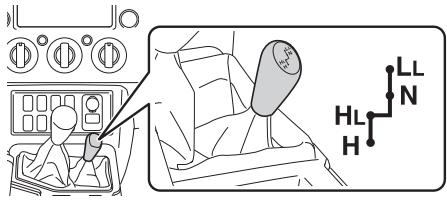

- H** High speed
- HL** High speed
Center differential locked. Depress the clutch pedal to shift from "LL."
- LL** Low speed
Center differential locked. Depress the clutch pedal to shift from "HL" when vehicle is stopped or when speed is below 5 mph.

NOTE: For best fuel economy and performance under normal driving conditions, shift vehicle into "H" position.

Rear differential lock button

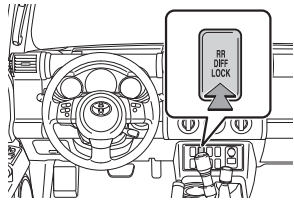

Before using the rear differential lock button:

- Shift the lever into "L4" (Automatic Transmission)
- Shift the lever into "LL" (Manual Transmission)

The following warning lights will illuminate when rear differential lock is engaged:



Rear differential lock/unlock

Parking brake

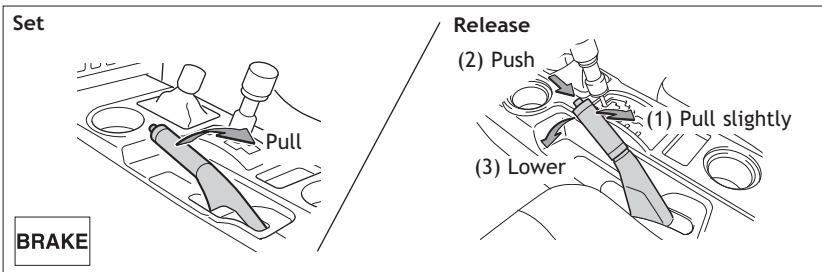

Seat adjustments-Front

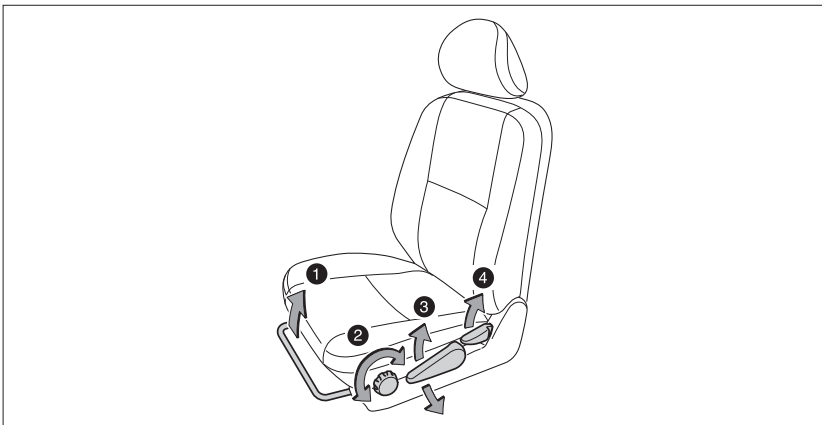

- ① Seat position (forward/backward)
- ② Cushion angle (driver side only)
- ③ Height crank (driver side only)
- ④ Seatback angle

Seats-Head restraints

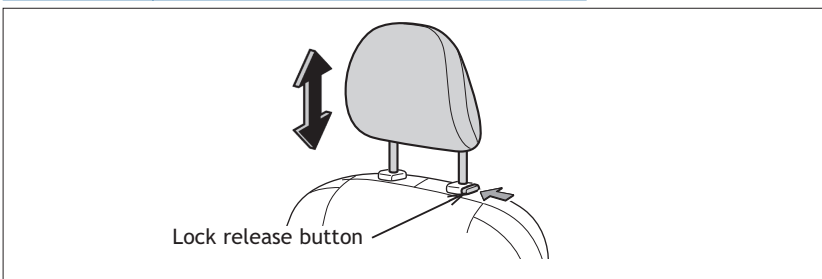

Seats-Folding rear seats

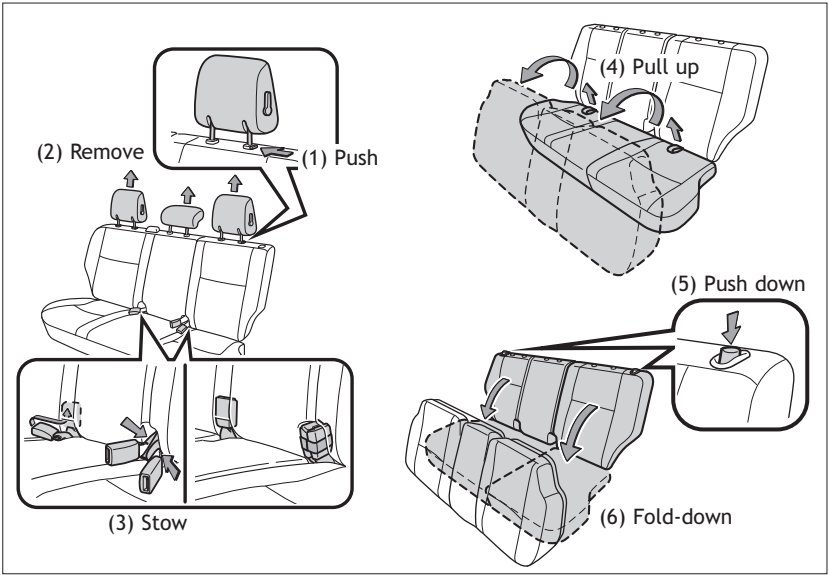

Seats-Removing rear seats

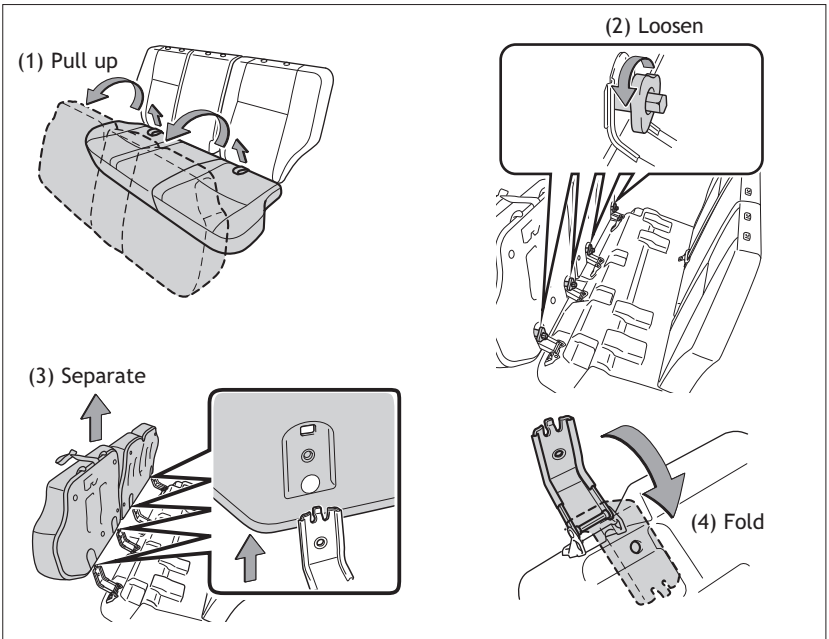

Lights & turn signals

Headlights

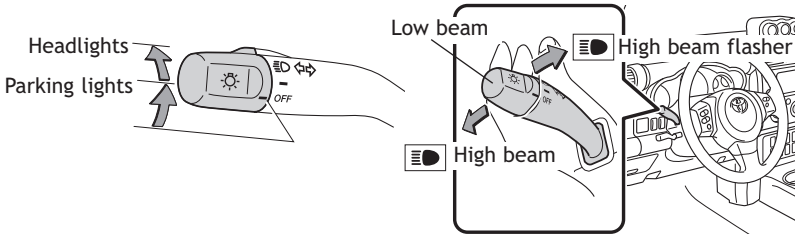

-Automatic light cutoff system Automatically turns lights off after 30 seconds when all doors are closed with the key in "ACC" or "LOCK." Lights may also be turned off by pushing lock button on remote after locking.

-Daytime Running Light system (DRL) (if equipped) Automatically turns on the headlights at a reduced intensity.

Turn signals

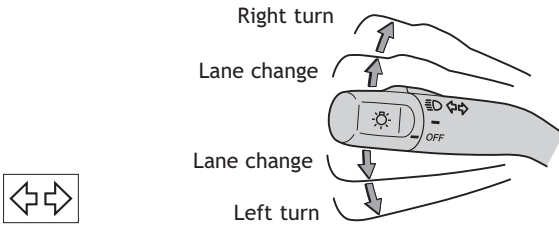

Windshield wipers & washers

Front

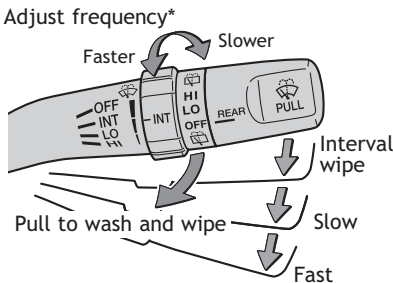

*** Intermittent windshield wiper frequency adjustment**
Rotate to increase/decrease wipe frequency.

Rear (if equipped)

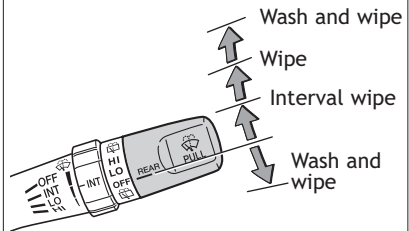

NOTE: Rear wiper and washer operate only when back window is fully closed.

Windows

Driver side

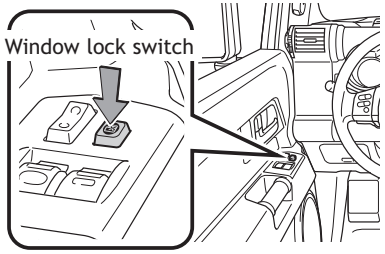
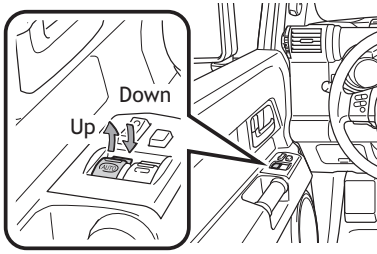

Automatic down operation (driver side only) Push the switch completely down and release to fully open. To stop window at any point, lightly pull the switch up.

Window lock switch Deactivates all passenger windows. Driver's window remains operable.

Door-Back

Open/Close

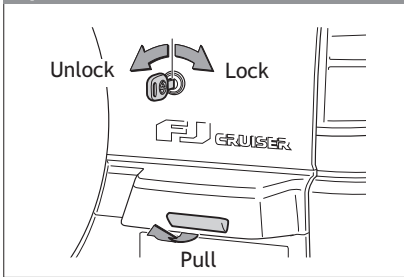

Lock in place

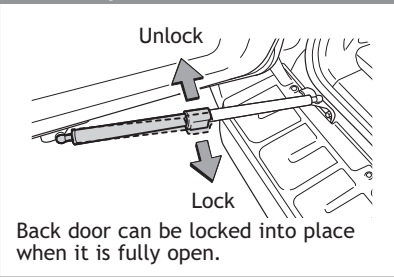

Accessory meter (if equipped)

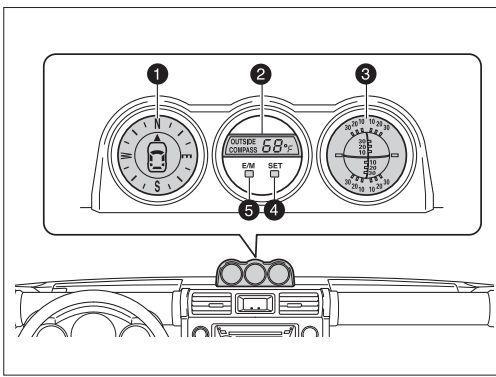

- ① Compass
- ② Outside temperature display
- ③ Clinometer-vehicle slant
- ④ Calibrating the compass setting
- ⑤ Switch between Fahrenheit and Celsius

Audio

Type 1

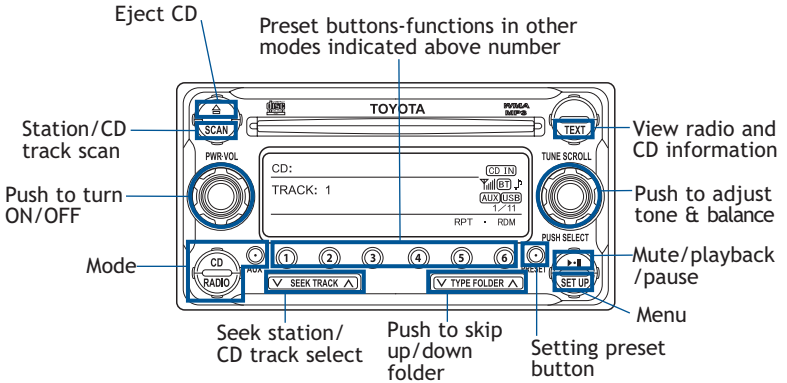

Type 2

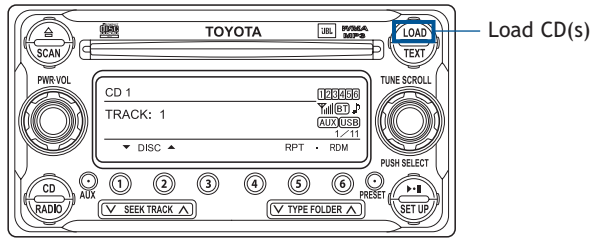

CD player

To scan tracks on a disc Push "SCAN." Push again to hold selection.

CD changer (Type 2)

- To load one disc Push "LOAD" and insert one disc.
- To load multiple discs Push and hold "LOAD" until you hear a beep. Insert one disc. Shutter will close and then re-open for next disc.
- To select a file (MP3/WMA only) Turn "TUNE/SCROLL."
- To select a folder (MP3/WMA only) Push either side of "TYPE/FOLDER."

Radio

Preset buttons Tune in the desired station and press a preset button (1-6) until you hear a beep. Push desired preset button (1-6) to select. "SCAN" Push and hold "SCAN" to scan preset stations. Push again to hold selection.

Steering wheel switches

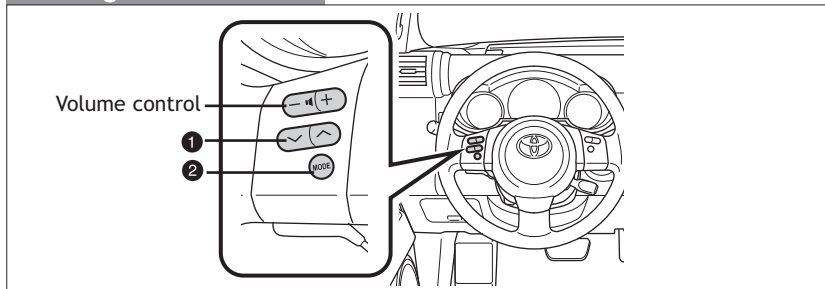

① “v ^”

Use to search within the selected audio medium (radio, CD, iPod®, etc.).

② “MODE”

Push to turn audio ON and select an audio mode. Push and hold to turn audio OFF.

AUX port/USB port

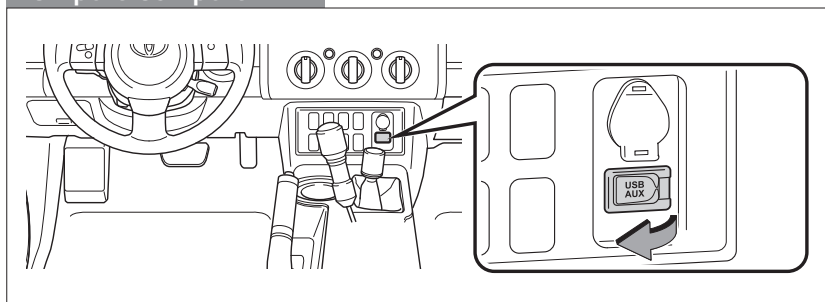

AUX port

By inserting a mini plug into the AUX port, you can listen to music from a portable audio device through the vehicle's speaker system while in AUX mode.

USB port

By connecting a USB-compatible portable audio device or USB memory to the USB port, you can listen to music from the portable audio device or USB memory through the vehicle's speaker system while in USB mode.

Clock

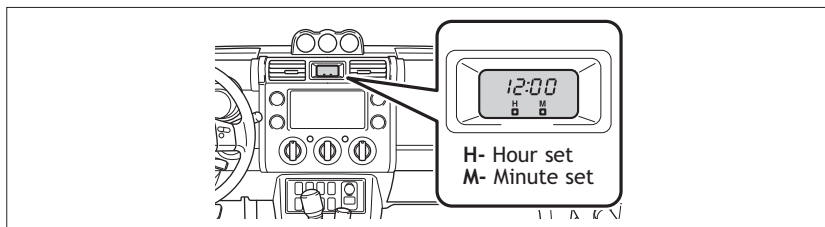

Air Conditioning/Heating

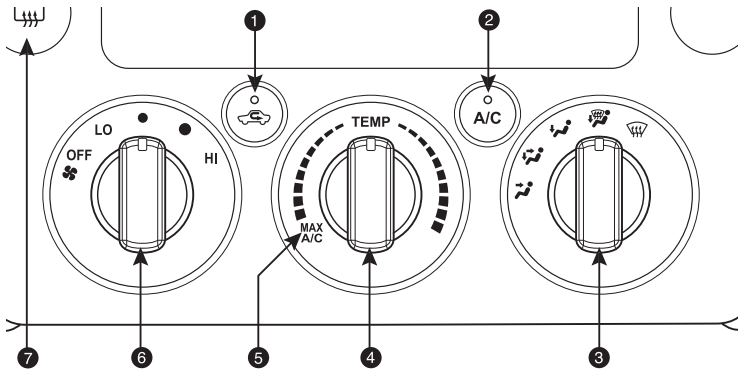

- ① Recirculated cabin air (fresh air when OFF)
- ② Air Conditioning ON/OFF
- ③ Airflow vent
In "👤" mode, use fresh air ("🚗" indicator OFF) to reduce window fogging. "🌬️" mode uses fresh air only.
- ④ Temperature selector
- ⑤ Select for maximum cooling. Air intake will automatically be set to recirculate.
- ⑥ Fan speed
- ⑦ Rear window defogger

Intuitive parking assist (if equipped)

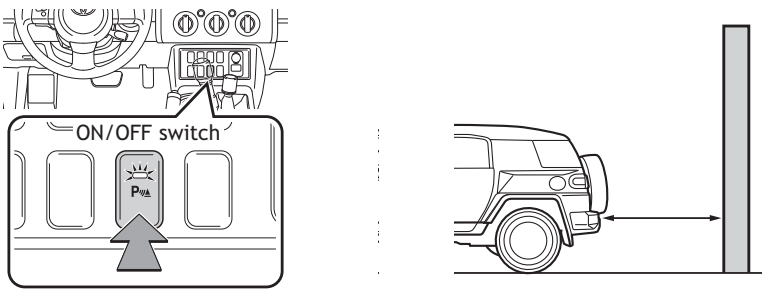

When vehicle is in reverse, a buzzer will sound to inform driver when nearing an obstacle. The system can only be used when the transmission is in the "R" position.

Telephone controls (Bluetooth®)

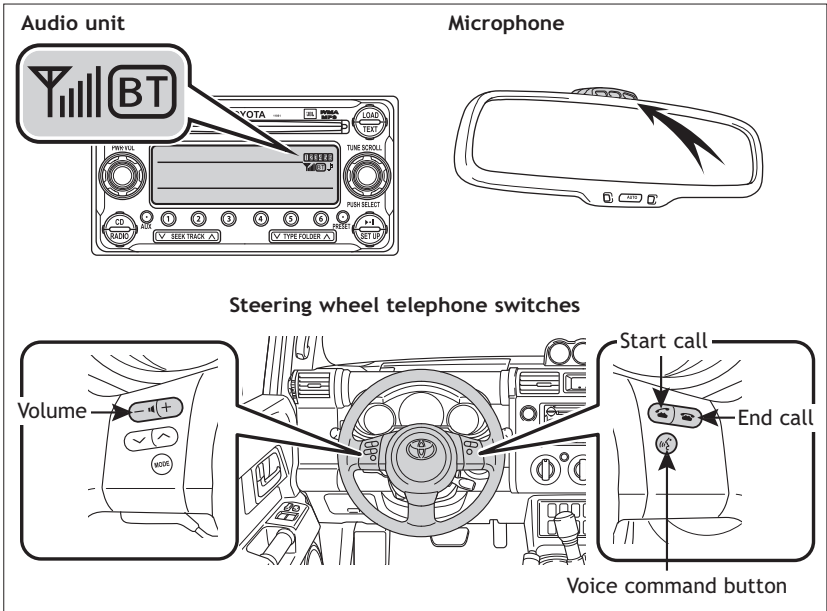

Bluetooth® technology allows dialing or receipt of calls without taking hands from the steering wheel or using a cable to connect the compatible telephone and the system.

Refer to "Using the hands-free phone system (for cellular phones)," Section 3-4 in the *Owner's Manual*, or go to Toyota.LetsTalk.com for more information about phone connections and compatibility.

Cruise control (if equipped)

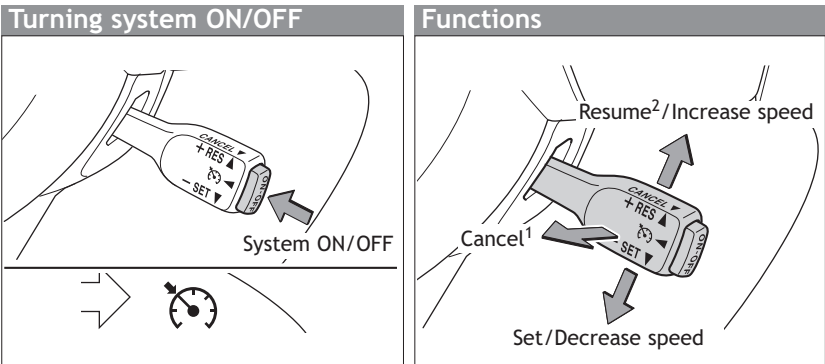

¹ The set speed may also be cancelled by depressing the brake pedal.

² The set speed may be resumed once vehicle speed exceeds 25 mph.

VSC OFF button

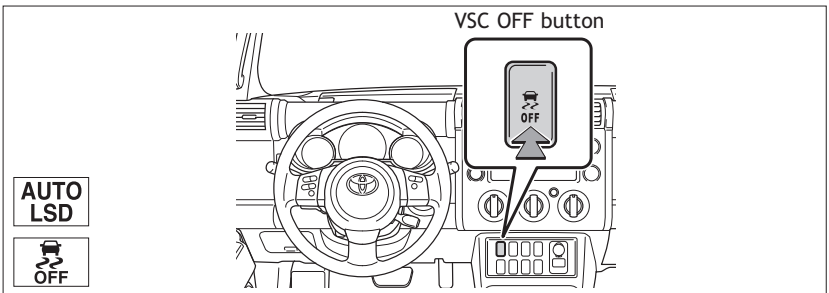

The VSC OFF button is used to switch between modes related to the TRAC, VSC and Auto LSD functions.

Refer to Section 2-4 of the *Owner's Manual* for more information.

Power outlet-12V DC

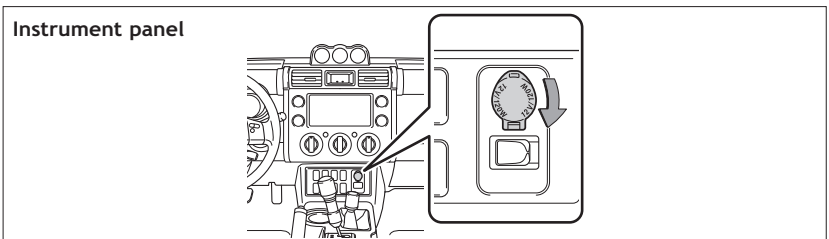

Key must be in the "ACC" or "ON" position to be used.

Power outlet-115V AC (if equipped)

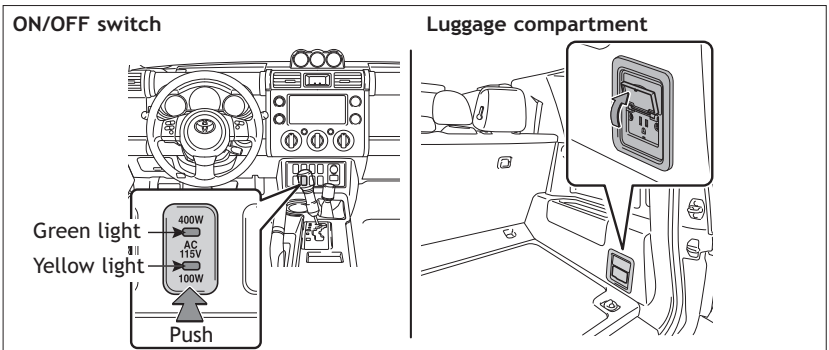

The illumination changes according to the maximum available capacity.

- Green and Yellow 115V AC/400W
- Yellow 115V AC/100W

Engine must be running in order to use the 115V AC power outlet.

Light control-Instrument panel

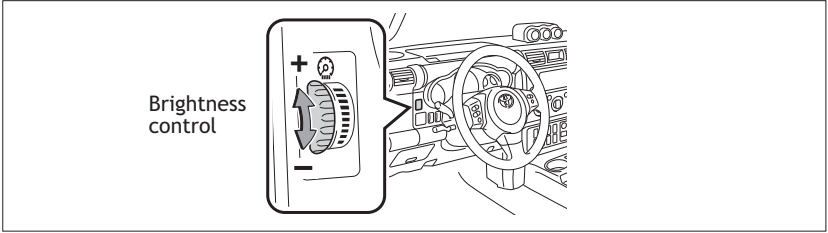

Bottle holders-Rear seat

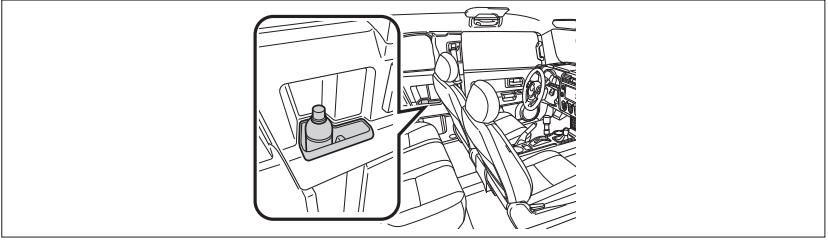

Cup holders

Automatic Transmission models

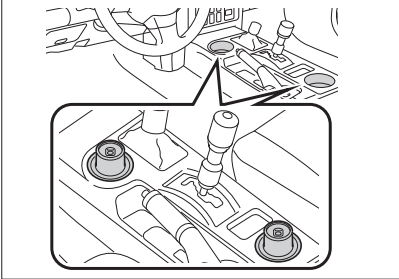

Manual Transmission models

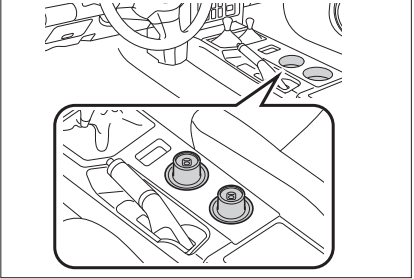

Rear console

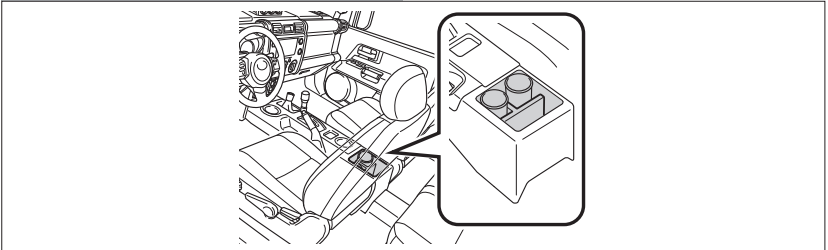

SAFETY AND EMERGENCY FEATURES

Seat belts

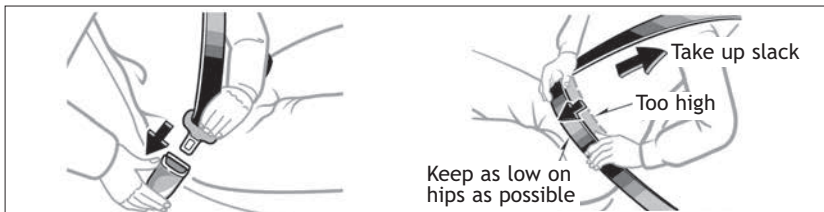

If belt is fully extended, then retracted even slightly, it cannot be re-extended beyond that point, unless fully retracted again. This feature is used to help hold child restraint systems securely.

To find more information about seat belts, and how to install a child restraint system, refer to the *Owner's Manual*.

Seat belts-Shoulder belt anchor

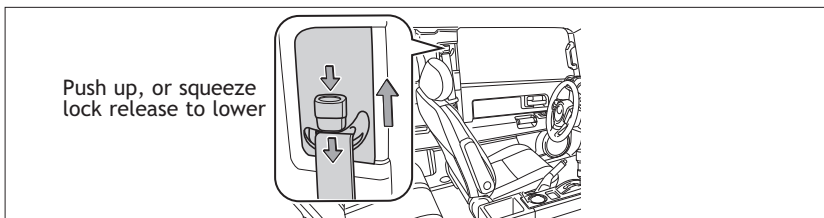

Door locks

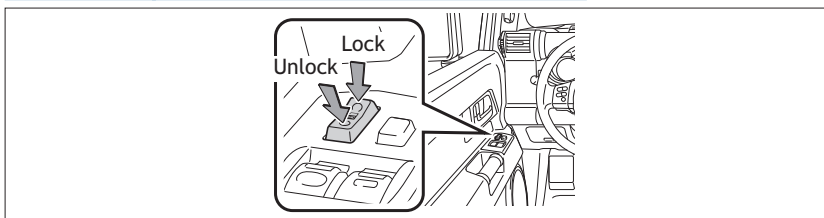

Tire Pressure Monitoring (warning) System

If the Tire Pressure Warning indicator “(U)” illuminates without blinking, adjust tire pressures to factory-specified levels.* The light will turn off after a few minutes. The warning light may come on due to temperature changes or changes in tire pressure from natural air leakage.

If the tire pressure indicator flashes for more than 60 seconds and then remains on, take the vehicle to your local Toyota dealer.

Refer to the *Owner's Manual* for more details.

* Refer to load label on door jamb or the *Owner's Manual* for tire inflation specifications.

Spare tire & tools

Tool location

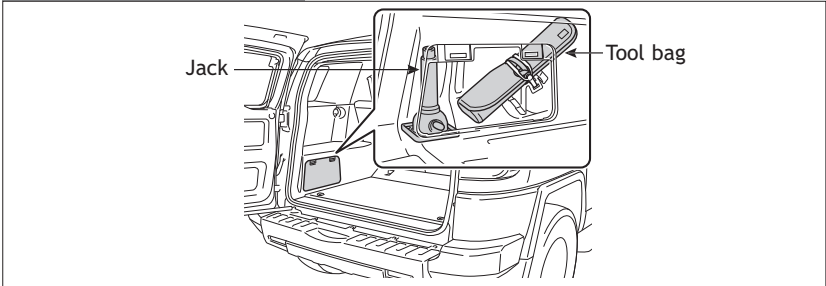

Removing the spare tire (vehicles without rear view monitor system)

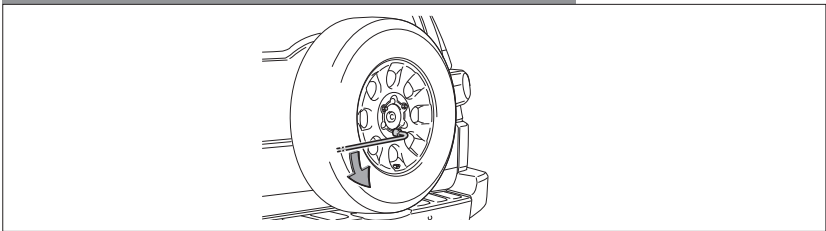

Turn the hold-down nuts counterclockwise and remove.

Removing the spare tire (vehicles with rear view monitor system)

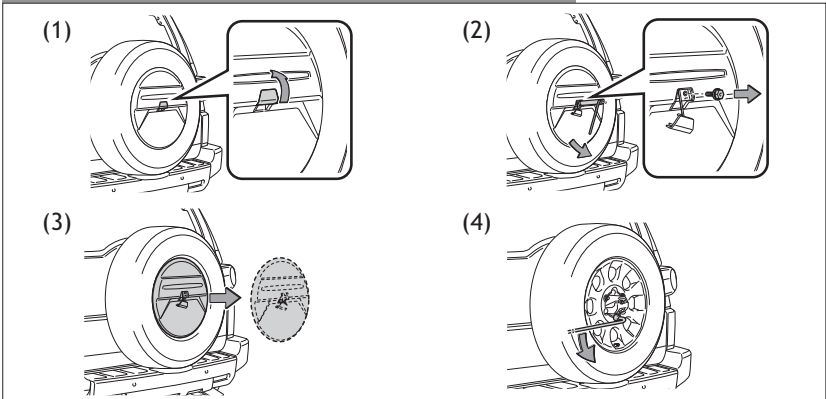

- (1) Remove the bolt cover.
- (2) Remove the bolt that fixes the spare wheel cover in place.
- (3) Remove the spare wheel cover.
- (4) Turn the hold-down nuts counterclockwise and remove.

Refer to the *Owner's Manual* for jack positioning and tire changing procedures.



CUSTOMER EXPERIENCE CENTER

1-800-331-4331



The following keys are provided with the vehicle.

► Vehicles with wireless remote control system

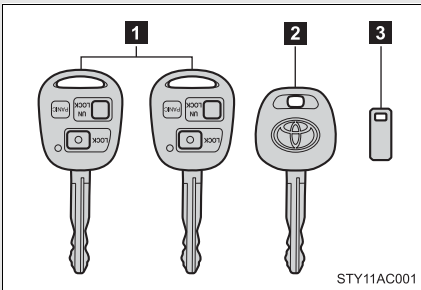

1 Master keys (with wireless remote control function)

Operating the wireless remote control function (→P. 28)

2 Valet key

3 Key number plate

► Vehicles without wireless remote control system

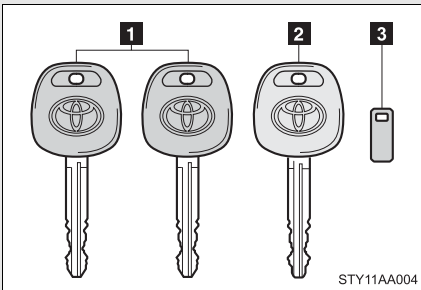

1 Master keys

2 Valet key

3 Key number plate

■ **Key number plate**

Keep the plate in a safe place such as your wallet, not in the vehicle. In the event that a key is lost, a new key can be made by your Toyota dealer using the key number plate. (→P. 455)

■ **When riding in an aircraft**

When bringing a wireless remote control key onto an aircraft, make sure you do not press any buttons on the wireless remote control key while inside the aircraft cabin. If you are carrying a wireless remote control key in your bag etc, ensure that the buttons are not likely to be pressed accidentally. Pressing a button may cause the wireless remote control key to emit radio waves that could interfere with the operation of the aircraft.

**NOTICE****n To prevent key damage**

- l** Do not subject the keys to strong shocks, expose them to high temperatures by placing them in direct sunlight, or get them wet.
- l** Do not expose the keys to electromagnetic materials or attach any material that blocks electromagnetic waves to the key surface.

1-2. Opening, closing and locking the doors Wireless remote control*

The wireless remote control can be used to lock and unlock the vehicle from outside the vehicle.

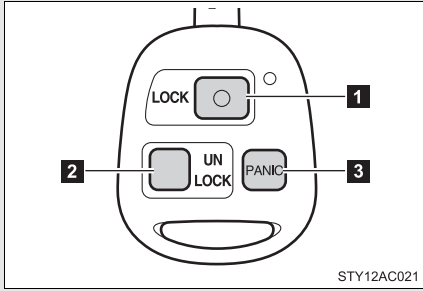

1 Locks all doors

2 Unlocks all doors

Pressing the button unlocks the driver's door. Pressing the button again within 3 seconds unlocks the other doors.

3 Sounds alarm
(push and hold)

▮ Operation signals

A buzzer sounds and the emergency flashers flash to indicate that the doors have been locked/unlocked. (Locked: Once; Unlocked: Twice)

▮ Panic mode

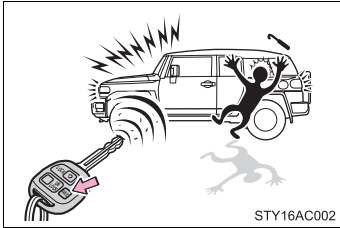

When PANIC button is pushed for longer than about one second, an alarm will sound for about 60 seconds and the vehicle lights will flash to deter any person from trying to break into or damage your vehicle.

To stop the alarm, push any button on the wireless remote control.

▮ Door lock buzzer

If a door or glass hatch is not fully closed, a buzzer sounds for 10 seconds if an attempt to lock the door and glass hatch are made. Fully close the door and glass hatch to stop the buzzer, and lock the vehicle once more.

*: If equipped

n **Key battery depletion**

The standard battery life is 1 to 2 years. (The battery becomes depleted even if the key is not used.) If the wireless remote control function does not operate, the battery may be depleted. Replace the battery when necessary. (→P. 397)

n **Security feature**

If a door is not opened within approximately 60 seconds after the vehicle is unlocked, the security feature automatically locks the vehicle again.

n **Conditions affecting operation**

The wireless remote control function may not operate normally in the following situations.

- l Near a TV tower, radio station, electric power plant, airport or other facility that generates strong radio waves
- l When carrying a portable radio, cellular phone or other wireless communication device
- l When multiple wireless keys are in the vicinity
- l When the wireless key has come into contact with, or is covered by a metallic object
- l When a wireless key (that emits radio waves) is being used nearby
- l When the wireless key has been left near an electrical appliance such as a personal computer

n **Customization that can be configured at Toyota dealer**

Settings (e.g. wireless remote control system) can be changed. (Customizable features →P. 493)

▮ **Certification for wireless remote control**

▶ For vehicles sold in U.S.A.

FCC ID: HYQ12BBT

FCC ID: HYQ13BBL

NOTE:

This device complies with part 15 of the FCC Rules. Operation is subject to the following two conditions: (1) This device may not cause harmful interference, and (2) this device must accept any interference received, including interference that may cause undesired operation.

FCC WARNING:

Changes or modifications not expressly approved by the party responsible for compliance could void the user's authority to operate the equipment.

▶ For vehicles sold in Canada

NOTE:

Operation is subject to the following two conditions: (1) this device may not cause interference, and (2) this device must accept any interference, including interference that may cause undesired operation of the device.

1-2. Opening, closing and locking the doors

Side doors

The vehicle can be locked/unlocked using the wireless remote control, key or door lock switch.

n Wireless remote control (if equipped)

→P. 28

n Key

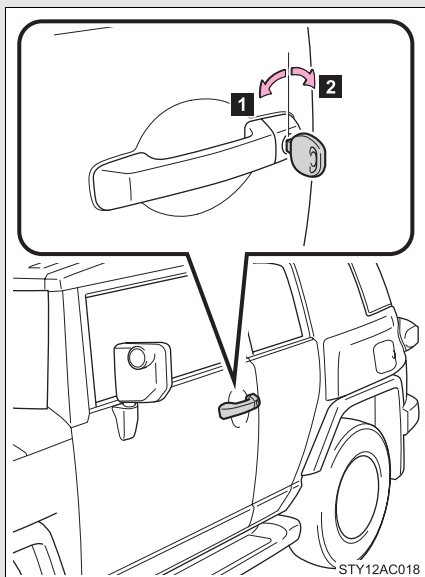

1 Locks all doors

2 Unlocks all doors

Turning the key a single time in the driver's door unlocks the driver's door, and turning the key again unlocks the other doors.

n Door lock switch

► Driver's door lock switch

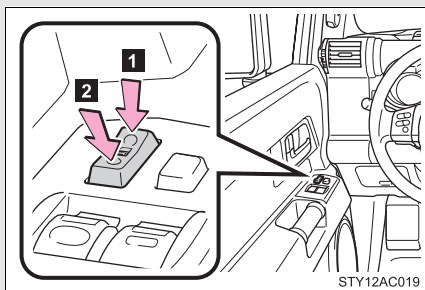

1 Locks all doors

2 Unlocks all doors

► Passenger's door lock switch

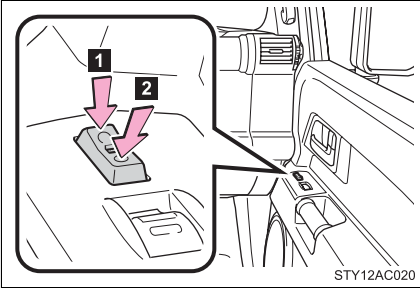

- 1 Locks all doors
- 2 Unlocks all doors

n Inside door lock button

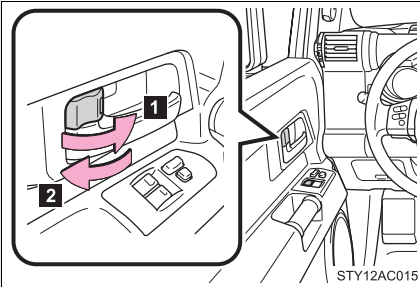

- 1 Locks the door
- 2 Unlocks the door

Pulling the inside handle can open the front door even if the inside door lock button is in the lock position.

Locking the front doors from the outside without a key

STEP 1 Move the inside door lock button to the lock position.

STEP 2 Close the door.

The door cannot be locked if a front door is open and the key is in the engine switch.

n **Key reminder buzzer**

A buzzer sounds if the driver's door is opened, while the engine switch is in the ACC or LOCK position to remind you to remove the key.

n **Customization that can be configured at Toyota dealer**

Settings (e.g. unlocking function using a key) can be changed. (Customizable features →P. 493)

CAUTION

n **To prevent an accident**

Observe the following precautions while driving the vehicle.

Failing to do so may result in a door opening and an occupant falling out, resulting in death or serious injury.

! Always use a seat belt.

! Always lock all doors.

! Ensure that all doors are properly closed.

! Do not pull the inside handle of the doors while driving.

The doors may be opened and the passengers are thrown out of the vehicle and it may result in serious injury or death.

Be especially careful for the side doors, as the doors may be opened even if the inside lock buttons are in locked position.

1-2. Opening, closing and locking the doors

Access doors

The access door (rear door) can be opened using the inside handle.

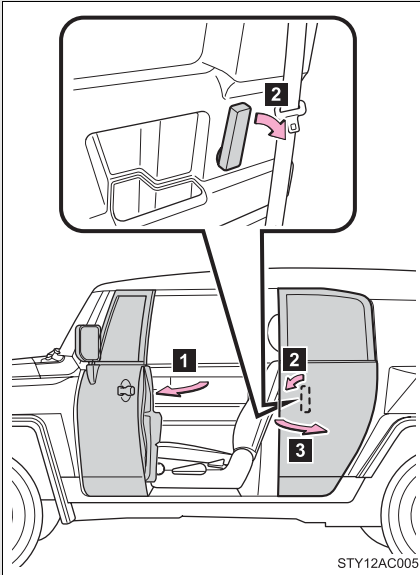

- 1 Open the front door widely
- 2 Pull (from the outside) or push (from the inside) the inside handle of the access door.
- 3 Open the access door

You can open and close the access door only when the front door is widely opened.

⚠ CAUTION

n When closing the access door

Observe the following precautions.
Failure to do so may result in serious injury.

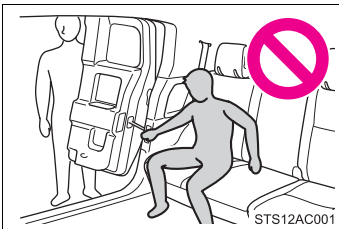

- 1 Confirm safety of the area around.
- 1 Keep the hands, fingers and other parts of the bodies of all occupants away from the access door.



NOTICE

n When opening or closing the front door and access door

The front door and access door could be damaged if they hit each other when being opened or closed.

1-2. Opening, closing and locking the doors

Back door

The back door can be locked/unlocked using a key, wireless remote control or door lock switch.

n **Wireless remote control (if equipped)**

→P. 28

n **Key**

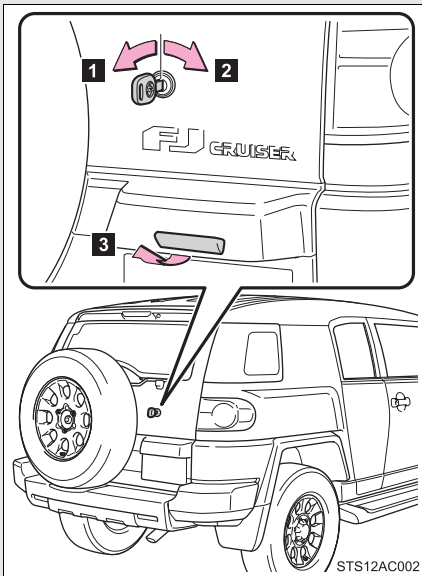

1 Unlocks the back door

2 Locks the back door

3 Opens the back door

When you turn the key clockwise and hold it for about 1 second, the glass hatch opens. (→P. 41)

n **Door lock switch**

→P. 31

n Back door fixing function

The back door can be held in the following positions:

► Half open position

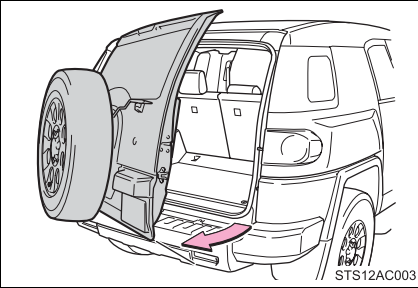

Open the back door to the half open position.

It cannot be held in this position when being closed.

► Full open position

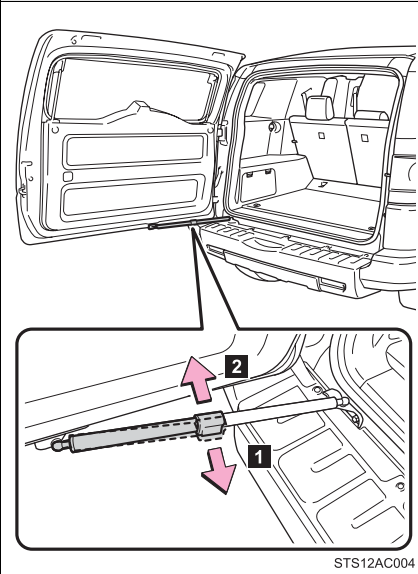

You can hold the back door in this position:

- 1** Locks the back door damper
- 2** Unlocks the back door damper

When closing the door, be sure to unlock the damper.

Rear step bumper

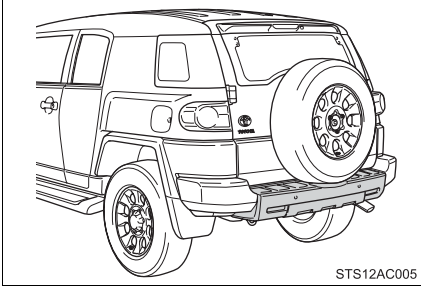

For rear end protection and easier step-up loading.

To get on the rear step bumper, use the shaded area in the illustration.

CAUTION

n Caution while driving

- I** Keep the back door closed while driving. If the back door is left open, it may hit near-by objects while driving or luggage may be unexpectedly thrown out, causing an accident. In addition, exhaust gases may enter the vehicle, causing death or a serious health hazard. Make sure to close the back door before driving.
- I** Before driving the vehicle, make sure that the back door is fully closed. If the back door is not fully closed, it may open unexpectedly while driving, causing an accident.
- I** Never let anyone sit in the luggage compartment. In the event of sudden braking or a collision, they are susceptible to death or serious injury.
- I** Do not get on the rear step bumper.

n When children are in the vehicle

Observe the following precautions. Failure to do so may result in death or serious injury.

- I** Do not leave children alone in the luggage compartment. If children are accidentally locked in the luggage compartment, they could have heat exhaustion.
- I** Do not allow children to open or close the back door. Doing so may cause the back door to operate unexpectedly, or cause the child's hands, head, or neck to be caught by the closing back door.

⚠ CAUTION

n Operating the back door

Observe the following precautions.

Failure to do so may cause parts of the body to be caught, resulting in death or serious injury.

- 1 When opening or closing the back door, thoroughly check to make sure the surrounding area is safe.
- 1 If anyone is in the vicinity, make sure they are safe and let them know that the back door is about to open or close.
- 1 Use caution when opening or closing the back door in windy weather as it may move abruptly in strong wind.

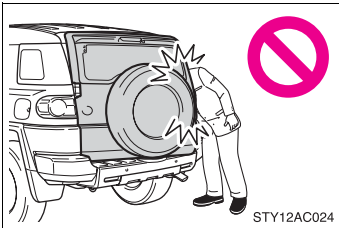

- 1 The back door may close if the back door damper is not opened fully. It is more difficult to open or close the back door on an incline than on a level surface, so beware of the back door unexpectedly opening or closing by itself. Make sure that the back door is fully open and secure before using the luggage compartment.

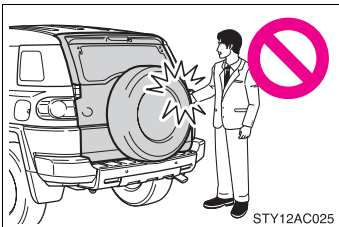

- 1 When closing the back door, take extra care to prevent your fingers etc. from being caught.
- 1 When closing the back door, make sure to press it lightly on its outer surface.

- 1 Do not pull on the back door damper stay to close the back door, and do not hang on the back door damper stay. Doing so may cause hands to be caught or the back door damper stay to break, causing an accident.
- 1 Do not attach any accessories other than genuine Toyota parts to the back door. Such additional weight on the back door may cause the back door to closed again after it is opened.

 NOTICE

n To prevent damage to the back door components

Do not allow more than one person to get on the rear step bumper at a time.

n Back door damper stays

The back door is equipped with damper stays that hold the back door in place.

Observe the following precautions.

Failure to do so may cause damage to the back door damper stay, resulting in malfunction.

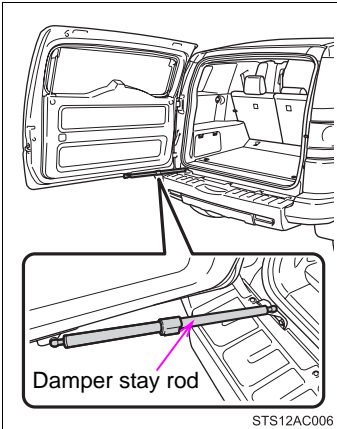

- I** Do not attach any foreign objects, such as stickers, plastic sheets, or adhesives to the damper stay rod.
- I** Do not touch the damper stay rod with gloves or other fabric items.
- I** Do not attach any accessories other than genuine Toyota parts to the back door.
- I** Do not place your hand on the damper stay or apply vertical forces to it.

- I** Ensure that the damper is unlocked before closing the back door.

1-2. Opening, closing and locking the doors

Glass hatch

The glass hatch can be opened using the key.

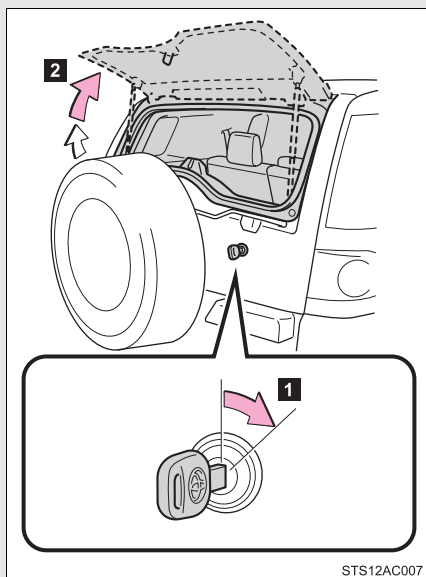

1 Turn the key clockwise and hold it for about 1 second.

2 Raise

1

Before driving

n **Opening the glass hatch**

- l The glass hatch opens slightly, after the back door is locked.
- l When the rear window wiper is working, the wiper returns to the original position and stops working.

The wiper restarts its working about 3 seconds after the glass hatch is closed.

n **Closing the glass hatch**

- l Make sure that the glass hatch is securely closed after closing it.
If the glass hatch is not securely closed, the rear window wiper and washer will not work.
- l Be careful not to lock your keys in the vehicle.

 **CAUTION**

n Caution while driving

- I** Keep the glass hatch closed while driving.

If the glass hatch is left open, it may hit near-by objects while driving or luggage may be unexpectedly thrown out, causing an accident.

In addition, exhaust gases may enter the vehicle, causing death or a serious health hazard. Make sure to close the glass hatch before driving.

- I** Before driving the vehicle, make sure that the glass hatch is fully closed. If the glass hatch is not fully closed, it may open unexpectedly while driving, causing an accident.
- I** Never let anyone sit in the luggage compartment. In the event of sudden braking or a collision, they are susceptible to death or serious injury.

n When children are in the vehicle

Observe the following precautions.

Failure to do so may result in death or serious injury.

- I** Do not leave children alone in the luggage compartment.

If children are accidentally locked in the luggage compartment, they could be overheated.

- I** Do not allow children to open or close the glass hatch.

Doing so may cause the glass hatch to operate unexpectedly, or cause the child's hands, head, or neck to be caught by the closing glass hatch.

n Operating the glass hatch

Observe the following precautions.

Failure to do so may cause parts of the body to be caught, resulting in death or serious injury.

- I** Do not open the glass hatch while the vehicle is moving.

- I** Remove any heavy loads, such as snow and ice, from the glass hatch before opening it. Failure to do so may cause the glass hatch fall closed again after it is opened.

- I** When opening or closing the glass hatch, thoroughly check to make sure the surrounding area is safe.

- I** If anyone is in the vicinity, make sure they are safe and let them know that the glass hatch is about to open or close.

⚠ CAUTION

n Operating the glass hatch

- ! Use caution when opening or closing the glass hatch in windy weather as it may move abruptly in strong wind.

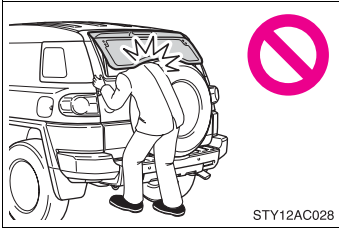

- ! The glass hatch may fall if it is not opened fully. It is more difficult to open or close the glass hatch on an incline than on a level surface, so beware of the glass hatch unexpectedly opening or closing by itself. Make sure that the glass hatch is fully open and secure before using the luggage compartment.

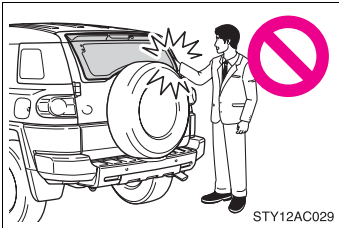

- ! When closing the glass hatch take extra care to prevent your fingers etc. from being caught.
- ! When closing the glass hatch, make sure to press it lightly on its outer surface.

- ! Do not pull on the glass hatch damper stay to close the glass hatch, and do not hang on the glass hatch damper stay. Doing so may cause hands to be caught or the glass hatch damper stay to break, causing an accident.

- ! Do not attach any accessories other than genuine Toyota parts to the glass hatch. Such additional weight on the glass hatch may cause the glass hatch to fall closed again after it is opened.

n Before you close the glass hatch

To avoid death or serious injury, you must do the following.

- ! Always make sure there is nobody around the glass hatch.
- ! Make sure all occupants are safe and let them know that the glass hatch is about to close.

 NOTICE

n Glass hatch damper stays

The glass hatch is equipped with damper stays that hold the glass hatch in place.

Observe the following precautions.

Failure to do so may cause damage to the glass hatch damper stay, resulting in malfunction.

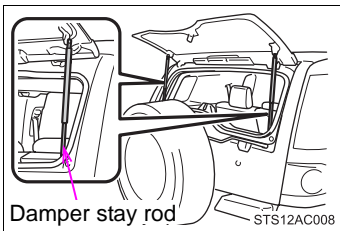

- I** Do not attach any foreign objects, such as stickers, plastic sheets, or adhesives to the damper stay rod.
- I** Do not touch the damper stay rod with gloves or other fabric items.
- I** Do not attach any accessories other than genuine Toyota parts to the glass hatch.
- I** Do not place your hand on the damper stay or apply lateral forces to it.

1-3. Adjustable components (seats, mirrors, steering wheel)

Front seats

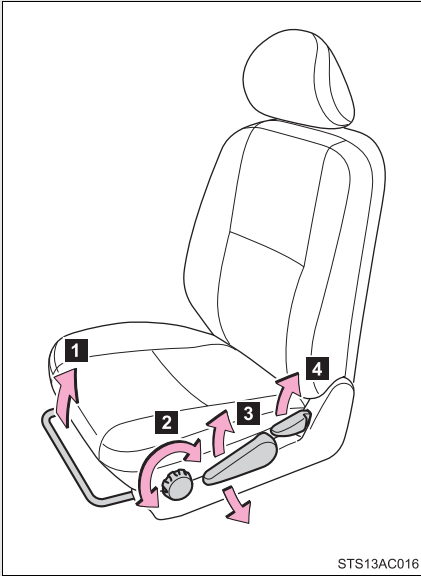

STS13AC016

- 1 Seat position adjustment lever
- 2 Seat cushion angle adjustment knob (driver's side only)
- 3 Seat height adjustment lever (driver's side only)
- 4 Seatback angle adjustment lever

1

Before driving

Active head restraints

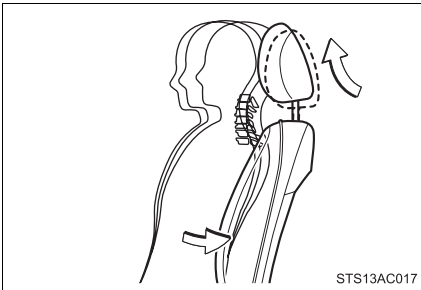

STS13AC017

When the occupant's lower back presses against the seatback during a rear-end collision, the head restraint moves slightly forward and upward to help reduce the risk of whiplash on the seat occupant.

n Active head restraints

Even small forces applied to the seatback may cause the head restraint to move. Pushing up a locked head restraint forcibly may show the head restraint inner structure. These do not indicate problems.

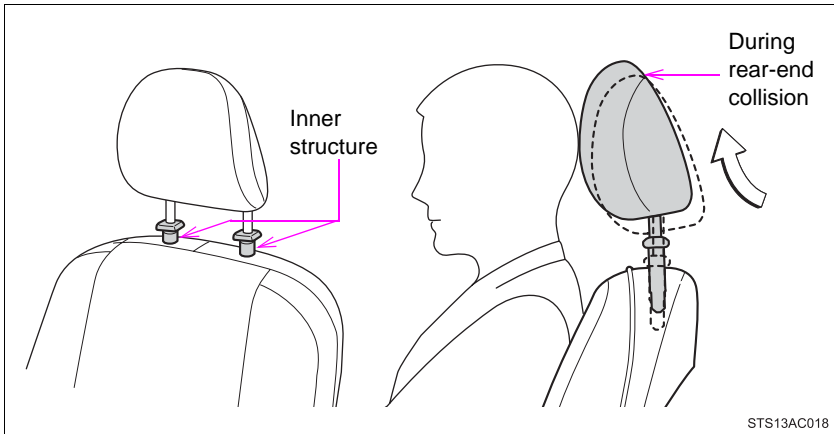

n Waterproof and water-repellent seats

Waterproof and water-repellent seats are installed in your vehicle; however, the water-repellent effect does not last forever.

⚠ CAUTION

n Seat adjustment

- ! Do not recline the seat more than necessary when the vehicle is in motion to reduce the risk of sliding under the lap belt. If the seat is too reclined, the lap belt may slide past the hips and apply restraint forces directly to the abdomen or your neck may contact the shoulder belt, increasing the risk of death or serious injury in the event of an accident.
- ! After adjusting the seat, make sure that the seat is locked in position.

1-3. Adjustable components (seats, mirrors, steering wheel)

Rear seats

The seatbacks of the rear seats can be folded down.

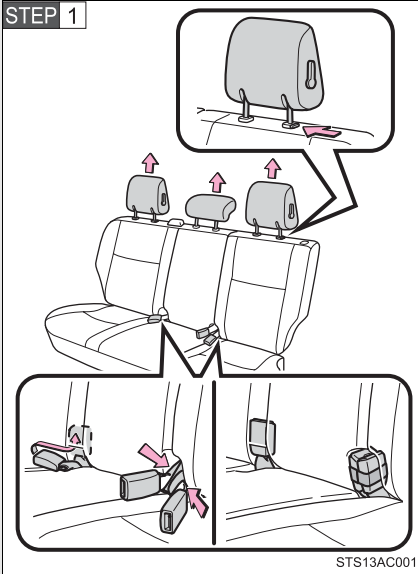

Stow the seat belt buckles and remove the head restraints.

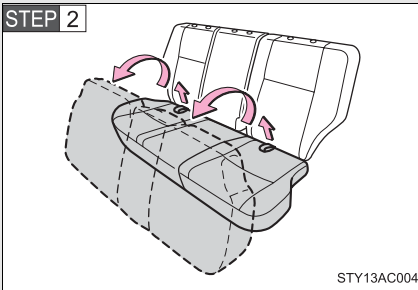

Swing the bottom cushion up by pulling the lock release strap.

1-3. Adjustable components (seats, mirrors, steering wheel)

STEP 3

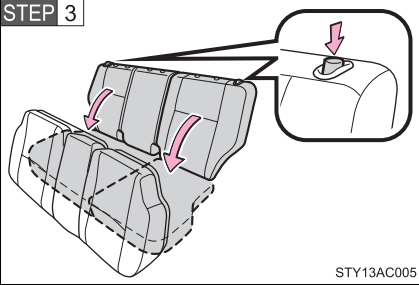

Push the lock release button and fold down the seatback.

Removing rear seat bottom cushions

STEP 1

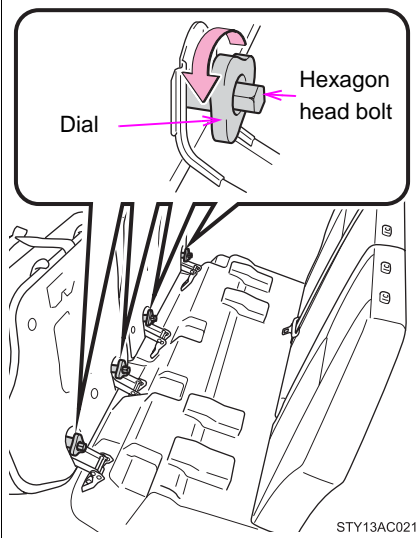

Loosen the bolts with a wrench at first and turn the dials by hand to remove them.

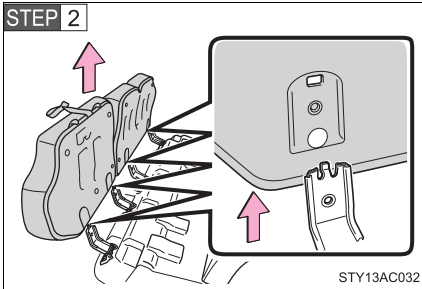

Separate the bottom cushion from the hinge.

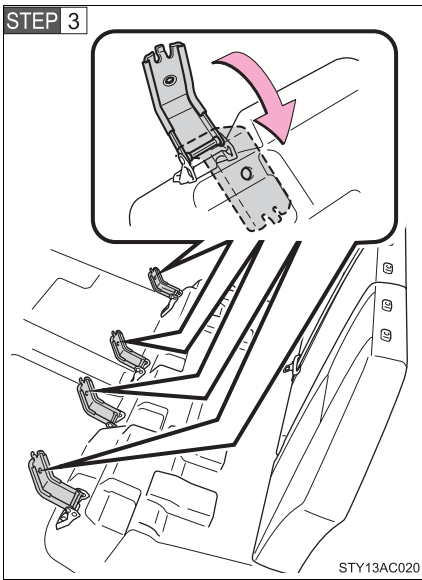

Fold the hinge as shown in the illustration.

n If you cannot raise the seatback

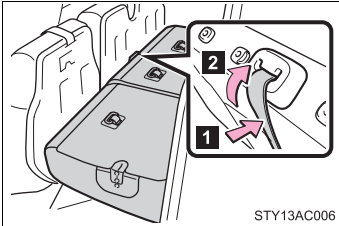

Release the seat belt lock by:

- 1** Pushing on the lower front edge of the seatback to slacken the seat belt.
- 2** Letting the seat belt retract a little.

n When the bottom cushion is reinstalled

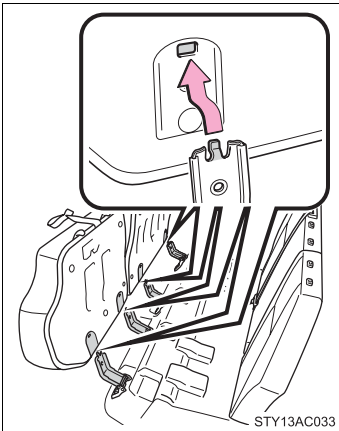

Click the claw of the hinge into the hole of the bottom cushion before refastening the dial.

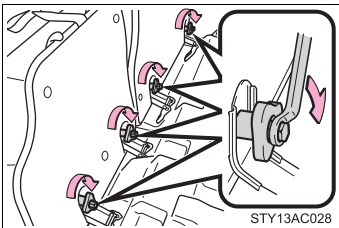

Firmly tighten the hexagon head bolts using a torque wrench.

Tightening torque:
12.5 ft-lbf (17 N-m, 1.7 kgf-m)

n Waterproof and water-repellent seats

Waterproof and water-repellent seats are installed in your vehicle: however, the water-repellent effect does not last forever.

 CAUTION**n When the seatback is folded**

Do not sit on or place anything on the seatback while the vehicle is in motion.

n When returning the seats to their original position

Observe the following precautions. Failure to do so may result in death or serious injury.

- l Do not return the seatback while the vehicle is in motion.
- l Be careful not to get your hands or feet pinched in the seat.
- l Make sure the seatbacks and bottom cushions are securely locked. Failure to do so will prevent the seat belt from operating properly.
- l Check that the seat belts are not twisted or caught under the seat.
- l Arrange the seat belts in the proper positions for ready use.

n When removing or reinstalling the bottom cushion

Observe the following precautions. Failure to do so may result in death or serious injury.

- l Do not remove or reinstall the bottom cushion while the vehicle is in motion.
- l Do not get in the vehicle with the bottom cushions uninstalled.
- l Do not leave the removed bottom cushion unsecured in the vehicle.
- l Do not try to sit on or place anything on the removed bottom cushion.
- l Do not drop the bottom cushion.
- l Have the hexagon head bolts tightened with a torque wrench to 12.5 ft·lbf (17 N·m, 1.7 kgf·m), or have them tightened by your Toyota dealer. Failure to do so may cause the dials to be loosened and the bottom cushions to be removed.

 NOTICE

n Before folding down or removing the seats

- l The seat belts buckles must be stowed.
- l The head restraints must be removed before you fold down the seatback.

n After returning the seatback and reinstalling the bottom cushion

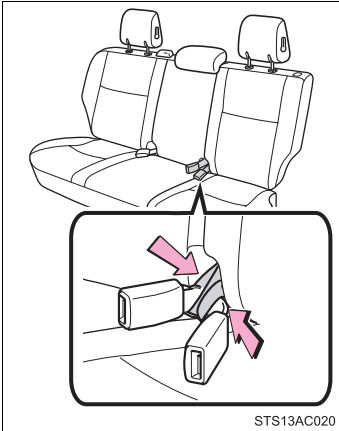

Return the seat belt buckles to their correct position.

Always pass seat belt buckles through the bands to secure them.

1-3. Adjustable components (seats, mirrors, steering wheel)

Head restraints

Head restraints are provided for all seats.

n Adjusting the head restraints

► Front seats

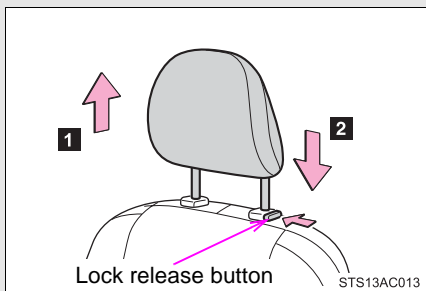

Vertical adjustment

1 Up

Pull the head restraints up.

2 Down

Push the head restraint down while pushing the lock release button.

► Rear seats

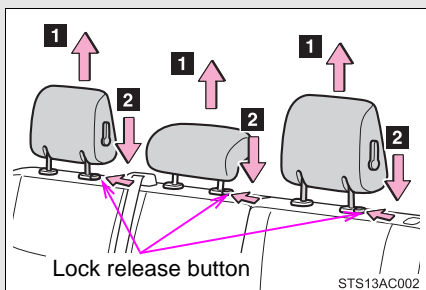

Vertical adjustment

1 Up

Pull the head restraints up.

2 Down

Push the head restraint down while pushing the lock release button.

n When using the rear outboard head restraints

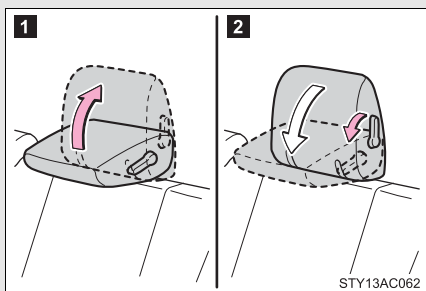

1 To use

Lift up the head restraint until it locks.

2 To fold

Pull the head restraint lock release lever to fold the head restraint.

n Removing the head restraints

► Front seats

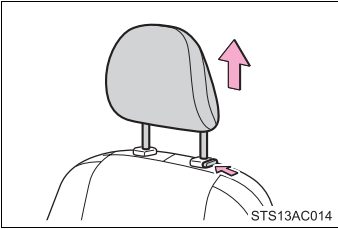

Pull the head restraint up while pushing the lock release button.

► Rear seats

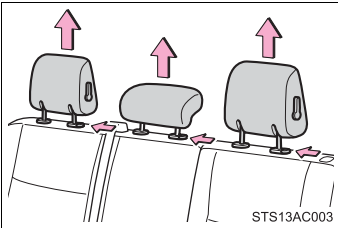

Pull the head restraint up while pushing the lock release button.

n Installing the head restraints

► Front seats

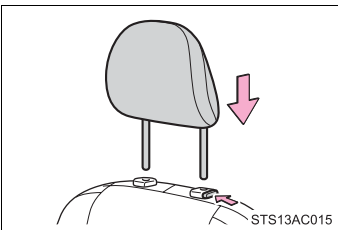

Align the head restraint with the installation holes and push it down to the lock position.

Press and hold the lock release button when lowering the head restraint.

► Rear seats

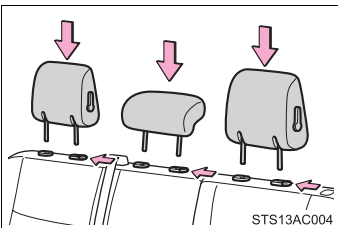

Align the head restraint with the installation holes and push it down to the lock position.

Press and hold the lock release button when lowering the head restraint.

n When installed the rear outboard head restraints to opposite direction

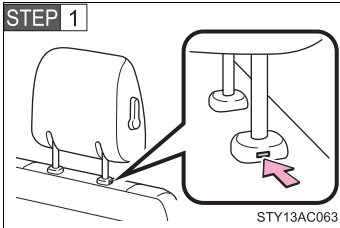

Push a flathead screwdriver into the slot. The slot is located on the right side of the right head restraint anchor.

STEP 2 While pressing in the screwdriver, pull up the head restraint.

n Adjusting the height of the front seat head restraints

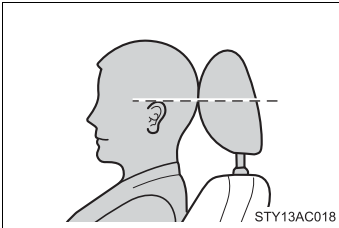

Make sure that the head restraints are adjusted so that the center of the head restraint is closest to the top of your ears.

n Adjusting the rear center seat head restraints

Always raise the head restraint one level from the stowed position when using.

⚠ CAUTION

n Head restraint precautions

Observe the following precautions regarding the head restraints. Failure to do so may result in death or serious injury.

- 1 Use the head restraints designed for each respective seat.
- 1 Adjust the head restraints to the correct position at all times.
- 1 After adjusting the head restraints, push down on them and make sure they are locked in position.
- 1 Do not drive with the head restraints removed.

1-3. Adjustable components (seats, mirrors, steering wheel)

Seat belts

Make sure that all occupants are wearing their seat belts before driving the vehicle.

n Correct use of the seat belts

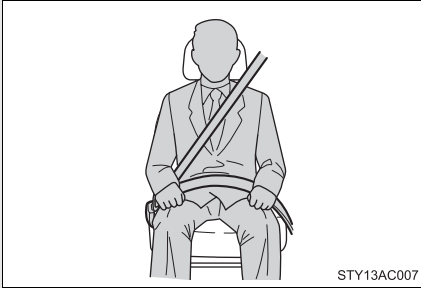

- 1 Extend the shoulder belt so that it comes fully over the shoulder, but does not come into contact with the neck or slide off the shoulder.
- 1 Position the lap belt as low as possible over the hips.
- 1 Adjust the position of the seatback. Sit up straight and well back in the seat.
- 1 Do not twist the seat belt.

n Fastening and releasing the seat belt

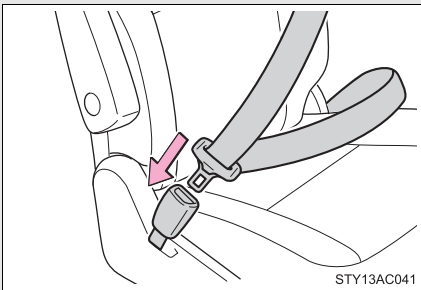

Fastening the belt

Push the tab into the buckle until a clicking sound is heard.

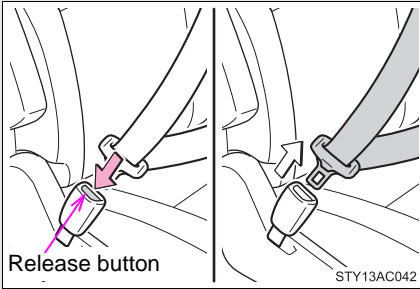

Releasing the belt

Press the release button.

n Adjusting the height of the belt (front seats)

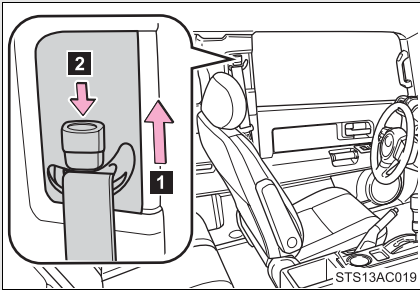

1 Up

Move the height adjuster up as needed until you hear a click.

2 Down

Push the lock release button and slide the height adjuster down.

Seat belt pretensioners (front seats)

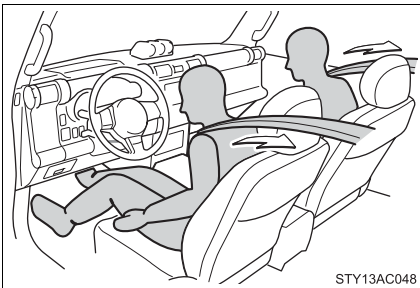

The pretensioner helps the seat belt to quickly restrain the occupant by retracting the seat belt when the vehicle is subjected to certain types of severe frontal collision or a vehicle rollover.

The pretensioner may not activate in the event of a minor frontal impact, a side impact or a rear impact.

n Emergency locking retractor (ELR)

The retractor will lock the belt during a sudden stop or on impact. It may also lock if you lean forward too quickly. A slow, easy motion will allow the belt to extend so that you can move around fully.

n Automatic locking retractor (ALR)

When a passenger's shoulder belt is completely extended and then retracted even slightly, the belt is locked in that position and cannot be extended. This feature is used to hold the child restraint system (CRS) firmly. To free the belt again, fully retract the belt and then pull the belt out once more. (→P. 101)

n Pregnant women

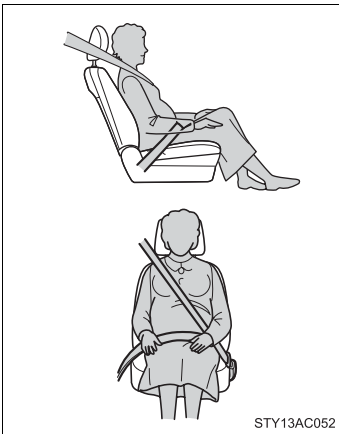

Obtain medical advice and wear the seat belt in the proper way. (→P. 56)

Women who are pregnant should position the lap belt as low as possible over the hips in the same manner as other occupants. Extend the shoulder belt completely over the shoulder and position the belt across the chest. Avoid belt contact over the rounding of the abdominal area.

If the seat belt is not worn properly, not only a pregnant woman, but also the fetus could suffer death or serious injury as a result of sudden braking or a collision.

n People suffering illness

Obtain medical advice and wear the seat belt in the proper way.

n Child seat belt usage

The seat belts of your vehicle were principally designed for persons of adult size.

1 Use a child restraint system appropriate for the child, until the child become large enough to properly wear the vehicle's seat belt. (→P. 97)

1 When the child becomes large enough to properly wear the vehicle's seat belt, follow the instructions on P. 56 regarding seat belt usage.

n Replacing the belt after the pretensioner has been activated

If the vehicle is involved in multiple collisions, the pretensioner will activate for the first collision, but will not activate for the second or subsequent collisions.

n Seat belt extender

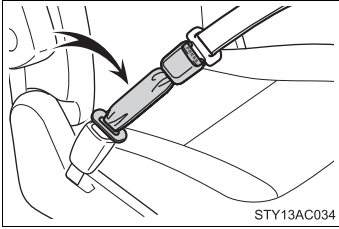

If your seat belts cannot be fastened securely because they are not long enough, a personalized seat belt extender is available from your Toyota dealer free of charge.

⚠ CAUTION

Observe the following precautions to reduce the risk of injury in the event of sudden braking, sudden swerving or an accident. Failing to do so may cause death or serious injury.

n Wearing a seat belt

- l Ensure that all passengers wear a seat belt.
- l Always wear a seat belt properly.
- l Each seat belt should be used by one person only. Do not use a seat belt for more than one person at once, including children.
- l Toyota recommends that children be seated in the rear seat and always use a seat belt and/or an appropriate child restraint system.
- l Do not recline the seat any more than necessary to achieve a proper seating position. The seat belt is most effective when the occupants are sitting up straight and well back in the seats.
- l Do not wear the shoulder belt under your arm.
- l Always wear your seat belt low and snug across your hips.

 CAUTION

n Adjustable shoulder anchor

Always make sure the shoulder belt is positioned across the center of your shoulder. The belt should be kept away from your neck, but not falling off your shoulder. Failure to do so could reduce the amount of protection in an accident and cause death or serious injuries in the event of sudden braking, sudden swerving or an accident. (→P. 57)

n Seat belt pretensioners

I Do not place anything, such as a cushion, on the front passenger's seat. Doing so will disperse the passenger's weight, which prevents the sensor from detecting the passenger's weight properly. As a result, the seat belt pretensioner for the front passenger's seat may not activate in the event of a collision.

I If the pretensioner has activated, the SRS warning light will come on. In that case, the seat belt cannot be used again and must be replaced at your Toyota dealer.

n Child restraint lock function belt precaution

Do not allow children to play with the child restraint lock function belt. If the belt becomes twisted around a child's neck, it will not be possible to pull the belt out leading to choking or other serious injuries that could result in death.

If this occurs and the buckle cannot be unfastened, scissors should be used to cut the belt.

n Seat belt damage and wear

I Do not damage the seat belts by allowing the belt, plate, or buckle to be jammed in the door.

I Inspect the seat belt system periodically. Check for cuts, fraying, and loose parts. Do not use a damaged seat belt until it is replaced. Damaged seat belt cannot protect an occupant from death or serious injury.

I Ensure that the belt and tab are locked and the belt is not twisted. If the seat belt does not function correctly, immediately contact your Toyota dealer.

I Replace the seat assembly, including the belts, if your vehicle has been involved in a serious accident, even if there is no obvious damage.

 CAUTION

n Seat belt damage and wear

- ! Do not attempt to install, remove, modify, disassemble or dispose of the seat belts. Have any necessary repairs carried out by your Toyota dealer. Inappropriate handling of the pretensioner may prevent it from operating properly resulting in death or serious injury.

n Using a seat belt extender

- ! Do not wear the seat belt extender, if you can fasten the seat belt without the extender.
- ! Do not use the seat belt extender when installing a child restraint system, because the belt will not securely hold the child restraint system, increasing the risk of death or serious injury in the event of an accident.
- ! The personalized extender may not be safe on another vehicle, when used by another person, or at a different seating position other than the one originally intended.

 NOTICE

n When using a seat belt extender

- When releasing the seat belt, press on the buckle release button on the extender, not on the seat belt.
This helps prevent damage to the vehicle interior and the extender itself.

1-3. Adjustable components (seats, mirrors, steering wheel)

Steering wheel

The steering wheel can be adjusted to a comfortable position.

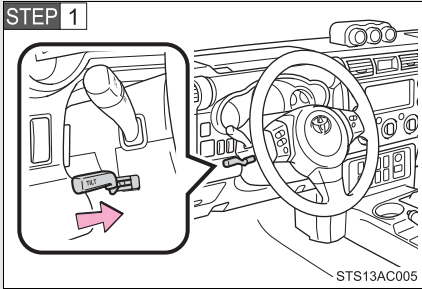

Hold the steering wheel and pull and hold the lever.

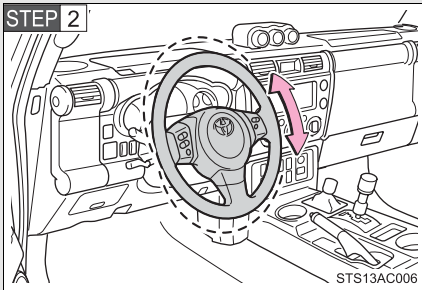

Adjust to the ideal position by moving the steering wheel vertically.

After adjustment, release the lever to secure the steering wheel.

CAUTION

n Caution while driving

Do not adjust the steering wheel while driving. Doing so may cause the driver to mishandle the vehicle and an accident may occur resulting in death or serious injury.

n After adjusting the steering wheel

Make sure that the steering wheel is securely locked. Otherwise, the steering wheel may move suddenly, possibly causing an accident and resulting in death or serious injury.

1-3. Adjustable components (seats, mirrors, steering wheel) Anti-glare inside rear view mirror

In automatic mode, sensors are used to detect the headlights of vehicles behind and automatically reduces the reflected light.

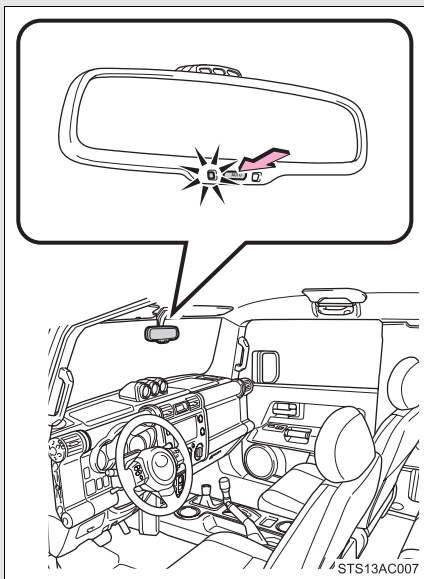

Turns automatic mode on/off

The indicator comes on when automatic mode is turned on.

The mirror will revert to the automatic mode each time the engine switch is turned on.

1
Before driving

Adjusting the height of rear view mirror

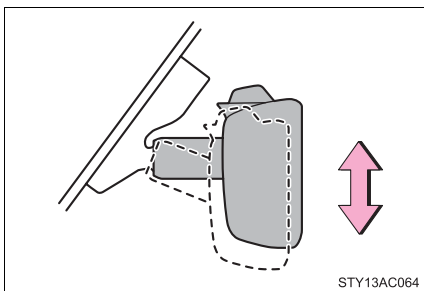

Adjust the height of the rear view mirror by moving it up and down.

n To prevent sensor error (vehicles with auto anti-glare inside rear view mirror)

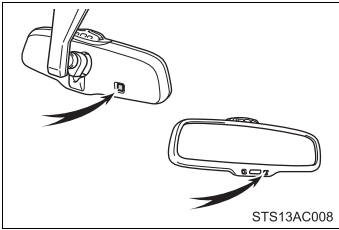

To ensure that the sensors operate properly, do not touch or cover them.

n If a sun visor interferes with the mirror

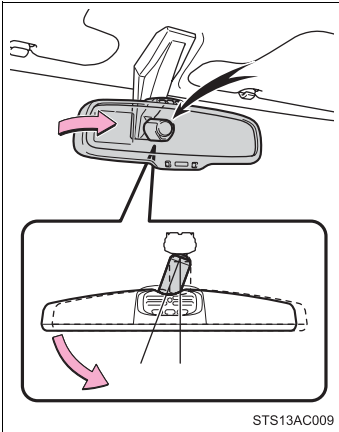

Hold and rotate the mirror to adjust the support.

⚠ CAUTION

n Caution while driving

Do not adjust the position of the mirror while driving.

Doing so may lead to mishandling of the vehicle and an accident, resulting in death or serious injury.

 NOTICE

n When adjusting the support

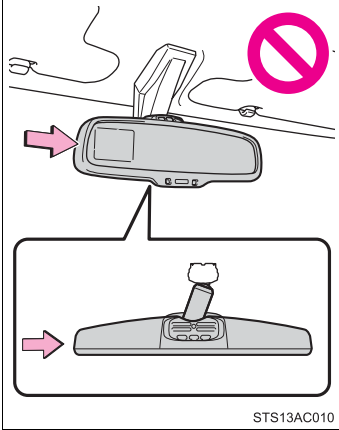

Do not push the mirror horizontally from the side. The mirror could fall off.

1-3. Adjustable components (seats, mirrors, steering wheel)

Outside rear view mirrors

Mirror angle can be adjusted.

► Power-adjustable type

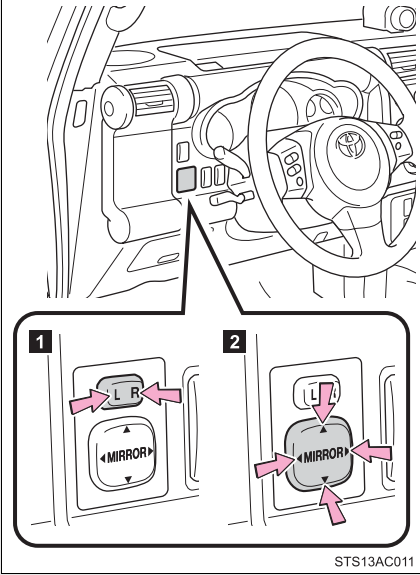

- 1 Select a mirror to adjust.
(L: left or R: right)
- 2 Adjust the mirror up, down, in or out using the switch.

► Manually adjustable type

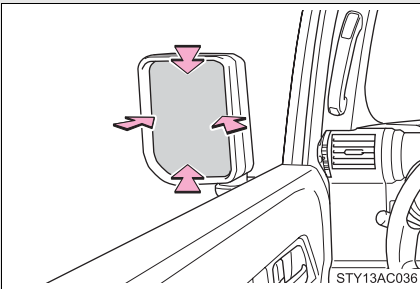

Adjust the mirror up, down, in or out by pushing the mirror surface.

Folding back the mirrors

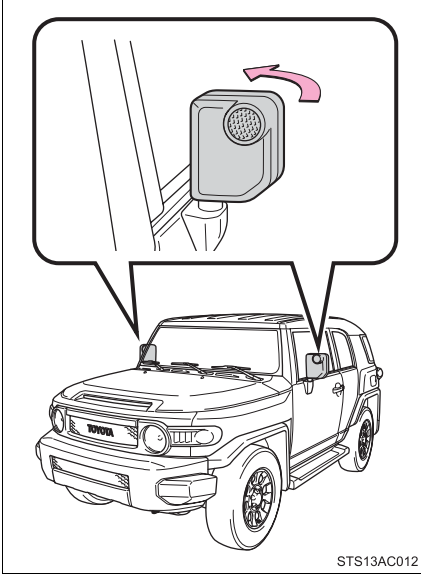

Push backward to fold the mirrors.

1

Before driving

n Mirror operating conditions (vehicles with power-adjustable type)

The engine switch is in the ACC or ON position.

⚠ CAUTION

n When driving the vehicle

Observe the following precautions while driving.

Failing to do so may result in loss of control of the vehicle and cause an accident, resulting in death or serious injury.

- I** Do not adjust the mirrors while driving.
- I** Do not drive with the mirrors folded back.
- I** Both the driver and passenger side mirrors must be extended and properly adjusted before driving.



NOTICE

n If ice should jam the mirror

Do not operate the control or scrape the mirror face. Use a spray de-icer to free the mirror.

1-4. Opening and closing the windows

Power windows

The power windows can be opened/closed using the following switches.

► Driver's power window switches

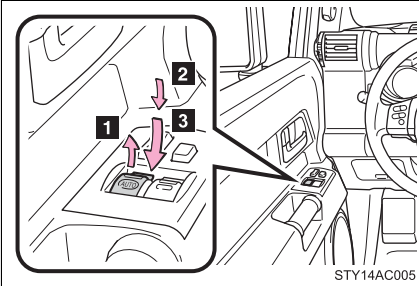

- 1 Closing
- 2 Opening
- 3 One-touch opening (driver's window only)*

*: Pressing the switch in the opposite direction will stop window travel partway.

► Front passenger's power window switch

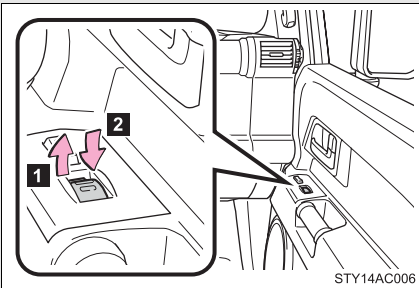

- 1 Closing
- 2 Opening

Lock switch

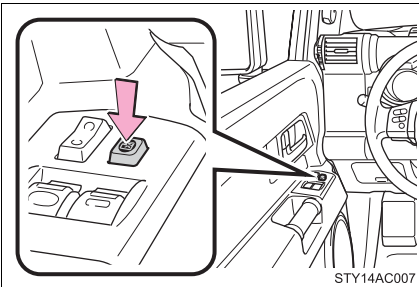

Press the switch down to lock passenger window switches.

Use this switch to prevent children from accidentally opening or closing a passenger window.

n The power windows can be operated when

The engine switch is in the ON position.

n Operating the power windows after turning the engine switch off

The power windows can be operated for approximately 45 seconds even after the engine switch is turned off. They cannot, however, be operated once either front door is opened.

⚠ CAUTION

n Closing the windows

Observe the following precautions.

Failing to do so may result in death or serious injury.

I Check to make sure that all passengers do not have any part of their body in a position where it could be caught when a window is being operated.

I Do not allow children to operate the power windows.

Closing a power window on someone can cause serious injury, and in some instances, even death.

Opening the fuel tank cap

Perform the following steps to open the fuel tank cap.

n Before refueling the vehicle

Turn the engine switch off and ensure that all the doors, windows and glass hatch are closed.

n Opening the fuel tank cap

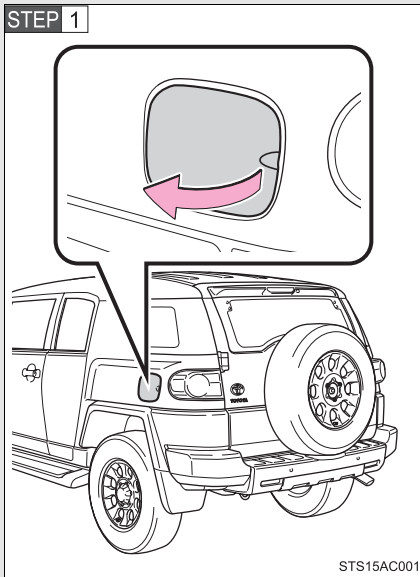

Open the fuel filler door.

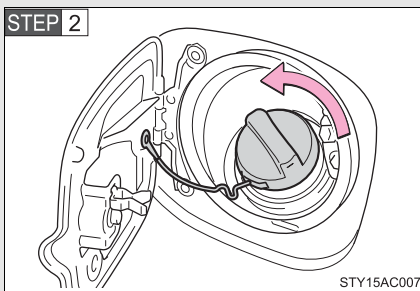

Turn the fuel tank cap slowly to open.

Closing the fuel tank cap

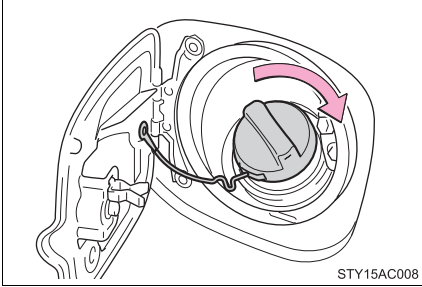

When installing the fuel tank cap, turn it until you hear a click.

The cap will turn slightly to the opposite direction when released.

n Fuel types

Use unleaded gasoline. (Octane Rating 87 [Research Octane Number 91] or higher)

n Fuel tank capacity

Approximately 19.0 gal. (72.0 L, 15.8 Imp. gal.)

⚠ CAUTION

n Refueling the vehicle

Observe the following precautions while refueling the vehicle. Failure to do so, may result in death or serious injury.

- 1 Touch the vehicle or some other metal surface to discharge any static electricity.
Sparks resulting from discharging static electricity may cause the fuel vapors to ignite.
- 1 Always hold the grips on the fuel tank cap and turn it slowly to remove it. A whooshing sound may be heard when the fuel tank cap is loosened. Wait until the sound cannot be heard before fully removing the cap. In hot weather, pressurized fuel may spray out of the filler neck and cause injury.
- 1 Do not allow anyone that has not discharged static electricity from their bodies to come close to an open fuel tank.

 **CAUTION****n Refueling the vehicle**

- i** Do not inhale vaporized fuel.
Fuel contains substances that are harmful if inhaled.
- i** Do not smoke while refueling the vehicle.
Doing so may cause the fuel to ignite and cause a fire.
- i** Do not return to the vehicle or touch any person or object that is statically charged.
This may cause static electricity to build up, resulting in a possible engine hazard.

n When replacing the fuel tank cap

Do not use anything but a genuine Toyota fuel tank cap designed for your vehicle. Doing so may cause a fire or other incident which may result in death or serious injury.

 **NOTICE****n Refueling**

Do not spill fuel during refueling.
Doing so may damage the vehicle, such as causing the exhaust systems to operate abnormally or damaging fuel system components or the vehicle's painted surface.

n To prevent damage to the fuel filler door

Do not apply excessive force.

1-6. Theft deterrent system Engine immobilizer system

The vehicle's keys have built-in transponder chips that prevent the engine from starting if the key has not been previously registered in the vehicle's on-board computer.

Never leave the keys inside the vehicle when you leave the vehicle.

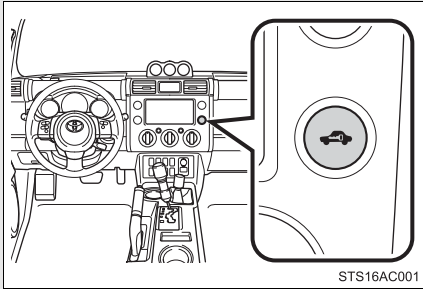

The indicator light flashes after the key has been removed from the engine switch to indicate that the system is operating.

The indicator light stops flashing after the registered key has been inserted into the engine switch to indicate that the system has been canceled.

n System maintenance

The vehicle has a maintenance-free type engine immobilizer system.

n Conditions that may cause the system to malfunction

- l If the key is in contact with a metallic object
- l If the key is in close proximity to or touching a key to the security system (key with a built-in transponder chip) of another vehicle

n Certifications for the engine immobilizer system

► For vehicles sold in U.S.A.

FCC ID: MOZRI-20BTY

This device complies with Part 15 of the FCC Rules. Operation is subject to the following two conditions: (1) this device may not cause harmful interference, and (2) this device must accept any interference received, including interference that may cause undesired operation.

FCC WARNING:

Changes or modifications not expressly approved by the party responsible for compliance could void the user's authority to operate the equipment.

► For vehicles sold in Canada

This device complies with RSS-210 of industry Canada. Operation is subject to the following two conditions: (1) this device may not cause interference, and (2) this device must accept any interference, including interference that may cause undesired operation of the device.



NOTICE

n To ensure the system operates correctly

Do not modify or remove the system. If modified or removed, the proper operation of the system cannot be guaranteed.

1-6. Theft deterrent system

Theft prevention labels (U.S.A.)

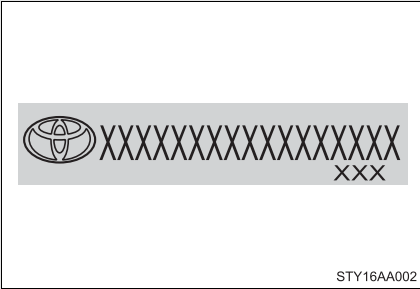

These labels are attached to the vehicle to reduce vehicle theft by facilitating the tracing and recovery of parts from stolen vehicles. Do not remove under penalty of law.

1-7. Safety information

Correct driving posture

Drive in a good posture as follows:

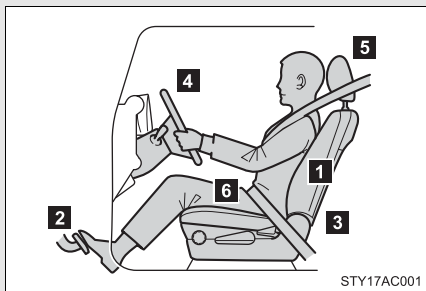

- 1 Sit upright and well back in the seat. (→P. 45)
- 2 Adjust the position of the seat forward or backward to ensure the pedals can be reached and easily depressed to the extent required. (→P. 45)
- 3 Adjust the seatback so that the controls are easily operable.
- 4 Adjust the tilt positions of the steering wheel downward so the airbag is facing your chest. (→P. 62)
- 5 Lock the head restraint in place with the center of the head restraint closest to the top of your ears. (→P. 53)
- 6 Wear the seat belt correctly. (→P. 56)

 **CAUTION**

n While driving

- I** Do not adjust the position of the driver's seat while driving. Doing so could cause the driver to lose control of the vehicle.
- I** Do not place a cushion between the driver or passenger and the seatback. A cushion may prevent correct posture from being achieved, and reduce the effectiveness of the seat belt and head restraint, increasing the risk of death or serious injury to the driver or passenger.
- I** Do not place anything under the front seats. Objects placed under the front seats may become jammed in the seat tracks and stop the seat from locking in place. This may lead to an accident. The adjustment mechanism may also be damaged.

n Adjusting the seat position

- I** Take care when adjusting the seat position to ensure that other passengers are not injured by the moving seat.
- I** Do not put your hands under the seat or near the moving parts to avoid injury. Fingers or hands may become jammed in the seat mechanism.

SRS airbags

The SRS airbags inflate when the vehicle is subjected to certain types of severe impacts that may cause significant injury to the occupants. They work together with the seat belts to help reduce the risk of death or serious injury.

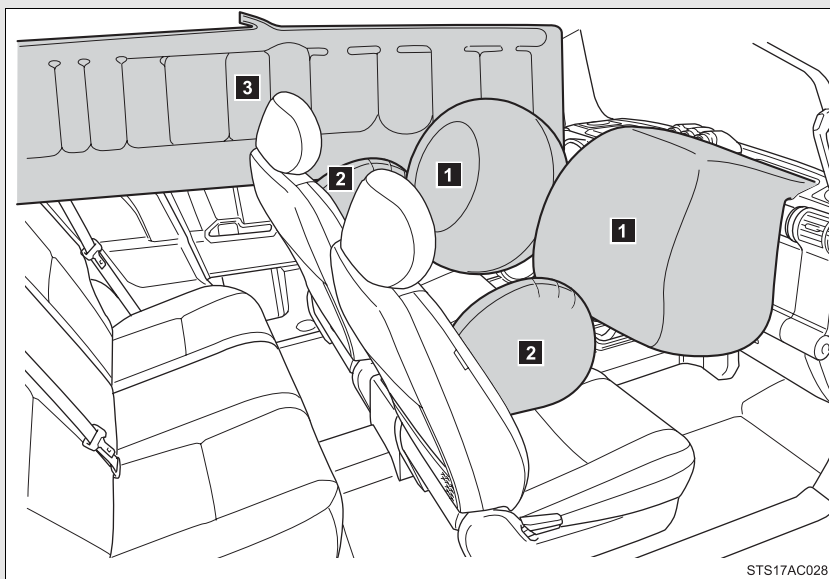

► Front airbags

1 Driver airbag/front passenger airbag

Can help protect the head and chest of the driver and front passenger from impact with interior components.

► Side and curtain shield airbags

2 Side airbags

Can help protect the torso of the front seat occupants.

3 Curtain shield airbags

Can help protect primarily the head of outside occupants.

Airbag system components

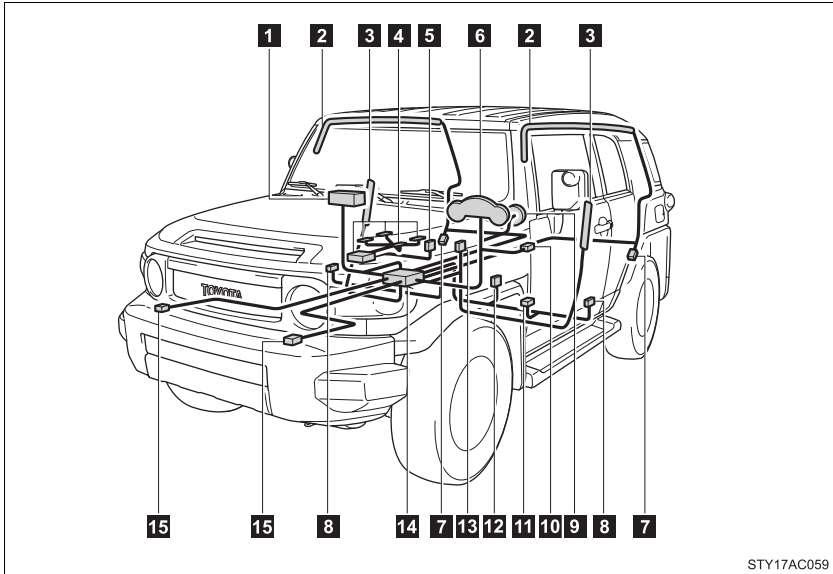

1 Front passenger airbag

2 Curtain shield airbags

3 Side airbags

4 Occupant detection system
(ECU and sensors)

5 Front passenger's seat belt
buckle switch

6 SRS warning light and
RSCA OFF indicator light

7 Curtain shield airbag sen-
sors

8 Side and curtain shield air-
bag sensors

9 Driver airbag

10 RSCA OFF switch

11 Driver's seat position sen-
sor

12 Driver's seat belt buckle
switch

13 AIR BAG ON and AIR BAG
OFF indicator lights

14 Airbag sensor assembly

15 Front airbag sensors

Your vehicle is equipped with ADVANCED AIRBAGS designed based on US motor vehicle safety standards (FMVSS208). The airbag system controls airbag deployment power for the driver and front passenger. The driver airbag system consists of the driver seat's position sensor etc. The front passenger's airbag system consists of the front passenger occupant classification sensor etc.

The main SRS airbag system components are shown above. The SRS airbag system is controlled by the airbag sensor assembly. The airbag sensor assembly consists of a safing sensor and an airbag sensor.

In certain types of severe frontal or side impacts, the SRS airbag system triggers the airbag inflators. A chemical reaction in the inflators quickly fills the airbags with non-toxic gas to help restrain the motion of the occupants.

n SRS warning light

This warning light system monitors the airbag sensor assembly, front airbag sensors, side and curtain shield airbag sensor assemblies, curtain shield airbag sensor assemblies, driver's seat position sensor, driver's seat belt buckle switch, front passenger occupant classification system, AIR BAG ON indicator light, AIR BAG OFF indicator light, front passenger's seat belt buckle switch, seat belt pretensioner assemblies, RSCA OFF indicator light, inflators, interconnecting wiring and power sources. (→P. 431)

n If the SRS airbags deploy (inflate)

- l Bruising and slight abrasions may result from contact with a deploying (inflating) SRS airbag.
- l A loud noise and white powder will be emitted.
- l Parts of the airbag module (steering wheel hub, airbag cover and inflator) as well as the front seats, and parts of the front and rear pillars and roof side rail, may be hot for several minutes. The airbag itself may also be hot.
- l The front windshield may crack.

n Operating conditions (front airbags)

- l The SRS front airbags will deploy in the event of an impact that exceeds the set threshold level (the level of force corresponding to an approximately 12-18 mph [20-30 km/h] frontal collision with a fixed wall that does not move or deform).

However, this threshold velocity will be considerably higher if the vehicle strikes an object, such as a parked vehicle or sign pole, which can move or deform on impact, or if the vehicle is involved in an underride collision (e.g. a collision in which the front of the vehicle “underrides”, or goes under, the bed of a truck, etc.).

- l It is possible that in some collisions where the forward deceleration of the vehicle is very close to the designed threshold level, the SRS front airbags and the seat belt pretensioners may not activate together.
- l The SRS front passenger airbag will not activate if there is no passenger sitting in the front passenger seat. However, the front passenger airbag may deploy if luggage is put in the seat, or the seat belt is fastened, even if the seat is unoccupied. (→P. 92)

n Operating conditions (SRS side airbags and SRS curtain shield airbags)

The SRS side airbags and SRS curtain shield airbags will deploy in the event of an impact that exceeds the set threshold level (the level of force corresponding to the impact force produced by an approximately 3307 lb. [1500 kg] vehicle colliding with the vehicle cabin from a direction perpendicular to the vehicle orientation at an approximate speed of 12-18 mph [20-30 km/h]).

n Operating conditions (side airbags)

The SRS side airbag on the passenger seat will not activate if there is no passenger sitting in the front passenger seat. However, the side airbag on the passenger seat may deploy if luggage is put in the seat, even if the seat is unoccupied. (→P. 92)

n Operating conditions (curtain shield airbags)

The SRS curtain shield airbags are designed to inflate when the passenger compartment is subjected to a severe impact from the side or vehicle roll-over.

11 Conditions under which the SRS airbags may deploy (inflate), other than a collision

The SRS front airbags may also deploy if a serious impact occurs to the underside of your vehicle. Some examples are shown in the illustration.

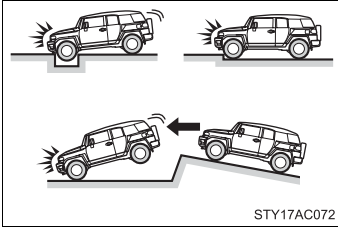

- 1 Hitting a curb, edge of pavement or hard surface
- 1 Falling into or jumping over a deep hole
- 1 Landing hard or vehicle falling

The SRS curtain shield airbags may also deploy under the situation shown in the illustration.

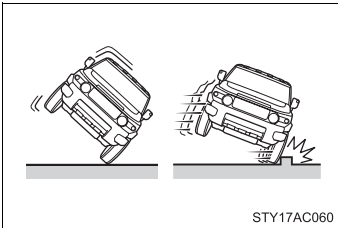

- 1 The angle of vehicle tip-up is marginal
- 1 The vehicle skids and hits a curb stone

11 Types of collisions that may not deploy the SRS airbag (front airbags)

The SRS front airbags are generally not designed to inflate if the vehicle is involved in a side or rear collision, if it rolls over, or if it is involved in a low-speed frontal collision. But, whenever a collision of any type causes sufficient forward deceleration of the vehicle, deployment of the SRS front airbags may occur.

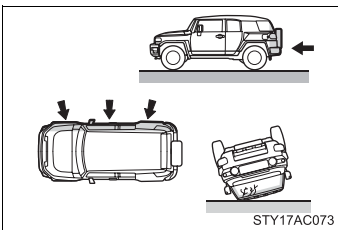

- 1 Collision from the side
- 1 Collision from the rear
- 1 Vehicle rollover

▮ **Types of collisions that may not deploy the SRS airbag (side airbags and curtain shield airbags)**

The SRS side airbag and curtain shield airbag system may not activate if the vehicle is subjected to a collision from the side at certain angles, or a collision to the side of the vehicle body other than the passenger compartment.

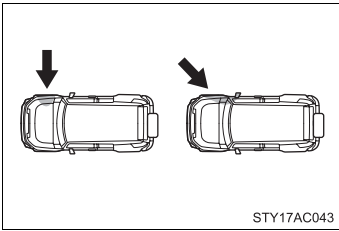

- | Collision from the side to the vehicle body other than the passenger compartment
- | Collision from the side at an angle

The SRS side airbags are not generally designed to inflate if the vehicle is involved in a frontal or rear collision, if it rolls over, or if it is involved in a low-speed side collision.

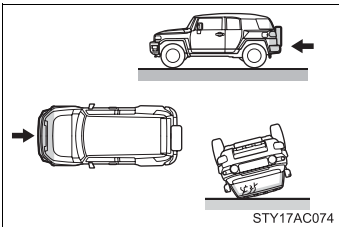

- | Collision from the front
- | Collision from the rear
- | Vehicle rollover

The SRS curtain shield airbags are not generally designed to inflate if the vehicle is involved in a frontal or rear collision, if it pitches end over end, or if it is involved in a low-speed side collision.

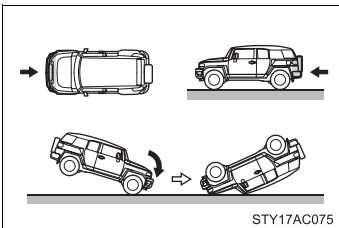

- | Collision from the front
- | Collision from the rear
- | Pitching end over end

11 When to contact your Toyota dealer

In the following cases, contact your Toyota dealer as soon as possible.

1 Any of the SRS airbags have been inflated.

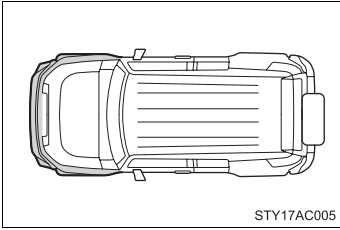

1 The front of the vehicle is damaged or deformed, or was involved in an accident that was not severe enough to cause the SRS airbags to inflate.

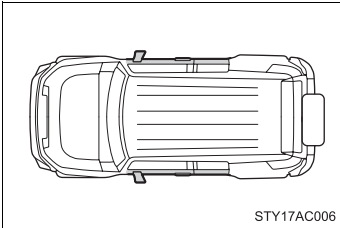

1 A portion of a door is damaged or deformed, or the vehicle was involved in an accident that was not severe enough to cause the SRS side airbags and curtain shield airbags to inflate.

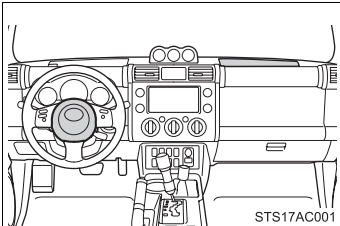

1 The pad section of the steering wheel or dashboard near the front passenger airbag is scratched, cracked, or otherwise damaged.

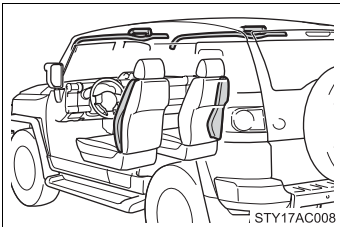

1 The surface of the seats with the side airbag is scratched, cracked or otherwise damaged.

1 The portion of the front pillars, rear pillars or roof side rail garnishes (padding) containing the curtain shield airbags inside is scratched, cracked or otherwise damaged.

 CAUTION

n SRS airbag precautions

Observe the following precautions regarding the airbags.
Failure to do so may cause death or serious injury.

I The driver and all passengers in the vehicle must wear their seat belts properly.

The SRS airbags are supplemental devices to be used with the seat belts.

I The SRS driver airbag deploys with considerable force, and can cause death or serious injury especially if the driver is very close to the airbag. The National Highway Traffic Safety Administration (“NHTSA”) advises:

Since the risk zone for driver’s airbag is the first 2 - 3 in. (50 - 75 mm) of inflation, placing yourself 10 in. (250 mm) from your driver airbag provides you with a clear margin of safety. This distance is measured from the center of the steering wheel to your breastbone. If you now sit less than 10 in. (250 mm) away, you can change your driving position in several ways:

- Move your seat to the rear as far as you can while still reaching the pedals comfortably.
- Slightly recline the back of the seat.
Although vehicle designs vary, many drivers can achieve the 10 in. (250 mm) distance, even with the driver seat all the way forward, simply by reclining the back of the seat somewhat. If reclining the back of your seat makes it hard to see the road, raise yourself by using a firm, non-slippery cushion, or raise the seat if your vehicle has that feature.
- If your steering wheel is adjustable, tilt it downward. This points the airbag toward your chest instead of your head and neck.

The seat should be adjusted as recommended by NHTSA above, while still maintaining control of the foot pedals, steering wheel, and your view of the instrument panel controls.

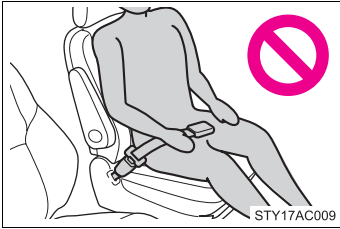
⚠ CAUTION**n SRS airbag precautions**

I If the seat belt extender has been connected to the driver's seat belt buckle but the seat belt extender has not also been fastened to the latch plate of the driver's seat belt, the SRS driver's airbag system will judge that the driver is wearing the seat belt even though the seat belt has not been connected. In this case, the driver's airbag may not activate correctly in a collision, resulting in death or serious injury in the event of collision. Be sure to wear the seat belt with the seat belt extender.

- I** The SRS front passenger airbag also deploys with considerable force, and can cause death or serious injury especially if the front passenger is very close to the airbag. The front passenger seat should be as far from the airbag as possible with the seatback adjusted, so the front passenger sits upright.
- I** Improperly seated and/or restrained infants and children can be killed or seriously injured by a deploying airbag. An infant or child who is too small to use a seat belt should be properly secured using a child restraint system. Toyota strongly recommends that all infants and children be placed in the rear seats of the vehicle and properly restrained. The rear seats are the safest for infants and children. (→P. 97)

! CAUTION

n SRS airbag precautions

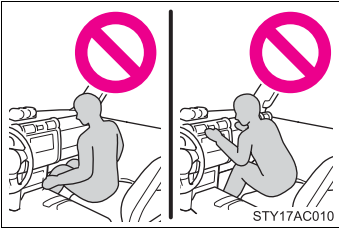

! Do not sit on the edge of the seat or lean against the dashboard.

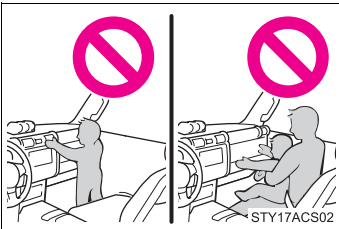

! Do not allow a child to stand in front of the SRS front passenger airbag unit or sit on the knees of a front passenger.

! Do not drive the vehicle while the driver or passenger has items resting on their knees.



! Do not lean against the door, the roof side rail or the front, side and rear pillars.



! Do not allow anyone to kneel on the passenger seat toward the door or put their head or hands outside the vehicle.

⚠ CAUTION

n SRS airbag precautions

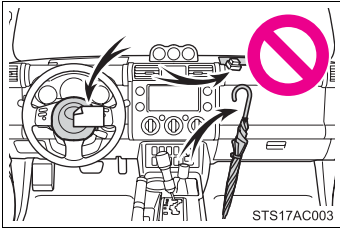

STS17AC003

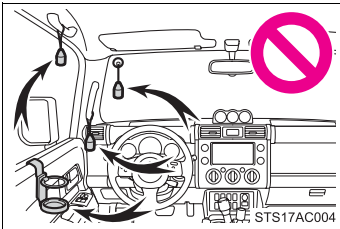

STS17AC004

- I Do not attach anything to or lean anything against areas such as the dashboard or steering wheel pad. These items can become projectiles when SRS driver and front passenger airbags deploy.
- I Do not attach anything to areas such as the door, windshield glass, side door glass, front and rear pillars, roof side rail or assist grip.
- I Do not use seat accessories which cover the parts where the SRS side airbags inflate as they may interfere with inflation of the airbags.
- I Do not strike or apply significant levels of force to the area of the SRS airbag components (→P. 80). Doing so can cause the SRS airbags to malfunction.
- I Do not touch any of the component parts immediately after the SRS airbags have deployed (inflated) as they may be hot.
- I If breathing becomes difficult after the SRS airbag has deployed, open a door or window to allow fresh air in, or leave the vehicle if it is safe to do so. Wash off any residue as soon as possible to prevent skin irritation.
- I If the areas where the SRS airbags are stored, such as the steering wheel pad and front and rear pillar garnishes, are damaged or cracked, have them replaced by your Toyota dealer.

⚠ CAUTION

n Modification and disposal of SRS airbag system components

Do not dispose of your vehicle or perform any of the following modifications without consulting your Toyota dealer.

The SRS airbags may malfunction or deploy (inflate) accidentally, causing death or serious injury.

- ! Installation, removal, disassembly and repair of the SRS airbags.
- ! Repairs, modifications, removal or replacement of the steering wheel, instrument panel, dashboard, seats or seat upholstery, front and rear pillars or roof side rails.
- ! Repairs or modifications of the front fender, front bumper, or side of the occupant compartment.
- ! Installation of snow plows, winches, etc. to the front grille (bull bars, kangaroo bar etc.).
- ! Modifications to the vehicle's suspension system.
- ! Installation of electronic devices such as mobile two-way radios or CD players.
- ! Modifications to your vehicle for a person with a physical disability.

Deactivating the curtain shield airbags in a vehicle rollover

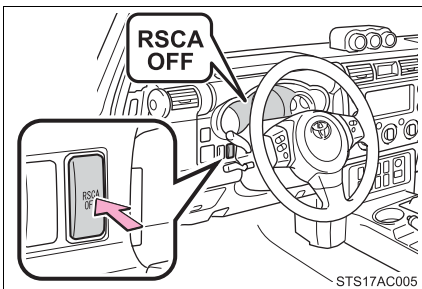

ON/OFF (hold for a few seconds)

The RSCA OFF indicator turns on. (only when the engine switch is in the ON position.)

The roll sensing function for the curtain shield airbags and seat belt pretensioners will turn back on automatically each time the engine switch is turned on.

n **The switch only should be used**

In a situation where inflation is not desired (such as during extreme off-road driving).

n **Operating conditions when the RSCA OFF indicator is on**

- l The curtain shield airbag and seat belt pretensioner will not activate in a vehicle rollover.
- l The curtain shield airbag will activate in a severe side impact.

 **CAUTION**

n **For normal driving**

Make sure the RSCA OFF indicator is not turned on. If it is left on, the curtain shield airbag will not activate in the event of an accident, which may result in death or serious injury.

Front passenger occupant classification system

Your vehicle is equipped with a front passenger occupant classification system. This system detects the conditions of the front passenger seat and activates or deactivates the devices for front passenger.

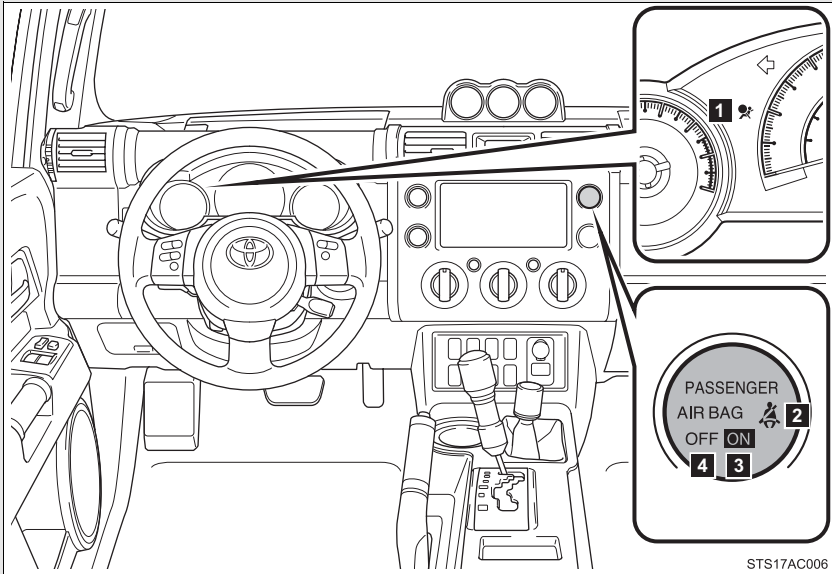

1 SRS warning light

2 Front passenger's seat belt reminder light

3 AIR BAG ON indicator light

4 AIR BAG OFF indicator light

Condition and operation in the front passenger occupant classification system

n Adult *1

Indicator/ warning light	AIR BAG ON and AIR BAG OFF indicator lights	AIR BAG ON
	SRS warning light	Off
	Front passenger's seat belt reminder light	Flashing*2
Devices	Front passenger airbag	Activated
	Side airbag on the front passenger seat	
	Curtain shield airbag in the front passenger side	
	Front passenger's seat belt pretensioner	

1

Before driving

n Child*3 or child restraint system*4

Indicator/ warning light	AIR BAG ON and AIR BAG OFF indicator lights	AIR BAG OFF*5
	SRS warning light	Off
	Front passenger's seat belt reminder light	Flashing*2
Devices	Front passenger airbag	Deactivated
	Side airbag on the front passenger seat	
	Curtain shield airbag in the front passenger side	Activated
	Front passenger's seat belt pretensioner	

n Unoccupied

Indicator/ warning light	AIR BAG ON and AIR BAG OFF indicator lights	Not illuminated
	SRS warning light	Off
	Front passenger's seat belt reminder light	
Devices	Front passenger airbag	Deactivated
	Side airbag on the front passenger seat	
	Curtain shield airbag in the front passenger side	Activated
	Front passenger's seat belt pretensioner	Deactivated

n There is a malfunction in the system

Indicator/ warning light	AIR BAG ON and AIR BAG OFF indicator lights	AIR BAG OFF
	SRS warning light	On
	Front passenger's seat belt reminder light	Off
Devices	Front passenger airbag	Deactivated
	Side airbag on the front passenger seat	
	Curtain shield airbag in the front passenger side	Activated
	Front passenger's seat belt pretensioner	

*1: The system judges a person of adult size as an adult. When a smaller adult sits in the front passenger seat, the system may recognize him/her as a child depending on his/her physique and posture.

*2: In the event the front passenger does not wear a seat belt.

*3: When a larger child who has outgrown a child restraint system sits in the front passenger seat, the system may recognize him/her as an adult depending on his/her physique or posture.

*4: Never install a rear-facing child restraint system on the front passenger seat. A forward-facing child restraint system should only be installed on the front passenger seat when it is unavoidable. (→P. 97)

*5: In case the indicator is not illuminated, consult this manual as for installing the child restraint system properly. (→P. 101)

 **CAUTION****n Front passenger occupant classification system precautions**

Observe the following precautions regarding front passenger occupant classification system.

Failure to do so may cause death or serious injury.

- I Wear the seat belt properly.
- I Make sure the front passenger's seat belt tab has not been left inserted into the buckle before someone sits in the front passenger seat.
- I Make sure the AIR BAG OFF indicator light is not illuminated when using the seat belt extender for the front passenger seat. If the AIR BAG OFF indicator light is illuminated, disconnect the extender tongue from the seat belt buckle, then reconnect the seat belt. Reconnect the seat belt extender after making sure the AIR BAG ON indicator light is illuminated. If you use the seat belt extender while the AIR BAG OFF indicator light is illuminated, the front passenger airbag and side airbag on the front passenger side may not activate correctly, which could cause death or serious injury in the event of an accident.
- I Do not apply a heavy load to the front passenger seat or equipment.
- I Do not put weight on the front passenger seat by putting your hands or feet on the front passenger seat seatback from the rear passenger seat.
- I Do not let a rear passenger lift the front passenger seat with their feet or press on the seatback with their legs.
- I Do not put objects under the front passenger seat.
- I Do not recline the front passenger seatback so far that it touches a rear seat. This may cause the AIR BAG OFF indicator light to be illuminated, which indicates that the passenger's airbags will not deploy in the event of a severe accident. If the seatback touches the rear seat, return the seatback to a position where it does not touch the rear seat. Keep the front passenger seatback as upright as possible when the vehicle is moving. Reclining the seatback excessively may lessen the effectiveness of the seat belt system.

 CAUTION

n Front passenger occupant classification system precautions

- I** If an adult sits in the front passenger seat, the AIR BAG ON indicator light is illuminated. If the AIR BAG OFF indicator is illuminated, ask the passenger to sit up straight, well back in the seat, feet on the floor, and with the seat belt worn correctly. If the AIR BAG OFF indicator still remain illuminated, either ask the passenger to move to the rear seat, or if that is not possible, move the front passenger seat fully rearward.
- I** When it is unavoidable to install the forward-facing child restraint system on the front passenger seat, install the child restraint system on the front passenger seat in the proper order. (→P. 101)
- I** Do not modify or remove the front seats.
- I** Do not kick the front passenger seat or subject it to severe impact. Otherwise, the SRS warning light may come on to indicate a malfunction of the detection system. In this case, contact your Toyota dealer immediately.
- I** Child restraint systems installed on the rear seat should not contact the front seatbacks.
- I** Do not use a seat accessory, such as a cushion or seat cover, that covers the seat cushion surface.
- I** Do not attach a commercial seatback table or other heavy item to the back of the front passenger seat.
- I** Do not modify or replace the upholstery of the front seat.

A child restraint system for a small child or baby must itself be properly restrained on the seat with the lap portion of the lap/shoulder belt.

The laws of all 50 states of the U.S.A. and Canada now require the use of child restraint systems.

Points to remember

Studies have shown that installing a child restraint on a rear seat is much safer than installing one to the front passenger seat.

1 Choose a child restraint system that suits your vehicle and is appropriate to the age and size of the child.

1 For installation details, follow the instructions provided with the child restraint system.

General installation instructions are provided in this manual.

(→P. 101)

Types of child restraints

Child restraint systems are classified into the following 3 types according to the age and size of the child.

► Rear facing — Infant seat/convertible seat



► Forward facing — Convertible seat



► Booster seat



n **Selecting an appropriate child restraint system**

- l Use a child restraint system appropriate for the child until the child becomes large enough to properly wear the vehicle's seat belts.
- l If a child is too large for a child restraint system, sit the child on a rear seat and use the vehicle's seat belt. (→P. 56)

 **CAUTION****n Child restraint precautions**

- I** For effective protection in automobile accidents and sudden stops, a child must be properly restrained, using a seat belt or child restraint system depending on the age and size of the child. Holding a child in your arms is not a substitute for a child restraint system. In an accident, the child can be crushed against the windshield, or between you and the vehicle's interior.
- I** Toyota strongly urges the use of a proper child restraint system that conforms to the size of the child, installed on the rear seat. According to accident statistics, the child is safer when properly restrained in the rear seat than in the front seat.
- I** Never install a rear-facing child restraint system on the front passenger seat even if AIR BAG OFF indicator light is illuminated. In the event of an accident, the force of the rapid inflation of the front passenger airbag can cause death or serious injury to the child if the rear-facing child restraint system is installed on the front passenger seat.
- I** A forward-facing child restraint system may to be installed on the front passenger seat only when it is unavoidable. A child restraint system that requires a top tether strap should not be used in the front passenger seat since there is no top tether strap anchor for the front passenger seat. Adjust the seatback as upright as possible and always move the seat as far back as possible even if AIR BAG OFF indicator light is illuminated, because the front passenger airbag could inflate with considerable speed and force. Otherwise, the child may be killed or seriously injured.
- I** Do not use the seat belt extender when installing a child restraint system on the front or rear passenger seat. If installing a child restraint system with the seat belt extender connected to the seat belt, the seat belt will not securely hold the child restraint system, which could cause death or serious injury to the child or other passengers in the event of a sudden braking, sudden swerving or an accident.
- I** Do not allow the child to lean his/her head or any part of his/her body against the door or the area of the seat, front and rear pillars or roof side rail from which the side airbags or curtain shield airbags deploy even if the child is seated in the child restraint system. It is dangerous if the side airbags and curtain shield airbags inflate, and the impact could cause death or serious injury to the child.

 CAUTION

n Child restraint precautions

I Make sure you have complied with all installation instructions provided by the child restraint manufacturer and that the system is properly secured. If it is not secured properly, it may cause death or serious injury to the child in the event of sudden braking, sudden swerving or an accident.

n Child restraint lock function belt precaution

Do not allow children to play with the child restraint lock function belt. If the belt becomes twisted around a child's neck, it will not be possible to pull the belt out leading to choking or other serious injuries that could result in death. If this occurs and the buckle cannot be unfastened, scissors should be used to cut the belt.

n When the child restraint system is not in use

I Keep the child restraint system properly secured on the seat even if it is not in use. Do not store the restraint unsecured in the passenger compartment.

I If it is necessary to detach the child restraint system, remove it from the vehicle or store it securely in the luggage compartment. This will prevent it from injuring passengers in the event of sudden braking, sudden swerving or an accident.

Installing child restraints

Follow the child restraint system manufacturer's instructions. Firmly secure child restraints to the rear seats using the LATCH anchors or a seat belt. Attach the top tether strap when installing a child restraint.

The lap/shoulder belt can be used if your child restraint system is not compatible with the LATCH (Lower Anchors and Tethers for Children) system.

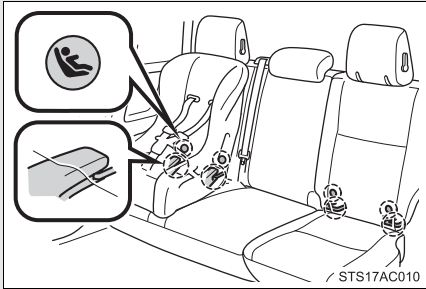

Child restraint LATCH anchors

LATCH anchors are provided for the outside rear seats. (Buttons displaying the location of the anchors are attached to the seats.)

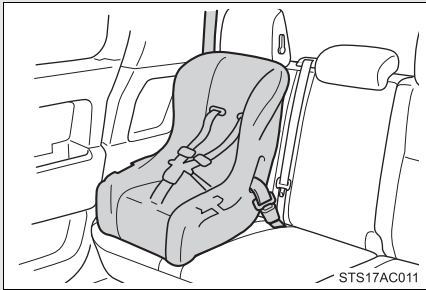

Seat belts equipped with a child restraint locking mechanism (ALR/ELR belts except driver's seat belt) (→P. 56)

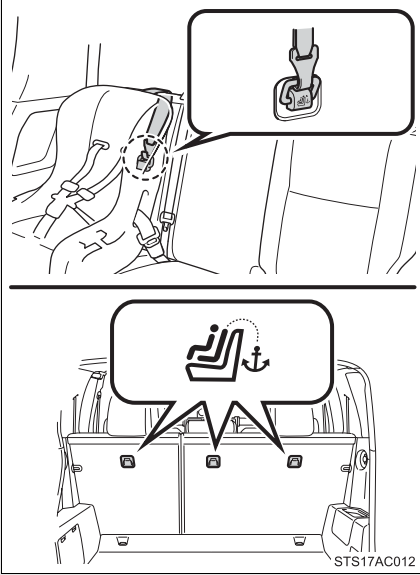

Anchor bracket (for top tether strap)

Anchor brackets are provided for all rear seats.

Installation with LATCH system

► Type A

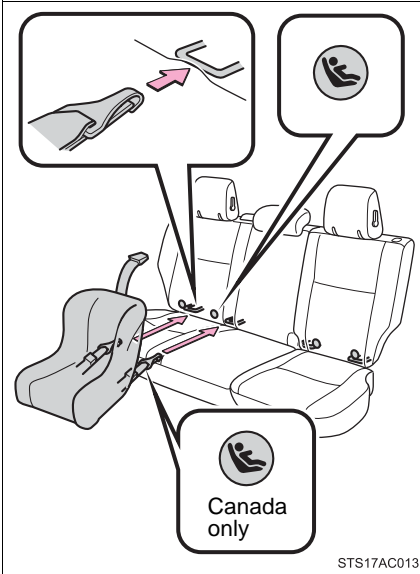

STEP 1 Widen the gap between the seat cushion and seatback slightly.

STEP 2 Latch the hooks of the lower straps onto the LATCH anchors and tighten the lower straps.

STEP 3 If the child restraint has a top tether strap, the top tether strap should be latched onto the top tether strap anchor. (→P. 108)

For owners in Canada:
The symbol on a child restraint system indicates the presence of a lower connector system.

► Type B

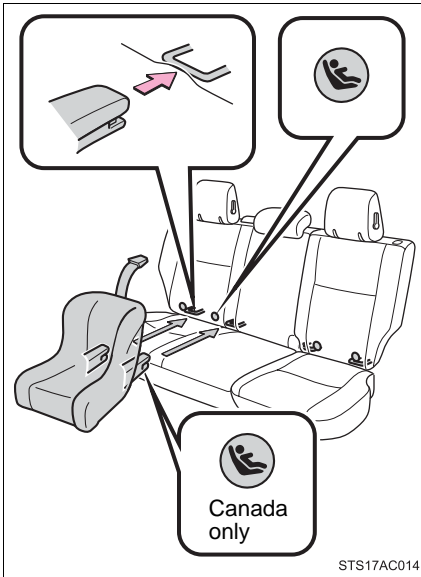

STEP 1 Widen the gap between the seat cushion and seatback slightly.

STEP 2 Latch the buckles onto the LATCH anchors.

STEP 3 If the child restraint has a top tether strap, the top tether strap should be latched onto the top tether strap anchor. (→P. 108)

For owners in Canada:
The symbol on a child restraint system indicates the presence of a lower connector system.

Installing child restraints using a seat belt (child restraint lock function belt)

n Rear facing — Infant seat/convertible seat

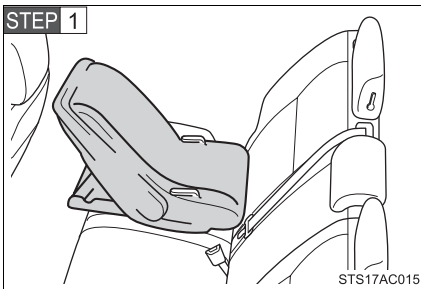

Place the child seat on the rear seat facing the rear of the vehicle.

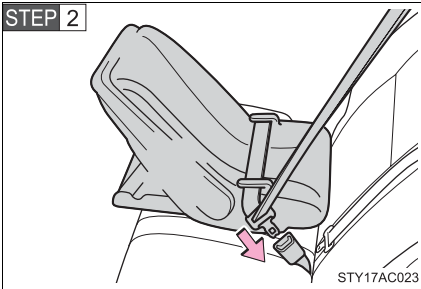

Run the seat belt through the child seat and insert the plate into the buckle. Make sure that the belt is not twisted.

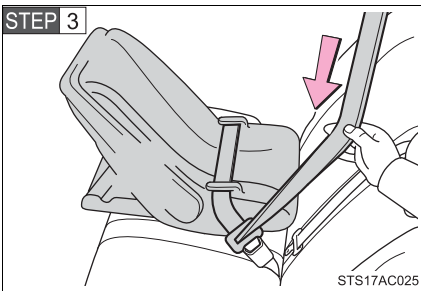

Fully extend the shoulder belt and then allow it to retract slightly in order to activate the ALR lock mode.

Lock mode allows the seat belt to retract only.

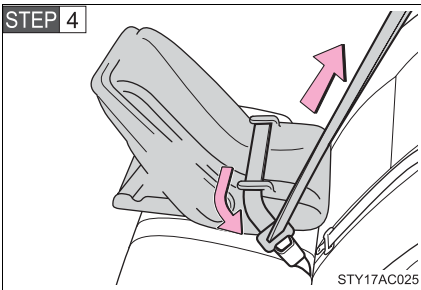

While pushing the child seat down into the rear seat, allow the shoulder belt to retract until the child seat is securely in place.

After the shoulder belt has retracted to a point where there is no slack in the belt, pull the belt to check that it cannot be extended.

n Forward facing — Convertible seat

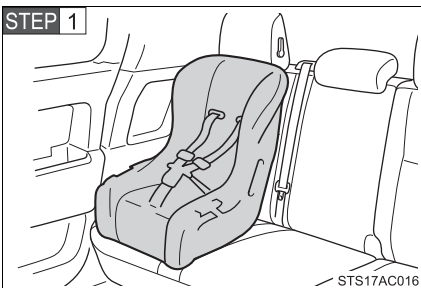

Place the child seat on the seat facing the front of the vehicle.

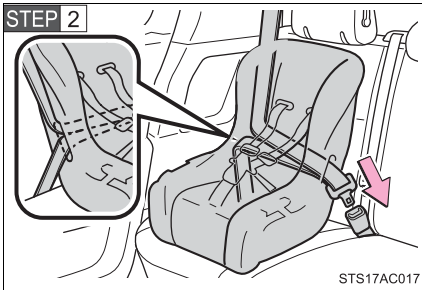

Run the seat belt through the child seat and insert the plate into the buckle. Make sure that the belt is not twisted.

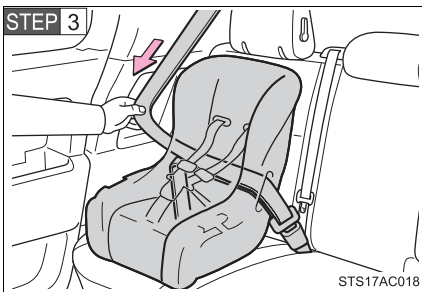

Fully extend the shoulder belt and then allow it to retract slightly in order to activate the ALR lock mode.

Lock mode allows the seat belt to retract only.

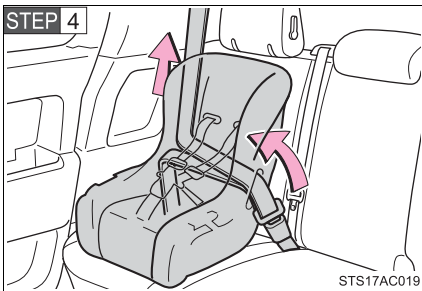

While pushing the child seat into the rear seat, allow the shoulder belt to retract until the child seat is securely in place.

After the shoulder belt has retracted to a point where there is no slack in the belt, pull the belt to check that it cannot be extended.

STEP 5 If the child restraint has a top tether strap, the top tether strap should be latched onto the top tether strap anchor. (→P. 108)

n Booster seat

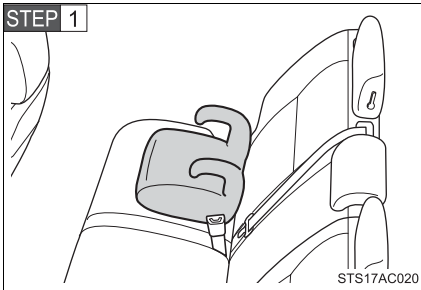

Place the booster seat on the seat facing the front of the vehicle.

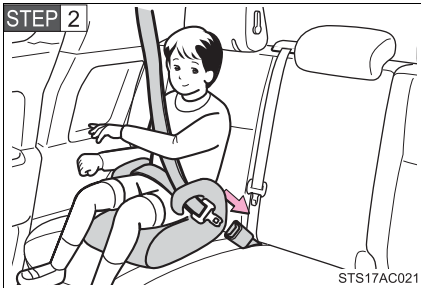

Sit the child in the booster seat. Fit the seat belt to the booster seat according to the manufacturer's instructions and insert the plate into the buckle. Make sure that the belt is not twisted.

Check that the shoulder belt is correctly positioned over the child's shoulder, and that the lap belt is as low as possible.
(→P. 56)

Removing a child restraint installed with a seat belt

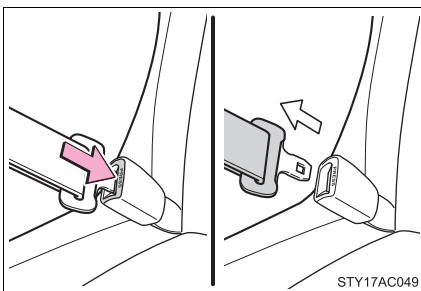

Push the buckle release button and fully retract the seat belt.

Child restraint systems with a top tether strap

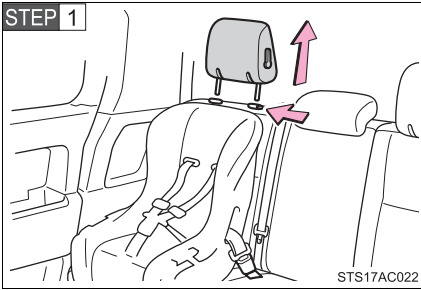

Secure the child restraint using the LATCH anchors or seat belt, and remove the head restraint.

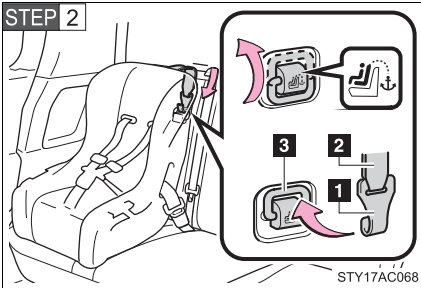

Raise the anchor bracket, latch the hook onto the anchor bracket and tighten the top tether strap.

Make sure the top tether strap is securely latched.

- 1 Hook
- 2 Top strap
- 3 Anchor bracket

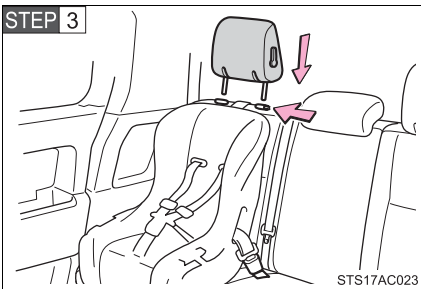

Reinstall the head restraint.

n Laws and regulations pertaining to anchorages

The LATCH system conforms to FMVSS225 or CMVSS210.2.

Child restraint systems conforming to FMVSS213 or CMVSS213 specifications can be used.

This vehicle is designed to conform to the SAE J1819.

ⓘ When the anchor bracket is not in use

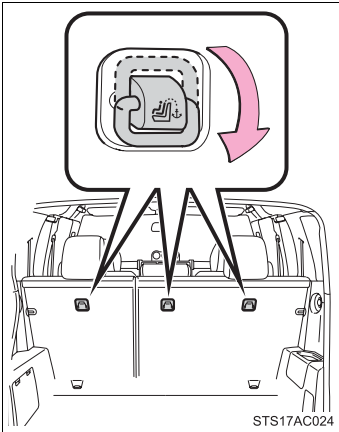

Lower the anchor bracket.

The anchor bracket is only designed to secure the top tether strap. Do not use the anchor bracket for any other purpose.

1

Before driving

⚠ CAUTION

ⓘ When installing a booster seat

Do not fully extend the shoulder belt to prevent the belt from going to ALR lock mode. (→P. 58)

ALR mode causes the belt to tighten only which could cause death or serious injury to the child.

! CAUTION

n When installing a child restraint system

Follow the directions given in the child restraint system installation manual and fix the child restraint system securely in place.

If the child restraint system is not correctly fixed in place, the child or other passengers may be seriously injured or even killed in the event of sudden braking, sudden swerving or an accident.

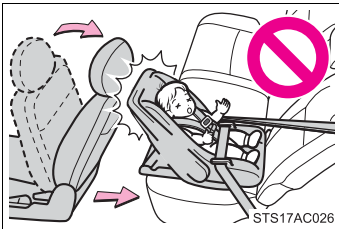

I If the driver's seat interferes with the child restraint system and prevents it from being attached correctly, attach the child restraint system to the right-hand rear seat.

I Adjust the front passenger seat so that it does not interfere with the child restraint system.

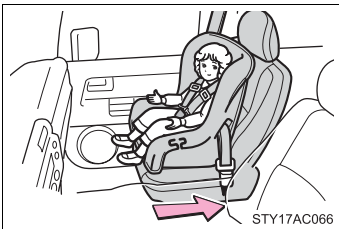

I Only put a forward facing or booster child seat on the front seat when unavoidable. When installing a forward facing or booster child seat on the front passenger seat, move the seat as far back as possible even if AIR BAG OFF indicator light is illuminated. Failing to do so may result in death or serious injury if the airbags deploy (inflate).

I When a booster seat is installed, always ensure that the shoulder belt is positioned across the center of the child's shoulder. The belt should be kept away from the child's neck, but not so that it could fall off the child's shoulder. Failing to do so may result in death or serious injury in the event of sudden braking, sudden swerving or an accident.

I Ensure that the belt and tab are securely locked and the seat belt is not twisted.

I Push and pull the child restraint system from side to side and forward to be sure it is secure.

I After securing a child restraint system, never adjust the seat.

I Follow all installation instructions provided by the child restraint system manufacturer.

 **CAUTION****n Do not use a seat belt extender**

If a seat belt extender is used when installing a child restraint system, the seat belt will not securely hold the child restraint system, which could cause death or serious injury to the child or other passengers in the event of sudden braking, sudden swerving or an accident.

n To correctly attach a child restraint system to the anchors

When using the LATCH anchors, be sure that there are no foreign objects around the anchors and that the seat belt is not caught behind the child restraint. Make sure the child restraint system is securely attached, or it may cause death or serious injury to the child or other passengers in the event of sudden braking, sudden swerving or an accident.

The following procedures should be observed to ensure safe driving.

n **Starting the engine (→P. 124)**

n **Driving**

▶ Automatic transmission

STEP 1 With the brake pedal depressed, shift the shift lever to D. (→P. 127)

STEP 2 Release the parking brake. (→P. 132)

STEP 3 Gradually release the brake pedal and gently depress the accelerator pedal to accelerate the vehicle.

▶ Manual transmission

STEP 1 With the clutch pedal fully depressed, shift the shift lever to 1. (→P. 129)

STEP 2 Release the parking brake. (→P. 132)

STEP 3 Gradually release the clutch pedal. At the same time, gently depress the accelerator pedal to accelerate the vehicle.

n **Stopping**

▶ Automatic transmission

STEP 1 With the shift lever in D, depress the brake pedal.

STEP 2 If necessary, set the parking brake.

When the vehicle is stopped for an extended period of time, shift the shift lever to P or N. (→P. 127)

▶ Manual transmission

STEP 1 With the clutch pedal fully depressed, depress the brake pedal.

STEP 2 If necessary, set the parking brake.

When the vehicle is stopped for an extended period of time, shift the shift lever to N. (→P. 129)

n Parking the vehicle

► Automatic transmission

STEP 1 With the shift lever in D, depress the brake pedal.

STEP 2 Set the parking brake. (→P. 132)

STEP 3 Shift the shift lever to P. (→P. 127)

When parking on a hill, if necessary, block the wheels.

STEP 4 Turn the engine switch off to stop the engine.

STEP 5 Lock the door, making sure that you have the key on your person.

► Manual transmission

STEP 1 With the clutch pedal fully depressed, depress the brake pedal.

STEP 2 Set the parking brake. (→P. 132)

STEP 3 Shift the shift lever to N. (→P. 129)

When parking on a hill, shift the shift lever to 1 or R. If necessary, block the wheels.

STEP 4 Turn the engine switch off to stop the engine.

STEP 5 Lock the door, making sure that you have the key on your person.

Starting on a steep uphill

► Automatic transmission

STEP 1 With the brake pedal depressed, firmly set the parking brake and shift the shift lever to D.

STEP 2 Gently depress the accelerator pedal.

STEP 3 Release the parking brake.

► Manual transmission

STEP 1 With the parking brake firmly set and the clutch pedal fully depressed, shift the shift lever to 1.

STEP 2 Lightly depress the accelerator pedal at the same time as gradually releasing the clutch pedal.

STEP 3 Release the parking brake.

n Driving in the rain

- l Drive carefully when it is raining, because visibility will be reduced, the windows may become fogged-up, and the road will be slippery.
- l Drive carefully when it starts to rain, because the road surface will be especially slippery.
- l Refrain from high speeds when driving on an expressway in the rain, because there may be a layer of water between the tires and the road surface, preventing the steering and brakes from operating properly.

n Breaking in your new Toyota

To extend the life of the vehicle, the following precautions are recommended to observe:

- l For the first 200 miles (300 km):
Avoid sudden stops.
- l For the first 500 miles (800 km):
Do not tow a trailer.
- l For the first 1000 miles (1600 km):
 - Do not drive at extremely high speeds.
 - Avoid sudden acceleration.
 - Do not drive continuously in the low gears.
 - Do not drive at a constant speed for extended periods.

n Drum-in disc type parking brake system

Your vehicle has a drum-in-disc type parking brake system. This type of brake system needs bedding-down of the brake shoes periodically or whenever the parking brake shoes and/or drum are replaced. Have your Toyota dealer perform the bedding down.

n Operating your vehicle in a foreign country

Comply with the relevant vehicle registration laws and confirm the availability of the correct fuel. (→P. 470)

 CAUTION**n When starting the vehicle**

Vehicles with an automatic transmission: Always keep your foot on the brake pedal while stopped with the engine running. This prevents the vehicle from creeping.

n When driving the vehicle

I Do not drive if you are unfamiliar with the location of the brake and accelerator pedals to avoid depressing the wrong pedal.

- Accidentally depressing the accelerator pedal instead of the brake pedal will result in sudden acceleration that may lead to an accident that could result in death or serious injury.
- When backing up, you may twist your body around, leading to a difficulty in operating the pedals. Make sure to operate the pedals properly.
- Make sure to keep a correct driving posture even when moving the vehicle only slightly, allowing you to depress the brake and accelerator pedals properly.
- Depress the brake pedal using your right foot. Depressing the brake pedal using your left foot may delay response in an emergency, resulting in an accident.

I Do not drive the vehicle over or stop the vehicle near flammable materials. The exhaust system and exhaust gases can be extremely hot. This may cause a fire if there is any flammable material nearby.

I Vehicles with an automatic transmission: Do not let the vehicle roll backwards while the shift lever is in a driving position, or roll forward while the shift lever is in R.

Doing so may cause the engine to stall or lead to poor brake and steering performance, resulting in an accident or damage to the vehicle.

I If the smell of exhaust is noticed inside the vehicle, open the windows and check that the back door and glass hatch are closed. Large amounts of exhaust in the vehicle can cause driver drowsiness and an accident, resulting in death or a serious health hazard. Have the vehicle inspected by your Toyota dealer immediately.

I Do not under any circumstances shift the shift lever to P, R or N (automatic transmission) or R (manual transmission) while the vehicle is moving.

Doing so can cause significant damage to the transmission system and may result in a loss of vehicle control.

 CAUTION

n When driving the vehicle

- I** Do not shift the shift lever to N while the vehicle is moving.
Doing so may cause the engine brake to not operate properly and lead to an accident.
- I** Do not turn the engine off while driving.
The power steering and brake booster systems will not operate properly if the engine is not running.
- I** Use engine braking (downshift) to maintain a safe speed when driving down a steep hill.
Using the brakes continuously may cause the brakes to overheat and lose effectiveness. (→P. 128, 130)
- I** When stopped on an inclined surface, use the brake pedal and parking brake to prevent the vehicle from rolling backward or forward and causing an accident.
- I** Do not adjust the position of the steering wheel, the seat, or the inside or outside rear view mirrors while driving.
Doing so may result in a loss of vehicle control that can cause accidents that may result in death or serious injury.
- I** Always check that all passengers' arms, heads or other parts of their bodies are not outside the vehicle, as this may result in death or serious injury.
- I** Do not drive in excess of the speed limit. Even if the legal speed limit permits it, do not drive over 85 mph (140 km/h) unless your vehicle has high-speed capability tires. Driving over 85 mph (140 km/h) may result in tire failure, loss of control and possible injury. Be sure to consult a tire dealer to determine whether the tires on your vehicle are high-speed capability tires or not before driving at such speeds.

 **CAUTION**
n When driving on slippery road surfaces

- I Sudden braking, acceleration and steering may cause tire slippage and reduce your ability to control the vehicle, resulting in an accident.
- I Sudden changes in engine speed, such as engine braking caused by up-shifting or down-shifting, may cause the vehicle to skid, resulting in an accident.
- I After driving through a puddle, lightly depress the brake pedal to make sure that the brakes are functioning properly. Wet brake pads may prevent the brakes from functioning properly. If the brakes on only one side are wet and not functioning properly, steering control may be affected, resulting in an accident.

n When shifting the shift lever

Vehicles with an automatic transmission: Be careful not to shift the shift lever with the accelerator pedal depressed.

This may lead to unexpected rapid acceleration of the vehicle that may cause an accident and result in death or serious injury.

n When the vehicle is stopped

- I Do not race the engine.
If the vehicle is in any gear other than P (automatic transmission only) or N, the vehicle may accelerate suddenly and unexpectedly, and may cause an accident.
- I Do not leave the vehicle with the engine running for a long time.
If such a situation cannot be avoided, park the vehicle in an open space and check that exhaust fumes do not enter the vehicle interior.
- I Vehicles with an automatic transmission: In order to prevent accidents due to the vehicle rolling away, always keep depressing the brake pedal while the engine is running, and apply the parking brake as necessary.
- I If the vehicle is stopped on an incline, in order to prevent accidents caused by the vehicle rolling forward or backward, always depress the brake pedal and securely apply the parking brake as needed.
- I Avoid revving or racing the engine. Running the engine at high speed while the vehicle is stopped may cause the exhaust system to overheat, which could result in a fire if combustible material is nearby.

 **CAUTION**

n When the vehicle is parked

I Do not leave glasses, cigarette lighters, spray cans, or soft drink cans in the vehicle when it is in the sun.

Doing so may result in the following.

- Gas may leak from a cigarette lighter or spray can, and may lead to a fire.
- The temperature inside the vehicle may cause the plastic lenses and plastic material of eye glasses to deform or crack.
- Soft drink cans may fracture, causing the contents to spray over the interior of the vehicle, and may also cause a short circuit in the vehicle's electrical components.

I Always apply the parking brake, shift the shift lever to P (automatic transmission only), stop the engine and lock the vehicle.

Do not leave the vehicle unattended while the engine is running.

I Do not touch the exhaust pipe while the engine is running or immediately after turning the engine off.

Doing so may cause burns.

I Do not leave the engine running in an area with snow build-up, or where it is snowing. If snowbanks build up around the vehicle while the engine is running, exhaust gases may collect and enter the vehicle. This may lead to death or a serious health hazard.

n Exhaust gases

Exhaust gases include harmful carbon monoxide (CO) that is colorless and odorless. Inhaling exhaust gases may lead to death or a serious health hazard.

I If the vehicle is in a poorly ventilated area, stop the engine. In a closed area, such as a garage, exhaust gases may collect and enter the vehicle. This may lead to death or a serious health hazard.

I The exhaust should be checked occasionally. If there is a hole or crack caused by corrosion, damage to a joint or abnormal exhaust noise, be sure to have the vehicle inspected and repaired by your Toyota dealer. Failure to do so may allow exhaust gases to enter the vehicle, resulting in death or a serious health hazard.

 **CAUTION****n When taking a nap in the vehicle**

Always turn the engine off. Otherwise, you may accidentally move the shift lever or depress the accelerator pedal, which could cause an accident or fire due to engine overheating. Additionally, if the vehicle is parked in a poorly ventilated area, exhaust gases may collect and enter the vehicle, leading to death or a serious health hazard.

n When braking the vehicle

I When the brakes are wet, drive more cautiously.

Braking distance increases when the brakes are wet, and may cause one side of the vehicle to brake differently than the other side. Also the parking brake may not securely hold the vehicle.

I If the power brake assist function does not operate, do not follow other vehicles closely and avoid downhills or sharp turns that require braking. In this case, braking is still possible, but it will require more force on the pedal than usual. Braking distance may also increase.

I Do not pump the brake pedal if the engine stalls.

Each push on the brake pedal uses up the reserve for the power-assisted brakes.

I The brake system consists of 2 individual hydraulic systems: If one of the systems fails, the other will still operate. In this case, the brake pedal should be depressed more firmly than usual and braking distance becomes longer.

Do not drive your vehicle with only a single brake system. Have your brakes fixed immediately.

 NOTICE

n When driving the vehicle

I Do not depress the accelerator and brake pedals at the same time during driving. If the brake pedal is depressed while driving with the accelerator pedal depressed, driving torque may be restrained.

▶ Vehicles with a manual transmission

I Do not rest your foot on the clutch pedal while driving.
Doing so may cause clutch trouble.

I Do not use any gears other than the first gear when starting off and moving forward.
Doing so may damage the clutch.

I Do not use the clutch to hold the vehicle when stopping on an uphill grade.
Doing so may damage the clutch.

▶ Vehicles with an automatic transmission

I Do not use the accelerator pedal or depress accelerator and brake pedals together to hold the vehicle on a hill.

n When parking the vehicle

Vehicles with an automatic transmission: Always put the shift lever in P. Failure to do so may cause the vehicle to move or the vehicle may accelerate suddenly if the accelerator pedal is accidentally depressed.

n Avoiding damage to vehicle parts

I Do not turn the steering wheel fully in either direction and hold it there for a long time.
Doing so may damage the power steering pump.

I When driving over bumps in the road, drive as slowly as possible to avoid damaging the wheels, underside of the vehicle, etc.

n If you hear a squealing or scraping noise while driving (brake pad wear limit indicators)

Have the brake pads checked and replaced by your Toyota dealer as soon as possible.

The rotor damage can result if the pads are not replaced when needed.

It is dangerous to drive the vehicle when the wear limits of the brake pads and/or that of the brake discs are exceeded.

 NOTICE**n If you get a flat tire while driving**

A flat or damaged tire may cause the following situations. Hold the steering wheel firmly and gradually press the brake pedal to slow down the vehicle.

- | It may be difficult to control your vehicle.
- | The vehicle will make abnormal sounds.
- | The vehicle will behave abnormally.

Replace a flat tire with a new one. (→P. 443)

n When encountering flooded roads

Do not drive on a road that has flooded after heavy rain etc. Doing so may cause the following serious damage to the vehicle.

- | Engine stalling
- | Short in electrical components
- | Engine damage caused by water immersion

In the event that you drive on a flooded road and the vehicle is flooded, be sure to have your Toyota dealer check the following.

- | Brake function
- | Changes in quantity and quality of oil and fluid used for the engine, transmission, transfer (4WD models), differentials, etc.
- | Lubricant condition for the propeller shaft, bearings and suspension joints (where possible) and the function of all joints, bearings, etc.

Engine (ignition) switch

n Engine switch

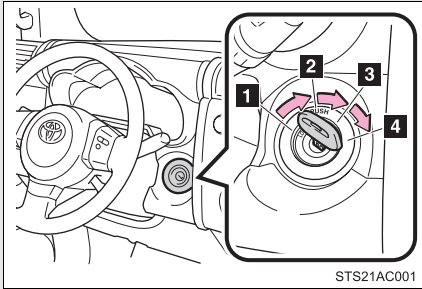

1 LOCK

The steering wheel is locked and the key can be removed. (Vehicles with an automatic transmission: The key can be removed only when the shift lever is in P.)

2 ACC

Some electrical components such as the audio system can be used.

3 ON

All electrical components can be used.

4 START

For starting the engine.

n Starting the engine

► Automatic transmission

STEP 1 Check that the parking brake is set.

STEP 2 Check that the shift lever is set in P.

STEP 3 Sit in the driver's seat and firmly depress the brake pedal.

STEP 4 Turn the engine switch to the START position and start the engine.

► Manual transmission

STEP 1 Check that the parking brake is set.

STEP 2 Check that the shift lever is set in N.

STEP 3 Firmly depress the brake pedal and clutch pedal.

STEP 4 Turn the engine switch to the START position and start the engine.

n Turning the key from ACC to LOCK

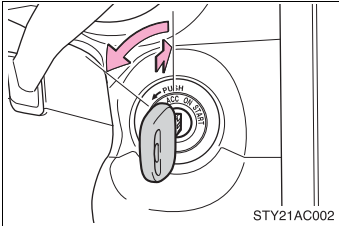

STEP 1 Shift the shift lever to P (automatic transmission) or N (manual transmission). (→P. 127, 129)

STEP 2 Push in the key and turn to the LOCK position.

n Steering lock release

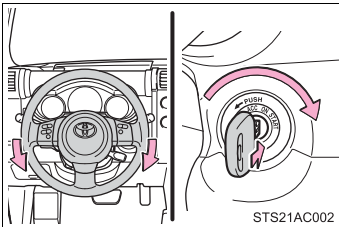

When starting the engine, the engine switch may seem stuck in the LOCK position. To free it, turn the key while turning the steering wheel slightly in either direction.

n If the engine does not start

The engine immobilizer system may not have been deactivated. (→P. 74)

n Key reminder function

A buzzer sounds if the driver's door is opened, while the engine switch is in the ACC or LOCK position to remind you to remove the key.

⚠ CAUTION

n When starting the engine

Always start the engine while sitting in the driver's seat. Do not depress the accelerator while starting the engine under any circumstances.

Doing so may cause an accident resulting in death or serious injury.

 CAUTION

n Caution while driving

Do not turn the engine switch to the LOCK position.

If in an emergency, you must turn the engine off while the vehicle is moving, turn the engine switch only to the ACC position.

 NOTICE

n To prevent battery discharge

Do not leave the engine switch in the ACC or ON position for long periods if the engine is not running.

n When starting the engine

! Do not crank for more than 30 seconds at a time. This may overheat the starter and wiring systems.

! Do not race a cold engine.

! If the engine becomes difficult to start or stalls frequently, have the engine checked immediately.

Select a shift position appropriate for the driving conditions.

n **Shifting the shift lever**

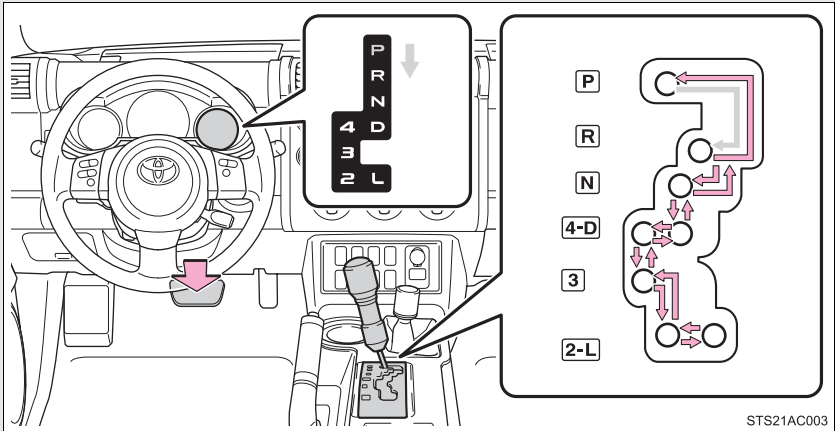

STS21AC003

← While the engine switch is on, depress the brake pedal and move the shift lever.

n **Shift position uses**

Shift position	Function
P	Parking the vehicle or starting the engine
R	Reversing
N	Neutral
D	Normal driving*
4	Position for engine braking
3, 2	Position for more powerful engine braking
L	Position for maximum engine braking

*: To improve fuel consumption and reduce noises, set the shift lever in D for normal driving.

▮ Downshifting restrictions

The shift lever cannot be downshifted if the following speeds are exceeded.

▶ 2WD models

Downshifting	Maximum speed mph (km/h)
4 → 3	91 (148)
3 → 2	61 (99)
2 → L	25 (41)

▶ 4WD models

Downshifting	Transfer position	Maximum speed mph (km/h)
4 → 3	H2 and H4	91 (148)
	L4	35 (57)
3 → 2	H2 and H4	61 (99)
	L4	23 (38)
2 → L	H2 and H4	25 (41)
	L4	9 (15)

▮ When driving with the cruise control system (if equipped)

The engine brake will not operate when downshifting from D to 4.(→P. 148)

▮ If the shift lever cannot be shifted from P (→P. 454)

▮ AI-SHIFT

The AI-SHIFT automatically shifts the gear to the optimal position according to the driver performance and driving conditions.

The AI-SHIFT automatically operates when the shift lever is in D.

Manual Transmission*

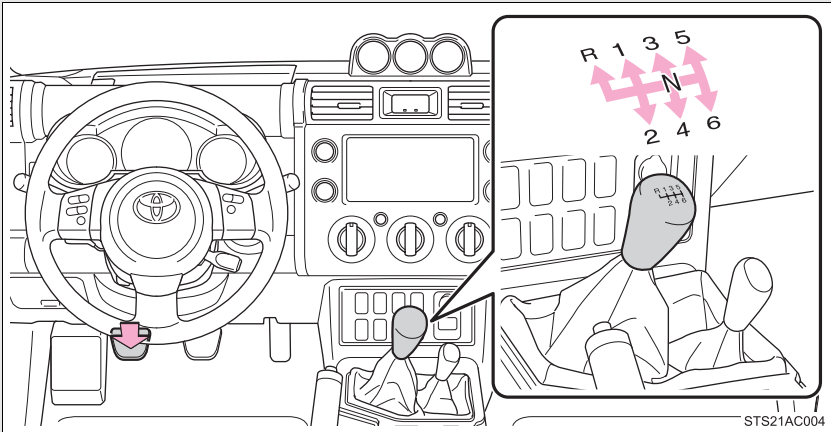

Fully depress the clutch pedal before operating the shift lever, and then release it slowly.

*: If equipped

▮ **Maximum allowable speed**

Observe the following maximum allowable speeds in each gear when maximum acceleration is necessary.

Shift position	Transfer position	Maximum speed mph (km/h)
1	H or HL	30 (48)
	LL	11 (18)
2	H or HL	58 (93)
	LL	22 (35)
3	H or HL	86 (138)
	LL	33 (53)
4	H or HL	107 (172)
	LL	41 (66)
5	H or HL	109 (175)
	LL	50 (80)

▮ **Reverse warning buzzer**

When shifting into R, a buzzer will sound to inform the driver that the shift lever is in R.

2-1. Driving procedures

Turn signal lever

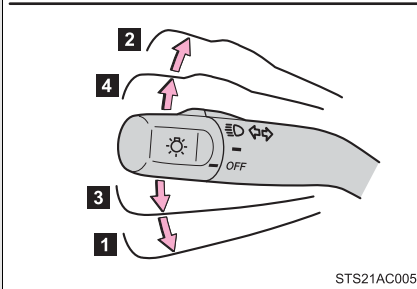
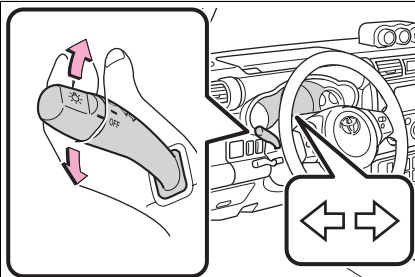

STS21AC005

- 1 Left turn
- 2 Right turn
- 3 Move and hold the lever partway to signal a lane change.

The left hand signal will flash until you release the lever.

- 4 Move and hold the lever partway to signal a lane change.

The right hand signal will flash until you release the lever.

n Turn signals can be operated when

The engine switch is in the ON position.

n If the indicators flash faster than usual

Check that a light bulb in the front or rear turn signal lights has not burned out.

2-1. Driving procedures

Parking brake

n Set the parking brake

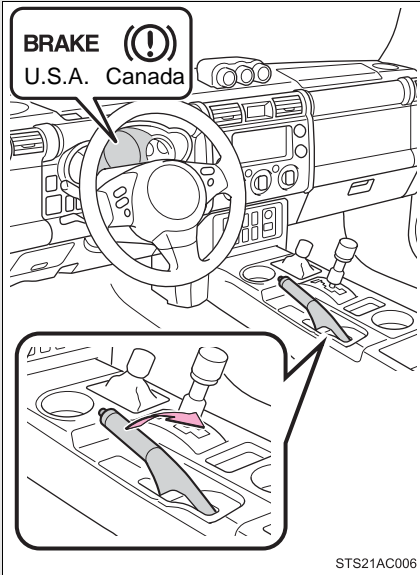

Fully set the parking brake while depressing the brake pedal.

At this time, the indicator will come on.

n Release the parking brake

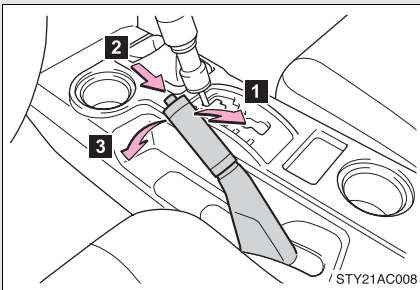

- 1 Slightly raise the lever
- 2 Press the button
- 3 Lower it completely

n Usage in winter time

See "Winter driving tips" for parking brake usage in winter time. (→P. 190)

**NOTICE****n Before driving**

Fully release the parking brake.

Driving the vehicle with the parking brake set will lead to brake components overheating, which may affect braking performance and increase brake wear.

Horn

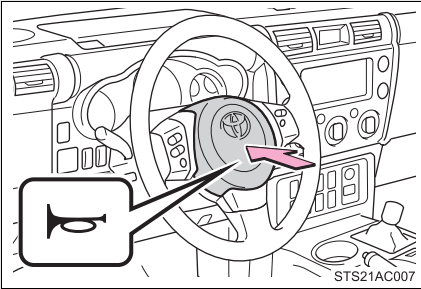

To sound the horn, press on or close to the  mark.

n **After adjusting the steering wheel**

Make sure that the steering wheel is securely locked.

The horn may not sound if the steering wheel is not securely locked.

(→P. 62)

2-2. Instrument cluster Gauges and meters

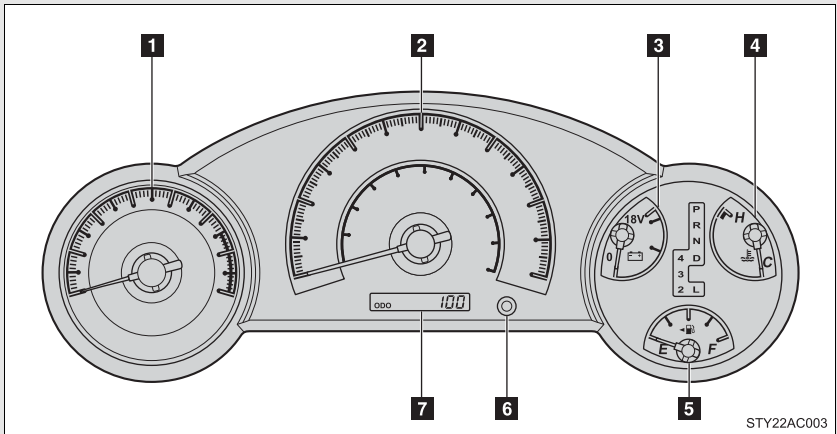

The following gauges, meters and displays illuminate when the engine switch is in the ON position.

1 Tachometer

Displays the engine speed in revolutions per minute.

2 Speedometer

Displays the vehicle speed.

3 Voltmeter

Displays the charge state.

4 Engine coolant temperature gauge

Displays the engine coolant temperature.

5 Fuel gauge

Displays the quantity of fuel remaining in the tank.

6 Odometer/trip meter switching and trip meter resetting button

Switches between odometer and trip meter displays. Pushing and holding the button will reset the trip meter when the trip meter is being displayed.

7 Odometer/trip meter

Odometer:

Displays the total distance the vehicle has been driven.

Trip meter:

Displays the distance the vehicle has been driven since the meter was last reset. Trip meters A and B can be used to record and display different distances independently.

Odometer and trip meter display button

Pressing this button switches between odometer and trip meter displays.

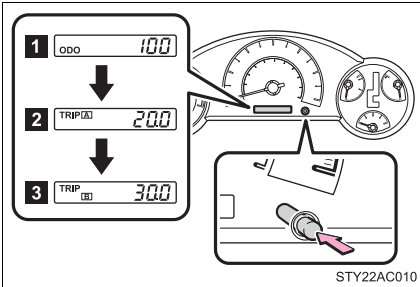

1 Odometer

2 Trip meter A *

3 Trip meter B *

*:Pushing and holding the button will reset the trip meter.

Instrument panel light control

The brightness of the instrument panel lights can be adjusted.

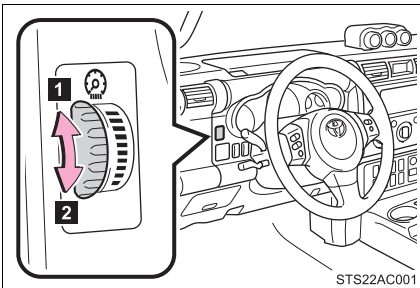

1 Brighter

2 Darker

**NOTICE****n To prevent damage to the engine and its components**

- l** Do not let the indicator needle of the tachometer enter the red zone, which indicates the maximum engine speed.
- l** The engine may be overheating if the temperature gauge is in the red zone (H). In this case, immediately stop the vehicle in a safe place, and check the engine after it has cooled completely. (→P. 459)

2-2. Instrument cluster

Indicators and warning lights

The indicator and warning lights on the instrument cluster and center panel inform the driver of the status of the vehicle's various systems.

► Instrument cluster

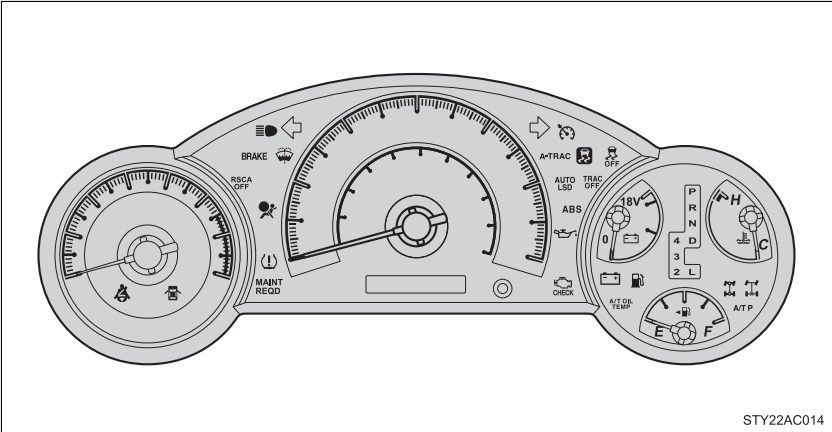

► Center panel

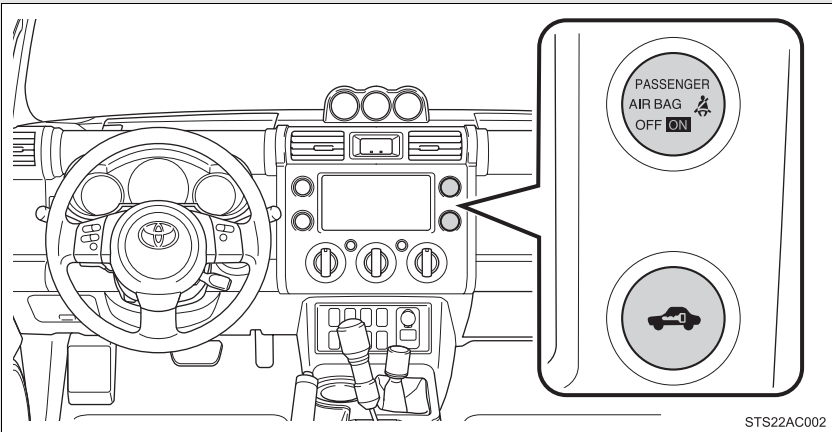

n Indicators

The indicators inform the driver of the operating state of the vehicle's various systems.



Turn signal indicator
(→P. 131)



Headlight high beam indicator (→P. 143)



Security indicator
(→P. 74)

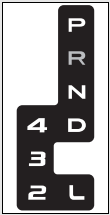

(Automatic transmission vehicles)

Shift position and shift range indicators
(→P. 127)



(if equipped)

Cruise control indicator
(→P. 148)



*1,2

Slip indicator
(→P. 167, 169, 175)



*1

VSC OFF indicator
(→P. 169, 176, 177)



(if equipped)

Active traction control system indicator
(→P. 167)

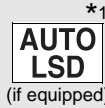

(if equipped)

*1

AUTO LSD indicator
(→P. 169, 176)



(if equipped)

Four-wheel drive indicator (→P. 164)



(if equipped)

Center differential lock indicator (→P. 161)



(if equipped)

*1

Rear differential lock indicator (→P. 171)



*1

AIR BAG ON indicator
(→P. 92)



*1

AIR BAG OFF indicator
(→P. 92)



*1

RSCA OFF indicator
(→P. 90)



(Canada)

*1

TRC OFF indicator
(→P. 176, 177)



(U.S.A.)

*1

TRAC OFF indicator
(→P. 176, 177)

n Warning lights

Warning lights inform the driver of malfunctions in any of the vehicle's systems. (→P. 430)

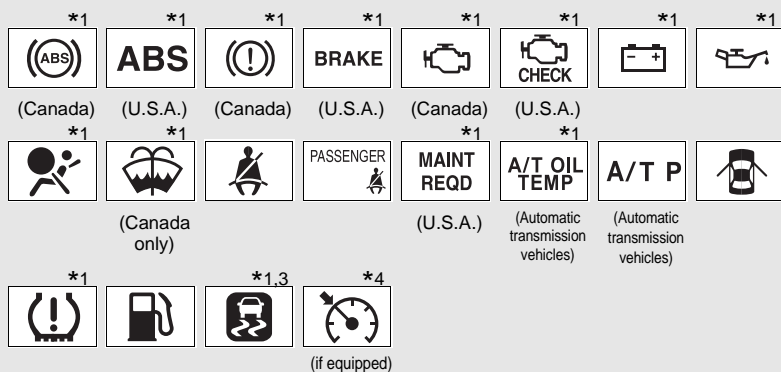

*1: These lights turn on when the engine switch is turned to the ON position to indicate that a system check is being performed. They will turn off after the engine is started, or after a few seconds. There may be a malfunction in a system if a light does not come on, or if the lights do not turn off. Have the vehicle inspected by your Toyota dealer.

*2: The indicator flashes to indicate that the system is operating.

*3: The indicator comes on to indicate a malfunction.

*4: The indicator flashes to indicate a malfunction.

⚠ CAUTION

n If a safety system warning light does not come on

Should a safety system light such as ABS and the SRS airbag warning light not come on when you start the engine, this could mean that these systems are not available to help protect you in an accident, which could result in death or serious injury. Have the vehicle inspected by your Toyota dealer immediately if this occurs.

2-2. Instrument cluster Accessory meter*

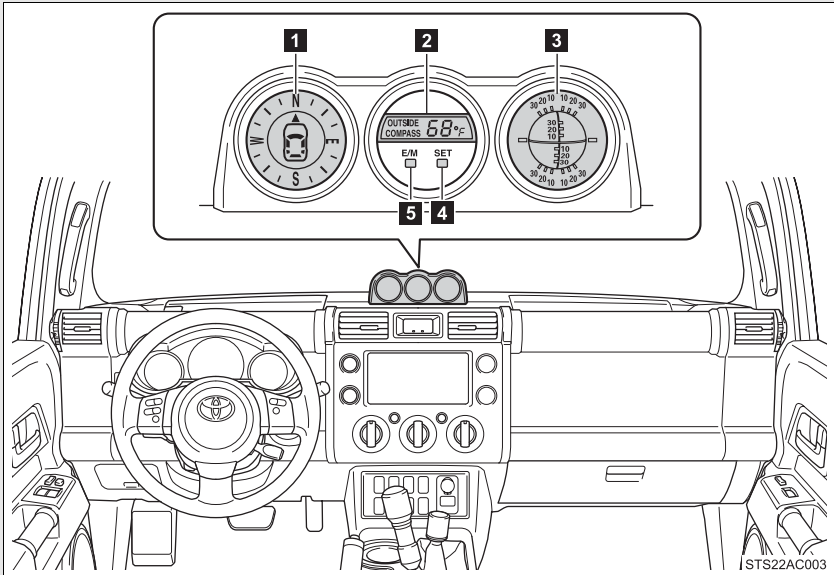

1 Compass

Displays the direction that the vehicle is heading. (→P. 343)

2 Outside temperature

Displays the outside air temperature. (→P. 328)

3 Clinometer

Displays the longitudinal and lateral inclination of the vehicle.

4 SET button

This button is used to calibrate the compass. (→P. 344)

5 E/M button

Outside temperature mode:

Switch between English/U.S. Customary System and metric units of the outside air temperature display by pressing this button quickly. (→P. 328)

Compass mode:

Select the zone number by pressing this button. (→P. 344)

*: If equipped

 **CAUTION**

n Caution while driving

Do not adjust the display.

Doing so may cause the driver to mishandle the vehicle and cause an accident, resulting in death or serious injury.

2-3. Operating the lights and wipers Headlight switch

The headlights can be operated manually.

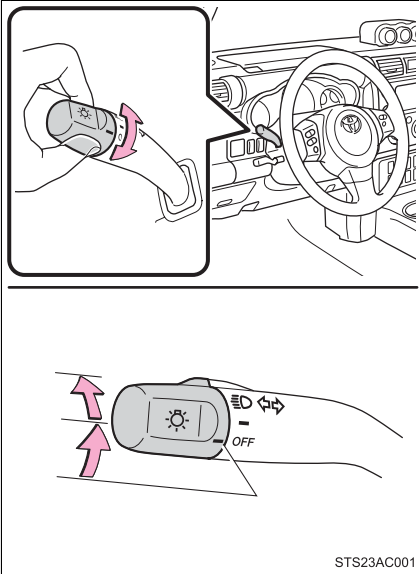

OFF Vehicles with daytime running light system:
The daytime running lights turn on.

— The side marker, parking, tail, license plate, outside rear view mirror illumination (if equipped), daytime running lights (if equipped) and instrument panel lights turn on.

☰ The headlights and all lights listed above (except daytime running lights) turn on.

Turning on the high beam headlights

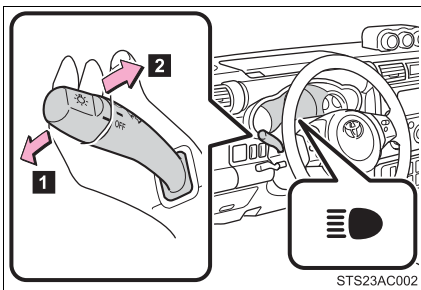

1 With the headlights on, push the lever forward to turn on the high beams.

Pull the lever back to the center position to turn the high beams off.

2 Pull the lever toward you to turn on the high beams.

Release the lever to turn them off. You can flash the high beams with the headlights on or off.



n Daytime running light system (if equipped)

- l To make your vehicle more visible to other drivers, the headlights turn on automatically (at a reduced intensity) whenever the engine is started and the parking brake is released. Daytime running lights are not designed for use at night.
- l Compared to turning on the headlights, the daytime running light system offers greater durability and consumes less electricity, so it can help improve fuel economy.

n Automatic light off system

- l When the headlights come on: The headlights and tail lights turn off 30 seconds after all doors and glass hatch are closed with the engine switch turned to the ACC or LOCK position. (The lights turn off immediately if the LOCK button on the wireless remote control is pressed twice after all doors are locked.)
- l When only the tail lights come on: The tail lights turn off automatically with the engine switch turned to the ACC or LOCK position and the driver's door is opened.

If the driver's door is kept open, the lights automatically turn off after 30 minutes.

To turn the lights on again, turn the engine switch to the ON position, or turn the headlight switch off once and then back to the  or  position.

n Customization that can be configured at Toyota dealer

Settings (automatic light off system) can be changed. (Customizable features →P. 493)

 **NOTICE**

n To prevent battery discharge

Do not leave the lights on longer than necessary when the engine is not running.

2-3. Operating the lights and wipers Windshield wipers and washer

Wiper intervals can be adjusted for intermittent operation (when INT is selected).

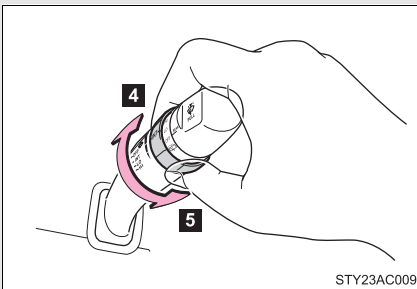
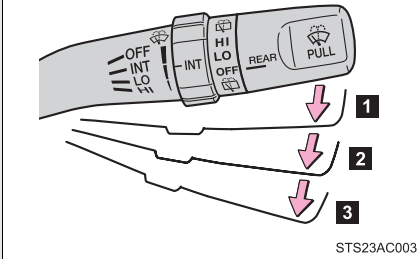
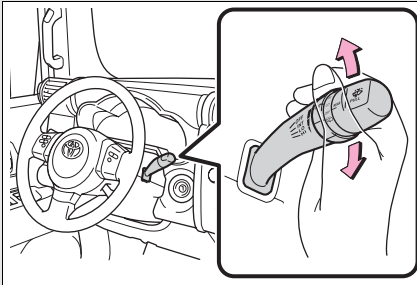

- 1 Intermittent windshield wiper operation
- 2 Low speed windshield wiper operation
- 3 High speed windshield wiper operation
- 4 Decreases the intermittent windshield wiper frequency
- 5 Increases the intermittent windshield wiper frequency

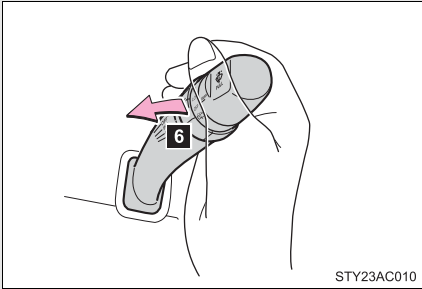

6 Washer/wiper dual operation

Wipers will automatically operate a couple of times after the washer squirts.

n The windshield wiper and washer can be operated when

The engine switch must be in the ON position.

n If no windshield washer fluid sprays

Check that the washer nozzles are not blocked and if there is washer fluid in the windshield washer fluid reservoir.

⚠ NOTICE

n When the windshield is dry

Do not use the wipers, as they may damage the windshield.

n When there is no washer fluid spray from the nozzle

Damage to the washer fluid pump may be caused if the lever is pulled toward you and held continually.

n When a nozzle becomes blocked

In this case, contact your Toyota dealer.

Do not try to clear it with a pin or other object. The nozzle will be damaged.

Rear window wiper and washer*

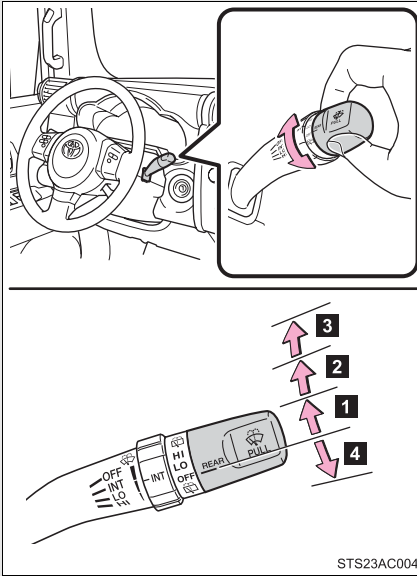

- 1 Intermittent window wiper operation.

The wiper operates 3 times at normal speed and then moves to intermittent mode.

- 2 Normal window wiper operation

- 3 Washer/wiper dual operation

- 4 Washer/wiper dual operation

The rear window wiper operates while the washer squirts.

n The rear window wiper and washer can be operated when

- 1 The engine switch must be in the ON position.
- 1 The glass hatch is closed.

⚠ NOTICE

n When the rear window is dry

Do not use the wipers, as they may damage the rear window.

n When there is no washer fluid spray from the nozzle

Damage to the washer fluid pump may be caused if the knob is continuously twisted upward or downward as far as it will go.

*: If equipped

2-4. Using other driving systems

Cruise control*

Use the cruise control to maintain a set speed without depressing the accelerator pedal.

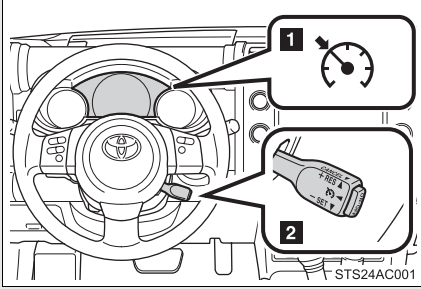

- 1 Indicator
- 2 Cruise control switch

n Setting the vehicle speed

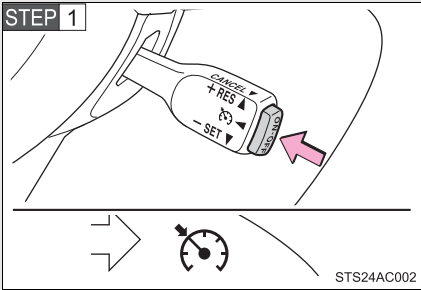

Press the ON-OFF button to activate the cruise control.

Press the button again to deactivate the cruise control.

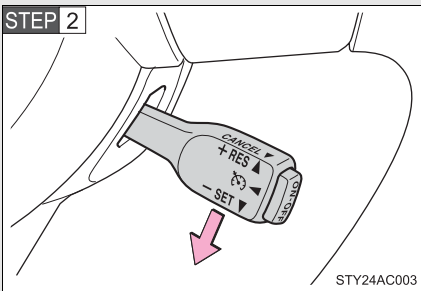

Accelerate or decelerate the vehicle to the desired speed, and push the lever down to set the speed.

*: If equipped

n Adjusting the set speed

To change the set speed, operate the lever until the desired set speed is obtained.

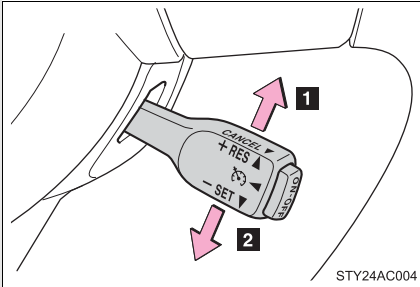

- 1** Increases the speed
- 2** Decreases the speed

Fine adjustment: Momentarily move the lever in the desired direction.

Large adjustment: Hold the lever in the desired direction.

The set speed will be increased or decreased as follows:

Fine adjustment: By approximately 1 mph (1.6 km/h) each time the lever is operated.

Large adjustment: The set speed can be increased or decreased continually until the lever is released.

n Canceling and resuming the constant speed control

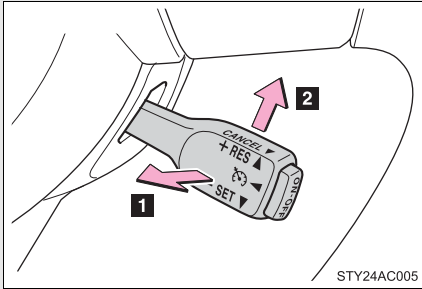

- 1 Pulling the lever toward you cancels the constant speed control.

The speed setting is also canceled when the brakes are applied or the clutch pedal (manual transmission only) is depressed.

- 2 Pushing the lever up resumes the constant speed control.

Resuming is available when the vehicle speed is more than approximately 25 mph (40 km/h).

n Cruise control can be set when

- l The shift lever is in the D or 4 range (vehicles with an automatic transmission).
- l Vehicle speed is above approximately 25 mph (40 km/h).

n Accelerating

The vehicle can be accelerated normally. After acceleration, the set speed resumes.

n Automatic cruise control cancellation

Cruise control will stop maintaining the vehicle speed in any of the following situations.

- l Actual vehicle speed falls more than approximately 10 mph (16 km/h) below the preset vehicle speed.
At this time, the memorized set speed is not retained.
- l Actual vehicle speed is below approximately 25 mph (40 km/h).
- l VSC is activated.

n If the cruise control indicator light flashes

Press the ON-OFF button once to deactivate the system, and then press the button again to reactivate the system.

If the cruise control speed cannot be set or if the cruise control cancels immediately after being activated, there may be a malfunction in the cruise control system. Have the vehicle inspected by your Toyota dealer.

⚠ CAUTION**n To avoid operating the cruise control by mistake**

Switch the cruise control off using the ON-OFF button when not in use.

n Situations unsuitable for cruise control

Do not use cruise control in any of the following situations.

Doing so may result in loss of control and could cause an accident resulting in death or serious injury.

- l In heavy traffic
- l On roads with sharp bends
- l On winding roads
- l On slippery roads, such as those covered with rain, ice or snow
- l On steep hills
Vehicle speed may exceed the set speed when driving down a steep hill
- l When your vehicle is towing a trailer or during emergency towing

2-4. Using other driving systems Intuitive parking assist*

The intuitive parking assist assists the driver by communicating the distance to obstacles measured by the sensors via the buzzer when parallel parking or maneuvering into a garage. Always check the surrounding area when using this system.

n Back sensors

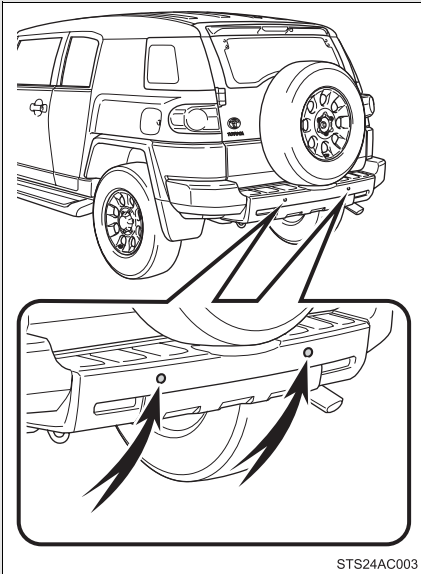

These sensors detect obstacles behind the vehicle.

*: If equipped

n Intuitive parking assist switch

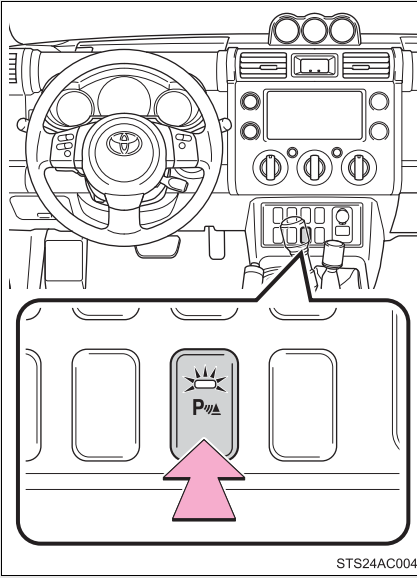

ON/OFF

When on, the buzzer sounds to inform the driver that the system is operational. At this time, the indicator will come on.

Press the switch to switch the ON/OFF mode.

The distance and buzzer

When a sensor detects an obstacle, the buzzer sounds.

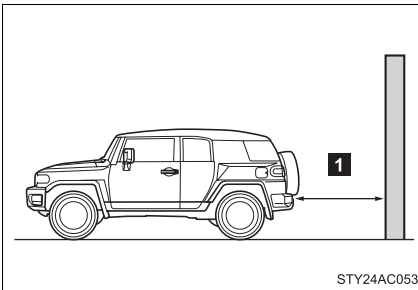

Distance shown as 1	4.9 to 3.3 ft. (150 to 100 cm)	3.3 to 1.6 ft. (100 to 50 cm)	1.6 ft. (50 cm)
Buzzer	Medium	Fast	Continuous

Sensors that operate and detection range

The following diagrams show the sensor detection range. Note that sensors may not be able to detect obstacles that are extremely close to the vehicle.

n Detection range of the sensors

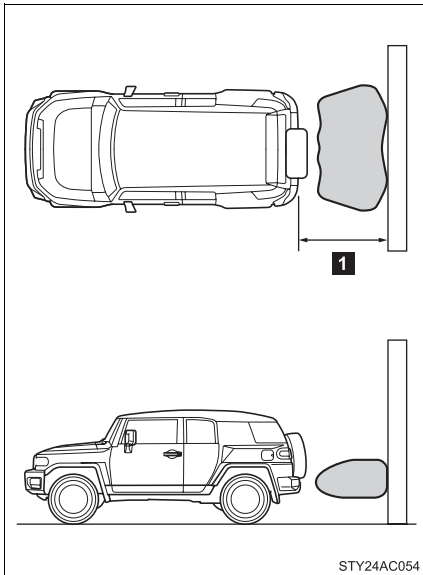

1 Approx. 4.9 ft. (150 cm)

The diagram shows the detection range of the sensors. Note that the sensors may not be able to detect obstacles that are extremely close to the vehicle.

The range of the sensors may change depending on the shape of the object etc.

n The intuitive parking assist system can be operated when

- l The engine switch is at the ON position.
- l The shift lever is in R.

n Sensor detection information

l Certain vehicle conditions and the surrounding environment may affect the ability of a sensor to correctly detect an obstacle. Particular instances where this may occur are listed below.

- There is dirt, snow or ice on a sensor.
- A sensor is frozen.
- A sensor is covered in any way.
- The vehicle is leaning considerably to one side.
- On an extremely bumpy road, on an incline, on gravel, or on grass.
- The vicinity of the vehicle is noisy due to vehicle horns, motorcycle engines, air brakes of large vehicles, or other loud noises producing ultrasonic waves.
- There is another vehicle equipped with parking assist sensors in the vicinity.
- A sensor is coated with a sheet of spray or heavy rain.
- The vehicle is equipped with a fender pole or radio antenna.
- A bumper or sensor receives a strong impact.
- The vehicle is approaching a tall or right-angled curb.
- In harsh sunlight or intense cold weather.
- The area directly under the bumpers is not detected.
Objects lower than the sensors or thin stakes etc. may be detected initially, but as they draw closer, they may cease to be detected.
- A towing hitch is mounted to the vehicle.
- A non-genuine Toyota suspension (lowered suspension etc.) is installed.
- When attaching a two-way radio antenna.
- When a towing eyelet is mounted on your vehicle.
- When the bumper is damaged.

In addition to the examples above, there are instances in which, because of their shapes, signs and other objects may be judged by a sensor to be closer than they are.

! The shape of the obstacle may prevent a sensor from detecting it. Pay particular attention to the following obstacles:

- Wires, fences, ropes, etc.
- Cotton, snow and other materials that absorb radio waves
- Sharply-angled objects
- Low obstacles
- Tall obstacles with upper sections projecting outwards in the direction of your vehicle
- A person near the vehicle (depending on the type of clothes worn)
- When the bumper is damaged.

n Certification (Canada only)

This ISM device complies with Canadian ICES-001.

! CAUTION

n Caution when using the intuitive parking assist

Observe the following precautions.

Failure to do so may result in the vehicle being unable to be driven safely and possibly cause an accident.

- ! Do not use the sensor at speeds in excess of 6 mph (10 km/h).
- ! Do not attach any accessories within the sensor range.

! NOTICE

n Notes when washing the vehicle

Do not apply intensive bursts of water or steam to the sensor area. Doing so may result in the sensor malfunctioning.

Rear view monitor system*

The rear view monitor system assists the driver by displaying an image of the area behind the vehicle. The image is displayed in reverse on the screen. This reversed image is a similar image to the one on the inside rear view mirror.

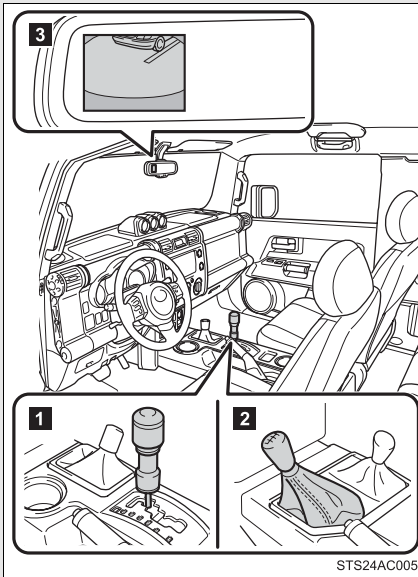

The rear view image is displayed on the inside rear view mirror when the shift lever is in the R.

The screen is turned off if any one of the following conditions are met:

- The shift lever is shifted out of R
- The back door opens
- The screen remains on for 5 minutes

- 1** Automatic transmission
- 2** Manual transmission
- 3** Screen

n The rear view monitor system can be operated when

The shift lever is in R, the back door is fully closed and the engine switch is ON.

n Switching the screen ON/OFF mode

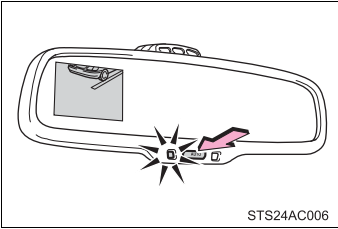

When the screen is displayed, press the AUTO button on the inside rear view mirror to switch the screen ON/OFF mode.

Screen ON mode: Green indicator comes on.

Screen OFF mode: Orange indicator comes on.

The auto anti-glare inside rear view mirror will revert to the screen ON mode each time the engine switch is turned on.

n Displayed area

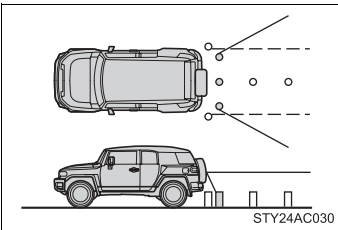

The area covered by the camera is limited. Objects that are close to either corner of the bumper or underneath the spare tire cannot be seen on the screen.

The area displayed on the screen may vary according to vehicle orientation or road conditions.

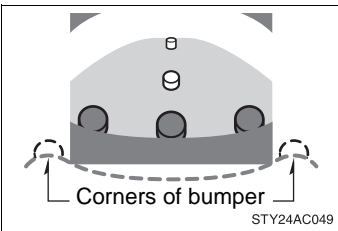

n Rear view monitor system camera

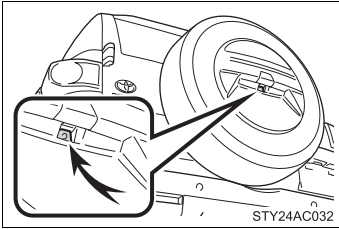

In the following cases, it may become difficult to see the images on the screen, even when the system is functioning correctly.

- l The vehicle is in a dark area, such as at night.
- l The temperature near the lens is extremely high or low.
- l Water droplets are on the camera lens or humidity is high, such as when it rains.
- l Foreign matter, such as snow or mud, adheres to the camera lens.
- l The sun or headlights are shining directly into the camera lens.
- l A bright object such as a white wall is reflected in the mirror surface over the monitor.
- l The camera has scratches or dirt on it.

n Smear effect

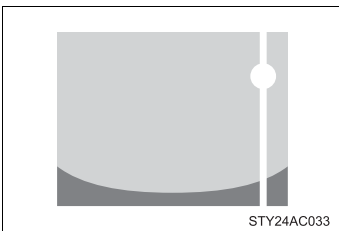

If a bright light, such as sunlight reflected off the vehicle body, is picked up by the camera, a smear effect* characteristic to the camera may occur.

*: Smear effect: A phenomenon that occurs when a bright light is picked up by the camera; when transmitted by the camera, the light source appears to have a vertical streak above and below it.

n Flicker effect

When the camera is used under fluorescent lights, sodium lights, mercury lights etc., the lights and the illuminated areas may appear to flicker.

 CAUTION

n When using the rear view monitor system, observe the following precautions to avoid an accident that could result in death or serious injuries.

- l** Never depend solely on the monitor system when reversing.
- l** Always check visually and with the mirrors to confirm your intended path is clear.
- l** Depicted distances between objects and flat surfaces differ from actual distances.

n Conditions which may affect the rear view monitor system

- l** If the back of the vehicle has been hit, the camera's position and mounting angle may have changed. Have the vehicle inspected by your Toyota dealer.
- l** Rapid temperature changes, such as when hot water is poured on the vehicle in cold weather, may cause the system to function abnormally.
- l** If the camera lens is dirty, it cannot transmit a clear image. Rinse with water and wipe with a soft cloth. If extremely dirty, wash with a mild cleanser and rinse.
- l** The displayed image may be darker and moving images may be slightly distorted when the system is cold.

 NOTICE

- l** As the camera has a water proof construction, do not detach, disassemble or modify it. This may cause incorrect operation.
- l** If the camera lens becomes dirty, it cannot transmit a clear image. If water droplets, snow, or mud adhere to the lens, rinse with water and wipe with a soft cloth. If the lens is extremely dirty, wash it with a mild cleanser and rinse.
- l** Do not allow organic solvent, car wax, window cleaner or glass coat to adhere to the camera. If this happens, wipe it off as soon as possible.
- l** When washing the vehicle, do not apply intensive bursts of water to the camera or camera area. Doing so may result in the camera malfunctioning.

2-4. Using other driving systems

Four-wheel drive system (4WD models with a manual transmission)

Use the four-wheel drive control lever to select the following transfer modes.

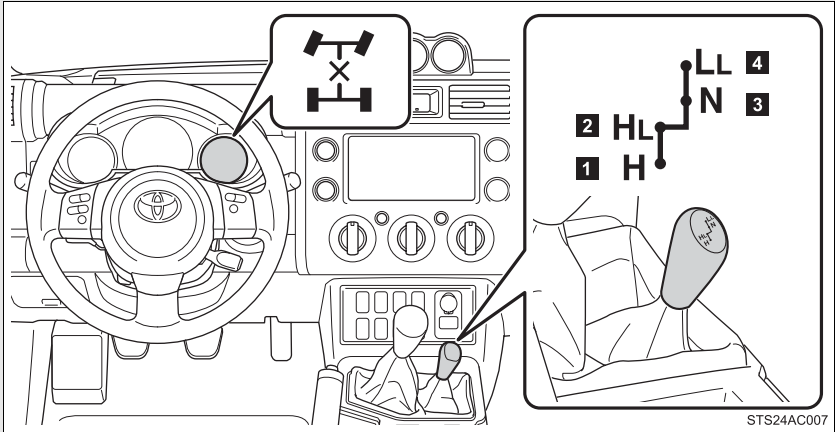

The center differential lock indicator comes on when the LL or HL mode is selected.

1 H (high speed position)

Use this for normal driving on dry hard-surfaced roads. This position gives greater economy, quietest ride and least wear.

2 HL (high speed position, center differential locked)

Use this for driving only on tracks that permit the tires slide, like off-road, icy or snow-covered roads.

3 N (neutral position)

No power is delivered to the wheels. The vehicle must be stopped.

4 LL (low speed position, center differential locked)

Use this for maximum power and traction. Use “LL” for climbing or descending steep hills, off-road driving, and hard pulling in sand, mud or deep snow.

n Shifting between H and HL

- l You need not to depress the clutch pedal.
- l If the center differential lock indicator does not come on when you shift from H to HL, drive straight ahead while accelerating or decelerating.
- l If the center differential lock indicator does not go off when you shift from HL to H, drive straight ahead while accelerating or decelerating, or drive in reverse.

n Shifting from HL to LL

Stop the vehicle or reduce your speed to less than 5 mph (8 km/h).
Depress the clutch pedal and move the four-wheel drive control lever.

n Shifting from LL to HL

Depress the clutch pedal and move the four-wheel drive control lever.

n Shifting to LL

VSC is automatically turned off.

 **CAUTION**

n Caution while driving

Avoid turning suddenly while the center differential is locked. If you do turn suddenly, the difference in turning speeds between the front and rear wheels may have a similar effect to braking, thus making driving difficult.

**NOTICE****n To prevent damage to the center differential**

- l For normal driving on dry and hard surface roads, unlock the center differential.
- l Shift to H after the wheels are out of the ditch or off the slippery or bumpy surface.
- l Do not shift to any position when the vehicle is cornering or when its wheels spinning freely off the ground.

n Shifting from H to HL while driving

Never operate the four-wheel drive control lever if the wheels are slipping. Stop the slipping or spinning before shifting.

2-4. Using other driving systems

Four-wheel drive system (4WD models with an automatic transmission)

Use the front-wheel drive control lever to select the following transfer modes.

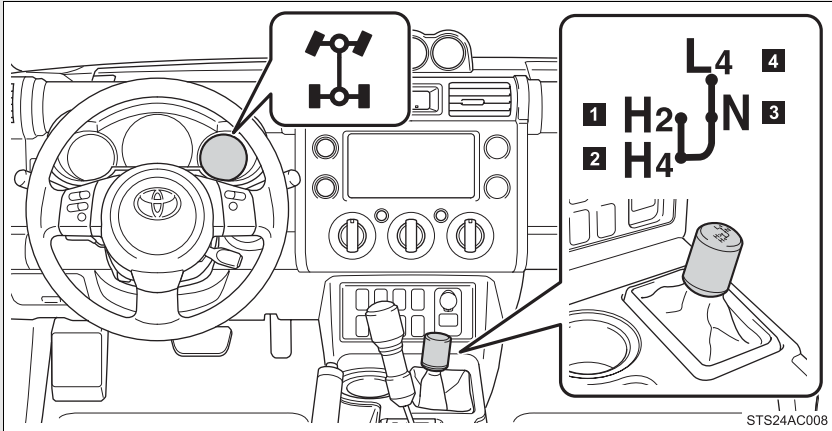

The four-wheel drive indicator comes on when the H4, N or L4 mode is selected.

1 H2 (high speed position, two-wheel drive)

Use this for normal driving on dry hard-surfaced roads. This position gives greater economy, quietest ride and least wear.

2 H4 (high speed position, four-wheel drive)

Use this for driving only on tracks that permit the tires slide, like off-road, icy or snow-covered roads. This position provides greater traction than two-wheel drive.

3 N (neutral position)

No power is delivered to the wheels. The vehicle must be stopped.

4 L4 (low speed position, four-wheel drive)

Use this for maximum power and traction. Use “L4” for climbing or descending steep hills, off-road driving, and hard pulling in sand, mud or deep snow.

n Shifting between H2 and H4

1 Reduce your speed to less than 50 mph (80 km/h) and shift the front-wheel drive control lever from H2 to H4.

If you have trouble shifting in cold weather, reduce your speed or stop the vehicle.

1 If the four-wheel drive indicator does not go off when you shift from H4 to H2, drive straight ahead while accelerating or decelerating, or drive in reverse.

n Shifting between H4 and L4

Stop the vehicle, shift the shift lever to N and shift the front-wheel drive control lever.

n Shifting to L4

VSC is automatically turned off.

n Four-wheel drive usage frequency

You should drive in four-wheel drive for at least 10 miles (16 km) each month.

This will assure that the front drive components are lubricated.

 CAUTION

n Caution while driving

- I** Never shift the front-wheel drive control lever from H2 to H4 if the wheels are slipping.
Stop the slipping or spinning before shifting.
- I** For normal driving on dry and hard surface roads, use H2 position. Driving on dry and hard surface roads in H4 or L4 position may cause drive component oil leakage, seizure, or other problems resulting in an accident. Further, it may cause tire wear and increased fuel consumption.
- I** Avoid turning suddenly in H4 or L4 position. If you do turn suddenly, the difference in turning speeds between the front and rear wheels may have a similar effect to braking, thus making driving difficult.
- I** Securely shift the front-wheel drive control lever to H4 or L4. Otherwise, the transfer may disengage both the front and rear driveshafts from the powertrain and allow the vehicle to move regardless of the shift position. If this happens, the vehicle may be free to roll even if the automatic transmission is in P.

Active traction control system*

The active traction control system automatically helps prevent the spinning of 4 wheels when the vehicle is started or accelerated on slippery road surfaces.

n System operation

STEP 1 Vehicles with an automatic transmission:

Stop the vehicle, shift the shift lever to N and shift the front-wheel drive control lever into L4.

Vehicles with a manual transmission:

Stop the vehicle or reduce your speed to less than 5 mph (8 km/h). Depress the clutch pedal and shift the four-wheel drive control lever into LL.

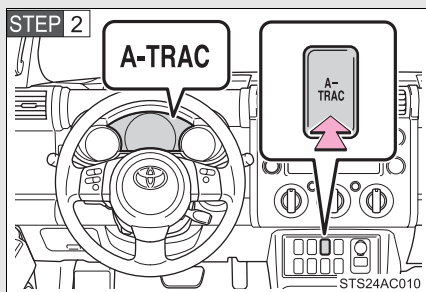

Press the A-TRAC switch to activate the system.

At this time, the active traction control system indicator will come on.

To cancel the system, push the switch again.

When the active traction control system is operating

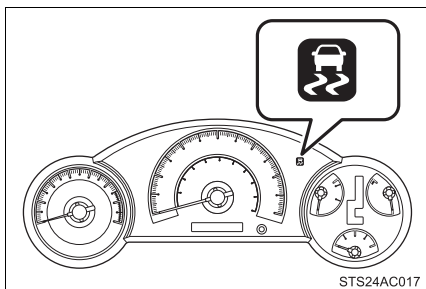

If any of the drive wheels spins, the slip indicator flashes to indicate that the active traction control system have been engaged.

*: If equipped

n When the rear differential is locked (vehicles with the rear differential lock system)

The active traction control system is activated only when the vehicle speed is less than 4 mph (6 km/h).

n Sounds and vibrations caused by the active traction control system

- I A sound may be heard from the engine compartment when the engine is started or just after the vehicle begins to move. This sound does not indicate that a malfunction has occurred in the system.
- I Vibrations may be felt through the vehicle body and steering. It may occur when the system is operating.

n If the brake system overheats

The system will cease operation and a buzzer will sound to alert the driver. Stop the vehicle in a safe place. (There is no problem with continuing normal driving.)

⚠ CAUTION

n The active traction control system may not operate effectively when

Directional control and power may not be achievable while driving on slippery road surfaces, even if the active traction control system is operating. Do not drive the vehicle in conditions where stability and power may be lost.

AUTO LSD system (2WD models)

The AUTO LSD system aids traction by using the traction control system to control engine performance and braking when one of the rear wheels begins to spin.

The system should be used only when wheel spinning occurs in a ditch or rough surface.

n System operation

The system is activated when driving at a speed under 62 mph (100 km/h).

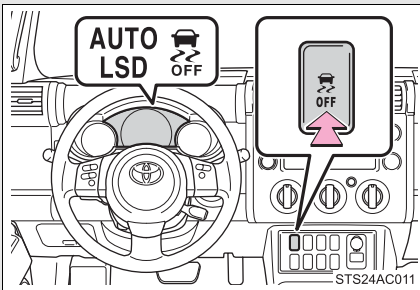

Press the VSC OFF switch to turn on the system.

At this time, the AUTO LSD and VSC OFF indicators will come on.

To turn off the system, push the switch again.

When the AUTO LSD system is operating

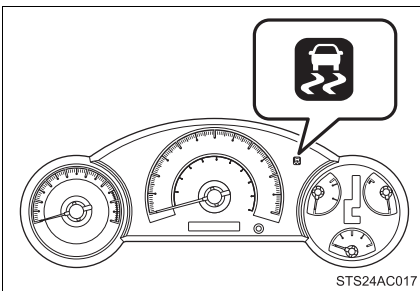

If the rear wheels spin, the slip indicator flashes to indicate that the AUTO LSD system has controlled the spinning of the rear wheels.

n If the engine is turned off and restarted

The AUTO LSD system and the indicators are automatically turned off.

n Reactivation of the VSC system linked to vehicle speed

When the AUTO LSD system is turned on, the VSC system will turn on automatically if vehicle speed increases.

n If the brake system overheats

The system will cease operation and a buzzer will sound to alert the driver. Stop the vehicle in a safe place. (There is no problem with continuing normal driving.)

The system will be automatically restored after a short time.

⚠ CAUTION

n To avoid an accident

I Do not use the AUTO LSD system in conditions other than the above.

A much greater steering effort and more careful cornering control will be required.

I Do not drive with the AUTO LSD system continuously turned on.

Rear differential lock system*

The rear differential lock system is provided for use only when wheel spinning occurs in a ditch or on a slippery or rugged surface.

The rear differential lock system is effective in case one of the rear wheels is spinning.

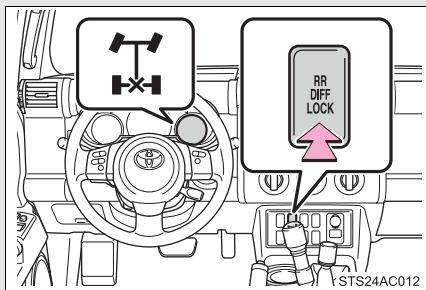

Press the RR DIFF LOCK switch to lock the rear differential.

At this time, the rear differential lock indicator will blink. Wait a few seconds for the system to complete operation. After the rear differential is locked, the indicator will stop blinking and remain on.

To unlock the rear differential, push the switch again.

Using the rear differential lock system

► Automatic transmission

STEP 1 4WD models: Before using the rear differential lock system.

Stop the vehicle, shift the shift lever to N and shift the front-wheel drive control lever into L4 to see if this is sufficient. If this has no effect, additionally use the rear differential lock system.

STEP 2 Be sure to stop the wheels.

STEP 3 Press the RR DIFF LOCK switch.

STEP 4 Gently depress the accelerator pedal.

After the rear differential is locked, the indicator will come on.

Unlock the rear differential as soon as the vehicle moves.

To unlock the rear differential, push the switch again.

*: If equipped

► Manual transmission

STEP 1 Before using the rear differential lock system.

Stop the vehicle or reduce your speed to less than 5 mph (8 km/h). Depress the clutch pedal and shift the four-wheel drive control lever into LL to see if this is sufficient. If this has no effect, additionally use the rear differential lock system.

STEP 2 Be sure to stop the wheels.

STEP 3 Depress the clutch pedal.

STEP 4 Press the RR DIFF LOCK switch.

STEP 5 Slowly release the clutch pedal.

After the rear differential is locked, the indicator will come on.

Unlock the rear differential as soon as the vehicle moves.

To unlock the rear differential, push the switch again.

n Locking the rear differential

- 1 When the rear differential is locked, VSC is automatically turned off. (The rear differential lock and VSC OFF indicators will come on.)
- 1 The following systems do not operate when the rear differential is locked. It is normal operation for the ABS warning light and VSC OFF indicator to be on at this time.
 - ABS
 - Brake assist system
 - VSC
 - TRAC (TRC)

n The rear differential lock is disengaged when

- 1 Shift the four-wheel drive control lever to H or HL. (4WD models with a manual transmission)
- 1 Shift the front-wheel drive control lever to H2 or H4. (4WD models with an automatic transmission)

Never forget to turn off the switch after using this feature.

n After unlocking the rear differential

Check that the indicator goes off.

 CAUTION**n To avoid an accident**

- I Do not use the rear differential lock system except when wheel spinning occurs in a ditch or on a slippery or ragged surface. Large steering effort and careful cornering control will be required.
- I Do not lock the rear differential until the wheels have stopped spinning. Otherwise, the vehicle may move in an unexpected direction when the differential lock is engaged, resulting in an accident. This may also lead to possible damage to rear differential lock component parts.
- I Do not drive over 5 mph (8 km/h) when the rear differential is locked.
- I Do not keep driving with the RR DIFF LOCK switch on.

2-4. Using other driving systems

Clutch start cancel switch (vehicles with a manual transmission)

The switch allows the vehicle to be driven out of difficult situations by cranking the engine with the clutch engaged.

Never use the switch for normal engine starting. Be sure to follow the starting procedure. (→P. 124)

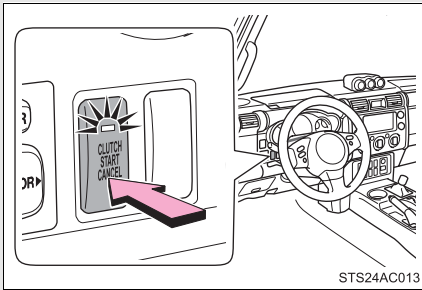

Press the CLUTCH START CANCEL switch to cancel the clutch start system with the engine switch is turned to the ON position.

The indicator will come on when the clutch start system is canceled.

The clutch start cancel switch is automatically turned off when the engine switch is turned off.

n Clutch start system

The system is designed to keep the starter motor from operating if the clutch pedal is not depressed all the way down.

2-4. Using other driving systems

Driving assist systems

To help enhance driving safety and performance, the following systems operate automatically in response to various driving situations. Be aware, however, that these systems are supplementary and should not be relied upon too heavily when operating the vehicle.

n **ABS (Anti-lock Brake System)**

Helps to prevent wheel lock when the brakes are applied suddenly, or if the brakes are applied while driving on a slippery road surface.

n **Brake Assist**

Generates an increased level of braking force after the brake pedal is depressed, when the system detects a panic stop situation.

n **VSC (Vehicle Stability Control)**

Helps the driver to control skidding when swerving suddenly or turning on slippery road surfaces.

n **TRAC/TRC (Traction Control)**

Maintains drive power and prevents the rear wheels (2WD models) or all wheels (4WD models) from spinning when starting the vehicle or accelerating on slippery roads.

When VSC/TRAC (TRC) are operating

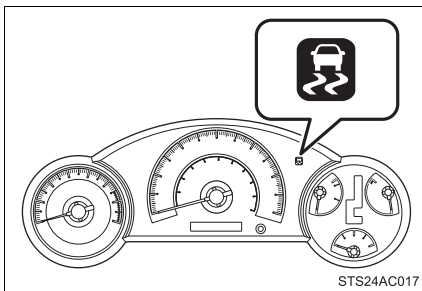

If the vehicle is in danger of slipping, or if the rear wheels (2WD models) or any of the drive wheels (4WD models) spins, the slip indicator flashes to indicate that VSC/TRAC (TRC) have been engaged.

To disable TRAC and/or VSC (2WD models)

If the vehicle gets stuck in fresh snow or mud, TRAC and VSC may reduce power from the engine to the wheels. You may need to turn the system off to enable you to rock the vehicle in order to free it.

n Turning off TRAC

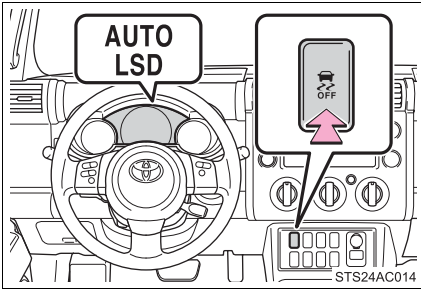

Press the VSC OFF switch to turn off TRAC.

The AUTO LSD indicator will come on.

Push the switch again to turn the system back on.

n Turning off TRAC and VSC

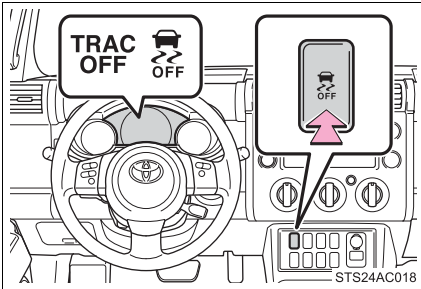

Press the VSC OFF switch for more than 3 seconds while the vehicle is stopped to turn off both TRAC and VSC.

The VSC OFF and TRAC OFF indicators will come on.

Push the switch again to turn both systems back on.

To disable TRAC (TRC) and/or VSC (H2 and H4 mode [automatic transmission] or H and HL mode [manual transmission] on 4WD models)

If the vehicle gets stuck in fresh snow or mud, TRAC (TRC) and VSC may reduce power from the engine to the wheels. You may need to turn the system off to enable you to rock the vehicle in order to free it.

n Turning off TRAC (TRC)

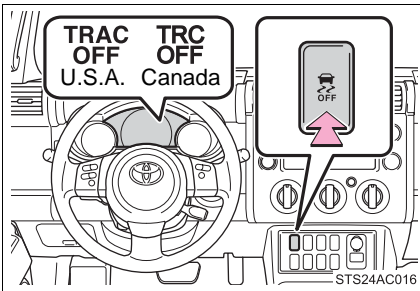

Press the VSC OFF switch to turn off TRAC (TRC).

The TRAC OFF (TRC OFF) indicator will come on.

Push the switch again to turn the system back on.

n Turning off TRAC (TRC) and VSC

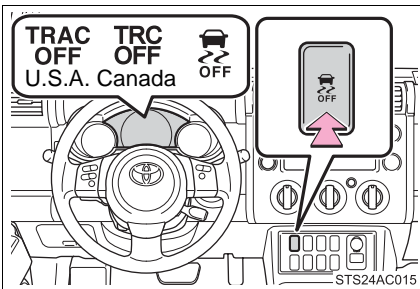

Press and hold the VSC OFF switch for more than 3 seconds while the vehicle is stopped to turn off both TRAC (TRC) and VSC.

The VSC OFF and TRAC OFF (TRC OFF) indicators will come on.

Push the switch again to turn both systems back on.

n Automatic reactivation of TRAC (TRC) and VSC

Turning the engine switch off after turning off the TRAC (TRC) and VSC systems will automatically re-enable them.

n Automatic VSC reactivation (2WD models)

If only the TRAC system is turned off, VSC OFF and AUTO LSD indicators turn on. The VSC system will turn on when the vehicle speed increases.

n Automatic TRAC (TRC) and VSC reactivation

If the TRAC (TRC) and VSC systems are turned off, the systems will not turn on, even when vehicle speed increases.

n Sounds and vibrations caused by the ABS, TRAC (TRC), VSC and brake assist system

I A sound may be heard from the engine compartment when the engine is started or just after the vehicle begins to move. This sound does not indicate that a malfunction has occurred in any of these systems.

I Any of the following conditions may occur when the above systems are operating. None of these indicates that a malfunction has occurred.

- Vibrations may be felt through the vehicle body and steering.
- A motor sound may be heard after the vehicle comes to a stop.
- The brake pedal may pulsate slightly after the ABS is activated.
- The brake pedal may move down slightly after the ABS is activated.

n If the brake system overheats

TRAC (TRC) will cease operation and a buzzer will sound to alert the driver. Stop the vehicle in a safe place. (There is no problem with continuing normal driving.)

 **CAUTION**
n The ABS does not operate effectively when

- l The limits of the gripping performance have been exceeded.
- l The vehicle hydroplanes while driving at high speed on the wet or slick road.

n Stopping distance when the ABS is operating will exceed that of normal conditions

The ABS is not designed to shorten the vehicle's stopping distance. Always maintain a safe distance from the vehicle in front of you in the following situations.

- l When driving on dirt, gravel or snow-covered roads
- l When driving with tire chains
- l When driving over bumps in the road
- l When driving over roads with potholes or roads with uneven roads

n When VSC is activated

The slip indicator flashes. Always drive carefully. Reckless driving may cause an accident. Exercise particular care when the indicator flashes.

n TRAC (TRC) may not operate effectively when

Directional control and power may not be achievable while driving on slippery road surfaces, even if TRAC (TRC) is operating.
Do not drive the vehicle in conditions where stability and power may be lost.

n Replacing tires

Make sure that all tires are of the same size, brand, tread pattern and total load capacity. In addition, make sure that the tires are inflated to the appropriate tire pressure level.

The ABS, VSC and TRAC (TRC) will not function correctly if different tires are fitted on the vehicle.

Contact your Toyota dealer for further information when replacing tires or wheels.

n Handling of tires and suspension

Using tires with any kind of problem or modifying the suspension will affect the driving assist systems, and may cause the system to malfunction.

Off-road precautions

This vehicle belongs to the utility vehicle class, which has higher ground clearance and narrower tread in relation to the height of its center of gravity to make it capable of performing in a wide variety of off-road applications.

Off-road vehicle feature

- 1 Specific design characteristics give it a higher center of gravity than ordinary passenger cars. This vehicle design feature causes this type of vehicle to be more likely to rollover. And, utility vehicles have a significantly higher rollover rate than other types of vehicles.
- 1 An advantage of the higher ground clearance is a better view of the road allowing you to anticipate problems.
- 1 It is not designed for cornering at the same speeds as ordinary passenger cars any more than low-slung sports cars designed to perform satisfactorily under off-road conditions. Therefore, sharp turns at excessive speeds may cause rollover.

 CAUTION**n Off-road vehicle precautions**

Always observe the following precautions to minimize the risk of serious personal injury or damage to your vehicle:

- I** In a rollover crash, an unbelted person is significantly more likely to die than a person wearing a seat belt. Therefore, the driver and all passengers should fasten their seat belts whenever the vehicle is moving.
- I** Avoid sharp turns or abrupt maneuvers, if at all possible.
Failure to operate this vehicle correctly may result in loss of control or vehicle rollover causing death or serious injury.
- I** Loading cargo on the roof luggage carrier will make the center of the vehicle gravity higher. Avoid high speeds, sudden starts, sharp turns, sudden braking or abrupt maneuvers, otherwise it may result in loss of control or vehicle rollover due to failure to operate this vehicle correctly.
- I** Always slow down in gusty crosswinds. Because of its profile and higher center of gravity, your vehicle is more sensitive to side winds than an ordinary passenger car. Slowing down will allow you to have better control.
- I** When driving off-road or in rugged terrain, do not drive at excessive speeds, jump, make sharp turns, strike objects, etc. This may cause loss of control or vehicle rollover causing death or serious injury. You are also risking expensive damage to your vehicle's suspension and chassis.
- I** Do not drive horizontally across steep slopes. Driving straight up or straight down is preferred. Your vehicle (or any similar off-road vehicle) can tip over sideways much more easily than forward or backward.

Off-road driving

When driving your vehicle off-road, please observe the following precautions to ensure your driving enjoyment and to help prevent the closure of areas to off-road vehicles.

- 1 Drive your vehicle only in areas where off-road vehicles are permitted to travel.
- 1 Respect private property. Get owner's permission before entering private property.
- 1 Do not enter areas that are closed. Honor gates, barriers and signs that restrict travel.
- 1 Stay on established roads. When conditions are wet, driving techniques should be changed or travel delayed to prevent damage to roads.

n **Additional information for off-road driving**

► For owners in U.S. mainland, Hawaii and Puerto Rico:

To obtain additional information pertaining to driving your vehicle off-road, consult the following organizations.

- 1 State and Local Parks and Recreation Departments
- 1 State Motor Vehicle Bureau
- 1 Recreational Vehicle Clubs
- 1 U.S. Forest Service and Bureau of Land Management

 **CAUTION****n Off-road driving precautions**

Always observe the following precautions to minimize the risk of serious personal injury or damage to your vehicle:

- I Drive carefully when off the road. Do not take unnecessary risks by driving in dangerous places.
- I Do not grip the steering wheel spokes when driving off-road. A bad bump could jerk the wheel and injure your hands. Keep both hands and especially your thumbs on the outside of the rim.
- I Always check your brakes for effectiveness immediately after driving in sand, mud, water or snow.
- I After driving through tall grass, mud, rock, sand, rivers, etc., check that there is no grass, bush, paper, rags, stone, sand, etc. adhering or trapped on the underbody. Clear off any such matter from the underbody. If the vehicle is used with these materials trapped or adhering to the underbody, a breakdown or fire could occur.
- I In a rollover crash, an unbelted person is significantly more likely to die than a person wearing a seat belt. Therefore, the driver and all passengers should fasten their seat belts whenever the vehicle is moving.
- I When driving off-road or in rugged terrain, do not drive at excessive speeds, jump, make sharp turns, strike objects, etc. This may cause loss of control or vehicle rollover causing death or serious injury. You are also risking expensive damage to your vehicle's suspension and chassis.

 NOTICE

n To prevent the water damage

- I** Take all necessary safety measures to ensure that water damage to the engine or other components does not occur.
- I** Water entering the engine air intake will cause severe engine damage.
- I** Water entering the automatic transmission will cause deterioration in shift quality, locking up of your transmission accompanied by vibration, and ultimately damage.
- I** Water can wash the grease from wheel bearings, causing rusting and premature failure, and may also enter the differentials, transmission and transfer case, reducing the gear oil's lubricating qualities.

n When you drive through water

If driving through water, such as when crossing shallow streams, first check the depth of the water and the bottom of the river bed for firmness. Drive slowly and avoid deep water.

n Inspection after off-road driving

- I** Sand and mud that has accumulated in brake drums and around brake discs may affect braking efficiency and may damage brake system components.
- I** Always perform a maintenance inspection after each day of off-road driving that has taken you through rough terrain, sand, mud, or water. For scheduled maintenance information, refer to the "Scheduled Maintenance Guide" or "Owner's Manual Supplement".

2-5. Driving information

Cargo and luggage

Take notice of the following information about storage precautions, cargo capacity and load.

- 1 Stow cargo and luggage in the luggage compartment whenever possible.
- 1 Be sure all items are secured in place.
- 1 Be careful to keep the vehicle level. Placing the weight as far forward as possible helps maintain vehicle balance.
- 1 For better fuel economy, do not carry unnecessary weight.

Capacity and distribution

Cargo capacity depends on the total weight of the occupants.

(Cargo capacity) = (Total load capacity) – (Total weight of occupants)

Steps for Determining Correct Load Limit—

- (1) Locate the statement “The combined weight of occupants and cargo should never exceed XXX kg or XXX lbs.” on your vehicle’s placard.
- (2) Determine the combined weight of the driver and passengers that will be riding in your vehicle.
- (3) Subtract the combined weight of the driver and passengers from XXX kg or XXX lbs.
- (4) The resulting figure equals the available amount of cargo and luggage load capacity.
For example, if the “XXX” amount equals 1400 lbs. and there will be five 150 lb passengers in your vehicle, the amount of available cargo and luggage load capacity is 650 lbs. (1400 – 750 (5 × 150) = 650 lbs.)
- (5) Determine the combined weight of luggage and cargo being loaded on the vehicle. That weight may not safely exceed the available cargo and luggage load capacity calculated in Step 4.

(6) If your vehicle will be towing a trailer, load from your trailer will be transferred to your vehicle. Consult this manual to determine how this reduces the available cargo and luggage load capacity of your vehicle.

Example on your vehicle

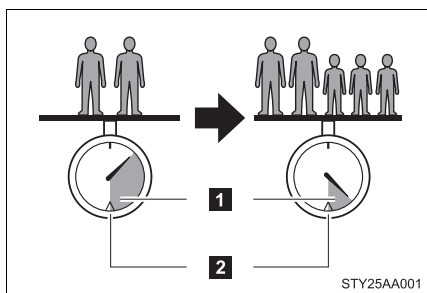

- 1 Cargo capacity
- 2 Total load capacity

When 2 people with the combined weight of 366 lb. (166 kg) are riding in your vehicle, which has a total load capacity of 1130 lb. (510 kg), the available amount of cargo and luggage load capacity will be as follows:

$$1130 \text{ lb.} - 366 \text{ lb.} = 764 \text{ lb.} \quad (510 \text{ kg} - 166 \text{ kg} = 344 \text{ kg})$$

In this condition, if 3 more passengers with the combined weight of 388 lb. (176 kg) get on, the available cargo and luggage load will be reduced as follows:

$$764 \text{ lb.} - 388 \text{ lb.} = 376 \text{ lb.} \quad (344 \text{ kg} - 176 \text{ kg} = 168 \text{ kg})$$

As shown in the above example, if the number of occupants increases, the cargo and luggage load will be reduced by an amount that equals the increased weight due to the additional occupants. In other words, if an increase in the number of occupants causes an excess of the total load capacity (combined weight of occupants plus cargo and luggage load), you must reduce the cargo and luggage on your vehicle.

 **CAUTION****n Things that must not be carried in the luggage compartment**

The following things may cause a fire if loaded in the luggage compartment.

- I Receptacles containing gasoline
- I Aerosol cans

n Storage precautions

Observe the following precautions.

Failing to do so may result in death or serious injury.

I Do not place cargo or luggage in or on the following locations as the item may get under the clutch, brake or accelerator pedal and prevent the pedals from being depressed properly, block the driver's vision, or hit the driver or passengers, causing an accident.

- Driver's feet
- Front passenger or rear seats (when stacking items)
- Instrument panel
- Dashboard
- Auxiliary box or tray that has no lid

I Do not stack anything in the luggage compartment higher than the seatbacks.

Such items may be thrown about and possibly injure people in the vehicle during sudden braking or in an accident.

I Secure all items in the occupant compartment, as they may shift and injure someone during sudden braking, sudden swerving or an accident.

I Never allow anyone to ride in the luggage compartment. It is not designed for passengers. They should ride in their seats with their seat belts properly fastened. Otherwise, they are much more likely to suffer death or serious injury, in the event of sudden braking, sudden swerving or an accident.

 CAUTION

n Capacity and distribution

- I** Do not exceed the maximum axle weight rating or the total vehicle weight rating.
- I** Even if the total load of occupant's weight and the cargo load is less than the total load capacity, do not apply the load unevenly. Improper loading may cause deterioration of steering or braking control which may cause death or serious injury.

2-5. Driving information

Vehicle load limits

Vehicle load limits include total load capacity, seating capacity, towing capacity and cargo capacity.

n Total load capacity: 1130 lb. (510 kg)

Total load capacity means the combined weight of occupants, cargo and luggage.

n Seating capacity: 5 occupants (Front 2, Rear 3)

Seating capacity means the maximum number of occupants whose estimated average weight is 150 lb. (68 kg) per person.

Even if the number of occupants are within the seating capacity, do not exceed the total load capacity.

n Towing capacity: 5000 lb. (2270 kg)

Towing capacity means the maximum gross trailer weight (trailer weight plus its cargo weight) that your vehicle is able to tow.

n Cargo capacity

Cargo capacity may increase or decrease depending on the weight and the number of occupants.

n Total load capacity and seating capacity

These details are also described on the tire and loading information label.(→P. 387)

⚠ CAUTION

n Overloading the vehicle

Do not overload the vehicle.

It may not only cause damage to the tires, but also degrade steering and braking ability, resulting in an accident.

2-5. Driving information

Winter driving tips

Carry out the necessary preparations and inspections before driving the vehicle in winter. Always drive the vehicle in a manner appropriate to the prevailing weather conditions.

n Pre-winter preparations

- 1 Use fluids that are appropriate to the prevailing outside temperatures.
 - Engine oil
 - Engine coolant
 - Washer fluid
- 1 Have a service technician inspect the level and specific gravity of battery electrolyte.
- 1 Have the vehicle fitted with four snow tires or purchase a set of tire chains for the rear tires.

Ensure that all tires are the same size and brand, and that chains match the size of the tires.

n Before driving the vehicle

Perform the following according to the driving conditions.

- 1 Do not try to forcibly open a window, scrape an outside rear view mirror surface or move a wiper or outside rear view mirror that is frozen. Pour warm water over the frozen area to melt the ice. Wipe away the water immediately to prevent it from freezing.
- 1 To ensure proper operation of the climate control system fan, remove any snow that has accumulated on the air inlet vents in front of the windshield.
- 1 Remove any ice that has accumulated on the vehicle chassis.
- 1 Periodically check for and remove any excess ice or snow that may have accumulated in the wheel well or on the brakes.

n When driving the vehicle

Accelerate the vehicle slowly and drive at a reduced speed suitable to road conditions.

n When parking the vehicle

Park the vehicle and move the shift lever to P (automatic transmission) or to 1 or R (manual transmission) without setting the parking brake. The parking brake may freeze up, preventing it from being released. If necessary, block the wheels to prevent inadvertent sliding or creeping.

Regulations on the use of snow chains

- 1 Regulations regarding the use of tire chains vary according to location and type of road. Always check local regulations before installing chains.
- 1 Install the chains on the rear tires.
- 1 Retighten the chains after driving 1/4 - 1/2 mile (0.5 - 1.0 km).

n Snow chain installation

Observe the following precautions when installing and removing chains.

- 1 Install and remove tire chains in a safe location.
- 1 Install tire chains on the rear tires only. Do not install tire chains on the front tires.
- 1 Install tire chains following the instructions provided in the accompanying instructions.

 CAUTION

n Driving with snow tires

Observe the following precautions to reduce the risk of accidents. Failing to do so may result in a loss of vehicle control and cause death or serious injury.

- I Use tires of the size specified for your vehicle.
- I Maintain the recommended level of air pressure.
- I Do not drive in excess of 75 mph (120 km/h) regardless of the type of snow tires being used.
- I Snow tires should be installed on all wheels.
- I 4WD models:
Do not mix tires of different makes, models, tread patterns or treadwear.

n Driving with snow chains

Observe the following precautions to reduce the risk of accidents. Failing to do so may result in the vehicle being unable to be driven safely, and may cause death or serious injury.

- I Do not drive in excess of the speed limit specified for the tire chains being used or 30 mph (50 km/h), whichever is lower.
- I Avoid driving on bumpy road surfaces or over potholes.
- I Avoid sudden turns and braking.
- I Slow down sufficiently before entering a curve to ensure that vehicle control is maintained.

 NOTICE

n Repairing or replacing snow tires

Request repairs of and obtain replacement snow tires from Toyota dealers or legitimate tire retailers.

This is because the removal and attachment of snow tires affects the operation of the tire pressure warning valves and transmitters.

n Fitting tire chains

The tire pressure warning valves and transmitters may not function correctly when tire chains are fitted.

Trailer towing

Your vehicle is designed primarily as a passenger-carrying vehicle, thus towing a trailer will have an adverse effect on handling, performance, braking, durability, and fuel consumption. For your safety and the safety of others, do not overload the vehicle or trailer.

Toyota warranties do not apply to damage or malfunction caused by towing a trailer for commercial purposes.

n **Weight limits**

Confirm the total trailer weight, gross vehicle weight, gross axle weight and trailer tongue load are all within the limits.

n **Gross vehicle weight**

The gross vehicle weight must not exceed the Gross Vehicle Weight Rating (GVWR) indicated on the Certification Label. The gross vehicle weight is the sum of the weights of the unloaded vehicle, driver, passengers, luggage, hitch, and the trailer tongue load. It also includes the weight of any special equipment installed on your vehicle.

n **Gross axle weight**

The load on either the front or rear axle resulting from distribution of the gross vehicle weight on both axles must not exceed the Gross Axle Weight Rating (GAWR) listed on the Certification Label.

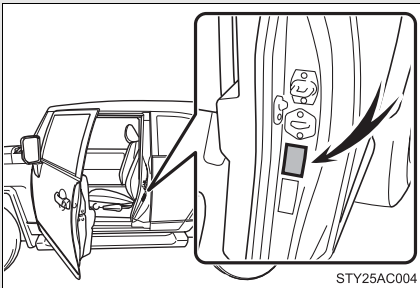

Certification label

n **Trailer tongue load**

The trailer cargo load should be distributed so that the tongue load is 9 to 11% of the total trailer weight, not exceeding the maximum 500 lb. (227 kg) ($\text{Tongue load} / \text{Total trailer weight} \times 100 = 9 \text{ to } 11\%$)

The total trailer weight and tongue load can be measured with platform scales found at a highway weighing station, building supply company, trucking company, junk yard, etc.

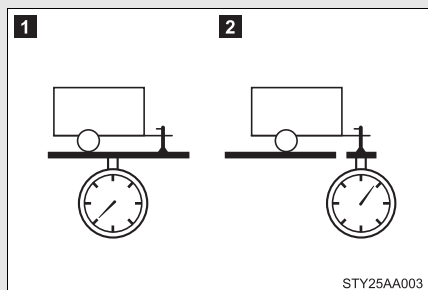

1 Total trailer weight

2 Tongue load

Towing a trailer

Consult your Toyota dealer for further information about additional requirements such as a towing kits, etc.

Hitch and tow hitch receiver

n **Hitch**

Trailer hitch assemblies have different weight capacities established by the hitch manufacturer. Even though the vehicle may be rated for towing a higher weight, the operator must never exceed the maximum weight rating specified for the trailer hitch.

Selecting trailer ball

Use the correct trailer ball for your application.

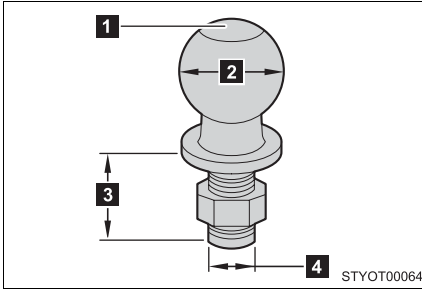

1 Trailer ball load rating

Matches or exceeds the gross trailer weight rating of the trailer.

2 Ball diameter

Matches the size of the trailer coupler. Most couplers are stamped with the required trailer ball size.

3 Shank length

Protrudes beyond the bottom of the lock washer and nut at least 2 threads.

4 Shank diameter

Matches the ball mount hole diameter size.

Connecting trailer lights

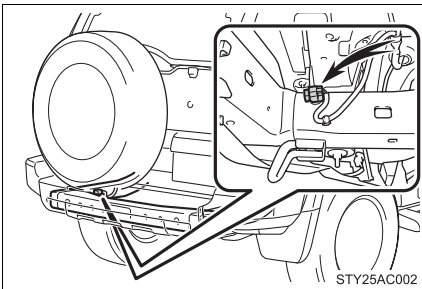

Use the wire harness stored in the rear end underbody.

▫ **Before towing**

Check that the following conditions are met:

- Ensure that your vehicle's tires are properly inflated. (→P. 477)
- Trailer tires should be inflated according to the trailer manufacturer's recommendation.
- All trailer lights work to be legal.
- Confirm all lights work each time you connect them.
- The trailer ball is set up at the proper height for the coupler on the trailer.
- Check that your vehicle remains level when a loaded or unloaded trailer is hitched. Do not drive if the vehicle is not level, and check for improper tongue load, overloading, worn suspension, or other possible causes.
- Make sure the trailer cargo is securely loaded.
- Check that your rear view mirrors conform to any federal, state/provincial or local regulations. If they do not, install rear view mirrors appropriate for towing purposes.

▫ **Break-in schedule**

Toyota recommends that you do not use a new vehicle or a vehicle with any new power train components (engine, transmission, differential, wheel bearings, etc.) to tow a trailer for the first 500 miles (800 km) of driving.

▫ **Maintenance**

- If you tow a trailer, your vehicle will require more frequent maintenance due to the additional load. (See "Scheduled Maintenance Guide" or "Owner's Manual Supplement".)
- Retighten the fixing bolts of the towing ball and bracket after approximately 600 miles (1000 km).

 **CAUTION****n To avoid accident or injury**

- I The total trailer weight (trailer weight plus the weight of cargo) must not exceed 5000 lb. (2270 kg)
- I If a trailer and cargo weight over 2000 lb. (907 kg), use a sway control device with sufficient capacity.
- I The gross combined weight (sum of your vehicle weight plus its load and the total trailer weight) must not exceed the following.
 - 2WD models:
9200 lb. (4173 kg)
 - 4WD models:
9500 lb. (4309 kg)
- I Do not exceed the trailer hitch assembly weight, gross vehicle weight, gross axle weight and trailer tongue load capacities.
- I Never load more weight in the back than in the front of the trailer. About 60% of the load should be in the front half of the trailer, and the remaining 40% in the rear.
- I The tow hitch receiver installed on your vehicle must never be used on another vehicle.

n Hitches

- I If you wish to install a trailer hitch, your Toyota dealer should be consulted.
- I Use only a hitch that conforms to the total trailer weight requirement.
- I Follow the directions supplied by the hitch manufacturer.
- I Lubricate the hitch ball with a light coat of grease.
- I Remove the trailer hitch whenever you are not towing a trailer to reduce the possibility of additional damage caused by the hitch if your vehicle is struck from behind.

 **CAUTION**

n When towing a trailer

- i** If the total trailer weight exceeds 1000 lb. (453 kg), trailer brakes are required.
- i** Never tap into your vehicle's hydraulic system, as this will lower the vehicle's braking effectiveness.
- i** Never tow a trailer without using a safety chain securely attached to both the trailer and the vehicle. If damage occurs to the coupling unit or hitch ball, there is danger of the trailer wandering into another lane.

 **NOTICE**

n When installing a trailer hitch

Use only the position recommended by your Toyota dealer. Do not install the trailer hitch on the bumper; this may cause body damage.

n Brakes

Toyota recommends trailers with brakes that conform to any applicable federal and state/provincial regulations.

n Safety chain

A safety chain must always be used between the towing vehicle and the trailer. Leave sufficient slack in the chain for turns. The chain should cross under the trailer tongue to prevent the tongue from dropping to the ground in the case that it becomes damaged or separated. For the correct safety chain installation procedure, ask your Toyota dealer.

n Do not directly splice trailer lights

Directly splicing trailer lights may damage your vehicle's electrical system and cause a malfunction.

Trailer towing tips

Your vehicle will handle differently when towing a trailer. In order to avoid accident, death or serious injury, keep the following in mind when towing:

- 1 Before starting out, check the trailer's light and the vehicle-trailer connections. Recheck after driving a short distance.
- 1 Practice turning, stopping and reversing with the trailer attached in an area away from traffic until you become accustomed to the feel of the vehicle.
- 1 Reversing with a trailer attached is difficult and requires practice. Grip the bottom of the steering wheel and move your hand to the left to move the trailer to the left. Move your hand to the right to move the trailer to the right. (This is generally opposite to reversing without a trailer attached.) Avoid sharp or prolonged turning. Have someone guide you when reversing to reduce the risk of an accident.
- 1 As stopping distance is increased when towing a trailer, vehicle-to-vehicle distance should be increased. For each 10 mph (16 km/h) of speed, allow at least one vehicle and trailer length.
- 1 Avoid sudden braking as you may skid, resulting in jackknifing and loss of control. This is especially true on wet or slippery surfaces.
- 1 Avoid jerky starts or sudden acceleration. Vehicles with a manual transmission, prevent excessive clutch slippage by keeping engine rpm low and not racing the engine. Always start out in first gear.
- 1 Avoid jerky steering and sharp turns, and slow down before making a turn.

- 1 Note that when making a turn, the trailer wheels will be closer than the vehicle wheels to the inside of the turn. Compensate by making a larger than normal turning radius.
- 1 Crosswinds and rough roads will adversely affect handling of your vehicle and trailer, causing sway. Periodically check the rear to prepare for being passed by large trucks or buses, which may cause your vehicle and trailer to sway. If swaying occurs, firmly grip the steering wheel, reduce speed immediately but gradually, and steer straight ahead. Never increase speed. If you make no extreme correction with the steering or brakes, your vehicle and trailer will stabilize.
- 1 Take care when passing other vehicles. Passing requires considerable distance. After passing a vehicle, do not forget the length of your trailer, and be sure you have plenty of room before changing lanes.
- 1 In order to maintain engine braking efficiency, do not use the transmission in D (automatic transmission) or 6 (manual transmission).
- 1 Due to the added load of the trailer, your vehicle's engine may overheat on hot days (at temperatures over 85°F [30°C]) when driving up a long or steep grade. If the engine coolant temperature gauge indicates overheating, immediately turn off the air conditioning (if in use), pull your vehicle off the road and stop in a safe spot. (→P. 459)

1 Always place wheel blocks under both the vehicle and the trailer wheels when parking. Apply the parking brake firmly, and put the transmission in P (automatic transmission) or in 1 or R (manual transmission). Avoid parking on a slope, but if unavoidable, do so only after performing the following:

STEP 1 Apply the brakes and keep them applied.

STEP 2 Have someone place wheel blocks under both the vehicle and trailer wheels.

STEP 3 When the wheel blocks are in place, release the brakes slowly until the blocks absorb the load.

STEP 4 Apply the parking brake firmly.

STEP 5 Shift into 1 or R (manual transmission) or P (automatic transmission) and turn off the engine.

1 When restarting after parking on a slope:

STEP 1 With the transmission in P (automatic transmission) or the clutch pedal (manual transmission) depressed, start the engine. On vehicles with an automatic transmission, be sure to keep the brake pedal pressed.

STEP 2 Shift into a forward gear. If reversing, shift into R.

STEP 3 Release the parking brake (also brake pedal on vehicles with an automatic transmission), and slowly pull or back away from the wheel blocks. Stop and apply the brakes.

STEP 4 Have someone retrieve the blocks.

 CAUTION

n To avoid an accident

- I** Do not exceed 45 mph (72 km/h) or posted towing speed limit, whichever is lower. As instability (swaying) of the towing vehicle-trailer combination increases as speed increases, exceeding 45 mph (72 km/h) may cause loss of control.
- I** Slow down and downshift before descending steep or long downhill grades. Do not make sudden downshifts.
- I** Avoid holding the brake pedal down too long or too frequently. This could cause the brakes to overheat and result in reduced braking efficiency.

2-5. Driving information

Dinghy towing

Your vehicle is not designed to be dinghy towed (with 4 wheels on the ground) behind a motor home.

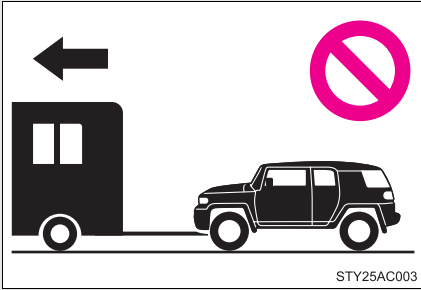

NOTICE

n To avoid serious damage to your vehicle

Do not tow your vehicle with four wheels on the ground.

3-1. Using the air conditioning system and defogger

Air conditioning system

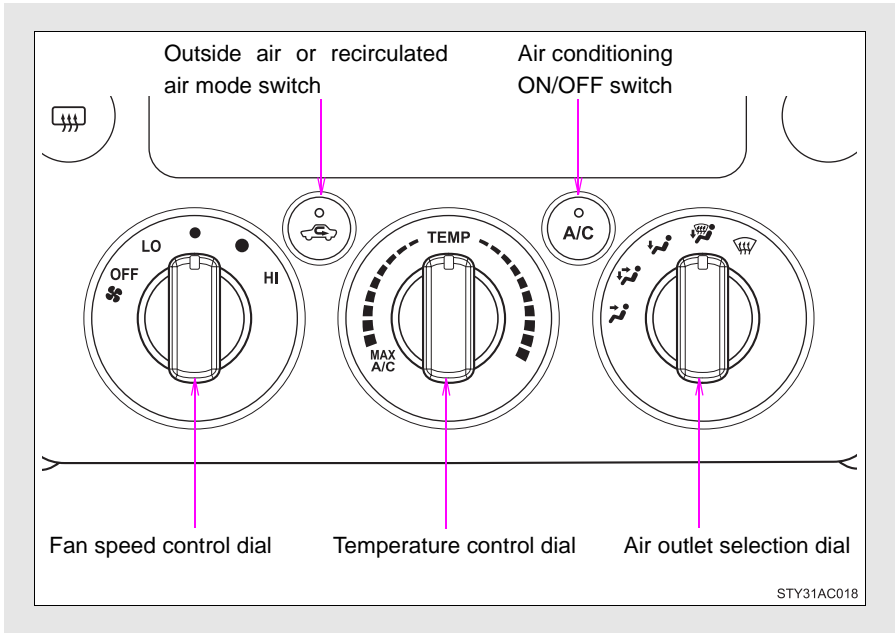

Adjusting the settings

n Adjusting the temperature setting

Turn the temperature control dial clockwise (warm) or counter-clockwise (cool).

If  is not pressed, the system will blow ambient temperature air or heated air.

For quick cooling, turn the temperature control dial to the MAX A/C position. The air conditioning will automatically turn on and the air intake selector will be set to recirculated air mode.

n Adjusting the fan speed

Turn the fan speed control dial clockwise (increase) or counter-clockwise (decrease).

Set the dial to OFF to turn the fan off.

n Selecting the air outlets

Set the air outlet selection dial to an appropriate position.

The positions between the air outlet selections shown below can also be selected for more detailed adjustment.

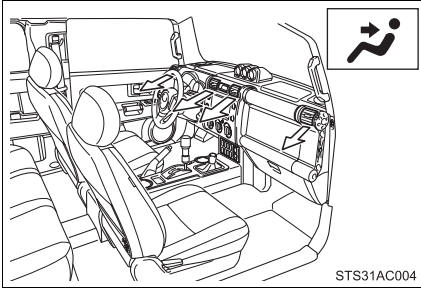

When the dial is set to , air flows to the upper body.

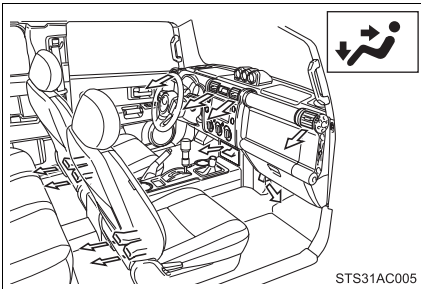

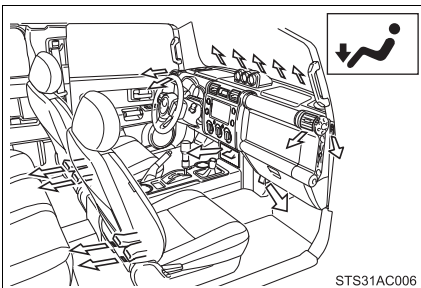

When the dial is set to , air flows to the upper body and feet.

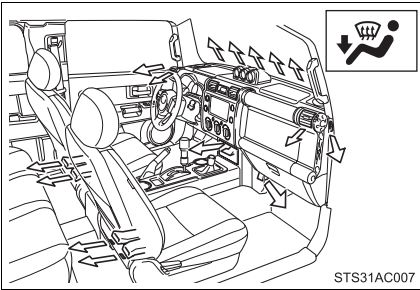

When the dial is set to , mainly air flows to the feet.

3-1. Using the air conditioning system and defogger



When the dial is set to , air flows to the feet and the windshield defogger operates.

The air intake selector is automatically set to outside air mode.

To return the recirculated air mode, press .

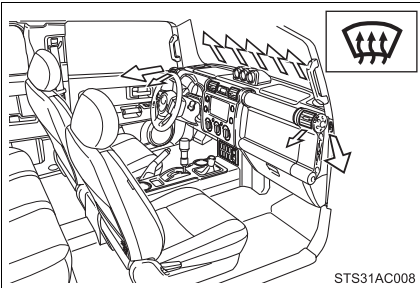



When the dial is set to , air flows to the windshield and side windows to defog them.

The air intake selector is automatically set to outside air mode.

In this position, the air intake selector cannot be changed to the recirculated air mode.

n Switching between outside air and recirculated air modes

Press .

The mode switches between  (outside air mode) and  (recirculated air mode) each time the switch is pressed.

n If the ambient temperature drops while using the recirculated air mode

The air intake mode automatically changes from recirculated air mode to outside air mode after a few minutes.

To cancel this function:

Press and hold  for longer than 2 seconds.

To reactivate this function:

Turn the engine switch to the LOCK or ACC position.

Adjusting the position of the air outlets

► Center outlets

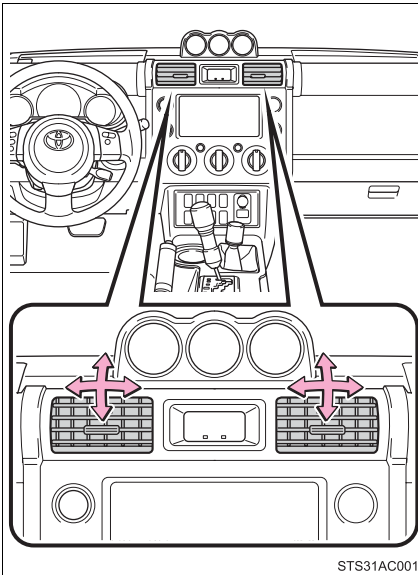

Direct air flow to the left or right, up or down.

► Right and left side outlets

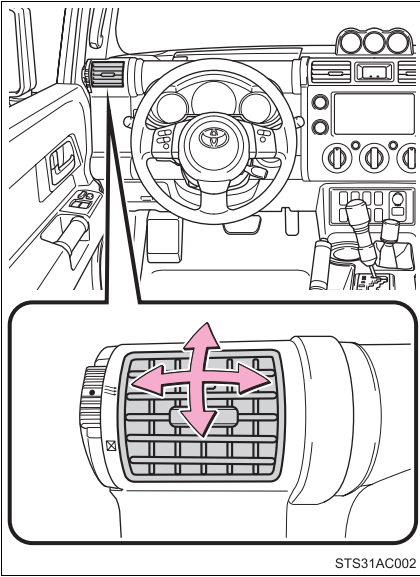

Direct air flow to the left or right, up or down.

Opening and closing the right and left side outlets

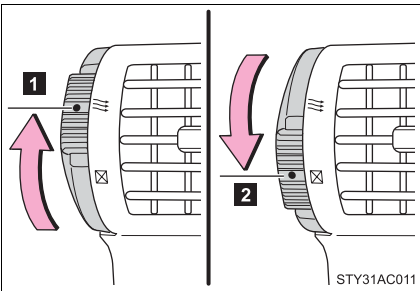

1 Open the vent.

2 Close the vent.

n Using the system in recirculated air mode

The windows will fog up more easily if the recirculated air mode is used for an extended period.

n When outside air temperature approaches 32°F (0°C)

The air conditioning system may not operate even when  is pressed.

n When  is selected for the air outlets used

For your driving comfort, air flowing to the feet may be warmer than air flowing to the upper body depending on the position of the temperature adjustment dial.

n When the indicator on  flashes

Press  and turn off the air conditioning system before turning it on once more. There may be a problem in the air conditioning system if the indicator continues to flash. Turn the air conditioning system off and have it inspected by your Toyota dealer.

n Air conditioning odors

- l During use, various odors from inside and outside the vehicle may enter into and accumulate in the air conditioning system. This may then cause odor to be emitted from the vents.
- l To reduce potential odors from occurring:
It is recommended that the air conditioning system be set to outside air mode prior to turning the vehicle off.

⚠ CAUTION**n To prevent the windshield from fogging up**

Do not set the air outlet selection dial to  during cool air operation in extremely humid weather. The difference between the temperature of the outside air and that of the windshield can cause the outer surface of the windshield to fog up, blocking your vision.

 NOTICE

n To prevent battery discharge

Do not leave the air conditioning system on longer than necessary when the engine is stopped.

3-1. Using the air conditioning system and defogger

Rear window defogger

This feature is used to defog the rear window.

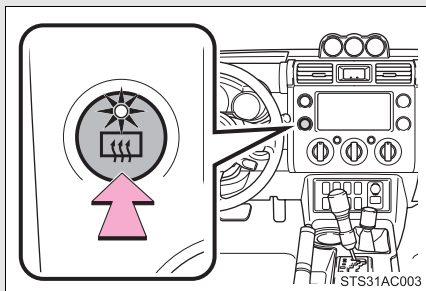

On/off

Press the button to turn on the rear window defogger. The indicator light will come on. The defogger will automatically turn off after 15 to 240 minutes. The operation time changes according to the ambient temperature and vehicle speed. Pressing the button again also turns the defogger off.

n **The rear window defogger can be operated when**

The engine switch is in the ON position.

NOTICE

n **To prevent battery discharge**

Turn the rear window defogger off when the engine is off.

3-2. Using the audio system

Audio system

Type A: CD player with changer controller and AM/FM radio

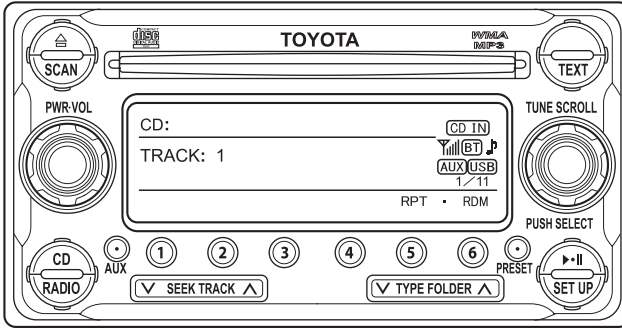

STY32AC020

Type B: CD player with changer and AM/FM radio

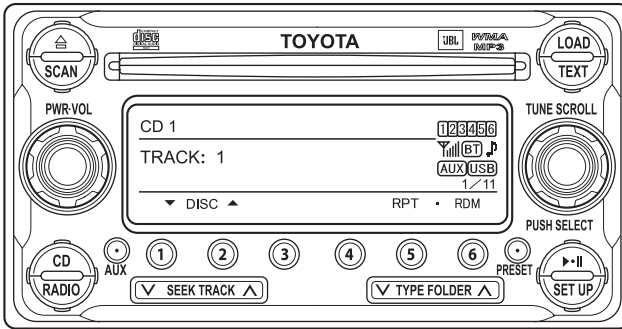

STY32AC019

Title	Page
Using the radio	P. 218
Using the CD player	P. 225
Playing MP3 and WMA discs	P. 233
Operating an iPod	P. 240
Operating a USB memory	P. 247
Optimal use of the audio system	P. 255
Using the AUX port	P. 258
Using the steering wheel audio switches	P. 259

Language settings

The language used for all voice guidance, voice recognition and messages may be changed.

STEP 1 Press .

STEP 2 Press  (MORE).

STEP 3 Press  (LANG).

STEP 4 Press  or  that corresponds to the desired language.

► For vehicles sold in the U.S.A.

“ENG” (English) or “ESP” (Spanish)

► For vehicles sold in Canada

“ENG” (English) or “FRAN” (French)

n Using cellular phones

Interference may be heard through the audio system's speakers if a cellular phone is being used inside or close to the vehicle while the audio system is operating.

n Certification for the audio system

This device complies with part 15 of the FCC Rules and RSS-Gen of the IC Rules. Operation is subject to the following two conditions: (1) This device may not cause harmful interference, and (2) this device must accept any interference received, including interference that may cause undesired operation.

⚠ CAUTION

n For vehicles sold in U.S.A. and Canada

I Part 15 of the FCC Rules and RSS-Gen of the IC Rules

FCC WARNING:

Changes or modifications not expressly approved by the party responsible for compliance could void the user's authority to operate the equipment.

I Laser products

- Do not take this unit apart or attempt to make any changes by yourself. This is an intricate unit that uses a laser pickup to retrieve information from the surface of compact discs. The laser is carefully shielded so that its rays remain inside the cabinet. Therefore, never try to disassemble the player or alter any of its parts since you may be exposed to laser rays and dangerous voltages.
- This product utilizes a laser. Use of controls or adjustments or performance of procedures other than those specified herein may result in hazardous radiation exposure.
- The use of optical instruments with this product will increase eye hazard.



NOTICE

n To prevent battery discharge

Do not leave the audio system on longer than necessary with the engine off.

n To avoid damaging the audio system

Take care not to spill drinks or other fluids over the audio system.

3-2. Using the audio system

Using the radio

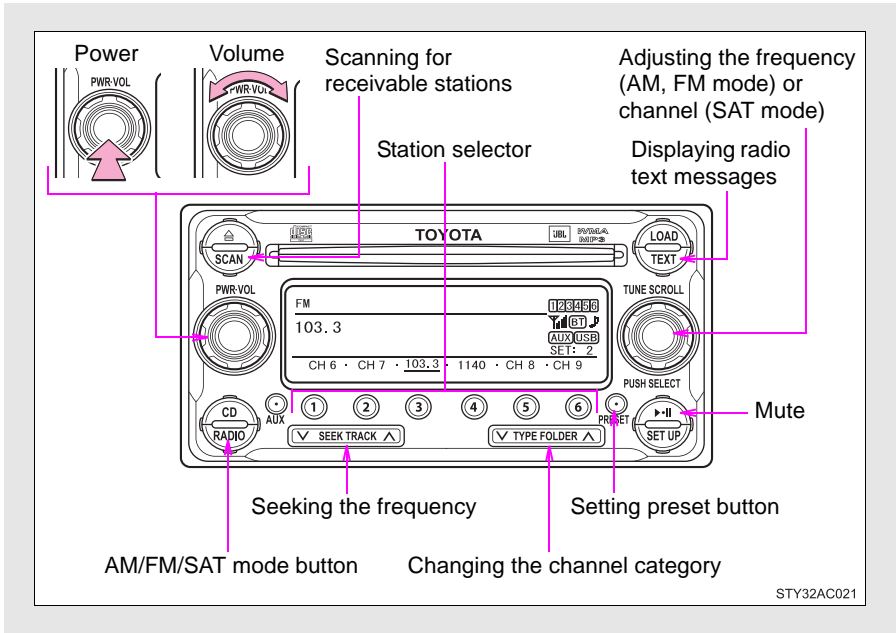

Setting station presets (excluding XM[®] Satellite Radio)

STEP 1 Search for desired stations by turning



or pressing

“**^**” or “**v**” on **SEEK TRACK**.

STEP 2 Press and hold a button (from **1** to **6**) until you hear a beep.

Each time **PRESET** is pressed, station pages are changed. There are a total of 6 pages.

Scanning radio stations (excluding XM[®] Satellite Radio)

n Scanning the preset radio stations

STEP 1 Press and hold  until you hear a beep.

Preset stations will be played for 5 seconds each.

STEP 2 When the desired station is reached, press  again.

n Scanning all radio stations within range

STEP 1 Press .

All the stations with reception will be played for 5 seconds each.

STEP 2 When the desired station is reached, press  again.

n Displaying radio text messages (FM mode only)

When a new radio text message is received, “MSG” is shown on the display. To display the message, press .

If the text continues past the end of the display, “▶” is displayed. Press and hold  until you hear a beep.



Text messages are not displayed while driving.

XM[®] Satellite Radio (if equipped)

n Receiving XM[®] Satellite Radio

STEP 1 Press .

The display changes as follows each time  is pressed.
AM → FM → XM

STEP 2 Turn  to select the desired channel in all the categories or press “^” or “v” on  to select the desired channel in the current category.

n Setting XM[®] Satellite Radio channel presets

Select the desired channel. Press and hold a button (from ① to ⑥) until you hear a beep.

Each time  is pressed, station pages are changed. There are a total of 6 pages.

n Changing the channel category

Press “^” or “v” on .

n Scanning XM[®] Satellite Radio channels

1 Scanning channels in the current category

STEP 1 Press .

STEP 2 When the desired channel is reached, press  again.

1 Scanning the preset channels

STEP 1 Press and hold  until you hear a beep.

STEP 2 When the desired channel is reached, press  again.

n Displaying text information

Press .

Each time  is pressed, the display changes in the following order:

Title (song/program title) → Name (artist name/feature)/Title (song/program title).

n Reception sensitivity

- l Cargo loaded on the roof luggage carrier, especially metal objects, may adversely affect the reception of XM[®] Satellite Radio.
- l Maintaining perfect radio reception at all times is difficult due to the continually changing position of the antenna, differences in signal strength and surrounding objects, such as trains, transmitters, etc.
- l The radio antenna is mounted on the right-side front fender. The antenna can be removed from the base by turning it.

n XM[®] Satellite Radio

An XM[®] Satellite Radio is a tuner designed exclusively to receive broadcasts provided under a separate subscription. Availability is limited to the 48 contiguous states and 10 Canadian provinces.

l XM[®] subscriptions

For detailed information about XM[®] Satellite Radio or to subscribe:

U.S.A. —

Visit on the web at www.xmradio.com or call 1-800-967-2346.

Canada —

Visit on the web at www.xmradio.ca or call 1-877-438-9677.

l Radio ID

You will need the radio ID when activating XM[®] service or reporting a

problem. Select “CH000” using  , and the receiver’s 8-character

ID number will appear.

l Satellite tuner

The tuner supports only Audio Services (Music and Talk) and the accompanying Text Information of XM[®] Satellite Radio.

■ If XM[®] Satellite Radio does not operate normally

If a problem occurs with the XM[®] tuner, a message will appear on the display. Refer to the table below to identify the problem, and take the suggested corrective action.

CHECK ANTENNA	The XM [®] antenna is not connected. Check whether the XM [®] antenna cable is attached securely.
	There is a short-circuit in the antenna or the surrounding antenna cable. See a Toyota certified dealer.
CHANNEL NOT AUTHORIZED	You have not subscribed to XM [®] Satellite Radio. The radio is being updated with the latest encryption code. Contact XM [®] Satellite Radio for subscription information. When a contract is canceled, you can choose the "CH000" and all free-to-air channels.
	The premium channel you selected is not authorized. Wait for about 2 seconds until the radio returns to the previous channel or "CH001". If it does not change automatically, select another channel. If you want to listen to the premium channel, contact XM [®] Satellite Radio.
NO SIGNAL	The XM [®] signal is too weak at the current location. Wait until your vehicle reaches a location with a stronger signal.
LOADING	The unit is acquiring audio or program information. Wait until the unit has received the information.
CHANNEL OFF AIR	The channel you selected is not broadcasting any programming. Select another channel.
Blank	There is no song/program title or artist name/feature associated with the channel at this time. No action needed.

CHANNEL NOT AVAILABLE

The channel you selected is no longer available. Wait for about 2 seconds until the radio returns to the previous channel or "CH001". If it does not change automatically, select another channel.

Contact the XM[®] Listener Care Center at 1-800-967-2346 (U.S.A.) or 1-877-438-9677 (Canada)

n Certifications for the radio tuner

This equipment has been tested and found to comply with the limits for a class B digital device, pursuant to Part 15 of the FCC Rules. These limits are designed to provide reasonable protection against harmful interference in a residential installation. This equipment generates, uses and can radiate radio frequency energy and, if not installed and used in accordance with the instructions, may cause harmful interference to radio communications. However, there is no guarantee that interference will not occur in a particular installation.

If this equipment does cause harmful interference to radio or television reception, which can be determined by turning the equipment off and on, the user is encouraged to try to correct the interference by trying one or more of the following:

- l Reorienting or relocating the receiving antenna.
- l Increasing the separation between the equipment and receiver.
- l Connecting the equipment into an outlet on a circuit different from that to which the receiver is connected.
- l Consulting the dealer or an experienced radio/TV technician for help.



NOTICE

n To prevent damage, remove the antenna in the following cases.

- l The antenna will touch the ceiling of a garage.
- l A cover will be put on the vehicle.

3-2. Using the audio system Using the CD player

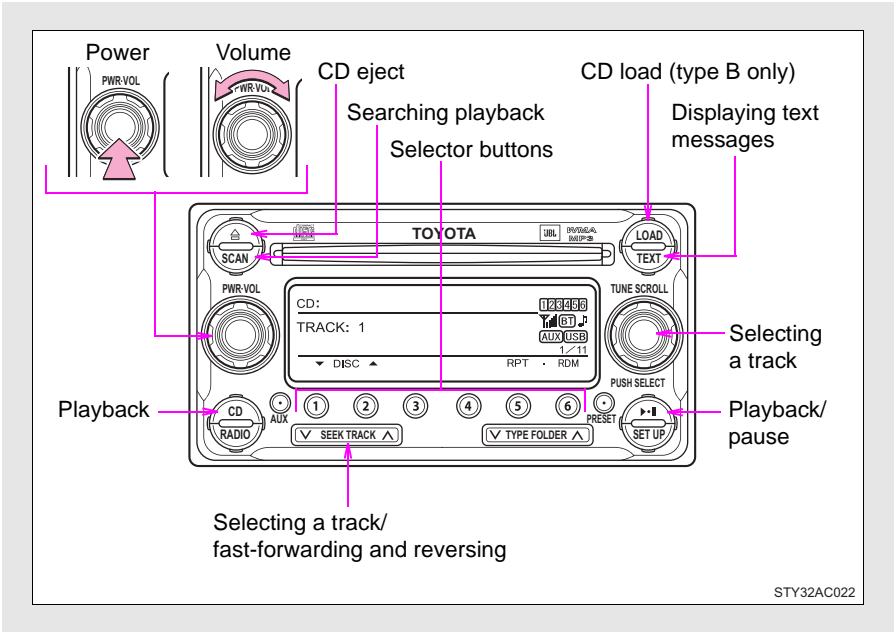

Loading CDs

n Loading a CD (type A)

Insert a CD.

n Loading a CD (type B)

STEP 1 Press .

STEP 2 When the indicator on the slot turns from amber to green, insert a CD.

n Loading multiple CDs (type B only)

STEP 1 Press and hold  until you hear a beep.

STEP 2 When the indicator on the slot turns from amber to green, insert a CD.

The indicator on the slot turns to amber when the CD is inserted.

STEP 3 When the indicator on the slot turns from amber to green again, insert the next CD.

Repeat the procedure for the remaining CDs.

To cancel, press . If you do not insert a disc within 15 seconds, loading will be canceled automatically.

Ejecting CDs

n Ejecting a CD (type A)

Press  and remove the CD.

n Ejecting a CD (type B)

STEP 1 To select the CD to be ejected, press ① (▼) or ② (▲).



The selected CD number is shown on the display.

STEP 2 Press  and remove the CD.

n Ejecting all the CDs (type B only)

Press and hold  until you hear a beep, and then remove the CDs.

Selecting a track

Turn  or press “^” or “v” on  to select the desired track.

Fast-forwarding and reversing tracks

Press and hold “^” or “v” on .

Scanning tracks

STEP 1 Press .

The first ten seconds of each track will be played.

To cancel, press  again.

STEP 2 Press  again when the desired track is reached.

Selecting a CD (type B only)

n Selecting a CD to play

Press ① (▼) or ② (▲).

n Scanning loaded CDs

STEP 1 Press and hold  until you hear a beep.

The first ten seconds of the first track on each CD will be played.

To cancel, press  again.

STEP 2 Press  again when the desired CD is reached.

Playing and pausing tracks

Press .

Random playback

n Current CD

Press ⑥ (RDM).

Songs are played in random order.

To cancel, press the button one more (type A), or twice more (type B).

n All CDs (type B only)

Press ⑥ (RDM) twice.

Tracks on all loaded CDs are played in random order.

To cancel, press the button again.

Repeat play

n Repeating a track

Press  (RPT).

To cancel, press the button once more (type A), or twice more (type B).

n Repeating all of the tracks on a CD (type B only)

Press  (RPT) twice.

To cancel, press the button again.

Switching the display

Press .

Each time  is pressed, the display changes in the following order:

Track title → Track name/Artist name → Track name/Elapsed time.

n Error messages

“CD CHECK”: This indicates a problem either with the CD or inside the player. The CD may be dirty, damaged or inserted up-side down.

“PLEASE WAIT”: Operation has stopped due to a high temperature inside the player. Wait for a while and then press . Contact your Toyota dealer if the CD still cannot be played back.

■ Discs that can be used

Discs with the marks shown below can be used.
Playback may not be possible depending on the recording format or disc features, or due to scratches, dirt or deterioration.



CDs with copy-protection features may not be used.

■ CD player protection feature

To protect the internal components, playback is automatically stopped when a problem is detected while the CD player is being used.

■ If CDs are left inside the CD player or in the ejected position for extended periods

CDs may be damaged and may not play properly.

■ Lens cleaners

Do not use lens cleaners. Doing so may damage the CD player.

 NOTICE

n CDs and adapters that cannot be used

Do not use the following types of CDs, 3 in. (8 cm) CD adapters or Dual Discs.

Doing so may damage the CD player and/or the CD insert/eject function.

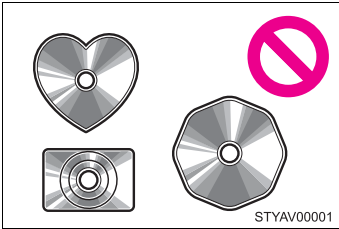

- 1 CD player with changer and AM/FM radio: CDs that have a diameter that is not 4.7 in. (12 cm)

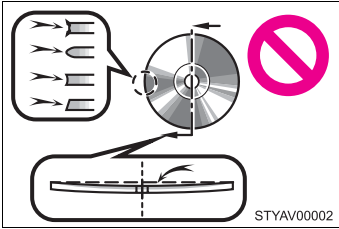

- 1 Low-quality and deformed CDs

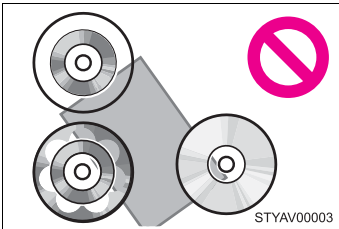

- 1 CDs with a transparent or translucent recording area

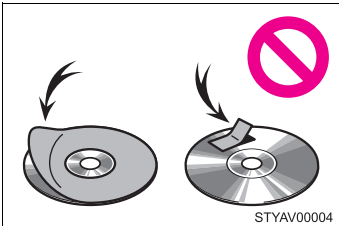

- 1 CDs that have had tape, stickers or CD-R labels attached to them, or that have had the label peeled off

 NOTICE

n CD player precautions

Failure to follow the precautions below may result in serious damage to the CDs or the player itself.

- | Do not insert anything other than CDs into the CD slot.
- | Do not apply oil to the CD player.
- | Store CDs away from direct sunlight.
- | Never try to disassemble any part of the CD player.



- | Do not insert more than one CD at a time.

3-2. Using the audio system Playing MP3 and WMA discs

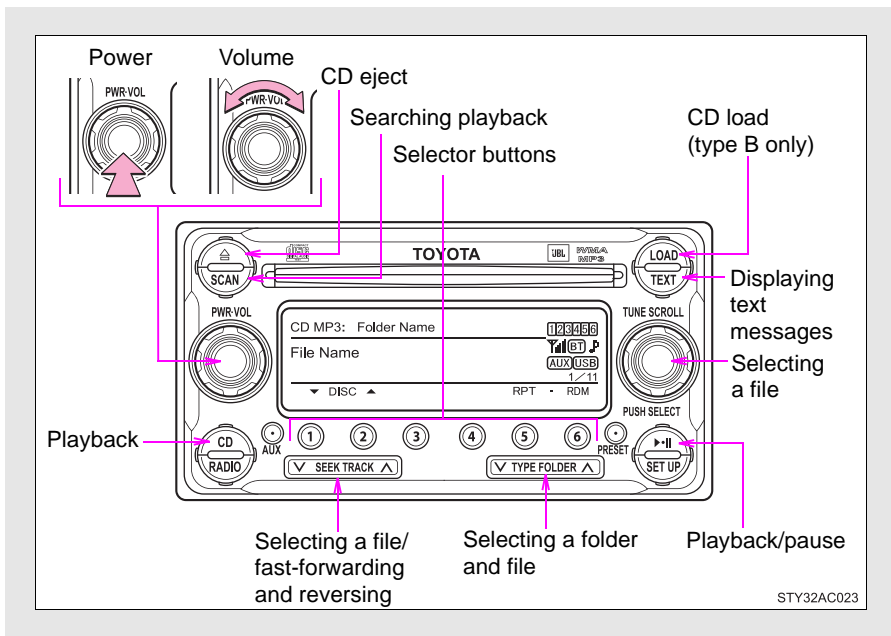

Loading and ejecting MP3 and WMA discs

→P. 225

Selecting MP3 and WMA discs (type B only)

→P. 227

Selecting and scanning a folder

n Selecting folders one at a time

Press “^” or “v” on  to select the desired folder.

n Scanning the first file of all the folders

STEP 1 Press and hold  until you hear a beep.

The first ten seconds of the first file in each folder will be played.



STEP 2 When the desired folder is reached, press  again.

n Returning to the first folder

Press and hold “v” on  until you hear a beep.

Selecting and scanning files

n Selecting one file at a time

Turn  or press “^” or “v” on  to select the desired file.

n Selecting the desired file by cueing the files in the folder

Press .

When the desired file is reached, press  once again.

Fast-forwarding and reversing files

Press and hold “^” or “v” on .

Playing and pausing files

Press .

Random playback

n **Playing files from a particular folder in random order**

Press  (RDM).

To cancel, press the button twice more.

n **Playing all of the files on a disc in random order**

Press  (RDM) twice.

To cancel, press the button again.

Repeat play

n **Repeating a file**

Press  (RPT).

To cancel, press the button twice more (type A), or three times more (type B).

n **Repeating all of the files in a folder**

Press  (RPT) twice.

To cancel, press the button once more (type A), or twice more (type B).

n **Repeating all of the files in a disc (type B only)**

Press  (RPT) three times.

To cancel, press the button again.

Switching the display

Press .

Each time  is pressed, the display changes in the following order:

Track title → Track title/Artist name → Track title/Album name (MP3 only)
→ Track title/Elapsed time.

n Error messages

“CD CHECK”: This indicates a problem either with the CD or inside the player. The CD may be dirty, damaged or inserted up-side down.

“PLEASE WAIT”: Operation has stopped due to a high temperature inside the player. Wait for a while and then press . Contact your Toyota dealer if the CD still cannot be played.

n Discs that can be used

→P. 230

n CD player protection feature

→P. 230

n If CDs are left inside the CD player or in the ejected position for extended periods

→P. 230

n Lens cleaners

→P. 230

■ MP3 and WMA files

MP3 (MPEG Audio LAYER3) is a standard audio compression format.

Files can be compressed to approximately 1/10 of their original size by using MP3 compression.

WMA (Windows Media Audio) is a Microsoft® audio compression format.

This format compresses audio data to a size smaller than that of the MP3 format.

There is a limit to the MP3 and WMA file standards and to the media/formats recorded by them that can be used.

┆ MP3 file compatibility

- Compatible standards
MP3 (MPEG1 LAYER3, MPEG2 LSF LAYER3)
- Compatible sampling frequencies
MPEG1 LAYER3: 32, 44.1, 48 (kHz)
MPEG2 LSF LAYER3: 16, 22.05, 24 (kHz)
- Compatible bit rates (compatible with VBR)
MPEG1 LAYER3: 64, 80, 96, 112, 128, 160, 192, 224, 256, 320 (kbps)
MPEG2 LSF LAYER3: 64, 80, 96, 112, 128, 144, 160 (kbps)
- Compatible channel modes: stereo, joint stereo, dual channel and monaural

┆ WMA file compatibility

- Compatible standards
WMA Ver. 7, 8, 9
- Compatible sampling frequencies
32, 44.1, 48 (kHz)
- Compatible bit rates (only compatible with 2-channel playback)
Ver. 7, 8: CBR 48, 64, 80, 96, 128, 160, 192 (kbps)
Ver. 9: CBR 48, 64, 80, 96, 128, 160, 192, 256, 320 (kbps)

┆ Compatible media

Media that can be used for MP3 and WMA playback are CD-Rs and CD-RWs.

Playback in some instances may not be possible, depending on the status of the CD-R or CD-RW. Playback may not be possible or the audio may jump if the disc is scratched or marked with fingerprints.

I Compatible disc formats

The following disc formats can be used.

- Disc formats: CD-ROM Mode 1 and Mode 2
CD-ROM XA Mode 2, Form 1 and Form 2
- File formats: ISO9660 Level 1, Level 2, (Romeo, Joliet)
MP3 and WMA files written in any format other than those listed above may not play correctly, and their file names and folder names may not be displayed correctly.

Items related to standards and limitations are as follows.

- Maximum directory hierarchy: 8 levels
- Maximum length of folder names/file names: 32 characters
- Maximum number of folders: 192 (including the root)
- Maximum number of files per disc: 255

I File names

The only files that can be recognized as MP3/WMA and played are those with the extension .mp3 or .wma.

I Multi-sessions

As the audio system is compatible with multi-sessions, it is possible to play discs that contain MP3 and WMA files. However, only the first session can be played.

I ID3 and WMA tags

ID3 tags can be added to MP3 files, making it possible to record the track title and artist name, etc.

The system is compatible with ID3 Ver. 1.0, 1.1, and Ver. 2.2, 2.3 ID3 tags. (The number of characters is based on ID3 Ver. 1.0 and 1.1.)

WMA tags can be added to WMA files, making it possible to record the track title and artist name in the same way as with ID3 tags.

I MP3 and WMA playback

When a disc containing MP3 or WMA files is inserted, all files on the disc are first checked. Once the file check is finished, the first MP3 or WMA file is played. To make the file check finish more quickly, we recommend you do not write in any files other than MP3 or WMA files or create any unnecessary folders.

If the discs contain a mixture of music data and MP3 or WMA format data, only music data can be played.

1 Extensions

If the file extensions .mp3 and .wma are used for files other than MP3 and WMA files, they will be mistakenly recognized and played as MP3 and WMA files. This may result in large amounts of interference and damage to the speakers.

1 Playback

- To play MP3 files with steady sound quality, we recommend a fixed bit rate of 128 kbps and a sampling frequency of 44.1 kHz.
- CD-R or CD-RW playback may not be possible in some instances, depending on the characteristics of the disc.
- There is a wide variety of freeware and other encoding software for MP3 and WMA files on the market, and depending on the status of the encoding and the file format, poor sound quality or noise at the start of playback may result. In some cases, playback may not be possible at all.
- When files other than MP3 or WMA files are recorded on a disc, it may take more time to recognize the disc. In some cases, playback may not be possible at all.
- Microsoft, Windows, and Windows Media are the registered trademarks of Microsoft Corporation in the U.S. and other countries.



NOTICE

n CDs and adapters that cannot be used (→P. 231)

n CD player precautions (→P. 232)

3-2. Using the audio system Operating an iPod

Connecting an iPod enables you to enjoy music from the vehicle speakers.

n Connecting an iPod

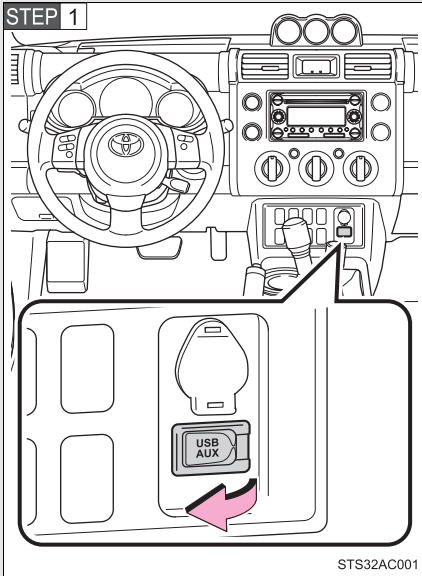

Open the cover and connect an iPod using an iPod cable.

Turn on the power of the iPod if it is not turned on.

STEP 2 Press  .

n Control panel

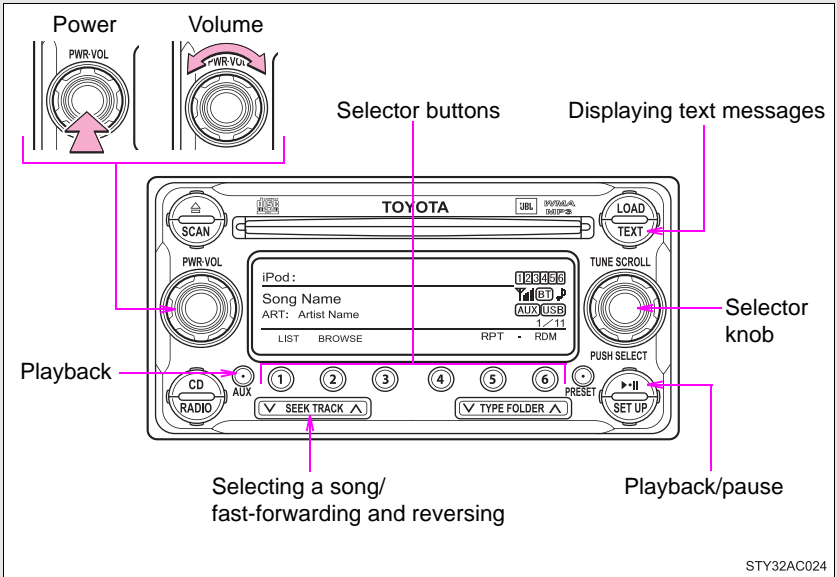

Selecting a play mode

STEP 1 Press (2) (BROWSE) to select iPod menu mode.

STEP 2 Press (2), (3), (4) or (5) as corresponds to the desired play mode.

Pressing (6) (MORE) to change to the second selection list.

n Play mode list

Play mode	First selection	Second selection	Third selection	Fourth selection
PLAYLIST	Playlist select	Songs select	-	-
ARTIST	Artist select	Albums select	Songs select	-
ALBUM	Albums select	Songs select	-	-
GENRE	Genre select	Artists select	Albums select	Songs select
SONGS	Songs select	-	-	-
PODCST	Albums select	Songs select	-	-
COMPSR	Composers select	Albums select	Songs select	-
BOOK	Songs select	-	-	-

Depending on the model, the name of your iPod may be displayed at the top of the list.

n Selecting a list

STEP 1 Turn  to display the first selection list.

STEP 2 Press  to select the desired item.

STEP 3 Repeat the same procedure to select the desired song name.

To return to the previous selection list, press  ().

Selecting songs from a song list



STEP 1 Press  (LIST).

The current playlist is displayed.

STEP 2 Turning  to select the desired song.

Press  returns the screen from list display to the previous screen.

Selecting songs

Turn  or press “^” or “v” on  to select the desired song.

Playing and pausing songs

Press .

Fast-forwarding and reversing songs

Press and hold “^” or “v” on .

Shuffle playback

n Playing songs from one playlist or album in random order

Press  (RDM).

To cancel, press the button twice.

n Playing songs from all the playlists or albums in random order

Press  (RDM) twice.

To cancel, press the button again.

Repeat play

Press  (RPT).

To cancel, press the button again.

Even when the repeat play option has not been selected, playback will automatically continue from the first song in the current play list once the last song has ended.

Switching the display

Press .

Each time  is pressed, the display changes in the following order:

Track title → Track title/Artist name → Track title/Album name → Track title/Elapsed time

n About iPod

- l Apple is not responsible for the operation of this device or its compliance with safety and regulatory standards.
- l iPod is a trademark of Apple Inc., registered in the U.S. and other countries.

n iPod functions

- l When an iPod is connected and the audio source is changed to iPod mode, the iPod will resume play from the same point at which it was last used.
- l Depending on the iPod that is connected to the system, certain functions may not be available. Disconnecting the device and reconnecting it once again may resolve some malfunctions.

n iPod problems

To resolve most problems encountered when using your iPod, disconnect your iPod from the vehicle iPod connection and reset it. For instructions on how to reset your iPod, refer to your iPod Owner's Manual.

n Error messages

- “iPod ERROR”: This indicates a problem in the iPod, inside the USB box or the connection between them.
- “NO SONGS”: This indicates that there is no music data in the iPod.
- “UPDATE YOUR iPod”: This indicates that the version of the iPod is not compatible.

n Compatible models

Model	Generation	Software version
iPod	5th generation	Ver. 1.2.0 or higher
iPod nano	1st generation	Ver. 1.3.0 or higher
	2nd generation	Ver. 1.1.2 or higher
	3rd generation	Ver. 1.0.0 or higher
iPod touch	1st generation	Ver. 1.1.0 or higher
iPod classic	1st generation	Ver. 1.0.0 or higher

Depending on differences between models or software version etc., some models listed above might be incompatible with this system.

iPod 4th generation and earlier models are not compatible with this system.

iPhone, iPod mini, iPod shuffle and iPod photo are not compatible with this system.

Items related to standards and limitations are as follows:

- l Maximum number of lists in device: 9999
- l Maximum number of songs in device: 65025
- l Maximum number of songs per list: 65025

 **CAUTION**

n Caution while driving

Do not connect iPod or operate the controls.

 **NOTICE**

n To prevent damage to iPod

- l Do not leave iPod in the vehicle. The temperature inside the vehicle may become high, resulting in damage to the player.
- l Do not push down on or apply unnecessary pressure to the iPod while it is connected as this may damage the iPod or its terminal.
- l Do not insert foreign objects into the port as this may damage the iPod or its terminal.

3-2. Using the audio system Operating a USB memory

Connecting a USB memory enables you to enjoy music from the vehicle speakers.

n Connecting a USB memory

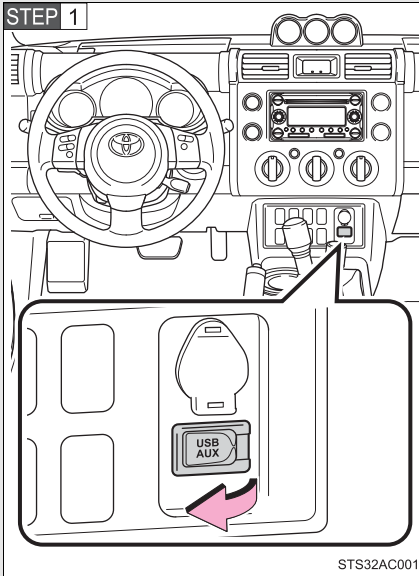

Open the cover and connect a USB memory.

Turn on the power of the USB memory if it is not turned on.

STEP 2 Press .

n Control panel

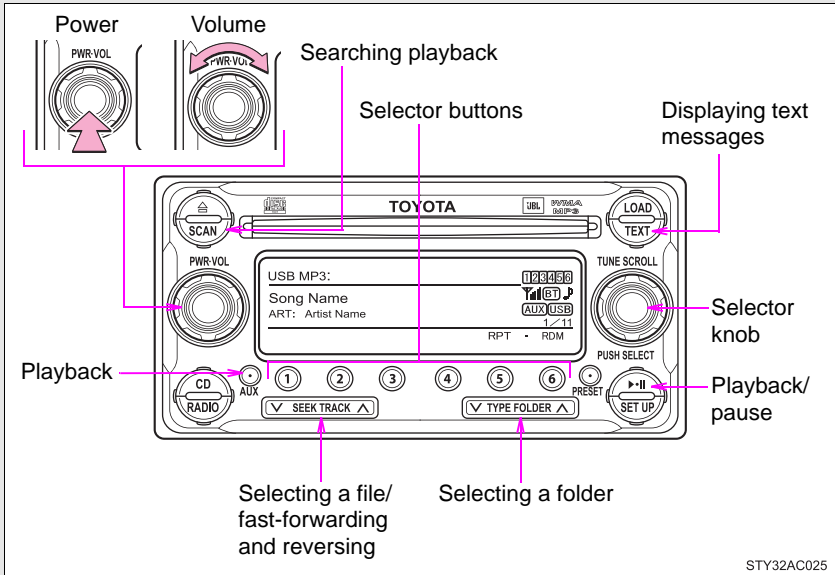

Selecting and scanning a folder

n Selecting a folder

Press “^” or “v” on  to select the desired folder.

n Returning to the first file of the first folder

Press and hold “v” on  until you hear a beep.

n Scanning the first file of all the folders



STEP 1 Press and hold  until you hear a beep.

The first ten seconds of the first file in each folder will be played.

STEP 2 When the desired folder is reached, press  again.

Selecting and scanning files

n Selecting a file

Turn  or press “^” or “v” on  to select the desired file.

n Scanning the files in a folder

Press .

The first ten seconds of each file will be played.

To cancel, press  again.

When the desired file is reached, press  again.

Playing and pausing files

Press .

Fast-forwarding and reversing files

Press and hold “^” or “v” on .

Random playback

n **Playing files from a folder in random order**

Press  (RDM).

To cancel, press the button twice.

n **Playing all the files from a USB memory in random order**

Press  (RDM) twice.

To cancel, press the button again.

Repeat play

n **Repeating a file**

Press  (RPT).

To cancel, press the button twice.

n **Repeating all the files in a folder**

Press  (RPT) twice.

To cancel, press the button again.

Switching the display

Press  .

Each time  is pressed, the display changes in the following order:

Track title → Track title/Artist name → Track title/Album name → Track title/Elapsed time

n USB memory functions

Depending on the USB memory that is connected to the system, certain functions may not be available. Disconnecting the device and reconnecting it once again may resolve some malfunctions.

n Error messages

“USB ERROR”: This indicates a problem in the USB memory, in the USB box or connection between them.

“NO SUPPORT”: This indicates that no MP3/WMA files are included in the USB memory.

n USB memory

l Compatible device

USB memory that can be used for MP3 and WMA playback.

Depending on the type of USB device, playback may not be possible.

l Compatible device formats

The following device formats can be used:

- USB communication formats: USB2.0 FS (12 mbps)
- File formats: FAT16/32 (Windows®)
- Correspondence class: Mass storage class

MP3 and WMA files written in any format other than those listed above may not play correctly, and their file names and folder names may not be displayed correctly.

Items related to standards and limitations are as follows:

- Maximum directory hierarchy: 8 levels
- Maximum number of folder in device: 999 (including the root)
- Maximum number of files in device: 65025
- Maximum number of files per folder: 255

I MP3 and WMA files

MP3 (MPEG Audio LAYER 3) is a standard audio compression format.

Files can be compressed to approximately 1/10 of their original size using MP3 compression.

WMA (Windows Media Audio) is a Microsoft® audio compression format.

This format compresses audio data to a size smaller than that of the MP3 format.

There is a limit to the MP3 and WMA file standards that can be used and to the media/formats on which the files are recorded.

I MP3 file compatibility

- Compatible standards
MP3 (MPEG1 AUDIO LAYERII, III, MPEG2 AUDIO LAYERII, III, MPEG2.5)
- Compatible sampling frequencies
MPEG1 AUDIO LAYERII, III: 32, 44.1, 48 (kHz)
MPEG2 AUDIO LAYERII, III: 16, 22.05, 24 (kHz)
MPEG2.5: 8, 11.025, 12 (kHz)
- Compatible bit rates (compatible with VBR)
MPEG1 AUDIO LAYERII, III: 32-320 (kbps)
MPEG2 AUDIO LAYERII, III: 32-160 (kbps)
MPEG2.5: 32-160 (kbps)
- Compatible channel modes: stereo, joint stereo, dual channel and monaural

I WMA file compatibility

- Compatible standards
WMA Ver. 9
- Compatible sampling frequencies
HIGH PROFILE 32, 44.1, 48 (kHz)
- Compatible bit rates
HIGH PROFILE 32-320 (kbps, VBR)

1 File names

The only files that can be recognized as MP3/WMA and played are those with the extension .mp3 or .wma.

1 ID3 and WMA tags

ID3 tags can be added to MP3 files, making it possible to record the track title, artist name, etc.

The system is compatible with ID3 Ver. 1.0, 1.1, and Ver. 2.2, 2.3, 2.4 ID3 tags. (The number of characters is based on ID3 Ver. 1.0 and 1.1.)

WMA tags can be added to WMA files, making it possible to record the track title and artist name in the same way as with ID3 tags.

1 MP3 and WMA playback

When a device containing MP3 or WMA files is plugged, all files in the USB memory device are first checked. Once the file check is finished, the first MP3 or WMA file is played. To make the file check finish more quickly, we recommend you do not write in any files other than MP3 or WMA files or create any unnecessary folders.

1 Extensions

If the file extensions .mp3 and .wma are used for files other than MP3 and WMA files, they will be mistakenly recognized and played as MP3 and WMA files. This may result in large amounts of interference and damage to the speakers.

1 Playback

- To play MP3 files with steady sound quality, we recommend a fixed bit rate of at least 128 kbps and a sampling frequency of 44.1 kHz.
- There is a wide variety of freeware and other encoding software for MP3 and WMA files on the market, and depending on the status of the encoding and the file format, poor sound quality or noise at the start of playback may result. In some cases, playback may not be possible at all.
- Microsoft, Windows, and Windows Media are the registered trademarks of Microsoft Corporation in the U.S.A. and other countries.

 CAUTION

n Caution while driving

Do not connect a USB memory or operate the controls.

 NOTICE

n To prevent damage to a USB memory

- l** Do not leave a USB memory in the vehicle. The temperature inside the vehicle may become high, resulting in damage to the player.
- l** Do not push down on or apply unnecessary pressure to the USB memory while it is connected as this may damage the USB memory or its terminal.
- l** Do not insert foreign objects into the port as this may damage the USB memory or its terminal.

3-2. Using the audio system

Optimal use of the audio system

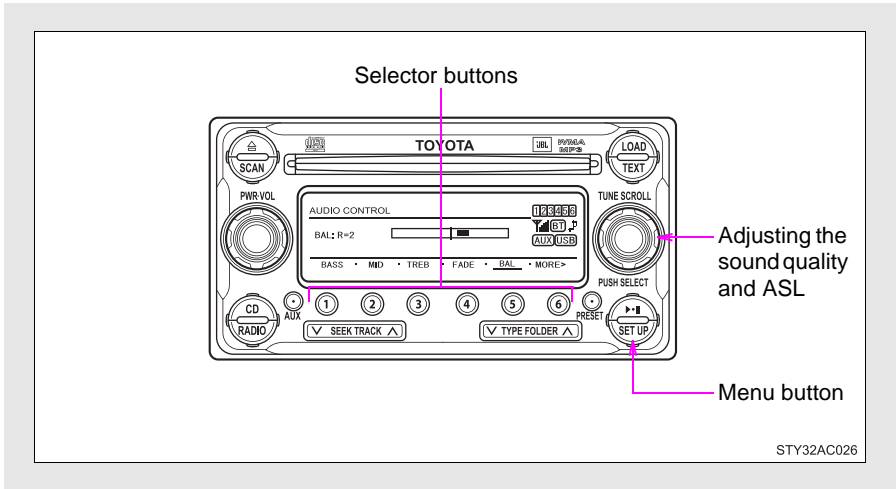

Using the audio control function

n Changing sound quality modes

STEP 1 Press .

STEP 2 Press , , ,  or  (type B only) as corresponds to the desired mode.

“BASS”, “MID” (type B only), “TREB”, “FADE”, or “BAL”

n Adjusting sound quality

Turning  adjusts the level.

Mode displayed	Sound quality mode	Level	Turn to the left	Turn to the right
BASS	Bass*	-5 to 5	Low	High
MID	Mid-range* (type B only)	-5 to 5		
TREB	Treble*	-5 to 5		
FADE	Front/rear volume balance	F7 to R7	Shifts to rear	Shifts to front
BAL	Left/right volume balance	L7 to R7	Shifts to left	Shifts to right



*:The sound quality level is adjusted individually in each audio mode.

n Adjusting the Automatic Sound Levelizer (ASL)

STEP 1 Press .

STEP 2 Press  (MORE).

STEP 3 Press  (ASL).

STEP 4 Press  (type A only) or  (type B only) as corresponds to the desired mode.

Type A: “LOW”, “MID”, “HIGH”, or “OFF”

Type B: “ON” or “OFF”

ASL automatically adjusts the volume and tone quality according to vehicle speed.







n Setting the number of preset pages

The number of preset pages desired can be set from 1 to 6. The initial setting is 6 pages.

STEP 1 Press .

STEP 2 Press  (MORE).

STEP 3 Press  (PRESET).

STEP 4 Press , , , ,  or  as corresponds to the desired number of preset pages.

n Language settings

→P. 215

n Trademark owned by SRS Labs, Inc. (type A only)



The audio systems utilize SRS FOCUS™ and SRS TruBass® audio enhancement technologies, under license from SRS Labs, Inc., in all modes except AM radio mode.

FOCUS, TruBass, SRS and  symbols are trademarks of SRS Labs, Inc.

FOCUS and TruBass technologies are incorporated under license from SRS Labs, Inc.

n Trademark owned by New Transducers Limited (type A only)



This vehicle incorporates NXT flat panel speaker technology by New Transducers Limited, UK.  is a registered trademarks of New Transducers Limited.

3-2. Using the audio system

Using the AUX port

This port can be used to connect a portable audio device and listen to it through the vehicle's speakers.

STEP 1 Open the cover and connect the portable audio device.

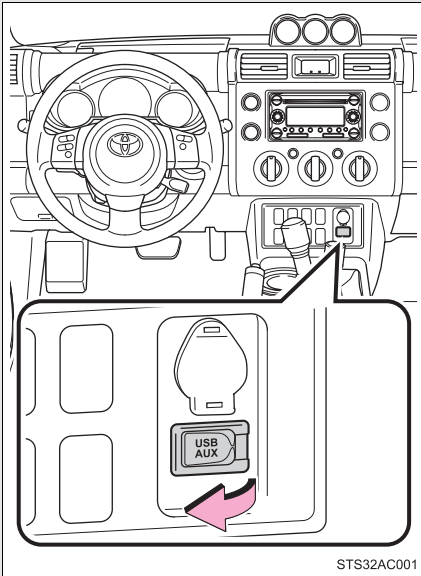

STEP 2 Press .

n Operating portable audio devices connected to the audio system

The volume can be adjusted using the vehicle's audio controls. All other adjustments must be made on the portable audio device itself.

n When using a portable audio device connected to the power outlet

Noise may occur during playback. Use the power source of the portable audio device.

Using the steering wheel audio switches

Some audio features can be controlled using the switches on the steering wheel.

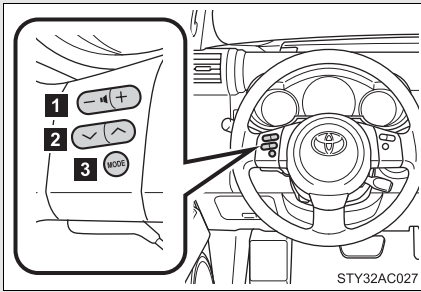

1 Increases/decreases volume

2 Radio mode: Selects radio station

CD mode: Selects tracks, files (MP3 and WMA) and discs (type B only)

iPod mode: Selects a song

USB memory mode: Selects a file and folder

Bluetooth[®] audio mode: Selects a track and album

3 Turns the power on, selects an audio source

Turning the power on

Press  when the audio system is turned off.

The audio system can be turned off by holding the switch down until you hear a beep.

Changing the audio source

Press  when the audio system is turned on. The audio source changes as follows each time the switch is pressed.

If no discs are inserted in the player, that mode will be skipped.

Type A:

FM→XM→CD→Bluetooth® audio→AUX→USB/iPod→AM

Type B:

FM→XM→CD changer→Bluetooth® audio→AUX→USB/iPod→AM

Adjusting the volume

Press “+” on  to increase the volume and “-” to decrease the volume.

Press and hold the switch to continue increasing or decreasing the volume.



Selecting a radio station

STEP 1 Press  to select the radio mode.



STEP 2 Press “√” or “^” on  to select a radio station.

To scan for receivable stations, press and hold “√” or “^” on  until you hear a beep.



Selecting a track/file or song

- STEP 1** Press  to select the CD, iPod, USB memory, Bluetooth® audio mode.
- STEP 2** Press “√” or “^” on  to select the desired track/file or song.

Selecting a folder or album

- STEP 1** Press  to select the CD, USB memory or Bluetooth® audio mode.
- STEP 2** Press and hold “√” or “^” on  until you hear a beep.

Selecting a disc in the CD player (type B only)

- STEP 1** Press  to select the CD mode.
- STEP 2** Press and hold “√” or “^” on  until you hear a beep.

CAUTION

n To reduce the risk of an accident

Exercise care when operating the audio switches on the steering wheel.

3-3. Using the Bluetooth® audio system

Bluetooth® audio system

The Bluetooth® audio system enables you to enjoy music played on a portable digital audio player (portable player) from the vehicle speakers via wireless communication.

This audio system supports Bluetooth®, a wireless data system capable of playing portable audio music without cables. If your portable player does not support Bluetooth®, the Bluetooth® audio system will not function.

Title	Page
Using the Bluetooth® audio system	P. 265
Operating a Bluetooth® enabled portable player	P. 270
Setting up a Bluetooth® enabled portable player	P. 272
Bluetooth® audio system setup	P. 277

n **Conditions under which the system will not operate**

- l If using a portable player that does not support Bluetooth®
- l If the portable player is switched off
- l If the portable player is not connected
- l If the portable player's battery is low
- l If the portable player is behind the seat or in the glove box or console box
- l If metal is covering or touching the portable player

n **When transferring ownership of the vehicle**

Be sure to initialize the system to prevent personal data from being improperly accessed. (→P. 305)

n About Bluetooth®



Bluetooth is a registered trademark of Bluetooth SIG, Inc.

n Compatible models

l Bluetooth® specifications:
Ver. 1.2

l Following Profiles:

- A2DP (Advanced Audio Distribution Profile) Ver. 1.0
- AVRCP (Audio/Video Remote Control Profile) Ver. 1.0 or higher (Ver. 1.3 or higher recommended)

Portable players must correspond to the above specifications in order to be connected to the Bluetooth® audio system. However, please note that some functions may be limited depending on the type of portable player.

n Certification for the Bluetooth® audio system

► For vehicles sold in U.S.A.

- Vehicles with CD changer
FCC ID: BABFT0001A
MADE IN JAPAN
- Vehicles without CD changer
FCC ID: AJDK025
MADE IN JAPAN

This device complies with part 15 of the FCC Rules. Operation is subject to the following two conditions: (1) This device may not cause harmful interference, and (2) this device must accept any interference received, including interference that may cause undesired operation.

► For vehicles sold in Canada

- Vehicles with CD changer

IC ID: 2024B-FT0001A

MADE IN JAPAN

- Vehicles without CD changer

IC ID: 775E-K025

MADE IN JAPAN

Operation is subject to the following two conditions: (1) this device may not cause interference, and (2) this device must accept any interference, including interference that may cause undesired operation of the device.

 CAUTION

n FCC WARNING

Changes or modifications not expressly approved by the party responsible for compliance could void the user's authority to operate the equipment.

Radio Frequency Radiation Exposure. This equipment complies with FCC/IC radiation exposure limits set forth for uncontrolled equipment and meets the FCC radio frequency (RF) Exposure Guidelines in Supplement C to OET65 and RSS-102 of the IC radio frequency (RF) Exposure rules. This equipment has very low levels of RF energy that it deemed to comply without maximum permissive exposure evaluation (MPE). But it is desirable that it should be installed and operated with at least 7.9 in. (20 cm) and more between the radiator and person's body (excluding extremities: hands, wrists, feet and ankles).

This transmitter must not be co-located or operated in conjunction with any other antenna or transmitter.

n Caution while driving

Do not connect portable players or operate the controls.

 NOTICE

n To prevent damage to portable players

Do not leave portable players in the vehicle. The temperature inside the vehicle may become high, resulting in damage to the player.

3-3. Using the Bluetooth® audio system

Using the Bluetooth® audio system

n Audio unit

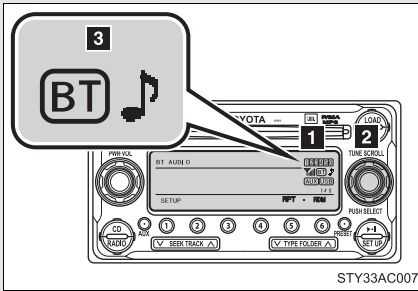

1 Display

Track title, Artist name, Album name, Elapsed time, “Streaming Audio”, etc. is displayed.

2 Selects items such as menu and number

Turn: Selects an item

Press: Inputs the selected item

3 Bluetooth-Audio connection condition

If “BT” is not displayed, the Bluetooth® audio system cannot be used.

n Microphone

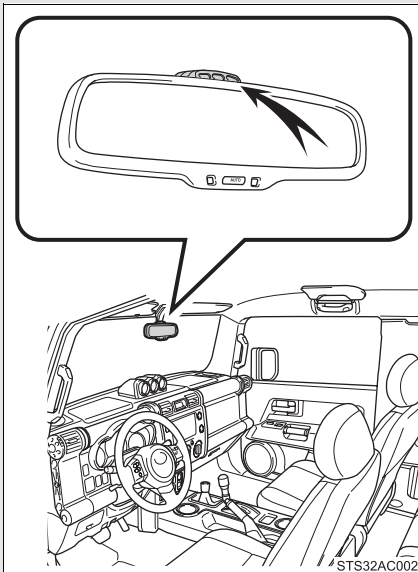

Operating the system using voice commands

By following voice guidance instructions output from the speaker, voice commands enable to the operation of the Bluetooth® audio system without the need to check the display or operate



n Operation procedure when using voice commands

Press the talk switch and follow the voice guidance instructions.

n Auxiliary commands when using voice commands

The following auxiliary commands can be used when operating the system using a voice command:

“Cancel”: Exits the Bluetooth® audio system

“Repeat”: Repeats the previous voice guidance instruction

“Go back”: Returns to the previous procedure

“Help”: Reads aloud the function summary if a help comment is registered for the selected function

Using the Bluetooth® audio system for the first time

Before using the Bluetooth® audio system, it is necessary to register a Bluetooth® enabled portable player in the system. Follow the procedure below to register (pair) a portable player:

STEP 1 Press  until “BT AUDIO” is displayed.

STEP 2 Press  (SETUP).

The introductory guidance and portable player name registration instructions are heard.

STEP 3 Select “Pair Audio Players (Pair Audio Player)” using a voice

command or

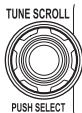

STEP 4 Register a portable player name by either of the following methods:

a. Select “Record Name” using  , and say the name to be registered.

b. Press the talk switch and say the name to be registered.

A voice guidance instruction to confirm the input is heard.

STEP 5 Select “Confirm” using a voice command or  .

A passkey is displayed and heard, and a voice guidance instruction for inputting the passkey into the portable player is heard.

STEP 6 Input the passkey into the portable player.

Refer to the manual that comes with the portable player for the operation of the portable player.

Guidance for registration completion is heard.

If the portable player has a Bluetooth® phone, the phone can be registered at the same time. (→P. 285)

Menu list of the Bluetooth® audio system

First menu	Second menu	Third menu	Operation detail
Setup	BT Audio Setup (BT audio setup)	Pair Audio Players (Pair audio player)	Registering a portable player
		Select Audio Player	Selecting a portable player to be used
		Change Name	Changing the registered name of a portable player
		List Audio Players	Listing the registered portable players
		Set Passkey	Changing the passkey
		Delete Audio Player	Deleting a registered portable player
	System Setup	Guidance Volume	Setting voice guidance volume
		Device Name	Displaying the Bluetooth® device address and name
		Reset Settings	Initializing the system

“BT Audio Setup” can be canceled by pressing the on-hook switch or saying the voice command, “Cancel”.

n When using a voice command

For numbers, say a combination of single digits from zero to nine.

Say the command correctly and clearly.

n Situations that the system may not recognize your voice

l When driving on rough roads

l When driving at high speeds

l When air is blowing out of the vents onto the microphone

l When the air conditioning fan emits a loud noise

n Operations that cannot be performed while driving

l Operating the system with



l Registering a portable player to the system

n Changing the passkey

→P. 275

3-3. Using the Bluetooth® audio system Operating a Bluetooth® enabled portable player

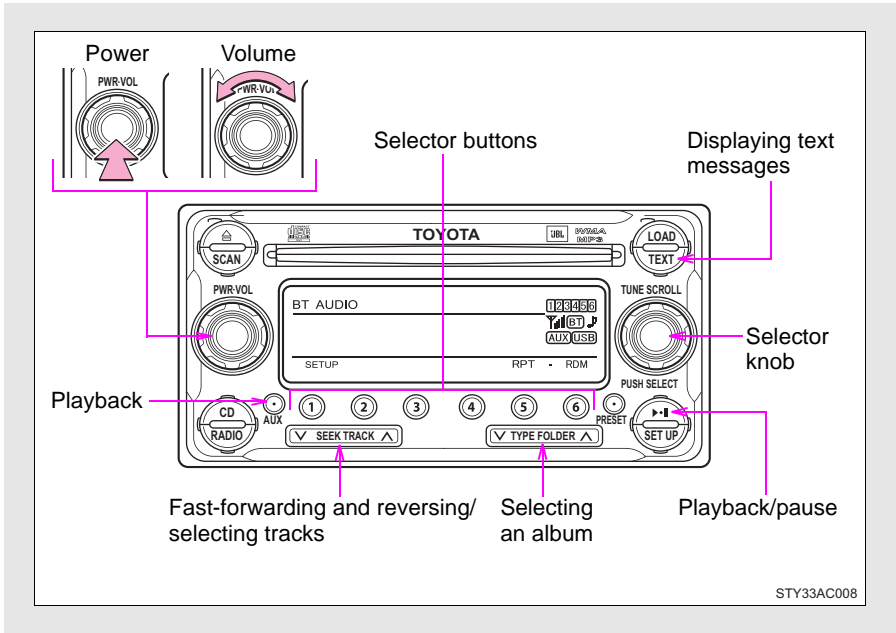

Selecting an album

Press "v" or "^" on .

Selecting tracks

Press "^" or "v" on .

Playing and pausing tracks

Press .

Fast-forwarding and reversing tracks

Press and hold “^” or “v” on .

Switching the display

Press .

Each time  is pressed, the display changes in the following order:

Track title → Track title/Artist name → Track title/Album name → Track title/Elapsed time

Using the steering wheel audio switches

→P. 259

n Bluetooth® audio system functions

Depending on the portable player that is connected to the system, certain functions may not be available.

Registering a portable player in the Bluetooth® audio system allows the system to function. The following functions can be used for registered portable players:

n Functions and operation procedures

STEP 1 Press  until “BT AUDIO” is displayed.

STEP 2 Press  (SETUP).

STEP 3 Select one of the following functions using a voice com-

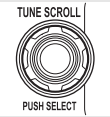
mand or .

- 1 Registering a portable player
“Pair Audio Players (Pair audio player)”
- 1 Selecting a portable player to be used
“Select Audio Player”
- 1 Changing the registered name of a portable player
“Change Name”
- 1 Listing the registered portable players
“List Audio Players”
- 1 Changing the passkey
“Set Passkey”
- 1 Deleting a registered portable player
“Delete Audio Player”

Registering a portable player

Select “Pair Audio Players (Pair audio player)” using a voice com-

mand or , and perform the procedure for registering a portable player. (→P. 266)

Selecting a portable player to be used

STEP 1 Select “Select Audio Player” using a voice command or

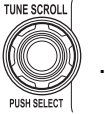

STEP 2 Select the portable player to be used by either of the following methods, and select “Confirm” using a voice command or

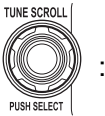

- a. Press the talk switch and say the name of the desired portable player.
- b. Press the talk switch and say “List Audio Players”. When the name of the desired portable player is read aloud, press the talk switch.

STEP 3 Press the talk switch and say “From Car” or “From Audio”, and

select “Confirm” using a voice command or

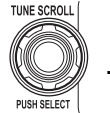

If “From Car” is selected, the portable player will be automatically connected whenever the engine switch is in either the ACC or ON position.

Changing the registered name of a portable player

STEP 1 Select “Change Name” using a voice command or



STEP 2 Select the name of the portable player to be changed by either of the following methods, and select “Confirm” using a

voice command or

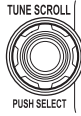

- a. Press the talk switch and say the name of desired portable player.
- b. Press the talk switch and say “List Audio Players”. When the name of the desired portable player is read aloud, press the talk switch.

STEP 3 Press the talk switch or select “Record Name” using



, and say the new name.

STEP 4 Select “Confirm” using a voice command or



Listing the registered portable players

Select “List Audio Players” using a voice command or

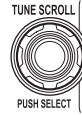

The list of registered portable players will be read aloud.

When listing is complete, the system returns to “BT Audio Setup”.

Pressing the talk switch while the name of a portable player is being read aloud selects the portable player, and the following functions will become available:

- 1 Selecting a portable player: “Select Audio Player”
- 1 Changing a registered name: “Change Name”
- 1 Deleting a portable player: “Delete Audio Player”

Changing the passkey

STEP 1 Select “Set Passkey” using a voice command or

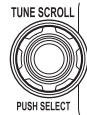

STEP 2 Press the talk switch, say a 4 to 8-digit number, and select

“Confirm” using a voice command or



STEP 3 When the entire number to be registered as a passkey has

been input, press



again.

Deleting a registered portable player

STEP 1 Select “Delete Audio Player” using a voice command or



STEP 2 Select the portable player to be deleted by either of the following methods and select “Confirm” using a voice command or



- a. Press the talk switch and say the name of the desired portable player.
- b. Press the talk switch and say “List Audio Players”. When the name of the desired portable player is read aloud, press the talk switch.

If the portable player to be deleted is paired as a Bluetooth® phone, the registration of the cellular phone can be deleted at the same time. A voice guidance instruction to delete a cellular phone is heard.

STEP 3 Select “Confirm” using a voice command or



n The number of portable players that can be registered

Up to 2 portable players can be registered in the system.

3-3. Using the Bluetooth® audio system

Bluetooth® audio system setup

n System setup items and operation procedures

→P. 302

3-4. Using the hands-free phone system (for cellular phone)

Hands-free phone system features

This system supports Bluetooth[®], which allows you to make or receive calls without using cables to connect a cellular phone and the system, and without operating the cellular phone.

n Hands-free system quick guide

STEP 1 Setting a cellular phone. (→P. 282)

STEP 2 Adding an entry to the phonebook (Up to 20 names can be stored). (→P. 307)

STEP 3 Dialing by inputting a name. (→P. 292)

Title	Page
Using the hands-free phone system n Operating the system using a voice command n Using the hands-free phone system for the first time n Menu list of the hands-free phone system	P. 282
Making a phone call n Dialing by inputting a number n Dialing by inputting a name n Speed dialing n When receiving a phone call n Transferring a call n Using the call history memory	P. 291
Setting a cellular phone n Registering a cellular phone n Selecting the cellular phone to be used n Changing a registered name n Listing the registered cellular phones n Deleting a cellular phone n Changing the passkey n Turning the hands-free phone automatic connection on/off	P. 296

Title	Page
Security and system setup <ul style="list-style-type: none"> n Setting or changing the PIN n Locking or unlocking the phone book n Setting voice guidance volume n Initialization 	P. 302
Using the phone book <ul style="list-style-type: none"> n Adding a new phone number n Setting speed dials n Changing a registered name n Deleting registered data n Deleting speed dials n Listing the registered data 	P. 307

n **Conditions under which the system will not operate**

- l If using a cellular phone that does not support Bluetooth®
- l If the cellular phone is switched off
- l If you are outside service range
- l If the cellular phone is not connected
- l If the cellular phone's battery is low
- l If the cellular phone is behind the seat or in the glove box or console box
- l If metal is covering or touching the cellular phone

n **When transferring ownership of the vehicle**

Be sure to initialize the system to prevent personal data from being improperly accessed.

n **Required profiles for the cellular phone**

- l HFP (Hands Free Profile) Ver. 1.0
- l OPP (Object Push Profile) Ver. 1.1

■ About Bluetooth®



Bluetooth is a registered trademark of Bluetooth SIG, Inc.

■ Certification for the hands-free phone system

▶ For vehicles sold in U.S.A.

- Vehicles with CD changer
FCC ID: BABFT0001A
MADE IN JAPAN
- Vehicles without CD changer
FCC ID: AJDK025
MADE IN JAPAN

This device complies with part 15 of the FCC Rules. Operation is subject to the following two conditions: (1) This device may not cause harmful interference, and (2) this device must accept any interference received, including interference that may cause undesired operation.

▶ For vehicles sold in Canada

- Vehicles with CD changer
IC ID: 2024B-FT0001A
MADE IN JAPAN
- Vehicles without CD changer
IC ID: 775E-K025
MADE IN JAPAN

Operation is subject to the following two conditions: (1) this device may not cause interference, and (2) this device must accept any interference, including interference that may cause undesired operation of the device.

 **CAUTION**

n FCC WARNING

Changes or modifications not expressly approved by the party responsible for compliance could void the user's authority to operate the equipment.

Radio Frequency Radiation Exposure. This equipment complies with FCC/IC radiation exposure limits set forth for uncontrolled equipment and meets the FCC radio frequency (RF) Exposure Guidelines in Supplement C to OET65 and RSS-102 of the IC radio frequency (RF) Exposure rules. This equipment has very low levels of RF energy that it deemed to comply without maximum permissive exposure evaluation (MPE). But it is desirable that it should be installed and operated with at least 7.9 in. (20 cm) and more between the radiator and person's body (excluding extremities: hands, wrists, feet and ankles).

This transmitter must not be co-located or operated in conjunction with any other antenna or transmitter.

n Caution while driving

Do not use a cellular phone, or connect the Bluetooth® phone.

 **NOTICE**

n To prevent damage to a cellular phone

Do not leave a cellular phone in the vehicle. The temperature inside may become high resulting in damage to the phone.

3-4. Using the hands-free phone system (for cellular phone) Using the hands-free phone system

n Audio unit

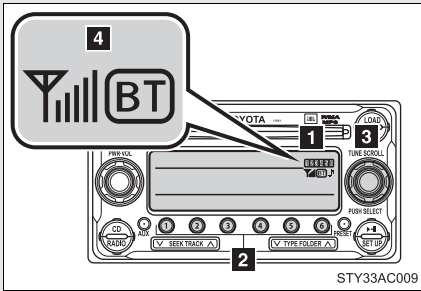

1 Display

A message, name, phone number, etc. is displayed.

Lower-case characters and special characters, such as an umlaut, cannot be displayed.

2 Selects speed dials

3 Selects items such as menu or number

Turn: Selects an item

Press: Inputs the selected item

4 Bluetooth® connection condition and reception level

If "BT" is not displayed, the hands-free phone system cannot be used.

n Steering wheel switches

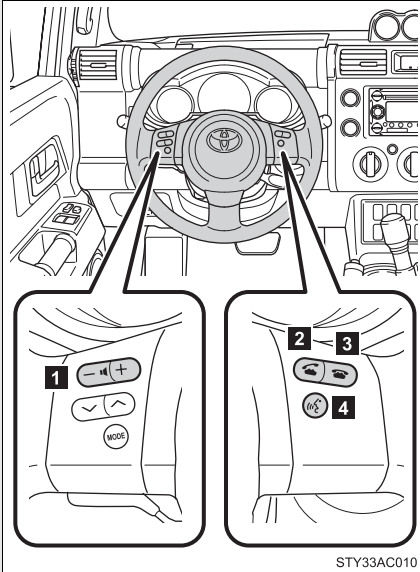

1 Volume

The voice guidance volume cannot be adjusted using this button.

2 Off-hook switch

Turns the hands-free system on/starts a call

3 On-hook switch

Turns the hands-free system off/ends a call/refuses a call

4 Talk switch

Turns the voice command system on (press)/turns the voice command system off (press and hold)

3-4. Using the hands-free phone system (for cellular phone)

n Microphone

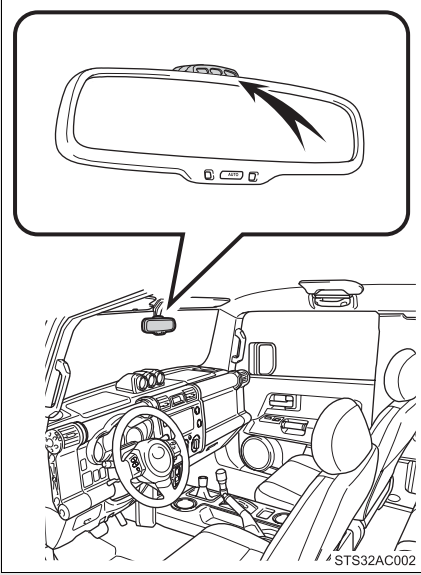

Operating the system by using a voice command

By following the voice guidance instructions output from the speaker, voice commands enable the operation of the hands-free phone system without the need to check the display or operate



n Operation procedure when using a voice command

Press the talk switch and follow the voice guidance instructions.

n Auxiliary commands when using a voice command

The following auxiliary commands can be used when operating the system using a voice command:

“Cancel”: Exits the hands-free phone system

“Repeat”: Repeats the previous voice guidance instruction

“Go back”: Returns to the previous procedure

“Help”: Reads aloud the function summary if a help comment is registered for the selected function

Using the hands-free phone system for the first time

Before using the hands-free phone system, it is necessary to register a cellular phone in the system. The phone registration mode will be entered automatically when starting the system with no cellular phone registered. Follow the procedure below to register a cellular phone:

STEP 1 Press the off-hook switch or the talk switch.

The introductory guidance and phone name registration instructions are heard.

STEP 2 Select “Pair Phone” using a voice command or



STEP 3 Register a phone name either of the following methods.

a. Select “Record Name” using  , and say a name to be registered.

b. Press the talk switch and say a name to be registered.

A voice guidance instruction to confirm the input is heard.

STEP 4 Select “Confirm” using a voice command or

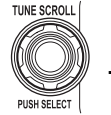

► Registration to the hands-free phone system only

STEP 5 Select “Phone Only” using a voice command or

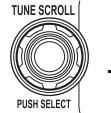

► Registration to the hands-free phone system and Bluetooth® audio system at the same time

STEP 5 Select “Int. Audio (Internal Audio)” using a voice command or

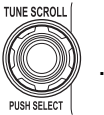

STEP 6 Select “Confirm” using a voice command or

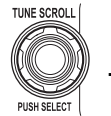

A passkey is displayed and heard, and a voice guidance instruction for inputting the passkey into the cellular phone is heard.

STEP 7 Input the passkey into the cellular phone.

Refer to the manual that comes with the cellular phone for the operation of the phone.

Guidance for registration completion is heard.

Menu list of the hands-free phone system

n Normal operation

First menu	Second menu	Third menu	Operation detail
CallBack (Callback)	-	-	Dialing a number stored in the incoming call history memory
Redial	-	-	Dialing a number stored in the outgoing call history memory
Dial by Number	-	-	Dialing by inputting a number
Dial by Name (Dial by name)	-	-	Dialing by inputting a name registered in the phone book
Phonebook	Add Entry	-	Adding a new number
	Change Name	-	Changing a name in the phone book
	Delete Entry	-	Deleting the phone book data
	Delete Speed Dial	-	Deleting a registered speed dial
	List Names	-	Listing the phone book data
	Speed Dial (Set speed dial)	-	Registering a speed dial

3-4. Using the hands-free phone system (for cellular phone)

First menu	Second menu	Third menu	Operation detail
Setup	Security	Set PIN	Setting a PIN code
		Phonebook Lock (Phone book lock)	Locking the phone book
		Phonebook Unlock (Phone book unlock)	Unlocking the phone book
	Phone Setup	Pair Phone	Registering the cellular phone to be used
		Change Phone Name (Change name)	Changing a registered name of a cellular phone
		Delete Phone	Deleting a registered cellular phone
		List phones	Listing the registered cellular phones
		Select Phone	Selecting a cellular phone to be used
		Set Passkey	Changing the passkey
		Handsfree Power	Setting the hands-free power on/off
	System Setup	Guidance Volume	Setting voice guidance volume
		Device Name	Displaying a device information
		Reset Settings	Initialization

n Using a short cut key

First menu	Second menu	Operation detail
Dial XXX (name)	-	Dialing a number registered in the phone book
Dial XXX (number)	-	Dialing the input numbers
Phone book add entry	-	Adding a new number
Phone book change name	-	Changing the name of a phone number in the phone book
Phone book delete entry	-	Deleting phone book data
Phone book set speed dial	-	Registering a speed dial
Phone book delete speed dial	-	Deleting a speed dial
Phone book List names	-	Listing the phone book data

n Automatic volume adjustment

When vehicle speed is 50 mph (80 km/h) or more, the volume automatically increases. The volume returns to the previous volume setting when vehicle speed drops to 43 mph (70 km/h) or less.

n When using a voice command

For numbers, say a combination of single digits from zero to nine, # (pound), * (star), and + (plus).

Say a command correctly and clearly.

n Situations that the system may not recognize your voice

- | When driving on a rough road
- | When driving at high speeds
- | When air is blowing out of the vents onto the microphone
- | When the air conditioning fan emits a loud noise

n Operations that cannot be performed while driving

- | Operating the system with 
- | Registering a cellular phone to the system

n Changing the passkey

→P. 300

Making a phone call

n Making a phone call

- 1 Dialing by inputting a number
“Dial by Number”
- 1 Dialing by inputting a name
“Dial by Name (Dial by name)”
- 1 Speed dialing
- 1 Dialing a number stored in the outgoing history memory
“Redial”
- 1 Dialing a number stored in the incoming history memory
“CallBack (Callback)”

n Receiving a phone call

- 1 Answering the phone call
- 1 Refusing the phone call

n Transferring a phone call

n Using the call history memory

- 1 Dialing
- 1 Storing data in the phone book
- 1 Deleting

Dialing by inputting a number

- STEP 1** Press the talk switch and say “Dial by Number”.
- STEP 2** Press the talk switch and say the phone number.
- STEP 3** Dial by one of the following methods:
 - a. Press the off-hook switch.
 - b. Press the talk switch and say “Dial”.

- c. Select “Dial” using



Dialing by inputting a name

- STEP 1** Press the talk switch and say “Dial by Name”.
- STEP 2** Select a registered name to be input by either of the following methods:
 - a. Press the talk switch and say a registered name.
 - b. Press the talk switch and say “List names”. Press the talk switch while the desired name is being read aloud.
- STEP 3** Dial by one of the following methods:
 - a. Press the off-hook switch.
 - b. Press the talk switch and say “Dial”.

- c. Select “Dial” using



Speed dialing

- STEP 1** Press the off-hook switch.
- STEP 2** Press the preset button in which the desired number is registered.
- STEP 3** Press the off-hook switch.

When receiving a phone call

n Answering a phone call

Press the off-hook switch.

n Refusing a phone call

Press the on-hook switch.

Transferring a call

A call can be transferred between the cellular phone and system while dialing, receiving a call, or during a call. Use one of the following methods:

a. Operate the cellular phone.

Refer to the manual that comes with the cellular phone for the operation of the phone.

b. Press the off-hook switch^{*1}.

c. Press the talk switch and say "Call Transfer"^{*2}.

^{*1}: This operation can be performed only when transferring a call from the cellular phone to the system during a call.

^{*2}: While the vehicle is in motion, a call cannot be transferred from the system to the cellular phone. Also, this operation is invalid while dialing or receiving a call.

Using the call history memory

Follow the procedure below to use a number stored in the call history memory:

STEP 1 Press the talk switch and say “Redial” (when using a number stored in the outgoing call history memory) or “CallBack” (when using a number stored in the incoming call history memory).

STEP 2 Select the number by either of the following methods:

- Say “Previous” or “Go back” until the desired number is displayed.

b. Select the desired number using

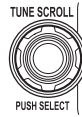

The following operations can be performed:

Dialing: Press the off-hook switch or select “Dial” using a voice

command or



Storing the number in the phone book: Select “Store” using a voice

command or



Deleting: Select “Delete” using a voice command or

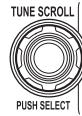

n Call history

Up to 5 numbers can be stored in each of the outgoing and incoming call history memories.

n When talking on the phone

- | Do not talk at the same time as the other party.
- | Keep the volume of the received voice down. Otherwise, voice echo will increase.

3-4. Using the hands-free phone system (for cellular phone) Setting a cellular phone

Registering a cellular phone in the hands-free phone system allows the system to function. The following functions can be used for registered cellular phones:

n Functions and operation procedures

To enter the menu for each function, follow the steps below using a

voice command or

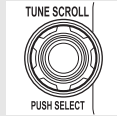

- 1 Registering a cellular phone
 1. "Setup" → 2. "Phone Setup" → 3. "Pair Phone"
- 1 Selecting the cellular phone to be used
 1. "Setup" → 2. "Phone Setup" → 3. "Select Phone"
- 1 Changing a registered name
 1. "Setup" → 2. "Phone Setup" → 3. "Change Phone Name (Change name)"
- 1 Listing the registered cellular phones
 1. "Setup" → 2. "Phone Setup" → 3. "List Phones"
- 1 Deleting a cellular phone
 1. "Setup" → 2. "Phone Setup" → 3. "Delete Phone"
- 1 Changing the passkey
 1. "Setup" → 2. "Phone Setup" → 3. "Set Passkey"
- 1 Turning the hands-free phone automatic connection on/off
 1. "Setup" → 2. "Phone Setup" → 3. "Handsfree Power"

Registering a cellular phone

Select “Pair Phone” using a voice command or  , and perform the procedure for registering a cellular phone. (→P. 285)

Selecting the cellular phone to be used

STEP 1 Select “Select Phone” using a voice command or



► Pattern A

STEP 2 Select the cellular phone to be used by either of the following methods, and select “Confirm” using a voice command or

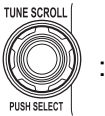

- a. Press the talk switch and say the desired phone name.
- b. Press the talk switch and say “List phones”. While the name of the desired cellular phone is being read aloud, press the talk switch.

► Pattern B

STEP 2 Select the cellular phone to be used using



Changing a registered name

STEP 1 Select “Change Phone Name (Change name)” using a voice

command or



.

STEP 2 Select the name of the cellular phone to be changed by either of the following methods:

a. Press the talk switch and say the desired phone name, and

select “Confirm” using a voice command or



.

b. Press the talk switch and say “List phones”. While the desired phone name is being read aloud, press the talk switch.

c. Select the desired phone name using



.

STEP 3 Press the talk switch or select “Record Name” using



, and say a new name.

STEP 4 Select “Confirm” using a voice command or



.

Listing the registered cellular phones

Selecting “List Phones” using a voice command or  causes the list of registered cellular phones to be read aloud. When listing is complete, the system returns to “Phone Setup”.

Pressing the talk switch while the name of a cellular phone is being read selects the cellular phone, and the following functions will be available:

- Selecting a cellular phone: “Select Phone”
- Changing a registered name: “Change Name”
- Deleting a cellular phone: “Delete Phone”

Deleting a cellular phone

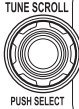
STEP 1 Select “Delete Phone” using a voice command or .

STEP 2 Select the cellular phone to be deleted by either of the following methods and select “Confirm” using a voice command or

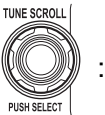

- Press the talk switch and say the name of the desired cellular phone.
- Press the talk switch and say “List phones”. While the name of the desired cellular phone is being read aloud, press the talk switch.

Changing the passkey

STEP 1 Select “Set Passkey” using a voice command or

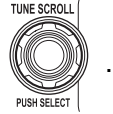

STEP 2 Press the talk switch, say a 4 to 8-digit number, and select

“Confirm” using a voice command or

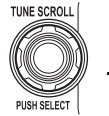

The number should be input 1 digit at a time.

STEP 3 When the entire number to be registered as a passkey has

been input, press



again.

Turning the hands-free phone automatic connection on/off

n Turning off the automatic connection

STEP 1 Select “Handsfree Power” using a voice command or

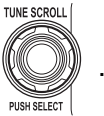

STEP 2 Select “Turn off” using a voice command or

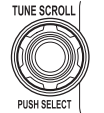

n Turning on the automatic connection

STEP 1 Select “Handsfree Power” using a voice command or

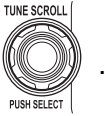

STEP 2 Select “Turn on” using a voice command or

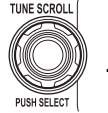

n The number of cellular phones that can be registered

Up to 6 cellular phones can be registered in the system.

3-4. Using the hands-free phone system (for cellular phone) Security and system setup

To enter the menu of each setting, follow the steps below:

n Security setting items and operation procedure

- 1 Setting or changing the PIN (Personal Identification Number)
 - 1. "Setup" → 2. "Security" → 3. "Set PIN"
- 1 Locking the phone book
 - 1. "Setup" → 2. "Security" → 3. "Phonebook Lock"
- 1 Unlocking the phone book
 - 1. "Setup" → 2. "Security" → 3. "Phonebook Unlock"

n System setup items and operation procedure

- 1 Setting voice guidance volume
 - 1. "Setup" → 2. "System Setup" → 3. "Guidance Volume"
- 1 Displaying the Bluetooth® device address and name
 - 1. "Setup" → 2. "System Setup" → 3. "Device Name"
- 1 Initialization
 - 1. "Setup" → 2. "System Setup" → 3. "Reset Settings"

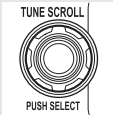

can only be used for system setup operation.

Setting or changing the PIN

n Setting a PIN

STEP 1 Select “Set PIN” using a voice command or



STEP 2 Enter a PIN using a voice command or



When using



, input the code 1 digit at a time.

n Changing the PIN

STEP 1 Select “Set PIN” using a voice command or



STEP 2 Enter the registered PIN using a voice command or



STEP 3 Enter a new PIN using a voice command or



When using



, input the code 1 digit at a time.

Locking or unlocking the phone book

STEP 1 Select “Phonebook Lock (Phone book lock)” or “Phonebook Unlock (Phone book unlock)” using a voice command or



STEP 2 Input the PIN by either of the following methods and select

“Confirm” using a voice command or  :

a. Press the talk switch and say the registered PIN.

b. Input a new PIN using



Setting voice guidance volume

STEP 1 Select “Guidance Volume” using

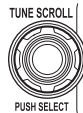

STEP 2 Change the voice guidance volume.

To decrease the volume: Turn



counterclockwise.

To increase the volume: Turn

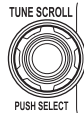

clockwise.

Displaying the Bluetooth® device address and name

STEP 1 Select “Device Name” using  .

STEP 2 Turn  to display the Bluetooth® device address and name.

STEP 3 Select “Go Back” using  to return to “System Setup”.

Initialization

STEP 1 Select “Reset Settings” and then “Confirm” using  .

STEP 2 Select “Confirm” using  .

n Initialization

l The following data in the system can be initialized:

- Phone book
- Outgoing and incoming call history
- Speed dials
- Registered cellular phone data
- Security code

l Once the initialization has been completed, the data cannot be restored to its original state.

n When the phone book is locked

The following functions cannot be used:

- l Dialing by inputting a name
- l Speed dialing
- l Dialing a number stored in the call history memory
- l Using the phone book

3-4. Using the hands-free phone system (for cellular phone) Using the phone book

To enter the menu of each setting, follow the steps below:

- 1 Adding a new phone number
 - 1. "Phonebook" → 2. "Add Entry"
- 1 Setting speed dial
 - 1. "Phonebook" → 2. "Speed Dial (Set speed dial)"
- 1 Changing a registered name
 - 1. "Phonebook" → 2. "Change Name"
- 1 Deleting registered data
 - 1. "Phonebook" → 2. "Delete Entry"
- 1 Deleting speed dial
 - 1. "Phonebook" → 2. "Delete Speed Dial"
- 1 Listing the registered data
 - 1. "Phonebook" → 2. "List Names"

Adding a new phone number

The following methods can be used to add a new phone number:

- 1 Inputting a phone number using a voice command
- 1 Transferring data from the cellular phone
- 1 Inputting a phone number using 
- 1 Selecting a phone number from outgoing or incoming call history

n Adding procedure

STEP 1 Select “Add Entry” using a voice command or



STEP 2 Use one of the following methods to input a telephone number:

► Inputting a telephone number using a voice command

STEP2-1 Select “By Voice (By voice)” using a voice com-

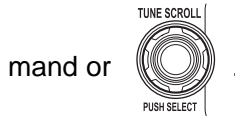

STEP2-2 Press the talk switch, say the desired number, and select “Confirm” using a voice command.

► Transferring data from the cellular phone

STEP2-1 Select “By Phone” and then “Confirm” using a voice

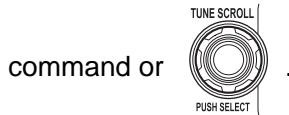

STEP2-2 Transfer the data from the cellular phone.

Refer to the manual that comes with the cellular phone for the details of transferring data.

STEP2-3 Select the data to be registered by either of the following methods:

a. Say “Previous” or “Next” until the desired data is displayed, and select “Confirm” using a voice command.

b. Select the desired data using



► Inputting a phone number using



STEP2-1 Select “Manual Input” using



STEP2-2 Input a phone number using



, and press



once again.

Input the phone number 1 digit at a time.

► Selecting a phone number from outgoing or incoming call history

STEP2-1 Select “Call History” using a voice command or



STEP2-2 Select “Outgoing Call History (Outgoing)” or “Incoming Call History (Incoming)” using a voice

command or

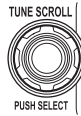

STEP2-3 Select the data to be registered by either of the following methods:

a. Say “Previous” or “Go back” until the desired data is displayed, and select “Confirm” using a voice command.

b. Select the desired data using



STEP 3 Select the name to be registered by either of the following methods, and select “Confirm” using a voice command or

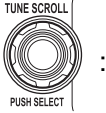

a. Press the talk switch and say the desired name.

b. Select “Record Name” using , and say the desired name.

STEP 4 Select “Confirm” using a voice command or  .

In **STEP 3**, selecting “Speed Dial (Set speed dial)” instead of “Confirm” registers the newly added phone number as a speed dial.

Setting speed dials

STEP 1 Select “Speed Dial (Set speed dial)” using a voice command



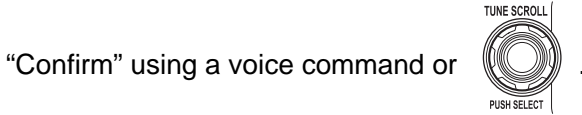

STEP 2 Select the data to be registered as a speed dial by either of the following methods:

a. Press the talk switch, say desired number, and select

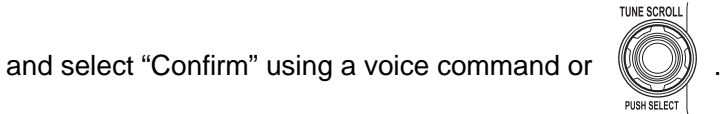

b. Press the talk switch, and say “List names”. While the desired name is being read aloud, press the talk switch,



c. Select the desired data using  .

STEP 3 Select the desired preset button, and register the data into speed dial by either of the following methods:

a. Press the desired preset button, and select “Confirm” using

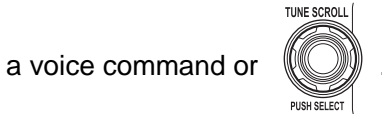

b. Press and hold the desired preset button.

Changing a registered name

STEP 1 Select “Change Name” using a voice command or



STEP 2 Select the name to be changed by either of the following methods.

a. Press the talk switch, say desired name, and select

“Confirm” using a voice command or



b. Press the talk switch, and say “List names”. While the desired name is being read aloud, press the talk switch and

select “Confirm” using a voice command or



c. Select the desired name using



STEP 3 Select “Record Name” with

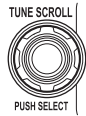

or the talk switch.

STEP 4 Say a new name, and select “Confirm” using a voice com-

mand or



Deleting registered data

STEP 1 Select “Delete Entry” using a voice command or



STEP 2 Select the data to be deleted by either of the following methods, and select “Confirm” using a voice command or

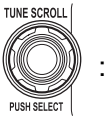

- a. Press the talk switch, and say the name of the desired phone number to be deleted.
- b. Press the talk switch and say “List phones”. While the name of the desired phone number is being read aloud, press the talk switch.

Deleting speed dials

STEP 1 Select “Delete Speed Dial” using a voice command or

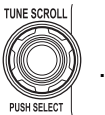

STEP 2 Press the preset button for which the desired speed dial is registered, and select “Confirm” using a voice command or

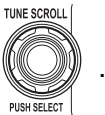

Listing the registered data

Selecting “List names” using a voice command causes a list of the registered data to be read aloud.

When listing is complete, the system returns to “Phonebook”. Pressing the talk switch while the desired data is being read aloud selects the data, and the following functions will be available.

- Dialing: “Dial”
- Changing a registered name: “Change Name”
- Deleting an entry: “Delete Entry”
- Setting a speed dial: “Speed Dial (Set speed dial)”

n Limitation of number of digits

A phone number that exceeds 24 digits cannot be registered.

Interior lights list

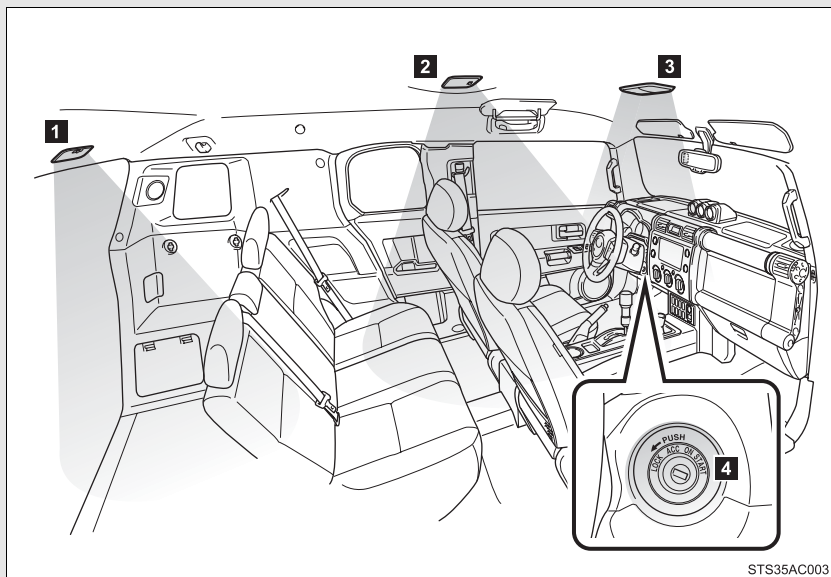

STS35AC003

1 Rear interior light (→P. 316)

2 Front interior light (→P. 316)

3 Personal lights (→P. 317)

4 Engine switch light

n Illuminated entry system

When the interior light switch is in the DOOR position, the interior light and engine switch light automatically turns on/off according to whether the doors are locked/unlocked and whether the doors are open/closed and the engine switch position.

n To prevent the battery from being discharged

If the interior light remains on when the door is not fully closed and the interior light switch is in the DOOR position, the light will go off automatically after 30 minutes.

n Customization that can be configured at Toyota dealer

Settings (e.g. The time elapsed before lights turn off) can be changed. (Customizable features →P. 493)

Interior lights

► Front

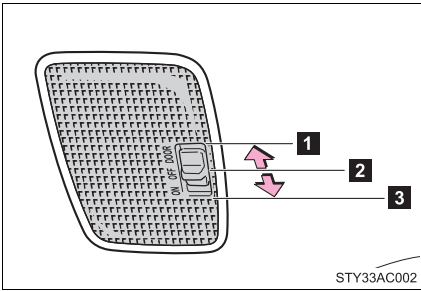

- 1** DOOR position
- 2** OFF
- 3** ON

► Rear

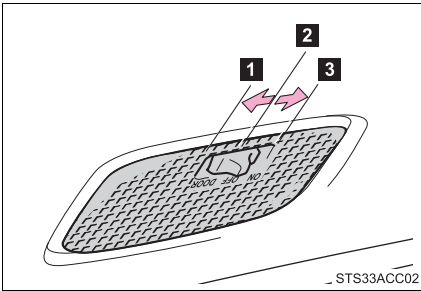

- 1** DOOR position
- 2** OFF
- 3** ON

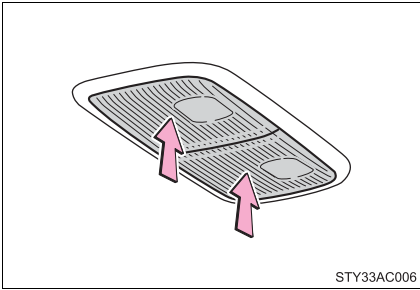
Personal lights

On/off

n To prevent the battery from being discharged

The personal lights will automatically turn off in about 30 minutes after the key is removed from the engine switch.

3-6. Using the storage features

List of storage features

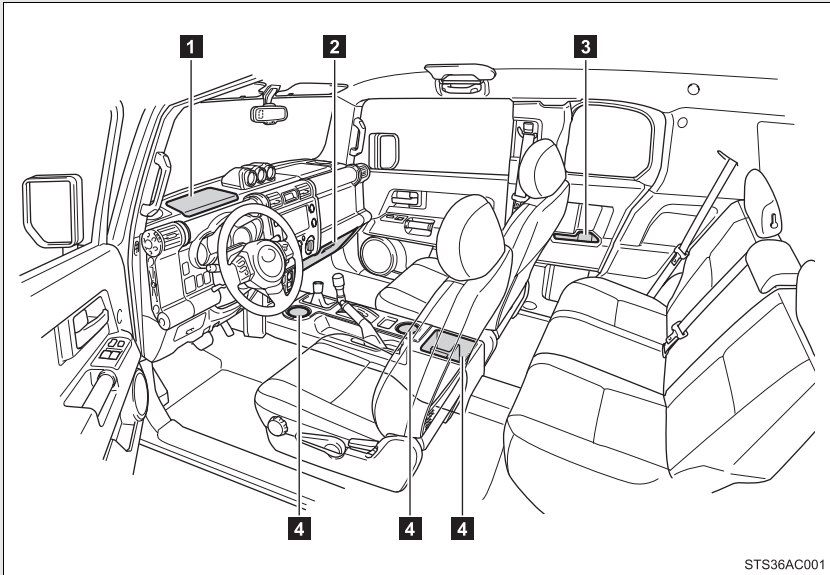

- 1 Auxiliary box
- 2 Glove box
- 3 Bottle holders
- 4 Cup holders

CAUTION

n Items that should not be left in the storage spaces

Do not leave glasses, lighters or spray cans in the storage spaces, as this may cause the following when cabin temperature becomes high:

- 1 Glasses may be deformed by heat or cracked if they come into contact with other stored items.
- 1 Lighters or spray cans may explode. If they come into contact with other stored items, the lighter may catch fire or the spray can may release gas, causing a fire hazard.

Glove box

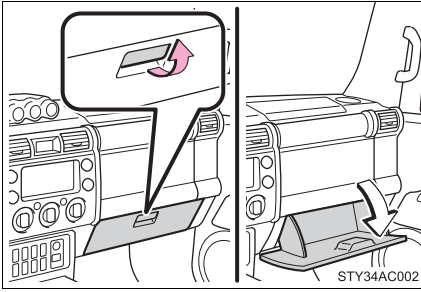

Pull up the lever.

⚠ CAUTION

■ Caution while driving

Keep the glove box closed.
Injuries may result in the event of an accident or sudden braking.

Cup holders (front)

▶ Vehicles with an automatic transmission

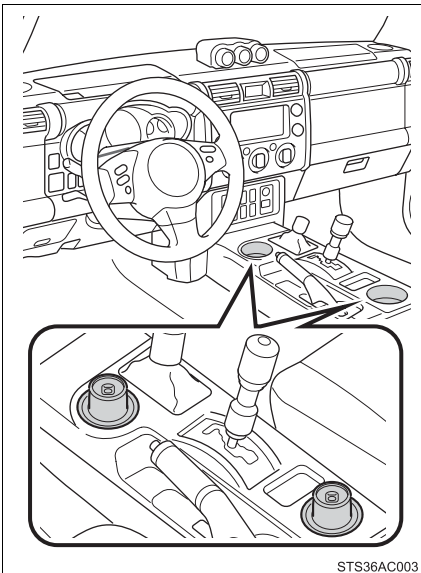

► Vehicles with a manual transmission

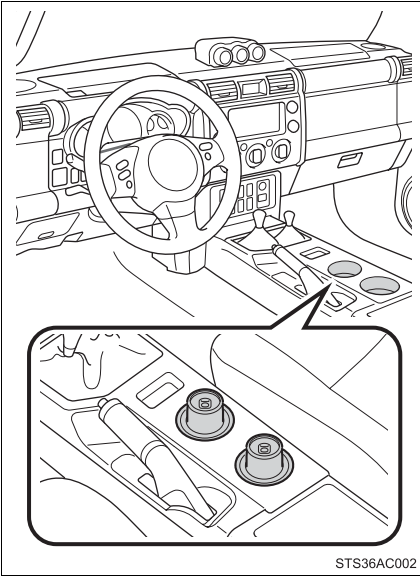

▢ Holding large cups

► Vehicles with an automatic transmission

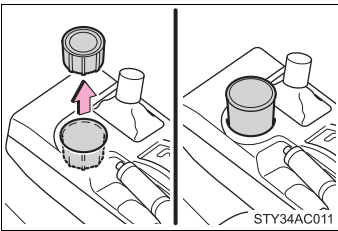

The adapter can be removed.

► Vehicles with a manual transmission

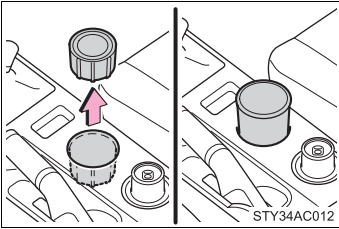

The adapter can be removed.

⚠ CAUTION

■ Items unsuitable for the cup holder

Do not place anything other than cups or beverage cans in the cup holders. Other items may be thrown out of the holders in the event of an accident or sudden braking and cause injury. If possible, cover hot drinks to prevent burns.

Cup holders (rear)

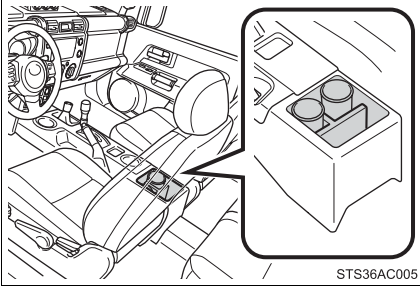

■ Removing the mat

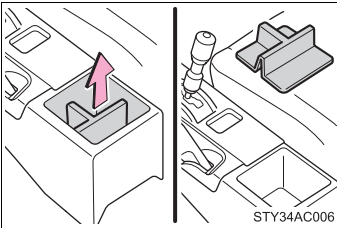

Pull up.

⚠ CAUTION

■ Items unsuitable for the cup holder

Do not place anything other than cups or beverage cans in the cup holders. Other items may be thrown out of the holders in the event of an accident or sudden braking and cause injury. If possible, cover hot drinks to prevent burns.

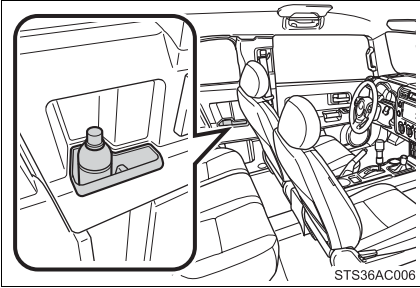
Bottle holders**n Bottle holders**

Depending on their size or shape, some bottles may not fit in the holders.

 **NOTICE****n Items that should not be stowed in the bottle holders**

Put the cap on before stowing a bottle. Do not place open bottles in the bottle holders, or glasses and paper cups containing liquid. The contents may spill and glasses may break.

Auxiliary box

STEP 1

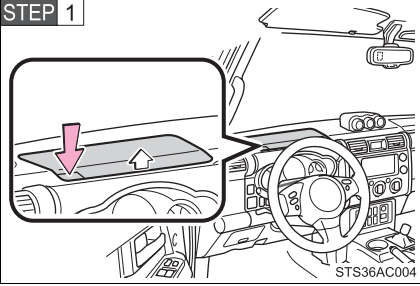

Push the button.

STEP 2

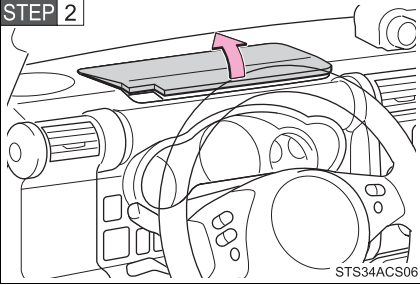

Pull up the lid.

CAUTION

n Caution while driving

Keep the auxiliary box closed.

Items may fall out and cause death or serious injury in case of an accident or sudden stop.

3-7. Other interior features

Sun visors

► Front

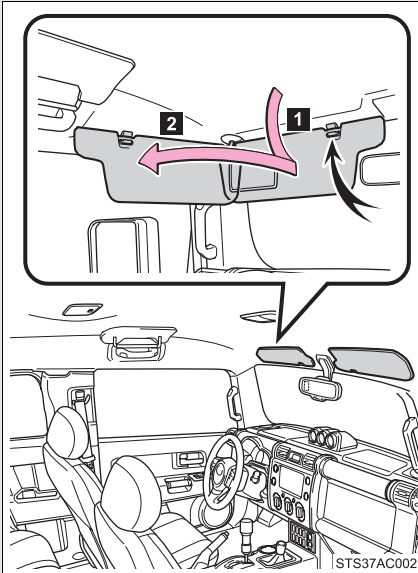

1 Forward position:
Flip down.

2 Side position:
Flip down, unhook, and
swing to the side.

► Side

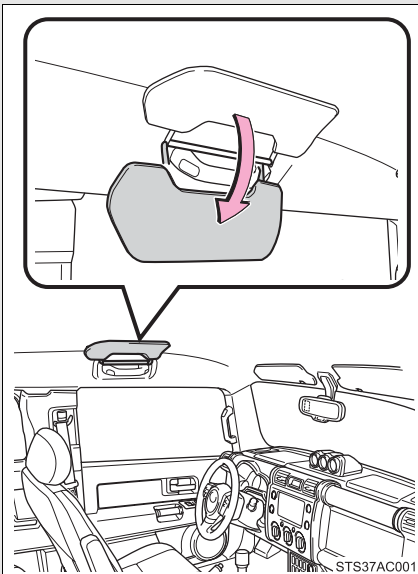

Flip down.

3-7. Other interior features

Vanity mirrors

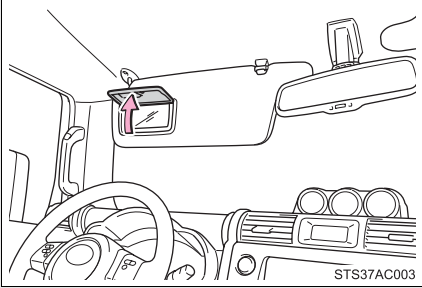

Open the cover.

Clock

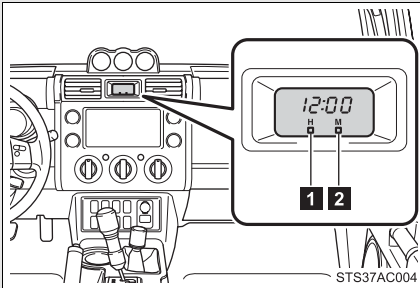

- 1** Adjusts the hours
- 2** Adjusts the minutes

n **The clock is displayed when**

The engine switch is in the ACC or ON position.

n **When disconnecting and reconnecting battery terminals**

The time display will automatically be set to 1:00.

Outside temperature display*

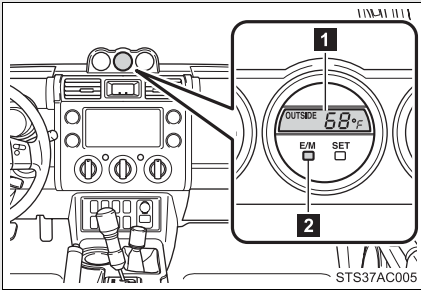

- 1 Displays the outside air temperature.

The temperature range that can be displayed is from -22°F (-30°C) to 122°F (50°C).

- 2 Switches the outside air temperature display between English/U.S. Customary System and metric.

■ **When --°C or --°F is displayed**

The system may be malfunctioning. Take your vehicle to your Toyota dealer.

■ **The outside air temperature is displayed when**

The engine switch is in the ON position.

■ **When disconnecting and reconnecting battery terminals**

The display will automatically be set to the initial mode.

■ **Display**

In the following situations, the correct outside temperature may not be displayed, or the display may take longer than normal to change.

- l When stopped, or driving at low speeds (less than 12 mph [20 km/h])
- l When the outside temperature has changed suddenly (at the entrance/exit of a garage, tunnel, etc.)

*: If equipped

Power outlet (12V DC)

The power outlet can be used for 12 V accessories that run on less than 10A.

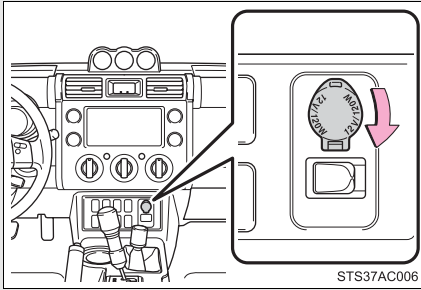

- n **The power outlet can be used when**
The engine switch is in the ACC or ON position.

NOTICE

- n **To avoid damaging the power outlet**
Close the power outlet lid when not in use.
Foreign objects or liquids that enter the power outlet may cause a short circuit.
- n **To prevent the fuse from being blown**
Do not use an accessory that uses more than 12V/10A.
- n **To prevent the battery discharge**
Do not use the power outlet longer than necessary when the engine is not running.

Power outlet (115V AC)*

The power outlet can be used for electrical appliances.

n Operation

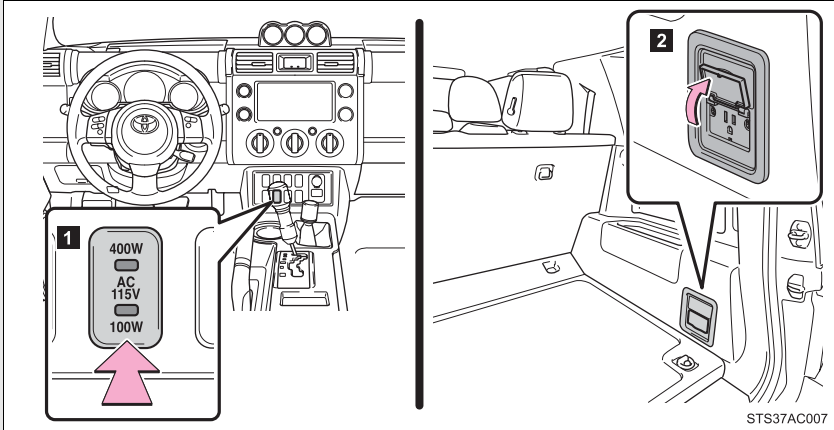

1 Main switch

To use the power outlet, turn on the main switch.

The power supply starts a few seconds after the main switch is pressed.

2 Power outlet socket

*: If equipped

Maximum available capacity of the power outlet**n While the vehicle is being driven**

The maximum capacity of the power outlet is always 115V AC/100W.

n When the vehicle is stationary

The maximum capacity of the power outlet varies depending on the following conditions.

1 The maximum capacity is 115V AC/400W when the following condition applies:

- The shift lever is in P or N. (automatic transmission)
- The shift lever is in N and the clutch pedal is not depressed. (manual transmission)

A maximum capacity of 400W can only be restored by turning the power outlet main switch off and then on again under condition described above.

1 The maximum capacity is 115V AC/100W when the following condition applies:

- The shift lever is moved to any positions other than P and N. (automatic transmission)
- The clutch pedal is depressed. (manual transmission)

■ **The power outlet can be used when**

The engine is started.

■ **The indicator light changes according the maximum available capacity, as follows:**

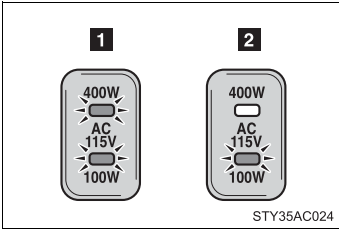

1 Indicates 115V AC/400W

2 Indicates 115V AC/100W

■ **When the power outlet is in operation**

The sound of the cooling fan may be heard from the right side of the luggage compartment. This is normal and does not indicate a malfunction.

■ **If the engine is started with the power outlet main switch on**

The maximum capacity of the power supply may decrease to below the standard, or may be cut off completely, even when the vehicle is stationary.

■ **The protection circuit may be activated to cut the power supply if any of the following conditions apply:**

- l The engine is started with the power outlet main switch on.
- l Use of electrical appliances exceeding the maximum capacity is attempted.

A sound may be heard when the protection circuit is activated.

This is normal and does not indicate a malfunction.

- l Electrical appliances, which consume power exceeding 100W, have been used continuously for a long time period.
- l The total power usage by all electrical features (headlights, air conditioning, etc.) has exceeded the total vehicle maximum for an extended period of time.

n If the protection circuit is activated and the power supply is cut, conduct the following procedure:

STEP 1 Park the vehicle in a safe place, and then securely apply the parking brake.

STEP 2 Check and ensure the following conditions

- The shift lever is in P or N. (automatic transmission)
- The shift lever is in N and the clutch pedal is not depressed. (manual transmission)

STEP 3 Make sure that the power consumption of the electric appliance is within the maximum capacity of the power outlet and the appliance is not broken.

STEP 4 Press the power outlet main switch again.

When the cabin temperature is high, open the windows to cool the temperature down. Once it reaches the normal temperature, turn the power outlet main switch on again.

If the power supply is not resumed even after performing the above procedure, have the vehicle inspected by a Toyota dealer.

⚠ CAUTION

n Using a power outlet

Observe the following precautions to reduce the risk of injury.

- 1** Use of the power outlet when it is wet with drinking water or snow may result in electrical shocks and is extremely dangerous. The power outlet must be thoroughly dried before use.
- 1** Do not allow children to use or play with the power outlet.
- 1** Be careful not to get any part of your body caught in the power outlet lid.
- 1** When using electrical appliances, strictly follow any cautions and notices written on their labels and in the manufacturers' instruction manuals.
- 1** Do not modify, disassemble or repair the power outlet or its inverter, in any way. Doing so may result in unexpected malfunctions or accidents, which could cause serious damage or injuries. Contact a Toyota dealer for any necessary repairs.

 CAUTION

n To prevent injuries and accidents, securely fix all electric appliances before use and do not use any appliances that may do any of the following:

- l** Distract the driver while driving, or hamper safe driving.
- l** Result in a fire or burn injuries due to the appliance rolling, falling or overheating while driving.
- l** Emit steam, while the windows of the cabin are closed.

n To prevent unexpected accidents, such as electric shocks, do not perform any of the following.

- l** Using the power outlet for electric heaters while sleeping.
- l** Contaminating the power outlet with liquid substances or mud.
- l** Handling electrical appliance plugs at the power outlet with wet hands or feet.
- l** Inserting foreign objects into the power outlet.
- l** Using malfunctioning electric appliances.
- l** Inserting inappropriate or badly fitting plugs into the power outlet.

 NOTICE

n To avoid damaging the power outlet and the plug

- l** Close the power outlet lid when not in use.
- l** Foreign objects or liquids that enter the power outlet may cause a short circuit.
- l** Do not use plug adaptors to connect too many plugs to the power outlet.
- l** After inserting a plug, gently close the power outlet lid.

n To prevent the fuse from being blown

Do not use a 115V AC appliance that requires more than maximum capacity. If a 115V AC appliance that consumes more than maximum capacity is used, the protection circuit will cut the power supply.

 NOTICE**n Appliances that may not operate properly (115V AC)**

The following 115V AC appliances may not operate even if their power consumption is under maximum capacity.

- l Appliances with high initial peak wattage
- l Measuring devices that process precise data
- l Other appliances that require an extremely stable power supply

n To prevent the battery from being discharged

Turn off all the vehicle's electronic equipment and accessories, such as the headlights and air conditioning, when electrical appliances that consume in excess of 100W are used continuously for long periods of time.

n To prevent any damage caused by heat

Do not use any electrical appliances that give off intense heat such as toasters, in any locations including the internal or external trim, seats and deck.

- l Do not use any electrical appliances, which are easily affected by vibration or heat, inside the vehicle.

Vibration while driving, or the heat of the sun while parking, may result in damage to those electrical appliances.

n If any electrical appliances are to be used while driving

Securely fasten both the appliances and their cables to prevent them from falling or getting caught any of the power train components.

n If the power outlet is loose when an electrical appliance plug is connected

Replace the outlet.

Contact a Toyota dealer for any necessary replacements.

n If the power outlet gets dirty

Turn the main switch off and use a soft, clean cloth to wipe it gently.

Do not use any cleansing materials, such as organic solvents, wax, or compound cleaners, as these may damage the power outlet or cause it to malfunction.

Armrest

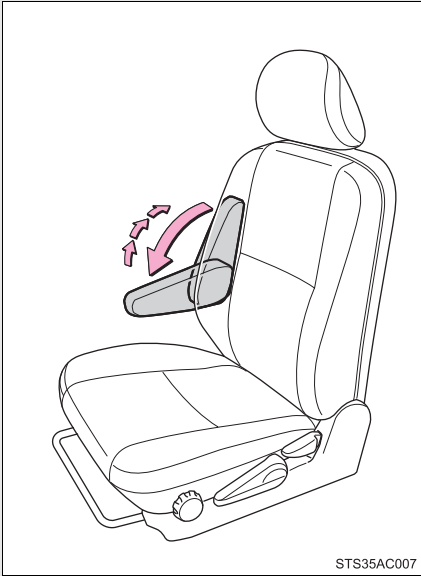

Adjusting to the desired angle:

STEP 1 Lower the armrest from the highest position to the lowest position.

STEP 2 Raise the armrest to the desired angle.

Unlock the armrest:
Lift the armrest to raise it to the highest position.

 **NOTICE**

n To prevent damage to the armrest

Do not place too much strain on the armrest.

Floor mat

Use only floor mats designed specifically for vehicles of the same model and model year as your vehicle. Fix them securely in place onto the carpet.

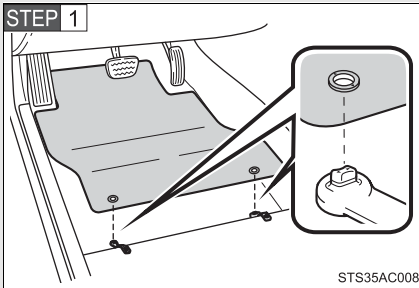

Insert the retaining hooks (clips) into the floor mat eyelets.

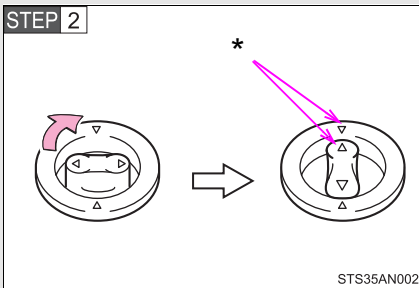

Turn the upper knob of each retaining hook (clip) to secure the floor mats in place.

*: Always align the \triangle mark.

The shape of the retaining hooks (clips) may differ from that shown in the illustration.

⚠ CAUTION

Observe the following precautions.

Failure to do so may cause the driver's floor mat to slip, possibly interfering with the pedals while driving. An unexpectedly high speed may result or it may become difficult to stop the vehicle, leading to a serious accident.

n When installing the driver's floor mat

- 1 Do not use floor mats designed for other models or different model year vehicles, even if they are Toyota Genuine floor mats.
- 1 Only use floor mats designed for the driver's seat.
- 1 Always install the floor mat securely using the retaining hooks (clips) provided.
- 1 Do not use two or more floor mats on top of each other.
- 1 Do not place the floor mat bottom-side up or upside-down.

n Before driving

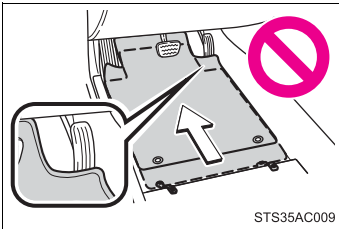

- 1 Check that the floor mat is securely fixed in the right place with all the provided retaining hooks (clips). Be especially careful to perform this check after cleaning the floor.
- 1 With the engine stopped and the shift lever in P (automatic transmission) or N (manual transmission), fully depress each pedal to the floor to make sure it does not interfere with the floor mat.

3-7. Other interior features

Luggage storage box (vehicles without sub woofer)

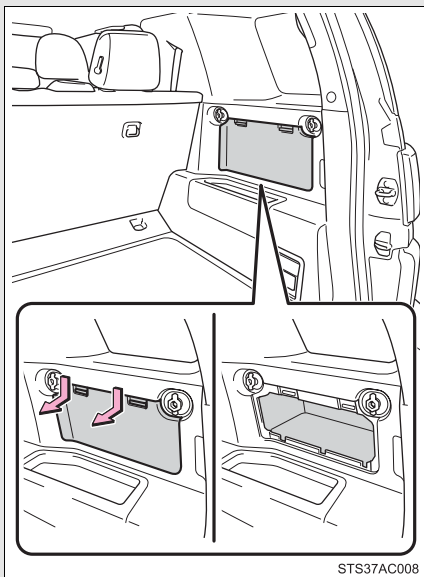

Push the lid down and pull it towards you.

⚠ CAUTION

n Caution while driving

Keep the luggage storage box closed. Injuries may result in the event of an accident or sudden braking.

Luggage compartment features

n Tie-down hooks

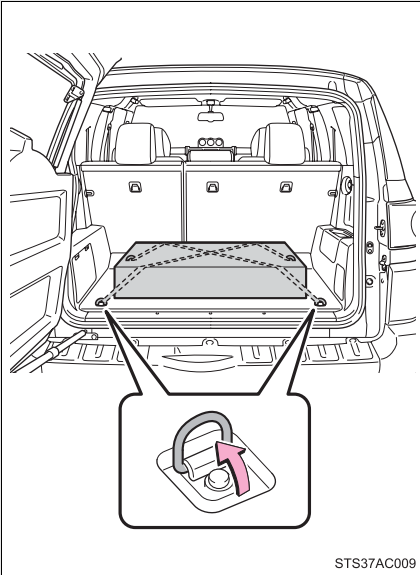

Tie-down hooks are provided for securing loose items.

n Cargo net hooks

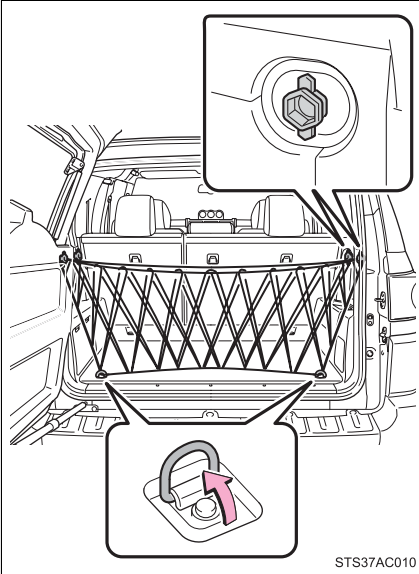

To hang the cargo net, use the cargo net hooks and tie-down hooks.

The cargo net itself is not included as an original equipment.

n Shopping bag hooks

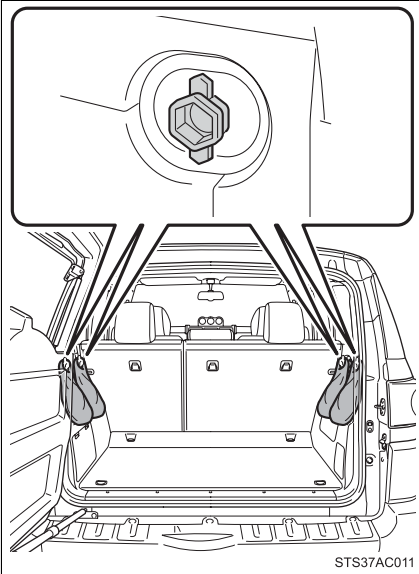

To hang the shopping bag, use the cargo net hooks.

⚠ CAUTION

n When the tie-down hooks and cargo net hooks are not in use

To avoid injury, always return the tie-down hooks and cargo net hooks to their positions when they are not in use.

⚠ NOTICE

n To prevent damage to the cargo net hooks and shopping bag hooks

- ⓘ Do not hang any object heavier than 8.8 lb. (4 kg) in them.
- ⓘ Avoid hanging things other than a cargo net on it when using the hooks as cargo net hooks.

Compass*

The compass indicates the direction that the vehicle is heading.

n Operation

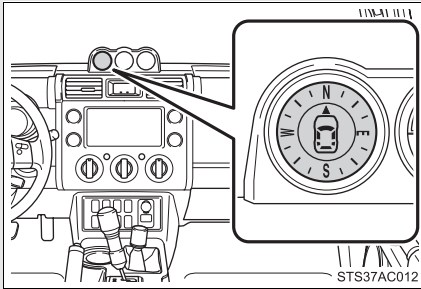

The compass points north for about 3 seconds after the engine switch is turned to the ON position, and then indicates the actual direction the vehicle facing.

When the engine switch is turned to the ACC or LOCK position, it indicates the actual direction for about 5 seconds and then points in a random direction.

n Displays and directions

Display	Direction
N	North
E	East
S	South
W	West

*: If equipped

Calibrating the compass

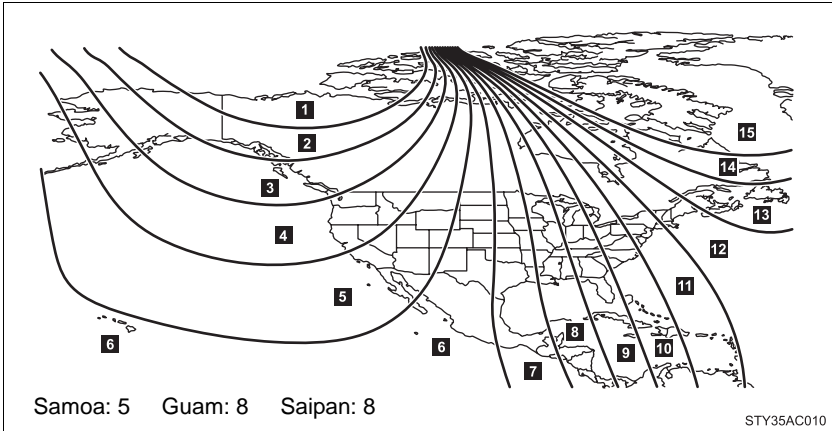

The direction display deviates from the true direction determined by the earth's magnetic field. The amount of deviation varies according to the geographic position of the vehicle.

If you cross over a map boundary shown in illustration, the compass will deviate.

To obtain higher precision or perfect calibration, refer to the following.

n Deviation calibration

STEP 1 Stop the vehicle where it is safe to drive in a circle.

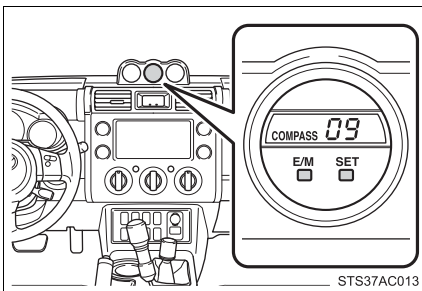

STEP 2 Press the SET button until a number (1 to 15) appears on the outside temperature display.

STEP 3 Press the E/M button, and referring to the map above, select the number of the zone where you are.

STEP 4 After calibration, leave the system for 6 seconds or press the SET button for about 2 seconds.

If the display returns to the outside temperature display, the calibration is complete.

n Circling calibration

STEP 1 Stop the vehicle where it is safe to drive in a circle.

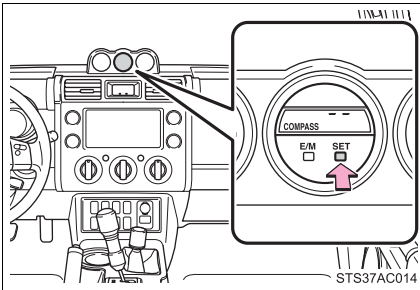

STEP 2 Press the SET button until the zone number appears on the outside temperature display.

STEP 3 Push the SET button. “- -” will start moving.

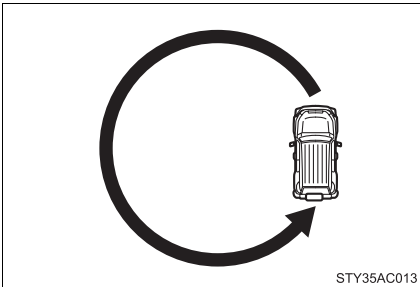

STEP 4 Drive the vehicle in a circle at 5 mph (8 km/h).

If there is not enough space to drive in a circle, drive around the block until the direction is displayed.

When the compass display returns to the outside temperature display, calibration is complete.

When circling calibration fails, Er is displayed for 2 seconds and then COMPASS flashes. It also flashes when circling calibration is not completed.

If you want to cancel the calibration before it is complete, press the SET button for about 2 seconds.

n Conditions unfavorable to correct operation

The compass may not show the correct direction in the following conditions:

l The vehicle is stopped immediately after turning.

The compass does not adjust while the vehicle is stopped.

l The engine switch is turned off immediately after turning.

l The vehicle is on an inclined surface.

l The vehicle is in a place where the earth's magnetic field is subject to interference by artificial magnetic fields (underground car park/parking lot, under a steel tower, between buildings, roof car park/parking lot, near an intersection, near a large vehicle, etc.).

l The vehicle has become magnetized.

(There is a magnet or metal object on or near the accessory meter.)

l The battery has been disconnected.

n When disconnecting and reconnecting battery terminals

COMPASS flashes and the compass is reset to its initial mode.



CAUTION

n While driving the vehicle

Do not adjust the display. Be sure to adjust the display only when the vehicle is stopped.

n When doing the circling calibration

Be sure to secure a wide space, and watch out for people and vehicles in the neighborhood. Do not violate any local traffic rules while performing circling calibration.

**NOTICE****n To avoid the compass malfunctions**

Do not place magnets or any metal objects on or near the accessory meter. Doing this may cause a malfunction of the compass sensor.

n To ensure normal operation of the compass

- l** Do not perform circling calibration of the compass in a place where the earth's magnetic field is subject to interference by artificial magnetic fields.
- l** During calibration, do not operate electric systems (power windows, etc.) as they may interfere with the calibration.

Cleaning and protecting the vehicle exterior

Perform the following to protect the vehicle and maintain it in prime condition.

1 Working from top to bottom, liberally apply water to the vehicle body, wheel wells and underside of the vehicle to remove any dirt and dust.

Wash the vehicle body using a sponge or soft cloth, such as a chamois.

1 For hard-to-remove marks, use car wash soap and rinse thoroughly with water.

1 Wipe away any water.

1 Wax the vehicle when the waterproof coating deteriorates.

If water does not bead on a clean surface, apply wax when the vehicle body is cool.

n Automatic car washes

1 Fold the mirrors and remove the detachable pole antenna before washing the vehicle. Start washing from the front of the vehicle. Make sure to re-install the detachable pole antenna and extend the mirrors before driving.

1 Brushes used in automatic car washes may scratch the vehicle surface and harm your vehicle's paint.

1 In certain automatic car washes, the roof antenna (if equipped) may interfere with machine operation. This may prevent the vehicle from being cleaned properly or result in damage to the roof antenna.

n High pressure car washes

Do not allow the nozzles of the car wash to come within close proximity of the windows. Before entering an automatic car wash, check that the fuel filler door on your vehicle is closed properly.

n Touch-up paint (if equipped)

Touch-up paint may be used to cover small chips or scratches.

Apply the paint soon after the damage occurs or corrosion may set in. To apply the touch-up paint so it is hardly noticeable the trick is to apply it only to the bare spots. Apply only the smallest amount possible and do not paint the surface around the scratch or chip.

n Aluminum wheels (if equipped)

l Remove any dirt immediately by using a neutral detergent. Do not use hard brushes or abrasive cleaners. Do not use strong or harsh chemical cleaners.

Use the same mild detergent and wax as used on the paint.

l Do not use detergent on the wheels when they are hot, for example after driving for long distance in the hot weather.

l Wash detergent from the wheels immediately after use.

n Bumpers, side moldings and over fenders

Do not scrub with abrasive cleaners.

⚠ CAUTION**n Caution about the exhaust pipe**

Exhaust gasses cause the exhaust pipe to become quite hot.

When washing the vehicle, be careful not to touch the pipe until it has cooled sufficiently, as touching a hot exhaust pipe can cause burns.

 NOTICE

n To prevent paint deterioration and corrosion on the body and components (aluminum wheels etc.)

! Wash the vehicle immediately in the following cases:

- After driving near the sea coast
- After driving on salted roads
- If you see coal tar or tree sap on the paint surface
- If you see dead insects, insect droppings or bird droppings on the paint
- After driving in an area contaminated with soot, oily smoke, mine dust, iron powder or chemical substances
- If the vehicle becomes heavily soiled in dust or mud
- If liquids such as benzene and gasoline are spilled on the paint surface

! If the paint is chipped or scratched, have it repaired immediately.

! To prevent the wheels from corroding, remove any dirt and store in a place with low humidity when storing the wheels.

n Cleaning the exterior lights

! Wash carefully. Do not use organic substances or scrub with a hard brush. This may damage the surfaces of the lights.

! Do not apply wax on the surfaces of the lights. Wax may cause damage to the lenses.

n Detachable pole antenna installation and removal precautions

! Before driving, ensure that the antenna is installed.

! When the antenna is removed, such as before entering an automatic car wash, make sure to store it in a suitable place so as not to lose it. Also, before driving, make sure to reinstall the antenna in its original position.

Cleaning and protecting the vehicle interior

The following procedures will help protect your vehicle's interior and keep it in top condition:

n Protecting the vehicle interior

Remove dirt and dust using a vacuum cleaner. Wipe dirty surfaces with a cloth dampened with lukewarm water.

n Cleaning the leather areas

1 Remove dirt and dust using a vacuum cleaner.

1 Wipe any excess dirt and dust with a soft cloth dampened with diluted detergent.

Use a diluted water solution of approximately 5% neutral wool detergent.

1 Wring out any excess water from the cloth and thoroughly wipe off all remaining traces of detergent.

1 Wipe the surface with a dry, soft cloth to remove any remaining moisture. Allow the leather to dry in a shaded and ventilated area.

n Cleaning the synthetic leather areas

1 Remove loose dirt using a vacuum cleaner.

1 Apply a mild soap solution to the synthetic leather using a sponge or soft cloth.

1 Allow the solution to soak in for a few minutes. Remove the dirt and wipe off the solution with a clean, damp cloth.

n Caring for leather areas

Toyota recommends cleaning the interior of the vehicle at least twice a year to maintain the quality of the vehicle's interior.

n Shampooing the carpets

There are several commercial foaming-type cleaners available. Use a sponge or brush to apply the foam. Rub in overlapping circles. Do not apply water. The excellent results are obtained when keeping the carpet as dry as possible.

n Seat belts

Clean with mild soap and lukewarm water using a cloth or sponge. Also check the belts periodically for excessive wear, fraying or cuts.

⚠ CAUTION

n Water in the vehicle

I Do not splash or spill liquid in the vehicle.

Doing so may cause the electrical components etc. to malfunction or catch fire.

I Do not get any of the SRS components or wiring in the vehicle interior wet. (→P. 79)

Electrical malfunction may cause the airbags to deploy or not function properly, resulting in death or serious injury.

n Cleaning the interior (especially instrument panel)

Do not use polish wax or polish cleaner. The instrument panel may reflect off the windshield, obstructing the driver's view and leading to an accident, resulting in death or serious injury.

 NOTICE**n Cleaning detergents**

- I Do not use organic substances such as benzene or gasoline, acidic or alkaline solutions, dye, bleach or other detergent. Doing so may discolor the vehicle interior or cause streaks or damage to painted surfaces.
- I Do not use polish wax or polish cleaner. The instrument panel's or other interior part's painted surface may be damaged.

n Preventing damage to leather surfaces

Observe the following precautions to avoid damage to and deterioration of leather surfaces.

- I Remove any dust or dirt on leather surfaces immediately.
- I Do not expose the vehicle to direct sunlight for extended periods of time. Park the vehicle in the shade, especially during summer.
- I Do not place items made of vinyl, plastic, or that contain wax on the upholstery, as they may stick to the leather surface if the vehicle interior heats up significantly.

n Water on the floor

Do not wash the vehicle floor with water.

Vehicle systems such as the audio system may be damaged if water comes into contact with electrical components under the floor of the vehicle, and may also cause the body to rust.

n Cleaning the inside of the rear window

- I Do not use glass cleaner to clean the rear window, as this may cause damage to the rear window defogger heater wires. Use a cloth dampened with lukewarm water to gently wipe the window clean. Wipe the window in strokes running parallel to the heater wires.
- I Be careful not to scratch or damage the heater wires.

Maintenance requirements

To ensure safe and economical driving, day-to-day care and regular maintenance is essential. It is the owner's responsibility to perform regular checks. Toyota recommends the following maintenance.

n General maintenance

Should be performed on a daily basis. This can be done by yourself or by a Toyota dealer.

n Scheduled maintenance

Should be performed at specified intervals according to the maintenance schedule.

For details about maintenance items and schedules, refer to the "Scheduled Maintenance Guide" or "Owner's Manual Supplement".

n Do-it-yourself maintenance

You can perform some maintenance procedures yourself. Please be aware that do-it-yourself maintenance may affect warranty coverage.

The use of Toyota Repair Manuals is recommended.

For details about warranty coverage, see the separate "Owner's Warranty Information Booklet", "Owner's Manual Supplement".

n Repair and replacement

It is recommended that genuine Toyota parts be used for repair to ensure performance of each system. If non-Toyota parts are used in replacement or if a repair shop other than Toyota dealer performs repairs, confirm the warranty coverage.

n Allow inspection and repairs to be performed by a Toyota dealer

- l Toyota technicians are well-trained specialists and are kept up to date with the latest service information. They are well informed about the operations of all systems on your vehicle.
- l Keep a copy of the repair order. It proves that the maintenance that has been performed is under warranty coverage. If any problem should arise while your vehicle is under warranty, your Toyota dealer will promptly take care of it.

⚠ CAUTION**n Warning in handling of battery**

- l Engine exhaust, some of its constituents, and a wide variety of automobile components contain or emit chemicals known to the State of California to cause cancer and birth defects and other reproductive harm. Work in a well ventilated area.
- l Oils, fuels and fluids contained in vehicles as well as waste produced by component wear contain or emit chemicals known to the State of California to cause cancer and birth defects or other reproductive harm. Avoid exposure and wash any affected area immediately.
- l Battery posts, terminals and related accessories contain lead and lead compounds which are known to cause brain damage. Wash your hands after handling. (→P. 376)

General maintenance

Listed below are the general maintenance items that should be performed at the intervals specified in the “Scheduled Maintenance Guide” or “Owner’s Manual Supplement”. It is recommended that any problem you notice should be brought to the attention of your Toyota dealer or qualified service shop for advice.

Engine compartment

Items	Check points
Battery	Maintenance-free. (→P. 376)
Brake fluid	At the correct level? (→P. 373)
Engine coolant	At the correct level? (→P. 372)
Engine oil	At the correct level? (→P. 368)
Exhaust system	No fumes or strange sounds?
Power steering fluid	At the correct level? (→P. 375)
Radiator/condenser/hoses	Not blocked with foreign matter? (→P. 373)
Washer fluid	At the correct level? (→P. 379)

Vehicle interior

Items	Check points
Accelerator pedal	<ul style="list-style-type: none"> • Moves smoothly (without uneven pedal effort or catching)?
Automatic transmission “Park” mechanism	<ul style="list-style-type: none"> • Can the vehicle be hold securely on an incline with the shift lever in P?
Brake pedal	<ul style="list-style-type: none"> • Moves smoothly? • Does it have appropriate clearance and correct amount of free play?
Brakes	<ul style="list-style-type: none"> • Not pull to one side when applied? • Loss of brake effectiveness? • Spongy feeling brake pedal? • Pedal almost touches floor?
Clutch pedal	<ul style="list-style-type: none"> • Moves smoothly? • Does it have correct amount of free play?
Head restraints	<ul style="list-style-type: none"> • Move smoothly and lock securely?
Indicators/buzzers	<ul style="list-style-type: none"> • Function properly?
Lights	<ul style="list-style-type: none"> • Do all the lights come on? • Headlights aimed correctly?
Parking brake	<ul style="list-style-type: none"> • Moves smoothly? • Can hold the vehicle securely on an incline?
Seat belts	<ul style="list-style-type: none"> • Does the seat belt system operate smoothly? • Are the belts undamaged?
Seats	<ul style="list-style-type: none"> • Do the seat controls operate properly?

Items	Check points
Steering wheel	<ul style="list-style-type: none"> • Moves smoothly? • Has correct free play? • No strange noises?

Vehicle exterior

Items	Check points
Door	<ul style="list-style-type: none"> • Operate smoothly?
Engine hood	<ul style="list-style-type: none"> • The lock system works properly?
Fluid leaks	<ul style="list-style-type: none"> • Is there any leakage after parking?
Tire	<ul style="list-style-type: none"> • Inflation pressure is correct? • Tire surfaces not worn or damaged? • Tires rotated according to the maintenance schedule? • Wheel nuts are not loose?

CAUTION

n If the engine is running

Turn the engine off and ensure that there is adequate ventilation before performing maintenance checks.

Some states have vehicle emission inspection programs which include OBD (On Board Diagnostics) checks. The OBD system monitors the operation of the emission control system.

n If the malfunction indicator lamp comes on

The OBD system determines that a problem exists somewhere in the emission control system. Your vehicle may not pass the I/M test and may need to be repaired. Contact your Toyota dealer to service the vehicle.

n Your vehicle may not pass the I/M test:

l When the battery is disconnected or discharged

Readiness codes that are set during ordinary driving are erased.

Also, depending on your driving habits, the readiness codes may not be completely set.

l When the fuel tank cap is loose

The malfunction indicator lamp comes on as a temporary malfunction and your vehicle may not pass the I/M test.

n When the malfunction indicator lamp goes off after several driving trips

The error code in the OBD system will not be cleared unless the vehicle is driven 40 or more times.

n If your vehicle does not pass the I/M test

Contact your Toyota dealer to prepare the vehicle for re-testing.

Do-it-yourself service precautions

If you perform maintenance yourself, be sure to follow the correct procedures as given in these sections.

Items	Parts and tools
Battery condition (→P. 376)	<ul style="list-style-type: none"> • Warm water • Baking soda • Grease • Conventional wrench (for terminal clamp bolts)
Brake fluid level (→P. 373)	<ul style="list-style-type: none"> • SAE J1703 or FMVSS No.116 DOT 3 brake fluid • Rag or paper towel
Engine coolant level (→P. 372)	<ul style="list-style-type: none"> • “Toyota Super Long Life Coolant” or similar high quality ethylene glycol based non-silicate, non-amine, non-nitrite and non-borate coolant with long-life hybrid organic acid technology. U.S.A.: “Toyota Super Long Life Coolant” is pre-mixed with 50% coolant and 50% deionized water. Canada: “Toyota Super Long Life Coolant” is pre-mixed with 55% coolant and 45% deionized water.
Engine oil level (→P. 368)	<ul style="list-style-type: none"> • Toyota Genuine Motor Oil or equivalent • Rag or paper towel • Funnel (used only for adding oil)
Fuses (→P. 399)	<ul style="list-style-type: none"> • Fuse with same amperage rating as original

Items	Parts and tools
Light bulbs (→P. 410)	<ul style="list-style-type: none"> • Bulb with same number and wattage rating as original • Phillips-head screwdriver
Power steering fluid level (→P. 375)	<ul style="list-style-type: none"> • Automatic transmission fluid DEXRON® II or III • Rag or paper towel
Radiator and condenser (→P. 373)	—
Tire inflation pressure (→P. 387)	<ul style="list-style-type: none"> • Tire pressure gauge • Compressed air source
Washer fluid (→P. 379)	<ul style="list-style-type: none"> • Water • Washer fluid containing antifreeze (for winter use)

 **CAUTION**

The engine compartment contains many mechanisms and fluids that may move suddenly, become hot, or become electrically energized. To avoid death or serious injury observe the following precautions.

n When working on the engine compartment

- I** Keep hands, clothing, and tools away from the moving fan and engine drive belt.
- I** Be careful not to touch the engine, radiator, exhaust manifold, etc. right after driving as they may be hot. Oil and other fluids may also be hot.
- I** Do not leave anything that may burn easily, such as paper or rags, in the engine compartment.
- I** Do not smoke, cause sparks or expose an open flame to fuel or the battery. Fuel and battery fumes are flammable.
- I** Be extremely cautious when working on the battery. It contains poisonous and corrosive sulfuric acid.
- I** Take care because brake fluid can harm your hands or eyes and damage painted surfaces.
If fluid gets on your hands or in your eyes, flush the affected area with clean water immediately.
If you still experience discomfort, see a doctor.

n When working near the cooling fan or radiator grille

Be sure the engine switch is off.

With the engine switch on, the cooling fan may automatically start to run if the air conditioning is on and/or the coolant temperature is high.

n Safety glasses

Wear safety glasses to prevent flying or falling material, fluid spray, etc. from getting in the eyes.

**NOTICE****n If you remove the air cleaner**

Driving with the air cleaner removed may cause excessive engine wear due to dirt in the air. Also a backfire could cause a fire in the engine compartment.

n If the fluid level is low or high

It is normal for the brake fluid level to go down slightly as the brake pads wear or when the fluid level in the accumulator is high.

If the reservoir needs frequent refilling, it may indicate a serious problem.

4-3. Do-it-yourself maintenance

Hood

Release the lock from the inside of the vehicle to open the hood.

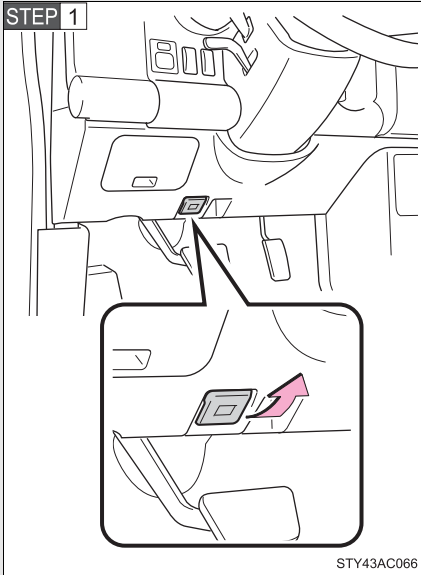

Pull the hood lock release lever.

The hood will pop up slightly.

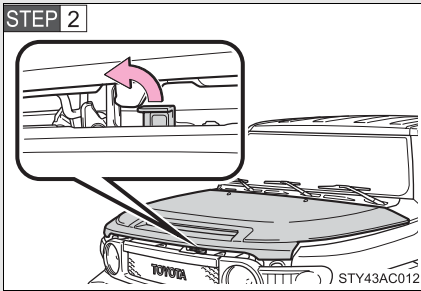

Pull up the hood catch lever and lift the hood.

⚠ CAUTION

■ Pre-driving check

Check that the hood is fully closed and locked.

If the hood is not locked properly, it may open while the vehicle is in motion and cause an accident, which may result in death or serious injury.

Engine compartment

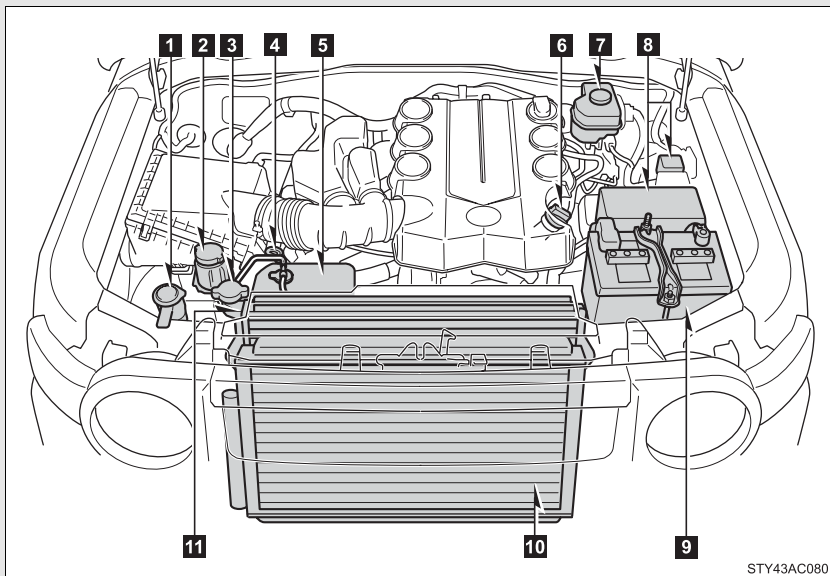

- | | |
|---------------------------------------------------|------------------------------------------|
| 1 Washer fluid tank (→P. 379) | 6 Engine oil filler cap (→P. 368) |
| 2 Power steering fluid reservoir (→P. 375) | 7 Brake fluid reservoir (→P. 373) |
| 3 Radiator cap | 8 Fuse box (→P. 399) |
| 4 Engine oil level dipstick (→P. 368) | 9 Battery (→P. 376) |
| 5 Engine coolant reservoir (→P. 372) | 10 Condenser (→P. 373) |
| | 11 Radiator (→P. 373) |

Engine oil

With the engine at operating temperature and turned off, check the oil level on the dipstick.

n Checking the engine oil

STEP 1 Park the vehicle on level ground. After turning off the engine, wait more than 5 minutes for the oil to drain back into the bottom of the engine.

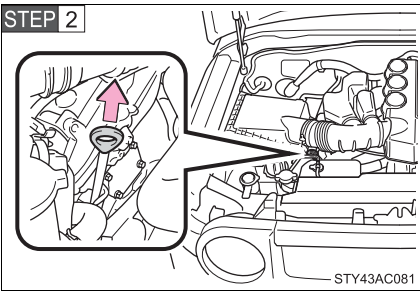

Hold a rag under the end and pull the dipstick out.

STEP 3 Wipe the dipstick clean.

STEP 4 Reinsert the dipstick fully.

STEP 5 Holding a rag under the end, pull the dipstick out and check the oil level.

STEP 6 Wipe the dipstick and reinsert it fully.

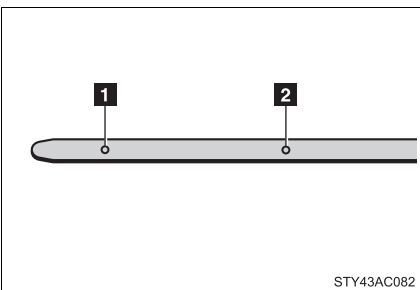

1 Low

2 Full

n Adding engine oil

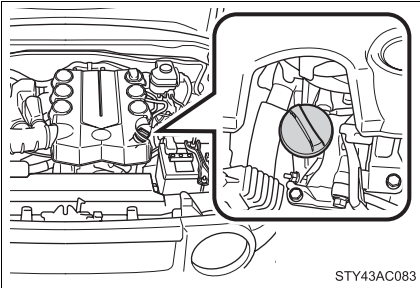

If the oil level is below or near the low level mark, add engine oil of the same type as already in the engine.

Make sure to check the oil type and prepare the items needed before adding oil.

Engine oil selection	→P. 471
Items	Clean funnel

STEP 1 Remove the oil filler cap, turning it counterclockwise.

STEP 2 Add engine oil slowly.

STEP 3 Checking the dipstick.

STEP 4 Reinstall the filler cap, turning it clockwise.

The approximate quantity of oil needed to raise the level between low and full on the dipstick is indicated as follows:

1.8 qt. (1.7 L, 1.5 Imp. qt.)

n Engine oil consumption

- | The amount of engine oil consumed depends on the oil viscosity, the quality of the oil and the way the vehicle is driven.
- | More oil is consumed under driving conditions such as high speeds and frequent acceleration and deceleration.
- | A new engine consumes more oil.
- | When judging the amount of oil consumption, keep in mind that the oil may have become diluted, making it difficult to judge the true level accurately.
- | Oil consumption: Max. 1.1 qt./600 miles (0.9 Imp.qt./600 miles, 1.0 L per 1000 km)
- | If you consume more than 1.1 qt. (1.0 L, 0.9 Imp.qt.) every 600 miles (1000 km), contact your Toyota dealer.

n After changing the engine oil (U.S.A. only)

The oil change system should be reset. Perform the following procedures:



STEP 1 Turn the engine switch off with the odometer reading shown.
(→P. 135)

STEP 2 Turn the engine switch to the ON position while holding down the trip meter reset button.

STEP 3 Continue to press and hold the button until the odometer displays 000000.

If the system fails to reset, the light will continue flashing.





 **CAUTION**
n Used engine oil

-  Used engine oil contains potentially harmful contaminants which may cause skin disorders such as inflammation or skin cancer, so care should be taken to avoid prolonged and repeated contact. To remove used engine oil from your skin, wash thoroughly with soap and water.
-  Dispose of used oil and filters only in a safe and acceptable manner. Do not dispose of used oil and filters in household trash, in sewers or onto the ground. Call your Toyota dealer, service station or auto parts store for information concerning recycling or disposal.
-  Do not leave used engine oil within the reach of children.

 **NOTICE**
n To prevent serious engine damage

Check the oil level on regular basis.

n When replacing the engine oil

-  Be careful not to spill engine oil on the vehicle components.
-  Avoid overfilling, as the engine could be damaged.
-  Check the oil level on the dipstick every time you refill the vehicle.
-  Be sure the engine oil filler cap is properly tightened.

Engine coolant

The coolant level is satisfactory if it is between the F (Full) and L (Low) lines on the reservoir when the engine is cold.

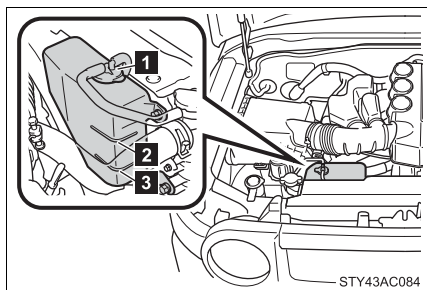

1 Reservoir cap

2 Full

3 Low

If the level is on or below the L line, add coolant up to the F line.

n If the coolant level drops within a short time after replenishing

Visually check the radiator, hoses, reservoir cap, radiator cap, drain cock and water pump.

If you cannot find a leak, have your Toyota dealer pressure test the cap and check for leaks in the cooling system.

n Coolant selection

Only use “Toyota Super Long Life Coolant” or similar high quality ethylene glycol based non-silicate, non-amine, non-nitrite and non-borate coolant with long-life hybrid organic acid technology.

U.S.A.: “Toyota Super Long Life Coolant” is a mixture of 50% coolant and 50% deionized water. (Enabled: -31°F [-35°C])

Canada: “Toyota Super Long Life Coolant” is a mixture of 55% coolant and 45% deionized water. (Enabled: -44°F [-42°C])

For more details about engine coolant, contact your Toyota dealer.

! CAUTION

n When the engine is hot

Do not remove the radiator cap.

The cooling system may be under pressure and may spray hot coolant if the cap is removed, causing burns or other injuries.

 NOTICE

n When adding engine coolant

Coolant is neither plain water nor straight antifreeze. The correct mixture of water and antifreeze must be used to provide proper lubrication, corrosion protection and cooling. Be sure to read the antifreeze or coolant label.

n If you spill coolant

Be sure to wash it off with water to prevent damage to parts or paint.

Radiator and condenser

Check the radiator and condenser and clear any foreign objects. If either of the above parts are extremely dirty or you are not sure of their condition, have your vehicle checked by your Toyota dealer.

 CAUTION

n When the engine is hot

Do not touch the radiator or condenser as they may be hot and may cause burns.

Brake fluid

n Checking fluid level

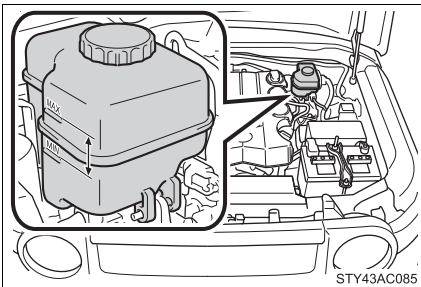

The brake fluid level should be between the MAX and MIN lines on the reservoir.

n Adding fluid

Make sure to check the fluid type and prepare the necessary items.

Fluid type	SAE J1703 or FMVSS No.116 DOT 3 brake fluid
Items	Rag or paper towel

STEP 1 Turn the engine switch off.

STEP 2 Depress the brake pedal 20 times or more.

STEP 3 Remove the reservoir cap.

STEP 4 Add newly opened brake fluid up to the MAX line.

n Brake fluid can absorb moisture from the air

Excess moisture in the fluid can cause a dangerous loss of braking efficiency. Use only newly opened brake fluid.

⚠ CAUTION**n When filling the reservoir**

Take care because brake fluid can harm your hands or eyes and damage painted surfaces.

If fluid gets on your hands or in your eyes, flush the affected area with clean water immediately.

If you still experience discomfort, see a doctor.

⚠ NOTICE**n If the fluid level is low or high**

It is normal for the brake fluid level to go down slightly as the brake pads wear or when the fluid level in the accumulator is high.

If the reservoir needs frequent refilling, it may indicate a serious problem.

n If you spill fluid

Be sure to wash it off with water to prevent damage to parts or paint.

Power steering fluid

n Fluid level

The fluid level should be within the appropriate range.

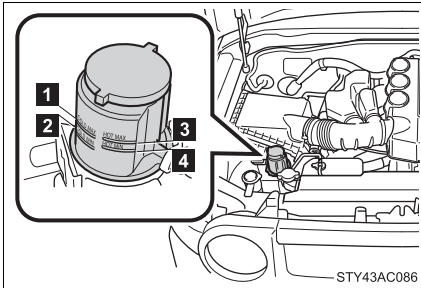

- 1 Full (when cold)
- 2 Add fluid (when cold)
- 3 Full (when hot)
- 4 Add fluid (when hot)

Hot: Vehicle has been driven around 50 mph (80 km/h) for 20 minutes, or slightly longer in frigid temperatures. (Fluid temperature, 140°F - 175°F [60°C - 80°C])

Cold: Engine has not been run for about 5 hours. (Room temperature, 50°F - 85°F [10°C - 30°C])

n Checking the fluid level

Make sure to check the fluid type and prepare the necessary items.

Fluid type	Automatic transmission fluid DEXRON® II or III
Items	Rag or paper towel

- STEP 1** Clean all dirt off the reservoir.
- STEP 2** Remove the cap by turning it counterclockwise.
- STEP 3** Wipe the dipstick clean.
- STEP 4** Reinstall and remove the reservoir cap again.
- STEP 5** Check the fluid level.

⚠ CAUTION

n Checking the fluid level

Take care, as the reservoir may be hot.

⚠ NOTICE

n When adding fluid

Avoid overfilling, or the power steering may be damaged.

n After replacing the reservoir cap

Check the steering box case, vane pump and hose connections for leaks or damage.

Battery

n Battery exterior

Make sure that the battery terminals are not corroded and that there are no loose connections, cracks, or loose clamps.

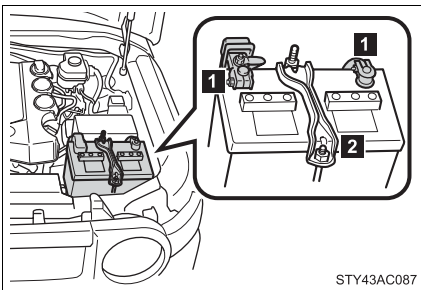

1 Terminals

2 Hold-down clamp

n Checking battery fluid

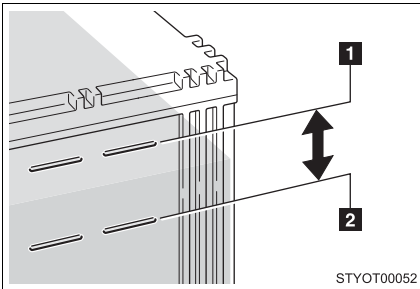

Check that the level is between the upper line and the lower line.

- 1 Upper line
- 2 Lower line

If the fluid level is at or below the lower line, add distilled water.

n Adding distilled water

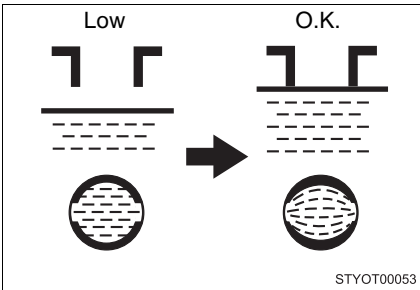

STEP 1 Remove the vent plug.

STEP 2 Add distilled water.

If the upper line cannot be seen, check the fluid level by looking directly at the cell.

STEP 3 Put the vent plug back on and close securely.

n Before recharging

When recharging, the battery produces hydrogen gas which is flammable and explosive. Therefore, before recharging:

- 1 If recharging with the battery installed on the vehicle, be sure to disconnect the ground cable.
- 1 Make sure the power switch on the charger is off when connecting and disconnecting the charger cables to the battery.

 **CAUTION**

n Chemicals in the battery

A battery contains poisonous and corrosive sulfuric acid and may produce hydrogen gas which is flammable and explosive. To reduce the risk of death or serious injury, take the following precautions while working on or near battery:

- I Do not cause sparks by touching the battery terminals with tools.
- I Do not smoke or light a match near the battery.
- I Avoid contact with eyes, skin and clothes.
- I Never inhale or swallow electrolyte.
- I Wear protective safety glasses when working near the battery.
- I Keep children away from the battery.

n Where to safety charge the battery

Always charge the battery in an open area. Do not charge the battery in a garage or closed room where there is not sufficient ventilation.

n Emergency measures regarding electrolyte

- I If electrolyte gets in your eyes
Flush your eyes with clean water for at least 15 minutes and get immediate medical attention. If possible, continue to apply water with a sponge or cloth while traveling to the nearest medical facility.
- I If electrolyte gets on your skin
Wash the affected area thoroughly. If you feel pain or burning, get medical attention immediately.
- I If electrolyte gets on your clothes
It can soak through clothing on to your skin. Immediately take off the clothing and follow the procedure above if necessary.
- I If you accidentally swallow electrolyte
Drink a large quantity of water or milk. Follow with milk of magnesia, beaten raw egg or vegetable oil. Get emergency medical attention immediately.

 NOTICE

n When recharging the battery

Never recharge the battery while the engine is running. Also, be sure all accessories are turned off.

n When adding distilled water

Avoid overfilling. Water spilled during battery recharging may cause corrosion.

Washer fluid

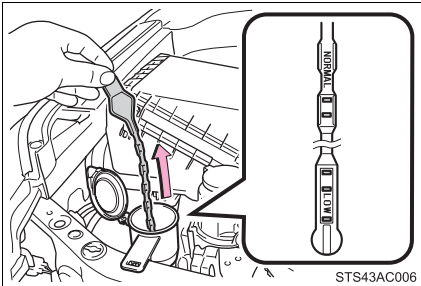

If the washer fluid level is at LOW, add washer fluid.

n Using the gauge

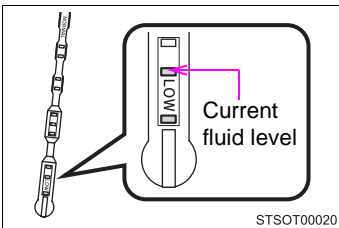

The washer fluid level can be checked by observing the position of the level on the liquid-covered holes in the gauge. If the level falls below the second hole from the bottom (the LOW position), refill the washer fluid.

 **CAUTION**

n When refilling the washer fluid

Do not refill the washer fluid when the engine is hot or running, as the washer fluid contains alcohol and may catch fire if spilled on the engine etc.

 **NOTICE**

n Do not use any fluid other than washer fluid

Do not use soapy water or engine antifreeze instead of washer fluid. Doing so may cause streaking on the vehicle's painted surfaces.

n Diluting washer fluid

Dilute washer fluid with water as necessary.

Refer to the freezing temperatures listed on the washer fluid tank.

Tires

Replace or rotate tires in accordance with maintenance schedules and treadwear.

n Checking tires

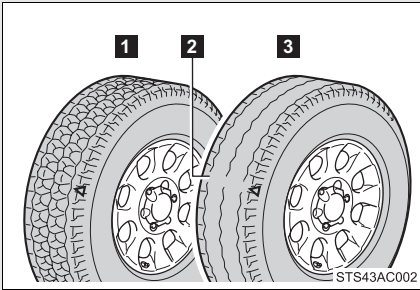

- 1 New tread
- 2 Treadwear indicator
- 3 Worn tread

The location of treadwear indicators is shown by the “TWI” or “△” marks, etc., molded on the sidewall of each tire.

Check spare tire condition and inflation pressure if not rotated.

n Tire rotation

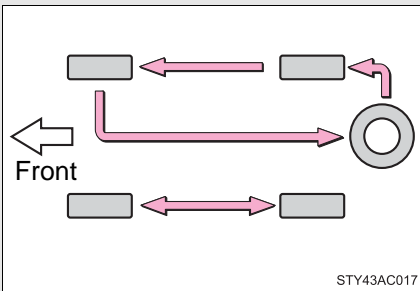

Rotate the tires in the order shown.

To equalize tire wear and extend tire life, Toyota recommends that tire rotation is carried out at the same interval as tire inspection.

n The tire pressure warning system

Your Toyota is equipped with a tire pressure warning system that uses tire pressure warning valves and transmitters to detect low tire inflation pressure before serious problems arise. (→P. 433)

Installing tire pressure warning valves and transmitters

When replacing tires or wheels, tire pressure warning valves and transmitters must also be installed.

When new tire pressure warning valves and transmitters are installed, new tire pressure warning valve and transmitter ID codes must be registered in the tire pressure warning computer and tire pressure warning system must be initialized. Have tire pressure warning valve and transmitter ID codes registered by your Toyota dealer.

Registering ID codes

The tire pressure warning valve and transmitter is equipped with a unique ID code. When replacing a tire pressure warning valve and transmitter, it is necessary to register the ID code of tire pressure warning valve and transmitter. Have the ID code registered by your Toyota dealer.

n When to replace your vehicle's tires

Tires should be replaced if:

- l You have tire damage such as cuts, splits, cracks deep enough to expose the fabric or bulges indicating internal damage
- l A tire goes flat repeatedly or cannot be properly repaired due to the size or location of a cut or other damage

If you are not sure, consult with your Toyota dealer.

n Replacing tires and wheels

If the ID code of the tire pressure warning valve and transmitter is not registered, the tire pressure warning system will not work properly. After driving for about 20 minutes, the tire pressure warning light comes on after blinking for 1 minute to indicate a system malfunction.

n Tire life

Any tire over 6 years old must be checked by a qualified technician even if they have seldom or never been used or damage is not obvious.

n If the tread wears down below 0.16 in. (4 mm) on snow tires

The effectiveness of snow tires is lost.

n Maximum load of tire

Check that the number given by dividing the maximum load by 1.10 of the replacement tire is greater than 1/2 of the Gross Axle Weight Ratings (GAWR) of either the front axle or the rear axle, whichever is greater.

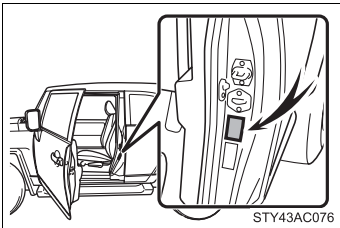

For the GAWR, see the Certification Label. For the maximum load of the tire, see the load limit at maximum cold tire inflation pressure mentioned on the sidewall of the tire. (→P. 482)

n Tire types

1 Summer tires

Summer tires are high-speed performance tires best suited to highway driving under dry conditions. Since summer tires do not have the same traction performance as snow tires, summer tires are inadequate for driving on snow-covered or icy roads. For driving on snow-covered roads or icy roads, the use of snow tires is recommended. When installing snow tires, be sure to replace all four tires.

2 All season tires

All season tires are designed to provide better traction in snow and to be adequate for driving in most winter conditions, as well as for use year round. All season tires, however, do not have adequate traction performance compared with snow tires in heavy or loose snow. Also, all season tires fall short in acceleration and handling performance compared with summer tires in highway driving.

3 Snow tires

For driving on snow-covered roads or icy roads, we recommend using snow tires. If you need snow tires, select tires of the same size, construction and load capacity as the originally installed tires. Since your vehicle has radial tires as original equipment, make sure your snow tires also have radial construction. Do not install studded tires without first checking local regulations for possible restriction. Snow tires should be installed on all wheels. (→P. 190)

n Routine tire inflation pressure checks

The tire pressure warning system does not replace routine tire inflation pressure checks. Make sure to check tire inflation pressure as part of your routine of daily vehicle checks.

n Tire pressure warning system certification

FCC ID: PAXPMV107J

FCC ID: HYQ13BCX

► For vehicles sold in the U.S.A.

NOTE:

This device complies with part 15 of the FCC Rules. Operation is subject to the following two conditions: (1) This device may not cause harmful interference, and (2) this device must accept any interference received, including interference that may cause undesired operation.

FCC WARNING:

Changes or modifications not expressly approved by the party responsible for compliance could void the user's authority to operate the equipment.

► For vehicles sold in Canada

NOTE:

Operation is subject to the following two conditions: (1) this device may not cause interference, and (2) this device must accept any interference, including interference that may cause undesired operation of the device.

 **CAUTION****n When inspecting or replacing tires**

Observe the following precautions to prevent accidents. Failure to do so may cause damage to parts of the drive train, as well as dangerous handling characteristics, which may lead to an accident resulting in death or serious injury.

- I Do not mix tires of different makes, models or tread patterns. Also, do not mix tires of remarkably different treadwear.
- I Do not use tire sizes other than those recommended by Toyota.
- I Do not mix differently constructed tires (radial, bias-belted or bias-ply tires).
- I Do not mix summer, all season and winter tires.

 NOTICE

n Repairing or replacing tires, wheels, tire pressure warning valves, transmitters and tire valve caps

l When removing or fitting the wheels, tires or the tire pressure warning valve and transmitter, contact your Toyota dealer as the tire pressure warning valve and transmitter may be damaged if not handled correctly.

l When replacing tire valve caps, do not use tire valve caps other than those specified. The cap may become stuck.

n To avoid damage to the tire pressure warning valves and transmitters

When a tire is repaired with liquid sealants, the tire pressure warning valve and transmitter may not operate properly. If a liquid sealant is used, contact your Toyota dealer or other qualified service shop as soon as possible. Make sure to replace the tire pressure warning valve and transmitter when replacing the tire. (→P. 382)

n Driving on rough roads

Take particular care when driving on roads with loose surfaces or potholes.

These conditions may cause losses in tire inflation pressure, reducing the cushioning ability of the tires. In addition driving on rough roads may cause damage to the tires themselves, as well as the vehicle's wheels and body.

n If tire inflation pressures become low while driving

Do not continue driving, or your tires and/or wheels may be ruined.

4-3. Do-it-yourself maintenance

Tire inflation pressure

n Tire inflation pressure

The recommended cold tire inflation pressure and tire size is displayed on the tire and loading information label. (→P. 477)

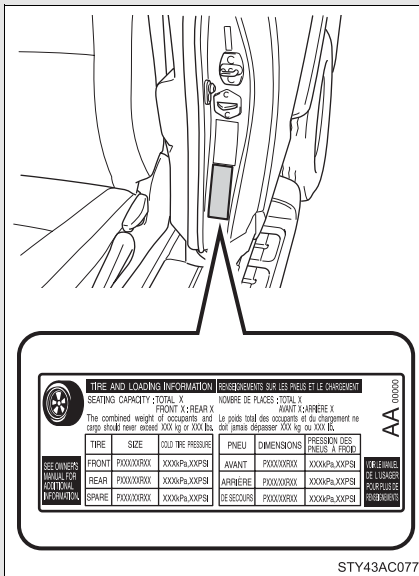

n Inspection and adjustment procedure

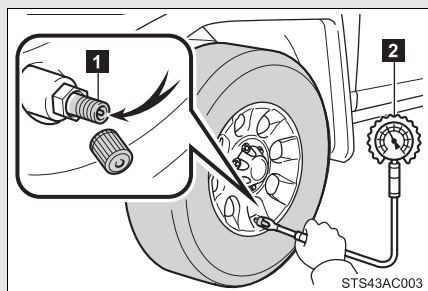

STEP 1 Remove the tire valve cap.

STEP 2 Press the tip of the tire pressure gauge onto the tire valve.

STEP 3 Read the pressure using the graduations of the gauge.

STEP 4 If the tire inflation pressure is not within the recommended levels, adjust inflate the tire.

If you add too much air, press the center of the valve to lower.

STEP 5 After completing the tire inflation pressure measurement and adjustment, apply soapy water to the valve and check for leakage.

STEP 6 Reinstall the tire valve cap.

n Tire inflation pressure check interval

You should check tire pressure every two weeks, or at least once a month.

Do not forget to check the spare.

n Effects of incorrect tire inflation pressure

Driving with incorrect tire inflation pressure may result in the following:

- l Reduced fuel efficiency
- l Reduced driving comfort and tire life
- l Reduced safety
- l Damage to the drive train

If a tire needs frequent refilling, have it checked by your Toyota dealer.

n Instructions for checking tire inflation pressure

When checking tire inflation pressure, observe the following:

- l Check only when the tires are cold.

If your vehicle has been parked for at least 3 hours and has not been driven for more than 1 mile or 1.5 km, you will get an accurate cold tire inflation pressure reading.

- l Always use a tire pressure gauge.

The appearance of the tire can be misleading. In addition, tire inflation pressures that are even just a few pounds off can degrade ride and handling.

- l Do not bleed or reduce tire inflation pressure after driving. It is normal for the tire inflation pressure to be higher after driving.

- l Never exceed the vehicle capacity weight.

Passengers and luggage weight should be placed so that the vehicle is balanced.

 CAUTION

n Proper inflation is critical to save tire performance

Keep your tires properly inflated.

Otherwise, the following conditions may occur and result in an accident causing death or serious injury.

- I Excessive wear
- I Uneven wear
- I Poor handling
- I Possibility of blowouts resulting from overheated tires
- I Poor sealing of the tire bead
- I Wheel deformation and/or tire separation
- I A greater possibility of tire damage from road hazards

 NOTICE

n When inspecting and adjusting tire inflation pressure

Be sure to reinstall the tire valve caps.

Without the valve caps, dirt or moisture could get into the valve and cause air leakage, which could result in an accident. If the caps have been lost, replace them as soon as possible.

Wheels

If a wheel is bent, cracked or heavily corroded, it should be replaced.

Otherwise, the tire may separate from the wheel or cause loss of handling control.

n Wheel selection

When replacing wheels, care should be taken to ensure that they are equivalent to those removed in load capacity, diameter, rim width, and inset*.

Replacement wheels are available at your Toyota dealer.

*: Conventionally referred to as “offset”.

Toyota does not recommend using:

- 1 Wheels of different sizes or types
- 1 Used wheels
- 1 Bent wheels that have been straightened

n Aluminum wheel precautions (if equipped)

- 1 Use only Toyota wheel nuts and wrench designed for use with your aluminum wheels.
- 1 When rotating, repairing or changing your tires, check that the wheel nuts are still tight after driving 1000 miles (1600 km).
- 1 Be careful not to damage the aluminum wheels when using tire chains.
- 1 Use only Toyota genuine balance weights or equivalent and a plastic or rubber hammer when balancing your wheels.

n When replacing wheels

The wheels of your Toyota are equipped with tire pressure warning valves and transmitters that allow the tire pressure warning system to provide advanced warning in the event of a loss in tire inflation pressure. Whenever wheels are replaced, the tire pressure warning valves and transmitters must be installed. (→P. 382)

⚠ CAUTION

n When replacing wheels

- I** Do not use wheels that are a different size from those recommended in the Owner's Manual, as this may result in loss of handling control.
- I** Never use an inner tube in a leaking wheel which is designed for a tubeless tire. Doing so may result in an accident, causing death or serious injury.

n When installing the wheel nuts

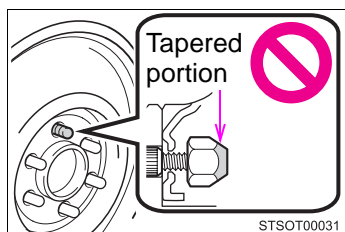

- I** Be sure to install the wheel nuts with the tapered end facing inward. Installing the nuts with the tapered end facing outward can cause wheel to break and eventually cause a wheel to come off while driving, which could lead to an accident resulting in death or serious injury.

- I** Never use oil or grease on the wheel bolts or wheel nuts. Oil and grease may cause the wheel nuts to be excessively tightened, leading to bolt or disc wheel damage. In addition, the oil or grease can cause the wheel nuts to loosen and the wheel may fall off, causing an accident and resulting in death or serious injury. Remove any oil or grease from the wheel bolts or wheel nuts.

**NOTICE****n Replacing tire pressure warning valves and transmitters**

- I** Because tire repair or replacement may affect the tire pressure warning valves and transmitters, make sure to have tires serviced by your Toyota dealer or other qualified service shop. In addition, make sure to purchase your tire pressure warning valves and transmitters at your Toyota dealer.
- I** Ensure that only Genuine Toyota wheels are used on your vehicle. Tire pressure warning valves and transmitters may not work properly with non-genuine wheels.

4-3. Do-it-yourself maintenance

Air conditioning filter

The air conditioning filter must be changed regularly to maintain air conditioning efficiency.

n Removal method

STEP 1 Turn the engine switch off.

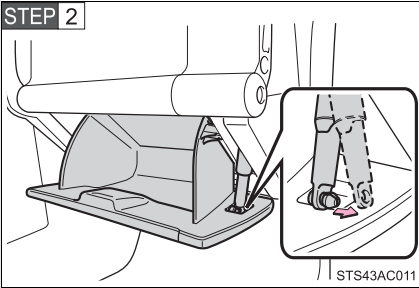

Open the glove box. Slide off the damper.

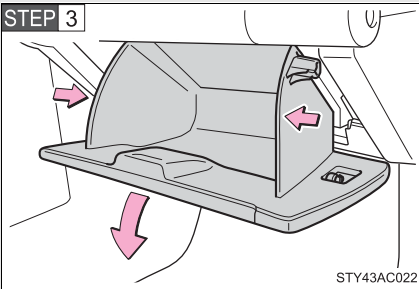

Push in each side of the glove box to disconnect the upper claws.

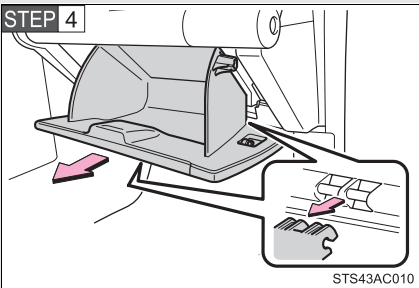

Then disconnect the claws at the bottom and remove the glove box.

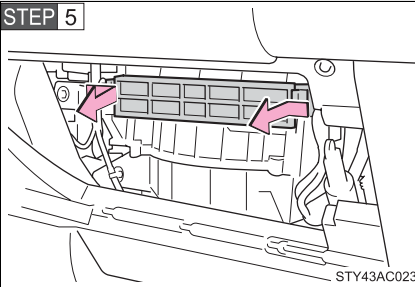
STEP 5

Remove the filter case.

n Replacement method

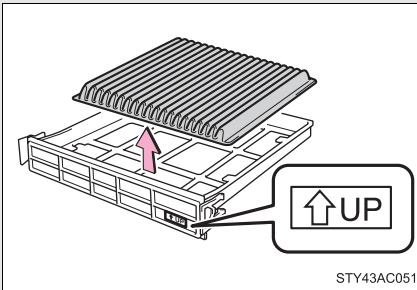

Remove the air conditioning filter and replace it with a new one.

The “↑UP” marks shown on the filter should be pointing up.

n Checking interval

Inspect and replace the air conditioning filter according to the maintenance schedule. In dusty areas or areas with heavy traffic flow, early replacement may be required. (For scheduled maintenance information, please refer to the “Scheduled Maintenance Guide” or “Owner’s Manual Supplement”.)

n If air flow from the vents decreases dramatically

The filter may be clogged. Check the filter and replace if necessary.

 NOTICE

n When using the air conditioning system

Make sure that a filter is always installed.

Using the air conditioning system without a filter may cause damage to the system.

Key battery

Replace the battery with a new one if it is discharged.

n You will need the following items:

- 1 Small Phillips-head screwdriver
- 1 Lithium battery CR2016

n Replacing the battery

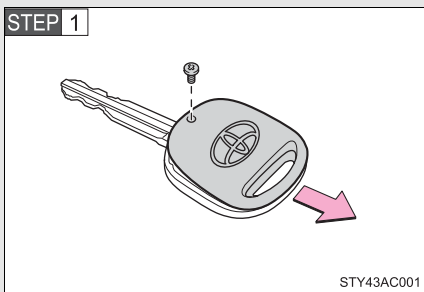

Remove the screw and cover.

Push the cover in the arrow direction.

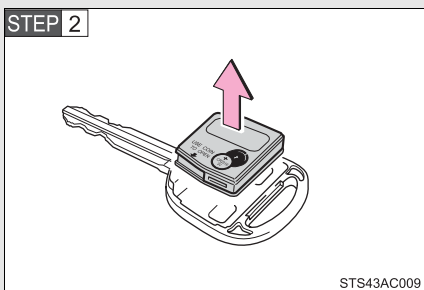

Remove the module.

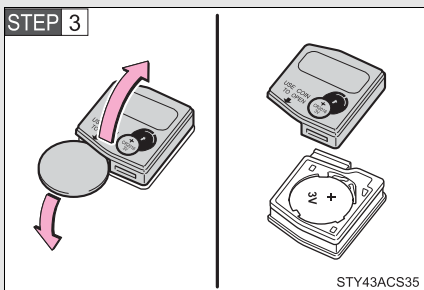

Open the case cover using a coin protected with tape etc. and remove the depleted battery.

Insert a new battery with the "+" terminal facing up.

n If the key battery is discharged

The following symptoms may occur.

- | The wireless remote control will not function properly.
- | The operational range is reduced.

n Use a CR2016 lithium battery

- | Batteries can be purchased at your Toyota dealer, jewelers, or camera stores.
- | Replace only with the same or equivalent type recommended by your Toyota dealer.
- | Dispose of used batteries according to the local laws.



CAUTION

n Removed battery and other parts

Keep away from children. These parts are small and if swallowed by a child, they can cause choking. Failure to do so could result in death or serious injury.



NOTICE

n For normal operation after replacing the battery

Observe the following precautions to prevent accidents.

- | Always work with dry hands.
Moisture may cause the battery to rust.
- | Do not touch or move any other components inside the remote control.
- | Do not bend either of the battery terminals.

4-3. Do-it-yourself maintenance

Checking and replacing fuses

If any of the electrical components do not operate, a fuse may have blown. If this happens, check and replace the fuses as necessary.

STEP 1 Turn the engine switch off.

STEP 2 The fuses are located in the following places. To check the fuses, follow the instructions below.

n Engine compartment

► Type A

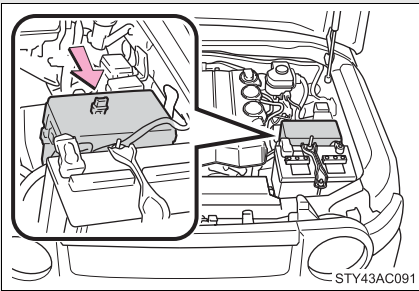

Push the tab in and lift the lid off.

► Type B (if equipped)

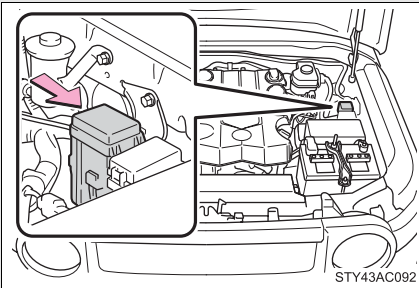

Push the tab in and lift the lid off.

n Under the instrument panel

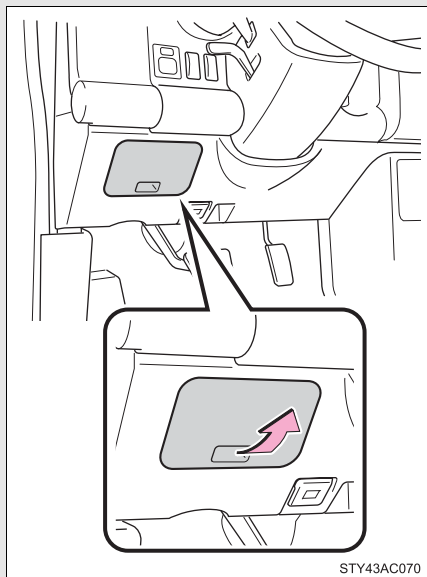

Remove the lid.

STEP 3 After a system failure, see “Fuse layout and amperage ratings” (→P. 403) for details about which fuse to check.

STEP 4

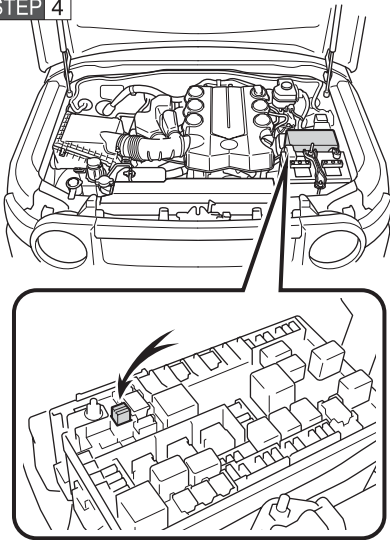

STY43AC093

Remove the fuse with the pull-out tool.

STEP 5 Check if the fuse has blown.

► Type A

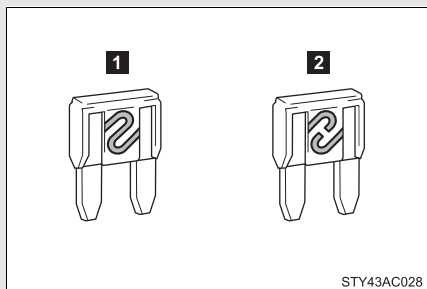

1 Normal fuse

2 Blown fuse

Replace it with one of an appropriate amperage rating. The amperage rating can be found on the fuse box lid.

► Type B

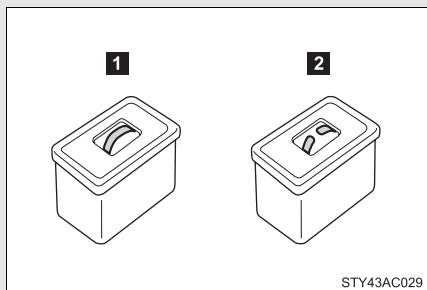

1 Normal fuse

2 Blown fuse

Replace it with one of an appropriate amperage rating. The amperage rating can be found on the fuse box lid.

► Type C

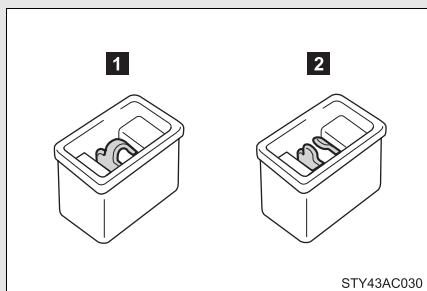

1 Normal fuse

2 Blown fuse

Replace it with one of an appropriate amperage rating. The amperage rating can be found on the fuse box lid.

Fuse layout and amperage ratings

n Engine compartment

► Type A

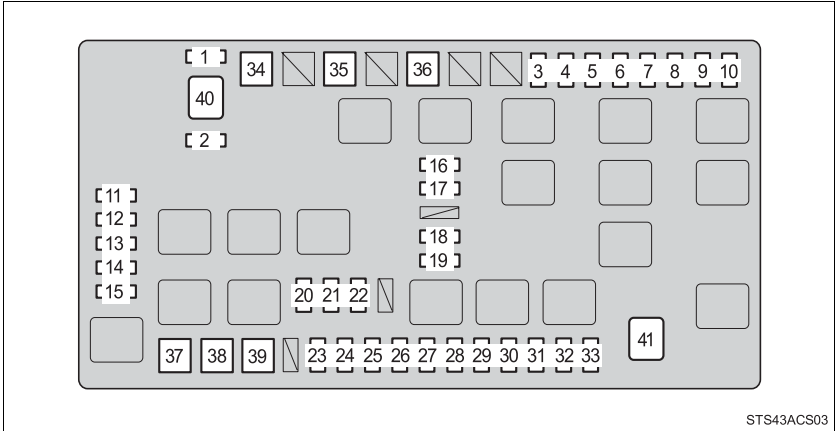

► Type B (if equipped)

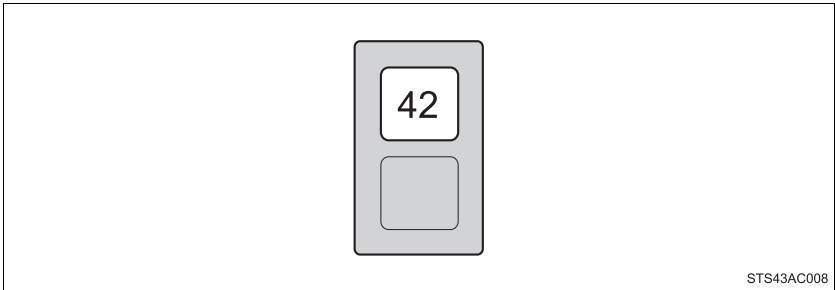

Fuse		Ampere	Circuit
1	SPARE	10 A	Spare fuse
2	SPARE	15 A	Spare fuse
3	TOWING TAIL	15 A	Trailer lights
4	RR FOG	10 A	No circuit
5	OFFROAD LP	15 A	Offroad lamp
6	STOP	10 A	Stop lights, high mounted stop-light, anti-lock brake system, traction control system, active traction control system, vehicle stability control system, AUTO LSD system, multiport fuel injection system/ sequential multiport fuel injection system, shift lock system
7	DEICER	20 A	No circuit
8	AUX LP	15 A	Driving lamp
9	TOWING BRK	30 A	No circuit
10	OBD	7.5 A	On-board diagnosis system
11	HEAD (LO RH)	10 A	Right-hand headlight (low beam) ^{*1}
			Right-hand headlight ^{*2}
12	HEAD (LO LH)	10 A	Left-hand headlight (low beam) ^{*1}
			Left-hand headlight ^{*2}
13	HEAD (HI RH)	10 A	Right-hand headlight (high beam) ^{*1}
14	HEAD (HI LH)	10 A	Left-hand headlight (high beam) ^{*1}
15	EFI NO.2	10 A	Multiport fuel injection system/ sequential multiport fuel injection system
16	INJ	10 A	Multiport fuel injection system/ sequential multiport fuel injection system
17	DRL	7.5 A	Daytime running light system

Fuse		Ampere	Circuit
18	DEFOG	30 A	Rear window defogger
19	DEFOG NO.2	10 A	Multiport fuel injection system/ sequential multiport fuel injection system
20	DOME	10 A	Interior light, personal lights, engine switch light, clock, acces- sory meter, meter and gauge
21	RADIO NO.1	20 A	Audio system
22	ECU-B	10 A	Air conditioning system, multiplex communication system, SRS air- bag system, front passenger occu- pant classification system
23	ALT-S	7.5 A	Charging system
24	AI-VSV	10 A	No circuit
25	HORN	10 A	Horn
26	A/F HEATER	15 A	Multiport fuel injection system/ sequential multiport fuel injection system
27	TRN-HAZ	15 A	Turn signal lights, emergency flashers
28	ETCS	10 A	Multiport fuel injection system/ sequential multiport fuel injection system, electronic throttle control system
29	EFI	20 A	EFI NO.2, multiport fuel injection system/sequential multiport fuel injection system
30	TOWING NO.2	30 A	No circuit
31	DR/LCK	20 A	Door lock system, multiplex com- munication system
32	TOWING	15 A	Towing converter
33	RADIO NO.2	20 A	Audio system

4-3. Do-it-yourself maintenance

Fuse		Ampere	Circuit
34	AIR PMP	50 A	No circuit
35	AM1	50 A	ACC, ECU-IG, IG1, RR WSH, FR WIP-WSH, 4WD/DIFF and STA
36	J/B	50 A	TAIL, PWR OUTLET, POWER
37	ABS MTR	40 A	Anti-lock brake system, vehicle stability control system, traction control system, active traction control system, AUTO LSD system
38	AM2	30 A	IGN and GAUGE, multiport fuel injection system/sequential multiport fuel injection system, starting system
39	ABS SOL	30 A	Anti-lock brake system, vehicle stability control system, traction control system, active traction control system, AUTO LSD system
40	ALT	120 A	AM1, AC 115V, DEFOG, DEFOG NO.2, STOP, OBD, J/B, TOWING TAIL, AUX LP and OFFROAD LP
41	HEATER	60 A	Air conditioning system
42	AC 115V	80 A	Power outlet

*1: Vehicles with daytime running light

*2: Vehicles without daytime running light

n Under the instrument panel

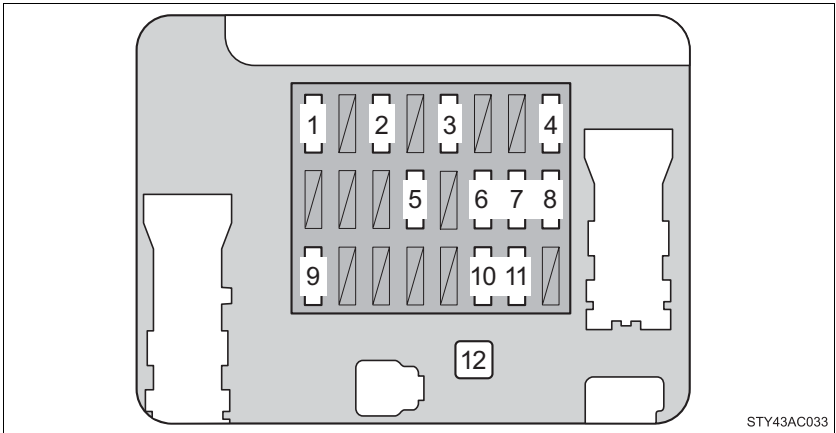

Fuse		Ampere	Circuit
1	IGN	10 A	Multiport fuel injection system/ sequential multiport fuel injection system, anti-lock brake system, vehicle stability control system, traction control system, active trac- tion control system, AUTO LSD system, SRS airbag system, front passenger occupant classification system
2	GAUGE	7.5 A	Meter and gauge
3	FR WIP-WSH	30 A	Windshield wipers and washer
4	4WD/DIFF	20 A	Four-wheel drive system, rear dif- ferential lock system
5	PWR OUTLET	15 A	Power outlet
6	RR WSH	15 A	Rear window wiper and washer, multiplex communication system

Fuse		Ampere	Circuit
7	ECU-IG	10 A	Anti-lock brake system, vehicle stability control system, traction control system, active traction control system, AUTO LSD system, cruise control system, back door lock system, shift lock system, multiplex communication system
8	IG1	15 A	Turn signal lights, air conditioning system, charging system, clutch start cancel switch, anti-lock brake system, traction control system, active traction control system, vehicle stability control system, AUTO LSD system, back-up lights, intuitive parking assist, rear differential lock system, power outlet, accessory meter, meter and gauge, rear view monitor system
9	STA	7.5 A	Starting system, clutch start cancel switch, power outlet
10	TAIL	10 A	Tail lights, license plate lights, parking lights, instrument panel light control, illuminations
11	ACC	7.5 A	Shift lock system, outside rear view mirrors, audio system, power outlet, clock, accessory meter, multiplex communication system
12	POWER	30 A	Power windows

n After a fuse is replaced

- l If the lights do not turn on even after the fuse has been replaced, a bulb may need replacement. (→P. 410)
- l If the replaced fuse blows again, have the vehicle inspected by your Toyota dealer.

n If there is an overload in the circuits

The fuses are designed to blow, protecting the wiring harness from damage.

⚠ CAUTION**n To prevent system breakdowns and vehicle fire**

Observe the following precautions.

Failing to do so may cause damage, and possibly a fire or injury.

- l Never use a fuse of a higher amperage rating than indicated, or use any other object in place of a fuse.
- l Always use a genuine Toyota fuse or equivalent.
Never replace a fuse with a wire, even as a temporary fix.
This can cause extensive damage or even fire.
- l Do not modify the fuse or the fuse box.

⚠ NOTICE**n Before replacing fuses**

Have the cause of electrical overload determined and repaired by your Toyota dealer as soon as possible.

Light bulbs

You may replace the following bulbs yourself. The difficulty level of replacement varies depending on the bulb. If necessary bulb replacement seems difficult to perform, contact your Toyota dealer.

For more information about replacing other light bulbs, contact your Toyota dealer.

n Prepare a replacement light bulb.

Check the wattage of the light bulb being replaced. (→P. 478)

n Front bulb locations

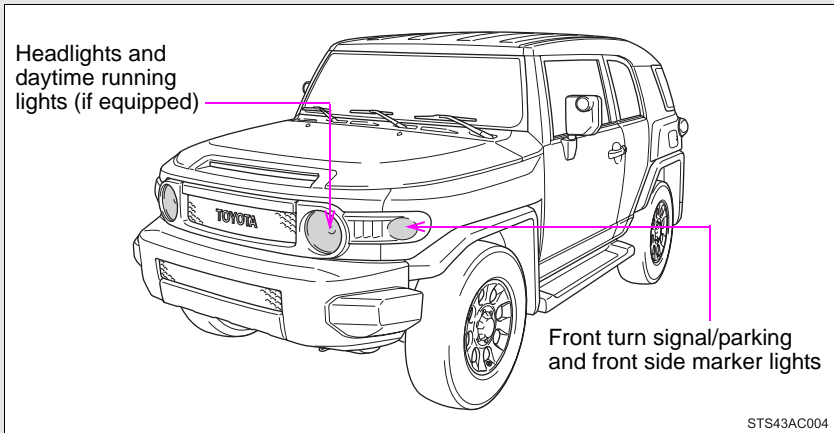

n Rear bulb locations

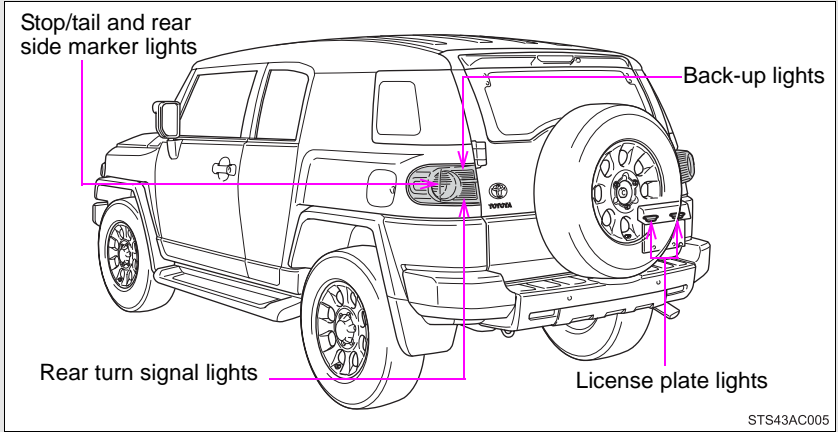

Replacing light bulbs

n Headlights and daytime running lights (if equipped)

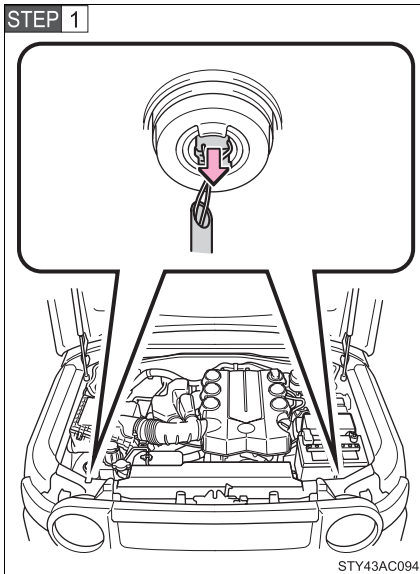

Unplug the connector.

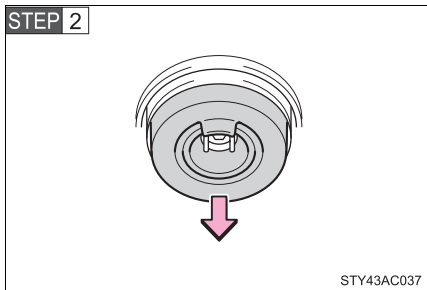

Remove the rubber cover.

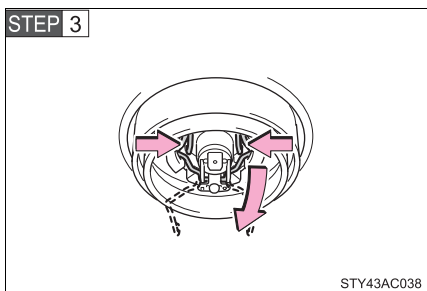

Release the bulb retaining spring.

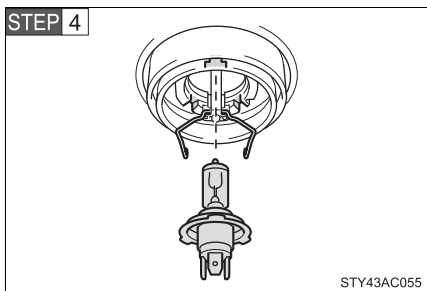

Remove the bulb.

To install a new bulb, align the tabs of the bulb with the cutouts of the mounting hole.

n Front turn signal/parking and front side marker lights

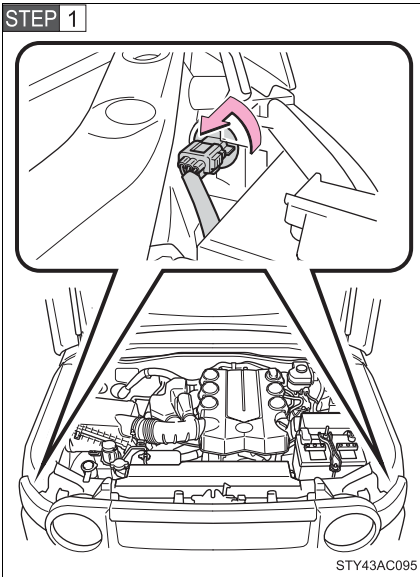

Turn the bulb base counterclockwise.

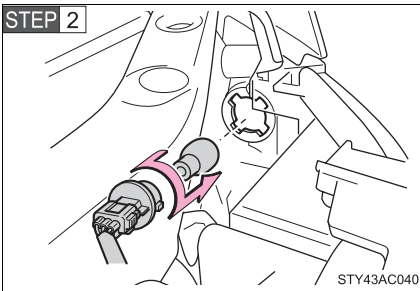

Remove the light bulb.

n Back-up lights, stop/tail and rear side marker and rear turn signal light bulbs

1 Removing the sub woofer speaker (vehicles with sub woofer)

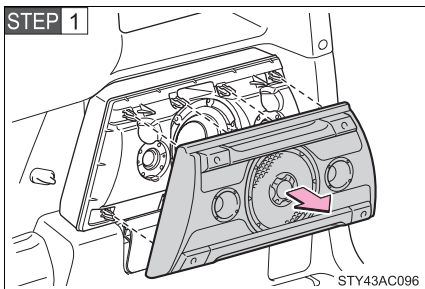

Remove the speaker cover.

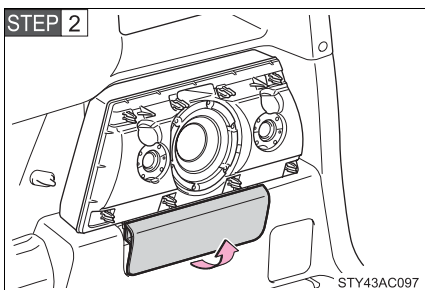

Remove the cover.

Installing the sub woofer speaker
(→P. 417)

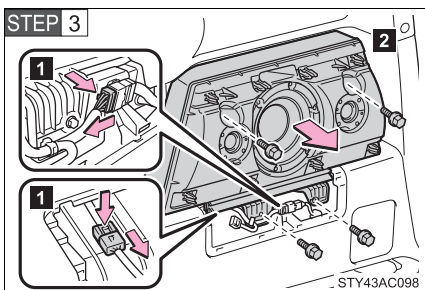

Remove the sub woofer speaker.

1 Disconnect the connectors.

2 Remove the 4 screws and the sub woofer speaker.

1 Removing the back-up, stop/tail and rear side marker and rear turn signal light bulbs

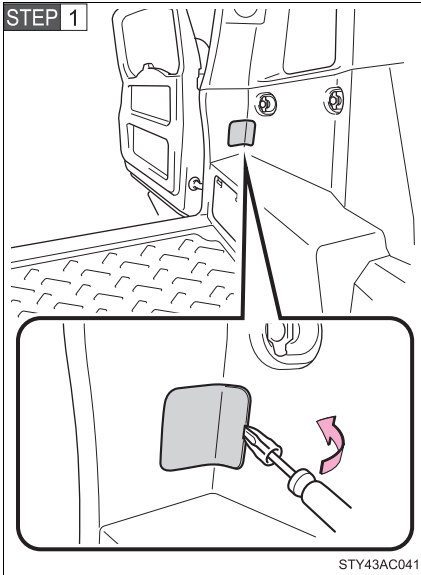

Open the back door and remove the cover.

Using a flathead screwdriver or equivalent which is wrapped with a cloth.

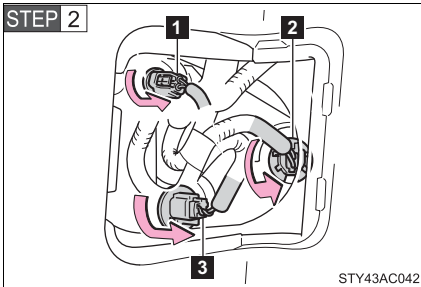

Turn the bulb bases counter-clockwise.

- 1** Back-up light
- 2** Stop/tail and rear side marker lights
- 3** Rear turn signal light

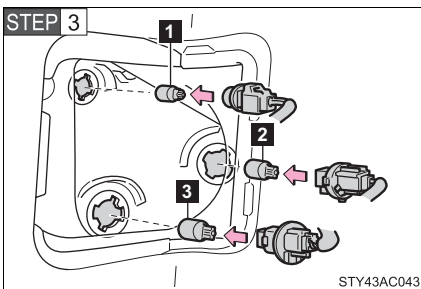

Remove the light bulb.

- 1** Back-up light
- 2** Stop/tail and rear side marker lights
- 3** Rear turn signal light

n License plate lights

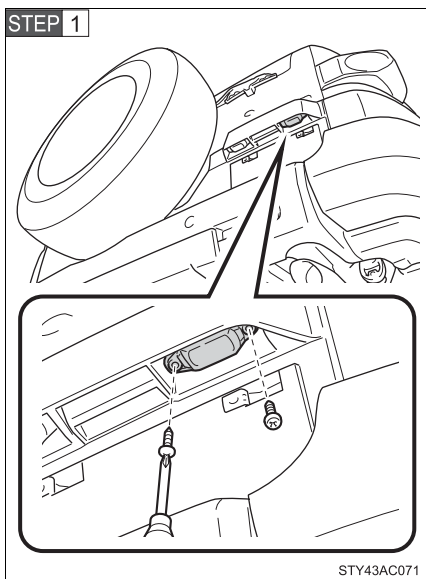

Remove the screws and cover.

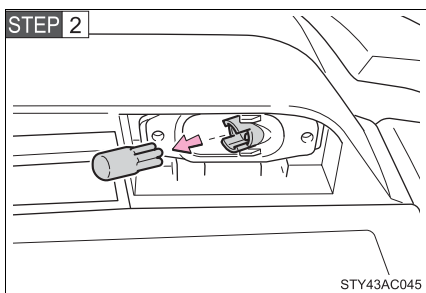

Remove the light bulb.

n Lights other than the above

If any of the lights listed below has burnt out, have it replaced by your Toyota dealer.

- Outside rear view mirror illumination lights (if equipped)
- High mounted stoplight

n Condensation build-up on the inside of the lens

Contact your Toyota dealer for more information in the following situations. Temporary condensation build-up on the inside of the headlight lens does not indicate a malfunction.

- l Large drops of water are built up on the inside of the lens.
- l Water has built up inside the headlight.

n LED high mounted stoplight

The high mounted stoplight consists of a number of LEDs. If any of the LEDs burn out, take your vehicle to your Toyota dealer to have the light replaced.

n Installing the sub woofer speaker (vehicles with sub woofer)

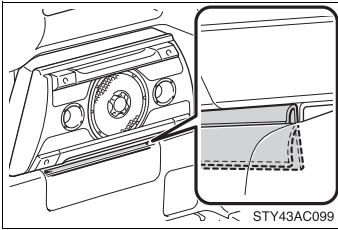

Install the rubber inside the panel as shown in the illustration.

⚠ CAUTION

n Replacing light bulbs

- l Turn off the headlights. Do not attempt to replace the bulb immediately after turning off the headlights. The bulbs become very hot and may cause burns.
- l Do not touch the glass portion of the light bulb with bare hands. Hold the bulb by the plastic or metal portion. If the bulb is scratched or dropped it may blow out or crack.
- l Fully install light bulbs and any parts used to secure them. Failing to do so may result in heat damage, fire, or water entering the headlight unit. This may damage the headlights or cause condensation to build up on the lens.

n To prevent damage or fire

Make sure bulbs are fully seated and locked.

5-1. Essential information

Emergency flashers

Use the emergency flashers if the vehicle malfunctions or is involved in an accident.

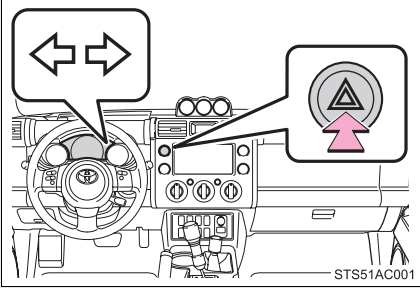

Press the switch to flash all the turn signal lights. To turn them off, press the switch once again.

NOTICE

n To prevent battery discharge

Do not leave the emergency flashers on longer than necessary when the engine is not running.

If your vehicle needs to be towed

If towing is necessary, we recommend having your vehicle towed by your Toyota dealer or a commercial towing service, using a lift-type truck or a flat bed truck.

Use a safety chain system for all towing, and abide by all state/provincial and local laws.

The wheels and axle on the ground must be in good condition.

If they are damaged, use a towing dolly or flat bed truck.

Before towing

The following may indicate a problem with your transmission. Contact your Toyota dealer before towing.

- 1 The engine is running, but the vehicle will not move.
- 1 The vehicle makes an abnormal sound.

Emergency towing

If a tow truck is not available, in an emergency your vehicle may be temporarily towed using a cable or chain secured to the emergency towing eyelet. This should only be attempted on hard, surfaced roads for short distances at low speeds.

A driver must be in the vehicle to steer and operate the brakes. The vehicle's wheels, drive train, axles, steering and brakes must be in good condition.

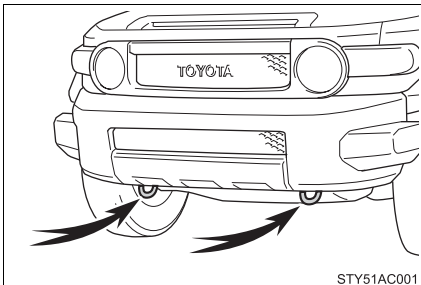

Towing eyelet

n Emergency towing procedure

STEP 1 The engine switch must be in the ACC (engine off) or the ON (engine running) position.

STEP 2 4WD models with an automatic transmission: Shift the front-wheel drive control lever in H2.

4WD models with a manual transmission: Unlock the center differential.

STEP 3 Put the shift lever in N.

STEP 4 Release the parking brake.

 **CAUTION**

n Caution while towing

I Use extreme caution when towing the vehicle.

Avoid sudden starts or erratic driving maneuvers which would place excessive stress on the emergency towing eyelet and the cables or chains. Always be cautious of the surroundings and other vehicles while towing.

I If the engine is not running, the power assist for the brakes and steering will not function, making steering and braking more difficult.

 **NOTICE**

n To prevent causing serious damage to the transmission (vehicles with an automatic transmission)

Never tow this vehicle from the rear with the four wheels on the ground. This may cause serious damage to the transmission.

n Emergency towing eyelet precautions

I Before emergency towing, check that the eyelet is not broken or damaged.

I Fasten the towing cable or chain securely to the eyelet.

I Do not jerk the eyelet. Apply steady and even force.

I To avoid damaging the eyelet, do not pull from the side or at a vertical angle. Always pull straight ahead.

Towing with a sling-type truck

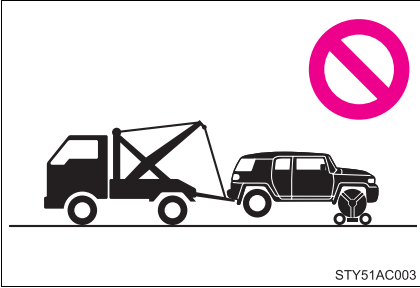

NOTICE

n To prevent body damage

Do not tow with a sling-type truck, either from the front or rear.

Towing with a wheel lift-type truck from the front

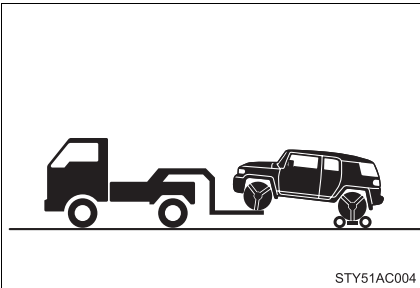

Use a towing dolly under the rear wheels.

NOTICE

n To prevent causing serious damage to the transmission

Never tow this vehicle wheels on the ground.

Towing with a wheel lift-type truck from the rear

► 2WD models

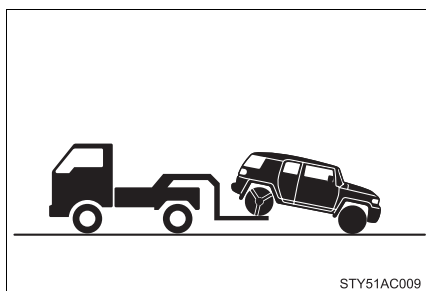

Turn the engine switch to the ACC position.

► 4WD models

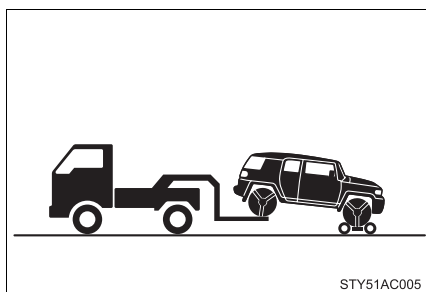

Vehicles with a manual transmission: Use a towing dolly under the front wheels.

Vehicles with an automatic transmission: When not using a towing dolly, turn the engine switch to the ACC position, shift the shift lever to N and shift the front-wheel drive control lever in H2.

⚠ NOTICE

■ To prevent causing serious damage to the transmission (4WD models)

Never tow this vehicle wheels on the ground.

■ To prevent damaging the vehicle

- ! Do not tow the vehicle with the key removed or in the LOCK position. The steering lock mechanism is not strong enough to hold the front wheel straight.
- ! When raising the vehicle, ensure adequate ground clearance for towing at the opposite end of the raised vehicle. Without adequate clearance, the vehicle could be damaged while being towed.

Using a flat bed truck

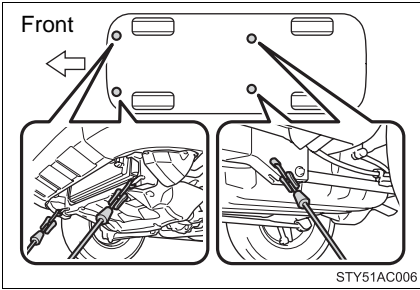

If your Toyota is transported by a flat bed truck, it should be tied down at the locations shown in the illustration.

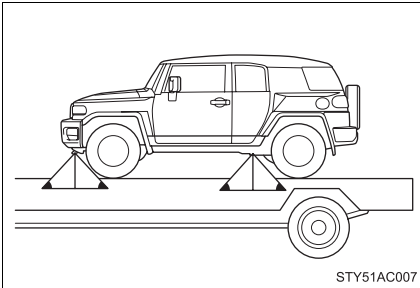

If you use chains or cables to tie down your vehicle, the angles shaded in black must be 45°.

Do not overly tighten the tie downs or the vehicle may be damaged.

Apply the parking brake firmly.

If you think something is wrong

If you notice any of the following symptoms, your vehicle probably needs adjustment or repair. Contact your Toyota dealer as soon as possible.

n Visible symptoms

- 1 Fluid leaks under the vehicle
(Water dripping from the air conditioning after use is normal.)
- 1 Flat-looking tires or uneven tire wear
- 1 Engine coolant temperature gauge needle continually points higher than normal
- 1 Voltmeter continually points higher or lower than normal.

n Audible symptoms

- 1 Changes in exhaust sound
- 1 Excessive tire squeal when cornering
- 1 Strange noises related to the suspension system
- 1 Pinging or other noises related to the engine

n Operational symptoms

- 1 Engine missing, stumbling or running rough
- 1 Appreciable loss of power
- 1 Vehicle pulls heavily to one side when braking
- 1 Vehicle pulls heavily to one side when driving on a level road
- 1 Loss of brake effectiveness, spongy feeling, pedal almost touches the floor

Fuel pump shut off system

To minimize the risk of fuel leakage when the engine stalls or an air-bag inflates upon collision, the fuel pump shut off system stops supplying fuel to the engine.

Follow the procedure below to restart the engine after the system is activated.

STEP 1 Turn the engine switch to the ACC or LOCK position.

STEP 2 Restart the engine.



NOTICE

n Before starting the engine

Inspect the ground under the vehicle.

If you find that fuel has leaked onto the ground, the fuel system has been damaged and is in need of repair. Do not restart the engine.

5-1. Essential information

Event data recorder

Your vehicle has computers that monitor and control certain aspects of your vehicle. These computers assist in driving and maintaining optimal vehicle performance.

Besides storing data useful for troubleshooting, there is an event data recorder (EDR) that records data in a crash or a near car crash event.

In a crash or a near car crash event

The SRS airbag sensor assembly contains the EDR. In a crash or a near car crash event, this device may record some or all of the following information:

- 1 Engine speed
- 1 Whether the brake pedal was applied or not
- 1 Vehicle speed
- 1 To what extent the accelerator pedal was depressed
- 1 Position of the transmission shift lever
- 1 Whether the driver and front passenger wore seat belts or not
- 1 Driver's seat position
- 1 SRS airbag deployment data
- 1 SRS airbag system diagnostic data
- 1 Front passenger's occupant classification
- 1 Whether the RSCA OFF indicator was turned on or off

The information above is intended to be used for the purpose of improving vehicle safety performance. Unlike general data recorders, the EDR does not record sound data such as conversation between passengers.

Disclosure of the data

Toyota will not disclose the data recorded in an EDR to a third party except when:

- 1 An agreement from the vehicle's owner (or the leasing company for a leased vehicle) is obtained
- 1 Officially requested by the police or other authorities
- 1 Used as a defense for Toyota in a law suit
- 1 Ordered by a court of law

However, if necessary Toyota will:

- 1 Use the data for research on Toyota vehicle safety performance
- 1 Disclose the data to a third party for research purposes without disclosing details of the vehicle owner, and only when it is deemed necessary
- 1 Disclose summarized data cleared of vehicle identification information to a non-Toyota organization for research purposes



5-2. Steps to take in an emergency

If a warning light turns on or a warning buzzer sounds...

Calmly perform the following actions if any of the warning lights turn on or flash. If a light turns on or flashes, but then turns off, this does not necessarily indicate a malfunction in the system.



Stop the vehicle immediately. Continuing to drive the vehicle may be dangerous.

The following warning indicates a possible problem in the brake system. Immediately stop the vehicle in a safe place and contact your Toyota dealer.

Warning light	Warning light/Details
 (U.S.A.)  (Canada)	Brake system warning light <ul style="list-style-type: none">• Low brake fluid• Malfunction in the brake system This light also comes on when the parking brake is not released. If the light turns off after the parking brake is fully released, the system is operating normally.

Stop the vehicle immediately.



The following warnings indicate the possibility of damage to the vehicle that may lead to an accident. Immediately stop the vehicle in a safe place and contact your Toyota dealer.







Warning light	Warning light/Details
	<p>Charging system warning light Indicates a malfunction in the vehicle's charging system.</p>
	<p>Low engine oil pressure warning light Indicates that the engine oil pressure is too low*.</p>

*: The light may come on when the oil level is extremely low. It is not designed to indicate low oil level, and the oil level must be checked using the engine oil level dipstick.

Have the vehicle inspected immediately.





Failing to investigate the cause of the following warnings may lead to the system operating abnormally and possibly cause an accident. Have the vehicle inspected by your Toyota dealer immediately.



Warning light	Warning light/Details
 (U.S.A.)	<p>Malfunction indicator lamp Indicates a malfunction in:</p> <ul style="list-style-type: none"> • The electronic engine control system; • The electronic throttle control system; • The electronic automatic transmission control system; or • Emission control system.
 (Canada)	

Warning light	Warning light/Details
	<p>SRS warning light Indicates a malfunction in:</p> <ul style="list-style-type: none"> • The SRS airbag system; • The front passenger occupant classification system; or • The seat belt pretensioner system.
 <p>(U.S.A.)</p>  <p>(Canada)</p>	<p>ABS warning light Indicates a malfunction in:</p> <ul style="list-style-type: none"> • The ABS; or • The brake assist system.
	<p>Slip indicator The indicator comes on to indicate a malfunction in:</p> <ul style="list-style-type: none"> • The VSC; • The TRAC (TRC); or • The active traction control system (if equipped); or • The AUTO LSD system (2WD models).
 <p>(Automatic transmission vehicles)</p>	<p>Automatic transmission fluid temperature warning light Indicates that the automatic transmission fluid temperature is too high.</p>
 <p>(Automatic transmission vehicles)</p>	<p>Unengaged “Park” warning light Malfunction in the transmission “Park” mechanism.</p>
 <p>(Flashes)</p>	<p>Cruise control indicator light (if equipped) Indicates a malfunction in the cruise control system.</p>

Follow the correction procedures.

After taking the specified steps to correct the suspected problem, check that the warning light turns off.

Warning light	Warning light/Details	Correction procedure
	Open door warning light Indicates that a door, back door or glass hatch is not fully closed.	Check that all doors and glass hatch are closed.
 (On the instrument cluster)	Driver's seat belt reminder light (warning buzzer)^{*1} Warns the driver to fasten his/her seat belt.	Fasten the seat belt.
 (On the center panel)	Front passenger's seat belt reminder light (warning buzzer)^{*2} Warns the front passenger to fasten his/her seat belt.	Fasten the seat belt.
	Tire pressure warning light • When the light comes on: Low tire inflation pressure. • When the light comes on after blinking for 1 minute: Malfunction in the tire pressure warning system.	Adjust the tire inflation pressure. (including spare tire) Have the system checked by your Toyota dealer.
	Low fuel level warning light Low level of fuel.	Refuel the vehicle.

Warning light	Warning light/Details	Correction procedure
 (Canada)	<p>Low washer fluid warning light</p> <p>Low level of washer fluid.</p>	<p>Fill the tank.</p>
 (U.S.A.)	<p>Engine oil replacement reminder light</p> <ul style="list-style-type: none"> • Illuminates for about 3 seconds and then flashes for about 12 seconds: Indicates that the engine oil is scheduled to be changed. • Comes on and remains: Indicates that the engine oil should be changed. 	<p>Check the engine oil, and change if necessary.</p> <p>Check and change the engine oil.</p>

*1: Driver's seat belt reminder:

The driver's seat belt reminder sounds to alert the driver that his or her seat belt is not fastened. Once the engine switch is turned to the ON or START position, the buzzer sounds for 6 seconds. If the vehicle has reached a speed of at least 12 mph (20 km/h), the buzzer sounds intermittently for 10 seconds. Then, if the seat belt is still unfastened, the buzzer will sound in a different tone for 20 more seconds.

*2: Front passenger's seat belt reminder:

The front passenger's seat belt reminder sounds to alert the front passenger that his or her seat belt is not fastened. The buzzer sounds intermittently for 10 seconds after the vehicle has reached a speed of at least 12 mph (20 km/h). Then, if the seat belt is still unfastened, the buzzer will sound in a different tone for 20 more seconds.

n **Key reminder buzzer**

The buzzer indicates that the key has not been removed (with the engine switch in the ACC or LOCK position and the driver's door opened).

n **If the malfunction indicator lamp comes on while driving**

First check the following:

- l Is your vehicle low on gas?
If it is, refuel the vehicle immediately.
- l Is the fuel tank cap loose?
If it is, tighten it securely.

The light will go off after taking several driving trips.

If the light does not go off even after several trips, contact your Toyota dealer as soon as possible.

n **Front passenger detection sensor and passenger seat belt reminder**

If luggage or other load is placed on the front passenger seat, depending on its weight, the reminder light to flash and buzzer to sound.

n **When the tire pressure warning light comes on**

Check the tire inflation pressure and adjust to the appropriate level.

n **The tire pressure warning light may turn on due to natural causes**

The tire pressure warning light may turn on due to natural causes such as natural air leaks or tire inflation pressure changes caused by temperature. In this case, adjusting the tire inflation pressure will turn off the warning light (after a few minutes).

n **When a tire is replaced with a spare tire**

The spare tire is also equipped with the tire pressure warning valve and transmitter. The tire pressure warning light will turn on if the tire inflation pressure of the spare tire is low. If a tire goes flat, even though the flat tire is replaced with the spare tire, the warning light does not turn off. Replace the spare tire with the repaired tire and adjust the proper tire inflation pressure. The tire pressure warning light will turn off after a few minutes.

n **If the tire pressure warning system is inoperative**

The tire pressure warning system will be disabled in the following conditions:

(When the condition becomes normal, the system will work properly.)

- 1 If tires not equipped with tire pressure warning valves and transmitters are used.
- 1 If the ID code on the tire pressure warning valves and transmitters is not registered in the tire pressure warning computer.
- 1 If the tire inflation pressure is 73 psi (500 kPa, 5.1 kgf/cm² or bar) or higher.

The tire pressure warning system may be disabled in the following conditions:

(When the condition becomes normal, the system will work properly.)

- 1 If electronic devices or facilities using similar radio wave frequencies are nearby.
 - 1 If a radio set at similar frequencies is in use in the vehicle.
 - 1 If a window tint that affects the radio wave signals is installed.
 - 1 If there is a lot of snow or ice on the vehicle, in particular around the wheels or wheel housings.
 - 1 If non-genuine Toyota wheels are used. (Even if you use Toyota wheels, the tire pressure warning system may not work properly with some types of tires.)
 - 1 If tire chains are used.
 - 1 If the spare tire is in a location subject to poor radio wave signal reception.
 - 1 If a large metallic object which can interfere with signal reception is put in the luggage compartment.
- ### n **If the tire pressure warning light comes on after blinking for 1 minute frequently**
- If the tire pressure warning light comes on after blinking for 1 minute frequently when the engine switch is turned to the ON position, have it checked by your Toyota dealer.

n **After changing the engine oil (U.S.A. only)**

Make sure to reset the oil maintenance data. (→P. 370)

n Customization that can be configured at Toyota dealer

The vehicle speed linked seat belt reminder buzzer can be disabled. (Customizable features →P. 493)

⚠ CAUTION

n If the tire pressure warning light comes on

Be sure to observe the following precautions. Failure to do so could cause loss of vehicle control and result in death or serious injury.

- 1** Stop your vehicle in a safe place as soon as possible. Adjust the tire inflation pressure immediately.
- 1** If the tire pressure warning light comes on even after tire inflation pressure adjustment, it is probable that you have a flat tire. Check the tires. If the tire is flat, change to the spare tire and have the flat tire repaired by the nearest Toyota dealer.
- 1** Avoid abrupt maneuvering and braking. If the vehicle tires deteriorate, you could lose control of the steering wheel or the brakes.

n If a blowout or sudden air leakage should occur

The tire pressure warning system may not activate immediately.

n Maintenance of the tire

Each tire, including the spare (if provided), should be checked monthly when cold and inflated to the inflation pressure recommended by the vehicle manufacturer on the vehicle placard or tire inflation pressure label (tire and load information label). (If your vehicle has tires of a different size than the size indicated on the vehicle placard or tire inflation pressure label [tire and load information label], you should determine the proper tire inflation pressure for those tires.)

 CAUTION

n Maintenance of the tire

As an added safety feature, your vehicle has been equipped with a tire pressure monitoring system (TPMS-tire pressure warning system) that illuminates a low tire pressure telltale (tire pressure warning light) when one or more of your tires is significantly under-inflated. Accordingly, when the low tire pressure telltale (tire pressure warning light) illuminates, you should stop and check your tires as soon as possible, and inflate them to the proper pressure. Driving on a significantly under-inflated tire causes the tire to overheat and can lead to tire failure. Under-inflation also reduces fuel efficiency and tire tread life, and may affect the vehicle's handling and stopping ability.

Please note that the TPMS (tire pressure warning system) is not a substitute for proper tire maintenance, and it is the driver's responsibility to maintain correct tire pressure, even if under-inflation has not reached the level to trigger illumination of the TPMS low tire pressure telltale (tire pressure warning light).

Your vehicle has also been equipped with a TPMS (tire pressure warning system) malfunction indicator to indicate when the system is not operating properly. The TPMS (tire pressure warning system) malfunction indicator is combined with the low tire pressure telltale (tire pressure warning light). When the system detects a malfunction, the telltale will flash for approximately one minute and then remain continuously illuminated. This sequence will continue upon subsequent vehicle start-ups as long as the malfunction exists. When the malfunction indicator is illuminated, the system may not be able to detect or signal low tire pressure as intended.

TPMS (tire pressure warning system) malfunctions may occur for a variety of reasons, including the installation of replacement or alternate tires or wheels on the vehicle that prevent the TPMS (tire pressure warning system) from functioning properly. Always check the TPMS (tire pressure warning system) malfunction telltale after replacing one or more tires or wheels on your vehicle to ensure that the replacement or alternate tires and wheels allow the TPMS (tire pressure warning system) to continue to function properly.



NOTICE

n Precaution when installing a different tire

When a tire of a different specification or maker is installed, the tire pressure warning system may not operate properly.

5-2. Steps to take in an emergency If you have a flat tire

Remove the flat tire and replace it with the spare provided.

■ Before jacking up the vehicle

- 1 Stop the vehicle on a hard, flat surface.
- 1 Set the parking brake.
- 1 Shift the shift lever to P (automatic transmission) or R (manual transmission).
- 1 Stop the engine.
- 1 Turn on the emergency flashers.

■ Location of the spare tire, jack and tools

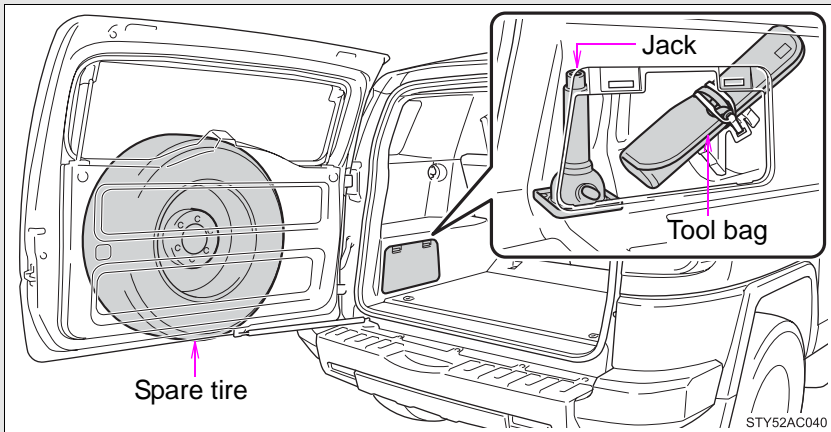

■ Tools

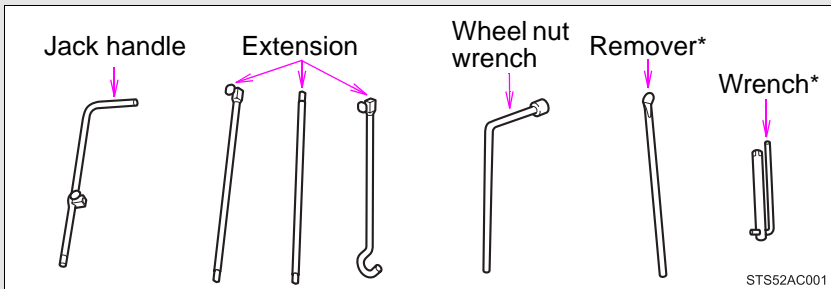

*: Vehicles with rear view monitor system

Taking out the jack and tool bag

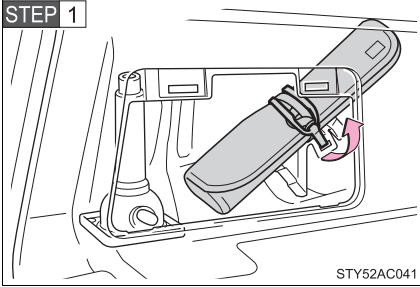

Remove the cover and loosen the strap.

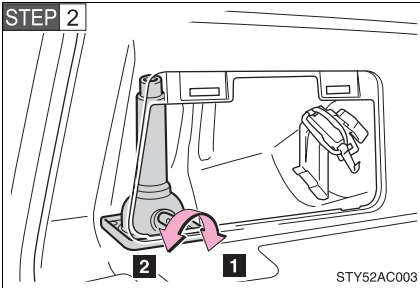

Loosen and remove the jack.

- 1 Tighten
- 2 Loosen

Taking out the spare tire (vehicles without rear view monitor system)

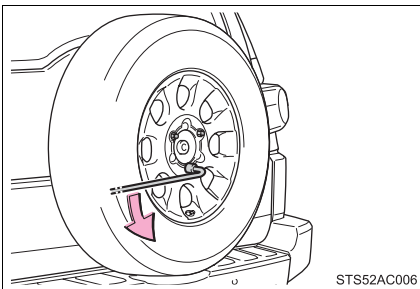

Turn the hold-down nuts counter-clockwise with the wheel nut wrench and remove them.

Taking out the spare tire (vehicles with rear view monitor system)

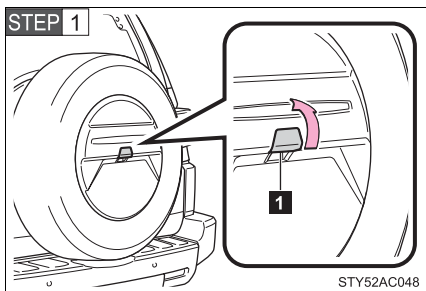

Remove the bolt cover.

1 Bolt cover

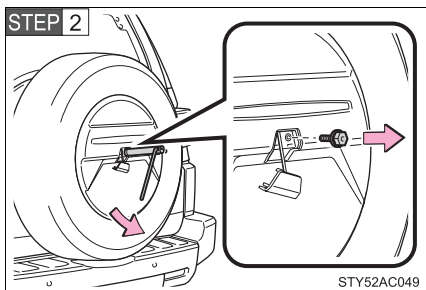

Remove the bolt which fixes the spare wheel cover using the wrench in the tool bag (→P. 440).

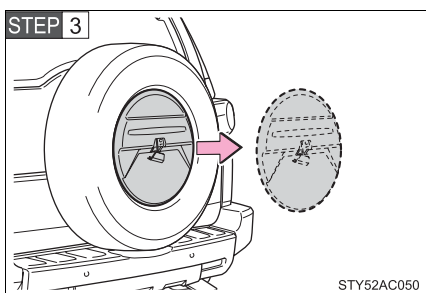

Remove the spare wheel cover.

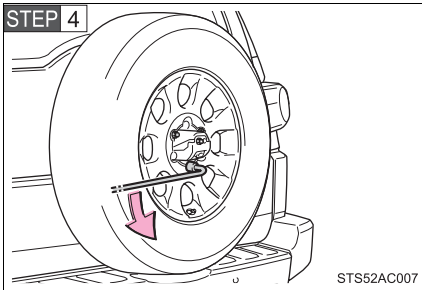

Turn the hold-down nuts counter-clockwise with the wheel nut wrench and remove them.

Replacing a flat tire

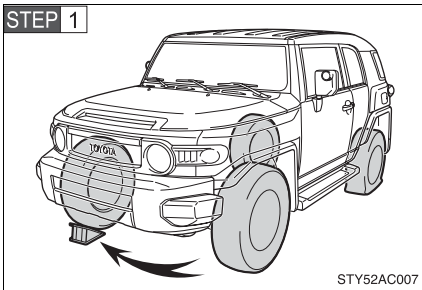

Chock the tires.

Flat tire		Wheel chock positions
Front	Left-hand side	Behind the rear right-hand side tire
	Right-hand side	Behind the rear left-hand side tire
Rear	Left-hand side	In front of the front right-hand side tire
	Right-hand side	In front of the front left-hand side tire

STEP 2 Remove the wheel ornament using the wheel nut wrench or the remover as shown.

To protect the wheel and wheel ornament, place a rag between the wheel nut wrench or the remover and the wheel ornament, as shown in the illustration.

▶ Aluminum wheel

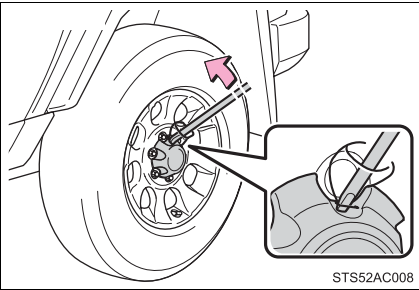

▶ Steel wheel

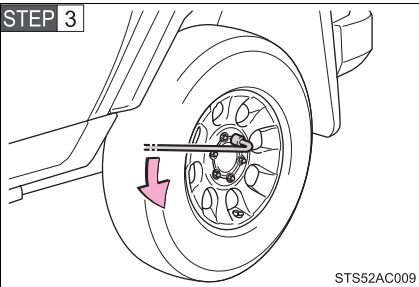
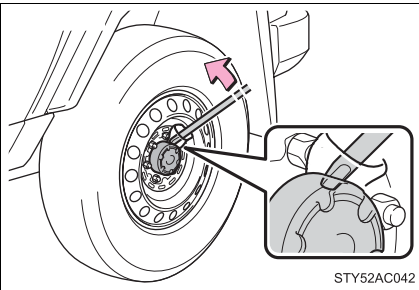

Slightly loosen the wheel nuts (one turn).

STEP 4 Assembling the jack handle.

Remove the jack handle, jack handle extension bar and jack handle bar from the tool bag and assemble by following these steps.

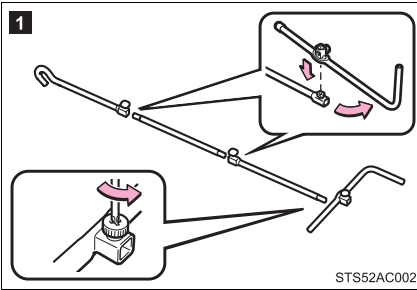

- 1** Loosen the bolts and the screw using either the jack handle or a screwdriver.

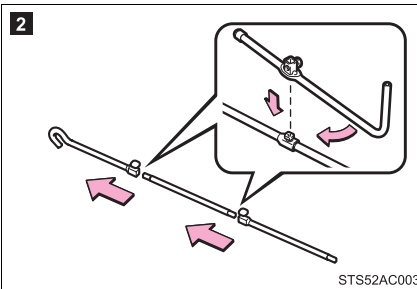

- 2** Assemble the jack handle extension bar and the jack handle bar and tighten the bolts.

Check that the bolts are firmly tightened.

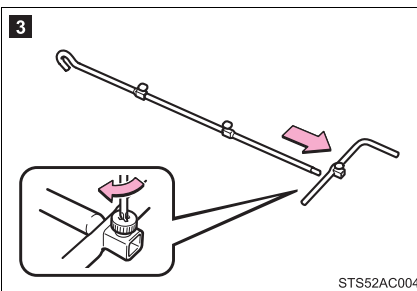

- 3** Assemble the jack handle extension bar and the jack handle and tighten the screw.

Check that the screw is firmly tightened.

5-2. Steps to take in an emergency

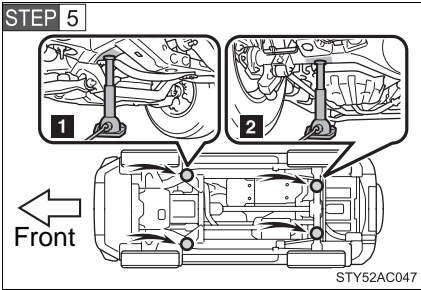

Position the jack at the correct jack point as shown.

- 1 Front
- 2 Rear

Make sure the jack is positioned on a level and solid place.

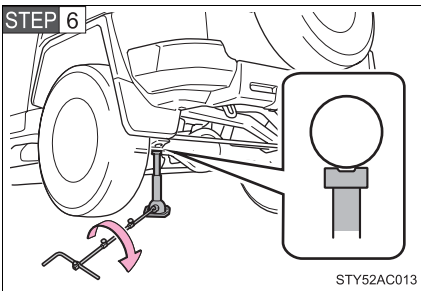

Raise the vehicle until the tire is slightly raised off the ground.

When positioning the jack under the rear axle housing, make sure the groove on the top of the jack fits with the rear axle housing.

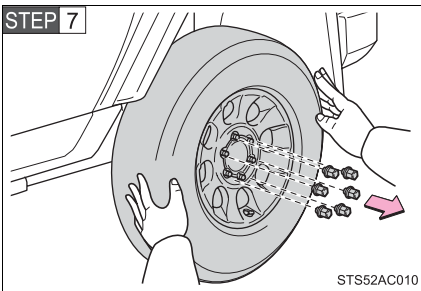

Remove all the wheel nuts and the tire.

When resting the tire on the ground, place the tire so that the wheel design faces up to avoid scratching the wheel surface.

Installing the tire

STEP 1

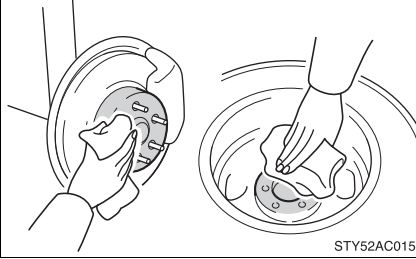

Remove any dirt or foreign matter from the wheel contact surface.

If foreign matter is on the wheel contact surface, the wheel nuts may loosen while the vehicle is in motion, and the tire may come off the vehicle.

STEP 2 Install the tire and loosely tighten each wheel nut by hand by approximately the same amount.

► Replacing a steel wheel

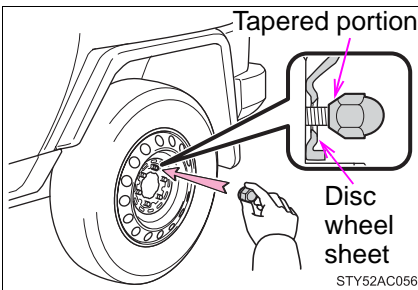

Tighten the nuts until the tapered portion comes into loose contact with the disc wheel sheet.

► Replacing an aluminum wheel

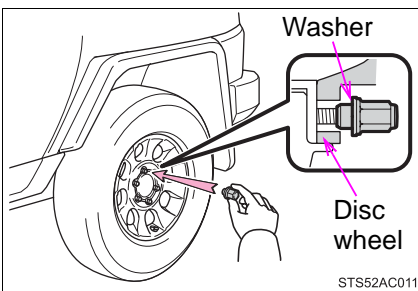

Tighten the nuts until the washer of the nut comes into loose contact with the disc wheel.

5-2. Steps to take in an emergency

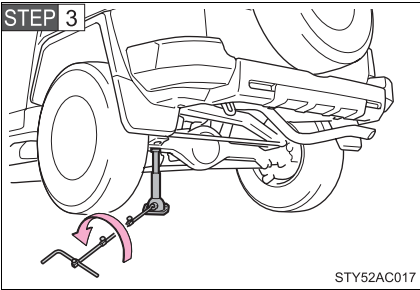

Lower the vehicle.

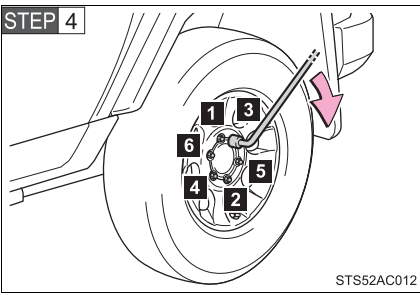

Firmly tighten each nut two or three times in the order shown in the illustration.

Tightening torque:
85 ft-lbf (113 N·m, 11.5 kgf·m)

STEP 5 Reinstall the wheel ornament.

► Aluminum wheel

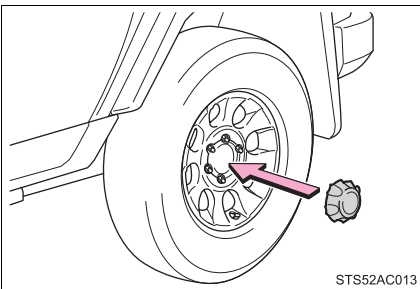

► Steel wheel

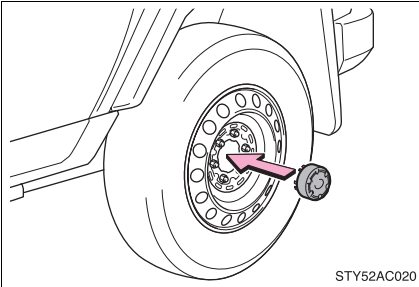

Stowing the flat tire, jack and all tools

STEP 1 Install the flat tire in the reverse order of removal.

Tightening torque:
44 ft·lbf (60 N·m, 6.1 kgf·m)

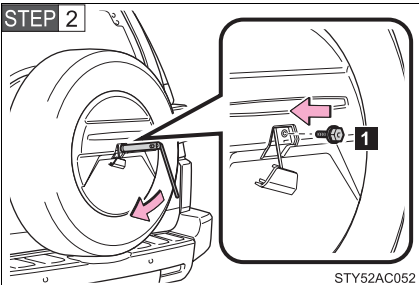

Vehicles with rear view monitor system: Install the spare wheel cover in the reverse order of removal.

1 Tighten the bolt.

Tightening torque:
10 ft·lbf (14 N·m, 1.4 kgf·m)

STEP 3 Stow the tools and jack securely.

n After completing the tire change

The tire pressure warning system must be reset. (→P. 382)

 CAUTION

n Using the jack

Improper use of the jack may lead to death or serious injuries due to the vehicle suddenly falling off the jack.

- 1 Do not use the jack for any purpose other than replacing tires or installing and removing tire chains.
- 1 Only use the jack that comes with this vehicle for replacing a flat tire. Do not use it on other vehicles, and do not use other jacks for replacing tires on this vehicle.
- 1 Always check that the jack is securely set to the jack point.
- 1 Do not put any part of your body under the vehicle supported by a jack.
- 1 Do not start or run the engine while your vehicle is supported by the jack.
- 1 Do not raise the vehicle while someone is in it.
- 1 When raising the vehicle, do not put an object on or under the jack.
- 1 Do not raise the vehicle to a height greater than that required to replace the tire.
- 1 Use a jack stand if it is necessary to get under the vehicle.

Take particular care when lowering the vehicle to ensure that no one working on or near the vehicle will be injured.

n Using the jack handle

Tighten all the square head bolts securely to prevent the extension parts from coming apart unexpectedly.

 **CAUTION****n Replacing a flat tire**

Observe the following precautions to reduce the risk of death or serious injury:

- I** Do not try to remove the wheel ornament by hand. Take due care in handling the ornament to avoid unexpected personal injury.
- I** Have the wheel nuts tightened with a torque wrench to 85 ft·lbf (113 N·m, 11.5 kgf·m) as soon as possible after changing wheels. Failure to follow these precautions could cause the nuts to loosen and the wheels may fall off, which could lead to an accident causing death or serious injury.
- I** Do not attach a heavily damaged wheel ornament, as it may fly off the wheel while the vehicle is moving.

n When installing the wheel nuts

Be sure to install the wheel nuts with the tapered end facing inward.
(→P. 392)

 NOTICE

n Do not drive the vehicle with a flat tire

Do not continue driving with a flat tire.

Driving even a short distance with a flat tire can damage the tire and the wheel beyond repair.

n When replacing the tires

l When removing or fitting the wheels, tires or the tire pressure warning valve and transmitter, contact your Toyota dealer as the tire pressure warning valve and transmitter may be damaged if not handled correctly.

l Replace the grommets for the tire pressure warning valves and transmitters as well.

n To avoid damage to the tire pressure warning valves and transmitters

When a tire is repaired with liquid sealants, the tire pressure warning valve and transmitter may not operate properly. If a liquid sealant is used, contact your Toyota dealer or other qualified service shop as soon as possible. Make sure to replace the tire pressure warning valve and transmitter when replacing the tire. (→P. 382)

n To prevent damage to the wheel ornament

Vehicles with a steel wheel: Do not attach wheel ornament to the wheel on the back door.

Vehicles with rear view monitor system: Do not install a wheel with the ornament attached onto the back door.

n To prevent damage to the camera (vehicles with rear view monitor system)

Be careful not to impact or damage the camera when installing or removing the spare tire.

5-2. Steps to take in an emergency If the engine will not start

If the engine still does not start after following the correct starting procedure (→P. 124) or releasing the steering lock (→P. 125), confirm the following points.

n The engine will not start even when the starter motor operates normally.

One of the following may be the cause of the problem.

- 1 There may not be sufficient fuel in the vehicle's tank.
Refuel the vehicle.
- 1 The engine may be flooded.
Try to restart the engine once more following correct starting procedures.
- 1 There may be a malfunction in the engine immobilizer system.
(→P. 74)

n The starter motor turns over slowly, the interior lights and headlights are dim, or the horn does not sound or sounds at a low volume.

One of the following may be the cause of the problem.

- 1 The battery may be discharged. (→P. 456)
- 1 The battery terminal connections may be loose or corroded.

n The starter motor does not turn over, the interior lights and headlights do not turn on, or the horn does not sound.

One of the following may be the cause of the problem.

- 1 One or both of the battery terminals may be disconnected.
- 1 The battery may be discharged. (→P. 456)

Contact your Toyota dealer if the problem cannot be repaired, or if repair procedures are unknown.

5-2. Steps to take in an emergency

If the shift lever cannot be shifted from P (vehicles with an automatic transmission)

If the shift lever cannot be shifted with your foot on the brake, there may be a problem with the shift lock system (a system to prevent accidental operation of the shift lever). Have the vehicle inspected by your Toyota dealer immediately.

The following steps may be used as an emergency measure to ensure that the shift lever can be shifted.

STEP 1 Set the parking brake.

STEP 2 Turn the engine switch to the ACC or ON position.

STEP 3 Depress the brake pedal.

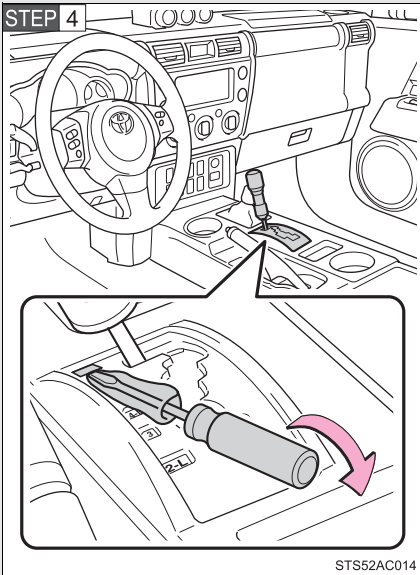

Pry the cover up with a flat-head screwdriver or equivalent.

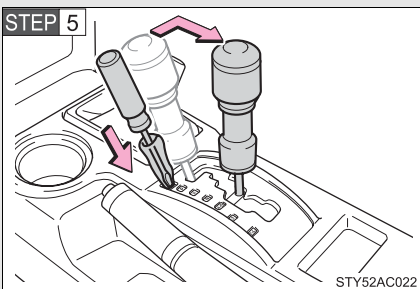

Press the shift lock override button.

The shift lever can be shifted while the button is pressed.

If you lose your keys

New genuine Toyota keys can be made by your Toyota dealer using one of the master keys and the key number stamped on your key number plate. (→P. 26)

n If you lose all your master keys

You cannot make new keys; the whole engine immobilizer system must be replaced.

5-2. Steps to take in an emergency

If the vehicle battery is discharged

The following procedures may be used to start the engine if the vehicle's battery is discharged.

You can call your Toyota dealer or qualified repair shop.

If you have a set of jumper (or booster) cables and a second vehicle with a 12-volt battery, you can jump start your Toyota following the steps below.

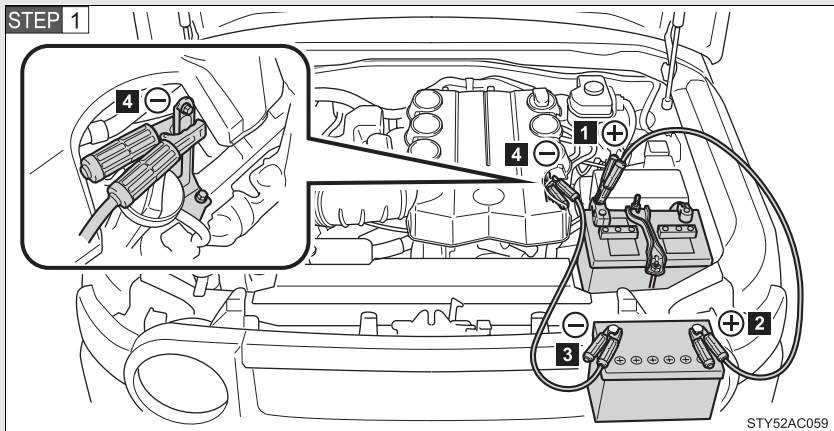

Connecting the jumper cables

- 1 Positive (+) battery terminal on your vehicle
- 2 Positive (+) battery terminal on the second vehicle
- 3 Negative (-) battery terminal on the second vehicle
- 4 Connect the jumper cable to ground on your vehicle as shown in the illustration.

STEP 2 Start the engine of the second vehicle. Increase the engine speed slightly and maintain at that level for approximately 5 minutes to recharge the battery of your vehicle.

STEP 3 Maintain the engine speed of the second vehicle and start the vehicle's engine.

STEP 4 Once the vehicle's engine has started, remove the jumper cables in the exact reverse order in which they were connected.

Once the engine starts, have the vehicle checked at your Toyota dealer as soon as possible.

n Starting the engine when the battery is discharged (vehicles with an automatic transmission)

The engine cannot be started by push-starting.

n Avoiding a discharged battery

- l Turn off the headlights and the audio system while the engine is turned off.
- l Turn off any unnecessary electrical components when the vehicle is running at a low speed for an extended period, such as in heavy traffic, etc.

⚠ CAUTION

n Avoiding battery fires or explosions

Observe the following precautions to prevent accidentally igniting the flammable gas that may be emitted from the battery.

- l Make sure the jumper cable is connected to the correct terminal and that it is not unintentionally in contact with any part other than the intended terminal.
- l Do not allow the jumper cables to come into contact with the "+" and "-" terminals.
- l Do not smoke, use matches, cigarette lighters or allow open flame near the battery.

 **CAUTION**

n Battery precautions

The battery contains poisonous and corrosive acidic electrolyte, while related parts contain lead and lead compounds. Observe the following precautions when handling the battery.

- I** When working with the battery, always wear safety glasses and take care not to allow any battery fluids (acid) to come into contact with skin, clothing or the vehicle body.
- I** Do not lean over the battery.
- I** In the event that battery fluid comes into contact with the skin or eyes, immediately wash the affected area with water and seek medical attention. Place a wet sponge or cloth over the affected area until medical attention can be received.
- I** Always wash your hands after handling the battery support, terminals, and other battery-related parts.
- I** Do not allow children near the battery.

 **NOTICE**

n To prevent damaging the vehicle (vehicles with a manual transmission)

Do not pull- or push-start the vehicle, because the three-way catalytic converter may overheat and become a fire hazard.

n When handling jumper cables

Be careful that the jumper cables do not become tangled in the cooling fan or any of the belts when connecting or disconnecting them.

5-2. Steps to take in an emergency If your vehicle overheats

If your engine overheats:

STEP 1 Stop the vehicle in a safe place and turn off the air conditioning system.

STEP 2 Check to see if steam is coming out from under the hood.

If you see steam:

Stop the engine. Carefully lift the hood after the steam subsides and then restart the engine.

If you do not see steam:

Leave the engine running and carefully lift the hood.

STEP 3 Check to see if the cooling fan is operating.

If the fan is operating:

Wait until the temperature of the engine (shown on the instrument cluster) begins to fall and then stop the engine.

If the fan is not operating:

Stop the engine immediately and call your local Toyota dealer.

STEP 4

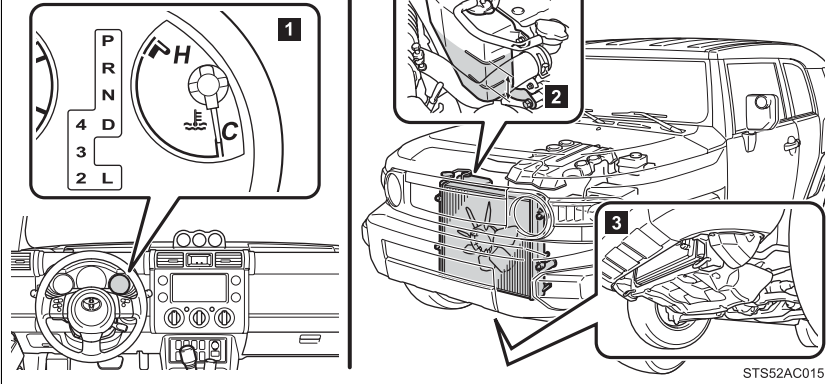

1 The engine has cooled down sufficiently.

The engine coolant temperature gauge indicates C.

2 Check the engine coolant level.

3 Look for obvious coolant leaks from the radiator, hoses and under the vehicle.

Note that water draining from the air conditioning is normal if it has been used.

STEP 5

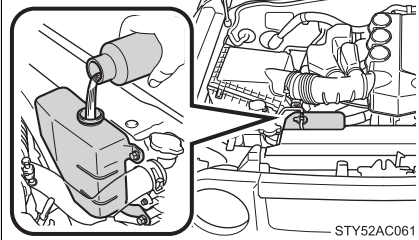

Add engine coolant if required.

Water can be used in an emergency if engine coolant is unavailable. (→P. 472)

Have the vehicle checked at your nearest Toyota dealer as soon as possible.

n **Overheating**

If you observe the following, your vehicle may be overheating.

- l The engine coolant temperature gauge enters the red zone or a loss of power is experienced.
- l Steam is coming from under the hood.

CAUTION

n **To prevent an accident or injury when inspecting under the hood of your vehicle**

- l If steam is seen coming from under the hood, do not open the hood until the steam has subsided. The engine compartment may be very hot, causing serious injury such as burns.
- l Keep hands and clothing away from the fan and other belts while the engine is running.
- l Do not loosen the radiator cap while the engine and radiator are hot. Serious injury, such as burns, may result from hot coolant and steam released under pressure.

NOTICE

n **When adding engine coolant**

Wait until the engine has cooled down before adding engine coolant. When adding coolant, do so slowly. Adding cool coolant to a hot engine too quickly can cause damage to the engine.

5-2. Steps to take in an emergency If the vehicle becomes stuck

Carry out the following procedures if the tires spin or the vehicle becomes stuck in mud, dirt, or snow.

- STEP 1** Stop the engine. Set the parking brake and put the shift lever in P (vehicles with an automatic transmission) or N (vehicles with a manual transmission).
- STEP 2** Remove the mud, snow, or sand from around the stuck tire.
- STEP 3** Place wood, stones or some other material to help provide traction under the tires.
- STEP 4** Restart the engine.
- STEP 5** Turn off the VSC. (→P. 176, 177)
- STEP 6** Carefully apply the accelerator to free the vehicle.

n **Emergency hook**

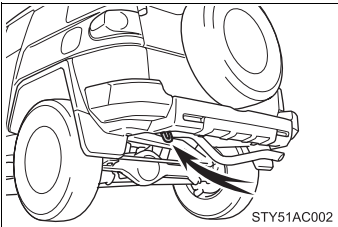

When your vehicle becomes stuck and cannot move, the emergency hook is used for another vehicle to pull your vehicle out in an emergency.

Your vehicle is not designed to tow another vehicle.

Do not use the rear hook. It is not designed for towing.

 **CAUTION****n When attempting to free a stuck vehicle**

If you choose to rock the vehicle back and forth to free it, make sure the surrounding area is clear, to avoid striking other vehicles, objects or persons. The vehicle may also lunge forward or lunge back suddenly as it becomes free. Use extreme caution.

n When shifting the shift lever

Vehicles with automatic transmission: Be careful not to shift the shift lever with the accelerator pedal depressed.

This may lead to unexpected rapid acceleration of the vehicle that may cause an accident and result in death or serious injury.

 **NOTICE****n To avoid damaging the transmission and other components**

- | Avoid spinning the wheels and do not rev the engine.
- | If the vehicle remains stuck after trying these procedures, the vehicle may require towing to be freed.

5-2. Steps to take in an emergency

If your vehicle has to be stopped in an emergency

Only in an emergency, such as if it becomes impossible to stop the vehicle in the normal way, stop the vehicle using the following procedure:

STEP 1 Steadily step on the brake pedal with both feet and firmly depress it.

Do not pump the brake pedal repeatedly as this will increase the effort required to slow the vehicle.

STEP 2 Shift the shift lever to N.

► If the shift lever is shifted to N

STEP 3 After slowing down, stop the vehicle in a safe place by the road.

STEP 4 Stop the engine.

► If the shift lever cannot be shifted to N

STEP 3 Keep depressing the brake pedal with both feet to reduce vehicle speed as much as possible.

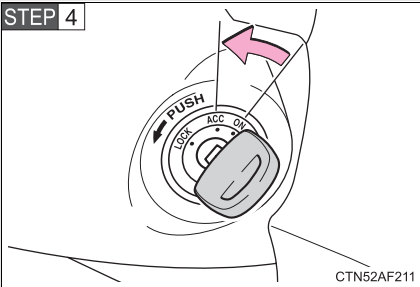

Stop the engine by turning the engine switch to the ACC position.

STEP 5 Stop the vehicle in a safe place by the road.

 CAUTION

n If the engine has to be turned off while driving

- l** Power assist for the brakes and steering wheel will be lost, making the brake pedal harder to depress and the steering wheel heavier to turn. Decelerate as much as possible before turning off the engine.
- l** Never attempt to remove the key, as doing so will lock the steering wheel.

6-1. Specifications

Maintenance data (fuel, oil level, etc.)

Dimensions and weight

Overall length		183.9 in. (4670 mm)
Overall width		75.0 in. (1905 mm)
Overall height*	2WD models	71.3 in. (1810 mm)
	4WD models	72.0 in. (1830 mm)
Wheelbase		105.9 in. (2690 mm)
Front tread		63.2 in. (1605 mm)
Rear tread		63.2 in. (1605 mm)
Vehicle capacity weight (Occupants + luggage)		1130 lb. (510 kg)
Towing capacity (Trailer weight + cargo)		5000 lb. (2270 kg)

*: Unladen vehicle

Vehicle identification

n Vehicle identification number

The vehicle identification number (VIN) is the legal identifier for your vehicle. This is the primary identification number for your Toyota. It is used in registering the ownership of your vehicle.

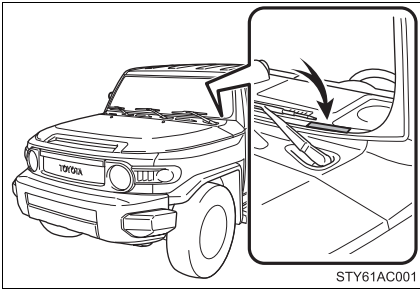

This number is stamped on the top left of the instrument panel.

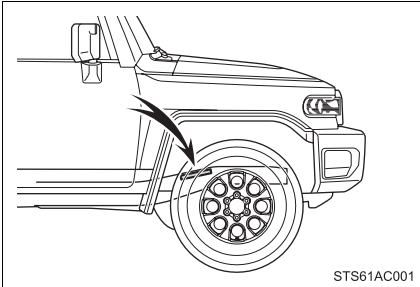

This number is stamped on the front right frame.

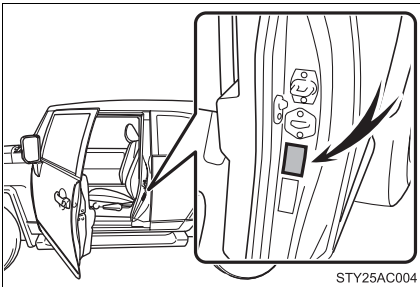

This number is also on the Certification Label.

n Engine number

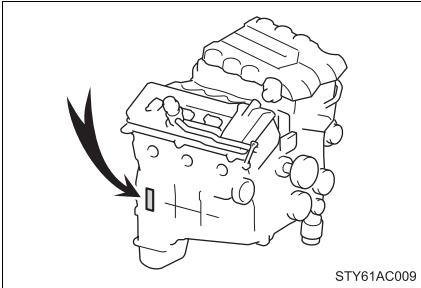

The engine number is stamped on the engine block as shown.

Engine

Model	1GR-FE
Type	6-cylinder V type, 4-cycle, gasoline
Bore and stroke	3.70 × 3.74 in. (94.0 × 95.0 mm)
Displacement	241.4 cu.in. (3956 cm ³)
Drive belt tension	Automatic adjustment
Valve clearance	Automatic adjustment

Fuel

Fuel type	Unleaded gasoline only
Octane rating	87 (Research octane number 91) or higher
Fuel tank capacity (Reference)	19.0 gal. (72.0 L, 15.8 Imp.gal.)

Lubrication system

Oil capacity (Drain and refill - reference)	
▶ With filter	6.4 qt. (6.1 L, 5.4 Imp.qt.)
▶ Without filter	6.0 qt. (5.7 L, 5.0 Imp.qt.)

n Engine oil selection

“Toyota Genuine Motor Oil” is used in your Toyota vehicle. Use Toyota approved “Toyota Genuine Motor Oil” or equivalent to satisfy the following grade and viscosity.

Oil grade: ILSAC multigrade engine oil

Recommended viscosity: SAE 0W-20

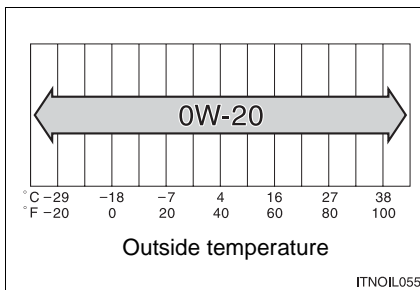

SAE 0W-20 is the best choice for good fuel economy and good starting in cold weather.

If SAE 0W-20 is not available, SAE 5W-20 oil may be used. However, it must be replaced with SAE 0W-20 at the next oil change.

The 0W portion of the oil viscosity rating indicates the characteristic of the oil which allows cold startability. Oils with a lower value before the W allow for easier starting of the engine in cold weather.

The 20 in 0W-20 indicates the oil viscosity when the oil is at its operating temperature. An oil with a higher viscosity may be better suited if the vehicle is operated at high speeds, or under extreme load conditions.

How to read oil container label:

The ILSAC (International Lubricant Standardization and Approval Committee) Certification Mark is added to some oil containers to help you select the oil you should use.

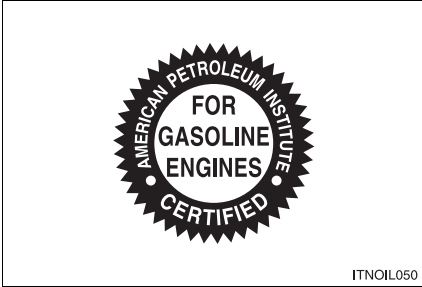

Cooling system

Capacity	<ul style="list-style-type: none"> ▶ Vehicles with an automatic transmission 10.4 qt. (9.8 L, 8.6 Imp.qt.) ▶ Vehicles with a manual transmission 9.9 qt. (9.4 L, 8.3 Imp.qt.)
Coolant type	<p>Use either of the following.</p> <ul style="list-style-type: none"> • “Toyota Super Long Life Coolant” • Similar high-quality ethylene glycol-based non-silicate, non-amine, non-nitrite, and non-borate coolant with long-life hybrid organic acid technology <p>Do not use plain water alone.</p>

Ignition system

Spark plug		
Make	DENSO	SK20HR11
Gap		0.043 in. (1.1 mm)

NOTICE

n Iridium-tipped spark plugs

Use only iridium-tipped spark plugs. Do not adjust gap when tuning engine.

Electrical system

Battery	
Specific gravity reading at 68°F (20°C):	1.250 — 1.290 Fully charged 1.160 — 1.200 Half charged 1.060 — 1.100 Discharged
Charging rates	
Quick charge	15 A max.
Slow charge	5 A max.

Differential

Oil capacity	Front (4WD models)	<ul style="list-style-type: none"> ▶ Vehicles with a manual transmission 1.48 qt. (1.40 L, 1.23 Imp.qt.) ▶ Vehicles with an automatic transmission 1.64 qt. (1.55 L, 1.36 Imp.qt.)
	Rear	<ul style="list-style-type: none"> ▶ Vehicles with a rear differential lock 2.59 qt. (2.45 L, 2.16 Imp.qt.) ▶ Vehicles without a rear differential lock 2.64 qt. (2.50 L, 2.20 Imp.qt.)
Oil type and viscosity*	Front (4WD models)	Toyota Genuine Differential Gear Oil LT 75W-85 GL-5 or equivalent
	Rear	Toyota Genuine Differential Gear Oil LT 75W-85 GL-5 or equivalent

*: Your Toyota vehicle is filled with “Toyota Genuine Differential Gear Oil” at the factory. Use Toyota approved “Toyota Genuine Differential Gear Oil” or an equivalent of matching quality to satisfy the above specification. Please contact your Toyota dealer for further details.

Automatic transmission

Fluid capacity*	11.3 qt. (10.7 L, 9.4 Imp.qt.)
Fluid type	Toyota Genuine ATF WS

*: The fluid capacity is the quantity of reference. If replacement is necessary, contact your Toyota dealer.

NOTICE

n Automatic transmission fluid type

Using automatic transmission fluid other than “Toyota Genuine ATF WS” may cause deterioration in shift quality, locking up of your transmission accompanied by vibration, and ultimately damage the automatic transmission of your vehicle.

Manual transmission

Gear oil capacity (Reference)	1.9 qt. (1.8 L, 1.6 Imp.qt.)
Gear oil type	Gear oil API GL-4 or GL-5
Recommended gear oil viscosity	SAE 75W-90

Clutch

Clutch free play	0.2 — 0.6 in. (5 — 15 mm)
Fluid type	SAE J1703 or FMVSS No. 116 DOT 3

Transfer (4WD models)

Oil capacity	<ul style="list-style-type: none"> ▶ Vehicles with an automatic transmission 1.1 qt. (1.0 L, 0.9 Imp.qt.) ▶ Vehicles with a manual transmission 1.5 qt. (1.4 L, 1.2 Imp.qt.)
Oil type*	Toyota Genuine Transfer Gear oil LF or equivalent
Recommended oil viscosity	SAE 75W

*: Your Toyota vehicle is filled with “Toyota Genuine Transfer Gear oil LF” at the factory. Use Toyota approved “Toyota Genuine Transfer Gear oil LF” or an equivalent of matching quality to satisfy the above specification. Please contact your Toyota dealer for further details.

Brakes

Pedal clearance ^{*1}	2.1 in. (54 mm) Min.
Pedal free play	0.04 — 0.24 in. (1 — 6 mm)
Brake pad wear limit	0.04 in. (1.0 mm)
Parking brake lining wear limit	0.04 in. (1.0 mm)
Parking brake lever travel ^{*2}	5 — 7 clicks
Fluid type	SAE J1703 or FMVSS No. 116 DOT 3

*1: Minimum pedal clearance when depressed with a force of 110 lbf (490 N, 50 kgf) with the engine running.

*2: Parking brake lever travel when pulled with a force of 44.1 lbf (196 N, 20.0 kgf).

Chassis lubrication

Propeller shafts	Spider	Lithium base chassis grease, NLGI No.2
	Slide yoke	Molybdenum — disulfide lithium base chassis grease, NLGI No.2 or lithium base chassis grease, NLGI No.2

Steering

Free play	Less than 1.2 in. (30 mm)
Power steering fluid type	Automatic transmission fluid DEXRON® II or III

Tires and wheels

Tire size	P265/70R17 113S
Tire inflation pressure (Recommended cold tire inflation pressure)	Front tires: 32 psi (220 kPa, 2.2 kgf/cm ² or bar) Rear tires: 32 psi (220 kPa, 2.2 kgf/cm ² or bar) Spare tire: 32 psi (220 kPa, 2.2 kgf/cm ² or bar)
Wheel size	17 × 7 1/2J
Wheel nut torque	85 ft·lbf (113 N·m, 11.5 kgf·m)

Light bulbs

	Light Bulbs	Bulb No.	W	Type
Exterior	Headlights and daytime running lights*	—	60/55	A
	Front turn signal/parking and front side marker lights	—	21/5	B
	Outside rear view mirror illumination lights	—	5	C
	Rear turn signal lights	—	21	D
	Stop/tail and rear side marker lights	7443	21/5	C
	Back-up lights	921	16	C
	License plate lights	—	5	C
Interior	Front interior light		8	E
	Personal lights	—	8	C
	Rear interior light		8	E

*: If equipped

A: HB2 halogen bulbs

B: Single end bulbs

C: Wedge base bulbs (clear)

D: Wedge base bulbs (amber)

E: Double end bulbs

Your vehicle must use only unleaded gasoline.

Select octane rating 87 (Research Octane Number 91) or higher. Use of unleaded gasoline with an octane rating lower than 87 may result in engine knocking. Persistent knocking can lead to engine damage.

At minimum, the gasoline you use should meet the specifications of ASTM D4814 in the U.S.A. and CGSB3.5-M93 in Canada.

n **Fuel tank opening for unleaded gasoline**

To help prevent incorrect fueling, your Toyota has a fuel tank opening that only accommodates the special nozzle on unleaded fuel pumps.

n **If your engine knocks**

l Consult your Toyota dealer.

l You may occasionally notice light knocking for a short time while accelerating or driving uphill. This is normal and there is no need for concern.

n **Gasoline quality**

In very few cases, driveability problems may be caused by the brand of gasoline you are using. If driveability problems persist, try changing the brand of gasoline. If this does not correct the problem, consult your Toyota dealer.

n **Gasoline quality standards**

l Automotive manufacturers in the US, Europe and Japan have developed a specification for fuel quality called World-Wide Fuel Charter (WWFC) that is expected to be applied worldwide.

l The WWFC consists of four categories that are based on required emission levels. In the US, category 4 has been adopted.

l The WWFC improves air quality by lowering emissions in vehicle fleets, and customer satisfaction through better performance.

▮ **Toyota recommends the use of gasoline containing detergent additives**

- ▮ Toyota recommends the use of gasoline that contains detergent additives to avoid build-up of engine deposits.
- ▮ All gasoline sold in the US contains detergent additives to clean and/or keep clean intake systems.

▮ **Toyota recommends the use of cleaner burning gasoline**

Cleaner burning gasoline, including reformulated gasoline that contains oxygenates such as ethanol or MTBE (Methyl Tertiary Butyl Ether) is available in many areas.

Toyota recommends the use of cleaner burning gasoline and appropriately blended reformulated gasoline. These types of gasoline provide excellent vehicle performance, reduce vehicle emissions and improve air quality.

▮ **Toyota does not recommend blended gasoline**

- ▮ Toyota allows the use of oxygenate blended gasoline where the oxygenate content is up to 10% ethanol or 15% MTBE.
- ▮ If you use gasohol in your Toyota, be sure that it has an octane rating no lower than 91.
- ▮ Toyota does not recommend the use of gasoline containing methanol.

▮ **Toyota does not recommend gasoline containing MMT**

Some gasoline contains octane enhancing additive called MMT (Methylcyclopentadienyl Manganese Tricarbonyl).

Toyota does not recommend the use of gasoline that contains MMT. If fuel containing MMT is used, your emission control system may be adversely affected.

The malfunction indicator lamp on the instrument cluster may come on. If this happens, contact your Toyota dealer for service.

 NOTICE**n Notice on fuel quality**

- l** Do not use improper fuels.
If improper fuels are used the engine will be damaged.
- l** Do not use leaded gasoline.
Leaded gasoline can cause damage to your vehicle's three-way catalytic converters causing the emission control system to malfunction.
- l** Do not use gasohol other than that stated here.
Other gasohol may cause fuel system damage or vehicle performance problems.
- l** Using unleaded gasoline with an octane number or rating lower than that stated here will cause persistent heavy knocking.
At worst, this will lead to engine damage.

n Fuel-related poor driveability

If after using a different type of fuel, poor driveability is encountered (poor hot starting, vaporization, engine knocking, etc.), discontinue the use of that type of fuel.

n When refueling with gasohol

Take care not to spill gasohol.
It can damage your vehicle's paint.

6-1. Specifications

Tire information

Typical tire symbols

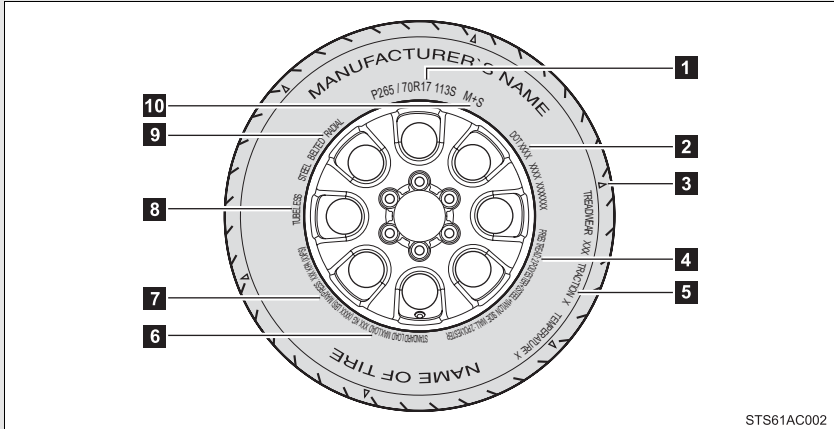

1 Tire size (→P. 484)

2 DOT and Tire Identification Number (TIN) (→P. 483)

3 Location of treadwear indicators (→P. 381)

4 Tire ply composition and materials

Ply is layers of rubber-coated parallel cords. Cords are the strands which form the plies in a tire.

5 Uniform tire quality grading

For details, see “Uniform Tire Quality Grading” that follows.

6 Load limit at maximum cold tire inflation pressure (→P. 487)

7 Maximum cold tire inflation pressure (→P. 487)

This means the pressure to which a tire may be inflated.

8 TUBELESS or TUBE TYPE

A tubeless tire does not have a tube and air is directly filled in the tire. A tube type tire has a tube inside the tire and the tube maintains the air pressure.

9 Radial tires or bias-ply tires

A radial tire has RADIAL on the sidewall. A tire not marked RADIAL is a bias-ply tire.

10 Summer tire or all season tire (→P. 383)

An all season tire has M+S on the sidewall. A tire not marked M+S is a summer tire.

Typical DOT and tire identification number (TIN)

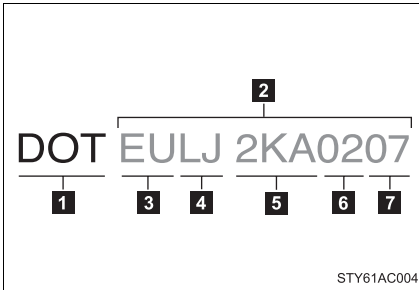
**1** DOT symbol***2** Tire Identification Number (TIN)**3** Tire manufacturer's identification mark**4** Tire size code**5** Manufacturer's optional tire type code (3 or 4 letters)**6** Manufacturing week**7** Manufacturing year

*:The DOT symbol certifies that the tire conforms to applicable Federal Motor Vehicle Safety Standards.

Tire size

n Typical tire size information

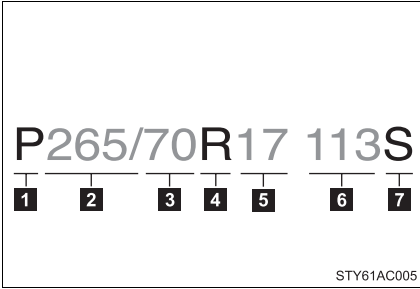

The illustration indicates typical tire size.

- 1** Tire use
(P = Passenger car,
T = Temporary use)
- 2** Section width (millimeters)
- 3** Aspect ratio
(tire height to section width)
- 4** Tire construction code
(R = Radial, D = Diagonal)
- 5** Wheel diameter (inches)
- 6** Load index (2 digits or 3 digits)
- 7** Speed symbol
(alphabet with one letter)

n Tire dimensions

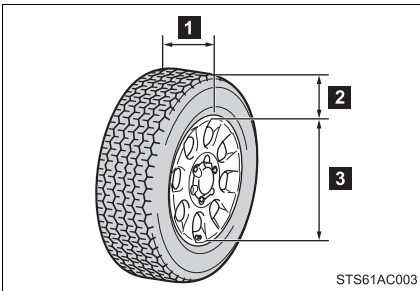

- 1** Section width
- 2** Tire height
- 3** Wheel diameter

Tire section names

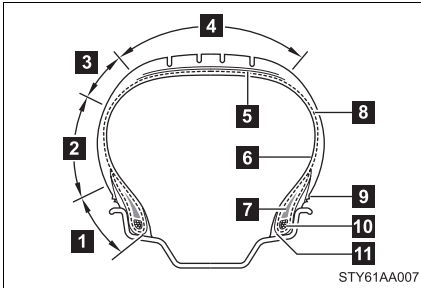

- 1** Bead
- 2** Sidewall
- 3** Shoulder
- 4** Tread
- 5** Belt
- 6** Inner liner
- 7** Reinforcing rubber
- 8** Carcass
- 9** Rim lines
- 10** Bead wires
- 11** Chafer

Uniform Tire Quality Grading

This information has been prepared in accordance with regulations issued by the National Highway Traffic Safety Administration of the U.S.A. Department of Transportation.

It provides the purchasers and/or prospective purchasers of Toyota vehicles with information on uniform tire quality grading.

Your Toyota dealer will help answer any questions you may have as you read this information.

n DOT quality grades

All passenger vehicle tires must conform to Federal Safety Requirements in addition to these grades. Quality grades can be found where applicable on the tire sidewall between tread shoulder and maximum section width.

For example: Treadwear 200 Traction AA Temperature A

n Treadwear

The treadwear grade is a comparative rating based on the wear rate of the tire when tested under controlled conditions on a specified government test course.

For example, a tire graded 150 would wear one and a half (1 - 1/2) times as well on the government course as a tire graded 100.

The relative performance of tires depends upon the actual conditions of their use, however, and may depart significantly from the norm due to variations in driving habits, service practices and differences in road characteristics and climate.

n Traction AA, A, B, C

The traction grades, from highest to lowest, are AA, A, B and C, and they represent the tire's ability to stop on wet pavement as measured under controlled conditions on specified government test surfaces of asphalt and concrete.

A tire marked C may have poor traction performance.

Warning: The traction grade assigned to this tire is based on braking (straight ahead) traction tests and does not include cornering (turning) traction.

n Temperature A, B, C

The temperature grades are A (the highest), B, and C, representing the tire's resistance to the generation of heat and its ability to dissipate heat when tested under controlled conditions on a specified indoor laboratory test wheel.

Sustained high temperature can cause the material of the tire to degenerate and reduce tire life, and excessive temperature can lead to sudden tire failure.

The grade C corresponds to a level of performance which all passenger car tires must meet under the Federal Motor Vehicle Safety Standard No. 109.

Grades B and A represent higher levels of performance on the laboratory test wheel than the minimum required by law.

Warning: The temperature grades for this tire are established for a tire that is properly inflated and not overloaded.

Excessive speed, underinflation, or excessive loading, either separately or in combination, can cause heat buildup and possible tire failure.

Glossary of tire terminology

Tire related term	Meaning
Cold tire inflation pressure	Tire pressure when the vehicle has been parked for three hours or more, or has not been driven more than 1 mile or 1.5 km under that condition
Maximum inflation pressure	The maximum cold inflated pressure to which a tire may be inflated, shown on the sidewall of the tire
Recommended inflation pressure	Cold tire inflation pressure recommended by a manufacturer
Accessory weight	The combined weight (in excess of those standard items which may be replaced) of transmission, power steering, power brakes, power windows, power seats, radio and heater, to the extent that these items are available as factory-installed equipment (whether installed or not)
Curb weight	The weight of a motor vehicle with standard equipment, including the maximum capacity of fuel, oil and coolant, and if so equipped, air conditioning and additional weight optional engine
Maximum loaded vehicle weight	The sum of: (a) Curb weight (b) Accessory weight (c) Vehicle capacity weight (d) Production options weight

Tire related term	Meaning
Normal occupant weight	150 lb. (68 kg) times the number of occupants specified in the second column of Table 1* that follows
Occupant distribution	Distribution of occupants in a vehicle as specified in the third column of Table 1* below
Production options weight	The combined weight of installed regular production options weighing over 5 lb. (2.3 kg) in excess of the standard items which they replace, not previously considered in curb weight or accessory weight, including heavy duty brakes, ride levelers, roof rack, heavy duty battery, and special trim
Rim	A metal support for a tire or a tire and tube assembly upon which the tire beads are seated
Rim diameter (Wheel diameter)	Nominal diameter of the bead seat
Rim size designation	Rim diameter and width
Rim type designation	The industry manufacturer's designation for a rim by style or code
Rim width	Nominal distance between rim flanges
Vehicle capacity weight (Total load capacity)	The rated cargo and luggage load plus 150 lb. (68 kg) times the vehicle's designated seating capacity
Vehicle maximum load on the tire	The load on an individual tire that is determined by distributing to each axle its share of the maximum loaded vehicle weight, and dividing by two
Vehicle normal load on the tire	The load on an individual tire that is determined by distributing to each axle its share of curb weight, accessory weight, and normal occupant weight (distributed in accordance with Table 1* below), and dividing by two

Tire related term	Meaning
Weather side	The surface area of the rim not covered by the inflated tire
Bead	The part of the tire that is made of steel wires, wrapped or reinforced by ply cords and that is shaped to fit the rim
Bead separation	A breakdown of the bond between components in the bead
Bias ply tire	A pneumatic tire in which the ply cords that extend to the beads are laid at alternate angles substantially less than 90 degrees to the centerline of the tread
Carcass	The tire structure, except tread and sidewall rubber which, when inflated, bears the load
Chunking	The breaking away of pieces of the tread or sidewall
Cord	The strands forming the plies in the tire
Cord separation	The parting of cords from adjacent rubber compounds
Cracking	Any parting within the tread, sidewall, or innerliner of the tire extending to cord material
CT	A pneumatic tire with an inverted flange tire and rim system in which the rim is designed with rim flanges pointed radially inward and the tire is designed to fit on the underside of the rim in a manner that encloses the rim flanges inside the air cavity of the tire
Extra load tire	A tire designed to operate at higher loads and at higher inflation pressures than the corresponding standard tire
Groove	The space between two adjacent tread ribs
Innerliner	The layer(s) forming the inside surface of a tubeless tire that contains the inflating medium within the tire

Tire related term	Meaning
Innerliner separation	The parting of the innerliner from cord material in the carcass
Intended outboard sidewall	(a)The sidewall that contains a whitewall, bears white lettering, or bears manufacturer, brand, and/or model name molding that is higher or deeper than the same molding on the other sidewall of the tire, or (b)The outward facing sidewall of asymmetrical tire that has a particular side that must always face outward when mounted on a vehicle
Light truck (LT) tire	A tire designated by its manufacturer as primarily intended for use on lightweight trucks or multipurpose passenger vehicles
Load rating	The maximum load that a tire is rated to carry for a given inflation pressure
Maximum load rating	The load rating for a tire at the maximum permissible inflation pressure for that tire
Maximum permissible inflation pressure	The maximum cold inflation pressure to which a tire may be inflated
Measuring rim	The rim on which a tire is fitted for physical dimension requirements
Open splice	Any parting at any junction of tread, sidewall, or innerliner that extends to cord material
Outer diameter	The overall diameter of an inflated new tire
Overall width	The linear distance between the exteriors of the sidewalls of an inflated tire, including elevations due to labeling, decorations, or protective bands or ribs
Passenger car tire	A tire intended for use on passenger cars, multipurpose passenger vehicles, and trucks, that have a gross vehicle weight rating (GVWR) of 10,000 lb. or less

Tire related term	Meaning
Ply	A layer of rubber-coated parallel cords
Ply separation	A parting of rubber compound between adjacent plies
Pneumatic tire	A mechanical device made of rubber, chemicals, fabric and steel or other materials, that, when mounted on an automotive wheel, provides the traction and contains the gas or fluid that sustains the load
Radial ply tire	A pneumatic tire in which the ply cords that extend to the beads are laid at substantially 90 degrees to the centerline of the tread
Reinforced tire	A tire designed to operate at higher loads and at higher inflation pressures than the corresponding standard tire
Section width	The linear distance between the exteriors of the sidewalls of an inflated tire, excluding elevations due to labeling, decoration, or protective bands
Sidewall	That portion of a tire between the tread and bead
Sidewall separation	The parting of the rubber compound from the cord material in the sidewall
Snow tire	A tire that attains a traction index equal to or greater than 110, compared to the ASTM E-1136 Standard Reference Test Tire, when using the snow traction test as described in ASTM F-1805-00, Standard Test Method for Single Wheel Driving Traction in a Straight Line on Snow-and Ice-Covered Surfaces, and which is marked with an Alpine Symbol () on at least one sidewall
Test rim	The rim on which a tire is fitted for testing, and may be any rim listed as appropriate for use with that tire

Tire related term	Meaning
Tread	That portion of a tire that comes into contact with the road
Tread rib	A tread section running circumferentially around a tire
Tread separation	Pulling away of the tread from the tire carcass
Treadwear indicators (TWI)	The projections within the principal grooves designed to give a visual indication of the degrees of wear of the tread
Wheel-holding fixture	The fixture used to hold the wheel and tire assembly securely during testing

*:Table 1 — Occupant loading and distribution for vehicle normal load for various designated seating capacities

Designated seating capacity, Number of occupants	Vehicle normal load, Number of occupants	Occupant distribution in a normally loaded vehicle
2 through 4	2	2 in front
5 through 10	3	2 in front, 1 in second seat
11 through 15	5	2 in front, 1 in second seat, 1 in third seat, 1 in fourth seat
16 through 20	7	2 in front, 2 in second seat, 2 in third seat, 1 in fourth seat

Customizable features

Your vehicle includes a variety of electronic features that can be personalized to your preferences. Programming these preferences requires specialized equipment and may be performed by an authorized Toyota dealership.

Some function settings are changed simultaneously with other functions being customized. Contact your Toyota dealer for further details.

Item	Function	Default setting	Customized setting
Wireless remote control (→P. 28)	Wireless remote control	ON	OFF
	Unlocking operation	Driver's door unlocked in one step, all doors unlocked in two steps	All doors unlocked in one step
	Time elapsed before automatic door lock function is activated if door is not opened after being unlocked	60 seconds	0 seconds
			30 seconds
			120 seconds
	Operation signal (Emergency flashers)	ON	OFF
	Door lock buzzer	ON	OFF
	Panic function	ON	OFF
Buzzer sounds when pushing LOCK with any door not closed	ON	OFF	
Door lock (→P. 31)	Unlocking using a key	Driver's door unlocked in one step, all doors unlocked in two steps	All doors unlocked in one step

Item	Function	Default setting	Customized setting
Automatic light off system (→P. 143)	Time elapsed before headlights automatically turn off after doors are closed	30 seconds	0 seconds
			60 seconds
			90 seconds
Illumination (→P. 315)	Time elapsed before lights turn off	15 seconds	7.5 seconds
			30 seconds
	Operation after the engine switch is turned to the LOCK position	ON	OFF
	Operation when the doors are unlocked	ON	OFF
Seat Belt Reminder Buzzer (→P. 433)	Vehicle speed linked seat belt reminder buzzer	ON	OFF

6-2. Customization

Items to initialize

The following items must be initialized for normal system operation in cases such as after the battery is reconnected, or maintenance is performed on the vehicle.

Item	When to initialize	Reference
Engine oil maintenance data	After changing engine oil	P. 370

Reporting safety defects for U.S. owners

If you believe that your vehicle has a defect which could cause a crash or could cause injury or death, you should immediately inform the National Highway Traffic Safety Administration (NHTSA) in addition to notifying Toyota Motor Sales, U.S.A., Inc. (Toll-free: 1-800-331-4331).

If NHTSA receives similar complaints, it may open an investigation, and if it finds that a safety defect exists in a group of vehicles, it may order a recall and remedy campaign. However, NHTSA cannot become involved in individual problems between you, your dealer, or Toyota Motor Sales, U.S.A., Inc.

To contact NHTSA, you may call the Vehicle Safety Hotline toll-free at 1-888-327-4236 (TTY: 1-800-424-9153); go to <http://www.safercar.gov>, or write to: Administrator, NHTSA, 1200 New Jersey Ave, S.E., Washington, DC 20590. You can also obtain other information about motor vehicle safety from <http://www.safercar.gov>.

Seat belt instructions for Canadian owners (in French)

The following is a French explanation of seat belt instructions extracted from the seat belt section in this manual.

See the seat belt section for more detailed seat belt instructions in English.

Utilisation correcte des ceintures de sécurité

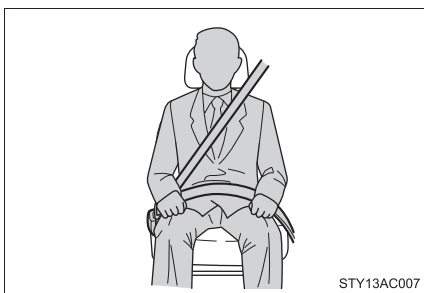

- Tirez sur la ceinture épaulière jusqu'à ce qu'elle recouvre entièrement l'épaule, mais elle ne doit pas toucher le cou ni glisser de l'épaule.
- Placez la sangle abdominale de la ceinture de sécurité le plus bas possible sur les hanches.
- Réglez la position du dossier du siège. Tenez-vous assis dans le fond du siège, le dos droit.
- Ne tournez pas la ceinture de sécurité.

Entretien et soins

■ Ceintures de sécurité

Avec un tissu ou une éponge, nettoyez à l'aide d'un savon doux et de l'eau tiède. Vérifiez aussi les ceintures régulièrement pour vous assurer qu'elles ne présentent pas d'usure excessive, d'effilochage ou de coupures.

ATTENTION

■ Dommages et usure de la ceinture de sécurité

Vérifiez périodiquement le système de ceintures de sécurité. Assurez-vous qu'il n'y a pas de coupures, d'effilochures ni de pièces desserrées. N'utilisez pas une ceinture de sécurité endommagée avant qu'elle soit remplacée. Une ceinture de sécurité endommagée ne peut pas protéger les occupants contre les blessures.

The following is a French explanation of SRS airbag instructions extracted from the SRS airbag section in this manual.

See the SRS airbag section for more detailed SRS airbag instructions in English.

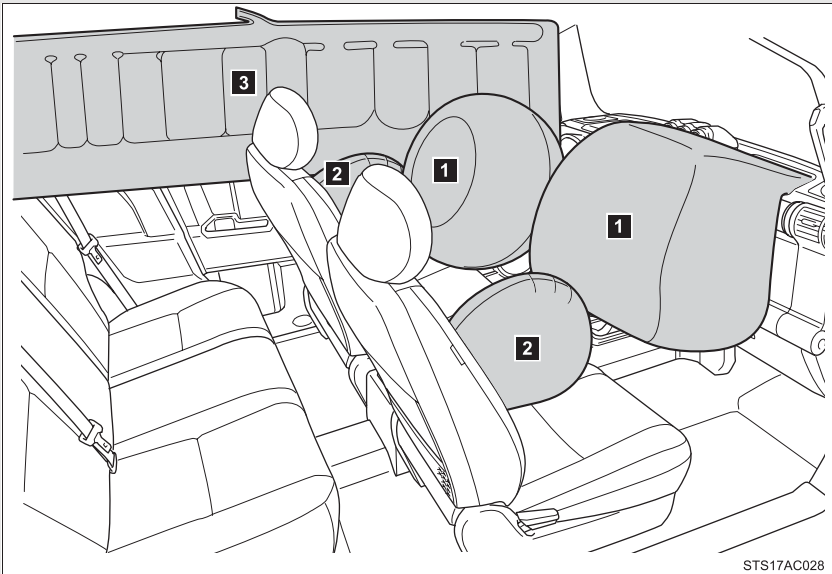

STS17AC028

► **Coussins gonflables avant**

1 **Coussin gonflable du conducteur/du passager avant**

Peut protéger la tête et la poitrine du conducteur et du passager avant contre les impacts avec des composants intérieurs.

► **Coussins gonflables latéraux et coussins gonflables en rideau**

2 **Coussins gonflables latéraux**

Peuvent protéger le torse des occupants des sièges avant.

3 **Coussins gonflables rideaux**

Peuvent surtout protéger la tête des occupants des places extérieures.

Composants du système de coussins gonflables

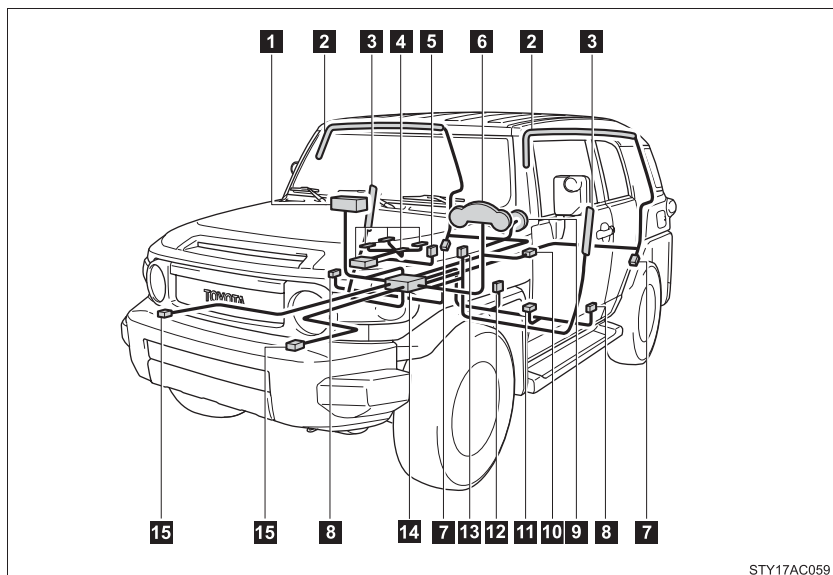

STY17AC059

- | | |
|-------------------------------------------------------------------------|----------------------------------------------------------------------|
| 1 Coussin gonflable du passager avant | 8 Capteurs de coussin gonflable en rideau et latéraux |
| 2 Coussins gonflables rideaux | 9 Coussin gonflable du conducteur |
| 3 Coussins gonflables latéraux | 10 Contacteur RSCA OFF |
| 4 Système de détection d'occupation du siège (ECU et capteurs) | 11 Capteur de position de siège du conducteur |
| 5 Contacteur de boucle de ceinture de sécurité du passager avant | 12 Contacteur de boucle de ceinture de sécurité du conducteur |
| 6 Lampes témoin SRS et RSCA OFF | 13 Lampes témoins AIR BAG ON et AIR BAG OFF |
| 7 Capteurs de coussin gonflable en rideau | 14 Module de capteur de coussin gonflable |
| | 15 Capteurs de coussin gonflable avant |

Votre véhicule est équipé de ADVANCED AIRBAGS (coussins de sécurité gonflables sophistiqués) dont la conception s'appuie sur les normes de sécurité des véhicules à moteur américains (FMVSS208). Le système de coussins gonflables contrôle la puissance de déploiement des coussins du conducteur et du passager avant. Le système du conducteur est constitué du capteur de position du siège du conducteur, etc. Le système du passager avant est constitué du capteur de classification de l'occupant du siège du passager avant, etc.

Les composants principaux du système de coussins gonflables SRS sont illustrés ci-dessus. Il est contrôlé par le module de capteur de coussin gonflable SRS. Le module de capteur de coussin gonflable est constitué d'un capteur de sûreté et d'un capteur de coussin gonflable.

Lors de certains types de collision frontale ou latérale violente, le système de coussins gonflables SRS déclenche les dispositifs de gonflage des coussins. Une réaction chimique se produit dans ces dispositifs et les coussins gonflables se remplissent rapidement d'un gaz non toxique pour empêcher tout mouvement des occupants.

ATTENTION

■ Précautions relatives aux coussins gonflables SRS

Observez les précautions suivantes en ce qui concerne les coussins gonflables.

Les négliger pourrait occasionner des blessures graves, voire mortelles.

- Le conducteur et tous les passagers du véhicule doivent porter leur ceinture de sécurité de la manière appropriée.

Les coussins gonflables SRS sont des dispositifs supplémentaires qui doivent être utilisés de concert avec les ceintures de sécurité.

- Le coussin gonflable SRS du conducteur se déploie avec une force considérable et peut occasionner des blessures graves, voire mortelles, notamment lorsque le conducteur se trouve très près du coussin gonflable. La National Highway Traffic Safety Administration (“NHTSA”), aux États-Unis, donne les recommandations suivantes:

La zone à risque d'un coussin gonflable côté conducteur couvre 2 - 3 in. (50 - 75 mm) de la zone de déploiement du coussin gonflable, pour assurer une marge de sécurité suffisante, restez à 10 in. (250 mm) du coussin gonflable. Cette distance est mesurée depuis le centre du volant jusqu'à votre sternum. Si vous vous tenez à moins de 10 in. (250 mm), vous pouvez changer votre position de conduite de plusieurs manières:

- Reculez votre siège à la position maximale vous permettant d'atteindre encore aisément les pédales.
- Inclinez légèrement le dossier du siège.

Même si les véhicules sont conçus différemment, la plupart des conducteurs peuvent maintenir une distance de 10 in. (250 mm), même si le siège se trouve complètement vers l'avant, simplement en inclinant un peu le dossier du siège vers l'arrière. Si la visibilité avant est moindre après avoir incliné le dossier du siège, utilisez un coussin ferme et non glissant pour être assis plus haut ou relevez l'assise du siège si cette option est disponible sur votre véhicule.

- Si votre volant est réglable en hauteur, inclinez-le vers le bas. Cela vous permet d'orienter le coussin gonflable vers votre buste plutôt que vers la tête et le cou.

Le siège doit être réglé de la manière recommandée ci-dessus par la NHTSA, tout en gardant le contrôle des pédales, du volant et la vue des commandes et des instruments.

ATTENTION

■ Précautions relatives aux coussins gonflables SRS

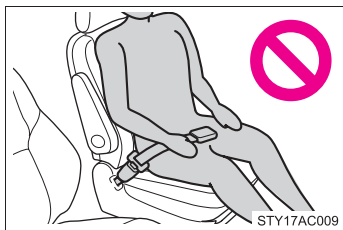

- Si la rallonge est reliée à la boucle de ceinture de sécurité du conducteur sans avoir été attachée à la plaque de blocage de la ceinture de sécurité du conducteur, le coussin gonflable SRS du conducteur considère que le conducteur porte tout de même sa ceinture même si elle n'est pas attachée. Le coussin gonflable du conducteur peut alors ne pas s'activer correctement lors d'une collision, ce qui représente un risque de blessures graves, voire mortelles. Bouclez toujours votre ceinture de sécurité lorsque vous utilisez la rallonge.
- Le coussin gonflable SRS du passager avant se déploie également avec une force considérable et peut occasionner des blessures graves, voire mortelles, notamment lorsque le passager avant se trouve très près du coussin gonflable. Le siège du passager avant doit se trouver le plus loin possible du coussin gonflable et le dossier doit être réglé de manière à ce que le passager avant soit assis bien droit.
- Le déploiement d'un coussin gonflable risque d'infliger des blessures graves, voire mortelles, aux bébés et aux enfants mal assis et/ou mal attachés. Un bébé ou un enfant trop petit pour utiliser une ceinture de sécurité doit être correctement retenu à l'aide d'un dispositif de retenue pour enfants. Toyota recommande vivement de placer et d'attacher correctement tous les bébés et enfants sur les sièges arrière du véhicule à l'aide de systèmes de retenue adaptés. Les sièges arrière constituent en effet l'endroit le plus sûr pour eux.

ATTENTION

■ Précautions relatives aux coussins gonflables SRS

● N'installez jamais un dispositif de retenue pour enfants de type dos à la route sur le siège du passager avant, même si la lampe témoin AIR BAG OFF est allumée. En cas d'accident, la force et la vitesse de déploiement du coussin gonflable du passager avant sont telles qu'elles pourraient infliger à l'enfant des blessures graves, voire mortelles, si le dispositif de retenue pour enfants du type dos à la route était installé sur le siège du passager avant.

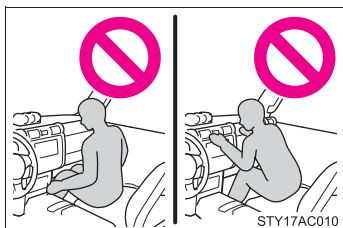

● Ne vous asseyez pas sur le bord du siège et ne vous appuyez pas sur le tableau de bord.

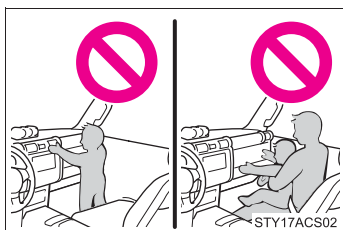

● Ne laissez pas un enfant se tenir face au coussin gonflable SRS du passager avant ou s'asseoir sur les genoux d'un passager avant.

● Ne conduisez pas le véhicule si vous ou le passager avez quelque chose sur les genoux.



● Ne vous appuyez pas sur la portière ou sur le longeron du toit, ni sur les montants avant, latéraux ou arrière.

⚠ ATTENTION

■ Précautions relatives aux coussins gonflables SRS



- Ne laissez personne s'agenouiller face à la portière sur le siège du passager ou sortir la tête ou les mains à l'extérieur du véhicule.

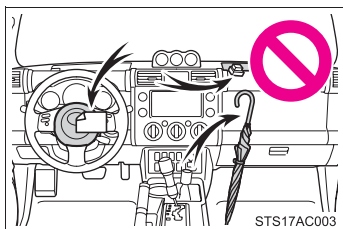

- Ne fixez et ne déposez rien sur des endroits tels que le tableau de bord ou le tampon de volant. Ces objets peuvent se transformer en projectiles lorsque les coussins gonflables SRS du conducteur ou du passager avant se déploient.

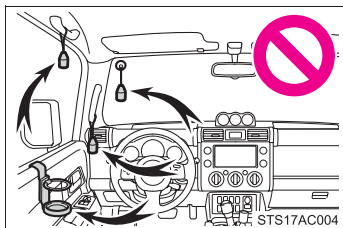

- Ne fixez rien sur les portières, le pare-brise, les glaces latérales, les montants avant et arrière, le longeron du toit ou la poignée de maintien.

- N'utilisez pas d'accessoires recouvrant les parties du siège où les coussins gonflables SRS latéraux se déploient, car ceux-ci pourraient nuire au déploiement de ces coussins.
- Ne frappez pas et n'appliquez pas une pression importante à l'emplacement des composants de coussins gonflables SRS (→P. 502). Ces actions peuvent entraîner un mauvais fonctionnement des coussins gonflables SRS.

ATTENTION

■ Précautions relatives aux coussins gonflables SRS

- Ne touchez à aucun composant des coussins gonflables SRS immédiatement après leur déploiement (gonflage), car ils pourraient être chauds.
- Si vous avez de la difficulté à respirer après le déploiement d'un coussin gonflable SRS, ouvrez une portière ou une glace pour laisser entrer l'air, ou quittez le véhicule si vous pouvez le faire en toute sécurité. Dès que possible, nettoyez tous les résidus afin d'éviter les irritations cutanées.
- Si les emplacements de stockage des coussins gonflables SRS, notamment le tampon de volant et les garnitures des montants avant et arrière, sont endommagés ou fissurés, faites-les remplacer par votre concessionnaire Toyota.

■ Modification et mise au rebut des composants du système de coussins gonflables SRS

Ne mettez pas le véhicule au rebut et n'effectuez aucune des modifications suivantes sans d'abord consulter votre concessionnaire Toyota.

Les coussins gonflables SRS pourraient fonctionner de manière incorrecte ou se déployer (gonfler) accidentellement, ce qui serait susceptible d'occasionner des blessures graves, voire mortelles.

- Installation, retrait, démontage et réparation des coussins gonflables SRS.
- Réparations, modifications, retrait ou remplacement du volant, du bloc d'instrumentation, du tableau de bord, des sièges ou du capitonnage des sièges, des montants avant, latéraux ou arrière et du longeron du toit.
- Réparations ou modifications de l'aile ou du pare-choc avant, ou du côté de l'habitacle.
- Installation de lames de déneigement, de treuils, etc. sur la calandre avant (barre safari, barre kangourou, etc.).
- Modifications au système de suspension du véhicule.
- Installation d'appareils électroniques tels qu'un émetteur-récepteur radio ou un lecteur de CD.
- Modifications à votre véhicule pour une personne aux capacités physiques réduites.

Désactivation des coussins gonflables rideau si le véhicule fait des tonneaux

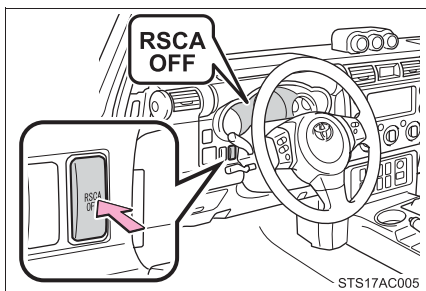

ON/OFF (maintenez enfoncé pendant quelques secondes)

La lampe témoin RSCA OFF s'allume. (uniquement si le contacteur du moteur est en position ON.)

La fonction de désactivation des coussins gonflables rideau et des dispositifs de tension des ceintures de sécurité en cas de tonneaux se réactivera automatiquement à chaque fois que le contacteur du moteur sera mis en position ON.

⚠ ATTENTION

■ Pour la conduite normale

Assurez-vous que la lampe témoin RSCA OFF n'est pas allumée. Si elle reste allumée, le coussin gonflable rideau ne se déploiera pas en cas d'accident, ce qui pourrait occasionner des blessures graves, voire mortelles.

A	A/C	206
	ABS	175
	Access doors	34
	Accessory meter	141
	Active traction control system	167
	Air conditioning filter	394
	Air conditioning system	
	Air conditioning filter.....	394
	Manual air conditioning system.....	206
	Airbags	
	Airbag operating conditions.....	82
	Airbag precautions for your child.....	86
	Airbag warning light.....	431
	Curtain shield airbag operating conditions.....	82
	Curtain shield airbag precautions.....	86
	Front passenger occupant classification system.....	92
	General airbag precautions.....	86
	Locations of airbags.....	79
	Modification and disposal of airbags.....	90
	Proper driving posture.....	77, 86
	Side airbag operating conditions.....	82
	Side airbag precautions.....	86
	SRS airbags.....	79
	Antenna	222

Anti-lock brake system	
ABS warning light.....	431
Anti-lock brake system.....	175
Armrest	336
Audio input	258
Audio remote controls	259
Audio system	
Antenna.....	222
Audio input.....	258
AUX port.....	258
CD player.....	225
MP3/WMA disc.....	233
Optimal use.....	255
Portable music player.....	258
Radio.....	218
Steering wheel audio switch.....	259
Type.....	214
AUTO LSD system	169
Automatic light off system	144
Automatic limited slip differential	169
Automatic transmission	
Automatic transmission.....	127
If the shift lever cannot be shifted from P.....	454
AUX port	258
Auxiliary box	318, 324
B	
Back door	36
Back door lock	36
Back-up lights	
Replacing light bulbs.....	410
Wattage.....	478
Back window	41

Battery

- Charging system warning
 - light 431
- Checking 376
- If the vehicle battery is
 - discharged 456
- Preparing and checking
 - before winter 190

Bluetooth audio® 262

Bluetooth phone® 278

Bottle holders 318, 323

Brake assist 175

Brakes

- Brake system warning
 - buzzer 168, 170, 178
- Brake system warning
 - light 430
- Fluid 373
- Parking brake 132

Break-in tips 116

C

Care

- Exterior 350
- Interior 353
- Seat belts 354

Cargo capacity 185

Cargo net hook 341

CD player 225

Center differential lock 161

Certification label 193, 469

Chains 191

Child restraint system

- Booster seats, definition 97
- Booster seats, installation 107
- Convertible seats, definition 97
- Convertible seats,
 - installation 105
- Front passenger occupant
 - classification system 92
- Infant seat, definition 97
- Infant seats, installation 104
- Installing CRS with LATCH
 - anchors 103
- Installing CRS with seat
 - belts 101
- Installing CRS with top tether
 - straps 108

Child safety

- Airbag precautions 86
- Battery precautions 378, 458
- Child restraint system 97
- How your child should wear
 - the seat belt 58
- Installing child restraints 101
- Power window lock switch 69
- Power window precautions 70
- Removed key battery
 - precautions 398
- Seat belt extender
 - precautions 59
- Seat belt precautions 59

Cleaning

- Exterior 350
- Interior 353
- Seat belts 354

Clinometer	141
Clock	327
Clutch start cancel switch	174
Compass	141, 343
Condenser	373
Cooling system	
Engine overheating	459
CRS	97
Cruise control	148
Cup holders	318, 319, 322
Curtain shield airbags	79
Customizable features	493

D

Daytime running light system	144
Defogger	
Rear window	213
Dimension	468
Dinghy towing	203
Do-it-yourself maintenance	362
Doors	
Access doors.....	34
Door glasses	69
Door lock	28, 31
Open door warning light	433
Side doors	31
Side mirrors.....	66
Driver's seat belt reminder buzzer	433
Driver's seat belt reminder light	433
Driving	
Break-in tips	116
Correct posture	77
Driving assist systems.....	175
Procedures.....	124
Winter driving tips.....	190

E

Emergency, in case of	
Blown fuse	399
If the engine will not start	453
If the shift lever cannot be shifted from P	454
If the vehicle battery is discharged	456
If a warning buzzer sounds	430
If a warning light turns on.....	430
If you have a flat tire	440
If you lose your keys	455
If you think something is wrong.....	426
If the vehicle becomes stuck	462
If your vehicle has to be stopped in an emergency.....	464
If your vehicle needs to be towed	421
If your vehicle overheats	459
Emergency flashers	
Switch	420
Engine	
Compartment	367
Engine switch.....	124
Exhaust gas	120
Hood	366
How to start the engine	124
Identification number.....	470
If the engine will not start	453
Ignition switch	124
Immobilizer system	74
Overheating	459
Warning light.....	431

Engine coolant	
Capacity	472
Checking	372
Preparing and checking	
before winter	190
Temperature gauge	135
Engine coolant temperature gauge	135
Engine immobilizer system	74
Engine oil	
Capacity	471
Checking	368
Preparing and checking before	
winter	190
Warning light	431, 433
Engine oil maintenance data	370
Engine switch	124
Event data recorder	428
F	
Floor mat	337
Fluid	
Brake	373
Washer	379
Four-wheel drive system	
Four-wheel drive control	
lever	161
Front-wheel drive control	
lever	164
Front passenger occupant classification system	92
Front passenger's seat belt reminder light	433
Front passenger's seat belt warning buzzer	433
Front seats	
Adjustment	45

Front side marker lights	
Replacing light bulbs	410
Switch	143
Wattage	478
Front turn signal lights	
Lever	131
Replacing light bulbs	410
Switch	131
Wattage	478
Fuel	
Capacity	470
Fuel gauge	135
Fuel pump shut off system	427
Gas station information	528
Information	479
Refueling	71
Type	470
Warning light	433
Fuel door	71
Fuel filler door	71
Fuel pump shut off system	427
Fuses	
Fuses	399
Locations	403, 407

G	
Gas station information	528
Gauges	135
Glass hatch	41
Glove box	319

H	
Hands-free phone system (for cellular phone)	278
Hazard lights	
Switch	420
Head restraints	
Adjusting	53

Headlights
 Replacing light bulbs 410
 Switch 143
 Wattage 478
Hood 366
Hooks
 Cargo net 341
 Shopping bag 342
Horn 134

I **I/M test** 361

Identification
 Engine 470
 Tire 483
 Vehicle 469
Ignition switch 124
Illuminated entry system 315
Immobilizer system 74
Indicator lights 138
Initialization
 Items to initialize 495
Inside rear view mirror 63
Interior lights
 Switch 316
 Wattage 478
Instrument panel light control 136
Intuitive parking assist 152

J **Jack**

Positioning the jack 443
 Vehicle-equipped jack 440
Jack handle 443

K **Keyless entry** 28

Keys
 Engine switch 124
 If you lose your keys 455
 Ignition switch 124
 Key battery 397
 Keyless entry 28
 Key number 26
 Keys 26
 Reminder buzzer 435
 Wireless remote control
 key 26, 28

L **License plate lights**

Replacing light bulbs 410
 Switch 143
 Wattage 478

Light bulbs

Replacing 410
 Wattage 478

Lights

Automatic light off system 144
 Emergency flasher switch 420
 Hazard light switch 420
 Headlights switch 143
 Instrument panel light control
 dial 136
 Interior light switch 316
 Personal lights switch 317
 Replacing light bulbs 410
 Turn signal lights switch 131
 Wattage 478

Limited slip differential 169
Load capacity 185, 189, 468
Lock steering column 62
Luggage storage box 339
Luggage compartment features 340

M	Maintenance	
	Do-it-yourself maintenance ..	362
	General maintenance	358
	Maintenance data	468
	Maintenance requirements...	356
	Vehicle exterior.....	350
	Vehicle interior.....	353
	Malfunction indicator lamp ...	431
	Manual air conditioning	
	system	206
	Manual transmission	129
	Meter	
	Accessory meter.....	141
	Instrument panel light	
	control	136
	Meters	135
	Mirrors	
	Inside rear view mirror.....	63
	Side mirrors.....	66
	Vanity mirrors	326
	MP3 disc.....	233
N	Noise from under vehicle	21
O	Odometer	135
	Off-road precautions	
	Driving	182
	Vehicle.....	180
	Oil	
	Engine oil.....	368
	Warning light	431,433
	Opener	
	Hood.....	366
	Outside rear view mirror	
	illumination lights	
	Replacing light bulbs	416
	Switch.....	143
	Wattage.....	478

	Outside rear view mirrors	
	Adjusting and folding.....	66
	Outside temperature	
	display	328
	Overheating, Engine	459
P	Parking assist.....	152
	Parking brake	132
	Parking lights	
	Replacing light bulbs	410
	Switch.....	143
	Wattage.....	478
	Personal lights	
	Switch.....	317
	Wattage.....	478
	Power outlet	329, 330
	Power steering	
	Fluid	375
	Power windows	69
R	Radiator	367, 373
	Radio	218
	Rear seat	
	Folding down.....	47
	Removing rear seat bottom	
	cushions.....	48
	Rear side marker lights	
	Replacing light bulbs	410
	Switch.....	143
	Wattage.....	478
	Rear turn signal lights	
	Lever	131
	Replacing light bulbs	410
	Switch.....	131
	Wattage.....	478

Rear view monitor system157
Rear window.....41
Rear window defogger213
Replacing
 Key battery397
 Fuses399
 Light bulbs.....410
 Tires381,440
 Wheels391
Rear differential lock system 171
Rear step bumper38
Rear window wiper147
Reporting safety defects for U.S. owners.....498
Roll sensing of curtain shield airbags off switch.....90

S

Seat belts
 Adjustment56
 ALR58
 Automatic Locking Retractor...58
 Child restraint system installation.....101
 Cleaning and maintaining.....354
 ELR58
 Emergency Locking Retractor58
 How to wear your seat belt.....56
 How your child should wear the seat belt58
 Pregnant women, proper seat belt use58
 Reminder buzzer.....433
 Reminder light.....433
 Seat belt extenders59
 Seat belt pretensioners57
Seating capacity.....189

Seats
 Adjustment45
 Adjustment precautions46
 Child seats/child restraint system installation101
 Cleaning.....350, 353
 Folding down the rear seat47
 Folding down the rear seat precautions51
 Front seat adjustment45
 Front seat adjustment precautions46
 Head restraint53
 Properly sitting in the seat.....77
Service reminder indicators 139
Shift lever
 Automatic transmission.....127
 Four-wheel drive161
 Front-wheel drive164
 If the shift lever cannot be shifted from P454
 Manual transmission129
Shift lock system454
Side airbags79
Side doors31
Side marker lights
 Replacing light bulbs.....413, 414
 Switch143
 Wattage.....478
Side mirror
 Adjusting and folding.....66
Spare tire
 Inflation pressure477
 Replacing440
 Storage location440
Spark plug473
Specifications468
Speedometer135

SRS airbags
 Curtain shield airbags..... 79
 Front airbags 79
 Precautions 86
 Roll sensing of curtain shield
 airbags off switch 90
 Side airbags 79

Steering wheel
 Adjustment 62
 Audio switches 259
 Telephone switches..... 283

Stop lights
 Replacing light bulbs 414
 Wattage 478

Storage feature..... 318

Storage precautions 185

Stuck
 If the vehicle becomes
 stuck..... 462

Sun visors
 Front..... 325
 Side 325

Switch
 Active traction control
 switch 167
 Clutch start cancel switch..... 174
 Cruise control switch 148
 Emergency flasher switch 420
 Engine switch 124
 Hazard light switch 420
 Headlights switch 143
 Ignition switch..... 124
 Intuitive parking assist
 switch 152
 Light switch..... 143
 Power door lock switch..... 31
 Power window switch 69
 Rear differential lock
 switch 171

T **Tachometer..... 135**

Tail lights
 Replacing light bulbs 410
 Switch..... 143
 Wattage..... 478

Talk switch..... 283

Telephone switch..... 283

Theft deterrent system
 Engine immobilizer system 74
 Theft prevention labels..... 76

Theft prevention labels..... 76

Tire inflation pressure 477

Tire information
 Glossary 487
 Size 484
 Tire identification number..... 483
 Uniform tire quality grading ... 485

Tires
 Chains 191
 Checking 381
 If you have a flat tire..... 440
 Identification number..... 483
 Inflation pressure..... 477
 Inflation pressure sensor 382
 Information 482
 Replacing 381, 440
 Rotating tires 381
 Size 477
 Snow tires 191
 Spare tire..... 440
 Tire pressure warning
 system 381, 436
 Warning light 433

Tools 440
Total load capacity..... 189
Towing
 Dinghy towing..... 203
 Emergency towing..... 421
 Trailer towing..... 193
Traction control system 175
TRAC (TRC) 175
Trip meter 135
Turn signal lights
 Lever 131
 Replacing light bulbs 410
 Switch..... 131
 Wattage..... 478

V
Vanity mirrors..... 326
Vehicle identification
 number 469
Vehicle stability control..... 175
Voltmeter 135
VSC..... 175

W
Warning buzzers
 Key reminder..... 435
 Seat belt reminder..... 433
Warning lights
 ABS 431
 Airbag system 431
 Anti-lock brake system 431
 Automatic transmission fluid
 temperature 431
 Brake system 430
 Charging system 431
 Driver's seat belt 433
 Electronic engine control
 system 431
 Engine oil replacement..... 433

Front passenger occupant
 classification system..... 431
 Front passenger's seat belt... 433
 Low brake fluid..... 430
 Low engine oil pressure 431
 Low fuel level 433
 Low tire inflation pressure 433
 Low washer fluid 434
 Malfunction indicator lamp 431
 Open door 433
 Seat belt..... 433
 Seat belt pretensioner
 system 431
 SRS..... 431
 SRS airbag system 431
 Tire pressure..... 433
 Tire pressure warning
 system 433
 Unengaged "Park"..... 431

Washer
 Checking 379
 Preparing and checking
 before winter..... 190
 Switch 145, 147

Washing and waxing 350

Weight
 Cargo capacity 185
 Load limits..... 189
 Weight..... 468

Wheels 391

Window glasses 41, 69

Window lock switch..... 69

Windows
 Power windows 69
 Rear window defogger 213
 Washer..... 145, 147

Windshield wipers 145, 147

Wireless remote control key	
Replacing the battery	397
Wireless remote control.....	28
Winter driving tips.....	190
WMA disc	233

What to do if...

What to do if...

A tire punctures

P. 440 If you have a flat tire

The engine does not start

P. 453 If the engine will not start

P. 74 Engine immobilizer system

P. 456 If the vehicle battery is discharged

The shift lever cannot be moved out

P. 454 If the shift lever cannot be shifted from P

The engine coolant temperature gauge enters the red zone

P. 459 If your vehicle overheats

Steam can be seen coming from under the hood

The key is lost

P. 455 If you lose your keys

The battery runs out

P. 456 If the vehicle battery is discharged

The doors cannot be locked

P. 31 Side doors

P. 34 Access doors

P. 36 Back door

The vehicle is stuck in mud or sand

P. 462 If the vehicle becomes stuck

The warning light or indicator light comes on

P. 430 If a warning light turns on

n **Instrument cluster**

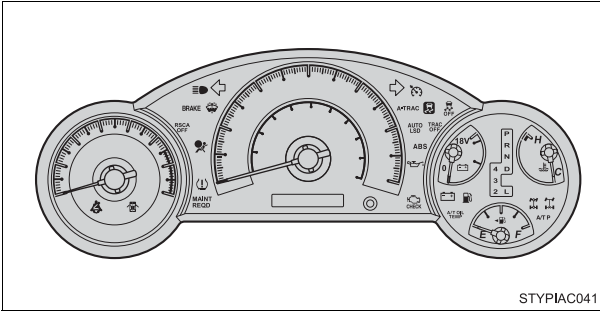

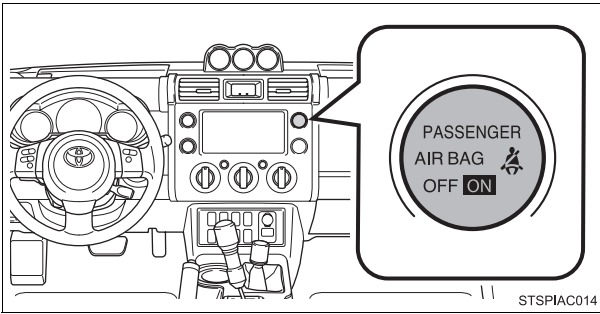

n **Center panel**





nWarning lights

BRAKE	Brake system warning light
or	
	P. 430

	Charging system warning light
	P. 431

	Low engine oil pressure warning light
	P. 431

	Malfunction indicator lamp
or	
	P. 431

ABS	ABS warning light
or	
	P. 432

MAINT REQD	Engine oil replacement reminder light
	P. 434

	SRS warning light
	P. 432

A/T OIL TEMP	Automatic transmission fluid temperature warning light
	P. 432

A/T P	Unengaged "Park" warning light
	P. 432

	Slip indicator*1
	P. 432

	Cruise control indicator light*2
	P. 432

	Tire pressure warning light
	P. 433

	Open door warning light
	P. 433

	Low fuel level warning light
	P. 433

	Driver's seat belt reminder light
	P. 433

PASSENGER	Front passenger's seat belt reminder light
	P. 433

	Low washer fluid warning light
	P. 434

*1: Slip indicator comes on.

*2: The indicator flashes to indicate a malfunction.

GAS STATION INFORMATION

Auxiliary catch lever

P. 366

Fuel filler door

P. 71

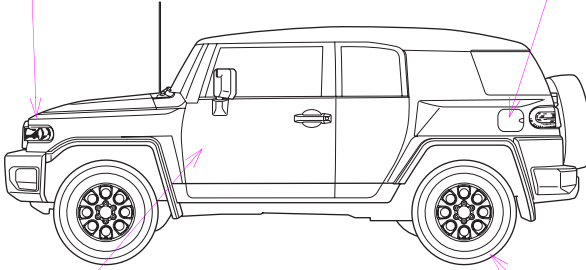

Hood lock release lever

P. 366

Tire inflation pressure STSPIAC012

P. 477

Fuel tank capacity (Reference)	19.0 gal. (72.0 L, 15.8 Imp.gal.)	
Fuel type	Unleaded gasoline, Octane Rating 87 (Research Octane Number 91) or higher	
Cold tire inflation pressure	P. 477	
Engine oil capacity (Drain and refill - reference)	With filter	qt. (L, Imp.qt.) 6.4 (6.1, 5.4)
	Without filter	6.0 (5.7, 5.0)
Engine oil type	Toyota Genuine Motor Oil or equivalent Oil grade: ILSAC multigrade engine oil Recommended oil viscosity: SAE 0W-20	P. 471