

## Abbreviation/Acronym list

ABBREVIATIONS	MEANING
A/C	Air Conditioning
ABS	Anti-lock Brake System
ALR	Automatic Locking Retractor
APGS	Advanced Parking Guidance System
CRS	Child Restraint System
DISP	Display
ECO	Economy/Ecology
ECU	Electronic Control Unit
EDR	Event Data Recorder
ELR	Emergency Locking Retractor
EPS	Electric Power Steering
EV	Electric Vehicle
GAWR	Gross Axle Weight Ratings
GPS	Global Positioning System
GVWR	Gross Vehicle Weight Rating
I/M	Emission Inspection and Maintenance
LATCH	Lower Anchors and Tethers for Children
LED	Light Emitting Diode
MMT	Methylcyclopentadienyl Manganese Tricarbonyl
M + S	Mud and Snow
MTBE	Methyl Tertiary Butyl Ether

ABBREVIATIONS	MEANING
OBD	On Board Diagnostics
PCS	Pre-Collision System
PWR	Power
SRS	Supplemental Restraint System
TIN	Tire Identification Number
TPMS	Tire Pressure Monitoring (Warning) System
TRAC	Traction Control
TWI	Treadwear Indicator
VIN	Vehicle Identification Number
VSC	Vehicle Stability Control

## For your information

### **Main Owner's Manual**

Please note that this manual applies to all models and explains all equipment, including options. Therefore, you may find some explanations for equipment not installed on your vehicle.

All specifications provided in this manual are current at the time of printing. However, because of the Toyota policy of continual product improvement, we reserve the right to make changes at any time without notice.

Depending on specifications, the vehicle shown in the illustrations may differ from your vehicle in terms of color and equipment.

### **Noise from under vehicle after turning off the hybrid system**

Approximately five hours after the hybrid system is turned off, you may hear sound coming from under the vehicle for several minutes. This is the sound of a fuel evaporation leakage check and, it does not indicate a malfunction.

### **Accessories, spare parts and modification of your Toyota**

A wide variety of non-genuine spare parts and accessories for Toyota vehicles are currently available in the market. You should know that Toyota does not warrant these products and is not responsible for their performance, repair, or replacement, or for any damage they may cause to, or adverse effect they may have on, your Toyota vehicle.

This vehicle should not be modified with non-genuine Toyota products. Modification with non-genuine Toyota products could affect its performance, safety or durability, and may even violate governmental regulations. In addition, damage or performance problems resulting from the modification may not be covered under warranty.

## **Installation of a mobile two-way radio system**

The installation of a mobile two-way radio system in your vehicle could affect electronic systems such as:

- Multiport fuel injection system/sequential multiport fuel injection system
- Cruise control system
- Anti-lock brake system
- SRS airbag system
- Seat belt pretensioner system

Be sure to check with your Toyota dealer for precautionary measures or special instructions regarding installation.

High voltage parts and cables on the hybrid vehicles emit approximately the same amount of electromagnetic waves as the conventional gasoline powered vehicles or home electronic appliances despite of their electromagnetic shielding.

Unwanted noise may occur in the reception of the mobile two-way radio.

## Vehicle control and operation data recording

Your Toyota is equipped with sophisticated computers that record certain information about your vehicle's operation, such as:

- Engine speed
- Electric motor speed (traction motor speed)
- Accelerator status
- Brake status
- Vehicle speed
- Shift position

The data recorded varies according to the grade level and options the vehicle is equipped with. The computers do not record conversations, sound or pictures.

### ● Data usage

Toyota may use the data recorded in these computers to diagnose malfunctions, conduct research and development, and improve quality.

Toyota will not disclose the recorded data to a third party except:

- With the consent of the vehicle owner or with the consent of the lessee if the vehicle is leased
- In response to an official request by the police, a court of law or a government agency
- For research purposes where the data is not tied to a specific vehicle or vehicle owner
- Usage of data collected through Safety Connect (U.S. mainland only)

If your Toyota has Safety Connect and if you have subscribed to those services, please refer to the Safety Connect Telematics Subscription Service Agreement for information on data collected and its usage.

## Event data recorder

This vehicle is equipped with an event data recorder (EDR). The main purpose of an EDR is to record, in certain crash or near crash-like situations, such as an air bag deployment or hitting a road obstacle, data that will assist in understanding how a vehicle's systems performed. The EDR is designed to record data related to vehicle dynamics and safety systems for a short period of time, typically 30 seconds or less.

The EDR in this vehicle is designed to record such data as:

- How various systems in your vehicle were operating;
- Whether or not the driver and passenger safety belts were buckled/fastened;
- How far (if at all) the driver was depressing the accelerator and/or brake pedal; and,
- How fast the vehicle was traveling.

These data can help provide a better understanding of the circumstances in which crashes and injuries occur.

NOTE: EDR data are recorded by your vehicle only if a non-trivial crash situation occurs; no data are recorded by the EDR under normal driving conditions and no personal data (e.g., name, gender, age, and crash location) are recorded. However, other parties, such as law enforcement, could combine the EDR data with the type of personally identifying data routinely acquired during a crash investigation.

To read data recorded by an EDR, special equipment is required, and access to the vehicle or the EDR is needed. In addition to the vehicle manufacturer, other parties, such as law enforcement, that have the special equipment, can read the information if they have access to the vehicle or the EDR.

● Disclosure of the EDR data

Toyota will not disclose the data recorded in an EDR to a third party except when:

- An agreement from the vehicle's owner (or the lessee for a leased vehicle) is obtained
- In response to official request by the police, a court of law or a government agency.
- For use by Toyota in a law suit

However, if necessary, Toyota may:

- Use the data for research on vehicle safety performance
- Disclose the data to a third party for research purposes without disclosing information about the specific vehicle or vehicle owner

## **Scrapping of your Toyota**

The SRS airbag and seat belt pretensioner devices in your Toyota contain explosive chemicals. If the vehicle is scrapped with the airbags and seat belt pretensioners left as they are, this may cause an accident such as fire. Be sure to have the systems of the SRS airbag and seat belt pretensioner removed and disposed of by a qualified service shop or by your Toyota dealer before you scrap your vehicle.

## **Perchlorate Material**

Special handling may apply,  
See [www.dtsc.ca.gov/hazardouswaste/perchlorate](http://www.dtsc.ca.gov/hazardouswaste/perchlorate).

Your vehicle has components that may contain perchlorate. These components may include airbag, seat belt pretensioners, and wireless remote control batteries.

 **CAUTION**

■ **General precautions while driving**

**Driving under the influence:** Never drive your vehicle when under the influence of alcohol or drugs that have impaired your ability to operate your vehicle. Alcohol and certain drugs delay reaction time, impair judgment and reduce coordination, which could lead to an accident that could result in death or serious injury.

**Defensive driving:** Always drive defensively. Anticipate mistakes that other drivers or pedestrians might make and be ready to avoid accidents.

**Driver distraction:** Always give your full attention to driving. Anything that distracts the driver, such as adjusting controls, talking on a cellular phone or reading can result in a collision with resulting death or serious injury to you, your occupants or others.

■ **General precaution regarding children's safety**

Never leave children unattended in the vehicle, and never allow children to have or use the key.

Children may be able to start the vehicle or shift the vehicle into neutral. There is also a danger that children may injure themselves by playing with the windows, the moon roof, or other features of the vehicle. In addition, heat build-up or extremely cold temperatures inside the vehicle can be fatal to children.

■ **Disposal of the hybrid battery (traction battery)**

If your vehicle is disposed of without the hybrid battery (traction battery) having been removed, there is a danger of serious electric shock if high voltage parts, cables and their connectors are touched. In the event that your vehicle must be disposed of, the hybrid battery (traction battery) must be disposed of by your Toyota dealer or a qualified service shop. If the hybrid battery (traction battery) is not disposed of properly, it may cause electric shock that can result in death or serious injury.



# Symbols used throughout this manual

## Cautions & Notices

**⚠ CAUTION**

This is a warning against something which, if ignored, may cause death or serious injury to people. You are informed about what you must or must not do in order to reduce the risk of death or serious injury to yourself and others.

**⚠ NOTICE**

This is a warning against something which, if ignored, may cause damage to the vehicle or its equipment. You are informed about what you must or must not do in order to avoid or reduce the risk of damage to your Toyota and its equipment.

## Symbols used in illustrations



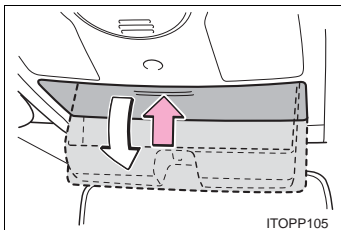

### Safety symbol

The symbol of a circle with a slash through it means “Do not”, “Do not do this”, or “Do not let this happen”.



### Arrows indicating operations

-  Indicates the action (pushing, turning, etc.) used to operate switches and other devices.
-  Indicates the outcome of an operation (e.g. a lid opens).

# TABLE OF CONTENTS

1	<b>Before driving</b>	Information on the hybrid system and adjusting and operating features such as door locks, mirrors, and steering column
2	<b>When driving</b>	Driving, stopping and safe-driving information
3	<b>Interior features</b>	Air conditioning and audio systems, as well as other interior features for a comfortable driving experience
4	<b>Maintenance and care</b>	Cleaning and protecting your vehicle, performing do-it-yourself maintenance, and maintenance information
5	<b>When trouble arises</b>	What to do if the vehicle needs to be towed, gets a flat tire, or is involved in an accident
6	<b>Vehicle specifications</b>	Detailed vehicle information
7	<b>For owners</b>	Reporting safety defects for U.S. owners, and seat belt and SRS airbag instructions for Canadian owners
	<b>Index</b>	Alphabetical listing of information contained in this manual

## Basic Operation

### How to operate unlocking and locking the doors

- **Front door handles**  
(including front passenger door handle if equipped with entry function)



**UNLOCK:** Grip the handle to unlock the doors.  
Make sure to touch the sensor on the back of the handle.  
The doors cannot be unlocked for 3 seconds after the doors are locked.

**LOCK:** Touch the lock sensor (the indentation on the upper part of the door handle) to lock the doors.

- **Back door (vehicles with entry function of front and back doors)**

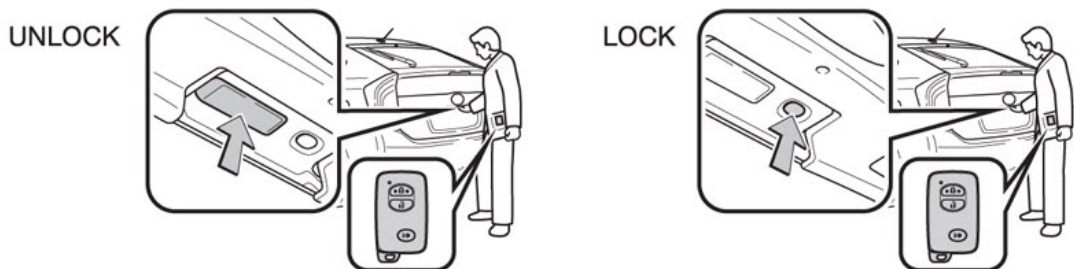

**UNLOCK:** Press the unlock button to unlock the doors.  
The doors cannot be unlocked for 3 seconds after the doors are locked.  
Lock the back door again when you leave the vehicle. The back door will not lock automatically after it has been opened and then closed.

**LOCK:** Press the lock button to lock all the doors.

## 2 How to operate PUSH BUTTON STARTING HYBRID SYSTEM

### ● Starting HYBRID SYSTEM

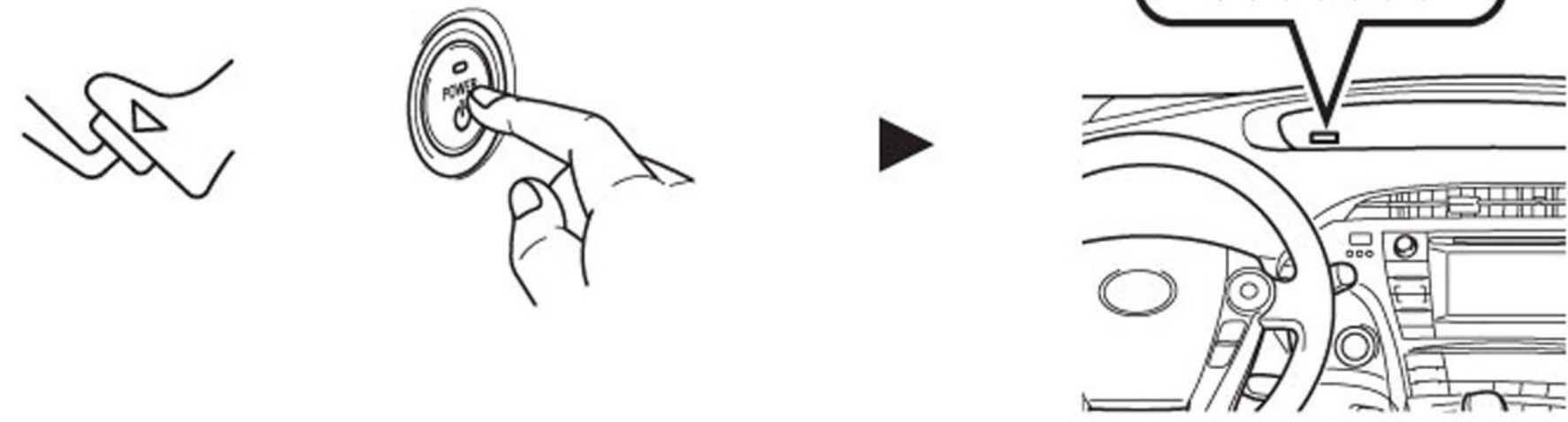

1. Apply the parking brake firmly.
2. Press the "POWER" switch with the brake pedal depressed firmly.
3. You can start driving your Prius when the "READY" indicator comes on after a few seconds and you hear a beep. (When the "READY" indicator is flashing, the shift position cannot be changed from P to another position even if the shift lever is operated.)

### ● Stopping HYBRID SYSTEM

Press the "POWER" switch with the vehicle at a stop. Check that the shift position indicator on the instrument cluster is set in P.

### ● Selecting ACCESSORY mode or ON mode

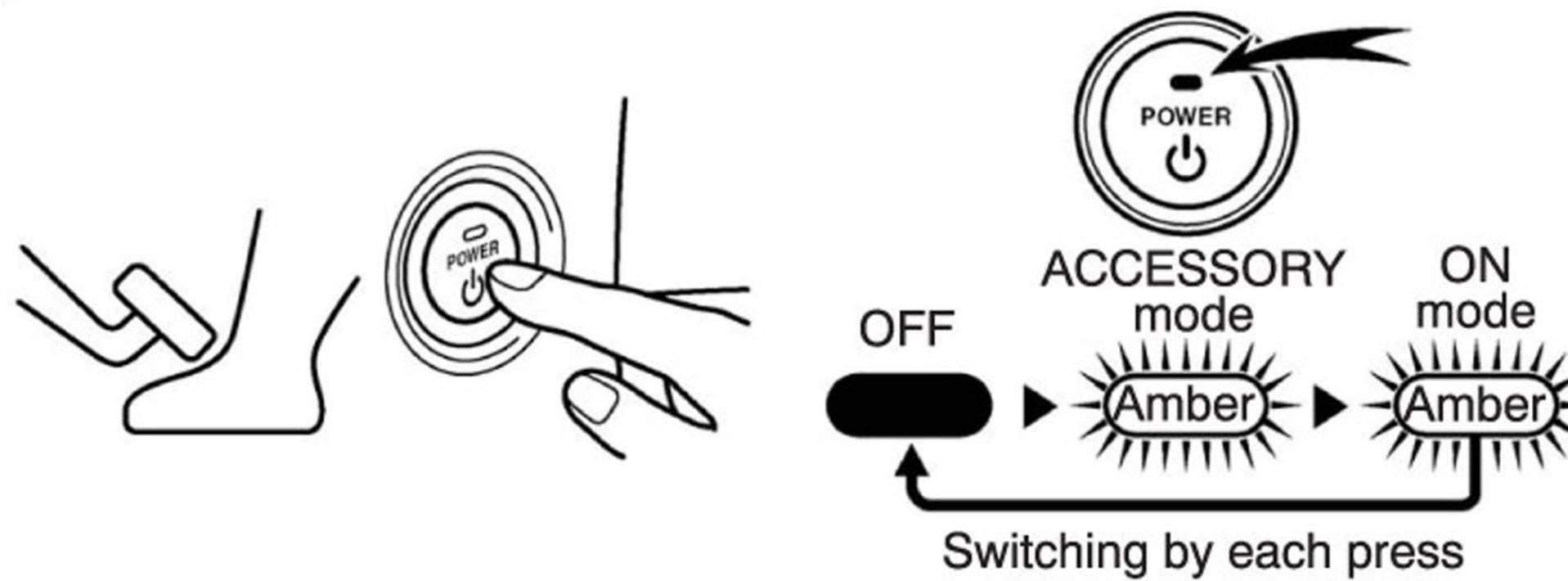

Press the "POWER" switch without depressing the brake pedal. Each press changes the hybrid system from off to ACCESSORY mode (accessories such as the radio on), to ON mode (all accessories on) and then back to off.

## 3 Shift lever operation

### ● Starting procedure

1. When the "READY" indicator comes on, shift the shift position to D or R and release it with the brake pedal depressed. The D or R position is selected and the lever returns to its home position. Confirm which position is selected with the shift position indicator in the instrument cluster.
2. Release the parking brake and your foot from the brake pedal gradually, and then start your Prius by depressing the accelerator pedal gently.

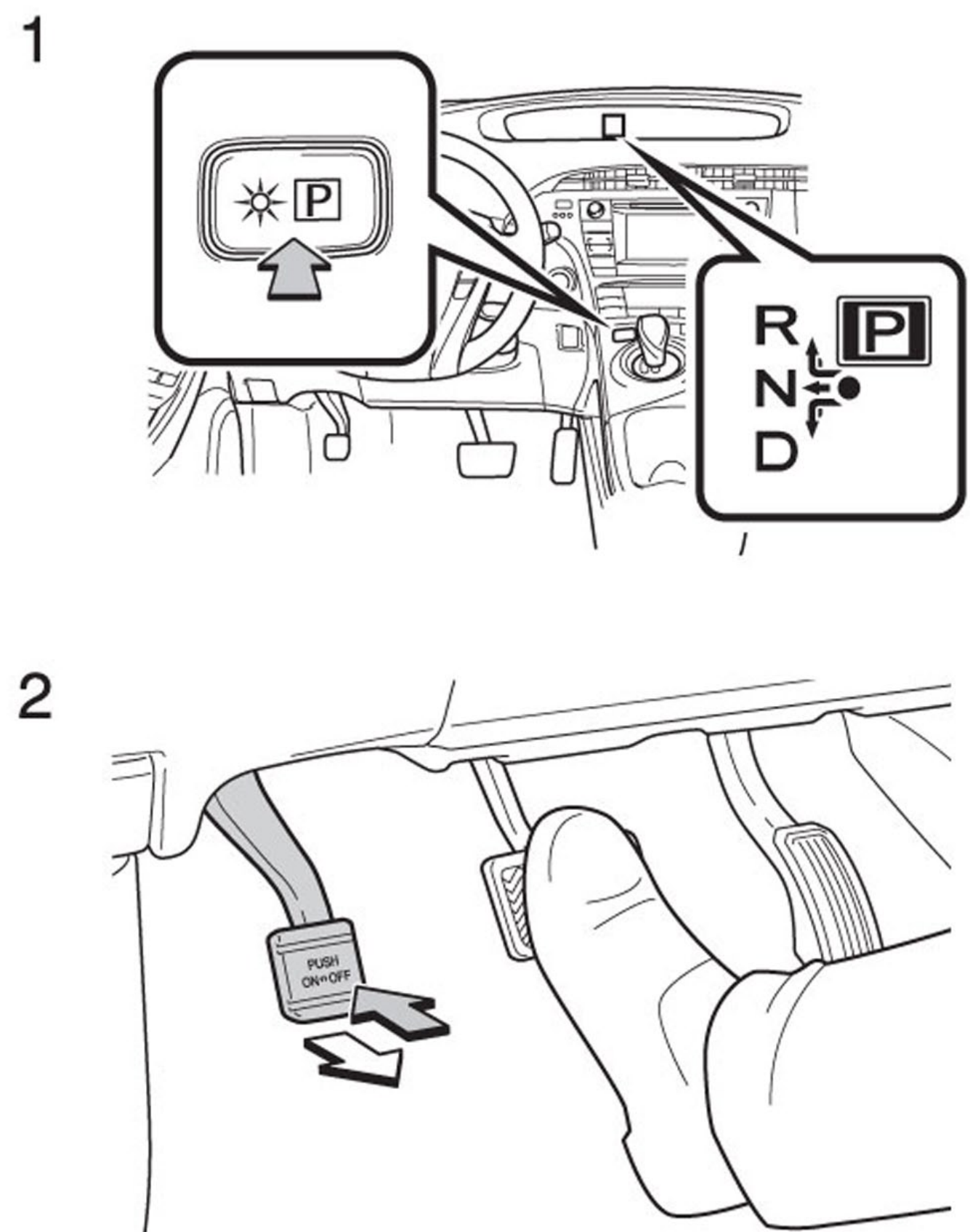

● **Stopping procedure**

1. Stop your Prius completely by depressing the brake pedal and then apply the parking brake.
2. Shift the shift position to P. Check that the shift position indicator on the instrument cluster is in P, and release the brake pedal gently after applying the parking brake.

**Note:**

Be sure to shift the shift position to P when parking. During traffic jams, use the D position and continue driving in that position. The hybrid battery (traction battery) cannot be charged in N. When releasing the accelerator pedal in B, engine braking will be applied stronger than in D. Compared with ordinary vehicles, you may feel less powerful engine braking during high speed driving.

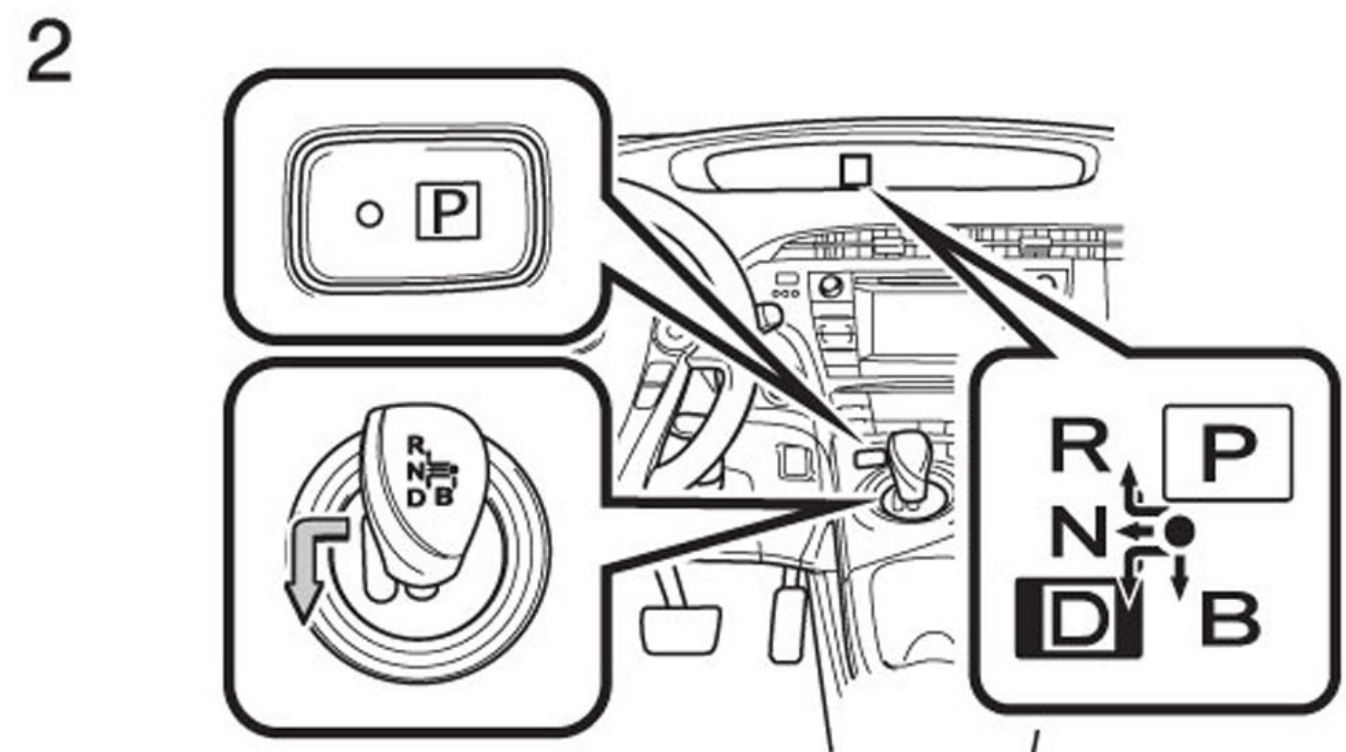
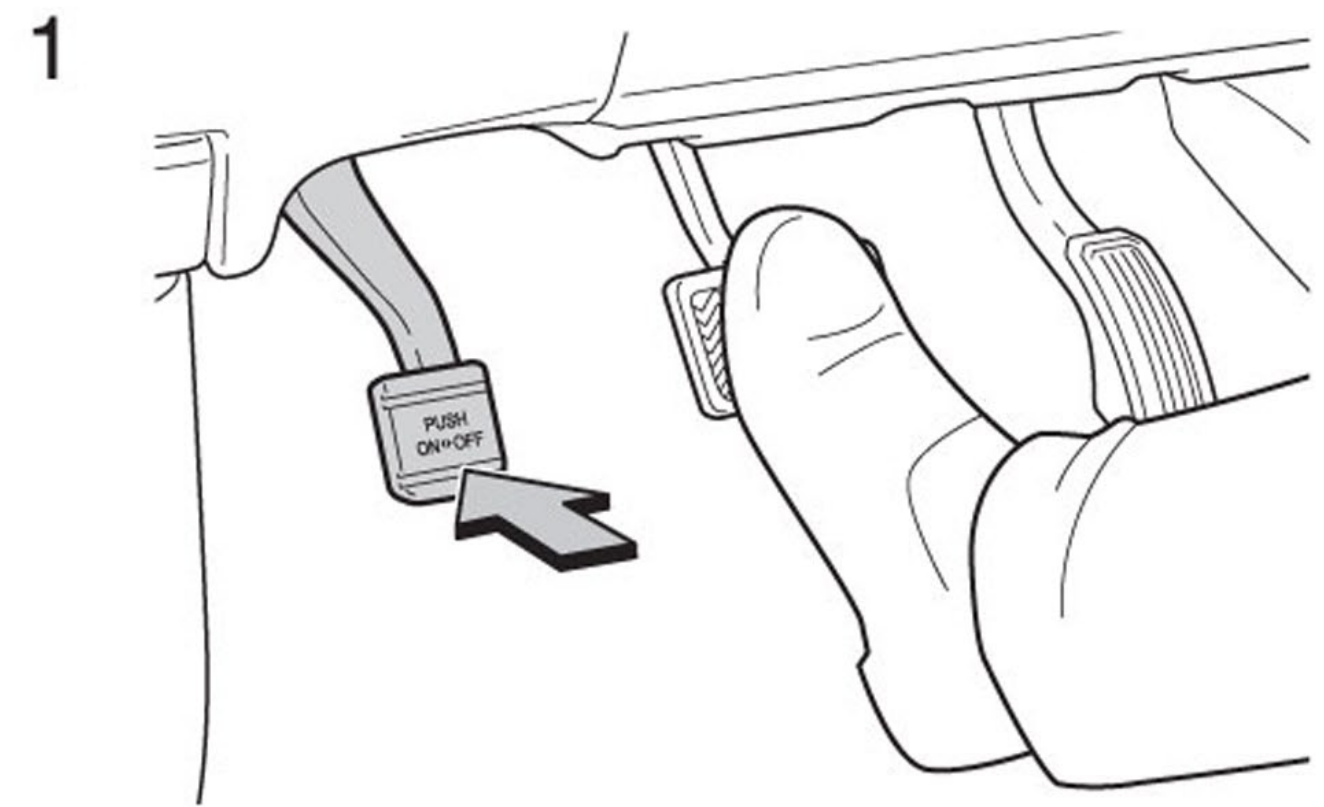

**4 How to operate the wipers and washers**

**Type A**

● **Windshield wipers and washer**

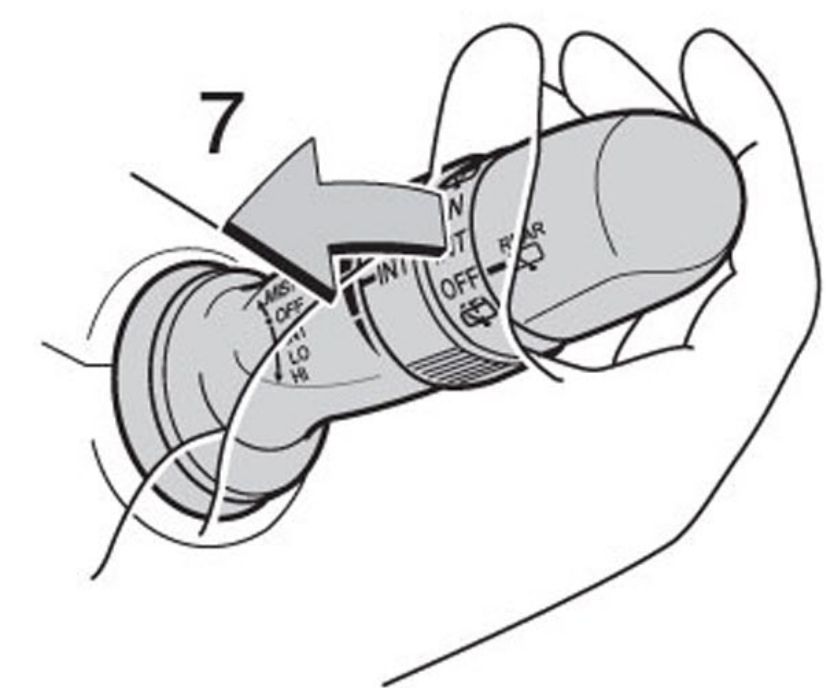
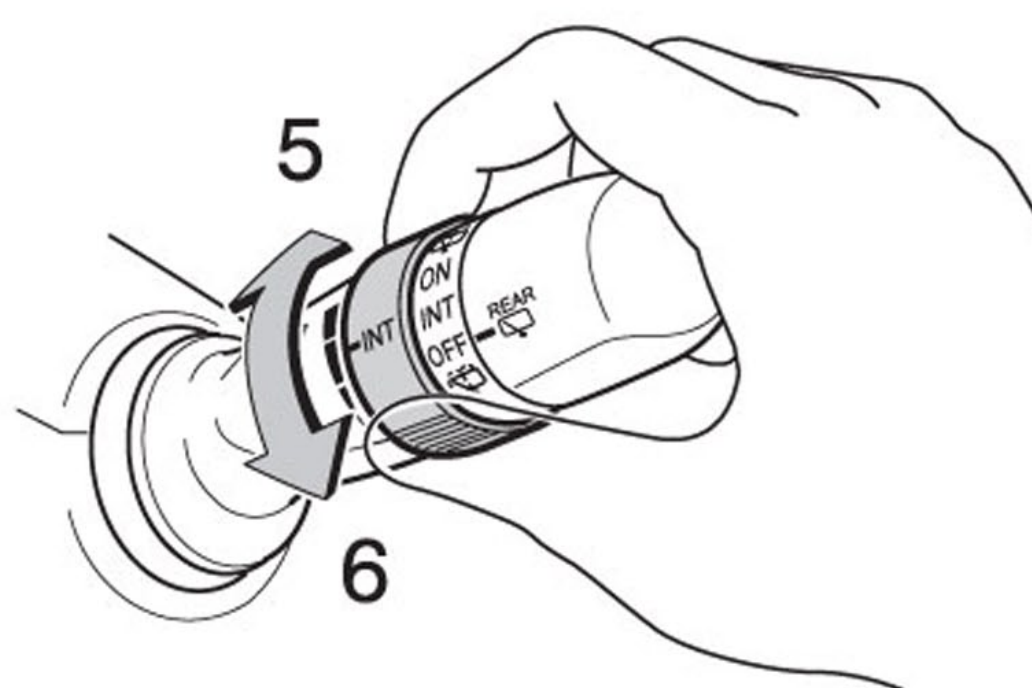
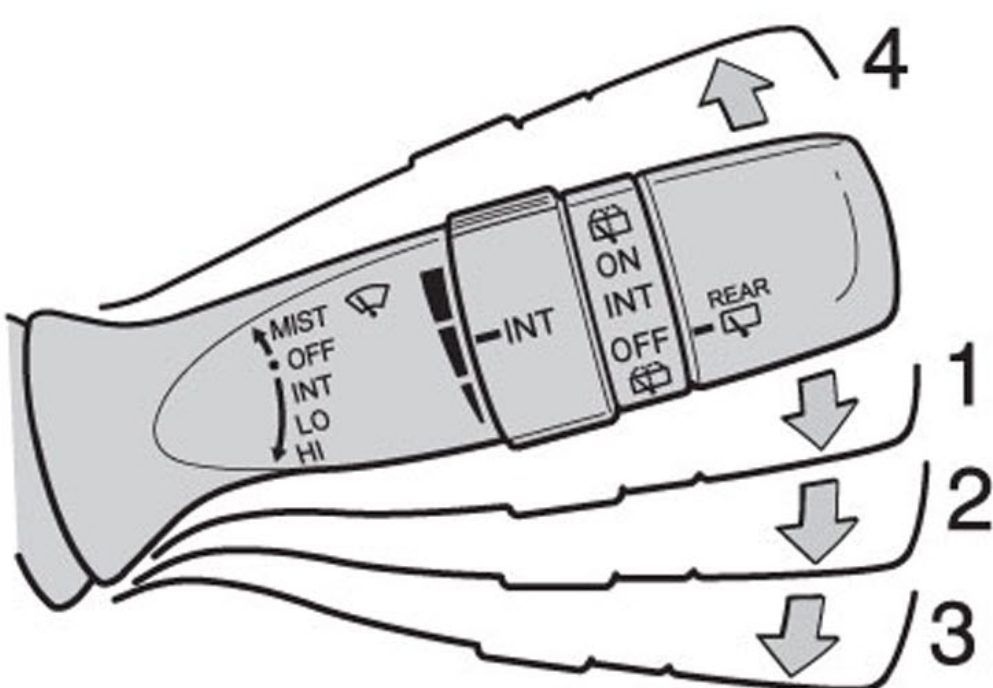

1. Intermittent windshield wiper operation
2. Low speed windshield wiper operation

3. High speed windshield wiper operation
4. Temporary operation
5. Increases the intermittent windshield wiper frequency

6. Decreases the intermittent windshield wiper frequency
7. Washer/wiper dual operation  
The wipers will automatically operate a couple of times after the washer squirts.

● **Rear window wiper and washer**

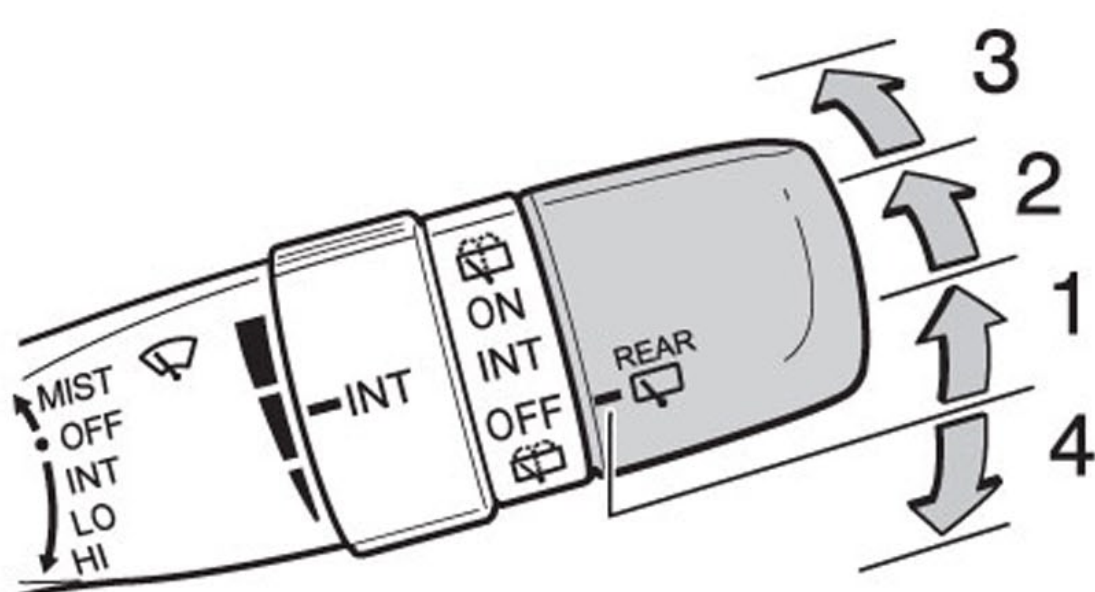

1. Intermittent window wiper operation
2. Normal window wiper operation
3. Washer/wiper dual operation
4. Washer/wiper dual operation

## Type B

### ● Windshield wipers and washer

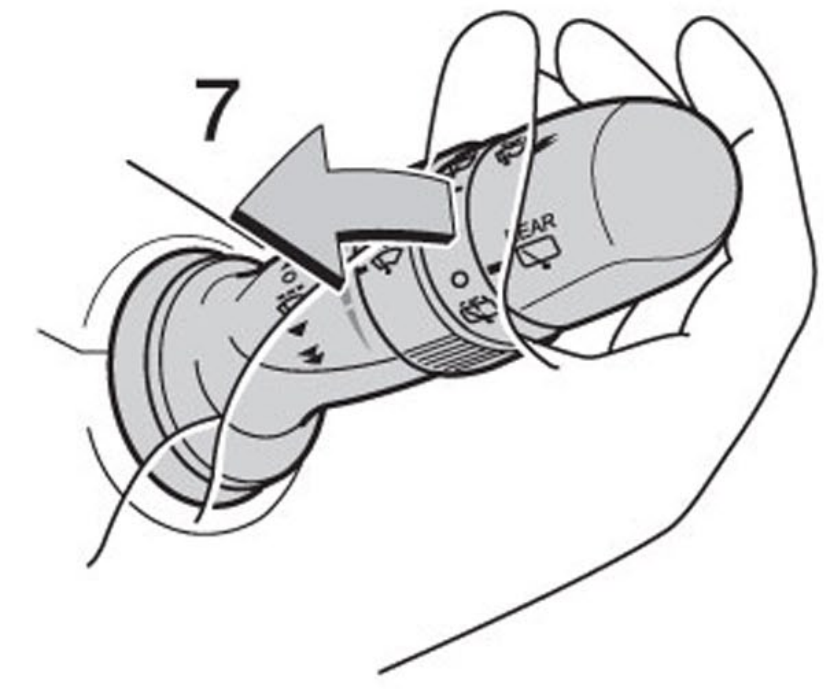
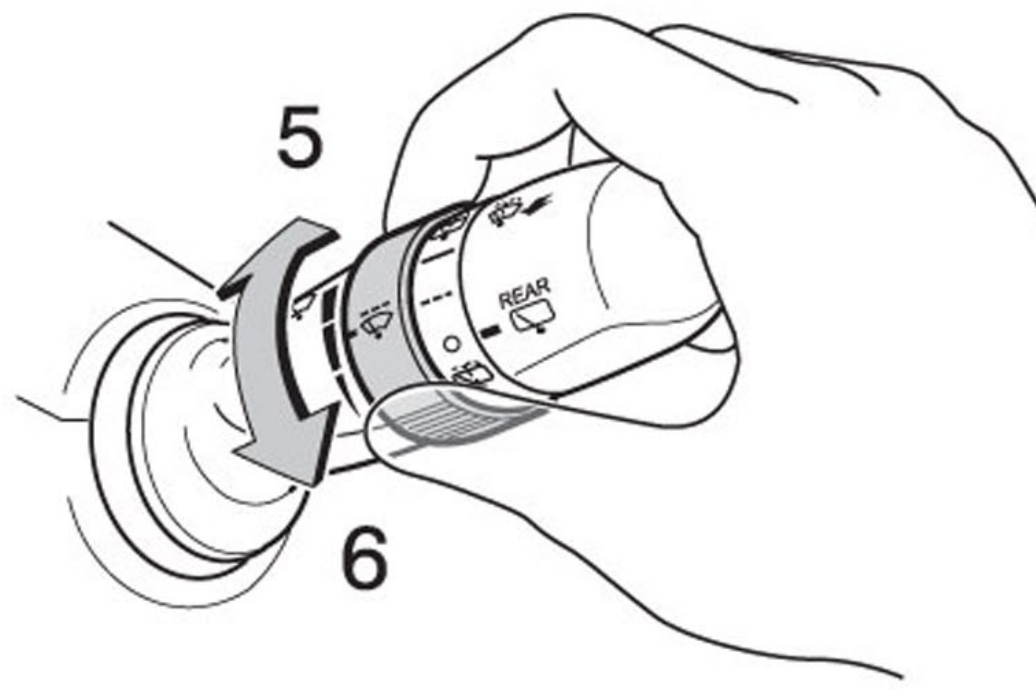
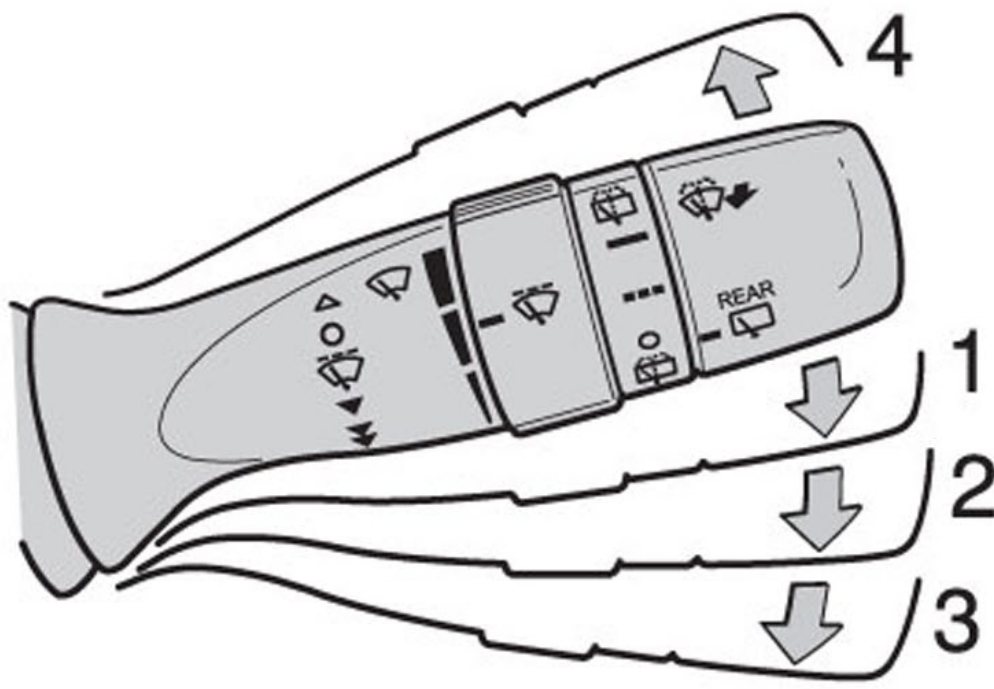

1. Intermittent windshield wiper operation
2. Low speed windshield wiper operation

3. High speed windshield wiper operation
4. Temporary operation
5. Increases the intermittent windshield wiper frequency

6. Decreases the intermittent windshield wiper frequency
7. Washer/wiper dual operation  
The wipers will automatically operate a couple of times after the washer squirts.

### ● Rear window wiper and washer

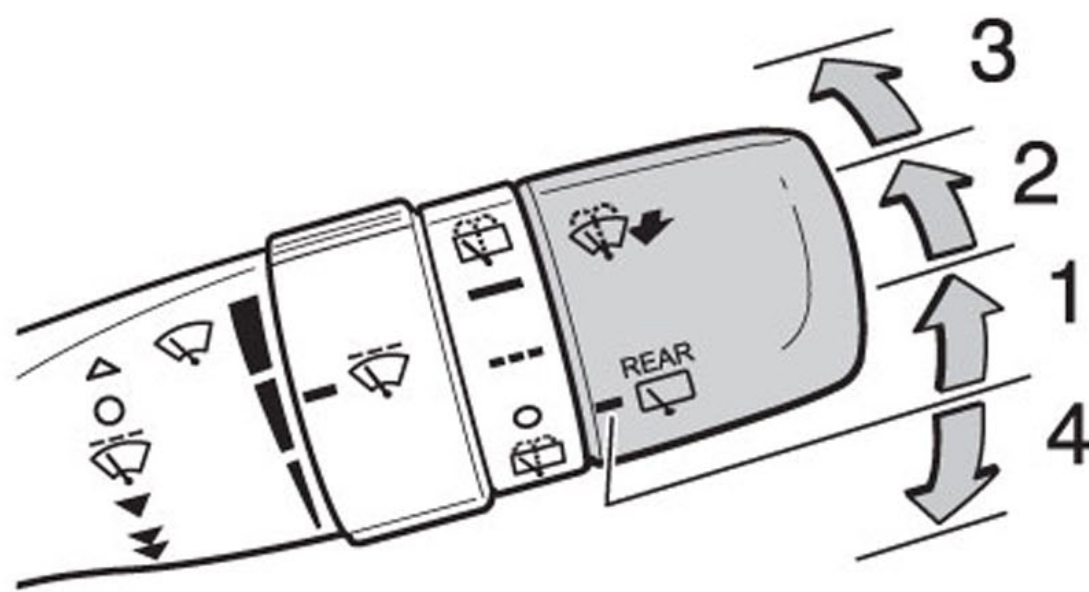

1. Intermittent window wiper operation
2. Normal window wiper operation
3. Washer/wiper dual operation
4. Washer/wiper dual operation

## 5 Dynamic radar cruise control operation (if equipped)

### ● Dynamic radar cruise control can be set when

- The shift position is in D.
- Vehicle speed is above approximately 30 mph (50 km/h).

### ● Set the vehicle speed

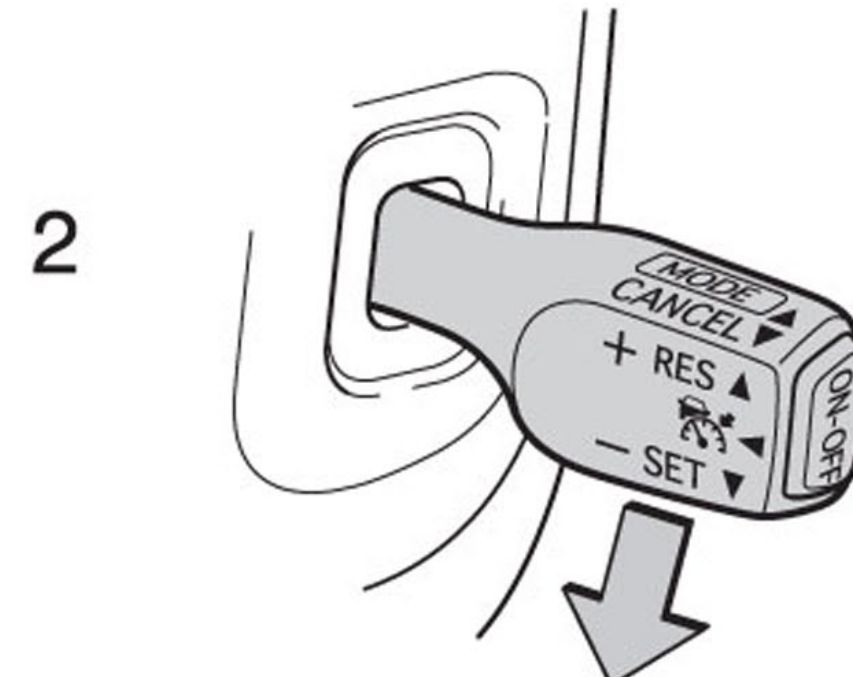
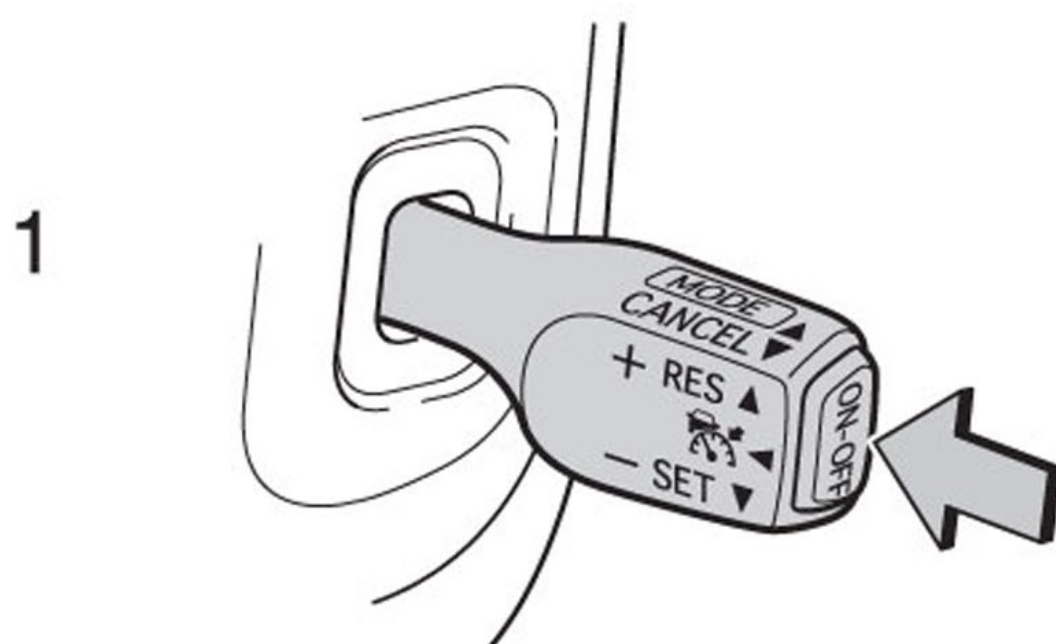

1. Press the "ON-OFF" button to activate the cruise control. Press the button once more to deactivate the cruise control.
2. Accelerate or decelerate to the desired speed and press the lever down to set the cruise control speed.

● **Changing the vehicle-to-vehicle distance**

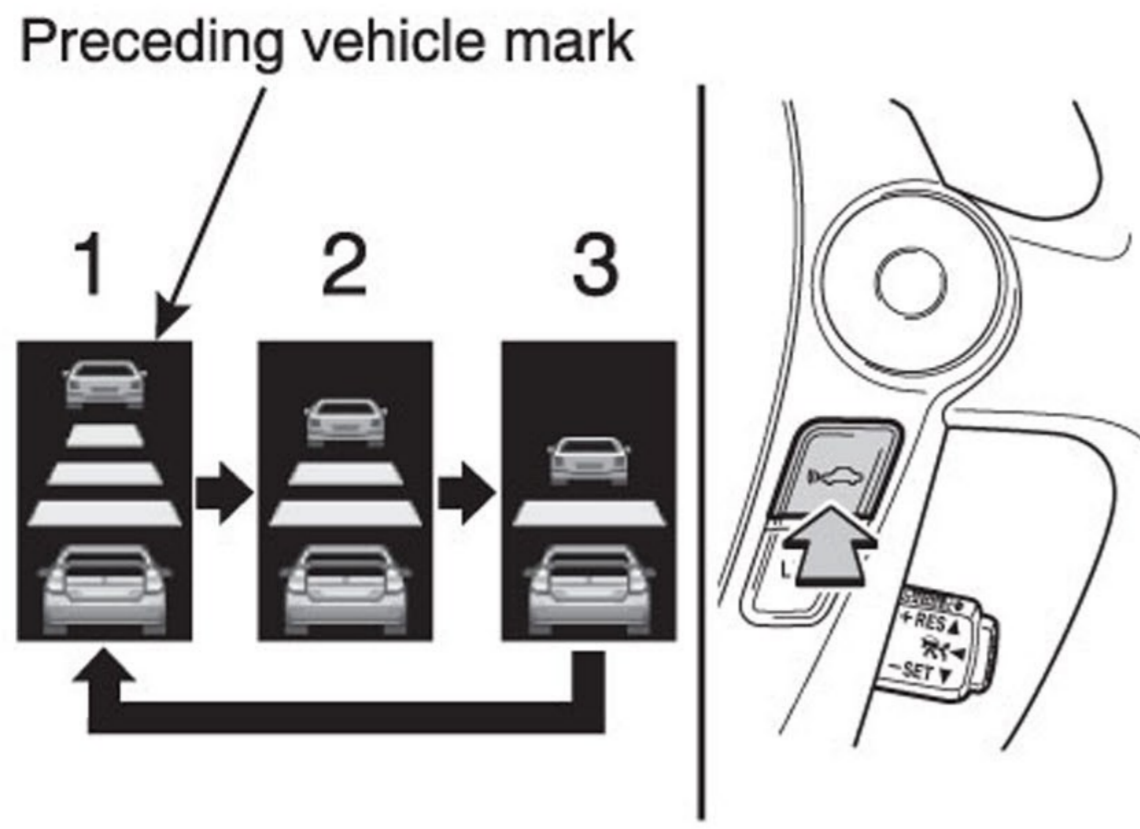

Each press of the switch changes the vehicle-to-vehicle distance.

1. Long
  2. Medium
  3. Short
- If a vehicle is running ahead of you, the preceding vehicle mark will also be displayed.

● **Adjusting the speed setting**

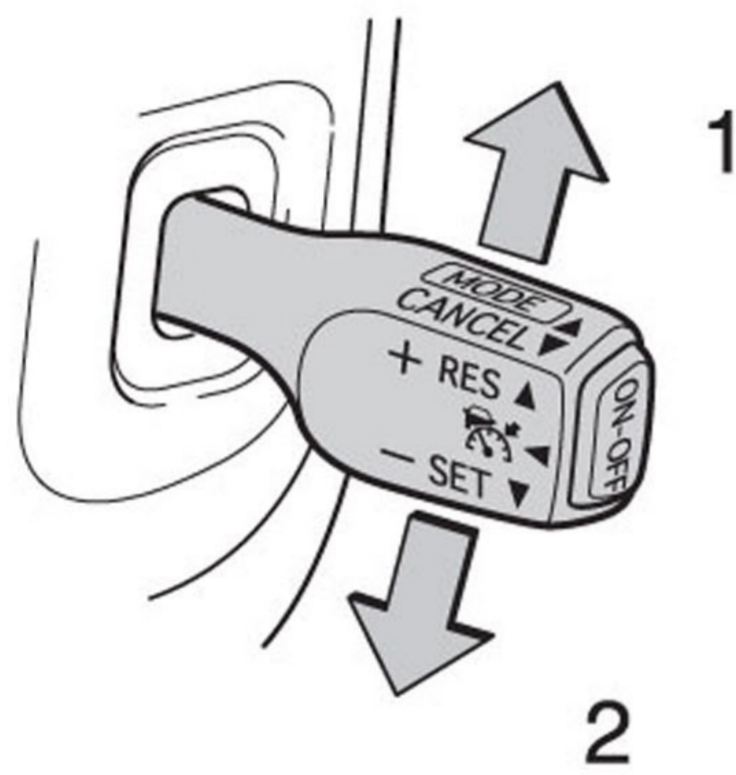

1. Increase speed
  2. Decrease speed
- Hold the lever until the desired speed setting is obtained.  
Fine adjustment of the set speed can be made by lightly pushing the lever up or down and releasing it.

● **Canceling and resuming regular acceleration**

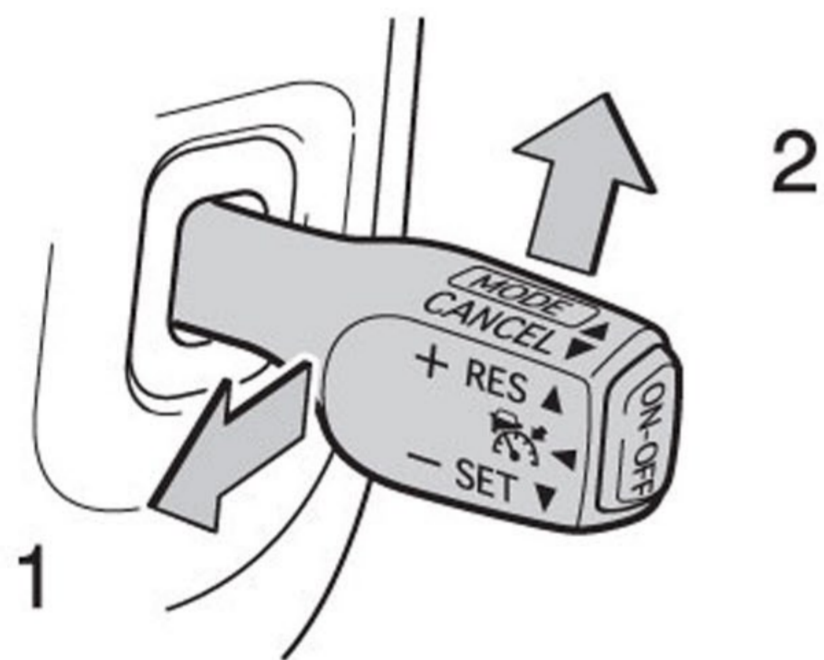

1. Cancel  
Pull the lever towards you to cancel cruise control.  
The speed setting is also canceled when the brakes are applied.
2. Resume  
To resume cruise control and return to the set speed, push the lever up.  
Resuming is available when the vehicle speed is more than approximately 25 mph (40 km/h).

● **Selecting conventional constant speed control mode**

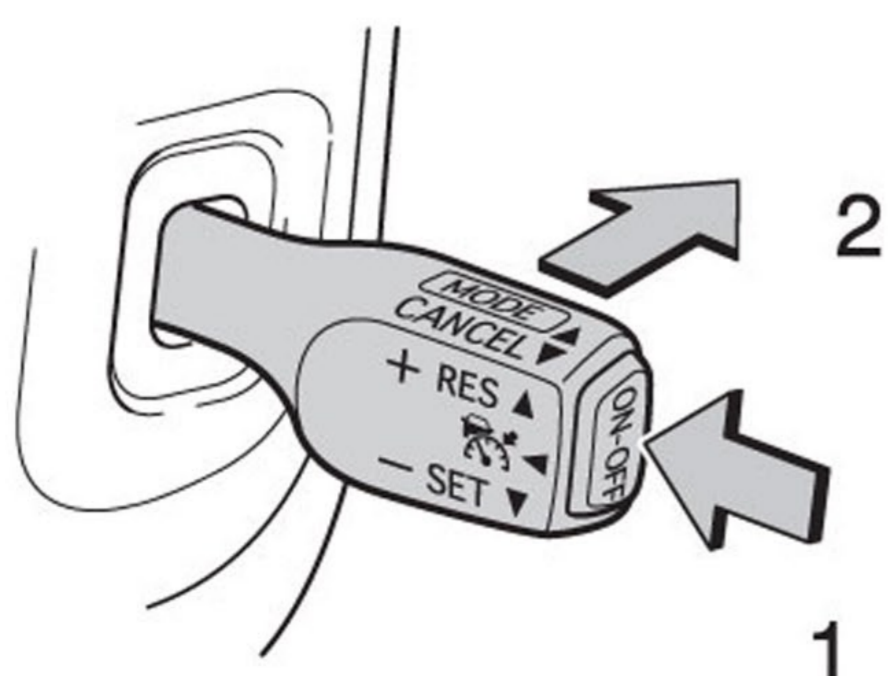

1. Press the "ON-OFF" button to activate the cruise control.  
Press the button again to deactivate the cruise control.
2. Switch to constant speed control mode.  
(Push the lever forward and hold for approximately 1 second.)

## **Cruise control operation (if equipped)**

- **Cruise control can be set when**
  - The shift position is in D.
  - Vehicle speed is above approximately 25 mph (40 km/h).
- **Set the vehicle speed**

See “Set the vehicle speed” on page 4.
- **Adjusting the speed setting**

See “Adjusting the speed setting” on page 5.
- **Canceling and resuming regular acceleration**

See “Canceling and resuming regular acceleration” on page 5.

## **Safety Connect (if equipped)**

Subscribers have the following Safety Connect services available:

- **Automatic Collision Notification**

Helps drivers receive necessary response from emergency service providers.
- **Stolen Vehicle Location**

Helps drivers in the event of vehicle theft.

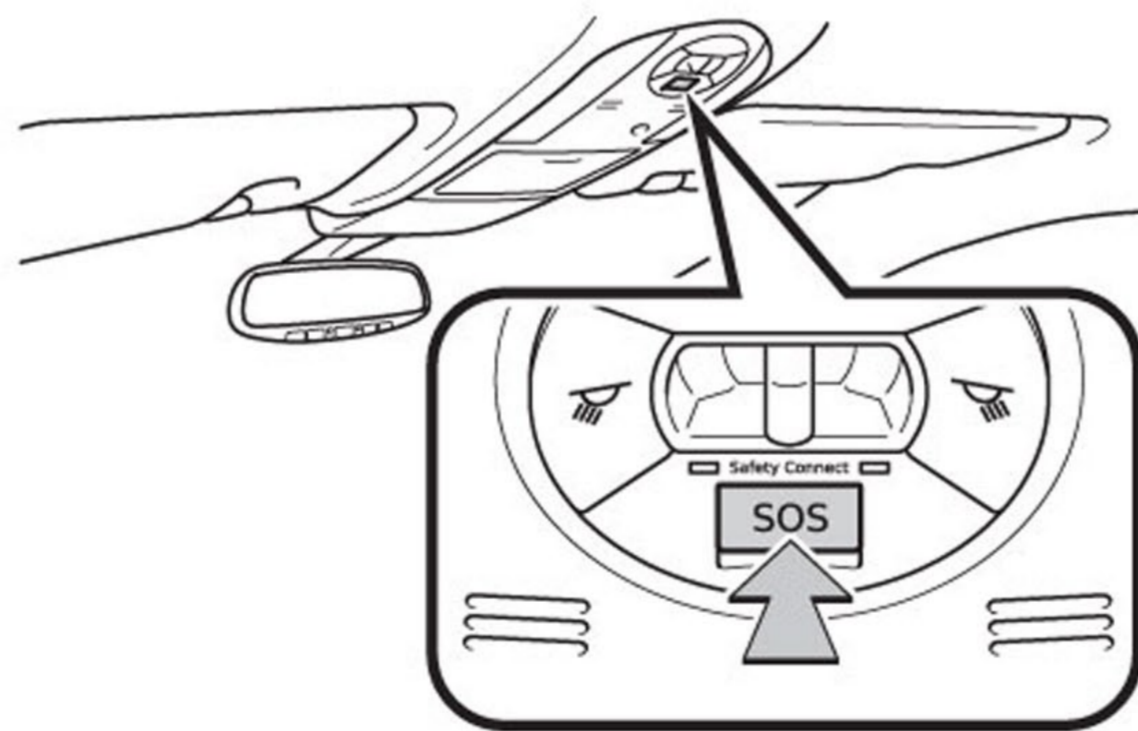

- **Emergency Assistance Button (SOS)**

Connects drivers to response-center support by pressing the “SOS” button.
- **Roadside Assistance**

Provides drivers various on-road assistance by pressing the “SOS” button.



# For Better Driving

## For Eco-friendly and economical driving

- **When depressing the accelerator pedal**

After accelerating, release the accelerator pedal and then gently depress it again. This increases use of the electric motor (traction motor).

- **When depressing the brake pedal**

Depress the brake pedal lightly and in good time. This allows a larger amount of electrical energy to be recharged while decelerating.

- **When in heavy traffic**

Use the accelerator pedal as little as possible, releasing the brake pedal instead to progress forward slowly. This helps to control excessive fuel consumption.

Repeatedly accelerating and decelerating and waiting for long periods of time at traffic lights can be detrimental to fuel economy. Make sure to check traffic information before leaving and to avoid delays whenever possible.

- **When driving at high speed**

Drive at a moderate and constant speed.

- **When the vehicle is stopped**

Shift the shift position to P. If the shift position is set to N while the gasoline engine is turning over, the gasoline engine will not stop, consuming excess fuel and preventing the hybrid battery (traction battery) from recharging.

- **Checking tire pressure**

Check the tire inflation pressure frequently to keep it at the proper level.

# Things You Must Know



There is an air intake vent on the right side of the rear seatback for the purpose of cooling the hybrid battery (traction battery). If the vent becomes blocked, the hybrid battery (traction battery) may overheat, leading to a reduction in hybrid battery (traction battery) output.

## The regenerative braking

- The motor generator converts kinetic energy to electric energy when the accelerator pedal is released or the brake pedal is depressed with the shift position in D or B.
- If the accelerator pedal is released while driving downhill, gasoline engine revolutions may increase. This is not a malfunction.

## Charging the battery

Shift the shift position to D when driving.

In the N position, the gasoline engine operates but electricity cannot be generated.

The hybrid battery (traction battery) will be discharged requiring unnecessary engine power to recharge.

## 1-1. Hybrid system

# Hybrid system features

Your vehicle is a hybrid vehicle. It has characteristics different from conventional vehicles. Be sure you are closely familiar with the characteristics of your vehicle, and operate with care.

The hybrid system combines the use of a gasoline engine and an electric motor (traction motor) according to driving conditions, improving fuel efficiency and reducing exhaust emissions.

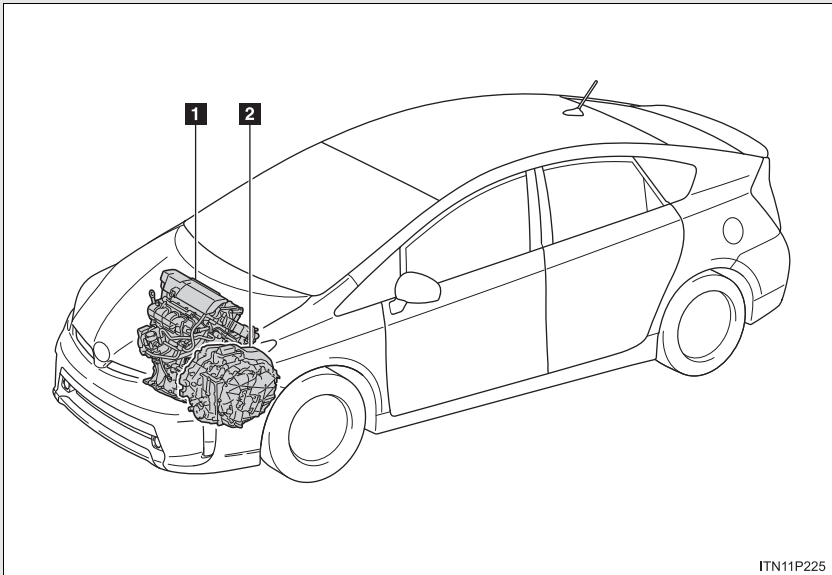

ITN11P225

- 1** Gasoline engine
- 2** Electric motor (traction motor)

### ■ When stopped/during start off

The gasoline engine stops\* when the vehicle is stopped. During start off, the electric motor (traction motor) drives the vehicle. At slow speeds or when traveling down a gentle slope, the engine is stopped\* and the electric motor (traction motor) is used.

When shift position is in N, the hybrid battery (traction battery) will not be charged. Thus, shift to P when the vehicle is stopped. In addition, when driving in heavy traffic, use D or B.

\*: However, when the hybrid battery (traction battery) need to be charged or while the engine is being warmed up, the gasoline engine may not stop automatically. (→P. 33)

### ■ During normal driving

The gasoline engine is predominantly used. The electric motor (traction motor) charges the hybrid battery (traction battery) as necessary.

### ■ When accelerating sharply

When the accelerator pedal is depressed heavily, the power of the hybrid battery (traction battery) is added to that of the gasoline engine via the electric motor (traction motor).

### ■ When braking (regenerative braking)

The electric motor (traction motor) charges the hybrid battery (traction battery).

## Vehicle proximity notification system

When driving with the gasoline engine stopped, a sound, which changes in accordance with the driving speed, will be played in order to warn people nearby of the vehicle's approach. The sound will stop when the vehicle speed exceeds approximately 15 mph (25 km/h).

## Regenerative braking

In the following situations, kinetic energy is converted to electric energy and deceleration force can be obtained in conjunction with the recharging of the hybrid battery (traction battery).

- The accelerator pedal is released while driving with the shift position in D or B.
- The brake pedal is depressed while driving with the shift position in D or B.

## Hybrid System Indicator

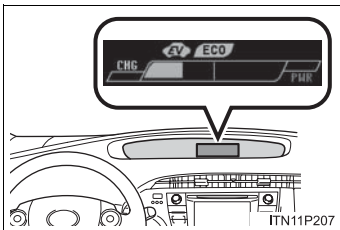

Hybrid System Indicator represents the hybrid system power output and regenerative charging. (→P. 225)

### ■ Conditions in which the gasoline engine may not stop

The gasoline engine starts and stops automatically. However, it may not stop automatically in the following conditions\*:

- During gasoline engine warm-up
- When the temperature of the hybrid battery (traction battery) is high or low
- During hybrid battery (traction battery) charging
- When the heater is switched on

\*: Depending on the circumstances, the gasoline engine may also not stop automatically in situations other than those above.

### ■ Charging the hybrid battery (traction battery)

- As the gasoline engine charges the hybrid battery (traction battery), the battery does not need to be charged from an outside source. However, if the vehicle is left parked for a long time the hybrid battery (traction battery) will slowly discharge. For this reason, be sure to drive the vehicle at least once every few months for at least 30 minutes or 10 miles (16 km). If the hybrid battery (traction battery) becomes fully discharged and you are unable to jump-start the vehicle with the 12-volt battery, contact your Toyota dealer.
- If the shift position is in N, the hybrid battery (traction battery) will not be charged. Always shift the shift position in P when the vehicle is stopped. When driving in heavy traffic, operate the vehicle with the shift position in D or B to avoid discharging the hybrid battery (traction battery).

### ■ Charging the 12-volt battery

→P. 546

### ■ After the 12-volt battery has discharged or has been changed or removed

The gasoline engine may not stop even if the vehicle is running on the hybrid battery (traction battery). If this continues for a few days, contact your Toyota dealer.

### ■ Sounds and vibrations specific to a hybrid vehicle

There may be no engine sounds or vibration even though the vehicle is able to move. For safety, apply the parking brake and make sure to shift the shift position to P when parked.

The following sounds or vibrations may occur when the hybrid system is operating and are not a malfunction:

- The brake system operation sound heard from the front of the vehicle when the driver's door is opened.
- Motor sounds may be heard from the engine compartment.
- Sounds may be heard from the hybrid battery (traction battery) when the hybrid system starts or stops.
- Sounds may be heard from the transmission when the gasoline engine starts or stops, when driving at low speeds, or during idling.
- Engine sounds may be heard when accelerating sharply.
- Sounds may be heard due to regenerative braking when the brake pedal is depressed and accelerator is loosened.
- Other sounds, such as motors and mechanical noises, may be heard from the brake system when the brake pedal is depressed.
- Vibration may be felt when the gasoline engine starts or stops.
- Cooling fan sounds may be heard from the air intake vent. (→P. 37)
- The operation sound of the air conditioning system (air conditioning compressor, blower motor).

### ■ Vehicle proximity notification system

In the following cases, the vehicle proximity notification system may be difficult for surrounding people to hear.

- In very noisy areas
- In the wind or the rain

Also, as the vehicle proximity notification system is installed on the front of the vehicle, it may be more difficult to hear from the rear of the vehicle compared to the front.

### ■ Maintenance, repair, recycling, and disposal

Contact your Toyota dealer regarding maintenance, repair, recycling and disposal. Do not dispose of the vehicle yourself.



## 1-1. Hybrid system

### Hybrid system precautions

Take care when handling the hybrid system, as it contains a high voltage system (about 650V at maximum) as well as parts that become extremely hot when the hybrid system is operating. Obey the caution labels attached to the vehicle.

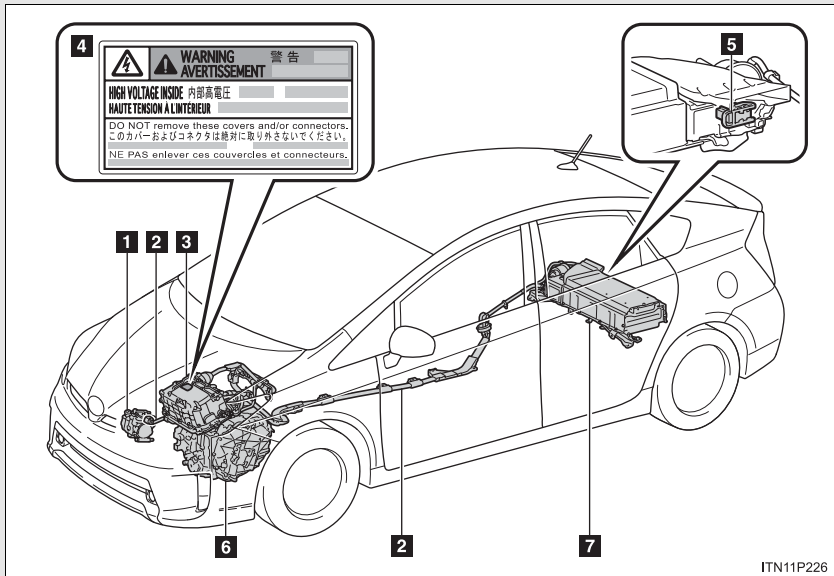

- 1** Air conditioning compressor
- 2** High voltage cables (orange)
- 3** Power control unit and DC/DC converter
- 4** Caution label
- 5** Service plug
- 6** Electric motor (traction motor)
- 7** Hybrid battery (traction battery)

### Hybrid battery (traction battery) air vent

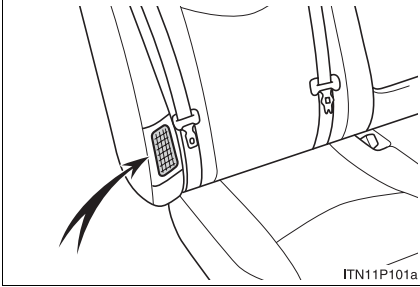

There is an air intake vent on the right side of the rear seatback for the purpose of cooling the hybrid battery (traction battery). If the vent becomes blocked, the hybrid battery (traction battery) may overheat, leading to a reduction in hybrid battery (traction battery) output.

1

Before driving

### Emergency shut off system

When a certain level of impact is detected by the impact sensor, the emergency shut off system blocks off the high voltage current and stops the fuel pump to minimize the risk of electrocution and fuel leakage. If the emergency shut off system activates, your vehicle will not restart. To restart the hybrid system, contact your Toyota dealer.

### Hybrid warning message

A message is automatically displayed when a malfunction occurs in the hybrid system or an improper operation is attempted.



If a warning message is shown on the multi-information display, read the message and follow the instructions. (→P. 507)

■ **If a warning light comes on, a warning message is displayed or the 12-volt battery is disconnected**

The hybrid system may not start. In that case, try to start the system again. If the “READY” indicator does not come on, contact your Toyota dealer.

■ **Running out of fuel**

When the vehicle has run out of fuel and the hybrid system cannot be started, refuel the vehicle with at least enough gasoline to make the low fuel level warning light (→P. 498) go off. If there is only a small amount of fuel, the hybrid system may not be able to start. (The minimum amount of fuel to add to make the low fuel level warning light go out is about 1.9 gal. [7.1 L, 1.6 Imp.gal.], when the vehicle is on a level surface. This value may vary when the vehicle is on a slope.)

■ **Electromagnetic waves**

- High voltage parts and cables on the hybrid vehicles incorporate electromagnetic shielding, and therefore emit approximately the same amount of electromagnetic waves as conventional gasoline powered vehicles or home electronic appliances.
- Your vehicle may cause sound interference in some third party-produced radio parts.

■ **Hybrid battery (traction battery)**

The hybrid battery (traction battery) has a limited service life. The lifespan of the hybrid battery (traction battery) can change in accordance with driving style and driving conditions.

**⚠ CAUTION****■ High voltage precautions**

The vehicle has high voltage DC and AC systems as well as a 12-volt system. DC and AC high voltage is very dangerous and can cause severe burns and electric shock that may result in death or serious injury.

- Never touch, disassemble, remove or replace the high voltage parts, cables or their connectors.
- The hybrid system will become hot after starting as the system uses high voltage. Be careful of both the high voltage and the high temperature, and always obey the caution labels attached to the vehicle.

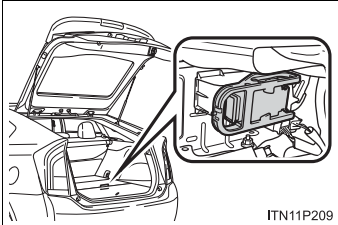

- Never try to open the service plug access hole located in the luggage compartment. The service plug is used only when the vehicle is serviced and is subject to high voltage.

 **CAUTION**

**■ Road accident cautions**

If your vehicle is involved in an accident, observe the following precautions to reduce the risk of death or serious injury:

- Stop the vehicle in a safe place to prevent subsequent accidents.  
While depressing the brake pedal, apply the parking brake, shift the shift position to P and turn the hybrid system off. Then, slowly release the brake pedal.
- Do not touch the high voltage parts, cables and connectors.
- If electric wires are exposed inside or outside your vehicle, an electric shock may occur. Never touch exposed electric wires.
- If a fluid leak occurs, do not touch the fluid as it may be strong alkaline electrolyte from the hybrid battery (traction battery). If it comes into contact with your skin or eyes, wash it off immediately with a large amount of water or, if possible, boric acid solution. Seek immediate medical attention.
- If a fire occurs in the hybrid vehicle, leave the vehicle as soon as possible. Never use a fire extinguisher that is not meant for electric fires. Using even a small amount of water may be dangerous.
- If your vehicle needs to be towed, do so with front wheels raised. If the wheels connected to the electric motor (traction motor) are on the ground when towing, the motor may continue to generate electricity. This may cause an electricity leakage leading to a fire. (→P. 485)
- Carefully inspect the ground under the vehicle. If you find that liquid has leaked onto the ground, the fuel system may have been damaged. Leave the vehicle as soon as possible.

**■ Hybrid battery (traction battery)**

Your vehicle contains a sealed nickel-metal hydride battery. If disposed of improperly, it is hazardous to the environment and there is a risk of severe burns and electrical shock that may result in death or serious injury.

 NOTICE**Hybrid battery (traction battery) air vent**

- Do not put foreign objects near the air vent. The hybrid battery (traction battery) may overheat and be damaged.
- Clean the air vent regularly to prevent the hybrid battery (traction battery) from overheating.
- Do not wet or allow foreign substances to enter the air vent as this may cause a short circuit and damage the hybrid battery (traction battery).
- Do not carry large amounts of water such as water cooler bottles in the vehicle. If water spills onto the hybrid battery (traction battery), the battery may be damaged. Have the vehicle inspected by your Toyota dealer.
- If the rear seat belt becomes separated from the guide (→P. 103), it could obstruct the hybrid battery (traction battery) air vent. Set the rear seat belt into the guide to use.

## 1-1. Hybrid system

# Energy monitor/consumption screen

You can view the status of your hybrid system on the Display Audio system screen, the navigation system screen or the multi-information display.

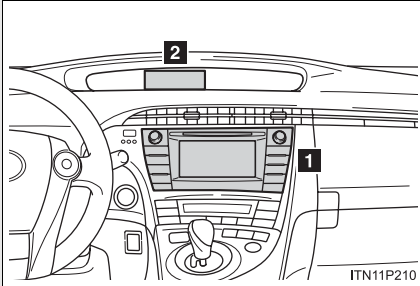

- 1 Display Audio system screen or navigation system screen
- 2 Multi-information display

## Energy monitor

Displays the flow of energy as it changes in accordance with driving conditions.

### Display Audio system

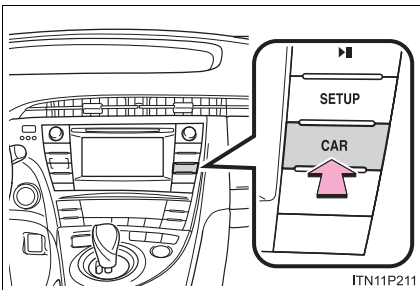

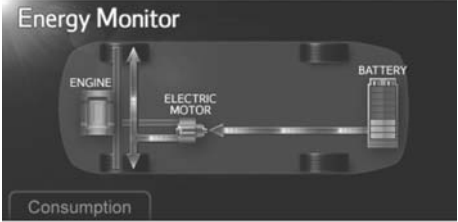
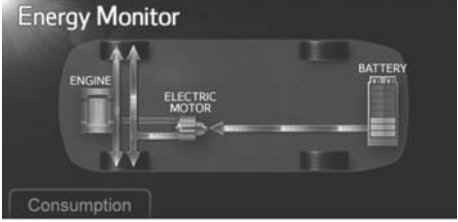
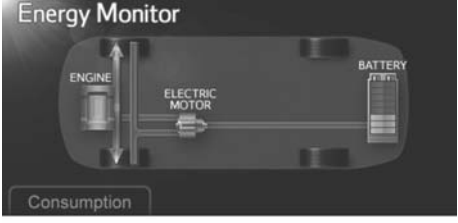

Press "CAR".

If the "Consumption" screen is displayed, touch "Energy".

Condition	Display
<p>When the vehicle is powered by the electric motor (traction motor)</p>	 <p>The Energy Monitor display shows a top-down view of the vehicle's drivetrain. The 'ENGINE' is on the left, the 'ELECTRIC MOTOR' is in the center, and the 'BATTERY' is on the right. A thick arrow points from the battery to the electric motor, indicating that the vehicle is powered by the battery. A 'Consumption' bar is visible at the bottom left of the display.</p>
<p>When the vehicle is powered by both the gasoline engine and the electric motor (traction motor)</p>	 <p>The Energy Monitor display shows a top-down view of the vehicle's drivetrain. The 'ENGINE' is on the left, the 'ELECTRIC MOTOR' is in the center, and the 'BATTERY' is on the right. Two thick arrows point towards the electric motor: one from the engine and one from the battery, indicating that both power sources are active. A 'Consumption' bar is visible at the bottom left of the display.</p>
<p>When the vehicle is powered by the gasoline engine</p>	 <p>The Energy Monitor display shows a top-down view of the vehicle's drivetrain. The 'ENGINE' is on the left, the 'ELECTRIC MOTOR' is in the center, and the 'BATTERY' is on the right. A thick arrow points from the engine to the electric motor, indicating that the vehicle is powered by the gasoline engine. A 'Consumption' bar is visible at the bottom left of the display.</p>

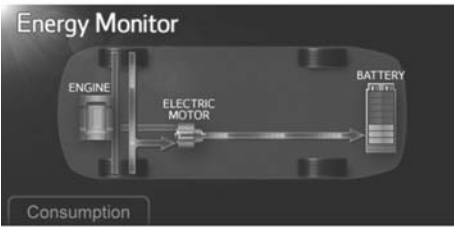

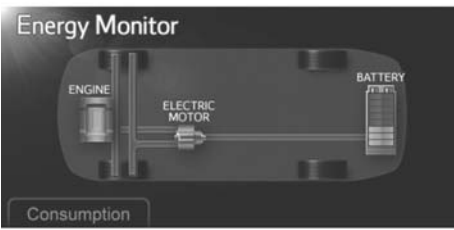
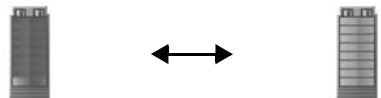
Condition	Display
<p>When the vehicle is charging the hybrid battery (traction battery)</p>	 <p>The Energy Monitor shows a top-down view of the vehicle chassis. The 'ENGINE' is on the left, the 'ELECTRIC MOTOR' is in the center, and the 'BATTERY' is on the right. A thick arrow points from the battery to the electric motor, indicating power flow for charging. A 'Consumption' bar at the bottom is partially filled.</p>
	 <p>This is an identical display to the one above, showing the vehicle charging the battery.</p>
<p>When there is no energy flow</p>	 <p>The Energy Monitor shows the same vehicle chassis view. No arrows are present between the engine, motor, and battery, indicating no energy flow. The 'Consumption' bar at the bottom is empty.</p>
<p>Hybrid battery (traction battery) status</p>	<p>Low <span style="margin-left: 200px;">Full</span></p>  <p>The battery status indicator consists of a vertical bar on the left labeled 'Low' and a vertical bar on the right labeled 'Full'. A double-headed horizontal arrow is positioned between the two bars, indicating the range of the battery's charge level.</p>

These images are examples only, and may vary slightly from actual conditions.

## Navigation system

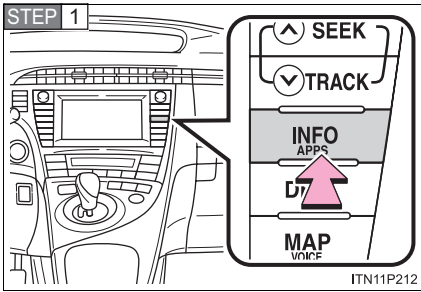

Press “INFO APPS” or “INFO”.

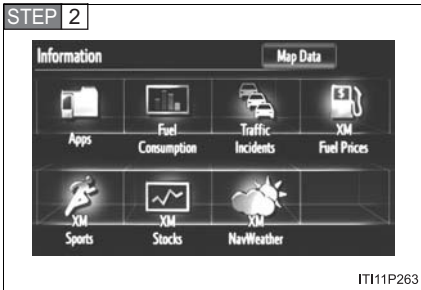

Touch “Fuel Consumption” on the “Information” screen.

If the “Consumption” screen is displayed, touch “Energy”.

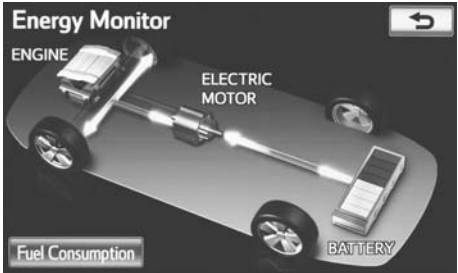
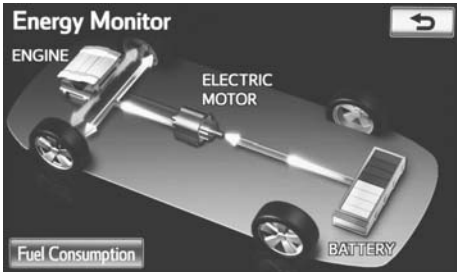
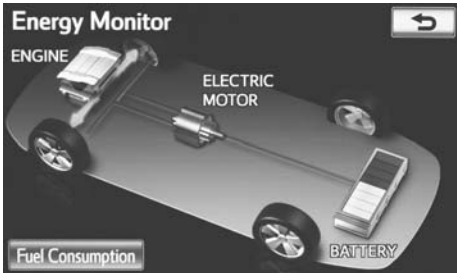
Condition	Display
<p>When the vehicle is powered by the electric motor (traction motor)</p>	 <p>The display shows a top-down view of a car chassis with the following components labeled: ENGINE, ELECTRIC MOTOR, and BATTERY. A blue arrow points from the ELECTRIC MOTOR to the rear axle, indicating power flow. A 'Fuel Consumption' gauge is visible in the bottom left, and a 'BATTERY' gauge is in the bottom right. A right-pointing arrow icon is in the top right corner.</p>
<p>When the vehicle is powered by both the gasoline engine and the electric motor (traction motor)</p>	 <p>The display shows a top-down view of a car chassis with the following components labeled: ENGINE, ELECTRIC MOTOR, and BATTERY. Blue arrows point from both the ENGINE and the ELECTRIC MOTOR to the rear axle, indicating power flow from both sources. A 'Fuel Consumption' gauge is visible in the bottom left, and a 'BATTERY' gauge is in the bottom right. A right-pointing arrow icon is in the top right corner.</p>
<p>When the vehicle is powered by the gasoline engine</p>	 <p>The display shows a top-down view of a car chassis with the following components labeled: ENGINE, ELECTRIC MOTOR, and BATTERY. A blue arrow points from the ENGINE to the rear axle, indicating power flow from the gasoline engine. A 'Fuel Consumption' gauge is visible in the bottom left, and a 'BATTERY' gauge is in the bottom right. A right-pointing arrow icon is in the top right corner.</p>

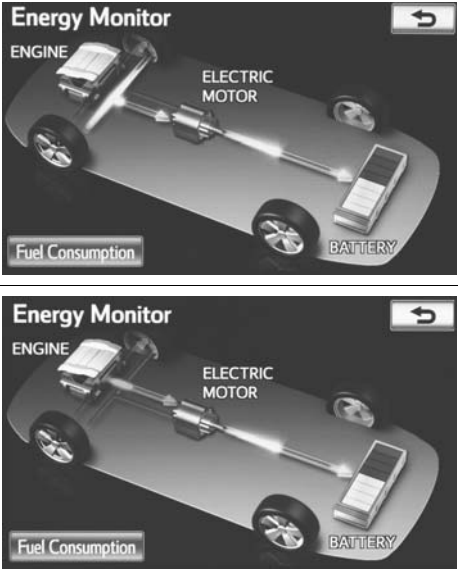
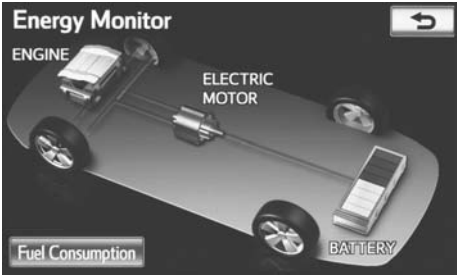
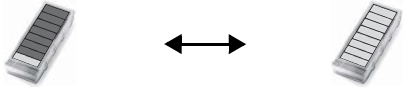
Condition	Display
<p>When the vehicle is charging the hybrid battery (traction battery)</p>	
<p>When there is no energy flow</p>	
<p>Hybrid battery (traction battery) status</p>	<p>Low <span style="margin-left: 200px;">Full</span></p> 

These images are examples only, and may vary slightly from actual conditions.

## Multi-information display

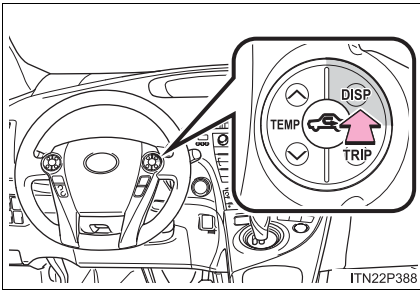





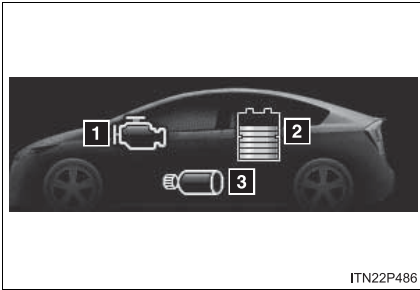

Press the “DISP” button to display the energy monitor.

### ■ Names and meaning of each icons

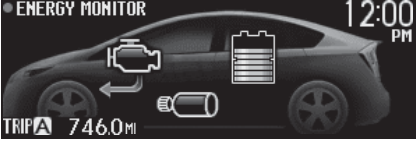
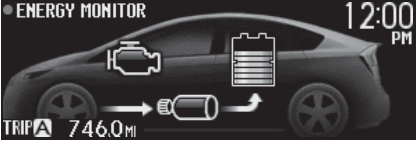

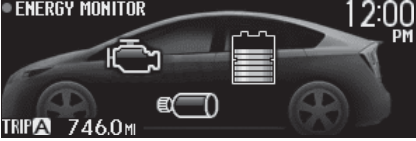
- 1 Gasoline engine
- 2 Hybrid battery (traction battery)
- 3 Electric motor (traction motor)

Condition	Display
When the vehicle is powered by the electric motor (traction motor)	
When the vehicle is powered by both the gasoline engine and the electric motor (traction motor)	

Condition	Display
When the vehicle is powered by the gasoline engine	
When the vehicle is charging the hybrid battery (traction battery)	
	
When there is no energy flow	
Hybrid battery (traction battery) status	<div style="display: flex; justify-content: space-between; align-items: center;"> <div style="text-align: center;"> <p>Low</p>  </div> <div style="text-align: center;">  </div> <div style="text-align: center;"> <p>Full</p>  </div> </div>

These images are examples only, and may vary slightly from actual conditions.

## Consumption screen

### Display Audio system

Press “CAR”.

If the “Energy Monitor” screen is displayed, touch “Consumption”.

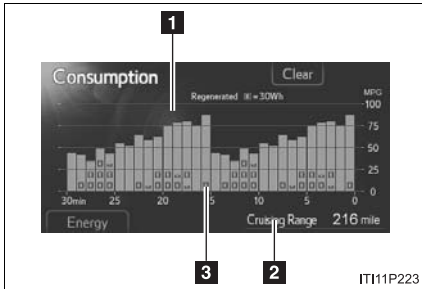

- 1 Fuel consumption in the past 30 minutes
- 2 Cruising range (→P. 55)
- 3 Regenerated energy in the past 30 minutes

One symbol indicates 30 Wh. Up to 4 symbols are shown.

The image is example only, and may vary slightly from actual conditions.

### Navigation system

**STEP 1** Press “INFO APPS” or “INFO”.

**STEP 2** Touch “Fuel Consumption” on the “Information” screen.

If the “Energy Monitor” screen is displayed, touch “Consumption”.

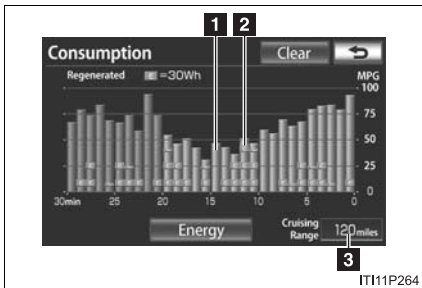

- 1 Fuel consumption in the past 30 minutes
- 2 Regenerated energy in the past 30 minutes
- 3 Cruising range (→P. 55)

One symbol indicates 30 Wh. Up to 4 symbols are shown.

The image is example only, and may vary slightly from actual conditions.

## Multi-information display

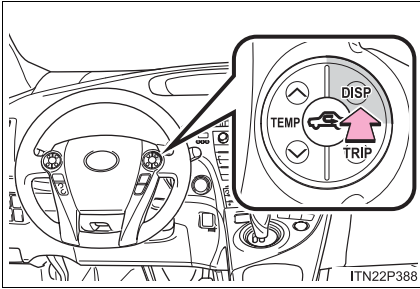

Press the “DISP” button to display the 5-minute or 1-minute fuel consumption display.

Press and hold the “DISP” button to switch between 5-minute and 1-minute fuel consumption displays.

The display will alternate with each press of the button.

### ► 5-minute interval fuel consumption

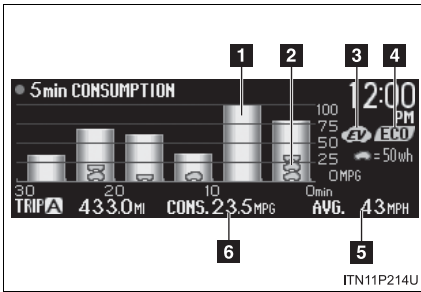

#### 1 Fuel consumption

Displays the average fuel consumption for the last 30 minutes in intervals of 5 minutes or the last 15 minutes in intervals of 1 minute.

#### 2 Regenerated energy

Displays the amount of energy generated over the last 30 minutes in intervals of 5 minutes or the last 15 minutes in intervals of 1 minute.

One symbol indicates 50 Wh (5-minute interval display) or 30 Wh (1-minute interval display). Up to 8 symbols are shown.

### ► 1-minute interval fuel consumption

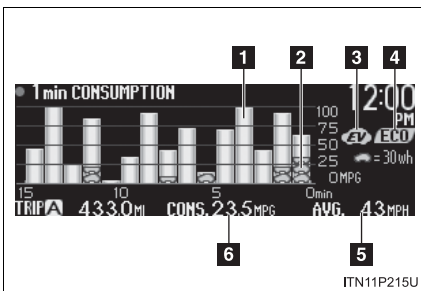



**3** EV indicator\*<sup>1</sup>

**4** Eco Driving Indicator Light\*<sup>1</sup>

**5** Average speed\*<sup>2</sup>

**6** Average fuel consumption/eco savings\*<sup>2</sup>

Use the displayed average fuel consumption as a reference.

\*<sup>1</sup>: →P. 225

\*<sup>2</sup>:The current amount since the trip meter was reset will be displayed. These functions can be reset by pressing and holding the “TRIP” button when either the 5-minute or 1-minute interval fuel consumption display is being shown.

The display can be switched between average fuel consumption/average speed and eco savings. (→P. 232)

## Monthly fuel consumption record/Eco savings record (multi-information display only)

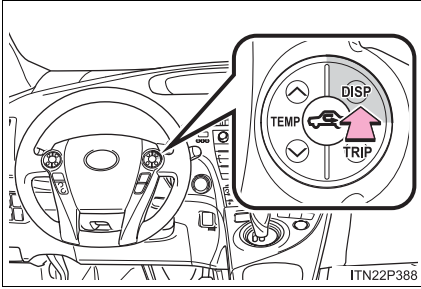

Press the “DISP” button to display the monthly fuel consumption record or eco savings record.

Press and hold the “DISP” button to switch the display between monthly fuel consumption record and eco savings record.

The display will alternate with each press of the button.

### ► Monthly fuel consumption record display

Displays the average fuel consumption for the previous 6 months.

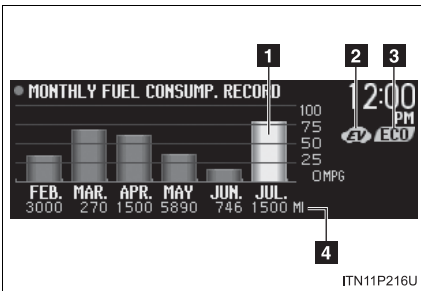

- 1** Average fuel consumption for the previous 6 months
- 2** EV indicator\*
- 3** Eco Driving Indicator Light\*
- 4** Driving distance for each month

\*: →P. 225

► Eco savings record display

By setting the comparison consumption and the gasoline value beforehand (→P. 231), the difference is calculated when the actual consumption is less than the comparison consumption, and the amount of money saved is displayed\*1.

If the comparison consumption is set to 0, the consumption cost is displayed\*1.

\*1: The displayed amount is intended only as a guide and may differ from the actual amount.

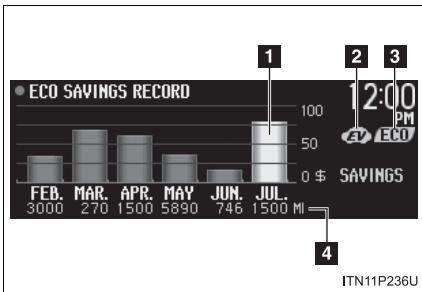

- 1 Savings or consumption costs for the previous 6 months
- 2 EV indicator\*2
- 3 Eco Driving Indicator Light\*2
- 4 Driving distance for each month

\*2: →P. 225

■ Remaining hybrid battery (traction battery) charge display

The charge amount of the hybrid battery (traction battery) is automatically controlled by the hybrid system. For this reason, even if electricity is recovered via the regenerative braking, or electricity is generated via the gasoline engine, the displayed hybrid battery (traction battery) charge amount may not reach the highest level (level 8). However, this does not indicate a malfunction.

## ■ Resetting the consumption data

### Display Audio system

Selecting “Clear” on the “Consumption” screen will reset the fuel consumption and the regenerated energy for the past 30 minutes.

Selecting “Yes” on the following screen will confirm resetting of all the data.

### Navigation system

Selecting “Clear” on the “Consumption” screen will reset the fuel consumption and the regenerated energy for the past 30 minutes.

Selecting “Yes” on the following screen will confirm resetting of all the data.

### Multi-information display

If the “POWER” switch is turned OFF, average fuel consumption and regenerated energy data will be reset.

## ■ Resetting the monthly fuel consumption/eco savings record

Press and hold the “TRIP” button while the monthly fuel consumption/eco savings record is displayed.

A confirmation message will be displayed.

Press and hold the “TRIP” button to reset the data.

Press the “DISP” button to cancel the reset operation. The screen will return to the previous display if no buttons are pressed for approximately 10 seconds.

## ■ Cruising range

Displays the estimated maximum distance that can be driven with the quantity of fuel remaining.

This distance is computed based on your average fuel consumption.

As a result, the actual distance that can be driven may differ from that displayed.

## ■ Odometer/trip meter/distance to empty

The odometer/trip meter/distance to empty will not be displayed while the monthly fuel consumption record or the eco savings record is being displayed.

**For economical and ecological driving, pay attention to the following points:**

■ **Using Eco drive mode**

When using Eco drive mode, the torque corresponding to the accelerator pedal depression amount can be generated more smoothly than it is in normal conditions. In addition, the operation of the air conditioning system (heating/cooling) will be minimized, improving the fuel economy. (→P. 204)

■ **Use of Hybrid System Indicator**

Eco-friendly driving is possible by keeping the indicate of Hybrid System Indicator within Eco area. (→P. 225)

■ **When braking the vehicle**

Make sure to operate the brakes gently and in good time. A greater amount of electrical energy can be retained when slowing down.

■ **Delays**

Repeated acceleration and deceleration, as well as long waits at traffic lights, will lead to bad fuel consumption. Check traffic reports before leaving and avoid delays as much as possible. When encountering a delay, gently release the brake pedal to allow the vehicle to move forward slightly while avoiding overuse of the accelerator pedal. Doing so can help control excessive gasoline consumption.

■ **Highway driving**

Control your speed and keep at a constant speed. Also, before stopping at a toll booth or similar, allow plenty of time to release the accelerator and gently apply the brakes. A greater amount of electrical energy can be retained when slowing down.

### ■ Air conditioning on/off

Switch the air conditioning (  ) to off when it is not needed. Doing so can help control excessive gasoline consumption.

In summer: In high temperatures, use the recirculated air mode. Doing so will help to reduce the burden on the air conditioner and reduce fuel consumption as well.

In winter: Because the gasoline engine will not automatically cut out until the gasoline engine and the interior of the vehicle are warm, it will consume fuel. Also, fuel consumption can be improved by avoiding overuse of the heater.

### ■ Checking tire inflation pressure

Make sure to check the tire inflation pressure frequently. Improper tire inflation pressure can cause poor fuel consumption.

Also, as snow tires can cause large amounts of friction, their use on dry roads can lead to poor fuel consumption. Use a tire that is appropriate for the season.

### ■ Luggage

Carrying heavy luggage can lead to poor fuel consumption. Avoid carrying unnecessary luggage. Installing a large roof rack can also cause poor fuel consumption.

### ■ Warming up before driving

Since the gasoline engine starts up and cuts out automatically when cold, warming up the engine is unnecessary. Moreover, frequently driving short distances will cause the engine to repeatedly warm up, which can lead to poor fuel consumption.

The following keys are provided with the vehicle.

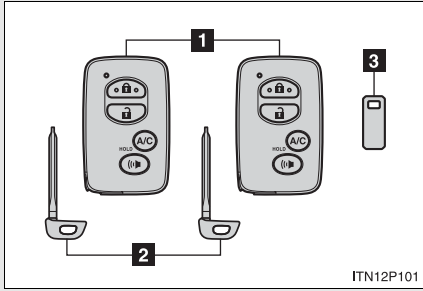

## 1 Electronic keys

- Operating the smart key system (→P. 61, 79)
- Operating the wireless remote control function (→P. 85)
- Operating the Remote Air Conditioning System\* (→P. 342)

## 2 Mechanical keys

## 3 Key number plate

\*: If equipped

## Using the mechanical key

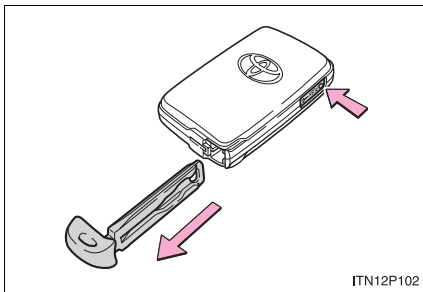

To take out the mechanical key, push the release button and take the key out.

After using the mechanical key, store it in the electronic key. Carry the mechanical key together with the electronic key. If the electronic key battery is depleted or the entry function does not operate properly, you will need the mechanical key. (→P. 541)

---

**■ Key number plate**

Keep the plate in a safe place such as your wallet, not in the vehicle. In the event that a mechanical key is lost, a new key can be made at your Toyota dealer using the key number plate. (→P. 540)

**■ When riding in an aircraft**

When bringing an electronic key onto an aircraft, make sure you do not press any buttons on the electronic key while inside the aircraft cabin. If you are carrying an electronic key in your bag etc., ensure that the buttons are not likely to be pressed accidentally. Pressing a button may cause the electronic key to emit radio waves that could interfere with the operation of the aircraft.



 NOTICE

■ **To prevent key damage**

Observe the following:

- Do not drop the keys, subject them to strong shocks or bend them.
- Do not expose the keys to high temperatures for long periods of time.
- Do not get the keys wet or wash them in an ultrasonic washer etc.
- Do not attach metallic or magnetic materials to the keys or place the keys close to such materials.
- Do not disassemble the keys.
- Do not attach a sticker or anything else to the surface of the electronic key.
- Do not place the keys near objects that produce magnetic fields, such as TVs, audio systems and glass top ranges, or medical electrical equipment, such as low-frequency therapy equipment.

■ **Carrying the electronic key on your person**

Carry the electronic key 3.9 in. (10 cm) or more away from electric appliances that are turned on. Radio waves emitted from electric appliances within 3.9 in. (10 cm) of the electronic key may interfere with the key, causing the key to not function properly.

■ **In case of a smart key system malfunction or other key-related problems**

Take your vehicle with all the electronic keys provided with your vehicle to your Toyota dealer.

■ **When a vehicle key is lost**

If the key remains lost, the risk of vehicle theft increases significantly. Visit your Toyota dealer immediately with all remaining electronic keys that was provided with your vehicle.

# 1-3. Opening, closing and locking the doors Smart key system (with entry function)

The following operations can be performed simply by carrying the electronic key on your person, for example in your pocket.  
(The driver should always carry the electronic key.)

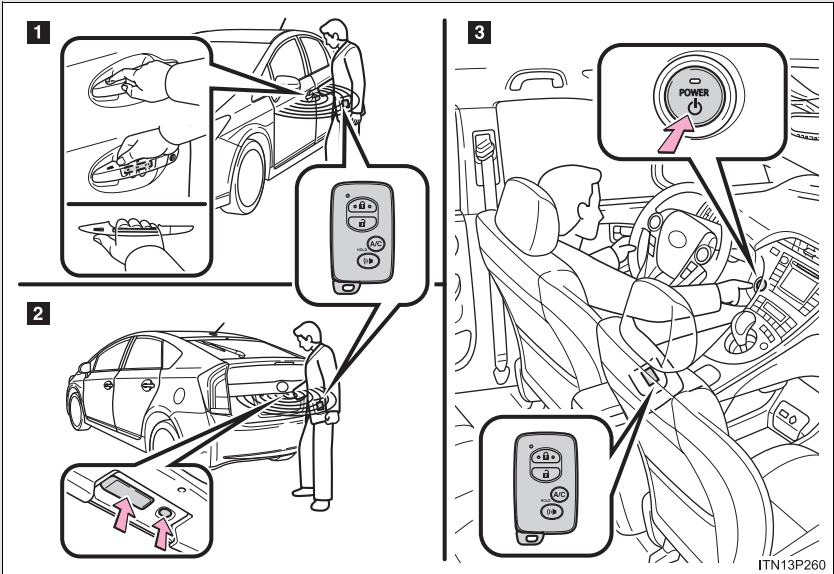

- 1** Unlocks and locks the side doors (→P. 62)
- 2** Unlocks and locks the back door (→P. 63)
- 3** Starts and stops the hybrid system (→P. 192)

## Unlocking and locking the doors

### Front door handles (including front passenger door handle if equipped with entry function)

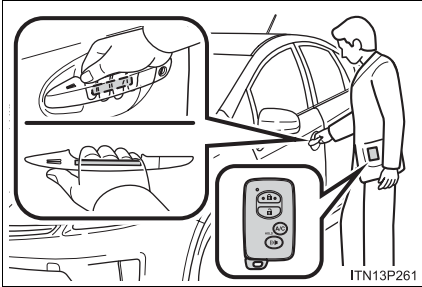

Grip the driver's door handle to unlock the door. Grip the passenger's door handle to unlock all the doors.\*

Make sure to touch the sensor on the back of the handle.

The doors cannot be unlocked for 3 seconds after the doors are locked.

\*: The door unlock settings can be changed. (→P. 70)

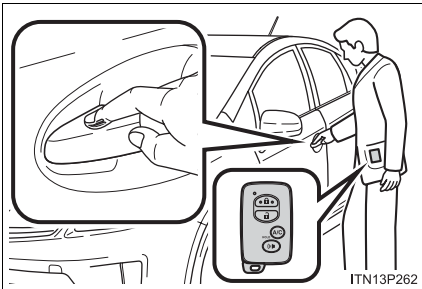

Touch the lock sensor (the indentation on the upper part of the door handle) to lock the doors.

### Back door (vehicles with entry function of front and back doors)

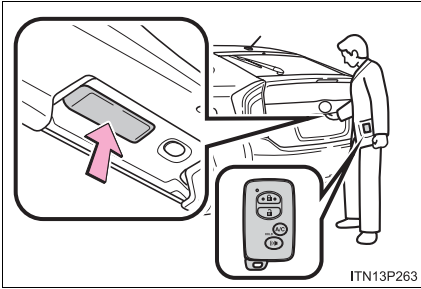

Press the unlock button to unlock all the doors.

The doors cannot be unlocked for 3 seconds after the doors are locked.

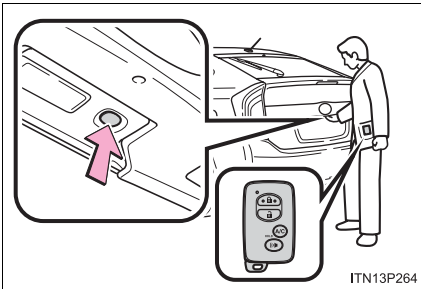

Press the lock button to lock all the doors.

## Antenna location and effective range

### ■ Antenna location

#### Vehicles with entry function of driver's door

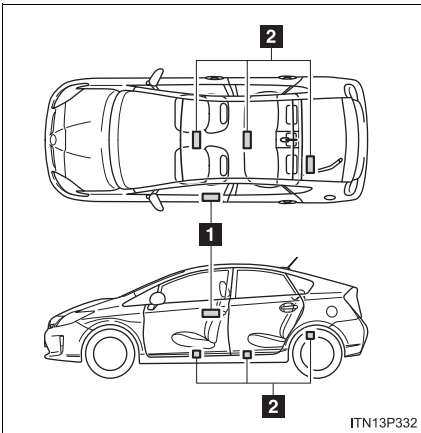

**1** Antennas outside cabin

**2** Antennas inside cabin

#### Vehicles with entry function of front and back doors

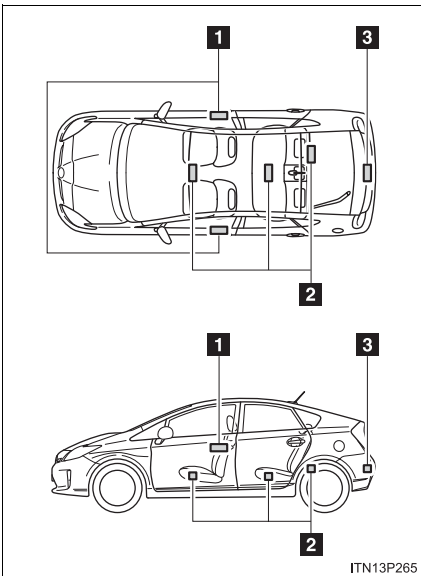

**1** Antennas outside the cabin

**2** Antennas inside the cabin

**3** Antenna outside the luggage compartment

■ **Effective range (areas within which the electronic key is detected)**

**Vehicles with entry function of driver's door**

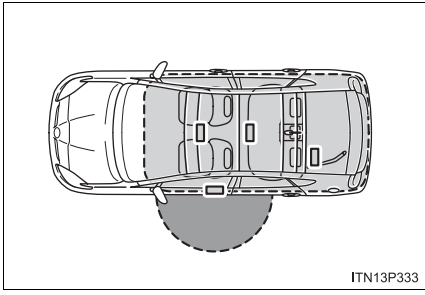

- When locking or unlocking the door

The system can be operated when the electronic key is within about 2.3 ft. (0.7 m) of driver's door handle.

- When starting the hybrid system or changing "POWER" switch modes

The system can be operated when the electronic key is inside the vehicle.

**Vehicles with entry function of front and back doors**

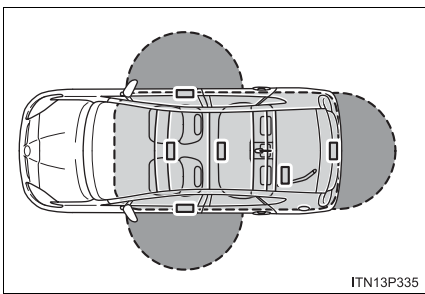

- When locking or unlocking the doors

The system can be operated when the electronic key is within about 2.3 ft. (0.7 m) of either of the outside front door handle and back door opener switch. (Only the doors detecting the key can be operated.)

- When starting the hybrid system or changing "POWER" switch modes

The system can be operated when the electronic key is inside the vehicle.

■ **Operation signals**

A buzzer sounds and the emergency flashers flash to indicate that the doors have been locked/unlocked. (Locked: Once; Unlocked: Twice)

■ **When the door cannot be locked by the lock sensor on the upper part of the door handle**

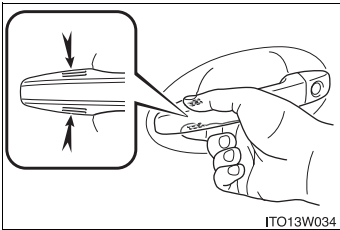

If the door will not lock even when the topside sensor area is touched, try touching both the topside and underside sensor areas at the same time.

## ■ Alarms and warning lights

A combination of exterior and interior alarms as well as warning lights are used to prevent theft of the vehicle and accidents resulting from erroneous operation. Take appropriate measures in response to any warning message shown on the multi-information display. (→P. 517)

The following table describes circumstances and correction procedures when only alarms are sounded.

Alarm	Situation	Correction procedure
Interior alarm pings once and exterior alarm sounds once for 5 seconds* <sup>1</sup>	An attempt was made to lock the doors using the entry function while the electronic key was still inside the passenger compartment	Retrieve the electronic key from the passenger compartment and lock the doors again
	An attempt was made to exit the vehicle and lock the doors without first turning the "POWER" switch off	Turn the "POWER" switch off and lock the doors again
Exterior alarm sounds once for 5 seconds	An attempt was made to lock the vehicle while a door is open	Close all of the doors and lock the doors again



1-3. Opening, closing and locking the doors

Alarm	Situation	Correction procedure
Interior alarm pings continuously*1	The "POWER" switch was turned to ACCESSORY mode while the driver's door was open (or the driver's door was opened while the "POWER" switch was in ACCESSORY mode)	Turn the "POWER" switch off and close the driver's door
Interior alarm sounds continuously*1	When the "POWER" switch is in ON mode or ACCESSORY mode, an attempt was made to open the door and exit the vehicle, and the shift position was not in P	Shift the shift position to P and turn the "POWER" switch off
Interior and exterior alarms sound continuously*1	When the "POWER" switch is in ON mode or ACCESSORY mode, the driver's door was closed after the key was carried outside the vehicle, and the shift position not in P	Shift the shift position to P, turn the "POWER" switch off and close the driver's door again

Alarm	Situation	Correction procedure
Interior alarm pings once* <sup>1</sup>	The electronic key has a low battery	Replace the electronic key battery
	An attempt was made to start the hybrid system without the electronic key being present, or the electronic key was not functioning normally	Start the hybrid system with the electronic key present* <sup>2</sup>
Interior alarm pings once and exterior alarm sounds 3 times* <sup>1</sup>	The driver's door was closed after the key was carried outside the vehicle, and the "POWER" switch was not turned OFF	Turn the "POWER" switch off and close the driver's door again
	An occupant carried the electronic key outside the vehicle and closed the door while the "POWER" switch was not OFF	Bring the electronic key back into the vehicle

\*<sup>1</sup>: A message will be shown on the multi-information display in the instrument cluster.

\*<sup>2</sup>: If the hybrid system does not start when the electronic key is inside the vehicle, the electronic key battery may be depleted or there may be difficulties receiving signal from the key. (→P. 541)



■ **Security feature**

If a door is not opened within approximately 60 seconds after the vehicle is unlocked, the security feature automatically locks the vehicle again.



■ **Switching the door unlock function**

It is possible to set which doors the entry function unlocks.

**STEP 1** Turn the “POWER” switch off.

**STEP 2** When the indicator on the key surface is turned off, push and hold  or  for approximately 5 seconds while pushing the  button on the key.

The setting changes each time an operation is performed, as shown below. (When changing the setting continuously, release the buttons, wait for at least 5 seconds, and repeat **STEP 2**.)

Multi-information display	Unlocking doors	Beep
	Hold the driver's door handle to unlock only the driver's door.	Exterior: Beeps three times Interior: Pings once
	Hold the passenger's door handle or back door opener to unlock all the doors.	
	Hold the front door handle or back door opener to unlock all the doors.	Exterior: Beeps twice Interior: Pings once

### ■ Battery-saving function

The battery-saving function will be activated in order to prevent the electronic key battery and the 12-volt battery from being discharged while the vehicle is not in operation for a long time.

- In the following situations, the smart key system may take some time to unlock the doors.
  - The electronic key has been left in an area of approximately 6 ft. (2 m) of the outside of the vehicle for 10 minutes or longer.
  - The smart key system has not been used for 5 days or longer.
- If the smart key system has not been used for 14 days or longer, the doors cannot be unlocked at any doors except the driver's door. In this case, take hold of the driver's door handle, or use the wireless remote control or the mechanical key, to unlock the doors.

### ■ Conditions affecting operation

The smart key system, wireless remote control and immobilizer system use weak radio waves. In the following situations, the communication between the electronic key and the vehicle may be affected, preventing the smart key system, wireless remote control and immobilizer system from operating properly. (Ways of coping: →P. 541)

- When the electronic key battery is depleted
- Near a TV tower, electric power plant, gas station, radio station, large display, airport or other facility that generates strong radio waves or electrical noise
- When carrying a portable radio, cellular phone, cordless phone or other wireless communication devices
- When the electronic key is in contact with, or is covered by the following metallic objects
  - Cards to which aluminum foil is attached
  - Cigarette boxes that have aluminum foil inside
  - Metallic wallets or bags
  - Coins
  - Hand warmers made of metal
  - Media such as CDs and DVDs
- When other wireless key (that emit radio waves) is being used nearby
- When carrying the electronic key together with the following devices that emit radio waves
  - Another vehicle's electronic key or a wireless key that emits radio waves
  - Personal computers or personal digital assistants (PDAs)
  - Digital audio players
  - Portable game systems
- If window tint with a metallic content or metallic objects are attached to the rear window

**■ Note for the entry function**

- Even when the electronic key is within the effective range (detection areas), the system may not operate properly in the following cases:
  - The electronic key is too close to the window or outside door handle, near the ground, or in a high place when the doors are locked or unlocked.
  - The electronic key is on the instrument panel, luggage cover, floor, or in the door pockets or glove box when the hybrid system is started or “POWER” switch modes are changed.
- Do not leave the electronic key on top of the instrument panel or near the door pockets when exiting the vehicle. Depending on the radio wave reception conditions, it may be detected by the antenna outside the cabin and the door will become lockable from the outside, possibly trapping the electronic key inside the vehicle.
- As long as the electronic key is within the effective range, the doors may be locked or unlocked by anyone.
- Even if the electronic key is not inside the vehicle, it may be possible to start the hybrid system if the electronic key is near the window.
- The doors may unlock if a large amount of water splashes on the door handle, such as in the rain or in a car wash when the electronic key is within the effective range. (The door will automatically be locked after approximately 60 seconds if the doors are not opened and closed.)
- If the wireless remote control is used to lock the doors when the electronic key is near the vehicle, there is a possibility that the door may not be unlocked by the entry function. (Use the wireless remote control to unlock the doors.)

### ■ Note for locking the doors

- Touching the door lock sensor while wearing gloves may delay or prevent lock operation. Remove the gloves and touch the lock sensor again.
- When the lock operation is performed using the lock sensor, recognition signals will be shown up to two consecutive times. After this, no recognition signals will be given.
- If the door handle becomes wet while the electronic key is within the effective range, the door may lock and unlock repeatedly. Place the key in a position 6 ft. (2 m) or more separate from the vehicle while the vehicle is being washed. (Take care to ensure that the key is not stolen.)
- If the electronic key is inside the vehicle and a door handle becomes wet during a car wash, a buzzer will sound outside the vehicle. To turn off the alarm, lock all the doors.
- The lock sensor may not work properly if it comes into contact with ice, snow, mud, etc. Clean the lock sensor and attempt to operate it again, or use the lock sensor on the lower part of the door handle.
- Fingernails may scrape against the door during operation of the door handle. Be careful not to injure fingernails or damage the surface of the door.

**■ Note for the unlocking function**

- A sudden approach to the effective range or door handle may prevent the doors from being unlocked. In this case, return the door handle to the original position and check that the doors unlock before pulling the door handle again.
- Gripping the door handle when wearing a glove may not unlock the door. Remove the gloves and touch the sensor on the back of the door handle again.
- If the door handle becomes wet while the electronic key is within the effective range, the door may lock and unlock repeatedly. Place the key in a position 6 ft. (2 m) or more separate from the vehicle while the vehicle is being washed. (Take care to ensure that the key is not stolen.)
- If there is another electronic key in the detection area, it may take slightly longer to unlock the doors after the door handle is gripped.
- Fingernails may scrape against the door during operation of the door handle. Be careful not to injure fingernails or damage the surface of the door.

**■ When the vehicle is not driven for extended periods**

- To prevent theft of the vehicle, do not leave the electronic key within 6 ft. (2 m) of the vehicle.
- The smart key system can be deactivated in advance. (→P. 590)

**■ To operate the system properly**

Make sure to carry the electronic key when operating the system. Do not get the electronic key too close to the vehicle when operating the system from the outside of the vehicle.

Depending on the position and holding condition of the electronic key, the key may not be detected correctly and the system may not operate properly. (The door lock prevention may not operate.)



### ■ If the smart key system does not operate properly

- Locking and unlocking the doors: Use the mechanical key. (→P. 541)
- Starting the hybrid system: →P. 542

### ■ Electronic key battery depletion

- The standard battery life is 1 to 2 years.
- If the battery becomes low, an alarm will sound in the cabin when the hybrid system stops. (→P. 67)
- As the electronic key always receives radio waves, the battery will become depleted even if the electronic key is not used. The following symptoms indicate that the electronic key battery may be depleted. Replace the battery when necessary. (→P. 454)
  - The smart key system or the wireless remote control does not operate.
  - The detection area becomes smaller.
  - The LED indicator on the key surface does not turn on.
- To avoid serious deterioration, do not leave the electronic key within 3 ft. (1 m) of the following electrical appliances that produce a magnetic field:
  - TVs
  - Personal computers
  - Cellular phones, cordless phones and battery chargers
  - Recharging cellular phones or cordless phones
  - Glass top ranges
  - Table lamps

### ■ When the electronic key battery is fully depleted

→P. 454

### ■ Customization

Settings (e.g. smart key system) can be changed.  
(Customizable features →P. 590)

■ **Certification for the smart key system**

**For vehicles sold in the U.S.A.**

FCC ID: NI4TMLF8-2

FCC ID: HYQ14ACX    FCC ID: HYQ14ADF

FCC ID: HYQ13CZD    FCC ID: HYQ13CZE

**NOTE:**

This device complies with Part 15 of the FCC Rules. Operation is subject to the following two conditions: (1) this device may not cause harmful interference, and (2) this device must accept any interference received, including interference that may cause undesired operation.

**FCC WARNING:**

Changes or modifications not expressly approved by the party responsible for compliance could void the user's authority to operate the equipment.

**For vehicles sold in Canada**

**NOTE:**

Operation is subject to the following two conditions: (1) this device may not cause interference, and (2) this device must accept any interference, including interference that may cause undesired operation of the device.

 CAUTION

■ **Caution regarding interference with electronic devices**

- People with implanted pacemakers or cardiac defibrillators should keep away from the smart key system antennas. (→P. 64)

The radio waves may affect the operation of such devices. If necessary, the entry function can be disabled. Ask your Toyota dealer for details, such as the frequency of radio waves and timing of emitting the radio waves. Then, consult your doctor to see if you should disable the entry function.

- Users of any electrical medical device other than implanted pacemakers and implanted cardiac defibrillators should consult the manufacturer of the device for information about its operation under the influence of radio waves.

Radio waves could have unexpected effects on the operation of such medical devices.

Ask your Toyota dealer for details on disabling the entry function.

On vehicles with the Display Audio system or the navigation system, the entry function can be disabled personally. (→P. 590)

### 1-3. Opening, closing and locking the doors

## Smart key system (without entry function)

Starting and stopping the hybrid system can be performed simply by carrying the electronic key on your person, for example in your pocket.

(The driver should always carry the electronic key.)

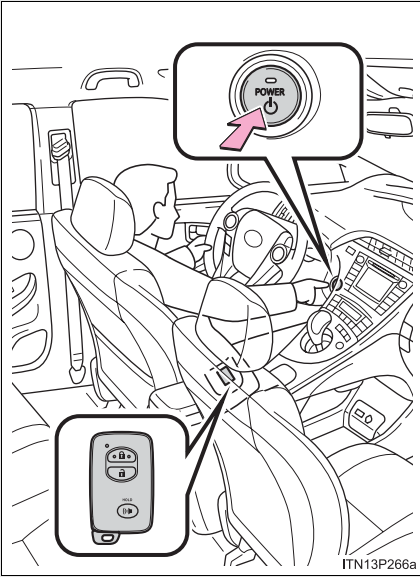

## Antenna location and effective range

### ■ Antenna location

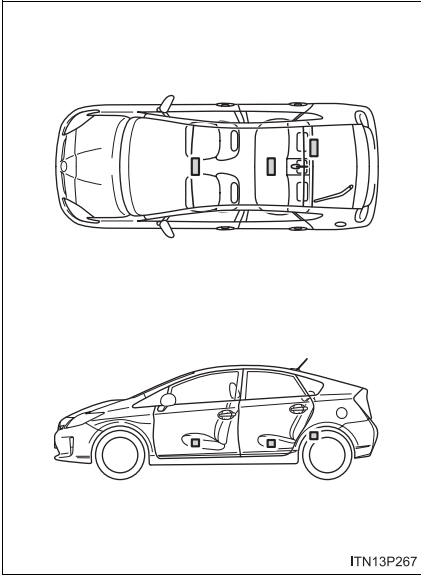

Antennas inside cabin

### ■ Effective range (areas within which the electronic key is detected)

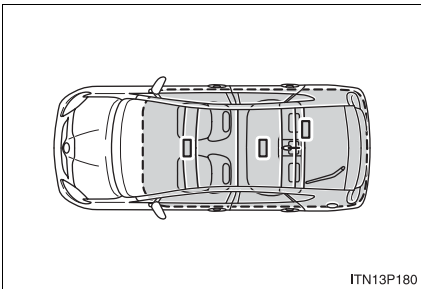

When starting the hybrid system or changing “POWER” switch modes

The system can be operated when the electronic key is inside the vehicle.

---

**■ Conditions affecting operation**

→P. 72

**■ Electronic key battery depletion**

→P. 76

**■ To operate the system properly**

Make sure to carry the electronic key when operating the system.

Depending on the position and holding condition of the electronic key, the key may not be detected correctly and the system may not operate properly. (The door lock prevention may not operate.)

**■ Note for the smart key system**

- Even when the electronic key is within the effective range (detection areas), the system may not operate properly.  
For example, the electronic key is on the instrument panel, luggage cover, floor or in the door pockets or glove box when the hybrid system is started or "POWER" switch modes are changed.
- Even if the electronic key is not inside the vehicle, it may be possible to start the hybrid system if the electronic key is near the window.

■ Alarms and warning indicators

A combination of exterior and interior alarms are used to prevent theft of the vehicle and unforeseeable accidents resulting from erroneous operation. Take appropriate measures in response to any warning message shown on the multi-information display. (→P. 517)

The following table describes circumstances and correction procedures when only alarms are sounded.

Alarm	Situation	Correction procedure
Exterior alarm sounds once for 5 seconds	An attempt was made to lock the vehicle while a door is open	Close all of the doors and lock the doors again
Interior alarm pings continuously*1	The "POWER" switch was turned to ACCESSORY mode while the driver's door was open (or the driver's door was opened while the "POWER" switch was in ACCESSORY mode)	Turn the "POWER" switch off and close the driver's door
Interior alarm sounds continuously*1	When the "POWER" switch is in ON mode or ACCESSORY mode, an attempt was made to open the door and exit the vehicle, and the shift position was not in P	Shift the shift position to P and turn the "POWER" switch off
Interior and exterior alarms sound continuously*1	When the "POWER" switch is in ON mode or ACCESSORY mode, the driver's door was closed after the key was carried outside the vehicle, and the shift position not in P	Shift the shift position to P, turn the "POWER" switch off and close the driver's door again

Alarm	Situation	Correction procedure
Interior alarm pings once* <sup>1</sup>	The electronic key has a low battery	Replace the electronic key battery
	An attempt was made to start the hybrid system without the electronic key being present, or the electronic key was not functioning normally	Start the hybrid system with the electronic key present* <sup>2</sup>
Interior alarm pings once and exterior alarm sounds 3 times* <sup>1</sup>	The driver's door was closed after the key was carried outside the vehicle, and the "POWER" switch was not turned OFF	Turn the "POWER" switch off and close the driver's door again
	An occupant carried the electronic key outside the vehicle and closed the door while the "POWER" switch was not OFF	Bring the electronic key back into the vehicle

\*<sup>1</sup>: A message will be shown on the multi-information display in the instrument cluster.

\*<sup>2</sup>: If the hybrid system does not start when the electronic key is inside the vehicle, the electronic key battery may be depleted or there may be difficulties receiving signal from the key. (→P. 541)

■ **If the electronic key does not operate properly**

→P. 541

■ **When the electronic key battery is fully depleted**

→P. 454

■ **Customization**

Settings (e.g. smart key system) can be changed.  
(Customizable features →P. 590)



■ **Certification for the smart key system**

**For vehicles sold in the U.S.A.**

FCC ID: NI4TMLF8-2

FCC ID: HYQ14ACX      FCC ID: HYQ14ADF

FCC ID: HYQ13CZD      FCC ID: HYQ13CZE

**NOTE:**

This device complies with Part 15 of the FCC Rules. Operation is subject to the following two conditions: (1) this device may not cause harmful interference, and (2) this device must accept any interference received, including interference that may cause undesired operation.

**FCC WARNING:**

Changes or modifications not expressly approved by the party responsible for compliance could void the user's authority to operate the equipment.

**For vehicles sold in Canada**

**NOTE:**

Operation is subject to the following two conditions: (1) this device may not cause interference, and (2) this device must accept any interference, including interference that may cause undesired operation of the device.

 **CAUTION**

■ **Caution regarding interference with electronic devices**

→P. 78

## 1-3. Opening, closing and locking the doors

### Wireless remote control

The wireless remote control can be used to lock and unlock the vehicle.

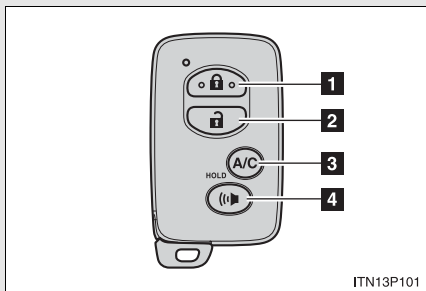

- 1** Locks all the doors
- 2** Unlocks all the doors

Pressing the button unlocks the driver's door. Pressing the button again within 3 seconds unlocks the other doors.

- 3** Operates Remote Air Conditioning System\* (→P. 342)
- 4** Sounds the alarm (press and hold) (→P. 86)

\*: If equipped

1

Before driving

#### ■ Operation signals

A buzzer sounds and the emergency flashers flash to indicate that the doors have been locked/unlocked. (Locked: Once; Unlocked: Twice)

#### ■ Door lock buzzer (vehicles with entry function)

If an attempt to lock the doors is made when a door is not fully closed, a buzzer sounds continuously for 5 seconds. Fully close the door to stop the buzzer, and lock the vehicle once more.

### ■ Panic mode

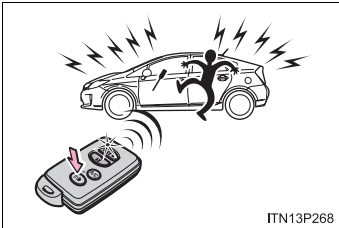

When  is pressed for longer than about one second, an alarm will sound intermittently and the vehicle lights will flash to deter any person from trying to break into or damage your vehicle.

To stop the alarm, press any button on the electronic key.

### ■ Security feature

→P. 70

### ■ Conditions affecting operation

→P. 72

### ■ If the wireless remote control does not operate properly

Locking and unlocking the doors: Use the mechanical key. (→P. 541)

### ■ Electronic key battery depletion

→P. 76

### ■ When the electronic key battery is fully depleted

→P. 454

### ■ Customization

Settings (e.g. door unlocking function) can be changed.  
(Customizable features →P. 590)

# 1-3. Opening, closing and locking the doors

## Side doors

The vehicle can be locked and unlocked using the entry function, wireless remote control or door lock switch.

### ■ Entry function (if equipped)

→P. 61

### ■ Wireless remote control

→P. 85

### ■ Door lock switch

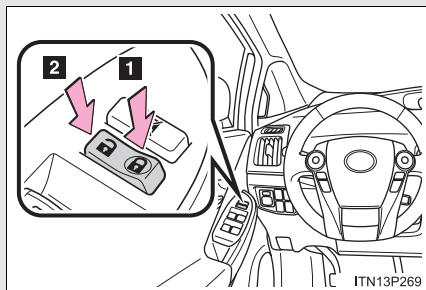

- 1** Locks all the doors
- 2** Unlocks all the doors

### ■ Inside lock buttons

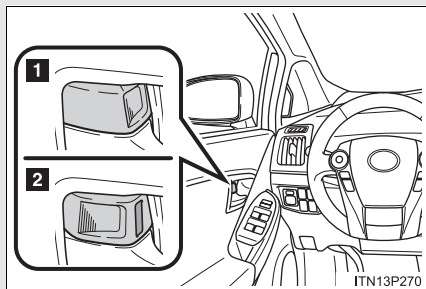

- 1** Locks the door
- 2** Unlocks the door

The front doors can be opened by pulling the inside handle even if the lock buttons are in the lock position.

### Locking the front doors from the outside without a key

**STEP 1** Move the inside lock button to the lock position.

**STEP 2** Close the door.

The door cannot be locked if the “POWER” switch is in ACCESSORY or ON mode, or the electronic key is left inside the vehicle.

The key may not be detected correctly and the door may be locked.

### Rear door child-protector lock

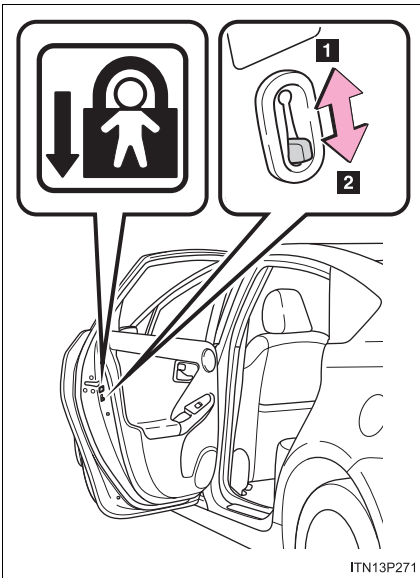

The door cannot be opened from inside the vehicle when the lock is set.

- 1** Unlock
- 2** Lock

These locks can be set to prevent children from opening the rear doors. Push down on each rear door switch to lock both rear doors.

## Automatic door locking and unlocking systems

The following functions can be set or canceled:

Function	Operation
Shift position linked door locking function	Shifting the shift position out of P locks all doors.
Shift position linked door unlocking function	Shifting the shift position to P unlocks all doors.
Speed linked door locking function	All doors are locked when the vehicle speed is approximately 12 mph (20 km/h) or higher.
Driver's door linked door unlocking function	All doors are unlocked when the driver's door is opened within 10 seconds after turning the "POWER" switch off.



### ■ Setting and canceling the functions

To switch between setting and canceling, follow the procedure below:

**STEP 1** Close all the doors and switch the "POWER" switch to ON mode. (Perform **STEP 2** within 20 seconds.)

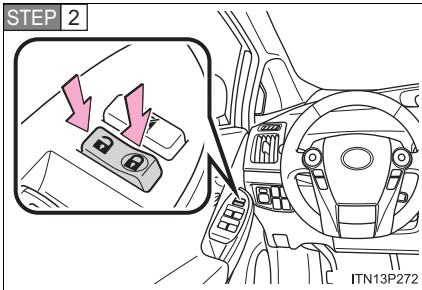



### 1-3. Opening, closing and locking the doors



Shift the shift position to P or N, and press and hold the door lock switch (  or  ) for about 5 seconds then release.

The shift position corresponding to the desired function to be set are shown as follows.

Use the same procedure to cancel the function.

Function	Shift position	Door lock switch position
Shift position linked door locking function	P	
Shift position linked door unlocking function		
Speed linked door locking function	N	
Driver's door linked door unlocking function		

When the setting or canceling operation is complete, all doors are locked and then unlocked.

---

■ **Using the mechanical key**

The doors can also be locked and unlocked with the mechanical key.  
(→P. 541)

■ **If a wrong key is used**

The key cylinder rotates freely to isolate inside mechanism.

■ **Customization**

Settings (e.g. unlocking function using a key) can be changed.  
(Customizable features →P. 590)



 CAUTION

■ **To prevent an accident**

Observe the following precautions while driving the vehicle.

Failure to do so may result in a door opening and an occupant falling out, resulting in death or serious injury.

- Always use a seat belt.
- Always lock all the doors.
- Ensure that all doors are properly closed.
- Do not pull the inside handle of the doors while driving.

The doors may be opened and the passengers are thrown out of the vehicle and it may result in serious injury or death.

Be especially careful for the front doors, as the doors may be opened even if the inside lock buttons are in locked position.

- Set the rear door child-protector locks when children are seated in the rear seats.

■ **When opening or closing a door**

Check the surroundings of the vehicle such as whether the vehicle is on an incline, whether there is enough space for a door to open and whether a strong wind is blowing. When opening or closing the door, hold the door handle tightly to prepare for any unpredictable movement.

# 1-3. Opening, closing and locking the doors

## Back door

The back door can be locked/unlocked and opened by the following procedures.

### ■ Locking and unlocking the back door

#### Entry function

→P. 61

#### Wireless remote control

→P. 85

#### Door lock switch

→P. 87

### ■ Opening the back door from outside the vehicle

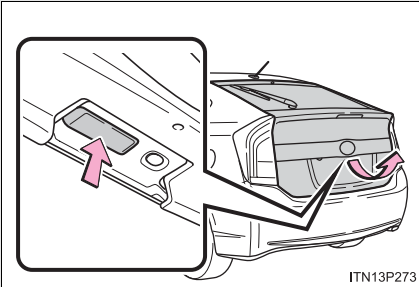

Raise the back door while pushing up the back door opener switch.

### When closing the back door

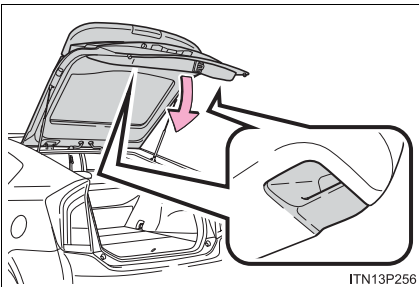

Lower the back door using the back door handle, and make sure to push the back door down from the outside to close it.

Be careful not to pull the back door sideways when closing the back door with the handle.

### ■ Luggage compartment light

The luggage compartment light turns on when the back door is opened with the luggage compartment light switch on.

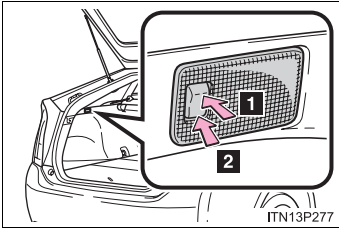

- 1** On
- 2** Off

### ■ If the back door opener is inoperative

The back door can be unlocked from the inside.

**STEP 1** Open the center deck board. (→P. 374)

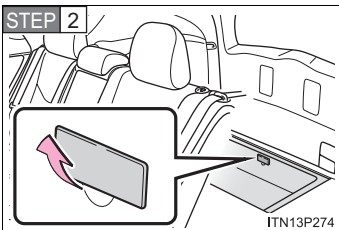

Remove the cover. (vehicles with center auxiliary box type B only)

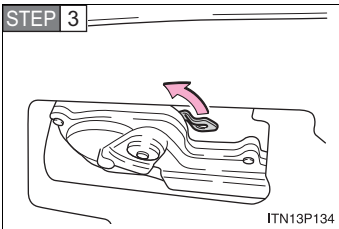

Move the lever.

 **CAUTION****■ Caution while driving**

- Keep the back door closed while driving.  
If the back door is left open, it may hit near-by objects while driving or luggage may be unexpectedly thrown out, causing an accident.  
In addition, exhaust gases may enter the vehicle, causing death or a serious health hazard. Make sure to close the back door before driving.
- Before driving the vehicle, make sure that the back door is fully closed. If the back door is not fully closed, it may open unexpectedly while driving, causing an accident.
- Never let anyone sit in the luggage compartment. In the event of sudden braking, sudden swerving or a collision, they are susceptible to death or serious injury.

**■ When children are in the vehicle**

Observe the following precautions.

Failure to do so may result in death or serious injury.

- Do not leave children alone in the luggage compartment.  
If a child is accidentally locked in the luggage compartment, they could have heat exhaustion.
- Do not allow a child to open or close the back door.  
Doing so may cause the back door to move unexpectedly, or cause the child's hands, head, or neck to be caught by the closing back door.

**! CAUTION**

**■ Operating the back door**

Observe the following precautions.

Failure to do so may cause parts of the body to be caught, resulting in death or serious injury.

- Remove any heavy loads, such as snow and ice, from the back door before opening it. Failure to do so may cause the back door to fall closed again after it is opened.
- When opening or closing the back door, thoroughly check to make sure the surrounding area is safe.
- If anyone is in the vicinity, make sure they are safe and let them know that the back door is about to open or close.
- Use caution when opening or closing the back door in windy weather as it may move abruptly in strong wind.

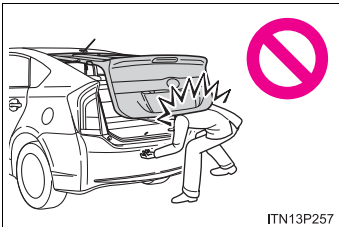

- The back door may fall if it is not opened fully. It is more difficult to open or close the back door on an incline than on a level surface, so beware of the back door unexpectedly opening or closing by itself. Make sure that the back door is fully open and secure before using the luggage compartment.

**! CAUTION**

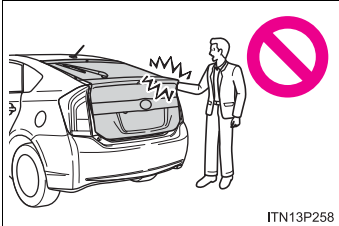

- When closing the back door, take extra care to prevent your fingers etc. from being caught.
  - When closing the back door, make sure to press it lightly on its outer surface. If the back door handle is used to fully close the back door, it may result in hands or arms being caught.
- Do not pull on the back door damper stay to close the back door, and do not hang on the back door damper stay. Doing so may cause hands to be caught or the back door damper stay to break, causing an accident.
  - If a bicycle carrier or similar heavy object is attached to the back door, it may fall closed again after being opened, causing someone's hands, head or neck to be caught and injured. When installing an accessory part to the back door, using a genuine Toyota part is recommended.

 NOTICE

■ **Back door damper stays**

The back door is equipped with damper stays that hold the back door in place.

Observe the following precautions.

Failure to do so may cause damage to the back door damper stay, resulting in malfunction.

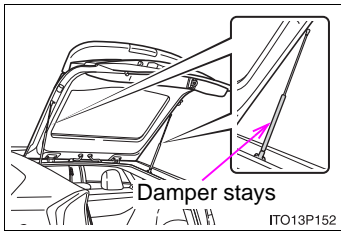

- Do not attach any foreign objects, such as stickers, plastic sheets, or adhesives to the damper stay rod.
- Do not touch the damper stay rod with gloves or other fabric items.
- Do not attach any accessories other than genuine Toyota parts to the back door.
- Do not place your hand on the damper stay or apply lateral forces to it.

# 1-4. Adjustable components (seats, mirrors, steering wheel)

## Front seats

### Manual seat (if equipped)

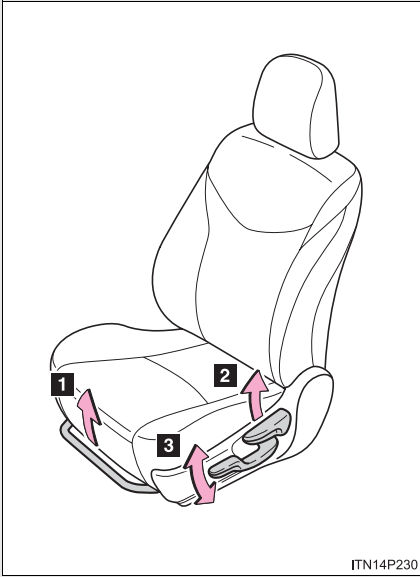

- 1** Seat position adjustment lever
- 2** Seatback angle adjustment lever
- 3** Vertical height adjustment lever (for driver's side)

1

Before driving



### Power seat (if equipped for driver's seat)

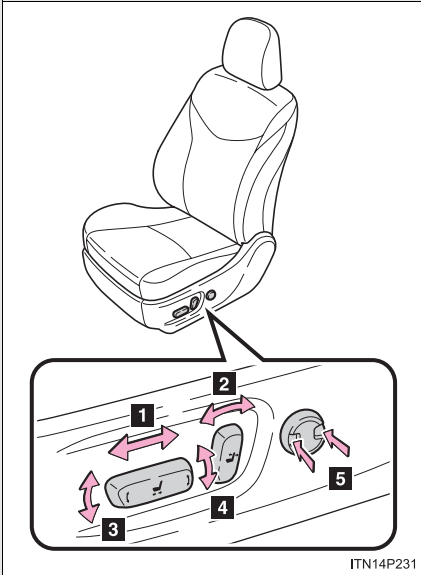

- 1** Seat position adjustment switch
- 2** Seatback angle adjustment switch
- 3** Seat cushion (front) angle adjustment switch
- 4** Vertical height adjustment switch
- 5** Lumbar support adjustment switch

### Active head restraints

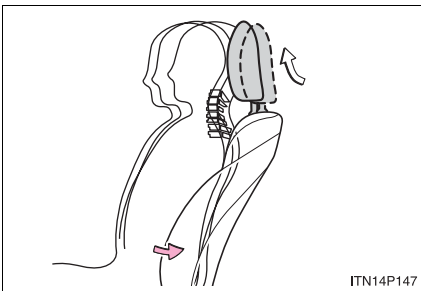

When the occupant's lower back presses against the seatback during a rear-end collision, the head restraint moves slightly forward and upward to help reduce the risk of whiplash on the seat occupant.

### ■ Active head restraints

Even small forces applied to the seatback may cause the head restraint to move. Pushing up a locked head restraint forcibly may make the inner structure of the head restraint appear. This does not indicate a problem.

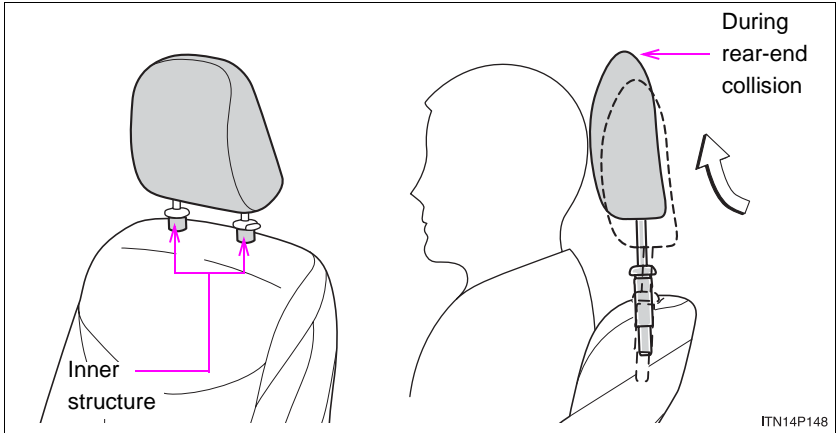

### ⚠ CAUTION

#### ■ Seat adjustment

- To reduce the risk of sliding under the lap belt during a collision, do not recline the seat more than necessary.

If the seat is too reclined, the lap belt may slide past the hips and apply restraint forces directly to the abdomen, or your neck may contact the shoulder belt, increasing the risk of death or serious injury in the event of an accident.

Adjustments should not be made while driving as the seat may unexpectedly move and cause the driver to lose control of the vehicle.

- After adjusting the seat, make sure that the seat is locked in position.

## 1-4. Adjustable components (seats, mirrors, steering wheel)

### Rear seats

**The seatbacks can be folded down.**

#### **Before folding down the seatbacks**

**STEP 1** Park the vehicle in a safe place.

Apply the parking brake firmly and shift the shift position to P.  
(→P. 205)

**STEP 2** Adjust the position of the front seat and the angle of the seat-back. (→P. 99)

Depending on the position of the front seat, if the seatback is folded backward, it may interfere with the operation of the rear seat.

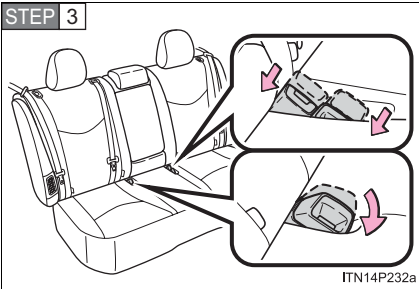

Stow the buckle of the seat belts.

**STEP 4** Lower the head restraint of the rear seat. (→P. 105)

**STEP 5** Vehicles with an armrest: Stow the armrest of the rear seat if it is pulled out. (→P. 371)

This step is not necessary when operating the driver's side seat only.

## Folding down the seatbacks

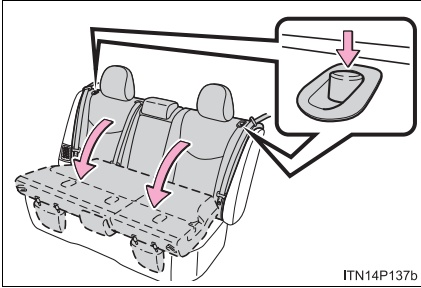

Fold the seatback down while pushing the lock release button.

To return the rear seatbacks to their original positions, lift them up until they lock.

1

Before driving

### ■ Remove the seat belt from the guide

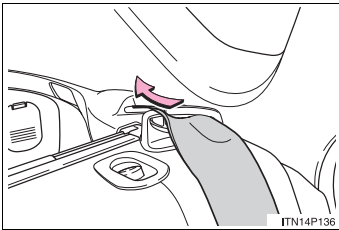

If the seat belt interferes with luggage on the folded seats, remove the seat belt from the guide.

### ■ Returning rear seatbacks

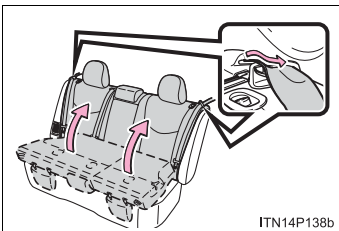

Tilt the rear seatback up until it locks, making sure that you hold the seat belt to prevent it from getting caught between the seatback and the inner side of the vehicle.

If the seat belt is removed from the guide, make sure the belt pass through the guide.

**! CAUTION**

**■ When folding the seatbacks down**

Observe the following precautions. Failure to do so may result in death or serious injury.

- Do not fold the seatbacks down while driving.
- Stop the vehicle on level ground, set the parking brake and shift the shift position to P.
- Do not allow anyone to sit on a folded seatback or in the luggage compartment while driving.
- Do not allow children to enter the luggage compartment.

**■ After returning the seatback to the upright position**

Observe the following precautions. Failure to do so may result in death or serious injury.

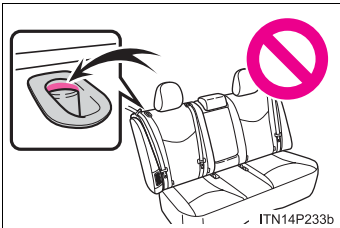

- Make sure that the seatback is securely locked in position by lightly pushing it back and forth.

If the seatbacks is not securely locked, the red marking will be visible on the seatback lock release button. Make sure that the red marking is not visible.

- Check that the seat belts are not twisted or caught in the seatback.

# 1-4. Adjustable components (seats, mirrors, steering wheel)

## Head restraints

Head restraints are provided for all seats.

### Front seats

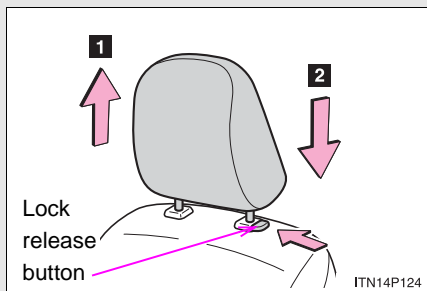

#### 1 Up

Pull the head restraints up.

#### 2 Down

Push and hold the lock release button when lowering the head restraint.

### Rear center seat

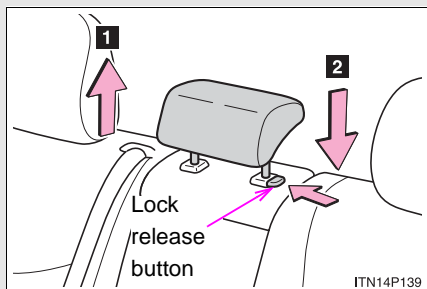

#### 1 Up

#### 2 Down

Pull up or push down the head restraint while pressing the lock release button.

### Foldable type rear outside seats

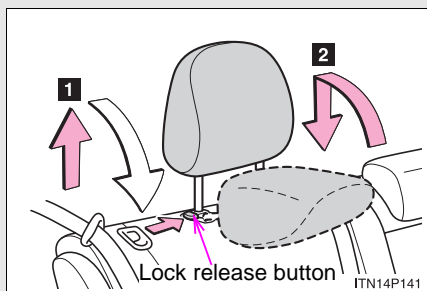

#### 1 To fold

Pull the head restraint up while pressing the lock release button.

#### 2 To use

Lift up and push down the head restraint to the lowest lock position.

## ■ Removing the head restraints

### Front and rear center seats

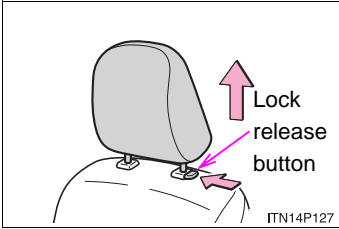

Pull the head restraint up while pressing the lock release button.

### Foldable type rear outside seats

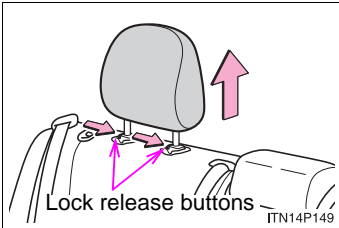

Pull the head restraint up while pressing the lock release buttons.

### Non-foldable type rear outside seats

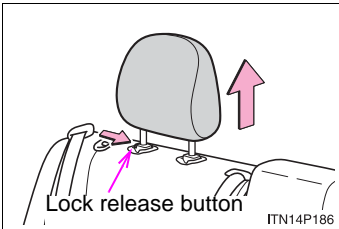

Pull the head restraint up while pressing the lock release button.

## ■ Installing the head restraints

### Front and rear center seats

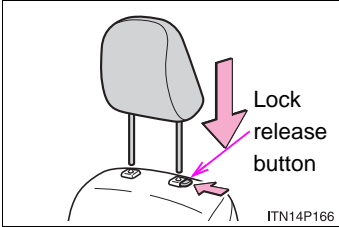

Align the head restraint with the installation holes and push it down to the lock position.

Press and hold the lock release button when lowering the head restraint.

### Rear outside seats

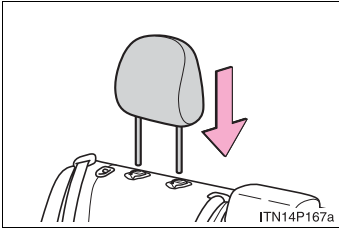

Align the head restraint with the installation holes and push it down to the lowest lock position.

## ■ Adjusting the height of the head restraints

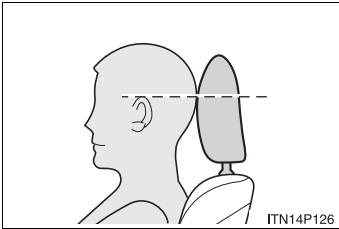

Make sure that the head restraints are adjusted so that the center of the head restraint is closest to the top of your ears.

## ■ Adjusting the rear center seat head restraint

Always raise the head restraint one level from the stowed position when using.



 CAUTION

■ **Head restraint precautions**

Observe the following precautions regarding the head restraints. Failure to do so may result in death or serious injury.

- Use the head restraints designed for each respective seat.
- Adjust the head restraints to the correct position at all times.
- After adjusting the head restraints, push down on them and make sure they are locked in position.
- Do not drive with the head restraints removed.

**Make sure that all occupants are wearing their seat belts before driving the vehicle.**

■ **Correct use of the seat belts**

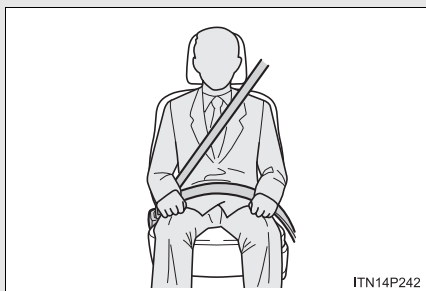

- Extend the shoulder belt so that it comes fully over the shoulder, but does not come into contact with the neck or slide off the shoulder.
- Position the lap belt as low as possible over the hips.
- Adjust the position of the seatback. Sit up straight and well back in the seat.
- Do not twist the seat belt.

■ **Fastening and releasing the seat belt**

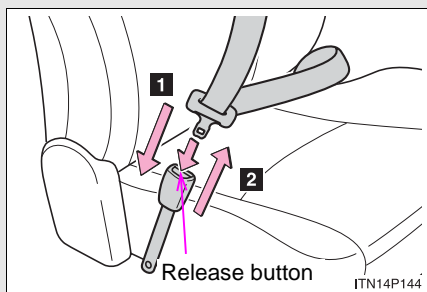

- 1** To fasten the seat belt, push the plate into the buckle until a click sound is heard.
- 2** To release the seat belt, press the release button.

### ■ Adjusting the seat belt shoulder anchor height (front seats)

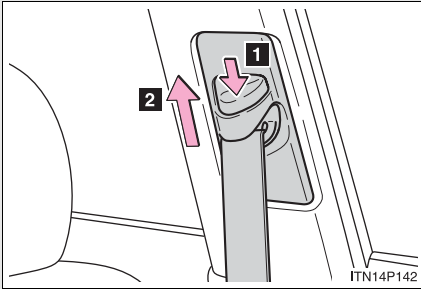

**1** Push the seat belt shoulder anchor down while pressing the release button.

**2** Push the seat belt shoulder anchor up.

Move the height adjuster up and down as needed until you hear a click.

### Seat belt pretensioners (front seats)

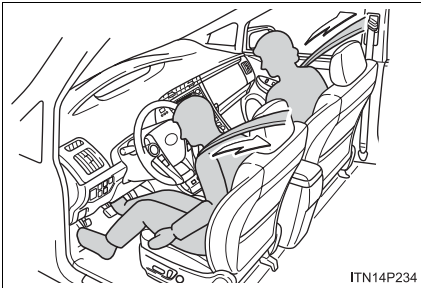

The pretensioner helps the seat belt to quickly restrain the occupant by retracting the seat belt when the vehicle is subjected to certain types of severe frontal collision.

The pretensioner does not activate in the event of a minor frontal impact, a side impact, a rear impact or a vehicle rollover.

## **Pre-collision seat belts (front seats of vehicles with pre-collision system)**

If the system determines that a collision is unavoidable, the front seat belts will retract before the collision. (→P. 303)

1

Before driving

### ■ **Emergency locking retractor (ELR)**

The retractor will lock the belt during a sudden stop or on impact. It may also lock if you lean forward too quickly. A slow, easy motion will allow the belt to extend so that you can move around fully.

### ■ **Automatic locking retractor (ALR)**

When a passenger's shoulder belt is completely extended and then retracted even slightly, the belt is locked in that position and cannot be extended. This feature is used to hold the child restraint system (CRS) firmly. To free the belt again, fully retract the belt and then pull the belt out once more. (→P. 165)

### ■ **Child seat belt usage**

The seat belts of your vehicle were principally designed for persons of adult size.

- Use a child restraint system appropriate for the child, until the child becomes large enough to properly wear the vehicle's seat belt. (→P. 160)
- When the child becomes large enough to properly wear the vehicle's seat belt, follow the instructions on P. 109 regarding seat belt usage.

### ■ **Replacing the belt after the pretensioner has been activated**

If the vehicle is involved in multiple collisions, the pretensioner will activate for the first collision, but will not activate for the second or subsequent collisions.

### ■ Seat belt extender

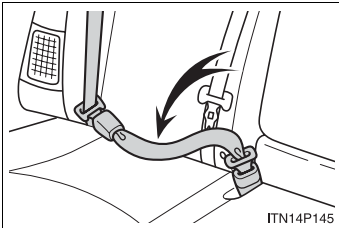

If your seat belts cannot be fastened securely because they are not long enough, a personalized seat belt extender is available from your Toyota dealer free of charge.

### ⚠ CAUTION

Observe the following precautions to reduce the risk of injury in the event of sudden braking, sudden swerving or an accident. Failing to do so may cause death or serious injury.

#### ■ Wearing a seat belt

- Ensure that all passengers wear a seat belt.
- Always wear a seat belt properly.
- Each seat belt should be used by one person only. Do not use a seat belt for more than one person at once, including children.
- Toyota recommends that children be seated in the rear seat and always use a seat belt and/or an appropriate child restraint system.
- To achieve a proper seating position, do not recline the seat more than necessary. The seat belt is most effective when the occupants are sitting up straight and well back in the seats.
- Do not wear the shoulder belt under your arm.
- Always wear your seat belt low and snug across your hips.
- When using the rear outside seat belts, make sure that the belt pass through the guide.

**! CAUTION**

**■ Pregnant women**

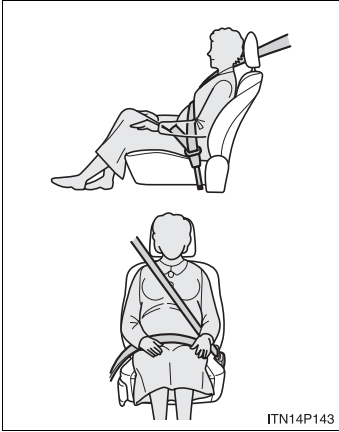

Obtain medical advice and wear the seat belt in the proper way. (→P. 109)

Women who are pregnant should position the lap belt as low as possible over the hips in the same manner as other occupants. Extend the shoulder belt completely over the shoulder and position the belt across the chest. Avoid belt contact over the rounding of the abdominal area.

If the seat belt is not worn properly, not only the pregnant woman, but also the fetus could suffer death or serious injury as a result of sudden braking or a collision.

**■ People suffering illness**

Obtain medical advice and wear the seat belt in the proper way. (→P. 109)

 **CAUTION**

■ **When children are in the vehicle**

Do not allow children to play with the seat belt. If the seat belt becomes twisted around a child's neck, it may lead to choking or other serious injuries that could result in death.

If this occurs and the buckle cannot be unfastened, scissors should be used to cut the belt.

■ **Seat belt pretensioners**

● Do not place anything, such as a cushion, on the front passenger's seat. Doing so will disperse the passenger's weight, which prevents the sensor from detecting the passenger's weight properly. As a result, the seat belt pretensioner for the front passenger's seat may not activate in the event of a collision.

● If the pretensioner has activated, the SRS warning light will come on. In that case, the seat belt cannot be used again and must be replaced at your Toyota dealer.

■ **Adjustable shoulder anchor**

Always make sure the shoulder belt is positioned across the center of your shoulder. The belt should be kept away from your neck, but not falling off your shoulder. Failure to do so could reduce the amount of protection in an accident and cause death or serious injuries in the event of a sudden stop, sudden swerve or accident. (→P. 110)

 CAUTION

■ **Seat belt damage and wear**

- Do not damage the seat belts by allowing the belt, plate, or buckle to be jammed in the door.
- Inspect the seat belt system periodically. Check for cuts, fraying, and loose parts. Do not use a damaged seat belt until it is replaced. Damaged seat belts cannot protect an occupant from death or serious injury.
- Ensure that the belt and plate are locked and the belt is not twisted. If the seat belt does not function correctly, immediately contact your Toyota dealer.
- Replace the seat assembly, including the belts, if your vehicle has been involved in a serious accident, even if there's no obvious damage.
- Do not attempt to install, remove, modify, disassemble or dispose of the seat belts. Have any necessary repairs carried out by your Toyota dealer. Inappropriate handling of the pretensioner may prevent it from operating properly, resulting in death or serious injury.



 CAUTION

■ **Using a seat belt extender**

- Do not wear the seat belt extender if you can fasten the seat belt without the extender.
- Do not use the seat belt extender when installing a child restraint system because the belt will not securely hold the child restraint system, increasing the risk of death or serious injury in the event of an accident.
- The personalized extender may not be safe on another vehicle, when used by another person, or at a different seating position other than the one originally intended.

 NOTICE

■ **When using a seat belt extender**

When releasing the seat belt, press on the buckle release button on the extender, not on the seat belt.

This helps prevent damage to the vehicle interior and the extender itself.

## 1-4. Adjustable components (seats, mirrors, steering wheel)

### Steering wheel

The steering wheel can be adjusted to a comfortable position.

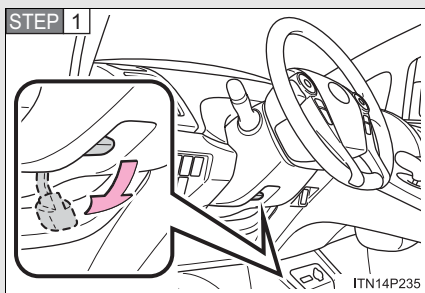

Hold the steering wheel and push the lever down.

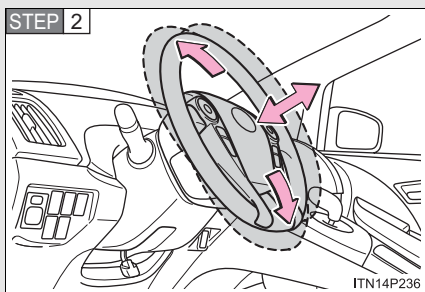

Adjust to the ideal position by moving the steering wheel horizontally and vertically.

After adjustment, pull the lever up to secure the steering wheel.

#### CAUTION

##### ■ Caution while driving

Do not adjust the steering wheel while driving. Doing so may cause the driver to mishandle the vehicle and cause an accident, resulting in death or serious injury.

##### ■ After adjusting the steering wheel

Make sure that the steering wheel is securely locked. Otherwise, the steering wheel may move suddenly, possibly causing an accident, and resulting in death or serious injury.

## 1-4. Adjustable components (seats, mirrors, steering wheel) Inside rear view mirror

The rear view mirror's position can be adjusted to enable sufficient confirmation of the rear view in accordance with the driver's seating posture.

### Adjusting the height of rear view mirror

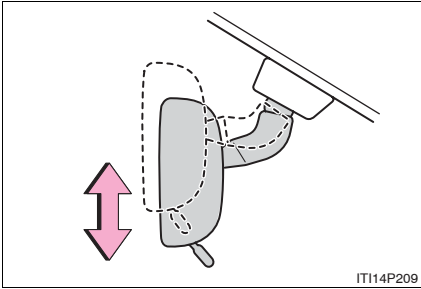

Adjust the height of the rear view mirror by moving it up and down.

### Anti-glare function

#### Manual anti-glare inside rear view mirror

Reflected light from the headlights of vehicles behind can be reduced by operating the lever.

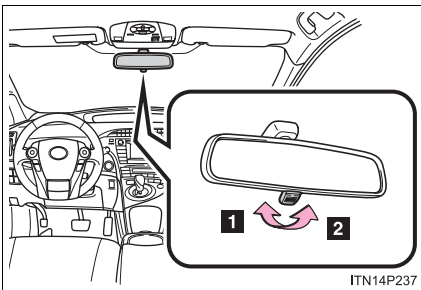

- 1** Normal position
- 2** Anti-glare position

### Auto anti-glare inside rear view mirror (without garage door opener)

Responding to the level of brightness of the headlights of vehicles behind, the reflected light is automatically reduced.

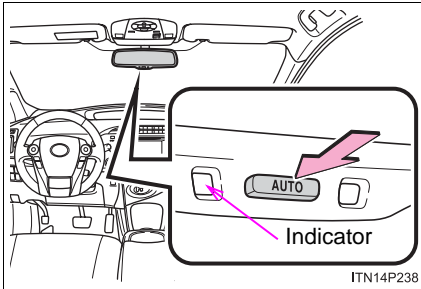

#### Changing automatic anti-glare function mode ON/OFF

When the automatic anti-glare function is in ON mode, the indicator illuminates.

The function will set to ON mode each time the “POWER” switch is turned to ON mode.

Pressing the button turns the function to OFF mode. (The indicator also turns off.)

### Auto anti-glare inside rear view mirror (with garage door opener)

Responding to the level of brightness of the headlights of vehicles behind, the reflected light is automatically reduced.

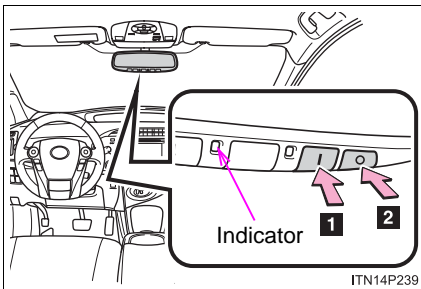

#### Changing automatic anti-glare function mode

- 1** ON
- 2** OFF

When the automatic anti-glare function is in ON mode, the indicator illuminates.

The function will set to ON mode each time the “POWER” switch is turned to ON mode.

Turns the function to OFF mode, the indicator turns off.

■ **To prevent sensor error (vehicles with auto anti-glare inside rear view mirror)**

**Without garage door opener**

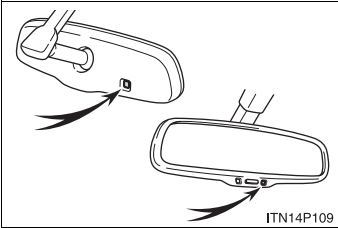

To ensure that the sensors operate properly, do not touch or cover them.

**With garage door opener**

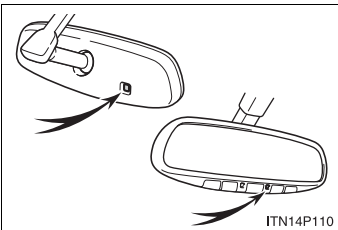

**⚠ CAUTION**

■ **Caution while driving**

Do not adjust the position of the mirror while driving.

Doing so may lead to mishandling of the vehicle and cause an accident, resulting in death or serious injury.

# 1-4. Adjustable components (seats, mirrors, steering wheel)

## Outside rear view mirrors

**Mirror angle can be adjusted using the switch.**

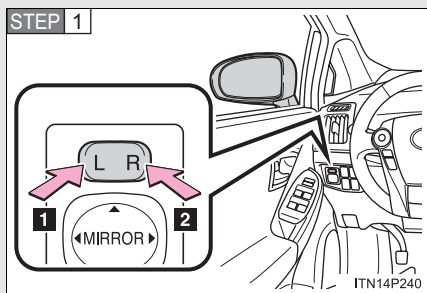

To select a mirror to adjust, press the switch.

- 1** Left
- 2** Right

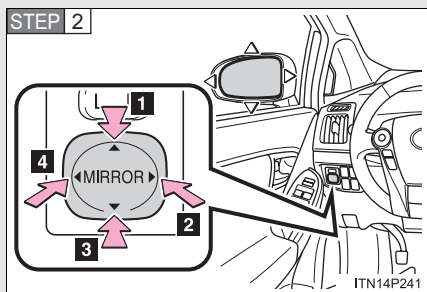

To adjust the mirror, press the switch.

- 1** Up
- 2** Right
- 3** Down
- 4** Left

### Folding the mirrors

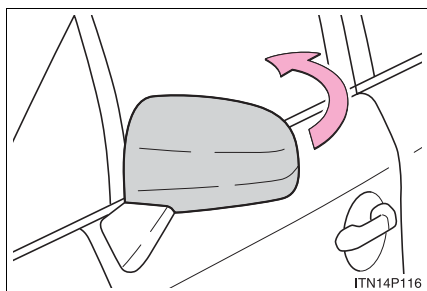

Push the mirror back in the direction of the vehicle's rear.

■ **Mirror angle can be adjusted when**

The "POWER" switch is in ACCESSORY or ON mode.

■ **When the mirrors are fogged up (vehicles with outside rear view mirror defoggers)**

The outside rear view mirrors can be cleared using the mirror defoggers. Turn on the rear window defogger to turn on the outside rear view mirror defoggers. (→P. 346)

 **CAUTION**

■ **When driving the vehicle**

Observe the following precautions while driving.

Failing to do so may result in loss of control of the vehicle and cause an accident, resulting in death or serious injury.

- Do not adjust the mirrors while driving.
- Do not drive with the mirrors folded.
- Both the driver and passenger side mirrors must be extended and properly adjusted before driving.

■ **When a mirror is moving**

To avoid personal injury and mirror malfunction, be careful not to get your hand caught by the moving mirror.

■ **When the mirror defoggers are operating (vehicles with outside rear view mirror defoggers)**

Do not touch the rear view mirror surfaces, as they can become very hot and burn you.

# 1-5. Opening and closing the windows and moon roof

## Power windows

**The power windows can be opened and closed using the switches.**

Operating the switch moves the windows as follows:

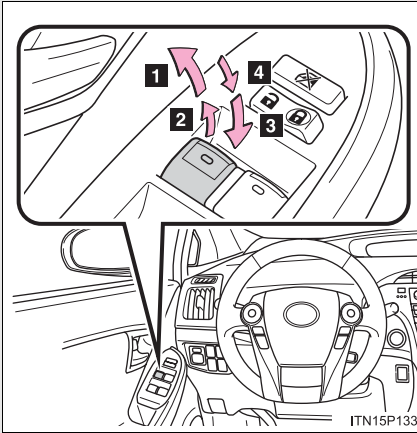

- 1** One-touch closing\*
- 2** Closing
- 3** One-touch opening\*
- 4** Opening

\*: Pushing the switch in the opposite direction will stop window travel partway.

### Window lock switch

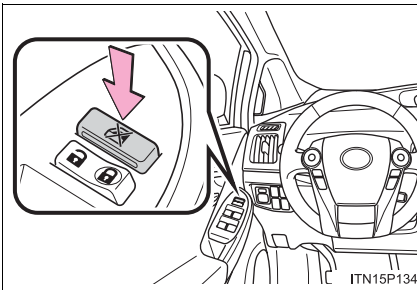

Press the switch down to lock the passenger windows.

Use this switch to prevent children from accidentally opening or closing a passenger window.

Press the switch again to unlock the passenger windows.

### ■ The power windows can be operated when

The "POWER" switch is in ON mode.



■ **Operating the power windows after turning the hybrid system off**

The power windows can be operated for approximately 45 seconds even after the “POWER” switch is turned to ACCESSORY mode or turned off. They cannot, however, be operated once either front door is opened.

■ **Jam protection function**

If an object becomes caught between the window and the window frame, window travel is stopped and the window is opened slightly.

■ **When the power window does not close normally**

If the jam protection function is operating abnormally and a window cannot be closed, perform the following operations using the power window switch on the relevant door.

- After stopping the vehicle, the window can be closed by holding the power window switch in the one-touch closing position while the “POWER” switch is turned to ON mode.
- If the window still cannot be closed even by carrying out the operation explained above, initialize the function by performing the following procedure.

**STEP 1** Hold the power window switch in the one-touch closing position. Continue holding the switch for a further 6 seconds after the window has closed.

**STEP 2** Hold the power window switch in the one-touch opening position. Continue holding the switch for a further 2 seconds after the window has opened completely.

**STEP 3** Hold the power window switch in the one-touch closing position once again. Continue holding the switch for a further 2 seconds after the window has closed.

If you release the switch while the window is moving, start again from the beginning.

If the window continues to close but then re-open slightly even after performing the above procedure correctly, have the vehicle inspected by your Toyota dealer.

## ■ Customization

The one-touch closing operation can be disabled, except for the driver's seat.

(Customizable features →P. 590)

### ⚠ CAUTION

#### ■ Closing the windows

Observe the following precautions.

Failing to do so may result in death or serious injury.

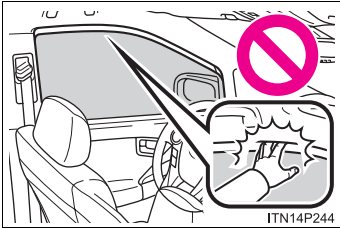

- Check to make sure that all passengers do not have any part of their body in a position where it could be caught when a window is being operated.
- Do not allow children to operate the power windows. Closing a power window on someone can cause serious injury, and in some instances, even death.

#### ■ Jam protection function

- Never use any part of your body to intentionally activate the jam protection function.
- The jam protection function may not work if something gets caught just before the window fully closes.

# 1-5. Opening and closing the windows and moon roof Moon roof with Solar Panel\*

Use the overhead switches to open, close, and tilt the moon roof up and down.

## ■ Open

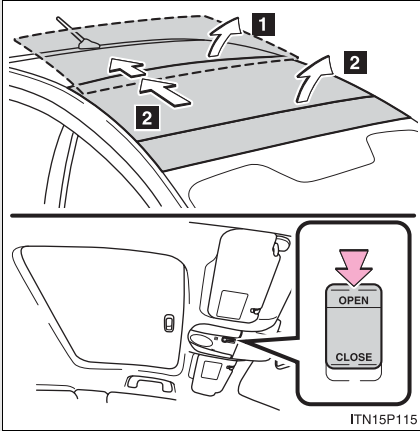

### 1 Tilt up

Push "OPEN".

The moon roof will open after pausing at the tilt up position, when pushing and holding the switch.

To tilt down, push and hold "CLOSE".

### 2 Open

Push "OPEN" at the tilt up position.

Lightly push on either side of the switch stops the moon roof partway.

The moon roof stops slightly before the fully open position to reduce the wind noise.

Push "OPEN" again to fully open.

\*: If equipped

## ■ Close

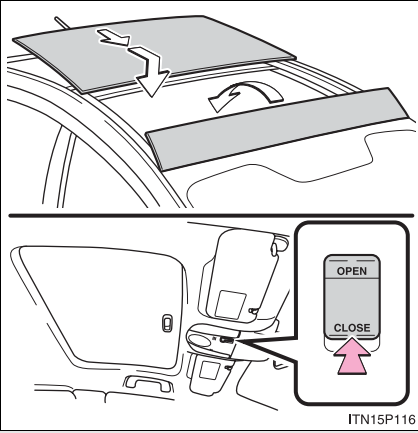

Push and hold “CLOSE”.

The moon roof stops once. Push and hold the switch again to fully close.

1

Before driving

### ■ The moon roof can be operated when

The “POWER” switch is in ON mode.

### ■ Operating the moon roof after turning the hybrid system OFF

The moon roof can be operated for approximately 45 seconds even after the “POWER” switch is turned to ACCESSORY mode or turned OFF. It cannot, however, be operated once either front door is opened.

■ **Jam protection function**

If an object is detected between the moon roof and the frame while closing or tilting down, travel is stopped and the moon roof opens slightly.

■ **To reduce moon roof wind noise**

When the moon roof is opened automatically, it will stop slightly before the fully open position. Driving with the moon roof in this position can help reduce wind noise.

■ **Sunshade**

The sunshade can be opened and closed manually. However, the sunshade will open automatically when the moon roof is opened.

■ **Solar Panel**

The solar panel contains solar cells, and produces energy to operate the Solar Ventilation System by receiving sunlight.

■ **Moon roof open warning buzzer**

The buzzer sounds when the “POWER” switch is turned off and the driver’s door is opened with the moon roof open.

■ **If the moon roof cannot be closed**

If the moon roof cannot be closed, such as when the jam protection function activates accidentally due to a malfunction, pressing and holding “CLOSE” switch closes the moon roof.

After this, to make the automatic opening function and jam protection function available again, press and hold the “OPEN” switch until the moon roof opens fully and then closes slightly.

If the functions do not activate, contact your Toyota dealer.

 **CAUTION****■ Opening the moon roof**

Observe the following precautions.

Failing to do so may cause death or serious injury.

- Do not allow any passengers to put their hands or heads outside the vehicle while it is moving.
- Do not sit on top of the moon roof.

**■ Closing the moon roof**

Observe the following precautions.

Failing to do so may result in death or serious injury.

- Check to make sure that all passengers do not have any part of their bodies in a position where they could be caught when the moon roof is being operated.
- Do not allow children to operate the moon roof.  
Closing the moon roof on someone can cause death or serious injury.

**■ Jam protection function**

- Never try jamming any part of your body to activate the jam protection function intentionally.
- The jam protection function may not work if something gets caught just before the moon roof fully closes.

**■ Precautions for moon roof with Solar Panel**

Be careful not to touch the solar panel surface in scorching sun weather conditions as it will rise very high in temperature and may cause burns.



## NOTICE

### ■ To prevent damage to the moon roof

- Before opening, make sure that there are no foreign objects such as stones or ice around the opening.
- Do not hit the face or edge of the moon roof with hard objects.
- Do not continue to press and hold the switch after the moon roof has opened or closed completely.

### ■ Operating the moon roof

There is the possibility that water or rain will get into the vehicle if you operate the moon roof after a rainfall, snowfall or car wash. Wipe the moon roof dry with a cloth before operating it.

# Opening the fuel tank cap

**Perform the following steps to open the fuel tank cap:**

■ **Before refueling the vehicle**

- Turn the “POWER” switch off and close all the doors and windows.
- Confirm the type of fuel. (→P. 132)

■ **Opening the fuel tank cap**

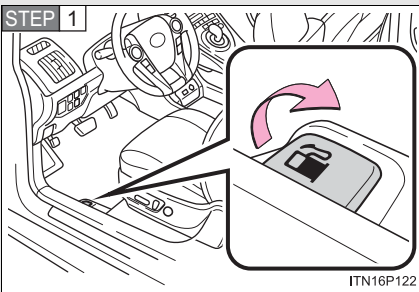

Pull up the opener to open the fuel filler door.

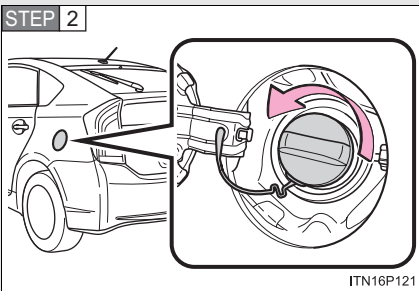

Turn the fuel tank cap slowly to open.

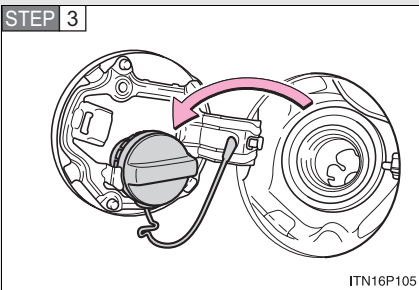

Hang the fuel tank cap on the back of the fuel filler door.



## Closing the fuel tank cap

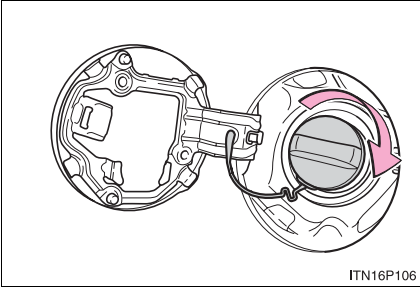

After refueling, turn the fuel tank cap until you hear a click. Once the cap is released, it will turn slightly in the opposite direction.

### ■ Fuel types

Use unleaded gasoline. (Octane rating 87 [Research Octane Number 91] or higher)

### ■ Gasoline price setting screen

After refueling more than approximately 1.3 gal. (5 L, 1.1 Imp.gal.) L and turning the "POWER" switch to ON mode, the gasoline price setting screen will be automatically displayed on the multi-information display. (→P. 231)

 **CAUTION****■ When refueling the vehicle**

Observe the following precautions while refueling the vehicle. Failure to do so may result in death or serious injury.

- After exiting the vehicle and before opening the fuel filler door, touch an unpainted metal surface to discharge any static electricity. It is important to discharge static electricity before refueling because sparks resulting from static electricity can cause fuel vapors to ignite while refueling.
- Always hold the grips on the fuel tank cap and turn it slowly to remove it. A whooshing sound may be heard when the fuel tank cap is loosened. Wait until the sound cannot be heard before fully removing the cap. In hot weather, pressurized fuel may spray out of the filler neck and cause injury.
- Do not allow anyone that has not discharged static electricity from their body to come close to an open fuel tank.
- Do not inhale vaporized fuel.  
Fuel contains substances that are harmful if inhaled.
- Do not smoke while refueling the vehicle.  
Doing so may cause the fuel to ignite and cause a fire.
- Do not return to the vehicle or touch any person or object that is statically charged.  
This may cause static electricity to build up, resulting in a possible ignition hazard.

**■ When refueling**

Observe the following precautions to prevent fuel overflowing from the fuel tank:

- Securely insert the fuel nozzle into the fuel filler neck
- Stop filling the tank after the fuel nozzle automatically clicks off
- Do not top off the fuel tank

**■ When replacing the fuel tank cap**

Do not use anything but a genuine Toyota fuel tank cap designed for your vehicle. Doing so may cause a fire or other incident which may result in death or serious injury.



**NOTICE**

■ **Refueling**

Do not spill fuel during refueling.

Doing so may damage the vehicle, such as causing the emission control system to operate abnormally or damaging fuel system components or the vehicle's painted surface.

## 1-7. Theft deterrent system Immobilizer system

The vehicle's keys have built-in transponder chips that prevent the hybrid system from starting if a key has not been previously registered in the vehicle's on-board computer.

**Never leave the keys inside the vehicle when you leave the vehicle.**

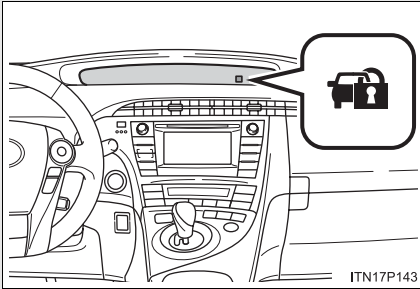

The indicator light flashes after the "POWER" switch has been turned off to indicate that the system is operating.

The indicator light stops flashing after the "POWER" switch has been turned to ACCESSORY or ON mode to indicate that the system has been canceled.

1

Before driving

### ■ System maintenance

The vehicle has a maintenance-free type immobilizer system.

### ■ Conditions affecting operation

Depending on the surrounding environment and conditions, the immobilizer system may not operate properly. This may prevent the hybrid system from starting. (→P. 72)

## ■ Certifications for the immobilizer system

### **For vehicles sold in the U.S.A.**

FCC ID: NI4TMIMB-1

This device complies with Part 15 of the FCC Rules. Operation is subject to the following two conditions: (1) this device may not cause harmful interference, and (2) this device must accept any interference received, including interference that may cause undesired operation.

#### **FCC WARNING:**

Changes or modifications not expressly approved by the party responsible for compliance could void the user's authority to operate the equipment.

### **For vehicles sold in Canada**

Operation is subject to the following two conditions: (1) this device may not cause interference, and (2) this device must accept any interference, including interference that may cause undesired operation of the device.



#### **NOTICE**

#### **■ To ensure the system operates correctly**

Do not modify or remove the system.

If modified or removed, the proper operation of the system cannot be guaranteed.

1-7. Theft deterrent system

Theft prevention labels (for the U.S.A.)

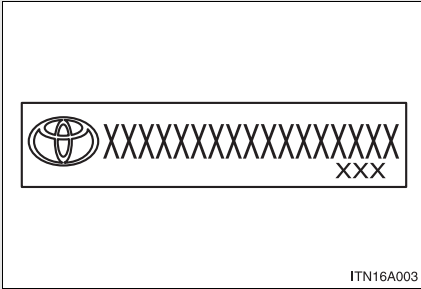

These labels are attached to the vehicle to reduce vehicle theft by facilitating the tracing and recovery of parts from stolen vehicles. Do not remove under penalty of law.

## Correct driving posture

Drive with a good posture as follows:

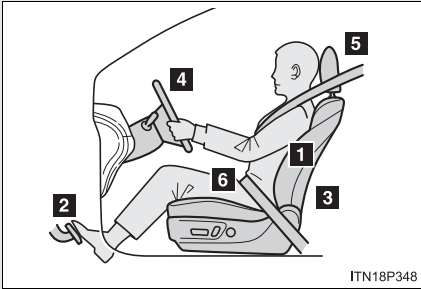

- 1** Sit upright and well back in the seat. (→P. 99)
- 2** Adjust the position of the seat forward or backward to ensure the pedals can be reached and easily depressed to the extent required. (→P. 99)
- 3** Adjust the seatback so that the controls are easily operable. (→P. 99)
- 4** Adjust the tilt and telescopic positions of the steering wheel downward so the air-bag is facing your chest. (→P. 117)
- 5** Lock the head restraint in place with the center of the head restraint closest to the top of your ears. (→P. 105)
- 6** Wear the seat belt correctly. (→P. 109)

 **CAUTION****■ While driving**

- Do not adjust the position of the driver's seat.  
Doing so could cause the driver to lose control of the vehicle.
- Do not place a cushion between the driver or passenger and the seatback.  
A cushion may prevent correct posture from being achieved, and reduce the effectiveness of the seat belt and head restraint, increasing the risk of death or serious injury to the driver or passenger.
- Do not place anything under the front seats.  
Objects placed under the front seats may become jammed in the seat tracks and stop the seat from locking in place. This may lead to an accident, resulting in death or serious injury. The adjustment mechanism may also be damaged.

**■ Adjusting the seat position**

- Take care when adjusting the seat position to ensure that other passengers are not injured by the moving seat.
- Do not put your hands under the seat or near the moving parts to avoid injury.  
Fingers or hands may become jammed in the seat mechanism.



## SRS airbags

The SRS airbags inflate when the vehicle is subjected to certain types of severe impacts that may cause significant injury to the occupants. They work together with the seat belts to help reduce the risk of death or serious injury.

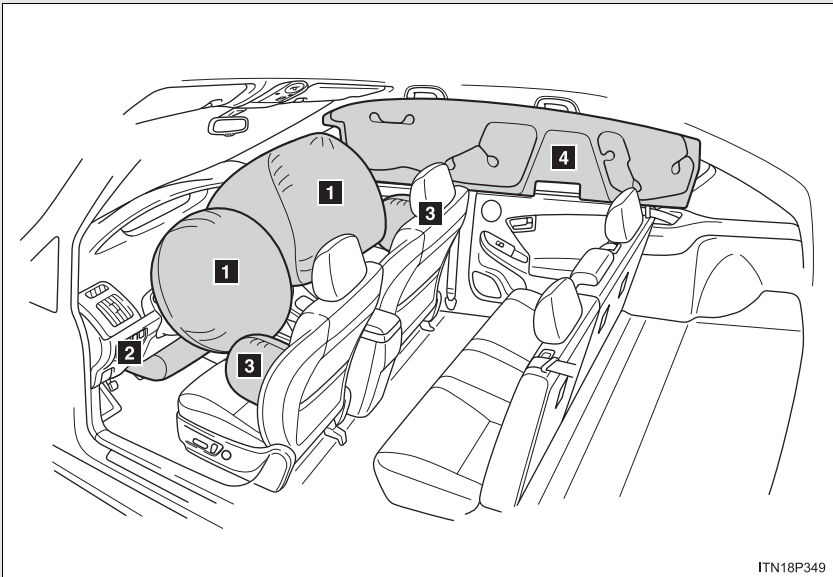

ITN18P349

### SRS front airbags

- 1** SRS driver airbag/front passenger airbag  
Can help protect the head and chest of the driver and front passenger from impact with interior components
- 2** SRS knee airbag  
Can help provide driver protection

### **SRS side and curtain shield airbags**

**3** SRS side airbags

Can help protect the torso of the front seat occupants

**4** SRS curtain shield airbags

Can help protect primarily the head of occupants in the outer seats

## SRS airbag system components

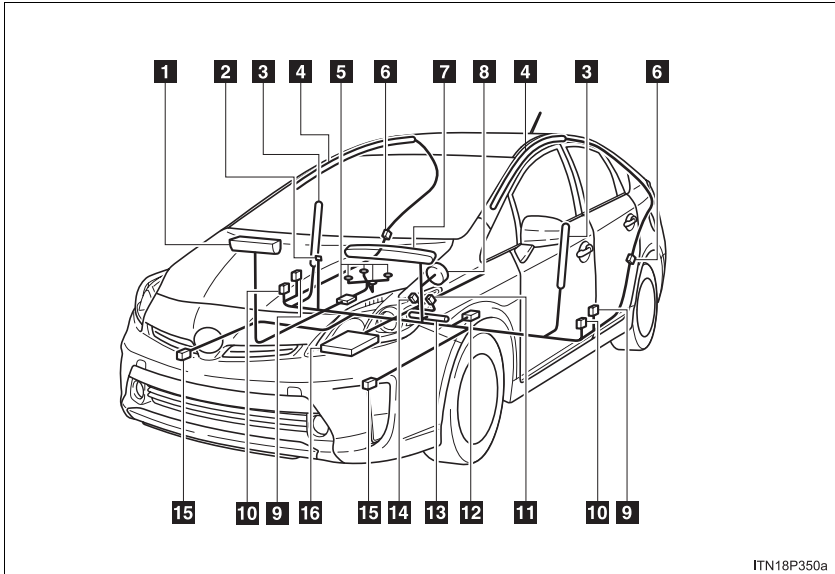

ITN18P350a

- |                                                                           |                                                      |
|---------------------------------------------------------------------------|------------------------------------------------------|
| <b>1</b> Front passenger airbag                                           | <b>9</b> Side impact sensors (front)                 |
| <b>2</b> "AIR BAG ON" and "AIR BAG OFF" indicator lights                  | <b>10</b> Seat belt pretensioners and force limiters |
| <b>3</b> Side airbags                                                     | <b>11</b> Driver's seat belt buckle switch           |
| <b>4</b> Curtain shield airbags                                           | <b>12</b> Driver's seat position sensor              |
| <b>5</b> Front passenger occupant classification system (ECU and sensors) | <b>13</b> Driver's knee airbag                       |
| <b>6</b> Side impact sensors (rear)                                       | <b>14</b> Front passenger's seat belt buckle switch  |
| <b>7</b> SRS warning light                                                | <b>15</b> Front impact sensors                       |
| <b>8</b> Driver airbag                                                    | <b>16</b> Airbag sensor assembly                     |

Your vehicle is equipped with ADVANCED AIRBAGS designed based on the US motor vehicle safety standards (FMVSS208). The airbag sensor assembly (ECU) controls airbag deployment based on information obtained from the sensors etc. shown in the system components diagram above. This information includes crash severity and occupant information. As the airbags deploy, a chemical reaction in the inflators quickly fills the airbags with nontoxic gas to help restrain the motion of the occupants.

---

■ **If the SRS airbags deploy (inflate)**

- Bruising and slight abrasions may result from contact with a deploying (inflating) SRS airbag.
- A loud noise and white powder will be emitted.
- Parts of the airbag module (steering wheel hub, airbag cover and inflator) as well as the front seats, parts of the front and rear pillars, and roof side rails, may be hot for several minutes. The airbag itself may also be hot.
- The windshield may crack.
- For Safety Connect subscribers, if the SRS airbags deploy or in the event of a severe rear-end collision, the system is designed to send an emergency call to the response center, notifying them of the vehicle's location (without needing to push the "SOS" button) and an agent will attempt to speak with the occupants to ascertain the level of emergency and assistance required. If the occupants are unable to communicate, the agent automatically treats the call as an emergency and helps to dispatch the necessary emergency services. (→P. 388)

### ■ SRS airbag deployment conditions (SRS front airbags)

- The SRS front airbags will deploy in the event of an impact that exceeds the set threshold level (the level of force corresponding to an approximately 12 - 18 mph [20 - 30 km/h] frontal collision with a fixed wall that does not move or deform).

However, this threshold velocity will be considerably higher in the following situations:

- If the vehicle strikes an object, such as a parked vehicle or sign pole, which can move or deform on impact
- If the vehicle is involved in an underride collision such as a collision in which the front of the vehicle “underrides”, or goes under, the bed of a truck
- Depending on the type of collision, it is possible that only the seat belt pretensioners will activate.
- The SRS front airbags for the front passenger will not activate if there is no passenger sitting in the front passenger seat. However, the SRS front airbags for the front passenger may deploy if luggage is put in the seat, even if the seat is unoccupied. (→P. 154)

### ■ SRS airbag deployment conditions (SRS side and curtain shield airbags)

The SRS side and curtain shield airbags will deploy in the event of an impact that exceeds the set threshold level (the level of force corresponding to the impact force produced by an approximately 3300 lb. [1500 kg] vehicle colliding with the vehicle cabin from a direction perpendicular to the vehicle orientation at an approximate speed of 12 - 18 mph [20 - 30 km/h]).

### ■ Conditions under which the SRS airbags may deploy (inflate), other than a collision

The SRS front airbags may also deploy if a serious impact occurs to the underside of your vehicle. Some examples are shown in the illustration.

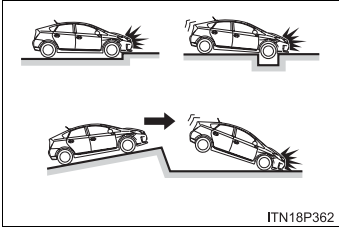

- Hitting a curb, edge of pavement or hard surface
- Falling into or jumping over a deep hole
- Landing hard or falling

### ■ Types of collisions that may not deploy the SRS airbags (SRS front airbags)

The SRS front airbags do not generally inflate if the vehicle is involved in a side or rear collision, if it rolls over, or if it is involved in a low-speed frontal collision. But, whenever a collision of any type causes sufficient forward deceleration of the vehicle, deployment of the SRS front airbags may occur.

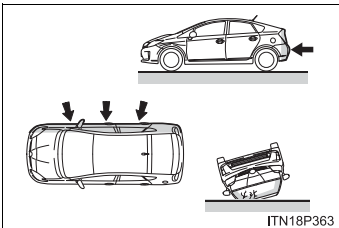

- Collision from the side
- Collision from the rear
- Vehicle rollover

### ■ Types of collisions that may not deploy the SRS airbags (SRS side and curtain shield airbags)

The SRS side and curtain shield airbags may not activate if the vehicle is subjected to a collision from the side at certain angles, or a collision to the side of the vehicle body other than the passenger compartment.

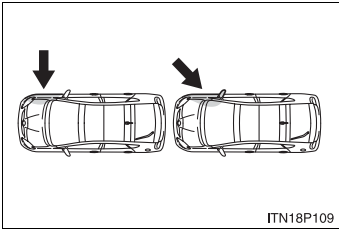

- Collision from the side to the vehicle body other than the passenger compartment
- Collision from the side at an angle

The SRS side and curtain shield airbags do not generally inflate if the vehicle is involved in a frontal or rear collision, if it rolls over, or if it is involved in a low-speed side collision.

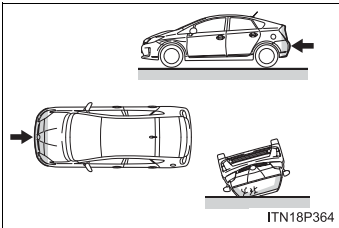

- Collision from the front
- Collision from the rear
- Vehicle rollover

### ■ When to contact your Toyota dealer

In the following cases, the vehicle will require inspection and/or repair. Contact your Toyota dealer as soon as possible.

- Any of the SRS airbags has been inflated.

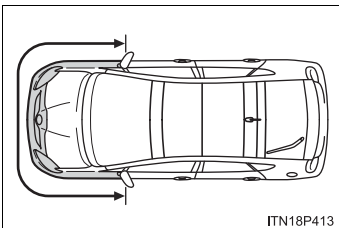

- The front of the vehicle is damaged or deformed, or was involved in an accident that was not severe enough to cause the SRS airbags to inflate.

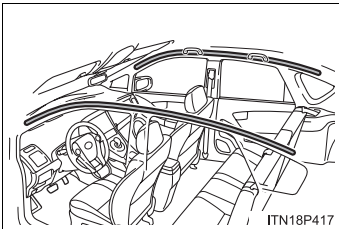
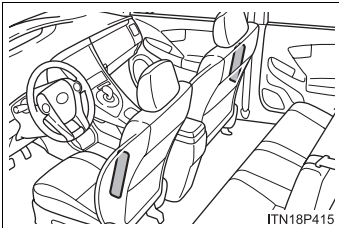
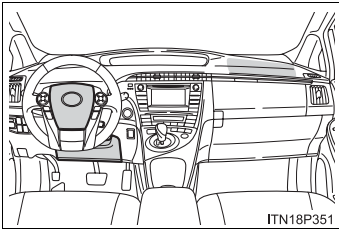
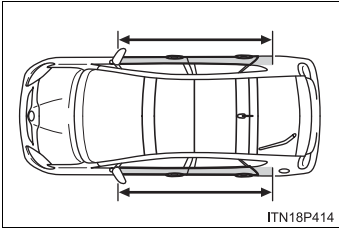

- A portion of a door is damaged or deformed, or the vehicle was involved in an accident that was not severe enough to cause the SRS side and curtain shield airbags to inflate.
- The pad section of the steering wheel, dashboard near the front passenger airbag or lower portion of the driver's side instrument panel is scratched, cracked, or otherwise damaged.
- The surface of the seats with the side airbag is scratched, cracked, or otherwise damaged.
- The portion of the front pillars, rear pillars or roof side rail garnishes (padding) containing the curtain shield airbags inside is scratched, cracked, or otherwise damaged.



 CAUTION

■ **SRS airbag precautions**

Observe the following precautions regarding the SRS airbags. Failure to do so may cause death or serious injury.

- The driver and all passengers in the vehicle must wear their seat belts properly.

The SRS airbags are supplemental devices to be used with the seat belts.

- The SRS driver airbag deploys with considerable force, and can cause death or serious injury especially if the driver is very close to the airbag. The National Highway Traffic Safety Administration (NHTSA) advises:

Since the risk zone for the driver's airbag is the first 2 - 3 in. (50 - 75 mm) of inflation, placing yourself 10 in. (250 mm) from your driver airbag provides you with a clear margin of safety. This distance is measured from the center of the steering wheel to your breastbone. If you sit less than 10 in. (250 mm) away now, you can change your driving position in several ways:

- Move your seat to the rear as far as you can while still reaching the pedals comfortably.
- Slightly recline the back of the seat.  
Although vehicle designs vary, many drivers can achieve the 10 in. (250 mm) distance, even with the driver seat all the way forward, simply by reclining the back of the seat somewhat. If reclining the back of your seat makes it hard to see the road, raise yourself by using a firm, non-slippery cushion, or raise the seat if your vehicle has that feature.
- If your steering wheel is adjustable, tilt it downward. This points the airbag toward your chest instead of your head and neck.

The seat should be adjusted as recommended by NHTSA above, while still maintaining control of the foot pedals, steering wheel, and your view of the instrument panel controls.

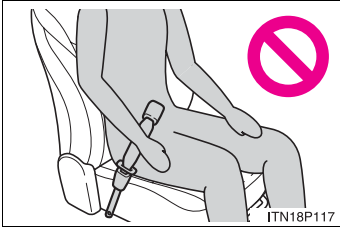
**! CAUTION****■ SRS airbag precautions**

- If the seat belt extender has been connected to the front seat belt buckles but the seat belt extender has not also been fastened to the latch plate of the seat belt, the SRS front airbags will judge that the driver and front passenger are wearing the seat belt even though the seat belt has not been connected. In this case, the SRS front airbags may not activate correctly in a collision, resulting in death or serious injury in the event of a collision. Be sure to wear the seat belt with the seat belt extender.
- The SRS front passenger airbag also deploys with considerable force, and can cause death or serious injury especially if the front passenger is very close to the airbag. The front passenger seat should be as far from the airbag as possible with the seatback adjusted, so the front passenger sits upright.
- Improperly seated and/or restrained infants and children can be killed or seriously injured by a deploying airbag. An infant or child who is too small to use a seat belt should be properly secured using a child restraint system. Toyota strongly recommends that all infants and children be placed in the rear seats of the vehicle and properly restrained. The rear seats are safer for infants and children than the front passenger seat. (→P. 160)

**! CAUTION**

**■ SRS airbag precautions**

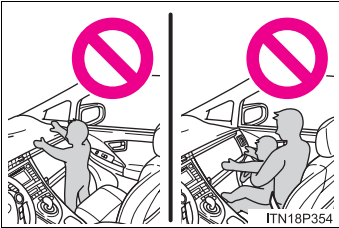
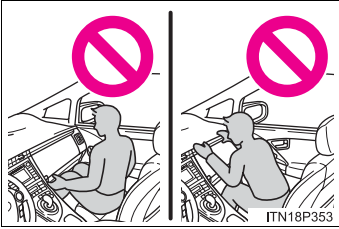

- Do not sit on the edge of the seat or lean against the dashboard.

- Do not allow a child to stand in front of the SRS front passenger airbag unit or sit on the knees of a front passenger.

- Do not allow the front seat occupants to hold items on their knees.

- Do not lean against the door, the roof side rail or the front, side and rear pillars.

- Do not allow anyone to kneel on the passenger seat toward the door or put their head or hands outside the vehicle.

**! CAUTION**

**■ SRS airbag precautions**

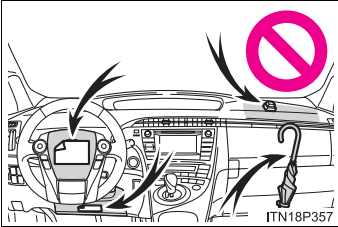

- Do not attach anything to or lean anything against areas such as the dashboard, steering wheel pad and lower portion of the instrument panel.

These items can become projectiles when the SRS driver, front passenger and knee airbags deploy.

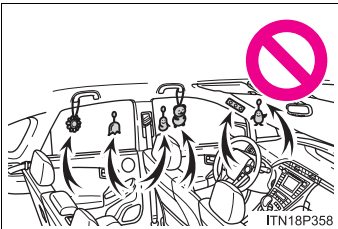

- Do not attach anything to areas such as a door, windshield glass, side door glass, front or rear pillar, roof side rail, and assist grip.

- Do not hang coat hangers or hard objects on the coat hooks. All of these items could become projectiles and may cause death or serious injury, should the SRS curtain shield airbags deploy.
- If a vinyl cover is put on the area where the SRS knee airbags will deploy, be sure to remove it.

 CAUTION

■ **SRS airbag precautions**

- Do not use seat accessories which cover the parts where the SRS side airbags inflate as they may interfere with inflation of the airbags. Such accessories may prevent the side airbags from activating correctly, disable the system or cause the side airbags to inflate accidentally, resulting in death or serious injury.
- Do not strike or apply significant levels of force to the area of the SRS airbag components.  
Doing so can cause the SRS airbags to malfunction.
- Do not touch any of the component parts immediately after the SRS airbags have deployed (inflated) as they may be hot.
- If breathing becomes difficult after the SRS airbags have deployed, open a door or window to allow fresh air in, or leave the vehicle if it is safe to do so. Wash off any residue as soon as possible to prevent skin irritation.
- If the areas where the SRS airbags are stored, such as the steering wheel pad and front and rear pillar garnishes, are damaged or cracked, have them replaced by your Toyota dealer.
- Do not place anything, such as a cushion, on the front passenger's seat. Doing so will disperse the passenger's weight, which prevents the sensor from detecting the passenger's weight properly. As a result, the SRS front airbags for the front passenger may not deploy in the event of a collision.

 **CAUTION****■ Modification and disposal of SRS airbag system components**

Do not dispose of your vehicle or perform any of the following modifications without consulting your Toyota dealer. The SRS airbags may malfunction or deploy (inflate) accidentally, causing death or serious injury.

- Installation, removal, disassembly and repair of the SRS airbags
- Repairs, modifications, removal or replacement of the steering wheel, instrument panel, dashboard, seats or seat upholstery, front, side and rear pillars or roof side rails
- Repairs or modifications of the front fender, front bumper, or side of the occupant compartment
- Installation of snow plows, winches, etc. to the front grille (bull bars or kangaroo bar etc.)
- Modifications to the vehicle's suspension system
- Installation of electronic devices such as mobile two-way radios and CD players
- Modifications to your vehicle for a person with a physical disability

## Front passenger occupant classification system

Your vehicle is equipped with a front passenger occupant classification system. This system detects the conditions of the front passenger seat and activates or deactivates the devices for the front passenger.

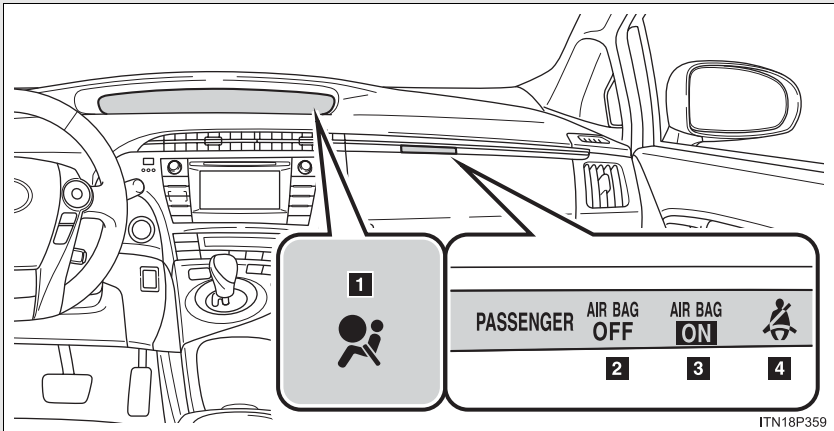

ITN18P359

- 1** SRS warning light
- 2** "AIR BAG OFF" indicator light
- 3** "AIR BAG ON" indicator light
- 4** Front passenger's seat belt reminder light

## Condition and operation in the front passenger occupant classification system

### ■ Adult\*1

Indicator/ warning light	“AIR BAG ON” and “AIR BAG OFF” indicator lights	“AIR BAG ON”
	SRS warning light	Off
	Front passenger’s seat belt reminder light	Flashing*2
Devices	Front passenger airbag	Activated
	Side airbag on the front passenger seat	
	Curtain shield airbag in the front passen- ger side	
	Front passenger’s seat belt pretensioner	

### ■ Child\*3 or child restraint system\*4

Indicator/ warning light	“AIR BAG ON” and “AIR BAG OFF” indicator lights	“AIR BAG OFF”*5
	SRS warning light	Off
	Front passenger’s seat belt reminder light	Flashing*2
Devices	Front passenger airbag	Deactivated
	Side airbag on the front passenger seat	Activated
	Curtain shield airbag in the front passen- ger side	
	Front passenger’s seat belt pretensioner	

1

Before driving



### ■ Unoccupied

Indicator/ warning light	“AIR BAG ON” and “AIR BAG OFF” indicator lights	Not illuminated
	SRS warning light	Off
	Front passenger’s seat belt reminder light	
Devices	Front passenger airbag	Deactivated
	Side airbag on the front passenger seat	Activated
	Curtain shield airbag in the front passenger side	
	Front passenger’s seat belt pretensioner	Deactivated

### ■ There is a malfunction in the system

Indicator/ warning light	“AIR BAG ON” and “AIR BAG OFF” indicator lights	“AIR BAG OFF”
	SRS warning light	On
	Front passenger’s seat belt reminder light	Off
Devices	Front passenger airbag	Deactivated
	Side airbag on the front passenger seat	Activated
	Curtain shield airbag in the front passenger side	
	Front passenger’s seat belt pretensioner	

- \*1: The system judges a person of adult size as an adult. When a smaller adult sits in the front passenger seat, the system may recognize him/her as a child depending on his/her physique and posture.
- \*2: In the event the front passenger does not wear a seat belt.
- \*3: When a larger child who has outgrown a child restraint system sits in the front passenger seat, the system may recognize him/her as an adult depending on his/her physique or posture.
- \*4: Never install a rear-facing child restraint system on the front passenger seat. A forward-facing child restraint system should only be installed on the front passenger seat when it is unavoidable. (→P. 160)
- \*5: In case the indicator light is not illuminated, consult this manual on how to install the child restraint system properly. (→P. 165)

 CAUTION

**■ Front passenger occupant classification system precautions**

Observe the following precautions regarding front passenger occupant classification system.

Failure to do so may cause death or serious injury.

- Wear the seat belt properly.
- Make sure the front passenger's seat belt plate has not been left inserted into the buckle before someone sits in the front passenger seat.
- Make sure the "AIR BAG OFF" indicator light is not illuminated when using the seat belt extender for the front passenger seat. If the "AIR BAG OFF" indicator light is illuminated, disconnect the extender tongue from the seat belt buckle, and reconnect the seat belt. Reconnect the seat belt extender after making sure the "AIR BAG ON" indicator light is illuminated. If you use the seat belt extender while the "AIR BAG OFF" indicator light is illuminated, the SRS airbags for the passenger may not activate correctly, which could cause death or serious injury in the event of a collision.
- Do not apply a heavy load to the front passenger seat or equipment (e.g. seatback pocket).
- Do not put weight on the front passenger seat by putting your hands or feet on the front passenger seat seatback from the rear passenger seat.
- Do not let a rear passenger lift the front passenger seat with their feet or press on the seatback with their legs.
- Do not put objects under the front passenger seat.

 CAUTION**Front passenger occupant classification system precautions**

- Do not recline the front passenger seatback so far that it touches a rear seat. This may cause the “AIR BAG OFF” indicator light to be illuminated, which indicates that the passenger’s airbags will not deploy in the event of a severe accident. If the seatback touches the rear seat, return the seatback to a position where it does not touch the rear seat. Keep the front passenger seatback as upright as possible when the vehicle is moving. Reclining the seatback excessively may lessen the effectiveness of the seat belt system.
- If an adult sits in the front passenger seat, the “AIR BAG ON” indicator light is illuminated. If the “AIR BAG OFF” indicator is illuminated, ask the passenger to sit up straight, well back in the seat, feet on the floor, and with the seat belt worn correctly. If the “AIR BAG OFF” indicator still remains illuminated, either ask the passenger to move to the rear seat, or if that is not possible, move the front passenger seat fully rearward.
- When it is unavoidable to install a forward-facing child restraint system on the front passenger seat, install the child restraint system on the front passenger seat in the proper order. (→P. 165)
- Do not modify or remove the front seats.
- Do not kick the front passenger seat or subject it to severe impact. Otherwise, the SRS warning light may come on to indicate a malfunction of the detection system. In this case, contact your Toyota dealer immediately.
- Child restraint systems installed on the rear seat should not contact the front seatbacks.
- Do not use a seat accessory, such as a cushion and seat cover, that covers the seat cushion surface.
- Do not modify or replace the upholstery of the front seat.

## Child restraint systems

**A child restraint system for a small child or baby must itself be properly restrained on the seat with the lap portion of the lap/shoulder belt.**

**The laws of all 50 states of the U.S.A. and Canada now require the use of child restraint systems.**

### Points to remember

Studies have shown that installing a child restraint on a rear seat is much safer than installing one to the front passenger seat.

- Choose a child restraint system that suits your vehicle and is appropriate to the age and size of the child.
- For installation details, follow the instructions provided with the child restraint system.

General installation instructions are provided in this manual.

(→P. 165)

## Types of child restraints

Child restraint systems are classified into the following 3 types according to the age and size of the child.

### Rear facing — Infant seat/convertible seat

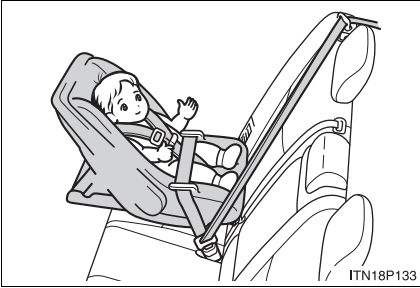

### Forward facing — Convertible seat



### Booster seat



### ■ When installing a child restraint system on the front passenger seat

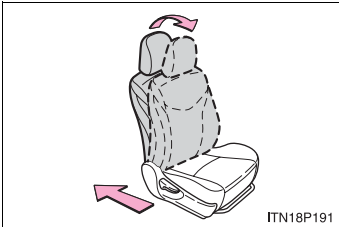

When you have to use a child restraint system on the front passenger seat, adjust the following:

- The seatback to the most upright position
- The seat cushion to the fully rearward position

### ■ Selecting an appropriate child restraint system

- Use a child restraint system appropriate for the child until the child becomes large enough to properly wear the vehicle's seat belt.
- If the child is too large for a child restraint system, sit the child on a rear seat and use the vehicle's seat belt. (→P. 109)

## ⚠ CAUTION

### ■ Child restraint precautions

- For effective protection in automobile accidents and sudden stops, a child must be properly restrained, using a seat belt or child restraint system depending on the age and size of the child. Holding a child in your arms is not a substitute for a child restraint system. In an accident, the child can be crushed against the windshield, or between you and the vehicle's interior.
- Toyota strongly urges the use of a proper child restraint system that conforms to the size of the child, installed on the rear seat. According to accident statistics, the child is safer when properly restrained in the rear seat than in the front seat.

 CAUTION**■ Child restraint precautions**

- Never install a rear-facing child restraint system on the front passenger seat even if the “AIR BAG OFF” indicator light is illuminated. In the event of an accident, the force of the rapid inflation of the front passenger airbag can cause death or serious injury to the child if the rear-facing child restraint system is installed on the front passenger seat.
- A forward-facing child restraint system may be installed on the front passenger seat only when it is unavoidable. A child restraint system that requires a top tether strap should not be used in the front passenger seat since there is no top tether strap anchor for the front passenger seat. Adjust the seatback as upright as possible and always move the seat as far back as possible even if the “AIR BAG OFF” indicator light is illuminated, because the front passenger airbag could inflate with considerable speed and force. Otherwise, the child may be killed or seriously injured.
- Do not use the seat belt extender when installing a child restraint system on the front or rear passenger seat. If installing a child restraint system with the seat belt extender connected to the seat belt, the seat belt will not securely hold the child restraint system, which could cause death or serious injury to the child or other passengers in the event of a sudden stop, sudden swerve or accident.
- Do not allow the child to lean his/her head or any part of his/her body against the door or the area of the seat, front and rear pillars or roof side rails from which the SRS side airbags or SRS curtain shield airbags deploy even if the child is seated in the child restraint system. It is dangerous if the SRS side airbags and curtain shield airbags inflate, and the impact could cause death or serious injury to the child.
- Make sure you have complied with all installation instructions provided by the child restraint manufacturer and that the system is properly secured. If it is not secured properly, it may cause death or serious injury to the child in the event of a sudden stop, sudden swerve or accident.



 CAUTION

■ **When children are in the vehicle**

Do not allow children to play with the seat belt. If the seat belt becomes twisted around a child's neck, it may lead to choking or other serious injuries that could result in death.

If this occurs and the buckle cannot be unfastened, scissors should be used to cut the belt.

■ **When the child restraint system is not in use**

- Keep the child restraint system properly secured on the seat even if it is not in use. Do not store the child restraint system unsecured in the passenger compartment.
- If it is necessary to detach the child restraint system, remove it from the vehicle or store it securely in the luggage compartment. This will prevent it from injuring passengers in the event of a sudden stop, sudden swerve or accident.

# Installing child restraints

**Follow the child restraint system manufacturer's instructions. Firmly secure child restraints to the seats using the LATCH anchors or a seat belt. Attach the top tether strap when installing a child restraint.**

**The lap/shoulder belt can be used if your child restraint system is not compatible with the LATCH (Lower Anchors and Tethers for Children) system.**

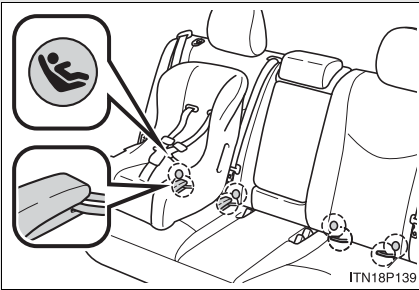

**Child restraint LATCH anchors**  
LATCH anchors are provided for the outer rear seats. (Buttons displaying the location of the anchors are attached to the seats.)

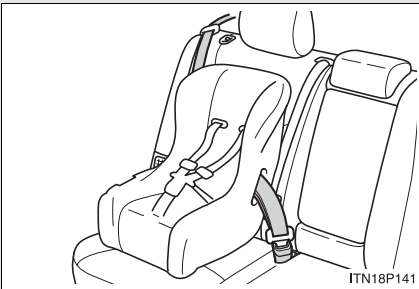

**Seat belts equipped with a child restraint locking mechanism (ALR/ELR belts except driver's seat belt) (→P. 109)**

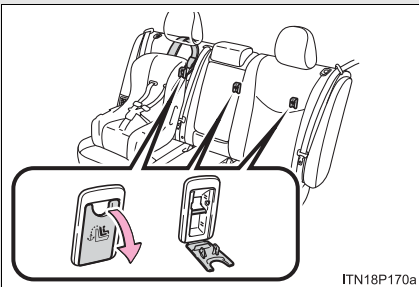

**Anchor brackets (for top tether strap)**

**An anchor bracket is provided for each rear seat.**

## Installation with LATCH system

**STEP 1** Widen the gap between the seat cushion and seatback slightly.

### Type A



Latch the hooks of the lower straps onto the LATCH anchors. If the child restraint has a top tether strap, the top tether strap should be latched onto the top tether strap anchor.

For owners in Canada:  
The symbol on a child restraint system indicates the presence of a lower connector system.

**Type B**

Latch the buckles onto the LATCH anchors. If the child restraint has a top tether strap, the top tether strap should be latched onto the top tether strap anchor.

For owners in Canada:  
The symbol on a child restraint system indicates the presence of a lower connector system.

1

Before driving

## Installing child restraints using a seat belt (child restraint lock function belt)

### ■ Rear facing — Infant seat/convertible seat

STEP 1

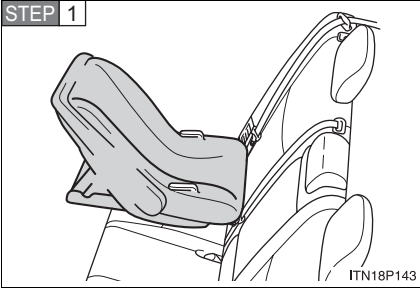

Place the child restraint system on the rear seat facing the rear of the vehicle.

STEP 2

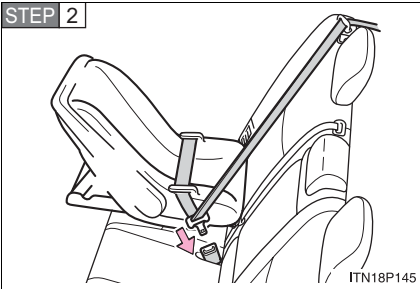

Run the seat belt through the child restraint system and insert the plate into the buckle. Make sure that the belt is not twisted.

STEP 3

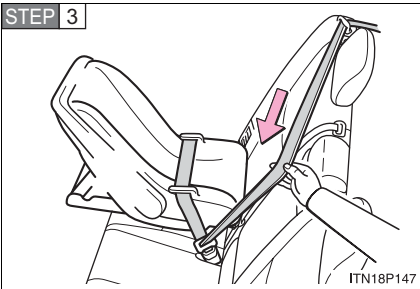

Fully extend the shoulder belt and then allow it to retract slightly in order to activate the ALR lock mode.

Lock mode allows the seat belt to retract only.

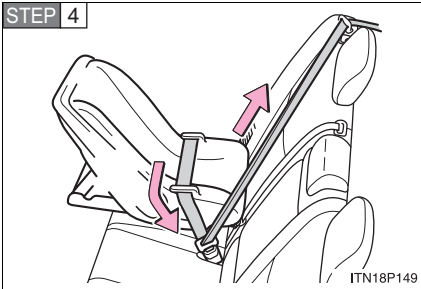

While pushing the child restraint system down into the rear seat, allow the shoulder belt to retract until the child restraint system is securely in place.

After the shoulder belt has retracted to a point where there is no slack in the belt, pull the belt to check that it cannot be extended.

### ■ Forward-facing — Convertible seat

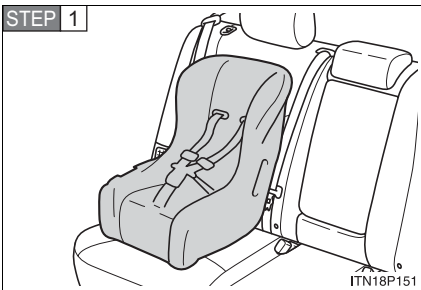

Place the child restraint system on the seat facing the front of the vehicle.

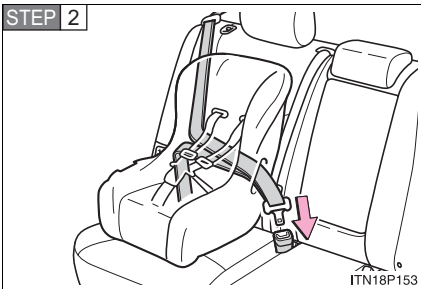

Run the seat belt through the child restraint system and insert the plate into the buckle. Make sure that the belt is not twisted.

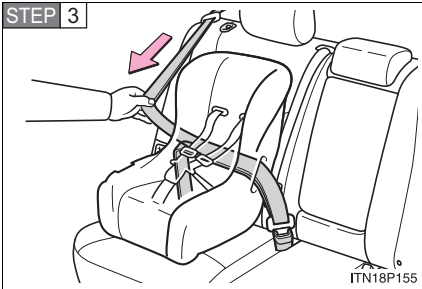

Fully extend the shoulder belt and then allow it to retract slightly in order to activate the ALR lock mode.

Lock mode allows the seat belt to retract only.

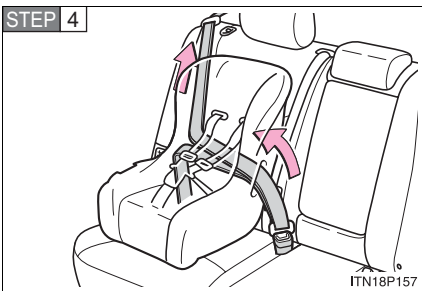

While pushing the child restraint system into the rear seat, allow the shoulder belt to retract until the child restraint system is securely in place.

After the shoulder belt has retracted to a point where there is no slack in the belt, pull the belt to check that it cannot be extended.

**STEP 5** If the child restraint has a top tether strap, the top tether strap should be latched onto the top tether strap anchor. (→P. 172)

## ■ Booster seat

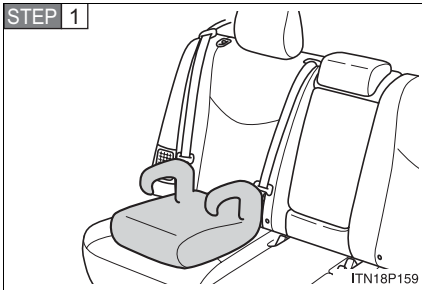

Place the child restraint system on the seat facing the front of the vehicle.

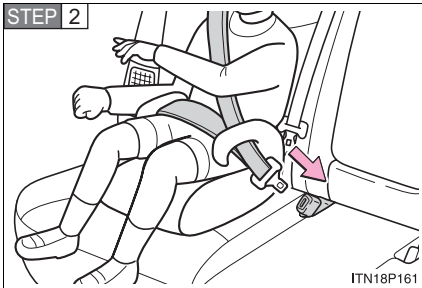

Sit the child in the child restraint system. Fit the seat belt to the child restraint system according to the manufacturer's instructions and insert the plate into the buckle. Make sure that the belt is not twisted.

Check that the shoulder belt is correctly positioned over the child's shoulder and that the lap belt is as low as possible.  
(→P. 109)



### Removing a child restraint installed with a seat belt

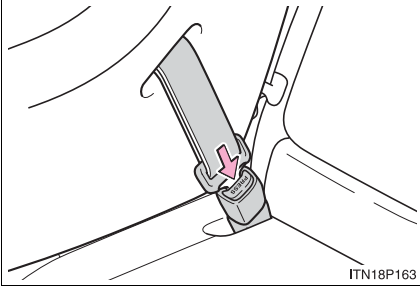

Press the buckle release button and fully retract the seat belt.

### Child restraint systems with a top tether strap

**STEP 1** Secure the child restraint system using a seat belt or the LATCH anchors, and do the following.

#### Foldable type outside seats

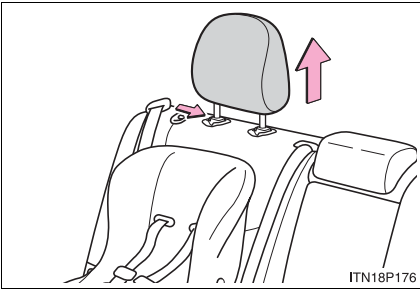

Adjust the head restraint to the upmost position.

### Non-foldable type outside seats

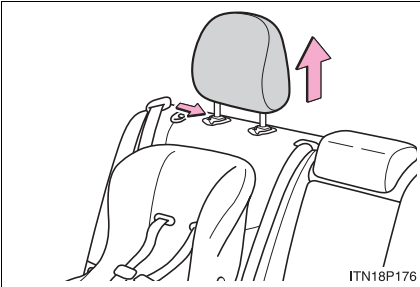

Remove the head restraint.

### Center seat

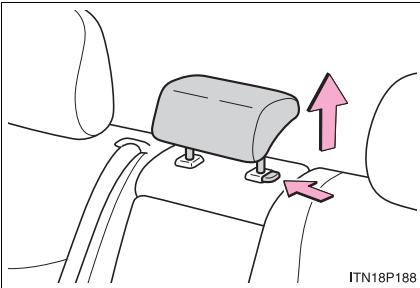

Adjust the head restraint to the upmost position.

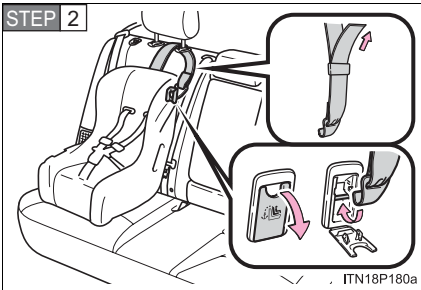

Open the anchor bracket cover, latch the hook onto the anchor bracket and tighten the top tether strap.

Make sure the top tether strap is securely latched.

**STEP 3** Outside only: Do the following.

### Foldable type

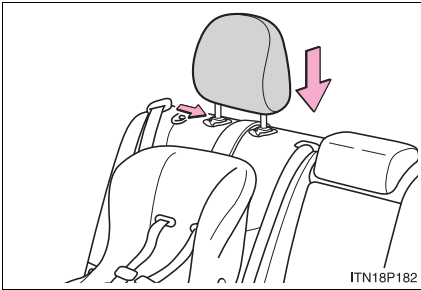

Adjust the head restraint to the downmost position.

### Non-foldable type

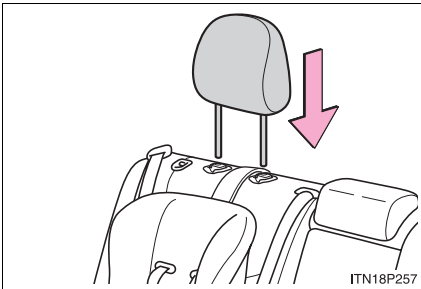

Install the head restraint.

## ■ Laws and regulations pertaining to anchors

The LATCH system conforms to FMVSS225 or CMVSS210.2.

Child restraint systems conforming to FMVSS213 or CMVSS213 specifications can be used.

This vehicle is designed to conform to the SAE J1819.

### ⚠ CAUTION

#### ■ When installing a booster seat

To prevent the belt from going into ALR lock mode, do not fully extend the shoulder belt. ALR mode causes the belt to tighten only. This could cause injury or discomfort to the child. (→P. 111)

#### ■ When installing a child restraint system

Follow the directions given in the child restraint system installation manual and fix the child restraint system securely in place.

If the child restraint system is not correctly fixed in place, the child or other passengers may be seriously injured or even killed in the event of sudden braking, sudden swerving or an accident.

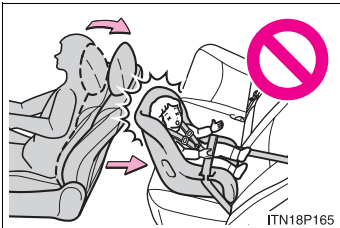

- If the driver's seat interferes with the child restraint system and prevents it from being attached correctly, attach the child restraint system to the right-hand rear seat.
- Adjust the front passenger seat so that it does not interfere with the child restraint system.

**! CAUTION**

**■ When installing a child restraint system**

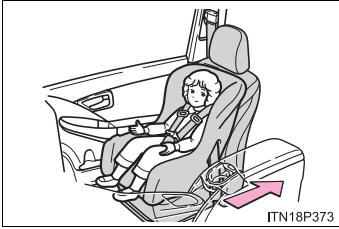

- Only put a forward-facing child restraint system on the front seat when unavoidable.

When installing a forward-facing child restraint system on the front passenger seat, move the seat as far back as possible even if the “AIR BAG OFF” indicator light is illuminated. Failure to do so may result in death or serious injury if the airbags deploy (inflate).

- When a booster seat is installed, always ensure that the shoulder belt is positioned across the center of the child’s shoulder. The belt should be kept away from the child’s neck, but not so that it could fall off the child’s shoulder. Failing to do so may result in death or serious injury in the event of sudden braking, sudden swerving or an accident.
- Ensure that the belt and plate are securely locked and the seat belt is not twisted.
- Shake the child restraint system left and right, and forward and backward to ensure that it has been securely installed.
- After securing a child restraint system, never adjust the seat.
- Follow all installation instructions provided by the child restraint system manufacturer.

 **CAUTION****■ Do not use a seat belt extender**

If a seat belt extender is used when installing a child restraint system, the seat belt will not securely hold the child restraint system, which could cause death or serious injury to the child or other passengers in the event of sudden braking, sudden swerving or an accident.

**■ To correctly attach a child restraint system to the anchors**

When using the LATCH anchors, be sure that there are no foreign objects around the anchors and that the seat belt is not caught behind the child restraint system. Make sure the child restraint system is securely attached, or it may cause death or serious injury to the child or other passengers in the event of a sudden braking, sudden swerve or accident.



The following procedures should be observed to ensure safe driving:

■ **Starting the hybrid system**

→P. 192

■ **Driving**

**STEP 1** With the brake pedal depressed, shift the shift position to D.  
(→P. 202)

Check that the shift position indicator shows D. (→P. 214)

**STEP 2** Release the parking brake. (→P. 212)

**STEP 3** Gradually release the brake pedal and gently depress the accelerator pedal to accelerate the vehicle.

■ **Stopping**

**STEP 1** With the shift position in D, depress the brake pedal.

**STEP 2** If necessary, set the parking brake.

When the vehicle will be stopped for an extended period of time, shift the shift position to P. (→P. 205)

■ **Parking the vehicle**

**STEP 1** Stop the vehicle completely.

**STEP 2** Set the parking brake. (→P. 212)

**STEP 3** Shift the shift position to P. (→P. 205)

Check that the shift position indicator shows P. (→P. 202)

**STEP 4** Press the “POWER” switch to stop the hybrid system.

**STEP 5** Slowly release the brake pedal.

**STEP 6** Lock the door, making sure that you have the electronic key on your person.

When parking on a hill, block the wheels as needed.



## Starting off on a uphill

- STEP 1** Firmly set the parking brake with the brake pedal depressed, and then shift the shift position to D.
- STEP 2** Release the brake pedal and gently depress the accelerator pedal.
- STEP 3** Release the parking brake.

### ■ When starting off on a uphill

The hill-start assist control is available. (→P. 301)

### ■ Driving in the rain

- Drive carefully when it is raining, because visibility will be reduced, the windows may become fogged-up, and the road will be slippery.
- Drive carefully when it starts to rain, because the road surface will be especially slippery.
- Refrain from high speeds when driving on an expressway in the rain, because there may be a layer of water between the tires and the road surface, preventing the steering and brakes from operating properly.

### ■ Breaking in your new Toyota

To extend the life of the vehicle, observing the following precautions is recommended:

- For the first 200 miles (300 km):
  - Avoid sudden stops.
- For the first 600 miles (1000 km):
  - Do not drive at extremely high speeds.
  - Avoid sudden acceleration.
  - Do not drive at a constant speed for extended periods.

### ■ Operating your vehicle in a foreign country

Comply with the relevant vehicle registration laws and confirm the availability of the correct fuel. (→P. 562)

### ■ For efficient use

- Shift the shift position to D when driving.

In the N position, the gasoline engine operates but electricity cannot be generated. The hybrid battery (traction battery) will discharge, requiring unnecessary engine power to recharge.

- Drive your vehicle smoothly.

Avoid abrupt acceleration and deceleration. Gradual acceleration and deceleration will make more effective use of the electric motor (traction motor) without having to use gasoline engine power.

- Avoid repeated acceleration.

Repeated acceleration consumes hybrid battery (traction battery) power, resulting in poor acceleration. Battery power can be restored by driving with the accelerator pedal slightly released.

- Shift the shift position to P when parking.

In the N position, the hybrid battery (traction battery) does not recharge. Leaving the shift position in the N position for an extended period of time may discharge the hybrid battery (traction battery). The vehicle cannot run if the hybrid battery (traction battery) is discharged.

 **CAUTION****■ When starting the vehicle**

Always keep your foot on the brake pedal while stopped with the hybrid system operating. This prevents the vehicle from creeping.

**■ When driving the vehicle**

- Do not drive if you are unfamiliar with the location of the brake and accelerator pedals to avoid depressing the wrong pedal.
  - Accidentally depressing the accelerator pedal instead of the brake pedal will result in sudden acceleration that may lead to an accident that could result in death or serious injury.
  - When backing up, you may twist your body around, leading to a difficulty in operating the pedals. Make sure to operate the pedals properly.
  - Make sure to keep a correct driving posture even when moving the vehicle only slightly. This allows you to depress the brake and accelerator pedals properly.
  - Depress the brake pedal using your right foot. Depressing the brake pedal using your left foot may delay response in an emergency, resulting in an accident.
- Because there is no engine noise when the vehicle is being driven using the electric motor, pedestrians in the vicinity may not notice the vehicle. Even though the vehicle is equipped with the vehicle proximity notification system, drive with care as pedestrians in the vicinity may still not notice the vehicle if the surrounding area is noisy.
- Do not drive the vehicle over or stop the vehicle near flammable materials. The exhaust system and exhaust gases can be extremely hot. These hot parts may cause a fire if there is any flammable material nearby.
- Do not let the vehicle roll backward while a forward driving position is selected, or roll forward while the shift position is in R. Doing so may result in an accident or damage to the vehicle.

 CAUTION

- If the smell of exhaust is noticed inside the vehicle, open the windows and check that the back door is closed. Large amounts of exhaust in the vehicle can cause driver drowsiness and an accident, resulting in death or a serious health hazard. Have the vehicle inspected by your Toyota dealer immediately.
- Do not shift the shift position to P while the vehicle is moving. Doing so can damage the transmission and may result in a loss of vehicle control.
- Do not shift the shift position to R while the vehicle is moving forward. Doing so can damage the transmission and may result in a loss of vehicle control.
- Do not shift the shift position to D while the vehicle is moving backward. Doing so can damage the transmission and may result in a loss of vehicle control.
- Moving the shift position to N while the vehicle is moving will disengage the hybrid system. Engine braking is not available with the hybrid system disengaged.
- During normal driving, do not turn off the hybrid system. Turning the hybrid system off while driving will not cause loss of steering or braking control, but the power assist to these systems will be lost. This will make it more difficult to steer and brake, so you should pull over and stop the vehicle as soon as it is safe to do so.  
However, in the event of an emergency, such as if it becomes impossible to stop the vehicle in the normal way: →P. 556
- Use engine braking (shift position B instead of shift position D) to maintain a safe speed when driving down a steep hill.  
Using the brakes continuously may cause the brakes to overheat and lose effectiveness. (→P. 202)

 **CAUTION**

- Do not adjust the positions of the steering wheel, the seat, or the inside or outside rear view mirrors while driving.  
Doing so may result in a loss of vehicle control that can cause accidents, resulting in death or serious injury.
  - Always check that all passengers' arms, heads or other parts of their body are not outside the vehicle, as this may result in death or serious injury.
  - Do not drive in excess of the speed limit. Even if the legal speed limit permits it, do not drive over 85 mph (140 km/h) unless your vehicle has high-speed capability tires. Driving over 85 mph (140 km/h) may result in tire failure, loss of control and possible injury. Be sure to consult a tire dealer to determine whether the tires on your vehicle are high-speed capability tires or not before driving at such speeds.
- **When driving on slippery road surfaces**
- Sudden braking, acceleration and steering may cause tire slippage and reduce your ability to control the vehicle, resulting in an accident.
  - Sudden acceleration, engine braking due to shift changing, or changes in engine speed could cause the vehicle to skid, resulting in an accident.
  - After driving through a puddle, depress the brake pedal to make sure that the brakes are functioning properly. Wet brake pads may prevent the brakes from functioning properly. If the brakes on only one side are wet and not functioning properly, steering control may be affected, resulting in an accident.

 **CAUTION**

■ **When changing the shift position**

Be careful not to change the shift position with the accelerator pedal depressed.

Changing the shift position to any positions other than P or N may cause the vehicle to accelerate abruptly, causing an accident and resulting in death or serious injury.

After changing the shift position, make sure to confirm the current shift position displayed on the shift position indicator inside the meter.

■ **If you hear a squealing or scraping noise (brake pad wear limit indicators)**

Have your Toyota dealer check and replace the brake pads as soon as possible.

Rotor damage may result if the pads are not replaced when needed.

It is dangerous to drive the vehicle when the wear limits of the brake pads and/or those of the brake discs are exceeded.

■ **When the vehicle is stopped**

- Do not depress the accelerator pedal unnecessarily.

If the vehicle is in any shift position other than P or N, the vehicle may accelerate suddenly and unexpectedly, causing an accident.

- Do not leave the vehicle with the hybrid system on for a long time.

If such a situation cannot be avoided, park the vehicle in an open space and check that exhaust fumes do not enter the vehicle interior.

- In order to prevent accidents due to the vehicle rolling away, always keep depressing the brake pedal while the “READY” indicator is on. Apply the parking brake as necessary.

 **CAUTION**

- If the vehicle is stopped on an incline, in order to prevent accidents caused by the vehicle rolling forward or backward, always depress the brake pedal and securely apply the parking brake as needed.
- Avoid revving or racing the engine.  
Running the engine at high speed while the vehicle is stopped may cause the exhaust system to overheat, which could result in a fire if combustible material is nearby.

**■ When the vehicle is parked**

- Make sure to firmly apply the parking brake and shift the shift position to P. Failure to do so may cause the vehicle to move, or the vehicle to accelerate suddenly if the accelerator pedal is accidentally depressed. Also, when leaving the vehicle, make sure to turn off the hybrid system and lock the vehicle.  
Sound or shuddering may not be noticed even when the hybrid vehicle is ready to drive (when the “READY” indicator is illuminated).
- Do not leave glasses, cigarette lighters, spray cans, or soft drink cans in the vehicle when it is in the sun.  
Doing so may result in the following:
  - Gas may leak from a cigarette lighter or spray can, and may lead to a fire.
  - The temperature inside the vehicle may cause the plastic lenses and plastic material of glasses to deform or crack.
  - Soft drink cans may fracture, causing the contents to spray over the interior of the vehicle, and may also cause a short circuit in the vehicle’s electrical components.

 **CAUTION**

- Do not leave cigarette lighters in the vehicle. If a cigarette lighter is in a place such as the glove box or on the floor, it may be lit accidentally when luggage is loaded or the seat is adjusted, causing a fire.
- Do not attach adhesive discs to the windshield or windows. Do not place containers such as air fresheners on the instrument panel or dashboard. Adhesive discs or containers may act as lenses, causing a fire in the vehicle.
- Do not leave a door or window open if the curved glass is coated with a metallized film such as a silver-colored one. Reflected sunlight may cause the glass to act as a lens, causing a fire.
- Do not touch the exhaust pipe while the hybrid system is operating or immediately after turning the hybrid system off. Doing so may cause burns.
- Do not leave the hybrid system operating in an area with snow build-up, or where it is snowing. If snowbanks build up around the vehicle while the hybrid system is operating, exhaust gases may collect and enter the vehicle. This may lead to death or a serious health hazard.

 **Exhaust gases**

Exhaust gases include harmful carbon monoxide (CO), which is colorless and odorless. Inhaling exhaust gases may lead to death or a serious health hazard.

- If the vehicle is in a poorly ventilated area, stop the hybrid system. In a closed area, such as a garage, exhaust gases may collect and enter the vehicle. This may lead to death or a serious health hazard.
- The exhaust system should be checked occasionally. If there is a hole or crack caused by corrosion, damage to a joint or abnormal exhaust noise, be sure to have the vehicle inspected and repaired by your Toyota dealer. Failure to do so may allow exhaust gases to enter the vehicle, resulting in death or a serious health hazard.



 **CAUTION****■ When taking a nap in the vehicle**

Always turn the hybrid system off. Otherwise, if you accidentally move the shift lever or depress the accelerator pedal, this could cause an accident or fire due to hybrid system overheating. Additionally, if the vehicle is parked in a poorly ventilated area, exhaust gases may collect and enter the vehicle, leading to death or a serious health hazard.

**■ When braking**

- When the brakes are wet, drive more cautiously.

Braking distance increases when the brakes are wet, and this may cause one side of the vehicle to brake differently than the other side. Also, the parking brake may not securely hold the vehicle.

- If the electronically controlled assist function does not operate, do not follow other vehicles closely and avoid downhill or sharp turns that require braking.

In this case, braking is still possible, but the brake pedal should be depressed more firmly than usual. Also, the braking distance will increase.

- The brake system consists of 2 individual hydraulic systems; if one of the systems fails, the others will still operate. In this case, the brake pedal should be depressed more firmly than usual and the braking distance will increase. If this happens, do not continue to drive the vehicle. If the brake system warning light (red indicator) comes on while driving, immediately stop the vehicle in a safe place and contact your Toyota dealer.

 NOTICE

■ **When driving the vehicle**

- Do not depress the accelerator and brake pedals at the same time during driving, as this may restrain driving torque.
- Do not use the accelerator pedal or depress the accelerator and brake pedals at the same time to hold the vehicle on a hill.

■ **Avoiding damage to vehicle parts**

- Do not turn the steering wheel fully in either direction and hold it there for an extended period of time.  
Doing so may damage the power steering motor.
- When driving over bumps in the road, drive as slowly as possible to avoid damaging the wheels, underside of the vehicle, etc.

■ **If you get a flat tire while driving**

A flat or damaged tire may cause the following situations. Hold the steering wheel firmly and gradually depress the brake pedal to slow down the vehicle.

- It may be difficult to control your vehicle.
- The vehicle will make abnormal sounds or vibrations.
- The vehicle will lean abnormally.

Information on what to do in case of a flat tire. (→P. 523)

 NOTICE**■ When encountering flooded roads**

Do not drive on a road that has flooded after heavy rain etc. Doing so may cause the following serious damage to the vehicle:

- Engine stalling
- Short in electrical components
- Engine damage caused by water immersion

In the event that you drive on a flooded road and the vehicle is flooded, be sure to have your Toyota dealer check the following:

- Brake function
- Changes in quantity and quality of engine oil, transmission fluid for the hybrid system, etc.
- Lubricant condition for the bearings and suspension joints (where possible), and the function of all joints, bearings, etc.

If the P position control system is damaged by flooding, it may not be possible to shift the shift position to P, or from P to other positions. When the shift position cannot be changed from P to any other position, the front wheels will lock, and you will be unable to tow the vehicle with the front wheels on the ground, as the front wheels may be locked. In this case, transport the vehicle with both front wheels or all four wheels lifted.

## 2-1. Driving procedures

### Power (ignition) switch

Performing the following operations when carrying the electronic key on your person starts the hybrid system or changes “POWER” switch modes.

#### ■ Starting the hybrid system

**STEP 1** Check that the parking brake is set.

**STEP 2** Firmly depress the brake pedal.

Check that the “POWER” switch indicator turns green. If the indicator does not turn green, the hybrid system cannot be started.

When the shift position is N, the hybrid system cannot start. Shift the shift position to P when starting the hybrid system. (→P. 205)



Press the “POWER” switch.

The hybrid system can be started from any “POWER” switch mode.

Continue depressing the brake pedal until the hybrid system is completely started.

**STEP 4** Check that the “READY” indicator is on.

If the “READY” indicator changes from a flashing light to a solid light and the buzzer sounds, the hybrid system is starting normally.

The vehicle will not move when the “READY” indicator is off.

The vehicle can move when the “READY” indicator is on even if the engine is stopped. (The gasoline engine starts or stops automatically in accordance with the state of the vehicle.)

### ■ Stopping the hybrid system

**STEP 1** Stop the vehicle completely.

**STEP 2** Set the parking brake. (→P. 212)

**STEP 3**

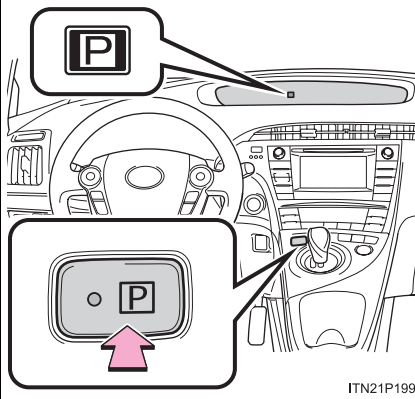

Shift the shift position to P.  
(→P. 205)

Check that the shift position  
indicator shows P. (→P. 202)

**STEP 4** Press the “POWER” switch.

The hybrid system will stop.

**STEP 5** Slowly release the brake pedal and check that the indicator on the “POWER” switch is off.

### ■ Changing “POWER” switch modes

Modes can be changed by pressing the “POWER” switch with the brake pedal released. (The mode changes each time the switch is pressed.)

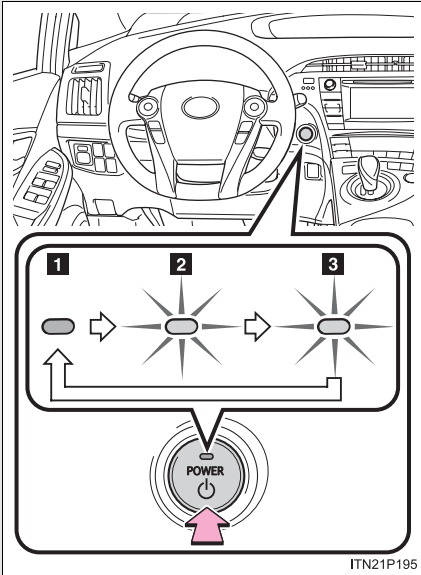

#### 1 Off

The emergency flashers can be used.

#### 2 ACCESSORY mode

Some electrical components such as the audio system can be used.

The “POWER” switch indicator turns amber.

#### 3 ON mode

All electrical components can be used.

The “POWER” switch indicator turns amber.

ITN21P195

---

**■ Auto power off function**

If the vehicle is left in ACCESSORY or ON mode (the hybrid system is not operating) for more than an hour with the shift position in P, the “POWER” switch will automatically turn off. However, this function cannot entirely prevent the 12-volt battery from discharging. Do not leave the vehicle with the “POWER” switch in ACCESSORY or ON mode for long periods of time when the hybrid system is not operating.

**■ Sounds and vibrations specific to a hybrid vehicle**

→P. 34

**■ Electronic key battery depletion**

→P. 76

**■ When the ambient temperature is low, such as during winter driving conditions**

The “READY” indicator may flash for a long time when the hybrid system is starting. Driving will become possible once the “READY” indicator has illuminated. Wait until the “READY” indicator has illuminated.

**■ Conditions affecting operation**

→P. 72

**■ Notes for the entry function**

→P. 73

**■ If the hybrid system does not start**

The immobilizer system may not have been deactivated. (→P. 135)  
Contact your Toyota dealer.

■ **When the “POWER” switch indicator flashes in amber**

The system may be malfunctioning. Have the vehicle inspected by your Toyota dealer immediately.

■ **If the “READY” indicator does not come on**

If the “READY” indicator does not come on when you press the “POWER” switch with the shift position in P and the brake pedal depressed, contact your Toyota dealer immediately.

■ **If the hybrid system is malfunctioning**

→P. 495

■ **If the electronic key battery is depleted**

→P. 454

■ **Operation of the “POWER” switch**

- When operating the “POWER” switch, one short, firm press is enough. If the switch is pressed improperly, the hybrid system may not start or the “POWER” switch mode may not change. It is not necessary to press and hold the switch.
- If attempting to restart the hybrid system immediately after turning the “POWER” switch off, the hybrid system may not start in some cases. After turning the “POWER” switch off, please wait a few seconds before restarting the hybrid system.

■ **Automatically P position selection function**

→P. 207



### ■ When the P position control system malfunctions

The “POWER” switch will not be able to be turned off. In such a case, the switch can be turned off after applying the parking brake.

Have the vehicle inspected by your Toyota dealer immediately.

### ■ Ending display

When the “POWER” switch is turned off, each of the following will be displayed on the multi-information display, and will extinguish after approximately 30 seconds.

- The driving distance, driving time, consumption and eco savings since the hybrid system was started.
- The odometer/trip meter
- The clock

## CAUTION

### ■ When starting the hybrid system

Always start the hybrid system while sitting in the driver's seat. Do not depress the accelerator pedal while starting the hybrid system under any circumstances.

Doing so may cause an accident resulting in death or serious injury.

### ■ Stopping the hybrid system in an emergency

If you want to stop the hybrid system in an emergency while driving the vehicle, press and hold the “POWER” switch for more than 3 seconds, or press it briefly 3 times or more in succession. (→P. 556)

However, do not touch the “POWER” switch while driving except in an emergency. Turning the hybrid system off while driving will not cause loss of steering or braking control, but the power assist to these systems will be lost. This will make it more difficult to steer and brake, so you should pull over and stop the vehicle as soon as it is safe to do so.

 NOTICE

■ **To prevent 12-volt battery discharge**

- Do not leave the “POWER” switch in ACCESSORY or ON mode for long periods of time without the hybrid system on.
- If the hybrid system is off, but the indicator on the “POWER” switch is illuminated, this indicates that the “POWER” switch is still turned on. When exiting the vehicle, always check that the “POWER” switch is off.

■ **Symptoms indicating a malfunction with the “POWER” switch**

If the “POWER” switch seems to be operating somewhat differently than usual, such as the switch sticking slightly, there may be a malfunction. Contact your Toyota dealer immediately.

## 2-1. Driving procedures

### EV drive mode

In EV drive mode, the electric motor (traction motor), powered by the hybrid battery (traction battery), is used to drive the vehicle.

This mode allows you to drive in residential areas late at night, or in indoor parking lots etc. without concern for noises and exhaust gas emissions.

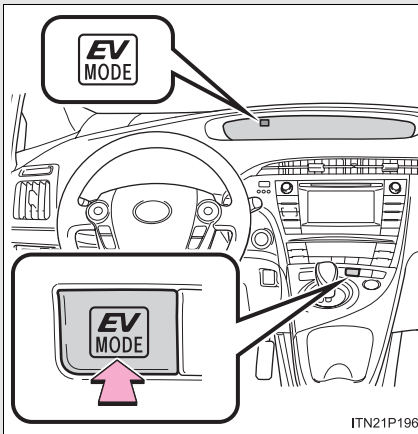

#### Turns EV drive mode on/off

When EV drive mode is turned on, the EV drive mode indicator will come on.

Pressing the switch when in EV drive mode will return the vehicle to normal driving (using the gasoline engine and electric motor [traction motor]).

### ■ Situations in which EV drive mode cannot be turned on

It may not be possible to turn EV drive mode on in the following situations.\*  
If it cannot be turned on, a buzzer will sound and a message will be shown on the multi-information display.

- The temperature of the hybrid system is high.  
The vehicle has been left in the sun, driven on a hill, driven at high speeds, etc.
- The temperature of the hybrid system is low.  
The vehicle has been left in temperatures lower than about 32 °F (0 °C) for a long period of time etc.
- The gasoline engine is warming up.
- The hybrid battery (traction battery) is low.  
When the amount of remaining hybrid battery (traction battery) charge displayed on the meter is low. (→P. 42)
- Vehicle speed is high.
- The accelerator pedal is depressed firmly or the vehicle is on a hill etc.
- The windshield defogger is in use.

\*: Depending on the circumstances, EV drive mode may also not be switched to in situations other than those above.

### ■ Switching to EV drive mode when the gasoline engine is cold

If the hybrid system is started while the gasoline engine is cold, the gasoline engine will start automatically after a short period of time in order to warm up. In this case, you will become unable to switch to EV drive mode.

After the hybrid system has started and the “READY” indicator has illuminated, press the EV drive mode switch before the gasoline engine starts to switch to EV drive mode.

### ■ Automatic cancelation of EV drive mode

When driving in EV drive mode, the gasoline engine may automatically restart in the following situations. When EV drive mode is canceled, a buzzer will sound and the EV drive mode indicator will flash and go off.

- The hybrid battery (traction battery) becomes low.
- Vehicle speed becomes high.
- The accelerator pedal is depressed firmly or the vehicle is on a hill etc.

### ■ Possible driving distance when driving in EV drive mode

In EV drive mode, it is possible to drive up to about 1.3 mile (2 km) if driving at a speed of about 25 mph (40 km/h) or less. (The distance that is possible depends on the hybrid battery [traction battery] level and driving conditions.)

### ■ Changing a driving mode when in EV drive mode

EV drive mode can be used in conjunction with Eco drive mode and power mode.

However, EV drive mode may be automatically canceled when used in conjunction with power mode.

### ■ Fuel economy

PRIUS is designed to achieve the best possible fuel economy during normal driving (using the gasoline engine and electric motor [traction motor]). Driving in EV drive mode more than necessary may lower fuel economy.

## CAUTION

### ■ While driving

When driving in EV drive mode, pay special attention to the area around the vehicle. Because there is no engine noise, pedestrians, people riding bicycles or other people and vehicles in the area may not be aware of the vehicle starting off or approaching them, so take extra care while driving.

## 2-1. Driving procedures

# Hybrid transmission

Select a shift position appropriate for the driving conditions.

### ■ Shifting the shift lever

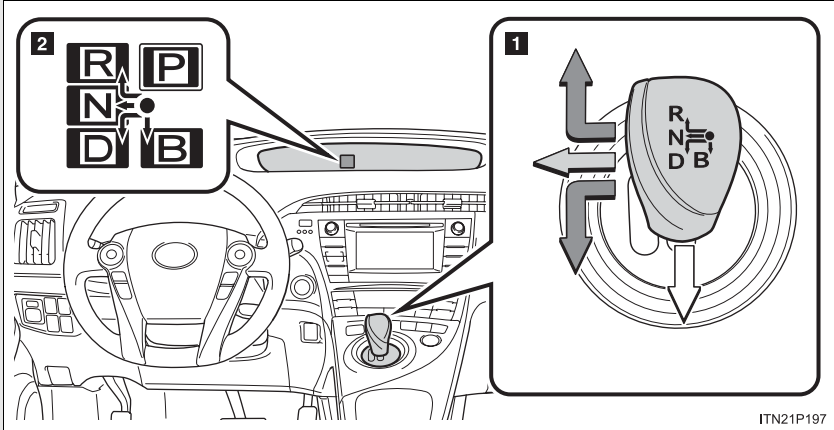

#### 1 Shift lever

Operate the shift lever gently and ensure correct shifting operation.



When shifting to the D or R positions, move the shift lever along the shift gate.



To shift to the N position, slide the shift lever to the left and hold it. The shift position will change to N.



Shifting to B is only possible when shift position D is selected.



The shift lever will always return to this original position after a shifting operation.

When shifting from P to N, D or R, from D to R, or from R to D, ensure that the brake pedal is being depressed and the vehicle is stationary.

## 2 Shift position indicator

The position of the frame on the shift position indicator changes in accordance with the current shift position.

When any shift position other than D or B is selected, the arrow toward B and B position indicator disappear from the shift position indicator.

When selecting the shift position, make sure that the shift position has been changed to the desired position by checking the shift position indicator provided on the instrument cluster.

### ■ Shift position purpose

Shift position	Function
P	Parking the vehicle/starting the hybrid system
R	Reversing
N	Neutral
D	Normal driving*
B	Applying moderate engine braking when driving down hills or on steep slopes

\*: For good fuel economy and noise reduction, the D position should usually be used.

## ■ Selecting a driving mode

The following modes can be selected to suit driving conditions:

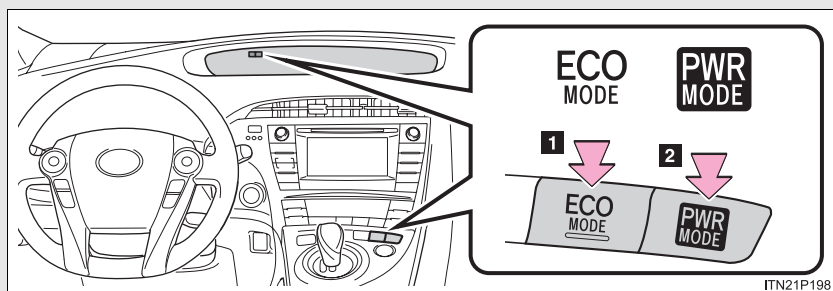

### 1 Eco drive mode

Suitable for improving the fuel economy, because the torque corresponding to the accelerator pedal depression amount can be generated more smoothly than it is in normal conditions and the operation of the air conditioning system (heating/cooling) will be minimized.

When the “ECO MODE” switch is pressed, the “ECO MODE” indicator comes on.

### 2 Power mode

Use when high levels of response and feeling are desirable, such as when driving in mountainous regions or when overtaking.

When the power mode switch is pressed, the power mode indicator comes on.



## P position switch

### ■ When shifting the shift position to P

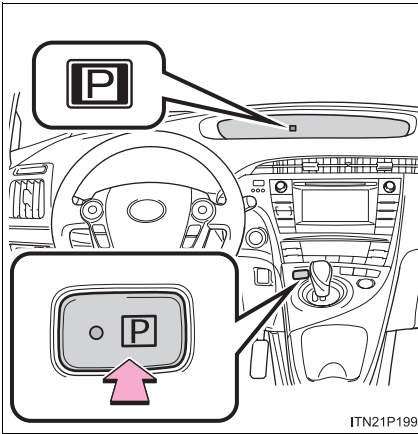

Fully stop the vehicle and set the parking brake, and then press the P position switch.

When the shift position is changed to P, the indicator comes on.

Check that the P position is illuminated on the shift position indicator.

### ■ Shifting the shift position from P to other positions

- While depressing the brake pedal firmly, operate the shift lever. If the shift lever is operated without depressing the brake pedal, the buzzer will sound and the shifting operation will be disabled.
- When selecting the shift position, make sure that the shift position has been changed to the desired position by checking the shift position indicator provided on the instrument cluster.
- The shift position cannot be changed from P to B directly.

### ■ Operation of the air conditioning system in Eco drive mode

Eco drive mode controls the heating/cooling operations and fan speed of the air conditioning system to enhance fuel efficiency. (→P. 204) To improve air conditioning performance, adjust the fan speed or turn off Eco drive mode.

### ■ For the shift positions

- When the “POWER” switch is off, the shift position cannot be changed.
- When the “POWER” switch is in ON mode (the hybrid system is not operating), the shift position can only be changed to N. The shift position will be changed to N even if the shift lever is shifted to D or R and held in that position.
- When the “READY” indicator is on, the shift position can be changed from P to D, N or R.
- When the “READY” indicator is flashing, the shift position cannot be changed from P to another position even if the shift lever is operated. Wait until the “READY” indicator changes from a flashing to a solid light, and then operate the shift lever again.
- The shift position can only be changed to B directly from D.

In addition, if an attempt is made to change the shift position by moving the shift lever in any of the following situations, the buzzer will sound and the shifting operation will be disabled or the shift position will automatically change to N. When this happens, select an appropriate shift position.

- Situations where the shifting operation will be disabled:
  - When an attempt is made to change the shift position from P to another position by moving the shift lever without depressing the brake pedal.
  - When an attempt is made to change the shift position from P or N to B by moving the shift lever.

● Situations where the shift position will automatically change to N:

- When the P position switch is pressed while the vehicle is running.\*1
- When an attempt is made to select the R position by moving the shift lever when the vehicle is moving forward.\*2
- When an attempt is made to select the D position by moving the shift lever when the vehicle is moving in reverse.\*3
- When an attempt is made to change the shift position from R to B by moving the shift lever.

\*1: Shift position may be changed to P when driving at extremely low speeds.

\*2: Shift position may be changed to R when driving at low speeds.

\*3: Shift position may be changed to D when driving at low speeds.

■ **Reverse warning buzzer**

When shifting into R, a buzzer will sound to inform the driver that the shift position is in R.

■ **Automatically P position selection function**

When the shift position is in a position other than P, pressing the “POWER” switch with the vehicle stopped completely will cause the shift position to change to P automatically, and then the “POWER” switch will turn off.

■ **If the shift position cannot be shifted from P**

There is a possibility that the 12-volt battery is discharged. Check the 12-volt battery in this situation. (→P. 543)

### ■ About engine braking

When shift position B is selected, releasing the accelerator pedal will apply engine braking.

- When the vehicle is driven at high speeds, compared to ordinary gasoline-fueled vehicles, the engine braking deceleration is felt less than that of other vehicles.
- The vehicle can be accelerated even when shift position B is selected.

If the vehicle is driven continuously in the B position, fuel efficiency will become low. Usually, shift the shift position to D.

### ■ When driving with cruise control or radar cruise control activated

Even if switching the driving mode to power mode with the intent of enabling engine braking, engine braking will not activate because cruise control or radar cruise control will not be canceled.

### ■ When canceling Eco drive mode/power mode

- Press the switch again. Also, power mode will be canceled automatically when the "POWER" switch is turned off. However, Eco drive mode will not be canceled automatically until the switch is pressed, even if the "POWER" switch is turned off.
- When in Eco drive mode, if the power mode switch is pressed or the operation is reversed, the mode will switch to that of the last switch to be pressed.

### ■ Switching the drive mode when in EV drive mode

→P. 201

### ■ After recharging/reconnecting the 12-volt battery

→P. 433

## ■ Customization

Settings (e.g. Reverse warning buzzer) can be changed.  
(Customizable features →P. 590)

### CAUTION

#### ■ When driving on slippery road surfaces

Do not accelerate or shift the shift position suddenly.

Sudden changes in engine braking may cause the vehicle to spin or skid, resulting in an accident.

#### ■ For the shift lever

Do not remove the shift lever knob or use anything but a genuine Toyota shift lever knob. Also, do not hang anything on the shift lever.

Doing so could prevent the shift lever from returning to position, causing unexpected accidents to occur when the vehicle is in motion.

#### ■ P position switch

Do not press the P position switch while the vehicle is moving.

If the P position switch is pressed when driving at very low speeds (for example, directly before stopping the vehicle), the vehicle may stop suddenly when the shift position switches to P, which could lead to an accident.

 NOTICE

■ **Hybrid battery (traction battery) charge**

If the shift position is in N, the hybrid battery (traction battery) will not be charged. To help prevent the battery from discharging, avoid leaving the N position selected for an extended period of time.

■ **Situations where P position control system malfunctions are possible**

If any of the following situations occurs, P position control system malfunctions are possible.

Immediately stop the vehicle in a safe place on level ground, apply the parking brake, and then contact your Toyota dealer.

- When the “P LOCK MALFUNCTION” warning message appears on the multi-information display. (→P. 509)
- When the shift position indicator remains off.

■ **Notes regarding shift lever and P position switch operation**

Avoid repeatedly operating the shift lever and P position switch in quick succession.

The system protection function may activate and it will not be temporarily possible to shift the shift position other than P. If this happens, please wait for a while before attempting to change the shift position again.

## 2-1. Driving procedures

### Turn signal lever

The turn signal lever can be used to show the following intention of the driver:

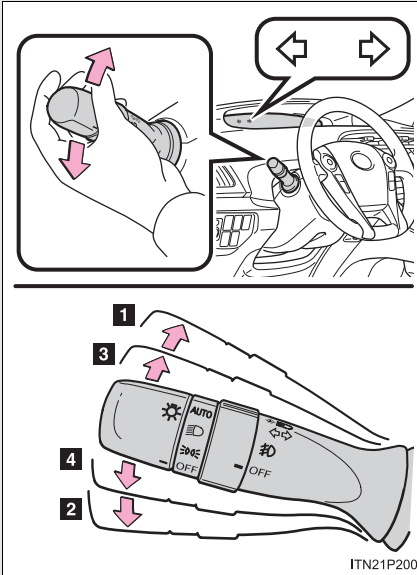

- 1 Right turn
- 2 Left turn
- 3 Lane change to the right (push and hold the lever partway)

The right hand signals will flash until you release the lever.

- 4 Lane change to the left (push and hold the lever partway)

The left hand signals will flash until you release the lever.

#### ■ Turn signals can be operated when

The "POWER" switch is in ON mode.

#### ■ If the indicator flashes faster than usual

Check that a light bulb in the front or rear turn signal lights has not burned out.

## 2-1. Driving procedures

### Parking brake

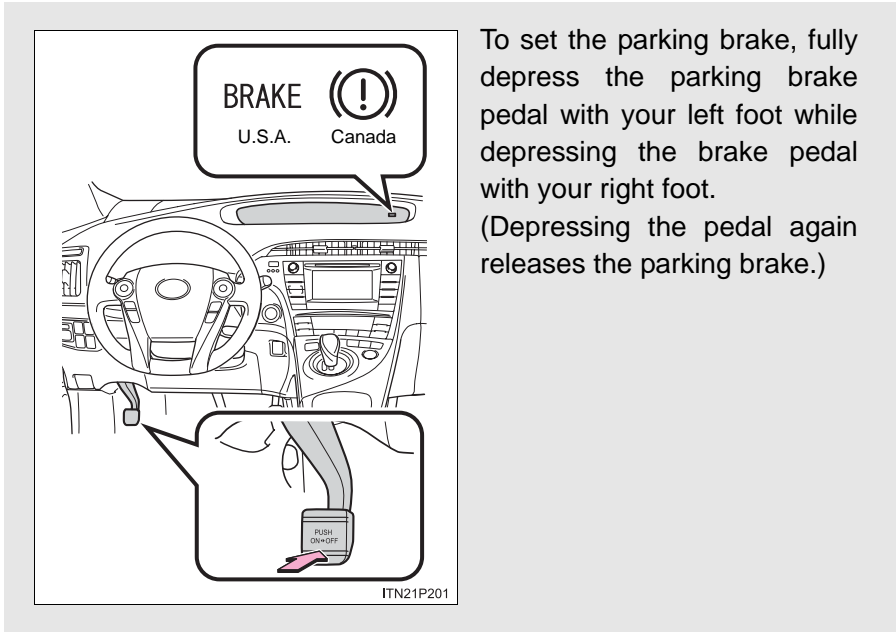

To set the parking brake, fully depress the parking brake pedal with your left foot while depressing the brake pedal with your right foot.

(Depressing the pedal again releases the parking brake.)

#### ■ Parking brake engaged warning buzzer

→P. 493

#### ■ Usage in winter time

→P. 317

#### ⚠ NOTICE

##### ■ Before driving

Fully release the parking brake.

Driving the vehicle with the parking brake set will lead to brake components overheating, which may affect braking performance and increase brake wear.



## Horn

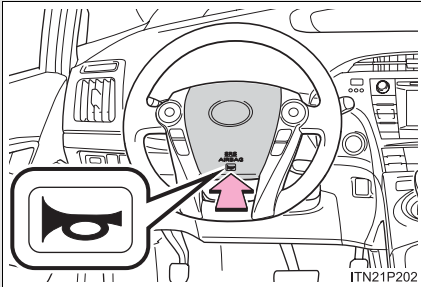

To sound the horn, press on or close to the  mark.

### ■ After adjusting the steering wheel

Make sure that the steering wheel is securely locked.

The horn may not sound if the steering wheel is not securely locked.

(→P. 117)

## 2-2. Instrument cluster Gauges and meters

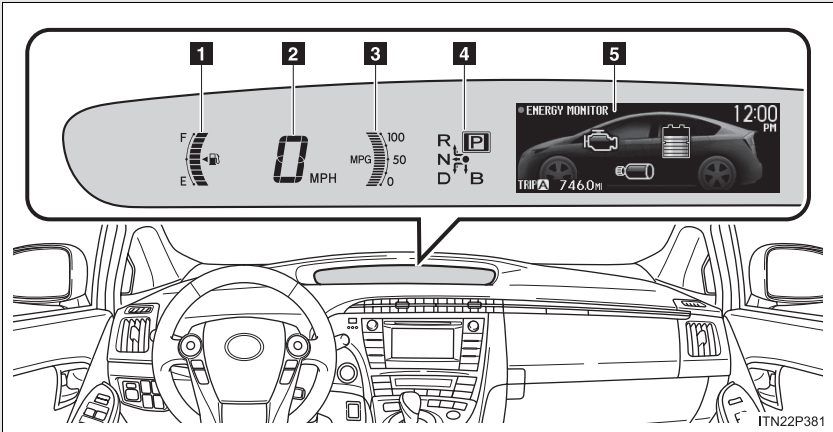

The units used on the display may differ depending on the target region.

The following gauges and meters and display illuminate when the “POWER” switch is in ON mode:

- 1 Fuel gauge**  
Displays the quantity of fuel remaining in the tank.
- 2 Speedometer**  
Displays the vehicle speed.
- 3 Instantaneous fuel consumption**  
Displays the current rate of fuel consumption.
- 4 Shift position indicators**  
Displays the shift position.
- 5 Multi-information display**  
Presents the driver with a variety of driving-related data. (→P. 223)

## Touch tracer display (if equipped)

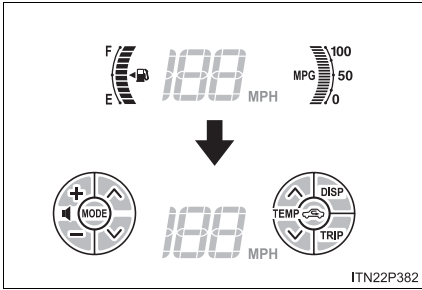

When the audio control switches, climate control switches, “DISP” button or “TRIP” button of the steering wheel are touched, the touch tracer display will appear in front of the gauges, with the touched button highlighted to allow the driver to identify the button that is being operated.

The button can then be operated by further presses.

If an audio/navigation system is used that is not compatible with the steering switches in this vehicle, the audio switch display may not operate correctly.

### MPH or km/h button

The speed units can be selected MPH or km/h.

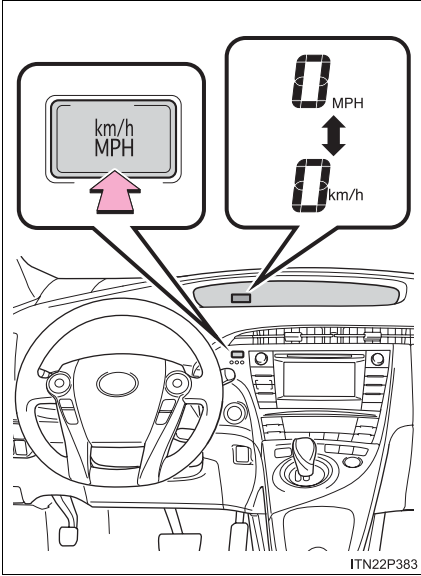

Press the button to switch the display between MPH and km/h.

## Instrument panel light control

The brightness of the instrument panel lights can be adjusted by turning the dial.

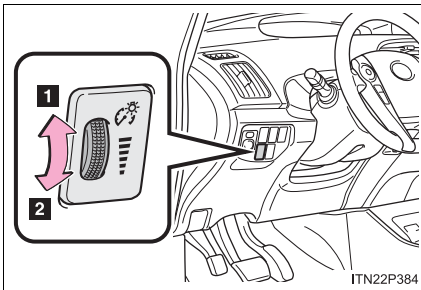

**1** Brighter

**2** Darker

### ■ Brightness of the instrument panel light

If the headlight switch is turned on while the surrounding area is dark, the instrument panel lights will dim.

**! CAUTION**

**■ To prevent an accident**

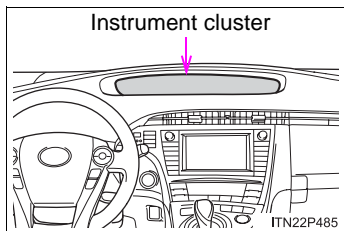

Do not place anything or attach a sticker in front of the instrument cluster. The item may obscure or obstruct the display, or could reflect off the display, possibly causing an accident.

**! NOTICE**

**■ To prevent damage to the engine and its components**

The engine may be overheating if the high coolant temperature warning light comes on or flashes. In this case, immediately stop the vehicle in a safe place, and check the engine after it has cooled completely. (→P. 549)



## ■ Indicators

The indicators inform the driver of the operating state of the vehicle's various systems.



Turn signal indicator  
(→P. 211)



"ECO MODE"  
indicator (→P. 204)



(U.S.A.)

Headlight indicator  
(→P. 250)



Power mode indicator  
(→P. 204)



(Canada)

Tail light indicator  
(→P. 250)



(if equipped)

Cruise control indicator  
(→P. 266, 270)



Headlight high beam  
indicator (→P. 253)



(if equipped)

Radar cruise control  
indicator (→P. 270)



Front fog light indicator  
(→P. 256)



(if equipped)

"SET" indicator  
(→P. 266, 270)



Security indicator  
(→P. 135)



(if equipped)

"LKA" indicator  
(→P. 286)



"READY" indicator  
(→P. 192)



\*1, 2

Slip indicator  
(→P. 297, 301)



Eco Driving Indicator  
Light (→P. 225)



EV indicator (→P. 225)





EV drive mode indicator (→P. 199)

\*1, 3



“PCS” warning (→P. 304)

(if equipped)



Shift position indicators (→P. 202)



“AIR BAG ON/OFF” indicator (→P. 154)

- \*1: These lights turn on when the “POWER” switch is turned to the ON mode to indicate that a system check is being performed. They will turn off after the hybrid system is on, or after a few seconds. There may be a malfunction in a system if a light does not come on, or if the lights do not turn off. Have the vehicle inspected by your Toyota dealer.
- \*2: The light flashes to indicate that the system is operating.
- \*3: The light comes on when the system is turned off. The light flashes faster than usual to indicate that the system is operating.

## ■ Warning lights

Warning lights inform the driver of malfunctions in any of the vehicle's systems. (→P. 493)

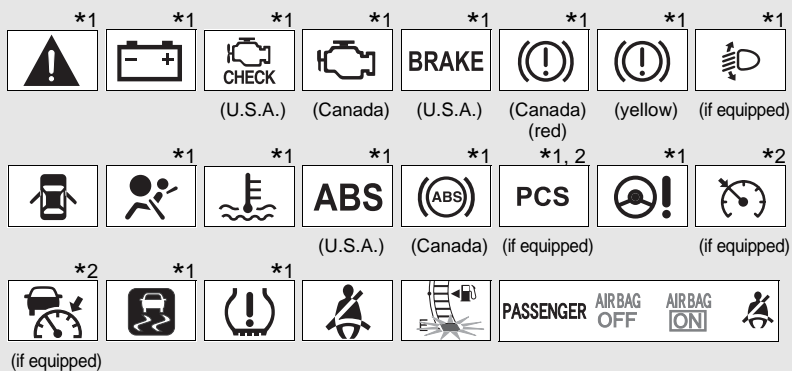

\*1: These lights turn on when the “POWER” switch is turned to ON mode to indicate that a system check is being performed. They will turn off after the hybrid system is on, or after a few seconds. There may be a malfunction in a system if a light does not come on, or if the lights do not turn off. Have the vehicle inspected by your Toyota dealer.

\*2: The light flashes to indicate a malfunction.

## ⚠ CAUTION

### ■ If a safety system warning light does not come on

Should a safety system light such as the ABS and SRS airbag warning light not come on when you start the hybrid system, this could mean that these systems are not available to help protect you in an accident, which could result in death or serious injury. Have the vehicle inspected by your Toyota dealer immediately if this occurs.

## Multi-information display

The multi-information display presents the driver with a variety of driving-related data, including the clock.

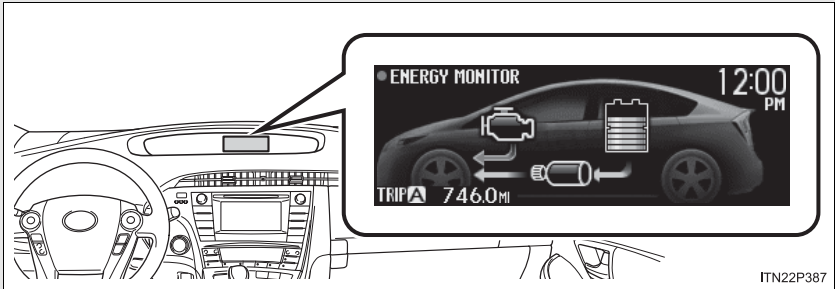

- Energy monitor (→P. 42)
- Hybrid System Indicator (→P. 225)
- 5-minute/1-minute fuel consumption (→P. 50)
- Monthly fuel consumption record/eco savings record (→P. 53)
- Odometer/trip meter/distance to empty (→P. 228)
- Clock (→P. 230)
- Calendar (→P. 230)
- Dynamic radar cruise control display (if equipped) (→P. 270)
- Lane-keeping assist display (if equipped) (→P. 286)
- Warning messages (→P. 507)

## Switching the display

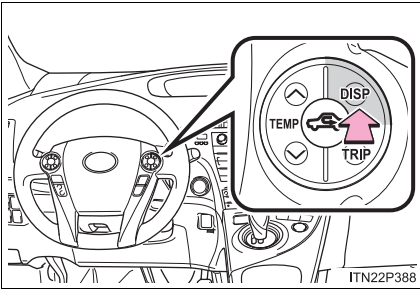

To switch the display, press “DISP” button.

On vehicles with touch tracer display, the steering switches operation status is displayed on the instrument cluster for confirmation purposes. (→P. 215)

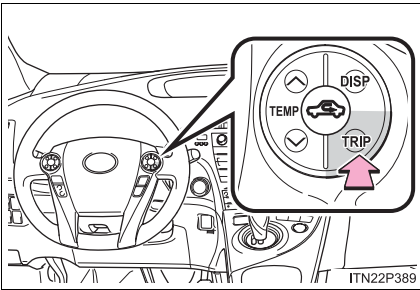

To switch the odometer, trip meter and distance to empty, press “TRIP” button.

## Hybrid System Indicator

Hybrid System Indicator displays the hybrid system operating condition and provides Eco-friendly driving assistance in accordance with the driving conditions and the acceleration.

### ■ Names and meaning of each icons

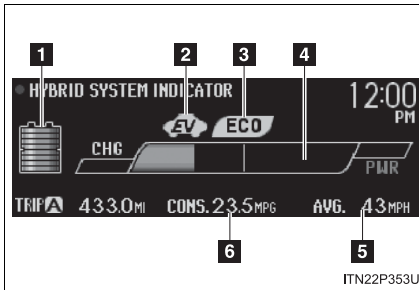

**1** Hybrid battery (traction battery) status (→P. 48)

**2** EV indicator

The EV indicator comes on when driving the vehicle using only the electric motor (traction motor).

**3** Eco Driving Indicator Light

Turns on when the vehicle is driven in Eco-friendly.

**4** Hybrid System Indicator

Refer to "Reading Hybrid System Indicator" below.

**5** Average speed\*

**6** Average fuel consumption/eco savings\*

Use the displayed average fuel consumption as a reference.

\*:The current amount since the trip meter was reset will be displayed. These functions can be reset by pressing and holding the "TRIP" button.



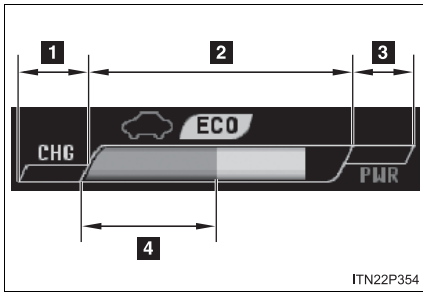

The display can be switched between average fuel consumption/average speed and eco savings. (→P. 232)

### ■ Reading Hybrid System Indicator



- 1** Charge area
- 2** Eco area
- 3** Power area
- 4** Hybrid Eco area

As shown below, the driving conditions of the vehicle can be confirmed by checking the status of the indicator bar.

	Hybrid System Indicator* <sup>1</sup>
Charge area: Shows regenerative charging. (→P. 32)	
Hybrid Eco area: Shows that gasoline engine power is not being used very often.* <sup>2</sup>	
Eco area: Shows that the vehicle is driven in Eco-friendly.	
Power area: Shows that the driving power is more than the upper limit of Eco driving (during full power driving etc.).	

\*<sup>1</sup>: The images are examples only, and may vary slightly from actual conditions.

\*<sup>2</sup>: The gasoline engine will automatically stop and restart under various conditions.

## Odometer/trip meter/distance to empty

### ■ Switching the display

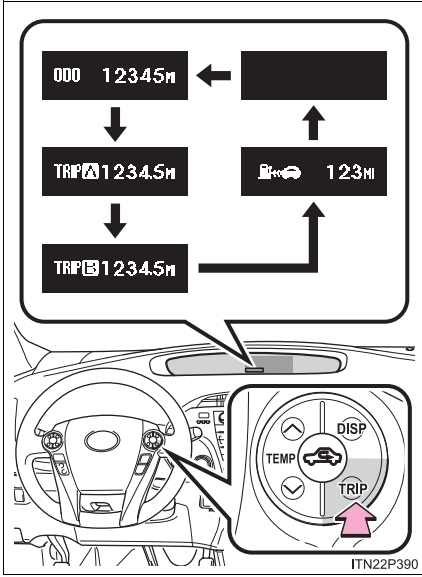

The display changes as follows each time the “TRIP” button is pressed. Also, if the button is kept pressed down while the trip meter is being displayed, the trip meter will be reset to 0.



## ■ Display items

### ● Odometer



Displays the total distance the vehicle has been driven.

### ● Trip meter



Displays the distance the vehicle has been driven since the meter was last reset. Trip meters A and B can be used to record and display different distances independently.

### ● Distance to empty



Displays the estimated maximum distance that can be driven with the quantity of fuel remaining.

- This distance is computed based on your average fuel consumption. As a result, the actual distance that can be driven may differ from that displayed.
- When only a small amount of fuel is added to the tank, the display may not be updated. When refueling, turn the “POWER” switch off. If the vehicle is refueled without turning the “POWER” switch off, the display may not be updated.

## Clock

The clock can be adjusted by pressing the buttons.

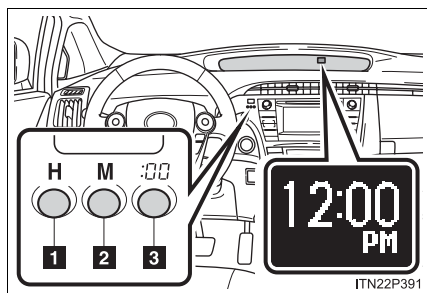

- 1 Adjust hours.
- 2 Adjust minutes.
- 3 Round the nearest hour.\*

\*: e.g. 1:00 to 1:29 → 1:00  
1:30 to 1:59 → 2:00

## Setting up the displays



Press the “DISP” button until the “SETTINGS” screen appears.

Calendar will be displayed.

- STEP 2** While the vehicle is stopped, press and hold the “DISP” button until the screen changes.

The selected item will change each time the “DISP” button is pressed.

## ■ Setting the gasoline price

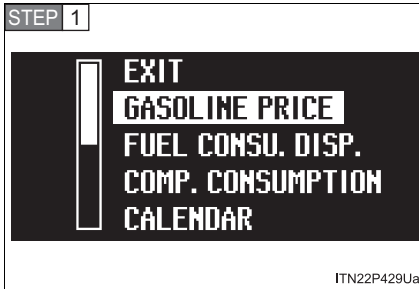

Select "GASOLINE PRICE".

Press and hold the "DISP" button to enter the setting mode.

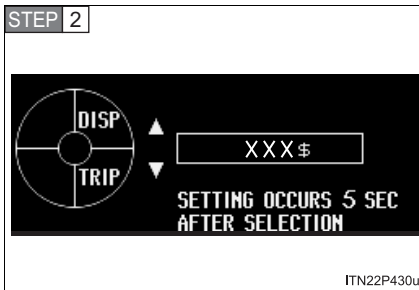

Select gasoline price by pressing the "DISP" or "TRIP" button.

Press and hold the button to change the amount continuously.

If neither button is operated for approximately 5 seconds, the setting will be changed and the screen will return to the previous display.

## ■ Switching the fuel consumption display

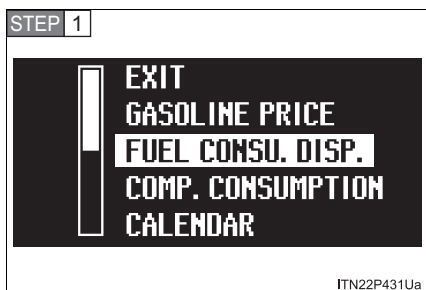

Select “FUEL CONSU. DISP.”.

Press and hold the “DISP” button to enter the setting mode.



Select “CONSUMP.” or “ECO SAVINGS”.

Press and hold the “DISP” button to finish setting.

## ■ Setting the comparison consumption

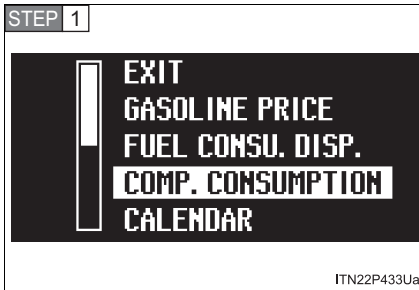

Select “COMP. CONSUMPTION”.

Press and hold the “DISP” button to enter the setting mode.

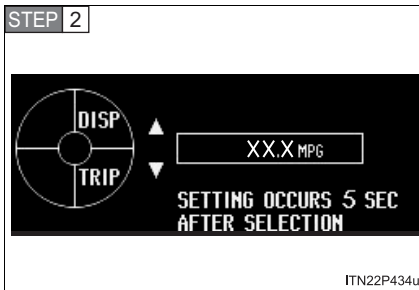

Select the comparison consumption by pressing the “DISP” or “TRIP” button.

Press and hold the button to change the amount continuously.

If neither button is operated for approximately 5 seconds, the setting will be changed and the screen will return to the previous display.

## ■ Setting the calendar

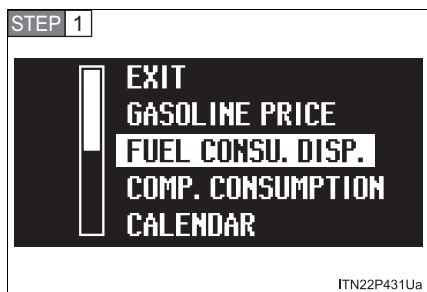

Select “CALENDAR”.

Press and hold the “DISP” button to enter the setting mode.

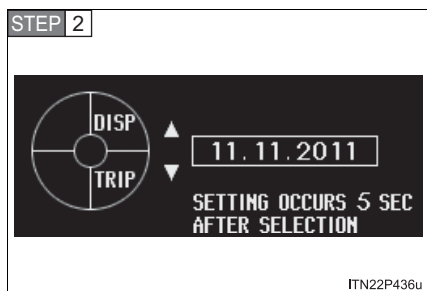

Select the date by pressing the “DISP” or “TRIP” button.

Press and hold the button to change the date continuously.

If neither button is operated for approximately 5 seconds, the setting will be changed and the screen will return to the previous display.

## ■ Switching the EV indicator and Eco Driving Indicator Light activated or deactivated

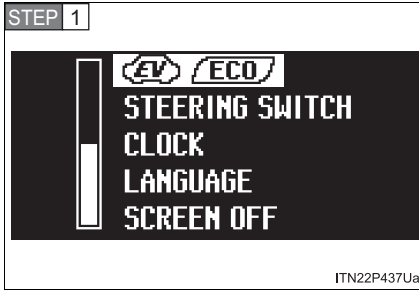

Select "EV/ECO".

Press and hold the "DISP" button to enter the setting mode.

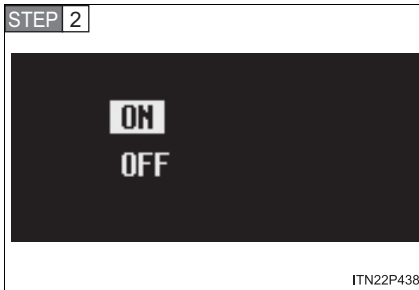

Select "ON" or "OFF".

Press and hold the "DISP" button to finish setting.

## ■ Switching the steering switch operation display on/off (if equipped)

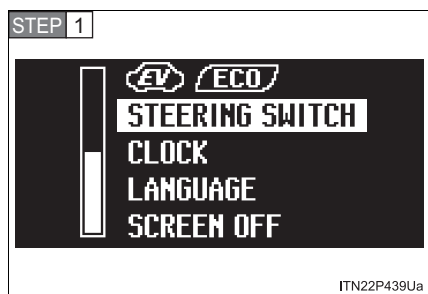

Select "STEERING SWITCH".

Press and hold the "DISP" button to enter the setting mode.



Select "ON" or "OFF".

Press and hold the "DISP" button to finish setting.



## ■ Selecting 12h/24h clock display

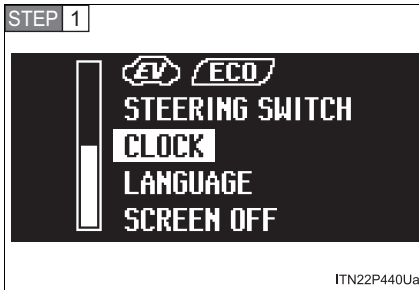

Select "CLOCK".

Press and hold the "DISP" button to enter the setting mode.

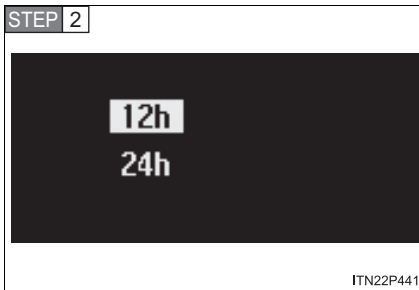

Select "12h" or "24h".

Press and hold the "DISP" button to finish setting.

## ■ Selecting the language

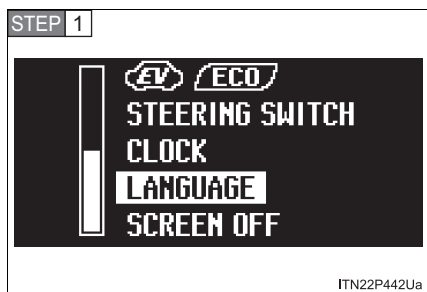

Select "LANGUAGE".

Press and hold the "DISP" button to enter the setting mode.



Select the language you want to read.

Press and hold the "DISP" button to set the language.

## ■ Turning off the multi-information display

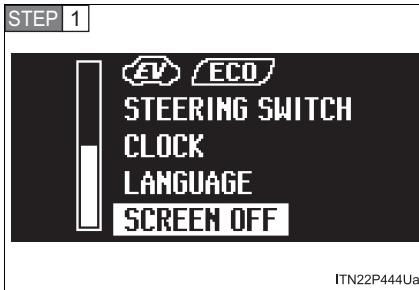

Select "SCREEN OFF".

Press and hold the "DISP" button to enter the setting mode.



Select "OFF".

Press and hold the "DISP" button to turn off the multi-information display.

To re-display the multi-information display, press the "DISP" button to display the "SETTINGS" screen and follow the same procedure, selecting "ON" instead of "OFF".

## ■ Returning to the previous screen

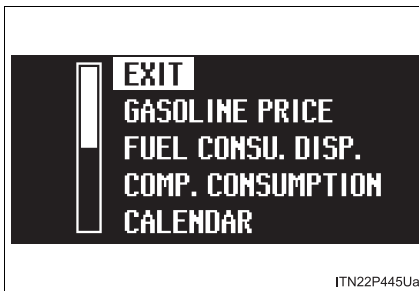

Select "EXIT" and press and hold the "DISP" button.

The screen will revert to the "SETTINGS" screen.

### ■ System check display



After switching the “POWER” switch to ON mode, “welcome to PRIUS” is displayed while system operation is checked. When the system check is complete, the normal screen will return.

### ■ Ending display

→P. 197

### ■ Eco Driving Indicator Light

Eco Driving Indicator Light will turn on when driving power is lower than the upper limit of Eco driving. It will turn off when the acceleration exceeds the Eco driving accelerator upper limit or when the vehicle is stopped.

Eco Driving Indicator Light will not operate in the following conditions:

- The shift position is anything other than D.
- The driving mode is set to power mode or EV drive mode. (→P. 199, 204)
- The vehicle speed is approximately 80 mph (130 km/h) or higher.

Eco Driving Indicator Light is also displayed when 5-minute consumption, 1-minute consumption, monthly fuel consumption record or eco savings record is displayed.

Eco Driving Indicator Light can be set to activated or deactivated. (→P. 235)

### ■ Driving in Eco drive mode

The multi-information display will automatically switch the display to Hybrid System Indicator, regardless of which display is currently being shown.

(→P. 225)

### ■ Touch tracer display

- The touch tracer display can be set to not display even if the steering switches are touched.
- Only the circular, rubber-covered switches have a built-in touch sensor. Touching any of the other switches will not display the touch tracer display.

### ■ Display settings can be changed when

The vehicle speed is less than approximately 5 mph (8 km/h).

### ■ Engine speed

On hybrid vehicles, engine speed is precisely controlled in order to help improve fuel efficiency and reduce exhaust emissions etc. There are times when the engine speed that is displayed may differ even when vehicle operation and driving conditions are the same.

### ■ When the 12-volt battery is disconnected

The following data will be reset.

- Average fuel consumption
- Distance to empty
- Average vehicle speed
- Clock
- Display settings
- Trip meter

### ■ Vacuum fluorescent display

Small spots or light spots may appear on the display. This phenomenon is characteristic of vacuum fluorescent displays, and there is no problem to continue using the display.

#### NOTICE

#### ■ Steering switches

To prevent damage to the steering switches, observe the following precautions.

- Do not touch the steering switches with wet hands
- Do not push hard or sharp objects into the steering switches
- Do not subject the steering switches to strong impacts
- Do not allow organic solvents containing thinner, benzene or gasoline, or acidic/alkaline soap to adhere to the surfaces of the steering switches

## 2-2. Instrument cluster Head-up display\*

The head-up display can be used to project vehicle speed and other information onto the windshield.

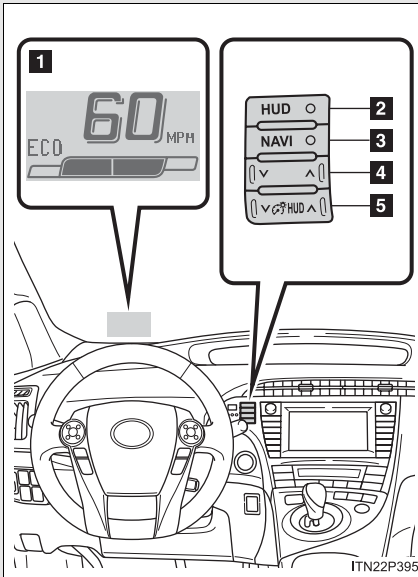

### 1 Head-up display

Display brightness will change automatically according to the brightness of the surrounding area.

### 2 HUD (Head-up display) main switch

### 3 Turn-by-turn navigation switch (if equipped)

### 4 Display position adjustment switch

### 5 Display brightness adjustment switch

Used to adjust the display brightness to the desired level.

### ■ Head-up display contents

- Speedometer

Displays the vehicle speed.

- Hybrid System Indicator

Provides assistance for Eco-friendly driving.

- Turn-by-turn navigation\*

Displays a notification of upcoming intersections during navigation system route guidance. (→P. 247)

- Dynamic radar cruise control\*

Indicates that there is a possibility of collision. (→P. 270)

- PCS (Pre-Collision System)\*

Displays the approach warning. (→P. 303)

- LKA (Lane-Keeping Assist)\*

Displays a warning message that alerts the driver of a deviation from the lane through use of the lane departure warning function. (→P. 498)

\*: If equipped



## Switching the head-up display

Display items can be switched by pressing the “HUD” main switch.

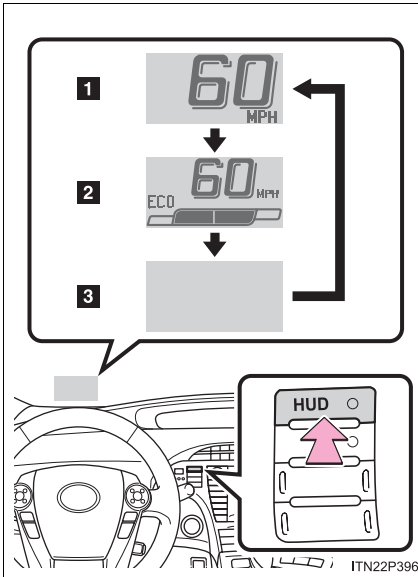

### 1 Speedometer

Displays the vehicle speed.

### 2 Speedometer and Hybrid System Indicator

Displays Hybrid System Indicator under the speedometer.  
(→P. 225)

### 3 Off

When on, the indicator light on the “HUD” main switch comes on.

2

When driving

## Switching the turn-by-turn navigation display (if equipped)

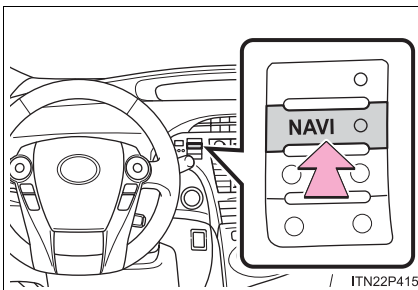

### On/off

When on, the indicator light on the “NAVI” button comes on.

## Setting up the display

### ■ Setting the brightness

The brightness of the display is automatically adjusted in accordance with the brightness of the surrounding environment. However, the brightness can also be manually adjusted in 5 stages.

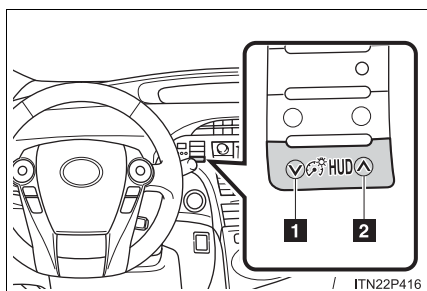

**1** Darker

**2** Brighter

The brightness can be manually adjusted in 5 stages.

### ■ Adjusting the display position

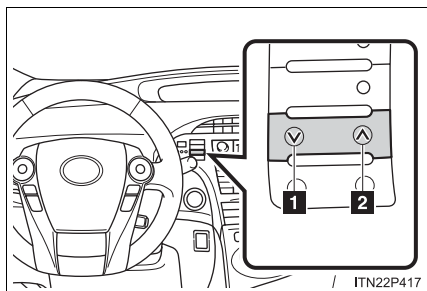

**1** Lower

**2** Higher

## Turn-by-turn navigation display (if equipped)

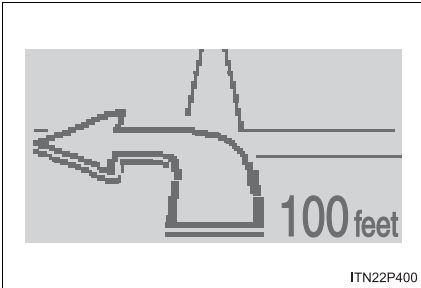

When the vehicle approaches an intersection, the direction the vehicle should go is guided by the arrow.

When the vehicle approaches an intersection, the route guidance will start and the distance\* to the intersection will also be displayed.

\*: The distance decreases in increments of 100 ft. (30 m) and the distance indication will disappear when the vehicle passes through the intersection.

2

When driving

### ■ System check display

When the "POWER" switch is turned OFF while the head-up display is on, and is then turned again to ON mode, "welcome to PRIUS" is displayed while system operation is checked. When the system check is complete, the normal screen will return.

### ■ When driving on snowy roads or in other bright environments

When the highest level of brightness has been reached, the display can be made even brighter by pressing and holding “^” on the brightness control button.

Pressing “v” on the brightness control button or turning the “POWER” switch off will cause the brightness level to revert to the original level.

### ■ Display speed setting function

The speedometer can be set to display only when a desired vehicle speed is reached.

**STEP 1** Press and hold the “HUD” main switch while the vehicle is stopped and while the head-up display is showing only the speedometer.

The speedometer will begin to flash.

**STEP 2** Set the desired display speed on the speedometer by pressing “^” and “v” on the display position adjustment button.

Press “^” to raise the speed and “v” to lower. The speed will change by 1 mph (1.6 km/h) each time the button is pressed, and continuously by 10 mph (16 km/h) when the button is pressed and held.

**STEP 3** Press and hold the “HUD” main switch to finish setting.

### ■ Head-up display

The head-up display may seem dark and hard to see when viewed through sunglasses, especially polarized sunglasses.

Adjust the brightness of the head-up display or remove your sunglasses.

### ■ When the 12-volt battery is disconnected

The head-up display settings will be reset.

**⚠ CAUTION****■ Before using the head-up display**

Check that the position and brightness of the head-up display image does not interfere with safe driving. Incorrect adjustment of the image's position or brightness may obstruct the driver's view and lead to an accident, resulting in death or serious injury.

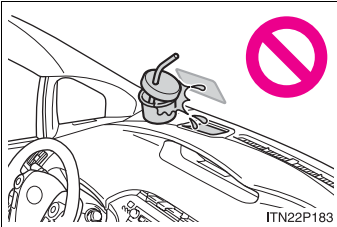
**⚠ NOTICE****■ To prevent damage to the components**

If an object falls into the opening of the head-up display, remove it immediately. Also, avoid spilling water or other liquids near the head-up display opening as this may cause mechanical damage.

## 2-3. Operating the lights and windshield wipers



### Headlight switch

The headlights can be operated manually or automatically.

Turning the end of the lever turns on the lights as follows:

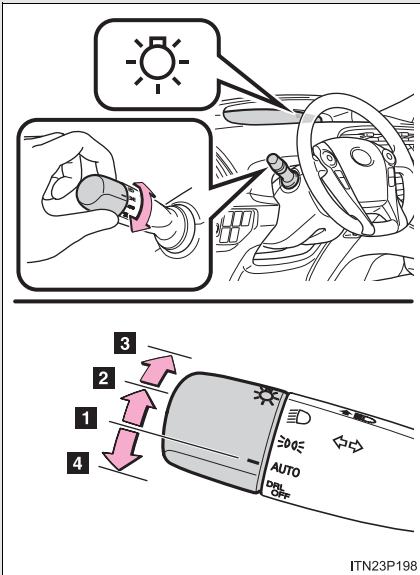

#### Type A



- 1 AUTO** (if equipped) The headlights, parking lights and so on turn on and off automatically (when the "POWER" switch is in ON mode).
- 2**  The side marker, parking, tail, license plate and instrument panel lights turn on.
- 3**  The headlights and all the lights listed above turn on.
- 4 DRL OFF** The daytime running lights turn off.

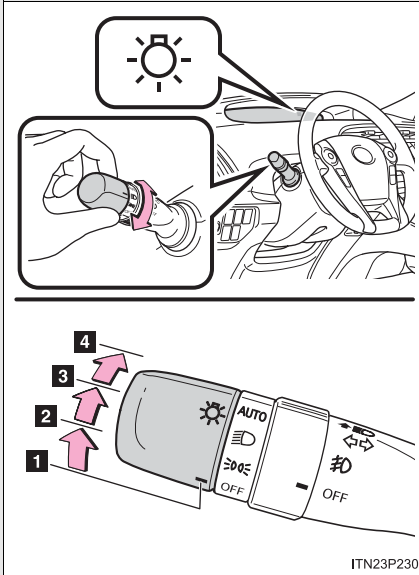

## Type B

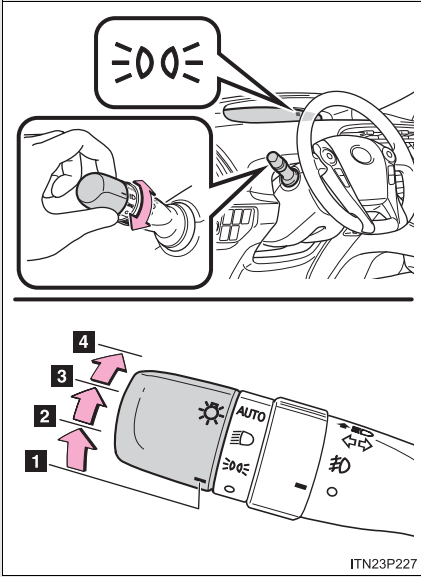

- 1 OFF** The lights (except daytime running lights) turn off.
- 2**  The side marker, parking, tail, license plate and instrument panel lights turn on.
- 3**  The headlights and all the lights listed above turn on.
- 4 AUTO** The headlights, parking lights and so on turn on and off automatically (when the "POWER" switch is in ON mode).

### Type C



- 1**  The daytime running lights turn on.
- 2**  The side marker, parking, tail, license plate, daytime running lights and instrument panel lights turn on.
- 3**  The headlights and all the lights listed above (except daytime running lights) turn on.
- 4** **AUTO** The headlights, parking lights, daytime running lights and so on turn on and off automatically (when the "POWER" switch is in ON mode).



## Turning on the high beam headlights

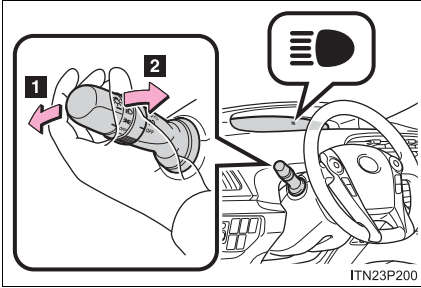

**1** With the headlights on, push the lever away from you to turn on the high beams.

Pull the lever toward you to the center position to turn the high beams off.

**2** Pull the lever toward you and release it to flash the high beams once.

You can flash the high beams with the headlights on or off.

2

When driving

### ■ Daytime running light system

- For the U.S.A.: To make your vehicle more visible to other drivers, the daytime running lights turn on automatically whenever the hybrid system is started and the parking brake is released.

Daytime running lights can be turned off by operating the switch. (if equipped)

For Canada: To make your vehicle more visible to other drivers, the daytime running lights turn on automatically (at a reduced intensity) whenever the hybrid system is started and the parking brake is released. Daytime running lights are not designed for use at night.

- For Canada: Compared to turning on the headlights, the daytime running light system offers greater durability and consumes less electricity, so it can help improve fuel economy.

### ■ Headlight control sensor (if equipped)

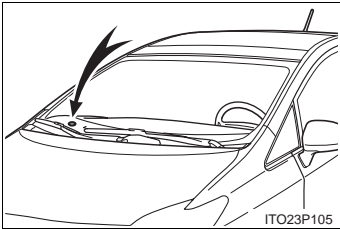



The sensor may not function properly if an object is placed on the sensor, or anything that blocks the sensor is affixed to the windshield.

Doing so interferes with the sensor detecting the level of ambient light and may cause the automatic headlight system to malfunction.

Air conditioning operation may also be interrupted.

### ■ Automatic light off system

- When the headlights come on: The headlights and tail lights turn off 30 seconds after a door is opened and closed if the “POWER” switch is turned to ACCESSORY mode or turned off. (The lights turn off immediately if  on the key is pressed after all the doors are locked.)
- When only the tail lights come on: The tail lights turn off automatically if the “POWER” switch is turned to ACCESSORY mode or turned off and the driver's door is opened.

To turn the lights on again, turn the “POWER” switch to ON mode, or turn the light switch off once and then back to  or .

**■ Automatic headlight leveling system (if equipped)**

The level of the headlights is automatically adjusted according to the number of passengers and the loading condition of the vehicle to ensure that the headlights do not interfere with other road users.

**■ Customization**

Settings (e.g. light sensor sensitivity) can be changed.  
(Customizable features →P. 590)

**NOTICE****■ To prevent 12-volt battery discharge**

Do not leave the lights on longer than necessary when the hybrid system is off.

## 2-3. Operating the lights and windshield wipers Fog light switch\*

The fog lights secure excellent visibility in difficult driving conditions, such as in rain and fog.

### Type A

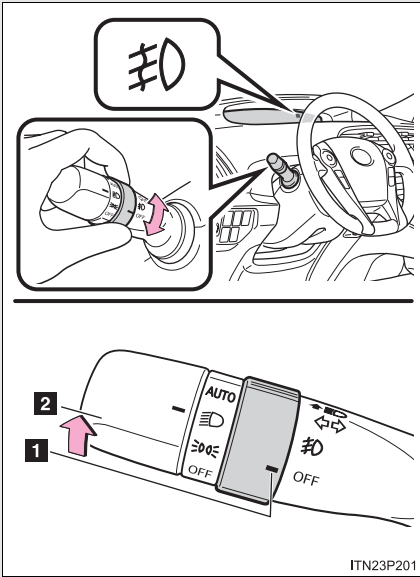

- 1** **⊘** OFF Turns the fog lights off
- 2** **⊘** Turns the fog lights on

ITN23P201

\*: If equipped

## Type B

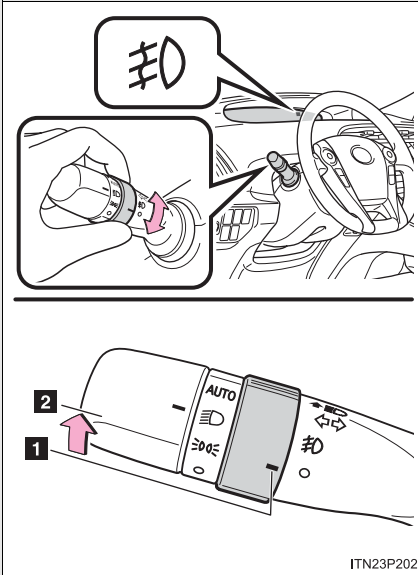

- 1 ○ Turns the fog lights off
- 2 ⊘ Turns the fog lights on

- **Fog lights can be used when**  
The headlights are on in low beam.

 NOTICE

■ **To prevent 12-volt battery discharge**

Do not leave the lights on longer than necessary when the hybrid system is off.

## 2-3. Operating the lights and windshield wipers

### Windshield wipers and washer

When intermittent windshield wiper operation is selected, wiper intervals can be also adjusted.

The wiper operation is selected by moving the lever as follows.

#### Type A

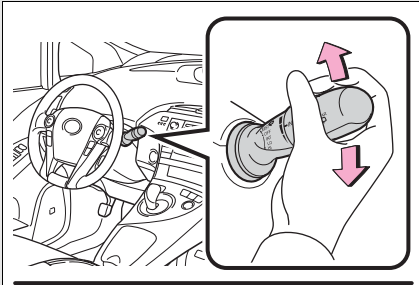

- 1 INT** Intermittent windshield wiper operation
- 2 LO** Low speed windshield wiper operation
- 3 HI** High speed windshield wiper operation
- 4 MIST** Temporary operation

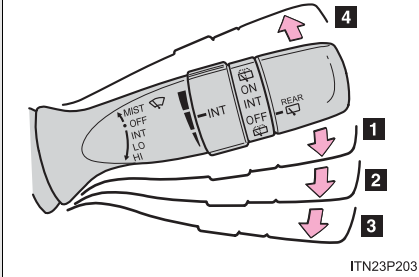

ITN23P203

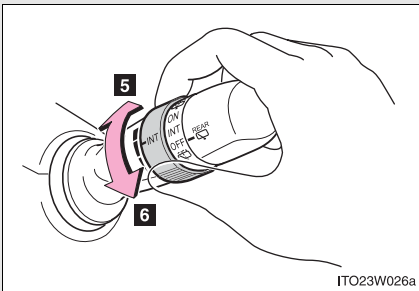

- 5** Increases the intermittent windshield wiper frequency (if equipped)
- 6** Decreases the intermittent windshield wiper frequency (if equipped)

ITO23W026a

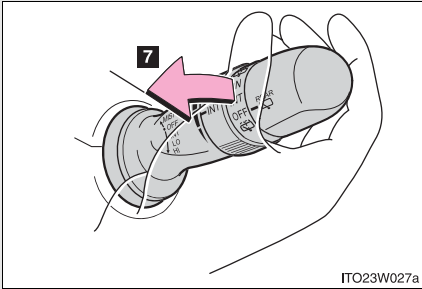





**7** Washer/wiper dual operation

The wipers will automatically operate a couple of times after the washer squirts.

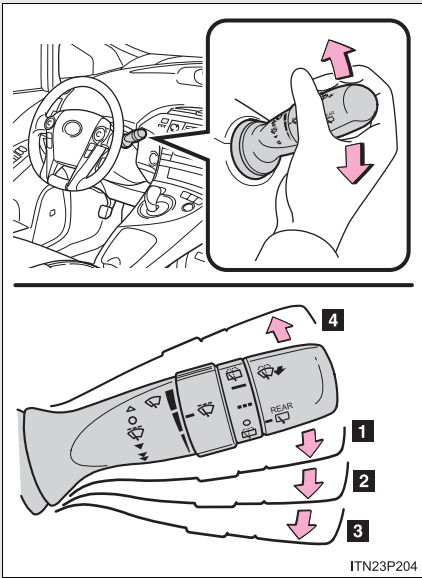
If the headlights are on, the headlight cleaner will operate once.

**Type B**



- 1**  Intermittent windshield wiper operation
- 2**  Low speed windshield wiper operation
- 3**  High speed windshield wiper operation
- 4**  Temporary operation

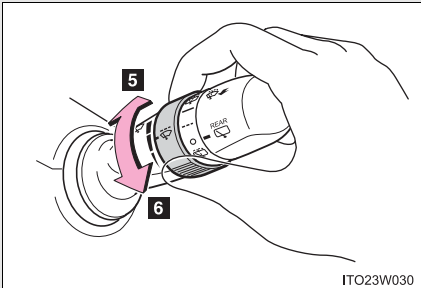

**5** Increases the intermittent windshield wiper frequency (if equipped)

**6** Decreases the intermittent windshield wiper frequency (if equipped)

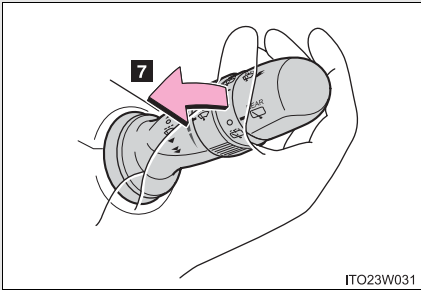

**7** Washer/wiper dual operation

The wipers will automatically operate a couple of times after the washer squirts.

If the headlights are on, the headlight cleaner will operate once.

---

■ **The windshield wipers and washer can be operated when**

The "POWER" switch is in ON mode.

■ **If no windshield washer fluid sprays**

Check that the washer nozzles are not blocked if there is washer fluid in the washer fluid tank.



 CAUTION**■ Caution regarding the use of washer fluid**

When it is cold, do not use the washer fluid until the windshield becomes warm. The fluid may freeze on the windshield and cause low visibility. This may lead to an accident, resulting in death or serious injury.

 NOTICE**■ When the windshield is dry**

Do not use the wipers, as they may damage the windshield.

**■ When the washer fluid tank is empty**

Do not operate the switch continually as the washer fluid pump may over-heat.

**■ When a nozzle becomes blocked**

In this case, contact your Toyota dealer.



Do not try to clear it with a pin or other object. The nozzle will be damaged.

**■ To prevent 12-volt battery discharge**

Do not leave the wipers on longer than necessary when the hybrid system is off.

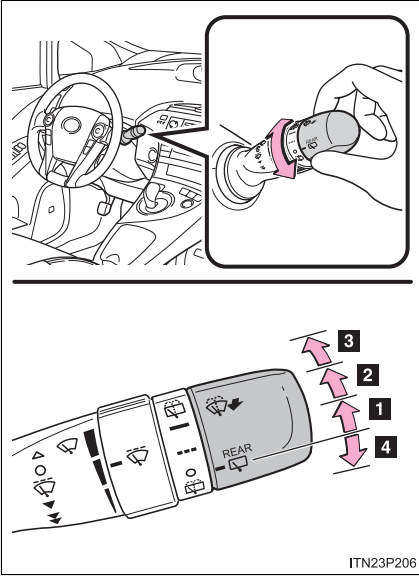

**Type B**

- |          |                                                                                   |                                     |
|----------|-----------------------------------------------------------------------------------|-------------------------------------|
| <b>1</b> | ---                                                                               | Intermittent window wiper operation |
| <b>2</b> | —                                                                                 | Normal window wiper operation       |
| <b>3</b> |  | Washer/wiper dual operation         |
| <b>4</b> |  | Washer/wiper dual operation         |

■ **The rear window wiper and washer can be operated when**

The "POWER" switch is in ON mode.

■ **If no washer fluid sprays**

Check that the washer nozzles are not blocked if there is washer fluid in the washer fluid reservoir.



**NOTICE**

■ **When the rear window is dry**

Do not use the wiper, as it may damage the rear window.

■ **When the washer fluid tank is empty**

Do not operate the switch continually as the washer fluid pump may over-heat.

## 2-3. Operating the lights and windshield wipers Headlight cleaner switch\*

**Washer fluid can be sprayed on the headlights.**

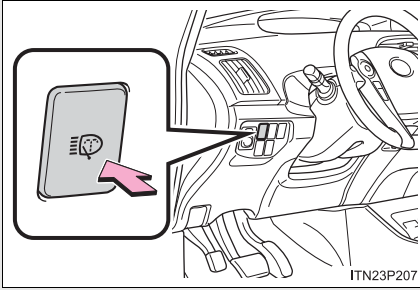

Press the switch to clean the headlights.

2

When driving

### ■ The headlight cleaners can be operated when

The "POWER" switch is in ON mode and the headlight switch is turned on. If equipped, the headlight switch is in the "AUTO" position and the headlight is on.

### ■ Windshield washer linked operation

Only for the first time when the windshield washer is operated with the "POWER" switch in ON mode and the headlights on, the headlight cleaners will operate once. (→P. 258)

### NOTICE

#### ■ When the washer fluid tank is empty

Do not press the switch continually as the washer fluid pump may overheat.

\*: If equipped

## Cruise control\*

Use the cruise control to maintain a set speed without depressing the accelerator pedal.

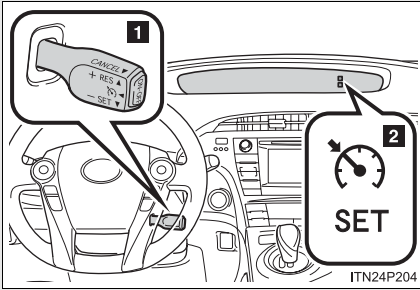

1 Cruise control switch

2 Indicators

### ■ Setting the vehicle speed

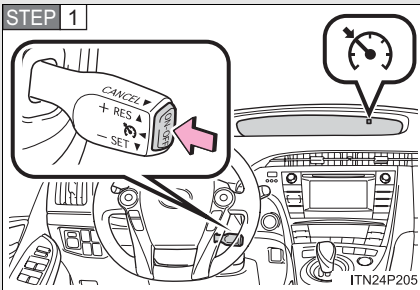

Press the “ON-OFF” button to activate the cruise control.

Cruise control indicator will come on.

Press the button again to deactivate the cruise control.

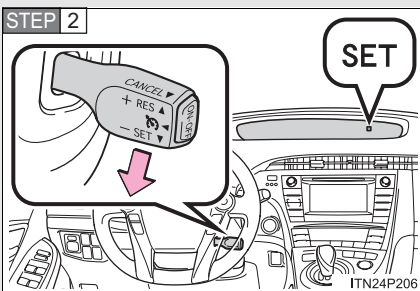

Accelerate or decelerate the vehicle to the desired speed, and push the lever down to set the speed.

“SET” indicator will come on. The vehicle speed at the moment the lever is released becomes the set speed.

\*: If equipped

### ■ Adjusting the set speed

To change the set speed, operate the lever until the desired set speed is obtained.

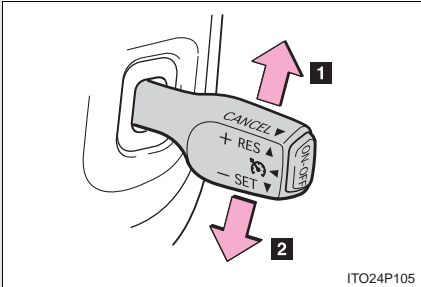

- 1** Increases the speed
- 2** Decreases the speed

Fine adjustment: Momentarily move the lever in the desired direction.

Large adjustment: Hold the lever in the desired direction.

The set speed will be increased or decreased as follows:

Fine adjustment: By approximately 1 mph (1.6 km/h) each time the lever is operated.

Large adjustment: The set speed can be increased or decreased continually until the lever is released.

### ■ Canceling and resuming the constant speed control

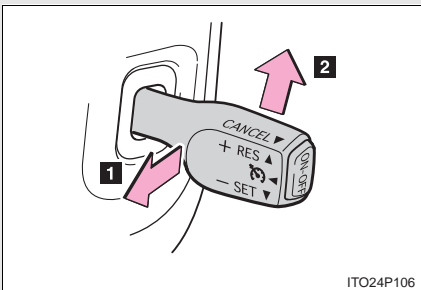

- 1** Pulling the lever toward you cancels the constant speed control.

The speed setting is also canceled when the brakes are applied.

- 2** Pushing the lever up resumes the constant speed control.

Resuming is available when the vehicle speed is more than approximately 25 mph (40 km/h).

■ **Cruise control can be set when**

- The shift position is in D.
- Vehicle speed is above approximately 25 mph (40 km/h).

■ **Accelerating after setting the vehicle speed**

- The vehicle can be accelerated normally. After acceleration, the set speed resumes.
- Even without canceling the cruise control, the set speed can be increased by first accelerating the vehicle to the desired speed and then pushing the lever down to set the new speed.

■ **Automatic cruise control cancelation**

Cruise control will stop maintaining the vehicle speed in any of the following situations.

- Actual vehicle speed falls more than approximately 10 mph (16 km/h) below the preset vehicle speed.  
At this time, the memorized set speed is not retained.
- Actual vehicle speed is below approximately 25 mph (40 km/h).
- Enhanced VSC is activated.

■ **If the cruise control indicator light flashes**

Press the “ON-OFF” button once to deactivate the system, and then press the button again to reactivate the system.

If the cruise control speed cannot be set or if the cruise control cancels immediately after being activated, there may be a malfunction in the cruise control system. Have the vehicle inspected by your Toyota dealer.



 **CAUTION****■ To avoid operating the cruise control by mistake**

Switch the cruise control off using the “ON-OFF” button when not in use.

**■ Situations unsuitable for cruise control**

Do not use cruise control in any of the following situations.

Doing so may result in loss of control and could cause an accident resulting in death or serious injury.

- In heavy traffic
- On roads with sharp bends
- On winding roads
- On slippery roads, such as those covered with rain, ice or snow
- On steep hills  
Vehicle speed may exceed the set speed when driving down a steep hill.
- During emergency towing

## 2-4. Using other driving systems

### Dynamic radar cruise control\*

Dynamic radar cruise control supplements conventional cruise control with a vehicle-to-vehicle distance control. In vehicle-to-vehicle distance control mode, the vehicle automatically accelerates or decelerates in order to maintain a set following distance from vehicles ahead.

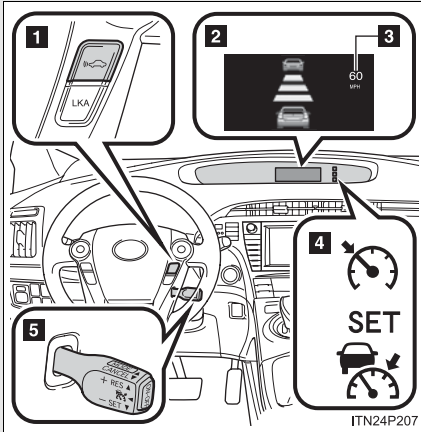

- 1 Vehicle-to-vehicle distance button
- 2 Display
- 3 Set speed
- 4 Indicators
- 5 Cruise control switch

\*: If equipped

## ■ Setting the vehicle speed (vehicle-to-vehicle distance control mode)

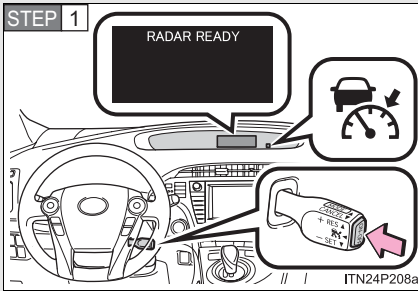

Press the “ON-OFF” button to activate the cruise control.

Radar cruise control indicator will come on.

Press the button again to deactivate the cruise control.

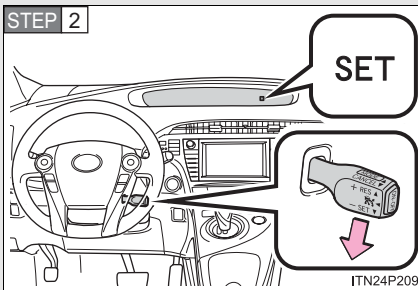

Accelerate or decelerate the vehicle to the desired speed, and push the lever down to set the speed.

“SET” indicator will come on.

The vehicle speed at the moment the lever is released becomes the set speed.

## ■ Adjusting the set speed

To change the set speed, operate the lever until the desired set speed is displayed.

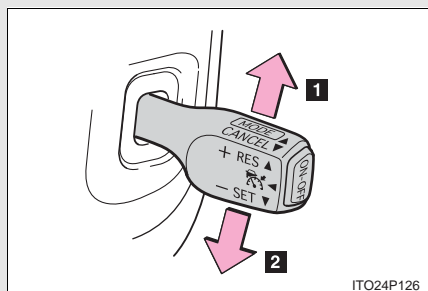

**1** Increases the speed

**2** Decreases the speed

Fine adjustment: Momentarily move the lever in the desired direction.

Large adjustment: Hold the lever in the desired direction.

In the vehicle-to-vehicle distance control mode, the set speed will be increased or decreased as follows:

- When the set speed is shown in “MPH”

Fine adjustment: By approximately 1 mph (1.6 km/h) each time the lever is operated

Large adjustment: By approximately 5 mph (8 km/h) for each 0.75 seconds the lever is held

- When the set speed is shown in “km/h”

Fine adjustment: By approximately 0.6 mph (1 km/h) each time the lever is operated

Large adjustment: By approximately 3.1 mph (5 km/h) for each 0.75 seconds the lever is held

In the constant speed control mode (→P. 278), the set speed will be increased or decreased as follows:

Fine adjustment: By approximately 1 mph (1.6 km/h) each time the lever is operated

Large adjustment: The set speed can be increased or decreased continually until the lever is released.

## ■ Changing the vehicle-to-vehicle distance

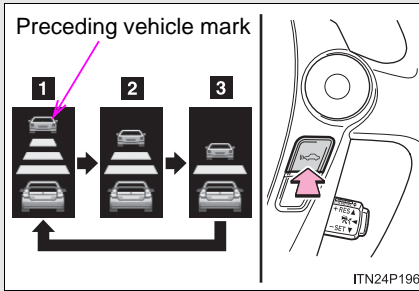

Pressing the button changes the vehicle-to-vehicle distance as follows:

- 1** Long
- 2** Medium
- 3** Short

The vehicle-to-vehicle distance is set automatically to long mode when the “POWER” switch is turned to ON mode.

If a vehicle is running ahead of you, the preceding vehicle mark will also be displayed.

## ■ Vehicle-to-vehicle distance settings

Select a distance from the table below. Note that the distances shown correspond to a vehicle speed of 50 mph (80 km/h). Vehicle-to-vehicle distance increases/decreases in accordance with vehicle speed.

Distance options	Vehicle-to-vehicle distance
Long	Approximately 160 ft. (50 m)
Medium	Approximately 130 ft. (40 m)
Short	Approximately 100 ft. (30 m)

### ■ Canceling and resuming the speed control

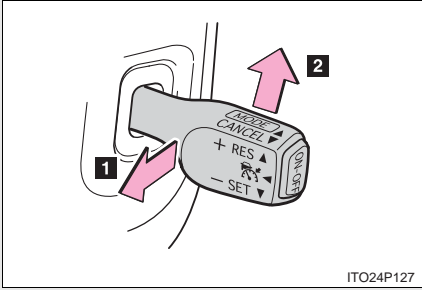

- 1** Pulling the lever toward you cancels the cruise control.

The speed setting is also canceled when the brakes are applied.

- 2** Pushing the lever up resumes the cruise control and returns vehicle speed to the set speed.

Resuming is available when the vehicle speed is more than approximately 25 mph (40 km/h).

### Driving in vehicle-to-vehicle distance control mode

This mode employs a radar sensor to detect the presence of vehicles up to approximately 400 ft. (120 m) ahead, determines the current vehicle-to-vehicle following distance, and operates to maintain a suitable following distance from the vehicle ahead.

Note that vehicle-to-vehicle distance will close in when traveling on long downhill slopes.

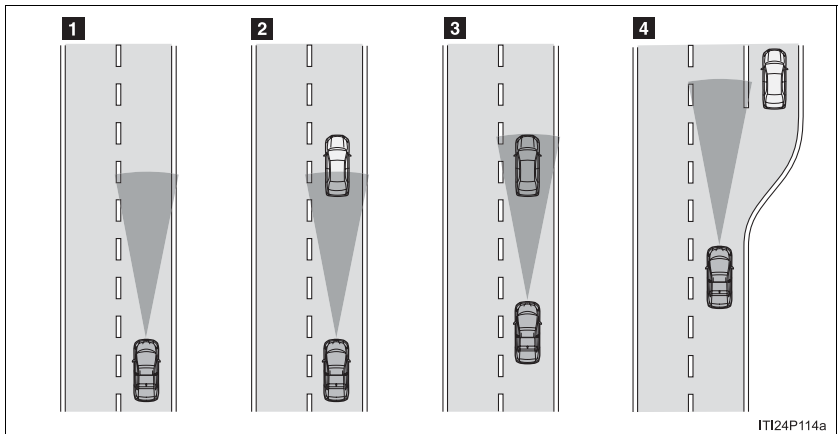

### **1** Example of constant speed cruising

When there are no vehicles ahead

The vehicle travels at the speed set by the driver. The desired vehicle-to-vehicle distance can also be set by operating the vehicle-to-vehicle distance control.

### **2** Example of deceleration cruising

When the vehicle ahead is driving slower than the set speed

When a vehicle is detected running ahead of you, the system automatically decelerates your vehicle. When a greater reduction in vehicle speed is necessary, the system applies the brakes. A warning tone warns you when the system cannot decelerate sufficiently to prevent your vehicle from closing in on the vehicle ahead.

### **3** Example of follow-up cruising

When following a vehicle driving slower than the set speed

The system continues follow-up cruising while adjusting for changes in the speed of the vehicle ahead in order to maintain the vehicle-to-vehicle distance set by the driver.

### **4** Example of acceleration

When there are no longer any vehicles ahead driving slower than the set speed

The system accelerates until the set speed is reached. The system then returns to constant speed cruising.



## Approach warning

When your vehicle is too close to a vehicle ahead, and sufficient automatic deceleration via the cruise control is not possible, the display will flash and the buzzer will sound to alert the driver. An example of this would be if another driver cuts in front of you while you are following a vehicle. Apply the brakes to ensure an appropriate vehicle-to-vehicle distance.

### ■ Warnings may not occur when

In the following instances, there is a possibility that the warnings will not occur:

- When the speed of the vehicle ahead matches or exceeds your vehicle speed
- When the vehicle ahead is traveling at an extremely slow speed
- Immediately after the cruise control speed was set
- At the instant the accelerator is applied

## Selecting conventional constant speed control mode

Constant speed control mode differs from vehicle-to-vehicle distance control mode. When constant speed mode is selected, your vehicle will maintain a set speed regardless of whether or not there are other vehicles in the lane ahead.

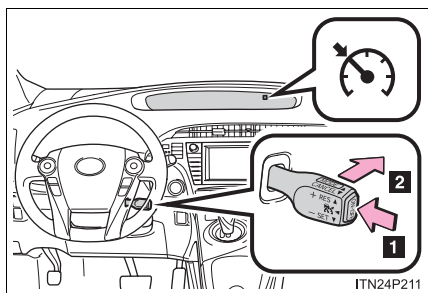

- 1** Press the “ON-OFF” button to activate the cruise control.

Press the button again to deactivate the cruise control.

- 2** Switch to constant speed control mode.

(Push the lever forward and hold for approximately 1 second.)

Cruise control indicator will come on.

When in constant speed control mode, to return to vehicle-to-vehicle distance control mode, push the lever forward again and hold for approximately 1 second.

After the desired speed has been set, it is not possible to return to vehicle-to-vehicle distance control mode.

If the "POWER" switch is turned off and then turned to ON mode again, the vehicle will automatically return to vehicle-to-vehicle distance control mode.

Adjusting the speed setting:  
→P. 272

Canceling and resuming the speed setting: →P. 274

---

### ■ Dynamic radar cruise control can be set when

- The shift position is in D.
- Vehicle speed is above approximately 30 mph (50 km/h).

### ■ Accelerating after setting the vehicle speed

The vehicle can accelerate normally. After acceleration, the set speed resumes. However, during vehicle-to-vehicle distance control mode, the vehicle speed may decrease below the set speed in order to maintain the distance to the vehicle ahead.

### ■ Set speed

The set speed may be unsustainable depending on driving circumstances.

### ■ Automatic cancelation of vehicle-to-vehicle distance control

Vehicle-to-vehicle distance control driving is automatically canceled in the following situations:

- Actual vehicle speed falls below approximately 25 mph (40 km/h).
- Enhanced VSC is activated.
- The sensor cannot operate correctly because it is covered in some way.
- The windshield wipers are operating at high speed (when the wiper switch is set to the high speed windshield wiper operation position).

If vehicle-to-vehicle distance control driving is automatically canceled for any other reason, there may be a malfunction in the system. Contact your Toyota dealer.

### ■ Automatic cancelation of constant speed control

The cruise control will stop maintaining the vehicle speed in the following situations:

- Actual vehicle speed is more than approximately 10 mph (16 km/h) below the set vehicle speed.  
At this time, the memorized set speed is not retained.
- Vehicle speed falls below approximately 25 mph (40 km/h).
- Enhanced VSC is activated.

### ■ Radar sensor and grille cover

Always keep the sensor and grille cover clean to ensure that the vehicle-to-vehicle distance control operates properly. (Some obstructions, such as snow, ice and plastic objects, cannot be detected by the obstruction sensor.) Dynamic radar cruise control (vehicle-to-vehicle distance control mode) will be canceled if dirt is detected. (Constant speed control mode can be used).

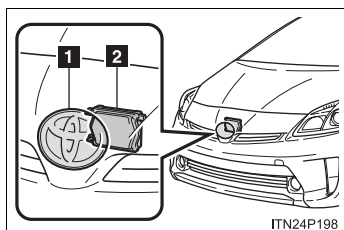

- 1 Grille cover
- 2 Radar sensor

## ■ Warning lights, messages and buzzers for dynamic radar cruise control

Warning lights, warning messages and buzzers are used to indicate a system malfunction or to inform the driver of the need for caution while driving.

## ■ Certification

### For vehicles sold in the U.S.A.

FCC ID: HYQDNMWR004

This device complies with part 15 of the FCC Rules. Operation is subject to the following two conditions: (1) This device may not cause harmful interference, and (2) this device must accept any interference received, including interference that may cause undesired operation.

### FCC WARNING

Changes or modifications not expressly approved by the party responsible for compliance could void the user's authority to operate the equipment.

Radiofrequency radiation exposure Information:

This equipment complies with FCC radiation exposure limits set forth for an uncontrolled environment.

This equipment should be installed and operated with minimum distance of 20 cm between the radiator (antenna) and your body.

This transmitter must not be co-located or operating in conjunction with any other antenna or transmitter.

### For vehicles sold in Canada

Operation is subject to the following two conditions: (1) this device may not cause interference, and (2) this device must accept any interference, including interference that may cause undesired operation of the device.

 CAUTION

■ **Before using dynamic radar cruise control**

Do not overly rely on vehicle-to-vehicle distance control.

Be aware of the set speed. If automatic deceleration/acceleration is not appropriate, adjust the vehicle speed, as well as the distance between your vehicle and vehicles ahead by applying the brakes etc.

■ **Cautions regarding the driving assist systems**

Observe the following precautions.

Failure to do so may cause an accident resulting in death or serious injury.

● **Assisting the driver to measure following distance**

The dynamic radar cruise control is only intended to help the driver in determining the following distance between the driver's own vehicle and a designated vehicle traveling ahead. It is not a mechanism that allows careless or inattentive driving, and it is not a system that can assist the driver in low-visibility conditions. It is still necessary for driver to pay close attention to the vehicle's surroundings.

● **Assisting the driver to judge proper following distance**

The dynamic radar cruise control determines whether the following distance between the driver's own vehicle and a designated vehicle traveling ahead is appropriate or not. It is not capable of making any other type of judgement. Therefore, it is absolutely necessary for the driver to remain vigilant and to determine whether or not there is a possibility of danger in any given situation.

● **Assisting the driver to operate the vehicle**

The dynamic radar cruise control has no capability to prevent or avoid a collision with a vehicle traveling ahead. Therefore, if there is ever any danger, the driver must take immediate and direct control of the vehicle and act appropriately in order to ensure the safety of all involved.

 **CAUTION****■ To avoid inadvertent cruise control activation**

Switch the cruise control off using the “ON-OFF” button when not in use.

**■ Situations unsuitable for dynamic radar cruise control**

Do not use dynamic radar cruise control in any of the following situations. Doing so may result in inappropriate speed control and could cause an accident resulting in death or serious injury.

- In heavy traffic
- On roads with sharp bends
- On winding roads
- On slippery roads, such as those covered with rain, ice or snow
- On steep downhill, or where there are sudden changes between sharp up and down gradients  
Vehicle speed may exceed the set speed when driving down a steep hill.
- At entrances to expressways
- When weather conditions are bad enough that they may prevent the sensors from functioning correctly (fog, snow, sandstorm, heavy rain, etc.)
- When an approach warning buzzer is heard often
- During emergency towing

 **CAUTION**

■ **When the sensor may not be correctly detecting the vehicle ahead**

Apply the brakes as necessary when any of the following types of vehicles are in front of you.

As the sensor may not be able to correctly detect these types of vehicles, the approach warning (→P. 277) will not be activated, and a fatal or serious accident may result.

- Vehicles that cut in suddenly
- Vehicles traveling at low speeds
- Vehicles that are not moving
- Vehicles with small rear ends (trailers with no load on board etc.)
- Motorcycles traveling in the same lane

■ **Conditions under which the vehicle-to-vehicle distance control may not function correctly**

Apply the brakes as necessary in the following conditions as the radar sensor may not be able to correctly detect vehicles ahead, and a fatal or serious accident may result:

- When water or snow thrown up by the surrounding vehicles hinders the functioning of the sensor
- When your vehicle is pointing upwards (caused by a heavy load in the luggage compartment etc.)
- When the road curves or when the lanes are narrow
- When steering wheel operation or your position in the lane is unstable
- When the vehicle ahead of you decelerates suddenly



 CAUTION**■ Handling the radar sensor**

Observe the following to ensure the cruise control system can function effectively.

Otherwise, the system may not function correctly and could result in an accident.

- Keep the sensor and grille cover clean at all times.  
Clean the sensor and grille cover with a soft cloth so you do not mark or damage them.
- Do not subject the sensor or surrounding area to a strong impact.  
If the sensor has moved out of position, the system may malfunction or operate incorrectly. If the sensor or surrounding area is subject to a strong impact, always have the area inspected and adjusted by a Toyota dealer.
- Do not disassemble the sensor.
- Do not attach accessories or stickers to the sensor, grille cover or surrounding area.
- Do not modify or paint the sensor and grille cover.
- Do not replace them with non-genuine parts.

## LKA (Lane-Keeping Assist)\*

**While driving on a freeway or motor highway that has lane markings, this system recognizes the lanes using a camera as a sensor to assist the driver with staying in the lane. The LKA system has two functions.**

### ■ Lane departure warning function

If the system judges that the vehicle may deviate from its lane, it alerts the driver using rapid beeping, indications on the multi-information display, and a sensory warning\* given via the steering wheel.

\*: A slight steering torque is applied for a short period of time in the direction of the center of the lane.

### ■ Lane keeping assist function

This function will be active when the vehicle-to-vehicle distance control mode of the cruise control (→P. 270) is set with vehicle speed above approx. 50 mph (approx. 75 km/h) and while the lane departure warning function is active. When the lane keeping assist function is active, a slight steering torque will be applied, to help the driver maintain the vehicle inside the lane.

\*: If equipped

### ■ Turning the LKA system on

The lane departure warning function and lane keeping assist function will be automatically activated depending on the recognition condition of lane markings, vehicle speed and the setting of radar cruise control (vehicle-to-vehicle distance control mode).

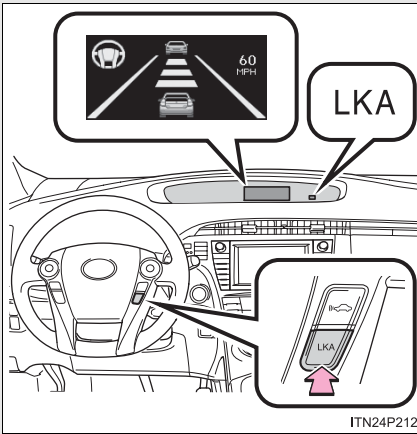

Press the LKA switch to activate the system.

“LKA” indicator will come on.

Press the switch again to turn the LKA system off.

■ Operating conditions for each function

“LKA” switch	Cruise control (vehicle-to-vehicle distance control mode)	Lane departure warning function *1	Lane keeping assist function *2
On	Off	Available	Not available
	On (While cruising in vehicle-to-vehicle distance control mode with the set vehicle speed approx. 45 mph [approx. 70 km/h] or less)	Available	Not available
	On (While cruising in vehicle-to-vehicle distance control mode with the set vehicle speed approx. 50 mph [approx. 75 km/h] or more)	Available	Available

\*1: Vehicle speed is between about 30 and 124 mph (50 and 200 km/h).

\*2: Vehicle speed is between about 50 and 112 mph (75 and 180 km/h).

## Indication on the multi-information display

While the LKA system is on, the lane line display and steering wheel display (in case of lane keeping assist function) are shown on the multi-information display to inform that the LKA system is on.

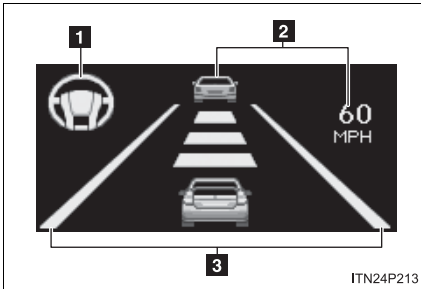

### 1 Steering wheel display

The lane keeping assist function is active.

### 2 Dynamic radar cruise control display

### 3 Lane line display

When thin lines are shown:

A lane marking is not recognized by the system, or the LKA system functions are temporarily canceled.

When solid lane lines are shown:  
The lane departure warning function is active.

■ **Temporary cancelation of the LKA system functions**

If any of the following occurs, the LKA system functions will be temporarily canceled. The functions will resume after the necessary operating conditions have returned.

- The turn signal lever is operated.
- The steering wheel is turned as far as necessary to cause the vehicle to change lanes.
- The brake pedal is depressed.  
However, the lane keeping assist function will not resume even after the brake pedal is released because depressing the brake pedal also cancels the dynamic radar cruise control. (Only lane departure warning function will resume.)
- The vehicle speed deviates from the operating range of the LKA system functions.
- When the lane lines cannot be recognized while driving.
- The wiper operates continuously.

■ **When the lane departure warning function is activated**

The lane departure warning function will be temporarily canceled and will not resume until a few seconds elapse after it is activated.

### ■ No-handed driving warning

If the steering wheel is not operated for about 15 seconds on a straight road or about 5 seconds on a curve, the buzzer will beep twice, indicators on the multi-information display will flash, and the lane keeping assist function will be temporarily canceled. If you drive the vehicle with your hands lightly touching the steering wheel, this may also be detected as no-handed driving.

### ■ When the vehicle has been parked in the sun

The LKA system functions may not be available for a while after driving has started. In such cases, turn the LKA system off and turn it on again after normal temperature returns. When the temperature in the cabin decreases and the temperature around the camera sensor becomes suitable for its operation, the functions will begin to operate.

### ■ Warning lights and warning messages for LKA

Warning lights and messages are used to indicate a system malfunction or to inform the driver of the need for caution while driving. (→P. 496, 510)

## CAUTION

### ■ Before using the LKA system

Do not rely on the LKA system to remain within a selected lane. The LKA system is not designed to enable inattentive driving. The steering wheel should be operated by the driver to maintain the vehicle in a suitable position within its lane. Always drive carefully.

 CAUTION

■ **Turn the LKA off while driving in any of the following conditions**

Do not use LKA in any of the following situations.

Otherwise, the system may not function correctly and could result in an accident.

- When driving with snow tires, snow chains, a spare tire, or similar equipment.
- When driving with non-standard parts or aftermarket equipment installed. (including modified tires and suspensions, etc.)
- When there are objects or structures along the roadside that might be misinterpreted as lane markers. (such as guardrails, curb, reflector posts, etc.)
- When there are wheel ruts, icy trademarks, etc. or if snow remains on the road surface.
- When there are shadows on the road running parallel with lane markers, or if a shadow covers the lane markers.
- When there are visible lines on the pavement from road repairs, or if the remains of old lane markers are still visible on the road.
- When driving on slippery roads, such as those covered with rain, ice or snow.
- When driving in a lane other than the driving or passing lanes on a freeway or highway.
- When driving on a road with lane closures due to maintenance, or when driving in a temporary lane.
- When driving on winding roads or roads that are rough or uneven.



 NOTICE**■ In the following situations, the LKA will not work, or will not perform reliably:**

- When lane markers are interrupted or are not present, such as before a tollbooth.
- When lane markers are only on one side of the road.
- When driving on a sharp curve.
- When lanes are extremely narrow or extremely wide.
- When the vehicle leans to one side an unusual amount due to a heavy load or improper tire inflation pressure.
- When the following distance between your vehicle and the vehicle ahead is extremely short.
- When the lane markers are broken, “Botts’ dots”, or “Raised pavement marker”.
- When lane markers are obscured or partially obscured by sand, dirt, etc.
- When driving on a particularly bright road surface, such as concrete.
- When driving on a road surface that is bright due to reflected light.

 NOTICE

- When driving in a location where the light level changes rapidly, such as the entrance to or exit from a tunnel.
- When sunlight or the headlights of oncoming vehicles are shining directly into the camera lens.
- When driving on roads that are branching or merging.
- When pavement lane markers are difficult to see due to rain, snow, fog, etc.
- When driving on a road surface that is wet due to rain, previous rainfall, standing water, etc.
- When the vehicle experiences strong up-and-down motion such as when driving on an extremely rough road or on a seam in the pavement.
- When headlight brightness is reduced due to dirt on the lenses, or when the headlights are misaligned.
- When driving with a strong crosswind.

 NOTICE

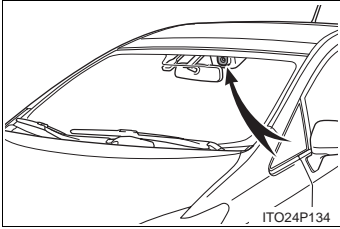
 Camera sensor

Observe the following to ensure that the LKA system functions correctly.

- Keep the windshield clean at all times.  
LKA performance may deteriorate due to the presence of raindrops, condensation, ice or snow on the windshield.
- Do not attach a sticker or other items to the windshield near the camera sensor.
- When adjusting the rear view mirror, make sure that it does not block the camera lens.
- When it is cold, using the heater with air blowing to the feet may allow the upper part of the windshield to fog up. This will have a negative effect on the images. In such a case, use the windshield defogger to provide warm, dry air to the windshield.
- Do not place anything on the dashboard.  
The camera sensor may recognize the image reflected on the windshield as lane markings by mistake.
- Do not scratch the camera lens, or let it get dirty.
- Do not change the installation position of the camera sensor or remove it.  
The direction of the camera sensor is precisely adjusted.
- Do not subject the camera sensor to strong impact or force, and do not disassemble the camera sensor.

## Driving assist systems

**To help enhance driving safety and performance, the following systems operate automatically in response to various driving situations. Be aware, however, that these systems are supplementary and should not be relied upon too heavily when operating the vehicle.**

■ **ABS (Anti-lock Brake System)**

Helps to prevent wheel lock when the brakes are applied suddenly, or if the brakes are applied while driving on a slippery road surface

■ **Brake assist**

Generates an increased level of braking force after the brake pedal is depressed when the system detects a panic stop situation

■ **VSC (Vehicle Stability Control)**

Helps the driver to control skidding when swerving suddenly or turning on slippery road surfaces

■ **TRAC (Traction Control)**

Helps to maintain drive power and prevent the drive wheels from spinning when starting the vehicle or accelerating on slippery roads

■ **EPS (Electric Power Steering)**

Employs an electric motor to reduce the amount of effort needed to turn the steering wheel

■ **Enhanced VSC (Enhanced Vehicle Stability Control)**

Provides cooperative control of the ABS, TRAC, VSC and EPS. Helps to maintain directional stability when swerving on slippery road surfaces by controlling steering performance.

■ **Hill-start assist control**

→P. 301

■ **PCS (Pre-Collision System) (if equipped)**

→P. 303

**When the TRAC/VSC/ABS systems are operating**

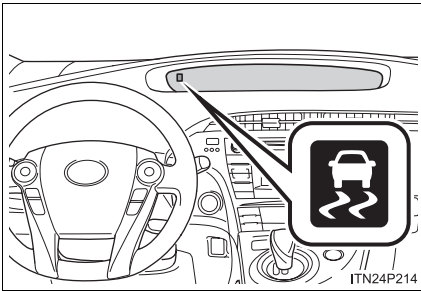

The slip indicator light will flash while the TRAC/VSC/ABS systems are operating.

■ **Sounds and vibrations caused by the ABS, brake assist, VSC and TRAC**

- A sound may be heard from the engine compartment when the hybrid system is started, just after the vehicle begins to move, if the brake pedal is depressed forcefully or repeatedly, or 1-2 minutes after the hybrid system is stopped. This sound does not indicate that a malfunction has occurred in any of these systems.
- Any of the following conditions may occur when the above systems are operating. None of these indicates that a malfunction has occurred.
  - Vibrations may be felt through the vehicle body and steering.
  - A motor sound may be heard after the vehicle comes to a stop.
  - The brake pedal may pulsate slightly after the ABS is activated.
  - The brake pedal may move down slightly after the ABS is activated.

■ **EPS operation sound**

When the steering wheel is operated, a motor sound (whirring sound) may be heard. This does not indicate a malfunction.

■ **Reduced effectiveness of the EPS system**

The effectiveness of the EPS system is reduced to prevent the system from overheating when there is frequent steering input over an extended period of time. The steering wheel may feel heavy as a result. Should this occur, refrain from excessive steering input or stop the vehicle and turn the hybrid system off. The EPS system should return to normal within 10 minutes.

■ **Electric power steering system warning light (warning buzzer)**

→P. 501

 **CAUTION****■ The ABS does not operate effectively when**

- Tires with inadequate gripping ability are used (such as excessively worn tires on a snow covered road).
- The vehicle hydroplanes while driving at high speed on wet or slick road.

**■ Stopping distance when the ABS is operating may exceed that of normal conditions**

The ABS is not designed to shorten the vehicle's stopping distance. Always maintain a safe distance from the vehicle in front of you in the following situations:

- When driving on dirt, gravel or snow-covered roads
- When driving with tire chains
- When driving over bumps in the road
- When driving over roads with potholes or uneven surfaces

**■ TRAC may not operate effectively when**

Directional control and power may not be achievable while driving on slippery road surfaces, even if the TRAC system is operating.

Do not drive the vehicle in conditions where stability and power may be lost.

**■ When the VSC is activated**

The slip indicator light flashes. Always drive carefully. Reckless driving may cause an accident. Exercise particular care when the indicator light flashes.

 CAUTION

■ **Replacing tires**

Make sure that all tires are of the specified size and of the same brand, tread pattern and total load capacity. In addition, make sure that the tires are inflated to the recommended tire inflation pressure level.

The ABS and VSC systems will not function correctly if different tires are installed on the vehicle.

Contact your Toyota dealer for further information when replacing tires or wheels.

■ **Handling of tires and the suspension**

Using tires with any kind of problem or modifying the suspension will affect the driving assist systems, and may cause a system to malfunction.



## 2-4. Using other driving systems

### Hill-start assist control

**Hill-start assist control helps to prevent the vehicle from rolling backwards when starting on an incline or slippery slope.**

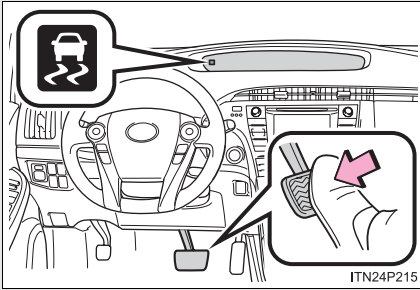

To engage hill-start assist control, further depress the brake pedal when the vehicle is stopped completely.

A buzzer will sound once to indicate the system is activated. The slip indicator will also start flashing.

#### ■ Hill-start assist control can be operated when

- The shift position is in a position other than P.
- The parking brake is not applied.
- The accelerator pedal is not depressed.

#### ■ Hill-start assist control

- While hill-start assist control is operating, the brakes remain automatically applied after the driver releases the brake pedal. The stop lights and the high mounted stoplight turn on.
- Hill-start assist control operates for about 2 seconds after the brake pedal is released.
- If the slip indicator does not flash and the buzzer does not sound when the brake pedal is further depressed, slightly reduce the pressure on the brake pedal (do not allow the vehicle to roll backward) and then firmly depress it again. If the system still does not operate, check if the operating conditions explained above have been met.

■ **Hill-start assist control buzzer**

- When hill-start assist control is activated, the buzzer will sound once.
- In the following situations, hill-start assist control will be canceled and the buzzer will sound twice.
  - No attempt is made to drive the vehicle within approximately 2 seconds of releasing the brake pedal.
  - Push the P position switch.
  - The parking brake is applied.
  - The brake pedal is depressed again.
  - The brake pedal has been depressed for more than approximately 3 minutes.

■ **If the slip indicator light comes on**

It may indicate a malfunction in the system. Contact your Toyota dealer.

 **CAUTION**

■ **Hill-start assist control**

- Do not overly rely on the hill-start assist control. Hill-start assist control may not operate effectively on extremely steep inclines or roads covered in ice.
- Unlike the parking brake, hill-start assist control is not intended to hold the vehicle stationary for an extended period of time. Do not attempt to use hill-start assist control to hold the vehicle on an incline for an extended period of time, as doing so may lead to an accident.

**When the radar sensor detects possibility of a frontal collision, the pre-collision systems such as the brakes and seat belts are automatically engaged to lessen impact as well as vehicle damage.**

■ **Pre-collision seat belts (front seat belts only)**

If the pre-collision sensor detects that a collision is unavoidable, the pre-collision system will retract the seat belt before the collision occurs. The same will happen if the driver makes an emergency braking or loses control of the vehicle. (→P. 111)

However, when the VSC system is disabled, the system will not operate in the event of skidding.

■ **Pre-collision brake assist**

When there is a high possibility of a frontal collision, the system applies greater braking force in relation to how strongly the brake pedal is depressed.

■ **Pre-collision braking**

When there is a high possibility of a frontal collision, the system warns the driver using a warning light, warning display and buzzer. If the system determines that a collision is unavoidable, the brakes are automatically applied to reduce the collision speed. Pre-collision braking can be disabled using the pre-collision braking off switch.

## Disabling pre-collision braking

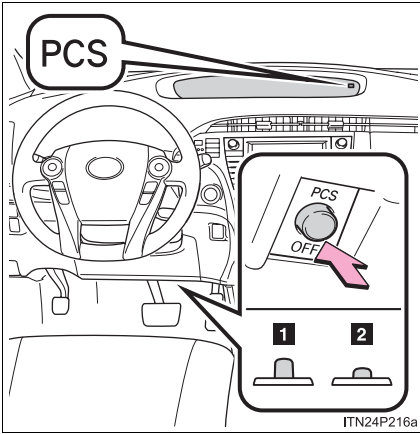

- 1 Pre-collision braking enabled
- 2 Pre-collision braking disabled

The "PCS" warning light will turn on when pre-collision braking is disabled.

## Radar sensor

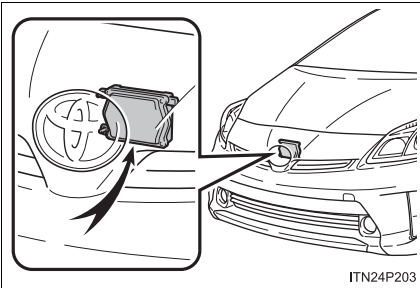

The radar sensor detects vehicles or other obstacles on or near the road ahead and determines whether a collision is imminent based on the position, speed, and heading of the obstacles.

---

**■ The pre-collision system is operational when**

- Pre-collision seat belts (type A)
  - Vehicle speed is greater than about 19 mph (30 km/h).
  - The system detects sudden braking or skidding.
  - The front occupants are wearing a seat belt.
- Pre-collision seat belts (type B)
  - Vehicle speed is greater than about 4 mph (5 km/h).
  - The speed at which your vehicle is approaching the obstacle or the vehicle running ahead of you is greater than about 19 mph (30 km/h).
  - The front occupants are wearing a seat belt.
- Pre-collision brake assist:
  - Vehicle speed is greater than about 19 mph (30 km/h).
  - The speed at which your vehicle is approaching the obstacle or the vehicle running ahead of you is greater than about 19 mph (30 km/h).
  - The brake pedal is depressed.
- Pre-collision braking:
  - Vehicle speed is greater than about 10 mph (15 km/h).
  - The speed at which your vehicle is approaching the obstacle or the vehicle running ahead of you is greater than about 10 mph (15 km/h).
  - The pre-collision braking off switch is not pressed.

■ **Conditions that may trigger the system even if there is no possibility of a collision**

- When there is an object by the roadside at the entrance to a curve
- When passing an oncoming vehicle on a curve
- When driving over a narrow iron bridge
- When there is a metal object on the road surface
- When driving on an uneven road surface (nose up, nose down)
- When passing an oncoming vehicle on a left-turn
- When your vehicle rapidly closes on the vehicle in front
- When a grade separation/interchange, sign, billboard, or other structure appears to be directly in the vehicle's line of travel
- When the steep angle of the road causes a metal object located beneath the road surface to be seen ahead of the vehicle
- When an extreme change in vehicle height occurs
- When the axis of the radar is out of adjustment
- When passing through certain toll gates
- When passing through an overpass

When the system is activated in the situations described above, there is also a possibility that the seat belts will retract quickly and the brakes will be applied with a force greater than normal. When the seat belt is locked in the retracted position, stop the vehicle in a safe place, release the seat belt and refasten it.

**■ Obstacles not detected**

The sensor cannot detect plastic obstacles such as traffic cones. There may also be occasions when the sensor cannot detect pedestrians, animals, bicycles, motorcycles, trees, or snowdrifts.

**■ Situations in which the pre-collision system does not function properly**

The system may not function effectively in situations such as the following:

- On roads with sharp bends or uneven surfaces
- If a vehicle suddenly moves in front of vehicle, such as at an intersection
- If a vehicle suddenly cuts in front of vehicle, such as when overtaking
- In inclement weather such as heavy rain, fog, snow or sand storms
- When your vehicle is skidding with the VSC system off
- When an extreme change in vehicle height occurs
- When the axis of the radar is out of adjustment

**■ Automatic cancelation of the pre-collision system**

When a malfunction occurs due to sensor contamination, etc. that results in the sensors being unable to detect obstacles, the pre-collision system will be automatically disabled. In this case, the system will not activate even if there is a collision possibility.

**■ When there is a malfunction in the system**

Warning lights and/or warning messages will turn on or flash. (→P. 496, 509)

## ■ Certification

### **For vehicles sold in the U.S.A.**

FCC ID: HYQDNMWR004

This device complies with part 15 of the FCC Rules. Operation is subject to the following two conditions: (1) This device may not cause harmful interference, and (2) this device must accept any interference received, including interference that may cause undesired operation.

### **FCC WARNING**

Changes or modifications not expressly approved by the party responsible for compliance could void the user's authority to operate the equipment.

Radiofrequency radiation exposure Information:

This equipment complies with FCC radiation exposure limits set forth for an uncontrolled environment.

This equipment should be installed and operated with minimum distance of 20 cm between the radiator (antenna) and your body.

This transmitter must not be co-located or operating in conjunction with any other antenna or transmitter.

### **For vehicles sold in Canada**

Operation is subject to the following two conditions: (1) this device may not cause interference, and (2) this device must accept any interference, including interference that may cause undesired operation of the device.



 **CAUTION****■ Limitations of the pre-collision system**

Do not overly rely on the pre-collision system. Always drive safely, taking care to observe your surroundings and checking for any obstacles or other road hazards.

Failure to do so may cause an accident resulting in death or serious injury.

**■ Cautions regarding the assist contents of the system**

By means of alarms and brake control, the pre-collision system is intended to assist the driver in avoiding collisions through the process of LOOK-JUDGE-ACT. There are limits to the degree of assistance the system can provide, so please keep in mind the following important points.

**● Assisting the driver in watching the road**

The pre-collision system is only able to detect obstacles directly in front of the vehicle, and only within a limited range. It is not a mechanism that allows careless or inattentive driving, and it is not a system that can assist the driver in low-visibility conditions. It is still necessary for the driver to pay close attention to the vehicle's surroundings.

**● Assisting the driver in making correct judgement**

When attempting to estimate the possibility of a collision, the only data available to the pre-collision system is that from obstacles it has detected directly in front of the vehicle. Therefore, it is absolutely necessary for the driver to remain vigilant and to determine whether or not there is a possibility of collision in any given situation.

**● Assisting the driver in taking action**

The pre-collision system's braking assist feature is designed to help reduce the severity of a collision, and so only acts when the system has judged that a collision is unavoidable. This system by itself is not capable of automatically avoiding a collision or bringing the vehicle to a stop safely. For this reason, when encountering a dangerous situation the driver must take direct and immediate action in order to ensure the safety of all involved.

 CAUTION

■ **When the sensor may not be correctly detecting the vehicle ahead**

Apply the brakes as necessary in any of the following situations.

- When water or snow thrown up by the surrounding vehicles hinders the functioning of the sensor
- When your vehicle is pointing upwards (caused by a heavy load in the luggage compartment etc.)
- Vehicles that cut in suddenly
- Vehicles with small rear ends (trailers with no load on board etc.)
- Motorcycles traveling in the same lane

■ **Handling the radar sensor**

Observe the following to ensure the pre-collision system can function effectively:

- Keep the sensor and grille cover clean at all times.  
Clean the sensor and grille cover with a soft cloth so you do not mark or damage them.
- Do not subject the sensor or surrounding area to a strong impact.  
If the sensor has moved out of position, the system may malfunction or operate incorrectly. If the sensor or surrounding area is subject to a strong impact, always have the area inspected and adjusted by your Toyota dealer.
- Do not disassemble the sensor.
- Do not attach accessories or stickers to the sensor, grille cover or surrounding area.
- Do not modify or paint the sensor and grille cover.

## Cargo and luggage

**Take notice of the following information about storage precautions, cargo capacity and load:**

- Stow cargo and luggage in the luggage compartment whenever possible.
- Be sure all items are secured in place.
- To maintain vehicle balance while driving, position luggage evenly within the luggage compartment.
- For better fuel economy, do not carry unnecessary weight.

## Capacity and distribution

Cargo capacity depends on the total weight of the occupants.

(Cargo capacity) = (Total load capacity) — (Total weight of occupants)

### Steps for Determining Correct Load Limit —

- (1) Locate the statement “The combined weight of occupants and cargo should never exceed XXX kg or XXX lbs.” on your vehicle’s placard.
- (2) Determine the combined weight of the driver and passengers that will be riding in your vehicle.
- (3) Subtract the combined weight of the driver and passengers from XXX kg or XXX lbs.
- (4) The resulting figure equals the available amount of cargo and luggage load capacity.

For example, if the “XXX” amount equals 1400 lbs. and there will be five 150 lb passengers in your vehicle, the amount of available cargo and luggage load capacity is 650 lbs. (1400 – 750 (5 × 150) = 650 lbs.)

- (5) Determine the combined weight of luggage and cargo being loaded on the vehicle. That weight may not safely exceed the available cargo and luggage load capacity calculated in Step 4.
- (6) If your vehicle will be towing a trailer, load from your trailer will be transferred to your vehicle. Consult this manual to determine how this reduces the available cargo and luggage load capacity of your vehicle. (→P. 316)

Toyota does not recommend towing a trailer with your vehicle. Your vehicle is not designed for trailer towing.

## Example based on your vehicle

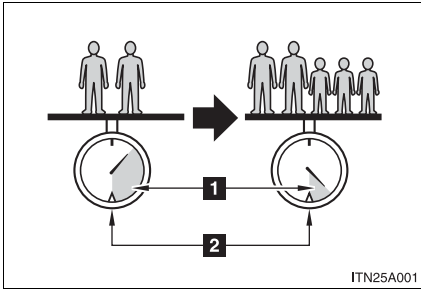

- 1** Cargo capacity
- 2** Total load capacity

When 2 people with the combined weight of 366 lb. (166 kg) are riding in your vehicle, which has a total load capacity of 830 lb. (375 kg), the available amount of cargo and luggage load capacity will be as follows:

$$830 \text{ lb.} - 366 \text{ lb.} = 464 \text{ lb.} \quad (375 \text{ kg} - 166 \text{ kg} = 209 \text{ kg})$$

In this condition, if 3 more passengers with the combined weight of 388 lb. (176 kg) get on, the available cargo and luggage load will be reduced as follows:

$$464 \text{ lb.} - 388 \text{ lb.} = 76 \text{ lb.} \quad (209 \text{ kg} - 176 \text{ kg} = 33 \text{ kg})$$

As shown in the example above, if the number of occupants increases, the cargo and luggage load will be reduced by an amount that equals the increased weight due to the additional occupants. In other words, if an increase in the number of occupants causes an excess of the total load capacity (combined weight of occupants plus cargo and luggage load), you must reduce the cargo and luggage on your vehicle.

 CAUTION

■ **Things that must not be carried in the luggage compartment**

The following things may cause a fire if loaded in the luggage compartment:

- Receptacles containing gasoline
- Aerosol cans

■ **Storage precautions**

Observe the following precautions.

Failure to do so may result in death or serious injury.

- Stow cargo and luggage in the luggage compartment whenever possible.
- Do not stack cargo and luggage in the luggage compartment higher than the seatbacks.  
Such items may be thrown about and possibly injure people in the vehicle in the event of sudden braking or in an accident.
- Do not place cargo or luggage in or on the following locations as the item may get under the brake or accelerator pedal and prevent the pedals from being depressed properly, block the driver's vision, or hit the driver or passengers, causing an accident:
  - At the feet of the driver
  - On the front passenger or rear seats (when stacking items)
  - On the luggage cover (if equipped)
  - On the instrument panel
  - On the dashboard

 **CAUTION**

- Secure all items in the occupant compartment, as they may shift and injure someone in the event of an accident or sudden braking.
- When you fold down the rear seats, long items should not be placed directly behind the front seats.
- Never allow anyone to ride in the luggage compartment. It is not designed for passengers. They should ride in their seats with their seat belts properly fastened. Otherwise, they are much more likely to suffer death or serious bodily injury, in the event of sudden braking or an accident.

**■ Capacity and distribution**

- Do not exceed the maximum axle weight rating or the total vehicle weight rating.
- Even if the total load of occupant's weight and the cargo load is less than the total load capacity, do not apply the load unevenly. Improper loading may cause deterioration of steering or braking control which may cause death or serious injury.

## 2-5. Driving information

### Vehicle load limits

**Vehicle load limits include total load capacity, seating capacity, towing capacity and cargo capacity.**

■ **Total load capacity: 825 lb. (370 kg)**

Total load capacity means the combined weight of occupants, cargo and luggage.

■ **Seating capacity: 5 occupants (Front 2, Rear 3)**

Seating capacity means the maximum number of occupants whose estimated average weight is 150 lb. (68 kg) per person.

■ **Towing capacity**

Toyota does not recommend towing a trailer with your vehicle.

■ **Cargo capacity**

Cargo capacity may increase or decrease depending on the weight and the number of occupants.

---

■ **Total load capacity and seating capacity**

These details are also described on the tire and loading information label. (→P. 447)

 **CAUTION**

■ **Overloading the vehicle**

Do not overload the vehicle.

It may not only cause damage to the tires, but also degrade steering and braking ability, resulting in an accident.



**Carry out the necessary preparations and inspections before driving the vehicle in winter. Always drive the vehicle in a manner appropriate to the prevailing weather conditions.**

■ **Pre-winter preparations**

- Use fluids that are appropriate to the prevailing outside temperatures.
  - Engine oil
  - Engine/power control unit coolant
  - Washer fluid
- Have a service technician inspect the condition of the 12-volt battery.
- Have the vehicle fitted with four snow tires or purchase a set of tire chains for the front tires.

Ensure that all tires are the same size and brand, and that chains match the size of the tires.

### ■ Before driving the vehicle

Perform the following according to the driving conditions:

- Do not try to forcibly open a window or move a wiper that is frozen. Pour warm water over the frozen area to melt the ice. Wipe away the water immediately to prevent it from freezing.
- To ensure proper operation of the climate control system fan, remove any snow that has accumulated on the air inlet vents in front of the windshield.
- Check for and remove any excess ice or snow that may have accumulated on the exterior lights, vehicle's roof, chassis, around the tires or on the brakes.
- Remove snow or mud from the bottom of your shoes before getting in the vehicle.

### ■ When driving the vehicle

Accelerate the vehicle slowly, keep a safe distance between you and the vehicle ahead, and drive at a reduced speed suitable to road conditions.

### ■ When parking the vehicle

Park the vehicle and shift the shift position to P and block the wheel under the vehicle without setting the parking brake. The parking brake may freeze up, preventing it from being released. If necessary, block the wheels to prevent inadvertent sliding or creeping.

## Selecting tire chains

### Vehicles with 17-inch tires

Use the correct tire chain size when mounting the tire chains. Chain size is regulated for each tire size.

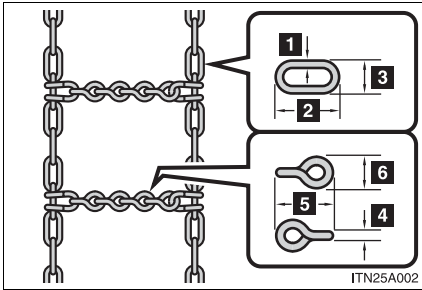

Side chain:

- 1 0.12 in. (3.0 mm)
- 2 1.18 in. (30.0 mm)
- 3 0.39 in. (10.0 mm)

Cross chain:

- 4 0.16 in. (4.0 mm)
- 5 0.98 in. (25.0 mm)
- 6 0.55 in. (14.0 mm)

### Vehicles with 15-inch tires

Use the tire chains of correct size and type.

Use SAE Class "S" type radial tire chains except radial cable chains or V-bar type chains.

## Regulations on the use of tire chains

Regulations regarding the use of tire chains vary depending on location and type of road. Always check local regulations before installing chains.

### ■ Tire chain installation

Observe the following precautions when installing and removing chains:

- Install and remove tire chains in a safe location.
- Install tire chains on the front tires only. Do not install tire chains on the rear tires.
- Install tire chains on front tires as tightly as possible. Retighten chains after driving 1/4 - 1/2 mile (0.5 - 1.0 km).
- Install tire chains following the instructions provided with the tire chains.

### CAUTION

#### ■ Driving with snow tires

Observe the following precautions to reduce the risk of accidents.

Failure to do so may result in a loss of vehicle control and cause death or serious injury.

- Use tires of the size specified.
- Maintain the recommended level of air pressure.
- Do not drive in excess of 75 mph (120 km/h), regardless of the type of snow tires being used.
- Use snow tires on all, not just some wheels.

 **CAUTION****■ Driving with tire chains**

Observe the following precautions to reduce the risk of accidents. Failure to do so may result in the vehicle being unable to be driven safely, and may cause death or serious injury.

- Do not drive in excess of the speed limit specified for the tire chains being used, or 30 mph (50 km/h), whichever is lower.
- Avoid driving on bumpy road surfaces or over potholes.
- Avoid sudden turns and braking, as use of chains may adversely affect vehicle handling.
- Slow down sufficiently before entering a curve to ensure that vehicle control is maintained.

 **NOTICE****■ Repairing or replacing snow tires**

Request repairs or replacement of snow tires from Toyota dealers or legitimate tire retailers.

This is because the removal and attachment of snow tires affects the operation of the tire pressure warning valves and transmitters.

**■ Fitting tire chains**

The tire pressure warning valves and transmitters may not function correctly when tire chains are fitted.

## Trailer towing

**Toyota does not recommend towing a trailer with your vehicle. Toyota also does not recommend the installation of a tow hitch or the use of a tow hitch carrier for a wheelchair, scooter, bicycle, etc. Your vehicle is not designed for trailer towing or for the use of tow hitch mounted carriers.**

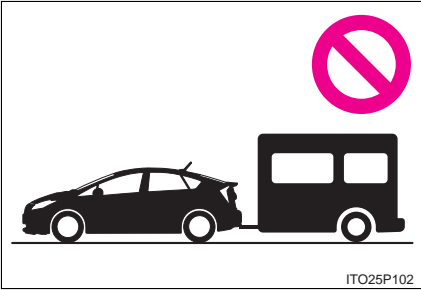

## 2-5. Driving information

### Dinghy towing

Your vehicle is not designed to be dinghy towed (with 4 wheels on the ground) behind a motor home.

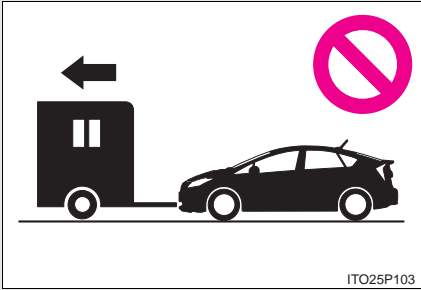

#### NOTICE

**■ To avoid serious damage to your vehicle**

Do not tow your vehicle with the four wheels on the ground.







### 3-1. Using the air conditioning system and defogger

## Air conditioning system

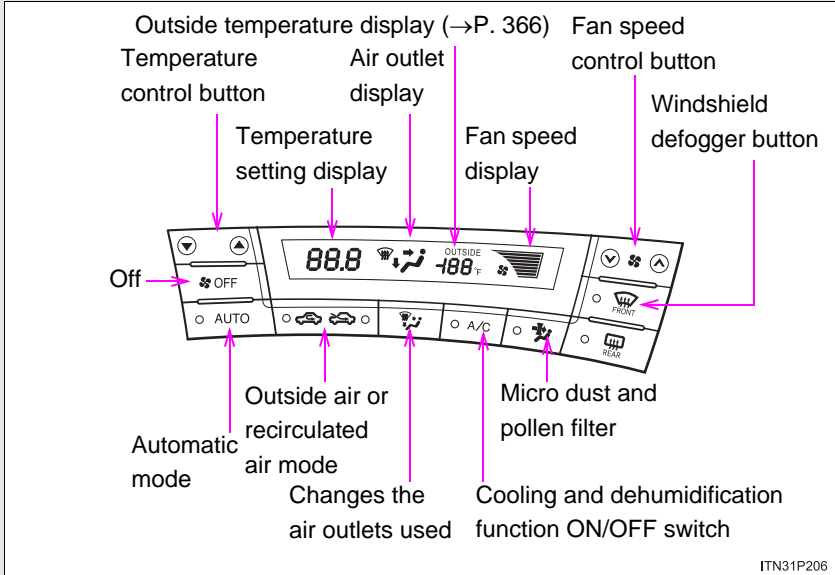
**Airflow and outlets are automatically adjusted according to the temperature setting.**



## Using the automatic mode

**STEP 1** Press .

The air conditioning system will begin to operate. Air outlets and fan speed are automatically adjusted according to the temperature setting.

**STEP 2** Press “▲” to increase the temperature and “▼” to decrease the temperature on the .

## Adjusting the settings

### ■ Changing the cooling and dehumidification function

Press .

The cooling and dehumidification function switches between on and off each time the button is pressed.

### ■ Adjusting the temperature setting

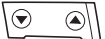
Press “▲” to increase the temperature and “▼” to decrease the temperature on the .

### ■ Adjusting the fan speed

Press ^ (increase) or v (decrease) on .

The fan speed is shown on the display. (7 levels)

Press  to turn the fan off.

■ Changing the air outlets

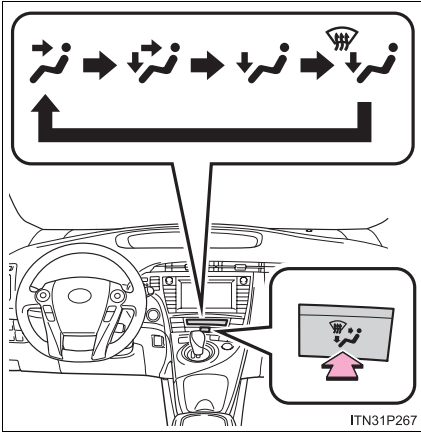

Press  .

The air outlets switch each time the button is pressed.

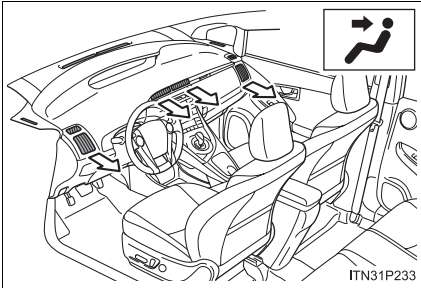

Air flows to the upper body.

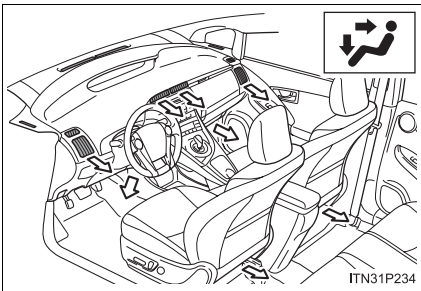

Air flows to the upper body and feet.

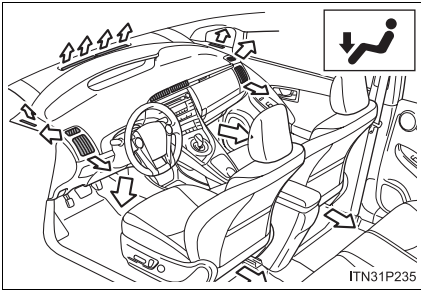

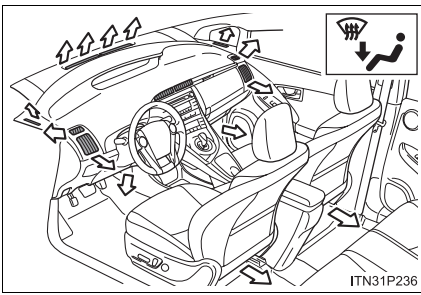

Mainly air flows to the feet.



Air flows to the feet and the windshield defogger operates.

### ■ Switching between outside air and recirculated air modes

Press .

The modes switches between  (recycles air inside the vehicle) and  (introduces air from outside the vehicle) modes each time the button is pressed.

## Defogging the windshield

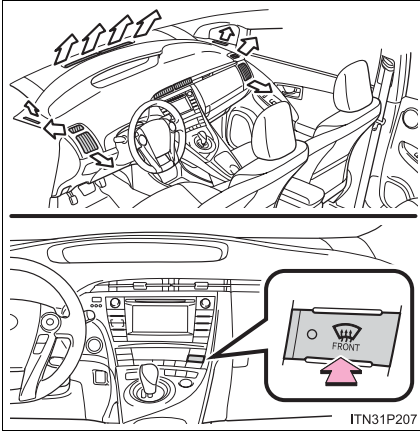

Press .

The air conditioning system control operates automatically.

Recirculated air mode will automatically switch to outside air mode.

## Micro dust and pollen filter

Press .

Outside air mode switches to recirculated air mode. Pollen is removed from the air and the air flows to the upper part of the body.

Usually the system will turn off automatically approximately 3 minutes later.

To stop the operation, press  again.

## Adjusting the position of and opening and closing the air outlets

### ■ Adjusting the air outlets

#### Center outlets

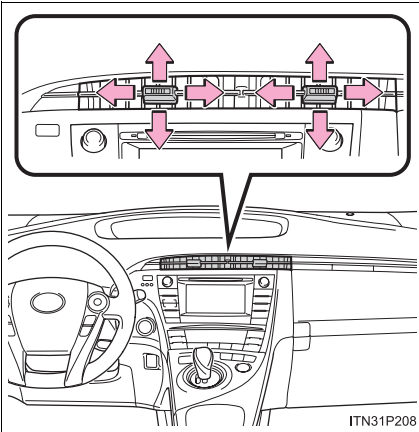

Direct air flow to the left or right, up or down.

#### Right and left side outlets

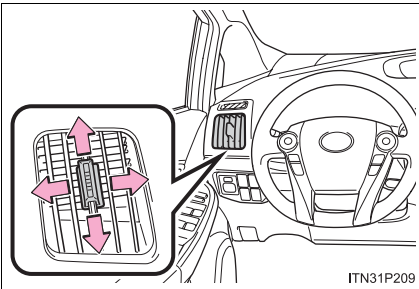

Direct air flow to the left or right, up or down.

## ■ Opening and closing the air outlets

### Center outlets

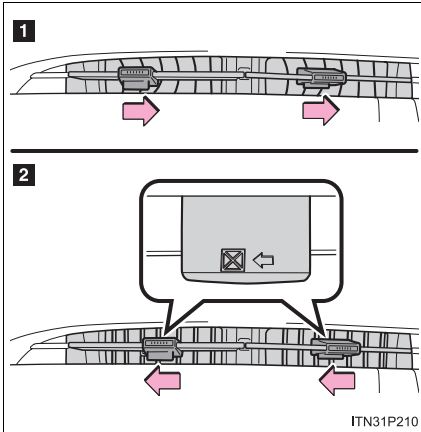

- 1 Open the vent.
- 2 Close the vent.

Move the knob in the direction of the printed arrow until a click is heard.

### Right and left side outlets

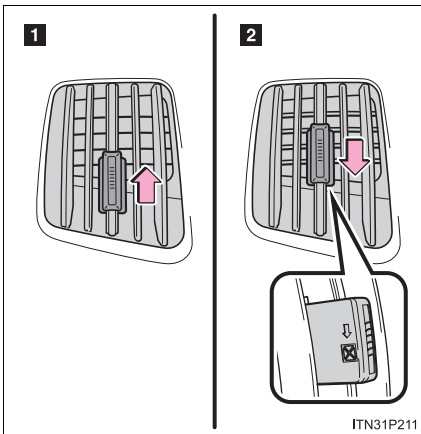

- 1 Open the vent.
- 2 Close the vent.

Move the knob in the direction of the printed arrow until a click is heard.

### ■ Using the automatic mode

Fan speed is adjusted automatically in accordance with the temperature setting and ambient conditions. As a result, the following may occur.

- Immediately after  is pressed, the fan may stop for a while until warm or cool air is ready to flow.
- Cool air may flow to the area around the upper body when the heater is on.

### ■ Switching between outside air and recirculated air modes

Recirculated air mode or outside air mode may be automatically switched to in accordance with under these condition, such as temperature setting and inside temperature.

Also, outside air mode may be automatically switched to when the outside temperature is low.

### ■ When the outside temperature exceeds 75 °F (24 °C) and the air conditioning system is on

- In order to reduce the air conditioning power consumption, the air conditioning system may switch to recirculated air mode automatically. This may also reduce fuel consumption.
- Recirculated air mode is selected as a default mode when the “POWER” switch is turned to ON mode.
- It is possible to switch to outside air mode at any time by pressing



### ■ Using the system in recirculated air mode

The windows will fog up more easily if the recirculated air mode is used.

### ■ Window defogger feature

- Recirculated air mode may automatically switch to outside air mode in situations where the windows need to be defogged.
- When the outside air temperature is low, it may take a while for the condensation to clear from the windshield.



■ **When  is selected for the air outlets used**

For your driving comfort, air flowing to the feet may be warmer than air flowing to the upper body depending on the temperature setting.

■ **Micro dust and pollen filter**

- In order to prevent the windows from fogging up when the outside air is cold, the following may occur.
  - Outside air mode does not switch to recirculated air mode.
  - The air conditioning system operates automatically.
  - The operation cancels after 1 minute.
- In rainy weather, the windows may fog up. Press  .
- Condensation may appear on the windows if this mode is used in abnormally high levels of humidity.
- Pollen will be collected by the filter even when micro dust and pollen filter mode is OFF.

■ **Maintenance of the air conditioning filter**

The air conditioning filter must be cleaned or changed regularly to maintain air conditioning efficiency according to the maintenance schedule. In dusty areas or areas with heavy traffic flow, early replacement may be required. (For scheduled maintenance information, refer to the “Owner’s Manual Supplement/ Scheduled Maintenance Guide”.)

When inspecting, cleaning and replacing the air conditioning filter, contact your Toyota dealer.

### ■ If air flow from the vents decreases dramatically

The filter may be clogged. Contact your Toyota dealer.

### ■ Operation of the air conditioning system in Eco drive mode

In the Eco drive mode, the air conditioning system is controlled as follows to prioritize fuel efficiency:

- Engine speed and compressor operation controlled to restrict heating/cooling capacity
- Fan speed restricted when automatic mode is selected

To improve air conditioning performance, perform the following operations:

- Adjust the fan speed
- Turn off Eco drive mode (→P. 204)
- Customize the air conditioning control of Eco drive mode. (→P. 590)

### ■ When outside air temperature is below 32 °F (0 °C)

The cooling and dehumidification function may not operate even when



is pressed.

### ■ Air conditioning odors

- During use, various odors from inside and outside the vehicle may enter into and accumulate in the air conditioning system. This may then cause odor to be emitted from the vents.
- To reduce potential odors from occurring:
  - It is recommended that the air conditioning system be set to outside air mode prior to turning the vehicle off.
  - The start timing of the blower may be delayed for a short period of time immediately after the air conditioning system is started in automatic mode.

### ■ Customization

Settings (e.g. enable/disable automatic operation of the air conditioning compressor when the “AUTO” switch ON) can be changed. (Customizable features →P. 590)

 CAUTION

■ **To prevent the windshield from fogging up**

Do not use  during cool air operation in extremely humid weather. The difference between the temperature of the outside air and that of the windshield can cause the outer surface of the windshield to fog up, blocking your vision.

 NOTICE

■ **To prevent 12-volt battery discharge**

Do not leave the air conditioning system on longer than necessary when the hybrid system is not operating.

### 3-1. Using the air conditioning system and defogger Using the steering wheel climate remote control switches

Some air conditioning features can be controlled using the switches on the steering wheel.

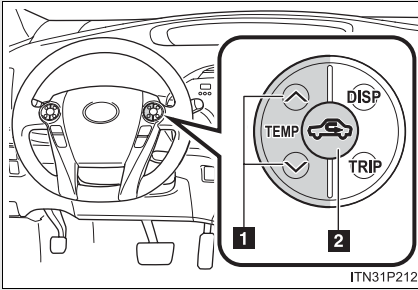

- 1 Temperature control
- 2 Outside air or recirculated air mode

#### Adjusting the temperature setting

Press “^” on  to increase the temperature and “v” to decrease the temperature.

#### Changing the outside air or recirculated air modes

Press .

The mode switches between outside air mode and recirculated air mode each time the switch is pressed.

■ **When operating the steering switches (vehicles with touch tracer display)**

- The steering switches operation status is displayed on the instrument cluster for confirmation purposes. (→P. 215)

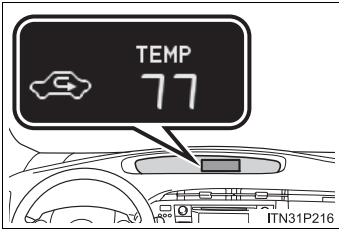

- Settings are shown on the multi-information display when the steering switch is operated.

**! CAUTION**

■ **To reduce the risk of an accident**

Exercise care when operating the air conditioning switches on the steering wheel.

## 3-1. Using the air conditioning system and defogger Solar Ventilation System\*

The Solar Ventilation System uses energy provided by solar panel built into the roof to operate a fan contained within the air conditioning system, allowing ventilation of the vehicle interior when the vehicle is parked in direct sunlight.

### ■ Activating the Solar Ventilation System

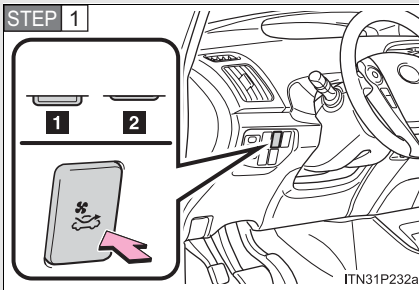

With the “POWER” switch in ON mode, turn on the ventilation switch.

- 1 Off
- 2 On

**STEP 2** Turn the “POWER” switch off.

After approximately 1 minute, outside air mode will be selected and the air vents will be put into upper body mode.

After approximately 10 minutes, the ventilation operation will commence.

The ventilation operation will be canceled if the “POWER” switch is turned to ON mode or the ventilation switch is turned off.

### ■ Operating conditions

The Solar Ventilation System may not operate under the following circumstances due to a lack of power from the solar panel:

- Low amount of sunlight
- Ever when a part of the solar panel is cast by a shadow.
- Ever when a part of the solar panel is covered by fallen leaves or dirt.
- The solar panel is not at a high temperature.

### ■ Before using the Solar Ventilation System

Remove dirt or fallen leaves from the solar panel in order to ensure sufficient electrical output.

### ■ Efficient use of the Solar Ventilation System

Efficient control of temperature increase can be achieved by using the system in conjunction with the Remote Air Conditioning System. (→P. 342)

### ■ When using the Solar Ventilation System

- Make sure that the “POWER” switch is in ON mode when turning the ventilation switch on. If the ventilation switch is turned on while the “POWER” switch is OFF, the air mode and the status of the air vents will remain unchanged.
- If the Solar Ventilation System is not needed, be sure to turn the ventilation switch off.  
Dirty air and exhaust fumes from other vehicles may be drawn from outside. Also, use in winter may cause heated interior air to leave the vehicle, thus leading to a drop in temperature.

### ■ Sounds when using the Solar Ventilation System

If the amount of sunlight is insufficient, you may hear a sound coming from the air conditioning system. This is the sound of a control function to preserve the fan and does not indicate a malfunction.

 CAUTION

■ **Solar Ventilation System precautions**

- Do not use the system if people are inside the vehicle.  
The Solar Ventilation System is not intended to ensure the performance of the air conditioning system. Do not leave children or pets in the vehicle. The temperature of the interior will remain high, possibly resulting in heat-stroke, dehydration, or even death.
- This system should be used only for the relief of discomfort when entering the vehicle, and should not be used for other purposes.

■ **Precautions for moon roof with Solar Panel**

→P. 129



## 3-1. Using the air conditioning system and defogger Remote Air Conditioning System\*

The Remote Air Conditioning System uses electrical energy stored in the hybrid battery (traction battery) and allows the air conditioning to be operated by remote control.

### ■ Before leaving the vehicle

Check the temperature setting of the air conditioning system.

The Remote Air Conditioning System will operate in accordance with the temperature settings of the air conditioning system.

### ■ Activating the Remote Air Conditioning System

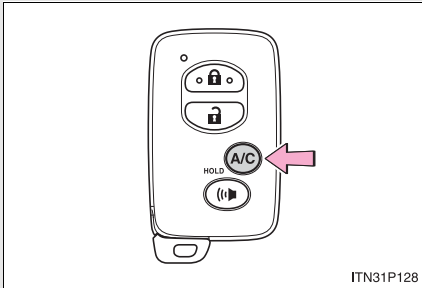

Press and hold the  to operate the Remote Air Conditioning System.

The system will shut off if a door is opened.

The system can be stopped by pressing the  twice.

### ■ Operating conditions

The system will only operate if all of the following conditions are met:

- The shift position is in P.
- The "POWER" switch is OFF.
- All doors are closed.
- The hood is closed.
- The brake pedal is not being depressed.
- The air conditioning is not set to "HI".

\*: If equipped

**■ Using the Remote Air Conditioning System effectively**

Efficiency can be increased by using the system in conjunction with the Solar Ventilation System. (→P. 339)

**■ When leaving the vehicle**

- Check that the headlights are switched to either off or “AUTO”.
- Check that the wiper switch is turned off.
- Check that all windows are closed.

**■ Remote Air Conditioning System automatic shut-off**

The system will automatically shut off under the following conditions:

- About 3 minutes have passed since operation began
- Any one of the operating conditions is not met

The system may also shut off if the charge level of the hybrid battery (traction battery) drops to low. (→P. 42)

**■ Conditions affecting operation**

The system may not start in the following situations:

- The charge level of the hybrid battery (traction battery) is low (→P. 42)
- The air conditioning temperature is set at a high level or outside temperature is low
- When the vehicle has been left parked for a number of days
- When the hybrid system is cool (for example, after being left for a long time in low temperatures)

■ **Security feature**

Any unlocked doors will be automatically locked when the system is operating. The buzzer will beep and the emergency flashers flash when the doors have been locked or the system has been turned off.

(The doors locked: Once; The system turned off: Twice)

■ **Conditions affecting operation**

→P. 72

■ **Electronic key battery depletion**

→P. 76

■ **When the electronic key battery is fully depleted**

→P. 76

■ **Customization**

Setting (e.g. Operation using the  on the wireless remote control) can be changed.

(Customizable features →P. 596)

 CAUTION**■ Precautions for the Remote Air Conditioning System**

- Do not use the system if people are in the vehicle.
  - Even when the system is in use, the internal temperature may still reach a high level due to features such as the automatic shut-off. Children and pets left inside the vehicle may suffer heatstroke or dehydration, or could result in death or serious injury.
  - The wipers can be operated during system operation. Children or pets left inside the vehicle may mistakenly operate these and cause an accident.
- Depending on the surrounding environment, signals from the wireless switch may transmit further than expected. Pay appropriate attention to the vehicle's surroundings and use the switch only when necessary.
- Turn the wipers off. If the Remote Air Conditioning System operates while the wiper switch is in the on position, the wipers may operate and objects may get caught in the wiper blades.
- Do not operate the  if the hood is open. The air conditioning may operate unintentionally and objects may be drawn into the electrical cooling fan.

 NOTICE**■ To prevent the hybrid battery (traction battery) from being discharged through incorrect operation**

Use the  only when necessary.

### 3-1. Using the air conditioning system and defogger Rear window and outside rear view mirror defogger switch

**Defoggers are used to defog the rear window, and to remove rain-drops, dew and frost from the outside rear view mirrors.**

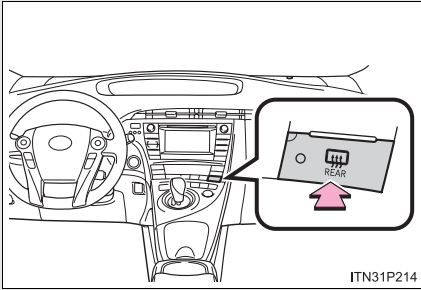

Turns the rear window and outside rear view mirror defoggers on/off

The defoggers will automatically turn off after approximately 15 minutes.

#### ■ Operating conditions

The "POWER" switch is in ON mode.

#### ■ The outside rear view mirror defoggers

Turning the rear window defogger on will turn the outside rear view mirror defoggers on.

#### ⚠ CAUTION

##### ■ When the outside rear view mirror defoggers are on

Do not touch the outside surface of the rear view mirrors, as they can become very hot and burn you.

#### ⚠ NOTICE

##### ■ To prevent 12-volt battery discharge

Do not leave the rear window defogger on longer than necessary when the hybrid system is off.

## 3-2. Using the audio system

### Audio system types

#### Vehicles with Display Audio system

##### Type A

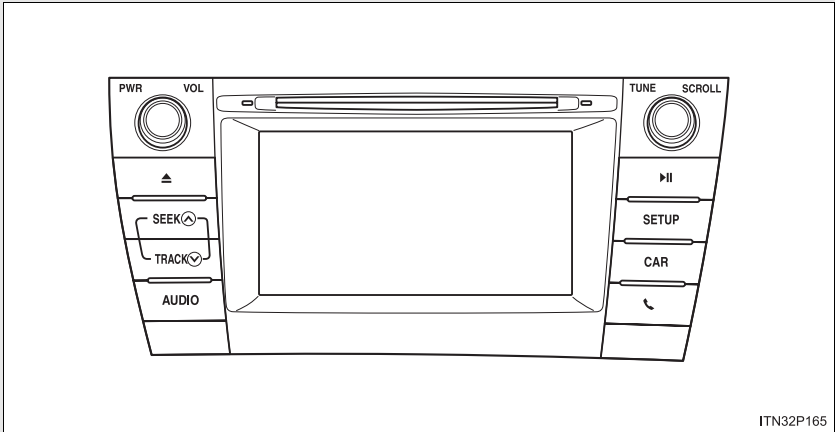

##### Type B

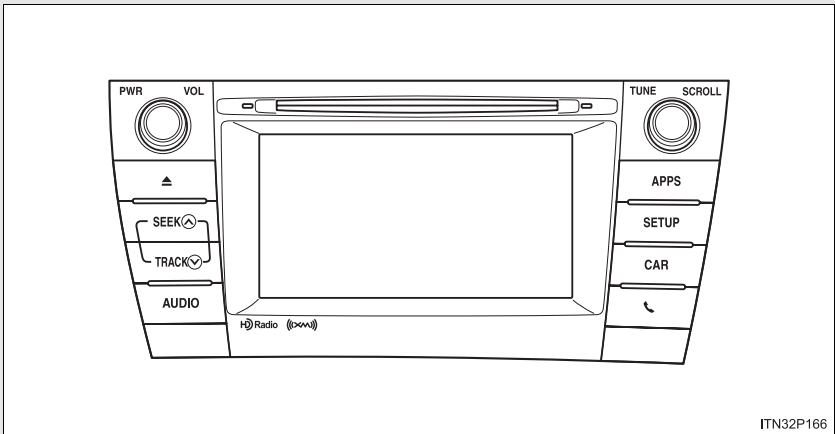

Refer to the “Display Audio System Owner’s Manual”.

### Vehicles with a navigation system

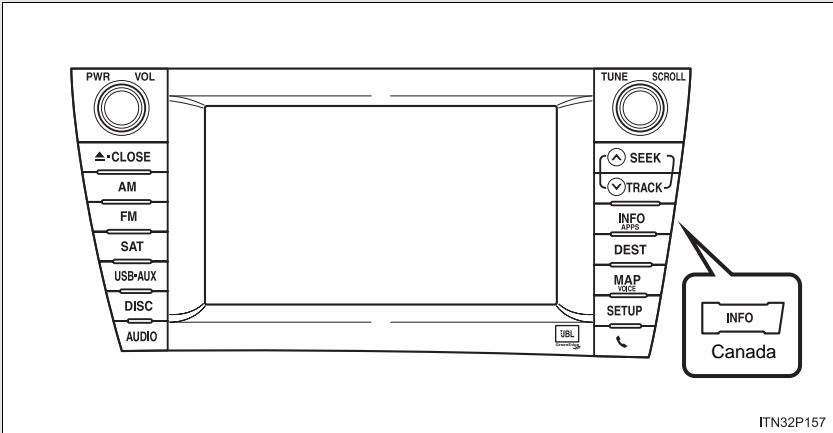

Refer to the “Navigation System Owner’s Manual”.

### Steering wheel audio switches

Some audio features can be controlled using the switches on the steering wheel. For details, refer to the “Display Audio System Owner’s Manual” or “Navigation System Owner’s Manual”.

Operation may differ and usage may not be possible with audio/navigation systems that are not compatible with the steering switches in this vehicle.

### ■ About Bluetooth® (vehicles with Display Audio system)



Bluetooth is a registered trade mark of Bluetooth SIG, Inc.

The Bluetooth word mark and logos are owned by the Bluetooth SIG, Inc. and any use of such marks by Panasonic Corporation is under license.

Other trademarks and trade names are those of their respective owners.

#### ⚠ CAUTION

#### ■ Certification for the Display Audio system

FCC ID: ACJ932CQ-US70G0

##### ● Part 15 of the FCC Rules

FCC Warning:

Any unauthorized changes or modifications to this equipment will void the user's authority to operate this device.

##### ● Laser products

- Do not take this unit apart or attempt to make any changes by yourself. This is an intricate unit that uses a laser pickup to retrieve information from the surface of compact discs. The laser is carefully shielded so that its rays remain inside the cabinet. Therefore, never try to disassemble the player or alter any of its parts since you may be exposed to laser rays and dangerous voltages.
- This product utilizes a laser. Use of controls or adjustments or performance of procedures other than those specified herein may result in hazardous radiation exposure.



 CAUTION

Properly shielded a grounded cables and connectors must be used for connection to host computer and / or peripherals in order to meet FCC emission limits.

This transmitter must not be co-located or operated in conjunction with any other antenna or transmitter.

This device complies with Part 15 of FCC Rules and Industry Canada licence-exempt RSS standard(s). Operation is subject to the following two conditions: (1) this device may not cause interference, and (2) this device must accept any interference, including interference that may cause undesired operation of this device.

Le présent appareil est conforme aux la partie 15 des règles de la FCC et CNR d'Industrie Canada applicables aux appareils radio exempts de licence. L'exploitation est autorisée aux deux conditions suivantes : (1) l'appareil ne doit pas produire de brouillage, et (2) l'utilisateur de l'appareil doit accepter tout brouillage radioélectrique subi, même si le brouillage est susceptible d'en compromettre le fonctionnement.

This equipment complies with FCC/IC radiation exposure limits set forth for an uncontrolled environment and meets the FCC radio frequency (RF) Exposure Guidelines in Supplement C to OET65 and RSS-102 of the IC radio frequency (RF) Exposure rules. This equipment has very low levels of RF energy that it deemed to comply without maximum permissive exposure evaluation (MPE).

But it is desirable that it should be installed and operated keeping the radiator at least 20 cm or more away from person's body (excluding extremities: hands, wrists, feet and ankles).

Cet équipement est conforme aux limites d'exposition aux rayonnements énoncées pour un environnement non contrôlé et respecte les règles les radioélectriques (RF) de la FCC lignes directices d'exposition dans le Supplément C à OET65 et d'exposition aux fréquences radioélectriques (RF) CNR-102 de l'IC. Cet équipement émet une énergie RF très faible qui est considérée conforme sans évaluation de l'exposition maximale autorisée.

Cependant, cet équipement doit être installé et utilisé en gardant une distance de 20 cm ou plus entre le dispositif rayonnant et le corps (à l'exception des extrémités : mains, poignets, pieds et chivilles).

 **CAUTION**

Under Industry Canada regulations, this radio transmitter may only operate using an antenna of a type and maximum (or lesser) gain approved for the transmitter by Industry Canada. To reduce potential radio interference to other users, the antenna type and its gain should be so chosen that the equivalent isotropically radiated power (e.i.r.p.) is not more than that necessary for successful communication.

Conformément à la réglementation d'Industrie Canada, le présent émetteur radio peut fonctionner avec une antenne d'un type et d'un gain maximal (ou inférieur) approuvé pour l'émetteur par Industrie Canada. Dans le but de réduire les risques de brouillage radioélectrique à l'intention des autres utilisateurs, il faut choisir le type d'antenne et son gain de sorte que la puissance isotrope rayonnée équivalente (p.i.r.e.) ne dépasse pas l'intensité nécessaire à l'établissement d'une communication satisfaisante.

## 3-2. Using the audio system

### Using the AUX port/USB port

**This port can be used to connect a portable audio device and listen to it through the vehicle's speakers.**

**STEP 1** Open the console box lid. (→P. 359)

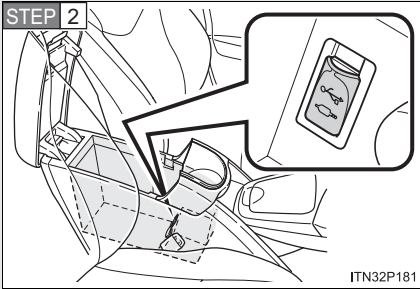

Connect the portable audio device.

#### ■ Operating portable audio devices connected to the audio system

The volume can be adjusted using the vehicle's audio controls. All other adjustments must be made on the portable audio device itself.

#### ■ When using a portable audio device connected to the power outlet

Noise may occur during playback. Use the power source of the portable audio device.

## Interior lights list

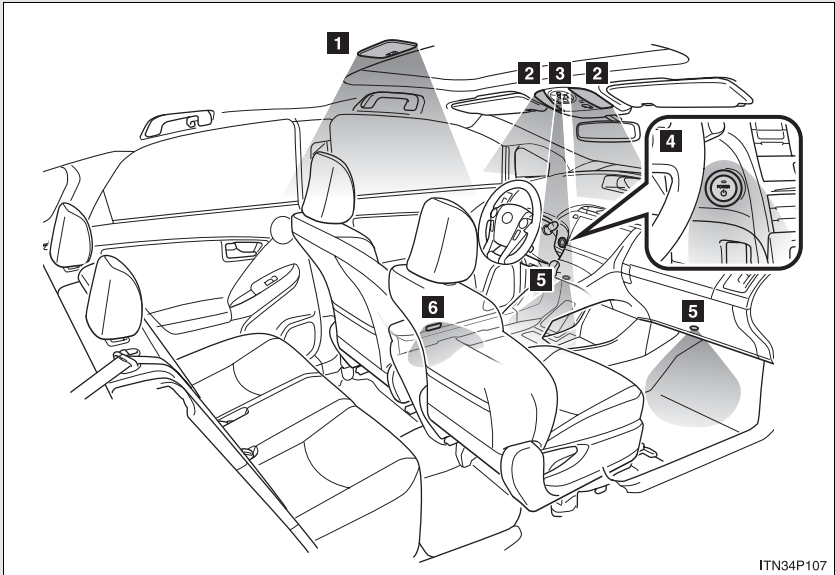

ITN34P107

- 1** Rear interior light (→P. 355)
- 2** Front interior/personal lights (→P. 354)
- 3** Shift lever lighting
- 4** “POWER” switch lighting
- 5** Foot lights (if equipped)
- 6** Front door courtesy lights

**Front interior lights**

**Type A**

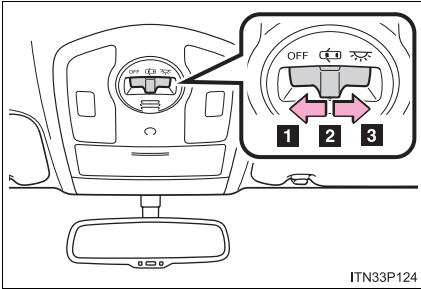

- 1** Turns the lights off
- 2** Turns the door position on
- 3** Turns the lights on

**Type B**

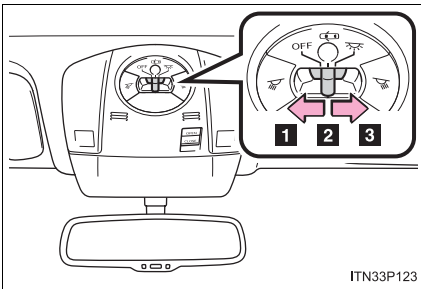

- 1** Turns the lights off
- 2** Turns the door position on
- 3** Turns the lights on

**Personal lights**

**Type A**

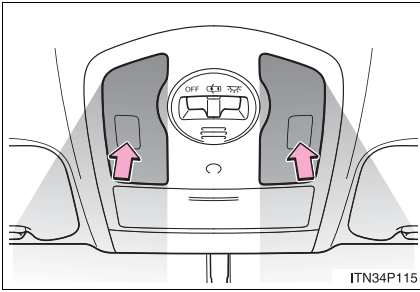

Turns the lights on/off

**Type B**

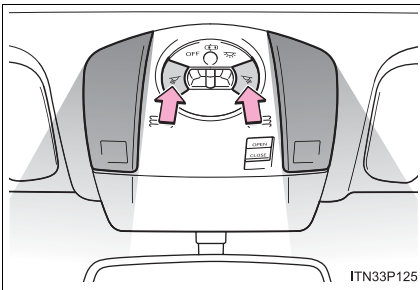

Turns the lights on/off

**Rear interior light**

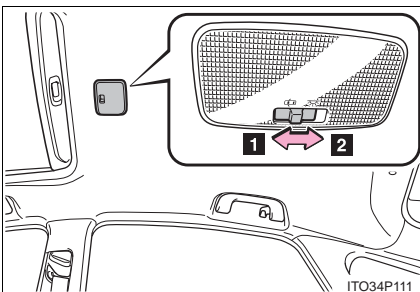

- 1** The light will turn on/off in conjunction with the front interior lights
- 2** Turns the light on

**■ Illuminated entry system**

The lights automatically turn on/off according to “POWER” switch mode, the presence of the electronic key, whether the doors are locked/unlocked, and whether the doors are opened/closed.

**■ To prevent 12-volt battery discharge**

If the interior lights remain on when the door is not fully closed and the interior light switch (door position on/off) is on, the lights will go off automatically after 20 minutes.

**■ Customization**

Setting (e.g. The time elapsed before lights turn off) can be changed.  
(Customizable features →P. 594)

 **NOTICE****■ To prevent 12-volt battery discharge**

Do not leave the lights on longer than necessary when the hybrid system is off.

## 3-4. Using the storage features

### List of storage features

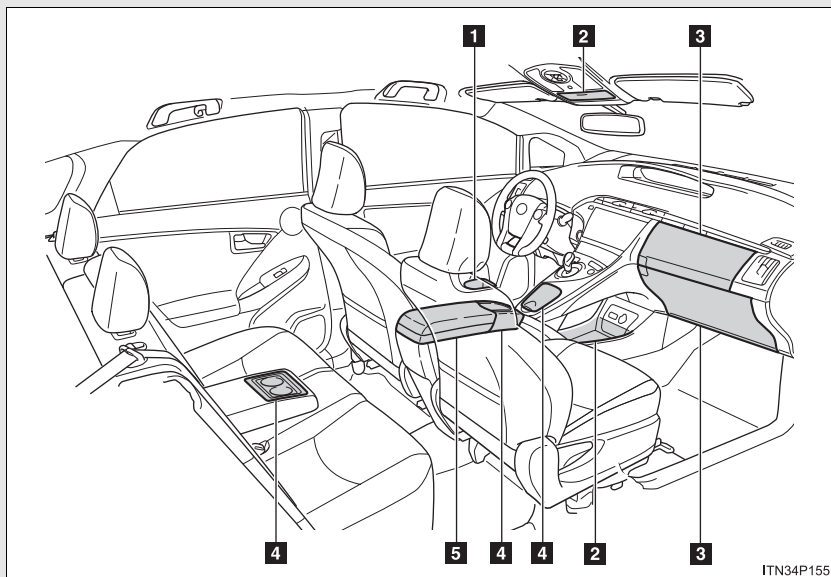

- 1** Bottle holders
- 2** Auxiliary boxes
- 3** Glove boxes
- 4** Cup holders
- 5** Console box

#### CAUTION

##### **■ Items that should not be left in the storage spaces**

Do not leave glasses, lighters or spray cans in the storage spaces, as this may cause the following when cabin temperature becomes high:

- Glasses may be deformed by heat or cracked if they come into contact with other stored items.
- Lighters or spray cans may explode. If they come into contact with other stored items, the lighter may catch fire or the spray can may release gas, causing a fire hazard.



## Glove boxes

### Upper glove box

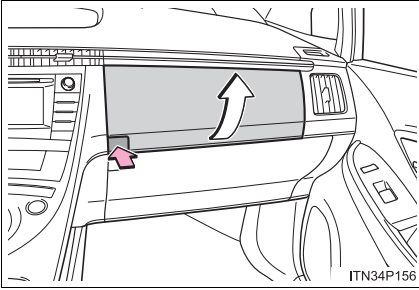

Push the button.

### Lower glove box

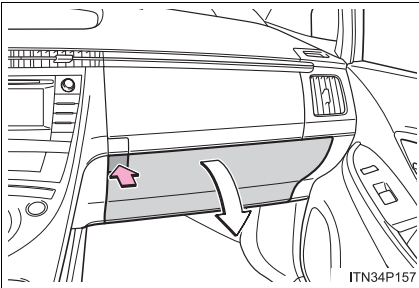

Push the button.

### ■ Glove box light (lower glove box only)

The glove box light turns on when the tail lights are on.

## ⚠ CAUTION

### ■ While driving

Keep the glove box closed when not in use. In the event of sudden braking or sudden swerving, an accident may occur due to an occupant being struck by the open glove box or the items stored inside.

## Console box

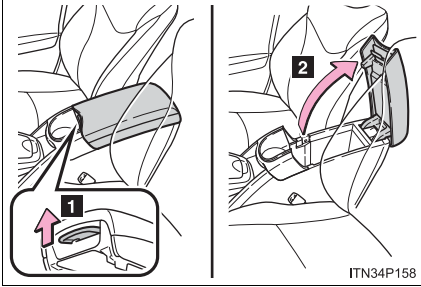

- 1** Pull up the lever to release the lock.
- 2** Lift the console box lid to open.

### CAUTION

#### ■ While driving

Keep the console box closed when not in use. In the event of sudden braking or sudden swerving, an accident may occur due to an occupant being struck by the open console box or the items stored inside.

**Cup holders**

**Front (type A)**

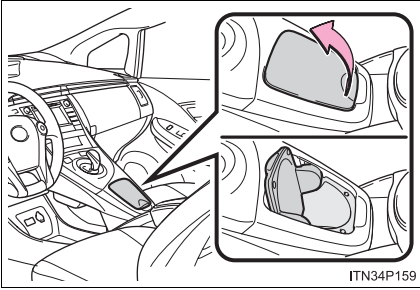

Lift the lid.

**Front (type B)**

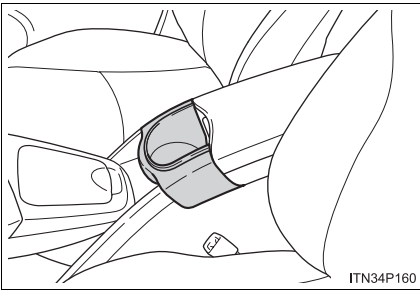

**Rear (if equipped)**

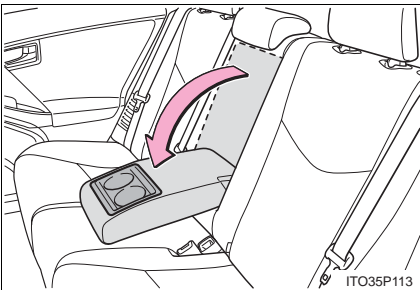

Pull down the armrest.

 **CAUTION****■ Items unsuitable for the cup holder**

Do not place anything other than cups or aluminum cans in the cup holders. Other items may be thrown out of the holders in the event of sudden braking, sudden swerving or an accident and cause injury. If possible, cover hot drinks to prevent burns.

**■ When not in use**

Keep the cup holders closed.

Injuries may result in the event of sudden braking, sudden swerving or an accident.

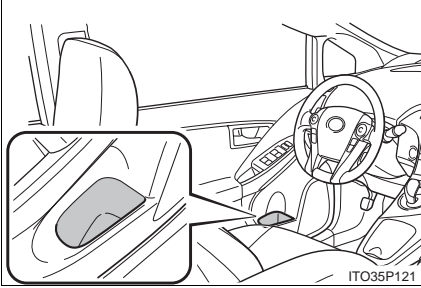
**Bottle holders****⚠ CAUTION****■ Items unsuitable for the bottle holder**

Do not place anything other than pet bottles in the bottle holders. Other items may be thrown out of the holders in the event of sudden braking, sudden swerving or an accident and cause injury.

**⚠ NOTICE****■ Items that should not be stowed in the bottle holders**

Put the cap on before stowing a bottle. Do not place open bottles in the bottle holders, or glasses and paper cups containing liquid. The contents may spill and glasses may break.

## Auxiliary boxes

### Type A

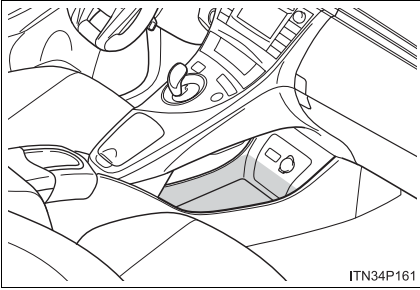

### Type B (if equipped)

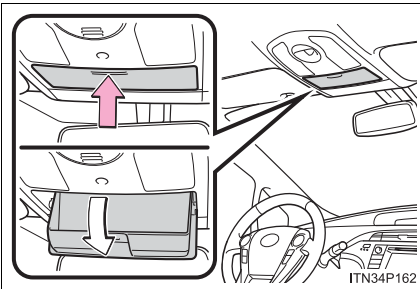

Push the lid.

The overhead console is useful for temporarily storing small items.

## ⚠ CAUTION

### ■ While driving

Do not leave the overhead console open. Items may fall out and cause injury.

### ■ Maximum storage weight

Do not place any object heavier than 0.4 lb. (200 g) in it. The console may be opened and cause injury.

## Sun visors

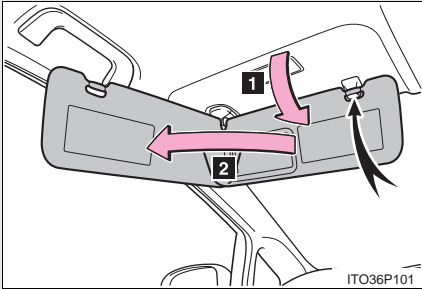

- 1** To set the visor in the forward position, flip it down.
- 2** To set the visor in the side position, flip down, unhook, and swing it to the side.

## Vanity mirrors

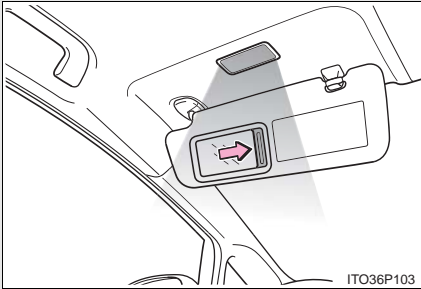

Slide the cover to open.

The light turns on when the cover is opened.

 NOTICE

■ **To prevent 12-volt battery discharge**

Do not leave the vanity lights on for extended periods while the hybrid system is off.



## Outside temperature display

The displayed temperature ranges from -22 °F (-30 °C) up to 122 °F (50 °C).

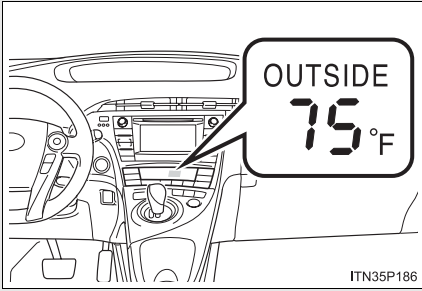

---

### ■ Operating conditions

The "POWER" switch is in ON mode.

### ■ Display

In the following situations, the correct outside temperature may not be displayed, or the display may take longer than normal to change.

- When stopped, or driving at low speeds (less than 16 mph [25 km/h])
- When the outside temperature has changed suddenly (at the entrance/exit of a garage, tunnel, etc.)

### ■ When -- is displayed

The system may be malfunctioning. Take your vehicle to your Toyota dealer.

## Power outlets

The power outlets can be used for 12 V accessories that run on less than 10 A.

### Instrument panel

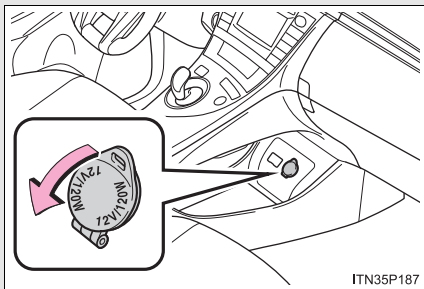

Open the cover.

### Rear console box

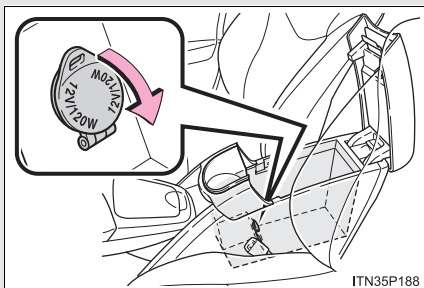

Open the cover.

■ **The power outlets can be used when**

The "POWER" switch is in ACCESSORY or ON mode.



## NOTICE

■ **To avoid damaging the power outlets**

Close the power outlet lid when the power outlet is not in use.

Foreign objects or liquids that enter the power outlet may cause a short circuit.

■ **To prevent blown fuse**

Do not use an accessory that uses more than 12 V 10 A.

■ **To prevent 12-volt battery discharge**

Do not use the power outlets longer than necessary when the hybrid system is off.

## Seat heaters\*

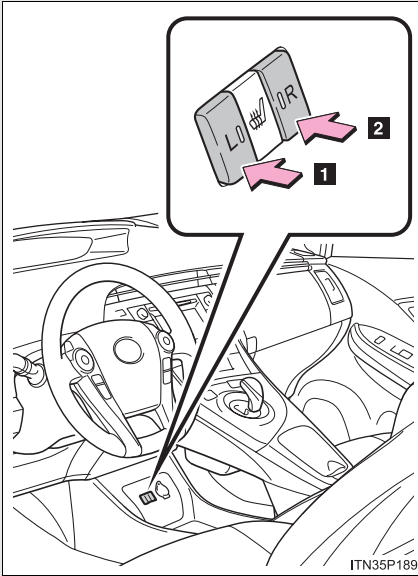

- 1** Heats the left front seat
- 2** Heats the right front seat

The indicator light comes on.

Press the button again to turn off the seat heater.

The indicator light turns off.

■ **The seat heaters can be used when**

The "POWER" switch is in ON mode.

■ **When not in use**

Turn the seat heater off.

\*: If equipped

 **CAUTION**

■ **Burns**

- Use caution when seating the following persons in a seat with the seat heater on to avoid the possibility of burns:
  - Babies, small children, the elderly, the sick and the physically challenged
  - Persons with sensitive skin
  - Persons who are fatigued
  - Persons who have taken alcohol or drugs that induce sleep (sleeping drugs, cold remedies, etc.)
- Do not cover the seat with anything when using the seat heater. Using the seat heater with a blanket or cushion increases the temperature of the seat and may lead to overheating.
- Do not use the seat heater more than necessary. Doing so may cause minor burns or overheating.

 **NOTICE**

■ **To prevent seat heater damage**

Do not put heavy objects that have an uneven surface on the seat and do not stick sharp objects (needles, nails, etc.) into the seat.

■ **To prevent 12-volt battery discharge**

Turn the seat heaters off when the hybrid system is off.

### 3-5. Other interior features

## Armrest\*

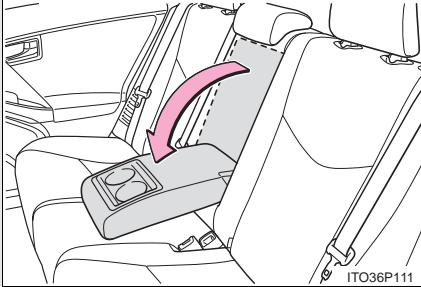

Pull the armrest down for use.

#### NOTICE

- **To prevent damage to the armrest**  
Do not place too much strain on the armrest.

## Floor mats

Use only floor mats designed specifically for vehicles of the same model and model year as your vehicle. Fix them securely in place onto the carpet.

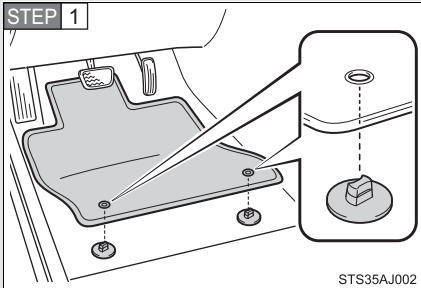

Insert the retaining hooks (clips) into the floor mat eyelets.

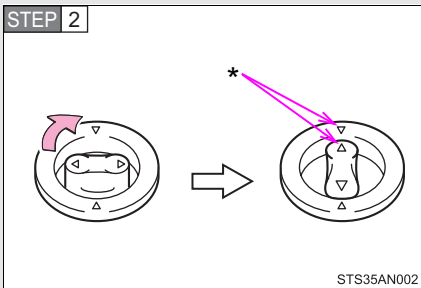

Turn the upper knob of each retaining hook (clip) to secure the floor mats in place.

\*: Always align the  $\triangle$  marks.

The shape of the retaining hooks (clips) may differ from that shown in the illustration.

## ⚠ CAUTION

Observe the following precautions.

Failure to do so may cause the driver's floor mat to slip, possibly interfering with the pedals while driving. An unexpectedly high speed may result or it may become difficult to stop the vehicle, leading to a serious accident.

### ■ When installing the driver's floor mat

- Do not use floor mats designed for other models or different model year vehicles, even if they are Toyota Genuine floor mats.
- Only use floor mats designed for the driver's seat.
- Always install the floor mat securely using the retaining hooks (clips) provided.
- Do not use two or more floor mats on top of each other.
- Do not place the floor mat bottom-side up or upside-down.

### ■ Before driving

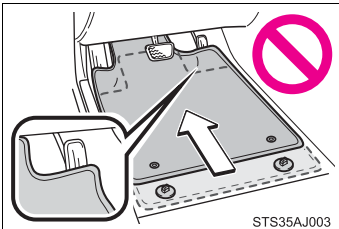

- Check that the floor mat is securely fixed in the correct place with all the provided retaining hooks (clips). Be especially careful to perform this check after cleaning the floor.
- With the hybrid system stopped and the shift position in P, fully depress each pedal to the floor to make sure it does not interfere with the floor mat.



### 3-5. Other interior features

## Luggage compartment features

#### ■ Cargo hooks

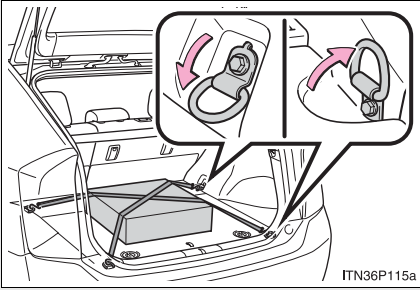

Raise the hook to use.

The cargo hooks are provided for securing loose items.

#### ■ Deck boards

##### Center (type A)

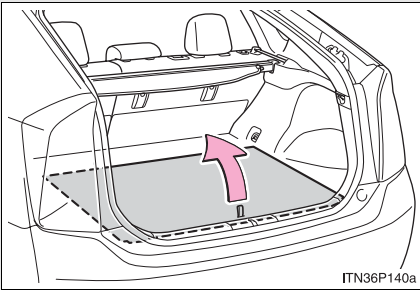

When using the auxiliary box, lift the center deck board.

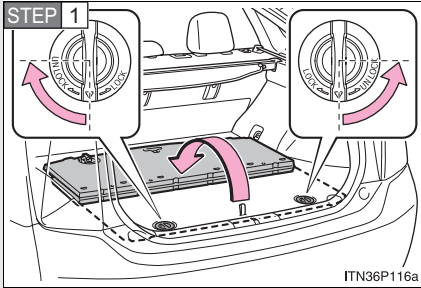
**Center (type B)**

When using the auxiliary box, turn the knob to the "UNLOCK" position and open the lid.

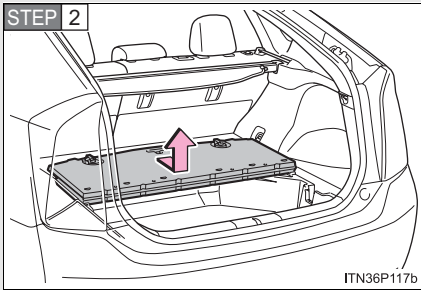

Lift the center deck board to remove it.

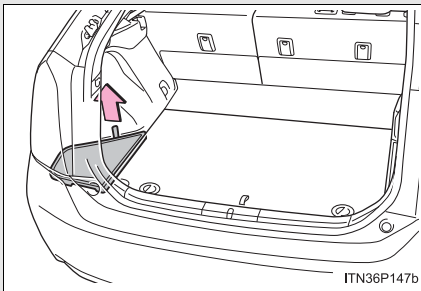
**Side**

Lift the side deck board to remove it.

■ Auxiliary boxes

Center (type A)

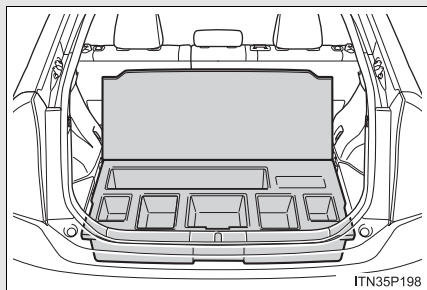

Center (type B)

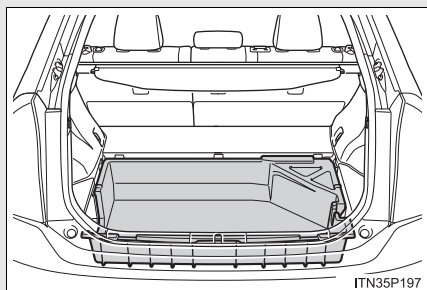

Side

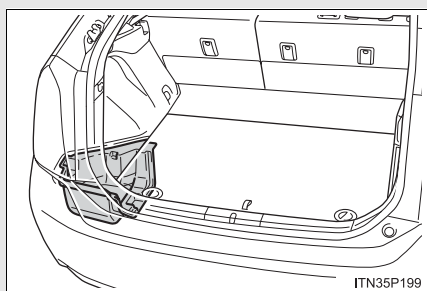

■ Luggage cover (if equipped)

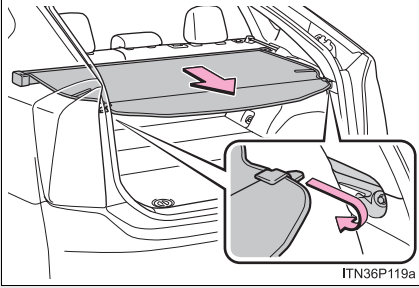

Pull out the luggage cover and secure it to the hook brackets.

Removing the luggage cover

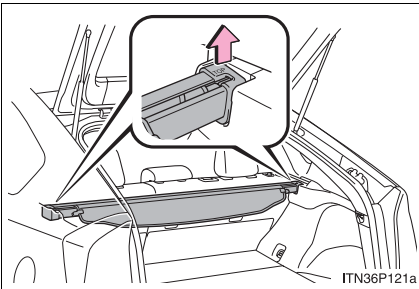

Lift it up.

**Stowing the luggage cover (vehicles with center auxiliary box type B only)**

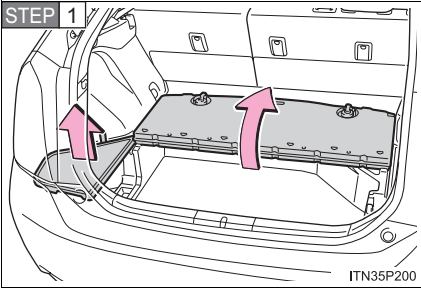

Remove the side deck board and open the center deck board.

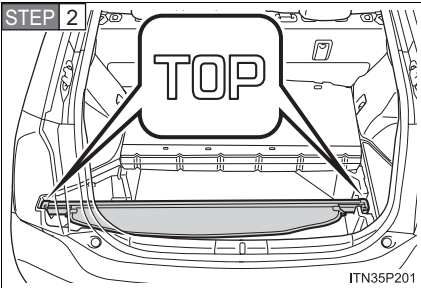

Adjust the cover so that "TOP" is facing up.

**STEP 3** Replace the side deck board and the center deck board.

 **CAUTION****■ When the cargo hooks are not in use**

To avoid injury, always return the cargo hooks to their stowed positions.

**■ Caution while driving**

Keep the lid of each storage spaces closed while driving. In the event of sudden braking or sudden swerving, an accident may occur due to an occupant being struck by an open auxiliary box or the items stored inside.

**■ Caution for the luggage cover**

- Do not allow children to climb on the luggage cover. Climbing on the luggage cover could result in damage to the luggage cover, possibly causing death or serious injury to the child.
- Make sure that the rear edge of the cover is laying flat. If the cover is installed with the rear edge raised, the view from the rear window may be obstructed, which could cause an accident.
- Make sure that seat belts are not caught up in the luggage cover. If a seat belt is caught up in the cover, it may not be able to restrain passengers properly.

### 3-5. Other interior features

## Garage door opener\*

The garage door opener can be programmed to operate garage doors, gates, entry doors, door locks, home lighting systems, security systems, and other devices.

The garage door opener (HomeLink® Universal Transceiver) is manufactured under license from HomeLink®.

### Programming the HomeLink® (for U.S.A. owners)

The HomeLink® compatible transceiver in your vehicle has 3 buttons which can be programmed to operate 3 different devices. Refer to the programming method below appropriate for the device.

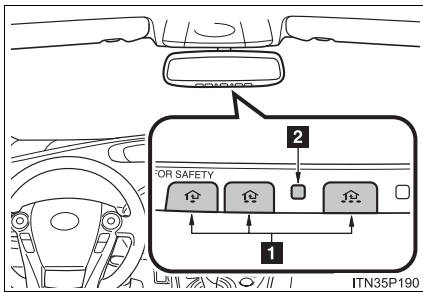

**1** Buttons

**2** Indicator light

\*: If equipped

## ■ Programming HomeLink®

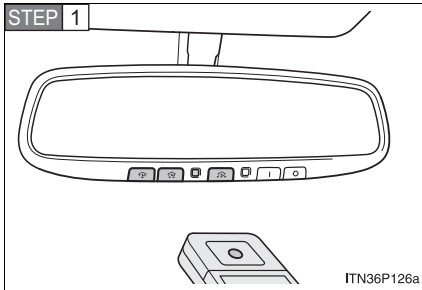

Point the remote control transmitter for the device 1 to 3 in. (25 to 75 mm) from the HomeLink® buttons.

Keep the HomeLink® indicator light in view while programming.

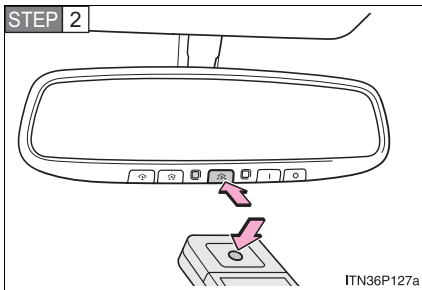

Press and hold one of the HomeLink® buttons and the transmitter button. When the HomeLink® indicator light changes from a slow to a rapid flash, you can release both buttons.

If the HomeLink® indicator light comes on but does not flash, or flashes rapidly for 2 seconds and remains lit, the HomeLink® button is already programmed. Use the other buttons or follow the “Reprogramming a HomeLink® button” instructions. (→P. 385)



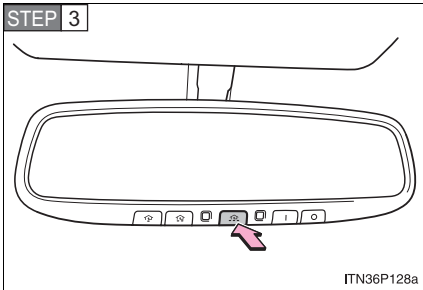

Test the HomeLink<sup>®</sup> operation by pressing the newly programmed button.

If a HomeLink<sup>®</sup> button has been programmed for a garage door, check to see if the garage door opens and closes. If the garage door does not operate, see if your garage transmitter is of the rolling code type. Press and hold the programmed HomeLink<sup>®</sup> button. The remote control transmitter is of the rolling code type if the HomeLink<sup>®</sup> indicator light flashes rapidly for 2 seconds and then remains lit. If your transmitter is the rolling code type, proceed to the heading “Programming a rolling code system”.

**STEP 4** Repeat the steps above to program another device for any of the remaining HomeLink<sup>®</sup> buttons.

### ■ Programming a rolling code system (for U.S.A. owners)

If your device is rolling code equipped, follow the steps under the heading “Programming HomeLink®” before proceeding with the steps listed below.

**STEP 1** Locate the training button on the ceiling mounted garage door opener motor. The exact location and color of the button may vary by brand of garage door opener motor.

Refer to the operation manual supplied with the garage door opener for the location of the training button.

**STEP 2** Press the training button.

Following this step, you have 30 seconds in which to initiate step 3 below.

**STEP 3** Press and hold the vehicle’s programmed HomeLink® button for 2 seconds and release it. Repeat this step once again. The garage door may open.

If the garage door opens, the programming process is complete. If the door does not open, press and hold the button a third time, and release after 2 seconds. This third press and release will complete the programming process by opening the garage door.

The ceiling mounted garage door opener motor should now recognize the HomeLink® signal and operate the garage door.

**STEP 4** Repeat the steps above to program another rolling code system for any of the remaining HomeLink® buttons.

### ■ Programming an entry gate (for U.S.A. owners)/Programming a devices in the Canadian market

**STEP 1** Place the remote control transmitter 1 to 3 in. (25 to 75 mm) away from the HomeLink<sup>®</sup> buttons.

Keep the HomeLink<sup>®</sup> indicator light in view while programming.

**STEP 2** Press and hold the selected HomeLink<sup>®</sup> button.

**STEP 3** Repeatedly press and release (cycle) the remote control transmitter for 2 seconds each until step 4 is completed.

**STEP 4** When the HomeLink<sup>®</sup> indicator light starts to flash rapidly, release the buttons.

**STEP 5** Test the HomeLink<sup>®</sup> operation by pressing the newly programmed button. Check to see if the gate/device operates correctly.

**STEP 6** Repeat the steps above to program another device for any of the remaining HomeLink<sup>®</sup> buttons.

### ■ Programming other devices

To program other devices such as home security systems, home door locks and lighting, contact your Toyota dealer for assistance.

### ■ Reprogramming a button

The individual HomeLink<sup>®</sup> buttons cannot be erased but can be reprogrammed. To reprogram a button, follow the “Reprogramming a HomeLink<sup>®</sup> button” instructions.

### Operating HomeLink®

Press the appropriate HomeLink® button. The HomeLink® indicator light should come on.

The HomeLink® compatible transceiver in your vehicle continues to send a signal for up to 20 seconds as long as the button is pressed.

### Reprogramming a HomeLink® button

Press and hold the desired HomeLink® button. After 20 seconds, the HomeLink® indicator light will start flashing slowly. Keep pressing the HomeLink® button and press and hold the transmitter button until the HomeLink® indicator light changes from a slow to a rapid flash. Release the buttons.

### Erasing the entire HomeLink® memory (all three programs)

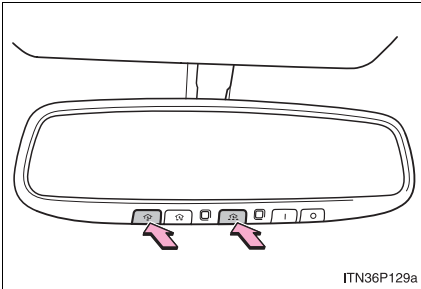

Press and hold the 2 outside buttons for 10 seconds until the indicator light flashes.

If you sell your vehicle, be sure to erase the programs stored in the HomeLink® memory.

■ **Before programming**

- Install a new battery in the remote control transmitter.
- The battery side of the remote control transmitter must be pointed away from the HomeLink® button.

■ **Certification for the garage door opener**

**For vehicles sold in the U.S.A.**

FCC ID: NZLOBIHL4

NOTE:

This device complies with Part 15 of the FCC Rules.

Operation is subject to the following two conditions: (1) this device may not cause harmful interference, and (2) this device must accept any interference received, including interference that may cause undesired operation.

FCC WARNING:

Changes or modifications not expressly approved by the party responsible for compliance could void the user's authority to operate the equipment.

**For vehicles sold in Canada**

IC ID: 4112A-OBIHL4

NOTE:

Operation is subject to the following two conditions: (1) this device may not cause interference, and (2) this device must accept any interference, including interference that may cause undesired operation of the device.

■ **When support is necessary**

Visit on the web at [www.homelink.com](http://www.homelink.com) or call 1-800-355-3515.

 **CAUTION****■ When programming a garage door or other remote control device**

The garage door or other device may operate, so ensure people and objects are out of danger to prevent potential harm.

**■ Conforming to federal safety standards**

Do not use the HomeLink<sup>®</sup> compatible transceiver with any garage door opener or device that lacks safety stop and reverse features as required by federal safety standards.

This includes any garage door that cannot detect an interfering object. A door or device without these features increases the risk of death or serious injury.

## Safety Connect\*

**Safety Connect is a subscription-based telematics service that uses Global Positioning System (GPS) data and embedded cellular technology to provide safety and security features to subscribers. Safety Connect is supported by Toyota's designated response center, which operates 24 hours per day, 7 days per week.**

**Safety Connect service is available by subscription on select, telematics hardware-equipped vehicles.**

**By using the Safety Connect service, you are agreeing to be bound by the Telematics Subscription Service Agreement and its Terms and Conditions, as in effect and amended from time to time, a current copy of which is available at Toyota.com. All use of the Safety Connect service is subject to such then-applicable Terms and Conditions.**

### ■ System components

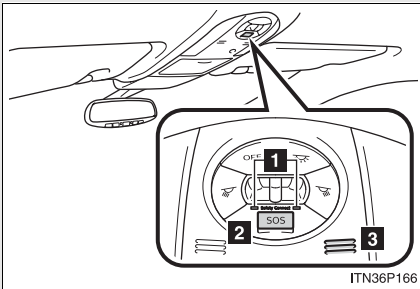

- 1** LED light indicators
- 2** "SOS" button
- 3** Microphone

\*: If equipped

## ■ Services

Subscribers have the following Safety Connect services available:

- Automatic Collision Notification\*

Helps drivers receive necessary response from emergency service providers. (→P. 391)

\*: U.S. Patent No. 7,508,298 B2

- Stolen Vehicle Location

Helps drivers in the event of vehicle theft. (→P. 392)

- Emergency Assistance Button (SOS)

Connects drivers to response-center support. (→P. 392)

- Enhanced Roadside Assistance

Provides drivers various on-road assistance. (→P. 392)

## ■ Subscription

After you have signed the Telematics Subscription Service Agreement and are enrolled, you can begin receiving services.

A variety of subscription terms is available for purchase. Contact your Toyota dealer, call 1-800-25-TOYOTA (1-800-255-3987) or push the “SOS” button in your vehicle for further subscription details.



### ■ Safety Connect Services Information

- Phone calls using the vehicles Bluetooth® technology will not be possible during Safety Connect.
- Safety Connect is available beginning Fall 2009 on select Toyota models. Contact with the Safety Connect response center is dependent upon the telematics device being in operative condition, cellular connection availability, and GPS satellite signal reception, which can limit the ability to reach the response center or receive emergency service support. Enrollment and Telematics Subscription Service Agreement required. A variety of subscription terms is available; charges vary by subscription term selected.
- Automatic Collision Notification, Emergency Assistance, Stolen Vehicle Location, and Enhanced Roadside Assistance will function in the United States, including Hawaii and Alaska, and in Canada. No Safety Connect services will function outside of the United States in countries other than Canada.
- Safety Connect services are not subject to section 255 of the Telecommunications Act and the device is not TTY compatible.

### ■ Languages

The Safety Connect response center will offer support in multiple languages. The Safety Connect system will offer voice prompts in English and Spanish. Please indicate your language of choice when enrolling.

### ■ When contacting the response center

You may be unable to contact the response center if the network is busy.

### ■ Safety Connect backup battery depletion

An exclusive backup battery is built in to assist the Automatic Collision Notification, which is activated when impact above a certain level is applied to the vehicle, or when the airbags operate. This battery is a primary battery, and cannot be recharged. The red LED indicator will flash to indicate that the battery should be replaced.

The backup battery will need to be replaced if the Automatic Collision Notification operates for 60 seconds or more. For replacement, consult your Toyota dealer.

### **Safety Connect LED light Indicators**

When the “POWER” switch is turned to ON mode, the red indicator light comes on for 2 seconds then turns off. Afterward, the green indicator light comes on, indicating that the service is active.

The following indicator light patterns indicate specific system usage conditions:

- Green indicator light on = Active service
- Green indicator light flashing = Safety Connect call in process
- Red indicator light (except at vehicle start-up) = System malfunction (contact your Toyota dealer)
- No indicator light (off) = Safety Connect service not active

### **Safety Connect services**

#### **■ Automatic Collision Notification**

In case of either airbag deployment or severe rear-end collision, the system is designed to automatically call the response center. The responding agent receives the vehicle’s location and attempts to speak with the vehicle occupants to assess the level of emergency. If the occupants are unable to communicate, the agent automatically treats the call as an emergency, contacts the nearest emergency services provider to describe the situation, and requests that assistance be sent to the location.

### ■ **Stolen Vehicle Location**

If your vehicle is stolen, Safety Connect can work with local authorities to assist them in locating and recovering the vehicle. After filing a police report, call the Safety Connect response center at 1-800-25-TOYOTA (1-800-255-3987) and follow the prompts for Safety Connect to initiate this service.

In addition to assisting law enforcement with recovery of a stolen vehicle, Safety-Connect-equipped vehicle location data may, under certain circumstances, be shared with third parties to locate your vehicle. Further information is available at [Toyota.com](http://Toyota.com).

### ■ **Emergency Assistance Button (“SOS”)**

In the event of an emergency on the road, push the “SOS” button to reach the Safety Connect response center. The answering agent will determine your vehicle’s location, assess the emergency, and dispatch the necessary assistance required.

If you accidentally press the “SOS” button, tell the response-center agent that you are not experiencing an emergency.

### ■ **Enhanced Roadside Assistance**

Enhanced Roadside Assistance adds GPS data to the already included warranty-based Toyota roadside service.

Subscribers can press the “SOS” button to reach a Safety Connect response-center agent, who can help with a wide range of needs, such as: towing, flat tire, fuel delivery, etc. For a description of the Roadside Assistance services and their limitations, please see the Safety Connect Terms and Conditions, which are available at [Toyota.com](http://Toyota.com).

## Safety information for Safety Connect

Important! Read this information before using Safety Connect.

### ■ Exposure to radio frequency signals

The Safety Connect system installed in your vehicle is a low-power radio transmitter and receiver. It receives and also sends out radio frequency (RF) signals.

In August 1996, the Federal Communications Commission (FCC) adopted RF exposure guidelines with safety levels for mobile wireless phones. Those guidelines are consistent with the safety standards previously set by the following U.S. and international standards bodies.

- ANSI (American National Standards Institute) C95.1 [1992]
- NCRP (National Council on Radiation Protection and Measurement) Report 86 [1986]
- ICNIRP (International Commission on Non-Ionizing Radiation Protection) [1996]

Those standards were based on comprehensive and periodic evaluations of the relevant scientific literature. Over 120 scientists, engineers, and physicians from universities, and government health agencies and industries reviewed the available body of research to develop the ANSI Standard (C95.1).

The design of Safety Connect complies with the FCC guidelines in addition to those standards.

■ **Certification for Safety Connect**

FCC ID: O9EGTM1

FCC ID: O6Y-CDMRF101

**NOTE:**

This device complies with part 15 of the FCC Rules. Operation is subject to the following two conditions: (1) This device may not cause harmful interference, and (2) this device must accept any interference received, including interference that may cause undesired operation.

**FCC WARNING:**

Changes or modifications not expressly approved by the party responsible for compliance could void the user's authority to operate the equipment.

## Cleaning and protecting the vehicle exterior

**Perform the following to protect the vehicle and maintain it in prime condition:**

- Working from top to bottom, liberally apply water to the vehicle body, wheel wells and underside of the vehicle to remove any dirt and dust.
- Wash the vehicle body using a sponge or soft cloth, such as a chamois.
- For hard-to-remove marks, use car wash soap and rinse thoroughly with water.
- Wipe away any water.
- Wax the vehicle when the waterproof coating deteriorates.

If water does not bead on a clean surface, apply wax when the vehicle body is cool.

---

### ■ Automatic car washes

- Fold the mirrors and remove the antenna before washing the vehicle. Start washing from the front of the vehicle. Make sure to re-install the antenna and extend the mirrors before driving.
- Brushes used in automatic car washes may scratch the vehicle surface and harm your vehicle's paint.
- Roof antenna, rear spoiler may not be washable in some automatic car washes. There may also be an increased risk of damage to vehicle.

### ■ High pressure car washes

- Do not allow the nozzles of the car wash to come within close proximity of the windows.
- Before using the car wash, check that the fuel filler door on your vehicle is closed properly.

### ■ When using a car wash

If the door handle becomes wet while the electronic key is within the effective range, the door may lock and unlock repeatedly. Place the key in a position 6 ft. (2 m) or more separate from the vehicle while the vehicle is being washed. (Take care to ensure that the key is not stolen.)

### ■ Aluminum wheels

- Remove any dirt immediately by using a neutral detergent. Do not use hard brushes or abrasive cleaners. Do not use strong or harsh chemical cleaners.  
Use the same mild detergent and wax as used on the paint.
- Do not use detergent on the wheels when they are hot, for example after driving for long distance in the hot weather.
- Wash detergent from the wheels immediately after use.

### ■ Bumpers

Do not scrub with abrasive cleaners.

## CAUTION

### ■ When washing the vehicle

Do not apply water to the inside of the engine compartment. Doing so may cause the electrical components etc. to catch fire.

### ■ Precautions regarding the exhaust pipe

Exhaust gasses cause the exhaust pipe to become quite hot.

When washing the vehicle, be careful not to touch the pipe until it has cooled sufficiently, as touching a hot exhaust pipe can cause burns.

 NOTICE

■ **To prevent paint deterioration and corrosion on the body and components (aluminum wheels etc.)**

● Wash the vehicle immediately in the following cases:

- After driving near the sea coast
- After driving on salted roads
- If coal tar or tree sap is present on the paint surface
- If dead insects, insect droppings or bird droppings are present on the paint surface
- After driving in an area contaminated with soot, oily smoke, mine dust, iron powder or chemical substances
- If the vehicle becomes heavily soiled with dust or mud
- If liquids such as benzene and gasoline are spilled on the paint surface

● If the paint is chipped or scratched, have it repaired immediately.

● To prevent the wheels from corroding, remove any dirt and store in a place with low humidity when storing the wheels.

■ **Cleaning the exterior lights**

● Wash carefully. Do not use organic substances or scrub with a hard brush. This may damage the surfaces of the lights.

● Do not apply wax to the surfaces of the lights. Wax may cause damage to the lenses.

■ **Antenna installation and removal precautions**

● Before driving, ensure that the antenna is installed.

● When the antenna is removed, such as before entering an automatic car wash, make sure to store it in a suitable place so as not to lose it. Also, before driving, make sure to reinstall the antenna in its original position.



## Cleaning and protecting the vehicle interior

**The following procedures will help protect your vehicle's interior and keep it in top condition:**

### ■ **Protecting the vehicle interior**

Remove dirt and dust using a vacuum cleaner. Wipe dirty surfaces with a cloth dampened with lukewarm water.

### ■ **Cleaning the leather areas**

- Remove dirt and dust using a vacuum cleaner.
- Wipe off any excess dirt and dust with a soft cloth dampened with diluted detergent.

Use a diluted water solution of approximately 5% neutral wool detergent.

- Wring out any excess water from the cloth and thoroughly wipe off all remaining traces of detergent.
- Wipe the surface with a dry, soft cloth to remove any remaining moisture. Allow the leather to dry in a shaded and ventilated area.

### ■ **Cleaning the synthetic leather areas**

- Remove loose dirt using a vacuum cleaner.
- Apply a mild soap solution to the synthetic leather using a sponge or soft cloth.
- Allow the solution to soak in for a few minutes. Remove the dirt and wipe off the solution with a clean, damp cloth.

### ■ Caring for leather areas

Toyota recommends cleaning the interior of the vehicle at least twice a year to maintain the quality of the vehicle's interior.

### ■ Shampooing the carpets

There are several commercial foaming-type cleaners available. Use a sponge or brush to apply the foam. Rub in overlapping circles. Do not use water. Wipe dirty surfaces and let them dry. Excellent results are obtained by keeping the carpet as dry as possible.

### ■ Seat belts

Clean with mild soap and lukewarm water using a cloth or sponge. Also check the belts periodically for excessive wear, fraying or cuts.

## CAUTION

### ■ Water in the vehicle

- Do not splash or spill liquid in the vehicle, such as on the floor, in the hybrid battery (traction battery) air vents, and in the luggage compartment. Doing so may cause the hybrid battery (traction battery), electrical components, etc. to malfunction or catch fire.

- Do not get any of the SRS components or wiring in the vehicle interior wet. (→P. 142)

An electrical malfunction may cause the airbags to deploy or not function properly, resulting in death or serious injury.

### ■ Cleaning the interior (especially instrument panel)

Do not use polish wax or polish cleaner. The instrument panel may reflect off the windshield, obstructing the driver's view and leading to an accident, resulting in death or serious injury.

 NOTICE**■ Cleaning detergents**

- Do not use the following types of detergent, as they may discolor the vehicle interior or cause streaks or damage to painted surfaces:
  - Non-seat portions: Organic substances such as benzene or gasoline, alkaline or acidic solutions, dye, and bleach
  - Seats: Alkaline or acidic solutions, such as thinner, benzene, and alcohol
- Do not use polish wax or polish cleaner. The instrument panel's or other interior part's painted surface may be damaged.

**■ Preventing damage to leather surfaces**

Observe the following precautions to avoid damage to and deterioration of leather surfaces:

- Remove any dust or dirt from leather surfaces immediately.
- Do not expose the vehicle to direct sunlight for extended periods of time. Park the vehicle in the shade, especially during summer.
- Do not place items made of vinyl, plastic, or containing wax on the upholstery, as they may stick to the leather surface if the vehicle interior heats up significantly.

**■ Water on the floor**

Do not wash the vehicle floor with water.

Vehicle systems such as the audio system may be damaged if water comes into contact with electrical components such as the audio system above or under the floor of the vehicle. Water may also cause the body to rust.

**■ Cleaning the inside of the rear window**

- Do not use glass cleaner to clean the rear window, as this may cause damage to the rear window defogger heater wires. Use a cloth dampened with lukewarm water to gently wipe the window clean. Wipe the window in strokes running parallel to the heater wires.
- Be careful not to scratch or damage the heater wires.

## Maintenance requirements

**To ensure safe and economical driving, day-to-day care and regular maintenance are essential. It is the owner's responsibility to perform regular checks. Toyota recommends performing the following maintenance:**

### ■ General maintenance

General maintenance should be performed on a daily basis. This can be done by yourself or by a Toyota dealer.

### ■ Scheduled maintenance

Scheduled maintenance should be performed at specified intervals according to the maintenance schedule.

For details about maintenance items and schedules, refer to the "Scheduled Maintenance Guide" or "Owner's Manual Supplement".

### ■ Do-it-yourself maintenance

You can perform some maintenance procedures by yourself. Please be aware that do-it-yourself maintenance may affect warranty coverage.

The use of Toyota repair manuals is recommended.

For details about warranty coverage, refer to the separate "Owner's Warranty Information Booklet" or "Owner's Manual Supplement".

---

### ■ Repair and replacement

It is recommended that genuine Toyota parts be used for repairs to ensure performance of each system. If non-Toyota parts are used in replacement or if a repair shop other than a Toyota dealer performs repairs, confirm the warranty coverage.

### ■ Reset the maintenance data (U.S.A. only)

After the required maintenance is performed according to the maintenance schedule, please reset the maintenance data.

To reset the data, follow the procedures described below:

- STEP 1** Turn the “POWER” switch off with the trip meter A shown.
- STEP 2** Turn the “POWER” switch to ON mode with the MPH or km/h button (→P. 216) held down.
- STEP 3** Keep pressing the button until the trip meter indicates “000000” and the multi-information display indicates that the reset is complete.

### ■ Allow inspection and repairs to be performed by a Toyota dealer

- Toyota technicians are well-trained specialists and are kept up to date with the latest service information. They are well informed about the operation of all systems on your vehicle.
- Keep a copy of the repair order. It proves that the maintenance that has been performed is under warranty coverage. If any problem should arise while your vehicle is under warranty, your Toyota dealer will promptly take care of it.

 **CAUTION**

■ **If your vehicle is not properly maintained**

Improper maintenance could result in serious damage to the vehicle and possible serious injury or death.

■ **Handling of the 12-volt battery**

- Engine exhaust, some of its constituents, and a wide variety of automobile components contain or emit chemicals known to the State of California to cause cancer and birth defects and other reproductive harm. Work in a well ventilated area.
- Oils, fuels and fluids contained in vehicles as well as waste produced by component wear contain or emit chemicals known to the State of California to cause cancer and birth defects or other reproductive harm. Avoid exposure and wash any affected area immediately.
- 12-volt battery posts, terminals and related accessories contain lead and lead compounds which are known to cause brain damage. Wash your hands after handling. (→P. 431)

## General maintenance

Listed below are the general maintenance items that should be performed at the intervals specified in the “Owner’s Warranty Information Booklet” or “Owner’s Manual Supplement/Scheduled Maintenance Guide”. It is recommended that any problem you notice should be brought to the attention of your Toyota dealer or qualified service shop for advice.

<b>Engine compartment</b>
---------------------------

Items	Check points
Brake fluid	Is the brake fluid at the correct level? (→P. 427)
Engine/power control unit coolant	Is the engine/power control unit coolant at the correct level? (→P. 424)
Engine oil	Is the engine oil at the correct level? (→P. 420)
Exhaust system	There should not be any fumes or strange sounds.
Radiator/condenser	The radiator and condenser should be free from foreign objects. (→P. 426)
Washer fluid	Is there sufficient washer fluid? (→P. 429)

## Luggage compartment

Items	Check points
12-volt battery	Check the connections. (→P. 431)

## Vehicle interior

Items	Check points
Accelerator pedal	<ul style="list-style-type: none"> <li>• The accelerator pedal should move smoothly (without uneven pedal effort or catching).</li> </ul>
Hybrid transmission “Park” mechanism	<ul style="list-style-type: none"> <li>• When parked on a slope and the shift position is in P, is the vehicle securely stopped?</li> </ul>
Brake pedal	<ul style="list-style-type: none"> <li>• Does the brake pedal move smoothly?</li> <li>• Does the brake pedal have appropriate clearance from the floor? (→P. 568)</li> <li>• Does the brake pedal have the correct amount of free play? (→P. 568)</li> </ul>
Brakes	<ul style="list-style-type: none"> <li>• The vehicle should not pull to one side when the brakes are applied.</li> <li>• The brakes should work effectively.</li> <li>• The brake pedal should not feel spongy.</li> <li>• The brake pedal should not get too close to the floor when the brakes are applied.</li> </ul>



Items	Check points
Head restraints	<ul style="list-style-type: none"> <li>• Do the head restraints move smoothly and lock securely?</li> </ul>
Indicators/buzzers	<ul style="list-style-type: none"> <li>• Do the indicators and buzzers function properly?</li> </ul>
Lights	<ul style="list-style-type: none"> <li>• Do all the lights come on?</li> </ul>
Parking brake	<ul style="list-style-type: none"> <li>• Does the parking brake pedal move smoothly?</li> <li>• When parked on a slope and the parking brake is on, is the vehicle securely stopped?</li> </ul>
Seat belts	<ul style="list-style-type: none"> <li>• Do the seat belts operate smoothly?</li> <li>• The seat belts should not be damaged.</li> </ul>
Seats	<ul style="list-style-type: none"> <li>• Do the seat controls operate properly?</li> </ul>
Steering wheel	<ul style="list-style-type: none"> <li>• Does the steering wheel rotate smoothly?</li> <li>• Does the steering wheel have the correct amount of free play?</li> <li>• There should not be any strange sounds coming from the steering wheel.</li> </ul>

**Vehicle exterior**

Items	Check points
Doors	<ul style="list-style-type: none"> <li>• Do the doors operate smoothly?</li> </ul>
Engine hood	<ul style="list-style-type: none"> <li>• Does the engine hood lock system work properly?</li> </ul>
Fluid leaks	<ul style="list-style-type: none"> <li>• There should not be any signs of fluid leakage after the vehicle has been parked.</li> </ul>
Tires	<ul style="list-style-type: none"> <li>• Is the tire inflation pressure correct?</li> <li>• The tires should not be damaged or excessively worn.</li> <li>• Have the tires been rotated according to the maintenance schedule?</li> <li>• The wheel nuts should not be loose.</li> </ul>

 **CAUTION**

**■ If the hybrid system is operating**

Turn the hybrid system off and ensure that there is adequate ventilation before performing maintenance checks.

**Some states have vehicle emission inspection programs which include OBD (On Board Diagnostics) checks. The OBD system monitors the operation of the emission control system.**

■ **If the malfunction indicator lamp comes on**

The OBD system determines that a problem exists somewhere in the emission control system. Your vehicle may not pass the I/M test and may need to be repaired. Contact your Toyota dealer to service the vehicle.

■ **Your vehicle may not pass the I/M test in the following situations:**

- When the 12-volt battery is disconnected or discharged

Readiness codes that are set during ordinary driving are erased.

Also, depending on your driving habits, the readiness codes may not be completely set.

- When the fuel tank cap is loose

The malfunction indicator lamp comes on indicating a temporary malfunction and your vehicle may not pass the I/M test.

■ **When the malfunction indicator lamp still remains on after several driving trips**

The error code in the OBD system will not be cleared unless the vehicle is driven 40 or more times.

■ **If your vehicle does not pass the I/M test**

Contact your Toyota dealer to prepare the vehicle for re-testing.

## Do-it-yourself service precautions

**If you perform maintenance by yourself, be sure to follow the correct procedure as given in these sections.**

Items	Parts and tools
12-volt battery condition (→P. 431)	<ul style="list-style-type: none"> <li>• Grease</li> <li>• Conventional wrench (for terminal clamp bolts)</li> </ul>
Brake fluid level (→P. 427)	<ul style="list-style-type: none"> <li>• FMVSS No.116 DOT 3 or SAE J1703 brake fluid</li> <li>• Rag or paper towel</li> <li>• Funnel (used only for adding brake fluid)</li> </ul>
Engine/power control unit coolant level (→P. 424)	<ul style="list-style-type: none"> <li>• “Toyota Super Long Life Coolant” or a similar high quality ethylene glycol-based non-silicate, non-amine, non-nitrite and non-borate coolant with long-life hybrid organic acid technology For the U.S.A.: “Toyota Super Long Life Coolant” is pre-mixed with 50% coolant and 50% deionized water. For Canada: “Toyota Super Long Life Coolant” is pre-mixed with 55% coolant and 45% deionized water.</li> <li>• Funnel (used only for adding coolant)</li> </ul>

Items	Parts and tools
Engine oil level (→P. 420)	<ul style="list-style-type: none"> <li>• “Toyota Genuine Motor Oil” or equivalent</li> <li>• Rag or paper towel</li> <li>• Funnel (used only for adding engine oil)</li> </ul>
Fuses (→P. 456)	<ul style="list-style-type: none"> <li>• Fuse with same amperage rating as original</li> </ul>
Light bulbs (→P. 467)	<ul style="list-style-type: none"> <li>• Bulb with same number and wattage rating as original</li> <li>• Phillips-head screwdriver</li> <li>• Flathead screwdriver</li> <li>• Wrench</li> </ul>
Radiator and condenser (→P. 426)	—
Tire inflation pressure (→P. 447)	<ul style="list-style-type: none"> <li>• Tire pressure gauge</li> <li>• Compressed air source</li> </ul>
Washer fluid (→P. 429)	<ul style="list-style-type: none"> <li>• Water or washer fluid containing antifreeze (for winter use)</li> <li>• Funnel (used only for adding water or washer fluid)</li> </ul>

 **CAUTION**

The engine compartment contains many mechanisms and fluids that may move suddenly, become hot, or become electrically energized. To avoid death or serious injury, observe the following precautions.

■ **When working on the engine compartment**

- Make sure that the indicator on the “POWER” switch and the “READY” indicator are both off.
- Keep hands, clothing and tools away from the moving fan.
- Be careful not to touch the engine, power control unit, radiator, exhaust manifold, etc. right after driving as they may be hot. Oil and other fluids may also be hot.
- Do not leave anything that may burn easily, such as paper and rags, in the engine compartment.
- Do not smoke, cause sparks or expose an open flame to fuel. Fuel fumes are flammable.

■ **When working near the electric cooling fans or radiator grille**

Be sure the “POWER” switch is off.

With the “POWER” switch in ON mode, the electric cooling fans may automatically start to run if the air conditioning is on and/or the coolant temperature is high. (→P. 426)

■ **Safety glasses**

Wear safety glasses to prevent flying or falling material, fluid spray, etc. from getting in your eyes.

 **NOTICE**

■ **If you remove the air cleaner filter**

Driving with the air cleaner filter removed may cause excessive engine wear due to dirt in the air. Also, a backfire could cause a fire in the engine compartment.

## 4-3. Do-it-yourself maintenance

### Hood

**Release the lock from the inside of the vehicle to open the hood.**

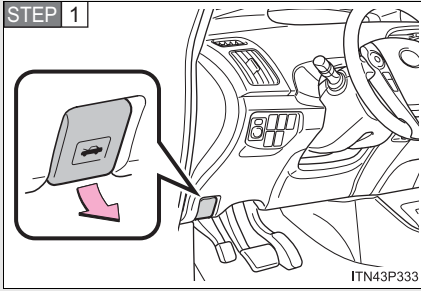

Pull the hood lock release lever.

The hood will pop up slightly.

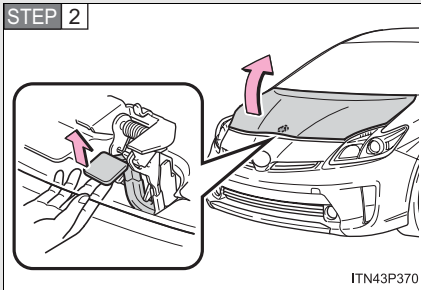

Pull up the auxiliary catch lever and lift the hood.

STEP 3

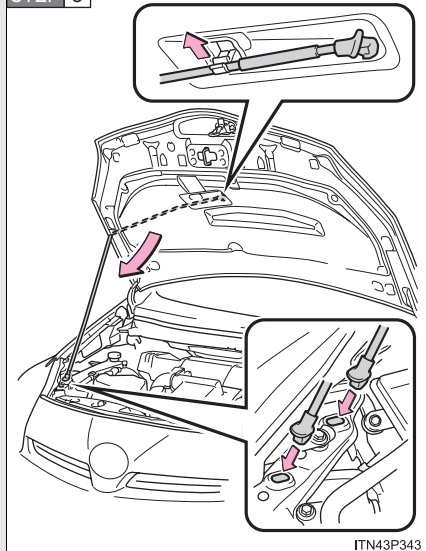

Hold the hood open by inserting the supporting rod into either of the slots.

Use the forward slot to open the hood normally, or use the rearward slot when the hood needs to be opened wide.

**⚠ CAUTION**

**■ Pre-driving check**

Check that the hood is fully closed and locked.

If the hood is not locked properly, it may open while the vehicle is in motion and cause an accident, which may result in death or serious injury.

**■ After installing the support rod into the slot**

Make sure the rod supports the hood securely from falling down on to your head or body.



**NOTICE****■ When closing the hood**

Be sure to return the support rod to its clip before closing the hood. Closing the hood without returning the support rod properly could cause the hood to bend.

## 4-3. Do-it-yourself maintenance

### Positioning a floor jack

When raising your vehicle with a floor jack, position the jack correctly. Improper placement (such as under rear suspension etc.) may damage your vehicle or cause injury.

#### ■ Front

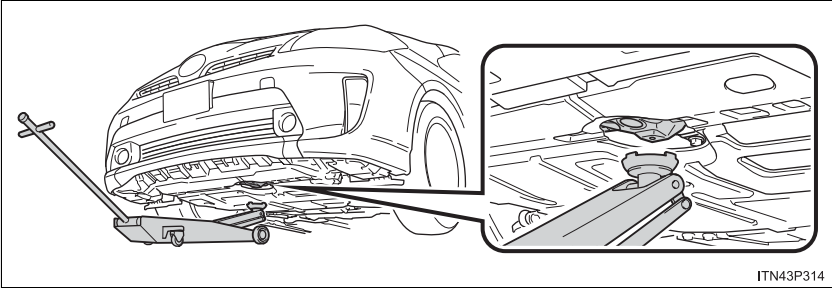

#### ■ Rear

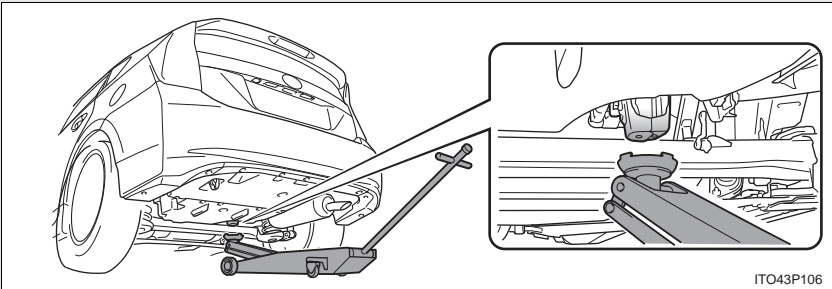

## ⚠ CAUTION

### ■ When raising your vehicle

Make sure to observe the following precautions to reduce the possibility of death or serious injury:

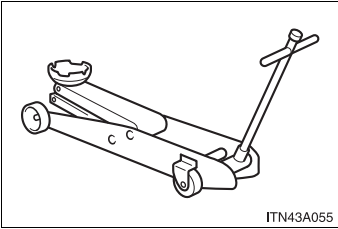

- Lift up the vehicle using a floor jack such as the one shown in the illustration.

- When using a floor jack, follow the instructions of the manual provided with the jack.
- Do not use the jack that was supplied with your vehicle.
- Do not put any part of your body underneath the vehicle when it is supported only by the floor jack.
- Always use floor jack and/or automotive jack stands on a solid, flat, level surface.
- Do not start the hybrid system while the vehicle is supported by the floor jack.
- Stop the vehicle on level, firm ground, firmly set the parking brake and shift the shift position to P.
- Make sure to set the floor jack properly at the jack point.  
Raising the vehicle with an improperly positioned floor jack will damage the vehicle and may cause the vehicle to fall off the floor jack.

**! CAUTION**

- Do not raise the vehicle while someone is in the vehicle.
- When raising the vehicle, do not place any object on top of or underneath the floor jack.

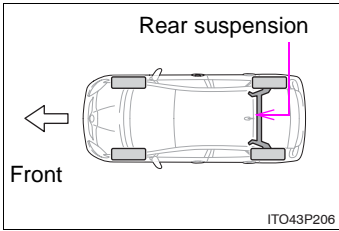

- When raising the vehicle, do not set the floor jack under the rear suspension.

## 4-3. Do-it-yourself maintenance

### Engine compartment

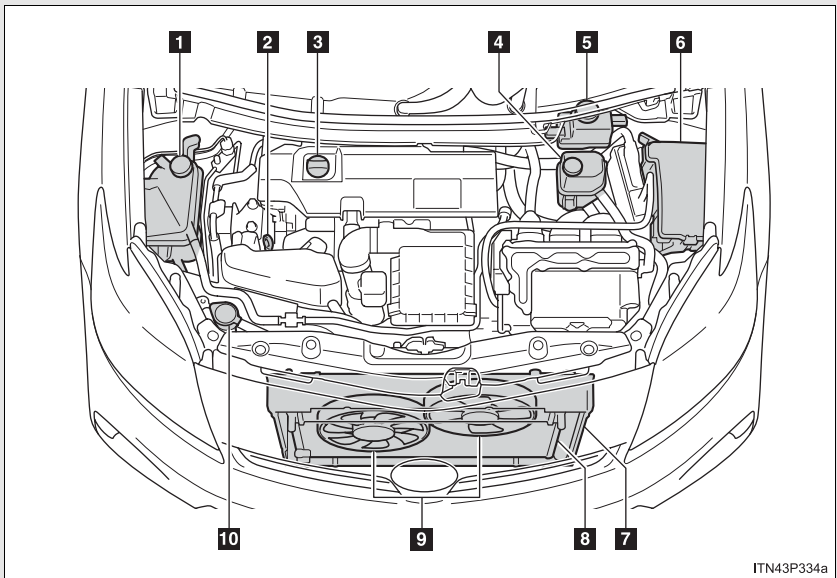

**1** Engine coolant reservoir  
(→P. 424)

**2** Engine oil level dipstick  
(→P. 420)

**3** Engine oil filler cap  
(→P. 420)

**4** Power control unit coolant reservoir  
(→P. 424)

**5** Brake fluid reservoir  
(→P. 427)

**6** Fuse box  
(→P. 456)

**7** Radiator  
(→P. 426)

**8** Condenser  
(→P. 426)

**9** Electric cooling fans  
(→P. 426)

**10** Washer fluid tank (→P. 429)

#### ■ 12-volt battery

→P. 431

## Engine oil

With the engine at operating temperature and turned off, check the oil level on the dipstick.

### ■ Checking the engine oil

**STEP 1** Park the vehicle on level ground. After warming up the engine and turning off the hybrid system, wait more than 5 minutes for the oil to drain back into the bottom of the engine.

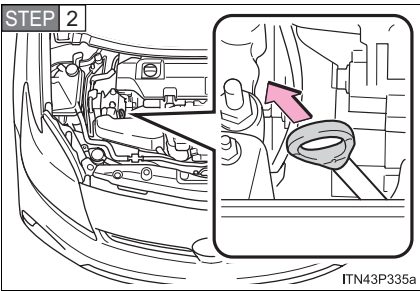

Holding a rag under the end, pull the dipstick out.

**STEP 3** Wipe the dipstick clean.

**STEP 4** Reinsert the dipstick fully.

**STEP 5** Holding a rag under the end, pull the dipstick out and check the oil level.

**STEP 6** Wipe the dipstick and reinsert it fully.

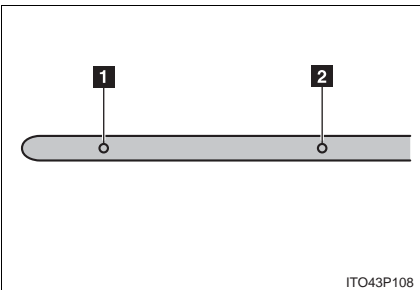

**1** Low

**2** Full

## ■ Adding engine oil

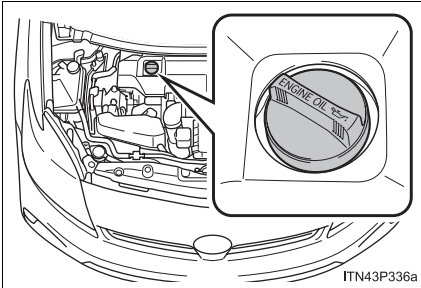

If the oil level is below or near the low level mark, add engine oil of the same type as that already in the engine.

Make sure to check the oil type and prepare the items needed before adding oil.

Engine oil selection	→P. 564
Oil quantity (Low → Full)	1.6 qt. (1.5 L, 1.3 Imp.qt.)
Items	Clean funnel

**STEP 1** Remove the oil filler cap by turning it counterclockwise.

**STEP 2** Add engine oil slowly, checking the dipstick.

**STEP 3** Install the oil filler cap by turning it clockwise.

### ■ Engine oil consumption

- The amount of engine oil consumed depends on the oil viscosity, the quality of the oil and the way the vehicle is driven.
- More oil is consumed under driving conditions such as high speeds and frequent acceleration and deceleration.
- A new engine consumes more oil.
- When judging the amount of oil consumption, keep in mind that the oil may have become diluted, making it difficult to judge the true level accurately.
- Oil consumption: Max. 1.1 qt./600 miles (1.0 L/1000 km, 0.9 Imp.qt./600 miles)
- If your vehicle consumes more than 1.1 qt. (1.0 L, 0.9 Imp.qt.) every 600 miles (1000 km), contact your Toyota dealer.



 **CAUTION****■ Used engine oil**

- Used engine oil contains potentially harmful contaminants which may cause skin disorders such as inflammation and skin cancer, so care should be taken to avoid prolonged and repeated contact. To remove used engine oil from your skin, wash thoroughly with soap and water.
- Dispose of used oil and filters only in a safe and acceptable manner. Do not dispose of used oil and filters in household trash, in sewers or onto the ground. Call your Toyota dealer, service station or auto parts store for information concerning recycling or disposal.
- Do not leave used engine oil within the reach of children.

 **NOTICE****■ To prevent serious engine damage**

Check the oil level on a regular basis.

**■ When replacing the engine oil**

- Be careful not to spill engine oil on the vehicle components.
- Avoid overfilling, or the engine could be damaged.
- Check the oil level on the dipstick every time you refill the vehicle.
- Be sure the engine oil filler cap is properly tightened.

## Coolant

The coolant level is satisfactory if it is between the full (“FULL” or “F”) and low (“LOW” or “L”) lines on the reservoir when the hybrid system is cold.

### Engine coolant reservoir

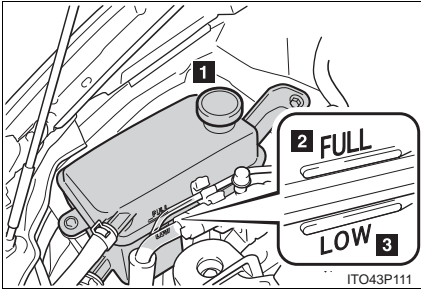

- 1 Reservoir cap
- 2 “FULL” line
- 3 “LOW” line

If the level is on or below the “LOW” line, add coolant up to the “FULL” line. (→P. 566)

### Power control unit coolant reservoir

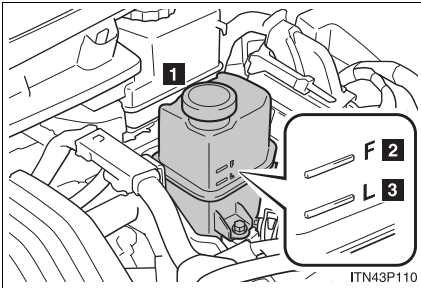

- 1 Reservoir cap
- 2 “F” line
- 3 “L” line

If the level is on or below the “L” line, add coolant up to the “F” line. (→P. 566)

### ■ Coolant selection

Only use “Toyota Super Long Life Coolant” or a similar high quality ethylene glycol based non-silicate, non-amine, non-nitrite, and non-borate coolant with long-life hybrid organic acid technology.

U.S.A.: “Toyota Super Long Life Coolant” is a mixture of 50% coolant and 50% deionized water. (Minimum temperature: -31 °F [-35 °C])

Canada: “Toyota Super Long Life Coolant” is a mixture of 55% coolant and 45% deionized water. (Minimum temperature: -44 °F [-42 °C])

For more details about coolant, contact your Toyota dealer.

### ■ If the coolant level drops within a short time of replenishing

Visually check the radiator, hoses, engine/power control unit coolant reservoir caps, drain cock and water pump.

If you cannot find a leak, have your Toyota dealer test the cap and check for leaks in the cooling system.

### CAUTION

#### ■ When the hybrid system is hot

Do not remove the engine/power control unit coolant reservoir caps.

The cooling system may be under pressure and may spray hot coolant if the cap is removed, causing serious injuries, such as burns.

 NOTICE

■ **When adding coolant**

Coolant is neither plain water nor straight antifreeze. The correct mixture of water and antifreeze must be used to provide proper lubrication, corrosion protection and cooling. Be sure to read the antifreeze or coolant label.

■ **If you spill coolant**

Be sure to wash it off with water to prevent it from damaging parts or paint.

**Radiator and condenser**

Check the radiator and condenser and clear away any foreign objects.

If either of the above parts is extremely dirty or you are not sure of their condition, have your vehicle inspected by your Toyota dealer.

 CAUTION

■ **When the hybrid system is hot**

Do not touch the radiator or condenser as they may be hot and cause serious injuries, such as burns.

## Brake fluid

### ■ Checking fluid level

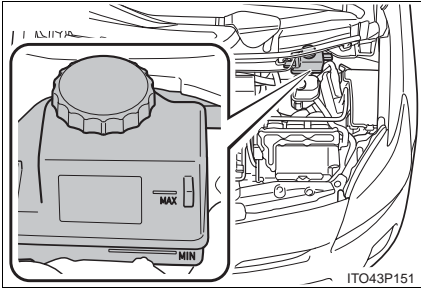

The brake fluid level should be between the "MAX" and "MIN" lines on the tank.

### ■ Adding fluid

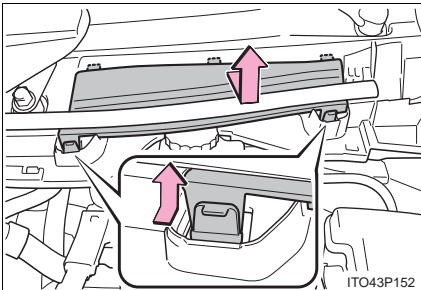

Push the tab in and lift the cover off.

Make sure to check the fluid type and prepare the necessary item.

Fluid type	FMVSS No.116 DOT 3 or SAE J1703 brake fluid
Items	Clean funnel

■ **Brake fluid can absorb moisture from the air**

Excess moisture in the brake fluid can cause a dangerous loss of braking efficiency. Use only newly opened brake fluid.

 **CAUTION**

■ **When filling the reservoir**

Take care as brake fluid can harm your hands and eyes and damage painted surfaces.

If fluid gets on your hands or in your eyes, flush the affected area with clean water immediately.

If you still experience discomfort, see a doctor.

 **NOTICE**

■ **If the fluid level is low or high**

It is normal for the brake fluid level to go down slightly as the brake pads wear out or when the fluid level in the accumulator is high.

If the reservoir needs frequent refilling, there may be a serious problem.

## Washer fluid

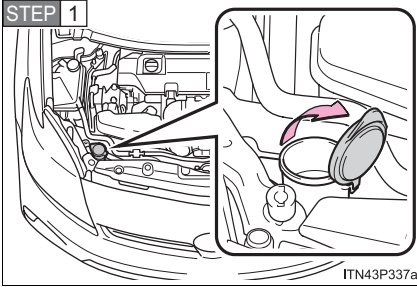

Open the lid.

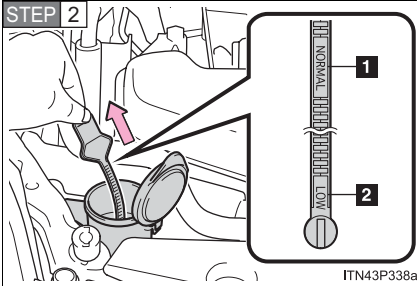

Check the washer fluid level on the level gauge.

**1** "NORMAL"

**2** "LOW"

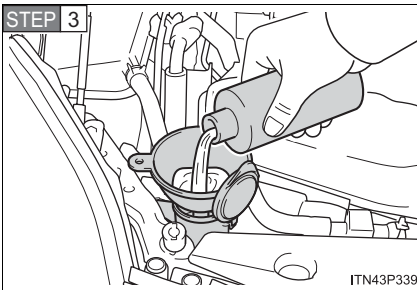

If the washer fluid level is at "LOW", add washer fluid.

 **CAUTION**

■ **When adding washer fluid**

Do not add washer fluid when the hybrid system is hot or operating as washer fluid contains alcohol and may catch fire if spilled on the engine etc.

 **NOTICE**

■ **Do not use any fluid other than washer fluid**

Do not use soapy water or engine antifreeze instead of washer fluid. Doing so may cause streaking on the vehicle's painted surfaces.

■ **Diluting washer fluid**

Dilute washer fluid with water as necessary.

Refer to the freezing temperatures listed on the label of the washer fluid bottle.



## 4-3. Do-it-yourself maintenance

### 12-volt battery

#### ■ Location

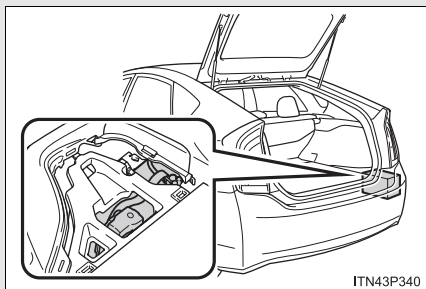

The 12-volt battery is located in the right-hand side of luggage compartment.

#### ■ Removing the 12-volt battery cover

**STEP 1** Open the center deck board. (→P. 374)

**STEP 2** Remove the center auxiliary box. (→P. 376)

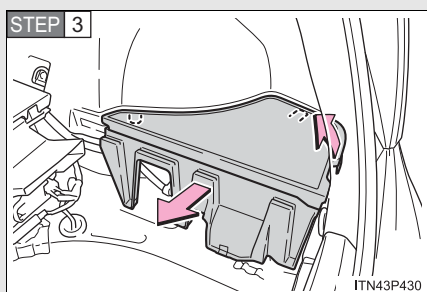

Remove the side deck board and 12-volt battery cover.

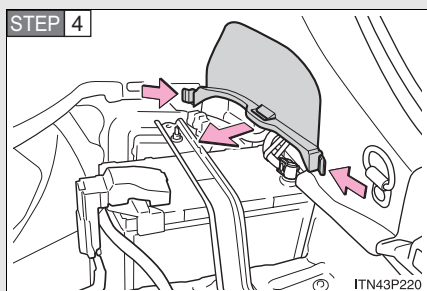

Remove the 12-volt battery maintenance cover.

### ■ Exterior

Make sure that the 12-volt battery terminals are not corroded and that there are no loose connections, cracks, or loose clamps.

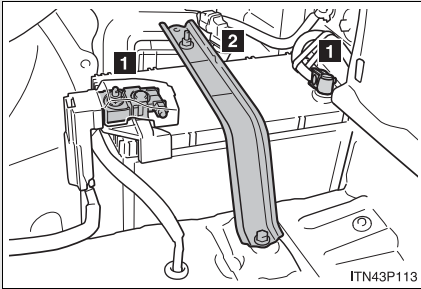

**1** Terminals

**2** Hold-down clamp

---

### ■ Before recharging

When recharging, the 12-volt battery produces hydrogen gas which is flammable and explosive. Therefore, observe the following precautions before recharging:

- If recharging with the 12-volt battery installed on the vehicle, be sure to disconnect the ground cable.
- Make sure the power switch on the charger is off when connecting and disconnecting the charger cables to the 12-volt battery.

**■ After recharging/reconnecting the 12-volt battery**

- Unlocking the doors using the smart key system may not be possible immediately after reconnecting the 12-volt battery. If this happens, use the wireless remote control or the mechanical key to lock/unlock the doors.
- Start the hybrid system with the “POWER” switch in ACCESSORY mode. The hybrid system may not start with the “POWER” switch turned off. However, the hybrid system will operate normally from the second attempt.
- The “POWER” switch mode is recorded by the vehicle. If the 12-volt battery is reconnected, the vehicle will return the “POWER” switch mode to the status it was in before the 12-volt battery was disconnected. Make sure to turn off the power before disconnect the 12-volt battery. Take extra care when connecting the 12-volt battery if the “POWER” switch mode prior to discharge is unknown.
- Restart the hybrid system, depress the brake pedal, and confirm that it is possible to shift into each shift position.

If the system will not start even after multiple attempts at all methods above, contact your Toyota dealer.

 **CAUTION**

■ **Chemicals in the 12-volt battery**

The 12-volt battery contains poisonous and corrosive sulfuric acid and may produce hydrogen gas which is flammable and explosive. To reduce the risk of death or serious injury, take the following precautions while working on or near the 12-volt battery:

- Do not cause sparks by touching the 12-volt battery terminals with tools.
- Do not smoke or light a match near the 12-volt battery.
- Avoid contact with eyes, skin and clothes.
- Never inhale or swallow electrolyte.
- Wear protective safety glasses when working near the 12-volt battery.
- Keep children away from the 12-volt battery.

■ **Where to safely charge the 12-volt battery**

Always charge the 12-volt battery in an open area. Do not charge the 12-volt battery in a garage or closed room where there is insufficient ventilation.

■ **How to recharge the 12-volt battery**

Only perform a slow charge (5 A or less). The 12-volt battery may explode if charged at a quicker rate.

 **CAUTION****■ Emergency measures regarding electrolyte**

- If electrolyte gets in your eyes

Flush your eyes with clean water for at least 15 minutes and get immediate medical attention. If possible, continue to apply water with a sponge or cloth while traveling to the nearest medical facility.

- If electrolyte gets on your skin

Wash the affected area thoroughly. If you feel pain or burning, get medical attention immediately.

- If electrolyte gets on your clothes

It can soak through clothing on to your skin. Immediately take off the clothing and follow the procedure above if necessary.

- If you accidentally swallow electrolyte

Drink a large quantity of water or milk. Get emergency medical attention immediately.

**■ When replacing the 12-volt battery**

Use a 12-volt battery designed for this vehicle. Failure to do so may cause gas (hydrogen) to enter the passenger compartment, causing a fire or explosion.

For replacement of the 12-volt battery, contact your Toyota dealer.

**⚠ CAUTION**

**■ When disconnecting the 12-volt battery**

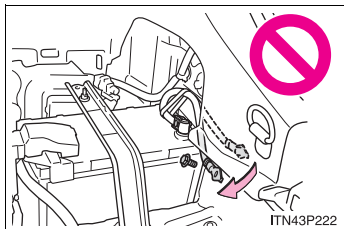

Do not disconnect the negative (-) terminal on the body side as shown. The disconnected negative (-) terminal may touch the positive (+) terminal, which may cause a short and result in death or serious injury.

**⚠ NOTICE**

**■ When recharging the 12-volt battery**

Never recharge the 12-volt battery while the hybrid system is operating. Also, be sure all accessories are turned off.

# Tires

Replace or rotate tires in accordance with maintenance schedules and treadwear.

## ■ Checking tires

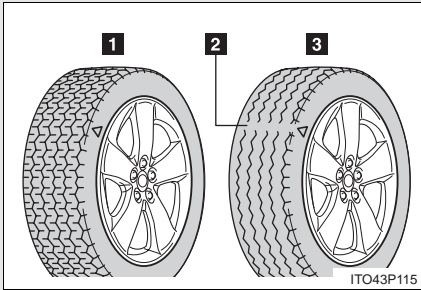

- 1 New tread
- 2 Treadwear indicator
- 3 Worn tread

The location of treadwear indicators is shown by the “TWI” or “Δ” marks, etc., molded on the sidewall of each tire.

Check spare tire condition and pressure if not rotated.

## ■ Tire rotation

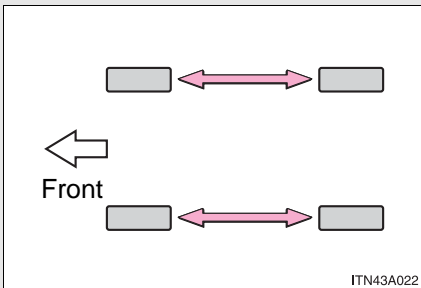

Rotate the tires in the order shown.

To equalize tire wear and extend tire life, Toyota recommends that tire rotation is carried out at the same interval as tire inspection.

Do not fail to initialize the tire pressure warning system after tire rotation.

### ■ Tire pressure warning system

Your vehicle is equipped with a tire pressure warning system that uses tire pressure warning valves and transmitters to detect low tire inflation pressure before serious problems arise.

(→P. 499)

The compact spare tire is not equipped with a tire pressure warning valve and transmitter.

### Installing tire pressure warning valves and transmitters

When replacing tires or wheels, tire pressure warning valves and transmitters must also be installed.

When new tire pressure warning valves and transmitters are installed, new ID codes must be registered in the tire pressure warning computer and the tire pressure warning system must be initialized. Have tire pressure warning valve and transmitter ID codes registered by your Toyota dealer. (→P. 440)



## Initializing the tire pressure warning system

### ■ The tire pressure warning system must be initialized in the following circumstances:

- When rotating front and rear tires which have different tire inflation pressures
- When changing the tire size

When the tire pressure warning system is initialized, the current tire inflation pressure is set as the benchmark pressure.

### ■ How to initialize the tire pressure warning system

**STEP 1** Park the vehicle in a safe place and turn the “POWER” switch off.

Initialization cannot be performed while the vehicle is moving.

**STEP 2** Adjust the tire inflation pressure to the specified cold tire inflation pressure level. (→P. 569)

Make sure to adjust the tire pressure to the specified cold tire inflation pressure level. The tire pressure warning system will operate based on this pressure level.

**STEP 3** Turn the “POWER” switch to ON mode.

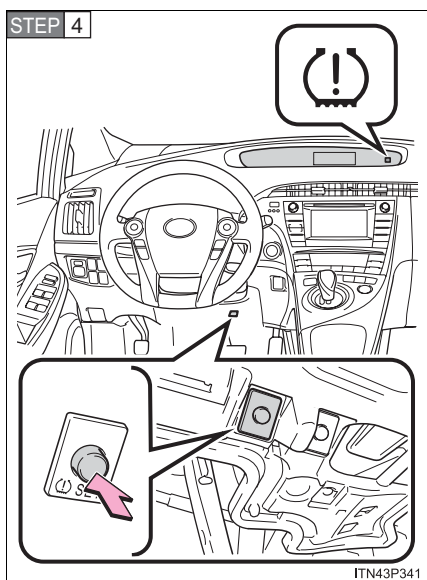

Press and hold the tire pressure warning reset switch until the tire pressure warning light blinks slowly 3 times.

**STEP 5** Wait for a few minutes with the “POWER” switch in ON mode and then turn the “POWER” switch off.

### Registering ID codes

The tire pressure warning valve and transmitter is equipped with a unique ID code. When replacing a tire pressure warning valve and transmitter, it is necessary to register the ID code. Have the ID code registered by your Toyota dealer.

---

### ■ When to replace your vehicle's tires

Tires should be replaced if:

- You have tire damage such as cuts, splits, cracks deep enough to expose the fabric, and bulges indicating internal damage.
- A tire goes flat repeatedly or cannot be properly repaired due to the size or location of a cut or other damage.

If you are not sure, consult with your Toyota dealer.

### ■ Replacing tires and wheels

If the ID code of the tire pressure warning valve and transmitter is not registered, the tire pressure warning system will not work properly. After driving for about 20 minutes, the tire pressure warning light blinks for 1 minute and stays on to indicate a system malfunction.

### ■ Tire life

Any tire over 6 years old must be checked by a qualified technician even if it has seldom or never been used or damage is not obvious.

### ■ Routine tire inflation pressure checks

The tire pressure warning system does not replace routine tire inflation pressure checks. Make sure to check tire inflation pressure as part of your routine of daily vehicle checks.

### ■ Low profile tires (vehicles with 17-inch tires)

Generally, low profile tires will wear more rapidly and tire grip performance will be reduced on snowy and/or icy roads when compared to standard tires. Be sure to use snow tires or tire chains on snowy and/or icy roads and drive carefully at a speed appropriate for road and weather conditions.

### ■ Maximum load of tire

Check that the maximum load of the replacement tire is greater than 1/2 of the Gross Axle Weight Ratings (GAWR) of either the front axle or the rear axle, whichever is greater.

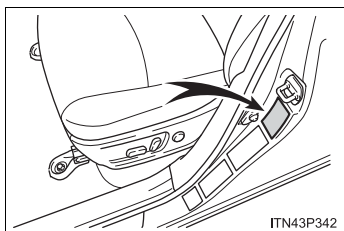

For the GAWR, see the Certification Label. For the maximum load of the tire, see the load limit at maximum cold tire inflation pressure mentioned on the sidewall of the tire. (→P. 575)

### ■ Tire types

#### ● Summer tires

Summer tires are high-speed performance tires best suited to highway driving under dry conditions. Since summer tires do not have the same traction performance as snow tires, summer tires are inadequate for driving on snow-covered or icy roads. For driving on snow-covered roads or icy roads, the use of snow tires is recommended. When installing snow tires, be sure to replace all four tires.

#### ● All season tires

All season tires are designed to provide better traction in snow and to be adequate for driving in most winter conditions as well as for use year-round. All season tires, however, do not have adequate traction performance compared with snow tires in heavy or loose snow. Also, all season tires fall short in acceleration and handling performance compared with summer tires in highway driving.

#### ● Snow tires

For driving on snow-covered roads or icy roads, we recommend using snow tires. If you need snow tires, select tires of the same size, construction and load capacity as the originally installed tires. Since your vehicle has radial tires as original equipment, make sure your snow tires also have radial construction. Do not install studded tires without first checking local regulations for possible restrictions. Snow tires should be installed on all wheels. (→P. 317)

**■ Initializing the tire pressure warning system**

Initialize the system with the tire inflation pressure adjusted to the specified level.

**■ If the tread on snow tires wears down below 0.16 in. (4 mm)**

The effectiveness of the tires as snow tires is lost.

**■ If you press the tire pressure warning reset switch accidentally**

If initialization is performed, adjust the tire inflation pressure to the specified level and initialize the tire pressure warning system again.

**■ When initialization of the tire pressure warning system has failed**

Initialization can be completed in a few minutes. However, in the following cases, the settings have not been recorded and the system will not operate properly. If repeated attempts to record tire inflation pressure settings are unsuccessful, have the vehicle inspected by your Toyota dealer.

- When operating the tire pressure warning reset switch, the tire pressure warning light does not blink 3 times.
- After carrying out the initialization procedure, the tire pressure warning light blinks for 1 minute then stays on after driving for 20 minutes.

### ■ Tire pressure warning system certification

#### **For vehicles sold in the U.S.A.**

MODEL/FCC IDs:

Transmitter: PAXPMV107J

Receiver: HYQ13BDE

#### **NOTE:**

This device complies with part 15 of the FCC Rules. Operation is subject to the following two conditions: (1) This device may not cause harmful interference, and (2) this device must accept any interference received, including interference that may cause undesired operation.

#### **FCC WARNING:**

Changes or modifications not expressly approved by the party responsible for compliance could void the user's authority to operate the equipment.

#### **For vehicles sold in Canada**

Operation is subject to the following two conditions; (1) this device may not cause interference, and (2) this device must accept any interference, including interference that may cause undesired operation of the device.

 **CAUTION****■ When inspecting or replacing tires**

Observe the following precautions to prevent accidents.

Failure to do so may cause damage to parts of the drive train as well as dangerous handling characteristics, which may lead to an accident resulting in death or serious injury.

- Do not mix tires of different makes, models or tread patterns.  
Also, do not mix tires of remarkably different treadwear.
- Do not use tire sizes other than those recommended by Toyota.
- Do not mix differently constructed tires (radial, bias-belted or bias-ply tires).
- Do not mix summer, all season and snow tires.
- Do not use tires that have been used on another vehicle.  
Do not use tires if you do not know how they were used previously.

**■ When initializing the tire pressure warning system**

Do not operate the tire pressure warning reset switch without first adjusting the tire inflation pressure to the specified level. Otherwise, the tire pressure warning light may not come on even if the tire inflation pressure is low, or it may come on when the tire inflation pressure is actually normal.

 NOTICE

■ **Repairing or replacing tires, wheels, tire pressure warning valves, transmitters and tire valve caps**

- When removing or fitting the wheels, tires or the tire pressure warning valves and transmitters, contact your Toyota dealer as the tire pressure warning valves and transmitters may be damaged if not handled correctly.
- When replacing tire valve caps, do not use tire valve caps other than those specified. The cap may become stuck.

■ **To avoid damage to the tire pressure warning valves and transmitters**

When a tire is repaired with liquid sealants, the tire pressure warning valve and transmitter may not operate properly. If a liquid sealant is used, contact your Toyota dealer or other qualified service shop as soon as possible. Make sure to replace the tire pressure warning valve and transmitter when replacing the tire. (→P. 438)

■ **Driving on rough roads**

Take particular care when driving on roads with loose surfaces or pot-holes.

These conditions may cause losses in tire inflation pressure, reducing the cushioning ability of the tires. In addition, driving on rough roads may cause damage to the tires themselves, as well as the vehicle's wheels and body.

■ **Low profile tires (vehicles with 17-inch tires)**

Low profile tires may cause greater damage than usual to the wheel when receiving impact from the road surface. Therefore pay attention to the following:

- Be sure to use proper tire inflation pressure. If tires are under-inflated, they may be damaged more severely.
- Avoid pot holes, uneven pavement, curbs and other road hazards. Failure to do so can lead to severe tire and wheel damage.

■ **If tire inflation pressure of each tire becomes low while driving**

Do not continue driving, or your tires and/or wheels may be ruined.





### ■ Inspection and adjustment procedure

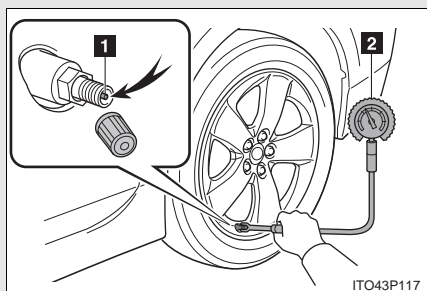

- 1 Tire valve
- 2 Tire pressure gauge

**STEP 1** Remove the tire valve cap.

**STEP 2** Press the tip of the tire pressure gauge onto the tire valve.

**STEP 3** Read the pressure using the gauge gradations.

**STEP 4** If the tire inflation pressure is not at the recommended level, adjust the pressure.

If you add too much air, press the center of the valve to deflate.

**STEP 5** After completing the tire inflation pressure measurement and adjustment, apply soapy water to the valve and check for leakage.

**STEP 6** Put the tire valve cap back on.

---

**■ Tire inflation pressure check interval**

You should check tire inflation pressure every two weeks, or at least once a month.

Do not forget to check the spare.

**■ Effects of incorrect tire inflation pressure**

Driving with incorrect tire inflation pressure may result in the following:

- Reduced fuel efficiency
- Reduced driving comfort and tire life
- Reduced safety
- Damage to the drive train

If a tire needs frequent inflating, have it checked by your Toyota dealer.

**■ Instructions for checking tire inflation pressure**

When checking tire inflation pressure, observe the following:

- Check only when the tires are cold.

If your vehicle has been parked for at least 3 hours or has not been driven for more than 1 mile or 1.5 km, you will get an accurate cold tire inflation pressure reading.

- Always use a tire pressure gauge.

The appearance of the tire can be misleading. In addition, tire inflation pressure that is even just a few pounds off can affect ride quality and handling.

- Do not reduce tire inflation pressure after driving. It is normal for tire inflation pressure to be higher after driving.

- Never exceed the vehicle capacity weight.

Passengers and luggage weight should be placed so that the vehicle is balanced.

 CAUTION

■ **Proper inflation is critical to save tire performance**

Keep your tires properly inflated. Otherwise, the following conditions may occur and result in an accident causing death or serious injury:

- Excessive wear
- Uneven wear
- Poor handling
- Possibility of blowouts resulting from overheated tires
- Poor sealing of the tire bead
- Wheel deformation and/or tire separation
- A greater possibility of tire damage from road hazards

 NOTICE

■ **When inspecting and adjusting tire inflation pressure**

Be sure to put the tire valve caps back on.

Without the valve caps, dirt or moisture could get into the valve and cause air leakage, which could result in an accident. If the caps are lost, replace them as soon as possible.

## Wheels

**If a wheel is bent, cracked or heavily corroded, it should be replaced. Otherwise, the tire may separate from the wheel or cause a loss of handling control.**

### ■ Wheel selection

When replacing wheels, care should be taken to ensure that they are equivalent to those removed in load capacity, diameter, rim width and inset\*.

Replacement wheels are available at your Toyota dealer.

\*: Conventionally referred to as “offset”.

Toyota does not recommend using the following:

- Wheels of different sizes or types
- Used wheels
- Bent wheels that have been straightened

### ■ Aluminum wheel precautions

- Use only Toyota wheel nuts and wrenches designed for use with your aluminum wheels.
- When rotating, repairing or changing your tires, check that the wheel nuts are still tight after driving 1000 miles (1600 km).
- Be careful not to damage the aluminum wheels when using tire chains.
- Use only Toyota genuine balance weights or equivalent and a plastic or rubber hammer when balancing your wheels.

### ■ When replacing wheels

The wheels of your vehicle are equipped with tire pressure warning valves and transmitters that allow the tire pressure warning system to provide advance warning in the event of a loss in tire inflation pressure. Whenever wheels are replaced, tire pressure warning valves and transmitters must be installed. (→P. 438)

### ⚠ CAUTION

#### ■ When replacing wheels

- Do not use wheels that are a different size from those recommended in the Owner's Manual, as this may result in a loss of handling control.
- Never use an inner tube in a leaking wheel which is designed for a tubeless tire. Doing so may result in an accident, causing death or serious injury.

#### ■ When installing the wheel nuts

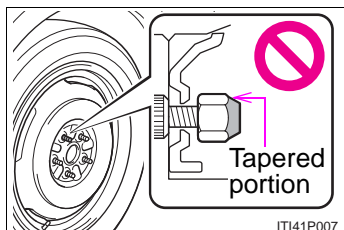

- Be sure to install the wheel nuts with the tapered ends facing inward. Installing the nuts with the tapered ends facing outward can cause the wheel to break and eventually cause the wheel to come off while driving, which could lead to an accident resulting in death or serious injury.

- Never use oil or grease on the wheel bolts or wheel nuts. Oil and grease may cause the wheel nuts to be excessively tightened, leading to bolt or disc wheel damage. In addition, the oil or grease can cause the wheel nuts to loosen and the wheel may fall off, causing an accident and resulting in death or serious injury. Remove any oil or grease from the wheel bolts or wheel nuts.

 **CAUTION****■ Use of defective wheels prohibited**

Do not use cracked or deformed wheels.

Doing so could cause the tire to leak air during driving, possibly causing an accident.

 **NOTICE****■ Replacing tire pressure warning valves and transmitters**

- Because tire repair or replacement may affect the tire pressure warning valves and transmitters, make sure to have tires serviced by your Toyota dealer or other qualified service shop. In addition, make sure to purchase your tire pressure warning valves and transmitters at your Toyota dealer.
- Ensure that only genuine Toyota wheels are used on your vehicle. Tire pressure warning valves and transmitters may not work properly with non-genuine wheels.

## 4-3. Do-it-yourself maintenance

### Electronic key battery

Replace the battery with a new one if it is depleted.

■ You will need the following items:

- Flathead screwdriver
- Lithium battery CR1632

■ Replacing the battery

STEP 1

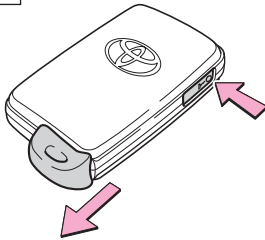

ITN43A007

Take out the mechanical key.

STEP 2

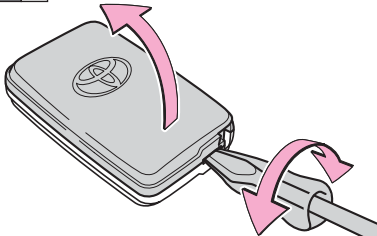

ITN43A008

Remove the cover.

To prevent damage, cover the tip of the screwdriver with a rag.

STEP 3

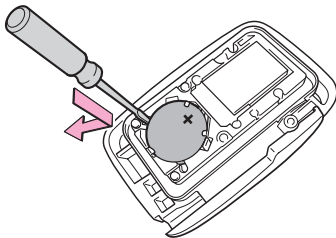

ITO43P194

Remove the depleted battery.

Insert a new battery with the "+" terminal facing up.

STEP 4 When installing, reverse the steps listed.



**■ Use a CR1632 lithium battery**

- Batteries can be purchased at your Toyota dealer, local electrical appliance shops or camera stores.
- Replace only with the same or equivalent type recommended by the manufacturer.
- Dispose of used batteries according to local laws.

**■ If the electronic key battery is depleted**

The following symptoms may occur:

- The smart key system and wireless remote control will not function properly.
- The operational range will be reduced.

**⚠ CAUTION****■ Removed battery and other parts**

Keep away from children. These parts are small and if swallowed by a child, they can cause choking. Failure to do so could result in death or serious injury.

**⚠ NOTICE****■ For normal operation after replacing the battery**

Observe the following precautions to prevent accidents:

- Always work with dry hands.  
Moisture may cause the battery to rust.
- Do not touch or move any other component inside the remote control.
- Do not bend either of the battery terminals.

## 4-3. Do-it-yourself maintenance

### Checking and replacing fuses

If any of the electrical components do not operate, a fuse may have blown. If this happens, check and replace the fuses as necessary.

**STEP 1** Turn the “POWER” switch off.

Vehicles with Solar Ventilation System: Turn the Solar Ventilation System off and make sure not to operate the Remote Air Conditioning System.

**STEP 2** Open the fuse box cover.

#### Engine compartment

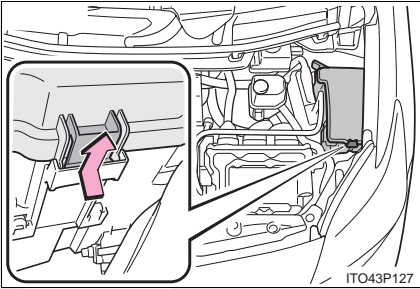

Push the tab in and lift the lid off.

When closing, first hook the lid onto the two rear tabs.

#### Left side instrument panel

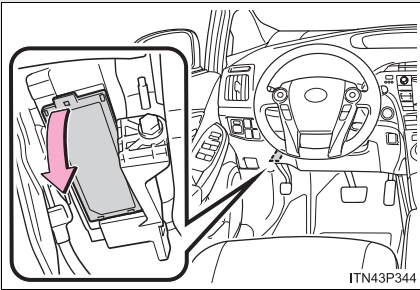

Remove the lid.

**STEP 3** After a system failure, see “Fuse layout and amperage ratings” (→P. 459) for details about which fuse to check.

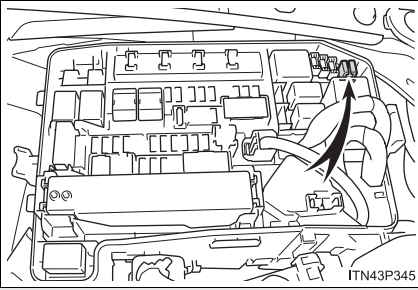
**STEP 4** Remove the fuse.

Only type A fuse can be removed using the pullout tool.

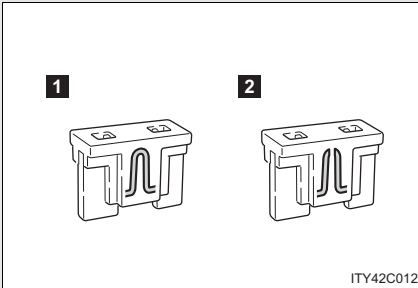
**STEP 5** Check if the fuse is blown.**Type A****1** Normal fuse**2** Blown fuse

Replace the blown fuse with a new fuse of an appropriate amperage rating. The amperage rating can be found on the fuse box lid.

### Type B

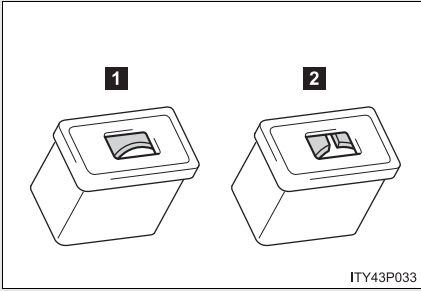

**1** Normal fuse

**2** Blown fuse

Replace the blown fuse with a new fuse of an appropriate amperage rating. The amperage rating can be found on the fuse box lid.

### Type C

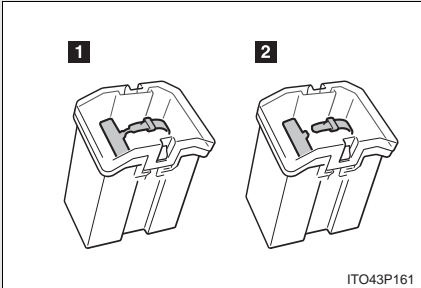

**1** Normal fuse

**2** Blown fuse

Replace the blown fuse with a new fuse of an appropriate amperage rating. The amperage rating can be found on the fuse box lid.

## Fuse layout and amperage ratings

### ■ Engine compartment

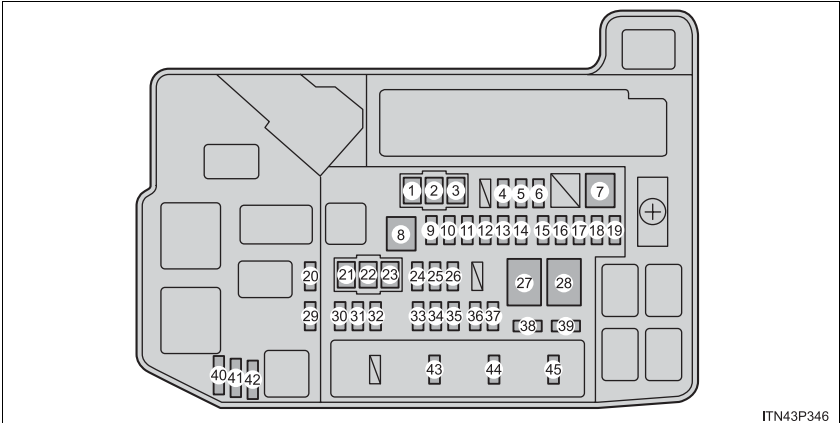

FUSE		Ampere	Circuit
1	HTR	50A	Air conditioning system
2	RDI	30A	Electric cooling fans
3	CDS	30A	Electric cooling fans
4	S-HORN	10A	No circuit
5	ENG W/P	30A	Cooling system
6	ABS MAIN NO.2	7.5A	Anti-lock brake system
7	H-LP CLN	30A	Headlight cleaner
8	P-CON MTR	30A	P position control system, trans- mission
9	AMP NO.1	30A	Audio system
10	IGCT	30A	PCU, IGCT NO.2, IGCT NO.3
11	DC/DC-S	5A	Inverter and converter
12	P CON MAIN	7.5A	P position control system, P posi- tion switch

FUSE		Ampere	Circuit
13	AM2	7.5A	Power management system
14	ECU-B2	7.5A	Smart key system, hybrid system
15	MAYDAY	10A	MAYDAY
16	ECU-B3	10A	Air conditioning system
17	TURN & HAZ	10A	Turn signal lights
18	ETCS	10A	Multiport fuel injection system/ sequential multiport fuel injection system
19	ABS MAIN NO.1	20A	Anti-lock brake system
20	H-LP LH LO	15A	Left-hand headlight (low beam)
21	P/I 2	40A	P position control system, horn, headlight low beams, back-up lights
22	ABS MTR 1	30A	Anti-lock brake system
23	ABS MTR 2	30A	Anti-lock brake system
24	H-LP HI MAIN	20A	Headlight high beams, daytime running lights
25	DRL	7.5A	Daytime running lights
26	AMP NO.2	30A	Audio system, navigation system
27	P/I 1	60A	IG2, EFI MAIN, BATT FAN
28	EPS	60A	Electric power steering
29	H-LP RH LO	15A	Right-hand headlight (low beam)
30	PCU	10A	Inverter and converter
31	IGCT NO.2	10A	Hybrid system, P position control system, power management sys- tem, multiport fuel injection sys- tem/sequential multiport fuel injection system

FUSE		Ampere	Circuit
32	MIR HTR	10A	Outside rear view mirror defoggers
33	RAD NO.1	15A	Audio system, navigation system
34	DOME	10A	Door courtesy lights, luggage compartment light, personal light, interior light, foot lights, vanity lights, inside rear view mirror, garage door opener
35	ECU-B	7.5A	Smart key system, personal lights, gauges and meters, emergency flashers
36	H-LP LH HI	10A	Left-hand headlight (high beam)
37	H-LP RH HI	10A	Right-hand headlight (high beam)
38	EFI NO.2	10A	Multiport fuel injection system/ sequential multiport fuel injection system
39	IGCT NO.3	10A	Cooling system
40	SPARE	30A	Spare fuse
41	SPARE	10A	Spare fuse
42	SPARE	7.5A	Spare fuse
43	EFI MAIN	20A	Multiport fuel injection system/ sequential multiport fuel injection system, cooling system, EFI NO.2
44	BATT FAN	10A	Battery cooling fan
45	IG2	20A	Multiport fuel injection system/ sequential multiport fuel injection system, MET, IGN, power management system

## ■ Left side instrument panel

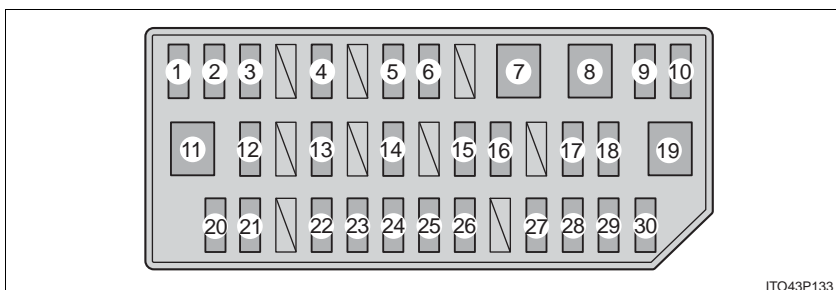

ITO43P133

FUSE		Ampere	Circuit
1	CIG	15A	Power outlets
2	ECU-ACC	10A	Multiplex communication system, outside rear view mirrors, driver support system, audio system, navigation system, advanced parking guidance system, head-up display
3	PWR OUTLET	15A	Power outlets
4	SEAT HTR FR	10A	Seat heater
5	SEAT HTR FL	10A	Seat heater
6	DOOR NO.1	25A	Power door lock system
7	PSB	30A	Pre-Collision System
8	PWR SEAT FR	30A	Front passenger's seat
9	DBL LOCK	25A	No circuit
10	FR FOG	7.5A	Front fog lights
11	PWR SEAT FL	30A	Driver's seat
12	OBD	7.5A	On-board diagnosis system
13	RR FOG	7.5A	No circuit
14	STOP	10A	Stop lights, high mounted stop-light, brake system, driver support system, vehicle proximity notification system



FUSE		Ampere	Circuit
15	P FR DOOR	25A	Power windows
16	D FR DOOR	25A	Power windows
17	DOOR RR	25A	Power windows
18	DOOR RL	25A	Power windows
19	S/ROOF	30A	Moon roof
20	ECU-IG NO.1	10A	Electric cooling fans, multiplex communication system, vehicle proximity notification system
21	ECU-IG NO.2	10A	Driver support system, Pre-Collision System, LKA system, inside rear view mirror, garage door opener, yaw rate & G sensor, brake system, electric power steering, navigation system, moon roof, tire pressure warning system, seat belt pretensioners, audio system, emergency flashers, turn signal lights, windshield wipers, headlight cleaner
22	GAUGE	10A	Headlight leveling system, gauges and meters, emergency flashers, turn signal lights
23	A/C	10A	Air conditioning system, Solar Ventilation System, Remote Air Conditioning System
24	WASHER	15A	Windshield washer

FUSE		Ampere	Circuit
25	RR WIP	20A	Rear window wiper and washer
26	WIP	30A	Windshield wipers
27	MET	7.5A	Gauges and meters
28	IGN	10A	Brake system, driver support system, multiport fuel injection system/sequential multiport fuel injection system, SRS airbag system, front passenger occupant classification system (ECU and sensors), power management system, smart key system, front passenger's seat belt reminder light
29	PANEL	10A	Air conditioning system, personal light, transmission, P position switch, navigation system, Solar Ventilation System, Remote Air Conditioning System, advanced parking guidance system, headlight cleaner, front passenger's seat belt reminder light, headlight leveling system, glove box light, clock, audio system, MPH or km/h switch
30	TAIL	10A	Headlight leveling system, parking lights, tail lights, license plate lights, front fog lights, side marker lights

**■ After a fuse is replaced**

- If the lights do not turn on even after the fuse has been replaced, a bulb may need replacement. (→P. 467)
- If the replaced fuse blows again, have the vehicle inspected by your Toyota dealer.

**■ If there is an overload in a circuit**

The fuses are designed to blow, protecting the wiring harness from damage.

**■ When replacing light bulbs**

Toyota recommends that you use genuine Toyota products designed for this vehicle. Because certain bulbs are connected to circuits designed to prevent overload, non-genuine parts or parts not designed for this vehicle may be unusable.

**⚠ CAUTION****■ To prevent system breakdowns and vehicle fire**

Observe the following precautions.

Failure to do so may cause damage, and possibly a fire or injury.

- Never use a fuse of a higher amperage rating than that indicated, or use any other object in place of a fuse.
- Always use a genuine Toyota fuse or equivalent.  
Never replace a fuse with a wire, even as a temporary fix.  
This can cause extensive damage or even fire.
- Do not modify the fuses or fuse boxes.

**■ Fuse box near the power control unit**

Never check or replace the fuses as there are high voltage parts and wiring near the fuse box.

Doing so may cause electric shock, resulting in death or serious injury.

 NOTICE

■ **Before replacing fuses**

Have the cause of electrical overload determined and repaired by your Toyota dealer as soon as possible.

## Light bulbs

You may replace the following bulbs by yourself. The difficulty level of replacement varies depending on the bulb. As there is a danger that components may be damaged, we recommend that replacement is carried out by your Toyota dealer.

### ■ Preparing for light bulb replacement

Check the wattage of the light bulb to be replaced. (→P. 570)

### ■ Front bulb locations

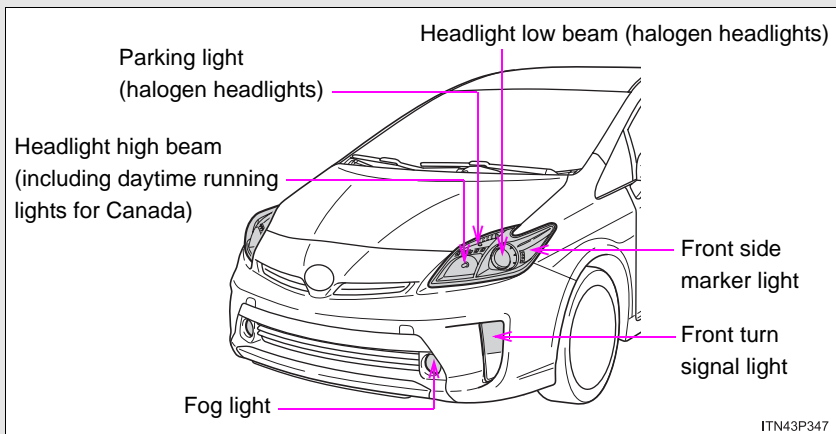

### ■ Rear bulb locations

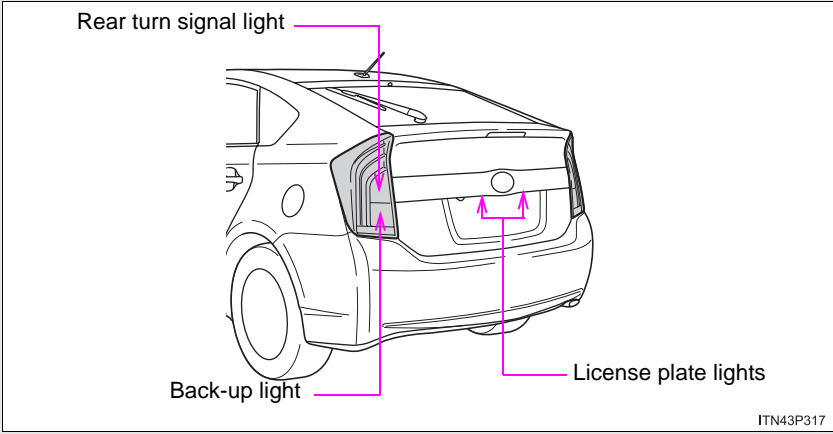

## Replacing light bulbs

### ■ Headlight low beams (halogen headlights)

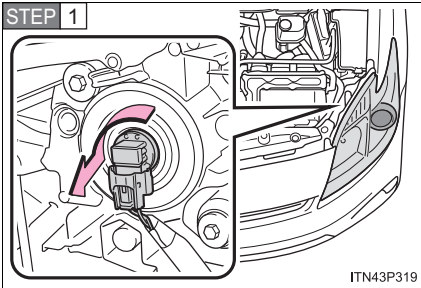

Turn the bulb base counterclockwise.

STEP 2

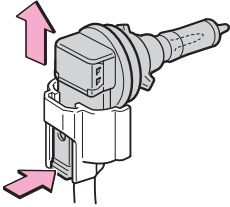

ITN43P163

Unplug the connector while pressing the lock release.

STEP 3

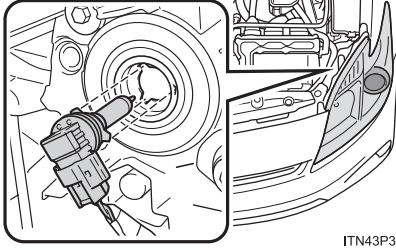

ITN43P380

Replace the light bulb, and install the bulb base.

Align the 3 tabs on the light bulb with the mounting, and insert.

STEP 4

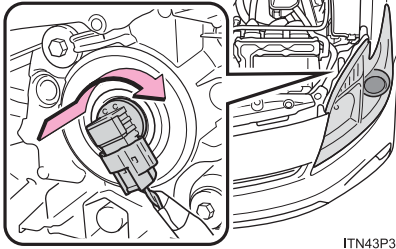

ITN43P381

Turn and secure the bulb base.

Shake the bulb base gently to check that it is not loose, turn the headlights on once and visually confirm that no light is leaking through the mounting.

## ■ Headlight high beams (including daytime running lights for Canada)

**STEP 1** Turn the bulb base counterclockwise.

### Vehicles with halogen headlights

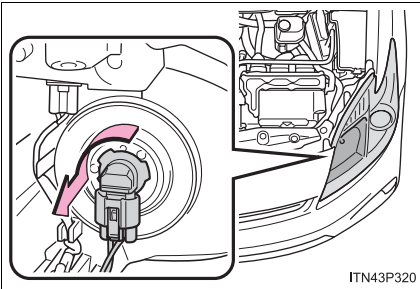

### Vehicles with LED headlights

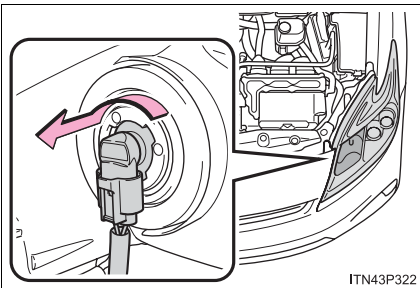

**STEP 2**

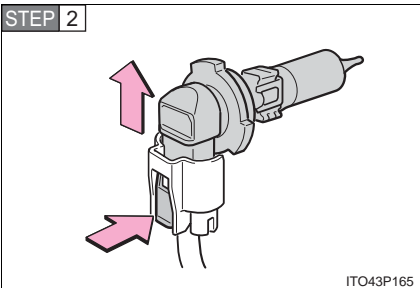

Unplug the connector while pressing the lock release.



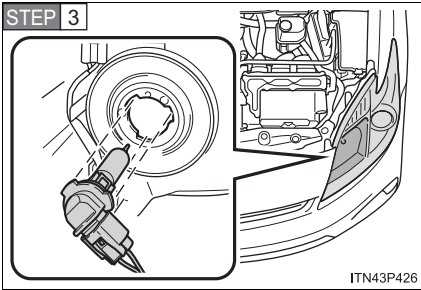

Replace the light bulb, and install the bulb base.

Align the 3 tabs on the light bulb with the mounting, and insert.

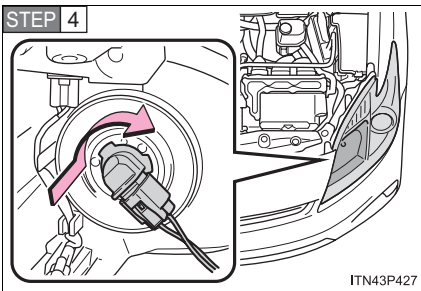

Turn and secure the bulb base.

Shake the bulb base gently to check that it is not loose, turn the headlights on once and visually confirm that no light is leaking through the mounting.

### ■ Parking lights (halogen headlights)

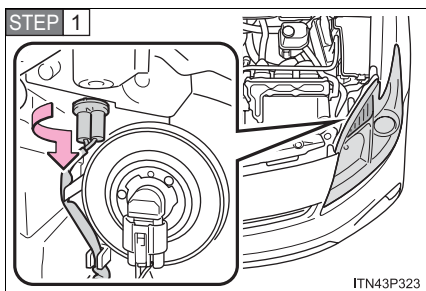

Turn the bulb base counterclockwise.

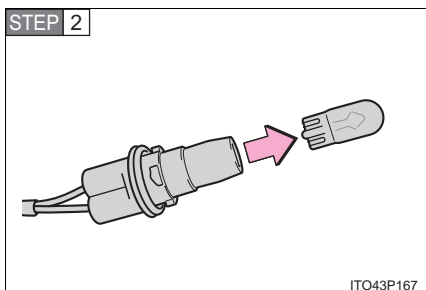

Remove the light bulb.

STEP 3 When installing, reverse the steps listed.

## ■ Front side marker lights

**STEP 1** Turn the bulb base counterclockwise.

### Vehicles with halogen headlights

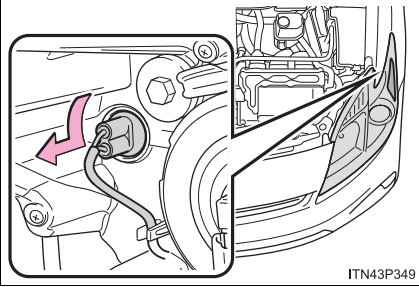

### Vehicles with LED headlights

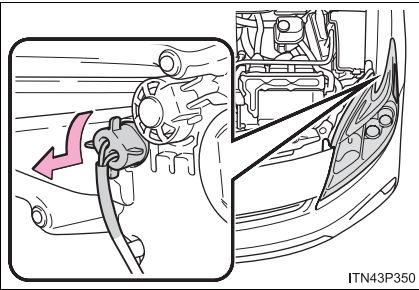

**STEP 2**

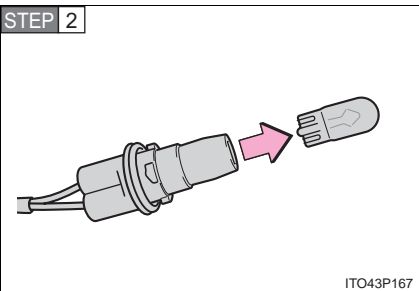

Remove the light bulb.

**STEP 3** When installing, reverse the steps listed.

### ■ Fog lights (if equipped)

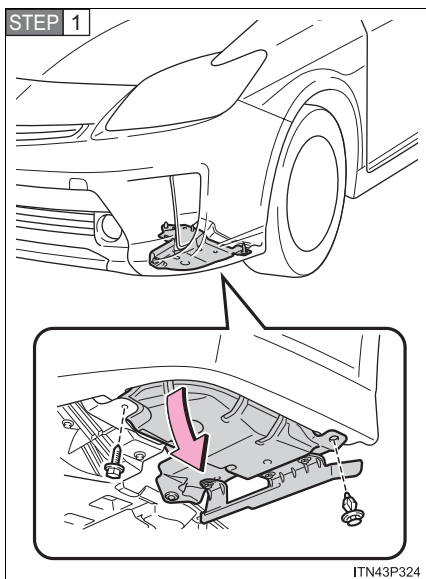

Remove the engine under cover bolt and clip and pull down the engine under cover.

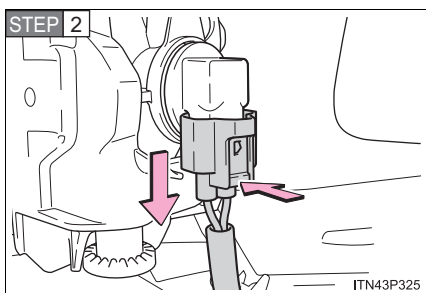

Unplug the connector while pressing the lock release.

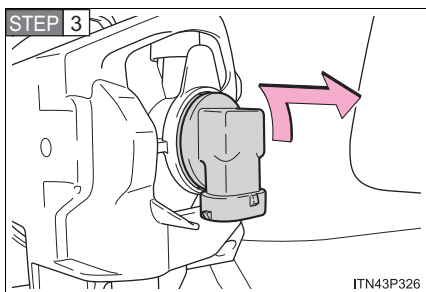

Turn the bulb base counterclockwise.

**STEP 4** When installing, reverse the steps listed.

After installing the bulb base, shake the bulb base gently to check that it is not loose.

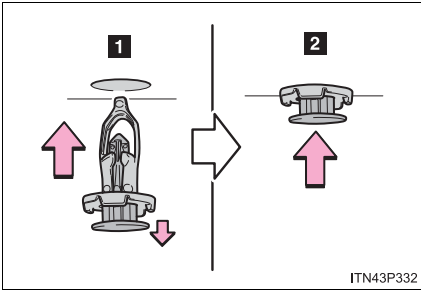

Insert the clip.

### ■ Front turn signal lights

**STEP 1** Remove the engine under cover bolt and clip and pull down the engine under cover. (→P. 474)

#### For the U.S.A.

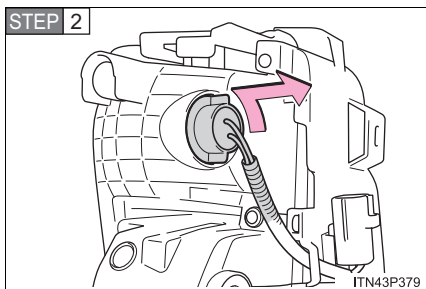

Turn the bulb base counterclockwise.

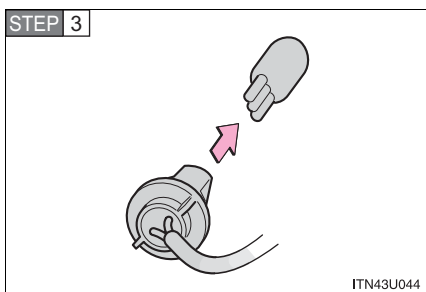

Remove the light bulb.

**For Canada**

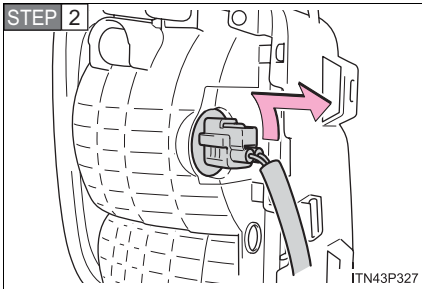

Turn the bulb base counterclockwise.

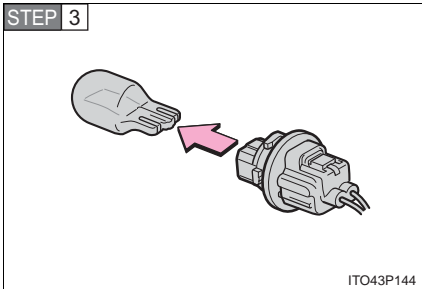

Remove the light bulb.

**STEP 4** When installing, reverse the steps listed.

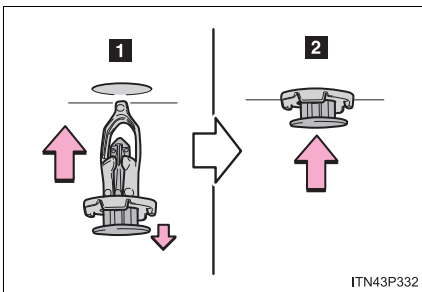

Insert the clip.

## ■ Rear turn signal lights and back-up lights

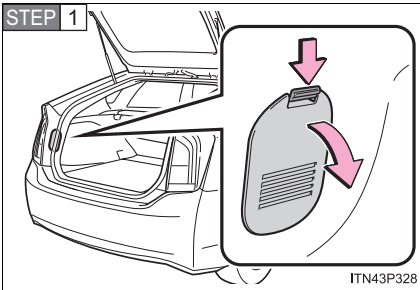

Open the back door and remove the cover.

To prevent damage, cover the tip of the screwdriver with a rag.

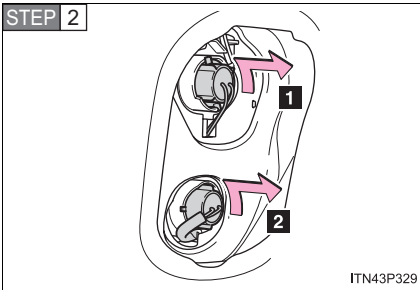

Turn the bulb base counterclockwise.

**1** Rear turn signal light

**2** Back-up light

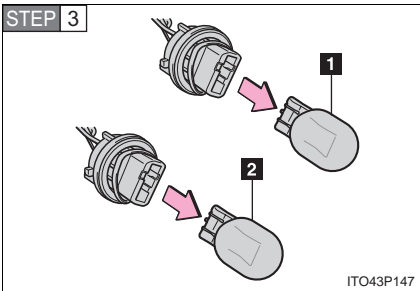

Remove the light bulb.

**1** Rear turn signal light

**2** Back-up light

**STEP 4** When installing, reverse the steps listed.



## ■ License plate lights

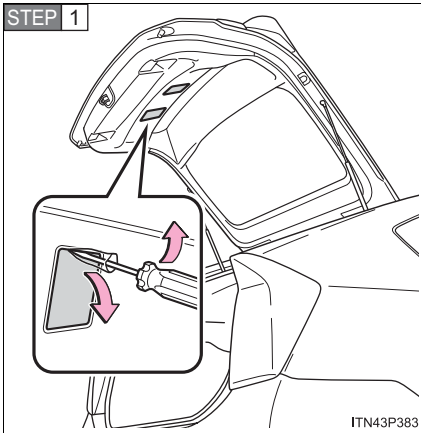

Open the back door and remove the cover.

To prevent damage, cover the tip of the screwdriver with a rag.

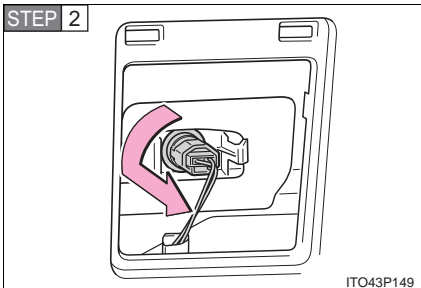

Turn the bulb base counterclockwise.

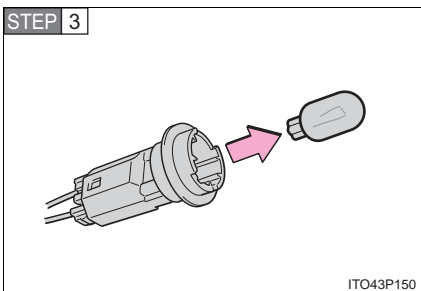

Remove the light bulb.

**STEP 4** When installing, reverse the steps listed.

### ■ Replacing the following bulbs

If any of the lights listed below has burnt out, have it replaced by your Toyota dealer.

- Headlight low beams (LED headlights)
- Parking lights (LED headlights)
- Stop lights
- Tail lights
- High mounted stoplight
- Daytime running lights (except for Canada)

---

### ■ LED lights

The headlight low beams (LED headlights), parking lights (LED headlights), stop lights, tail lights, high mounted stoplight and daytime running lights (except for Canada) consist of a number of LEDs. If any of the LEDs burn out, take your vehicle to your Toyota dealer to have the light replaced.

### ■ Condensation build-up on the inside of the lens

Contact your Toyota dealer for more information in the following situations. Temporary condensation build-up on the inside of the headlight lens does not indicate a malfunction.

- Large drops of water have built up on the inside of the lens.
- Water has built up inside the headlight.

### ■ When replacing light bulbs

→P. 465

 **CAUTION****■ Replacing light bulbs**

- Be sure to stop the hybrid system and turn off the lights. Do not attempt to replace the bulb immediately after turning off the lights. The bulbs become very hot and may cause burns.
- Do not touch the glass portion of the light bulb with bare hands. Hold the bulb by the plastic or metal portion. If the bulb is scratched or dropped, it may blow out or crack.
- Fully install light bulbs and any parts used to secure them. Failure to do so may result in heat damage, fire, or water entering the headlight unit. This may damage the headlights or cause condensation to build up on the lens.

**■ To prevent damage or fire**

Make sure bulbs are fully seated and locked.



## 5-1. Essential information

# Emergency flashers

The emergency flashers are used to warn other drivers when the vehicle has to be stopped in the road due to a breakdown, etc.

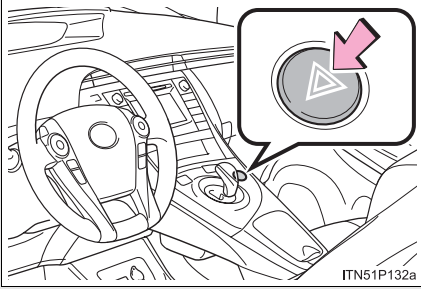

Press the switch.

All the turn signal lights will flash.

To turn them off, press the switch once again.

### ■ Emergency flashers

If the emergency flashers are used for a long time while the hybrid system is not operating (while the "READY" indicator is not illuminated), the 12-volt battery may discharge.

## If your vehicle needs to be towed

**If towing is necessary, we recommend having your vehicle towed by your Toyota dealer or a commercial towing service, using a lift-type truck or flat bed truck.**

**Use a safety chain system for all towing, and abide by all state/provincial and local laws.**

### **Before towing**

The following may indicate a problem with your hybrid transmission. Contact your Toyota dealer before towing.

- The hybrid system is operating but the vehicle will not move.
- The vehicle makes an abnormal sound.

If there is a malfunction in the P position control system, the smart key system or the immobilizer system, or if the 12-volt battery is discharged, the vehicle cannot be towed with the front wheels on the ground, as the front wheels may be locked. In this case, transport the vehicle with both front wheels or all four wheels lifted.

## Emergency towing

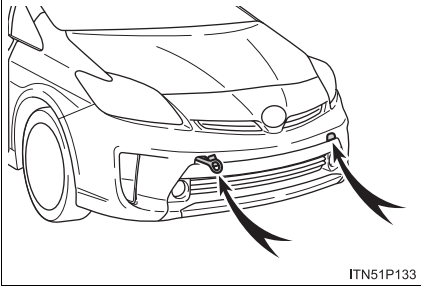

If a tow truck is not available in an emergency, your vehicle may be temporarily towed using a cable or chain secured to the emergency towing eyelet(s). This should only be attempted on hard surfaced roads for short distances at under 18 mph (30 km/h).

A driver must be in the vehicle to steer and operate the brakes. The vehicle's wheels, drive train, axles, steering and brakes must be in good condition.

## Installing towing eyelets

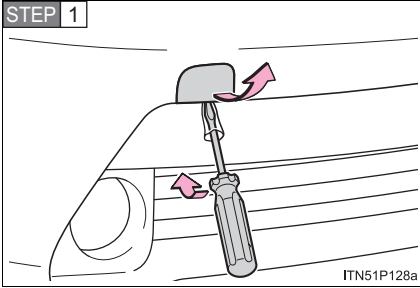

Remove the eyelet cover using a flathead screwdriver.

To prevent damage, cover the tip of the screwdriver with a rag.

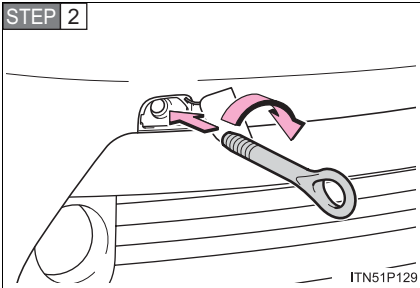

Insert the towing eyelet into the hole and tighten partially by hand.

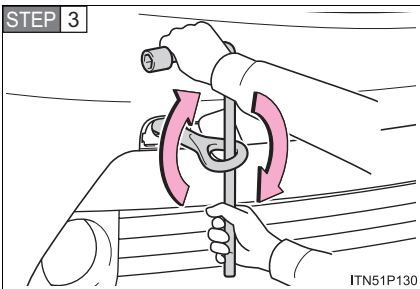

Tighten down the towing eyelet securely using a wheel nut wrench.



### Towing with a sling-type truck

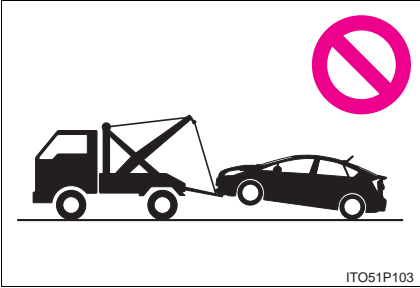

Do not tow with a sling-type truck to prevent body damage.

### Towing with a wheel-lift type truck

#### From the front

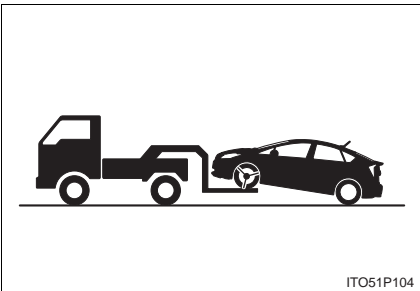

Release the parking brake.

#### From the rear

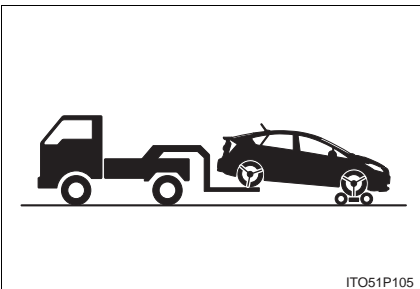

Use a towing dolly under the front wheels.

## Using a flat bed truck

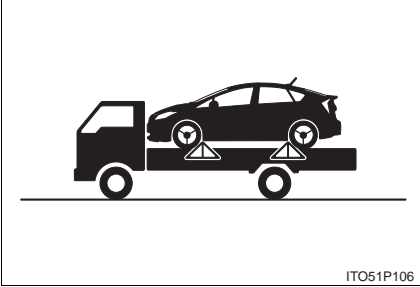

If you use chains or cables to tie down your vehicle, the angles shaded in black must be 45°.

Do not overly tighten the tie downs or the vehicle may be damaged.

### ■ Before emergency towing

- STEP 1** Turn the “POWER” switch to ON mode.  
Do not turn the “POWER” switch to ACCESSORY mode.
- STEP 2** Shift the shift position to N.
- STEP 3** Release the parking brake.

### ■ Emergency towing eyelet location

→P. 523

 **CAUTION**

■ **Caution while towing**

- Use extreme caution when towing the vehicle.  
Avoid sudden starts or erratic driving maneuvers which place excessive stress on the emergency towing eyelets and the cables or chains. Always be cautious of the surroundings and other vehicles while towing.
- Do not turn the “POWER” switch off.  
This may lead to an accident as the front wheels will be locked by the parking lock.
- If the hybrid system is off, the power assist for the brakes and steering will not function, making steering and braking more difficult.

■ **Installing towing eyelets to the vehicle**

Make sure that towing eyelets are installed securely.

If not securely installed, towing eyelets may come loose during towing. This may lead to accidents that cause serious injury or even death.

 NOTICE**■ To prevent damaging the vehicle**

When raising the vehicle, ensure adequate ground clearance for towing at the opposite end of the raised vehicle. Without adequate clearance, the vehicle could be damaged while being towed.

**■ To prevent causing serious damage to the hybrid transmission when towing using a wheel-lift type truck**

Never tow this vehicle from the front with the rear wheels on the ground.

**■ To prevent body damage when towing with a sling-type truck**

Do not tow with a sling-type truck, either from the front or rear.

**■ To prevent causing serious damage to the hybrid transmission in emergency towing**

Never tow a vehicle from the rear with four wheels on the ground. This may cause serious damage to the hybrid transmission.

## If you think something is wrong

**If you notice any of the following symptoms, your vehicle probably needs adjustment or repair. Contact your Toyota dealer as soon as possible.**

### ■ Visible symptoms

- Fluid leaks under the vehicle  
(Water dripping from the air conditioning after use is normal.)
- Flat-looking tires or uneven tire wear
- High engine coolant temperature warning light flashes or comes on

### ■ Audible symptoms

- Changes in exhaust sound
- Excessive tire squeal when cornering
- Strange noises related to the suspension system
- Pinging or other noises related to the hybrid system

### ■ Operational symptoms

- Engine missing, stumbling or running roughly
- Appreciable loss of power
- Vehicle pulls heavily to one side when braking
- Vehicle pulls heavily to one side when driving on a level road
- Loss of brake effectiveness, spongy feeling, pedal almost touches the floor



## 5-2. Steps to take in an emergency

### If a warning light turns on or a warning buzzer sounds

**Calmly perform the following actions if any of the warning lights comes on or flashes. If a light comes on or flashes, but then goes off, this does not necessarily indicate a malfunction in the system. However, if this continues to occur, have the vehicle inspected by your Toyota dealer.**

**Stop the vehicle immediately. Continuing to drive the vehicle may be dangerous.**

The following warning indicates a possible problem in the brake system. Immediately stop the vehicle in a safe place and contact your Toyota dealer.



Warning light	Warning light/Details
 (U.S.A.)	<b>Brake system warning light and warning buzzer (red indicator)*</b> <ul style="list-style-type: none"><li>• Low brake fluid</li><li>• Malfunction in the brake system</li></ul> This light also comes on when the parking brake is not released. If the light turns off after the parking brake is fully released, the system is operating normally.
 (Canada)	

\*: Parking brake engaged warning buzzer:

A buzzer will sound if the vehicle is driven at a speed of approximately 3 mph (5 km/h) or more.







**Stop the vehicle immediately.**

The following warning indicates the possibility of damage to the vehicle that may lead to an accident. Immediately stop the vehicle in a safe place and contact your Toyota dealer.



Warning light	Warning light/Details
	<p><b>Charging system warning light</b> Indicates a malfunction in the vehicle's charging system</p>
	<p><b>High coolant temperature warning light</b> Indicates that the coolant temperature is too high Changes from a flashing to a solid light when the engine coolant temperature increases.</p>



**Have the vehicle inspected by your Toyota dealer immediately.**

Failure to investigate the cause of the following warnings may lead to the system operating abnormally and possibly cause an accident. Have the vehicle inspected by your Toyota dealer immediately.

Warning light	Warning light/Details
 (U.S.A.)  (Canada)	<p><b>Malfunction indicator lamp</b>            Indicates a malfunction in:</p> <ul style="list-style-type: none"> <li>• The hybrid system;</li> <li>• The electronic engine control system; or</li> <li>• The electronic throttle control system</li> </ul>
	<p><b>SRS warning light</b>            Indicates a malfunction in:</p> <ul style="list-style-type: none"> <li>• The SRS airbag system;</li> <li>• The front passenger occupant classification system; or</li> <li>• The seat belt pretensioner system</li> </ul>
 (U.S.A.)  (Canada)	<p><b>ABS warning light</b>            Indicates a malfunction in:</p> <ul style="list-style-type: none"> <li>• The ABS; or</li> <li>• The brake assist system</li> </ul>
	<p><b>Electric power steering system warning light (warning buzzer)</b>            Indicates a malfunction in the EPS system</p>









Warning light	Warning light/Details
<div style="border: 1px solid black; padding: 5px; width: fit-content; margin: 0 auto;"> <p style="margin: 0;"><b>PCS</b></p> </div> <p>(Flashes) (If equipped)</p>	<p><b>Pre-collision system warning light</b> Indicates a malfunction in the pre-collision system The warning light will operate as follows, even when the system is not malfunctioning:</p> <ul style="list-style-type: none"> <li>• The light will flash quickly when the system is operating. (→P. 303)</li> <li>• The light will turn on when the pre-collision braking is disabled. (→P. 304)</li> <li>• The light will turn on when the system cannot temporarily be used. (→P. 512)</li> </ul>
<div style="border: 1px solid black; padding: 5px; width: fit-content; margin: 0 auto;">  </div> <p>(Turns on)</p>	<p><b>Slip indicator light</b> Indicates a malfunction in:</p> <ul style="list-style-type: none"> <li>• VSC;</li> <li>• TRAC; or</li> <li>• Hill-start assist control</li> </ul> <p>Flashes when the above systems and/or ABS are operating. (→P. 297)</p>
<div style="border: 1px solid black; padding: 5px; width: fit-content; margin: 0 auto;"> <p style="margin: 0;"><b>LKA</b></p> </div> <p>(Flashes) (If equipped)</p>	<p><b>LKA indicator light</b> Indicates a malfunction in the LKA. (→P. 286)</p>
<div style="border: 1px solid black; padding: 5px; width: fit-content; margin: 0 auto;">  </div>	<p><b>Brake system warning light (yellow indicator)</b> Indicates a malfunction in:</p> <ul style="list-style-type: none"> <li>• The regenerative braking system; or</li> <li>• The electronically controlled brake system</li> </ul>

Warning light	Warning light/Details
 (If equipped)	<p><b>Automatic headlight leveling system warning light</b>            Indicates a malfunction in the automatic headlight leveling system</p>
 (Flashes) (If equipped)	<p><b>Cruise control indicator</b>            Indicates a malfunction in the cruise control/dynamic radar cruise control</p>
 (Flashes) (If equipped)	<p><b>Radar cruise control indicator</b>            Indicates a malfunction in the dynamic radar cruise control</p>

**Follow the correction procedures.**

After taking the specified steps to correct the suspected problem, check that the warning light goes off.

Warning light	Warning light/Details	Correction procedure
	<p><b>Open door warning light (warning buzzer)*<sup>1</sup></b>                      Indicates that a door is not fully closed</p>	<p>Check that all the doors are closed.</p>
	<p><b>Low fuel level warning light</b>                      Indicates remaining fuel is approximately 1.6 gal. (6.0 L, 1.3 Imp.gal.) or less</p>	<p>Refuel the vehicle.</p>
	<p><b>Driver's seat belt reminder light (warning buzzer)*<sup>2</sup></b>                      Warns the driver to fasten his/her seat belts.</p>	<p>Fasten the seat belt.</p>
 <p>(On the instrument panel)</p>	<p><b>Front passenger's seat belt reminder light (warning buzzer)*<sup>2</sup></b>                      Warns the front passenger to fasten his/her seat belt.</p>	<p>Fasten the seat belt.</p>

Warning light	Warning light/Details	Correction procedure
	<b>Tire pressure warning light</b>	
	<p>When the light comes on:            Low tire inflation pressure such as</p> <ul style="list-style-type: none"> <li>• Natural causes (→P. 501)</li> <li>• Flat tire (→P. 523)</li> </ul>	<p>Adjust the tire inflation pressure to the specified level.            The light will turn off after a few minutes. In case the light does not turn off even if the tire inflation pressure is adjusted, have the system checked by your Toyota dealer.</p>
	<p>When the light comes on after blinking for 1 minute:            Malfunction in the tire pressure warning system (→P. 503)</p>	<p>Have the system checked by your Toyota dealer.</p>
	<b>Master warning light</b> The warning light comes on and flashes to indicate that the master warning system has detected a malfunction.	<p>→P. 507</p>

### \*1: Open door warning buzzer:

The open door warning buzzer sounds to alert one or more of the doors is not fully closed (with the vehicle having reached a speed of 3 mph [5 km/h]).

### \*2: Seat belt warning buzzer:

The driver's and front passenger's seat belts reminder sounds to alert the driver and front passenger that his or her seat belt is not fastened. The buzzer sounds intermittently for 10 seconds after the vehicle has reached a speed of at least 12 mph (20 km/h). Then, if the seat belt is still unfastened, the buzzer will sound in a different tone for 20 more seconds.

---

### ■ SRS warning light

This warning light system monitors the airbag sensor assembly, front impact sensors, side impact sensors (front), side impact sensors (rear), driver's seat position sensor, driver's seat belt buckle switch, front passenger occupant classification system (ECU and sensors), "AIR BAG ON" indicator light, "AIR BAG OFF" indicator light, front passenger's seat belt buckle switch, seat belt pretensioner assemblies, airbags, interconnecting wiring and power sources. (→P. 140)

### ■ Front passenger occupant classification system (ECU and sensors), seat belt reminder and warning buzzer

- If luggage is placed on the front passenger seat, the front passenger occupant classification system (ECU and sensors) may cause the warning light to flash and the warning buzzer to sound even if a passenger is not sitting in the seat.
- If a cushion is placed on the seat, the front passenger occupant classification system (ECU and sensors) may not detect a passenger, and the warning light may not operate properly.

**■ Electric power steering system warning light**

When the 12-volt battery charge becomes insufficient or the voltage temporarily drops, the electric power steering system warning light may come on.

**■ If the malfunction indicator lamp comes on while driving**

First check the following:

- Is the fuel tank cap loose?  
If it is, tighten it securely.

The malfunction indicator lamp will go off after several driving trips.

If the malfunction indicator lamp does not go off even after several trips, contact your Toyota dealer as soon as possible.

**■ When the tire pressure warning light comes on**

Check the tire inflation pressure and adjust to the appropriate level. Pushing the tire pressure warning reset switch will not turn off the tire pressure warning light.

**■ The tire pressure warning light may come on due to natural causes**

The tire pressure warning light may come on due to natural causes such as natural air leaks and tire inflation pressure changes caused by temperature. In this case, adjusting the tire inflation pressure will turn off the warning light (after a few minutes).

**■ When a tire is replaced with a spare tire**

The compact spare tire is not equipped with a tire pressure warning valve and transmitter. If a tire goes flat, the tire pressure warning light will not turn off even though the flat tire has been replaced with the spare tire. Replace the spare tire with the repaired tire and adjust the tire inflation pressure. The tire pressure warning light will go off after a few minutes.

■ **If the tire pressure warning system is not functioning**

The tire pressure warning system will be disabled in the following conditions:

(When the condition becomes normal, the system will work properly.)

- If tires not equipped with tire pressure warning valves and transmitters are used
- If the ID code on the tire pressure warning valves and transmitters is not registered in the tire pressure warning computer
- If the tire inflation pressure is 73 psi (500 kPa, 5.1 kgf/cm<sup>2</sup> or bar) or higher

The tire pressure warning system may be disabled in the following conditions:

(When the condition becomes normal, the system will work properly.)

- If electronic devices or facilities using similar radio wave frequencies are nearby
- If a radio set at a similar frequency is in use in the vehicle
- If a window tint that affects the radio wave signals is installed
- If there is a lot of snow or ice on the vehicle, particularly around the wheels or wheel housings
- If non-genuine Toyota wheels are used (Even if you use Toyota wheels, the tire pressure warning system may not work properly with some types of tires.)
- If tire chains are used

■ **If the tire pressure warning light frequently comes on after blinking for 1 minute**

If the tire pressure warning light frequently comes on after blinking for 1 minute when the “POWER” switch is turned to ON mode, have it checked by your Toyota dealer.

■ **Customization**

The vehicle speed linked seat belt reminder buzzer can be disabled. (Customizable features →P. 590) However, Toyota recommends that the seat belt reminder buzzer be operational to alert the driver and front passenger when seat belts are not fastened.

 **CAUTION**

■ **If both the ABS and the brake system warning lights remain on**

Stop your vehicle in a safe place immediately and contact your Toyota dealer. The vehicle will become extremely unstable during braking, and the ABS system may fail, which could cause an accident resulting in death or serious injury.

■ **When the electric power steering system warning light comes on**

The steering wheel may become extremely heavy.  
If the steering wheel becomes heavier than usual when operating, hold firmly and operate using more force than usual.



 **CAUTION**

■ **If the tire pressure warning light comes on**

Be sure to observe the following precautions. Failure to do so could cause a loss of vehicle control and result in death or serious injury.

- Stop your vehicle in a safe place as soon as possible. Adjust the tire inflation pressure immediately.
- If the tire pressure warning light comes on even after tire inflation pressure adjustment, it is probable that you have a flat tire. Check the tires. If a tire is flat, change it with the spare tire and have the flat tire repaired by the nearest Toyota dealer.
- Avoid abrupt maneuvering and braking. If the vehicle tires deteriorate, you could lose control of the steering wheel or the brakes.

■ **If a blowout or sudden air leakage should occur**

The tire pressure warning system may not activate immediately.

■ **Maintenance of the tires**

Each tire, including the spare (if provided), should be checked monthly when cold and inflated to the inflation pressure recommended by the vehicle manufacturer on the vehicle placard or tire inflation pressure label (tire and load information label). (If your vehicle has tires of a different size than the size indicated on the vehicle placard or tire inflation pressure label [tire and load information label], you should determine the proper tire inflation pressure for those tires.)

 CAUTION

As an added safety feature, your vehicle has been equipped with a tire pressure monitoring system (TPMS-tire pressure warning system) that illuminates a low tire pressure telltale (tire pressure warning light) when one or more of your tires is significantly under-inflated. Accordingly, when the low tire pressure telltale (tire pressure warning light) illuminates, you should stop and check your tires as soon as possible, and inflate them to the proper pressure. Driving on a significantly under-inflated tire causes the tire to overheat and can lead to tire failure. Under-inflation also reduces fuel efficiency and tire tread life, and may affect the vehicle's handling and stopping ability.

Please note that the TPMS (tire pressure warning system) is not a substitute for proper tire maintenance, and it is the driver's responsibility to maintain correct tire pressure, even if under-inflation has not reached the level to trigger illumination of the TPMS low tire pressure telltale (tire pressure warning light).

Your vehicle has also been equipped with a TPMS (tire pressure warning system) malfunction indicator to indicate when the system is not operating properly. The TPMS (tire pressure warning system) malfunction indicator is combined with the low tire pressure telltale (tire pressure warning light). When the system detects a malfunction, the telltale will flash for approximately one minute and then remain continuously illuminated. This sequence will continue upon subsequent vehicle start-ups as long as the malfunction exists. When the malfunction indicator is illuminated, the system may not be able to detect or signal low tire pressure as intended.

 CAUTION

TPMS (tire pressure warning system) malfunctions may occur for a variety of reasons, including the installation of replacement or alternate tires or wheels on the vehicle that prevent the TPMS (tire pressure warning system) from functioning properly. Always check the TPMS (tire pressure warning system) malfunction telltale after replacing one or more tires or wheels on your vehicle to ensure that the replacement or alternate tires and wheels allow the TPMS (tire pressure warning system) to continue to function properly.

 NOTICE

■ **Precaution when installing a different tire**

When a tire of a different specification or maker is installed, the tire pressure warning system may not operate properly.

## If a warning message is displayed

**If a warning is shown on the multi-information display, stay calm and perform the following actions:**

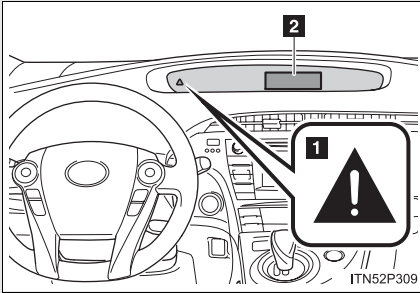





- 1** Master warning light
- 2** Multi-information display

The master warning light also comes on or flashes in order to indicate that a message is currently being displayed on the multi-information display.

If any of the warning light turns on again after performing the following actions, contact your Toyota dealer.

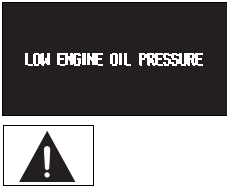





**Stop the vehicle immediately.**

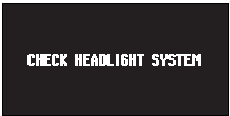

A buzzer sounds and a warning message is shown on the multi-information display. The following warnings indicate the possibility of damage to the vehicle that may lead to an accident. Immediately stop the vehicle in a safe place and contact your Toyota dealer.

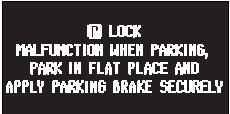
Warning message	Details
 <p>LOW ENGINE OIL PRESSURE</p> 	<p>Indicates an abnormal engine oil pressure. The warning light may turn on if the engine oil pressure is too low.</p>
 <p>CHECK HYBRID SYSTEM STOP THE VEHICLE IN A SAFE PLACE</p> 	<p>Indicates a malfunction in the hybrid system.</p>

### Have the vehicle inspected immediately.





Failure to investigate the cause of the following warnings may lead to the system operating abnormally and possibly cause an accident. Have the vehicle inspected by your Toyota dealer immediately.

Warning message	Details
  (If equipped)	<p>Indicates a malfunction in the LED headlight system.</p>
 	<p>Indicates a malfunction in the P position control system.</p> <p>In this situation, there is a possibility that the parking lock mechanism will not work.</p> <p>When parking, park the vehicle on a flat surface and apply the parking brake securely. Also, it may not be possible to turn the "POWER" switch off. If this happens, applying the parking brake will enable the switch to be turned off.</p>
   (If equipped)	<p>Indicates a malfunction in the pre-collision system. A buzzer also sounds.</p>

Warning message	Details
<div data-bbox="80 269 309 383" style="background-color: black; color: white; padding: 5px; text-align: center;"> <p><b>CHECK CRUISE CONTROL SYSTEM</b></p> </div> <div data-bbox="80 391 174 456" style="border: 1px solid black; padding: 2px;">  </div> <p data-bbox="181 402 288 435">(Flashes)</p> <div data-bbox="80 464 174 529" style="border: 1px solid black; padding: 2px;">  </div> <p data-bbox="120 532 263 565">(If equipped)</p>	<p data-bbox="338 329 944 386">Indicates a malfunction in the radar cruise control system.</p> <p data-bbox="352 394 919 516">A buzzer also sounds. Press the “ON-OFF” button once to deactivate the system, and then press the button again to reactivate the system.</p>
<div data-bbox="80 607 309 721" style="background-color: black; color: white; padding: 5px; text-align: center;"> <p><b>CHECK LKA SYSTEM</b></p> </div> <div data-bbox="80 729 174 794" style="border: 1px solid black; padding: 2px;"> <p data-bbox="88 740 167 779"><b>LKA</b></p> </div> <p data-bbox="181 743 288 776">(Flashes)</p> <div data-bbox="80 802 174 867" style="border: 1px solid black; padding: 2px;">  </div> <p data-bbox="120 870 263 902">(If equipped)</p>	<p data-bbox="338 732 732 789">Indicates a malfunction in the LKA. A buzzer also sounds.</p>

### Follow the correction procedures.







After taking the specified steps to correct the suspected problem, check that the warning message turns off.



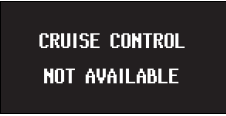

Warning message	Details	Correction procedure
  (U.S.A. only)	Indicates that all maintenance according to the driven distance on the maintenance schedule* should be performed soon.	If necessary, perform maintenance.
	Comes on approximately 4500 miles (7200 km) after the maintenance data has been reset.	
  (U.S.A. only)	Indicates that all maintenance is required to correspond to the driven distance on the maintenance schedule*.	Perform the necessary maintenance. Please reset the maintenance data after the maintenance is performed. (→P. 403)
	Comes on approximately 5000 miles (8000 km) after the maintenance data has been reset. (The indicator will not work properly unless the maintenance data has been reset.)	

\*: Refer to the separate “Scheduled Maintenance Guide” or “Owner’s Manual Supplement” for the maintenance interval applicable to your vehicle.















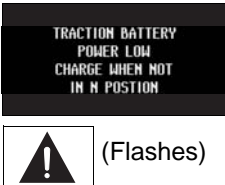

5-2. Steps to take in an emergency



Warning message	Details	Correction procedure
 <p>PCS NOT CURRENTLY AVAILABLE</p>  <p>PCS</p> <p>(If equipped)</p>	<ul style="list-style-type: none"> <li>Indicates that the pre-collision system is not currently functional because the grille or the sensor is dirty.</li> <li>This message also appears when the pre-collision system is not functional due to overheating.</li> </ul>	<ul style="list-style-type: none"> <li>Check the grille and the sensor and clean them if they are dirty.</li> <li>In case of overheating, the system will become functional once the system cools down.</li> </ul>
 <p>CLEAN RADAR SENSOR</p>  <p>(Flashes)</p>  <p>(If equipped)</p>	<p>Indicates that the radar cruise control sensor is dirty or covered with ice.</p>	<p>Clean the sensor.</p>
 <p>CRUISE CONTROL NOT AVAILABLE</p>  <p>(Flashes)</p>  <p>(If equipped)</p>	<p>Indicates that the radar cruise control system is unable to judge vehicle-to-vehicle distance.</p>	<p>If the windshield wipers are on, turn them off or set them to either the intermittent or the slow mode.</p>

Warning message	Details	Correction procedure
 <p><b>PCS</b> (Flashes rapidly) (If equipped)</p>	<p>Indicates that there is a high possibility of a collision, or that the pre-collision braking function is operating. A buzzer also sounds. At the same time,  will appear on the head-up display (the image flashes).</p>	<p>Slow the vehicle by applying the brakes.</p>
 <p>(If equipped)</p>	<p>Indicates that there is a high possibility of a collision.</p>	<p>Slow the vehicle by applying the brakes.</p>
 <p>(If equipped, flashes)</p>	<p>Indicates that your vehicle is nearing the vehicle ahead (in radar cruise mode). A buzzer also sounds. At the same time,  will appear on the head-up display (the image flashes).</p>	<p>Slow the vehicle by applying the brakes.</p>

## 5-2. Steps to take in an emergency

Warning message	Details	Correction procedure
 <p>(If equipped)</p>	<p>Indicates that the LKA is not currently functional.</p>	<p>Restart the LKA. In case of overheating, the system will become functional once the system cools down.</p>
	<p>Alerts the driver that the vehicle is out of the lanes (while the LKA system is operating). A buzzer also sounds. The lane markings and/or the steering wheel marking flash. At the same time,  will appear on the head-up display (the image flashes).</p>	<p>Check around the vehicle and back to inside of the lane markings.</p>
	<p>The hybrid system has overheated. A buzzer also sounds. This message may be displayed when driving under severe operating conditions. (For example, when driving up a long steep hill.)</p>	<p>Stop and check. (→P. 549)</p>
 <p>(Flashes)</p>	<p>The hybrid battery (traction battery) is low. A buzzer also sounds.</p>	<p>When stopping the vehicle for a long period of time, shift the shift position to P. The hybrid battery (traction battery) cannot be charged with the shift position in N.</p>

Warning message	Details	Correction procedure
  (Flashes)	<p>The hybrid battery (traction battery) power has dropped because a long period of time has elapsed after shifting the shift position to N. A buzzer also sounds.</p>	<p>Restart the hybrid system when starting the vehicle.</p>
  (Flashes)	<p>The transmission is out of P when attempting to start the hybrid system.</p>	<p>Shift the shift position to P before pressing the "POWER" switch.</p>
  (Flashes)	<p>The driver's door is opened when the transmission is out of P with the hybrid system on.</p>	<p>Shift the shift position to P.</p>
  (Flashes)	<p>Indicates that the accelerator pedal is depressed while the shift position is in N. A buzzer also sounds.</p>	<p>Release the accelerator pedal and shift the shift position to D or R.</p>
	<p>EV drive mode cannot be switched to. A buzzer also sounds. The reason why EV drive mode cannot be used is shown on the second line (may not be shown in some instances.)</p>	<p>Use the EV drive mode when it becomes available.</p>

Warning message	Details	Correction procedure
  (Flashes 3 times)	<p>EV drive mode has been automatically canceled.            A buzzer also sounds.            The reason why EV drive mode cannot be used is shown on the second line (may not be shown in some instances.)</p>	<p>Drive normally for a short time.</p>





**■ Approach warning message**

In the following instances, there is the possibility that the approach warning will not activate even when the vehicle-to-vehicle distance decreases.





- When your vehicle and the vehicle ahead are traveling at the same speed or the vehicle ahead is traveling more quickly than your vehicle.
- When the vehicle ahead is traveling at very low speed.
- Immediately after cruise control speed is set.
- At the instant the accelerator pedal is depressed.

**Have the malfunction repaired immediately.**

After taking the specified steps to correct the suspected problem, check that the warning message and light turn off.

Interior buzzer	Exterior buzzer	Warning message	Details	Correction procedure
Once	—	 <p>(Comes on for 15 seconds.)</p>  <p>(Flashes)</p>	The electronic key is not detected when attempting to start the hybrid system.	Confirm the location of the electronic key.
Once	3 times	  <p>(Flashes)</p>	An open door other than the driver's door is closed while the electronic key is outside the detection range and the "POWER" switch is in ACCESSORY or ON mode.	Confirm the location of the electronic key.

5-2. Steps to take in an emergency







Interior buzzer	Exterior buzzer	Warning message	Details	Correction procedure
Once	3 times	  (Flashes)	An open door other than the driver's door is closed while the electronic key is outside the detection range and the "POWER" switch is in ACCESSORY or ON mode with the shift position in P.	Turn the "POWER" switch to OFF or confirm the location of the electronic key.
Continuous	—	  (Flashes)	The driver's door has been opened with the shift position in a position other than P and without first turning the "POWER" switch is OFF.	Shift the shift position to P.

Interior buzzer	Exterior buzzer	Warning message	Details	Correction procedure
Once	Continuous	<div data-bbox="359 310 589 423" style="background-color: black; color: white; text-align: center; padding: 5px;">KEY NOT DETECTED</div> <div data-bbox="359 440 589 553" style="background-color: black; color: white; text-align: center; padding: 5px;">TURN POWER OFF</div> <p data-bbox="344 558 600 586">(Displayed alternately)</p> <div data-bbox="359 594 451 656" style="border: 1px solid black; padding: 5px; display: inline-block;">  </div> <p data-bbox="458 607 564 634">(Flashes)</p>	<p>The electronic key has been taken outside the vehicle and the doors have been locked without first turning the “POWER” switch to OFF. (vehicles with entry function)</p>	<p>Turn the “POWER” switch to OFF and lock the doors again.</p>



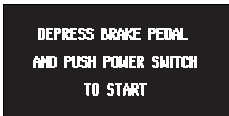

5-2. Steps to take in an emergency

Interior buzzer	Exterior buzzer	Warning message	Details	Correction procedure
Once	Continuous	<div data-bbox="327 618 558 732" style="background-color: black; color: white; padding: 5px; text-align: center; margin-bottom: 5px;">KEY DETECTED IN VEHICLE</div> <div data-bbox="327 740 421 802" style="border: 1px solid black; padding: 5px; display: inline-block;">  </div> <span data-bbox="426 748 536 781">(Flashes)</span>	<p data-bbox="596 293 780 639">An attempt to lock the doors has been made using the smart key system while the electronic key is inside the vehicle. (vehicles with entry function)</p> <p data-bbox="596 659 780 1101">With the key inside the vehicle, a front door has been opened, the lock lever has been pulled in the lock direction, the door has been closed and an attempt has been made to lock the door.</p>	<p data-bbox="817 570 934 824">Take the electronic key outside the vehicle, and lock the doors again.</p>

Interior buzzer	Exterior buzzer	Warning message	Details	Correction procedure
Continuous	Continuous	  (Displayed alternately)  (Flashes)	An open door other than the driver's door is closed while the electronic key is outside the detection range and the "POWER" switch is in ACCESSORY or ON mode with the shift position not in P.	<ul style="list-style-type: none"> <li>• Shift the shift position to P.</li> <li>• Confirm the location of the electronic key.</li> </ul>
Once	—	 (Comes on for 15 seconds.) 	The electronic key battery is low.	Replace the battery. (→P. 454)
Once	—	  (Flashes)	An open door has been closed and the "POWER" switch has been turned twice to the ACCESSORY mode from OFF.	Press the "POWER" switch while applying the brakes.

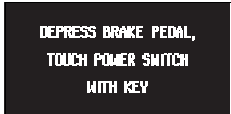
## 5-2. Steps to take in an emergency

Interior buzzer	Exterior buzzer	Warning message	Details	Correction procedure
Once	—	  (Flashes)	The electronic key does not operate properly.	→P. 541
—	—		Power was turned off due to the automatic power off function.	Next time when starting the hybrid system, increase the engine speed slightly and maintain that level for approximately 5 minutes to recharge the battery.

### NOTICE

#### ■ While the engine oil level warning is displayed

Continued engine operation with low engine oil will damage the engine.

#### ■ Engine oil maintenance message

The warning message is based on the projected driving range after engine oil maintenance message is reset.

The system does not monitor the purity of the engine oil.

## 5-2. Steps to take in an emergency If you have a flat tire

**Remove the flat tire and replace it with the spare provided.**

■ **Before jacking up the vehicle**

- Stop the vehicle on a hard, flat surface.
- Set the parking brake.
- Shift the shift position to P.
- Stop the hybrid system.
- Turn on the emergency flashers.

■ **Location of the spare tire, jack and tools**

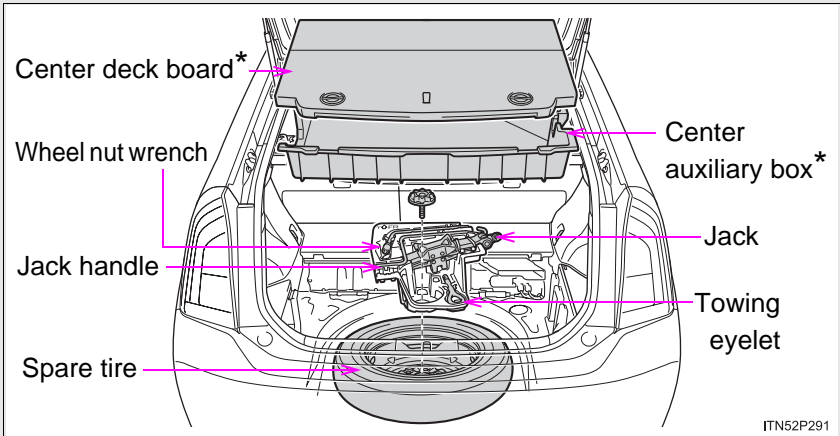

\*: The shape may differ depending on the grade, etc.

## Taking out the jack

**STEP 1** Remove the center deck board and center auxiliary box.

### Type A

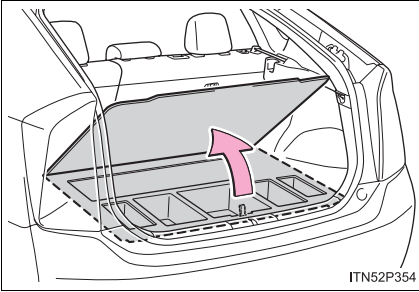

Pull the strap up to open the center deck board, lift up the center auxiliary box, and unload it from the vehicle.

### Type B

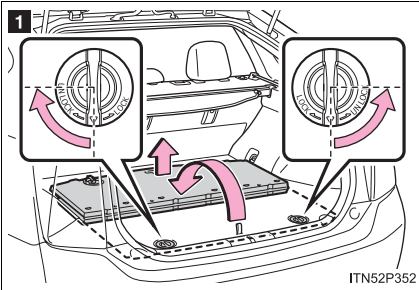

**1** Turn the knob to the UNLOCK position to unfasten the lock, and remove the center deck board.

Fold the center deck board toward the front of the vehicle, and unload it from the vehicle.

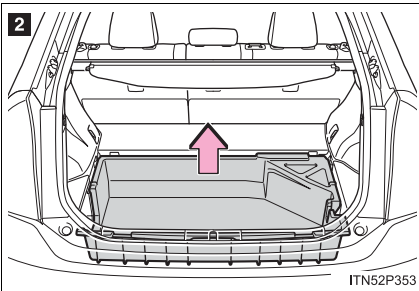

**2** Remove the center auxiliary box.

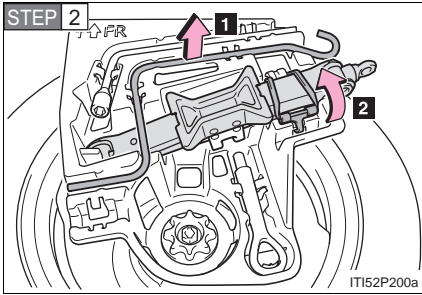

- 1 Remove the jack handle.
- 2 Unhook the tightening strap.

After storing the jack, make sure it is securely held by the tightening strap.

### Taking out the spare tire

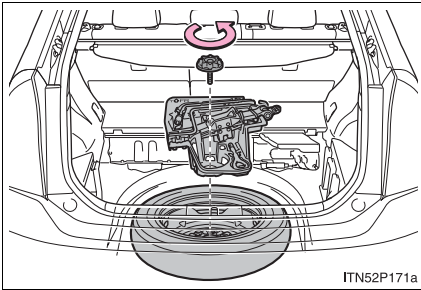

Loosen the center fastener that secures the spare tire.

### CAUTION

#### Service plug

Be careful not to hit the service plug when loading or unloading the tool holder or the spare tire. (→P. 36)

## Replacing a flat tire

STEP 1

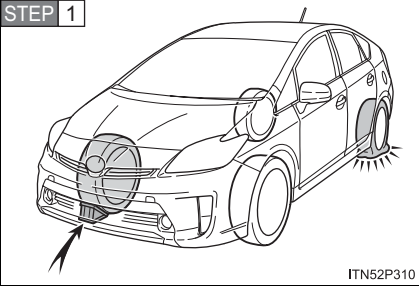

Chock the tires.

	Flat tire	Wheel chock positions
Front	Left-hand side	Behind the rear right-hand side tire
	Right-hand side	Behind the rear left-hand side tire
Rear	Left-hand side	In front of the front right-hand side tire
	Right-hand side	In front of the front left-hand side tire

STEP 2

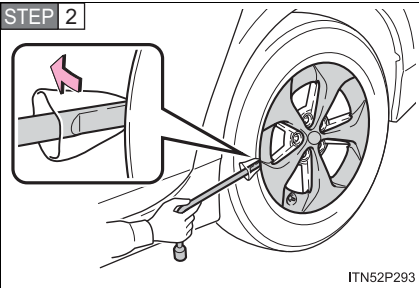

Vehicles with wheel ornament, remove the wheel ornament using the wrench.

To prevent damage, cover the tip of the wrench with a rag.

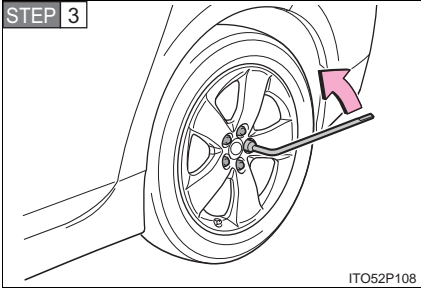

Slightly loosen the wheel nuts (one turn).

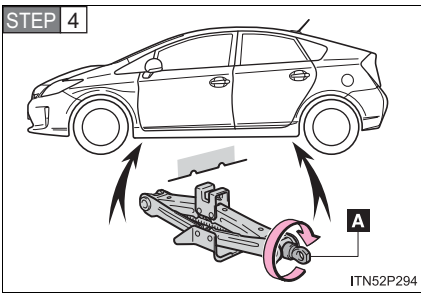

Turn the tire jack portion "A" by hand until the notch of the jack is in contact with the jack point.

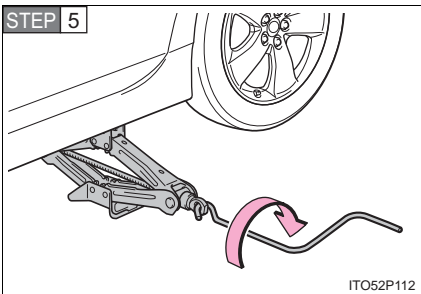

Raise the vehicle until the tire is slightly raised off the ground.



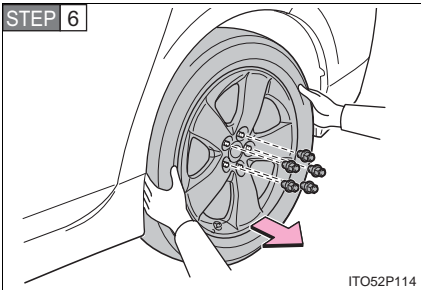

Remove all the wheel nuts and the tire.

When resting the tire on the ground, place the tire so that the wheel design faces up to avoid scratching the wheel surface.

### Installing the spare tire

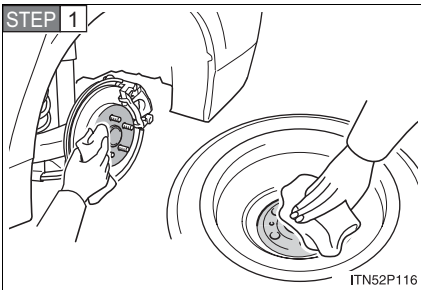

Remove any dirt or foreign matter from the wheel contact surface.

If foreign matter is on the wheel contact surface, the wheel nuts may loosen while the vehicle is in motion, and the tire may come off the vehicle.

**STEP 2** Install the tire and loosely tighten each wheel nut by hand by approximately the same amount.

### Replacing an aluminum wheel with a compact spare tire

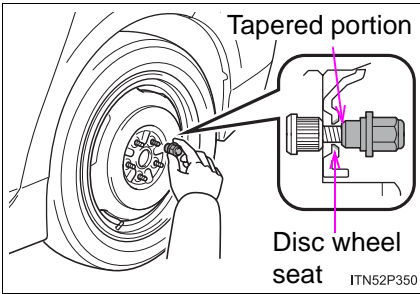

Tighten the nuts until the tapered portion comes into loose contact with the disc wheel seat.

### Replacing an aluminum wheel with an aluminum wheel

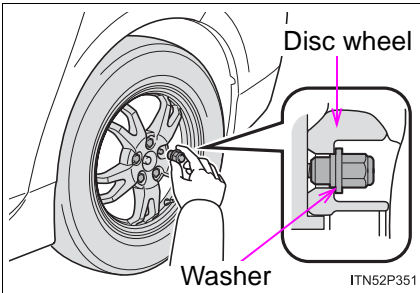

Turn the nut washers until they come into contact with the disc wheel.

## 5-2. Steps to take in an emergency

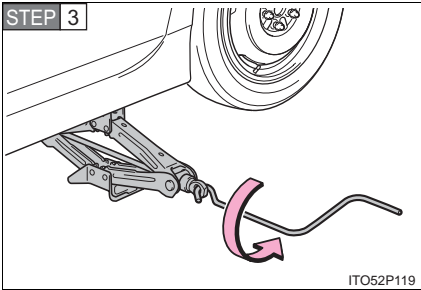

Lower the vehicle.

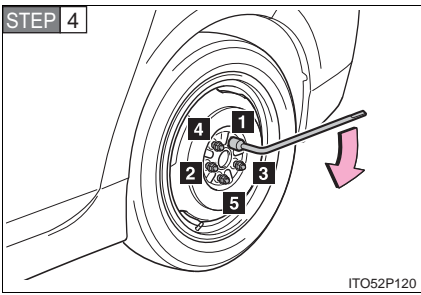

Firmly tighten each nut two or three times in the order shown in the illustration.

**Tightening torque:**  
76 ft•lbf (103 N•m, 10.5 kgf•m)

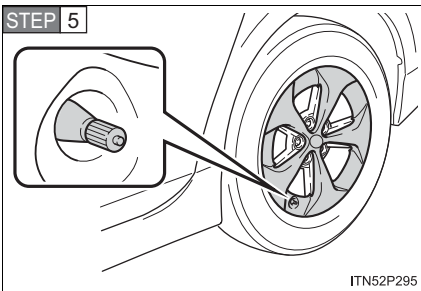

Vehicles with wheel ornament, reinstall the wheel ornament.\*

Align the cutout of the wheel ornament with the valve stem as shown.

\*: The wheel ornament cannot be installed on the compact spare tire.

**STEP 6** Stow the flat tire, the tire jack and all tools.

## Stowing the flat tire

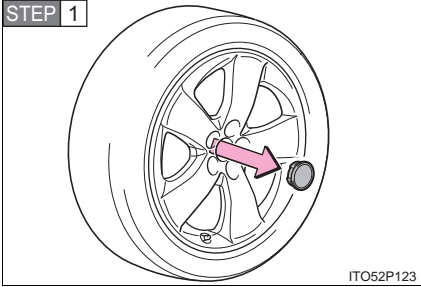

For vehicles with a 17-inch wheel: Before stowing the flat tire, remove the center wheel ornament by pushing from the reverse side.

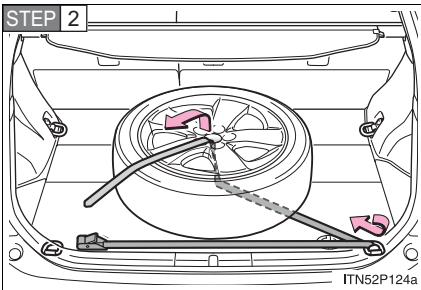

Place the flat tire on the deck board, and pass the belt through the lower-right cargo hook and then through the hole in the center of the tire.

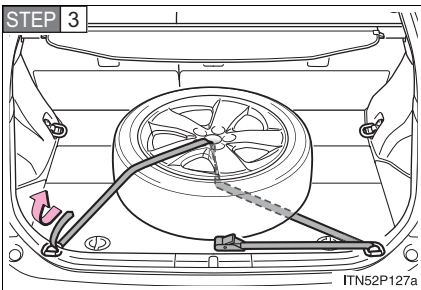

Pass the belt through the lower-left cargo hook.

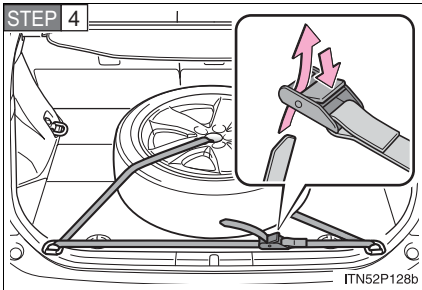

Pass the belt through the buckle and secure the tire firmly. Check that the belt is securely held by the buckle.

The belt cannot be fastened securely if the buckle is facing the wrong direction.

### ■ The compact spare tire

- The compact spare tire is identified by the label “TEMPORARY USE ONLY” on the tire sidewall. Use the compact spare tire temporarily, and only in an emergency.
- Make sure to check the tire inflation pressure of the compact spare tire. (→P. 569)

### ■ After completing the tire change

The tire pressure warning system must be reset. (→P. 439)

### ■ When using the compact spare tire

As the compact spare tire is not equipped with a tire pressure warning valve and transmitter, low inflation pressure of the spare tire will not be indicated by the tire pressure warning system. Also, if you replace the compact spare tire after the tire pressure warning light comes on, the light remains on.

### ■ If you have a flat front tire on a road covered with snow or ice

Install the compact spare tire on one of the rear wheels of the vehicle. Perform the following steps and fit tire chains to the front tires:

**STEP 1** Replace a rear tire with the compact spare tire.

**STEP 2** Replace the flat front tire with the tire removed from the rear of the vehicle.

**STEP 3** Fit tire chains to the front tires.

### ■ Jack point guide

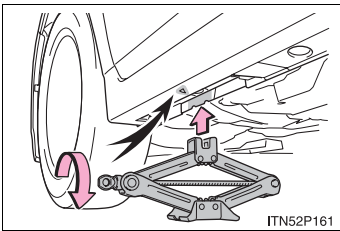

The jack point guides are located under the rocker panel. They indicate the jack point positions.

### ⚠ CAUTION

#### ■ When using the compact spare tire

- Remember that the spare tire provided is specifically designed for use with your vehicle. Do not use your spare tire on another vehicle.
- Do not use more than one spare tires simultaneously.
- Replace the spare tire with a standard tire as soon as possible.
- Avoid sudden acceleration, deceleration and braking, as well as sharp cornering.

#### ■ When storing the compact spare tire

Be careful not to catch fingers or other body parts between the compact spare tire and the body of the vehicle.

 CAUTION

■ **When the compact spare tire is attached**

The vehicle speed may not be correctly detected, and the following systems may not operate correctly:

- ABS & Brake assist
- VSC
- TRAC
- Cruise control (if equipped)
- Dynamic radar cruise control (if equipped)
- Pre-collision system (if equipped)
- LKA (if equipped)
- EPS
- Rear view monitor system (if equipped)
- Advanced parking guidance system (if equipped)
- Navigation system (if equipped)

■ **Speed limit when using the compact spare tire**

Do not drive at speeds in excess of 50 mph (80 km/h) when a compact spare tire is installed on the vehicle.

The compact spare tire is not designed for driving at high speeds. Failure to observe this precaution may lead to an accident causing death or serious injury.

 CAUTION**■ Using the tire jack**

Improper use of the tire jack may cause the vehicle to suddenly fall off the jack, leading to death or serious injury.

Observe the following precautions:

- Do not use the tire jack for any purpose other than replacing tires or installing and removing tire chains.
- Only use the tire jack that comes with this vehicle for replacing a flat tire.  
Do not use it on other vehicles, and do not use other tire jacks for replacing tires on this vehicle.
- Always check that the tire jack is securely set to the jack point.
- Do not put any part of your body under the vehicle while it is supported by the jack.
- Do not start or run the hybrid system while your vehicle is supported by the jack.
- Do not raise the vehicle while someone is inside.
- When raising the vehicle, do not put an object on or under the jack.
- Do not raise the vehicle to a height greater than that required to replace the tire.
- Use a jack stand if it is necessary to get under the vehicle.

Take particular care when lowering the vehicle to ensure that no one working on or near the vehicle may be injured.



 CAUTION

■ **Replacing a flat tire**

- Do not touch the disc wheels or the area around the brakes immediately after the vehicle has been driven.

After the vehicle has been driven the disc wheels and the area around the brakes will be extremely hot. Touching these areas with hands, feet or other body parts while changing a tire, etc. may result in burns.

- Failure to follow these precautions could cause the wheel nuts to loosen and the tire to fall off, resulting in death or serious injury.
  - Have the wheel nuts tightened with a torque wrench to 76 ft•lbf (103 N•m, 10.5 kgf•m) as soon as possible after changing wheels.
  - When installing a tire, only use wheel nuts that have been specifically designed for that wheel.
  - If there are any cracks or deformations in the bolt screws, nut threads or bolt holes of the wheel, have the vehicle inspected by your Toyota dealer.
  - When installing the wheel nuts, be sure to install the wheel nuts with the tapered end facing inward. (→P. 452)

■ **After using the tools and jack**

Before driving, make sure all the tools and jack are securely in place in their storage location to reduce the possibility of personal injury during a collision or sudden braking.

■ **When stowing the flat tire**

- Make sure the rear seatbacks are in their original position.
- Secure it using a tire tie-down belt. Otherwise, the flat tire may fly out in case of sudden braking or an accident, resulting in death or serious injury.

 NOTICE**■ Do not drive the vehicle with a flat tire**

Do not continue driving with a flat tire.

Driving even a short distance with a flat tire can damage the tire and the wheel beyond repair.

**■ Be careful when driving over bumps with the compact spare tire installed on the vehicle**

The vehicle becomes lower when driving with the compact spare tire compared to when driving with standard tires. Be careful when driving over uneven road surfaces.

**■ Driving with tire chains and the compact spare tire**

Do not fit tire chains to the compact spare tire.

Tire chains may damage the vehicle body and adversely affect driving performance.

**■ When replacing the tires**

When removing or fitting the wheels, tires or the tire pressure warning valve and transmitter, contact your Toyota dealer as the tire pressure warning valve and transmitter may be damaged if not handled correctly.

**■ To avoid damage to the tire pressure warning valves and transmitters**

When a tire is repaired with liquid sealants, the tire pressure warning valve and transmitter may not operate properly. If a liquid sealant is used, contact your Toyota dealer or other qualified service shop as soon as possible. Make sure to replace the tire pressure warning valve and transmitter when replacing the tire. (→P. 438)

## If the hybrid system will not start

**Reasons for the hybrid system not starting vary depending on the situation. Check the following and perform the appropriate procedure:**

■ **The hybrid system will not start even though the correct starting procedure is being followed (→P. 192)**

One of the following may be the cause of the problem:

- The electronic key may not be functioning properly.\*  
(→P. 541)
- There may not be sufficient fuel in the vehicle's tank.  
Refuel the vehicle.
- There may be a malfunction in the immobilizer system.\*  
(→P. 135)
- There may be a malfunction in the P position control system.\*  
(→P. 197, 509)

\*: It may not be possible to shift the shift position from P to another position.

■ **The interior lights and headlights are dim, or the horn does not sound or sounds at a low volume**

One of the following may be the cause of the problem:

- The 12-volt battery may be discharged. (→P. 543)
- The 12-volt battery terminal connections may be loose or corroded.

■ **The interior lights and headlights do not turn on, or the horn does not sound**

One of the following may be the cause of the problem:

- One or both of the 12-volt battery terminals may be disconnected.
- The 12-volt battery may be discharged. (→P. 543)

Contact your Toyota dealer if the problem cannot be repaired, or if repair procedures are unknown.

### Emergency start function

When the hybrid system does not start, the following steps can be used as an interim measure to start the hybrid system if the “POWER” switch is functioning normally:

**STEP 1** Set the parking brake.

**STEP 2** Turn the “POWER” switch to ACCESSORY mode.

**STEP 3** Press and hold the “POWER” switch for about 15 seconds while depressing the brake pedal firmly.

Even if the hybrid system can be started using the above steps, the system may be malfunctioning. Have the vehicle inspected by your Toyota dealer.

## If you lose your keys

**New genuine keys can be made by your Toyota dealer using the other key and the key number stamped on your key number plate.**

If communication between the electronic key and vehicle is interrupted (→P. 72) or the electronic key cannot be used because the battery is depleted, the smart key system and wireless remote control cannot be used. In such cases, the doors can be opened and the hybrid system can be started by following the procedure below.

### Locking and unlocking the doors

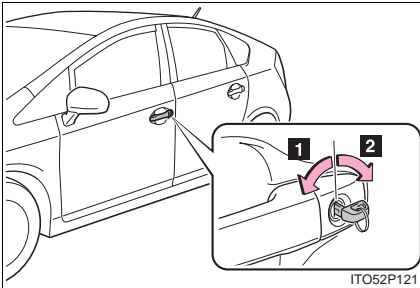

Use the mechanical key (→P. 58) in order to perform the following operations:

- 1** Locks all the doors
- 2** Unlocks the door

Turning the key rearward unlocks the driver's door. Turning the key once again within 3 seconds unlocks the other doors.

## Changing “POWER” switch modes and starting the hybrid system

**STEP 1** Depress the brake pedal.

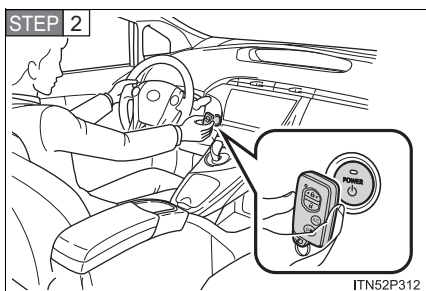

Touch the Toyota emblem side of the electronic key to the “POWER” switch.

If any of the doors is opened or closed while the key is being touched to the switch, an alarm will sound to indicate that the start function cannot detect the electronic key.

**STEP 3** Perform the following operations.

To change “POWER” switch modes: Within 10 seconds of the buzzer sounding, release the brake pedal and press the “POWER” switch. Modes can be changed each time the switch is pressed. (→P. 194)

To start the hybrid system: Press the “POWER” switch within 10 seconds of the buzzer sounding, keeping the brake pedal depressed.

In the event that the hybrid system still cannot be operated, contact your Toyota dealer.

### ■ Stopping the hybrid system

Set the parking brake, shift the shift position to P and press the “POWER” switch as you normally do when stopping the hybrid system.

### ■ Replacing the key battery

As the above procedure is a temporary measure, it is recommended that the electronic key battery be replaced immediately when the battery is depleted. (→P. 454)

## 5-2. Steps to take in an emergency If the 12-volt battery is discharged

The following procedures may be used to start the hybrid system if the vehicle's 12-volt battery is discharged.

You can also call your Toyota dealer or a qualified repair shop.

If you have a set of jumper (or booster) cables and a second vehicle with a 12-volt battery, you can jump start your vehicle by following the steps below.

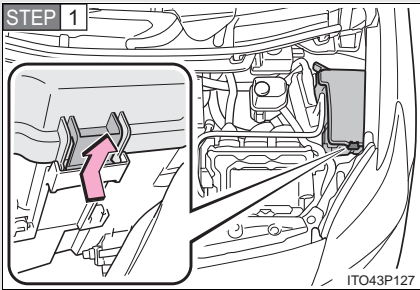

Open the hood and fuse block cover.

When closing, first hook the lid onto the two rear tabs.

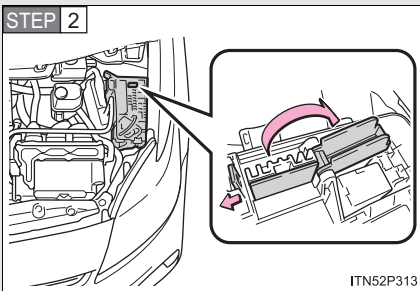

Open the exclusive jump starting terminal cover.



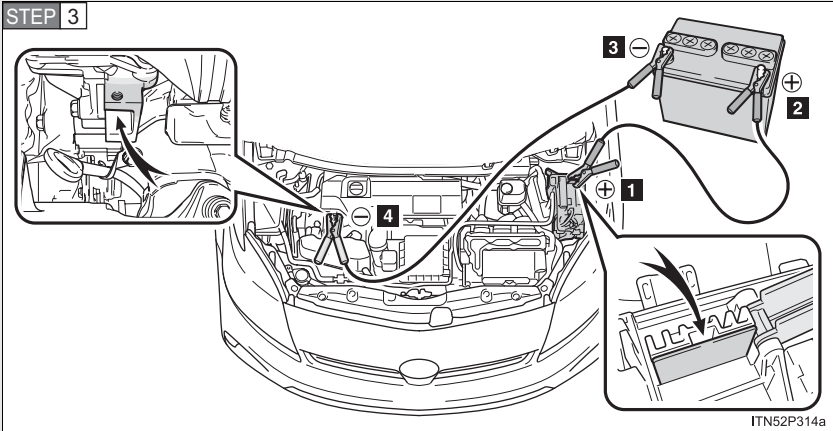

Connect the jumper cables according to the following procedure:

- 1** Connect a positive jumper cable clamp to the exclusive jump starting terminal on your vehicle.
- 2** Connect the clamp on the other end of the positive cable to the positive (+) battery terminal on the second vehicle.
- 3** Connect a negative cable clamp to the negative (-) battery terminal on the second vehicle.
- 4** Connect the clamp at the other end of the negative cable to a solid, stationary, unpainted metallic point away from the exclusive jump starting terminal and any moving parts, as shown in the illustration.

- STEP 4** Start the engine of the second vehicle. Increase the engine speed slightly and maintain at that level for approximately 5 minutes to recharge the battery of your vehicle.
- STEP 5** Maintain the engine speed of the second vehicle and start the hybrid system of your vehicle by turning the “POWER” switch to ON mode.
- STEP 6** Make sure the “READY” indicator comes on. If the indicator light does not come on, contact your Toyota dealer.
- STEP 7** Once the hybrid system has started, remove the jumper cables in the exact reverse order from which they were connected.
- STEP 8** Close the exclusive jump starting terminal cover, and reinstall the fuse box cover to its original position.

When installing, first hook the fuse box cover onto the two rear tabs.

Once the hybrid system starts, have the vehicle inspected at your Toyota dealer as soon as possible.

■ **Starting the hybrid system when the 12-volt battery is discharged**

The hybrid system cannot be started by push-starting.

■ **To prevent 12-volt battery discharge**

- Turn off the headlights and the audio system while the hybrid system is off.
- Turn off any unnecessary electrical components when the vehicle is running at a low speed for an extended period, such as in heavy traffic.

■ **When the 12-volt battery is removed or discharged**

- The hybrid system may not start. (→P. 433)
- If the 12-volt battery is depleted with the shift position in P, it will not be possible to shift the shift position other than P. In this case, the vehicle cannot be towed without lifting both front wheels because the front wheels are locked by the parking lock. (→P. 485)
- When the 12-volt battery is reconnected, start the hybrid system, depress the brake pedal, and confirm that it is possible to shift into each shift position.

■ **Charging the 12-volt battery**

The electricity stored in the 12-volt battery will discharge gradually even when the vehicle is not in use, due to natural discharge and the draining effects of certain electrical appliances. If the vehicle is left for a long time, the 12-volt battery may discharge, and the hybrid system may be unable to start. (The 12-volt battery recharges automatically while the hybrid system is operating.)

 **CAUTION****■ Avoiding 12-volt battery fires or explosions**

Observe the following precautions to prevent accidentally igniting the flammable gas that may be emitted from the 12-volt battery:

- Make sure each jumper cable is connected to the correct terminal and that it is not unintentionally in contact with any other than the intended terminal.
- Do not allow the other end of the jumper cable connected to the “+” terminal to come into contact with any other parts or metal surfaces in the area, such as brackets or unpainted metal.
- Do not allow the + and - clamps of the jumper cables to come into contact with each other.
- Do not smoke, use matches, cigarette lighters or allow open flame near the 12-volt battery.

**■ 12-volt battery precautions**

The 12-volt battery contains poisonous and corrosive acidic electrolyte, while related parts contain lead and lead compounds. Observe the following precautions when handling the 12-volt battery:

- When working with the 12-volt battery, always wear safety glasses and take care not to allow any battery fluids (acid) to come into contact with skin, clothing or the vehicle body.
- Do not lean over the 12-volt battery.
- In the event that battery fluid comes into contact with the skin or eyes, immediately wash the affected area with water and seek medical attention. Place a wet sponge or cloth over the affected area until medical attention can be received.
- Always wash your hands after handling the battery support, terminals, and other battery-related parts.
- Do not allow children near the 12-volt battery.

 CAUTION

■ **After recharging the 12-volt battery**

Have the 12-volt battery inspected at your Toyota dealer as soon as possible.

If the 12-volt battery is deteriorating, continued use may cause the 12-volt battery to emit a malodorous gas, which may be detrimental to the health of passengers.

■ **When replacing the 12-volt battery**

→P. 435

 NOTICE

■ **When handling jumper cables**

When connecting the jumper cables, ensure that they do not become entangled in the cooling fans, etc.

■ **Exclusive jump starting terminal**

The exclusive jump starting terminal is to be used when charging the 12-volt battery from another vehicle in an emergency. It cannot be used to jump start another vehicle.

## 5-2. Steps to take in an emergency If your vehicle overheats

### The following may indicate that your vehicle is overheating:

- The high coolant temperature warning light flashes or comes on:  
The engine may be overheating.
- “HYBRID SYSTEM OVERHEAT” is shown on the multi-information display:  
The power control unit may be overheating.

Follow the correction procedure as described below.

### Correction procedures

#### ■ If the high coolant temperature warning light flashes or comes on

**STEP 1** Stop the vehicle in a safe place and turn off the air conditioning system.

**STEP 2** Check to see if steam is coming out from under the hood.

If you see steam:

Stop the hybrid system. Carefully lift the hood after the steam subsides and then restart the hybrid system.

If you do not see steam:

Leave the hybrid system operating and carefully lift the hood.

**STEP 3** Check to see if the cooling fans are operating.

If the fans are operating:

Wait until the high coolant temperature warning light goes off and then stop the hybrid system.

If the fans are not operating:

Stop the hybrid system immediately and call your Toyota dealer.

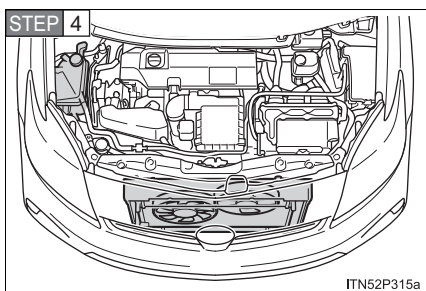

After the hybrid system has cooled down sufficiently, check the engine coolant level and inspect the cooling system for leaks.

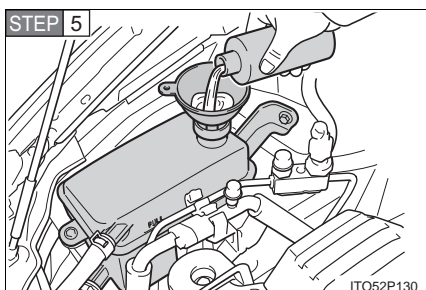

If necessary, add engine coolant up to the "FULL" line.

Water can be used in an emergency measure if engine coolant is unavailable. (→P. 566)

Have the vehicle checked at nearest Toyota dealer as soon as possible.

■ If “HYBRID SYSTEM OVERHEAT” is shown on the multi-information display

**STEP 1** Stop the vehicle in a safe place and turn off the air conditioning system.

**STEP 2** Leave the hybrid system operating and carefully lift the hood.

**STEP 3** Check if the cooling fans are operating.

If the fans are operating:

Wait until “HYBRID SYSTEM OVERHEAT” disappears and then stop the hybrid system.

If the warning light does not turn off, call your Toyota dealer.

If the fans are not operating:

Stop the hybrid system immediately and call your Toyota dealer.

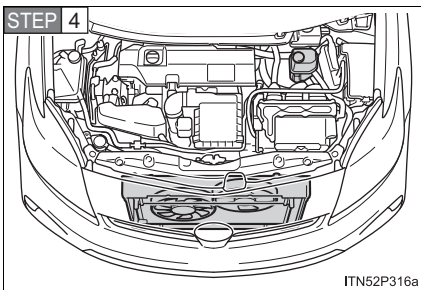

After the hybrid system has cooled down, check the power control unit coolant level and inspect the cooling system for leaks.



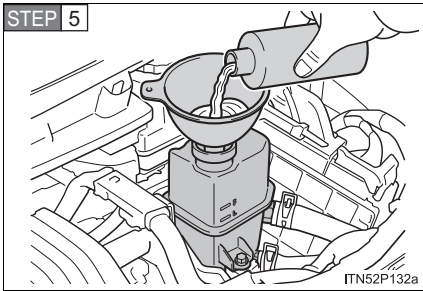

If necessary, add power control unit coolant up to the “F” line.

Water can be used in an emergency measure if power control unit coolant is unavailable.  
(→P. 566)

Have the vehicle checked at nearest Toyota dealer as soon as possible.

---

### ■ Overheating

The following symptoms may occur when your vehicle is overheating:

- Hybrid system output decrease
- Steam is coming from under the hood

 **CAUTION**

■ **To prevent an accident or injury when inspecting under the hood of your vehicle**

- If steam is seen coming from under the hood, do not open the hood until the steam has subsided. The engine compartment may be very hot, causing serious injuries such as burns.
- Check that the indicator on the “POWER” switch and the “READY” indicator are off.
- For vehicles with a hybrid system, there are times when the gasoline engine automatically starts to run or the cooling fans suddenly start to operate. Do not touch or approach the rotating parts of the fans, etc. Doing so may lead to fingers, clothes or tools getting caught, resulting in injury.
- Do not loosen the coolant reservoir cap while the hybrid system and radiator are hot.  
Serious injury, such as burns, may result from hot coolant and steam released under pressure.

 **NOTICE**

■ **When adding engine/power control unit coolant**

Wait until the hybrid system has cooled down before adding engine/power control unit coolant.

When adding coolant, do so slowly. Adding cool coolant to a hot hybrid system too quickly can cause damage to the hybrid system.

■ **To prevent damage to the cooling system**

Observe the following precautions:

- Avoid contaminating the coolant with foreign matter (such as sand or dust etc.)
- Do not use commercially available coolant additives

## 5-2. Steps to take in an emergency If the vehicle becomes stuck

**Carry out the following procedures if the tires spin or the vehicle becomes stuck in mud, dirt or snow:**

- STEP 1** Set the parking brake and shift the shift position to P. Stop the hybrid system.
- STEP 2** Remove the mud, snow or sand from around the stuck tire.
- STEP 3** Place wood, stones or some other material under the tires to help provide traction.
- STEP 4** Restart the hybrid system.
- STEP 5** Shift the shift position to D or R, release the parking brake and carefully apply the accelerator to free the vehicle.

### CAUTION

#### ■ **When attempting to free a stuck vehicle**

If you choose to push the vehicle back and forth to free it, make sure the surrounding area is clear to avoid striking other vehicles, objects or people. The vehicle may also lunge forward or lunge back suddenly as it becomes free. Use extreme caution.

#### ■ **When changing the shift position**

Be careful not to change the shift position with the accelerator pedal depressed.

Changing the shift position to any positions other than P or N may cause the vehicle to accelerate abruptly, causing an accident and resulting in death or serious injury.

**NOTICE****■ To avoid damage to the hybrid transmission and other components**

- Avoid spinning the wheels and depressing the accelerator pedal more than necessary.
- If the vehicle remains stuck even after these procedures are performed, the vehicle may require towing to be freed.

## 5-2. Steps to take in an emergency

### If your vehicle has to be stopped in an emergency

**Only in an emergency, such as if it becomes impossible to stop the vehicle in the normal way, stop the vehicle using the following procedure:**

**STEP 1** Steadily step on the brake pedal with both feet and firmly depress it.

Do not pump the brake pedal repeatedly as this will increase the effort required to slow the vehicle.

**STEP 2** Shift the shift position to N.

**If the shift position is shifted to N**

**STEP 3** After slowing down, stop the vehicle in a safe place by the road.

**STEP 4** Stop the hybrid system.

**If the shift position cannot be shifted to N**

**STEP 3** Keep depressing the brake pedal with both feet to reduce vehicle speed as much as possible.

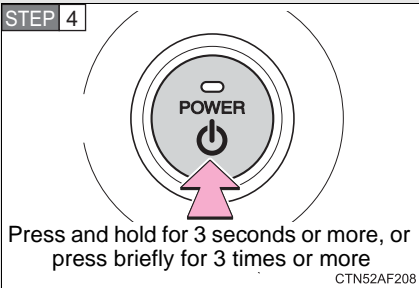

To stop the hybrid system, press and hold the “POWER” switch for 3 consecutive seconds or more, or press it briefly for 3 times or more in succession.

**STEP 5** Stop the vehicle in a safe place by the road.

 CAUTION**■ If the hybrid system has to be turned off while driving**

Power assist for the brakes and steering wheel will be lost, making the brake pedal harder to depress and the steering wheel heavier to turn. Decelerate as much as possible before turning off the hybrid system.



## 6-1. Specifications

### Maintenance data (fuel, oil level, etc.)

#### Dimensions and weight

Overall length	176.4 in. (4480 mm)	
Overall width	68.7 in. (1745 mm)	
Overall height* <sup>1</sup>	58.7 in. (1490 mm) <sup>*2</sup> 59.3 in. (1505 mm) <sup>*3</sup>	
Wheelbase	106.3 in. (2700 mm)	
Tread	Front	60.0 in. (1525 mm) <sup>*4</sup> 59.6 in. (1515 mm) <sup>*5</sup>
	Rear	59.8 in. (1520 mm) <sup>*4</sup> 59.4 in. (1510 mm) <sup>*5</sup>
Vehicle capacity weight (Occupants + luggage)	825 lb. (370 kg)	

\*1: Unladen vehicle

\*2: Vehicles without moon roof with Solar Panel

\*3: Vehicles with moon roof with Solar Panel

\*4: Vehicles with 15-inch tires

\*5: Vehicles with 17-inch tires



## Vehicle identification

### ■ Vehicle identification number

The vehicle identification number (VIN) is the legal identifier for your vehicle. This is the primary identification number for your Toyota. It is used in registering the ownership of your vehicle.

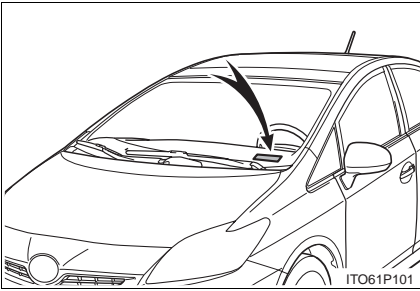

This number is stamped on the top left of the instrument panel.

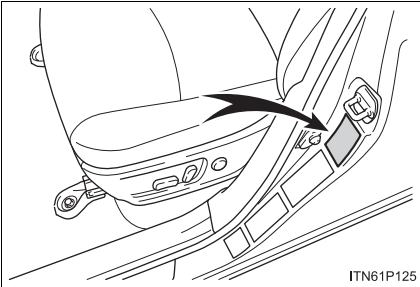

This number is also on the Certification Label.

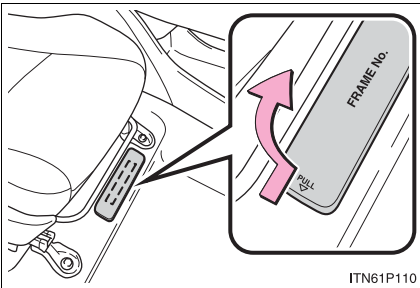

This number is also stamped under the right-hand front seat.

■ Engine number

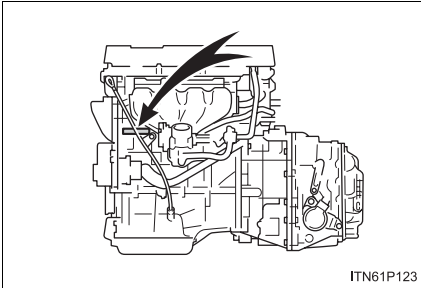

The engine number is stamped on the engine block as shown.

ITN61P123

**Engine**

Model	1.8 L 4-cylinder (2ZR-FXE)
Type	4-cylinder in line, 4-cycle, gasoline
Bore and stroke	3.17 × 3.48 in. (80.5 × 88.3 mm)
Displacement	109.7 cu.in. (1798 cm <sup>3</sup> )
Valve clearance (engine cold)	Automatic adjustment

**Fuel**

Fuel type	Unleaded gasoline only
Octane Rating	87 (Research Octane Number 91) or higher
Fuel tank capacity (Reference)	11.9 gal. (45 L, 9.9 Imp.gal.)

**Electric motor (Traction motor)**

Type	Permanent magnet motor
Maximum output	60 kW
Maximum torque	153 ft•lbf (207 N•m, 21.1 kgf•m)

**Hybrid battery (traction battery)**

Type	Nickel-Metal hydride battery
Voltage	7.2 V/module
Capacity	6.5 Ah (3HR)
Quantity	28 modules
Overall voltage	201.6 V

**Lubrication system**

Oil capacity (Drain and refill — reference*)	
With filter	4.4 qt. (4.2 L, 3.7 Imp.qt.)
Without filter	4.1 qt. (3.9 L, 3.4 Imp.qt.)

\*: The engine oil capacity is a reference quantity to be used when changing the engine oil. Warm up the engine and turn off the hybrid system, wait more than 5 minutes, and check the oil level on the dipstick.

### ■ Engine oil selection

“Toyota Genuine Motor Oil” is used in your Toyota vehicle. Use Toyota approved “Toyota Genuine Motor Oil” or equivalent to satisfy the following grade and viscosity.

Oil grade: ILSAC multigrade engine oil

Recommended viscosity: SAE 0W-20

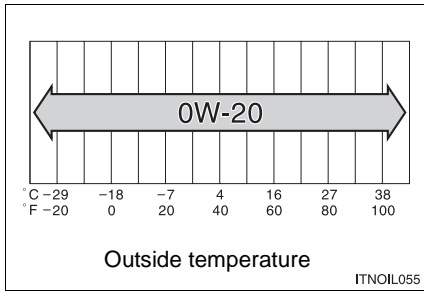

SAE 0W-20 is the good choice for good fuel economy and good starting in cold weather.

If SAE 0W-20 is not available, SAE 5W-20 oil may be used. However, it must be replaced with SAE 0W-20 at the next oil change.

Oil viscosity (0W-20 is explained here as an example):

- The 0W in 0W-20 indicates the characteristic of the oil which allows cold startability. Oils with a lower value before the W allow for easier starting of the engine in cold weather.
- The 20 in 0W-20 indicates the viscosity characteristic of the oil when the oil is at high temperature. An oil with a higher viscosity (one with a higher value) may be better suited if the vehicle is operated at high speeds, or under extreme load conditions.

How to read oil container label:

The ILSAC (International Lubricant Standardization and Approval Committee) Certification Mark is added to some oil containers to help you select the oil you should use.



### Cooling system

Capacity	Gasoline engine	<b>Without an exhaust heat recovery system</b> 6.9 qt. (6.5 L, 5.7 Imp.qt.) <b>With an exhaust heat recovery system</b> 7.6 qt. (7.2 L, 6.3 Imp.qt.)
	Power control unit	2.2 qt. (2.1 L, 1.8 Imp.qt.)
Coolant type		Use either of the following: <ul style="list-style-type: none"> <li>• “Toyota Super Long Life Coolant”</li> <li>• Similar high-quality ethylene glycol-based non-silicate, non-amine, non-nitrite, and non-borate coolant with long-life hybrid organic acid technology</li> </ul> Do not use plain water alone.

### Ignition system

Spark plug	
Make	DENSO SC20HR11
Gap	0.043 in. (1.1 mm)

### NOTICE

#### Iridium-tipped spark plugs

Use only iridium-tipped spark plugs. Do not adjust the spark plug gap.

## Electrical system

12-volt battery Open voltage at 68 °F (20 °C):	12.6 — 12.8 V Fully charged 12.2 — 12.4 V Half charged 11.5 — 11.9 V Discharged (Voltage is checked 20 minutes after the hybrid system and all lights are turned off.)
Charging rates	5 A max.

## Transmission

Fluid capacity*	3.6 qt. (3.4 L, 3.0 Imp.qt.)
Fluid type	Toyota Genuine ATF WS

\*: The fluid capacity is the quantity of reference.  
If replacement is necessary, contact your Toyota dealer.

### NOTICE

#### ■ Transmission fluid type

Using transmission fluid other than “Toyota Genuine ATF WS” may cause deterioration in shift quality, locking up of your transmission accompanied by vibration, and ultimately damage the transmission of your vehicle.

**Brakes**

Pedal clearance <sup>*1</sup>	3.03 in. (77 mm) Min.
Pedal free play	0.04 — 0.24 in. (1.0 — 6.0 mm)
Brake pad wear limit	0.04 in. (1.0 mm)
Parking brake lining wear limit	0.04 in. (1.0 mm)
Parking brake pedal travel <sup>*2</sup>	8 — 11 clicks
Fluid type	SAE J1703 or FMVSS No. 116 DOT 3

\*1: Minimum pedal clearance when depressed with a force of 44.1 lbf (196 N, 20.0 kgf) while the hybrid system is operating.

\*2: Parking brake pedal travel when depressed with a force of 67.5 lbf (300 N, 30.6 kgf).

**Steering**

Free play	Less than 1.2 in. (30 mm)
-----------	---------------------------



<b>Tires and wheels</b>
-------------------------

**Type A**

Tire size	P195/65R15 89S
Tire inflation pressure (Recommended cold tire inflation pressure)	<b>Front tire</b> 35 psi (240 kPa, 2.4 kgf/cm <sup>2</sup> or bar) <b>Rear tire</b> 33 psi (230 kPa, 2.3 kgf/cm <sup>2</sup> or bar)
Wheel size	15 × 6J
Wheel nut torque	76 ft•lbf (103 N•m, 10.5 kgf•m)

**Type B**

Tire size	P215/45R17 87V
Tire inflation pressure (Recommended cold tire inflation pressure)	<b>Front tire</b> 33 psi (230 kPa, 2.3 kgf/cm <sup>2</sup> or bar) <b>Rear tire</b> 32 psi (220 kPa, 2.2 kgf/cm <sup>2</sup> or bar)
Wheel size	17 × 7J
Wheel nut torque	76 ft•lbf (103 N•m, 10.5 kgf•m)

**Compact spare tire**

Tire size	T135/80D16 101M
Spare tire inflation pressure (Recommended cold tire inflation pressure)	60 psi (420 kPa, 4.2 kgf/cm <sup>2</sup> or bar)
Wheel size	16 × 4T
Wheel nut torque	76 ft•lbf (103 N•m, 10.5 kgf•m)

<b>Light bulbs</b>
--------------------

	Light Bulbs	Bulb No.	W	Type
Exterior	Halogen headlights Low beam	H11	55	A
	High beam	9005	60	B
	LED headlights High beam	9005	60	B
	Fog lights*	H16	19	C
	Front turn signal lights	WY21W	21	D
	Front side marker lights	W5W	5	E
	Parking lights (halogen headlights)	W5W	5	E
	Rear turn signal lights	WY21W	21	D
	Back-up lights	W21W	21	E
License plate lights	W5W	5	E	
Interior	Front interior/personal lights	—	5	E
	Rear interior light	—	8	F
	Vanity lights	—	8	E
	Door courtesy lights	—	5	E
	Luggage compartment light	—	5	F

A: H11 halogen bulbs

B: HB3 halogen bulbs

C: H16 halogen bulbs

D: Wedge base bulbs (amber)

E: Wedge base bulbs (clear)

F: Double end bulbs

\*: If equipped

**You must only use unleaded gasoline in your vehicle.**

**Select octane rating 87 (Research Octane Number 91) or higher. Use of unleaded gasoline with an octane rating lower than 87 may result in engine knocking. Persistent knocking can lead to engine damage.**

At minimum, the gasoline you use should meet the specifications of ASTM D4814 in the U.S.A. and CGSB3.5-M93 in Canada.

---

### ■ Fuel tank opening for unleaded gasoline

To help prevent incorrect fueling, your vehicle has a fuel tank opening that only accommodates the special nozzle on unleaded fuel pumps.

### ■ Gasoline quality

In very few cases, driveability problems may be caused by the brand of gasoline you are using. If driveability problems persist, try changing the brand of gasoline. If this does not correct the problem, consult your Toyota dealer.

■ **Gasoline quality standards**

- Automotive manufacturers in the U.S.A., Europe and Japan have developed a specification for fuel quality called the World-Wide Fuel Charter (WWFC), which is expected to be applied worldwide.
- The WWFC consists of four categories that are based on required emission levels. In the U.S., category 4 has been adopted.
- The WWFC improves air quality by lowering emissions in vehicle fleets, and improves customer satisfaction through better performance.

■ **Recommendation of the use of gasoline containing detergent additives**

- Toyota recommends the use of gasoline that contains detergent additives to avoid the build-up of engine deposits.
- All gasoline sold in the U.S.A. contains detergent additives to clean and/or keep clean intake systems.

■ **Recommendation of the use of cleaner burning gasoline**

Cleaner burning gasoline, including reformulated gasoline that contains oxygenates such as ethanol or MTBE (Methyl Tertiary Butyl Ether) is available in many areas.

Toyota recommends the use of cleaner burning gasoline and appropriately blended reformulated gasoline. These types of gasoline provide excellent vehicle performance, reduce vehicle emissions and improve air quality.

## ■ Non-recommendation of the use of blended gasoline

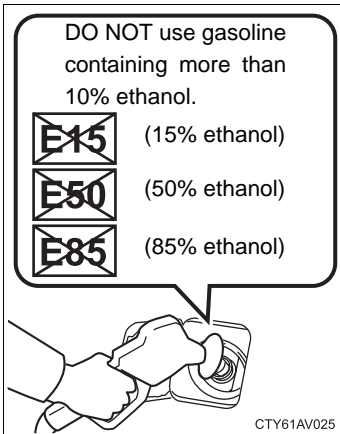

- Use only gasoline containing a maximum of 10% ethanol.

DO NOT use any flex-fuel or gasoline that could contain more than 10% ethanol, including from any pump labeled E15, E30, E50, E85 (which are only some examples of fuel containing more than 10% ethanol).

- If you use gasohol in your vehicle, be sure that it has an octane rating no lower than 87.
- Toyota does not recommend the use of gasoline containing methanol.

## ■ Non-recommendation of the use of gasoline containing MMT

Some gasoline contains an octane enhancing additive called MMT (Methylcyclopentadienyl Manganese Tricarbonyl).

Toyota does not recommend the use of gasoline that contains MMT. If fuel containing MMT is used, your emission control system may be adversely affected.

The malfunction indicator lamp on the instrument cluster may come on. If this happens, contact your Toyota dealer for service.

## ■ If your engine knocks

- Consult your Toyota dealer.
- You may occasionally notice light knocking for a short time while accelerating or driving uphill. This is normal and there is no need for concern.

 NOTICE

■ **Notice on fuel quality**

- Do not use improper fuels. If improper fuels are used, the engine will be damaged.
- Do not use leaded gasoline.  
Leaded gasoline can cause damage to your vehicle's three-way catalytic converters causing the emission control system to malfunction.
- Do not use gasohol other than the type previously stated.  
Other gasohol may cause fuel system damage or vehicle performance problems.
- Using unleaded gasoline with an octane number or rating lower than the level previously stated will cause persistent heavy knocking.  
At worst, this will lead to engine damage.

■ **Fuel-related poor driveability**

If poor driveability is encountered after using a different type of fuel (poor hot starting, vaporization, engine knocking, etc.), discontinue the use of that type of fuel.

■ **When refueling with gasohol**

Take care not to spill gasohol. It can damage your vehicle's paint.

# 6-1. Specifications

## Tire information

### Typical tire symbols

#### Full-size tire

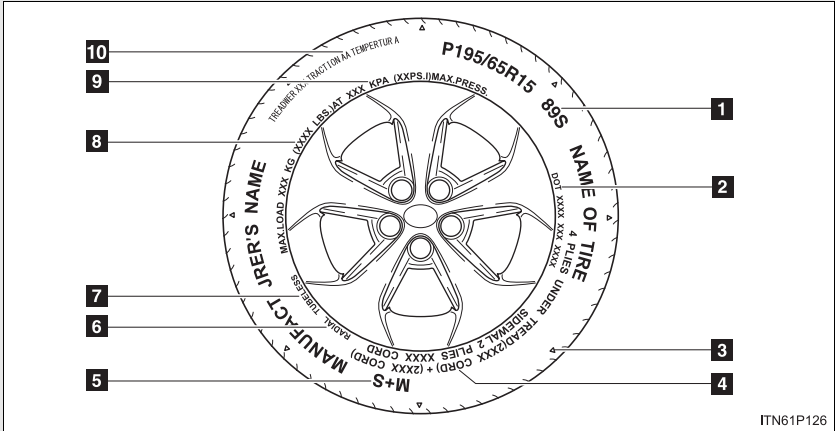

ITN61P126

#### Compact spare tire

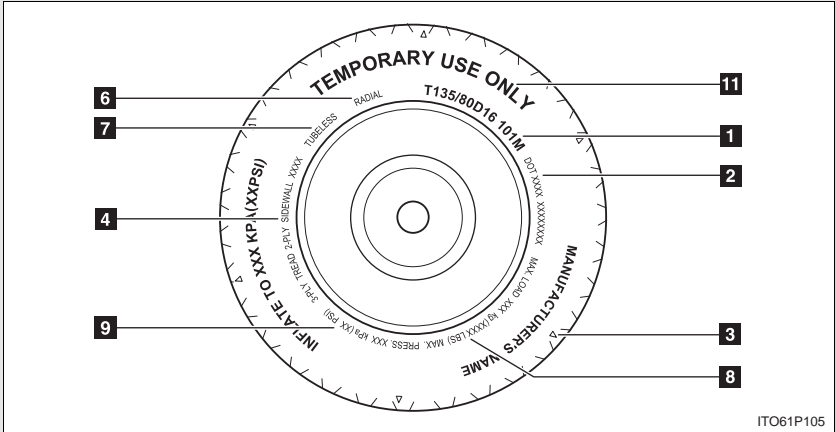

ITO61P105

- 1** Tire size (→P. 578)
- 2** DOT and Tire Identification Number (TIN) (→P. 577)
- 3** Location of treadwear indicators (→P. 437)

**4** Tire ply composition and materials

Plies are layers of rubber-coated parallel cords. Cords are the strands which form the plies in a tire.

**5** Summer tires or all season tires (→P. 442)

An all season tire has “M+S” on the sidewall. A tire not marked “M+S” is a summer tire.

**6** Radial tires or bias-ply tires

A radial tire has “RADIAL” on the sidewall. A tire not marked “RADIAL” is a bias-ply tire.

**7** TUBELESS or TUBE TYPE

A tubeless tire does not have a tube and air is directly put into the tire. A tube type tire has a tube inside the tire and the tube maintains the air pressure.

**8** Load limit at maximum cold tire inflation pressure (→P. 442)

**9** Maximum cold tire inflation pressure (→P. 569)

This means the pressure to which a tire may be inflated.

**10** Uniform tire quality grading

For details, see “Uniform Tire Quality Grading” that follows.

**11** “TEMPORARY USE ONLY”

A compact spare tire is identified by the phrase “TEMPORARY USE ONLY” molded on its sidewall. This tire is designed for temporary emergency use only.



## Typical DOT and Tire Identification Number (TIN)

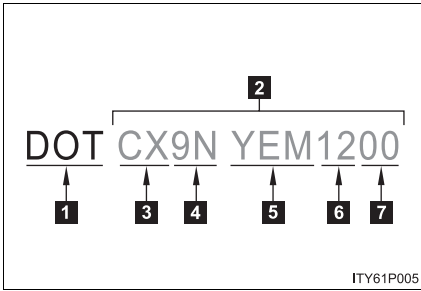

- 1 DOT symbol\*
- 2 Tire Identification Number (TIN)
- 3 Tire manufacturer's identification mark
- 4 Tire size code
- 5 Manufacturer's optional tire type code (3 or 4 letters)
- 6 Manufacturing week
- 7 Manufacturing year

\*: The DOT symbol certifies that the tire conforms to applicable Federal Motor Vehicle Safety Standards.

## Tire size

### ■ Typical tire size information

The illustration indicates typical tire size.

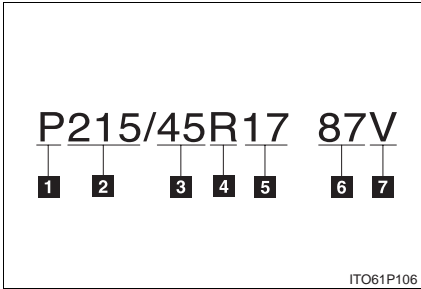

- 1** Tire use  
(P = Passenger car,  
T = Temporary use)
- 2** Section width (millimeters)
- 3** Aspect ratio  
(tire height to section width)
- 4** Tire construction code  
(R = Radial, D = Diagonal)
- 5** Wheel diameter (inches)
- 6** Load index (2 digits or 3 digits)
- 7** Speed symbol  
(alphabet with one letter)

### ■ Tire dimensions

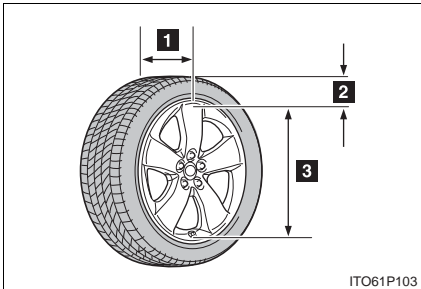

- 1** Section width
- 2** Tire height
- 3** Wheel diameter

## Tire section names

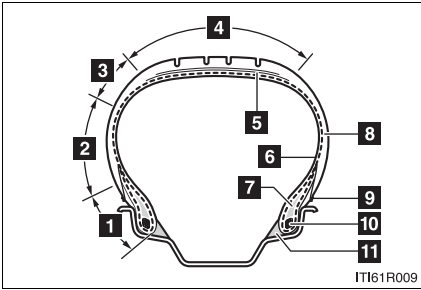

- 1** Bead
- 2** Sidewall
- 3** Shoulder
- 4** Tread
- 5** Belt
- 6** Inner liner
- 7** Reinforcing rubber
- 8** Carcass
- 9** Rim lines
- 10** Bead wires
- 11** Chafer

## **Uniform Tire Quality Grading**

This information has been prepared in accordance with regulations issued by the National Highway Traffic Safety Administration of the U.S. Department of Transportation.

It provides the purchasers and/or prospective purchasers of Toyota vehicles with information on uniform tire quality grading.

Your Toyota dealer will help answer any questions you may have as you read this information.

### **■ DOT quality grades**

All passenger vehicle tires must conform to Federal Safety Requirements in addition to these grades. Quality grades can be found where applicable on the tire sidewall between tread shoulder and maximum section width.

For example: Treadwear 200 Traction AA Temperature A

### **■ Treadwear**

The treadwear grade is a comparative rating based on the wear rate of the tire when tested under controlled conditions on a specified government test course.

For example, a tire graded 150 would wear one and a half (1 - 1/2) times as well on the government course as a tire graded 100.

The relative performance of tires depends upon the actual conditions of their use. Performance may differ significantly from the norm due to variations in driving habits, service practices and differences in road characteristics and climate.

### ■ Traction AA, A, B, C

The traction grades, from highest to lowest, are AA, A, B and C, and they represent the tire's ability to stop on wet pavement as measured under controlled conditions on specified government test surfaces of asphalt and concrete.

A tire marked C may have poor traction performance.

Warning: The traction grade assigned to this tire is based on braking (straight ahead) traction tests and does not include cornering (turning) traction.

### ■ Temperature A, B, C

The temperature grades are A (the highest), B, and C, representing the tire's resistance to the generation of heat and its ability to dissipate heat when tested under controlled conditions on a specified indoor laboratory test wheel.

Sustained high temperature can cause the material of the tire to degenerate and reduce tire life, and excessive temperature can lead to sudden tire failure.

Grade C corresponds to a level of performance which all passenger car tires must meet under the Federal Motor Vehicle Safety Standard No. 109.

Grades B and A represent higher levels of performance on the laboratory test wheel than the minimum required by law.

Warning: The temperature grades of a tire assume that it is properly inflated and not overloaded.

Excessive speed, underinflation, or excessive loading, either separately or in combination, can cause heat buildup and possible tire failure.

<b>Glossary of tire terminology</b>
-------------------------------------

Tire related term	Meaning
Cold tire inflation pressure	Tire pressure when the vehicle has been parked for three hours or more, or has not been driven more than 1 mile or 1.5 km under that condition
Maximum inflation pressure	The maximum cold inflated pressure to which a tire may be inflated, shown on the sidewall of the tire
Recommended inflation pressure	Cold tire inflation pressure recommended by a manufacturer
Accessory weight	The combined weight (in excess of those standard items which may be replaced) of automatic transmission, power steering, power brakes, power windows, power seats, radio and heater, to the extent that these items are available as factory-installed equipment (whether installed or not)
Curb weight	The weight of a motor vehicle with standard equipment, including the maximum capacity of fuel, oil and coolant, and if so equipped, air conditioning and additional weight optional engine
Maximum loaded vehicle weight	The sum of: (a) Curb weight (b) Accessory weight (c) Vehicle capacity weight (d) Production options weight

Tire related term	Meaning
Normal occupant weight	150 lb. (68 kg) times the number of occupants specified in the second column of Table 1* that follows
Occupant distribution	Distribution of occupants in a vehicle as specified in the third column of Table 1* below
Production options weight	The combined weight of installed regular production options weighing over 5 lb. (2.3 kg) in excess of the standard items which they replace, not previously considered in curb weight or accessory weight, including heavy duty brakes, ride levelers, roof rack, heavy duty 12-volt battery, and special trim
Rim	A metal support for a tire or a tire and tube assembly upon which the tire beads are seated
Rim diameter (Wheel diameter)	Nominal diameter of the bead seat
Rim size designation	Rim diameter and width
Rim type designation	The industry manufacturer's designation for a rim by style or code
Rim width	Nominal distance between rim flanges
Vehicle capacity weight (Total load capacity)	The rated cargo and luggage load plus 150 lb. (68 kg) times the vehicle's designated seating capacity

Tire related term	Meaning
Vehicle maximum load on the tire	The load on an individual tire that is determined by distributing to each axle its share of the maximum loaded vehicle weight, and dividing by two
Vehicle normal load on the tire	The load on an individual tire that is determined by distributing to each axle its share of curb weight, accessory weight, and normal occupant weight (distributed in accordance with Table 1* below), and dividing by two
Weather side	The surface area of the rim not covered by the inflated tire
Bead	The part of the tire that is made of steel wires, wrapped or reinforced by ply cords and that is shaped to fit the rim
Bead separation	A breakdown of the bond between components in the bead
Bias ply tire	A pneumatic tire in which the ply cords that extend to the beads are laid at alternate angles substantially less than 90 degrees to the centerline of the tread
Carcass	The tire structure, except tread and sidewall rubber which, when inflated, bears the load
Chunking	The breaking away of pieces of the tread or sidewall



Tire related term	Meaning
Cord	The strands forming the plies in the tire
Cord separation	The parting of cords from adjacent rubber compounds
Cracking	Any parting within the tread, sidewall, or innerliner of the tire extending to cord material
CT	A pneumatic tire with an inverted flange tire and rim system in which the rim is designed with rim flanges pointed radially inward and the tire is designed to fit on the underside of the rim in a manner that encloses the rim flanges inside the air cavity of the tire
Extra load tire	A tire designed to operate at higher loads and at higher inflation pressures than the corresponding standard tire
Groove	The space between two adjacent tread ribs
Innerliner	The layer(s) forming the inside surface of a tubeless tire that contains the inflating medium within the tire
Innerliner separation	The parting of the innerliner from cord material in the carcass

Tire related term	Meaning
Intended outboard sidewall	(a) The sidewall that contains a whitewall, bears white lettering, or bears manufacturer, brand, and/or model name molding that is higher or deeper than the same molding on the other sidewall of the tire, or (b) The outward facing sidewall of an asymmetrical tire that has a particular side that must always face outward when mounted on a vehicle
Light truck (LT) tire	A tire designated by its manufacturer as primarily intended for use on lightweight trucks or multipurpose passenger vehicles
Load rating	The maximum load that a tire is rated to carry for a given inflation pressure
Maximum load rating	The load rating for a tire at the maximum permissible inflation pressure for that tire
Maximum permissible inflation pressure	The maximum cold inflation pressure to which a tire may be inflated
Measuring rim	The rim on which a tire is fitted for physical dimension requirements
Open splice	Any parting at any junction of tread, sidewall, or innerliner that extends to cord material
Outer diameter	The overall diameter of an inflated new tire

Tire related term	Meaning
Overall width	The linear distance between the exteriors of the sidewalls of an inflated tire, including elevations due to labeling, decorations, or protective bands or ribs
Passenger car tire	A tire intended for use on passenger cars, multipurpose passenger vehicles, and trucks, that have a gross vehicle weight rating (GVWR) of 10,000 lb. or less.
Ply	A layer of rubber-coated parallel cords
Ply separation	A parting of rubber compound between adjacent plies
Pneumatic tire	A mechanical device made of rubber, chemicals, fabric and steel or other materials, that, when mounted on an automotive wheel, provides the traction and contains the gas or fluid that sustains the load
Radial ply tire	A pneumatic tire in which the ply cords that extend to the beads are laid at substantially 90 degrees to the centerline of the tread
Reinforced tire	A tire designed to operate at higher loads and at higher inflation pressures than the corresponding standard tire

Tire related term	Meaning
Section width	The linear distance between the exteriors of the sidewalls of an inflated tire, excluding elevations due to labeling, decoration, or protective bands
Sidewall	That portion of a tire between the tread and bead
Sidewall separation	The parting of the rubber compound from the cord material in the sidewall
Snow tire	A tire that attains a traction index equal to or greater than 110, compared to the ASTM E-1136 Standard Reference Test Tire, when using the snow traction test as described in ASTM F-1805-00, Standard Test Method for Single Wheel Driving Traction in a Straight Line on Snow-and Ice-Covered Surfaces, and which is marked with an Alpine Symbol (  ) on at least one sidewall
Test rim	The rim on which a tire is fitted for testing, and may be any rim listed as appropriate for use with that tire
Tread	That portion of a tire that comes into contact with the road
Tread rib	A tread section running circumferentially around a tire

Tire related term	Meaning
Tread separation	Pulling away of the tread from the tire carcass
Treadwear indicators (TWI)	The projections within the principal grooves designed to give a visual indication of the degrees of wear of the tread
Wheel-holding fixture	The fixture used to hold the wheel and tire assembly securely during testing

\*:Table 1 — Occupant loading and distribution for vehicle normal load for various designated seating capacities

Designated seating capacity, Number of occupants	Vehicle normal load, Number of occupants	Occupant distribution in a normally loaded vehicle
2 through 4	2	2 in front
5 through 10	3	2 in front, 1 in second seat
11 through 15	5	2 in front, 1 in second seat, 1 in third seat, 1 in fourth seat
16 through 20	7	2 in front, 2 in second seat, 2 in third seat, 1 in fourth seat

## Customizable features

**Your vehicle includes a variety of electronic features that can be personalized to suit your preferences. Programming these preferences requires specialized equipment and may be performed by your Toyota dealer.**

Some function settings are changed simultaneously with other functions being customized. Contact your Toyota dealer for further details.

### Customizable features

- 1** Vehicles with a Display Audio system: Settings that can be changed using the Display Audio system  
(For further information on customizing settings using the “Display Audio”, refer to the “Display Audio System Owner’s Manual”.)
  - 2** Vehicles with a navigation system: Settings that can be changed using the navigation system  
(For further information on customizing settings using the navigation system, refer to the “Navigation System Owner’s Manual”.)
  - 3** Settings that can be changed by your Toyota dealer
- Definition of symbols: O = Available, — = Not available

Item	Function	Default setting	Customized setting	1	2	3
Smart key system (→P. 61)	Smart key system	ON	OFF	○	○	○
	Select doors to unlock	Driver's door	All doors	○	○	○
Wireless remote control (→P. 85)	Wireless remote control	ON	OFF	–	–	○
	Unlocking operation	Driver's door unlocked in 1-step, all doors unlocked in 2-step	All doors unlocked in 1-step	○	○	○
	Panic function	ON	OFF	–	–	○
	Buzzer sounds when pushing  with any door not closed	ON	OFF	–	–	○

Item	Function	Default setting	Customized setting	1	2	3
Smart key system (→P. 61) and wireless remote control (→P. 85)	Operation signals (Emergency flashers)	ON	OFF	–	○	○
	Operation signals (Buzzers)	Level 7	Level 1 to 6	○	○	○
			OFF			
	Time elapsed before automatic door lock function is activated if door is not opened after being unlocked	60 seconds	OFF	–	○	○
			30 seconds			
			120 seconds			



Item	Function	Default setting	Customized setting	1	2	3
Door lock (→P. 87, 541)	Unlocking using a key	Driver's door unlocked in 1-step, all doors unlocked in 2-step	All doors unlocked in 1-step	–	○	○
	Speed-detecting automatic door lock function	OFF	ON	○	○	○
	Shifting the shift position to any position other than P locks all doors	ON	OFF	○	○	○
	Shifting the shift position to P unlocks all doors	ON	OFF	○	○	○
	Opening driver's door unlocks all doors	OFF	ON	–	○	○
Automatic light control system (→P. 250)	Light sensor sensitivity	Level 3	Levels 1 to 5	○	○	○
	Time elapsed before headlights automatically turn off after doors are closed	30 seconds	0 seconds	○	○	○
			60 seconds			
			90 seconds			
Daytime running lights*	ON	OFF	○	○	○	

\*: This function cannot be customized for vehicles sold in Canada.

Item	Function	Default setting	Customized setting	1	2	3
Power windows (→P. 123)	The one-touch closing operation except for driver's seat	ON	OFF	–	–	○
Illumination (→P. 353)	Time elapsed before lights turn off	15 seconds	OFF	–	○	○
			7.5 seconds			
			30 seconds			
	Operation when the doors are unlocked*	ON	OFF	–	○	○
	Operation after the "POWER" switch turned OFF*	ON	OFF	–	○	○
	Operation when you approach the vehicle with the electric key on your person (When the personal/interior light main switch is door position)*	ON	OFF	–	○	○
	Foot lights	ON	OFF	–	–	○
Foot lights operation when the vehicle is running	ON	OFF	–	–	○	

\*: When the customized settings are changed using the navigation system, these functions will be changed between ON and OFF simultaneously.

Item	Function	Default setting	Customized setting	1	2	3
Meter and instrument panel (→P. 214)	Sensor sensitivity for darkening the brightness of the meter, navigation system and instrument panel depending on the outside brightness	0	-2 to +2	-	-	0
	Sensor sensitivity for returning the brightness of the meter, navigation system and instrument panel to the original level depending on the outside brightness	0	-2 to +2	-	-	0
Automatic air conditioning system (→P. 326)	Enable/disable automatic operation of the air conditioning compressor when the "AUTO" switch ON	ON	OFF	-	0	0
	Heating/cooling operation minimized in Eco drive mode	ON	OFF	-	-	0

Item	Function	Default setting	Customized setting	1	2	3
Remote Air Conditioning System (→P. 342)	Operation using the "A/C" button on the wireless remote control	Push and hold for 0.8 seconds	Push once	-	-	O
			Push twice			
			Push and hold for 2.4 seconds			
			OFF			
	Stopping the operation using the "A/C" button on the wireless remote control	Push twice	Push once	-	-	O
			Push and hold for 0.8 seconds			
			Push and hold for 2.4 seconds			
			OFF			
Reverse warning buzzer (→P. 207)	Operation signals (Buzzer) when shifting into R	Beeps repeatedly	Beeps once	-	-	O
Seat belt reminder (→P. 500)	Vehicle speed linked seat belt reminder buzzer	ON	OFF	-	-	O

**Multi-information display (→P. 223)**

Available languages	English, French and Spanish
---------------------	-----------------------------

## Items to initialize

**The following items must be initialized for normal system operation after such cases as the 12-volt battery being reconnected, or maintenance being performed on the vehicle.**

Item	When to initialize	Reference
Maintenance data	After the maintenance is performed	P. 403
Tire pressure warning system	<ul style="list-style-type: none"> <li>• When rotating the tires on vehicles with differing front and rear tire inflation pressures</li> <li>• When changing the tire size</li> </ul>	P. 439



## Reporting safety defects for U.S. owners

If you believe that your vehicle has a defect which could cause a crash or could cause injury or death, you should immediately inform the National Highway Traffic Safety Administration (NHTSA) in addition to notifying Toyota Motor Sales, U.S.A., Inc. (Toll-free: 1-800-331-4331).

If NHTSA receives similar complaints, it may open an investigation, and if it finds that a safety defect exists in a group of vehicles, it may order a recall and remedy campaign. However, NHTSA cannot become involved in individual problems between you, your dealer, or Toyota Motor Sales, U.S.A., Inc.

To contact NHTSA, you may call the Vehicle Safety Hotline toll-free at 1-888-327-4236 (TTY: 1-800-424-9153); go to <http://www.safercar.gov>; or write to: Administrator, NHTSA, 1200 New Jersey Ave, S.E., Washington, DC 20590. You can also obtain other information about motor vehicle safety from <http://www.safercar.gov>.

The following is a French explanation of seat belt instructions extracted from the seat belt section in this manual.

See the seat belt section for more detailed seat belt instructions in English.

## Utilisation adéquate des ceintures de sécurité

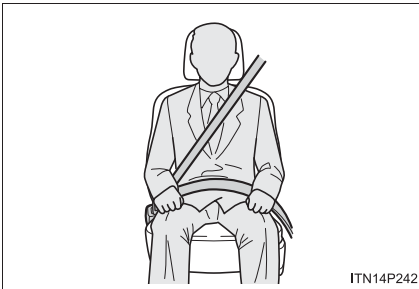

- Tirez sur la ceinture épaulière jusqu'à ce qu'elle recouvre entièrement l'épaule; elle ne doit cependant pas toucher le cou ni glisser de l'épaule.
- Placez la ceinture abdominale le plus bas possible sur les hanches.
- Réglez la position du dossier. Tenez-vous assis bien au fond du siège, le dos droit.
- Ne vrillez pas la ceinture de sécurité.



## Entretien et nettoyage

### ■ Ceintures de sécurité

Avec un chiffon ou une éponge, nettoyez à l'aide d'un savon doux et de l'eau tiède. Vérifiez aussi les ceintures régulièrement pour vous assurer qu'elles ne présentent pas d'usure excessive, d'effilochage ou de coupures.

### ATTENTION

#### ■ Dommages et usure de la ceinture de sécurité

Vérifiez périodiquement le système de ceintures de sécurité. Assurez-vous qu'il n'y a pas de coupures, d'effilochures ni de pièces desserrées. N'utilisez pas une ceinture de sécurité endommagée avant qu'elle soit remplacée. Les ceintures de sécurité endommagées ne peuvent pas protéger les occupants contre les blessures graves, voire mortelles.

The following is a French explanation of SRS airbag instructions extracted from the SRS airbag section in this manual.

See the SRS airbag section for more detailed SRS airbag instructions in English.

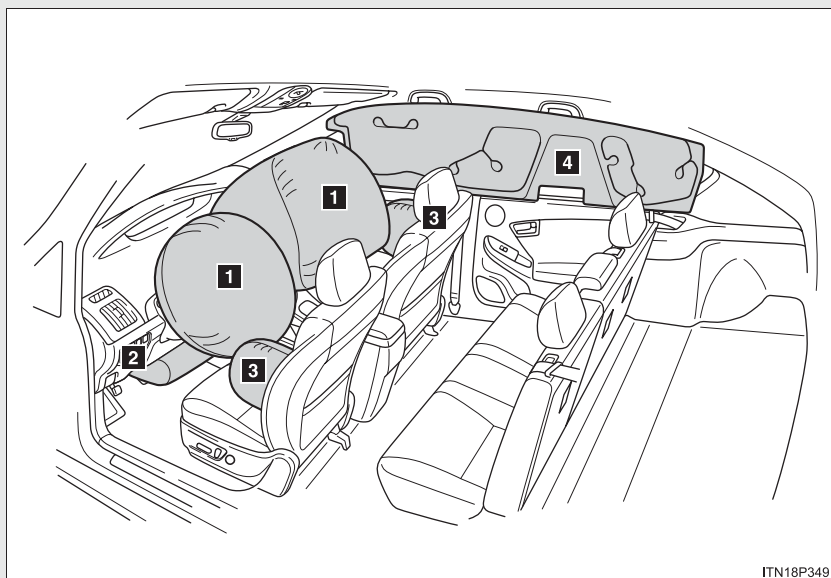

ITN18P349

## Coussins gonflables SRS avant

- 1** Coussin gonflable SRS du conducteur/du passager avant  
Peuvent aider à protéger la tête et la poitrine du conducteur et du passager avant contre les impacts avec des composants intérieurs
- 2** Coussin gonflable SRS de protection des genoux  
Peut aider à protéger le conducteur

## **Coussins gonflables SRS latéraux et en rideau**

### **3** Coussins gonflables SRS latéraux

Peuvent aider à protéger le torse des occupants des sièges avant

### **4** Coussins gonflables SRS en rideau

Peuvent aider à protéger principalement la tête des occupants des sièges latéraux

## Composants du système de coussins gonflables SRS

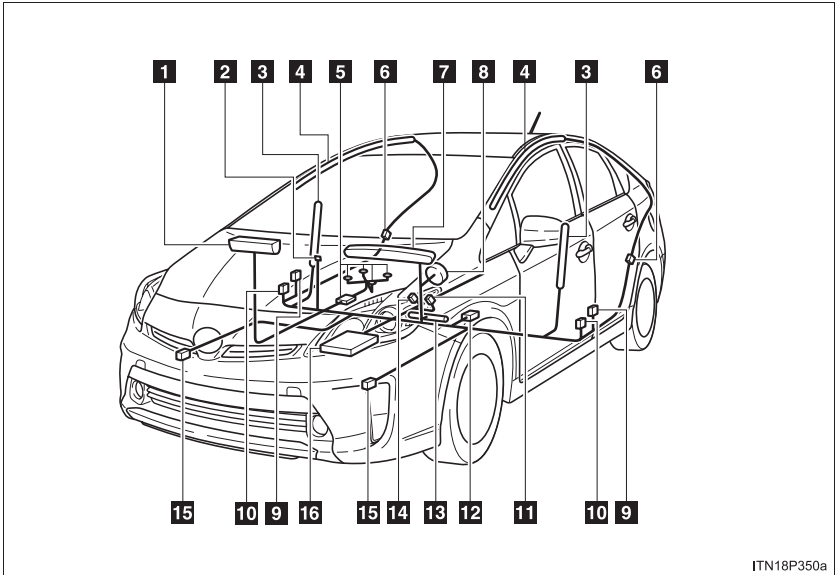

ITN18P350a

- |                                                                                               |                                                                                  |
|-----------------------------------------------------------------------------------------------|----------------------------------------------------------------------------------|
| <b>1</b> Coussin gonflable du passager avant                                                  | <b>10</b> Dispositifs de tension et limiteurs de force des ceintures de sécurité |
| <b>2</b> Lampes témoins “AIR BAG ON” et “AIR BAG OFF”                                         | <b>11</b> Contacteur de boucle de ceinture de sécurité du conducteur             |
| <b>3</b> Coussins gonflables latéraux                                                         | <b>12</b> Capteur de position de siège du conducteur                             |
| <b>4</b> Coussins gonflables en rideau                                                        | <b>13</b> Coussin gonflable de protection des genoux du conducteur               |
| <b>5</b> Système de classification de l’occupant du siège du passager avant (ECU et capteurs) | <b>14</b> Contacteur de boucle de ceinture de sécurité du passager avant         |
| <b>6</b> Capteurs de choc latéral (arrière)                                                   | <b>15</b> Capteurs de choc avant                                                 |
| <b>7</b> Lampe témoin SRS                                                                     | <b>16</b> Module de capteur de coussin gonflable                                 |
| <b>8</b> Coussin gonflable du conducteur                                                      |                                                                                  |
| <b>9</b> Capteurs de choc latéral (avant)                                                     |                                                                                  |

Votre véhicule est doté de COUSSINS GONFLABLES ÉVOLUÉS dont la conception s'appuie sur les normes de sécurité des véhicules à moteur américains (FMVSS208). Le module de capteur de coussin gonflable (ECU) contrôle le déploiement des coussins gonflables en fonction des informations obtenues des capteurs et d'autres éléments affichés dans le diagramme des composants du système ci-dessus. Ces informations comprennent des données relatives à la gravité de l'impact et aux passagers. Au moment du déploiement des coussins gonflables, une réaction chimique se produit dans les gonfleurs et les coussins gonflables se remplissent rapidement d'un gaz non toxique pour limiter le mouvement des occupants.

## ATTENTION

### ■ Précautions relatives aux coussins gonflables SRS

Observez les précautions suivantes en ce qui concerne les coussins gonflables SRS.

Les négliger pourrait occasionner des blessures graves, voire mortelles.

- Le conducteur et tous les passagers du véhicule doivent porter leur ceinture de sécurité de la manière appropriée.

Les coussins gonflables SRS sont des dispositifs supplémentaires qui doivent être utilisés de concert avec les ceintures de sécurité.

- Le coussin gonflable SRS du conducteur se déploie avec une force considérable et peut occasionner des blessures graves, voire mortelles, notamment lorsque le conducteur se trouve très près du coussin gonflable. La National Highway Traffic Safety Administration (NHTSA), aux États-Unis, donne les recommandations suivantes:

La zone à risque d'un coussin gonflable côté conducteur couvre 2 à 3 in. (50 à 75 mm) de la zone de déploiement du coussin gonflable. Pour assurer une marge de sécurité suffisante, restez à 10 in. (250 mm) du coussin gonflable. Cette distance est mesurée depuis le centre du volant jusqu'à votre sternum. Si vous vous tenez à moins de 10 in. (250 mm), vous pouvez changer votre position de conduite de plusieurs manières:

- Reculez votre siège à la position maximale vous permettant d'atteindre encore aisément les pédales.
- Inclinez légèrement le dossier du siège.

Même si les véhicules sont conçus différemment, la plupart des conducteurs peuvent maintenir une distance de 10 in. (250 mm), même si le siège se trouve complètement vers l'avant, simplement en inclinant un peu le dossier du siège vers l'arrière. Si la visibilité avant est moindre après avoir incliné le dossier du siège, utilisez un coussin ferme et non glissant pour être assis plus haut ou relevez le siège si cette option est disponible sur votre véhicule.

- Si votre volant est réglable en hauteur, inclinez-le vers le bas. Cela vous permet d'orienter le coussin gonflable vers votre buste plutôt que vers la tête et vers le cou.

Le siège doit être réglé de la manière recommandée ci-dessus par la NHTSA, tout en gardant le contrôle des pédales et du volant, et la vue sur les commandes du bloc d'instrumentation.

## ⚠ ATTENTION

### ■ Précautions relatives aux coussins gonflables SRS

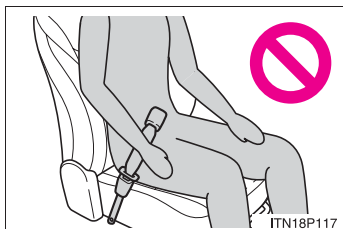

- Si la rallonge de ceinture de sécurité a été reliée à la boucle des ceintures de sécurité des sièges avant sans avoir été attachée à la plaque de blocage des ceintures de sécurité, les coussins gonflables SRS avant considéreront que le conducteur et le passager avant portent tout de même leur ceinture même si elles ne sont pas attachées. Les coussins gonflables SRS avant peuvent alors ne pas s'activer correctement lors d'une collision, ce qui représente un risque de blessures graves, voire mortelles. Bouclez toujours votre ceinture de sécurité lorsque vous utilisez la rallonge.
- Le coussin gonflable SRS du passager avant se déploie également avec une force considérable et peut occasionner des blessures graves, voire mortelles, notamment lorsque le passager avant se trouve très près du coussin gonflable. Le siège du passager avant doit se trouver le plus loin possible du coussin gonflable et le dossier doit être réglé de manière à ce que le passager avant soit assis bien droit.

 ATTENTION

■ **Précautions relatives aux coussins gonflables SRS**

- Le déploiement d'un coussin gonflable risque d'infliger des blessures graves, voire mortelles, aux bébés et aux enfants mal assis ou mal attachés. Un bébé ou un enfant trop petit pour utiliser une ceinture de sécurité doit être correctement retenu à l'aide d'un dispositif de retenue pour enfants. Toyota recommande vivement d'installer et d'attacher correctement les bébés et les enfants sur les sièges arrière du véhicule à l'aide d'un dispositif de retenue adapté. Les sièges arrière sont plus sécuritaires pour les bébés et les enfants que le siège du passager avant.
- N'installez jamais un dispositif de retenue pour enfants de type dos à la route sur le siège du passager avant, même si la lampe témoin "AIR BAG OFF" est allumée. En cas d'accident, la force et la vitesse de déploiement du coussin gonflable du passager avant sont telles qu'elles pourraient infliger à l'enfant des blessures graves, voire mortelles, si le dispositif de retenue pour enfants du type dos à la route était installé sur le siège du passager avant.



## ATTENTION

### ■ Précautions relatives aux coussins gonflables SRS

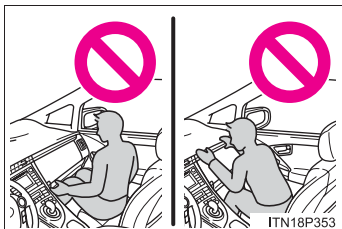

- Ne vous asseyez pas sur le bord du siège et ne vous appuyez pas sur le tableau de bord.

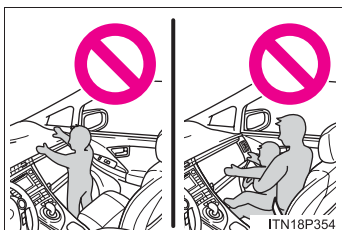

- Ne laissez pas un enfant se tenir face au coussin gonflable SRS du passager avant ni s'asseoir sur les genoux d'un passager avant.
- Ne laissez pas les occupants du siège avant tenir des objets sur leurs genoux.



- Ne vous appuyez pas sur la portière ou sur le longeron du toit, ni sur les montants avant, latéraux ou arrière.



- Ne laissez personne s'agenouiller face à la portière sur le siège du passager ou sortir la tête ou les mains à l'extérieur du véhicule.

## ! ATTENTION

### ■ Précautions relatives aux coussins gonflables SRS

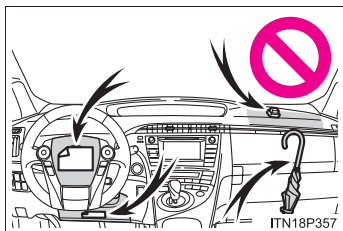

- Ne fixez et n'appuyez rien sur des zones telles que le tableau de bord, le centre de volant ou encore la partie inférieure du bloc d'instrumentation. Ces objets peuvent se transformer en projectiles lorsque les coussins gonflables SRS du conducteur, du passager avant ou de protection des genoux se déploient.



- Ne fixez rien sur les portières, le pare-brise, les glaces latérales, les montants avant ou arrière, le longeron du toit et la poignée de maintien.

- N'accrochez pas de cintres ni d'objets rigides sur les crochets porte-vêtements. Tous ces objets pourraient se transformer en projectiles et vous occasionner des blessures graves, voire mortelles, en cas de déploiement des coussins gonflables SRS en rideau.
- Si un recouvrement de vinyle est placé sur la zone de déploiement des coussins gonflables SRS de protection des genoux, veillez à le retirer.
- N'utilisez pas d'accessoires recouvrant les parties du siège où les coussins gonflables SRS latéraux se déploient, car ceux-ci pourraient nuire au déploiement de ces coussins. De tels accessoires peuvent empêcher les coussins gonflables latéraux de se déployer correctement, rendre le système inopérant ou provoquer accidentellement le déploiement des coussins gonflables latéraux, occasionnant des blessures graves, voire mortelles.

## ATTENTION

### ■ Précautions relatives aux coussins gonflables SRS

- Ne frappez pas et n'appliquez pas une pression importante à l'emplacement des composants de coussins gonflables SRS.  
Vous risqueriez de provoquer un mauvais fonctionnement des coussins gonflables SRS.
- Ne touchez à aucun composant des coussins gonflables SRS immédiatement après leur déploiement (gonflage), car ils pourraient être chauds.
- Si vous avez de la difficulté à respirer après le déploiement des coussins gonflables SRS, ouvrez une portière ou une glace pour laisser entrer l'air, ou quittez le véhicule si vous pouvez le faire en toute sécurité. Dès que possible, nettoyez tous les résidus afin d'éviter les irritations cutanées.
- Si les emplacements de stockage des coussins gonflables SRS, notamment le tampon de volant et les garnitures des montants avant et arrière, sont endommagés ou fissurés, faites-les remplacer par votre concessionnaire Toyota.
- Ne placez aucun objet, par exemple un coussin, sur le siège du passager avant. Un tel objet fausserait les données sur le poids du passager enregistrées par le capteur. Cela pourrait empêcher le déploiement du coussin gonflable SRS du passager avant en cas de collision.

## ATTENTION

### ■ **Modification et mise au rebut des composants du système de coussins gonflables SRS**

Ne mettez pas le véhicule au rebut et n'effectuez aucune des modifications suivantes sans d'abord consulter votre concessionnaire Toyota. Les coussins gonflables SRS pourraient fonctionner de manière incorrecte ou se déployer (gonfler) accidentellement, ce qui serait susceptible d'occasionner des blessures graves, voire mortelles.

- Installation, retrait, démontage et réparation des coussins gonflables SRS
- Réparations, modifications, retrait ou remplacement du volant, du bloc d'instrumentation, du tableau de bord, des sièges ou du capitonnage des sièges, des montants avant, latéraux ou arrière et des longerons du toit
- Réparations ou modifications de l'aile ou du pare-chocs avant, ou du côté de l'habitacle
- Installation de lames de déneigement, de treuils, etc. sur la calandre avant (barre safari, barre kangourou, etc.)
- Modifications du système de suspension du véhicule
- Installation d'appareils électroniques tels qu'un émetteur-récepteur radio ou un lecteur de CD
- Modifications à votre véhicule pour une personne aux capacités physiques réduites



**A**

**A/C**

Automatic air conditioning  
system ..... 326

**ABS** ..... 296

**Active head restraint** ..... 100

**Air conditioning system**

Automatic air conditioning  
system ..... 326

Remote Air Conditioning  
System ..... 342

Steering wheel climate  
remote control switches ..... 337

**Airbags**

Airbag operating  
conditions ..... 144

Airbag precautions for your  
child ..... 148

Airbag warning light ..... 495  
Curtain shield airbag operating  
conditions ..... 144

Curtain shield airbag  
precautions ..... 148

Front passenger occupant  
classification system ..... 154

General airbag precautions... 148

Knee airbag ..... 140

Locations of airbags ..... 140

Modification and disposal of  
airbags ..... 153

Proper driving posture ..... 138

Side airbag operating  
conditions ..... 144

Side airbag precautions ..... 148

Side and curtain shield airbags  
operating conditions ..... 144

Side and curtain shield airbags  
precautions ..... 148

SRS airbags ..... 140

SRS airbag instructions for  
Canadian owners ..... 603

**Antenna** ..... 398

**Anti-lock brake system** ..... 296

**Armrest** ..... 371

**Audio input** \* ..... 352

**Audio remote control  
switches** \*

**Audio system** \*

**Audio/video system** \*

**Automatic air conditioning  
system**

Air conditioning system ..... 326

Automatic air conditioning  
system ..... 326

Remote Air Conditioning  
System ..... 342

Steering wheel climate  
remote control switches ..... 337

**Automatic headlight leveling  
system** ..... 255

**Automatic light control  
system** ..... 250

**AUX port** \* ..... 352

**Auxiliary box** ..... 363, 376

**B**

**Back door**  
 Back door ..... 93  
 Smart key system ..... 61  
 Wireless remote control ..... 85

**Back-up lights**  
 Replacing light bulbs ..... 467  
 Wattage ..... 570

**Battery**  
 Checking ..... 431  
 If the 12-volt battery is  
 discharged ..... 543  
 Preparing and checking  
 before winter ..... 317

**Bluetooth®\***

**Bottle holders ..... 362**

**Brake**  
 Fluid ..... 568  
 Parking brake ..... 212

**Brake assist ..... 296**

**Break-in tips ..... 181**

**Brightness control**  
 Instrument panel light  
 control ..... 217

**C**

**Camera\***

**Care**  
 Exterior ..... 396  
 Interior ..... 399  
 Seat belts ..... 400

**Cargo capacity ..... 316**

**Cargo hooks ..... 374**

**CD player\***

**Chains ..... 319**

**Child restraint system**  
 Booster seats, definition ..... 160  
 Booster seats, installation ..... 168  
 Convertible seats,  
 definition ..... 160  
 Convertible seats,  
 installation ..... 168  
 Front passenger occupant  
 classification system ..... 154  
 Infant seats, definition ..... 160  
 Infant seats, installation ..... 168  
 Installing child restraint system  
 with LATCH anchors ..... 166  
 Installing child restraint system  
 with seat belts ..... 168  
 Installing child restraint system  
 with top tether strap ..... 172

\*: Refer to “Display Audio System Owner’s Manual” or “Navigation System Owner’s Manual”.

**Child safety**  
 Airbag precautions ..... 148  
 Back door precautions ..... 95  
 Child restraint system..... 160  
 Child-protectors.....88  
 How your child should wear  
 the seat belt ..... 111  
 Installing child restraints..... 165  
 Power window lock switch.... 123  
 Power window precautions ... 125  
 Removed electronic key battery  
 precautions ..... 455  
 Seat belt extender  
 precautions ..... 116  
 Seat belt precautions ..... 112  
 Seat heater precautions.....370  
 12-volt battery precautions... 434  
**Child-protectors .....88**  
**Cleaning**  
 Exterior.....396  
 Interior.....399  
 Seat belts ..... 400  
**Clock .....230**  
**Condenser .....426**  
**Console box .....359**  
**Cooling system**  
 Engine overheating ..... 549  
 Hybrid system overheating.... 549  
**Cruise control**  
 Cruise control.....266  
 Dynamic radar cruise  
 control .....270  
**Cup holders .....360**  
**Curtain shield airbags ..... 140**  
**Customizable features.....590**

**D** **Daytime running light  
 system ..... 253**  
**Deck board ..... 374**  
**Defogger**  
 Rear window ..... 346  
 Side mirrors..... 346  
**Dimensions .....560**  
**Dinghy towing ..... 323**  
**Display**  
 Dynamic radar cruise  
 control.....270  
 Multi-information ..... 223  
 Warning messages ..... 507  
**Do-it-yourself maintenance .... 410**  
**Door lock**  
 Back door..... 93  
 Side doors..... 87  
 Smart key system ..... 61  
 Wireless remote control ..... 85  
**Doors**  
 Back door..... 93  
 Door glasses ..... 123  
 Door lock..... 61, 85, 87  
 Rear door child-protector ..... 88  
 Side doors..... 87  
**Driver's seat belt reminder  
 light..... 498**  
**Driving**  
 Break-in tips ..... 181  
 Correct posture ..... 138  
 Procedures..... 180  
 Winter driving tips ..... 317



<b>E</b>	<b>Eco drive mode switch</b> .....	<b>204</b>
	<b>Electric power steering</b> .....	<b>296</b>
	<b>Electronic key</b>	
	If the electronic key does not operate properly.....	541
	Replacing battery .....	454
	<b>Emergency, in case of</b>	
	If a warning buzzer sounds .....	493
	If a warning light turns on .....	493
	If the electronic key does not operate properly.....	541
	If the hybrid system will not start.....	538
	If the 12-volt battery is discharged .....	543
	If you have a flat tire .....	523
	If you lose your keys.....	540
	If you think something is wrong .....	492
	If your vehicle becomes stuck.....	554
	If your vehicle has to be stopped in an emergency .....	556
	If your vehicle needs to be towed .....	485
	If your vehicle overheats .....	549
	<b>Emergency flashers</b>	
	Switch.....	484

<b>Engine</b>	
Accessory mode.....	194
Compartment .....	419
Hood.....	413
How to start the hybrid system .....	192
Identification number.....	561
If the hybrid system will not start.....	538
Ignition switch.....	192
Overheating.....	549
“POWER” switch .....	192
<b>Engine coolant</b>	
Capacity .....	566
Checking .....	424
Preparing and checking before winter .....	317
<b>Engine/power control unit coolant</b>	
Capacity .....	566
Checking .....	424
Preparing and checking before winter .....	317
<b>Engine oil</b>	
Capacity .....	563
Checking .....	420
Preparing and checking before winter .....	317
<b>Enhanced VSC</b> .....	<b>296</b>
<b>EPS</b> .....	<b>296</b>
<b>EV drive mode switch</b> .....	<b>199</b>
<b>Event data recorder</b> .....	<b>25</b>

<b>F</b>	<b>Floor mats</b> .....	<b>372</b>
	<b>Fluid</b>	
	Brake.....	568
	Washer.....	429
	<b>Fog lights</b>	
	Replacing light bulbs.....	467
	Switch.....	256
	Wattage.....	570
	<b>Foot lights</b> .....	<b>353</b>
	<b>Front fog lights</b>	
	Replacing light bulbs.....	467
	Switch.....	256
	Wattage.....	570
	<b>Front passenger occupant classification system</b> .....	<b>154</b>
	<b>Front passenger's seat belt reminder light</b> .....	<b>498</b>
	<b>Front seats</b>	
	Adjustment.....	99
	<b>Front side marker light</b>	
	Replacing light bulbs.....	467
	Wattage.....	570
	<b>Front turn signal lights</b>	
	Replacing light bulbs.....	467
	Switch.....	211
	Wattage.....	570
	<b>Fuel</b>	
	Capacity.....	562
	Fuel gauge.....	214
	Information.....	571
	Refueling.....	131
	Type.....	571
	<b>Fuel door</b> .....	<b>131</b>
	<b>Fuel filler door</b> .....	<b>131</b>
	<b>Fuses</b> .....	<b>456</b>

<b>G</b>	<b>Garage door opener</b> .....	<b>380</b>
	<b>Gauges</b> .....	<b>214</b>
	<b>Glove boxes</b> .....	<b>358</b>
<b>H</b>	<b>Hands-free system (for cellular phone)*</b>	
	<b>Hazard lights</b>	
	Switch.....	484
	<b>Head restraints</b>	
	Adjustment.....	105
	<b>Headlight cleaner</b> .....	<b>265</b>
	<b>Headlights</b>	
	Cleaner.....	265
	Replacing light bulbs.....	467
	Switch.....	250
	Wattage.....	570
	<b>Heaters</b>	
	Automatic air conditioning system.....	326
	Seat heaters.....	369
	Side mirrors.....	346
	<b>Hill-start assist control</b> .....	<b>301</b>
	<b>Hood</b> .....	<b>413</b>
	<b>Hooks</b>	
	Cargo.....	374
	<b>Horn</b> .....	<b>213</b>
	<b>Hybrid system</b>	
	Eco savings record.....	53
	Emergency shut off system.....	37
	Energy monitor/ consumption screen.....	42
	High voltage components.....	36
	Hybrid System Indicator.....	225
	Ignition switch.....	192
	Monthly fuel consumption record.....	53
	"POWER" switch.....	192

<b>I</b>	<b>I/M test</b> .....	<b>409</b>
	<b>Identification</b>	
	Engine .....	562
	Vehicle.....	561
	<b>Ignition switch</b> .....	<b>192</b>
	<b>Illuminated entry system</b> .....	<b>353</b>
	<b>Immobilizer system</b> .....	<b>135</b>
	<b>Indicator lights</b> .....	<b>219</b>
	<b>Initialization</b>	
	Items to initialize.....	597
	<b>Inside rear view mirror</b> .....	<b>118</b>
	<b>Instrument panel light control</b> .....	<b>217</b>
	<b>Interior lights</b>	
	Interior lights.....	354, 355
	Switch.....	354, 355
	Wattage .....	570
<b>J</b>	<b>Jack</b>	
	Positioning a floor jack .....	416
	Vehicle-equipped jack .....	523
	<b>Jack handle</b> .....	<b>523</b>
<b>K</b>	<b>Keyless entry</b> .....	<b>85</b>
	<b>Keys</b>	
	Electronic key .....	58
	If the electronic key does not operate properly.....	541
	If you lose your keys.....	540
	Key number .....	58
	Keyless entry.....	85
	Keys .....	58
	Mechanical key.....	58
	“POWER” switch .....	192
	Wireless remote control key.....	85
	<b>Knee airbag</b> .....	<b>140</b>

<b>L</b>	<b>Lane-Keeping Assist</b> .....	<b>286</b>
	<b>Language</b> .....	<b>238</b>
	<b>License plate lights</b>	
	Replacing light bulbs .....	467
	Wattage.....	570
	<b>Light bulbs</b>	
	Replacing .....	467
	Wattage.....	570
	<b>Lights</b>	
	Emergency flasher switch .....	484
	Fog light switch .....	256
	Foot lights.....	353
	Hazard light switch .....	484
	Headlight switch .....	250
	Interior lights.....	354, 355
	Personal lights.....	355
	Replacing light bulbs .....	467
	Shift lever lighting.....	353
	Turn signal lever.....	211
	Turn signal light switch.....	211
	Vanity lights.....	365
	Wattage.....	570
	<b>LKA</b> .....	<b>286</b>
	<b>Load capacity</b> .....	<b>316</b>
	<b>Luggage compartment light</b>	
	Switch.....	94
	Wattage.....	570
	<b>Luggage cover</b> .....	<b>377</b>

\*: Refer to “Display Audio System Owner’s Manual” or “Navigation System Owner’s Manual”.

<b>M</b>	<b>Maintenance</b>	
	Do-it-yourself	
	maintenance .....	410
	General maintenance.....	405
	Maintenance data.....	560
	Maintenance requirements....	402
	<b>Maintenance data.....</b>	<b>403</b>
	<b>Meter</b>	
	Instrument panel light	
	control.....	217
	Meters .....	214
	Speed unit select button.....	216
	Trip information display.....	229
	<b>Micro dust and pollen filter.....</b>	<b>330</b>
	<b>Microphone *</b> .....	<b>388</b>
	<b>Mirrors</b>	
	Inside rear view mirror.....	118
	Side mirror heater .....	346
	Side mirrors.....	121
	Vanity mirrors.....	365
	<b>MP3 disc*</b>	
	<b>Multi-information display .....</b>	<b>223</b>
<b>N</b>	<b>Navigation system</b>	
	(refer to “Navigation	
	System Owner’s Manual”)	
	<b>Noise from under vehicle.....</b>	<b>22</b>
<b>O</b>	<b>Odometer .....</b>	<b>214</b>
	<b>Oil</b>	
	Engine oil .....	420
	<b>Opener</b>	
	Back door.....	93
	Fuel filler door .....	131
	Hood.....	413
	<b>Outside rear view mirrors</b>	
	Adjusting and folding.....	121
	<b>Outside rear view mirror</b>	
	defogger switch .....	346

	<b>Outside temperature</b>	
	display .....	366
	<b>Overheating.....</b>	<b>549</b>
<b>P</b>	<b>Parking brake.....</b>	<b>212</b>
	<b>Parking lights</b>	
	Switch .....	250
	<b>PCS .....</b>	<b>303</b>
	<b>Personal lights</b>	
	Switch .....	355
	Wattage.....	570
	<b>Power outlets .....</b>	<b>367</b>
	<b>“POWER” switch .....</b>	<b>192</b>
	<b>Power windows.....</b>	<b>123</b>
	<b>Pre-collision system.....</b>	<b>303</b>

<b>R</b>	<b>Radar cruise control</b>	
	system .....	270
	<b>Radiator .....</b>	<b>426</b>
	<b>Radio*</b>	
	<b>Radio data system*</b>	
	<b>RDS*</b>	
	<b>Rear seats</b>	
	Adjustment.....	102
	Folding down.....	103
	<b>Rear turn signal lights</b>	
	Replacing light bulbs.....	467
	Wattage.....	570
	<b>Rear view mirror .....</b>	<b>118, 121</b>
	<b>Rear view monitor system*</b>	
	<b>Rear window and outside</b>	
	rear view mirror	
	defoggers .....	346
	<b>Rear window wiper and</b>	
	washer .....	262
	<b>Remote Air Conditioning</b>	
	System.....	342

**Replacing**

- Electronic key battery ..... 454
- Fuses..... 456
- Light bulbs ..... 467
- Tires ..... 523

**Reporting safety defects for**

- U.S. owners ..... 600**

**S**

- Safety Connect ..... 388**

- Seat belt reminder light ..... 498**

**Seat belts**

- Adjusting the seat belt ..... 110
- Automatic Locking Retractor (ALR) ..... 111
- Child restraint system
  - installation ..... 165
- Cleaning and maintaining
  - the seat belt ..... 400
- Emergency Locking Retractor (ELR) ..... 111
- How to wear your
  - seat belt ..... 109
- How your child should wear
  - the seat belt ..... 111
- Pre-collision seat belts ..... 303
- Pregnant women,
  - proper seat belt use ..... 113
- Reminder light ..... 498
- Seat belt extenders ..... 112
- Seat belt instructions
  - for Canadian owners..... 601
  - Seat belt pretensioners ..... 110

- Seat heaters ..... 369**

- Seating capacity ..... 316**

**Seats**

- Adjustment .....99, 102
- Adjustment
  - precautions .....101, 104
- Child seats/child restraint
  - system installation .....165
- Cleaning .....399
- Folding down the
  - seatbacks..... 103
- Head restraint..... 105
- Properly sitting in the seat..... 138
- Seat heaters.....369

**Service reminder**

- indicators .....219**

**Shift lever**

- Transmission.....202

- Side airbags.....140**

**Side marker lights**

- Replacing light bulbs .....467
- Switch.....250
- Wattage.....570

**Side mirrors**

- Adjusting and folding..... 121

**Smart key system**

- Antenna location .....64
- Entry functions .....61
- Starting the hybrid system..... 192

- Solar Ventilation System.....339**

- SOS button .....388**

**Spare tire**

- Inflation pressure.....569
- Storage location .....523

- Spark plug .....566**

- Specifications.....560**

- Speedometer .....214**

\*: Refer to “Display Audio System Owner’s Manual” or “Navigation System Owner’s Manual”.

**Steering wheel**  
 Adjustment ..... 117  
 Audio switches\*

**Storage feature.....357**

**Stuck**  
 If your vehicle becomes  
 stuck .....554

**Sun visors.....364**

**Switch**  
 Audio remote control switches\*  
 Cruise control switch .....266  
 Driving mode select  
 switch.....204  
 Eco drive mode switch .....204  
 Emergency flasher switch .....484  
 EV drive mode switch.....199  
 Fog light switch .....256  
 Hazard light switch .....484  
 Headlight cleaner switch .....265  
 Ignition switch.....192  
 Light switches.....250  
 Power door lock switch .....87  
 "POWER" switch .....192  
 Power window switch .....123  
 Pre-collision braking off  
 switch.....304  
 Talk switch\*  
 Telephone switch\*  
 Ventilation switch .....339  
 Window lock switch.....123  
 Wipers and washer switch ....258

**T**

**Tail lights**  
 Switch .....250

**Talk switch\***

**Telephone switch\***

**Theft deterrent system**  
 Immobilizer system .....135

**Theft prevention labels .....137**

**Tire inflation pressure .....447**

**Tire information**  
 Glossary.....582  
 Size .....578  
 Tire identification number.....577  
 Uniform Tire Quality  
 Grading.....580

**Tires**  
 Chains.....319  
 Checking .....437  
 If you have a flat tire.....523  
 Inflation pressure .....447  
 Inflation pressure sensor.....438  
 Information .....575  
 Replacing .....523  
 Rotating tires.....437  
 Size .....569  
 Snow tires .....317  
 Spare tire .....523  
 Tire pressure warning  
 system .....437, 499

**Tonneau cover**..... 377

**Tools**..... 523

**Touch tracer display** ..... 215

**Total load capacity**..... 316

**Towing**

    Dinghy towing..... 323

    Emergency towing..... 486

    Trailer towing..... 322

**TRAC** ..... 296

**Traction control**..... 296

**Trailer towing**..... 322

**Transmission**

    Hybrid transmission..... 202

    P position switch..... 205

**Trip information**..... 229

**Trip meter**..... 214

**Turn signal lights**

    Replacing light bulbs ..... 467

    Switch..... 211

    Wattage..... 570

**U**

**USB port\*** ..... 352

**V**

**Vanity lights**

    Vanity lights..... 365

    Wattage..... 570

**Vanity mirrors**..... 365

**Vehicle control and operation**

**data recording**..... 24

**Vehicle identification**

**number**..... 561

**Vehicle proximity notification**

**system** ..... 32

**Vehicle stability control**..... 296

**VSC**..... 296

**W**

**Warning buzzers**

    Brake system .....493

    Open door .....498

    Seat belt reminder.....498

**Warning lights**

    Anti-lock brake system  
        (ABS) .....495

    Automatic headlight leveling  
        system .....497

    Brake system .....493, 496

    Charging system .....494

    Cruise control .....497

    Electric power steering  
        system .....495

    High coolant temperature.....494

    Hybrid system .....495

    Low fuel level .....498

    Low tire pressure.....499

    Malfunction indicator lamp ....495

    Open door .....498

    Pre-collision system .....496

    Radar cruise control. ....497

    Seat belt warning light.....498

    Slip indicator.....496

    SRS airbags.....495

    Tire pressure warning light....499

\*: Refer to “Display Audio System Owner’s Manual” or “Navigation System Owner’s Manual”.

<b>Warning messages .....</b>	<b>507</b>
<b>Washer</b>	
Checking .....	429
Preparing and checking before winter .....	317
Switch.....	258
<b>Washing and waxing .....</b>	<b>396</b>
<b>Weight</b>	
Cargo capacity .....	316
Load limits .....	316
Weight.....	560
<b>Wheels .....</b>	<b>451</b>
<b>Window glasses .....</b>	<b>123</b>
<b>Window lock switch.....</b>	<b>123</b>
<b>Windows</b>	
Power windows .....	123
Rear window defogger .....	346
Washer.....	258
<b>Windshield wipers .....</b>	<b>258</b>
<b>Winter driving tips .....</b>	<b>317</b>
<b>Wireless remote control key</b>	
Locking/Unlocking.....	85
Replacing the battery .....	454
<b>WMA disc*</b>	



\*: Refer to “Display Audio System Owner’s Manual”  
or “Navigation System Owner’s Manual”.

What to do if...

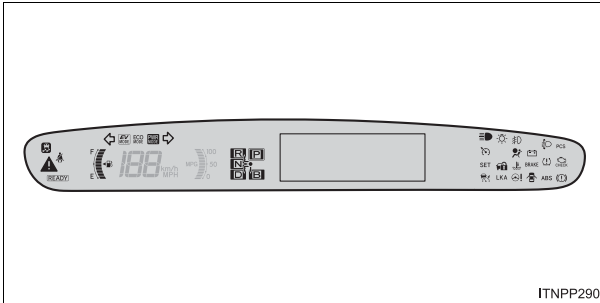

What to do if...

A tire punctures	P. 523	If you have a flat tire
The hybrid system does not start	P. 538	If the hybrid system will not start
	P. 135	Immobilizer system
	P. 543	If the 12-volt battery is discharged
The high coolant temperature warning light flashes or comes on	P. 549	If your vehicle overheats
“HYBRID SYSTEM OVERHEAT” is displayed		
Steam can be seen coming from under the hood		
The key is lost	P. 540	If you lose your keys
The 12-volt battery runs out	P. 543	If the 12-volt battery is discharged
The doors cannot be locked	P. 87	Side doors
	P. 93	Back door
The vehicle is stuck in mud or sand	P. 554	If the vehicle becomes stuck
A warning light or indicator light comes on	P. 493	If a warning light turns on or a warning buzzer sounds





## ■ Warning lights

 Master warning light  
P. 499



 Brake system warning light (red indicator)  
OR  
 P. 493

 Charging system warning light P. 494  
High coolant

 temperature warning light  
P. 494

 Malfunction indicator lamp  
OR  
 P. 495

 SRS warning light  
P. 495

 ABS warning light  
OR  
 P. 495  
Electric power steering system warning light  
P. 495

 Pre-collision system warning light\* P. 496

 Slip indicator light  
P. 496  
Brake system warning light (yellow indicator)  
P. 496

 Automatic headlight leveling system warning light P. 497

 Cruise control indicator light\* P. 497



Radar cruise control indicator light\* P. 497



Driver's belt reminder light P. 498



"LKA" indicator light\* P. 496



Tire pressure warning light P. 499



Open door warning light P. 498



Front passenger's seat belt reminder light P. 498



Low fuel level warning light P. 498

\*: The light flashes to indicate a malfunction.







## GAS STATION INFORMATION

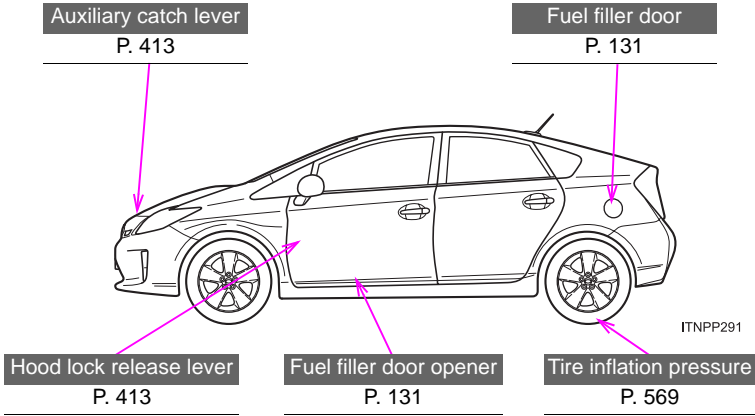

Fuel tank capacity (Reference)	11.9 gal. (45 L, 9.9 Imp.gal.)	
Fuel type	Unleaded gasoline only	P. 562
Cold tire inflation pressure		P. 569
Engine oil capacity (Drain and refill — reference)	With filter Without filter	qt. (L, Imp.qt.) 4.4 (4.2, 3.7) 4.1 (3.9, 3.4)
Engine oil type	Toyota Genuine Motor Oil or equivalent Oil grade: ILSAC multigrade engine oil	P. 563