

TABLE OF CONTENTS

1	Before driving	Information on the hybrid system and adjusting and operating features such as door locks, mirrors, and steering column.
2	When driving	Driving, stopping and safe-driving information.
3	Interior features	Air conditioning and audio systems, as well as other interior features for a comfortable driving experience.
4	Maintenance and care	Cleaning and protecting your vehicle, performing do-it-yourself maintenance, and maintenance information.
5	When trouble arises	What to do if the vehicle needs to be towed, gets a flat tire, or is involved in an accident.
6	Vehicle specifications	Detailed vehicle information.
7	For owners	Reporting safety defects for U.S. owners, seat belt and SRS airbag instructions for Canadian owners.
	Index	Alphabetical listing of information contained in this manual.

1 Before driving

1-1. Hybrid system
 Hybrid system features 24
 Hybrid system precautions 29
 Energy monitor/
 consumption screen 35
 Hybrid vehicle driving tips 42

1-2. Key information
 Keys 44

1-3. Opening, closing and locking the doors
 Smart key system..... 47
 Wireless remote control 61
 Side doors 65
 Back door 71

1-4. Adjustable components (seats, mirrors, steering wheel)
 Front seats 76
 Rear seats 77
 Head restraints 81
 Seat belts 84
 Steering wheel 93
 Anti-glare inside rear view mirror 94
 Outside rear view mirrors 96

1-5. Opening and closing the windows and moon roof
 Power windows 98
 Moon roof 101

1-6. Refueling
 Opening the fuel tank cap 105

1-7. Theft deterrent system
 Immobilizer system 110
 Theft prevention labels 113

1-8. Safety information
 Correct driving posture 114
 SRS airbags 116
 Front passenger occupant classification system 130
 Child restraint systems 136
 Installing child restraints 140

2 When driving

2-1. Driving procedures
 Driving the vehicle 150
 Engine (ignition) switch 160
 Power (ignition) switch 164
 EV drive mode 172
 Hybrid transmission 175
 Turn signal lever 178
 Parking brake 179
 Horn 180

2-2. Instrument cluster

Gauges and meters	181
Indicators and warning lights	184
Multi-information display	187

2-3. Operating the lights and wipers

Headlight switch	204
Fog light switch	208
Windshield wipers and washer	210
Rear window wiper and washer	214

2-4. Using other driving systems

Cruise control	217
Driving assist systems	221

2-5. Driving information

Cargo and luggage	226
Vehicle load limits	230
Winter driving tips	231
Trailer towing	235
Dinghy towing	236

3 Interior features

3-1. Using the air conditioning system and defogger

Automatic air conditioning system	238
Rear window and outside rear view mirror defoggers	247

3-2. Using the audio system

Audio system types	248
Using the radio	254
Using the CD player	256
Playing back MP3 and WMA discs	261
Operating an iPod	268
Operating a USB memory	276
Optimal use of the audio system	284
Using the AUX port	287
Using the steering wheel audio switches	288

3-3. Using the Bluetooth® audio system

Bluetooth® audio/phone	291
Using the Bluetooth® audio/phone	295
Operating a Bluetooth® enabled portable player	300
Making a phone call	303
Using the "SET UP" menu ("Bluetooth" menu)	308
Using the "SET UP" menu ("Phone" menu)	314

3-4. Using the interior lights
 Interior lights list 321
 • Interior lights/
 personal lights 322

3-5. Using the storage features
 List of storage features 324
 • Glove box 325
 • Console box 325
 • Auxiliary boxes 327
 • Cup holders 329
 • Bottle holders 330

3-6. Other interior features
 Sun visors 332
 Vanity mirrors 333
 Outside temperature
 display 334
 Power outlet 336
 Seat heaters 337
 Coat hooks 339
 Assist grips 340
 Floor mat 341
 Luggage cover 343

4 Maintenance and care

4-1. Maintenance and care
 Cleaning and protecting
 the vehicle exterior 346
 Cleaning and protecting
 the vehicle interior 349

4-2. Maintenance
 Maintenance
 requirements 352
 General maintenance 355
 Emission inspection and
 maintenance (I/M)
 programs 359

**4-3. Do-it-yourself
 maintenance**
 Do-it-yourself service
 precautions 360
 Hood 364
 Positioning a floor jack 366
 Engine compartment 368
 12-volt battery 379
 Tires 384
 Tire inflation pressure 392
 Wheels 396
 Air conditioning filter 399
 Wireless remote control/
 electronic key battery 401
 Checking and replacing
 fuses 404
 Light bulbs 415

5 When trouble arises

5-1. Essential information

- Emergency flashers 428
- If your vehicle needs to be towed 429
- If you think something is wrong 436

5-2. Steps to take in an emergency

- If a warning light turns on or a warning buzzer sounds 437
- If a warning message is displayed..... 447
- If you have a flat tire..... 463
- If the hybrid system will not start..... 475
- If the shift lever cannot be shifted from P..... 477
- If you lose your keys 478
- If the electronic key does not operate properly..... 479
- If the vehicle 12-volt battery is discharged..... 481
- If your vehicle overheats 487
- If the vehicle becomes stuck 492
- If your vehicle has to be stopped in an emergency 493

6 Vehicle specifications

6-1. Specifications

- Maintenance data (fuel, oil level, etc.) 496
- Fuel information..... 506
- Tire information 509

6-2. Customization

- Customizable features..... 522
- Items to initialize..... 528

7 For owners

- Reporting safety defects for U.S. owners 530
- Seat belt instructions for Canadian owners (in French)..... 531
- SRS airbag instructions for Canadian owners (in French)..... 533

Index

Abbreviation list..... 544

Alphabetical index 546

What to do if... 558

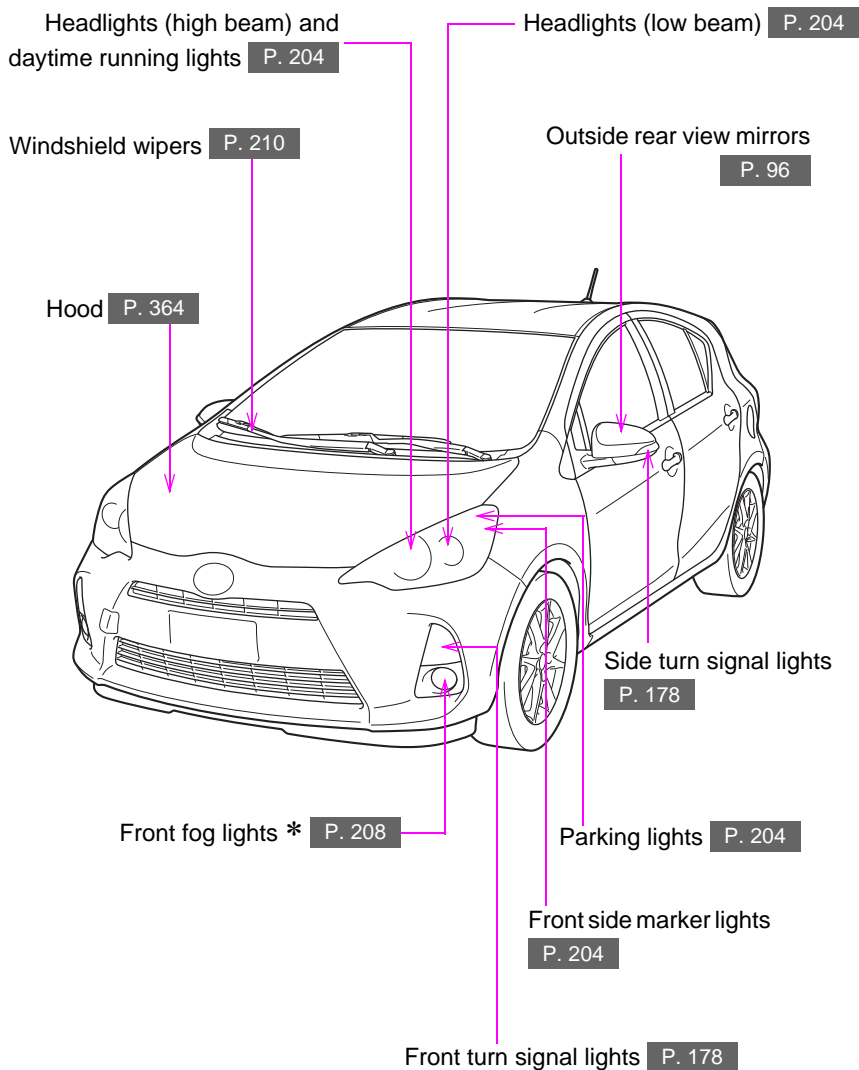

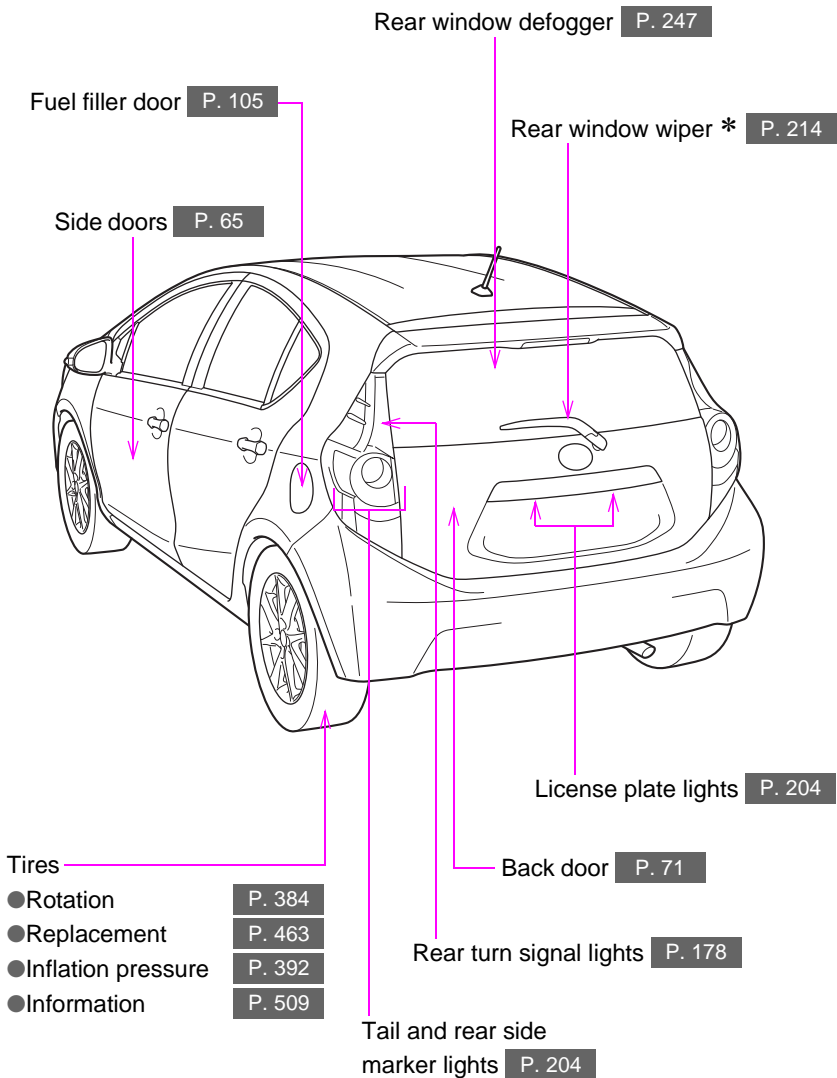

*: If equipped

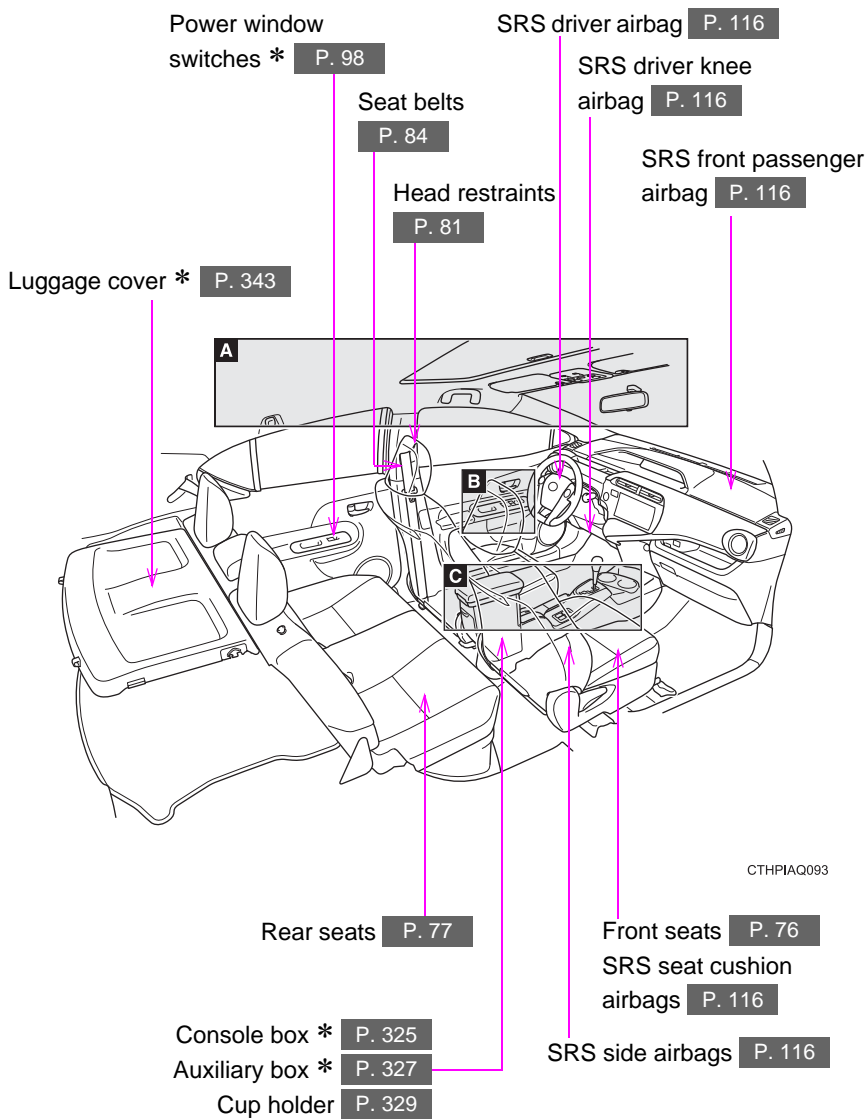

A

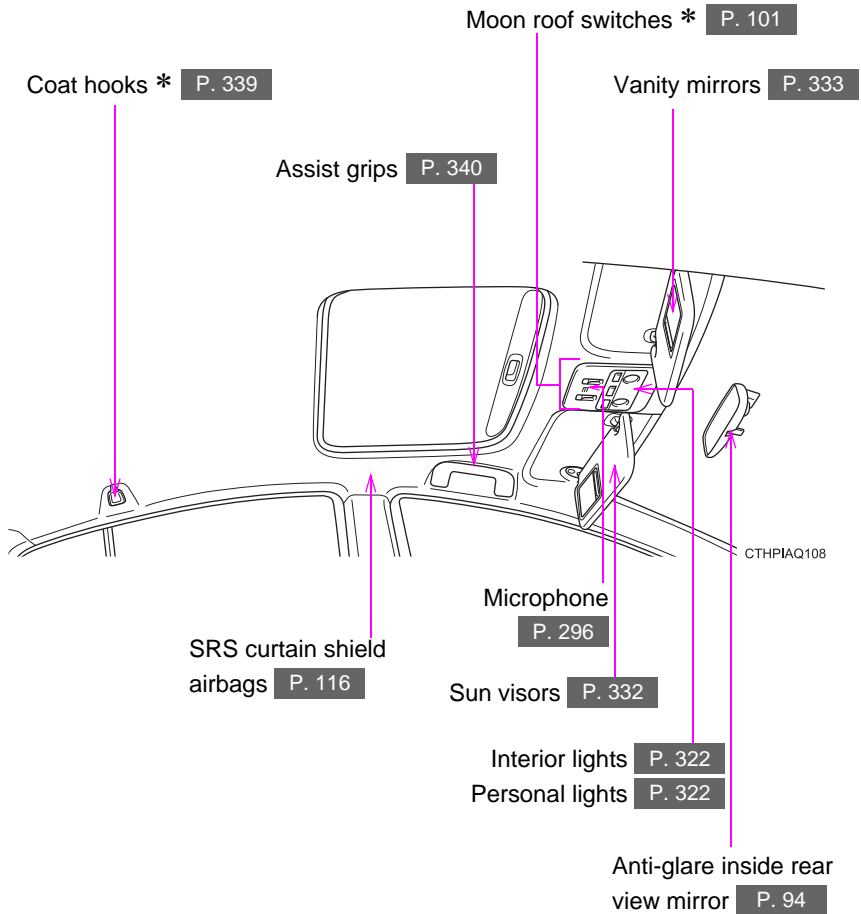

*: If equipped

B

Type A

Window lock switch P. 98

Door lock switch P. 65

Inside door lock buttons P. 66

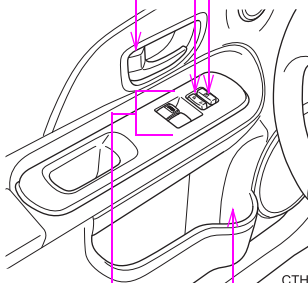

CTHP1AQ081

Bottle holders P. 330

Power window switches P. 98

Type B

Window lock switch P. 98

Door lock switch P. 65

Inside door lock buttons P. 66

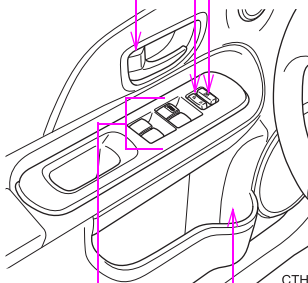

CTHP1AQ080

Bottle holders P. 330

Power window switches P. 98

C

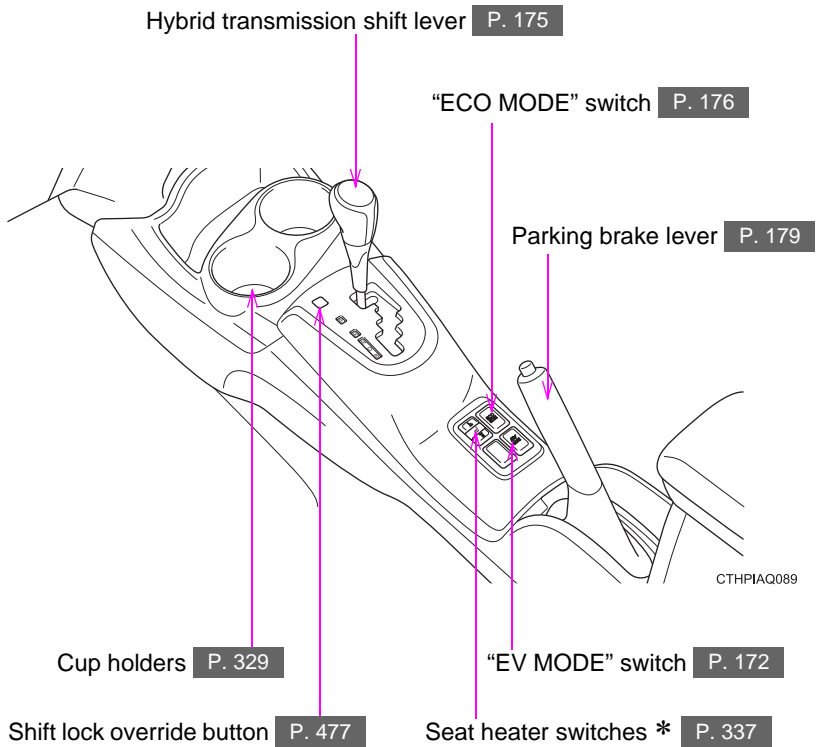

*: If equipped

Windshield wiper and washer switch P. 210

Rear window wiper and washer switch * P. 214

Emergency flasher switch P. 428

Headlight switch P. 204

Turn signal lever P. 178

Fog light switch * P. 208

Gauges and meters P. 181

Multi-information display P. 187

Audio system * P. 248

Display Audio system *, *

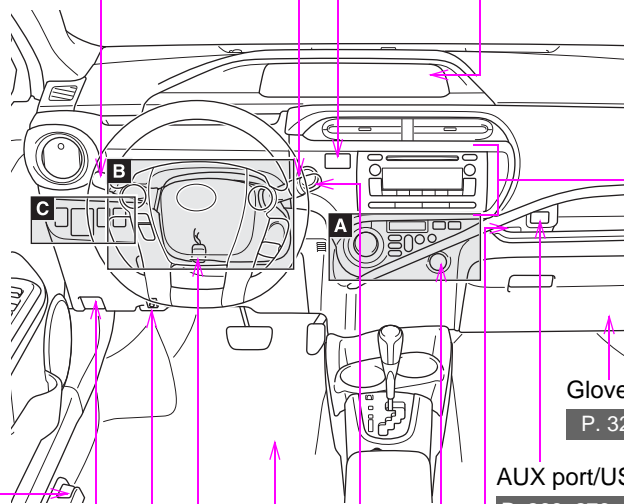

Glove box

P. 325

AUX port/USB port

P. 268, 276, 287

CTHP1AQ090

Cord hook P. 272

Power outlet P. 336

Power (ignition) switch (vehicles with a smart key system) P. 160

Floor mat P. 341

Tilt and telescopic steering lock release lever P. 93

Tire pressure warning reset switch P. 385

Hood lock release lever P. 364

Fuel filler door opener P. 105

A

Air conditioning system P. 238

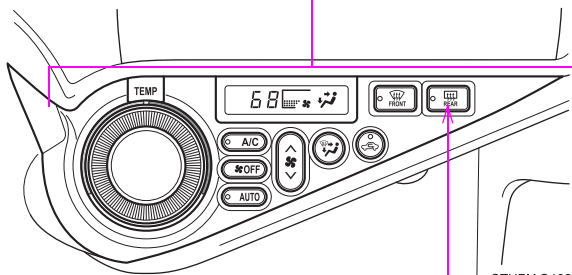

CTHPIAQ102

Rear window defogger button * P. 247

Rear window and outside rear view mirror

defogger button * P. 247

*: If equipped

*: Refer to "Display Audio System Owner's Manual".

B

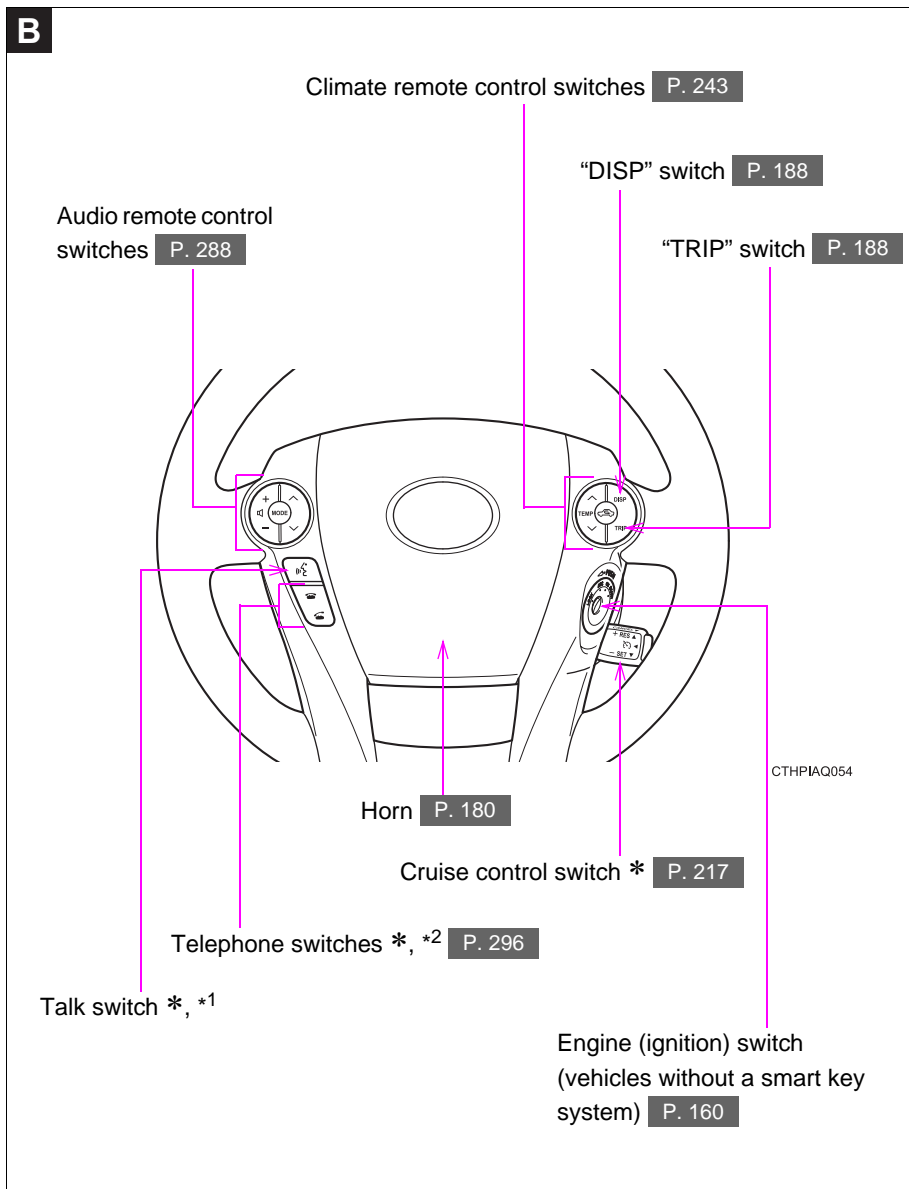

C

Outside rear view mirror switches P. 96

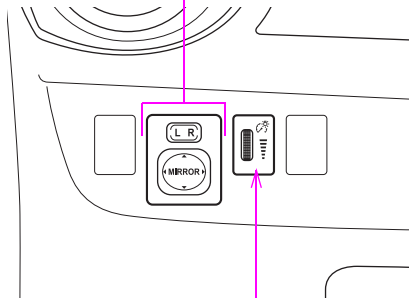

CTHPIAQ055

Instrument panel light control dial P. 182

*: If equipped

*1: Refer to "Display Audio System Owner's Manual".

*2: For vehicles with a Display Audio system, refer to "Display Audio System Owner's Manual".

For your information

Main Owner's Manual

Please note that this manual applies to all models and all equipment, including options. Therefore, you may find some explanations for equipment not installed on your vehicle.

All specifications provided in this manual are current at the time of printing. However, because of the Toyota policy of continual product improvement, we reserve the right to make changes at any time without notice.

Depending on specifications, the vehicle shown in the illustrations may differ from your vehicle in terms of equipment.

Noise from under vehicle after turning off the hybrid system

Approximately five hours after the hybrid system is turned off, you may hear sound coming from under the vehicle for several minutes. This is the sound of a fuel evaporation leakage check and, it does not indicate a malfunction.

Accessories, spare parts and modification of your Toyota

A wide variety of non-genuine spare parts and accessories for Toyota vehicles are currently available on the market. You should know that Toyota does not warrant these products and is not responsible for their performance, repair, or replacement, or for any damage they may cause to, or adverse effect they may have on, your Toyota vehicle.

This vehicle should not be modified with non-genuine Toyota products. Modification with non-genuine Toyota products could affect its performance, safety or durability, and may even violate governmental regulations. In addition, damage or performance problems resulting from the modification may not be covered under warranty.

Installation of a mobile two-way radio system

The installation of a mobile two-way radio system in your vehicle could affect electronic systems such as:

- Multiport fuel injection system/sequential multiport fuel injection system
- Cruise control system
- Anti-lock brake system
- SRS airbag system
- Seat belt pretensioner system

Be sure to check with your Toyota dealer for precautionary measures or special instructions regarding installation of a mobile two-way radio system.

High voltage parts and cables on the hybrid vehicles emit approximately the same amount of electromagnetic waves as the conventional gasoline powered vehicles or home electronic appliances despite of their electromagnetic shielding.

Unwanted noise may occur in the reception of the mobile two-way radio.

Vehicle data recordings

Your Toyota is equipped with several sophisticated computers that will record certain data, such as:

- Engine speed
- Electric motor speed (traction motor speed)
- Accelerator status
- Brake status
- Vehicle speed
- Shift position
- Hybrid battery (traction battery) status

The recorded data varies according to the vehicle grade level and options with which it is equipped. Furthermore, these computers do not record conversations, sounds or pictures.

● Data usage

Toyota may use the data recorded in these computers to diagnose malfunctions, conduct research and development, and improve quality.

Toyota will not disclose the recorded data to a third party except:

- With the consent of the vehicle owner or with the consent of the lessee if the vehicle is leased
- In response to an official request by the police, a court of law or a government agency
- For use by Toyota in a law suit
- For research purposes where the data is not tied to a specific vehicle or vehicle owner

Event data recorder

This vehicle is equipped with an event data recorder (EDR). The main purpose of an EDR is to record, in certain crash or near crash-like situations, such as an air bag deployment or hitting a road obstacle, data that will assist in understanding how a vehicle's systems performed. The EDR is designed to record data related to vehicle dynamics and safety systems for a short period of time, typically 30 seconds or less.

The EDR in this vehicle is designed to record such data as:

- How various systems in your vehicle were operating;
- Whether or not the driver and passenger safety belts were buckled/fastened;
- How far (if at all) the driver was depressing the accelerator and/or brake pedal; and,
- How fast the vehicle was traveling.

These data can help provide a better understanding of the circumstances in which crashes and injuries occur.

NOTE: EDR data are recorded by your vehicle only if a non-trivial crash situation occurs; no data are recorded by the EDR under normal driving conditions and no personal data (e.g., name, gender, age, and crash location) are recorded. However, other parties, such as law enforcement, could combine the EDR data with the type of personally identifying data routinely acquired during a crash investigation.

To read data recorded by an EDR, special equipment is required, and access to the vehicle or the EDR is needed. In addition to the vehicle manufacturer, other parties, such as law enforcement, that have the special equipment, can read the information if they have access to the vehicle or the EDR.

● Disclosure of the EDR data

Toyota will not disclose the data recorded in an EDR to a third party except when:

- An agreement from the vehicle's owner (or the lessee for a leased vehicle) is obtained
- In response to an official request by the police, a court of law or a government agency
- For use by Toyota in a law suit

However, if necessary, Toyota may:

- Use the data for research on vehicle safety performance
- Disclose the data to a third party for research purposes without disclosing information about the specific vehicle or vehicle owner

Scrapping of your Toyota

The SRS airbag and seat belt pretensioner devices in your Toyota contain explosive chemicals. If the vehicle is scrapped with the airbags and seat belt pretensioners left as they are, this may cause an accident such as fire. Be sure to have the systems of the SRS airbag and seat belt pretensioner removed and disposed of by a qualified service shop or by your Toyota dealer before you scrap your vehicle.

Perchlorate Material

Special handling may apply, See www.dtsc.ca.gov/hazardouswaste/perchlorate.

Your vehicle has components that may contain perchlorate. These components may include airbag, seat belt pretensioners, and wireless remote control batteries.

CAUTION

■ General precautions while driving

Driving under the influence: Never drive your vehicle when under the influence of alcohol or drugs that have impaired your ability to operate your vehicle. Alcohol and certain drugs delay reaction time, impair judgment and reduce coordination, which could lead to an accident that could result in death or serious injury.

Defensive driving: Always drive defensively. Anticipate mistakes that other drivers or pedestrians might make and be ready to avoid accidents.

Driver distraction: Always give your full attention to driving. Anything that distracts the driver, such as adjusting controls, talking on a cellular phone or reading can result in a collision with resulting death or serious injury to you, your occupants or others.

■ General precaution regarding children's safety

Never leave children unattended in the vehicle, and never allow children to have or use the key.

Children may be able to start the vehicle or shift the vehicle into neutral. There is also a danger that children may injure themselves by playing with the cigarette lighter, the windows, or other features of the vehicle. In addition, heat build-up or extremely cold temperatures inside the vehicle can be fatal to children.

 CAUTION

■ **Hybrid battery (traction battery)**

Never resell, hand over or modify the hybrid battery. To prevent accidents, hybrid batteries that have been removed from a disposed vehicle are collected through Toyota dealers. Do not dispose of the battery yourself.

Unless the battery is properly collected, the following may occur, resulting in death or serious injury:

- The hybrid battery may be illegally disposed of or dumped, and someone may touch a high voltage part, resulting in an electric shock.
- The hybrid battery is intended to be used exclusively with your hybrid vehicle. If the hybrid battery is used outside of your vehicle or modified in any way, accidents such as electric shock, heat generation, smoke generation, an explosion and electrolyte leakage may occur.

When reselling or handing over your vehicle, the possibility of an accident is extremely high because the person receiving the vehicle may not be aware of these dangers.

■ **Disposal of the hybrid battery (traction battery)**

If your vehicle is disposed of without the hybrid battery having been removed, there is a danger of serious electric shock if high voltage parts, cables and their connectors are touched. In the event that your vehicle must be disposed of, the hybrid battery must be disposed of by your Toyota dealer or a qualified service shop. If the hybrid battery is not disposed of properly, it may cause electric shock that can result in death or serious injury.

Symbols used throughout this manual

Cautions & Notices

⚠ CAUTION

This is a warning against something which, if ignored, may cause death or serious injury to people. You are informed about what you must or must not do in order to reduce the risk of death or serious injury to yourself and others.

⚠ NOTICE

This is a warning against something which, if ignored, may cause damage to the vehicle or its equipment. You are informed about what you must or must not do in order to avoid or reduce the risk of damage to your Toyota and its equipment.



Symbols used in illustrations

⊘ Safety symbol

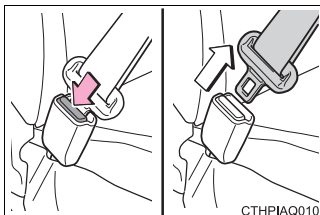
The symbol of a circle with a slash through it means “Do not”, “Do not do this”, or “Do not let this happen”.



Arrows indicating operations

-  Indicates the action (pushing, turning, etc.) used to operate switches and other devices.
-  Indicates the outcome of an operation (e.g. a lid opens).

1-1. Hybrid system		1-5. Opening and closing the windows and moon roof	
Hybrid system features	24	Power windows	98
Hybrid system precautions	29	Moon roof	101
Energy monitor/ consumption screen.....	35	1-6. Refueling	
Hybrid vehicle driving tips	42	Opening the fuel tank cap	105
1-2. Key information		1-7. Theft deterrent system	
Keys	44	Immobilizer system	110
1-3. Opening, closing and locking the doors		Theft prevention labels.....	113
Smart key system	47	1-8. Safety information	
Wireless remote control	61	Correct driving posture.....	114
Side doors.....	65	SRS airbags.....	116
Back door.....	71	Front passenger occupant classification system	130
1-4. Adjustable components (seats, mirrors, steering wheel)		Child restraint systems.....	136
Front seats	76	Installing child restraints	140
Rear seats.....	77		
Head restraints.....	81		
Seat belts	84		
Steering wheel	93		
Anti-glare inside rear view mirror	94		
Outside rear view mirrors	96		

1-1. Hybrid system

Hybrid system features

Your vehicle is a hybrid vehicle. It has characteristics different from conventional vehicles. Be sure you are closely familiar with the characteristics of your vehicle, and operate with care.

The hybrid system combines the use of a gasoline engine and an electric motor (traction motor) according to driving conditions, improving fuel efficiency and reducing exhaust emissions.

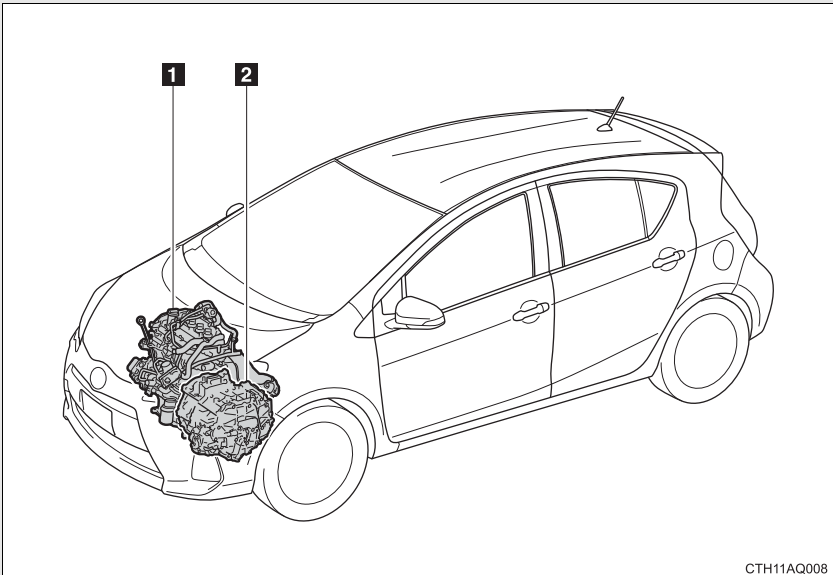

CTH11AQ008

- 1** Gasoline engine
- 2** Electric motor (Traction motor)

■ When stopped/during start off

The gasoline engine stops* when the vehicle is stopped. During start-off, the electric motor (traction motor) drives the vehicle. At slow speeds or when traveling down a gentle slope, the engine is stopped* and the motor is used.

*: However, when the hybrid battery (traction battery) needs to be charged or while the engine is being warmed up, the gasoline engine may not stop automatically. (→P. 26)

■ During normal driving

The gasoline engine is predominantly used. The electric motor (traction motor) charges the hybrid battery as necessary.

■ When accelerating sharply

The power of the hybrid battery (traction battery) is added to that of the gasoline engine via the electric motor (traction motor).

■ When braking (regenerative braking)

The electric motor (traction motor) charges the hybrid battery (traction battery).

Vehicle Proximity Notification System

When the gasoline engine is off while driving, a sound is produced to warn pedestrians, people riding bicycles or other people and vehicles in the surrounding area that the vehicle is approaching. The pitch of the sound adjusts according to vehicle speed. When vehicle speed is approximately 16 mph (25 km/h) or more, the warning system turns off.

■ Regenerative braking

In the following situations, kinetic energy is converted to electric energy and deceleration force can be obtained in conjunction with the recharging of the hybrid battery (traction battery).

- The accelerator pedal is released with the shift lever in D or B.
- The brake pedal is depressed with the shift lever in D or B.

■ EV drive indicator lamp

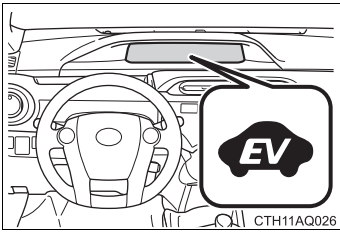

The EV drive indicator lamp comes on when the vehicle is driven using only the electric motor (traction motor) or the gasoline engine is stopped.

Displayed when “ECO Score” or the basic display of “ECO Savings” is selected. (→P. 191)

■ Conditions in which the gasoline engine may not stop

The gasoline engine starts and stops automatically. However, it may not stop automatically in the following conditions:

- During gasoline engine warm-up
- During hybrid battery (traction battery) charging
- When the temperature of the hybrid battery (traction battery) is high or low
- When the heater is switched on

■ Charging the hybrid battery (traction battery)

- As the gasoline engine charges the hybrid battery (traction battery), the battery does not need to be charged from an outside source. However, if the vehicle is left parked for a long time the hybrid battery will slowly discharge. For this reason, be sure to drive the vehicle at least once every few months for at least 30 minutes or 10 miles (16 km). If the hybrid battery becomes fully discharged and you are unable to jump-start the vehicle with the 12-volt battery, contact your Toyota dealer.
- If the shift lever is in N, the hybrid battery (traction battery) will not be charged. Always put the shift lever in P when the vehicle is stopped. When driving in heavy traffic, operate the vehicle with the shift lever in D or B to avoid discharging the battery.

■ Charging the 12-volt battery

→P. 484

■ After the 12-volt battery has discharged or has been changed or removed

The gasoline engine may not stop even if the vehicle is running on the hybrid battery (traction battery). If this continues for a few days, contact your Toyota dealer.

■ Sounds and vibrations specific to a hybrid vehicle

There may be no engine sounds or vibration even though the vehicle is able to move. For safety, apply the parking brake and make sure to shift the shift lever to P when parked.

The following sounds or vibrations may occur when the hybrid system is operating and are not a malfunction:

- Motor sounds may be heard from the engine compartment.
- Sounds may be heard from the hybrid battery (traction battery) behind the rear seats when the hybrid system starts or stops.
- Sounds from the hybrid system may be heard when the back door is open.
- Sounds may be heard from the transmission when the gasoline engine starts or stops, when driving at low speeds, or during idling.
- Engine sounds may be heard when accelerating sharply.
- Sounds may be heard due to regenerative braking when the brake pedal is depressed.
- Vibration may be felt when the gasoline engine starts or stops.
- Cooling fan sounds may be heard from the air intake vent on the side of the lower part of the rear left seat.

■ Vehicle Proximity Notification System

In the following cases, the Vehicle Proximity Notification System sound may be difficult for pedestrians, people riding bicycles or other people and vehicles in the surrounding area to hear:

- When there is a lot of noise in the vicinity
- When it is raining or during strong winds
- When in the area surrounding the rear of the vehicle, rather than in front of the vehicle

■ Maintenance, repair, recycling, and disposal

Contact your Toyota dealer regarding maintenance, repair, recycling and disposal. Do not dispose of the vehicle yourself.

■ Customization that can be configured at Toyota dealer

Settings (e. g. the volume of Vehicle Proximity Notification System sound) can be changed. (Customizable features: →P. 522)

Hybrid system precautions

Take care when handling the hybrid system, as it contains a high voltage system (about 520 V at maximum) as well as parts that become extremely hot when the hybrid system is operating. Obey the caution labels attached to the vehicle.

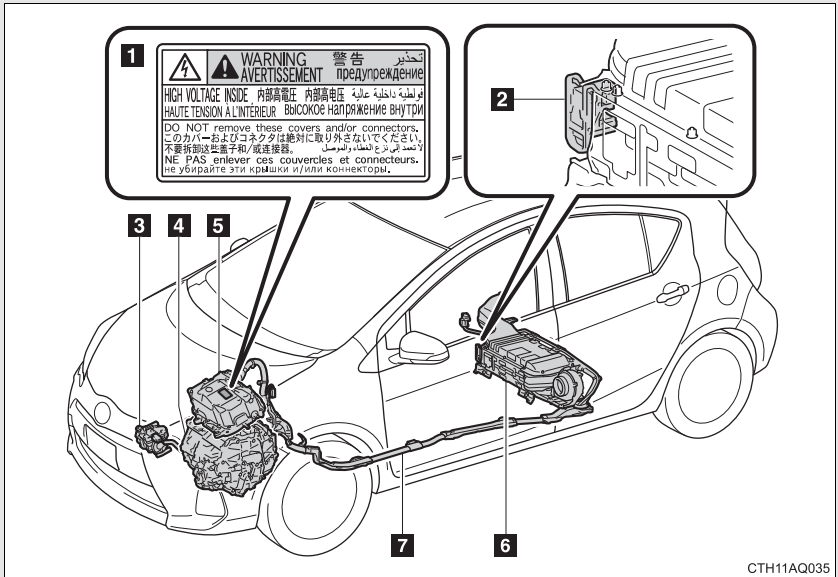

1 Caution label

2 Service plug

3 Air conditioning compressor

4 Electric motor (traction motor)

5 Power control unit with DC/DC converter

6 Hybrid battery (traction battery)

7 High voltage cables (orange)

CTH11AQ035

Hybrid battery air vent

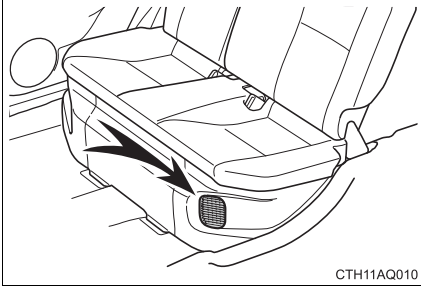

There is an air intake vent on the side of the lower part of the rear left seat for the purpose of cooling the hybrid battery (traction battery). If the vent becomes blocked, the hybrid battery may overheat, leading to a reduction in hybrid battery output.

Emergency shut off system

When a certain level of impact is detected by the impact sensor, the emergency shut off system blocks off the high voltage current and stops the fuel pump to minimize the risk of electrocution and fuel leakage. If the emergency shut off system activates, your vehicle will not restart. To restart the hybrid system, contact your Toyota dealer.

Hybrid warning message

A message is automatically displayed when a malfunction occurs in the hybrid system or an improper operation is attempted.

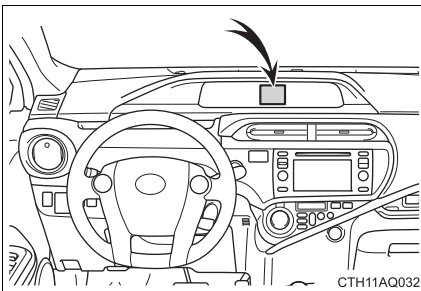

If a warning message is shown on the multi-information display, read the message and follow the instructions. (→P. 447)

■ **If a warning light comes on, a warning message is displayed, or the 12-volt battery has been disconnected**

The hybrid system may not start. In that case, try to start the system again. If the “READY” indicator does not come on, contact your Toyota dealer.

■ **Running out of fuel**

When the vehicle has run out of fuel and the hybrid system cannot be started, refuel the vehicle with at least enough gasoline to make the low fuel level warning light (→P. 439) stop flashing. If there is only a small amount of fuel, the hybrid system may not be able to start. (The minimum amount of fuel to add to make the low fuel level warning light stop flashing is about 1.3 gal. [5.0 L, 1.1 Imp. gal.] when the vehicle is on a level surface. This value may vary when the vehicle is on a slope.)

■ **Electromagnetic waves**

- High voltage parts and cables on the hybrid vehicles incorporate electromagnetic shielding, and therefore emit approximately the same amount of electromagnetic waves as conventional gasoline powered vehicles or home electronic appliances.
- Your vehicle may cause sound interference in some third party-produced radio parts.

■ **Hybrid battery (traction battery)**

The hybrid battery (traction battery) has a limited service life. The lifespan of the hybrid battery (traction battery) can change in accordance with driving style and driving conditions.

⚠ CAUTION

■ High voltage and high temperature precautions

The vehicle has high voltage DC and AC systems as well as a 12-volt system. DC and AC high voltage is very dangerous and can cause severe burns and electric shock that may result in death or serious injury.

- Never touch, disassemble, remove or replace the high voltage parts, cables or their connectors.
- The hybrid system will become hot after starting as the system uses high voltage. Be careful of both the high voltage and the high temperature, and always obey the caution labels attached to the vehicle.

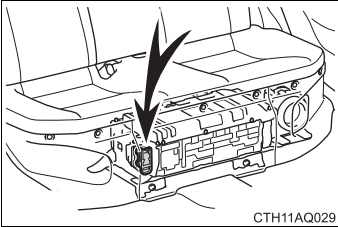

- Never try to open the service plug access hole located under the rear seat. The service plug is used only when the vehicle is serviced and is subject to high voltage.

 **CAUTION****■ Road accident cautions**

If your vehicle is involved in an accident, observe the following precautions to reduce the risk of death or serious injury:

- Stop the vehicle in a safe place to prevent subsequent accidents, shift the shift lever to P, apply the parking brake, and turn the hybrid system off. (→P. 150)
- Do not touch the high voltage parts, cables or connectors. Carefully check to see if there are exposed high voltage parts or cables.
- If electric wires are exposed inside or outside your vehicle, an electric shock may occur. Never touch exposed electric wires.
- If a fluid leak occurs, do not touch the fluid as it may be strong alkaline electrolyte from the hybrid battery (traction battery). If it comes into contact with your skin or eyes, wash it off immediately with a large amount of water or, if possible, boric acid solution. Seek immediate medical attention.
- If a fire occurs in the hybrid vehicle, leave the vehicle as soon as possible. Never use a fire extinguisher that is not meant for electric fires. Using even a small amount of water may be dangerous.
- If your vehicle needs to be towed, do so with the front wheels raised. If the wheels connected to the electric motor (traction motor) are on the ground when towing, the motor may continue to generate electricity. This may cause a fire. (→P. 429)
- Carefully inspect the ground under the vehicle. If you find that liquid has leaked onto the ground, the fuel system may have been damaged. Leave the vehicle as soon as possible and contact your Toyota dealer.

■ Nickel-metal hydride battery

Your vehicle contains a sealed nickel-metal hydride battery. If disposed of improperly, it is hazardous to the environment and there is a risk of severe burns and electrical shock that may result in death or serious injury.



NOTICE

■ Hybrid battery air vent

- Do not place foreign objects over or in front of the air vent. The hybrid battery (traction battery) may overheat and be damaged.
- Clean the air vent regularly to prevent the hybrid battery (traction battery) from overheating.
- Do not wet the air vent as this may cause a short circuit and damage the hybrid battery (traction battery).
- Do not carry large amounts of water such as water cooler bottles in the vehicle. If water spills onto the hybrid battery (traction battery), the battery may be damaged.

You can view the status of your hybrid system on the multi-information display and Display Audio system.

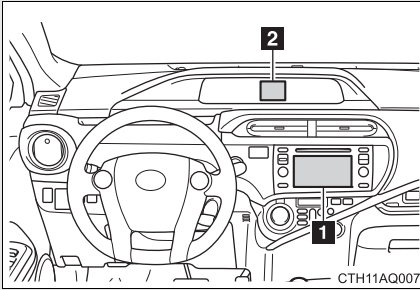

- 1 Display Audio system (if equipped)
- 2 Multi-information display

Energy monitor

Display Audio system (if equipped)

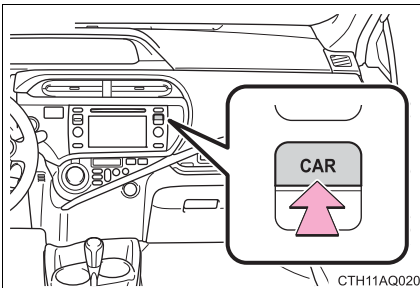







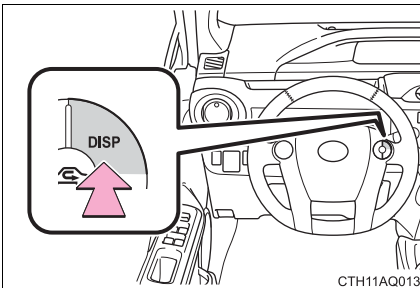

Press "CAR".

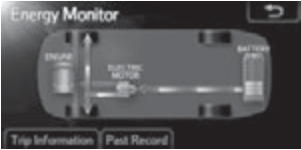
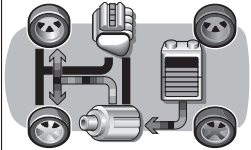

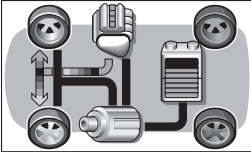

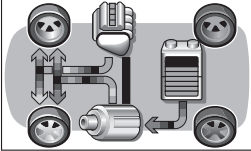
If the "Trip Information" is displayed, touch "Energy".

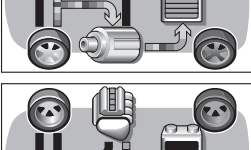
Multi-information display

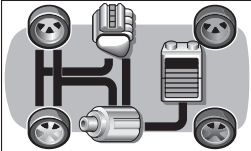

Push the "DISP" switch on the steering wheel several times to select the energy monitor display.

	Display Audio system	Multi-information display
<p>When the vehicle is powered by the electric motor (traction motor)</p>		
<p>When the vehicle is powered by the gasoline engine</p>		
<p>When the vehicle is powered by both the gasoline engine and the electric motor (traction motor)</p>		
<p>When the vehicle is charging the hybrid battery (traction battery)</p>		
<p>When there is no energy flow</p>		

	Display Audio system	Multi-information display
Hybrid battery (traction battery) status	 	 

These images are examples only, and may vary slightly from actual conditions.

Trip Information screen (Display Audio system)

Press "CAR". (→P. 35)

If the "Energy Monitor" screen is displayed, touch "Trip Information".

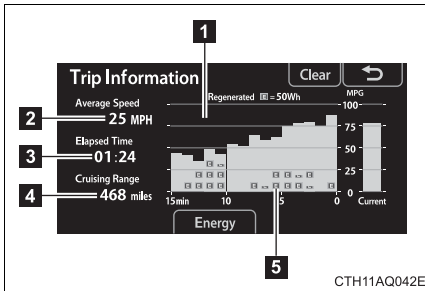

- 1** Fuel consumption in the past 15 minutes
- 2** Displays the average vehicle speed since the hybrid system was started.
- 3** Displays the driving time since the hybrid system was started.
- 4** Cruising range
- 5** Regenerated energy in the past 15 minutes

One symbol indicates 50 Wh.
Up to 5 symbols are shown.

The image is example only, and may vary slightly from actual conditions.

Fuel consumption screen (Multi-information display)

There are 2 menu items available for the fuel consumption screen. After pressing the “DISP” switch, select one of the menu items below and the system will change to the details screen.

The “5min Consumption”, “Past Record” and “ECO Savings Record” (→P. 196) screens are set to off (initialized settings) at the time of shipping. (→P. 41)

■ “5min Consumption” screen

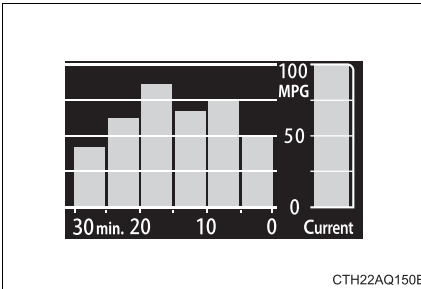

Displays the fuel consumption history since the hybrid system was started in intervals of 5 minutes. Current fuel consumption is simultaneously displayed, enabling it to be compared with fuel consumption of up to the last 30 minutes.

■ “Past Record”

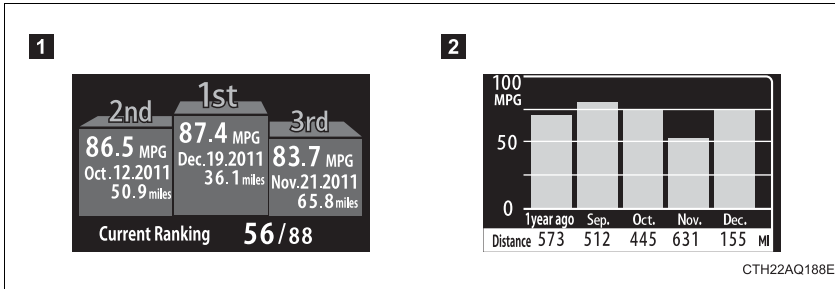

There are 2 types of displays for the past record.

Personal best and monthly average can be changed between on the settings screen. (→P. 41)

1 Personal Best

Displays the best 3 fuel consumption records and the current fuel consumption ranking.

Depending on whether the odometer or trip meter is displayed, the displayed contents differ.

- When the odometer is displayed: the record since the hybrid system was started is displayed.
- When the trip meter is displayed: the record since the trip meter was reset is displayed. The record for trip meter A and trip meter B is displayed separately.

The top 100 rankings are displayed. Records that are outside the top 100 are not displayed as a ranking.

Fuel consumption data for trips of less than 0.1 miles are not recorded.

2 Monthly Average

Displays average fuel consumption by the month.

The current month, the last 3 months and the same month last year are displayed, enabling a comparison to be made.

The past record can be reset on the settings screen. (→P. 41)

■ Remaining hybrid battery (traction battery) charge display

The charge amount of the hybrid battery (traction battery) is automatically controlled by the hybrid system. For this reason, even if electricity is recovered via the regenerative braking, or electricity is generated via the gasoline engine, the displayed hybrid battery (traction battery) charge amount may not reach the highest level (level 8). However, this does not indicate a malfunction.

■ Resetting the consumption data (Display Audio System)

Selecting “Clear” on the “Trip Information” screen will reset the fuel consumption and the regenerated energy for the past 15 minutes. Selecting “Yes” on the following screen will confirm resetting of all the data.

■ Menu screen selection (Multi-information display)

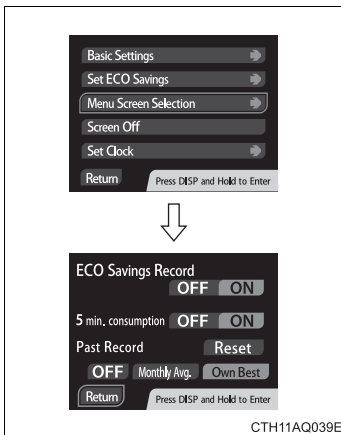

Press the “DISP” switch and select “Settings & Screen Off”. Press and hold the “DISP” switch while the cursor is on “Menu Screen Selection” to change to the settings screen.

The following screen changes and settings can be performed:

- The eco savings record screen can be switched on or off. (→P. 187)
- The 5 minute fuel consumption screen can be switched on or off.
- Past record can be reset.
- The past record screen can be switched between off, monthly average and personal best.

For economical and ecological driving, pay attention to the following points:

■ **Using Eco drive mode**

→P. 176

■ **Use of Hybrid System Indicator**

By keeping Hybrid System Indicator within Eco area, more Eco-friendly driving may be possible. (→P. 197)

■ **When braking the vehicle**

Make sure to operate the brakes gently and in good time. A greater amount of electrical energy can be retained when slowing down.

■ **Delays**

Repeated acceleration and deceleration, as well as long waits at traffic lights, will lead to bad fuel consumption. Check traffic reports before leaving and avoid delays as much as possible. When encountering a delay, gently release the brake pedal to allow the vehicle to move forward slightly while avoiding overuse of the accelerator pedal. Doing so can help control excessive gasoline consumption.

■ **Highway driving**

Control your speed and keep at a constant speed. Also, before stopping at a toll booth or similar, allow plenty of time to release the accelerator and gently apply the brakes. A greater amount of electrical energy can be retained when slowing down.

■ **Air conditioning**

Use the air conditioning only when necessary. Doing so can help control excessive gasoline consumption.

In summer: In high temperatures, use the recirculated air mode. Doing so will help to reduce the burden on the air conditioning and reduce fuel consumption as well.

In winter: Because the gasoline engine will not automatically cut out until the gasoline engine and the interior of the vehicle are warm, it will consume fuel. Also, fuel consumption can be improved by avoiding overuse of the heater.

■ **Checking tire inflation pressure**

Make sure to check the tire inflation pressure frequently. Improper tire inflation pressure can cause poor fuel consumption.

Also, as snow tires can cause large amounts of friction, their use on dry roads can lead to poor fuel consumption. Use a tire that is appropriate for the season.

■ **Luggage**

Carrying heavy luggage can lead to poor fuel consumption. Avoid carrying unnecessary luggage. Installing a large roof rack can also cause poor fuel consumption.

■ **Warming up before driving**

Since the gasoline engine starts up and cuts out automatically when cold, warming up the engine is unnecessary. Moreover, frequently driving short distances will cause the engine to repeatedly warm up, which can lead to poor fuel consumption.

Keys

The following keys are provided with the vehicle.

Vehicles without a smart key system (vehicles without immobilizer system)

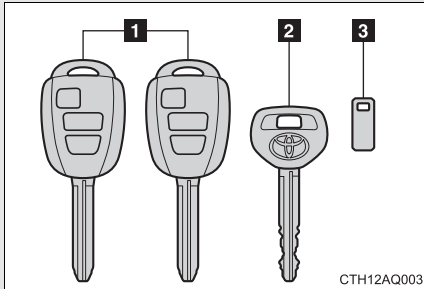

1 Master keys

Operating the wireless remote control function (→P. 61)

2 Valet key

3 Key number plate

Vehicles without a smart key system (vehicles with immobilizer system)

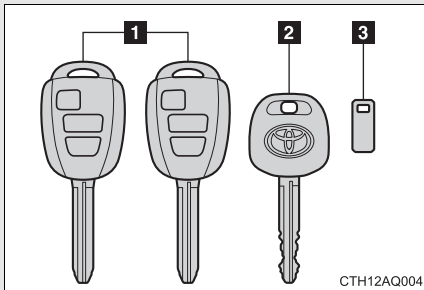

1 Master keys

Operating the wireless remote control function (→P. 61)

2 Valet key

3 Key number plate

Vehicles with a smart key system

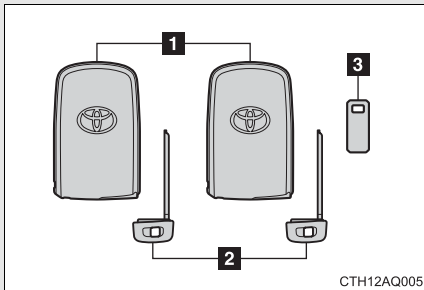

1 Electronic keys

- Operating the smart key system (→P. 47)
- Operating the wireless remote control function (→P. 61)

2 Mechanical keys

3 Key number plate

Using the mechanical key (vehicles with a smart key system)

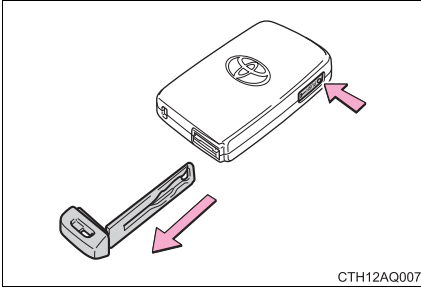

To take out the mechanical key, slide the release lever and take the key out.

The mechanical key can only be inserted in one direction, as the key only has grooves on one side. If the key cannot be inserted in a lock cylinder, turn it over and re-attempt to insert it.

After using the mechanical key, store it in the electronic key. Carry the mechanical key together with the electronic key. If the electronic key battery is depleted or the entry function does not operate properly, you will need the mechanical key. (→P. 479)

1

Before driving

■ Key number plate

Keep the plate in a safe place such as your wallet, not in the vehicle. In the event that a key (without a smart key system) or mechanical key (with a smart key system) is lost, a new key can be made by your Toyota dealer using the key number plate. (→P. 478)

■ When riding in an aircraft

When bringing a key with wireless remote control function onto an aircraft, make sure you do not press any buttons on the key while inside the aircraft cabin. If you are carrying the key in your bag etc., ensure that the buttons are not likely to be pressed accidentally. Pressing a button may cause the key to emit radio waves that could interfere with the operation of the aircraft.

 NOTICE

■ **To prevent key damage**

Observe the following:

- Do not drop the keys, subject them to strong shocks or bend them.
- Do not expose the keys to high temperatures for long periods of time.
- Do not get the keys wet or wash them in an ultrasonic washer etc.
- Do not attach metallic or magnetic materials to the keys or place the keys close to such materials.
- Do not disassemble the keys.
- Do not attach a sticker or anything else to the surface of the key.
- Do not place the keys near objects that produce magnetic fields, such as TVs, audio systems and induction cookers, or medical electrical equipment, such as low-frequency therapy equipment.

■ **Carrying the electronic key on your person (vehicles with a smart key system)**

Carry the electronic key 3.9 in. (10 cm) or more away from electric appliances that are turned on. Radio waves emitted from electric appliances within 3.9 in. (10 cm) of the electronic key may interfere with the key, causing the key to not function properly.

■ **In case of a smart key system malfunction or other key-related problems (vehicles with a smart key system)**

Take your vehicle with all the electronic keys provided with your vehicle to your Toyota dealer.

■ **When a vehicle key is lost (vehicles with a smart key system)**

If the key remains lost, the risk of vehicle theft increases significantly. Visit your Toyota dealer immediately with all remaining electronic keys that was provided with your vehicle.

1-3. Opening, closing and locking the doors Smart key system*

The following operations can be performed simply by carrying the electronic key on your person, for example in your pocket.

(The driver should always carry the electronic key.)

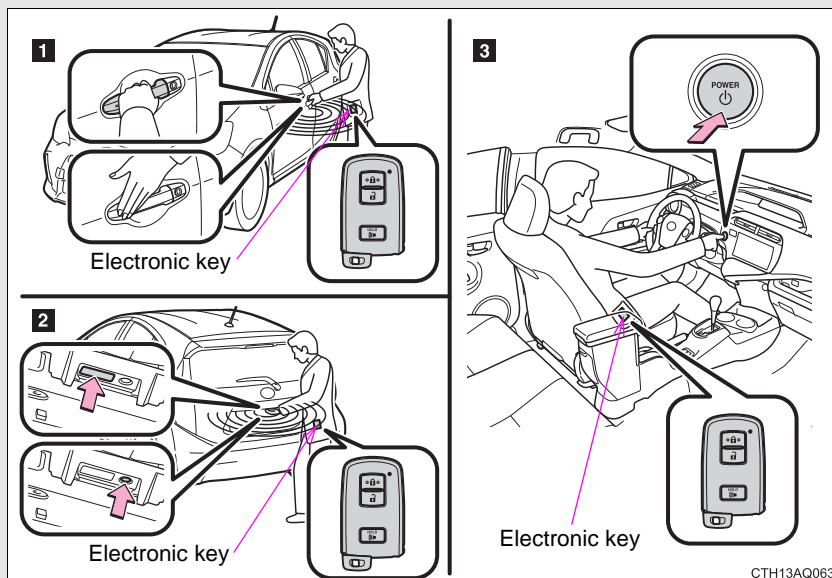

1 Unlocks and locks the side doors (→P. 48)

2 Unlocks and locks the back door (→P. 49)

3 Starts the hybrid system (→P. 164)

*: If equipped

Unlocking and locking the doors (front door handles only)

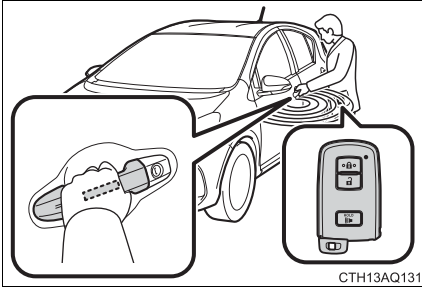

Grip the driver's door handle to unlock the door.* (Grip the passenger's door handle to unlock all doors.)

Make sure to touch the sensor on the back of the handle.

The doors cannot be unlocked for 3 seconds after the doors are locked.

*: The door unlock settings can be changed. (→P. 53)

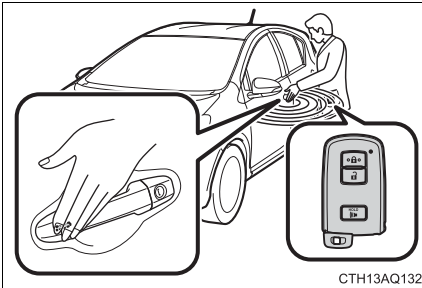

Touch the lock sensor (the indentation on the side of the door handle) to lock the doors.

Check that the door is securely locked.

Unlocking and locking the back door

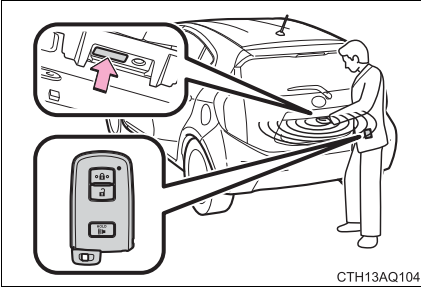

Press the button to unlock the back door.

The door cannot be unlocked for 3 seconds after the door is locked.

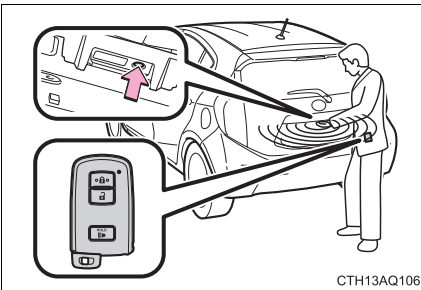

Press the button to lock the back door.

Check that the door is securely locked.

Antenna location and effective range

■ Antenna location

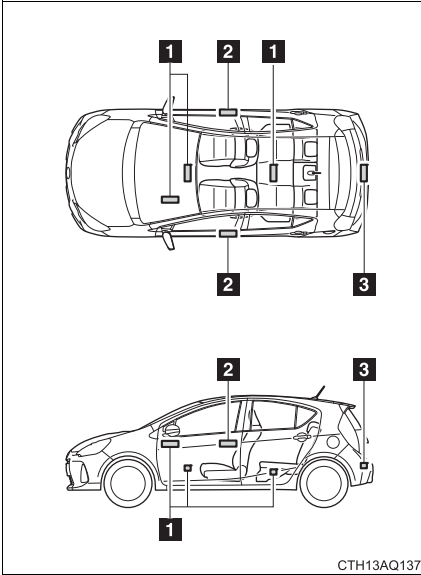

- 1** Antennas inside the cabin
- 2** Antennas outside the cabin
- 3** Antenna outside the luggage compartment

■ Effective range (areas within which the electronic key is detected)

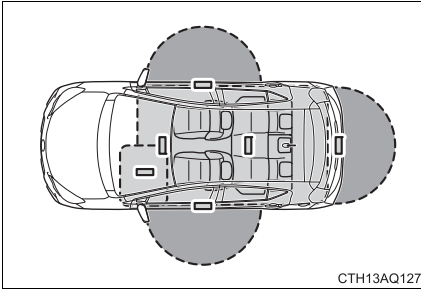

- When locking or unlocking the doors

The system can be operated when the electronic key is within about 2.3 ft. (0.7 m) of an outside door handle. (Only the doors detecting the key can be operated.)

- When starting the hybrid system or changing "POWER" switch modes

The system can be operated when the electronic key is inside the vehicle.

1

Before driving

■ Operation signals

A buzzer sounds and the emergency flashers flash to indicate that the doors have been locked/unlocked. (Locked: once; Unlocked: twice)

■ **When the door cannot be locked by the lock sensor on the surface of the door handle**

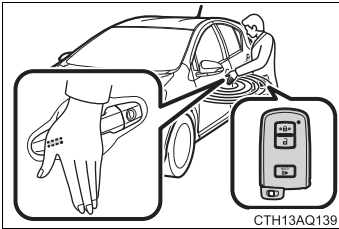

Use your palm to touch the lock sensor.

■ **Alarms and warning indicators**

A combination of exterior and interior alarms as well as warning messages shown on the multi-information display is used to prevent theft of the vehicle and accidents resulting from erroneous operation. Take appropriate measures in response to any warning message on the multi-information display. (→P. 447)

The following table describes circumstances and correction procedures when only alarms are sounded.

Alarm	Situation	Correction procedure
Exterior alarm sounds once for 5 seconds	An attempt was made to lock the vehicle while a door was open.	Close all of the doors and lock the doors again.
Interior alarm sounds continuously	The "POWER" switch was turned to ACCESSORY mode while the driver's door was open (or the driver's door was opened when the "POWER" switch was in ACCESSORY mode.)	Turn the "POWER" switch off and close the driver's door.



■ **Security feature**

If a door is not opened within approximately 60 seconds after the vehicle is unlocked, the security feature automatically locks the vehicle again. (However, depending on the location of the electronic key, the key may be detected as being in the vehicle. In this case, vehicle may be unlocked.)

■ Switching the door unlock function

It is possible to set which doors the entry function unlocks using the wireless remote control.

STEP 1 Turn the “POWER” switch off.

STEP 2 When the indicator light on the key surface is not on, press and hold  or  for about 5 seconds while pressing and holding  .

The setting changes each time an operation is performed, as shown below. (When changing the setting continuously, release the buttons, wait for at least 5 seconds, and repeat step 2.)

Unlocking doors	Beep
Holding the driver's door handle unlocks only the driver's door.	Exterior: Beeps 3 times Interior: Beeps once
Holding the front passenger's door handle unlocks all the doors.	
Holding either front door handle unlocks all the doors.	Exterior: Beeps twice Interior: Beeps once

■ Battery-saving function



The battery-saving function will be activated in order to prevent the electronic key battery and the 12-volt battery from being discharged while the vehicle is not in operation for a long time.

- In the following situations, the smart key system may take some time to unlock the doors.
 - The electronic key has been left in an area of approximately 6 ft. (2 m) of the outside of the vehicle for 10 minutes or longer.
 - The smart key system has not been used for 5 days or longer.
- If the smart key system has not been used for 14 days or longer, the doors cannot be unlocked at any of the doors except the driver's door. In this case, take hold of the driver's door handle, or use the wireless remote control or the mechanical key, to unlock the doors.

■ Electronic key battery-saving function

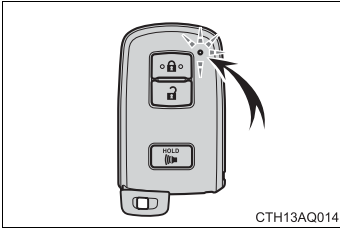
When battery-saving mode is set, battery depletion is minimized by stopping the electronic key from receiving radio waves.



Press  twice while pressing and holding . Confirm that the electronic key indicator flashes 4 times.

While the battery-saving mode is set, the smart key system cannot be used. To cancel the function, press any of the electronic key buttons.

■ Conditions affecting operation

The smart key system uses weak radio waves. In the following situations, the communication between the electronic key and the vehicle may be affected, preventing the smart key system, wireless remote control and immobilizer system from operating properly.

(Ways of coping: →P. 479)

- When the electronic key battery is depleted
- Near a TV tower, electric power plant, gas station, radio station, large display, airport or other facility that generates strong radio waves or electrical noise
- When the electronic key is in contact with, or is covered by the following metallic objects
 - Cards to which aluminum foil is attached
 - Cigarette boxes that have aluminum foil inside
 - Metallic wallets or bags
 - Coins
 - Hand warmers made of metal
 - Media such as CDs and DVDs
- When other wireless keys (that emit radio waves) are being used nearby
- When carrying the electronic key together with the following devices that emit radio waves
 - A portable radio, cellular phone, cordless phone or other wireless communication device
 - Another vehicle's electronic key or a wireless key that emits radio waves
 - Personal computers or personal digital assistants (PDAs)
 - Digital audio players
 - Portable game systems
- If window tint with a metallic content or metallic objects are attached to the rear window
- When the electronic key is placed near a battery charger or electronic devices

■ Notes for the entry function

- Even when the electronic key is within the effective range (detection areas), the system may not operate properly in the following cases:
 - The electronic key is too close to the window or outside door handle, near the ground, or in a high place when the doors are locked or unlocked.
 - The electronic key is on the instrument panel, luggage cover or floor, in the door pockets or glove box when the hybrid system is started or “POWER” switch modes are changed.
- Do not exit the vehicle with the electronic key placed on the instrument panel or near the door pockets. Depending on the radio wave reception conditions, it may be detected by the antenna outside the cabin and the door will become lockable from the outside, possibly trapping the electronic key inside the vehicle.
- As long as the electronic key is within the effective range, the doors may be locked or unlocked by anyone.
- Whether or not the electronic key is inside the vehicle, the hybrid system could be started if the electronic key is near the window.
- The doors may unlock if a large amount of water splashes on the door handle, such as in the rain or in a car wash when the electronic key is within the effective range. (The door will automatically be locked after approximately 60 seconds if the doors are not opened and closed.)
- The lock and unlock sensors may not work properly if they come into contact with ice, snow, mud, etc. Clean the sensors and attempt to operate them again.
- If the wireless remote control is used to lock the doors when the electronic key is near the vehicle, there is a possibility that the door may not be unlocked by the entry function. (Using the wireless remote control to unlock the doors may resume the function.)
- If the door handle becomes wet while the electronic key is within the effective range, the door may lock and unlock repeatedly. In that case, follow the following correction procedures to wash the vehicle:
 - Place the electronic key in a location 6 ft. (2 m) or more away from the vehicle. (Take care to ensure that the key is not stolen.)
 - Set the electronic key to battery-saving mode to disable the smart key system. (→P. 54)

■ Notes for locking the doors

- Touching the door lock sensor while wearing gloves may delay or prevent lock operation. Remove the gloves and touch the lock sensor again.
- When the lock operation is performed using the lock sensor, recognition signals will be shown up to two consecutive times. After this, no recognition signals will be given.
- If the electronic key is inside the vehicle and a door handle becomes wet during a car wash, a buzzer will sound outside the vehicle. To turn off the alarm, lock all the doors.

■ Notes for the unlocking function

- A sudden approach to the effective range or door handle may prevent the doors from being unlocked. In this case, return the door handle to the original position and check that the doors unlock before pulling the door handle again.
- Gripping the door handle when wearing a glove may not unlock the door. Remove the gloves and touch the sensor on the back of the handle again.
- If there is another electronic key in the detection area, it may take slightly longer to unlock the doors after the door handle is gripped.

■ When the vehicle is not driven for extended periods

- To prevent theft of the vehicle, do not leave the electronic key within 6 ft. (2 m) of the vehicle.
- The smart key system can be deactivated in advance. Ask your Toyota dealer for details.

■ To operate the smart key system properly

Make sure to carry the electronic key when operating the system. Do not get the electronic key too close to the vehicle when operating the system from the outside of the vehicle.

Depending on the position and holding condition of the electronic key, the key may not be detected correctly and the system may not operate properly. (The alarm may go off accidentally, or the door lock prevention function may not operate.)

■ If the smart key system does not operate properly

- Locking and unlocking the doors: Use the mechanical key. (→P. 479)
- Starting the hybrid system: →P. 479

■ **Electronic key battery depletion**

- The standard battery life is 1 to 2 years.
- If the battery becomes low, an alarm will sound in the cabin when the hybrid system stops. (→P. 455)
- As the electronic key always receives radio waves, the battery will become depleted even if the electronic key is not used. The following symptoms indicate that the electronic key battery may be depleted. Replace the battery when necessary. (→P. 401)
 - The smart key system or the wireless remote control does not operate.
 - The detection area becomes smaller.
 - The LED indicator on the key surface does not turn on.
- To avoid serious deterioration, do not leave the electronic key within 3 ft. (1 m) of the following electrical appliances that produce a magnetic field:
 - TVs
 - Personal computers
 - Cellular phones, cordless phones and battery chargers
 - Recharging cellular phones or cordless phones
 - Induction cookers
 - Table lamps

■ **When the electronic key battery is fully depleted**

→P. 401

■ **If the smart key system has been deactivated in a customized setting**

- Locking and unlocking the doors: Use the wireless remote control or mechanical key. (→P. 61, 479)
- Starting the hybrid system and changing “POWER” switch modes: →P. 479
- Stopping the hybrid system: →P. 480

■ **Customization that can be configured at Toyota dealer**

Settings (e. g. operation signals) can be changed.
(Customizable features: →P. 522)

■ Certification for the smart key system**U.S.A.**

FCC ID: HYQ23AAB

FCC ID: HYQ14FBA

NOTE:

This device complies with part 15 of the FCC Rules. Operation is subject to the following two conditions: (1) This device may not cause harmful interference, and (2) this device must accept any interference received, including interference that may cause undesired operation.

FCC WARNING:

Changes or modifications not expressly approved by the party responsible for compliance could void the user's authority to operate the equipment.

Canada**NOTE:**

Operation is subject to the following two conditions: (1) this device may not cause interference, and (2) this device must accept any interference, including interference that may cause undesired operation of the device.

U.S.A.

FCC ID: NI4TMLF10-6

FCC ID: NI4TMLF10-7

NOTE:

This device complies with part 15 of the FCC Rules. Operation is subject to the following two conditions: (1) This device may not cause harmful interference, and (2) this device must accept any interference received, including interference that may cause undesired operation.

FCC WARNING:

Changes or modifications not expressly approved by the party responsible for compliance could void the user's authority to operate the equipment.

Canada**NOTE:**

This device complies with Industry Canada licence-exempt RSS standard(s). Operation is subject to the following two conditions: (1) this device may not cause interference, and (2) this device must accept any interference, including interference that may cause undesired operation of the device.

 CAUTION

■ **Caution regarding interference with electronic devices**

- People with implantable cardiac pacemakers, cardiac resynchronization therapy-pacemakers or implantable cardioverter defibrillators should keep away from the smart key system antennas. (→P. 50)

The radio waves may affect the operation of such devices. If necessary, the entry function can be disabled. Ask your Toyota dealer for details, such as the frequency of radio waves and timing of the emitted radio waves. Then, consult your doctor to see if you should disable the entry function.

- Users of any electrical medical device other than implantable cardiac pacemakers, cardiac resynchronization therapy-pacemakers or implantable cardioverter defibrillators should consult the manufacturer of the device for information about its operation under the influence of radio waves.

Radio waves could have unexpected effects on the operation of such medical devices.

Ask your Toyota dealer for details for disabling the entry function.

1-3. Opening, closing and locking the doors

Wireless remote control

1

Before driving

The wireless remote control can be used to lock and unlock the vehicle.

Vehicles without a smart key system

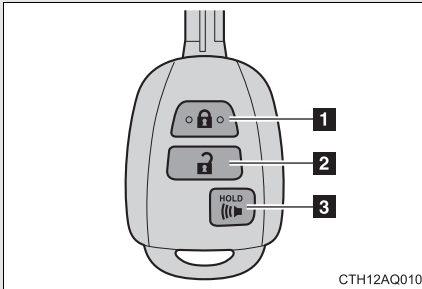

1 Locks all the doors

Check that the door is securely locked.

2 Unlocks all the doors

Pressing the button unlocks the driver's door. Pressing the button again within 5 seconds unlocks the other doors.

3 Sounds the alarm
(press and hold)

Vehicles with a smart key system

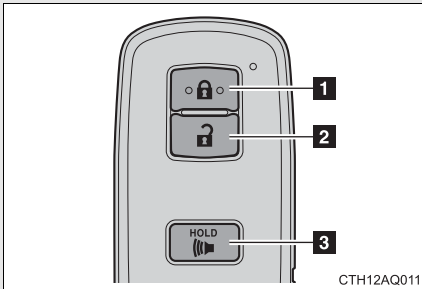

1 Locks all the doors

Check that the door is securely locked.

2 Unlocks all the doors

Pressing the button unlocks the driver's door. Pressing the button again within 5 seconds unlocks the other doors.

3 Sounds the alarm
(press and hold)

■ Operation signals

Vehicles without a smart key system

The emergency flashers flash to indicate that the doors have been locked/unlocked. (Locked: once; Unlocked: twice)

Vehicles with a smart key system

A buzzer sounds and the emergency flashers flash to indicate that the doors have been locked/unlocked. (Locked: once; Unlocked: twice)

■ Panic mode

Vehicles without a smart key system

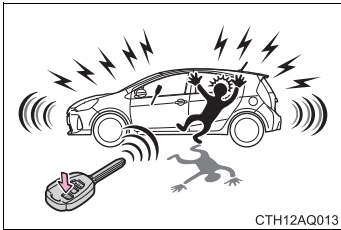

When  is pressed for longer than about one second, an alarm will sound intermittently and the vehicle lights will flash to deter any person from trying to break into or damage your vehicle.

To stop the alarm, press any button on the wireless remote control.

Vehicles with a smart key system

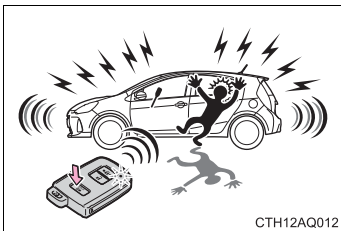

When  is pressed for longer than about one second, an alarm will sound intermittently and the vehicle lights will flash to deter any person from trying to break into or damage your vehicle.

To stop the alarm, press any button on the electronic key.

■ Door lock buzzer (vehicles with a smart key system)

If an attempt to lock the doors is made when a door is not fully closed, a buzzer sounds continuously. Fully close the door to stop the buzzer, and lock the vehicle once more.

■ Security feature

If a door is not opened within approximately 60 seconds after the vehicle is unlocked, the security feature automatically locks the vehicle again.

■ Conditions affecting operation

Vehicles without a smart key system

The wireless remote control function may not operate normally in the following situations:

- When the wireless key battery is depleted
- Near a TV tower, electric power plant, gas station, radio station, large display, airport or other facility that generates strong radio waves or electrical noise
- When carrying a portable radio, cellular phone or other wireless communication device
- When the wireless key is in contact with, or is covered by a metallic object
- When other wireless keys (that emits radio waves) are being used nearby
- If window tint with a metallic content or metallic objects are attached to the rear window

Vehicles with a smart key system

→P. 55

■ If the wireless remote control does not operate properly (vehicles with a smart key system)

Locking and unlocking the doors: Use the mechanical key.
(→P. 479)

■ Key battery depletion

Vehicles without a smart key system

If the wireless remote control function does not operate, the battery may be depleted. Replace the battery when necessary. (→P. 401)

Vehicles with a smart key system

→P. 58

■ When the electronic key battery is fully depleted

→P. 401

■ **Confirmation of the registered key number (vehicles with a smart key system)**

The number of keys already registered to the vehicle can be confirmed. Ask your Toyota dealer for details.

■ **Customization that can be configured at Toyota dealer**

Settings (e.g. wireless remote control system) can be changed.
(Customizable features →P. 522)

■ **Certification for wireless remote control**

U.S.A.

FCC ID: HYQ23AAC

FCC ID: HYQ12BDM

NOTE:

This device complies with part 15 of the FCC Rules. Operation is subject to the following two conditions: (1) This device may not cause harmful interference, and (2) this device must accept any interference received, including interference that may cause undesired operation.

FCC WARNING:

Changes or modifications not expressly approved by the party responsible for compliance could void the user's authority to operate the equipment.

Canada

NOTE:

Operation is subject to the following two conditions: (1) this device may not cause interference, and (2) this device must accept any interference, including interference that may cause undesired operation of the device.

1-3. Opening, closing and locking the doors

Side doors

The vehicle can be locked and unlocked using the entry function, wireless remote control, key or door lock switch.

■ Entry function (if equipped)

→P. 47

■ Wireless remote control

→P. 61

■ Key

Turning the key operates the doors as follows:

Vehicles without a smart key system

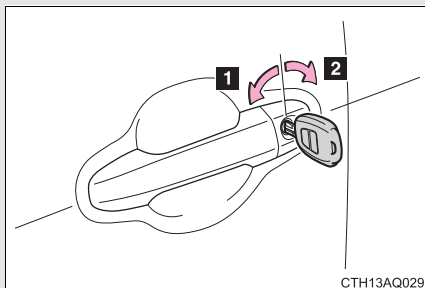

- 1 Locks all the doors
- 2 Unlocks all the doors

Driver's side only: Turning the key unlocks the driver's door. Turning the key again within 5 seconds unlocks the other doors.

Vehicles with a smart key system

The doors can also be locked and unlocked with the mechanical key. (→P. 479)

■ Door lock switch

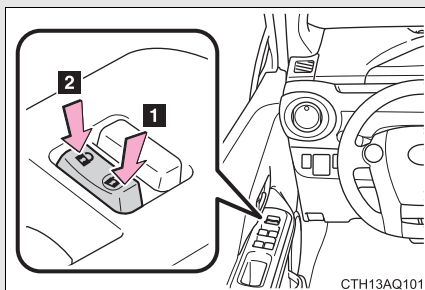

- 1 Locks all the doors
- 2 Unlocks all the doors

■ Inside lock buttons

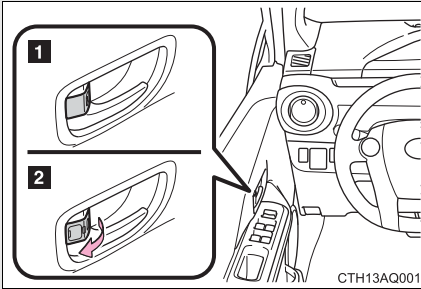

1 Locks the door

2 Unlocks the door

The front doors can be opened by pulling the inside handle even if the lock buttons are in the lock position.

Locking the front doors from the outside without a key

STEP 1 Move the inside door lock button to the lock position.

STEP 2 Close the door.

Vehicles without a smart key system

The door cannot be locked if either of the front doors is open and the key is in the engine switch.

Vehicles with a smart key system

The door cannot be locked if the “POWER” switch is in ACCESSORY or ON mode, or the electronic key is left inside the vehicle.

The key may not be detected correctly and the door may be locked.

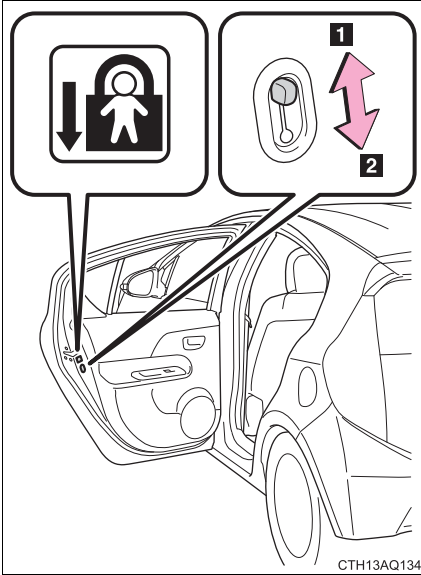
Rear door child-protector lock

The door cannot be opened from inside the vehicle when the lock is set.

1 Unlock

2 Lock

These locks can be set to prevent children from opening the rear doors. Push down on each rear door switch to lock both rear doors.

Automatic door locking and unlocking systems

The following functions can be set or canceled:

Function	Operation
Shift position linked door locking function	Shifting the shift lever out of P locks all doors.
Shift position linked door unlocking function	Shifting the shift lever to P unlocks all doors.
Speed linked door locking function (vehicles with a smart key system)	All doors are locked when the vehicle speed is approximately 12 mph (20 km/h) or higher.
Driver's door linked door unlocking function (vehicles without a smart key system)	All doors are unlocked when the driver's door is opened within 45 seconds after turning the engine switch to "ACC" or "LOCK".
Driver's door linked door unlocking function (vehicles with a smart key system)	All doors are unlocked when the driver's door is opened within 45 seconds after turning the "POWER" switch off.

■ Setting and canceling the functions

To switch between setting and canceling, follow the procedure below:

STEP 1 Vehicles without a smart key system

Close all the doors and turn the engine switch to the "ON" position. (Perform **STEP 2** within 20 seconds.)

Vehicles with a smart key system

Close all the doors and switch the "POWER" switch to ON mode. (Perform **STEP 2** within 20 seconds.)

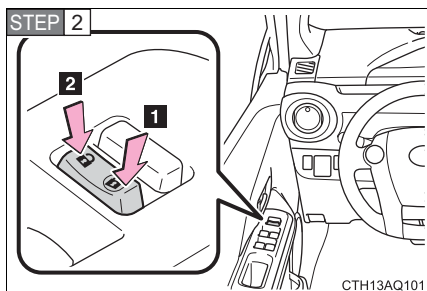

Shift the shift lever to P or N, and press and hold the door lock switch (**1** or **2**) for about 5 seconds then release.

The shift position corresponding to the desired function to be set are shown as follows.

Use the same procedure to cancel the function.

Function	Shift position	Door lock switch position
Shift position linked door locking function	P	1
Shift position linked door unlocking function		2
Speed linked door locking function	N	1
Driver's door linked door unlocking function		2

When the setting or canceling operation is complete, all doors are locked and then unlocked.

■ Using the mechanical key (vehicles with a smart key system)

The doors can also be locked and unlocked with the mechanical key. (→P. 479)

■ If a wrong key is used (vehicles with a smart key system)

The key cylinder rotates freely to isolate inside mechanism.

■ Customization that can be configured at Toyota dealer

Settings (e.g. unlocking function using a key) can be changed. (Customizable features →P. 522)

 CAUTION

■ **To prevent an accident**

Observe the following precautions while driving the vehicle.

Failure to do so may result in a door opening and an occupant falling out, resulting in death or serious injury.

- Always use a seat belt.
- Always lock all the doors.
- Ensure that all the doors are properly closed.
- Do not pull the inside handle of the doors while driving.

The doors may be opened and the passengers are thrown out of the vehicle and it may result in serious injury or death.

Be especially careful for the front doors, as the doors may be opened even if the inside lock buttons are in locked position.

- Set the rear door child-protector locks when children are seated in the rear seats.

Back door

The back door can be locked/unlocked and opened by the following procedures.

■ Locking and unlocking the back door

Wireless remote control

→P. 61

Door lock switches

→P. 65

Entry function (if equipped)

→P. 47

■ Opening the back door from outside the vehicle

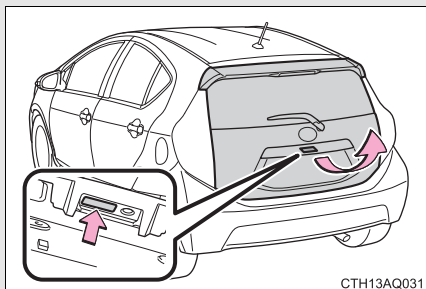

Raise the back door while pushing up the back door opener switch.

The back door cannot be closed immediately after the back door opener switch is pushed.

When closing the back door

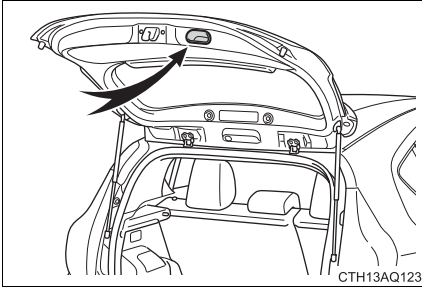

Lower the back door using the back door handle, and make sure to push the back door down from the outside to close it.

⚠ CAUTION

■ Caution while driving

- Keep the back door closed while driving. If the back door is left open, it may hit near-by objects while driving or luggage may be unexpectedly thrown out, causing an accident. In addition, exhaust gases may enter the vehicle, causing death or a serious health hazard. Make sure to close the back door before driving.
- Before driving the vehicle, make sure that the back door is fully closed. If the back door is not fully closed, it may open unexpectedly while driving, causing an accident.
- Never let anyone sit in the luggage compartment. In the event of sudden braking or a collision, they are susceptible to death or serious injury.

 **CAUTION****■ When children are in the vehicle**

Observe the following precautions.

Failure to do so may result in death or serious injury.

- Do not allow children to play in the luggage compartment.

If a child is accidentally locked in the luggage compartment, they could have heat exhaustion or other injuries.

- Do not allow a child to open or close the back door.

Doing so may cause the back door to move unexpectedly, or cause the child's hands, head, or neck to be caught by the closing back door.

■ Operating the back door

Observe the following precautions.

Failure to do so may cause parts of the body to be caught, resulting in death or serious injury.

- Remove any heavy loads, such as snow and ice, from the back door before opening it. Failure to do so may cause the back door to suddenly shut again after it is opened.
- When opening or closing the back door, thoroughly check to make sure the surrounding area is safe.
- If anyone is in the vicinity, make sure they are safe and let them know that the back door is about to open or close.
- Use caution when opening or closing the back door in windy weather as it may move abruptly in strong wind.

! CAUTION

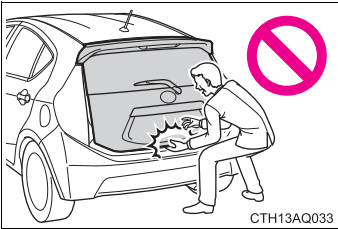
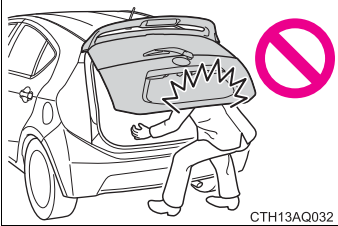

- The back door may suddenly shut if it is not opened fully. It is more difficult to open or close the back door on an incline than on a level surface, so beware of the back door unexpectedly opening or closing by itself. Make sure that the back door is fully open and secure before using the luggage compartment.

- When closing the back door, take extra care to prevent your fingers etc. from being caught.

- When closing the back door, make sure to press it lightly on its outer surface. If the back door handle is used to fully close the back door, it may result in hands or arms being caught.

- Do not pull on the back door damper stay to close the back door, and do not hang on the back door damper stay. Doing so may cause hands to be caught or the back door damper stay to break, causing an accident.
- If a bicycle carrier or similar heavy object is attached to the back door, it may suddenly shut again after being opened, causing someone's hands, head or neck to be caught and injured. When installing an accessory part to the back door, using a genuine Toyota part is recommended.

 NOTICE**■ Back door damper stays**

The back door is equipped with damper stays that hold the back door in place.

Observe the following precautions.

Failure to do so may cause damage to the back door damper stay, resulting in malfunction.

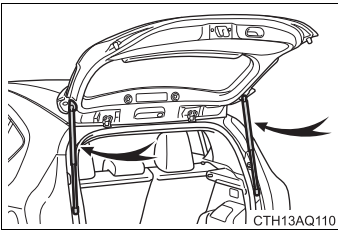

- Do not attach any foreign objects, such as stickers, plastic sheets, or adhesives to the damper stay rod.
- Do not touch the damper stay rod with gloves or other fabric items.
- Do not attach any accessories other than genuine Toyota parts to the back door.
- Do not place your hand on the damper stay or apply lateral forces to it.

Front seats

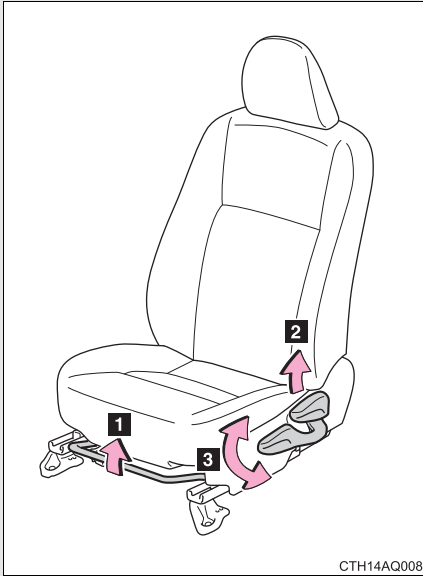

- 1 Seat position adjustment lever
- 2 Seatback angle adjustment lever
- 3 Vertical height adjustment lever (if equipped)

CAUTION

■ Seat adjustment

- Be careful that the seat does not hit passengers or luggage.
- To reduce the risk of sliding under the lap belt during a collision, do not recline the seat more than necessary.

If the seat is too reclined, the lap belt may slide past the hips and apply restraint forces directly to the abdomen, or your neck may contact the shoulder belt, increasing the risk of death or serious injury in the event of an accident.

Adjustments should not be made while driving as the seat may unexpectedly move and cause the driver to lose control of the vehicle.

- After adjusting the seat, make sure that the seat is locked in position.

1-4. Adjustable components (seats, mirrors, steering wheel)

Rear seats

The seatbacks of the rear seats can be folded down.

Folding down the rear seatbacks

■ Before folding down the rear seatbacks

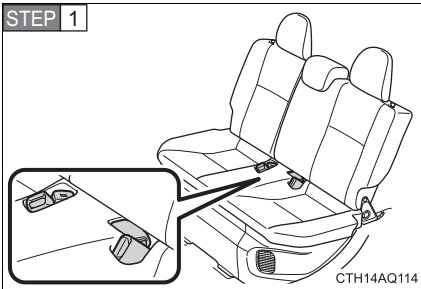

Stow the rear seat belt buckles as shown.

STEP 2 Stow the seat belts.

Center

→P. 86

Outside

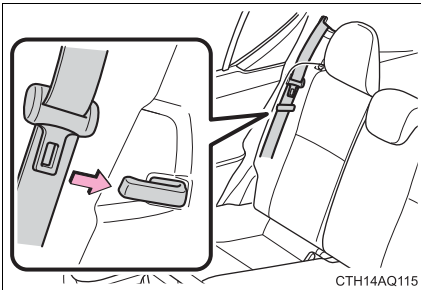

Use the seat belt hangers to prevent the belts from being tangled.

1

Before driving

STEP 3 Remove the outside head restraints. (→P. 81)

STEP 4 Lower the center head restraint to the lowest position.
(→P. 81)

■ Folding down rear seatbacks

Vehicles with a split rear seats

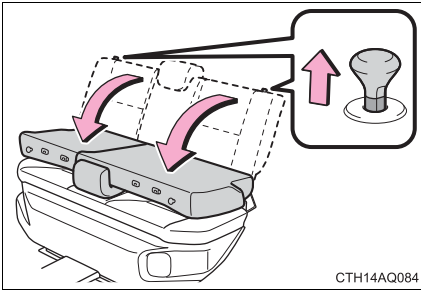

Pull the seatback lock release knob and fold the seatback down.

Each seatback may be folded separately.

Vehicles with a non-split rear seat

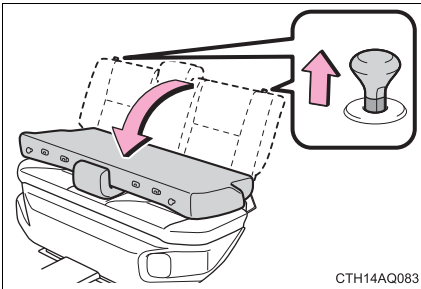

Pull both seatback lock release knobs at the same time and fold the seatback down.

 CAUTION**■ When folding the rear seatbacks down**

Observe the following precautions. Failure to do so may result in death or serious injury.

- Do not fold the seatbacks down while driving.
- Stop the vehicle on level ground, set the parking brake and shift the shift lever to P.
- Do not allow anyone to sit on a folded seatback or in the luggage compartment while driving.
- Do not allow children to enter the luggage compartment.
- For vehicles with split rear seats, do not allow anyone sit on the rear center seat if the rear right seat is folded down, as the seat belt buckle for the rear center seat belt is then concealed under the folded seat and cannot be used.
- Be careful not to catch your hand when folding the rear seatbacks.
- If it is necessary to detach the head restraints, remove it from the vehicle or store it securely in the luggage compartment. This will prevent it from injuring passengers in the event of sudden braking, sudden swerving or an accident.
- Adjust the position of the front seat before folding down the rear seatbacks so that the front seat does not interfere with the rear seatbacks when folding down the rear seatbacks.

⚠ CAUTION

■ **After returning the rear seatback to the upright position**

Observe the following precautions. Failure to do so may result in death or serious injury.

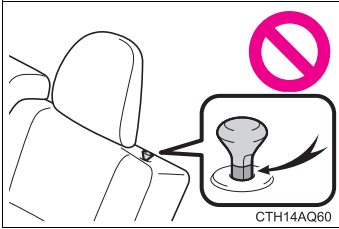

- Make sure that the seatback is securely locked in position by lightly pushing it back and forth.
If the seatback is not securely locked, the red marking will be visible on the seatback lock release knob. Make sure that the red marking is not visible.

- Check that the seat belts are not twisted or caught in the seatback.

⚠ NOTICE

■ **Stowing the seat belts**

The seat belts and the buckles must be stowed before you fold down the rear seatbacks.

1-4. Adjustable components (seats, mirrors, steering wheel)

Head restraints

Head restraints are provided for all seats.

Vehicles with adjustable type head restraints

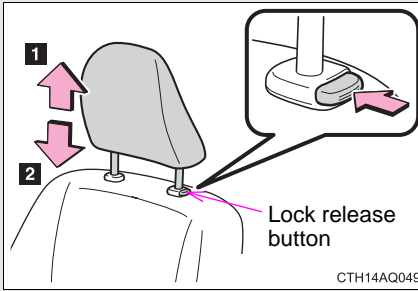

1 Up

Pull the head restraint up.

2 Down

Push the head restraint down while pushing the lock release button.

1

Before driving

■ Removing the head restraints

Front adjustable and rear center head restraints

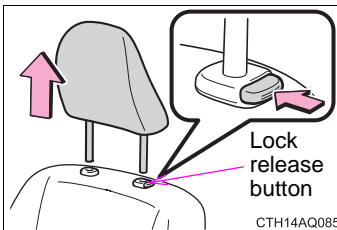

Pull the head restraint up while pushing the lock release button.

Rear outside head restraints

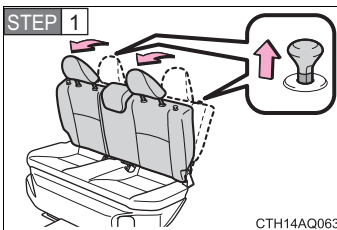

Pull the seatback lock release knob and fold down the seatback until it reaches the position where the head restraints can be removed.

1-4. Adjustable components (seats, mirrors, steering wheel)

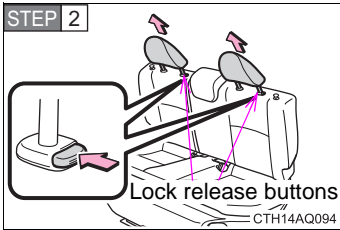

Pull the head restraint up while pressing the lock release button.

■ Installing the head restraints

Front adjustable and rear center head restraints

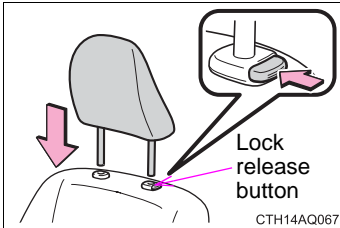

Align the head restraint with installation holes and push it down to the lock position.

Press and hold the lock release button when lowering the head restraint.

Rear outside head restraints

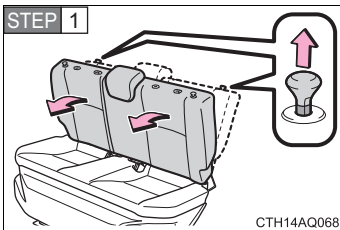

Pull the lock release knob and fold down the seatback until it reaches the position where the head restraints can be installed.

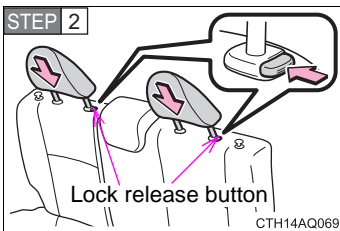

Align the head restraint with installation holes and push it down to the lock position.

Press and hold the lock release button when lowering the head restraint.

■ **Adjusting the height of the head restraints (vehicles with adjustable type head restraints)**

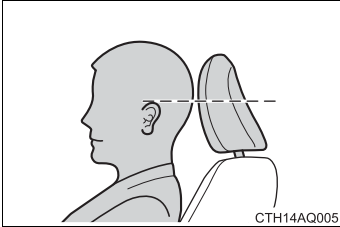

Make sure that the head restraints are adjusted so that the center of the head restraint is closest to the top of your ears.

■ **Adjusting the rear center seat head restraints**

Always raise the head restraint one level from the stowed position when using.

⚠ CAUTION

■ **Head restraint precautions (vehicles with adjustable type head restraints)**

Observe the following precautions regarding the head restraints. Failure to do so may result in death or serious injury.

- Use the head restraints designed for each respective seat.
- Adjust the head restraints to the correct position at all times.
- After adjusting the head restraints, push down on them and make sure they are locked in position.
- Do not drive with the head restraints removed.

1-4. Adjustable components (seats, mirrors, steering wheel)

Seat belts

Make sure that all occupants are wearing their seat belts before driving the vehicle.

■ Correct use of the seat belts

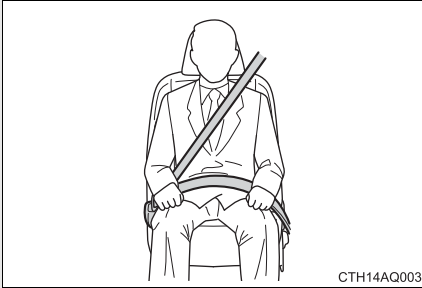

- Extend the shoulder belt so that it comes fully over the shoulder, but does not come into contact with the neck or slide off the shoulder.
- Position the lap belt as low as possible over the hips.
- Adjust the position of the seatback. Sit up straight and well back in the seat.
- Do not twist the seat belt.

■ Fastening and releasing the seat belt

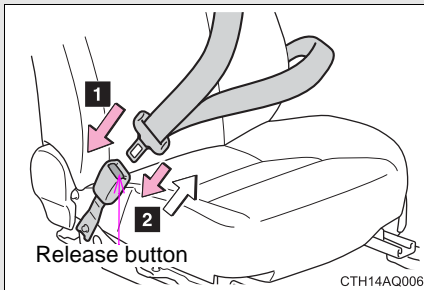

- 1** To fasten the seat belt, push the plate into the buckle until a click sound is heard.
- 2** To release the seat belt, press the release button.

Rear center seat belt

■ Fastening the seat belt

The rear center seat belt is a 3-point type restraint with 2 buckles. Both seat belt buckles must be correctly located and securely latched for proper operation.

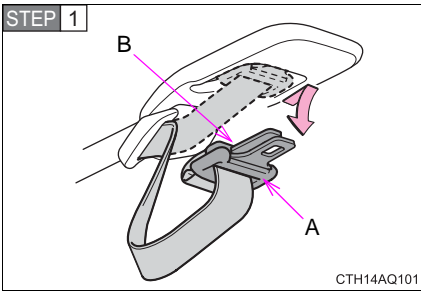

Push the tabs back all the way into the cover and then remove the tabs.

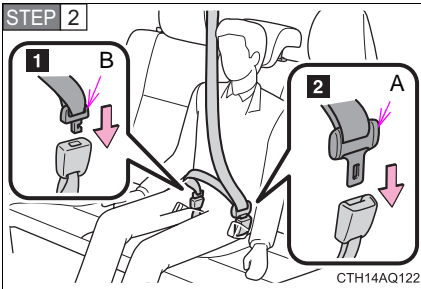

- 1** Push tab “B” into the buckle until a click sound is heard.
- 2** Push tab “A” into the buckle until a click sound is heard.

■ Releasing the seat belt

Release the rear center seat belt only when necessary, such as when folding down the rear seat. For safety, always store the plate in the designated place after releasing it.

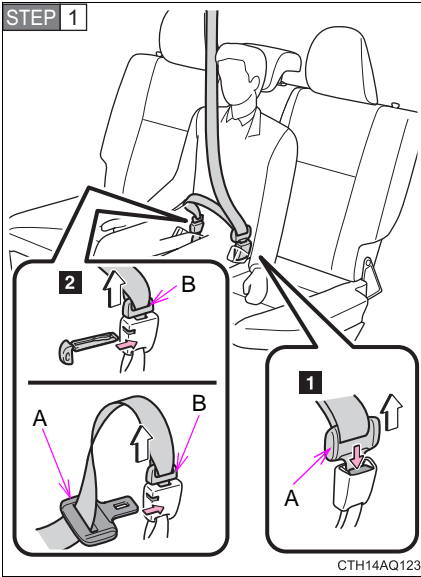

1 To release tab “A”, press the release button.

2 To release tab “B”, insert the key (→P. 44) or tab “A” into the hole on the buckle.

Retract the belt slowly when releasing and stowing the seat belt.

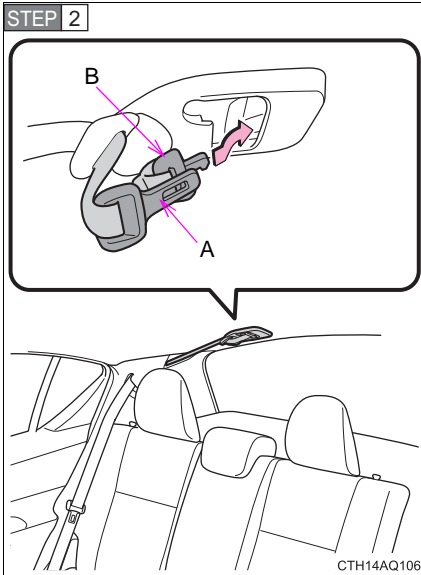

Holding tab “A” and “B” together, insert both tabs all the way into the cover on the roof.

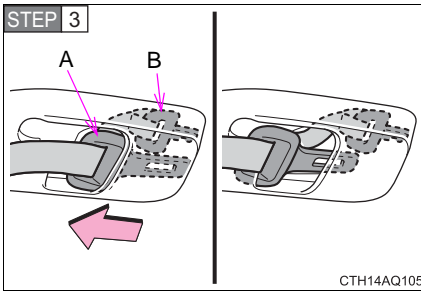

With tab “B” inserted all the way into the cover, move tab “A” slightly back toward the cover’s inlet, so that it blocks the inlet.

Seat belt pretensioners (front seats)

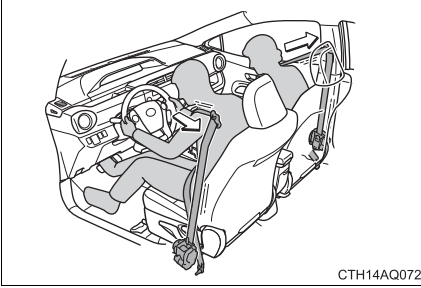

The pretensioner helps the seat belt to quickly restrain the occupant by retracting the seat belt when the vehicle is subjected to certain types of severe frontal or side collision.

The pretensioner does not activate in the event of a minor frontal impact, a minor side impact, a rear impact or a vehicle rollover.

■ Emergency locking retractor (ELR)

The retractor will lock the belt during a sudden stop or on impact. It may also lock if you lean forward too quickly. A slow, easy motion will allow the belt to extend so that you can move around fully.

■ Automatic locking retractor (ALR)

When a passenger's shoulder belt is completely extended and then retracted even slightly, the belt is locked in that position and cannot be extended. This feature is used to hold the child restraint system (CRS) firmly. To free the belt again, fully retract the belt and then pull the belt out once more. (→P. 140)

■ Child seat belt usage

The seat belts of your vehicle were principally designed for persons of adult size.

- Use a child restraint system appropriate for the child, until the child becomes large enough to properly wear the vehicle's seat belt. (→P. 136)
- When the child becomes large enough to properly wear the vehicle's seat belt, follow the instructions on P. 84 regarding seat belt usage.

■ Replacing the belt after the pretensioner has been activated

If the vehicle is involved in multiple collisions, the pretensioner will activate for the first collision, but will not activate for the second or subsequent collisions.

■ Seat belt extender

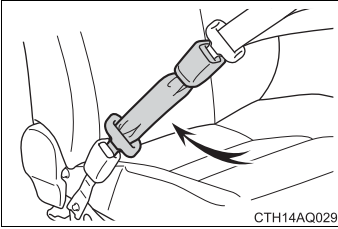

If your seat belts cannot be fastened securely because they are not long enough, a personalized seat belt extender is available from your Toyota dealer free of charge.

▲ CAUTION

Observe the following precautions to reduce the risk of injury in the event of sudden braking, sudden swerving or an accident. Failure to do so may cause death or serious injury.

■ Wearing a seat belt

- Ensure that all passengers wear a seat belt.
- Always wear a seat belt properly.
- Each seat belt should be used by one person only. Do not use a seat belt for more than one person at once, including children.
- Toyota recommends that children be seated in the rear seat and always use a seat belt and/or an appropriate child restraint system.
- To achieve a proper seating position, do not recline the seat more than necessary. The seat belt is most effective when the occupants are sitting up straight and well back in the seats.
- Do not wear the shoulder belt under your arm.
- Always wear your seat belt low and snug across your hips.

! CAUTION

■ Pregnant women

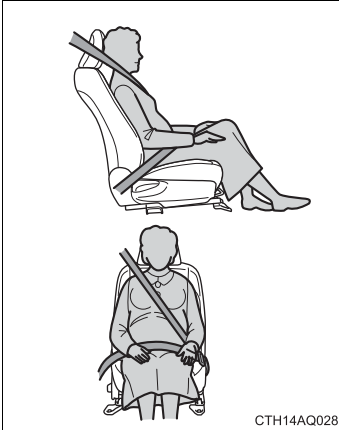

Obtain medical advice and wear the seat belt in the proper way. (→P. 84)

Women who are pregnant should position the lap belt as low as possible over the hips in the same manner as other occupants. Extend the shoulder belt completely over the shoulder and position the belt across the chest. Avoid belt contact over the rounding of the abdominal area.

If the seat belt is not worn properly, not only the pregnant woman, but also the fetus could suffer death or serious injury as a result of sudden braking or a collision.

■ People suffering illness

Obtain medical advice and wear the seat belt in the proper way. (→P. 84)

■ When children are in the vehicle

Do not allow children to play with the seat belt. If the seat belt becomes twisted around a child's neck, it may lead to choking or other serious injuries that could result in death.

If this occurs and the buckle cannot be unfastened, scissors should be used to cut the belt.

■ Seat belt pretensioners

● Do not place anything, such as a cushion, on the front passenger's seat. Doing so will disperse the passenger's weight, which prevents the sensor from detecting the passenger's weight properly. As a result, the seat belt pretensioner for the front passenger's seat may not activate in the event of a collision.

● If the pretensioner has activated, the SRS warning light will come on. In that case, the seat belt cannot be used again and must be replaced at your Toyota dealer.

⚠ CAUTION**■ Seat belt damage and wear**

- Do not damage the seat belts by allowing the belt, plate, or buckle to be jammed in the door.
- Inspect the seat belt system periodically. Check for cuts, fraying, and loose parts. Do not use a damaged seat belt until it is replaced. Damaged seat belts cannot protect an occupant from death or serious injury.
- Ensure that the belt and plate are locked and the belt is not twisted. If the seat belt does not function correctly, immediately contact your Toyota dealer.
- Replace the seat assembly, including the belts, if your vehicle has been involved in a serious accident, even if there's no obvious damage.
- Do not attempt to install, remove, modify, disassemble or dispose of the seat belts. Have any necessary repairs carried out by your Toyota dealer. Inappropriate handling of the pretensioner may prevent it from operating properly, resulting in death or serious injury.

■ When using or storing the rear center seat belt

- Do not use the rear center seat belt with either buckle released.

Fastening only one of the buckles may result in death or serious injury in case of sudden braking or a collision.

- For vehicles with split rear seats, do not allow anyone sit on the rear center seat if the rear right seat is folded down, as the seat belt buckle for the rear center seat belt is then concealed under the folded seat and cannot be used.
- When storing the rear center seat belt, ensure that the tabs are securely inserted into the cover on the roof. If the tabs are not stowed properly, they may drop from the cover while driving, resulting in serious injury.

 **CAUTION**

■ **Using a seat belt extender**

- Do not wear the seat belt extender if you can fasten the seat belt without the extender.
- Do not use the seat belt extender when installing a child restraint system because the belt will not securely hold the child restraint system, increasing the risk of death or serious injury in the event of an accident.
- The personalized extender may not be safe on another vehicle, when used by another person, or at a different seating position other than the one originally intended.

 **NOTICE**

■ **When using a seat belt extender**

When releasing the seat belt, press on the buckle release button on the extender, not on the seat belt.

This helps prevent damage to the vehicle interior and the extender itself.

1-4. Adjustable components (seats, mirrors, steering wheel)

Steering wheel

The steering wheel can be adjusted to a comfortable position.

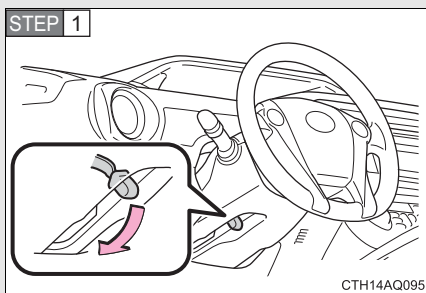

Hold the steering wheel and push the lever down.

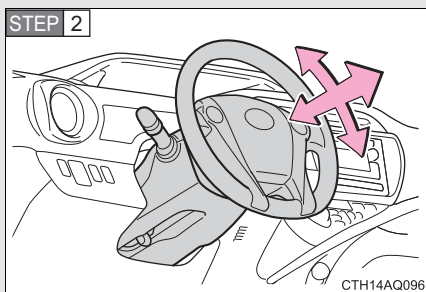

Adjust to the ideal position by moving the steering wheel horizontally and vertically.

After adjustment, pull the lever up to secure the steering wheel.

⚠ CAUTION

■ **Caution while driving**

Do not adjust the steering wheel while driving. Doing so may cause the driver to mishandle the vehicle and cause an accident, resulting in death or serious injury.

■ **After adjusting the steering wheel**

Make sure that the steering wheel is securely locked. Otherwise, the steering wheel may move suddenly, possibly causing an accident, and resulting in death or serious injury.

1-4. Adjustable components (seats, mirrors, steering wheel) Anti-glare inside rear view mirror

The rear view mirror's position can be adjusted to enable sufficient confirmation of the rear view in accordance with the driver's seating posture.

Adjusting the height of rear view mirror

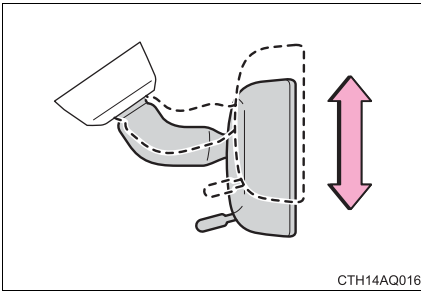

Adjust the height of the rear view mirror by moving it up and down.

Anti-glare function

Reflected light from the headlamps of vehicles behind can be reduced by operating the lever.

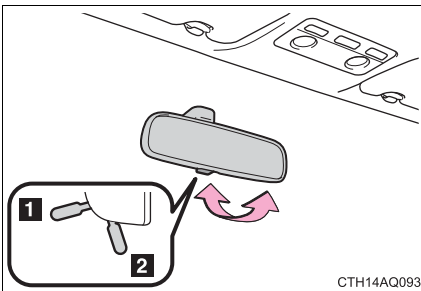

- 1 Normal position
- 2 Anti-glare position

 CAUTION

■ **Caution while driving**

Do not adjust the position of the mirror while driving.

Doing so may lead to mishandling of the vehicle and cause an accident, resulting in death or serious injury.

1-4. Adjustable components (seats, mirrors, steering wheel)

Outside rear view mirrors

Mirror angle can be adjusted using the switch.

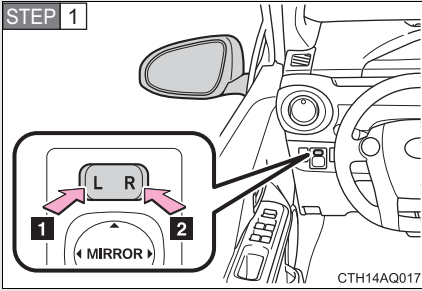

To select a mirror to adjust, press the switch.

- 1** Left
- 2** Right

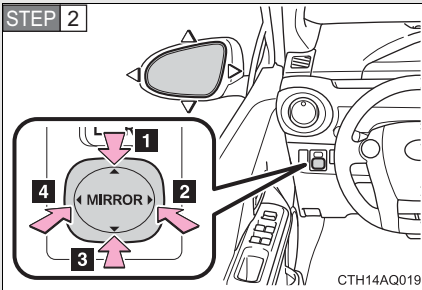

To adjust the mirror, press the switch.

- 1** Up
- 2** Right
- 3** Down
- 4** Left

Folding the mirrors

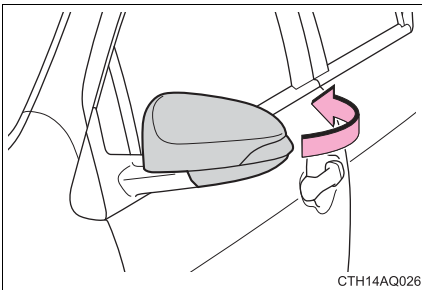

Push the mirror back in the direction of the vehicle's rear.

■ **Mirror angle can be adjusted when**

Vehicles without a smart key system

The engine switch is in the "ACC" or "ON" position.

Vehicles with a smart key system

The "POWER" switch is in ACCESSORY or ON mode.

■ **When the mirrors are fogged up (vehicles with outside rear view mirror defoggers)**

The outside rear view mirrors can be cleared using the mirror defoggers. Turn on the rear window defogger to turn on the outside rear view mirror defoggers. (→P. 247)

 **CAUTION**

■ **When driving the vehicle**

Observe the following precautions while driving.

Failure to do so may result in loss of control of the vehicle and cause an accident, resulting in death or serious injury.

- Do not adjust the mirrors while driving.
- Do not drive with the mirrors folded.
- Both the driver and passenger side mirrors must be extended and properly adjusted before driving.

■ **When a mirror is moving**

To avoid personal injury and mirror malfunction, be careful not to get your hand caught by the moving mirror.

■ **When the mirror defoggers are operating (vehicles with an outside rear view mirror defoggers)**

Do not touch the rear view mirror surfaces, as they can become very hot and burn you.

1-5. Opening and closing the windows and moon roof Power windows*

The power windows can be opened and closed using the switches.

Operating the switch moves the windows as follows:

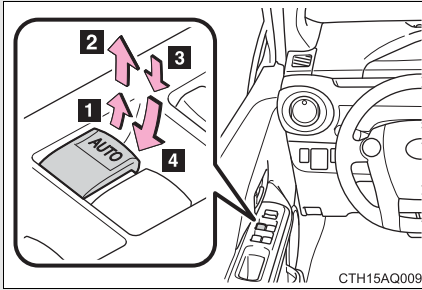

- 1 Closing
- 2 One-touch closing (driver's window only)*
- 3 Opening
- 4 One-touch opening (driver's window only)*

*: To stop the window partway, operate the switch in the opposite direction.

Window lock switch

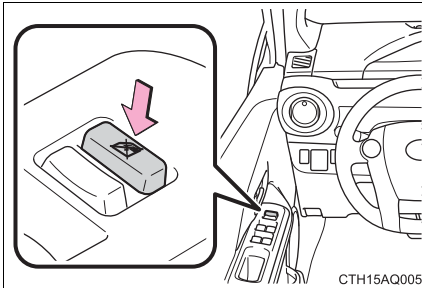

Press the switch down to lock the passenger window switches.

Use this switch to prevent children from accidentally opening or closing a passenger window.

*: If equipped

■ The power windows can be operated when**Vehicles without a smart key system**

The engine switch is in the "ON" position.

Vehicles with a smart key system

The "POWER" switch is in ON mode.

■ Operating the power windows after turning the hybrid system off**Vehicles without a smart key system**

The power windows can be operated for approximately 45 seconds even after the engine switch is turned to the "ACC" or "LOCK" position. They cannot, however, be operated once either front door is opened.

Vehicles with a smart key system

The power windows can be operated for approximately 45 seconds even after the "POWER" switch is turned to ACCESSORY mode or turned off. They cannot, however, be operated once either front door is opened.

■ Jam protection function (driver's window only)

If an object becomes caught between the window and the window frame, window travel is stopped and the window is opened slightly.

■ When the power window does not close normally (driver's window only)

If the jam protection function is operating abnormally and a window cannot be closed, perform the following operations using the power window switch on the driver's door.

- Vehicles without a smart key system: After stopping the vehicle, the window can be closed by holding the power window switch in the one-touch closing position while the engine switch is turned to the "ON" position.
- Vehicles with a smart key system: After stopping the vehicle, the window can be closed by holding the power window switch in the one-touch closing position while the "POWER" switch is turned to ON mode.
- If the window still cannot be closed even by carrying out the operation explained above, initialize the function by performing the following procedure.

STEP 1 Hold the power window switch in the one-touch closing position. Continue holding the switch for a further 6 seconds after the window has closed.

STEP 2 Hold the power window switch in the one-touch opening position. Continue holding the switch for a further 2 seconds after the window has opened completely.

STEP 3 Hold the power window switch in the one-touch closing position once again. Continue holding the switch for a further 2 seconds after the window has closed.

If you release the switch while the window is moving, start again from the beginning.

If the window continues to close but then re-open slightly even after performing the above procedure correctly, have the vehicle inspected by your Toyota dealer.

 **CAUTION**

■ Closing the windows

Observe the following precautions.

Failure to do so may result in death or serious injury.

- Check to make sure that all passengers do not have any part of their body in a position where it could be caught when a window is being operated.
- Do not allow children to operate the power windows.
Closing a power window on someone can cause death or serious injury. The driver is responsible for instructing children not to operate the power windows.

■ Jam protection function (driver's window only)

- Never use any part of your body to intentionally activate the jam protection function.
- The jam protection function may not work if something gets caught just before the window fully closes.

1-5. Opening and closing the windows and moon roof Moon roof*

Use the overhead switches to open and close the moon roof and tilt it up and down.

■ Opening and closing

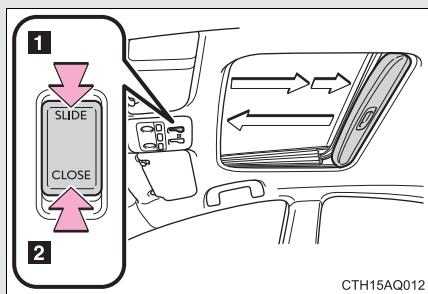

CTH15AQ012

1 Opens the moon roof*

The moon roof stops slightly before the fully open position to reduce wind noise.

Press the switch again to fully open the moon roof.

2 Closes the moon roof*

*: Lightly press either of the moon roof switches to stop the moon roof partway.

■ Tilting up and down

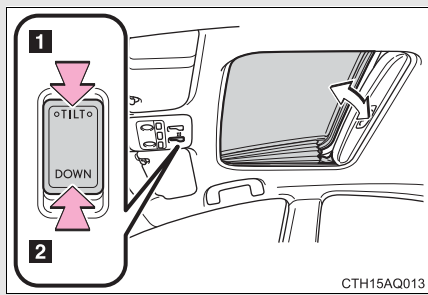

CTH15AQ013

1 Tilts the moon roof up*

2 Tilts the moon roof down*

*: Lightly press either of the moon roof switches to stop the moon roof partway.

*: If equipped

■ **The moon roof can be operated when**

The "POWER" switch is in ON mode.

■ **Operating the moon roof after turning the hybrid system off**

The moon roof can be operated for approximately 45 seconds after the "POWER" switch is turned to ACCESSORY mode or turned off. It cannot, however, be operated once either front door is opened.

■ **Jam protection function**

If an object is detected between the moon roof and the frame while the moon roof is closing or tilting down, travel is stopped and the moon roof opens slightly.

■ **Sunshade**

The sunshade can be opened and closed manually. However, the sunshade will open automatically when the moon roof is opened.

■ When the moon roof does not close normally

Perform the following procedure:

- If the moon roof closes but then re-opens slightly

STEP 1 Stop the vehicle.

STEP 2 Press and hold the “CLOSE” switch.*¹

The moon roof will close, re-open and pause for approximately 10 seconds.*² Then it will close again, tilt up and pause for approximately 1 second. Finally, it will tilt down, open and close.

STEP 3 Check to make sure that the moon roof is completely closed and then release the switch.

- If the moon roof tilts down but then tilts back up

STEP 1 Stop the vehicle.

STEP 2 Press and hold the “TILT” switch*¹ until the moon roof moves into the tilt up position and stops.

STEP 3 Release the “TILT” switch once and then press and hold the “TILT” switch again.*¹

The moon roof will pause for approximately 10 seconds in the tilt up position.*² Then it will adjust slightly and pause for approximately 1 second. Finally, it will tilt down, open and close.

STEP 4 Check to make sure that the moon roof is completely closed and then release the switch.

*¹: If the switch is released at the incorrect time, the procedure will have to be performed again from the beginning.

*²: If the switch is released after the above mentioned 10 second pause, automatic operation will be disabled. In that case, press and hold the “CLOSE” or “TILT” switch, and the moon roof will tilt up and pause for approximately 1 second. Then it will tilt down, open and close. Check to make sure that the moon roof is completely closed and then release the switch.

If the moon roof does not fully close even after performing the above procedure correctly, have the vehicle inspected by your Toyota dealer.

■ Moon roof open reminder function

An alarm will sound and a message is shown on the multi-information display when the driver's door is opened with the moon roof not fully closed and the "POWER" switch off.

CAUTION

■ Opening the moon roof

Observe the following precautions.

Failure to do so may cause death or serious injury.

- Do not allow any passengers to put their hands or heads outside the vehicle while it is moving.
- Do not sit on top of the moon roof.

■ Closing the moon roof

Observe the following precautions.

Failure to do so may result in death or serious injury.

- Check to make sure that all passengers do not have any part of their body in a position where it could be caught when the moon roof is being operated.
- Do not allow children to operate the moon roof.
Closing the moon roof on someone can cause death or serious injury. The driver is responsible for instructing children not to operate the moon roof.

■ Jam protection function

- Never use any part of your body to intentionally activate the jam protection function.
- The jam protection function may not work if something gets caught just before the moon roof fully closes.

Opening the fuel tank cap

Perform the following steps to open the fuel tank cap:

■ **Before refueling the vehicle**

- Vehicles without a smart key system

Turn the engine switch off and ensure that all the doors and windows are closed.

- Vehicles with a smart key system

Turn the “POWER” switch off and ensure that all the doors and windows are closed.

- Confirm the type of fuel. (→P. 107)

■ **Opening the fuel tank cap**

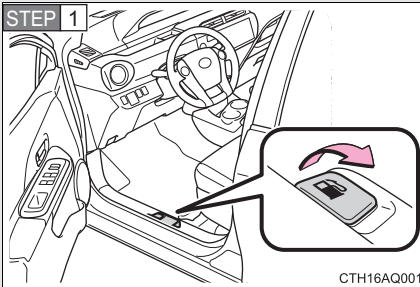

Pull up the opener to open the fuel filler door.

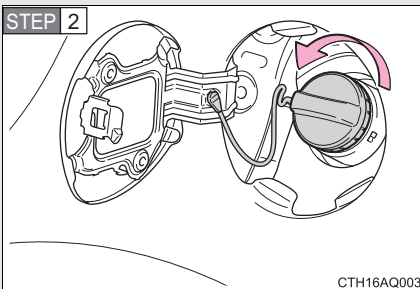

Turn the fuel tank cap slowly to open.

STEP 3

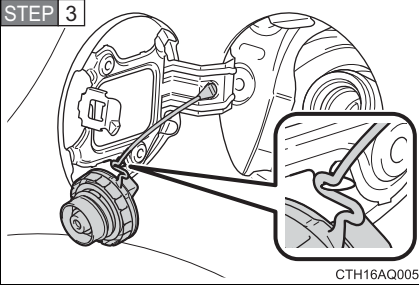

Hang the fuel tank cap on the back of the fuel filler door.

Closing the fuel tank cap

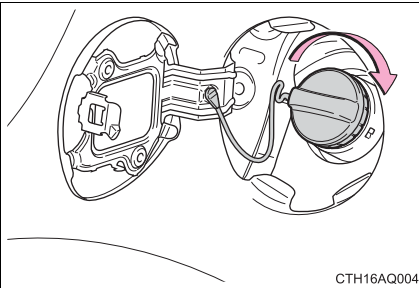

After refueling, turn the fuel tank cap until you hear a click. Once the cap is released, it will turn slightly in the opposite direction.

■ Fuel types

Unleaded gasoline (Octane rating 87 [Research Octane Number 91] or higher)

■ Use of ethanol blended gasoline in a gasoline engine

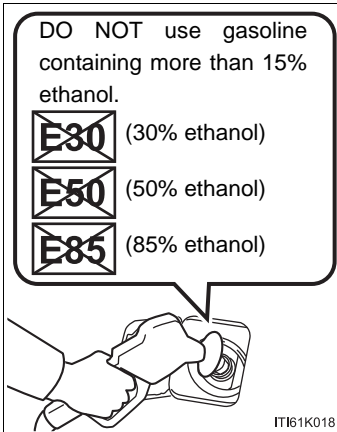

- Use only gasoline containing up to 15% ethanol.

DO NOT use any flex-fuel or gasoline that could contain more than 15% ethanol, including from any pump labeled E30, E50, E85 (which are only some examples of fuel containing more than 15% ethanol).

- Make sure that the ethanol blended gasoline to be used has a suitable Research Octane Number as outlined in “Fuel types”.

 **CAUTION**

■ **When refueling the vehicle**

Observe the following precautions while refueling the vehicle. Failure to do so may result in death or serious injury.

- After exiting the vehicle and before opening the fuel door, touch an unpainted metal surface to discharge any static electricity. It is important to discharge static electricity before refueling because sparks resulting from static electricity can cause fuel vapors to ignite while refueling.
- Always hold the grips on the fuel tank cap and turn it slowly to remove it. A whooshing sound may be heard when the fuel tank cap is loosened. Wait until the sound cannot be heard before fully removing the cap. In hot weather, pressurized fuel may spray out the filler neck and cause injury.
- Do not allow anyone that has not discharged static electricity from their body to come close to an open fuel tank.
- Do not inhale vaporized fuel.
Fuel contains substances that are harmful if inhaled.
- Do not smoke while refueling the vehicle.
Doing so may cause the fuel to ignite and cause a fire.
- Do not return to the vehicle or touch any person or object that is statically charged.
This may cause static electricity to build up, resulting in a possible ignition hazard.

■ **When refueling**

Observe the following precautions to prevent fuel overflowing from the fuel tank:

- Securely insert the fuel nozzle into the fuel filler neck
- Stop filling the tank after the fuel nozzle automatically clicks off
- Do not top off the fuel tank

■ **When replacing the fuel cap**

Do not use anything but a genuine Toyota fuel tank cap designed for your vehicle. Doing so may cause a fire or other incident which may result in death or serious injury.

**NOTICE****■ Refueling**

Do not spill fuel during refueling.

Doing so may damage the vehicle, such as causing the emission control system to operate abnormally or damaging fuel system components or the vehicle's painted surface.

1-7. Theft deterrent system Immobilizer system*

The vehicle's keys have built-in transponder chips that prevent the hybrid system from starting if a key has not been previously registered in the vehicle's on-board computer.

Never leave the keys inside the vehicle when you leave the vehicle.

This system is designed to help prevent vehicle theft but does not guarantee absolute security against all vehicle thefts.

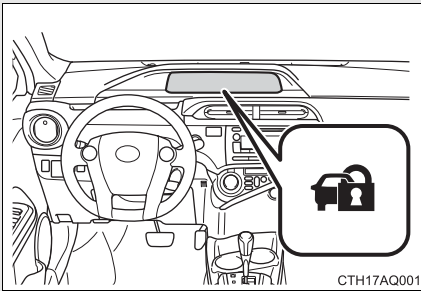

Vehicles without a smart key system

The indicator light flashes after the key has been removed from the engine switch to indicate that the system is operating.

The indicator light stops flashing after the registered key has been inserted into the engine switch to indicate that the system has been canceled.

*: If equipped

Vehicles with a smart key system

The indicator light flashes after the “POWER” switch has been turned off to indicate that the system is operating.

The indicator light stops flashing after the “POWER” switch has been turned to ACCESSORY or ON mode to indicate that the system has been canceled.

■ System maintenance

The vehicle has a maintenance-free type immobilizer system.

■ Conditions affecting operation

Depending on the surrounding environment and conditions, the immobilizer system may not operate properly. This may prevent the hybrid system from starting. (→P. 55)

■ Certifications for the immobilizer system

U.S.A.

FCC ID: NI4TMIMB-3

FCC ID: MOZRI-33BTY

This device complies with part 15 of the FCC Rules. Operation is subject to the following two conditions: (1) This device may not cause harmful interference, and (2) this device must accept any interference received, including interference that may cause undesired operation.

Changes or modifications not expressly approved by the party responsible for compliance could void the user's authority to operate the equipment.

Canada

This device complies with Industry Canada licence-exempt RSS standard(s). Operation is subject to the following two conditions: (1) this device may not cause interference, and (2) this device must accept any interference, including interference that may cause undesired operation of the device.

CAUTION

■ Certifications for the immobilizer system

Changes or modifications not expressly approved by the party responsible for compliance could void the user's authority to operate the equipment.

NOTICE

■ To ensure the system operates correctly

Do not modify or remove the system. If modified or removed, the proper operation of the system cannot be guaranteed.

1-7. Theft deterrent system

Theft prevention labels

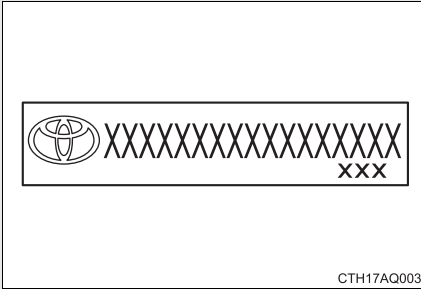

These labels are attached to the vehicle to reduce vehicle theft by facilitating the tracing and recovery of parts from stolen vehicles. Do not remove under penalty of law.

Correct driving posture

Drive with a good posture as follows:

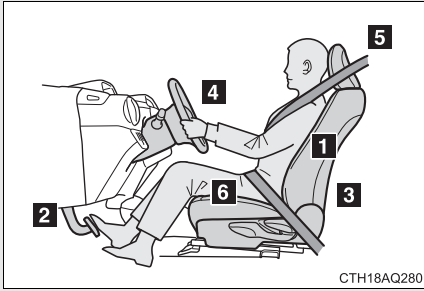

- 1** Sit upright and well back in the seat. (→P. 76)
- 2** Adjust the position of the seat forward or backward to ensure the pedals can be reached and easily depressed to the extent required. (→P. 76)
- 3** Adjust the seatback so that the controls are easily operable. (→P. 76)
- 4** Adjust the tilt and telescopic positions of the steering wheel downward so the air-bag is facing your chest. (→P. 93)
- 5** Vehicles with adjustable type head restraints: Lock the head restraint in place with the center of the head restraint closest to the top of your ears. (→P. 81)
- 6** Wear the seat belt correctly. (→P. 84)

 **CAUTION****■ While driving**

- Do not adjust the position of the driver's seat.
Doing so could cause the driver to lose control of the vehicle.
- Do not place a cushion between the driver or passenger and the seatback.
A cushion may prevent correct posture from being achieved, and reduce the effectiveness of the seat belt and head restraint, increasing the risk of death or serious injury to the driver or passenger.
- Do not place anything under the front seats.
Objects placed under the front seats may become jammed in the seat tracks and stop the seat from locking in place. This may lead to an accident, resulting in death or serious injury. The adjustment mechanism may also be damaged.

■ Adjusting the seat position

- Take care when adjusting the seat position to ensure that other passengers are not injured by the moving seat.
- Do not put your hands under the seat or near the moving parts to avoid injury.
Fingers or hands may become jammed in the seat mechanism.

SRS airbags

The SRS airbags inflate when the vehicle is subjected to certain types of severe impacts that may cause significant injury to the occupants. They work together with the seat belts to help reduce the risk of death or serious injury.

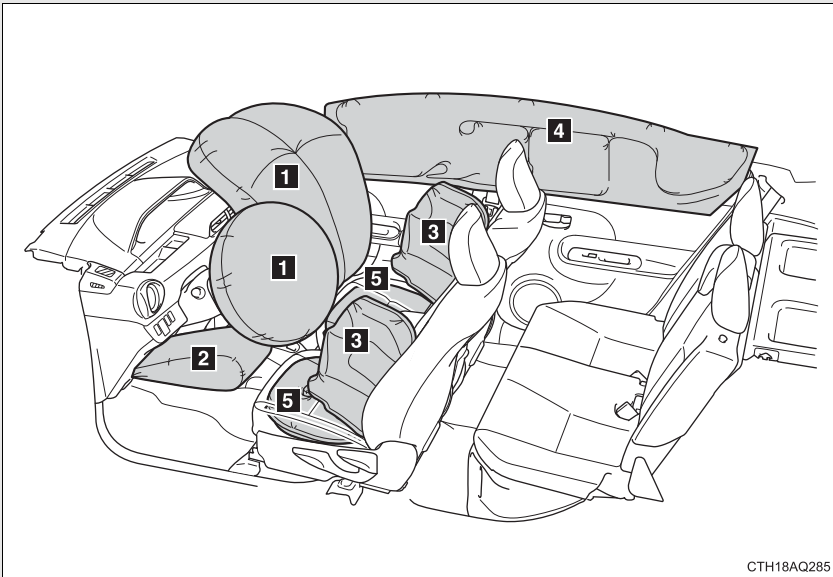

CTH18AQ285

SRS front airbags

- 1** SRS driver airbag/front passenger airbag
Can help protect the head and chest of the driver and front passenger from impact with interior components.
- 2** SRS driver knee airbag
Can help provide driver protection.

SRS side and curtain shield airbags**3** SRS side airbags

Can help protect the torso of the front seat occupants.

4 SRS curtain shield airbags

Can help protect primarily the head of occupants in the outer seats.

Other SRS airbags**5** SRS seat cushion airbags

Can help restrain the driver and front passenger.

SRS airbag system components

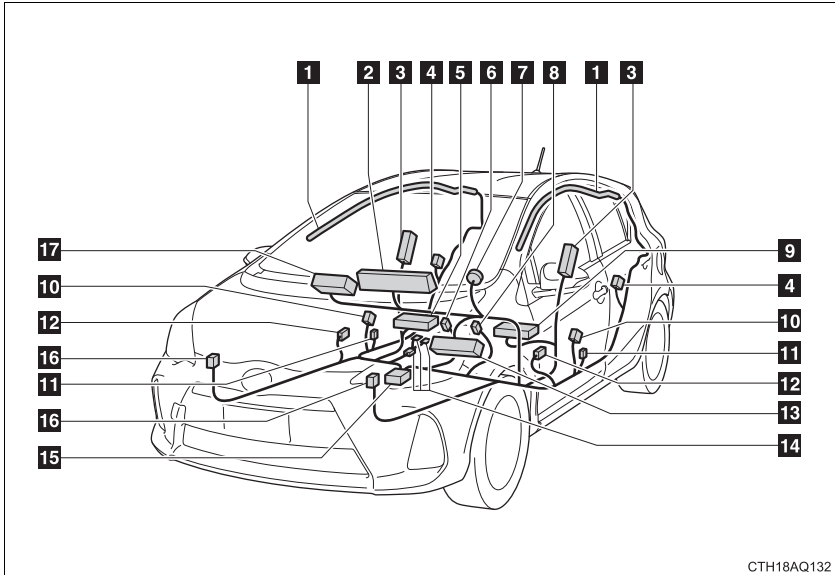

CTH18AQ132

- | | |
|--|--|
| 1 Curtain shield airbags | 9 Driver's seat cushion airbag |
| 2 SRS warning light and "AIR BAG ON" and "AIR BAG OFF" indicator lights | 10 Side impact sensors (front) |
| 3 Side airbags | 11 Seat belt pretensioners and force limiters |
| 4 Side impact sensors (rear) | 12 Side impact sensors (front door) |
| 5 Front passenger's seat cushion airbag | 13 Driver's knee airbag |
| 6 Front passenger's seat belt buckle switch | 14 Front passenger occupant classification system (ECU and sensors) |
| 7 Driver airbag | 15 Airbag sensor assembly |
| 8 Driver's seat belt buckle switch | 16 Front impact sensors |
| | 17 Front passenger airbag |

Your vehicle is equipped with ADVANCED AIRBAGS designed based on the US motor vehicle safety standards (FMVSS208). The airbag sensor assembly (ECU) controls airbag deployment based on information obtained from the sensors etc. shown in the system components diagram above. This information includes crash severity and occupant information. As the airbags deploy, a chemical reaction in the inflators quickly fills the airbags with non-toxic gas to help restrain the motion of the occupants.

■ **If the SRS airbags deploy (inflate)**

- Bruising and slight abrasions may result from contact with a deploying (inflating) SRS airbag.
- A loud noise and white powder will be emitted.
- Parts of the airbag module (steering wheel hub, airbag cover and inflator) as well as the front seats, parts of the front and rear pillars, and roof side rails, may be hot for several minutes. The airbag itself may also be hot.
- The windshield may crack.

■ **SRS airbag deployment conditions (SRS front airbags/SRS seat cushion airbags)**

- The SRS front airbags and SRS seat cushion airbags will deploy in the event of an impact that exceeds the set threshold level (the level of force corresponding to an approximately 12 - 18 mph [20 - 30 km/h] frontal collision with a fixed wall that does not move or deform).

However, this threshold velocity will be considerably higher in the following situations:

- If the vehicle strikes an object, such as a parked vehicle or sign pole, which can move or deform on impact
- If the vehicle is involved in an underride collision, such as a collision in which the front of the vehicle “underrides”, or goes under, the bed of a truck
- Depending on the type of collision, it is possible that only the seat belt pretensioners will activate.
- The SRS front airbags and seat cushion airbag for the front passenger will not activate if there is no passenger sitting in the front passenger seat. However, the SRS front airbags and seat cushion airbag for the front passenger may deploy if luggage is put in the seat, even if the seat is unoccupied.
- The SRS seat cushion airbags on the front seats will not operate if the occupant is not wearing a seat belt.

■ SRS airbag deployment conditions (SRS side and curtain shield airbags)

- The SRS side and curtain shield airbags will deploy in the event of an impact that exceeds the set threshold level (the level of force corresponding to the impact force produced by an approximately 3300 lb. [1500 kg] vehicle colliding with the vehicle cabin from a direction perpendicular to the vehicle orientation at an approximate speed of 12 - 18 mph [20 - 30 km/h]).
- The SRS curtain shield airbags may also deploy in the event of a severe frontal collision.

■ Conditions under which the SRS airbags may deploy (inflate), other than a collision

The SRS front airbags and SRS seat cushion airbags may also deploy if a serious impact occurs to the underside of your vehicle. Some examples are shown in the illustration.

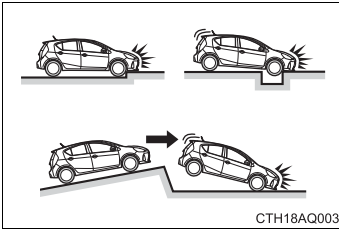

- Hitting a curb, edge of pavement or hard surface
- Falling into or jumping over a deep hole
- Landing hard or falling

■ **Types of collisions that may not deploy the SRS airbags (SRS front airbags/SRS seat cushion airbags)**

The SRS front airbags and SRS seat cushion airbags do not generally inflate if the vehicle is involved in a side or rear collision, if it rolls over, or if it is involved in a low-speed frontal collision. But, whenever a collision of any type causes sufficient forward deceleration of the vehicle, deployment of the SRS front airbags and SRS seat cushion airbags may occur.

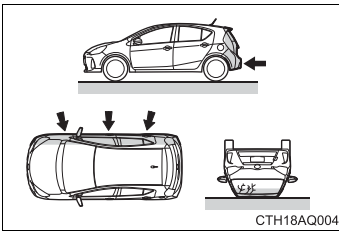

- Collision from the side
- Collision from the rear
- Vehicle rollover

■ Types of collisions that may not deploy the SRS airbags (SRS side and curtain shield airbags)

The SRS side and curtain shield airbags may not activate if the vehicle is subjected to a collision from the side at certain angles, or a collision to the side of the vehicle body other than the passenger compartment.

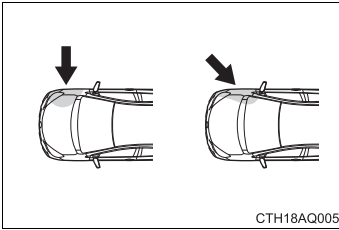

- Collision from the side to the vehicle body other than the passenger compartment
- Collision from the side at an angle

The SRS side and curtain shield airbags do not generally inflate if the vehicle is involved in a frontal or rear collision, if it rolls over, or if it is involved in a low-speed side collision.

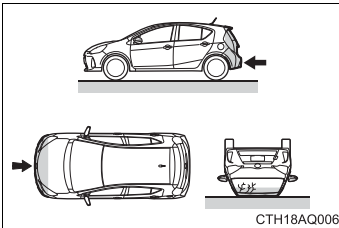

- Collision from the front*
- Collision from the rear
- Vehicle rollover

*: Depending on the conditions and type of accident, the curtain shield airbags may deploy (inflate) upon frontal impact.

■ When to contact your Toyota dealer

In the following cases, the vehicle will require inspection and/or repair. Contact your Toyota dealer as soon as possible.

- Any of the SRS airbags have been inflated.

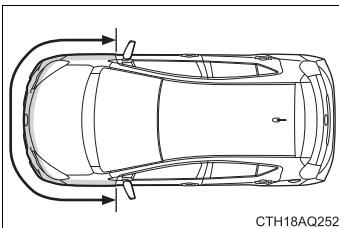

- The front of the vehicle is damaged or deformed, or was involved in an accident that was not severe enough to cause the SRS front airbags and SRS seat cushion airbags to inflate.

1-8. Safety information

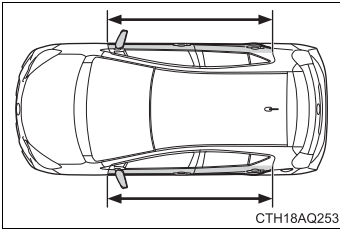

- A portion of a door is damaged or deformed, or the vehicle was involved in an accident that was not severe enough to cause the SRS side and curtain shield airbags to inflate.

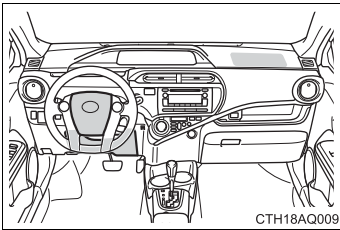

- The pad section of the steering wheel, dashboard near the front passenger airbag or lower portion of the instrument panel is scratched, cracked, or otherwise damaged.

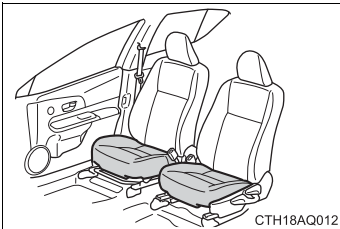

- The front seat cushion surface is scratched, cracked, or otherwise damaged.

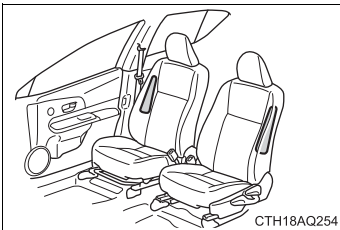

- The surface of the seats with the side airbag is scratched, cracked or otherwise damaged.

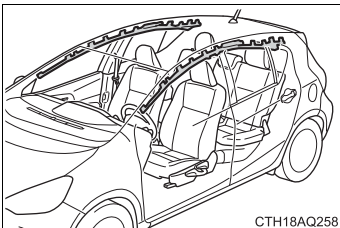

- The portion of the front pillars, rear pillars or roof side rail garnishes (padding) containing the curtain shield airbags inside is scratched, cracked, or otherwise damaged.

 CAUTION**■ SRS airbag precautions**

Observe the following precautions regarding the SRS airbags. Failure to do so may cause death or serious injury.

- The driver and all passengers in the vehicle must wear their seat belts properly.

The SRS airbags are supplemental devices to be used with the seat belts.

- The SRS driver airbag deploys with considerable force, and can cause death or serious injury especially if the driver is very close to the airbag. The National Highway Traffic Safety Administration (NHTSA) advises:

Since the risk zone for the driver's airbag is the first 2 - 3 in. (50 - 75 mm) of inflation, placing yourself 10 in. (250 mm) from your driver airbag provides you with a clear margin of safety. This distance is measured from the center of the steering wheel to your breastbone. If you sit less than 10 in. (250 mm) away now, you can change your driving position in several ways:

- Move your seat to the rear as far as you can while still reaching the pedals comfortably.
- Slightly recline the back of the seat. Although vehicle designs vary, many drivers can achieve the 10 in. (250 mm) distance, even with the driver seat all the way forward, simply by reclining the back of the seat somewhat. If reclining the back of your seat makes it hard to see the road, raise yourself by using a firm, non-slippery cushion, or raise the seat if your vehicle has that feature.
- If your steering wheel is adjustable, tilt it downward. This points the airbag toward your chest instead of your head and neck.

The seat should be adjusted as recommended by NHTSA above, while still maintaining control of the foot pedals, steering wheel, and your view of the instrument panel controls.

⚠ CAUTION

■ SRS airbag precautions



- If the seat belt extender has been connected to the front seat belt buckles but the seat belt extender has not also been fastened to the latch plate of the seat belt, the SRS front airbags will judge that the driver and front passenger are wearing the seat belt even though the seat belt has not been connected. In this case, the SRS front airbags may not activate correctly in a collision, resulting in death or serious injury in the event of a collision. Be sure to wear the seat belt with the seat belt extender.

- The SRS front passenger airbag also deploys with considerable force, and can cause death or serious injury especially if the front passenger is very close to the airbag. The front passenger seat should be as far from the airbag as possible with the seatback adjusted, so the front passenger sits upright.
- Improperly seated and/or restrained infants and children can be killed or seriously injured by a deploying airbag. An infant or child who is too small to use a seat belt should be properly secured using a child restraint system. Toyota strongly recommends that all infants and children be placed in the rear seats of the vehicle and properly restrained. The rear seats are safer for infants and children than the front passenger seat. (→P. 136)

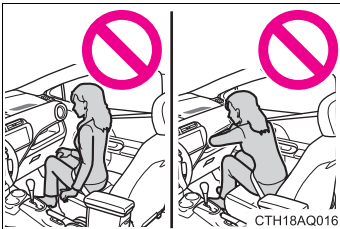

- Do not sit on the edge of the seat or lean against the dashboard.

 CAUTION

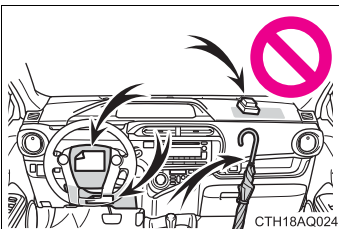
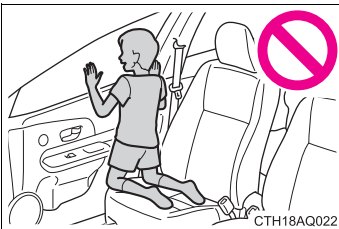
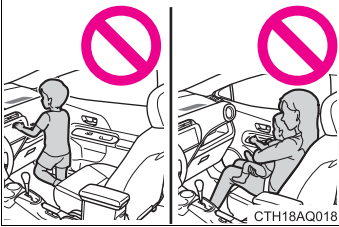
■ SRS airbag precautions

- Do not allow a child to stand in front of the SRS front passenger airbag unit or sit on the knees of a front passenger.
- Do not allow the front seat occupants to hold items on their knees.
- Do not lean against the door, the roof side rail or the front, side and rear pillars.
- Do not allow anyone to kneel on the passenger seat toward the door or put their head or hands outside the vehicle.
- Do not attach anything to or lean anything against areas such as the dashboard, steering wheel pad and lower portion of the instrument panel. These items can become projectiles when the SRS driver, front passenger and driver knee airbags deploy.

CAUTION

SRS airbag precautions

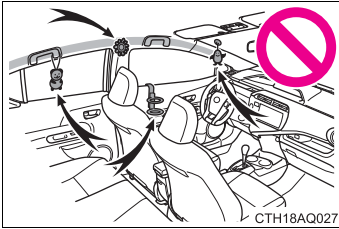

- Do not attach anything to areas such as a door, windshield glass, side door glass, front or rear pillar, roof side rail and assist grip.

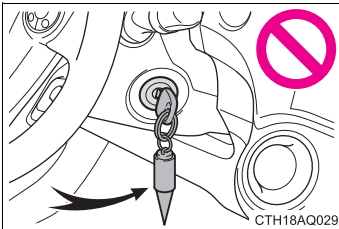

- Vehicles without a smart key system: Do not attach any heavy, sharp or hard objects such as keys and accessories to the key. The objects may restrict the SRS driver knee airbag inflation or be thrust into the driver's seat area by the force of the deploying airbag, thus causing a danger.

- Do not hang coat hangers or other hard objects on the coat hooks. All of these items could become projectiles and may cause death or serious injury, should the SRS curtain shield airbags deploy.
- If a vinyl cover is put on the area where the SRS driver knee airbag will deploy, be sure to remove it.
- Do not use seat accessories which cover the parts where the SRS side airbags and SRS seat cushion airbags inflate as they may interfere with inflation of the SRS airbags. Such accessories may prevent the side airbags and seat cushion airbags from activating correctly, disable the system or cause the side airbags and seat cushion airbags to inflate accidentally, resulting in death or serious injury.
- Do not strike or apply significant levels of force to the area of the SRS airbag components.
Doing so can cause the SRS airbags to malfunction.
- Do not touch any of the component parts immediately after the SRS airbags have deployed (inflated) as they may be hot.

 **CAUTION****■ SRS airbag precautions**

- If breathing becomes difficult after the SRS airbags have deployed, open a door or window to allow fresh air in, or leave the vehicle if it is safe to do so. Wash off any residue as soon as possible to prevent skin irritation.
- If the areas where the SRS airbags are stored, such as the steering wheel pad and front and rear pillar garnishes, are damaged or cracked, have them replaced by your Toyota dealer.
- Do not place anything, such as a cushion, on the front passenger's seat. Doing so will disperse the passenger's weight, which prevents the sensor from detecting the passenger's weight properly. As a result, the SRS front airbags for the front passenger may not deploy in the event of a collision.

■ Modification and disposal of SRS airbag system components

Do not dispose of your vehicle or perform any of the following modifications without consulting your Toyota dealer. The SRS airbags may malfunction or deploy (inflate) accidentally, causing death or serious injury.

- Installation, removal, disassembly and repair of the SRS airbags.
- Repairs, modifications, removal or replacement of the steering wheel, instrument panel, dashboard, seats or seat upholstery, front, side and rear pillars or roof side rails.
- Repairs or modifications of the front fender, front bumper, or side of the occupant compartment.
- Installation of a grille guard (bull bars, kangaroo bar, etc.), snow plows or winches.
- Modifications to the vehicle's suspension system.
- Installation of electronic devices such as mobile two-way radios and CD players.
- Modifications to your vehicle for a person with a physical disability.

Front passenger occupant classification system

Your vehicle is equipped with a front passenger occupant classification system. This system detects the conditions of the front passenger seat and activates or deactivates the devices for the front passenger.

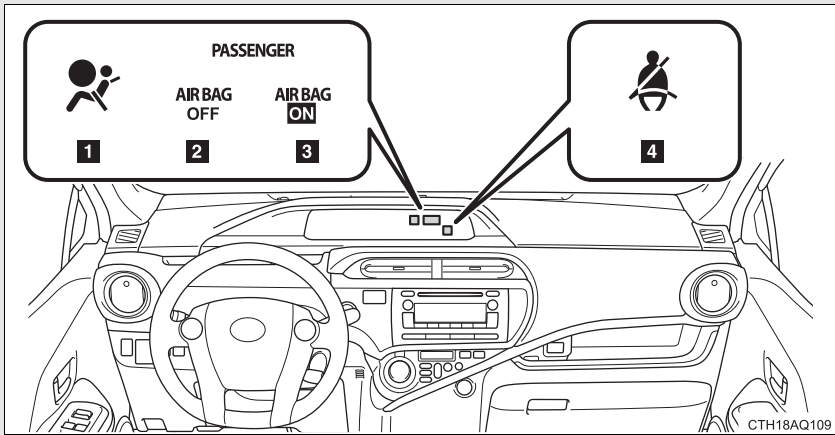

- 1** SRS warning light
- 2** "AIR BAG OFF" indicator light
- 3** "AIR BAG ON" indicator light
- 4** Seat belt reminder light

Condition and operation in the front passenger occupant classification system
--

<p>■ Adult^{*1}</p>

Indicator/ warning light	“AIR BAG ON” and “AIR BAG OFF” indicator lights	“AIR BAG ON”
	SRS warning light	Off
	Seat belt reminder light	Off ^{*2} or flashing ^{*3}
Devices	Front passenger airbag	Activated
	Side airbag on the front passenger seat	
	Curtain shield airbag in the front passenger side	
	Seat cushion airbag in the front passenger side	Activated ^{*2} or deactivated ^{*3}
	Front passenger’s seat belt pretensioner	Activated

1

Before driving

<p>■ Child^{*4}</p>

Indicator/ warning light	“AIR BAG ON” and “AIR BAG OFF” indicator lights	“AIR BAG OFF” or “AIR BAG ON” ^{*4}
	SRS warning light	Off
	Seat belt reminder light	Off ^{*2} or flashing ^{*3}
Devices	Front passenger airbag	Deactivated or activated ^{*4}
	Side airbag on the front passenger seat	Activated
	Curtain shield airbag in the front passenger side	
	Seat cushion airbag in the front passenger side	Deactivated or activated ^{*4, *2}
	Front passenger’s seat belt pretensioner	Activated

■ **Child restraint system with infant^{*5}**

Indicator/ warning light	“AIR BAG ON” and “AIR BAG OFF” indicator lights	“AIR BAG OFF” ^{*6}
	SRS warning light	Off
	Seat belt reminder light	Off ^{*2} or flashing ^{*3}
Devices	Front passenger airbag	Deactivated
	Side airbag on the front passenger seat	Activated
	Curtain shield airbag in the front passenger side	
	Seat cushion airbag in the front passenger side	Deactivated
	Front passenger’s seat belt pretensioner	Activated

■ **Unoccupied**

Indicator/ warning light	“AIR BAG ON” and “AIR BAG OFF” indicator lights	“AIR BAG OFF”
	SRS warning light	Off
	Seat belt reminder light	
Devices	Front passenger airbag	Deactivated
	Side airbag on the front passenger seat	Activated
	Curtain shield airbag in the front passenger side	
	Seat cushion airbag in the front passenger side	Deactivated
	Front passenger’s seat belt pretensioner	Activated

■ There is a malfunction in the system

Indicator/ warning light	“AIR BAG ON” and “AIR BAG OFF” indicator lights	“AIR BAG OFF”
	SRS warning light	On
	Seat belt reminder light	
Devices	Front passenger airbag	Deactivated
	Side airbag on the front passenger seat	Activated
	Curtain shield airbag in the front passenger side	
	Seat cushion airbag in the front passenger side	Deactivated
	Front passenger’s seat belt pretensioner	Activated

- *1: The system judges a person of adult size as an adult. When a smaller adult sits in the front passenger seat, the system may not recognize him/her as an adult depending on his/her physique and posture.
- *2: In the event the front passenger is wearing a seat belt.
- *3: In the event the front passenger does not wear a seat belt.
- *4: For some children, child in seat, child in booster seat or child in convertible seat, the system may not recognize him/her as a child. Factors which may affect this can be the physique or posture.
- *5: Never install a rear-facing child restraint system on the front passenger seat. A forward-facing child restraint system should only be installed on the front passenger seat when it is unavoidable. (→P. 136)
- *6: In case the indicator light is not illuminated, consult this manual on how to install the child restraint system properly. (→P. 140)

 CAUTION

■ Front passenger occupant classification system precautions

Observe the following precautions regarding the front passenger occupant classification system.

Failure to do so may cause death or serious injury.

- Wear the seat belt properly.
- Make sure the front passenger's seat belt plate has not been left inserted into the buckle before someone sits in the front passenger seat.
- Make sure the "AIR BAG OFF" indicator light is not illuminated when using the seat belt extender for the front passenger seat. If the "AIR BAG OFF" indicator light is illuminated, disconnect the extender tongue from the seat belt buckle, and reconnect the seat belt. Reconnect the seat belt extender after making sure the "AIR BAG ON" indicator light is illuminated. If you use the seat belt extender while the "AIR BAG OFF" indicator light is illuminated, the SRS airbags for the passenger may not activate correctly, which could cause death or serious injury in the event of a collision.
- Do not apply a heavy load to the front passenger seat or equipment. (e.g. seatback pocket)
- Do not put weight on the front passenger seat by putting your hands or feet on the front passenger seat seatback from the rear passenger seat.
- Do not let a rear passenger lift the front passenger seat with their feet or press on the seatback with their legs.
- Do not put objects under the front passenger seat.

 CAUTION**Front passenger occupant classification system precautions**

- Do not recline the front passenger seatback so far that it touches a rear seat. This may cause the “AIR BAG OFF” indicator light to be illuminated, which indicates that the passenger’s airbags will not deploy in the event of a severe accident. If the seatback touches the rear seat, return the seatback to a position where it does not touch the rear seat. Keep the front passenger seatback as upright as possible when the vehicle is moving. Reclining the seatback excessively may lessen the effectiveness of the seat belt system.
- If an adult sits in the front passenger seat, the “AIR BAG ON” indicator light is illuminated. If the “AIR BAG OFF” indicator is illuminated, ask the passenger to sit up straight, well back in the seat, feet on the floor, and with the seat belt worn correctly. If the “AIR BAG OFF” indicator still remains illuminated, either ask the passenger to move to the rear seat, or if that is not possible, move the front passenger seat fully rearward.
- When it is unavoidable to install a forward-facing child restraint system on the front passenger seat, install the child restraint system on the front passenger seat in the proper order. (→P. 140)
- Do not modify or remove the front seats.
- Do not kick the front passenger seat or subject it to severe impact. Otherwise, the SRS warning light may come on to indicate a malfunction of the detection system. In this case, contact your Toyota dealer immediately.
- Child restraint systems installed on the rear seat should not contact the front seatbacks.
- Do not use a seat accessory, such as a cushion and seat cover, that covers the seat cushion surface.
- Do not modify or replace the upholstery of the front seat.

Child restraint systems

A child restraint system for a small child or baby must itself be properly restrained on the seat with the lap portion of the lap/shoulder belt.

The laws of all 50 states of the U.S.A. and Canada now require the use of child restraint systems.

Points to remember

Studies have shown that installing a child restraint on a rear seat is much safer than installing one on the front passenger seat.

- Choose a child restraint system that suits your vehicle and is appropriate to the age and size of the child.
- For installation details, follow the instructions provided with the child restraint system.

General installation instructions are provided in this manual.

(→P. 140)

Types of child restraints

Child restraint systems are classified into the following 3 types according to the age and size of the child:

Rear facing — Infant seat/convertible seat



Forward facing — Convertible seat



Booster seat



■ Selecting an appropriate child restraint system

- Use a child restraint system appropriate for the child until the child becomes large enough to properly wear the vehicle's seat belt.
- If the child is too large for a child restraint system, sit the child on a rear seat and use the vehicle's seat belt. (→P. 84)

 CAUTION

■ **Child restraint precautions**

- For effective protection in automobile accidents and sudden stops, a child must be properly restrained, using a seat belt or child restraint system depending on the age and size of the child. Holding a child in your arms is not a substitute for a child restraint system. In an accident, the child can be crushed against the windshield, or between you and the vehicle's interior.
- Toyota strongly urges the use of a proper child restraint system that conforms to the size of the child, installed on the rear seat. According to accident statistics, the child is safer when properly restrained in the rear seat than in the front seat.
- Never install a rear-facing child restraint system on the front passenger seat even if the "AIR BAG OFF" indicator light is illuminated. In the event of an accident, the force of the rapid inflation of the front passenger airbag and seat cushion airbag in the front passenger side can cause death or serious injury to the child if the rear-facing child restraint system is installed on the front passenger seat.
- A forward-facing child restraint system may be installed on the front passenger seat only when it is unavoidable. A child restraint system that requires a top tether strap should not be used in the front passenger seat since there is no top tether strap anchor for the front passenger seat. Adjust the seatback as upright as possible and always move the seat as far back as possible even if the "AIR BAG OFF" indicator light is illuminated, because the front passenger airbag and seat cushion airbag in the front passenger side could inflate with considerable speed and force. Otherwise, the child may be killed or seriously injured.
- Do not use the seat belt extender when installing a child restraint system on the front or rear passenger seat. If installing a child restraint system with the seat belt extender connected to the seat belt, the seat belt will not securely hold the child restraint system, which could cause death or serious injury to the child or other passengers in the event of a sudden stop, sudden swerve or an accident.

 **CAUTION****■ Child restraint precautions**

- Do not allow the child to lean his/her head or any part of his/her body against the door or the area of the seat, front and rear pillars or roof side rails from which the SRS side airbags or SRS curtain shield airbags deploy even if the child is seated in the child restraint system. It is dangerous if the SRS side airbags and curtain shield airbags inflate, and the impact could cause death or serious injury to the child.
- Make sure you have complied with all installation instructions provided by the child restraint manufacturer and that the system is properly secured. If it is not secured properly, it may cause death or serious injury to the child in the event of a sudden stop or an accident.

■ When children are in the vehicle

Do not allow children to play with the seat belt. If the seat belt becomes twisted around a child's neck, it may lead to choking or other serious injuries that could result in death.

If this occurs and the buckle cannot be unfastened, scissors should be used to cut the belt.

■ When the child restraint system is not in use

- Keep the child restraint system properly secured on the seat even if it is not in use. Do not store the child restraint system unsecured in the passenger compartment.
- If it is necessary to detach the child restraint system, remove it from the vehicle or store it securely in the luggage compartment. This will prevent it from injuring passengers in the event of sudden stop, sudden swerve or an accident.

Installing child restraints

Follow the child restraint system manufacturer's instructions. Firmly secure child restraints to the rear seats using the LATCH anchors or a seat belt. Attach the top tether strap when installing a child restraint.

The lap/shoulder belt can be used if your child restraint system is not compatible with the LATCH (Lower Anchors and Tethers for Children) system.

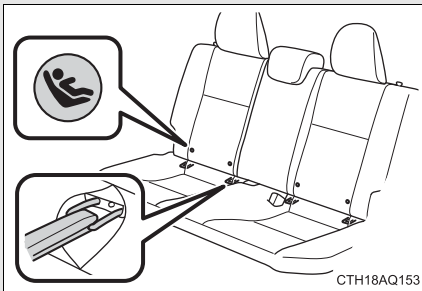

Child restraint LATCH anchors

LATCH anchors are provided for the outside rear seats. (Buttons displaying the location of the anchors are attached to the seats.)



Seat belts equipped with a child restraint locking mechanism (ALR/ELR belts except driver's seat belt) (→P. 84)

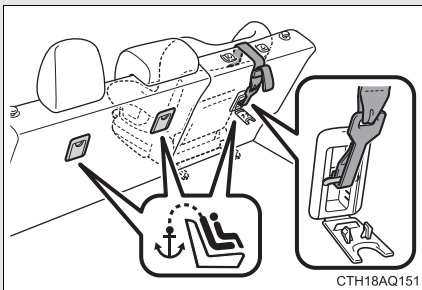

Anchor brackets (for top tether strap)

An anchor bracket is provided for each rear seat.

Installation with LATCH system

Type A

STEP 1 Widen the gap in the seat cushion slightly.

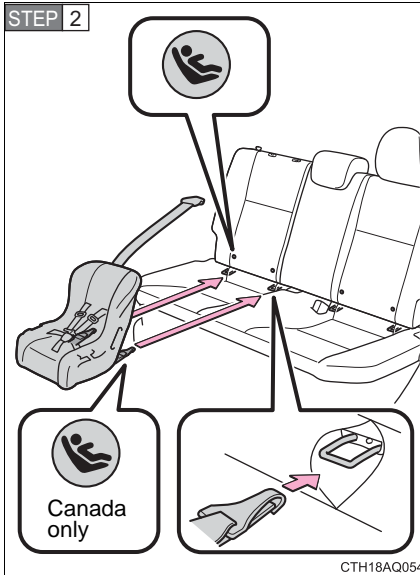

Latch the hooks of the lower straps onto the LATCH anchors. If the child restraint has a top tether strap, the top tether strap should be latched onto the top tether strap anchor.

For owners in Canada:
The symbol on a child restraint system indicates the presence of a lower connector system.

1

Before driving

Type B

STEP 1 Widen the gap in the seat cushion slightly.

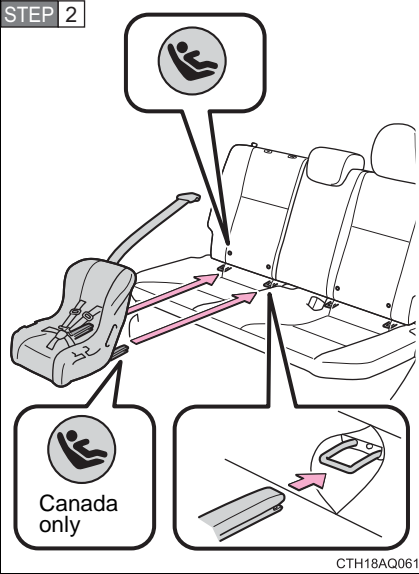

Latch the buckles onto the LATCH anchors. If the child restraint has a top tether strap, the top tether strap should be latched onto the top tether strap anchor.

For owners in Canada:
The symbol on a child restraint system indicates the presence of a lower connector system.

Installing child restraints using a seat belt (child restraint lock function belt)

■ Rear facing — Infant seat/convertible seat

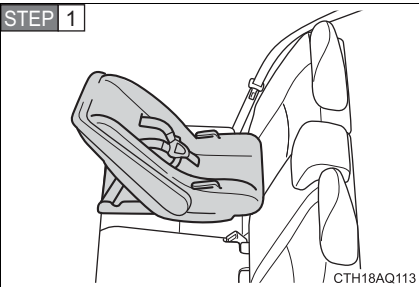

Place the child restraint system on the rear seat facing the rear of the vehicle.

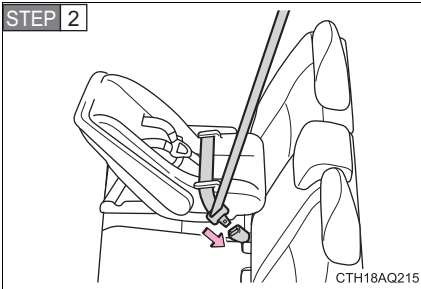

Run the seat belt through the child restraint system and insert the plate into the buckle. Make sure that the belt is not twisted.

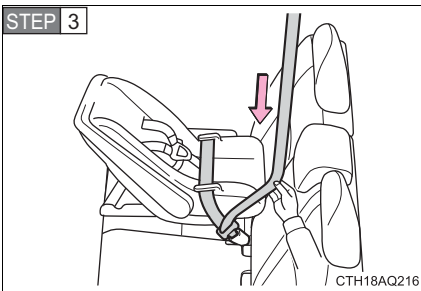

Fully extend the shoulder belt and allow it to retract to put it in lock mode. In lock mode, the belt cannot be extended.

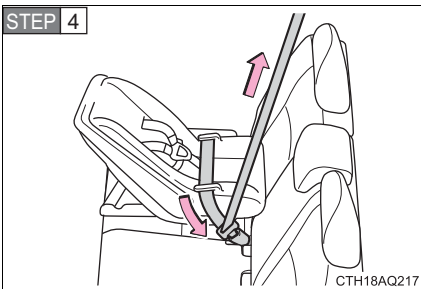

While pushing the child restraint system down into the rear seat, allow the shoulder belt to retract until the child restraint system is securely in place.

After the shoulder belt has retracted to a point where there is no slack in the belt, pull the belt to check that it cannot be extended.

■ Forward facing — Convertible seat

STEP 1 Rear center seat: Adjust the head restraint to the upmost position. (→P. 81)

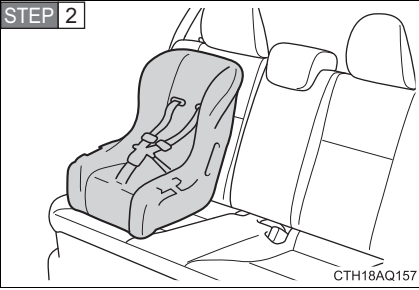

Place the child restraint system on the seat facing the front of the vehicle.

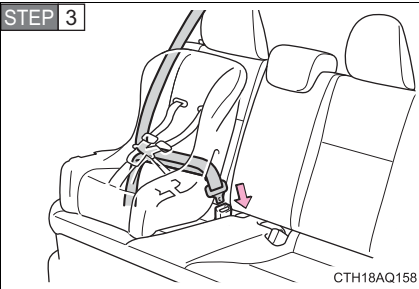

Run the seat belt through the child restraint system and insert the plate into the buckle. Make sure that the belt is not twisted.

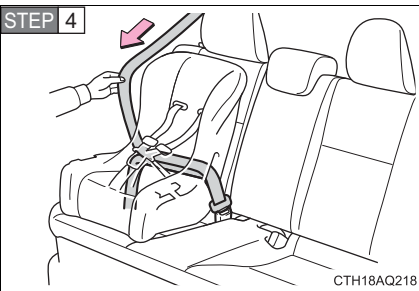

Fully extend the shoulder belt and allow it to retract to put it in lock mode. In lock mode, the belt cannot be extended.

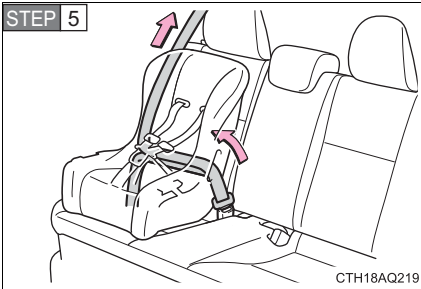

While pushing the child restraint system into the rear seat, allow the shoulder belt to retract until the child restraint system is securely in place.

After the shoulder belt has retracted to a point where there is no slack in the belt, pull the belt to check that it cannot be extended.

STEP 6 If the child restraint has a top tether strap, the top tether strap should be latched onto the top tether strap anchor. (→P. 146)

■ Booster seat

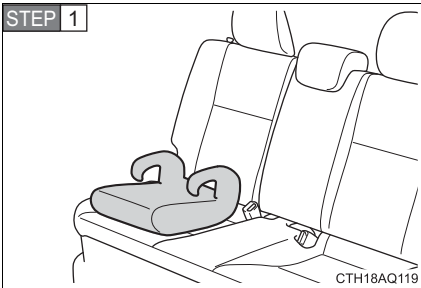

Place the child restraint system on the seat facing the front of the vehicle.



Sit the child in the child restraint system. Fit the seat belt to the child restraint system according to the manufacturer's instructions and insert the plate into the buckle. Make sure that the belt is not twisted.

Check that the shoulder belt is correctly positioned over the child's shoulder and that the lap belt is as low as possible. (→P. 84)

Removing a child restraint installed with a seat belt

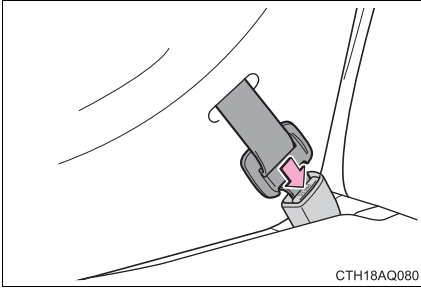

Push the buckle release button and fully retract the seat belt.

Child restraint systems with a top tether strap

STEP 1 Remove the luggage cover (if equipped). (→P. 343)

STEP 2 Remove the head restraint (→P. 81)

STEP 3 Secure the child restraint system using the LATCH anchors or a seat belt.

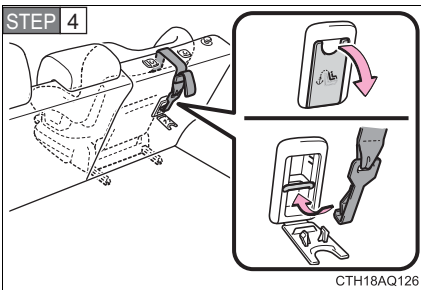

Open the anchor bracket cover, latch the hook onto the anchor bracket and tighten the top tether strap.

Make sure the top tether strap is securely latched.

STEP 5 Reinstall the luggage cover (if equipped) and the head restraint.

■ Laws and regulations pertaining to anchorages

The LATCH system conforms to FMVSS225 or CMVSS210.2.

Child restraint systems conforming to FMVSS213 or CMVSS213 specifications can be used.

This vehicle is designed to conform to SAE J1819.

⚠ CAUTION

■ When installing a booster seat

To prevent the belt from going into ALR lock mode, do not fully extend the shoulder belt. ALR mode causes the belt to tighten only. This could cause injury or discomfort to the child. (→P. 88)

■ When installing a child restraint system

Follow the directions given in the child restraint system installation manual and fix the child restraint system securely in place.

If the child restraint system is not correctly fixed in place, the child or other passengers may be seriously injured or even killed in the event of sudden braking, sudden swerving or an accident.

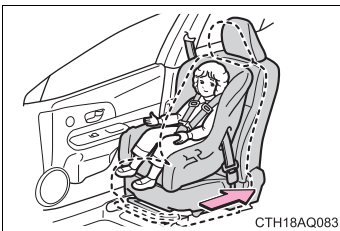
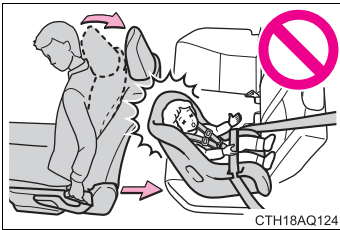

- If the driver's seat interferes with the child restraint system and prevents it from being attached correctly, attach the child restraint system to the right-hand rear seat.
- Adjust the front passenger seat so that it does not interfere with the child restraint system.
- Only put a forward-facing child restraint system on the front seat when unavoidable. When installing a forward-facing child restraint system on the front passenger seat, move the seat as far back as possible even if the "AIR BAG OFF" indicator light is illuminated. Failure to do so may result in death or serious injury if the airbags deploy (inflate).

- When a booster seat is installed, always ensure that the shoulder belt is positioned across the center of the child's shoulder. The belt should be kept away from the child's neck, but not so that it could fall off the child's shoulder. Failure to do so may result in death or serious injury in the event of sudden braking, sudden swerving or an accident.
- Ensure that the belt and plate are securely locked and the seat belt is not twisted.

⚠ CAUTION

■ When installing a child restraint system

- Shake the child restraint system left and right, and forward and backward to ensure that it has been securely installed.
- After securing a child restraint system, never adjust the seat.
- Follow all installation instructions provided by the child restraint system manufacturer.
- When a child restraint system with a top tether strap is installed, do not install the head restraint. The head restraint may interfere with the top tether strap preventing secure installation of the child restraint system.
- Make sure to properly store the removed head restraint in a secure place when you use the child restraint system on the rear seat.

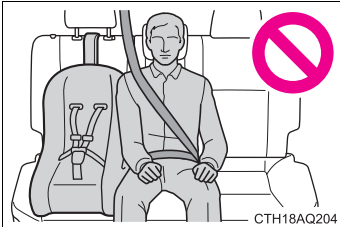

- When using the right side seat for the child restraint system, do not sit in the center seat. Seat belt function may be impaired, such as being positioned overly high or loose-fitting, which may result in death or serious injury in the event of sudden braking or an accident.

■ Do not use a seat belt extender

If a seat belt extender is used when installing a child restraint system, the seat belt will not securely hold the child restraint system, which could cause death or serious injury to the child or other passengers in the event of sudden braking, sudden swerving or an accident.

■ To correctly attach a child restraint system to the anchors

When using the LATCH anchors, be sure that there are no foreign objects around the anchors and that the seat belt is not caught behind the child restraint. Make sure the child restraint system is securely attached, or it may cause death or serious injury to the child or other passengers in the event of sudden braking, sudden swerving or an accident.

2-1. Driving procedures

Driving the vehicle.....	150
Engine (ignition) switch.....	160
Power (ignition) switch.....	164
EV drive mode	172
Hybrid transmission	175
Turn signal lever	178
Parking brake.....	179
Horn	180

2-2. Instrument cluster

Gauges and meters	181
Indicators and warning lights.....	184
Multi-information display.....	187

2-3. Operating the lights and wipers

Headlight switch.....	204
Fog light switch	208
Windshield wipers and washer	210
Rear window wiper and washer	214

2-4. Using other driving systems

Cruise control.....	217
Driving assist systems	221

2-5. Driving information

Cargo and luggage	226
Vehicle load limits	230
Winter driving tips	231
Trailer towing	235
Dinghy towing	236

2-1. Driving procedures

Driving the vehicle

The following procedures should be observed to ensure safe driving:

■ Starting the hybrid system

→ P. 160, 164

■ Driving

STEP 1 With the brake pedal depressed, shift the shift lever to D.
(→P. 175)

STEP 2 Release the parking brake. (→P. 179)

STEP 3 Gradually release the brake pedal and gently depress the accelerator pedal to accelerate the vehicle.

■ Stopping

STEP 1 With the shift lever in D, depress the brake pedal.

STEP 2 If necessary, set the parking brake.

If the vehicle is to be stopped for an extended period of time, shift the shift lever to P. (→P. 175)

■ Parking the vehicle

STEP 1 With the shift lever in D, depress the brake pedal.

STEP 2 Shift the shift lever to P. (→P. 175)

STEP 3 Set the parking brake. (→P. 179)

STEP 4 **Vehicles without a smart key system**

Turn the engine switch to the “LOCK” position to stop the hybrid system.

Vehicles with a smart key system

Press the “POWER” switch to stop the hybrid system.

STEP 5 Lock the door, making sure that you have the key on your person.

If parking on a hill, block the wheels as needed.

Starting off on a steep uphill

- STEP 1** Make sure that the parking brake is set and shift the shift lever to D.
- STEP 2** Gently depress the accelerator pedal.
- STEP 3** Release the parking brake.

■ When starting off on a uphill

The hill-start assist control will activate. (→P. 221)

■ Driving in the rain

- Drive carefully when it is raining, because visibility will be reduced, the windows may become fogged-up, and the road will be slippery.
- Drive carefully when it starts to rain, because the road surface will be especially slippery.
- Refrain from high speeds when driving on an expressway in the rain, because there may be a layer of water between the tires and the road surface, preventing the steering and brakes from operating properly.

■ Engine speed while driving

In the following conditions, the engine speed may become high while driving. This is due to automatic up-shifting control or down-shifting implementation to meet driving conditions. It does not indicate sudden acceleration.

- The vehicle is judged to be driving uphill or downhill
- When the accelerator pedal is released

■ Breaking in your new Toyota

To extend the life of the vehicle, observing the following precautions is recommended:

- For the first 200 miles (300 km):
Avoid sudden stops.
- For the first 1000 miles (1600 km):
 - Do not drive at extremely high speeds.
 - Avoid sudden acceleration.
 - Do not drive at a constant speed for extended periods.

■ Operating your vehicle in a foreign country

Comply with the relevant vehicle registration laws and confirm the availability of the correct fuel. (→P. 498)

■ For efficient use

- Shift the shift lever to D when driving.

In the N position, the gasoline engine operates but electricity cannot be generated. The hybrid battery (traction battery) will discharge, requiring unnecessary engine power to recharge.

- Drive your vehicle smoothly.

Avoid abrupt acceleration and deceleration. Gradual acceleration and deceleration will make more effective use of the electric motor (traction motor) without having to use gasoline engine power.

- Avoid repeated acceleration.

Repeated acceleration consumes hybrid battery (traction battery) power, resulting in poor acceleration. Battery power can be restored by driving with the accelerator pedal slightly released.

- Shift the shift lever to P when parking.

In the N position, the hybrid battery (traction battery) does not recharge. Leaving the shift lever in the N position for an extended period of time may discharge the hybrid battery. The vehicle cannot run if the hybrid battery is discharged.

 **CAUTION**
■ When starting the vehicle

Always keep your foot on the brake pedal while stopped with the hybrid system operating. This prevents the vehicle from creeping.

■ When driving the vehicle

- Do not drive if you are unfamiliar with the location of the brake and accelerator pedals to avoid depressing the wrong pedal.
 - Accidentally depressing the accelerator pedal instead of the brake pedal will result in sudden acceleration that may lead to an accident that could result in death or serious injury.
 - When backing up, you may twist your body around, leading to a difficulty in operating the pedals. Make sure to operate the pedals properly.
 - Make sure to keep a correct driving posture even when moving the vehicle only slightly. This allows you to depress the brake and accelerator pedals properly.
 - Depress the brake pedal using your right foot. Depressing the brake pedal using your left foot may delay response in an emergency, resulting in an accident.
- The driver should pay extra attention to pedestrians when the vehicle is powered only by the electric motor (traction motor). Because there is no engine noise, the pedestrians may misjudge the vehicle's movement.
- Do not drive the vehicle over or stop the vehicle near flammable materials. The exhaust system and exhaust gases can be extremely hot. These hot parts may cause a fire if there is any flammable material nearby.
- Do not let the vehicle roll backward while the shift lever is in a driving position, or roll forward while the shift lever is in R. Doing so may result in an accident or damage to the vehicle.
- If the smell of exhaust is noticed inside the vehicle, open the windows and check that the back door is closed. Large amounts of exhaust in the vehicle can cause driver drowsiness and an accident, resulting in death or a serious health hazard. Have the vehicle inspected by your Toyota dealer immediately.
- Do not shift the shift lever to P while the vehicle is moving. Doing so can damage the transmission and may result in a loss of vehicle control.

 CAUTION

- Do not shift the shift lever to R while the vehicle is moving forward. Doing so can damage the transmission and may result in a loss of vehicle control.
- Do not shift the shift lever to D while the vehicle is moving backward. Doing so can damage the transmission and may result in a loss of vehicle control.
- Moving the shift lever to N while the vehicle is moving will disengage the hybrid system. Engine braking is not available with the hybrid system disengaged.
- During normal driving, do not turn off the hybrid system. Turning the hybrid system off while driving will not cause loss of steering or braking control, however, power assist to the steering will be lost. This will make it more difficult to steer smoothly, so you should pull over and stop the vehicle as soon as it is safe to do so.
In the event of an emergency, such as if it becomes impossible to stop the vehicle in the normal way: →P. 493
- Use engine braking (shift position B) to maintain a safe speed when driving down a steep hill.
Using the brakes continuously may cause the brakes to overheat and lose effectiveness. (→P. 176)
- Do not adjust the positions of the steering wheel, the seat, or the inside or outside rear view mirrors while driving.
Doing so may result in a loss of vehicle control that can cause accidents, resulting in death or serious injury.
- Always check that all passengers' arms, heads or other parts of their body are not outside the vehicle, as this may result in death or serious injury.
- Do not drive in excess of the speed limit. Even if the legal speed limit permits it, do not drive over 85 mph (140 km/h) unless your vehicle has high-speed capability tires. Driving over 85 mph (140 km/h) may result in tire failure, loss of control and possible injury. Be sure to consult a tire dealer to determine whether the tires on your vehicle are high-speed capability tires or not before driving at such speeds.

 **CAUTION****■ When driving on slippery road surfaces**

- Sudden braking, acceleration and steering may cause tire slippage and reduce your ability to control the vehicle, resulting in an accident.
- Sudden acceleration, engine braking due to shift changing, or changes in engine speed could cause the vehicle to skid, resulting in an accident.
- After driving through a puddle, lightly depress the brake pedal to make sure that the brakes are functioning properly. Wet brake pads may prevent the brakes from functioning properly. If the brakes on only one side are wet and not functioning properly, steering control may be affected, resulting in an accident.

■ When shifting the shift lever

Be careful not to shift the shift lever with the accelerator pedal depressed. Shifting the shift lever to a gear other than P or N may lead to unexpected rapid acceleration of the vehicle that may cause an accident and result in death or serious injury.

■ If you hear a squealing or scraping noise (brake pad wear limit indicators)

Have the brake pads checked and replaced by your Toyota dealer as soon as possible.

Rotor damage may result if the pads are not replaced when needed.

It is dangerous to drive the vehicle when the wear limits of the brake pads and/or those of the brake discs are exceeded.

 CAUTION

■ **When the vehicle is stopped**

- Do not depress the accelerator pedal unnecessarily.
If the vehicle is in any gear other than P or N, the vehicle may accelerate suddenly and unexpectedly, causing an accident.
- Do not leave the vehicle with the hybrid system on for a long time.
If such a situation cannot be avoided, park the vehicle in an open space and check that exhaust fumes do not enter the vehicle interior.
- In order to prevent accidents due to the vehicle rolling away, always keep depressing the brake pedal while the “READY” indicator is on. Apply the parking brake as necessary.
- If the vehicle is stopped on an incline, in order to prevent accidents caused by the vehicle rolling forward or backward, always depress the brake pedal and securely apply the parking brake as needed.
- Avoid revving or racing the engine.
Running the engine at high speed while the vehicle is stopped may cause the exhaust system to overheat, which could result in a fire if combustible material is nearby.

■ **When the vehicle is parked**

- Do not leave glasses, cigarette lighters, spray cans, or soft drink cans in the vehicle when it is in the sun.
Doing so may result in the following:
 - Gas may leak from a cigarette lighter or spray can, and may lead to a fire.
 - The temperature inside the vehicle may cause the plastic lenses and plastic material of glasses to deform or crack.
 - Soft drink cans may fracture, causing the contents to spray over the interior of the vehicle, and may also cause a short circuit in the vehicle's electrical components.
- Do not leave cigarette lighters in the vehicle. If a cigarette lighter is in a place such as the glove box or on the floor, it may be lit accidentally when luggage is loaded or the seat is adjusted, causing a fire.

⚠ CAUTION

- Do not attach adhesive discs to the windshield or windows. Do not place containers such as air fresheners on the instrument panel or dashboard. Adhesive discs or containers may act as lenses, causing a fire in the vehicle.
- Do not leave a door or window open if the curved glass is coated with a metallized film such as a silver-colored one. Reflected sunlight may cause the glass to act as a lens, causing a fire.
- Always apply the parking brake, shift the shift lever to P, stop the hybrid system and lock the vehicle.
Do not leave the vehicle unattended while the hybrid system is operating. Sound or shuddering may not be noticed even when the hybrid vehicle is ready to drive (when the “READY” indicator is illuminated).
- Do not touch the exhaust pipe while the hybrid system is operating or immediately after turning the hybrid system off.
Doing so may cause burns.
- Do not leave the hybrid system operating in an area with snow build-up, or where it is snowing. If snowbanks build up around the vehicle while the hybrid system is operating, exhaust gases may collect and enter the vehicle. This may lead to death or a serious health hazard.

■ Exhaust gases

Exhaust gases include harmful carbon monoxide (CO), which is colorless and odorless. Inhaling exhaust gases may lead to death or a serious health hazard.

- If the vehicle is in a poorly ventilated area, stop the hybrid system. In a closed area, such as a garage, exhaust gases may collect and enter the vehicle. This may lead to death or a serious health hazard.
- The exhaust system should be checked occasionally. If there is a hole or crack caused by corrosion, damage to a joint or abnormal exhaust noise, be sure to have the vehicle inspected and repaired by your Toyota dealer. Failure to do so may allow exhaust gases to enter the vehicle, resulting in death or a serious health hazard.

 CAUTION

■ **When taking a nap in the vehicle**

Always turn the hybrid system off. Otherwise, if you accidentally move the shift lever or depress the accelerator pedal, this could cause an accident or fire due to hybrid system overheating. Additionally, if the vehicle is parked in a poorly ventilated area, exhaust gases may collect and enter the vehicle, leading to death or a serious health hazard.

■ **When braking**

- When the brakes are wet, drive more cautiously.

Braking distance increases when the brakes are wet, and this may cause one side of the vehicle to brake differently than the other side. Also, the parking brake may not securely hold the vehicle.

- If the electronically controlled brake system does not operate, do not follow other vehicles closely and avoid hills or sharp turns that require braking.

In this case, braking is still possible, but the brake pedal should be depressed more firmly than usual. Also, the braking distance will increase. Have your brakes fixed immediately.

- The brake system consists of 2 or more individual hydraulic systems; if one of the systems fails, the other(s) will still operate. In this case, the brake pedal should be depressed more firmly than usual and the braking distance will increase. Have your brakes fixed immediately.

 NOTICE

■ **When driving the vehicle**

- Do not depress the accelerator and brake pedals at the same time during driving, as this may restrain driving torque.
- Do not use the accelerator pedal or depress the accelerator and brake pedals at the same time to hold the vehicle on a hill.

■ **When parking the vehicle**

Always shift the shift lever to P. Failure to do so may cause the vehicle to move or the vehicle may accelerate suddenly if the accelerator pedal is accidentally depressed.

 NOTICE

■ Avoiding damage to vehicle parts

- Do not turn the steering wheel fully in either direction and hold it there for an extended period of time.
Doing so may damage the power steering motor.
- When driving over bumps in the road, drive as slowly as possible to avoid damaging the wheels, underside of the vehicle, etc.

■ If you get a flat tire while driving

A flat or damaged tire may cause the following situations. Hold the steering wheel firmly and gradually depress the brake pedal to slow down the vehicle.

- It may be difficult to control your vehicle.
- The vehicle will make abnormal sounds or vibrations.
- The vehicle will lean abnormally.

Information on what to do in case of a flat tire (→P. 463)

■ When encountering flooded roads

Do not drive on a road that has flooded after heavy rain etc. Doing so may cause the following serious damage to the vehicle:

- Engine stalling
- Short in electrical components
- Engine damage caused by water immersion

In the event that you drive on a flooded road and the vehicle is flooded, be sure to have your Toyota dealer check the following:

- Brake function
- Changes in quantity and quality of oil and fluid used for the engine, hybrid transmission, etc.
- Lubricant condition of the bearings and suspension joints (where possible), and the function of all joints, bearings, etc.

2-1. Driving procedures

Engine (ignition) switch (vehicles without a smart key system)

■ Starting the hybrid system

STEP 1 Check that the parking brake is set.

STEP 2 Check that the shift lever is set in P.

STEP 3 Firmly depress the brake pedal.

STEP 4

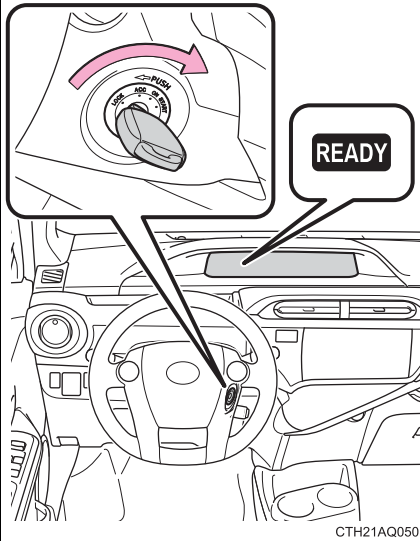

Turn the engine switch to the “START” position to start the hybrid system.

Continue depressing the brake pedal until the hybrid system is completely started.

STEP 5 Check that the “READY” indicator is on.

If the “READY” indicator changes from a flashing light to a solid light and a beep sound, the hybrid system is starting normally.

The vehicle will not move when the “READY” indicator is off.

The vehicle can move when the “READY” indicator is on even if the engine is stopped. (The engine starts or stops automatically in accordance with the state of the vehicle.)

■ Changing the engine switch positions

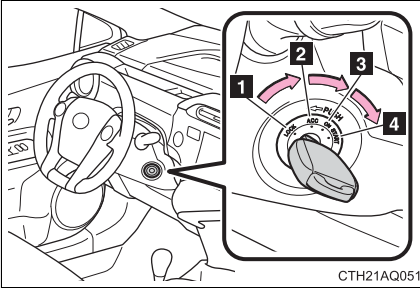

1 "LOCK"

The steering wheel is locked and the key can be removed. (The key can be removed only when the shift lever is in P.)

2 "ACC"

Some electrical components such as the power outlet can be used.

3 "ON"

All electrical components can be used.

4 "START"

For starting the hybrid system.

■ Turning the key from "ACC" to "LOCK"

STEP 1 Shift the shift lever to P.

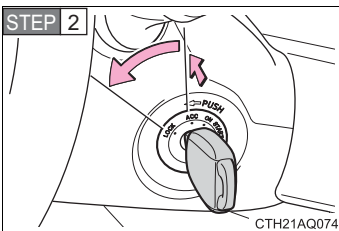

Push in the key and turn it to the "LOCK" position.

■ Sounds and vibrations specific to a hybrid vehicle

→P. 28

■ When the ambient temperature is low, such as during winter driving conditions

It may take time until the "READY" indicator comes on.

■ **If the hybrid system does not start (vehicles with immobilizer system)**

The immobilizer system may not have been deactivated. (→P. 110)
Contact your Toyota dealer.

■ **When the steering lock cannot be released**

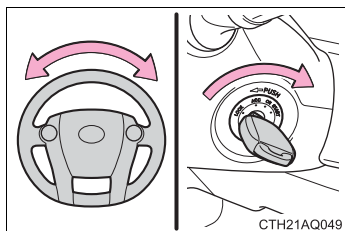

When starting the hybrid system, the engine switch may seem stuck in the “LOCK” position. To free it, turn the key while turning the steering wheel slightly left and right.

■ **If the “READY” indicator does not come on**

If the “READY” indicator does not come on when you turn the engine switch with the shift lever in P and the brake pedal depressed, contact your Toyota dealer immediately.

■ **If the hybrid system is malfunctioning**

→P. 448

■ **Key reminder function**

A buzzer sounds if the driver’s door is opened while the engine switch is in the “LOCK” or “ACC” position to remind you to remove the key.

⚠ CAUTION

■ **When starting the hybrid system**

Always start the hybrid system while sitting in the driver’s seat. Do not depress the accelerator pedal while starting the hybrid system under any circumstances.

Doing so may cause an accident resulting in death or serious injury.

■ **Caution when driving**

Do not turn the engine switch to the “LOCK” position while driving. If, in an emergency, you must turn the hybrid system off while the vehicle is moving, turn the engine switch only to the “ACC” position to stop the hybrid system.

An accident may result if the hybrid system is stopped while driving.

(→P. 493)

**NOTICE****■ To prevent 12-volt battery discharge**

Do not leave the engine switch in the “ACC” or “ON” position for long periods of time without the hybrid system on.

■ When starting the hybrid system

If the hybrid system becomes difficult to start, have your vehicle checked by your Toyota dealer immediately.

2-1. Driving procedures

Power (ignition) switch (vehicles with a smart key system)

Performing the following operations when carrying the electronic key on your person starts the hybrid system or changes “POWER” switch modes.

■ Starting the hybrid system

STEP 1 Check that the parking brake is set.

STEP 2 Check that the shift lever is set in P.

If the shift lever is not set in P, the hybrid system may not be started. (→P. 175)

STEP 3 Firmly depress the brake pedal.



will be displayed on the multi-information display.

If it is not displayed, the hybrid system cannot be started.

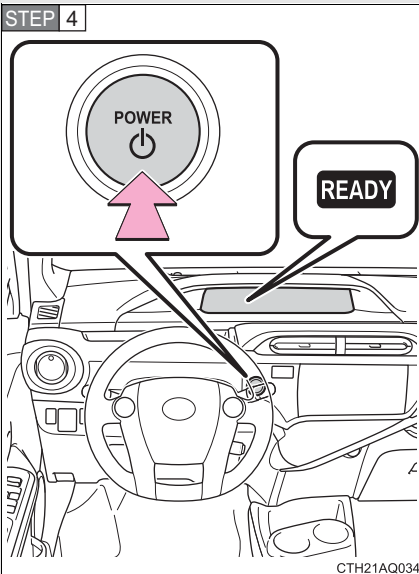

Press the “POWER” switch.

Continue depressing the brake pedal until the hybrid system is completely started.

The hybrid system can be started from any “POWER” switch mode.

STEP 5 Check that the “READY” indicator is on.

If the “READY” indicator changes from a flashing light to a solid light and a beep sound, the hybrid system is starting normally.

The vehicle will not move when the “READY” indicator is off.

The vehicle can move when the “READY” indicator is on even if the engine is stopped. (The engine starts or stops automatically in accordance with the state of the vehicle.)

■ Stopping the hybrid system

STEP 1 Stop the vehicle completely.

STEP 2 Shift the shift lever to P.

STEP 3 Set the parking brake. (→P. 179)

STEP 4 Press the “POWER” switch.

STEP 5 Slowly release the brake pedal and check that  on the multi-information display is off.

■ Changing “POWER” switch modes

Modes can be changed by pressing the “POWER” switch with brake pedal released. (The mode changes each time the switch is pressed.)

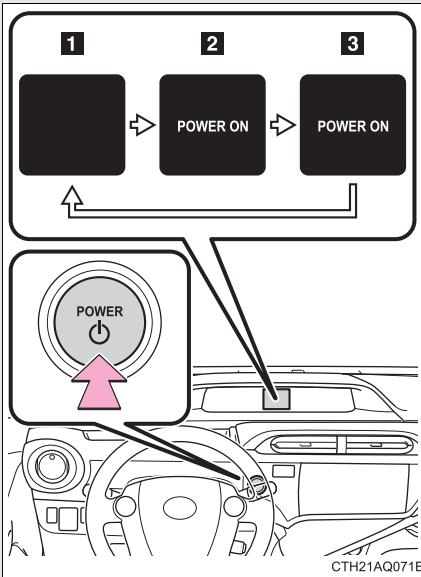

1 Off*

The emergency flashers can be used.

The multi-information display is off.

2 ACCESSORY mode

Some electrical components such as the power outlet can be used.

POWER ON will be displayed on the multi-information display.

3 ON mode

All electrical components can be used.

POWER ON will be displayed on the multi-information display.

*: If the shift lever is in a position other than P when turning off the hybrid system, the “POWER” switch will be turned to ACCESSORY mode, not to off.

When stopping the hybrid system with the shift lever in a position other than P

If the hybrid system is stopped with the shift lever in a position other than P, the “POWER” switch will not be turned off but instead be turned to ACCESSORY mode. Perform the following procedure to turn the switch off:

STEP 1 Check that the parking brake is set.

STEP 2 Shift the shift lever to P.

STEP 3 Check that  is displayed on the multi-information display and then press the “POWER” switch once.

STEP 4 Check that  on the multi-information display is off.

■ Auto power off function

When the shift lever is in P, if the vehicle is left in ACCESSORY or ON mode with the hybrid system not operating for more than 20 minutes (ACCESSORY mode) or one hour (ON mode), the “POWER” switch will automatically turn off. However, this function cannot entirely prevent 12-volt battery discharge. Do not leave the vehicle with the “POWER” switch in ACCESSORY or ON mode for long periods of time when the hybrid system is not operating.

■ Sounds and vibrations specific to a hybrid vehicle

→P. 28

■ Electronic key battery depletion

→P. 58

■ When the ambient temperature is low, such as during winter driving conditions

It may take time until the “READY” indicator comes on.

■ Conditions affecting operation

→P. 55

■ Notes for the entry function

→P. 56

■ If the hybrid system does not start

- The immobilizer system may not have been deactivated. (→P. 110)
Contact your Toyota dealer.

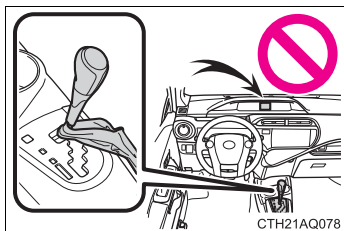

- Check that the shift lever is securely set in P. The hybrid system may not start if the shift lever is not securely in the P position. "SHIFT TO P POSITION TO START" will be displayed on the multi-information display.

■ Steering lock

After turning the "POWER" switch off and opening and closing the doors, the steering wheel will be locked due to the steering lock function. Operating the "POWER" switch again automatically cancels the steering lock.

■ When the steering lock cannot be released

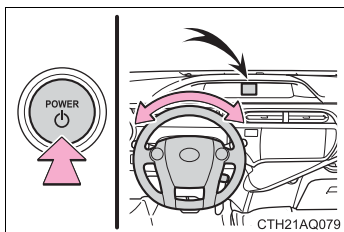

"STEERING LOCK ACTIVE" will be displayed on the multi-information display.

Check that the shift lever is set in P. Press the "POWER" switch while turning the steering wheel left and right.

■ Steering lock motor overheating prevention

To prevent the steering lock motor from overheating, the motor may be suspended if the hybrid system is turned on and off repeatedly in a short period of time. In this case, refrain from operating the hybrid system. After about 10 seconds, the steering lock motor will resume functioning.

■ If the “READY” indicator does not come on

If the “READY” indicator does not come on when you press the “POWER” switch with the shift lever in P and the brake pedal depressed, contact your Toyota dealer immediately.

■ If the hybrid system is malfunctioning

→P. 448

■ If the electronic key battery is depleted

→P. 401

■ Operation of the “POWER” switch

- When operating the “POWER” switch, one short, firm press is enough. If the switch is pressed improperly, the hybrid system may not start or the “POWER” switch mode may not change. It is not necessary to press and hold the switch.
- If attempting to restart the hybrid system immediately after turning the “POWER” switch off, the hybrid system may not start in some cases. After turning the “POWER” switch off, please wait a few seconds before restarting the hybrid system.

 **CAUTION**

■ **When starting the hybrid system**

Always start the hybrid system while sitting in the driver's seat. Do not depress the accelerator pedal while starting the hybrid system under any circumstances.

Doing so may cause an accident resulting in death or serious injury.

■ **Caution while driving**

If a hybrid system failure occurs while the vehicle is moving, do not lock or open the doors until the vehicle reaches a safe and complete stop. Doing so may cause activation of the steering lock which may lead to an accident, resulting in death or serious injury.

■ **When "CHECK SMART KEY SYSTEM" is displayed on the multi-information display**

The system may be malfunctioning. Have the vehicle inspected by your Toyota dealer immediately. Failure to do so may lead to the system operating abnormally and possibly cause an accident or damage to the vehicle.

■ **Stopping the hybrid system in an emergency**

If you want to stop the hybrid system in an emergency while driving the vehicle, press and hold the "POWER" switch for more than 2 seconds, or press it briefly 3 times or more in succession. (→P. 493)

However, do not touch the "POWER" switch while driving except in an emergency. Turning the hybrid system off while driving will not cause loss of steering or braking control, however, power assist to the steering will be lost. This will make it more difficult to steer smoothly, so you should pull over and stop the vehicle as soon as it is safe to do so.

 NOTICE**■ To prevent 12-volt battery discharge**

- Do not leave the “POWER” switch in ACCESSORY or ON mode for long periods of time without the hybrid system on.
- If  is displayed on the multi-information display, the “POWER” switch is not off. Exit the vehicle after turning the “POWER” switch off.
- Do not stop the hybrid system when the shift lever is in a position other than P. If the hybrid system is stopped in another shift lever position, the “POWER” switch will not be turned off but instead be turned to ACCESSORY mode. If the vehicle is left in ACCESSORY mode, 12-volt battery discharge may occur.

■ When starting the hybrid system

If the hybrid system becomes difficult to start, have your vehicle checked by your Toyota dealer immediately.

■ Symptoms indicating a malfunction with the “POWER” switch

If the “POWER” switch seems to be operating somewhat differently than usual, such as the switch sticking slightly, there may be a malfunction. Contact your Toyota dealer immediately.

2-1. Driving procedures

EV drive mode

In EV drive mode, the electric motor (traction motor), powered by the hybrid battery (traction battery), is used to drive the vehicle.

This mode allows you to drive in residential areas early in the morning and late at night, or in indoor parking lots etc. without concern for noises and exhaust gas emissions.

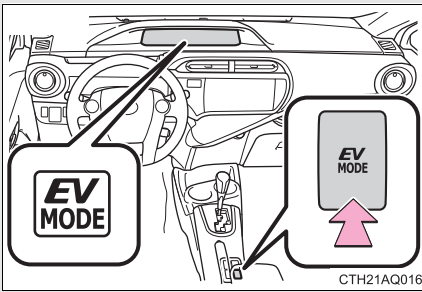

Turns EV drive mode on/off

When EV drive mode is turned on, the EV drive mode indicator will come on.

Pressing the switch when in EV drive mode will return the vehicle to normal driving (using the gasoline engine and electric motor [traction motor]).

■ Switching to EV drive mode when the gasoline engine is cold

If the hybrid system is started while the gasoline engine is cold, the gasoline engine will start automatically after a short period of time in order to warm up. In this case, you will become unable to switch to EV drive mode.

After the hybrid system has started and the "READY" indicator has illuminated, press the EV drive mode switch before the gasoline engine starts to switch to EV drive mode.

■ Situations in which EV drive mode cannot be turned on

It may not be possible to turn EV drive mode on in the following situations. If it cannot be turned on, a buzzer will sound and a message will be shown on the multi-information display.

- The temperature of the hybrid system is high.
The vehicle has been left in the sun, driven on a hill, driven at high speeds, etc.
- The temperature of the hybrid system is low.
The vehicle has been left in temperatures lower than about 68°F (20°C) for a long period of time etc.
- The gasoline engine is warming up.
- The hybrid battery (traction battery) is low.
When the amount of remaining hybrid battery (traction battery) charge displayed on the meter or Display Audio system is low. (→P. 35)
- Vehicle speed is high.
- The accelerator pedal is depressed firmly or the vehicle is on a hill etc.
- The windshield defogger is in use.

■ Automatic cancelation of EV drive mode

When driving in EV drive mode, the gasoline engine may automatically restart in the following situations. When EV drive mode is canceled, a buzzer will sound and the EV drive mode indicator will flash and go off.

- The hybrid battery (traction battery) becomes low.
- Vehicle speed becomes high.
- The accelerator pedal is depressed firmly or the vehicle is on a hill etc.

■ Possible driving distance when driving in EV drive mode

In EV drive mode, it is possible to drive up to about 1.3 miles (2 km) if driving at a speed of about 25 mph (40 km/h) or less. (The distance that is possible depends on the hybrid battery [traction battery] level and driving conditions.)

■ Fuel economy

PRIUS c is designed to achieve the best possible fuel economy during normal driving (using the gasoline engine and electric motor [traction motor]). Driving in EV drive mode more than necessary may lower fuel economy.

■ Vehicle Proximity Notification System sound

Even when EV drive mode is turned on, the Vehicle Proximity Notification System may produce a sound. (→P. 25)

CAUTION

■ Caution while driving

When driving in EV drive mode no engine noise is made. As such, pedestrians, people riding bicycles or other people and vehicles in the surrounding area may not be aware of the vehicle starting off or approaching them even if the Vehicle Proximity Notification System is active. Therefore, take extra care while driving.

2-1. Driving procedures

Hybrid transmission

Select a shift position appropriate for the driving conditions.

■ Shifting the shift lever

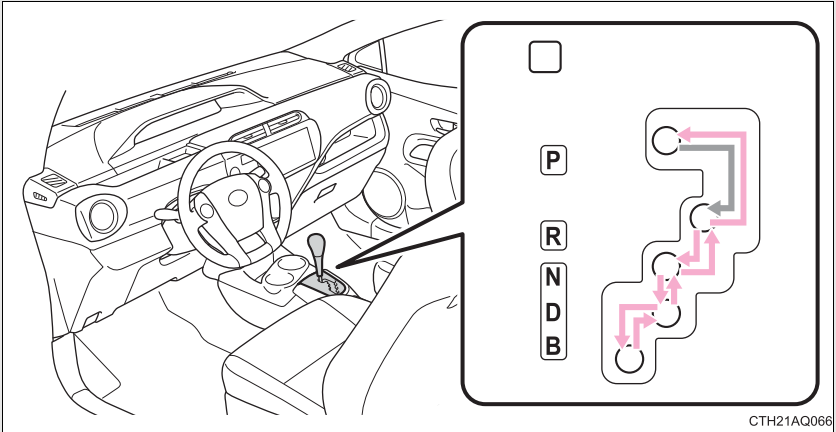

Vehicles without a smart key system

While the engine switch is in the “ON” position, move the shift lever with the brake pedal depressed.

Vehicles with a smart key system

While the “POWER” switch is in ON mode, move the shift lever with the brake pedal depressed.

When shifting from P to another position; from D to R or P; or from R to P, D or B; ensure that the brake pedal is being depressed and the vehicle is stationary.

■ Shift position purpose

Shift position	Function
P	Parking the vehicle/starting the hybrid system
R	Reversing
N	Neutral
D	Normal driving*
B	Position for engine braking

*: To improve fuel efficiency and reduce noises, set the shift lever in the D position for normal driving.

■ Selecting Eco drive mode

Suitable for enhancing the fuel economy, because the torque corresponding to the accelerator pedal depression amount can be generated more smoothly than it is in normal conditions and the operation of the air conditioning system (heating/cooling) will be minimized.

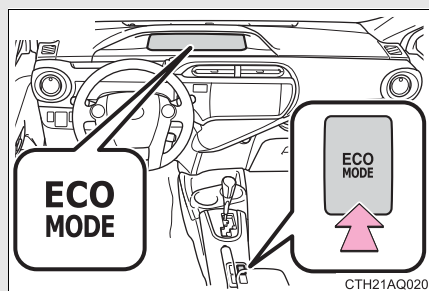

Eco drive mode

When Eco drive mode is turned on, the “ECO MODE” indicator will come on.

Pressing the “ECO MODE” switch again turns Eco drive mode off.

■ Operation of the air conditioning system in Eco drive mode

Eco drive mode controls the heating/cooling operations and fan speed of the air conditioning system to enhance fuel efficiency. (→P. 244) To improve air conditioning performance, adjust the temperature setting or fan speed, or turn off Eco drive mode.

■ When in heavy traffic

If the shift lever is in N, the hybrid battery (traction battery) will not be charged. To help prevent the battery from discharging, avoid putting the shift lever in N for an extended period of time.

■ If the shift lever cannot be shifted from P

→P. 477

▲ CAUTION**■ When driving on slippery road surfaces**

Do not accelerate or shift gears suddenly.
Sudden changes in engine braking may cause the vehicle to spin or skid, resulting in an accident.

2-1. Driving procedures

Turn signal lever

The turn signal lever can be used to show the following intentions of the driver:

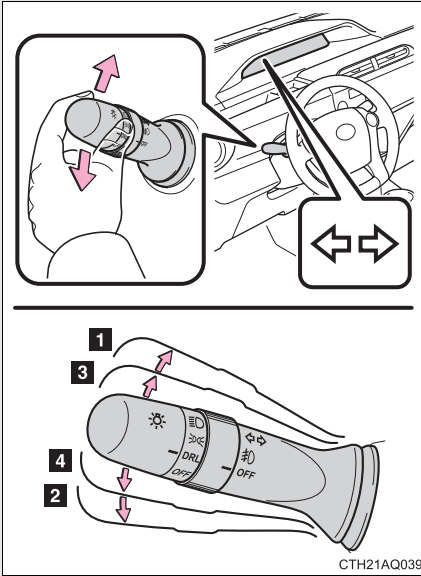

1 Right turn

2 Left turn

3 Lane change to the right
(push and hold the lever partway)

The right hand signals will flash until you release the lever.

4 Lane change to the left
(push and hold the lever partway)

The left hand signals will flash until you release the lever.

■ Turn signals can be operated when

Vehicles without a smart key system

The engine switch is in the "ON" position.

Vehicles with a smart key system

The "POWER" switch is in ON mode.

■ If the indicator flashes faster than usual

Check that a light bulb in the front or rear turn signal lights has not burned out.

2-1. Driving procedures

Parking brake

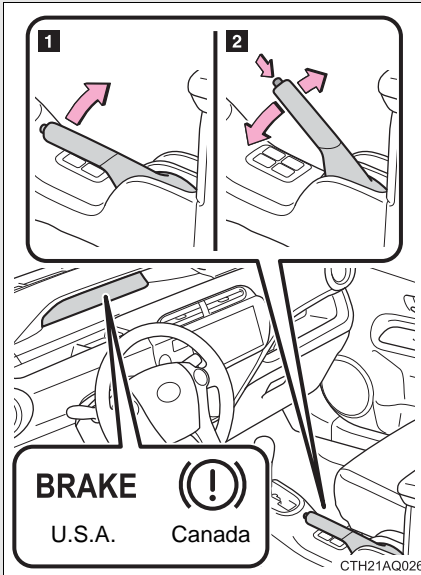

1 To set the parking brake, fully pull the parking brake lever while depressing the brake pedal.

2 To release the parking brake, slightly raise the lever and lower it completely while pressing the button.

2

When driving

■ Parking brake engaged warning buzzer

A buzzer will sound if the vehicle is driven at a speed of approximately 3 mph (5 km/h) or more with the parking brake engaged. (→P. 450)

■ Usage in winter time

→P. 231

⚠ NOTICE

■ Before driving

Fully release the parking brake.

Driving the vehicle with the parking brake set will lead to brake components overheating, which may affect braking performance and increase brake wear.

Horn

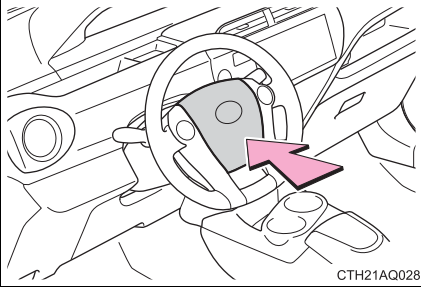

To sound the horn, press on or close to the  mark.

■ After adjusting the steering wheel

Make sure that the steering wheel is securely locked.

The horn may not sound if the steering wheel is not securely locked.

(→P. 93)

2-2. Instrument cluster Gauges and meters

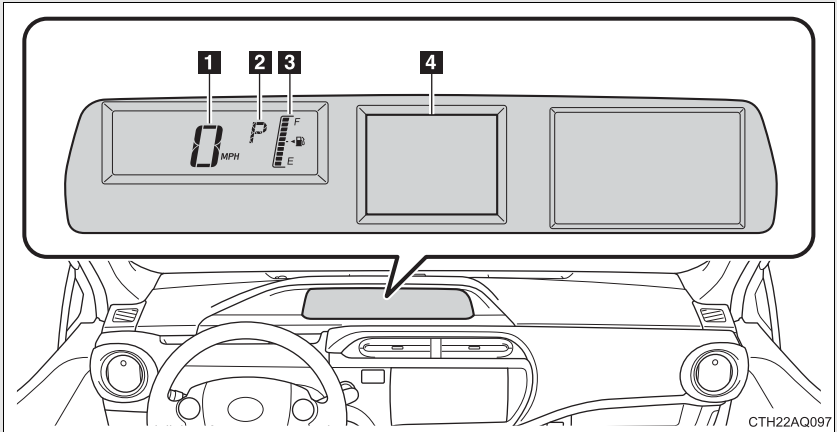

1 Speedometer

Displays the vehicle speed.

2 Shift position display

Displays the selected shift position. (→P. 175)

3 Fuel gauge

Displays the quantity of fuel remaining in the tank.

4 Multi-information display

Presents the driver with a variety of driving-related data. (→P. 187)

Instrument panel light control

The brightness of the instrument panel lights can be adjusted by turning the dial.

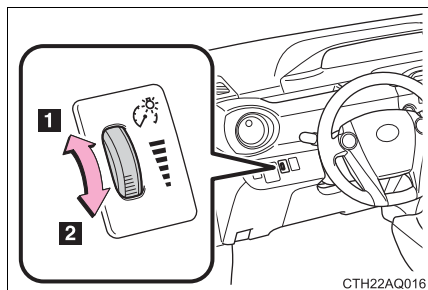

1 Brighter

2 Darker

■ The meters and multi-information display illuminate when

Vehicles without a smart key system

The engine switch is in the “ON” position.

Vehicles with a smart key system

The “POWER” switch is in ON mode.

■ The brightness of the instrument panel lights

When the tail lights are turned on, the brightness will be reduced slightly unless the control dial is turned up fully.

■ Engine speed

On hybrid vehicles, engine speed is precisely controlled in order to help improve fuel efficiency and reduce exhaust emissions etc.

There are times when the engine speed that is displayed may differ even when vehicle operation and driving conditions are the same.

 NOTICE**■ To prevent damage to the engine and its components**

This vehicle is not installed with an engine coolant temperature gauge.

Instead,  is shown on the multi-information display. The engine may

be overheating if  is shown on the multi-information display. In this case, immediately stop the vehicle in a safe place. (→P. 487)

Indicators and warning lights

The indicators and warning lights on the instrument cluster inform the driver of the status of the vehicle's various systems.

For the purpose of explanation, the following illustration displays all indicators and warning lights illuminated.

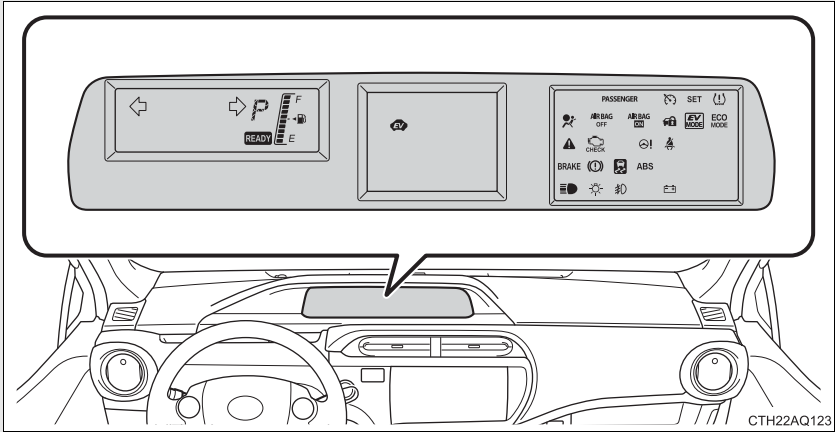

■ Indicators

The indicators inform the driver of the operating state of the vehicle's various systems.



Turn signal indicator
(→P. 178)



Headlight high beam
indicator (→P. 205)



(U.S.A.)

Headlight indicator
(→P. 204)



(Canada)

Tail light indicator
(→P. 204)



(if equipped)

Front fog light indicator
(→P. 208)



(if equipped)

Immobilizer system indi-
cator (→P. 110)



^{*1}
SRS airbag
on-off indica-
tor (→P. 130)



Driving ready indicator
(→P. 160, 164)



EV drive mode indica-
tor (→P. 172)



Shift position indicator
(→P. 176)



"ECO MODE" indicator
(→P. 176)



EV drive indicator lamp
(→P. 194)



(if equipped)

Cruise control indicator
(→P. 217)



(if equipped)

Cruise control set indi-
cator (→P. 217)



^{*1,2}
Slip indicator (→P. 222)

^{*1}: These lights turn on when the engine switch is turned to the "ON" position (vehicles without a smart key system) or the "POWER" switch is turned to ON mode (vehicles with a smart key system) to indicate that a system check is being performed. They will turn off after the hybrid system is on, or after a few seconds. There may be a malfunction in a system if a light does not come on, or if the lights do not turn off. Have the vehicle inspected by your Toyota dealer.

^{*2}: The light flashes to indicate that the system is operating.

■ Warning lights

Warning lights inform the driver of malfunctions in any of the vehicle's systems. (→P. 437)

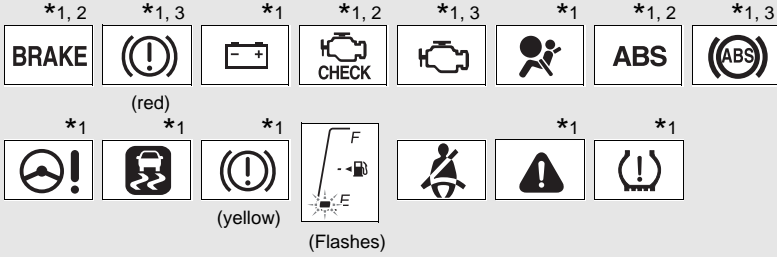

*1: These lights turn on when the engine switch is turned to the “ON” position (vehicles without a smart key system) or the “POWER” switch is turned to ON mode (vehicles with a smart key system) to indicate that a system check is being performed. They will turn off after the hybrid system is on, or after a few seconds. There may be a malfunction in a system if a light does not come on, or if the lights do not turn off. Have the vehicle inspected by your Toyota dealer.

*2: For vehicles sold in U.S.A.

*3: For vehicles sold in Canada

▲ CAUTION

■ If a safety system warning light does not come on

Should a safety system light such as the ABS or SRS warning light not come on when you start the hybrid system, this could mean that these systems are not available to help protect you in an accident, which could result in death or serious injury. Have the vehicle inspected by your Toyota dealer immediately if this occurs.

Multi-information display

The multi-information display presents the driver with a variety of driving-related data including the current outside air temperature.

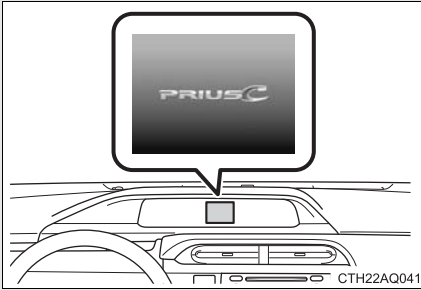

- Drive information

Displays information such as the hybrid system operating conditions and fuel consumption.

- Settings and screen off

Perform operations such as changing the date/time and screen settings.

- Warning messages

(→P. 447)

Automatically displayed if a malfunction occurs in one of the vehicle's systems.

Touch tracer display (vehicles with Display Audio system)

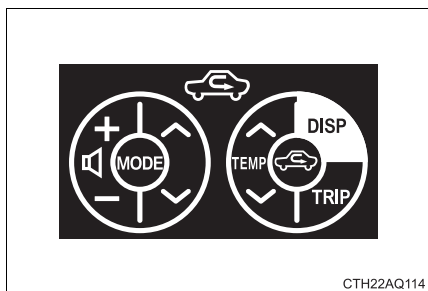

When a steering wheel switch is touched, an illustration of the switch is shown on the screen, helping the driver to confirm which switch they are touching without needing to look down at their hands.

The touch tracer display can be turned off. (→P. 199)

If an audio/navigation system is used that is not compatible with the steering switches in this vehicle, the audio switch display may not operate correctly.

Switching the display

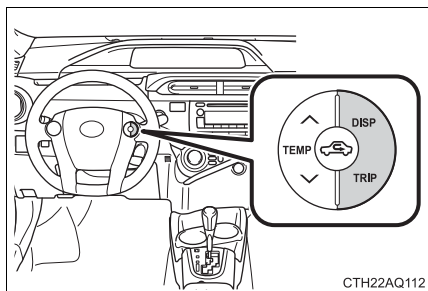

Press the “DISP” switch on the steering wheel to change the displayed item. The “TRIP” switch may also be used for certain items.

Items displayed in the upper part of the screen

The following items are always displayed in the upper part of the screen. (When using some menu items, these items will not be displayed.)

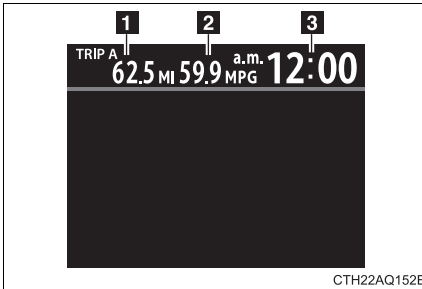

1 Odometer/trip meter

→P. 190

2 Average fuel consumption

Depending on whether the odometer or trip meter is displayed, the displayed contents differ. Use the displayed average fuel consumption as a reference.

- When the odometer is displayed: the average fuel consumption since the hybrid system was started is displayed.
- When the trip meter is displayed: the average fuel consumption since the trip meter was reset is displayed. The average fuel consumption for trip meter A and trip meter B is displayed separately.

When the trip meter is reset, average fuel consumption is also reset. (→P. 190)

3 Clock

Change the time on the settings screen. (→P. 199)

■ Odometer/trip meter

Each time the “TRIP” switch is pressed, the display changes as follows:

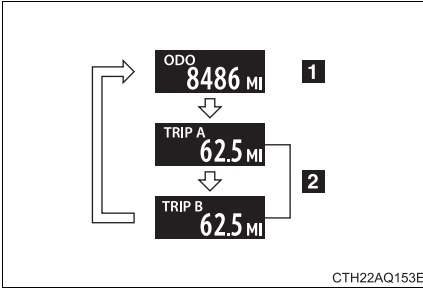

1 Odometer

Displays the total distance that the vehicle has been driven.

Some models, pressing and holding the “TRIP” switch will switch the display between MPH and km/h.

2 Trip meter

Displays the distance the vehicle has been driven since the meter was last reset. The trip meters can be split and used in 2 categories, A or B.

Pressing and holding the “TRIP” switch will reset the trip meter.

Switching menu screens

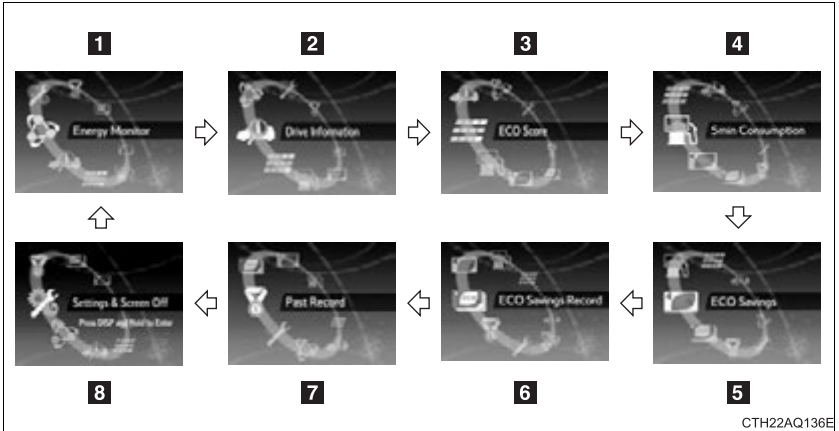

Each time the “DISP” switch is pressed, the menu screen changes. When the desired menu screen is displayed, stop pressing the “DISP” switch. The details screen will soon be displayed.

However, to display the “Settings & Screen Off” details screen, press and hold the “DISP” switch after the “Settings & Screen Off” menu screen is displayed.

1 “Energy Monitor”

Operating conditions of the hybrid system can be confirmed. (→P. 35)

2 “Drive Information”

Average speed, driving time, EV driving rate/EV driven distance, cruising range and outside temperature (→P. 334) are displayed. (→P. 192)

3 “ECO Score”

Evaluates the level of Eco-friendly driving and displays the results. (→P. 194)

4 “5min Consumption”*

Displays the average fuel consumption in intervals of 5 minutes. Current fuel consumption is simultaneously displayed, allowing it to be compared with previous fuel consumption rates. (→P. 39)

5 “ECO Savings”

If the price of gasoline is input, the cost of the consumed fuel according to the driven distance is displayed. If the fuel consumption comparison is set, the difference between the input fuel consumption and your vehicle's actual fuel consumption is expressed as an amount of money that was possibly saved. (→P. 195)

6 “ECO Savings Record”*

Displays eco savings record. (→P. 196)

7 “Past Record”*

Displays the best 3 fuel consumption records and the current fuel consumption ranking. Fuel consumption can also be displayed by the month. (→P. 40)

8 “Settings & Screen Off”

Operations such as changing each screen's setting and the date/time can be performed. (→P. 198)

*: Settings are set to off (initialized settings) at the time of shipping. (→P. 201)

■ “Drive Information”

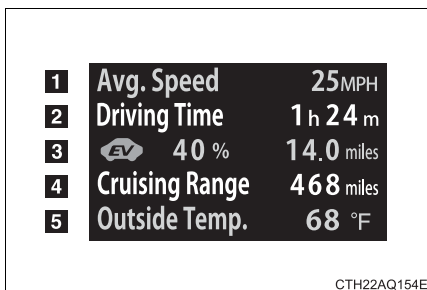

Depending on whether the odometer or trip meter is displayed, the displayed contents of average speed, driving time, and EV driving rate/EV driven distance differ.

- When the odometer is displayed: the record since the hybrid system was started is displayed.

- When the trip meter is displayed: the record since the trip meter was reset is displayed. The record for trip meter A and trip meter B is displayed separately.

When the trip meter is reset, the record is also reset. (→P. 190)

1 Average speed

Average speed will be displayed.

2 Driving time

Driving time will be displayed.

3 EV driving rate/EV driven distance

EV driving rate and driven distance (percentage and distance driven using just the electric motor [traction motor] only) will be displayed.

4 Cruising range

Displays the estimated maximum distance that can be driven with the quantity of fuel remaining.

- This distance is computed based on your average fuel consumption. As a result, the actual distance that can be driven may differ from that displayed.
- When only a small amount of fuel is added to the tank, the display may not be updated.

Vehicles without a smart key system:

when refueling, turn the engine switch to the “LOCK” position. If the vehicle is refueled without turning the engine switch to the “LOCK” position, the display may not be updated.

Vehicles with a smart key system:

when refueling, turn the “POWER” switch off. If the vehicle is refueled without turning the “POWER” switch off, the display may not be updated.

5 Outside temperature

→P. 334

■ “ECO Score”

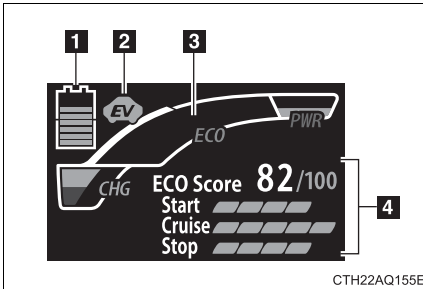

1 Hybrid battery (traction battery) charge level display

2 EV drive indicator lamp

Illuminates when only the electric motor is used to drive the vehicle

3 Hybrid System Indicator

Hybrid System Indicator represents the hybrid system power output and regenerative charging. (→P. 197)

4 Eco driving conditions display

Driving conditions are displayed in 5 stages and divided into 3 categories: start, cruise and stop. Every time the vehicle is stopped, the score is displayed. (Every time the vehicle is accelerated the score that was last displayed is reset. Accumulative scores are not calculated.)

■ “ECO Savings”

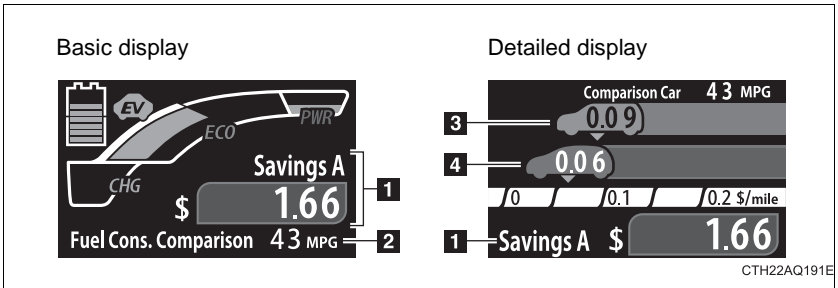

With 2 types of displays available, the cost of the consumed fuel can be displayed or the fuel consumption's comparison can be displayed.

Switching between basic display and detailed display can be performed on the screen settings screen. (→P. 200)

1 Savings and fuel cost

If the fuel consumption comparison is input (→P. 200), the possible savings are displayed. If the fuel consumption comparison has not been input, your vehicle's actual fuel cost will be displayed.

Depending on whether the odometer or trip meter is displayed, the displayed contents differ.

- When the odometer is displayed: the savings or fuel cost since the hybrid system was started is displayed.
- When the trip meter is displayed: the savings or fuel cost since the trip meter was reset is displayed. The savings or fuel cost for trip meter A or trip meter B is displayed separately.

When the trip meter is reset, savings or fuel cost is also reset.
(→P. 190)

2 “Fuel Cons. Comparison”

On the settings screen, input the fuel consumption comparison.
(→P. 200)

3 The cost of consumed fuel per mile/kilometer (comparison car)

Based on the fuel consumption comparison, the calculated value is displayed.

4 The cost of consumed fuel per mile/kilometer (your car)

The more fuel efficient your driving is, the further left the vehicle mark moves.

■ “ECO Savings Record”

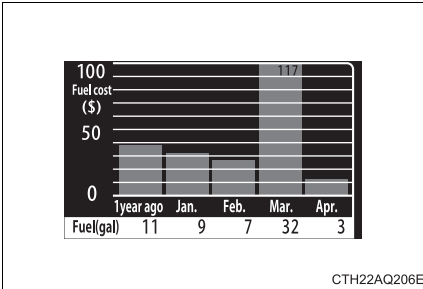

If the fuel consumption comparison is input in “ECO Savings”, the savings history will be displayed. If the fuel consumption comparison is not input, fuel cost history will be displayed.

Fuel costs for the current month, the last 3 months and the same month last year are displayed, enabling a comparison to be made.

If the dollar amount exceeds \$ 100, the numerical value will be displayed on the graph.

Hybrid System Indicator

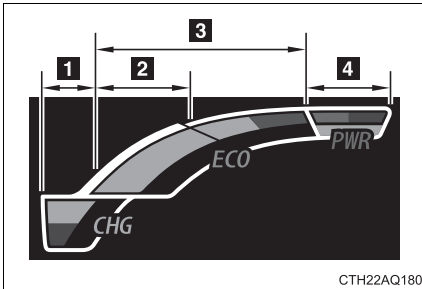

1 Charge area

Shows energy regeneration* status. Regenerated energy will be used to charge the hybrid battery (traction battery).

*: When used in this manual, “regeneration” refers to the conversion of energy created by the movement of the vehicle into electrical energy.

2 Hybrid Eco area

Shows that gasoline engine power is not being used very often.

The gasoline engine will automatically stop and restart under various conditions.

3 Eco area

Shows that the vehicle is being driven in an Eco-friendly manner.

4 Power area

Shows that the driving power is more than the upper limit of Eco driving. (during full power driving etc.)

Keeping the indicator within Eco area can help Eco-friendly driving.

Screen settings

If “Settings & Screen Off” is selected on the menu screen, the following items can be set. Always perform this operation after stopping the vehicle in a safe place. (Some items cannot be set while driving.)

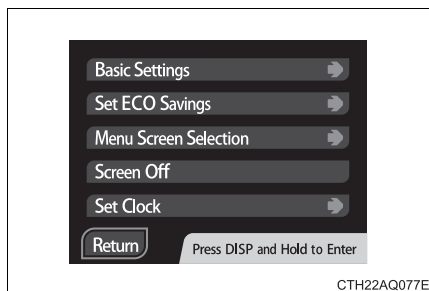

Press the “DISP” switch on the steering wheel to move the cursor. To switch to the settings screen, press and hold the “DISP” switch while the cursor is on the desired item.

■ Basic settings/Changing the clock shortcut

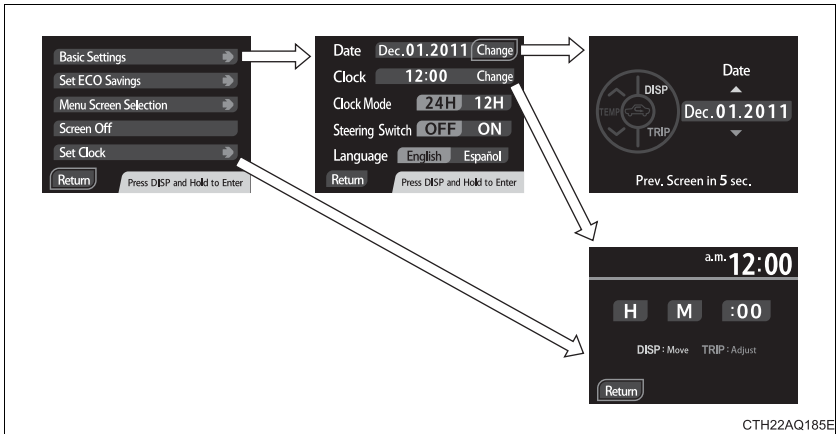

The date, time, clock mode (12 or 24 hour), touch tracer settings and the displayed language can be changed.

- Pressing the “DISP” (forward) or “TRIP” (back) switch changes the date.
- Press the “DISP” switch to select hours or minutes. Pressing the “TRIP” switch adjusts the hours or minutes.
- If set clock is selected, the screen will change to the clock settings screen.

■ “ECO savings” settings

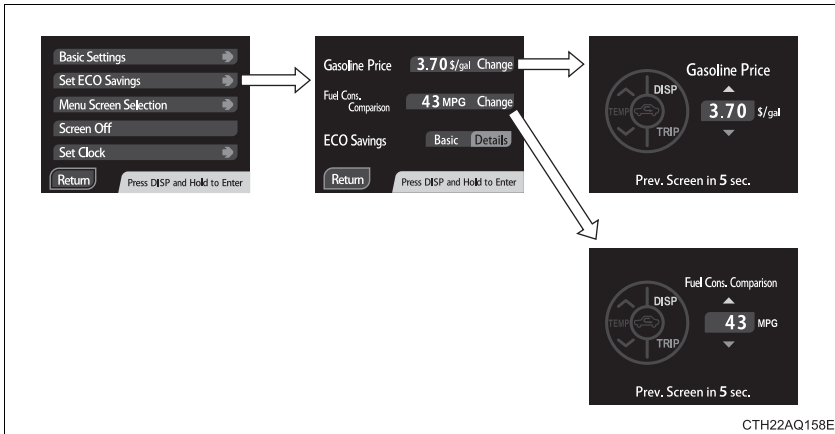

The gasoline price and fuel consumption comparison settings can be set, and the screen settings can be changed between basic and detailed.

- To input the gasoline price, press the “DISP” (to increase) or “TRIP” (to reduce) switch.

When the engine switch is turned to the “ON” position (vehicles without a smart key system) or the “POWER” switch is turned to ON mode (vehicles with a smart key system) after refueling, the gasoline price input screen is automatically displayed.

- To input the fuel consumption comparison, press the “DISP” (to increase) or “TRIP” (to reduce) switch.

When the fuel consumption comparison is input, the estimated savings in fuel costs are displayed. If the fuel consumption comparison is not input, the cost of the consumed fuel will be displayed.

■ Menu screen selection



The following screen changes and settings can be performed:

- The eco savings record screen can be switched on or off.
- The 5 minute fuel consumption screen can be switched on or off.
- Past record can be reset.
- The past record screen can be switched between off, monthly average and personal best.

■ Screen off

The screen can be turned off.

The upper part of the screen is always displayed and cannot be turned off.

Trip summary display

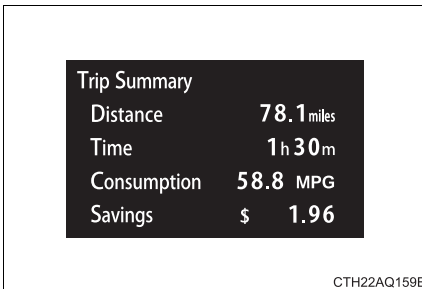

When the hybrid system is turned off, drive information data since the system was started is displayed after the ending animation.

When the doors are locked, the screen turns off.

■ **The clock is displayed when**

Vehicles without a smart key system

The engine switch is in the “ON” position.

Vehicles with a smart key system

The “POWER” switch is in ON mode.

■ **Eco score**

- As the accelerator pedal is not depressed, the driven distance using cruise control (if equipped) is not included in the eco score.
- As the eco score evaluation differs according to driving conditions and environmental factors, in some cases it may not be linked to fuel consumption.

■ **Eco savings**

- Fuel cost and savings should be used as a guide only.
- Depending on refueling methods, driving conditions and environmental factors, the actual and displayed fuel costs may differ.
- In some cases, fuel cost and savings may not be linked to the eco score evaluation.

■ **When disconnecting and reconnecting 12-volt battery terminals**

The following information data will be reset:

- Clock
- Past record (aside from the top 3 results)
- Average fuel consumption
- Cruising range
- Average vehicle speed
- Driving time
- EV driving rate/EV driven distance

Additionally, some displays may return to their default settings.

■ **Liquid crystal display**

Small spots or light spots may appear on the display. This phenomenon is characteristic of liquid crystal displays, and there is no problem continuing to use the display.

 **CAUTION****Eco score**

Eco score should be used as a guide only. Always drive safely in accordance with road and traffic conditions.

 **NOTICE****The multi-information display at low temperatures**

Allow the interior of the vehicle to warm up before using the liquid crystal information display. At extremely low temperatures, the information display monitor may respond slowly, and display changes may be delayed.

2-3. Operating the lights and wipers



Headlight switch

The headlights can be operated manually.

Turning the end of the lever turns on the lights as follows:

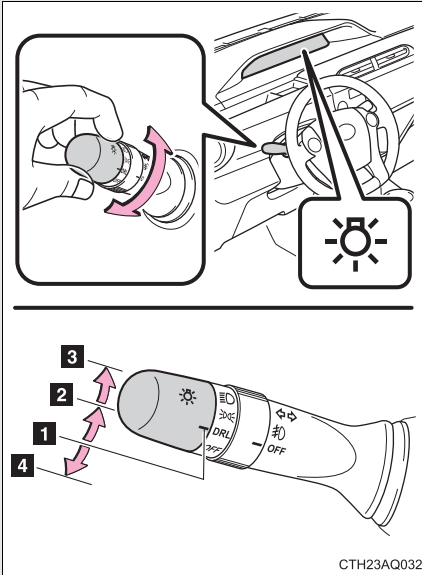

Type A

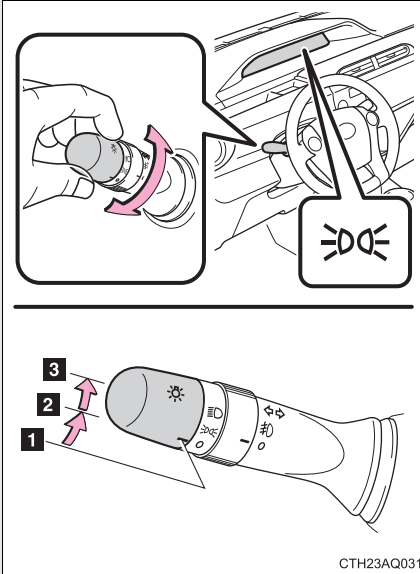

- 1 DRL** The daytime running lights turn on.
- 2**  The side marker, parking, tail, license plate, daytime running lights and instrument panel lights turn on.
- 3**  The headlights and all lights listed above (except daytime running lights) turn on.
- 4 OFF** The daytime running lights turn off.

Type B



- 1  The daytime running lights turn on.
- 2  The side marker, parking, tail, license plate, daytime running lights and instrument panel lights turn on.
- 3  The headlights and all lights listed above (except daytime running lights) turn on.

Turning on the high beam headlights

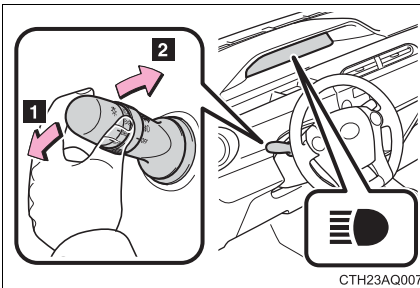

- 1 With the headlights on, push the lever away from you to turn on the high beams.
Pull the lever toward you to the center position to turn the high beams off.
- 2 Pull the lever toward you and release it to flash the high beams once.

You can flash the high beams with the headlights on or off.

■ Daytime running light system

- To make your vehicle more visible to other drivers, the headlights turn on automatically (at a reduced intensity) whenever the hybrid system is started and the parking brake is released. Daytime running lights are not designed for use at night.

For type A: Daytime running lights can be turned off by operating the switch.

- Compared to turning on the headlights, the daytime running light system offers greater durability and consumes less electricity, so it can help improve fuel economy.

■ Light reminder buzzer

Vehicles without a smart key system

A buzzer sounds when the engine switch is turned to the “LOCK” or “ACC” position and the driver's door is opened while the lights are turned on.

Vehicles with a smart key system

A buzzer sounds when the “POWER” switch is turned off or turned to ACCESSORY mode and the driver's door is opened while the lights are turned on.

■ Battery-saving function

In the following conditions, the remaining lights will go off automatically after 20 minutes in order to prevent the vehicle battery from being discharged:

- The headlights and/or tail lights are on.
- The engine switch is turned to the “ACC” or “LOCK” position (vehicles without a smart key system) or the “POWER” switch is turned to ACCESSORY mode or turned off (vehicles with a smart key system).

This function will be canceled in any of the following situations:

- When the engine switch is turned to the “ON” position (vehicles without a smart key system) or the “POWER” switch is turned to ON mode (vehicles with a smart key system).
- When the light switch is operated.
- When the door is opened or closed.

■ **Customization that can be configured at Toyota dealer**

Setting of the daytime running light system can be changed.
(Customizable features: →P. 522)



NOTICE

■ **To prevent 12-volt battery discharge**

Do not leave the lights on longer than necessary when the hybrid system is off.

2-3. Operating the lights and wipers Fog light switch*

The fog lights secure excellent visibility in difficult driving conditions, such as in rain and fog.

Type A

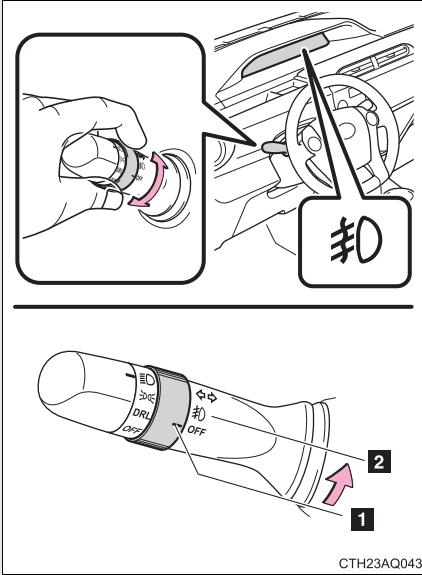

- 1 OFF** Turns the front fog lights off
- 2 Fog** Turns the front fog lights on

*: If equipped

Type B

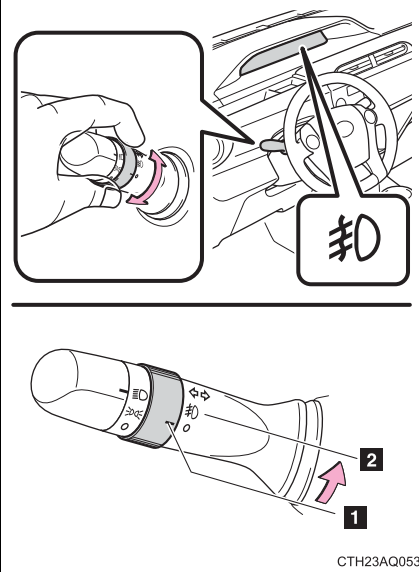

- 1 ○ Turns the front fog lights off
- 2 ≡○ Turns the front fog lights on

- **Fog lights can be used when**
The headlights are on in low beam.

2-3. Operating the lights and wipers Windshield wipers and washer

The wiper operation is selected by moving the lever as follows:

Type A

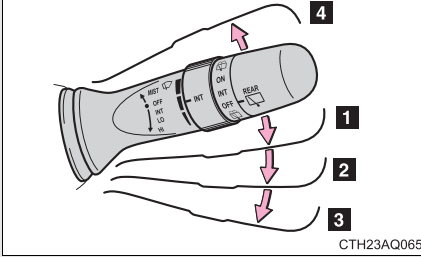
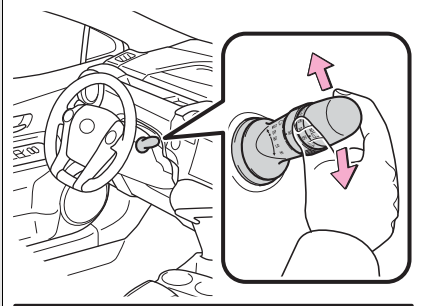

CTH23AQ065

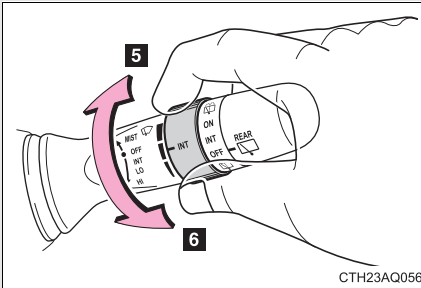

CTH23AQ056

- 1 INT** Intermittent windshield wiper operation
- 2 LO** Low speed windshield wiper operation
- 3 HI** High speed windshield wiper operation
- 4 MIST** Temporary operation

- 5** Increases the intermittent windshield wiper frequency*
- 6** Decreases the intermittent windshield wiper frequency*

*: The interval adjuster may not be equipped depending on vehicle grade.

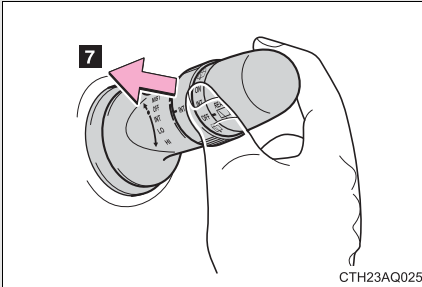

7 Washer/wiper dual operation

The wipers will automatically operate a couple of times after the washer squirts.

Type B

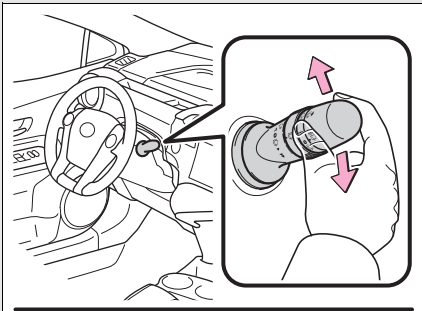

1  Intermittent windshield wiper operation

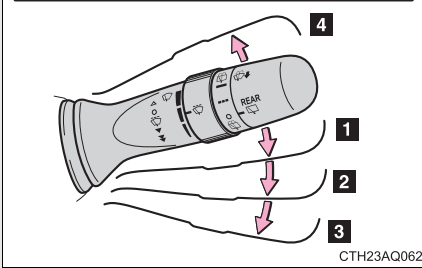

2  Low speed windshield wiper operation

3  High speed windshield wiper operation

4  Temporary operation

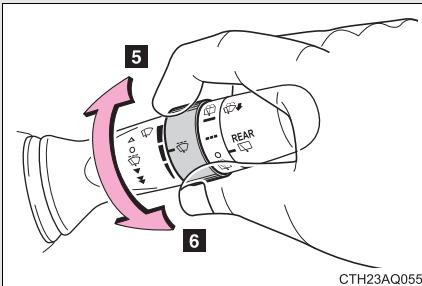

5 Increases the intermittent windshield wiper frequency*

6 Decreases the intermittent windshield wiper frequency*

*: The interval adjuster may not be equipped depending on vehicle grade.

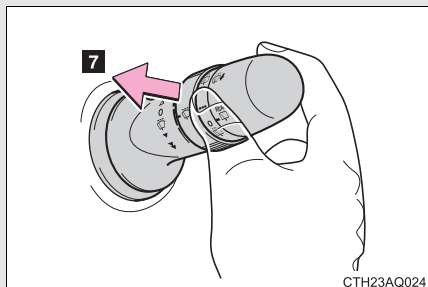

7 Washer/wiper dual operation

The wipers will automatically operate a couple of times after the washer squirts.

■ The windshield wipers and washer can be operated when

Vehicles without a smart key system

The engine switch is in the “ON” position.

Vehicles with a smart key system

The “POWER” switch is in ON mode.

■ If no windshield washer fluid sprays

Check that the washer nozzles are not blocked if there is washer fluid in the windshield washer fluid reservoir.

⚠ CAUTION

■ Caution regarding the use of washer fluid

When it is cold, do not use the washer fluid until the windshield becomes warm. The fluid may freeze on the windshield and cause low visibility. This may lead to an accident, resulting in death or serious injury.

**NOTICE****■ When the windshield is dry**

Do not use the wipers, as they may damage the windshield.

■ When the washer fluid tank is empty

Do not operate the switch continually as the washer fluid pump may over-heat.

■ When a nozzle becomes blocked

In this case, contact your Toyota dealer.



Do not try to clear it with a pin or other object. The nozzle will be damaged.

Rear window wiper and washer*

The wiper operation is selected by moving the lever as follows:

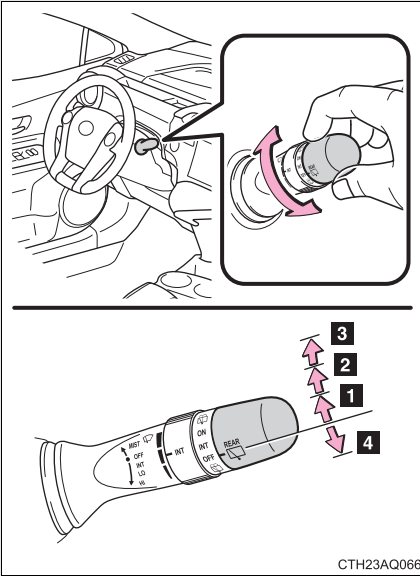
Type A



- 1 INT** Intermittent window wiper operation
- 2 ON** Normal window wiper operation
- 3**  Washer/wiper dual operation
- 4**  Washer/wiper dual operation

The wipers will automatically operate a couple of times after the washer squirts.

CTH23AQ066

*: If equipped

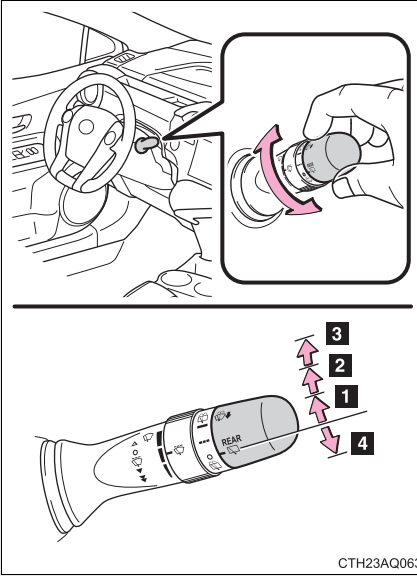
Type B

- 1 Intermittent window wiper operation
- 2 Normal window wiper operation
- 3 Washer/wiper dual operation
- 4 Washer/wiper dual operation

The wipers will automatically operate a couple of times after the washer squirts.

■ **The rear window wiper and washer can be operated when**

Vehicles without a smart key system

The engine switch is in the "ON" position.

Vehicles with a smart key system

The "POWER" switch is in ON mode.

■ **If no washer fluid sprays**

Check that the washer nozzle is not blocked if there is washer fluid in the washer fluid reservoir.

 NOTICE

■ **When the rear window is dry**

Do not use the wiper, as it may damage the rear window.

■ **When the washer fluid tank is empty**

Do not operate the switch continually as the washer fluid pump may over-heat.

■ **When a nozzle becomes blocked**

In this case, contact your Toyota dealer.

Do not try to clear it with a pin or other object. The nozzle will be damaged.

2-4. Using other driving systems Cruise control*

Use the cruise control to maintain a set speed without depressing the accelerator pedal.

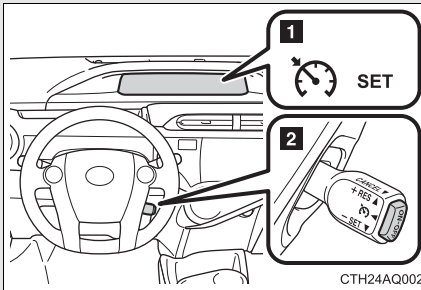

- 1 Indicators
- 2 Cruise control switch

■ Setting the vehicle speed

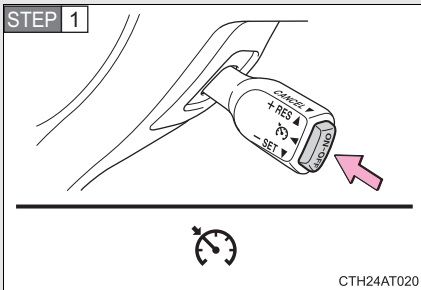

Press the “ON-OFF” button to activate the cruise control.

Cruise control indicator will come on.

Press the button again to deactivate the cruise control.

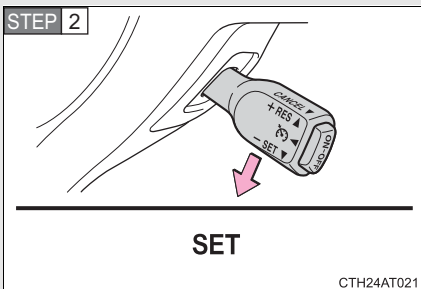

Accelerate or decelerate the vehicle to the desired speed, and push the lever down to set the speed.

“SET” indicator will come on.

The vehicle speed at the moment the lever is released becomes the set speed.

*: If equipped

■ Adjusting the set speed

To change the set speed, operate the lever until the desired set speed is obtained.

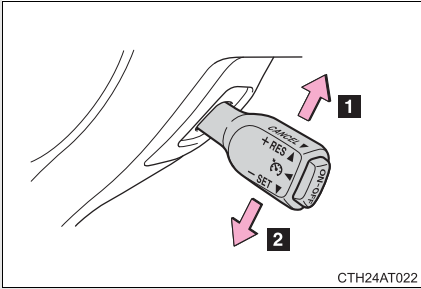

1 Increases the speed

2 Decreases the speed

Fine adjustment: Momentarily move the lever in the desired direction.

Large adjustment: Hold the lever in the desired direction.

The set speed will be increased or decreased as follows:

Fine adjustment: By approximately 1 mph (1.6 km/h) each time the lever is operated.

Large adjustment: The set speed can be increased or decreased continually until the lever is released.

■ Canceling and resuming the constant speed control

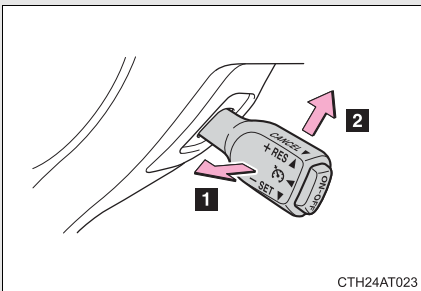

1 Pulling the lever toward you cancels the constant speed control.

The speed setting is also canceled when the brakes are applied.

2 Pushing the lever up resumes the constant speed control.

Resuming is available when the vehicle speed is more than approximately 25 mph (40 km/h).

■ Cruise control can be set when

- The shift lever is in D.
- Vehicle speed is above approximately 25 mph (40 km/h).

■ Accelerating after setting the vehicle speed

- The vehicle can be accelerated normally. After acceleration, the set speed resumes.
- Even without canceling the cruise control, the set speed can be increased by first accelerating the vehicle to the desired speed and then pushing the lever down to set the new speed.

■ Automatic cruise control cancelation

Cruise control will stop maintaining the vehicle speed in any of the following situations.

- Actual vehicle speed falls more than approximately 10 mph (16 km/h) below the preset vehicle speed.
At this time, the memorized set speed is not retained.
- Actual vehicle speed is below approximately 25 mph (40 km/h).
- VSC is activated.

■ If “CHECK CRUISE CONTROL SYSTEM” is shown on the multi-information display

Press the “ON-OFF” button once to deactivate the system, and then press the button again to reactivate the system.

If the cruise control speed cannot be set or if the cruise control cancels immediately after being activated, there may be a malfunction in the cruise control system. Have the vehicle inspected by your Toyota dealer.

 **CAUTION**

■ **To avoid operating the cruise control by mistake**

Switch the cruise control off using the “ON-OFF” button when not in use.

■ **Situations unsuitable for cruise control**

Do not use cruise control in any of the following situations.

Doing so may result in loss of control and could cause an accident resulting in death or serious injury.

- In heavy traffic
- On roads with sharp bends
- On winding roads
- On slippery roads, such as those covered with rain, ice or snow
- On steep hills

Vehicle speed may exceed the set speed when driving down a steep hill.

To help enhance driving safety and performance, the following systems operate automatically in response to various driving situations. Be aware, however, that these systems are supplementary and should not be relied upon too heavily when operating the vehicle.

■ **ABS (Anti-lock Brake System)**

Helps to prevent wheel lock when the brakes are applied suddenly, or if the brakes are applied while driving on a slippery road surface

■ **Brake assist**

Generates an increased level of braking force after the brake pedal is depressed when the system detects a panic stop situation

■ **VSC (Vehicle Stability Control)**

Helps the driver to control skidding when swerving suddenly or turning on slippery road surfaces

■ **TRAC (Traction Control)**

Helps to maintain drive power and prevent the drive wheels from spinning when starting the vehicle or accelerating on slippery roads

■ **Hill-start assist control**

Helps to prevent the vehicle from rolling backward when starting on an incline

■ **EPS (Electric Power Steering)**

Employs an electric motor to reduce the amount of effort needed to turn the steering wheel

When the TRAC/VSC/ABS systems are operating

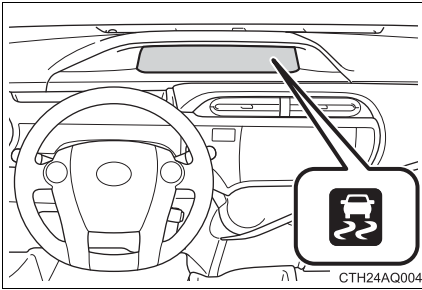

The slip indicator light will flash while the TRAC/VSC/ABS systems are operating.

■ Sounds and vibrations caused by the ABS, brake assist, TRAC, VSC and hill-start assist control systems

- A sound may be heard from the engine compartment when the hybrid system is started or just after the vehicle begins to move, if the brake pedal is depressed forcefully or repeatedly, or 1 - 2 minutes after the hybrid system is stopped. This sound does not indicate that a malfunction has occurred in any of these systems.
- Any of the following conditions may occur when the above systems are operating. None of these indicates that a malfunction has occurred.
 - Vibrations may be felt through the vehicle body and steering.
 - A motor sound may be heard after the vehicle comes to a stop.
 - The brake pedal may pulsate slightly after the ABS is activated.
 - The brake pedal may move down slightly after the ABS is activated.

■ EPS operation sound

When the steering wheel is operated, a motor sound (whirring sound) may be heard. This does not indicate a malfunction.

■ Reduced effectiveness of the EPS system

The effectiveness of the EPS system is reduced to prevent the system from overheating when there is frequent steering input over an extended period of time. The steering wheel may feel heavy as a result. Should this occur, refrain from excessive steering input or stop the vehicle and turn the hybrid system off. The EPS system should return to normal within 10 minutes.

■ Operating conditions of hill-start assist control

When the following four conditions are met, the hill-start assist control will operate:

- The shift lever is in a position other than P or N (when starting off forward/backward on an upward incline).
- The vehicle is stopped.
- The accelerator pedal is not depressed.
- The parking brake is not engaged.

■ Automatic system cancelation of hill-start assist control

The hill-start assist control will turn off in any of the following situations:

- The shift lever is moved to P or N.
- The accelerator pedal is depressed.
- The parking brake is engaged.
- Approximately 2 seconds elapse after the brake pedal is released.

 **CAUTION**

■ **The ABS does not operate effectively when**

- The limits of tire gripping performance have been exceeded (such as excessively worn tires on a snow covered road).
- The vehicle hydroplanes while driving at high speed on wet or slick roads.

■ **Stopping distance when the ABS is operating may exceed that of normal conditions**

The ABS is not designed to shorten the vehicle's stopping distance. Always maintain a safe distance from the vehicle in front of you, especially in the following situations:

- When driving on dirt, gravel or snow-covered roads
- When driving with tire chains
- When driving over bumps in the road
- When driving over roads with potholes or uneven surfaces

■ **TRAC may not operate effectively when**

Directional control and power may not be achievable while driving on slippery road surfaces, even if the TRAC system is operating.

Drive the vehicle carefully in conditions where stability and power may be lost.

■ **Hill-start assist control**

- Do not overly rely on hill-start assist control. Hill-start assist control may not operate effectively on steep inclines and roads covered with ice.
- Unlike the parking brake, hill-start assist control is not intended to hold the vehicle stationary for an extended period of time. Do not attempt to use hill-start assist control to hold the vehicle on an incline, as doing so may lead to an accident.

 **CAUTION****■ When the TRAC/VSC/ABS are activated**

The slip indicator light flashes. Always drive carefully. Reckless driving may cause an accident. Exercise particular care when the indicator light flashes.

■ Replacing tires

Make sure that all tires are of the specified size, brand, tread pattern and total load capacity. In addition, make sure that the tires are inflated to the recommended tire inflation pressure level.

The ABS, TRAC and VSC systems will not function correctly if different tires are installed on the vehicle.

Contact your Toyota dealer for further information when replacing tires or wheels.

■ Handling of tires and the suspension

Using tires with any kind of problem or modifying the suspension will affect the driving assist systems, and may cause a system to malfunction.

2-5. Driving information

Cargo and luggage

Take notice of the following information about storage precautions, cargo capacity and load:

- Stow cargo and luggage in the luggage compartment whenever possible.
- Be sure all items are secured in place.
- To maintain vehicle balance while driving, position luggage evenly within the luggage compartment.
- For better fuel economy, do not carry unnecessary weight.

Capacity and distribution

Cargo capacity depends on the total weight of the occupants.

(Cargo capacity) = (Total load capacity) — (Total weight of occupants)

Steps for Determining Correct Load Limit—

- (1) Locate the statement “The combined weight of occupants and cargo should never exceed XXX kg or XXX lbs.” on your vehicle's placard.
- (2) Determine the combined weight of the driver and passengers that will be riding in your vehicle.
- (3) Subtract the combined weight of the driver and passengers from XXX kg or XXX lbs.
- (4) The resulting figure equals the available amount of cargo and luggage load capacity.
For example, if the “XXX” amount equals 1400 lbs. and there will be five 150 lb passengers in your vehicle, the amount of available cargo and luggage load capacity is 650 lbs. (1400 - 750 (5 × 150) = 650 lbs.)
- (5) Determine the combined weight of luggage and cargo being loaded on the vehicle. That weight may not safely exceed the available cargo and luggage load capacity calculated in Step 4.

(6) If your vehicle will be towing a trailer, load from your trailer will be transferred to your vehicle. Consult this manual to determine how this reduces the available cargo and luggage load capacity of your vehicle.

(→P. 496)

Toyota does not recommend towing a trailer with your vehicle. Your vehicle is not designed for trailer towing.

Calculation formula for your vehicle

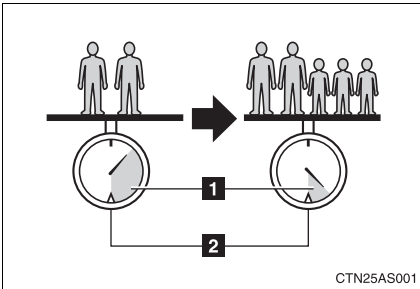

1 Cargo capacity

2 Total load capacity (vehicle capacity weight) (→P. 496)

When 2 people with the combined weight of A lb. (kg) are riding in your vehicle, which has a total load capacity (vehicle capacity weight) of B lb. (kg), the available amount of cargo and luggage load capacity will be C lb. (kg) as follows:

$$B^{*2} \text{ lb. (kg)} - A^{*1} \text{ lb. (kg)} = C^{*3} \text{ lb. (kg)}$$

*1: A =Weight of people

*2: B =Total load capacity

*3: C =Available cargo and luggage load

In this condition, if 3 more passengers with the combined weight of D lb. (kg) get on, the available cargo and luggage load will be reduced E lb. (kg) as follows:

$$C \text{ lb. (kg)} - D^{*4} \text{ lb. (kg)} = E^{*5} \text{ lb. (kg)}$$

*4: D =Additional weight of people

*5: E =Available cargo and luggage load

As shown in the example above, if the number of occupants increases, the cargo and luggage load will be reduced by an amount that equals the increased weight due to the additional occupants. In other words, if an increase in the number of occupants causes an excess of the total load capacity (combined weight of occupants plus cargo and luggage load), you must reduce the cargo and luggage on your vehicle.

 **CAUTION**

■ Things that must not be carried in the luggage compartment

The following things may cause a fire if loaded in the luggage compartment:

- Receptacles containing gasoline
- Aerosol cans

■ Storage precautions

Observe the following precautions.

Failure to do so may result in death or serious injury.

- Stow cargo and luggage in the luggage compartment whenever possible.
- Do not stack cargo and luggage in the luggage compartment higher than the seatbacks.
Such items may be thrown about and possibly injure people in the vehicle in the event of sudden braking or in an accident.
- Do not place cargo or luggage in or on the following locations as the item may get under the brake or accelerator pedal and prevent the pedals from being depressed properly, block the driver's vision, or hit the driver or passengers, causing an accident:
 - At the feet of the driver
 - On the front passenger or rear seats (when stacking items)
 - On the luggage cover (if equipped)
 - On the instrument panel
 - On the dashboard

 CAUTION

- Secure all items in the occupant compartment, as they may shift and injure someone during sudden braking, sudden swerving or an accident.
- When you fold down the rear seats, long items should not be placed directly behind the front seats.
- Never allow anyone to ride in the luggage compartment. It is not designed for passengers. They should ride in their seats with their seat belts properly fastened. Otherwise, they are much more likely to suffer death or serious bodily injury, in the event of sudden braking, sudden swerving or an accident.

■ Capacity and distribution

- Do not exceed the maximum axle weight rating or the total vehicle weight rating.
- Even if the total load of occupant's weight and the cargo load is less than the total load capacity, do not apply the load unevenly. Improper loading may cause deterioration of steering or braking control which may cause death or serious injury.

2-5. Driving information

Vehicle load limits

Vehicle load limits include total load capacity, seating capacity, towing capacity and cargo capacity.

■ **Total load capacity (vehicle capacity weight): (→P. 496)**

Total load capacity means the combined weight of occupants, cargo and luggage.

■ **Seating capacity: 5 occupants (Front 2, Rear 3)**

Seating capacity means the maximum number of occupants whose estimated average weight is 150 lb. (68 kg) per person.

■ **Towing capacity**

Toyota does not recommend towing a trailer with your vehicle.

■ **Cargo capacity**

Cargo capacity may increase or decrease depending on the weight and the number of occupants.

■ **Total load capacity and seating capacity**

These details are also described on the tire and loading information label. (→P. 392)

 **CAUTION**

■ **Overloading the vehicle**

Do not overload the vehicle.

It may not only cause damage to the tires, but also degrade steering and braking ability, resulting in an accident.

Carry out the necessary preparations and inspections before driving the vehicle in winter. Always drive the vehicle in a manner appropriate to the prevailing weather conditions.

■ **Pre-winter preparations**

- Use fluids that are appropriate to the prevailing outside temperatures.
 - Engine oil
 - Engine/power control unit coolant
 - Washer fluid
- Have a service technician inspect the condition of the 12-volt battery.
- Have the vehicle fitted with four snow tires or purchase a set of tire chains for the front tires.

Ensure that all tires are the same size and brand, and that chains match the size of the tires.

■ **Before driving the vehicle**

Perform the following according to the driving conditions:

- Do not try to forcibly open a window or move a wiper that is frozen. Pour warm water over the frozen area to melt the ice. Wipe away the water immediately to prevent it from freezing.
- To ensure proper operation of the climate control system fan, remove any snow that has accumulated on the air inlet vents in front of the windshield.
- Check for and remove any excess ice or snow that may have accumulated on the exterior lights, vehicle's roof, chassis, around the tires or on the brakes.
- Remove any snow or mud from the bottom of your shoes before getting in the vehicle.

■ When driving the vehicle

Accelerate the vehicle slowly, keep a safe distance between you and the vehicle ahead, and drive at a reduced speed suitable to road conditions.

■ When parking the vehicle

Park the vehicle and move the shift lever to P without setting the parking brake. The parking brake may freeze up, preventing it from being released. If necessary, block the wheels to prevent inadvertent sliding or creeping.

Selecting tire chains

Use the correct tire chain size when mounting the tire chains. Chain size is regulated for each tire size.

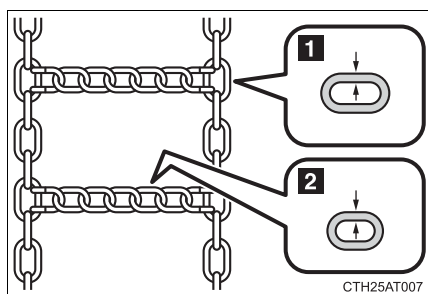

- 1 Side chain
(0.12 in. [3.0 mm] in diameter)
- 2 Cross chain
(0.16 in. [4.0 mm] in diameter)

Regulations on the use of tire chains

Regulations regarding the use of tire chains vary depending on location and type of road. Always check local regulations before installing chains.

■ Tire chain installation

Observe the following precautions when installing and removing chains:

- Install and remove tire chains in a safe location.
- Install tire chains on the front tires only. Do not install tire chains on the rear tires.
- Install tire chains on front tires as tightly as possible. Retighten chains after driving 1/4 — 1/2 mile (0.5 — 1.0 km).
- Install tire chains following the instructions provided with the tire chains.

CAUTION

■ Driving with snow tires

Observe the following precautions to reduce the risk of accidents.

Failure to do so may result in a loss of vehicle control and cause death or serious injury.

- Use tires of the size specified.
- Maintain the recommended level of air pressure.
- Do not drive in excess of 75 mph (120 km/h), regardless of the type of snow tires being used.
- Use snow tires on all, not just some wheels.

 **CAUTION**

■ Driving with tire chains

Observe the following precautions to reduce the risk of accidents.

Failure to do so may result in the vehicle being unable to be driven safely, and may cause death or serious injury.

- Do not drive in excess of the speed limit specified for the tire chains being used, or 30 mph (50 km/h), whichever is lower.
- Avoid driving on bumpy road surfaces or over potholes.
- Avoid sudden turns and braking, as use of chains may adversely affect vehicle handling.
- Slow down sufficiently before entering a curve to ensure that vehicle control is maintained.

 **NOTICE**

■ Repairing or replacing snow tires

Request repairs or replacement of snow tires from Toyota dealers or legitimate tire retailers.

This is because the removal and attachment of snow tires affects the operation of the tire pressure warning valves and transmitters.

■ Fitting tire chains

The tire pressure warning valves and transmitters may not function correctly when tire chains are fitted.

Trailer towing

Toyota does not recommend towing a trailer with your vehicle. Toyota also does not recommend the installation of a tow hitch or the use of a tow hitch carrier for a wheelchair, scooter, bicycle, etc. Your vehicle is not designed for trailer towing or for the use of tow hitch mounted carriers.

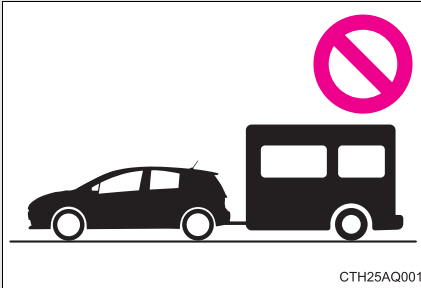

2-5. Driving information

Dinghy towing

Your vehicle is not designed to be dinghy towed (with 4 wheels on the ground) behind a motor home.

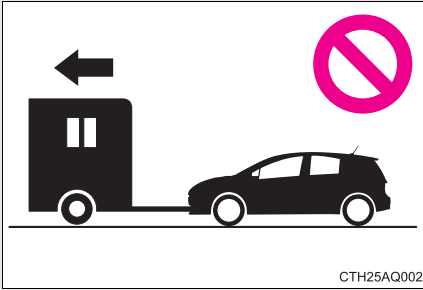

NOTICE

■ To avoid serious damage to your vehicle

Do not tow your vehicle with the four wheels on the ground.

3-1. Using the air conditioning system and defogger

Automatic air conditioning system	238
Rear window and outside rear view mirror defoggers	247

3-2. Using the audio system

Audio system types	248
Using the radio	254
Using the CD player	256
Playing back MP3 and WMA discs	261
Operating an iPod	268
Operating a USB memory	276
Optimal use of the audio system	284
Using the AUX port	287
Using the steering wheel audio switches	288

3-3. Using the Bluetooth® audio system

Bluetooth® audio/phone	291
Using the Bluetooth® audio/phone	295
Operating a Bluetooth® enabled portable player	300
Making a phone call	303

Using the “SET UP” menu (“Bluetooth” menu)	308
--	-----

Using the “SET UP” menu (“Phone” menu)	314
--	-----

3-4. Using the interior lights

Interior lights list	321
• Interior lights/ personal lights	322

3-5. Using the storage features

List of storage features	324
• Glove box	325
• Console box	325
• Auxiliary boxes	327
• Cup holders	329
• Bottle holders	330

3-6. Other interior features

Sun visors	332
Vanity mirrors	333
Outside temperature display	334
Power outlet	336
Seat heaters	337
Coat hooks	339
Assist grips	340
Floor mat	341
Luggage cover	343

3-1. Using the air conditioning system and defogger

Automatic air conditioning system

Air outlets and fan speed are automatically adjusted according to the temperature setting.

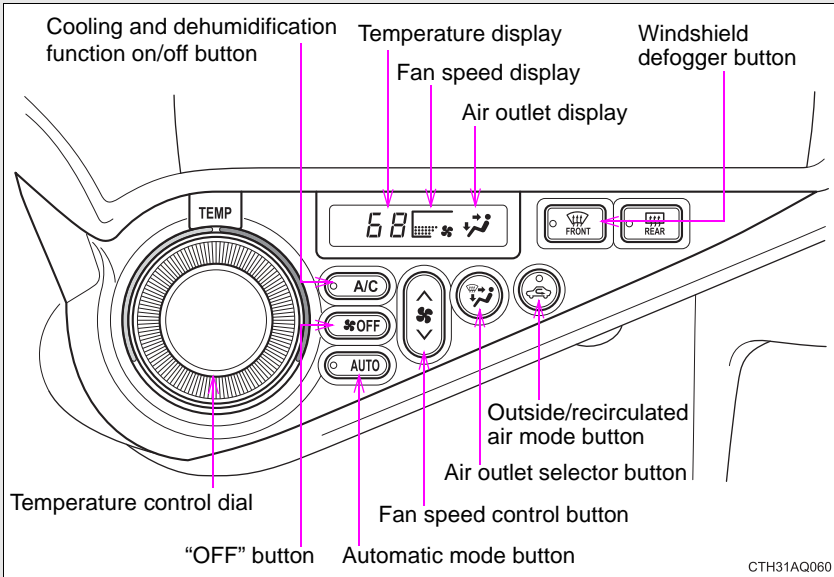

Using the automatic air conditioning system

STEP 1 Press .

The air conditioning system begins to operate. Air outlets and fan speed are automatically adjusted according to the temperature setting.

STEP 2 To adjust the temperature setting, turn  clockwise to

increase the temperature and turn  counterclockwise to decrease the temperature.

■ Automatic mode indicator

If fan speed setting or air flow modes are operated, the automatic mode indicator goes off. However, automatic mode for functions other than that operated are maintained.

Adjusting the settings manually

STEP 1 To adjust the fan speed, press “^” on  to increase the fan speed and “v” to decrease the fan speed.

Press  to turn the fan off.

STEP 2 To adjust the temperature setting, turn  clockwise to

increase the temperature and turn  counterclockwise to decrease the temperature.

STEP 3 To change the air outlets, press .

The air outlets used are switched each time the button is pressed.

Defogging the windshield

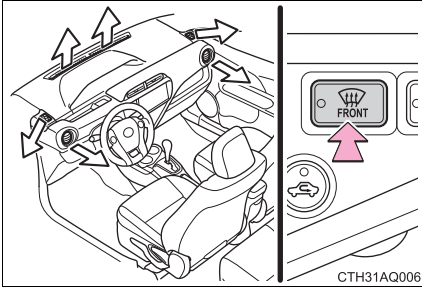

Press .

The dehumidification function operates and fan speed increases.

Set the outside/recirculated air mode button to the outside air mode if the recirculated air mode is used. (It may switch automatically.)

To defog the windshield and the side windows early, turn the air flow and temperature up.

To return to the previous mode,

press  again when the windshield is defogged.

Air outlets and air flow

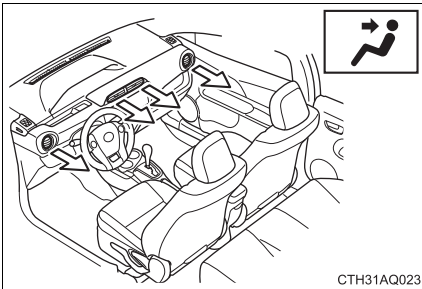

Air flows to the upper body.

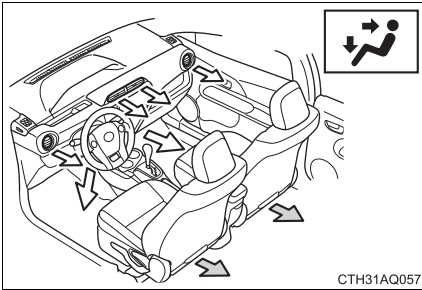

Air flows to the upper body and feet.

← : Some models

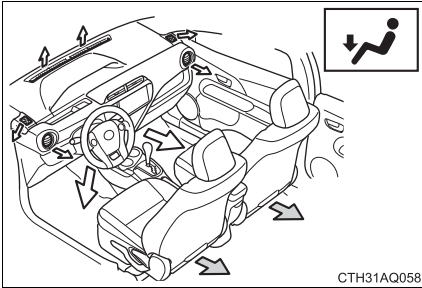

Air flows mainly to the feet.

*: When the warming function is operating, air flows to the upper body as well to warm the upper body effectively.

← : Some models

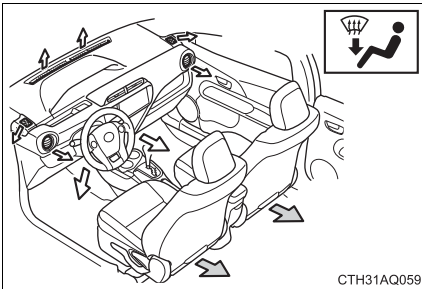

Air flows to the feet and the windshield defogger operates.

← : Some models

Switching between outside air and recirculated air modes

Press .

The mode switches between outside air mode (the indicator is off) and recirculated air mode (the indicator is on) each time the button is pressed.

Adjusting the position of and opening and closing the air outlets

Center outlets

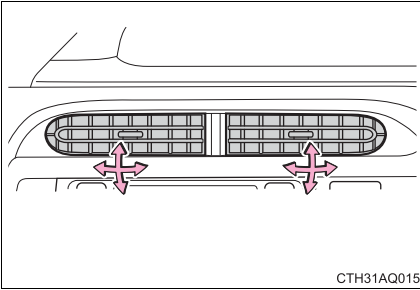

Direct air flow to the left or right, up or down.

Right and left side outlets

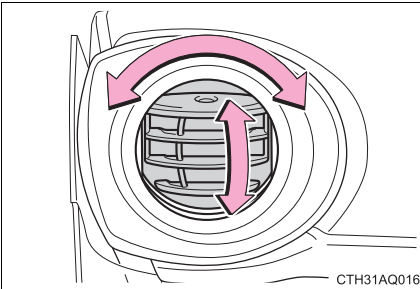

Direct air flow to the left or right, up or down.

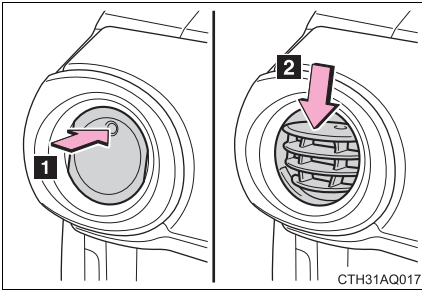

1 Open the vent.

2 Close the vent.

Steering wheel switches

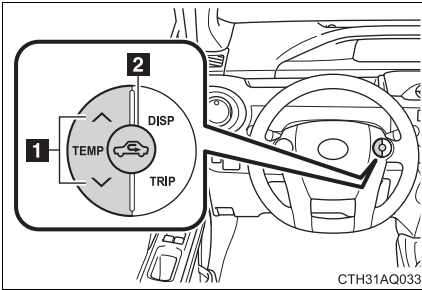

1 Temperature control

Press “^” on  to increase the temperature and “v” to decrease the temperature.

2 Outside air or recirculated air mode

The mode switches between outside air mode and recirculated air mode each time  is pressed.

■ Operation of the air conditioning system in Eco drive mode

In Eco drive mode, the air conditioning system is controlled as follows to prioritize fuel efficiency:

- Heating/cooling capacity is restricted.
- Outside/recirculated air mode may automatically switch depending on the temperature setting or the inside temperature.
- Fan speed restricted when automatic mode is selected

To improve air conditioning performance, perform the following operations:

- Adjust the fan speed or the temperature setting
- Turn off Eco drive mode

■ Using automatic mode

Fan speed is adjusted automatically according to the temperature setting and the ambient conditions.

Therefore, the fan may stop for a while until warm or cool air is ready to flow immediately after  is pressed.

■ Fogging up of the windows

- The windows will easily fog up when the humidity in the vehicle is high.

Turning  on will dehumidify the air from the outlets and defog the windshield effectively.

- If you turn  off, the windows may fog up more easily.
- The windows may fog up if the recirculated air mode is used.

■ Outside/recirculated air mode

- When driving on dusty roads such as tunnels or in heavy traffic, set the outside/recirculated air mode button to the recirculated air mode. This is effective in preventing outside air from entering the vehicle interior. During cooling operation, setting the recirculated air mode will also cool the vehicle interior effectively.
- Outside/recirculated air mode may automatically switch depending on the temperature setting or the inside temperature.

■ When the outside temperature exceeds 75°F (24°C) and the air conditioning system is on

- In order to reduce the air conditioning power consumption, the air conditioning system may switch to recirculated air mode automatically. This may also reduce fuel consumption.
- Recirculated air mode is selected as a default mode when the engine switch is turned to the “ON” position (vehicles without a smart key system) or the “POWER” switch is turned to ON mode (vehicles with a smart key system).
- It is possible to switch to outside air mode at any time by pressing



■ When the outside temperature falls to nearly 32°F (0°C)

The dehumidification function may not operate even when  is pressed.

■ Air conditioning odors

- During use, various odors from inside and outside the vehicle may enter into and accumulate in the air conditioning system. This may then cause odor to be emitted from the vents.
- To reduce potential odors from occurring:
 - It is recommended that the air conditioning system be set to outside air mode prior to turning the vehicle off.
 - The start timing of the blower may be delayed for a short period of time immediately after the air conditioning system is started in automatic mode.

■ **Air conditioning filter**

→P. 399

■ **When operating the steering switches**

→P. 188

■ **Customization**

The air conditioning control of Eco drive mode can be changed to the same setting as that used in normal drive mode.

(Customizable features →P. 522)

 **CAUTION**

■ **To prevent the windshield from fogging up**

Do not use  during cool air operation in extremely humid weather.

The difference between the temperature of the outside air and that of the windshield can cause the outer surface of the windshield to fog up, blocking your vision.

 **NOTICE**

■ **To prevent 12-volt battery discharge**

Do not leave the air conditioning system on longer than necessary when the hybrid system is off.

3-1. Using the air conditioning system and defogger Rear window and outside rear view mirror defoggers

Defoggers are used to defog the rear window, and to remove rain-drops, dew and frost from the outside rear view mirrors.

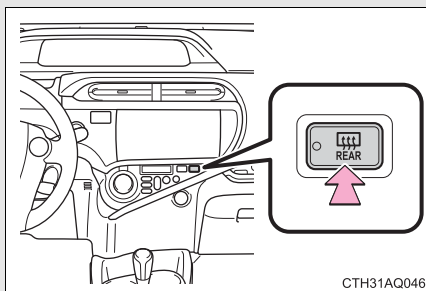

Turns the defoggers on/off

The defoggers will automatically turn off after approximately 15 minutes.

■ The defoggers can be operated when

Vehicles without a smart key system

The engine switch is in the "ON" position.

Vehicles with a smart key system

The "POWER" switch is in ON mode.

■ The outside rear view mirror defoggers (if equipped)

Turning the rear window defogger on will turn the outside rear view mirror defoggers on.

▲ CAUTION

■ When the outside rear view mirror defoggers are on (if equipped)

Do not touch the outside surface of the rear view mirrors, as they can become very hot and burn you.

3-2. Using the audio system

Audio system types

Without Display Audio system

CD player and AM/FM radio

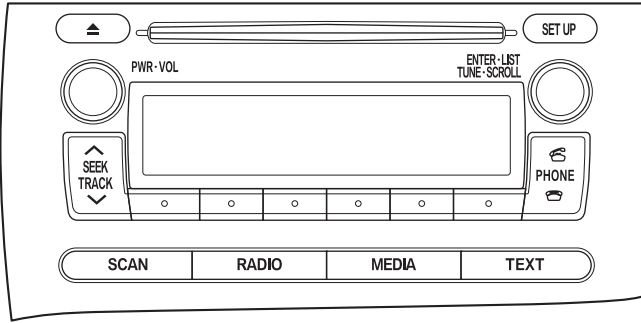

CTH32AQ042

Title	Page
Using the radio	P. 254
Using the CD player	P. 256
Playing back MP3 and WMA discs	P. 261
Operating an iPod	P. 268
Operating a USB memory	P. 276
Optimal use of the audio system	P. 284
Using the AUX port	P. 287

With Display Audio system

Owners of models equipped with a Display Audio system should refer to the “Display Audio System Owner’s Manual”.

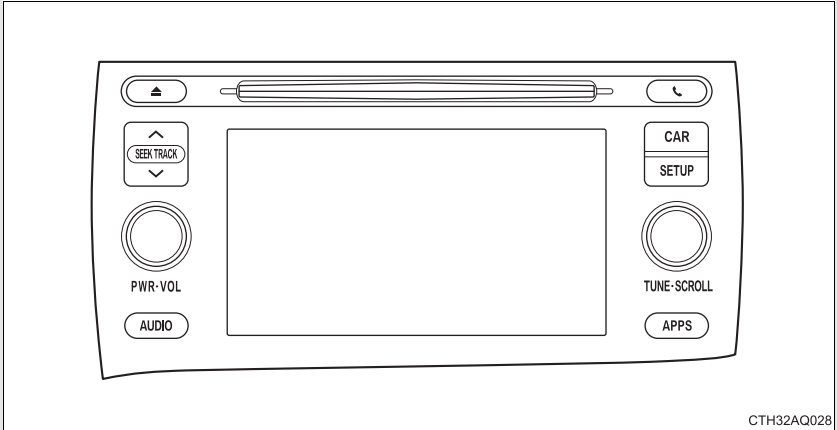

■ About Bluetooth®

The Bluetooth wordmark and logo are owned by Bluetooth SIG. and permission has been granted to use the trademark of the licensee Panasonic Corporation. Other trademarks and trade names are owned by various different owners.

 **CAUTION**

■ **U.S.A. (without Display Audio system)**

Part 15 of the FCC Rules

FCC ID: ACJ932PTA184

FCC WARNING

Changes or modifications not expressly approved by the party responsible for compliance could void the user's authority to operate the equipment.

This transmitter must not be co-located or operated in conjunction with any other antenna or transmitter.

This equipment complies with FCC radiation exposure limits set forth for an uncontrolled environment and meets the FCC radio frequency (RF) Exposure Guidelines in Supplement C to OET65. This equipment has very low levels of RF energy that it deemed to comply without maximum permissive exposure evaluation (MPE). But it is desirable that it should be installed and operated keeping the radiator at least 20cm or more away from person's body (excluding extremities: hands, wrists, feet and ankles).

■ **Canada (without Display Audio system)**

This device complies with Industry Canada licence-exempt RSS standard(s). Operation is subject to the following two conditions: (1) this device may not cause interference, and (2) this device must accept any interference, including interference that may cause undesired operation of the device.

Le présent appareil est conforme aux CNR d'Industrie Canada applicables aux appareils radio exempts de licence.

L'exploitation est autorisée aux deux conditions suivantes : (1) l'appareil ne doit pas produire de brouillage, et (2) l'utilisateur de l'appareil doit accepter tout brouillage radioélectrique subi, même si le brouillage est susceptible d'en compromettre le fonctionnement.

⚠ CAUTION

Under Industry Canada regulations, this radio transmitter may only operate using an antenna of a type and maximum (or lesser) gain approved for the transmitter by Industry Canada. To reduce potential radio interference to other users, the antenna type and its gain should be so chosen that the equivalent isotropically radiated power (e.i.r.p.) is not more than that necessary for successful communication.

Conformément à la réglementation d'Industrie Canada, le présent émetteur radio peut fonctionner avec une antenne d'un type et d'un gain maximal (ou inférieur) approuvé pour l'émetteur par Industrie Canada. Dans le but de réduire les risques de brouillage radioélectrique à l'intention des autres utilisateurs, il faut choisir le type d'antenne et son gain de sorte que la puissance isotrope rayonnée équivalente (p.i.r.e.) ne dépasse pas l'intensité nécessaire à l'établissement d'une communication satisfaisante.

This equipment complies with IC radiation exposure limits set forth for an uncontrolled environment and meets RSS-102 of the IC radio frequency (RF) Exposure rules. This equipment has very low levels of RF energy that it deemed to comply without maximum permissive exposure evaluation (MPE). But it is desirable that it should be installed and operated keeping the radiator at least 20cm or more away from person's body (excluding extremities: hands, wrists, feet and ankles).

Cet équipement est conforme aux limites d'exposition aux rayonnements énoncées pour un environnement non contrôlé et respecte les règles d'exposition aux fréquences radioélectriques (RF) CNR-102 de l'IC. Cet équipement émet une énergie RF très faible qui est considérée conforme sans évaluation de l'exposition maximale autorisée.

Cependant, cet équipement doit être installé et utilisé en gardant une distance de 20 cm ou plus entre le dispositif rayonnant et le corps (à l'exception des extrémités : mains, poignets, pieds et chevilles).

 **CAUTION**

■ For vehicles sold in the U.S.A. (with Display Audio system)

FCC ID: BABFT0032A

This device complies with part 15 of the FCC Rules. Operation is subject to the following two conditions: (1) This device may not cause harmful interference, and (2) this device must accept any interference received, including interference that may cause undesired operation.

FCC WARNING

Changes or modifications not expressly approved by the party responsible for compliance could void the user's authority to operate the equipment.

CAUTION: Radio Frequency Radiation Exposure

This equipment complies with FCC radiation exposure limits set forth for uncontrolled equipment and meets the FCC radio frequency (RF) Exposure Guidelines in Supplement C to OET65. This equipment has very low levels of RF energy that it deemed to comply without maximum permissive exposure evaluation (MPE). But it is desirable that it should be installed and operated with at least 20cm and more between the radiator and person's body (excluding extremities: hands, wrists, feet and ankles).

Co-location: This transmitter must not be co-located or operated in conjunction with any other antenna or transmitter.

 CAUTION

■ **For vehicles sold in Canada (with Display Audio system)**

IC: 2024B-FT0032A

CAUTION: Radio Frequency Radiation Exposure

This equipment complies with IC radiation exposure limits set forth for uncontrolled equipment and meets RSS-102 of the IC radio frequency (RF) Exposure rules. This equipment has very low levels of RF energy that it deemed to comply without maximum permissive exposure evaluation (MPE). But it is desirable that it should be installed and operated with at least 20cm and more between the radiator and person's body (excluding extremities: hands, wrists, feet and ankles).

This Category II radiocommunication device complies with Industry Canada Standard RSS-310.

Ce dispositif de radiocommunication de catégorie II respecte la norme CNR-310 d'Industrie Canada.

This device complies with Industry Canada licence-exempt RSS standard(s). Operation is subject to the following two conditions: (1) this device may not cause interference, and (2) this device must accept any interference, including interference that may cause undesired operation of the device.

Le présent appareil est conforme aux CNR d'Industrie Canada applicables aux appareils radio exempts de licence. L'exploitation est autorisée aux deux conditions suivantes : (1) l'appareil ne doit pas produire de brouillage, et (2) l'utilisateur de l'appareil doit accepter tout brouillage radioélectrique subi, même si le brouillage est susceptible d'en compromettre le fonctionnement.

 NOTICE

■ **To prevent 12-volt battery discharge**

Do not leave the audio system on longer than necessary when the hybrid system is off.

■ **To avoid damaging the audio system**

Take care not to spill drinks or other fluids over the audio system.

3-2. Using the audio system

Using the radio

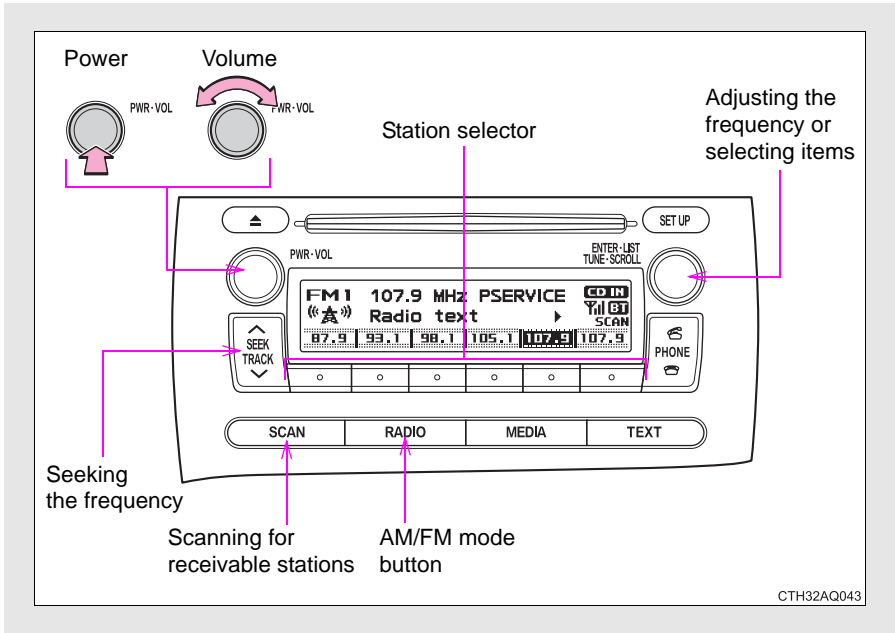

Setting station presets

STEP 1 Search for desired stations by turning  or pressing "∧"

or "∨" on .

STEP 2 Press and hold a desired station selector button until you hear a beep.

Scanning radio stations

■ Scanning the preset radio stations

STEP 1 Press and hold  until you hear a beep.

Preset stations will be played for 5 seconds each.

STEP 2 When the desired station is reached, press  again.

■ Scanning all the radio stations within range

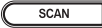
STEP 1 Press .

All the stations with reception will be played for 5 seconds each.

STEP 2 When the desired station is reached, press  again.

■ When the 12-volt battery is disconnected

Preset stations are erased.

■ Reception sensitivity

- Maintaining perfect radio reception at all times is difficult due to the continually changing position of the antenna when driving, differences in signal strength and surrounding objects, such as trains, transmitters, etc.
- When  is used, automatic station selection may not be possible.
- The radio antenna is mounted on the rear roof. The antenna can be removed from the base by turning it.

NOTICE

■ To prevent damage, remove the antenna in the following cases.

- The antenna will touch the ceiling of a garage.
- A car cover will be put on the roof.

3-2. Using the audio system Using the CD player

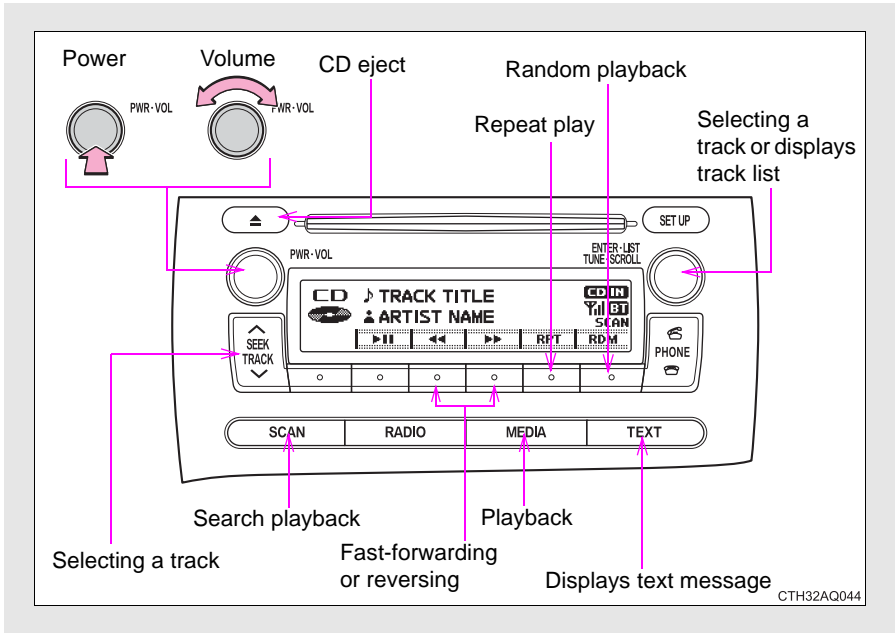



Loading CDs

Insert a CD.

Ejecting CDs

Press  and remove the CD.

Selecting a track

Turn  or press “^” to move up or “v” to move down using  until the desired track number is displayed.

Selecting a track from a track list

STEP 1 Press .

The track list will be displayed.

STEP 2 Turn and press  to select a track.

To return to the previous display, press  (BACK).



Scanning tracks

STEP 1 Press .

The first 10 seconds of each track will be played.

STEP 2 Press  again when the desired track is reached.

Fast-forwarding and reversing tracks

To fast-forward or reverse, press and hold  (◀◀) or  (▶▶).

Random playback

Press  (RDM).

To cancel, press  (RDM) again.

Repeat play

Press  (RPT).

To cancel, press  (RPT) again.

Switching the display

Press  .

To return to the previous display, press  or  (BACK).

■ Display

Up to 12 characters can be displayed at a time.

If there are 13 characters or more, pressing and holding  for 1 second or more will display the remaining characters. A maximum of 64 characters can be displayed.

If  is pressed for 1 second or more again, or has not been pressed for 6 seconds or more, the display will return to the first 12 characters.

Depending on the contents recorded, the characters may not be displayed properly or may not be displayed at all.

■ Error messages

“ERROR”: This indicates a problem either in the CD or inside the player.

“CD CHECK”: The CD may be dirty, damaged or inserted up-side down.

“WAIT”: Operation has stopped due to a high temperature inside the player. Wait for a while and then press  . If the CD still cannot be played back, contact your Toyota dealer.

■ Discs that can be used

Discs with the marks shown below can be used.

Playback may not be possible depending on recording format or disc features, or due to scratches, dirt or deterioration.



CDs with copy-protect features may not be used.

■ CD player protection feature

To protect the internal components, playback is automatically stopped when a problem is detected while the CD player is being used.

⚠ CAUTION**■ Certification for the CD player**

This product is a class I laser product.

Do not open the cover of the player or attempt to repair the unit yourself. Refer servicing to qualified personnel.

⚠ NOTICE**■ CDs and adapters that cannot be used**

Do not use the following types of CDs.

Also, do not use 8 cm (3 in.) CD adapters, DualDiscs or printable discs.

Doing so may damage the CD player and/or the CD insert/eject function.

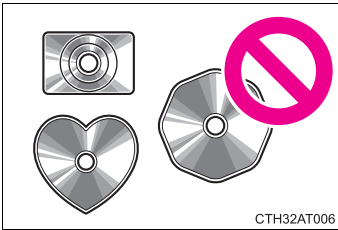

- CDs that have a diameter that is not 4.7 in. (12 cm)

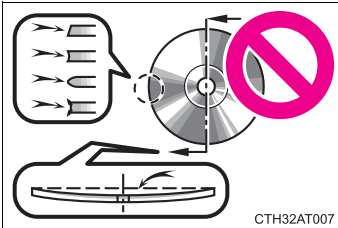

- Low-quality and deformed CDs

 NOTICE

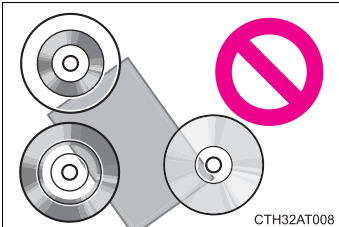

- CDs with a transparent or translucent recording area

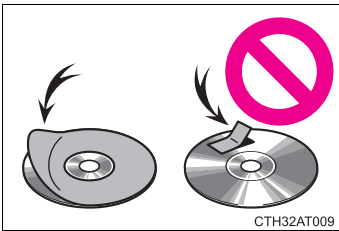

- CDs that have had tape, stickers or CD-R labels attached to them, or that have had the label peeled off

■ **CD player precautions**

Failure to follow the precautions below may result in serious damage to the CDs or the player itself.

- Do not insert anything other than CDs into the CD slot.
 - Do not apply oil to the CD player.
 - Store CDs away from direct sunlight.
 - Never try to disassemble any part of the CD player.
- **If a CD is left inside the CD player or in the ejected position for extended periods**
- The CD may be damaged and may not play properly.
- **Lens cleaners**
- Do not use lens cleaners. Doing so may damage the CD player.

3-2. Using the audio system

Playing back MP3 and WMA discs

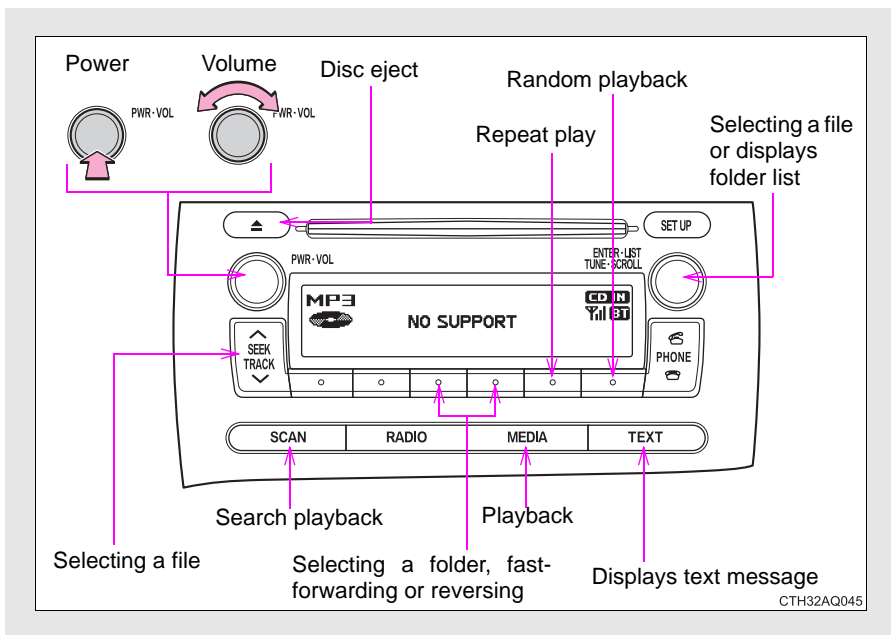



Loading and ejecting MP3 and WMA discs

→P. 256

Selecting a folder

■ Selecting folders one at a time

Press  (<) or  (>) to select the desired folder.

■ Selecting a folder and file from a folder list

STEP 1 Press .

The folder list will be displayed.

STEP 2 Turn and press  to select a folder and a file.

To return to the previous display, press  (BACK).

■ Returning to the first folder

Press and hold  (<) until you hear a beep.



Scanning a folder

STEP 1 Press and hold  until you hear a beep.

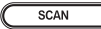
The first 10 seconds of the first file in the each folder will be played.

STEP 2 When the desired folder is reached, press  again.

Selecting files

Turn  or press “^” or “v” on  to select the desired file.



Scanning files

STEP 1 Press  .

The first 10 seconds of all files in the folder will be played.

STEP 2 When the desired file is reached, press  again.

Fast-forwarding and reversing files

To fast-forward or reverse, press and hold  (<<<) or  (>>>).

Random playback

Pressing  (RDM) changes modes in the following order:
Folder random → Disc random → Off

Repeat play

Pressing  (RPT) changes modes in the following order:
File repeat → Folder repeat* → Off

*: Available except when RDM (random playback) is selected

Switching the display

Press  .

Track title, Artist name and Album title (MP3 only) are shown on the display.

To return to the previous display, press  or  (BACK).

■ **Display**

→P. 258

■ **Error messages**

“ERROR”: This indicates a problem either in the CD or inside the player.

“CD CHECK”: The CD may be dirty, damaged or inserted up-side down.

“NO SUPPORT”: This indicates that MP3/WMA files are not included in the CD.

■ **Discs that can be used**

Discs with the marks shown below can be used.

Playback may not be possible depending on recording format or disc features, or due to scratches, dirt or deterioration.



■ **CD player protection feature**

To protect the internal components, playback is automatically stopped when a problem is detected while the CD player is being used.

■ MP3 and WMA files

MP3 (MPEG Audio LAYER3) is a standard audio compression format.

Files can be compressed to approximately 1/10 of their original size by using MP3 compression.

WMA (Windows Media Audio) is a Microsoft audio compression format.

This format compresses audio data to a size smaller than that of the MP3 format.

There is a limit to the MP3 and WMA file standards and to the media/formats recorded by them that can be used.

● MP3 file compatibility

- Compatible standards
MP3 (MPEG1 LAYER3, MPEG2 LSF LAYER3)
- Compatible sampling frequencies
MPEG1 LAYER3: 32, 44.1, 48 (kHz)
MPEG2 LSF LAYER3: 16, 22.05, 24 (kHz)
- Compatible bit rates (compatible with VBR)
MPEG1 LAYER3: 32, 40, 48, 56, 64, 80, 96, 112, 128, 160, 192, 224, 256, 320 (kbps)
MPEG2 LSF LAYER3: 8, 16, 24, 32, 40, 48, 56, 64, 80, 96, 112, 128, 144, 160 (kbps)
- Compatible channel modes: stereo, joint stereo, dual channel and monaural

● WMA file compatibility

- Compatible standards
WMA Ver. 7, 8, 9
- Compatible sampling frequencies
32, 44.1, 48 (kHz)
- Compatible bit rates (only compatible with 2-channel playback)
Ver. 7, 8: CBR 48, 64, 80, 96, 128, 160, 192 (kbps)
Ver. 9: CBR 48, 64, 80, 96, 128, 160, 192, 256, 320 (kbps)

● Compatible media

Media that can be used for MP3 and WMA playback are CD-Rs and CD-RWs.

Playback in some instances may not be possible, depending on the status of the CD-R or CD-RW. Playback may not be possible or the audio may jump if the disc is scratched or marked with fingerprints.

● Compatible disc formats

The following disc formats can be used.

- Disc formats: CD-ROM Mode 1 and Mode 2
CD-ROM XA Mode 2, Form 1 and Form 2
- File formats: ISO9660 Level 1, Level 2, (Romeo, Joliet)
MP3 and WMA files written in any format other than those listed above may not play correctly, and their file names and folder names may not be displayed correctly.

Items related to standards and limitations are as follows.

- Maximum directory hierarchy: 8 levels
- Maximum length of folder names/file names: 32 characters
- Maximum number of folders: 192 (including the root)
- Maximum number of files per disc: 255

● File names

The only files that can be recognized as MP3/WMA and played are those with the extension .mp3 or .wma.

● Multi-sessions

As the audio system is compatible with multi-sessions, it is possible to play discs that contain MP3 and WMA files. However, only the first session can be played.

● ID3 and WMA tags

ID3 tags can be added to MP3 files, making it possible to record the track title, artist name, etc.

The system is compatible with ID3 Ver. 1.0, 1.1, and Ver. 2.2, 2.3 ID3 tags. (The number of characters is based on ID3 Ver. 1.0 and 1.1.)

WMA tags can be added to WMA files, making it possible to record the track title and artist name in the same way as with ID3 tags.

● MP3 and WMA playback

When a disc containing MP3 or WMA files is inserted, all files on the disc are first checked. Once the file check is finished, the first MP3 or WMA file is played. To make the file check finish more quickly, we recommend you do not write in any files other than MP3 or WMA files or create any unnecessary folders.

If the discs contain a mixture of music data and MP3 or WMA format data, only music data can be played.

● Extensions

If the file extensions .mp3 and .wma are used for files other than MP3 and WMA files, they will be mistakenly recognized and played as MP3 and WMA files. This may result in large amounts of interference and damage to the speakers.

● Playback

- To play MP3 files with steady sound quality, we recommend a fixed bit rate of 128 kbps and a sampling frequency of 44.1 kHz.
- CD-R or CD-RW playback may not be possible in some instances, depending on the characteristics of the disc.
- There is a wide variety of freeware and other encoding software for MP3 and WMA files on the market, and depending on the status of the encoding and the file format, poor sound quality or noise at the start of playback may result. In some cases, playback may not be possible at all.
- When files other than MP3 or WMA files are recorded on a disc, it may take more time to recognize the disc and in some cases, playback may not be possible at all.
- Microsoft, Windows, and Windows Media are the registered trademarks of Microsoft Corporation in the U.S. and other countries.



NOTICE

■ **CDs and adapters that cannot be used (→P. 259)**

■ **CD player precautions (→P. 260)**

■ **If a CD is left inside the CD player or in the ejected position for extended periods (→P. 260)**

■ **Lens cleaners (→P. 260)**

3-2. Using the audio system Operating an iPod

Connecting an iPod enables you to enjoy music from the vehicle speakers.

■ Connecting an iPod

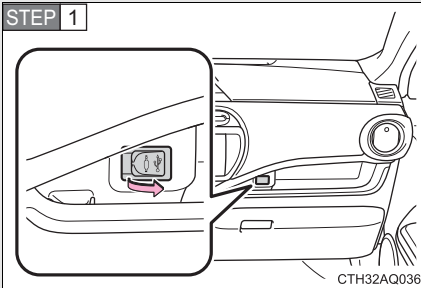

Open the cover and connect an iPod using an iPod cable.

Turn on the power of the iPod if it is not turned on.

STEP 2 Press **MEDIA**.

■ Control panel

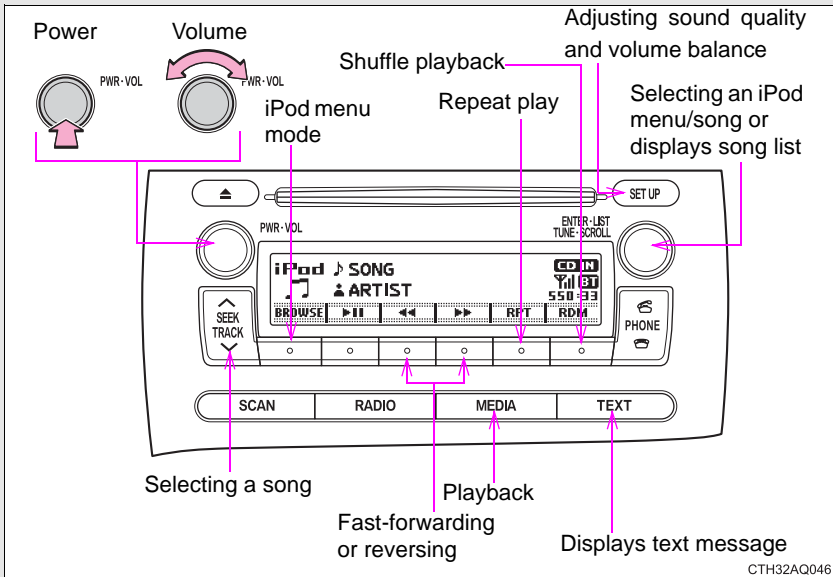

Selecting a play mode

STEP 1 Press  (BROWSE) to select iPod menu mode.

STEP 2 Turning  clockwise changes the play mode in the following order:

“Playlists”→“Artists”→“Albums”→“Songs”→“Podcasts”→“Genres”
→“Composers”→“Audiobooks”

STEP 3 Press  to select the desired play mode.

■ Play mode list

Play mode	First selection	Second selection	Third selection	Fourth selection
“Playlists”	Playlists select	Songs select	-	-
“Artists”	Artists select	Albums select	Songs select	-
“Albums”	Albums select	Songs select	-	-
“Songs”	Songs select	-	-	-
“Podcasts”	Podcasts select	Episodes select	-	-
“Genres”	Genre select	Artists select	Albums select	Songs select
“Composers”	Composers select	Albums select	Songs select	-
“Audiobooks”	Audiobooks select	Chapters select	-	-

■ Selecting a list

STEP 1 Turn  to display the first selection list.

STEP 2 Press  to select the desired item.

Pressing the knob changes to the second selection list.

STEP 3 Repeat the same procedure to select the desired item.

To return to the previous selection list, press  (BACK).

Selecting songs

Turn  or press “^” or “v” on  to select the desired song.

Selecting a song from the song list

STEP 1 Press .



The song list will be displayed.

STEP 2 Turn  to select a song.

STEP 3 Press  to play the song.

To return to the previous display, press  (BACK).

Fast-forwarding and reversing songs

To fast-forward or reverse, press and hold  (◀◀) or  (▶▶).

Shuffle playback

Pressing  (RDM) changes modes in the following order:
Track shuffle → Album shuffle → Off

Repeat play

Press  (RPT).

To cancel, press  (RPT) again.

Switching the display

Press  .

Track title, Artist name and Album title are shown on the display.

To return to the previous display, press  or  (BACK).

Adjusting sound quality and volume balance

STEP 1 Press  to enter iPod menu mode.

STEP 2 Press  to change sound modes. (→P. 284)

■ Cord hook

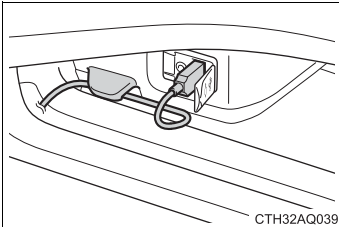

A cord can be secured as shown in the illustration.

Cords with a diameter of approximately 0.2 in. (5 mm) can be secured.

■ About iPod

Made for



iPod



iPhone

- “Made for iPod” and “Made for iPhone” mean that an electronic accessory has been designed to connect specifically to iPod, or iPhone, respectively, and has been certified by the developer to meet Apple performance standards.
- Apple is not responsible for the operation of this device or its compliance with safety and regulatory standards. Please note that the use of this accessory with iPod or iPhone may affect wireless performance.
- iPhone, iPod, iPod classic, iPod nano and iPod touch are trademarks of Apple Inc., registered in the U.S. and other countries.

■ iPod functions

- When an iPod is connected and the audio source is changed to iPod mode, the iPod will resume play from the same point in which it was last used.
- Depending on the iPod that is connected to the system, certain functions may not be available. If a function is unavailable due to a malfunction (as opposed to a system specification), disconnecting the device and reconnecting it once again may resolve the problem.
- While connected to the system, the iPod cannot be operated with its own controls. It is necessary to use the controls of the vehicle's audio system instead.

■ iPod problems

To resolve most problems encountered when using your iPod, disconnect your iPod from the vehicle iPod connection and reset it.

For instructions on how to reset your iPod, refer to your iPod Owner's Manual.

■ Display

→P. 258

■ Error messages

- "iPod ERROR": This indicates that the data in the iPod cannot be read.
- "ERROR 3": This indicates that the iPod may be malfunctioning.
- "ERROR 4": This indicates that an over current error has occurred.
- "ERROR 5": This indicates that an iPod communication error has occurred.
- "ERROR 6": This indicates that an authentication error has occurred.
- "NO SONGS": This indicates that there is no music data in the iPod.
- "NO PLAYLIST": This indicates that some available songs are not found in a selected playlist.
- "UPDATE YOUR iPod": This indicates that the version of the iPod is not compatible. Upgrade your iPod software to the latest version.

■ Compatible models

The following iPod[®], iPod nano[®], iPod classic[®], iPod touch[®] and iPhone[®] devices can be used with this system.

● Made for

- iPod touch (4th generation)
- iPod touch (3rd generation)
- iPod touch (2nd generation)
- iPod touch (1st generation)
- iPod classic
- iPod with video
- iPod nano (6th generation)
- iPod nano (5th generation)
- iPod nano (4th generation)
- iPod nano (3rd generation)
- iPod nano (2nd generation)
- iPod nano (1st generation)
- iPhone 4
- iPhone 3GS
- iPhone 3G
- iPhone

Depending on differences between models or software versions etc., some models might be incompatible with this system.

Items related to standards and limitations are as follows:

- Maximum number of lists in device: 9999
- Maximum number of songs in device: 65535
- Maximum number of songs per list: 65535

CAUTION

■ Caution while driving

Do not connect iPod or operate the controls.

**NOTICE****■ Cord hook**

Do not secure items other than cords on the cord hook. Doing so may damage the cord hook.

■ To prevent damage to iPod

- Do not leave iPod in the vehicle. The temperature inside the vehicle may become high, resulting in damage to the iPod.
- Do not push down on or apply unnecessary pressure to the iPod while it is connected as this may damage the iPod or its terminal.
- Do not insert foreign objects into the port as this may damage the iPod or its terminal.

3-2. Using the audio system Operating a USB memory

Connecting a USB memory enables you to enjoy music from the vehicle speakers.

■ Connecting a USB memory

STEP 1

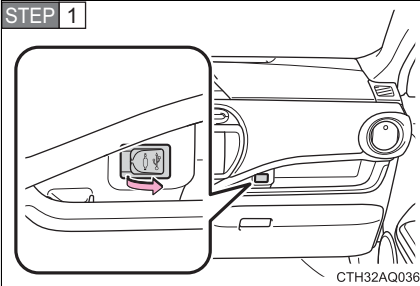

Open the cover and connect a USB memory.

Turn on the power of the USB memory if it is not turned on.

STEP 2

Press



■ Control panel

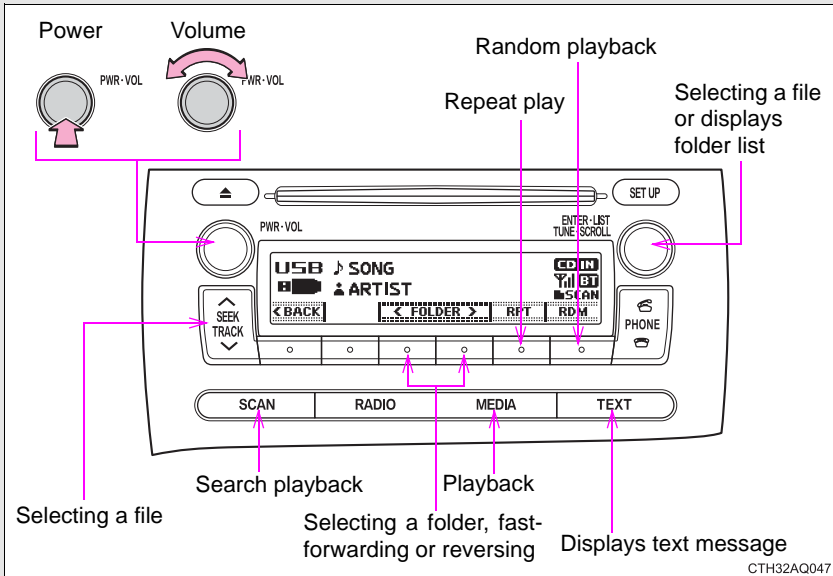

Selecting a folder

■ Selecting folders one at a time

To select the desired folder, press  (<) or  (>).

■ Selecting a folder and file from a folder list

STEP 1 Press .

The folder list will be displayed.

STEP 2 Turn and press  to select a folder and a file.

To return to the previous display, press  (BACK).

■ Returning to the first folder

Press and hold  (<) until you hear a beep.



Scanning a folder

STEP 1 Press and hold  until you hear a beep.

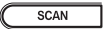
The first 10 seconds of the first file in the each folder will be played.

STEP 2 When the desired folder is reached, press  again.

Selecting files

Turn , or press “^” or “v” on  to select the desired file.



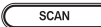

Scanning files

STEP 1 Press  .

The first 10 seconds of all files in the folder will be played.

STEP 2 When the desired folder is reached, press  again.

Fast-forwarding and reversing files

To fast-forward or reverse, press and hold  () or  () .

Random playback

Pressing  (RDM) changes modes in the following order:
Folder random → Disc random → Off

Repeat play



Pressing  (RPT) changes modes in the following order:
File repeat → Folder repeat* → Off

*: Available except when RDM (random playback) is selected

Switching the display

Press  .

Track title, Artist name and Album title (MP3 only) are shown on the display.

To return to the previous display, press  or  (BACK).

■ Cord hook

→P. 272

■ USB memory functions

- Depending on the USB memory that is connected to the system, the device itself may not be operable and certain functions may not be available. If the device is inoperable or a function is unavailable due to a malfunction (as opposed to a system specification), disconnecting the device and reconnecting it once again may resolve the problem.
- If the USB memory still does not begin operation after being disconnected and reconnected, format the memory.

■ Display

→P. 258

■ Error messages

- “ERROR”: This indicates a problem in the USB memory or its connection.
- “NO MUSIC”: This indicates that no MP3/WMA files are included in the USB memory.

■ USB memory

- Compatible devices

USB memory that can be used for MP3 and WMA playback

- Compatible device formats

The following device formats can be used:

- USB communication formats: USB2.0 FS (12 Mbps)
- File formats: FAT12/16/32 (Windows)
- Correspondence class: Mass storage class

MP3 and WMA files written in any format other than those listed above may not play correctly, and their file names and folder names may not be displayed correctly.

Items related to standards and limitations are as follows:

- Maximum directory hierarchy: 8 levels
- Maximum number of folders in a device: 999 (including the root)
- Maximum number of files in a device: 9999
- Maximum number of files per folder: 255

- MP3 and WMA files

MP3 (MPEG Audio LAYER 3) is a standard audio compression format.

Files can be compressed to approximately 1/10 of their original size using MP3 compression.

WMA (Windows Media Audio) is a Microsoft audio compression format.

This format compresses audio data to a size smaller than that of the MP3 format.

There is a limit to the MP3 and WMA file standards that can be used and to the media/formats on which the files are recorded.

- MP3 file compatibility

- Compatible standards
MP3 (MPEG1 AUDIO LAYERIII, MPEG2 AUDIO LAYERIII, MPEG2.5)
- Compatible sampling frequencies
MPEG1 AUDIO LAYERII, III: 32, 44.1, 48 (kHz)
MPEG2 AUDIO LAYERII, III: 16, 22.05, 24 (kHz)
MPEG2.5: 8, 11.025, 12 (kHz)
- Compatible bit rates (compatible with VBR)
MPEG1 AUDIO LAYERII, III: 32-320 (kbps)
MPEG2 AUDIO LAYERII, III: 32-160 (kbps)
MPEG2.5: 8-160 (kbps)
- Compatible channel modes: stereo, joint stereo, dual channel and monaural

- WMA file compatibility

- Compatible standards
WMA Ver. 7, 8, 9
- Compatible sampling frequencies
HIGH PROFILE 32, 44.1, 48 (kHz)
- Compatible bit rates
HIGH PROFILE 48-320 (kbps, CBR)

- File names

The only files that can be recognized as MP3/WMA and played are those with the extension .mp3 or .wma.

- ID3 and WMA tags

ID3 tags can be added to MP3 files, making it possible to record the track title, artist name, etc.

The system is compatible with ID3 Ver. 1.0, 1.1, and Ver. 2.2, 2.3, 2.4 ID3 tags. (The number of characters is based on ID3 Ver. 1.0 and 1.1.)

WMA tags can be added to WMA files, making it possible to record the track title and artist name in the same way as with ID3 tags.

● MP3 and WMA playback

- When a device containing MP3 or WMA files is connected, all files in the USB memory are checked. Once the file check is finished, the first MP3 or WMA file is played. To make the file check finish more quickly, we recommend that you do not include any files other than MP3 or WMA files or create any unnecessary folders.
- When the USB memory is connected and the audio source is changed to USB memory mode, the USB memory will start playing the first file in the first folder. If the same device is removed and reinserted (and the contents have not been changed), the USB memory will resume play from the same point in which it was last used.

● Extensions

If the file extensions .mp3 and .wma are used for files other than MP3 and WMA files, they will be skipped (not played).

● Playback

- To play MP3 files with steady sound quality, we recommend a fixed bit rate of at least 128 kbps and a sampling frequency of 44.1 kHz.
- There is a wide variety of freeware and other encoding software for MP3 and WMA files on the market, and depending on the status of the encoding and the file format, poor sound quality or noise at the start of playback may result. In some cases, playback may not be possible at all.
- Microsoft, Windows, and Windows Media are registered trademarks of Microsoft Corporation in the U.S.A. and other countries.



CAUTION

■ Caution while driving

Do not connect USB memory or operate the controls.

**NOTICE****■ Cord hook (→P. 275)****■ To prevent damage to USB memory**

- Do not leave USB memory in the vehicle. The temperature inside the vehicle may become high, resulting in damage to the player.
- Do not push down on or apply unnecessary pressure to the USB memory while it is connected as this may damage the USB memory or its terminal.
- Do not insert foreign objects into the port as this may damage the USB memory or its terminal.

3-2. Using the audio system

Optimal use of the audio system

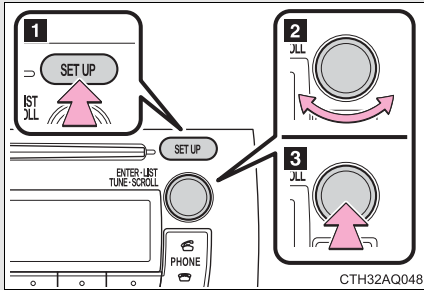

1 Displays the current mode

2 Changes the following settings

- Sound quality and volume balance (→P. 285)

The sound quality and balance setting can be changed to produce the best sound.

- Automatic Sound Levelizer on/off (→P. 286)

3 Selecting the mode

Using the audio control function

■ Changing sound quality modes

STEP 1 Press .

STEP 2 Turn  to select “Sound Setting”.

STEP 3 Press .

STEP 4 Turn  to select the desired mode.

“BASS”, “TREBLE”, “FADER”, “BALANCE”, or “ASL”

STEP 5 Press .

■ Adjusting sound quality

Turning  adjusts the level.

Mode displayed	Sound quality mode	Level	Turn to the left	Turn to the right
“BASS”	Bass*	-5 to 5	Low	High
“TREBLE”	Treble*	-5 to 5		
“FADER”	Front/rear volume balance	R7 to F7	Shifts to rear	Shifts to front
“BALANCE”	Left/right volume balance	L7 to R7	Shifts to left	Shifts to right

*: The sound quality level is adjusted individually in each audio mode.

■ Adjusting the Automatic Sound Levelizer (ASL)

When ASL is selected, turning  to the right changes the amount of ASL in the order of “LOW”, “MID” and “HIGH”.

Turning  to the left turns ASL off.

ASL automatically adjusts the volume and tone quality according to vehicle speed.

3-2. Using the audio system

Using the AUX port

This port can be used to connect a portable audio device and listen to it through the vehicle's speakers.

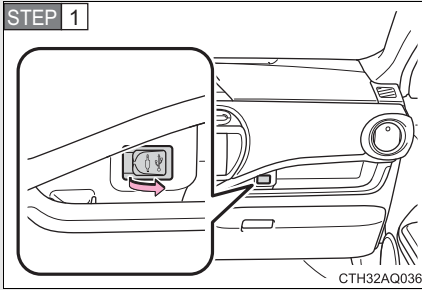

Open the cover and connect the portable audio device.

STEP 2 Press **MEDIA** until "AUX" is displayed.

■ Operating portable audio devices connected to the audio system

The volume can be adjusted using the vehicle's audio controls. All other adjustments must be made on the portable audio device itself.

■ When using a portable audio device connected to the power outlet

Noise may occur during playback. Use the power source of the portable audio device.

Using the steering wheel audio switches

Some audio features can be controlled using the switches on the steering wheel.

Operation may differ and usage may not be possible with audio/navigation systems that are not compatible with the steering switches in this vehicle.

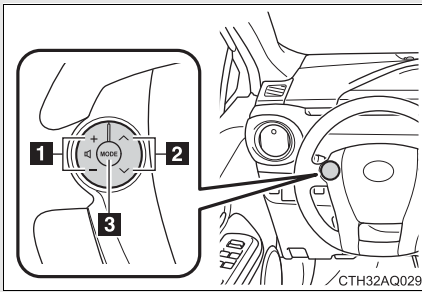



- 1 Volume
- 2 Radio mode: Select radio stations
CD mode: Select tracks and files (MP3 and WMA)
iPod mode: Selects a song
USB memory mode: Selects a folder and file
Bluetooth® audio mode: Selects an album and track
- 3 Power on, select audio source

Turning on the power

Press  when the audio system is turned off.

Changing the audio source

Press  when the audio system is turned on. The audio source changes as follows each time  is pressed. If a mode cannot be used, it will be skipped.

AM → FM → CD mode → iPod or USB memory mode → Bluetooth® audio → AUX





Adjusting the volume

Press “+” on  to increase the volume and “-” to decrease the volume.

Hold down “+” or “-” on  to continue increasing or decreasing the volume.

Silencing a sound

Press and hold .

To cancel, press and hold  again.

Selecting a radio station

STEP 1 Press  to select the radio mode.

STEP 2 Press “^” or “v” on  to select a preset station.

To scan for receivable stations, press and hold “^” or “v” on  until you hear a beep.

Selecting a track/file or song

STEP 1 Press  to select CD, iPod, USB memory or Bluetooth® audio mode.

STEP 2 Press “^” or “v” on  to select the desired track/file or song.

Selecting a folder or album (MP3 and WMA, USB memory and Bluetooth® audio)

STEP 1 Press  to select CD, USB memory or Bluetooth® audio mode.

STEP 2 Press and hold “^” or “v” on  until you hear a beep.

CAUTION

■ To reduce the risk of an accident

Exercise care when operating the audio switches on the steering wheel.

3-3. Using the Bluetooth® audio system

Bluetooth® audio/phone

■ Bluetooth® audio

The Bluetooth® audio system enables you to enjoy music played on a portable digital audio player (portable player) from the vehicle speakers via wireless communication.

This audio system supports Bluetooth®, a wireless data system capable of playing portable audio music without cables. If your portable player does not support Bluetooth®, the Bluetooth® audio system will not function.

■ Bluetooth® phone (hands-free phone system)

This system supports Bluetooth®, which allows you to make or receive calls without using cables to connect a cellular phone and the system, and without operating the cellular phone.

■ **Conditions affecting operation**

The Bluetooth® audio/phone may not operate normally in the following situations:

- The portable player does not support Bluetooth®
- The cellular phone is located outside the service area
- The Bluetooth® device is switched off
- The Bluetooth® device has a low battery
- The Bluetooth® device is not connected to the system
- The Bluetooth® device is behind the seat or in the glove box or console box, or metal material covers or touches the device

■ **When transferring ownership of the vehicle**

Be sure to initialize the system to prevent personal data from being improperly accessed. (→P. 313)

■ **About Bluetooth®**



Bluetooth is a registered trademark of Bluetooth SIG, Inc.

■ Compatible models

- Bluetooth® specifications:
Ver. 1.1, or higher (recommended: Ver. 2.1 + EDR or higher)
- Following Profiles:
 - A2DP (Advanced Audio Distribution Profile) Ver. 1.0, or higher (recommended: Ver. 1.2 or higher)
 - AVRCP (Audio/Video Remote Control Profile) Ver. 1.0 or higher (recommended: Ver. 1.3 or higher)

Portable players must correspond to the above specifications in order to be connected to the Bluetooth® audio system. However, please note that some functions may be limited depending on the type of portable player.

- Cellular phone
 - HFP (Hands Free Profile) Ver. 1.0 or higher (recommended: Ver. 1.5)
 - OPP (Object Push Profile) Ver. 1.1
 - PBAP (Phone Book Access Profile) Ver. 1.0

 CAUTION

■ **Caution while driving**

- Do not use a cellular phone.
- Do not connect Bluetooth® device or operate the controls.

■ **Caution regarding interference with electronic devices**

- Your audio unit is fitted with Bluetooth® antennas. People with implantable cardiac pacemakers, cardiac resynchronization therapy-pacemakers or implantable cardioverter defibrillators should maintain a reasonable distance between themselves and the Bluetooth® antennas. The radio waves may affect the operation of such devices.
- Before using Bluetooth® devices, users of any electrical medical device other than implantable cardiac pacemakers, cardiac resynchronization therapy-pacemakers or implantable cardioverter defibrillators should consult the manufacturer of the device for information about its operation under the influence of radio waves. Radio waves could have unexpected effects on the operation of such medical devices.

 NOTICE

■ **To prevent damage to Bluetooth® device**

Do not leave Bluetooth® device in the vehicle. The temperature inside the vehicle may become high, resulting in damage to the device.

3-3. Using the Bluetooth® audio system

Using the Bluetooth® audio/phone

■ Audio unit

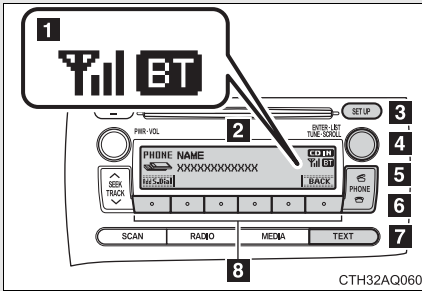

- 1 Bluetooth® connection condition

If “BT” is not displayed, the Bluetooth® audio/phone cannot be used.

- 2 Display

A message, name, number, etc. is displayed.

Lower-case characters and special characters cannot be displayed.

- 3 Displays the set up menu

- 4 Selects items such as menu and number

Turn: Selects an item

Press: Inputs the selected item

- 5 Off-hook switch

Turns the hands-free system on/starts a call

- 6 On-hook switch

Turns the hands-free system off/ends a call/refuses a call

- 7 Displays information that is too long to be displayed at one time on the display (press and hold)

- 8 Selects speed dials

■ **Audio switches**

→P. 288

■ **Telephone switches**

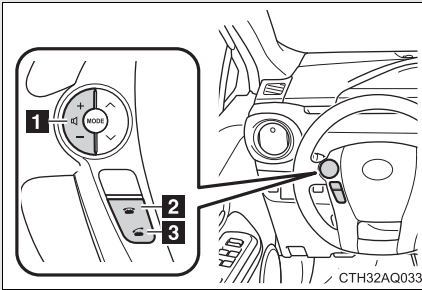

1 Volume

2 On-hook switch

Turns the hands-free system off/ends a call/refuses a call

3 Off-hook switch

Turns the hands-free system on/starts a call

■ **Microphone**

Vehicles without moon roof

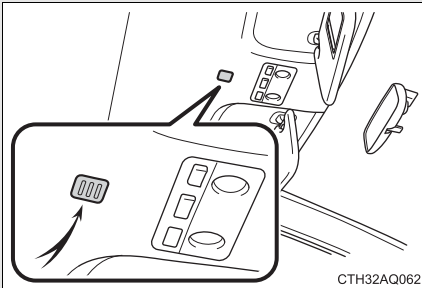



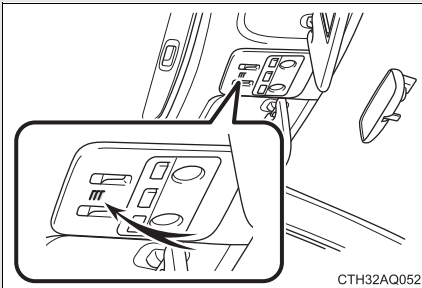

Vehicles with moon roof



Using the Bluetooth® audio/phone for the first time

Before using the Bluetooth® audio/phone, it is necessary to register a Bluetooth® device in the system. Follow the procedure below to register (pair) a device:

STEP 1 Press  and select “Bluetooth” using .

STEP 2 Press  and select “Pairing” using .

A passkey will be displayed.

STEP 3 SSP (Secure Simple Pairing) incompatible Bluetooth® devices: Input the passkey into the device.

SSP (Secure Simple Pairing) compatible Bluetooth® devices: Select “Yes” to register the device. Depending on the type of device, it may register automatically.

If a Bluetooth® device has both music player and cellular phone functions, both functions will be registered at the same time. When deleting the device, both functions will be deleted at the same time.

If the off-hook switch is pressed and the “PHONE” mode is entered when no phones have been registered, the registration screen will be automatically displayed.

Menu list of the Bluetooth® audio/phone

First menu	Second menu	Third menu	Operation details
"Bluetooth"	"BT Pairing"	-	Registering a Bluetooth® device
	"List Phone"	-	Listing the registered cellular phones
	"List Audio"	-	Listing the registered portable players
	"Passkey"	-	Changing the passkey
	"BT Power"	-	Setting automatic connection of the device on or off
	"Bluetooth info"	"Device Name" "Device Address"	Displaying the device status
	"Display Setting"	-	Setting the automatic connection confirmation display to on or off
	"Initialize"	-	Initializing the settings

First menu	Second menu	Third menu	Operation details
"Phone"	"Phonebook"	"Add contacts"	Adding a new number
		"Add SD"	Registering a speed dial
		"Delete Call History"	Deleting a number stored in the call history
		"Delete contacts"	Deleting a number stored in the phonebook
		"Delete other PB"	Deleting a phonebook's data
	"HF Sound Setting"	"Call volume"	Setting call volume
		"Ringtone volume"	Setting ringtone volume
		"Ringtone"	Setting the ringtone
	"Transfer Histories"	-	Transferring the call histories

■ Bluetooth® audio/phone system functions

Depending on the Bluetooth® device, certain functions may not be available.

3-3. Using the Bluetooth® audio system Operating a Bluetooth® enabled portable player

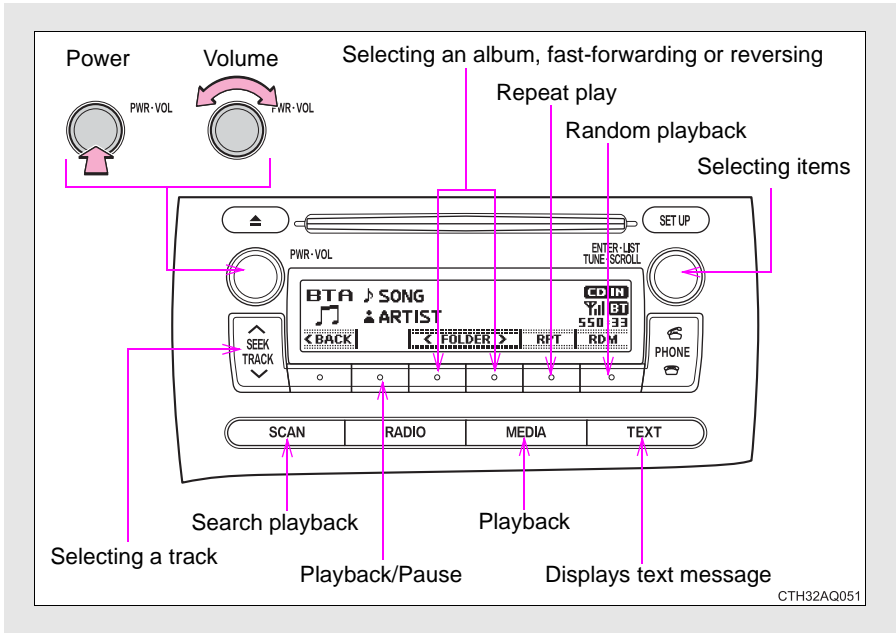

Selecting an album

Press  (<) or  (>) to select the desired album.

Scanning an album

STEP 1 Press and hold  until you hear a beep.

The first 10 seconds of the first track in the each album will be played.

STEP 2 When the desired album is reached, press  again.

Selecting tracks

Press “^” or “v” on  to select the desired track.

Scanning tracks

STEP 1 Press .





The first 10 seconds of all tracks in the album will be played.

STEP 2 When the desired track is reached, press  again.

Playing and pausing tracks

Press  () to play or pause a track.

Fast-forwarding and reversing tracks

To fast-forward or reverse, press and hold  () or  ().

Random playback

Pressing  (RDM) changes modes in the following order:
Album random → All track random → Off

Repeat play



Pressing  (RPT) changes modes in the following order:
Track repeat → Album repeat* → Off

*: Available except when RDM (random playback) is selected

Switching the display

Press .

Track title and Artist name are displayed on the display.

To return to the previous display, press  or  (BACK).

■ **Bluetooth® audio system functions**

Depending on the portable player that is connected to the system, certain functions may not be available.

Making a phone call

To enter the “PHONE” mode, press the off-hook switch.

■ Making a phone call

- Dialing by selecting a name
- Speed dialing
- Dialing by entering the number
- Dialing from call histories

■ Receiving a phone call

- Answering the phone
- Refusing the call

■ Operations during a call



- Transferring a call
- Muting your voice
- Inputting digits
- Setting call volume

■ Adjusting the ringtone volume when receiving a call

Dialing by selecting a name



STEP 1 Select “Phonebook” using  .



STEP 2 Select the desired name using  and press the off-hook switch.

By pressing  (Add S. Dial) and then one of the speed dial buttons (from  to ) while the desired name is selected, it can be registered as a speed dial.

Speed dialing

STEP 1 Select “Speed dials” using  .

STEP 2 Press the desired preset button (from  to ) and press the off-hook switch.

By pressing  (Add S. Dial) and then one of the speed dial buttons (from  to ) while the desired name is selected, it can be registered as a speed dial.

Dialing by entering the number

STEP 1 Select “Dial by number” using  .

STEP 2 Enter the phone number and press the off-hook switch.



Dialing from call histories

STEP 1 Select “All calls”, “Missed calls”, “Incoming calls” or “Outgoing calls” using .



STEP 2 Select the desired number using  and press the off-hook switch.

The following operations can be performed:

- Registering a number as a speed dial

Press  (Add S. Dial) and then press and hold the desired preset button (from  to ).

- Deleting the selected number

Press  (DELETE) and press  (YES).

When receiving a phone call

- **Answering the phone**

Press the off-hook switch.

- **Refusing the call**

Press the on-hook switch.

- **Receiving a call when on another call**

Press the off-hook switch.

Pressing the off-hook switch again returns you to the previous call.

Operations during a call

● Transferring a call

A call can be transferred between the cellular phone and system while dialing, receiving a call, or during a call. Use one of the following methods:

- a. Operate the cellular phone.

Refer to the manual that comes with the cellular phone for the operation of the phone.

- b. Press the  * (PHONE).



*: This operation can be performed only when transferring a call from the cellular phone to the system during a call.

● Muting your voice

Press  (MUTE).

● Inputting digits

Press  (0 - 9) and use  to input the desired digits.

- To send the input digits press  (SEND).
- When finished, press  (EXIT) to return to the previous screen.

● Setting call volume

Change the call volume using .

To decrease the volume: Turn  counterclockwise.

To increase the volume: Turn  clockwise.

Adjusting the ringtone volume when receiving a call

Change the ringtone volume using .

To decrease the volume: Turn  counterclockwise.

To increase the volume: Turn  clockwise.

■ When talking on the phone

- Do not talk simultaneously with the other party.
- Keep the volume of the received voice down. Otherwise, voice echo will increase.

■ Automatic volume adjustment

When vehicle speed is 50 mph (80 km/h) or more, the volume automatically increases. The volume returns to the previous volume setting when vehicle speed drops to 43 mph (70 km/h) or less.

■ Phone call system functions

Depending on the cellular phone, certain functions may not be available.



■ Situations where the system may not recognize your voice



- When driving on a rough road
- When driving at high speeds
- When air is blowing out of the vents onto the microphone
- When the air conditioning fan emits a loud noise

Using the "SET UP" menu ("Bluetooth" menu)

Registering a Bluetooth® device in the system allows the system to function. The following functions can be used for registered devices:

■ Functions and operation procedures

STEP 1 Press  and select "Bluetooth" using .

STEP 2 Press  and select one of the following functions using .

- Registering a Bluetooth® device
"BT Pairing"
- Listing the registered cellular phones
"List Phone"
- Listing the registered portable players
"List Audio"
- Changing the passkey
"Passkey"
- Setting automatic connection of the device on or off
"BT Power"
- Displaying the device status
"Bluetooth info"
- Setting the automatic connection confirmation display to on or off
"Display Setting"
- Initialization
"Initialize"

Registering a portable player

Select “Pairing” using , and perform the procedure for registering a portable player. (→P. 297)

Listing the registered cellular phones

Select “List Phone” using . The list of registered cellular phones will be displayed.

● Connecting the registered cellular phone to the audio system

STEP 1 Select the name of the cellular phone to be connected

using .

STEP 2 Select “Select” using .

● Deleting a registered cellular phone

STEP 1 Select the name of the cellular phone to be deleted using

.

STEP 2 Select “Delete” using .

STEP 3 Press  (YES).

Listing the registered portable players

Select “List Audio” using  . The list of registered portable players will be displayed.

● Connecting the registered portable player to the audio system

STEP 1 Select the name of the portable player to be connected

using  .

STEP 2 Select “Select” using  .

● Deleting the registered portable player

STEP 1 Select the name of the portable player to be deleted using

 .

STEP 2 Select “Delete” using  .

STEP 3 Press  (YES).

Changing the passkey

STEP 1 Select “Passkey” using .

STEP 2 Select a 4 to 8-digit passkey using .

Input the number 1 digit at a time.

STEP 3 When the entire number to be registered as a passkey has been input, press  again.

If the passkey to be registered has 8 digits, pressing  again is not necessary.

Setting automatic connection of the device on or off

If “BT Power” is set to on, the registered device will be connected automatically when the engine switch is turned to the “ACC” position.

STEP 1 Select “BT Power” using .

STEP 2 Select “ON” or “OFF” using .

Displaying the device status

Select “Bluetooth info” using  .

- Displaying the device name

Select “Device Name” using  .

- Displaying the device address

Select “Device Address” using  .

Setting the automatic connection confirmation display to on or off

If the “Display Setting” is set to on, the portable player connection status will be displayed when the engine switch is turned to the “ACC” or “ON” position.

STEP 1 Select “Display Setting” using  .

STEP 2 Select “ON” or “OFF” using  .

Initialization

Select “Initialize” using .

- Initializing the sound settings

Select “Sound setting” using  and press  (YES).

For details about sound settings: →P. 314

- Initializing the device information

Select “Car Device Info” using  and press  (YES).

Automatic connection of a portable device, automatic connection confirmation display and the passkey will be initialized.

- Initializing all the settings

Select “All Initialize” using  and press  (YES).

■ The number of Bluetooth® devices that can be registered

Up to 5 Bluetooth® devices can be registered in the system.

Using the "SET UP" menu ("Phone" menu)

■ Functions and operation procedures

To enter the menu of each function, press  and follow the



steps below using  :

- Adding a new phone number
 1. "Phone" → 2. "Phonebook" → 3. "Add contacts"
- Setting speed dials
 1. "Phone" → 2. "Phonebook" → 3. "Add SD"
- Deleting call histories
 1. "Phone" → 2. "Phonebook" → 3. "Delete Call History"
- Deleting a registered phone number
 1. "Phone" → 2. "Phonebook" → 3. "Delete contacts"
- Deleting another cellular phone's phonebook
 1. "Phone" → 2. "Phonebook" → 3. "Delete other PB"
- Setting call volume
 1. "Phone" → 2. "HF Sound Setting" → 3. "Call Volume"
- Setting ringtone volume
 1. "Phone" → 2. "HF Sound Setting" → 3. "Ringtone Volume"
- Setting ringtone
 1. "Phone" → 2. "HF Sound Setting" → 3. "Ringtone"
- Transferring call histories
 1. "Phone" → 2. "Transfer Histories"

Adding a new phone number

Select “Add contacts” using .

- Transferring all contacts from the cellular phone

Select “Overwrite all contacts” using  and press  (YES).



- Transferring one contact from the cellular phone

Select “Add one contact” using  and press  (YES).

Setting speed dials

STEP 1 Select “Add SD” using .

STEP 2 Select the desired data using .

STEP 3 Press and hold the desired preset button (from  to ).

For details about setting speed dials from the call history: →P. 305



For details about deleting speed dials: →P. 304



Deleting call histories

Select “Delete Call History” using .

● Deleting outgoing call history



STEP 1 Select “Outgoing Calls” using .



STEP 2 Select the desired phone number using  and press  (YES).

To delete all outgoing call history data, press  (ALL) and then press  (YES).

● Deleting incoming call history

STEP 1 Select “Incoming calls” using .

STEP 2 Select the desired phone number using  and press  (YES).



To delete all incoming call history data, press  (ALL) and then press  (YES).

- Deleting missed call history

STEP 1 Select “Missed Calls” using .

STEP 2 Select the desired phone number using  and press

 (YES).



To delete all missed call history data, press  (ALL) and then press  (YES).

- Deleting a number from all call histories (Outgoing calls, Incoming calls and Missed calls)

STEP 1 Select “All Calls” using .



STEP 2 Select the desired phone number using  and press



 (YES).

To delete all of the call histories data, press  (ALL) and then press  (YES).

Deleting a registered phone number



STEP 1 Select “Delete contacts” using  .

STEP 2 Select the desired phone number using  and press  (YES).

To delete all of the registered phone numbers, select “All delete” using  and press  (YES).

Deleting another cellular phone’s phonebook

STEP 1 Select “Delete other PB” using  .

STEP 2 Select the desired phonebook using  and press  (YES).

Setting call volume

STEP 1 Select “Call Volume” using  .

STEP 2 Change the call volume.

To decrease the volume: Turn  counterclockwise.

To increase the volume: Turn  clockwise.

Setting ringtone volume

STEP 1 Select “Ringtone Volume” using .



STEP 2 Change the ringtone volume.

To decrease the volume: Turn  counterclockwise.

To increase the volume: Turn  clockwise.

Setting ringtone

STEP 1 Select “Ringtone” using .

STEP 2 Using , select a ringtone (1 - 3). To set the selected ringtone, press .

Transferring call histories

Select “Transfer Histories” using  and press  (YES).

■ **Phone number**

Up to 1000 names can be stored.

■ **Call history**

Up to 10 numbers can be stored in each of the outgoing, incoming and missed call history memories.

■ **Limitation of number of digits**

A phone number that exceeds 24 digits cannot be registered.

3-4. Using the interior lights

Interior lights list

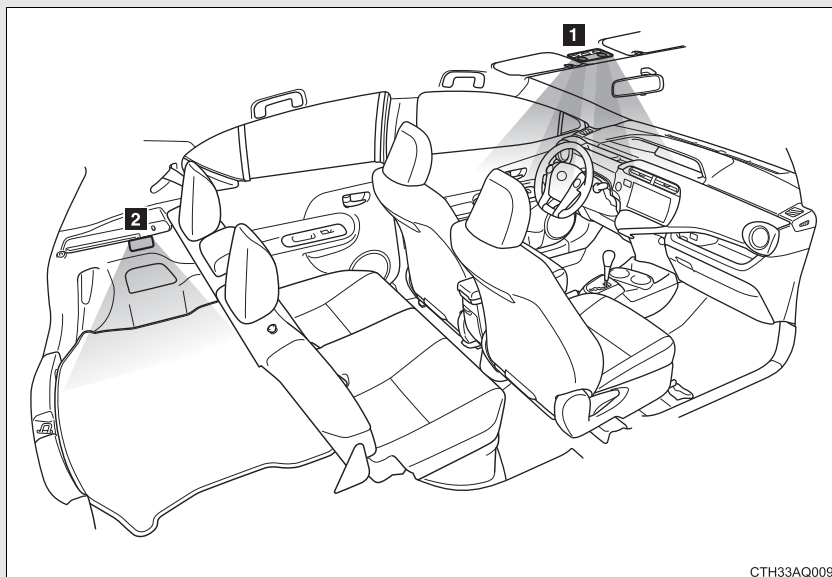

CTH33AQ009

- 1** Interior lights/personal lights (→P. 322)
- 2** Luggage compartment light (if equipped)

Interior lights/personal lights

Interior lights

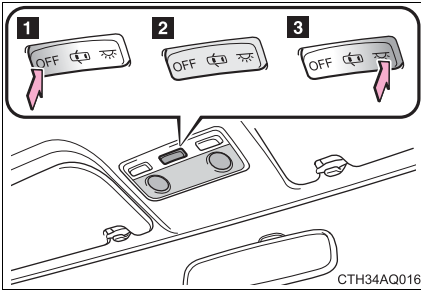

- 1** Turns the lights off
- 2** Turns the lights on/off linked to door positions
- 3** Turns the lights on

Personal lights

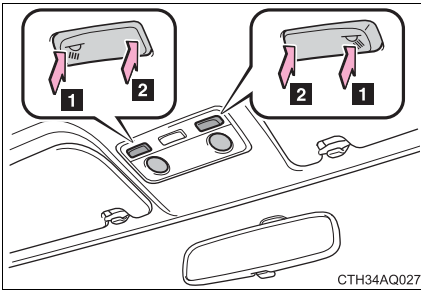

- 1** Turns the lights on
- 2** Turns the lights off

■ Illuminated entry system

Vehicles without a smart key system

When the interior lights switch is in the “DOOR” position, the interior lights automatically turn on/off according to the engine switch position, whether the doors are locked/unlocked, and whether the doors are open/closed.

Vehicles with a smart key system

When the interior lights switch is in the “DOOR” position, the interior lights automatically turn on/off according to “POWER” switch mode, the presence of the electronic key, whether the doors are locked/unlocked, and whether the doors are open/closed.

■ To prevent 12-volt battery discharge

Vehicles without a smart key system

If the interior lights, personal lights or luggage compartment light remain on when the engine switch is “LOCK” position, the lights will go off automatically after 20 minutes.

Vehicles with a smart key system

If the interior lights, personal lights or luggage compartment light remain on when the “POWER” switch is off, the lights will go off automatically after 20 minutes.

■ Customization that can be configured at Toyota dealer

Settings (e.g. the time elapsed before lights turn off) can be changed.
(Customizable features →P. 522)



NOTICE

■ To prevent 12-volt battery discharge

Do not leave the lights on longer than necessary when the hybrid system is off.

3-5. Using the storage features

List of storage features

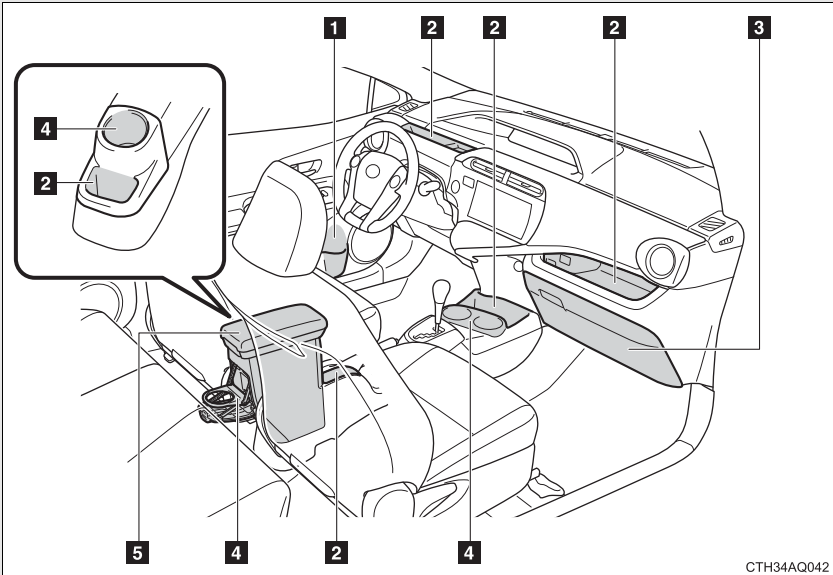

CTH34AQ042

- 1** Bottle holders
- 2** Auxiliary boxes (if equipped)
- 3** Glove box
- 4** Cup holders
- 5** Console box (if equipped)

CAUTION

■ Items that should not be left in the storage spaces

Do not leave glasses, lighters or spray cans in the storage spaces, as this may cause the following when cabin temperature becomes high:

- Glasses may be deformed by heat or cracked if they come into contact with other stored items.
- Lighters or spray cans may explode. If they come into contact with other stored items, the lighter may catch fire or the spray can may release gas, causing a fire hazard.

Glove box

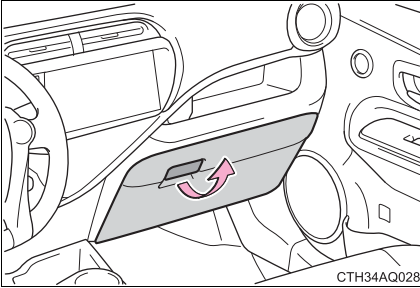

Pull up the lever to open the glove box.

⚠ CAUTION

■ Caution while driving

Keep the glove box closed. In the event of sudden braking or sudden swerving, an accident may occur due to an occupant being struck by the open glove box or the items stored inside.

Console box (if equipped)

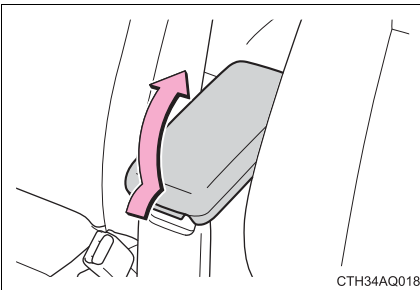

Lift the lid while pulling up the knob to release the lock.

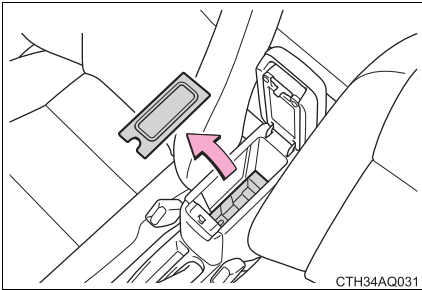

Remove the lid at the bottom of the console box.

Small items can be stored in this space.

■ **When using the console box lid as an armrest**

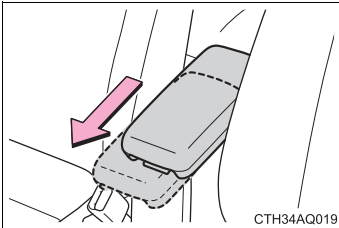

The lid can be slid forward or backwards.

⚠ CAUTION

■ **Caution while driving**

Keep the console box closed. In the event of sudden braking, an accident may occur due to an occupant being struck by the open console box or the items stored inside.

Auxiliary boxes

Type A

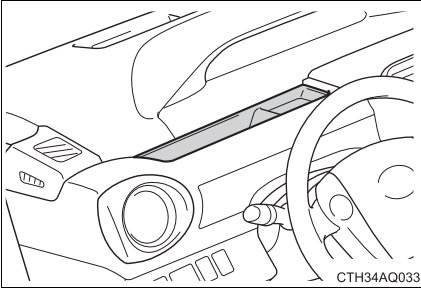

Type B

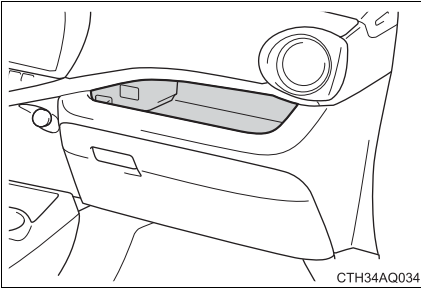

Type C

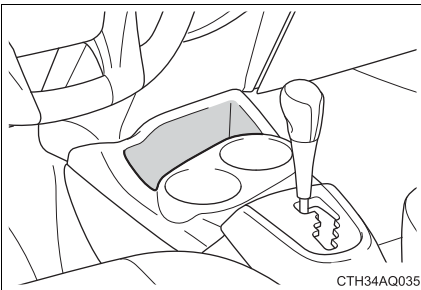

Type D

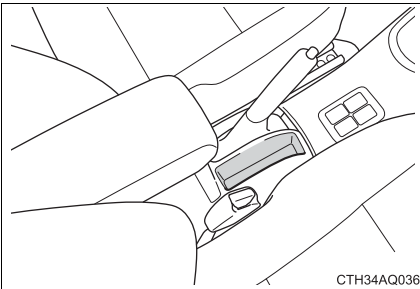

Type E (if equipped)

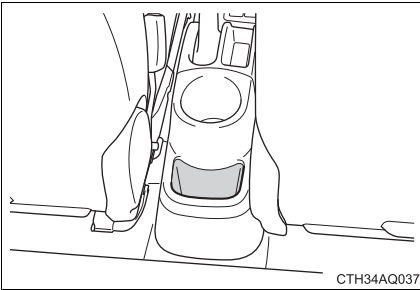

CAUTION

Items unsuitable for the box

Do not place items that easily roll over or extend past the box's rim. The items may be thrown out of the tray, causing an accident.

Cup holders

Front

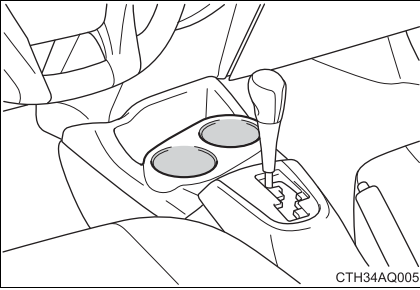

Rear (type A)

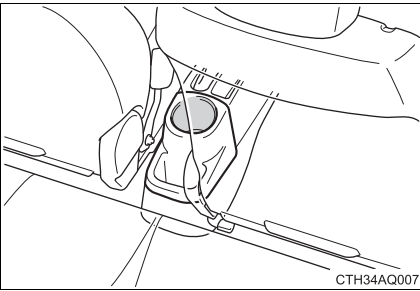

Rear (type B)

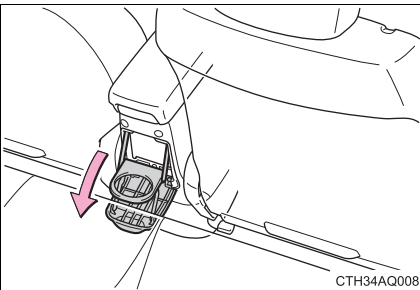

Pull down the cup holder lid.

⚠ CAUTION**■ Items unsuitable for the cup holder**

Do not place anything other than cups or beverage cans in the cup holders. Items in the cup holders may be thrown out of the holders in the event of an accident or sudden braking, causing injury. If possible, cover hot drinks to prevent burns.

■ When not in use rear cup holder (type B)

Keep the cup holder closed. In the event of sudden braking, an accident may occur due to an occupant being struck by the open cup holder.

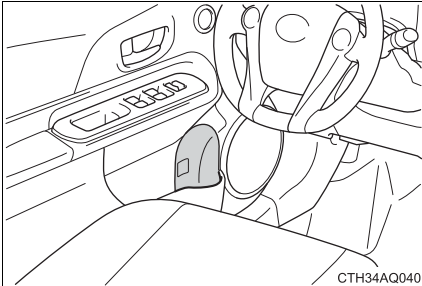
Bottle holders**■ When using the bottle holder**

- When storing a bottle, close the cap.
- The bottle may not be stored depending on its size or shape.

⚠ CAUTION**■ Items unsuitable for the bottle holder**

Do not place anything other than a bottle in the bottle holders. Items in the bottle holders may be thrown out of the holders in the event of an accident or sudden braking and cause injury.

**NOTICE****■ Items that should not be stowed in the bottle holders**

Put the cap on before stowing a bottle. Do not place open bottles in the bottle holders, or glasses and paper cups containing liquid. The contents may spill and glasses may break.

Sun visors

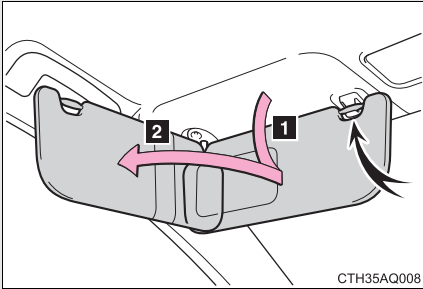

- 1** To set the visor in the forward position, flip it down.
- 2** To set the visor in the side position, flip down, unhook, and swing it to the side.

Vanity mirrors

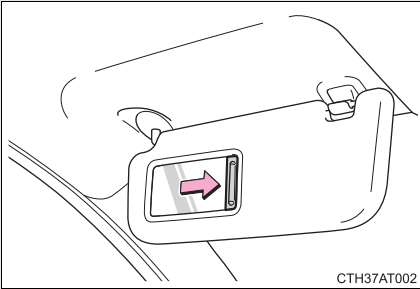

Slide the cover to open.

Outside temperature display

The temperature display shows temperatures within the range of -40°F (-40°C) and 122°F (50°C).

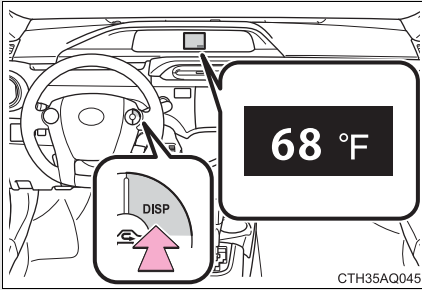

The outside temperature display of the “Drive Information” screen can be displayed by pressing the “DISP” switch. (→P. 191)

■ The outside temperature is displayed when

Vehicles without a smart key system

The engine switch is in the “ON” position.

Vehicles with a smart key system

The “POWER” switch is in ON mode.

■ Outside temperature display

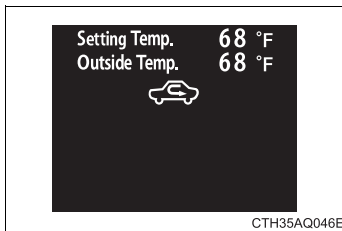

The outside temperature is shown on the multi-information display when the steering wheel climate remote control switches are used to adjust the air conditioning system’s temperature or change between outside and recirculated air modes. (→P. 243)

■ Display

In the following situations, the correct outside temperature may not be displayed, or the display may take longer than normal to change:

- When the vehicle is stopped, or moving at low speeds (less than 16 mph [25 km/h])
- When the outside temperature has changed suddenly (at the entrance/exit of a garage, tunnel, etc.)

■ When “--” or “E” is displayed

The system may be malfunctioning. Take your vehicle to your Toyota dealer.

Power outlet

The power outlet can be used for 12 V accessories that run on less than 10 A.

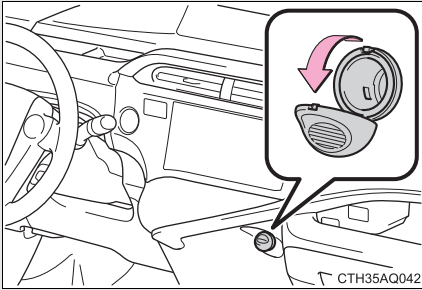

■ The power outlet can be used when

Vehicles without a smart key system

The engine switch is in the “ACC” or “ON” position.

Vehicles with a smart key system

The “POWER” switch is in ACCESSORY or ON mode.

⚠ NOTICE

■ To avoid damaging the power outlet

Close the power outlet lid when the power outlet is not in use.

Foreign objects or liquids that enter the power outlet may cause a short circuit.

■ To prevent blown fuse

Do not use an accessory that uses more than 12 V 10 A.

■ To prevent 12-volt battery discharge

Do not use the power outlet longer than necessary when the hybrid system is off.

Seat heaters*

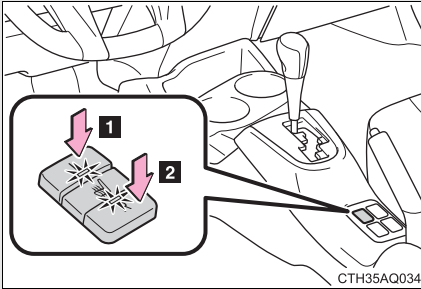

1 Turns on the front left seat heater

2 Turns on the front right seat heater

The indicator light comes on.

Push the switch once again to turn off the seat heater.

■ **The seat heaters can be used when**

The "POWER" switch is in ON mode.

■ **When not in use**

Turn the seat heater off. The indicator light goes off.

 CAUTION

■ **Burns**

- Use caution when seating the following persons in a seat with the seat heater on to avoid the possibility of burns:
 - Babies, small children, the elderly, the sick and the physically challenged
 - Persons with sensitive skin
 - Persons who are fatigued
 - Persons who have taken alcohol or drugs that induce sleep (sleeping drugs, cold remedies, etc.)
- Do not cover the seat with anything when using the seat heater. Using the seat heater with a blanket or cushion increases the temperature of the seat and may lead to overheating.
- Do not use the seat heater more than necessary. Doing so may cause minor burns or overheating.

 NOTICE

■ **To prevent seat heater damage**

Do not put heavy objects that have an uneven surface on the seat and do not stick sharp objects (needles, nails, etc.) into the seat.

■ **To prevent 12-volt battery discharge**

Turn the seat heaters off when the hybrid system is off, and check that the indicator is off.

3-6. Other interior features

Coat hooks*

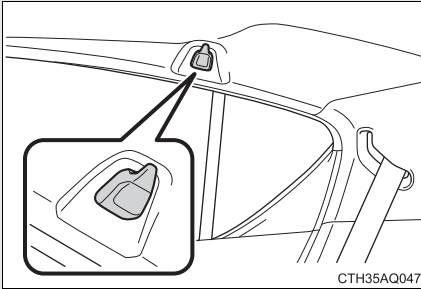

⚠ CAUTION

■ Items that cannot be hung on the coat hook

Do not hang coat hangers or other hard or sharp objects on the hook. If the SRS curtain shield airbags deploy, these items may become projectiles, causing death or serious injury.

Assist grips

An assist grip installed on the ceiling can be used to support your body while sitting on the seat.

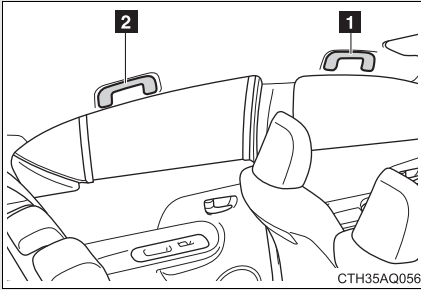

- 1 Front
- 2 Rear (if equipped)

CAUTION

■ Assist grip

Do not use the assist grip when getting in or out of the vehicle or rising from your seat.

NOTICE

■ To prevent damage to the assist grip

Do not hang any heavy object or put a heavy load on the assist grip.

Floor mat

Use only floor mats designed specifically for vehicles of the same model and model year as your vehicle. Fix them securely in place onto the carpet.

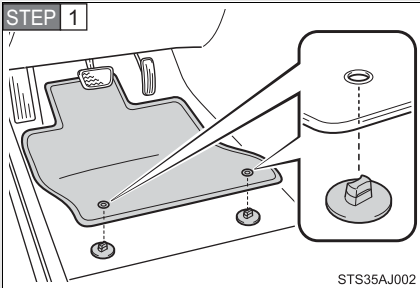

Insert the retaining hooks (clips) into the floor mat eyelets.

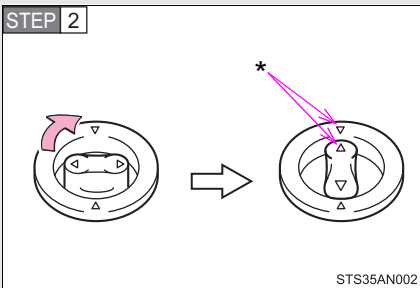

Turn the upper knob of each retaining hook (clip) to secure the floor mats in place.

*: Always align the Δ marks.

The shape of the retaining hooks (clips) may differ from that shown in the illustration.

⚠ CAUTION

Observe the following precautions.

Failure to do so may cause the driver's floor mat to slip, possibly interfering with the pedals while driving. An unexpectedly high speed may result or it may become difficult to stop the vehicle, leading to a serious accident.

■ When installing the driver's floor mat

- Do not use floor mats designed for other models or different model year vehicles, even if they are Toyota Genuine floor mats.
- Only use floor mats designed for the driver's seat.
- Always install the floor mat securely using the retaining hooks (clips) provided.
- Do not use two or more floor mats on top of each other.
- Do not place the floor mat bottom-side up or upside-down.

■ Before driving

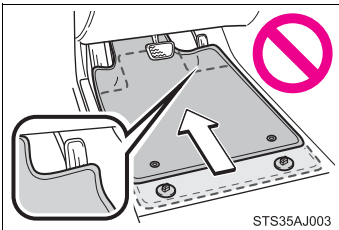

- Check that the floor mat is securely fixed in the correct place with all the provided retaining hooks (clips). Be especially careful to perform this check after cleaning the floor.
- With the hybrid system stopped and the shift lever in P, fully depress each pedal to the floor to make sure it does not interfere with the floor mat.

Luggage cover*

■ Removing the luggage cover

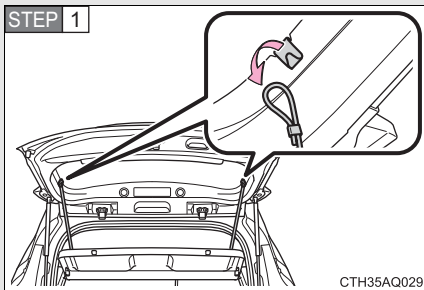

Unhook the cords.

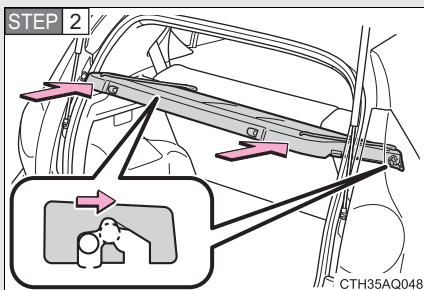

Push the luggage cover forward to disengage the anchors.

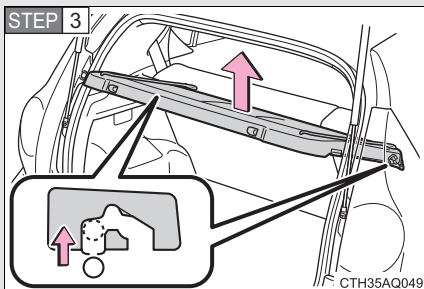

Remove the luggage cover.

*: If equipped

■ Installing the luggage cover

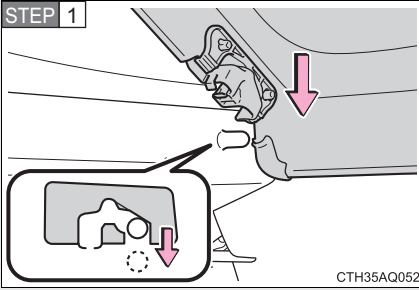

Place the luggage cover on the anchors.

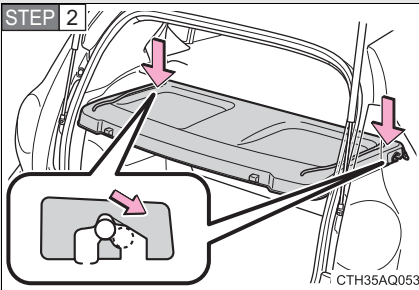

Push the luggage cover until a click sound is heard.

STEP 3 Hook the cords.

4-1. Maintenance and care

Cleaning and protecting
the vehicle exterior..... 346

Cleaning and protecting
the vehicle interior..... 349

4-2. Maintenance

Maintenance
requirements 352

General maintenance..... 355

Emission inspection and
maintenance (I/M)
programs..... 359

**4-3. Do-it-yourself
maintenance**

Do-it-yourself service
precautions 360

Hood 364

Positioning a floor jack..... 366

Engine compartment..... 368

12-volt battery 379

Tires 384

Tire inflation pressure 392

Wheels 396

Air conditioning filter..... 399

Wireless remote control/
electronic key battery..... 401

Checking and replacing
fuses 404

Light bulbs..... 415

Cleaning and protecting the vehicle exterior

Perform the following to protect the vehicle and maintain it in prime condition:

- Working from top to bottom, liberally apply water to the vehicle body, wheel wells and underside of the vehicle to remove any dirt and dust.
- Wash the vehicle body using a sponge or soft cloth, such as a chamois.
- For hard-to-remove marks, use car wash soap and rinse thoroughly with water.
- Wipe away any water.
- Wax the vehicle when the waterproof coating deteriorates.

If water does not bead on a clean surface, apply wax when the vehicle body is cool.

■ Automatic car washes

- Fold the mirrors and remove the antenna before washing the vehicle. Start washing from the front of the vehicle. Make sure to re-install the antenna and extend the mirrors before driving.
- Brushes used in automatic car washes may scratch the vehicle surface and harm your vehicle's paint.
- In certain automatic car washes, the rear spoiler may interfere with machine operation. This may prevent the vehicle from being cleaned properly or result in damage to the rear spoiler.

■ High pressure car washes

- Do not allow the nozzles of the car wash to come within close proximity of the windows.
- Before using the car wash, check that the fuel filler door on your vehicle is closed properly.

■ When using a car wash (vehicles with a smart key system)

If the door handle becomes wet while the electronic key is within the effective range, the door may lock and unlock repeatedly. In that case, follow the following correction procedures to wash the vehicle:

- Place the electronic key in a location 6 ft. (2 m) or more away from the vehicle. (Take care to ensure that the key is not stolen.)
- Set the electronic key to battery-saving mode to disable the smart key system. (→P. 53)

■ Aluminum wheels (if equipped)

- Remove any dirt immediately by using a neutral detergent. Do not use hard brushes or abrasive cleaners. Do not use strong or harsh chemical cleaners.
Use the same mild detergent and wax as used on the paint.
- Do not use detergent on the wheels when they are hot, for example after driving for long distance in the hot weather.
- Wash detergent from the wheels immediately after use.

■ Bumpers

Do not scrub with abrasive cleaners.

CAUTION

■ When washing the vehicle

Do not apply water to the inside of the engine compartment. Doing so may cause the electrical components etc. to catch fire.

■ Precautions regarding the exhaust pipe

Exhaust gasses cause the exhaust pipe to become quite hot.

When washing the vehicle, be careful not to touch the pipe until it has cooled sufficiently, as touching a hot exhaust pipe can cause burns.

 NOTICE

■ **To prevent paint deterioration and corrosion on the body and components (aluminum wheels etc.)**

● Wash the vehicle immediately in the following cases:

- After driving near the sea coast
- After driving on salted roads
- If coal tar or tree sap is present on the paint surface
- If dead insects, insect droppings or bird droppings are present on the paint surface
- After driving in an area contaminated with soot, oily smoke, mine dust, iron powder or chemical substances
- If the vehicle becomes heavily soiled with dust or mud
- If liquids such as benzene and gasoline are spilled on the paint surface

● If the paint is chipped or scratched, have it repaired immediately.

● To prevent the wheels from corroding, remove any dirt and store in a place with low humidity when storing the wheels.

■ **Cleaning the exterior lights**

● Wash carefully. Do not use organic substances or scrub with a hard brush. This may damage the surfaces of the lights.

● Do not apply wax to the surfaces of the lights. Wax may cause damage to the lenses.

■ **To prevent damage to the antenna**

Remove the antenna in the following situations:

- When the antenna will touch the ceiling of a garage or other such places
- When a car cover is to be used to cover the vehicle

■ **Antenna installation and removal precautions**

● Before driving, ensure that the antenna is installed.

● When the antenna is removed, such as before entering an automatic car wash, make sure to store it in a suitable place so as not to lose it. Also, before driving, make sure to reinstall the antenna in its original position.

Cleaning and protecting the vehicle interior

The following procedures will help protect your vehicle's interior and keep it in top condition:

■ Protecting the vehicle interior

Remove dirt and dust using a vacuum cleaner. Wipe dirty surfaces with a cloth dampened with lukewarm water.

■ Cleaning the synthetic leather areas

- Remove loose dirt using a vacuum cleaner.
- Apply a mild soap solution to the synthetic leather using a sponge or soft cloth.
- Allow the solution to soak in for a few minutes. Remove the dirt and wipe off the solution with a clean, damp cloth.

■ Shampooing the carpets

There are several commercial foaming-type cleaners available. Use a sponge or brush to apply the foam. Rub in overlapping circles. Do not use water. Wipe dirty surfaces and let them dry. Excellent results are obtained by keeping the carpet as dry as possible.

■ Seat belts

Clean with mild soap and lukewarm water using a cloth or sponge. Also check the belts periodically for excessive wear, fraying or cuts.

 **CAUTION**

■ **Water in the vehicle**

● Do not splash or spill liquid in the vehicle, such as on the floor, in the hybrid battery (traction battery) air vents, and in the luggage compartment. Doing so may cause the hybrid battery, electrical components, etc. to malfunction or catch fire.

● Do not get any of the SRS components or wiring in the vehicle interior wet. (→P. 118)

An electrical malfunction may cause the airbags to deploy or not function properly, resulting in death or serious injury.

■ **Cleaning the interior (especially instrument panel)**

Do not use polish wax or polish cleaner. The instrument panel may reflect off the windshield, obstructing the driver's view and leading to an accident, resulting in death or serious injury.

 NOTICE**■ Cleaning detergents**

- Do not use the following types of detergent, as they may discolor the vehicle interior or cause streaks or damage to painted surfaces:
 - Non-seat portions: Organic substances such as benzene or gasoline, alkaline or acidic solutions, dye, and bleach
 - Seats: Alkaline or acidic solutions, such as thinner, benzene, and alcohol
- Do not use polish wax or polish cleaner. The instrument panel's or other interior part's painted surface may be damaged.

■ Water on the floor

Do not wash the vehicle floor with water.

Vehicle systems such as the audio system may be damaged if water comes into contact with electrical components such as the audio system above or under the floor of the vehicle. Water may also cause the body to rust.

■ Cleaning the inside of the rear window

- Do not use glass cleaner to clean the rear window, as this may cause damage to the rear window defogger heater wires. Use a cloth dampened with lukewarm water to gently wipe the window clean. Wipe the window in strokes running parallel to the heater wires.
- Be careful not to scratch or damage the heater wires.

Maintenance requirements

To ensure safe and economical driving, day-to-day care and regular maintenance are essential. It is the owner's responsibility to perform regular checks. Toyota recommends the following maintenance:

■ General maintenance

General maintenance should be performed on a daily basis. This can be done by yourself or by a Toyota dealer.

■ Scheduled maintenance

Scheduled maintenance should be performed at specified intervals according to the maintenance schedule.

For details about maintenance items and schedules, refer to the "Scheduled Maintenance Guide" or "Owner's Manual Supplement".

■ Do-it-yourself maintenance

You can perform some maintenance procedures by yourself. Please be aware that do-it-yourself maintenance may affect warranty coverage.

The use of Toyota Repair Manuals is recommended.

For details about warranty coverage, see the separate "Owner's Warranty Information Booklet" or "Owner's Manual Supplement".

■ Repair and replacement

It is recommended that genuine Toyota parts be used for repairs to ensure performance of each system. If non-Toyota parts are used in replacement or if a repair shop other than a Toyota dealer performs repairs, confirm the warranty coverage.

■ Reset the maintenance data (U.S.A. only)

After the required maintenance is performed according to the maintenance schedule, please reset the maintenance data.

To reset the data, follow the procedures described below:

STEP 1 Vehicles without a smart key system

Switch the display to the odometer (→P. 190) and then turn the engine switch off.

Vehicles with a smart key system

Switch the display to the odometer (→P. 190) and then turn the "POWER" switch off.

STEP 2 Vehicles without a smart key system

Turn the engine switch to the "ON" position. The multi-information display's initial screen will be displayed for a few seconds. While the initial screen is being displayed, press the "TRIP" steering switch (→P. 188) 3 times, pressing and holding the switch on the third time.

Vehicles with a smart key system

Turn the "POWER" switch to ON mode. The multi-information display's initial screen will be displayed for a few seconds. While the initial screen is being displayed, press the "TRIP" steering switch (→P. 188) 3 times, pressing and holding the switch on the third time.

STEP 3 Continue to press and hold the button until the trip meter displays "000000".

■ Allow inspection and repairs to be performed by a Toyota dealer

- Toyota technicians are well-trained specialists and are kept up to date with the latest service information. They are well informed about the operations of all systems on your vehicle.
- Keep a copy of the repair order. It proves that the maintenance that has been performed is under warranty coverage. If any problem should arise while your vehicle is under warranty, your Toyota dealer will promptly take care of it.

 **CAUTION**

■ **If your vehicle is not properly maintained**

Improper maintenance could result in serious damage to the vehicle and possible serious injury or death.

■ **Handling of the 12-volt battery**

- Engine exhaust, some of its constituents, and a wide variety of automobile components contain or emit chemicals known to the State of California to cause cancer and birth defects and other reproductive harm. Work in a well ventilated area.
- Oils, fuels and fluids contained in vehicles as well as waste produced by component wear contain or emit chemicals known to the State of California to cause cancer and birth defects or other reproductive harm. Avoid exposure and wash any affected area immediately.
- 12-volt battery posts, terminals and related accessories contain lead and lead compounds which are known to cause brain damage. Wash your hands after handling. (→P. 379)

General maintenance

Listed below are the general maintenance items that should be performed at the intervals specified in the “Owner's Warranty Information Booklet” or “Owner's Manual Supplement/Scheduled Maintenance Guide”. It is recommended that any problem you notice should be brought to the attention of your Toyota dealer or qualified service shop for advice.

Engine compartment

Items	Check points
Brake fluid	Is the brake fluid at the correct level? (→P. 375)
Coolant	Is the engine/power control unit coolant at the correct level? (→P. 373)
Engine oil	Is the engine oil at the correct level? (→P. 369)
Exhaust system	There should not be any fumes or strange sounds.
Radiator/condenser	The radiator and condenser should be free from foreign objects. (→P. 375)
Washer fluid	Is there sufficient washer fluid? (→P. 378)

Vehicle interior

Items	Check points
12-volt battery	Check the connections. (→P. 379)
Accelerator pedal	<ul style="list-style-type: none"> • The accelerator pedal should move smoothly (without uneven pedal effort or catching).
Brake pedal	<ul style="list-style-type: none"> • Does the brake pedal move smoothly? • Does the brake pedal have appropriate clearance from the floor? (→P. 503) • Does the brake pedal have the correct amount of free play? (→P. 503)
Brakes	<ul style="list-style-type: none"> • The vehicle should not pull to one side when the brakes are applied. • The brakes should work effectively. • The brake pedal should not feel spongy. • The brake pedal should not get too close to the floor when the brakes are applied.
Head restraints (Adjustable type)	<ul style="list-style-type: none"> • Do the head restraints move smoothly and lock securely?
Hybrid transmission “Park” mechanism	<ul style="list-style-type: none"> • When parked on a slope and the parking brake is on, is the vehicle securely stopped?
Indicators/buzzers	<ul style="list-style-type: none"> • Do the indicators and buzzers function properly?
Lights	<ul style="list-style-type: none"> • Do all the lights come on?

Items	Check points
Parking brake	<ul style="list-style-type: none"> • Does the parking brake lever operate normally? • When parked on a slope and the parking brake is on, is the vehicle securely stopped?
Seat belts	<ul style="list-style-type: none"> • Do the seat belts operate smoothly? • The seat belts should not be damaged.
Seats	<ul style="list-style-type: none"> • Do the seat controls operate properly?
Steering wheel	<ul style="list-style-type: none"> • Does the steering wheel rotate smoothly? • Does the steering wheel have the correct amount of free play? • There should not be any strange sounds coming from the steering wheel.

Vehicle exterior

Items	Check points
Doors	<ul style="list-style-type: none"> • Do the doors operate smoothly?
Engine hood	<ul style="list-style-type: none"> • Does the engine hood lock system work properly?
Fluid leaks	<ul style="list-style-type: none"> • There should not be any signs of fluid leakage after the vehicle has been parked.
Tires	<ul style="list-style-type: none"> • Is the tire inflation pressure correct? • The tires should not be damaged or excessively worn. • Have the tires been rotated according to the maintenance schedule? • The wheel nuts should not be loose.
Windshield wipers/rear window wiper (if equipped)	<ul style="list-style-type: none"> • The wiper blades should not show any signs of cracking, splitting, wear, contamination or deformation. • The wiper blades should clear the windshield/rear window without streaking or skipping.

 **CAUTION**

■ If the hybrid system is operating

Turn the hybrid system off and ensure that there is adequate ventilation before performing maintenance checks.

Some states have vehicle emission inspection programs which include OBD (On Board Diagnostics) checks. The OBD system monitors the operation of the emission control system.

■ **If the malfunction indicator lamp comes on**

The OBD system determines that a problem exists somewhere in the emission control system. Your vehicle may not pass the I/M test and may need to be repaired. Contact your Toyota dealer to service the vehicle.

■ **Your vehicle may not pass the I/M test in the following situations:**

- When the 12-volt battery is disconnected or discharged

Readiness codes that are set during ordinary driving are erased.

Also, depending on your driving habits, the readiness codes may not be completely set.

- When the fuel tank cap is loose

The malfunction indicator lamp comes on indicating a temporary malfunction and your vehicle may not pass the I/M test.

■ **When the malfunction indicator lamp still remains on after several driving trips**

The error code in the OBD system will not be cleared unless the vehicle is driven 40 or more times.

■ **If your vehicle does not pass the I/M test**

Contact your Toyota dealer to prepare the vehicle for re-testing.

Do-it-yourself service precautions

If you perform maintenance by yourself, be sure to follow the correct procedure as given in these sections.

Items	Parts and tools
12-volt battery condition(→P. 379)	<ul style="list-style-type: none"> • Grease • Conventional wrench (for terminal clamp bolts)
Brake fluid level (→P. 375)	<ul style="list-style-type: none"> • FMVSS No.116 DOT 3 or SAE J1703 brake fluid • Rag or paper towel • Funnel (used only for adding brake fluid)
Engine/power control unit coolant level (→P. 373)	<ul style="list-style-type: none"> • “Toyota Super Long Life Coolant” or a similar high quality ethylene glycol based non-silicate, non-amine, non-nitrite and non-borate coolant with long-life hybrid organic acid technology For the U.S.A.: “Toyota Super Long Life Coolant” is pre-mixed with 50% coolant and 50% deionized water. For Canada: “Toyota Super Long Life Coolant” is pre-mixed with 55% coolant and 45% deionized water. • Funnel (used only for adding coolant)

Items	Parts and tools
Engine oil level (→P. 369)	<ul style="list-style-type: none"> • “Toyota Genuine Motor Oil” or equivalent • Rag or paper towel • Funnel (used only for adding engine oil)
Fuses (→P. 404)	<ul style="list-style-type: none"> • Fuse with same amperage rating as original
Light bulbs (→P. 415)	<ul style="list-style-type: none"> • Bulb with same number and wattage rating as original • Phillips-head screwdriver • Flathead screwdriver • Wrench
Radiator and condenser (→P. 375)	—
Tire inflation pressure (→P. 392)	<ul style="list-style-type: none"> • Tire pressure gauge • Compressed air source
Washer fluid (→P. 378)	<ul style="list-style-type: none"> • Water or washer fluid containing antifreeze (for winter use) • Funnel (used only for adding water or washer fluid)

 **CAUTION**

The engine compartment contains many mechanisms and fluids that may move suddenly, become hot, or become electrically energized. To avoid death or serious injury, observe the following precautions:

■ When working on the engine compartment

- Vehicles without a smart key system: Make sure that the engine switch is in the “LOCK” position and the “READY” indicator is off.

Vehicles with a smart key system: Make sure that the indicator on the “POWER” switch and the “READY” indicator are both off.

- Keep hands, clothing and tools away from the moving fan and engine drive belt.
- Be careful not to touch the engine, power control unit, radiator, exhaust manifold, etc. right after driving as they may be hot. Oil and other fluids may also be hot.
- Do not leave anything that may burn easily, such as paper and rags, in the engine compartment.
- Do not smoke, cause sparks or expose an open flame to fuel. Fuel fumes are flammable.

■ When working near the electric cooling fan or radiator grille

Vehicles without a smart key system: The electric cooling fan may keep rotating for about 3 minutes even after the engine switch is turned to the “LOCK” position.

With the engine switch in the “ON” position, the electric cooling fan may automatically start to run if the air conditioning is on and/or the coolant temperature is high. Be sure the engine switch is in the “LOCK” position when working near the electric cooling fan or radiator grille.

Vehicles with a smart key system: The electric cooling fan may keep rotating for about 3 minutes even after the “POWER” switch is off.

With the “POWER” switch in ON mode, the electric cooling fan may automatically start to run if the air conditioning is on and/or the coolant temperature is high. Be sure the “POWER” switch is off when working near the electric cooling fan or radiator grille.

 **CAUTION****■ Safety glasses**

Wear safety glasses to prevent flying or falling material, fluid spray, etc. from getting in your eyes.

 **NOTICE****■ If you remove the air cleaner filter**

Driving with the air cleaner filter removed may cause excessive engine wear due to dirt in the air.

4-3. Do-it-yourself maintenance

Hood

Release the lock from the inside of the vehicle to open the hood.

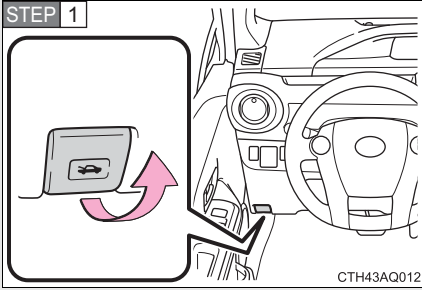

Pull the hood lock release lever.

The hood will pop up slightly.

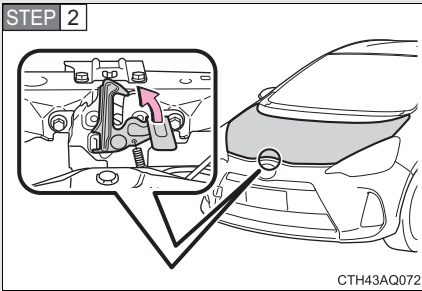

Pull up the auxiliary catch lever and lift the hood.

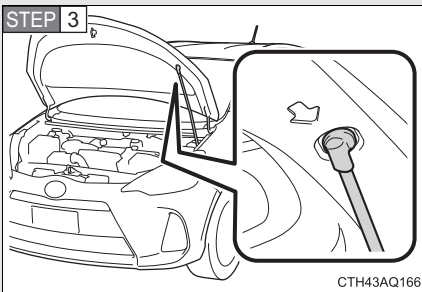

Hold the hood open by inserting the supporting rod into the slot.

 **CAUTION****■ Pre-driving check**

Check that the hood is fully closed and locked.

If the hood is not locked properly, it may open while the vehicle is in motion and cause an accident, which may result in death or serious injury.

■ After installing the support rod into the slot

Make sure the rod supports the hood securely from falling down on to your head or body.

 **NOTICE****■ When closing the hood**

Be sure to return the support rod to its clip before closing the hood. Closing the hood with the support rod up could cause the hood to bend.

4-3. Do-it-yourself maintenance

Positioning a floor jack

When raising your vehicle with a floor jack, position the jack correctly. Improper placement may damage your vehicle or cause injury.

Front

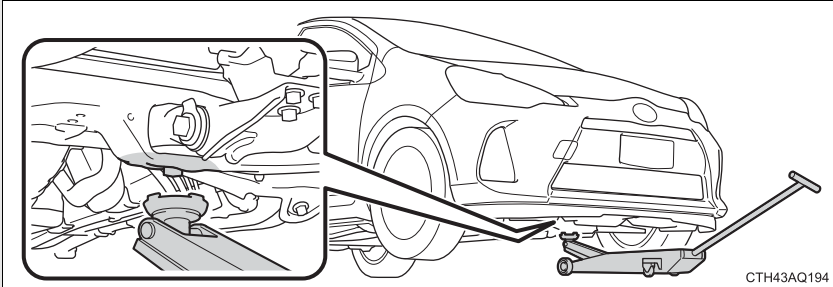

Rear

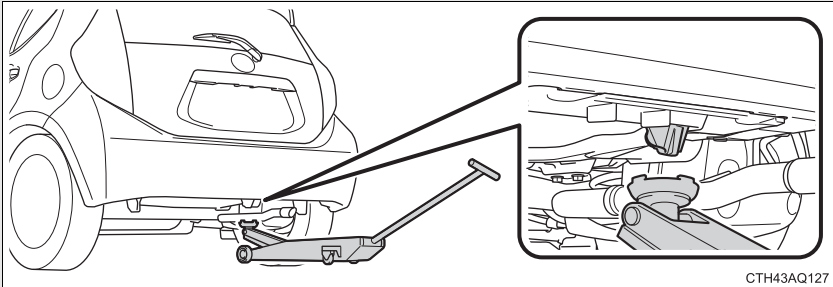

⚠ CAUTION

■ When raising your vehicle

Make sure to observe the following precautions to reduce the possibility of death or serious injury:

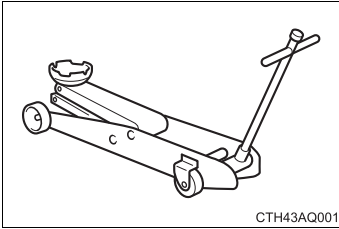

- Lift up the vehicle using a floor jack such as the one shown in the illustration.

- When using a floor jack, follow the instructions of the manual provided with the jack.
- Do not use the jack that was supplied with your vehicle.
- Do not put any part of your body underneath the vehicle when it is supported only by the floor jack.
- Always use floor jack and/or automotive jack stands on a solid, flat, level surface.
- Do not start the hybrid system while the vehicle is supported by the floor jack.
- Stop the vehicle on level, firm ground, set the parking brake and shift the shift lever to P.
- Make sure to set the floor jack properly at the jack point.
Raising the vehicle with an improperly positioned floor jack will damage the vehicle and may cause the vehicle to fall off the floor jack.
- Do not raise the vehicle while someone is in the vehicle.
- When raising the vehicle, do not place any object on top of or underneath the floor jack.

Engine compartment

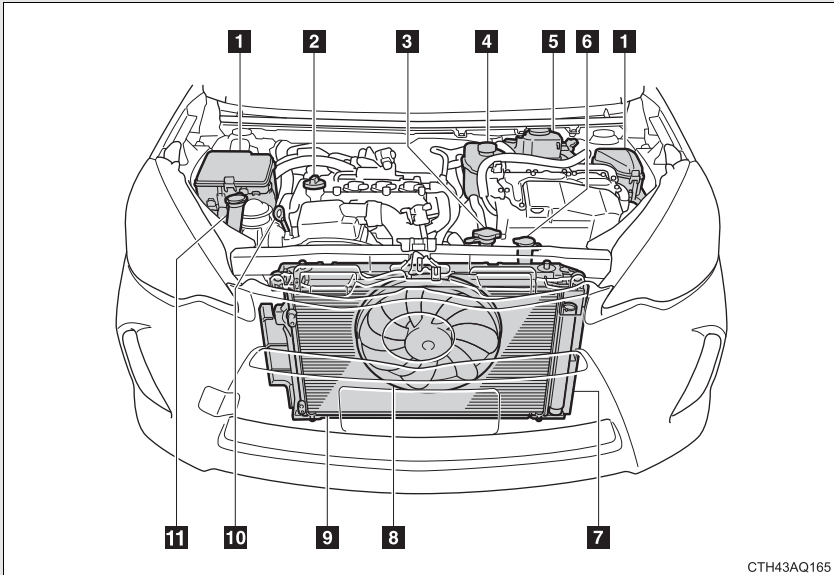

CTH43AQ165

- | | |
|---|---|
| 1 Fuse boxes (→P. 404) | 7 Engine/power control unit coolant radiator (→P. 375) |
| 2 Engine oil filler cap (→P. 370) | 8 Electric cooling fan |
| 3 Engine coolant radiator cap | 9 Condenser (→P. 375) |
| 4 Power control unit coolant reservoir (→P. 373) | 10 Engine oil level dipstick (→P. 369) |
| 5 Brake fluid reservoir (→P. 375) | 11 Washer fluid tank (→P. 378) |
| 6 Engine coolant reservoir (→P. 373) | |

Engine oil

With the engine at operating temperature and turned off, check the oil level on the dipstick.

■ Checking the engine oil

STEP 1 Park the vehicle on level ground. After warming up the engine and turning off the hybrid system, wait more than 5 minutes for the oil to drain back into the bottom of the engine.

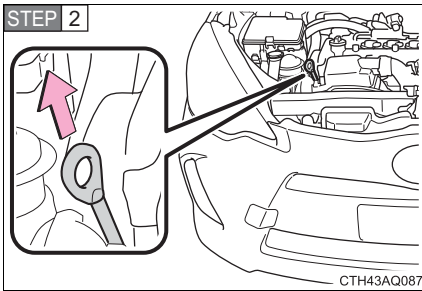

Holding a rag under the end, pull the dipstick out.

STEP 3 Wipe the dipstick clean.

STEP 4 Reinsert the dipstick fully.

STEP 5 Holding a rag under the end, pull the dipstick out and check the oil level.

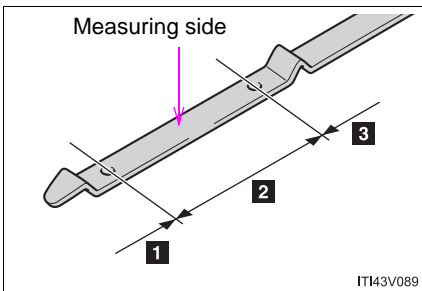

1 Low

2 Normal

3 Excessive

The shape of the dipstick may differ depending on the type of vehicle or engine.

STEP 6 Wipe the dipstick and reinsert it fully.

■ Adding engine oil

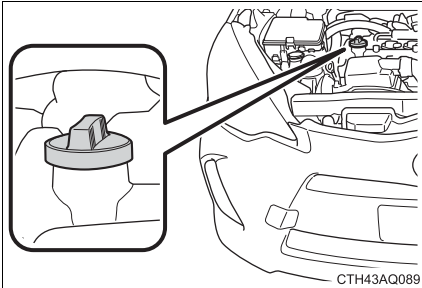

If the oil level is below or near the low level mark, add engine oil of the same type as that already in the engine.

Make sure to check the oil type and prepare the items needed before adding oil.

Engine oil selection	→P. 499
Oil quantity (Low → Full)	1.6 qt. (1.5 L, 1.3 Imp. qt.)
Item	Clean funnel

STEP 1 Remove the oil filler cap by turning it counterclockwise.

STEP 2 Add engine oil slowly, checking the dipstick.

STEP 3 Install the oil filler cap by turning it clockwise.

■ Engine oil consumption

A certain amount of engine oil will be consumed while driving. In the following situations, oil consumption may increase, and engine oil may need to be refilled in between oil maintenance intervals.

- When the engine is new, for example directly after purchasing the vehicle or after replacing the engine
- If low quality oil or oil of an inappropriate viscosity is used
- When driving at high engine speeds or with a heavy load, or when driving while accelerating or decelerating frequently
- When leaving the engine idling for a long time, or when driving frequently through heavy traffic

CAUTION

■ Used engine oil

- Used engine oil contains potentially harmful contaminants which may cause skin disorders such as inflammation and skin cancer, so care should be taken to avoid prolonged and repeated contact. To remove used engine oil from your skin, wash thoroughly with soap and water.
- Dispose of used oil and filters only in a safe and acceptable manner. Do not dispose of used oil and filters in household trash, in sewers or onto the ground. Call your Toyota dealer, service station or auto parts store for information concerning recycling or disposal.
- Do not leave used engine oil within the reach of children.



NOTICE

■ **To prevent serious engine damage**

Check the oil level on a regular basis.

■ **When replacing the engine oil**

- Be careful not to spill engine oil on the vehicle components.
- Avoid overfilling, or the engine could be damaged.
- Check the oil level on the dipstick every time you refill the vehicle.
- Be sure the engine oil filler cap is properly tightened.

Coolant

Engine coolant reservoir

The coolant level is satisfactory if it is between the “FULL” and “LOW” lines on the reservoir when the engine is cold.

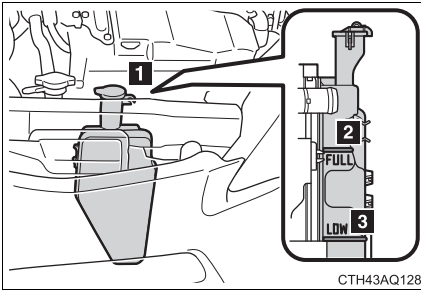

CTH43AQ128

- 1 Reservoir cap
- 2 “FULL” line
- 3 “LOW” line

If the level is on or below the “LOW” line, add coolant up to the “FULL” line. (→P. 487)

Power control unit coolant reservoir

The coolant level is satisfactory if it is between the “F” and “L” lines on the reservoir when the hybrid system is cold.

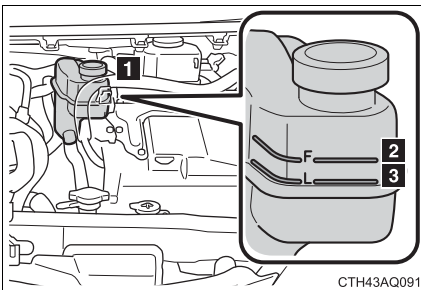

CTH43AQ091

- 1 Reservoir cap
- 2 “F” line
- 3 “L” line

If the level is on or below the “L” line, add coolant up to the “F” line. (→P. 487)

■ Coolant selection

Only use “Toyota Super Long Life Coolant” or a similar high quality ethylene glycol based non-silicate, non-amine, non-nitrite, and non-borate coolant with long-life hybrid organic acid technology.

U.S.A.: “Toyota Super Long Life Coolant” is a mixture of 50% coolant and 50% deionized water. (Minimum temperature: -31°F [-35°C])

Canada: “Toyota Super Long Life Coolant” is a mixture of 55% coolant and 45% deionized water. (Minimum temperature: -44°F [-42°C])

For more details about coolant, contact your Toyota dealer.

■ If the coolant level drops within a short time of replenishing

Visually check the radiators, hoses, engine/power control unit coolant reservoir caps, drain cock and water pump.

If you cannot find a leak, have your Toyota dealer test the cap and check for leaks in the cooling systems.

CAUTION

■ When the hybrid system is hot

Do not remove the engine coolant radiator cap and power control unit coolant reservoir cap.

The cooling system may be under pressure and may spray hot coolant if the cap is removed, causing serious injuries, such as burns.

NOTICE

■ When adding coolant

Coolant is neither plain water nor straight antifreeze. The correct mixture of water and antifreeze must be used to provide proper lubrication, corrosion protection and cooling. Be sure to read the antifreeze or coolant label.

■ If you spill coolant

Be sure to wash it off with water to prevent it from damaging parts or paint.

Radiator and condenser

Check the radiator and condenser and clear away any foreign objects.

If either of the above parts is extremely dirty or you are not sure of their condition, have your vehicle inspected by your Toyota dealer.

CAUTION

When the hybrid system is hot

Do not touch the radiators or condenser as they may be hot and cause serious injuries, such as burns.

Brake fluid

■ Checking fluid level

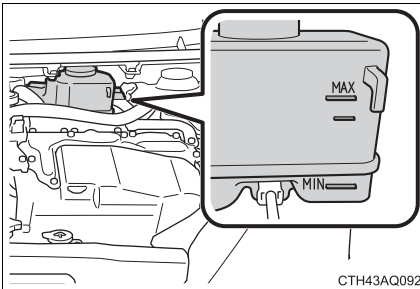

The brake fluid level should be between the “MAX” and “MIN” lines on the tank.

■ Adding fluid

Make sure to check the fluid type and prepare the necessary item.

Fluid type	FMVSS No.116 DOT 3 or SAE J1703 brake fluid
Item	Clean funnel

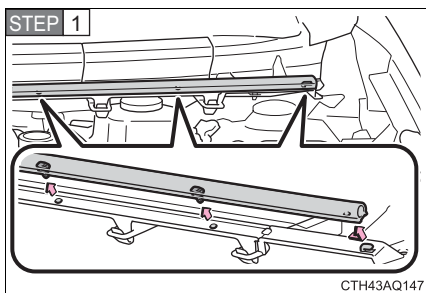

Slide and lift up the rubber strip and clips to partly remove it as shown.

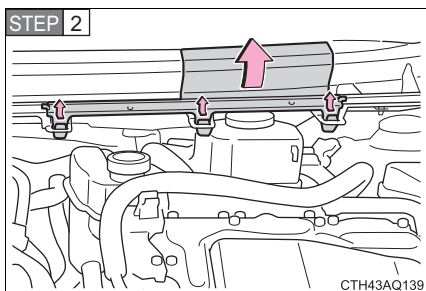

Disconnect the claws and remove the service cover.

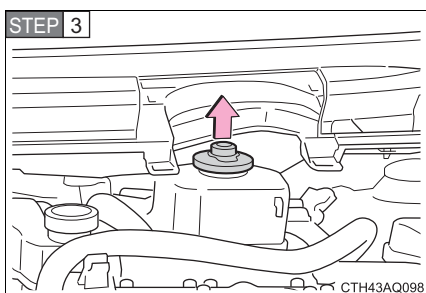

Remove the reservoir cap.

STEP 4 Add brake fluid slowly while checking the fluid level.

■ Brake fluid can absorb moisture from the air

Excess moisture in the brake fluid can cause a dangerous loss of braking efficiency. Use only newly opened brake fluid.

⚠ CAUTION**■ When filling the reservoir**

Take care as brake fluid can harm your hands and eyes and damage painted surfaces.

If fluid gets on your hands or in your eyes, flush the affected area with clean water immediately.

If you still experience discomfort, see a doctor.

⚠ NOTICE**■ If the fluid level is low or high**

It is normal for the brake fluid level to go down slightly as the brake pads wear out or when the fluid level in the accumulator is high.

If the reservoir needs frequent refilling, there may be a serious problem.

Washer fluid

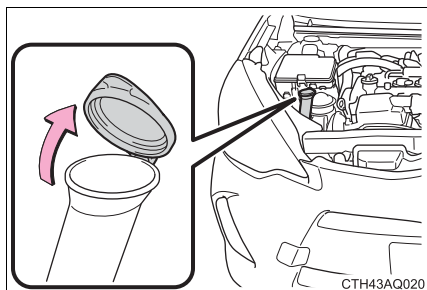

If the amount of washer fluid is insufficient, add washer fluid.

CAUTION

When adding washer fluid

Add washer fluid after the hybrid system has been stopped and cooled down sufficiently. Washer fluid contains alcohol and may catch fire if spilled inside a hot engine compartment.

NOTICE

Do not use any fluid other than washer fluid

Do not use soapy water or engine antifreeze instead of washer fluid. Doing so may cause streaking on the vehicle's painted surfaces.

Diluting washer fluid

Dilute washer fluid with water as necessary.

Refer to the freezing temperatures listed on the label of the washer fluid bottle.

4-3. Do-it-yourself maintenance 12-volt battery

■ Location

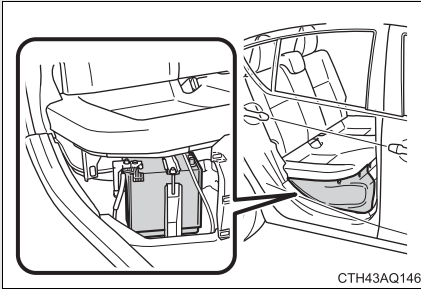

The 12-volt battery is located under the rear right seat.

■ Removing the 12-volt battery cover

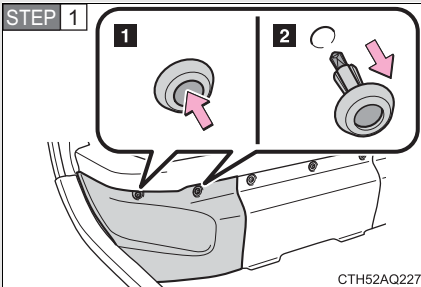

1 Push in the center part of the clips

2 Remove the clips

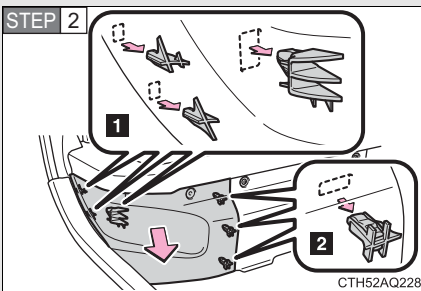

Disengage the 3 clips and 3 guides on the back of the cover and remove the 12-volt battery cover.

1 Guides

2 Clips

■ Exterior

Make sure that the 12-volt battery terminals are not corroded and that there are no loose connections, cracks, or loose clamps.

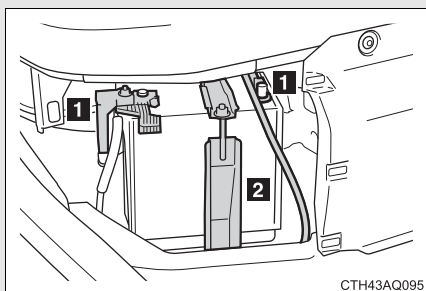

- 1** Terminals
- 2** Hold-down clamp

■ Installing the 12-volt battery cover

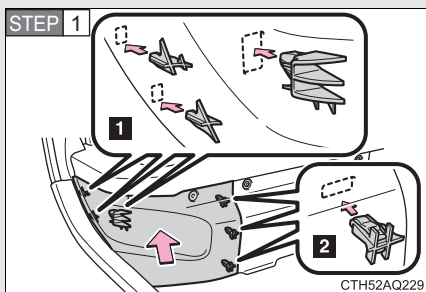

Install the 12-volt battery cover.

- 1** Guides
- 2** Clips

Check if the clips and guides on the back of the cover are engaging properly if the cover cannot be installed.

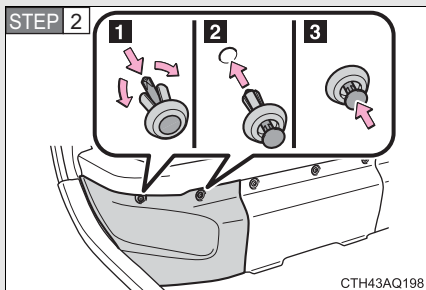

- 1** Push out the center part of the clips
- 2** Insert the clips
- 3** Push in the center part of the clips

■ Before recharging

When recharging, the 12-volt battery produces hydrogen gas which is flammable and explosive. Therefore, observe the following precautions before recharging:

- If recharging with the 12-volt battery installed on the vehicle, be sure to disconnect the ground cable.
- Make sure the power switch on the charger is off when connecting and disconnecting the charger cables to the 12-volt battery.

■ When disconnecting the 12-volt battery terminals

Always disconnect the negative (-) terminal first.

■ After recharging/reconnecting the 12-volt battery (vehicles with a smart key system)

- Unlocking the doors using the smart key system may not be possible immediately after reconnecting the 12-volt battery. If this happens, use the wireless remote control or the mechanical key to lock/unlock the doors.
- Start the hybrid system with the “POWER” switch in ACCESSORY mode. The hybrid system may not start with the “POWER” switch turned off. However, the hybrid system will operate normally from the second attempt.
- The “POWER” switch mode is recorded by the vehicle. If the 12-volt battery is reconnected, the vehicle will return the “POWER” switch mode to the status it was in before the 12-volt battery was disconnected. Make sure to turn off the power before disconnect the 12-volt battery. Take extra care when connecting the 12-volt battery if the “POWER” switch mode prior to discharge is unknown.

If the system will not start even after multiple attempts, contact your Toyota dealer.

 CAUTION

■ **Chemicals in the 12-volt battery**

The 12-volt battery contains poisonous and corrosive sulfuric acid and may produce hydrogen gas which is flammable and explosive. To reduce the risk of death or serious injury, take the following precautions while working on or near the 12-volt battery:

- Do not cause sparks by touching the 12-volt battery terminals with tools.
- Do not smoke or light a match near the 12-volt battery.
- Avoid contact with eyes, skin and clothes.
- Never inhale or swallow electrolyte.
- Wear protective safety glasses when working near the 12-volt battery.
- Keep children away from the 12-volt battery.

■ **Where to safely charge the 12-volt battery**

Always charge the 12-volt battery in an open area. Do not charge the 12-volt battery in a garage or closed room where there is insufficient ventilation.

■ **When disconnecting the 12-volt battery terminals**

Always disconnect the negative (-) terminal first. If the positive (+) terminal is disconnected first and touches a surrounding metal surface it may cause sparks resulting in a fire or it may result in an electric shock, death or serious injury.

■ **How to recharge the 12-volt battery**

Only perform a slow charge (3.5 A or less). The 12-volt battery may explode if charged at a quicker rate.

 **CAUTION****■ Emergency measures regarding electrolyte**

- If electrolyte gets in your eyes

Flush your eyes with clean water for at least 15 minutes and get immediate medical attention. If possible, continue to apply water with a sponge or cloth while traveling to the nearest medical facility.

- If electrolyte gets on your skin

Wash the affected area thoroughly. If you feel pain or burning, get medical attention immediately.

- If electrolyte gets on your clothes

It can soak through clothing on to your skin. Immediately take off the clothing and follow the procedure above if necessary.

- If you accidentally swallow electrolyte

Drink a large quantity of water or milk. Get emergency medical attention immediately.

■ When replacing the 12-volt battery

Use a 12-volt battery designed for this vehicle. Failure to do so may cause gas (hydrogen) to enter the passenger compartment, causing a fire or explosion.

For replacement of the 12-volt battery, contact your Toyota dealer.

 **NOTICE****■ When recharging the 12-volt battery**

Never recharge the 12-volt battery while the hybrid system is operating. Also, be sure all accessories are turned off.

Tires

Replace or rotate tires in accordance with maintenance schedules and treadwear.

■ Checking tires

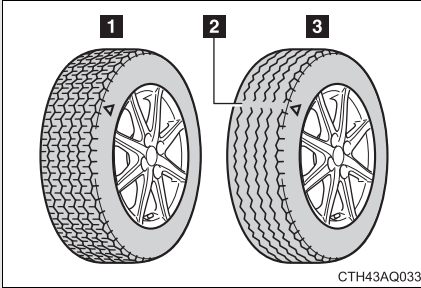

- 1 New tread
- 2 Treadwear indicator
- 3 Worn tread

The location of treadwear indicators is shown by the “TWI” or “Δ” marks, etc., molded on the sidewall of each tire.

Check spare tire condition and pressure if not rotated.

■ Tire rotation

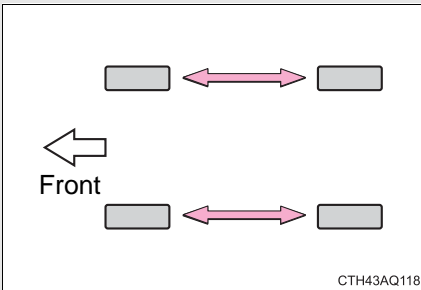

Rotate the tires in the order shown.

To equalize tire wear and extend tire life, Toyota recommends that tire rotation is carried out at the same interval as tire inspection.

Do not fail to initialize the tire pressure warning system after tire rotation.

■ Tire pressure warning system

Your vehicle is equipped with a tire pressure warning system that uses tire pressure warning valves and transmitters to detect low tire inflation pressure before serious problems arise.

(→P. 439)

Installing tire pressure warning valves and transmitters

When replacing tires or wheels, tire pressure warning valves and transmitters must also be installed.

When new tire pressure warning valves and transmitters are installed, new ID codes must be registered in the tire pressure warning computer and the tire pressure warning system must be initialized. Have tire pressure warning valve and transmitter ID codes registered by your Toyota dealer. (→P. 386)

■ The tire pressure warning system must be initialized in the following circumstances:

- When rotating front and rear tires which have different tire inflation pressures
- When changing the tire size

When the tire pressure warning system is initialized, the current tire inflation pressure is set as the benchmark pressure.

■ How to initialize the tire pressure warning system

STEP 1 Park the vehicle in a safe place and turn the engine switch (vehicles without a smart key system) or the “POWER” switch (vehicles with a smart key system) off.

Initialization cannot be performed while the vehicle is moving.

STEP 2 Adjust the tire inflation pressure to the specified cold tire inflation pressure level. (→P. 504)

Make sure to adjust the tire pressure to the specified cold tire inflation pressure level. The tire pressure warning system will operate based on this pressure level.

STEP 3 Turn the engine switch to the “ON” position (vehicles without a smart key system) or “POWER” switch to ON mode (vehicles with a smart key system).

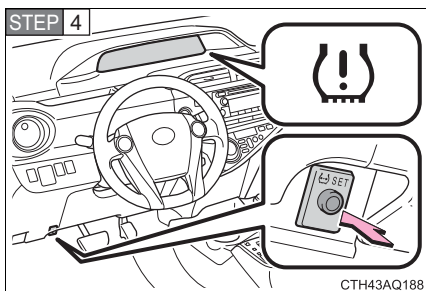

Press and hold the tire pressure warning reset switch until the tire pressure warning light blinks slowly 3 times.

STEP 5 Vehicles without a smart key system: Wait for a few minutes with the engine switch in the “ON” position and then turn the engine switch to the “ACC” or “LOCK” position.
Vehicles with a smart key system: Wait for a few minutes with the “POWER” switch in ON mode and then turn the “POWER” switch off.

Registering ID codes

The tire pressure warning valve and transmitter is equipped with a unique ID code. When replacing a tire pressure warning valve and transmitter, it is necessary to register the ID code. Have the ID code registered by your Toyota dealer.

■ When to replace your vehicle’s tires

Tires should be replaced if:

- You have tire damage such as cuts, splits, cracks deep enough to expose the fabric, and bulges indicating internal damage
- A tire goes flat repeatedly or cannot be properly repaired due to the size or location of a cut or other damage

If you are not sure, consult with your Toyota dealer.

■ Replacing tires and wheels

If the ID code of the tire pressure warning valve and transmitter is not registered, the tire pressure warning system will not work properly. After driving for about 20 minutes, the tire pressure warning light blinks for 1 minute and stays on to indicate a system malfunction.

■ Tire life

Any tire over 6 years old must be checked by a qualified technician even if it has seldom or never been used or damage is not obvious.

■ Routine tire inflation pressure checks

The tire pressure warning system does not replace routine tire inflation pressure checks. Make sure to check tire inflation pressure as part of your routine of daily vehicle checks.

■ Low profile tires (vehicles with P195/50R16 tires)

Generally, low profile tires will wear more rapidly and tire grip performance will be reduced on snowy and/or icy roads when compared to standard tires. Be sure to use snow tires or tire chains on snowy and/or icy roads and drive carefully at a speed appropriate for road and weather conditions.

■ Maximum load of tire

Check that the maximum load of the replacement tire is greater than 1/2 of the Gross Axle Weight Ratings (GAWR) of either the front axle or the rear axle, whichever is greater.

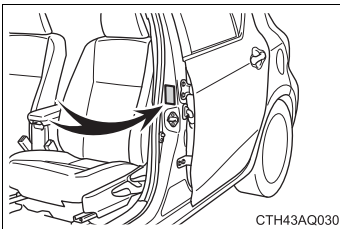

For the GAWR, see the Certification Label. For the maximum load of the tire, see the load limit at maximum cold tire inflation pressure mentioned on the sidewall of the tire. (→P. 509)

■ Tire types

● Summer tires

Summer tires are high-speed performance tires best suited to highway driving under dry conditions. Since summer tires do not have the same traction performance as snow tires, summer tires are inadequate for driving on snow-covered or icy roads. For driving on snow-covered roads or icy roads, the use of snow tires is recommended. When installing snow tires, be sure to replace all four tires.

● All season tires

All season tires are designed to provide better traction in snow and to be adequate for driving in most winter conditions as well as for use year-round. All season tires, however, do not have adequate traction performance compared with snow tires in heavy or loose snow. Also, all season tires fall short in acceleration and handling performance compared with summer tires in highway driving.

● Snow tires

For driving on snow-covered roads or icy roads, we recommend using snow tires. If you need snow tires, select tires of the same size, construction and load capacity as the originally installed tires. Since your vehicle has radial tires as original equipment, make sure your snow tires also have radial construction. Do not install studded tires without first checking local regulations for possible restrictions. Snow tires should be installed on all wheels. (→P. 231)

■ Initializing the tire pressure warning system

Initialize the system with the tire inflation pressure adjusted to the specified level.

■ If the tread on snow tires wears down below 0.16 in. (4 mm)

The effectiveness of the tires as snow tires is lost.

■ If you press the tire pressure warning reset switch accidentally

If initialization is performed, adjust the tire inflation pressure to the specified level and initialize the tire pressure warning system again.

■ When the initialization of the tire pressure warning system has failed

Initialization can be completed in a few minutes. However, in the following cases, the settings have not been recorded and the system will not operate properly. If repeated attempts to record tire inflation pressure settings are unsuccessful, have the vehicle inspected by your Toyota dealer.

- When operating the tire pressure warning reset switch, the tire pressure warning light does not blink 3 times.
- After driving for a certain period of time since the initialization has been completed, the warning light comes on after blinking for 1 minute.

■ Tire pressure warning system certification

U.S.A.

FCC ID: PAXPMVC010

This device complies with part 15 of the FCC Rules. Operation is subject to the following two conditions: (1) This device may not cause harmful interference, and (2) this device must accept any interference received, including interference that may cause undesired operation.

FCC WARNING:

Changes or modifications not expressly approved by the party responsible for compliance could void the user's authority to operate the equipment.

Canada

Operation is subject to the following two conditions: (1) this device may not cause interference, and (2) this device must accept any interference, including interference that may cause undesired operation of the device.

 CAUTION

■ **When inspecting or replacing tires**

Observe the following precautions to prevent accidents.

Failure to do so may cause damage to parts of the drive train as well as dangerous handling characteristics, which may lead to an accident resulting in death or serious injury.

- Do not mix tires of different makes, models or tread patterns.
Also, do not mix tires of remarkably different treadwear.
- Do not use tire sizes other than those recommended by Toyota.
- Do not mix differently constructed tires (radial, bias-belted or bias-ply tires).
- Do not mix summer, all season and snow tires.
- Do not use tires that have been used on another vehicle.
Do not use tires if you do not know how they were used previously.
- Do not tow if your vehicle has a compact spare tire installed.

■ **When initializing the tire pressure warning system**

Do not operate the tire pressure warning reset switch without first adjusting the tire inflation pressure to the specified level. Otherwise, the tire pressure warning light may not come on even if the tire inflation pressure is low, or it may come on when the tire inflation pressure is actually normal.

 NOTICE

■ **Repairing or replacing tires, wheels, tire pressure warning valves, transmitters and tire valve caps**

- When removing or fitting the wheels, tires or the tire pressure warning valves and transmitters, contact your Toyota dealer as the tire pressure warning valves and transmitters may be damaged if not handled correctly.
- When replacing tire valve caps, do not use tire valve caps other than those specified. The cap may become stuck.

■ **To avoid damage to the tire pressure warning valves and transmitters**

When a tire is repaired with liquid sealants, the tire pressure warning valve and transmitter may not operate properly. If a liquid sealant is used, contact your Toyota dealer or other qualified service shop as soon as possible. Make sure to replace the tire pressure warning valve and transmitter when replacing the tire. (→P. 385)

■ **Driving on rough roads**

Take particular care when driving on roads with loose surfaces or potholes.

These conditions may cause losses in tire inflation pressure, reducing the cushioning ability of the tires. In addition, driving on rough roads may cause damage to the tires themselves, as well as the vehicle's wheels and body.

■ **Low profile tires (vehicles with P195/50R16 tires)**

Low profile tires may cause greater damage than usual to the tire wheel when sustaining impact from the road surface. Therefore, pay attention to the following:

- Be sure to use proper tire inflation pressure. If tires are under-inflated, they may be damaged more severely.
- Avoid potholes, uneven pavement, curbs and other road hazards. Failure to do so may lead to severe tire and wheel damage.

■ **If tire inflation pressure of each tire becomes low while driving**

Do not continue driving, or your tires and/or wheels may be ruined.

4-3. Do-it-yourself maintenance

Tire inflation pressure

■ Tire inflation pressure

The recommended cold tire inflation pressure and tire size are displayed on the tire and loading information label. (→P. 504)

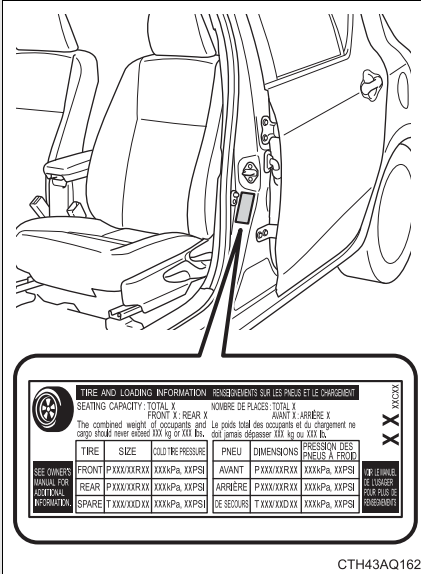

■ Inspection and adjustment procedure

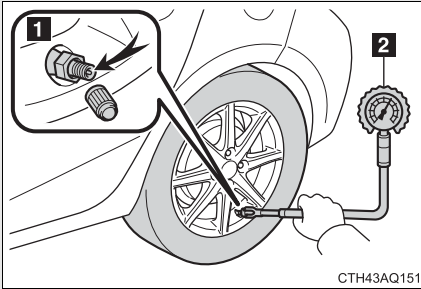

- 1 Tire valve
- 2 Tire pressure gauge

STEP 1 Remove the tire valve cap.

STEP 2 Press the tip of the tire pressure gauge onto the tire valve.

STEP 3 Read the pressure using the gauge gradations.

STEP 4 If the tire inflation pressure is not at the recommended level, adjust the pressure.
If you add too much air, press the center of the valve to deflate.

STEP 5 After completing the tire inflation pressure measurement and adjustment, apply soapy water to the valve and check for leakage.

STEP 6 Put the tire valve cap back on.

■ **Tire inflation pressure check interval**

You should check tire inflation pressure every two weeks, or at least once a month.

Do not forget to check the spare.

■ **Effects of incorrect tire inflation pressure**

Driving with incorrect tire inflation pressure may result in the following:

- Reduced fuel efficiency
- Reduced driving comfort and tire life
- Reduced safety
- Damage to the drive train

If a tire needs frequent inflating, have it checked by your Toyota dealer.

■ **Instructions for checking tire inflation pressure**

When checking tire inflation pressure, observe the following:

- Check only when the tires are cold.

If your vehicle has been parked for at least 3 hours or has not been driven for more than 1 mile or 1.5 km, you will get an accurate cold tire inflation pressure reading.

- Always use a tire pressure gauge.

The appearance of the tire can be misleading. In addition, tire inflation pressure that is even just a few pounds off can affect ride quality and handling.

- Do not reduce tire inflation pressure after driving. It is normal for tire inflation pressure to be higher after driving.

- Never exceed the vehicle capacity weight.

Passengers and luggage weight should be placed so that the vehicle is balanced.

 CAUTION**■ Proper inflation is critical to save tire performance**

Keep your tires properly inflated. Otherwise, the following conditions may occur and result in an accident causing death or serious injury:

- Excessive wear
- Uneven wear
- Poor handling
- Possibility of blowouts resulting from overheated tires
- Poor sealing of the tire bead
- Wheel deformation and/or tire separation
- A greater possibility of tire damage from road hazards

 NOTICE**■ When inspecting and adjusting tire inflation pressure**

Be sure to put the tire valve caps back on.

Without the valve caps, dirt or moisture could get into the valve and cause air leakage, which could result in an accident. If the caps are lost, replace them as soon as possible.

Wheels

If a wheel is bent, cracked or heavily corroded, it should be replaced. Otherwise, the tire may separate from the wheel or cause a loss of handling control.

■ Wheel selection

When replacing wheels, care should be taken to ensure that they are equivalent to those removed in load capacity, diameter, rim width and inset*.

Replacement wheels are available at your Toyota dealer.

*: Conventionally referred to as “offset”.

Toyota does not recommend using the following:

- Wheels of different sizes or types
- Used wheels
- Bent wheels that have been straightened

■ Aluminum wheel precautions (if equipped)

- Use only Toyota wheel nuts and wrenches designed for use with your aluminum wheels.
- When rotating, repairing or changing your tires, check that the wheel nuts are still tight after driving 1000 miles (1600 km).
- Be careful not to damage the aluminum wheels when using tire chains.
- Use only Toyota genuine balance weights or equivalent and use a plastic or rubber hammer when balancing your wheels.

■ When replacing wheels

The wheels of your vehicle are equipped with tire pressure warning valves and transmitters that allow the tire pressure warning system to provide advance warning in the event of a loss in tire inflation pressure. Whenever wheels are replaced, tire pressure warning valves and transmitters must be installed. (→P. 385)

▲ CAUTION

■ When replacing wheels

- Do not use wheels that are a different size from those recommended in the Owner's Manual, as this may result in a loss of handling control.
- Never use an inner tube in a leaking wheel which is designed for a tubeless tire. Doing so may result in an accident, causing death or serious injury.

■ When installing the wheel nuts

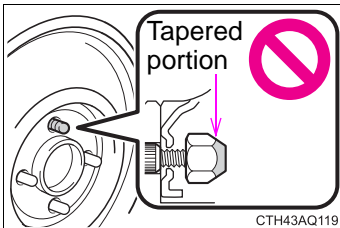

- Be sure to install the wheel nuts with the tapered ends facing inward. Installing the nuts with the tapered ends facing outward can cause the wheel to break and eventually cause the wheel to come off while driving, which could lead to an accident resulting in death or serious injury.

- Never use oil or grease on the wheel bolts or wheel nuts. Oil and grease may cause the wheel nuts to be excessively tightened, leading to bolt or disc wheel damage. In addition, the oil or grease can cause the wheel nuts to loosen and the wheel may fall off, causing an accident and resulting in death or serious injury. Remove any oil or grease from the wheel bolts or wheel nuts.

 NOTICE

■ **Replacing tire pressure warning valves and transmitters**

- Because tire repair or replacement may affect the tire pressure warning valves and transmitters, make sure to have tires serviced by your Toyota dealer or other qualified service shop. In addition, make sure to purchase your tire pressure warning valves and transmitters at your Toyota dealer.
- Ensure that only genuine Toyota wheels are used on your vehicle. Tire pressure warning valves and transmitters may not work properly with non-genuine wheels.

4-3. Do-it-yourself maintenance

Air conditioning filter

The air conditioning filter must be changed regularly to maintain air conditioning efficiency.

■ Replacement method

STEP 1 Vehicles without a smart key system

Turn the engine switch to the "LOCK" position.

Vehicles with a smart key system

Turn the "POWER" switch off.

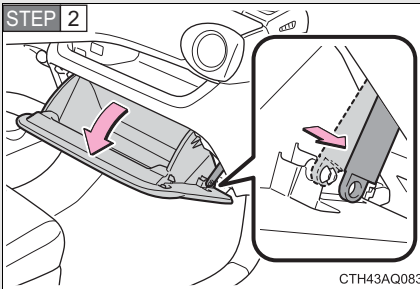

Open the glove box. Slide off the damper.

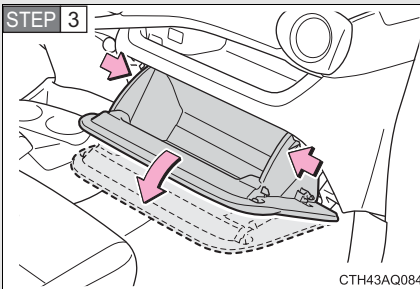

Push in each side of the glove box to disconnect the upper claws.

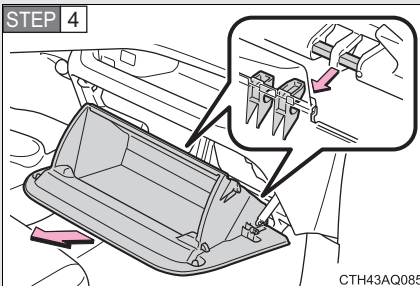

Pull out the glove box and disconnect the lower claws.

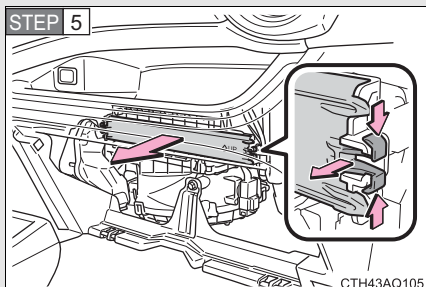

Remove the filter cover.

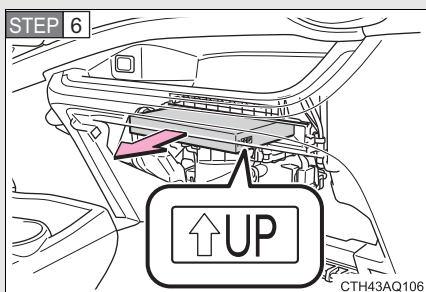

Remove the air conditioning filter and replace it with a new one.

The “↑UP” mark shown on the filter should be pointing up.

■ Checking interval

Inspect and replace the air conditioning filter according to the maintenance schedule. In dusty areas or areas with heavy traffic flow, more frequent cleaning or early replacement may be required. (For scheduled maintenance information, please refer to the “Scheduled Maintenance Guide” or “Owner’s Manual Supplement”.)

■ If air flow from the vents decreases dramatically

The filter may be clogged. Check the filter and replace if necessary.

⚠ NOTICE

■ When using the air conditioning system

Make sure that a filter is always installed.

Using the air conditioning system without a filter may cause damage to the system.

Replace the battery with a new one if it is depleted.

■ **You will need the following items:**

- Flathead screwdriver
- Small flathead screwdriver
- Lithium battery CR2016 (vehicles without a smart key system), or CR2032 (vehicles with a smart key system)

■ **Replacing the battery (vehicles without a smart key system)**

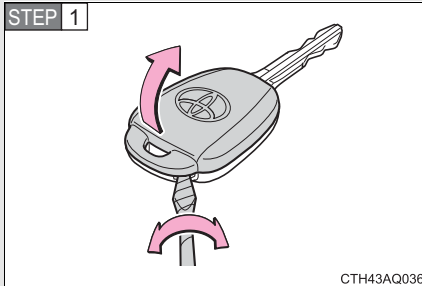

Remove the cover.

To prevent damage to the key, cover the tip of the screwdriver with a rag.

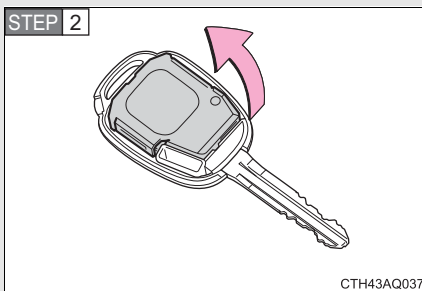

Remove the module.

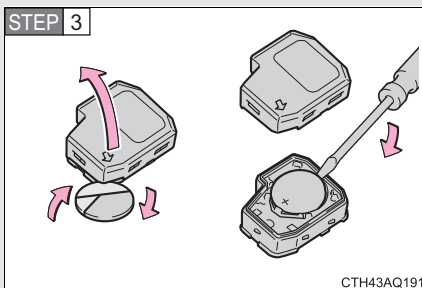

Open the case cover using a coin protected with tape etc. and remove the depleted battery using a small flathead screwdriver.

Insert a new battery with the “+” terminal facing up.

■ Replacing the battery (vehicles with a smart key system)

STEP 1

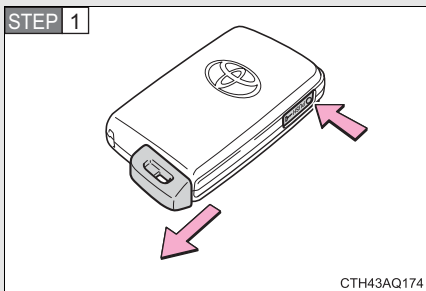

Take out the mechanical key.

STEP 2

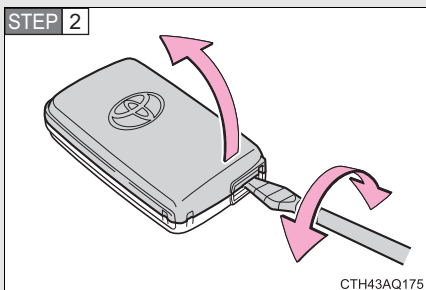

Remove the cover.

To prevent damage to the key, cover the tip of the screwdriver with a rag.

STEP 3

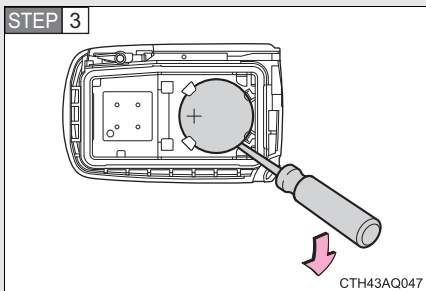

Remove the depleted battery using a small flathead screwdriver.

Insert a new battery with the "+" terminal facing up.

■ **Use a CR2016 (vehicles without a smart key system) or CR2032 (vehicles with a smart key system) lithium battery**

- Batteries can be purchased at your Toyota dealer, local electrical appliance shops or camera stores.
- Replace only with the same or equivalent type recommended by the manufacturer.
- Dispose of used batteries according to local laws.

■ **If the key battery is depleted**

The following symptoms may occur:

- The smart key system and wireless remote control will not function properly.
- The operational range will be reduced.

 **CAUTION**

■ **Removed battery and other parts**

These parts are small and if swallowed by a child, they can cause choking. Keep away from children. Failure to do so could result in death or serious injury.

 **NOTICE**

■ **For normal operation after replacing the battery**

Observe the following precautions to prevent accidents:

- Always work with dry hands.
Moisture may cause the battery to rust.
- Do not touch or move any other component inside the remote control.
- Do not bend either of the battery terminals.

4-3. Do-it-yourself maintenance

Checking and replacing fuses

If any of the electrical components do not operate, a fuse may have blown. If this happens, check and replace the fuses as necessary.

STEP 1 Vehicles without a smart key system

Turn the engine switch off.

Vehicles with a smart key system

Turn the "POWER" switch off.

STEP 2 Open the fuse box cover.

Engine compartment (type A fuse box)

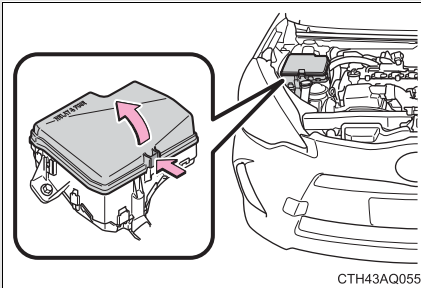

CTH43AQ055

Push the tab in and lift the cover off.

Engine compartment (type B fuse box)

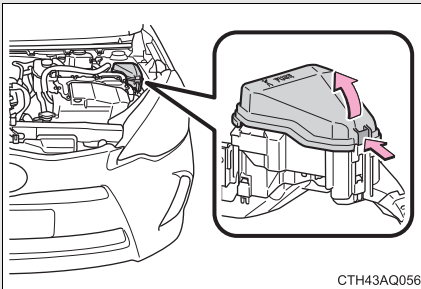

CTH43AQ056

Push the tab in and lift the cover off.

Under the instrument panel

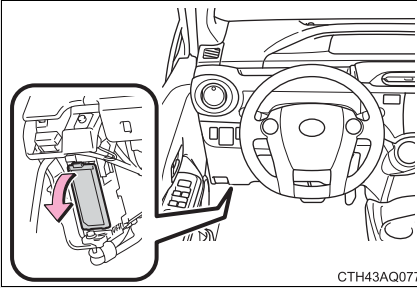

Remove the cover.

STEP 3 After a system failure, see “Fuse layout and amperage ratings” (→P. 408) for details about which fuse to check.

STEP 4 Remove the fuse with the pull-out tool.

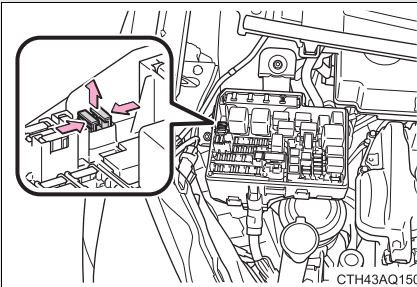

Only type A fuse can be removed using the pullout tool.

STEP 5 Check if the fuse is blown.

Type A

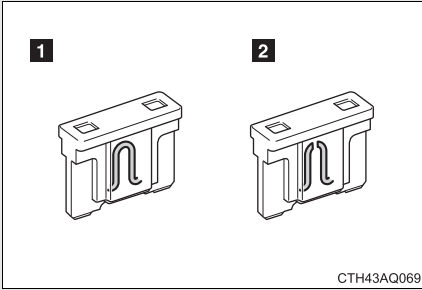

1 Normal fuse

2 Blown fuse

Replace the blown fuse with a new fuse of an appropriate amperage rating. The amperage rating can be found on the fuse box lid.

Type B

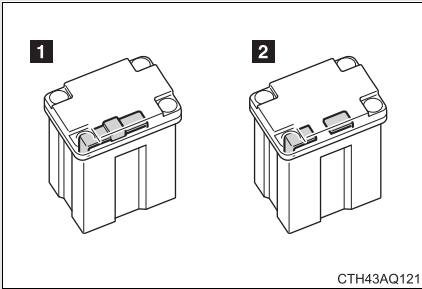

1 Normal fuse

2 Blown fuse

Replace the blown fuse with a new fuse of an appropriate amperage rating. The amperage rating can be found on the fuse box lid.

Type C

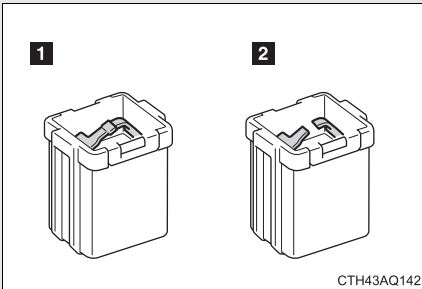

1 Normal fuse

2 Blown fuse

Replace the blown fuse with a new fuse of an appropriate amperage rating. The amperage rating can be found on the fuse box lid.

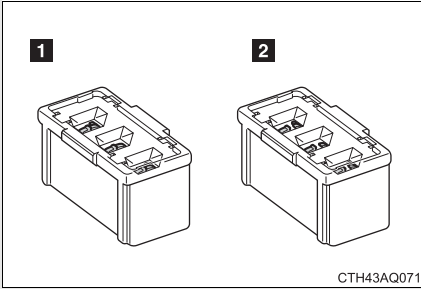
Type D**1** Normal fuse**2** Blown fuse

Replace the blown fuse with a new fuse of an appropriate amperage rating. The amperage rating can be found on the fuse box lid.

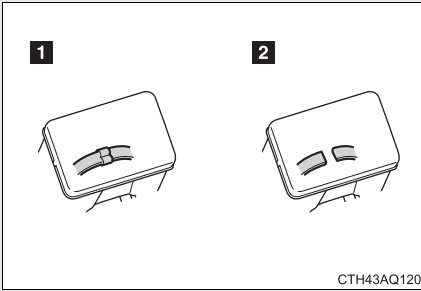
Type E**1** Normal fuse**2** Blown fuse

Contact your Toyota dealer.

Fuse layout and amperage ratings

Engine compartment (type A fuse box)

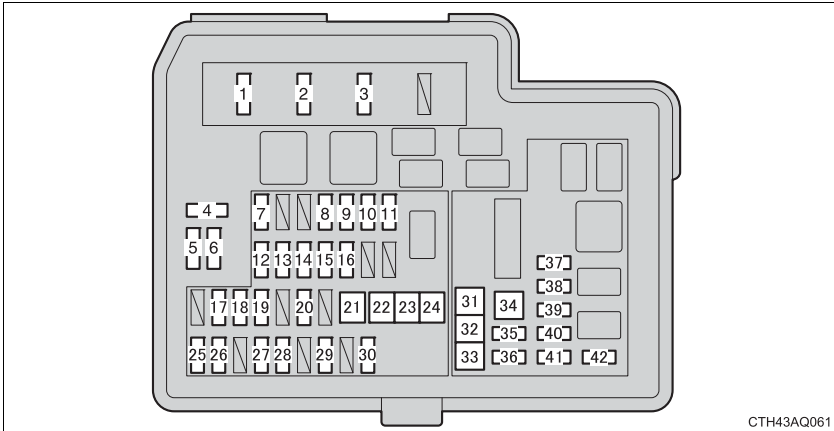

CTH43AQ061

Fuse		Ampere	Circuit
1	EFI-MAIN	20 A	Multiport fuel injection system/ sequential multiport fuel injection system, EFI NO.2
2	HORN	10 A	Horn
3	IG2	30 A	IG2 NO.2, METER, IGN
4	SPARE	7.5 A	Spare fuse
5	SPARE	15 A	Spare fuse
6	SPARE	30 A	Spare fuse
7	EFI NO.2	10 A	Multiport fuel injection system/ sequential multiport fuel injection system
8	H-LP RH-LO	10 A	Right-hand headlight (low beam)
9	H-LP LH-LO	10 A	Left-hand headlight (low beam), gauge and meters
10	H-LP RH-HI	10 A	Right-hand headlight (high beam)
11	H-LP LH-HI	10 A	Left-hand headlight (high beam), gauge and meters

Fuse		Ampere	Circuit
12	IG2 NO.2	10 A	Multiport fuel injection system/ sequential multiport fuel injection system, steering switches, brake system, starter system, smart key system, occupant classification system, SRS airbag system
13	DOME	15 A	Audio system, vehicle control and operation data recording, main body ECU, personal lights, lug- gage compartment light
14	ECU-B NO.1	7.5 A	Main body ECU, smart key system
15	METER	7.5 A	Gauge and meters
16	IGN	15 A	Multiport fuel injection system/ sequential multiport fuel injection system
17	HAZ	10 A	Emergency flashers
18	ETCS	10 A	Multiport fuel injection system/ sequential multiport fuel injection system
19	ABS NO.1	20 A	Brake system
20	ENG W/PMP	30 A	Multiport fuel injection system/ sequential multiport fuel injection system
21	H-LP-MAIN	40 A	H-LP LH-LO, H-LP RH-LO, H-LP LH-HI, H-LP RH-HI, daytime run- ning light system
22	H-LP CLN	30 A	No circuit
23	ABS MTR NO.1	30 A	Brake system
24	P/I	50 A	EFI-MAIN, HORN, IG2

Fuse		Ampere	Circuit
25	ECU-B NO.2	7.5 A	Air conditioning system, gauge and meters, occupant classification system, tire pressure warning system, starter system, smart key system, power door lock system
26	AM2	7.5 A	Starter system
27	STRG LOCK	20 A	Starter system
28	ABS NO.2	10 A	Brake system
29	IGCT-MAIN	30 A	IGCT NO.2, IGCT NO.3, IGCT NO.4, PCU, BATT FAN
30	D/C CUT	30 A	DOME, ECU-B NO.1
31	PTC HTR NO.1	30 A	PTC heater
32	PTC HTR NO.2	30 A	PTC heater
33	FAN	30 A	Electric cooling fan
34	PTC HTR NO.3	30 A	PTC heater
35	DEF	30 A	MIR HTR, rear window defogger
36	DEICER	20 A	No circuit
37	BATT FAN	10 A	Battery cooling fan
38	IGCT NO.2	10 A	Hybrid system
39	IGCT NO.4	10 A	Hybrid system
40	PCU	10 A	Hybrid system
41	IGCT NO.3	10 A	Hybrid system
42	MIR HTR	10 A	Outside rear view mirror defoggers

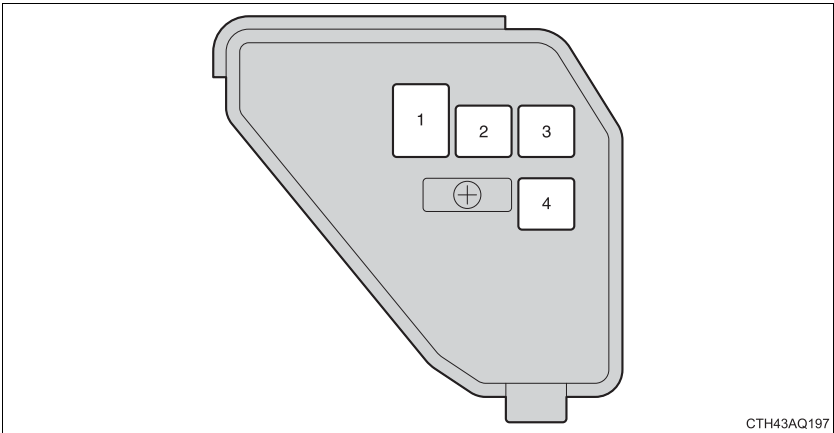
Engine compartment (type B fuse box)

CTH43AQ197

Fuse		Ampere	Circuit
1	DC/DC	100 A	Hybrid system
2	ABS MTR NO.2	30 A	Brake system
3	HTR	40 A	Air conditioning system
4	EPS	50 A	Electric power steering system

Under the driver's side instrument panel

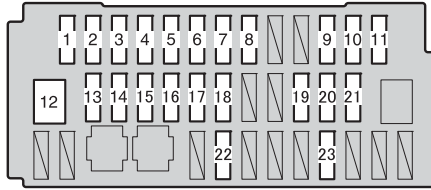

CTH43AQ065

Fuse		Ampere	Circuit
1	TAIL	10 A	Parking lights, side marker lights, tail lights, license plate lights, front fog lights, gauge and meters
2	PANEL	5 A	Instrument panel lights
3	DOOR R/R	20 A	Rear power window (right side)
4	DOOR P	20 A	Front power window (right side)
5	ECU-IG NO.1	5 A	Rear window defogger, tire pressure warning system, main body ECU, brake system, vehicle stability control system, power door lock system, smart key system
6	ECU-IG NO.2	5 A	Electric power steering system
7	HTR-IG	7.5 A	Air conditioning system, PTC heater
8	GAUGE	10 A	Back-up lights, audio system, shift lock control system, moon roof, vehicle control and operation data recording, vehicle proximity notification system
9	WASHER	15 A	Windshield wipers and washer
10	WIPER	25 A	Windshield wipers and washer
11	WIPER RR	15 A	Windshield wipers and washer
12	P/W	30 A	Power window

Fuse		Ampere	Circuit
13	DOOR R/L	20 A	Rear power window (left side)
14	DOOR D	20 A	Front power window (left side)
15	CIG	15 A	Power outlet
16	ACC	5 A	Main body ECU, audio system, outside rear view mirrors, shift lock control system
17	D/L	25 A	Power door lock system
18	OBD	7.5 A	On-board diagnosis
19	STOP	7.5 A	Starter system, shift lock control system, vehicle proximity notification system, brake system, stop lights, high mounted stoplight
20	AM1	7.5 A	Starter system
21	FOG FR	15 A	Front fog lights
22	S/ROOF	25 A	Moon roof
23	S/HTR	15 A	Seat heaters, air conditioning system

■ After a fuse is replaced

- If the lights do not turn on even after the fuse has been replaced, a bulb may need replacement. (→P. 415)
- If the replaced fuse blows again, have the vehicle inspected by your Toyota dealer.

■ If there is an overload in a circuit

The fuses are designed to blow, protecting the wiring harness from damage.

 **CAUTION**

■ **To prevent system breakdowns and vehicle fire**

Observe the following precautions.

Failure to do so may cause damage to the vehicle, and possibly a fire or injury.

- Never use a fuse of a higher amperage rating than that indicated, or use any other object in place of a fuse.
- Always use a genuine Toyota fuse or equivalent.
Never replace a fuse with a wire, even as a temporary fix.
- Do not modify the fuses or fuse boxes.

■ **Fuse box near the power control unit**

Never check or replace the fuses as there are high voltage parts and wiring near the fuse box.

Doing so may cause electric shock, resulting in death or serious injury.

 **NOTICE**

■ **Before replacing fuses**

Have the cause of electrical overload determined and repaired by your Toyota dealer as soon as possible.

Light bulbs

You may replace the following bulbs by yourself. The difficulty level of replacement varies depending on the bulb. As there is a danger that components may be damaged, we recommend that replacement is carried out by your Toyota dealer.

■ Preparing for light bulb replacement

Check the wattage of the light bulb to be replaced. (→P. 505)

■ Front bulb locations

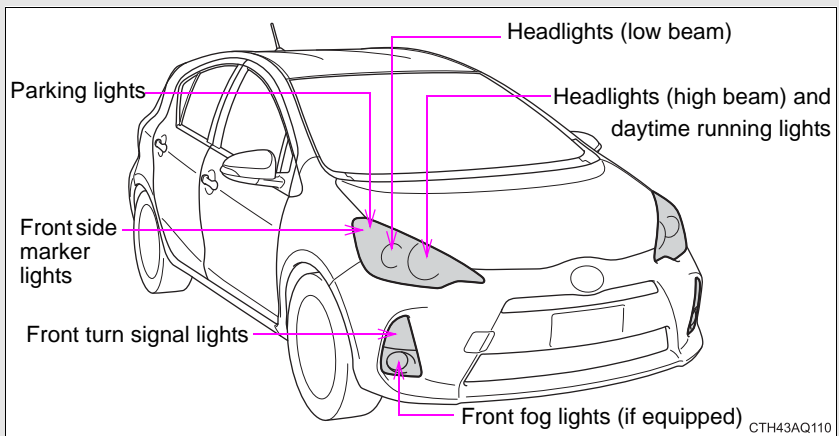

■ Rear bulb locations

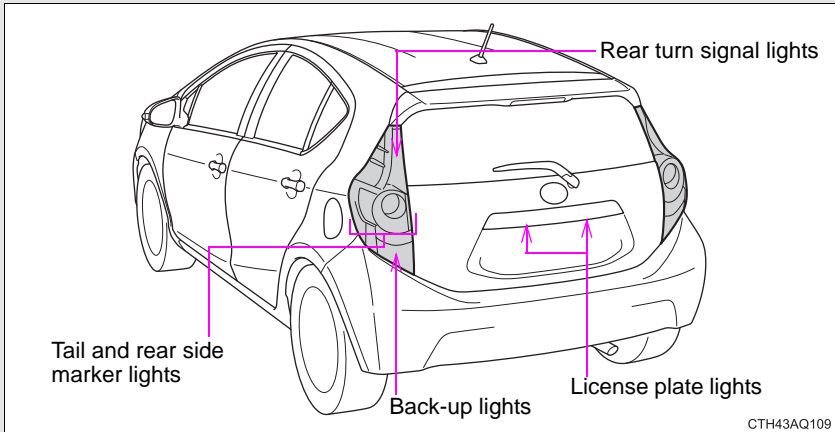

Replacing light bulbs

■ Headlights and daytime running lights

STEP 1

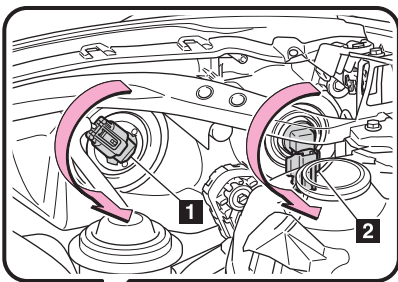

Turn the bulb base counterclockwise.

- 1 High beam and daytime running lights (inside)
- 2 Low beam (outside)

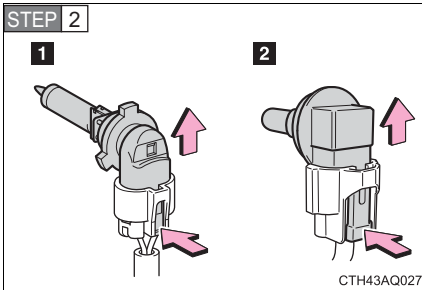

Unplug the connector while pushing the lock release.

- 1** High beam and daytime running lights
- 2** Low beam

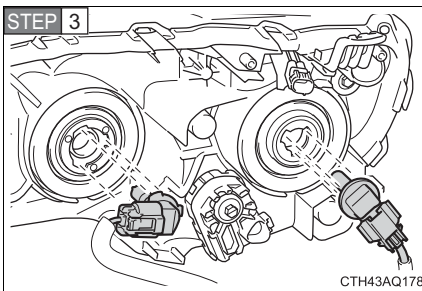

Replace the light bulb, and install the bulb base.

Align the 3 tabs on the light bulb with the mounting, and insert.

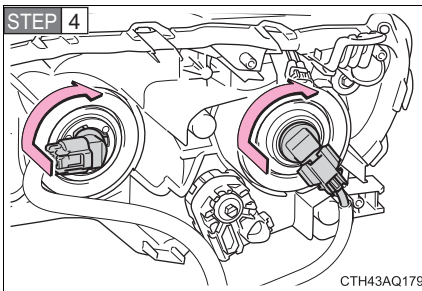

Turn and secure the bulb base.

Shake the bulb base gently to check that it is not loose, turn the headlights and daytime running lights and headlight low beams on once and visually confirm that no light is leaking through the mounting.

■ Front fog lights (if equipped)

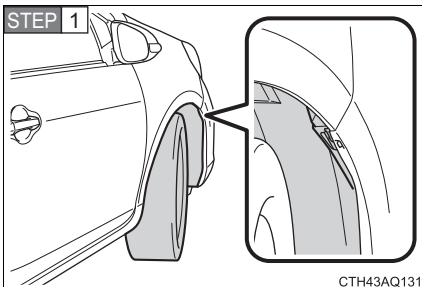

Turn the steering wheel in the opposite direction of the light to be replaced.

Turn the steering wheel to a point that allows your hand to easily fit between the tire and fender liner.

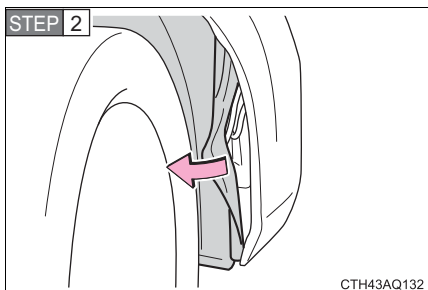

Partly remove the fender liner.

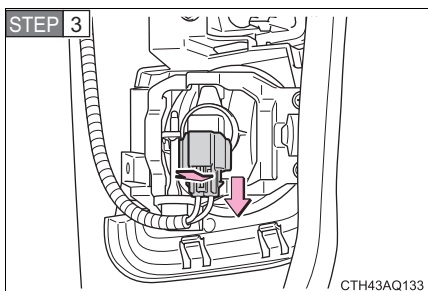

Unplug the connector while pushing the lock release.

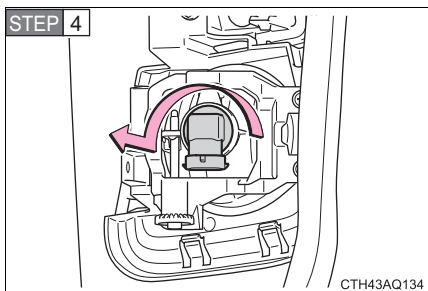

Turn the bulb base counterclockwise.

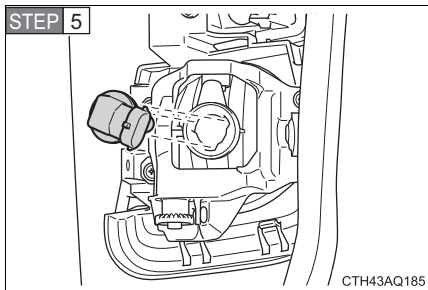

Install a new bulb.

Align the 3 tabs on the light bulb with the mounting, and insert.

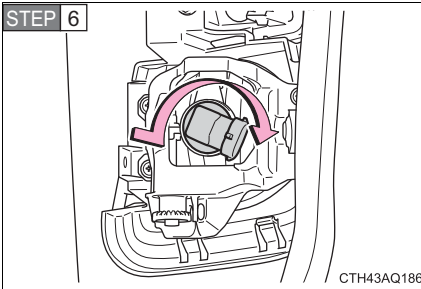

Turn and secure the bulb. Install the connector.

Shake the bulb base gently to check that it is not loose, turn the front fog light on once and visually confirm that no light is leaking through the mounting.

STEP 7 When installing the fender liner, install by conducting **STEP 2** with the directions reversed.

■ Parking lights

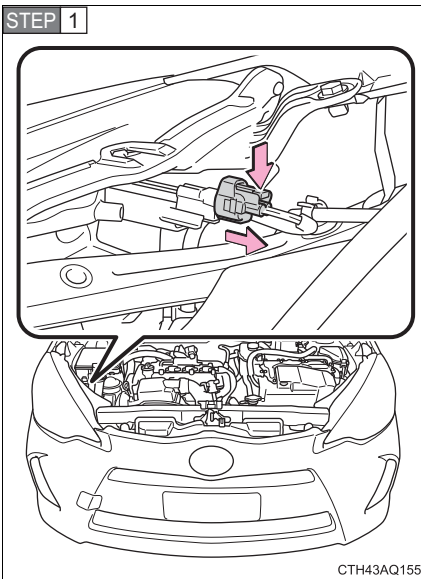

Unplug the connector while pushing the lock release.

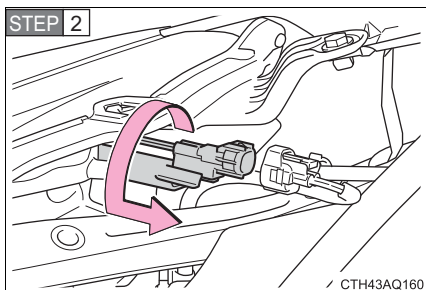

Turn the bulb base counterclockwise.

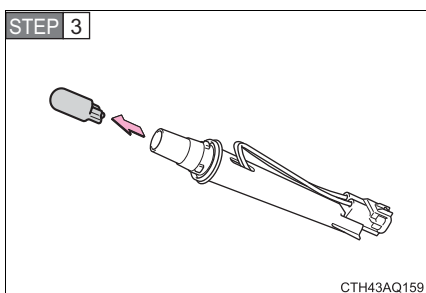

Remove the light bulb.

STEP 4 When installing, reverse the steps listed.

■ Front side marker lights

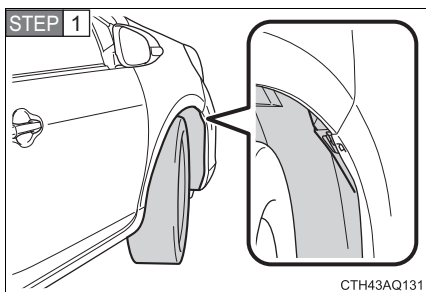

Turn the steering wheel in the opposite direction of the light to be replaced.

Turn the steering wheel to a point that allows your hand to easily fit between the tire and fender liner.

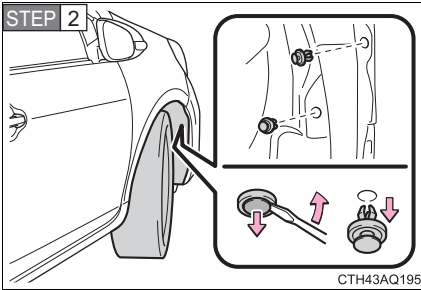

Remove the clips.

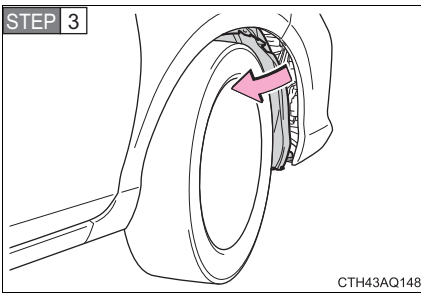

Partly remove the fender liner.

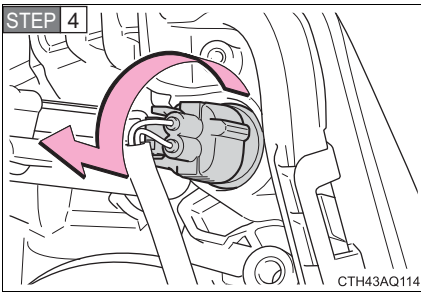

Turn the bulb base counterclockwise.

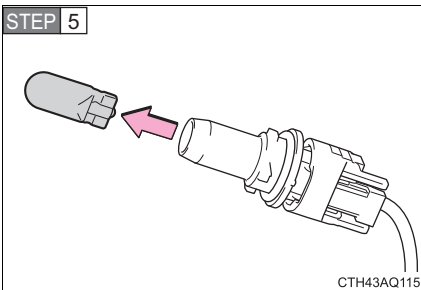

Remove the light bulb.

STEP 6 When installing the light bulb and bulb base, reverse the steps listed.

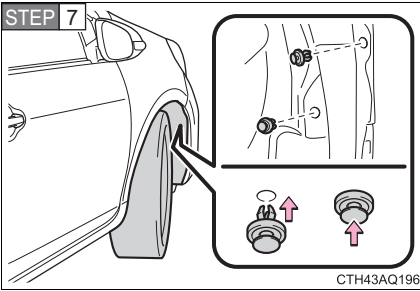

Installing the clips.

■ Front turn signal lights

STEP 1 Partly remove the fender liner as described in **STEP 1** and **STEP 2** of “Front fog lights”. (→P. 417)

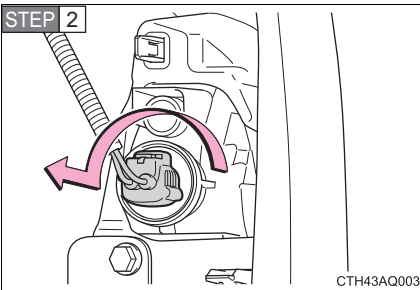

Turn the bulb base counterclockwise.

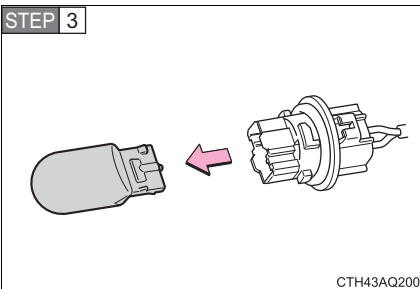

Remove the light bulb.

STEP 4 When installing, reverse the steps listed.

■ Rear turn signal lights, tail and rear side marker lights, and back-up lights

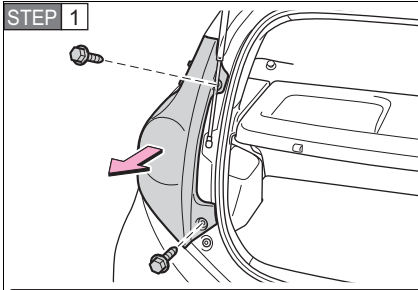

Open the back door and remove the bolts. Pull the lamp assembly straight back to disengage the clip and 2 pins.

1 Where the clip attaches

2 Pin

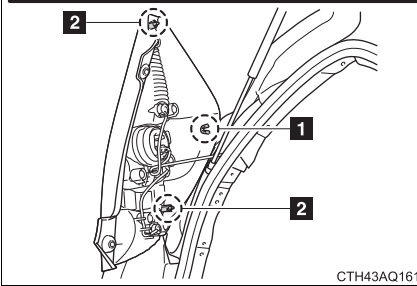

CTH43AQ161

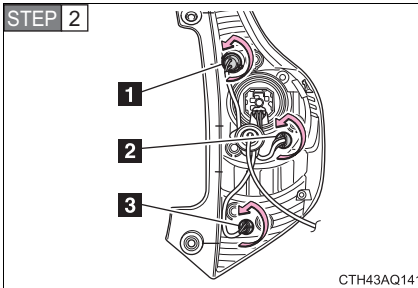

CTH43AQ141

Turn the bulb base counterclockwise.

1 Rear turn signal light

2 Tail and rear side marker light

3 Back-up light

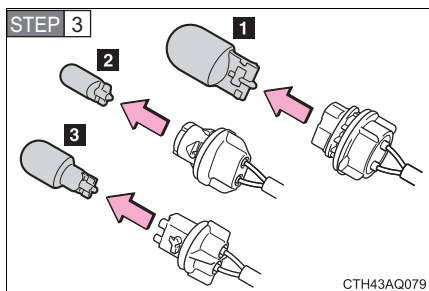

Remove the light bulb.

- 1 Rear turn signal light
- 2 Tail and rear side marker light
- 3 Back-up light

STEP 4 When installing, reverse the steps listed.

■ License plate light

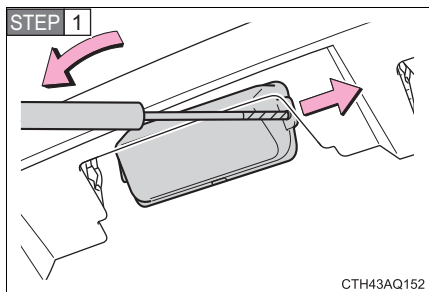

Remove the cover.

Insert a properly sized screwdriver into the hole of the cover, and pry off the cover as shown in the illustration.

To prevent damaging the vehicle, wrap the tip of the screwdriver with tape.

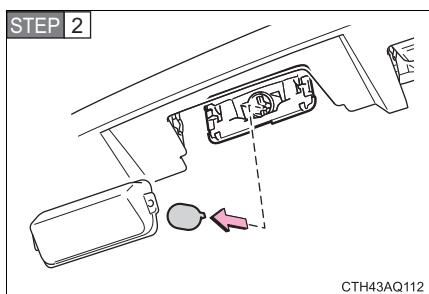

Remove the light bulb.

STEP 3 When installing, reverse the steps listed.

■ Lights other than the above

If any of the lights listed below has burnt out, have it replaced by your Toyota dealer.

- Side turn signal lights
- Stop lights
- High mounted stoplight

■ LED light bulbs

The stop lights and high mounted stoplight consist of a number of LEDs. If any of the LEDs burn out, take your vehicle to your Toyota dealer to have the light replaced.

■ Condensation build-up on the inside of the lens

Temporary condensation build-up on the inside of the headlight lens does not indicate a malfunction. Contact your Toyota dealer for more information in the following situations:

- Large drops of water have built up on the inside of the lens.
- Water has built up inside the headlight.

 CAUTION

■ **Replacing light bulbs**

- Turn off the lights. Do not attempt to replace the bulb immediately after turning off the lights.
The bulbs become very hot and may cause burns.
- Do not touch the glass portion of the light bulb with bare hands. When it is unavoidable to hold the glass portion, use and hold with a clean dry cloth to avoid getting moisture and oils on the bulb.
Also, if the bulb is scratched or dropped, it may blow out or crack.
- Fully install light bulbs and any parts used to secure them. Failure to do so may result in heat damage, fire, or water entering the headlight unit. This may damage the headlights or cause condensation to build up on the lens.

■ **To prevent damage or fire**

Make sure bulbs are fully seated and locked.

5-1. Essential information

Emergency flashers 428
If your vehicle needs to
be towed 429
If you think something
is wrong 436

**5-2. Steps to take in an
emergency**

If a warning light turns
on or a warning buzzer
sounds 437
If a warning message is
displayed..... 447
If you have a flat tire..... 463
If the hybrid system will
not start..... 475
If the shift lever cannot
be shifted from P..... 477
If you lose your keys 478
If the electronic key does
not operate properly..... 479
If the vehicle 12-volt
battery is discharged..... 481
If your vehicle
overheats 487
If the vehicle becomes
stuck 492
If your vehicle has to be
stopped in an
emergency 493

5-1. Essential information

Emergency flashers

The emergency flashers are used to warn other drivers when the vehicle has to be stopped in the road due to a breakdown, etc.

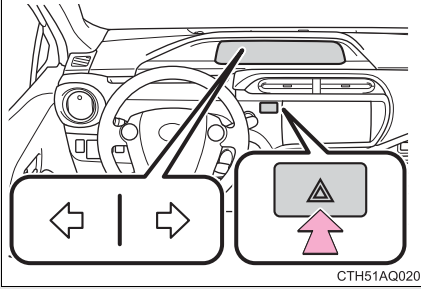

Press the switch.

All the turn signal lights will flash. To turn them off, press the switch once again.

■ Emergency flashers

If the emergency flashers are used for a long time while the hybrid system is not operating (while the "READY" indicator is not illuminated), the 12-volt battery may discharge.

If your vehicle needs to be towed

If towing is necessary, we recommend having your vehicle towed by your Toyota dealer or a commercial towing service, using a lift-type truck or flatbed truck.

Use a safety chain system for all towing, and abide by all state/provincial and local laws.

If towing your vehicle with a wheel-lift type truck from the front, the vehicle's rear wheels and axles must be in good conditions.

(→P. 430, 434)

If they are damaged, use a towing dolly or flatbed truck.

Situations needs to contact dealers before towing

The following may indicate a problem with your transmission. Contact your Toyota dealer before towing.

- A warning message for the hybrid system is shown on the multi-information display and the vehicle does not move.
- The vehicle makes an abnormal sound.

Towing with a sling-type truck

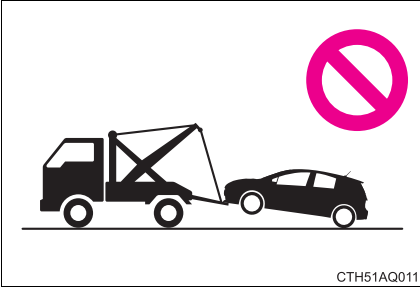

Do not tow with a sling-type truck to prevent body damage.

Towing with a wheel-lift type truck

From the front

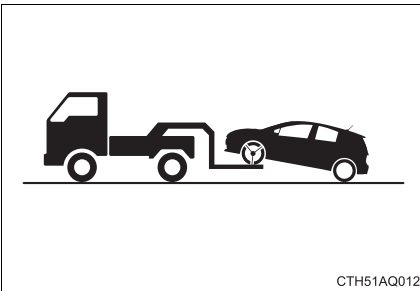

Release the parking brake.

From the rear

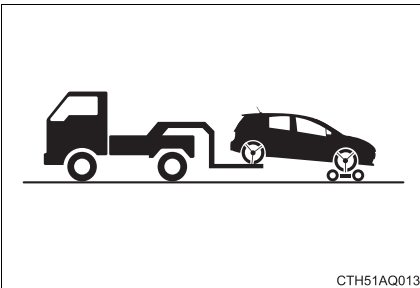

Use a towing dolly under the front wheels.

Using a flatbed truck

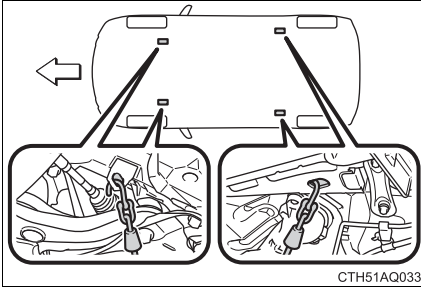

If your Toyota is transported by a flatbed truck, it should be tied down at the locations shown in the illustration.

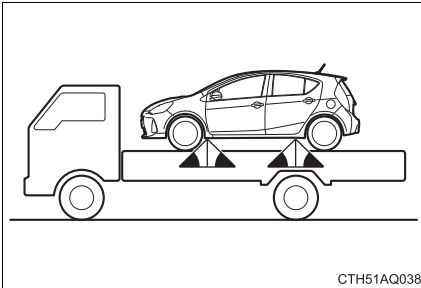

If you use chains or cables to tie down your vehicle, the angles shaded in black must be 45°.

Do not overly tighten the tie downs or the vehicle may be damaged.

Emergency towing

If a tow truck is not available in an emergency, your vehicle may be temporarily towed using a cable or chain secured to the emergency towing eyelet. This should only be attempted on hard surfaced roads for short distances at under 18 mph (30 km/h).

A driver must be in the vehicle to steer and operate the brakes. The vehicle's wheels, drive train, axles, steering and brakes must be in good condition.

Emergency towing procedure

STEP 1 Take out the towing eyelet. (→P. 463)

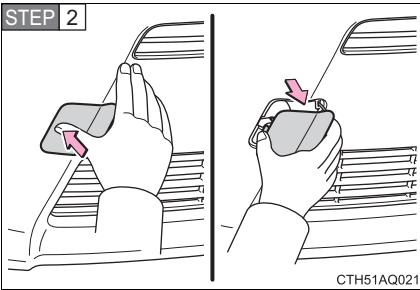

Push the eyelet cover and then open it.

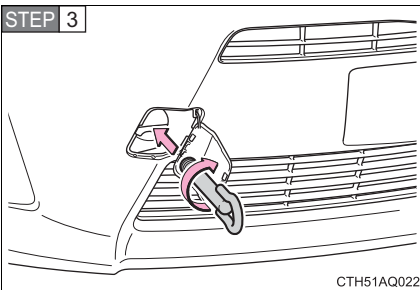

Insert the towing eyelet into the hole and tighten partially by hand.

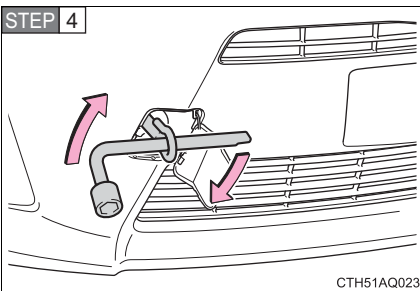

Tighten down the towing eyelet securely using a wheel nut wrench.

STEP 5 Securely attach a cable or chain to the towing eyelet.
Take care not to damage the vehicle body.

STEP 6 Vehicles without a smart key system: Enter the vehicle being towed and start the hybrid system.

If the hybrid system does not start, turn the engine switch to the “ON” position.

Vehicles with a smart key system: Enter the vehicle being towed and start the hybrid system.

If the hybrid system does not start, turn the “POWER” switch to ON mode.

STEP 7 Shift the shift lever to N and release the parking brake.

When the shift lever cannot be shifted: →P. 477

■ While towing

If the hybrid system is off, the power assist for the brakes and steering will not function, making steering and braking more difficult.

■ Wheel nut wrench

Wheel nut wrench is installed in luggage compartment. (→P. 463)

⚠ CAUTION

Observe the following precautions.

Failure to do so may result in death or serious injury.

■ When towing the vehicle

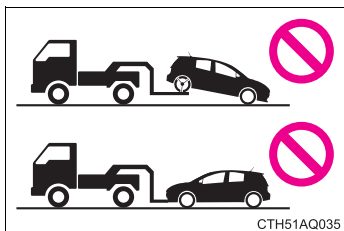

Be sure to transport the vehicle with the front wheels raised or with all four wheels raised off the ground. If the vehicle is towed with the front wheels contacting the ground, the drivetrain and related parts may be damaged or electricity generated by the operation of the motor may cause a fire to occur depending on the nature of the damage or malfunction.

■ While towing

- When towing using a rope, avoid sudden starts, etc. which place excessive stress on the towing hook and rope. The towing hook or rope may become damaged, broken debris may hit people and cause serious damage.
- Do not turn the engine switch off (vehicles without a smart key system) or the "POWER" switch off (vehicles with a smart key system). There is a possibility that the steering wheel is locked and can not be operated.

■ Installing towing eyelet to the vehicle

Make sure that towing eyelet is installed securely.

If not securely installed, towing eyelet may come loose during towing.

**NOTICE****■ To prevent damage to the vehicle when towing using a wheel-lift type truck**

When raising the vehicle, ensure adequate ground clearance for towing at the opposite end of the raised vehicle. Without adequate clearance, the vehicle could be damaged while being towed.

■ To prevent body damage when towing with a sling-type truck

Do not tow with a sling-type truck, either from the front or rear.

If you think something is wrong

If you notice any of the following symptoms, your vehicle probably needs adjustment or repair. Contact your Toyota dealer as soon as possible.

■ Visible symptoms

- Fluid leaks under the vehicle
(Water dripping from the air conditioning after use is normal.)
- Flat-looking tires or uneven tire wear
-  is shown on the multi-information display

■ Audible symptoms

- Changes in exhaust sound
- Excessive tire squeal when cornering
- Strange noises related to the suspension system
- Pinging or other noises related to the hybrid system

■ Operational symptoms

- Engine missing, stumbling or running roughly
- Appreciable loss of power
- Vehicle pulls heavily to one side when braking
- Vehicle pulls heavily to one side when driving on a level road
- Loss of brake effectiveness, spongy feeling, pedal almost touches the floor



5-2. Steps to take in an emergency

If a warning light turns on or a warning buzzer sounds

Calmly perform the following actions if any of the warning lights comes on or flashes. If a light comes on or flashes, but then goes off, this does not necessarily indicate a malfunction in the system. However, if this continues to occur, have the vehicle inspected by your Toyota dealer.

Stop the vehicle immediately. Continuing to drive the vehicle may be dangerous.

The following warning indicates a possible problem in the brake system. Immediately stop the vehicle in a safe place and contact your Toyota dealer.

Warning light	Warning light/Details
 (U.S.A.)	Brake system warning light in red (warning buzzer)* <ul style="list-style-type: none">• Low brake fluid• Malfunction in the brake system This light also comes on when the parking brake is not released. If the light turns off after the parking brake is fully released the system is operating normally.
 (Canada)	

***: Brake system warning buzzer:**

When there is a possible problem that could affect braking performance, the warning light will come on and a warning buzzer will sound.

Parking brake engaged warning buzzer:

→P. 450





Stop the vehicle immediately.



The following warning indicates the possibility of damage to the vehicle that may lead to an accident. Immediately stop the vehicle in a safe place and contact your Toyota dealer.

Warning light	Warning light/Details
	<p>Charging system warning light Indicates a malfunction in the vehicle's charging system</p>

Have the vehicle inspected by your Toyota dealer immediately.

Failure to investigate the cause of the following warnings may lead to the system operating abnormally and possibly cause an accident. Have the vehicle inspected by your Toyota dealer immediately.



Warning light	Warning light/Details
 (U.S.A.)  (Canada)	<p>Malfunction indicator lamp Indicates a malfunction in:</p> <ul style="list-style-type: none"> • The hybrid system; • The electronic engine control system; or • The electronic throttle control system
	<p>SRS warning light Indicates a malfunction in:</p> <ul style="list-style-type: none"> • The SRS airbag system; • The front passenger occupant classification system; or • The seat belt pretensioner system
 (U.S.A.)  (Canada)	<p>ABS warning light Indicates a malfunction in:</p> <ul style="list-style-type: none"> • The ABS; or • The brake assist system

Warning light	Warning light/Details
	<p>Electric power steering system warning light (warning buzzer) Indicates a malfunction in the EPS (Electric Power Steering) system</p>
 (Comes on)	<p>Slip indicator light Indicates a malfunction in:</p> <ul style="list-style-type: none"> • Vehicle stability control; • Traction control; or • Hill-start assist control
	<p>Brake system warning light in yellow Indicates a malfunction in:</p> <ul style="list-style-type: none"> • The regenerative brake system; or • The electronically controlled brake system

Follow the correction procedures.

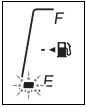
After taking the specified steps to correct the suspected problem, check that the warning light goes off.

Warning light	Warning light/Details	Correction procedure
 (Flashes)	<p>Low fuel level warning light Remaining fuel is low When the remaining fuel is approximately 1.3 gal. (5.0 L, 1.1 Imp. gal.) or less, a buzzer sounds and the lowest segment of the fuel gauge flashes</p>	<p>Refuel the vehicle.</p>

Warning light	Warning light/Details	Correction procedure
	<p>Seat belt reminder light (warning buzzer)* Warns the driver and front passenger to fasten their seat belt</p>	<p>Fasten the seat belt. If the front passenger's seat is occupied, the front passenger's seat belt also needs to be fastened to make the reminder light (warning buzzer) go off.</p>
	<p>Master warning light A buzzer sounds and the warning light comes on and flashes to indicate that the master warning system has detected a malfunction</p>	<p>→P. 447</p>
	<p>Tire pressure warning light</p>	
	<p>When the light comes on: Low tire inflation pressure such as</p> <ul style="list-style-type: none"> • Natural causes (→P. 442) • Flat tire (→P. 463) 	<p>Adjust the tire inflation pressure to the specified level. The light will turn off after a few minutes. In case the light does not turn off even if the tire inflation pressure is adjusted, have the system checked by your Toyota dealer.</p>
	<p>When the light comes on after blinking for 1 minute: Malfunction in the tire pressure warning system (→P. 443)</p>	<p>Have the system checked by your Toyota dealer.</p>

***: Driver's and front passenger's seat belt buzzer:**

The driver's and front passenger's seat belt buzzer sounds to alert the driver and front passenger that his or her seat belt is not fastened. Once the engine switch is turned to the "ON" or "START" position (vehicles without a smart key system) or the "POWER" switch is turned to ON mode (vehicles with a smart key system), the buzzer sounds for 6 seconds. If the vehicle reaches a speed of 12 mph (20 km/h), the buzzer sounds once. If the seat belt is still unfastened after 30 seconds, the buzzer will sound intermittently for 10 seconds. Then, if the seat belt is still unfastened, the buzzer will sound in a different tone for 20 more seconds.

■ SRS warning light

This warning light system monitors the airbag sensor assembly, front impact sensors, side impact sensors, driver's seat belt buckle switch, front passenger occupant classification system (ECU and sensors), "AIR BAG ON" indicator light, "AIR BAG OFF" indicator light, front passenger's seat belt buckle switch, seat belt pretensioner assemblies, airbags, interconnecting wiring and power sources. (→P. 438)

■ Front passenger detection sensor, passenger seat belt reminder and warning buzzer

- If luggage is placed on the front passenger seat, the front passenger detection sensor may cause the warning light to flash and the warning buzzer to sound even if a passenger is not sitting in the seat.
- If a cushion is placed on the seat, the sensor may not detect a passenger, and the warning light may not operate properly.

■ Electric power steering system warning light (warning buzzer)

When the 12-volt battery charge becomes insufficient or the voltage temporarily drops, the electric power steering system warning light may come on and the warning buzzer may sound.

■ If the malfunction indicator lamp comes on while driving

The malfunction indicator lamp will come on if the fuel tank cap becomes loose. If the fuel tank cap is loose, tighten it securely. The malfunction indicator lamp will go off after several trips.

If the malfunction indicator lamp does not go off even after several trips, contact your Toyota dealer as soon as possible.

■ When the tire pressure warning light comes on

Check the tire inflation pressure and adjust to the appropriate level. Pushing the tire pressure warning reset switch will not turn off the tire pressure warning light.

■ The tire pressure warning light may come on due to natural causes

The tire pressure warning light may come on due to natural causes such as natural air leaks and tire inflation pressure changes caused by temperature. In this case, adjusting the tire inflation pressure will turn off the warning light (after a few minutes).

■ When a tire is replaced with a spare tire

The compact spare tire is not equipped with a tire pressure warning valve and transmitter. If a tire goes flat, the tire pressure warning light will not turn off even though the flat tire has been replaced with the spare tire. Replace the spare tire with the repaired tire and adjust the tire inflation pressure. The tire pressure warning light will go off after a few minutes.

■ If the tire pressure warning system is not functioning

The tire pressure warning system will be disabled in the following conditions:

(When the condition becomes normal, the system will work properly.)

- If tires not equipped with tire pressure warning valves and transmitters are used
- If the ID code on the tire pressure warning valves and transmitters is not registered in the tire pressure warning computer
- If the tire inflation pressure is 73 psi (500 kPa, 5.1 kgf/cm² or bar) or higher

The tire pressure warning system may be disabled in the following conditions:

(When the condition becomes normal, the system will work properly.)

- If electronic devices or facilities using similar radio wave frequencies are nearby
- If a radio set at a similar frequency is in use in the vehicle
- If a window tint that affects the radio wave signals is installed
- If there is a lot of snow or ice on the vehicle, particularly around the wheels or wheel housings
- If non-genuine Toyota wheels are used (Even if you use Toyota wheels, the tire pressure warning system may not work properly with some types of tires.)
- If tire chains are used

■ If the tire pressure warning light frequently comes on after blinking for 1 minute

If the tire pressure warning light frequently comes on after blinking for 1 minute when the engine switch is turned to the “ON” position (vehicles without a smart key system) or the “POWER” switch is turned to ON mode (vehicles with a smart key system), have it checked by your Toyota dealer.

■ Customization that can be configured at Toyota dealer

The vehicle speed linked seat belt reminder buzzer can be disabled. (Customizable features →P. 522) However, Toyota recommends that the seat belt reminder buzzer be operational to alert the driver and front passenger when seat belts are not fastened.

 CAUTION

■ **When the electric power steering system warning light comes on**

The steering wheel may become extremely heavy.

If the steering wheel becomes heavier than usual when operating, hold firmly and operate using more force than usual.

■ **If the tire pressure warning light comes on**

Be sure to observe the following precautions. Failure to do so could cause a loss of vehicle control and result in death or serious injury.

- Stop your vehicle in a safe place as soon as possible. Adjust the tire inflation pressure immediately.
- If the tire pressure warning light comes on even after tire inflation pressure adjustment, it is probable that you have a flat tire. Check the tires. If a tire is flat, change it with the spare tire and have the flat tire repaired by the nearest Toyota dealer.
- Avoid abrupt maneuvering and braking. If the vehicle tires deteriorate, you could lose control of the steering wheel or the brakes.

■ **If a blowout or sudden air leakage should occur**

The tire pressure warning system may not activate immediately.

 CAUTION**■ Maintenance of the tires**

Each tire, including the spare (if provided), should be checked monthly when cold and inflated to the inflation pressure recommended by the vehicle manufacturer on the vehicle placard or tire inflation pressure label (tire and load information label). (If your vehicle has tires of a different size than the size indicated on the vehicle placard or tire inflation pressure label [tire and load information label], you should determine the proper tire inflation pressure for those tires.)

As an added safety feature, your vehicle has been equipped with a tire pressure monitoring system (TPMS-tire pressure warning system) that illuminates a low tire pressure telltale (tire pressure warning light) when one or more of your tires is significantly under-inflated. Accordingly, when the low tire pressure telltale (tire pressure warning light) illuminates, you should stop and check your tires as soon as possible, and inflate them to the proper pressure. Driving on a significantly under-inflated tire causes the tire to overheat and can lead to tire failure. Under-inflation also reduces fuel efficiency and tire tread life, and may affect the vehicle's handling and stopping ability.

Please note that the TPMS (tire pressure warning system) is not a substitute for proper tire maintenance, and it is the driver's responsibility to maintain correct tire pressure, even if under-inflation has not reached the level to trigger illumination of the TPMS low tire pressure telltale (tire pressure warning light).

Your vehicle has also been equipped with a TPMS (tire pressure warning system) malfunction indicator to indicate when the system is not operating properly. The TPMS (tire pressure warning system) malfunction indicator is combined with the low tire pressure telltale (tire pressure warning light). When the system detects a malfunction, the telltale will flash for approximately one minute and then remain continuously illuminated. This sequence will continue upon subsequent vehicle start-ups as long as the malfunction exists. When the malfunction indicator is illuminated, the system may not be able to detect or signal low tire pressure as intended.

 CAUTION

TPMS (tire pressure warning system) malfunctions may occur for a variety of reasons, including the installation of replacement or alternate tires or wheels on the vehicle that prevent the TPMS (tire pressure warning system) from functioning properly. Always check the TPMS (tire pressure warning system) malfunction telltale after replacing one or more tires or wheels on your vehicle to ensure that the replacement or alternate tires and wheels allow the TPMS (tire pressure warning system) to continue to function properly.

 NOTICE

■ **To ensure the tire pressure warning system operates properly**

Do not install tires with different specifications or makers, as the tire pressure warning system may not operate properly.

If a warning message is displayed

If a warning is shown on the multi-information display, stay calm and perform the following actions:

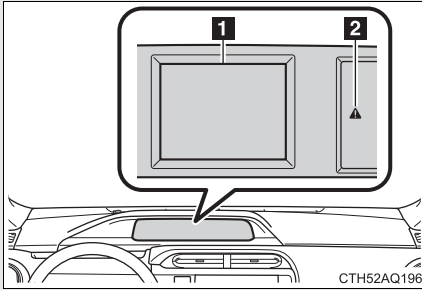

1 Multi-information display

Warning message details and/or correction procedures are shown on the multi-information display.





2 Master warning light

The master warning light also comes on or flashes in order to indicate that a message is currently being displayed on the multi-information display.

If any of the warning lights comes on again after the following actions have been performed, contact your Toyota dealer.

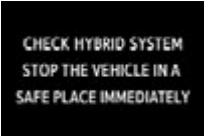

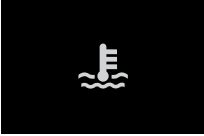

Stop the vehicle immediately.

The following warning indicates the possibility of damage to the vehicle that may lead to an accident. Immediately stop the vehicle in a safe place and contact your Toyota dealer.

Warning message	Details
 	<p>Indicates a malfunction in the hybrid system A buzzer sounds in accordance with the warning message that is displayed.</p>
	<p>Indicates that the high engine coolant temperature is too high</p>
 	<p>Indicates abnormal engine oil pressure A buzzer also sounds. The warning message is shown if the engine oil pressure is too low.</p>





Have the vehicle inspected immediately.





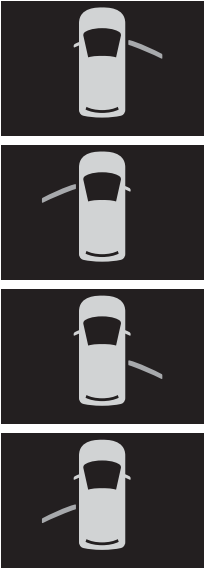

A buzzer sounds and a warning message is shown on the multi-information display. Failure to investigate the cause of the following warnings may lead to the system operating abnormally and possibly cause an accident. Have the vehicle inspected by your Toyota dealer immediately.

Warning message	Details
  (Flashes) (If equipped)	<ul style="list-style-type: none"> • Indicates a malfunction in the smart key system • Indicates a malfunction in the steering lock system A buzzer also sounds.
  (If equipped)	<p>Indicates a malfunction in the cruise control system</p> A buzzer also sounds.





Follow the correction procedures.









A buzzer sounds and a warning message is shown on the multi-information display. After taking the specified steps to correct the suspected problem, check that the warning message goes off.



Warning message	Details	Correction procedure
	<p>Indicates that one or more of the side doors is not fully closed</p> <p>The system also indicates which doors are not fully closed. If the vehicle reaches a speed of 3 mph (5 km/h),  flashes and a buzzer sounds to indicate that the door(s) are not yet fully closed.</p>	<p>Make sure that all the side doors are closed.</p>
	<p>Indicates that the back door is not fully closed</p> <p>If the vehicle reaches a speed of 3 mph (5 km/h),  flashes and a buzzer sounds to indicate that the back door is not yet fully closed.</p>	<p>Close the back door.</p>

Warning message	Details	Correction procedure
  (Flashes) (If equipped)	<p>Indicates that the moon roof is not fully closed (with the “POWER” switch off and the driver's door is open)</p> <p>A buzzer also sounds.</p>	<p>Close the moon roof.</p>
  (U.S.A.)  (Canada) (red)	<p>Indicates that the parking brake is still engaged</p> <p>If the vehicle reaches a speed of 3 mph (5 km/h),  flashes and a buzzer sounds to indicate that the parking brake is still engaged.</p>	<p>Release the parking brake.</p>
 (U.S.A. only)	<p>Indicates that all maintenance according to the driven distance on the maintenance schedule*1 should be performed soon</p> <p>Comes on approximately 4500 miles (7200 km) after the maintenance data has been reset</p>	<p>If necessary, perform maintenance.</p>

5-2. Steps to take in an emergency

Warning message	Details	Correction procedure
 <p>(U.S.A. only)</p>	<p>Indicates that all maintenance is required to correspond to the driven distance on the maintenance schedule*1</p> <p>Comes on approximately 5000 miles (8000 km) after the maintenance data has been reset (The indicator will not work properly unless the maintenance data has been reset)</p>	<p>Perform the necessary maintenance. Please reset the maintenance data after the maintenance is performed.(→P. 353)</p>
 	<p>Indicates that the hybrid system has overheated</p> <p>A buzzer also sounds. This message may be displayed when driving under severe operating conditions. (For example, when driving up a long steep hill.)</p>	<p>Stop and check. (→P. 487)</p>
  <p>(Flashes)</p>	<p>Indicates that the hybrid battery (traction battery) is low</p> <p>A buzzer also sounds.</p>	<p>When stopping the vehicle for a long period of time, shift the shift lever to P. The hybrid battery (traction battery) cannot be charged with the shift position in N.</p>

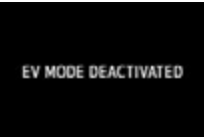
Warning message	Details	Correction procedure
  (Flashes)	<p>Indicates that the hybrid battery (traction battery) power has dropped because a long period of time has elapsed after shifting the shift lever to N</p> <p>A buzzer also sounds.</p>	<p>Shift the shift lever to P and restart the hybrid system when starting the vehicle.</p>
  (Flashes)	<p>Indicates that the driver's door was opened with the shift position in N, D or B</p> <p>A buzzer also sounds.</p>	<p>Shift the shift lever to P.</p>
  (Flashes)	<p>Indicates that the accelerator pedal is depressed while the shift position is in N</p> <p>A buzzer also sounds.</p>	<p>Release the accelerator pedal and shift the shift lever to D, B or R.</p>
  (Flashes)	<p>Indicates that the engine switch is turned to the "ACC" or "LOCK" position (vehicles without a smart key system) or the "POWER" switch is turned to ACCESSORY mode or turned off (vehicles with a smart key system) and the driver's door is opened while the lights are turned on</p> <p>A buzzer also sounds.</p>	<p>Turn the lights off.</p>



Warning message	Details	Correction procedure
	<p>Indicates that the EV drive mode is not available*2</p> <p>A buzzer also sounds. The reason the EV drive mode is not available (the vehicle is idling, battery charge is low, speed is higher than the EV drive mode operating speed range, accelerator pedal is depressed too much) may be displayed.</p>	<p>Use the EV drive mode when it becomes available.</p>
  (Flashes 3 times)	<p>Indicates that the EV drive mode has been automatically cancelled*2</p> <p>A buzzer also sounds. The reason the EV drive mode is not available (the battery charge is low, speed is higher than the EV drive mode speed range, accelerator pedal is depressed too much) may be displayed.</p>	<p>Drive the vehicle for a while.</p>

*1: Refer to the separate “Scheduled Maintenance Guide” or “Owner’s Manual Supplement” for the maintenance interval applicable to your vehicle.



*2: For the EV drive mode operating conditions:
→P. 172





Have the malfunction repaired immediately. (vehicles with a smart key system)

After taking the specified steps to correct the suspected problem, check that the warning message and light go off.



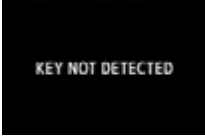

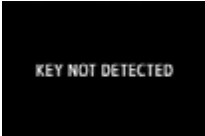
Interior buzzer	Exterior buzzer	Warning message	Details	Correction procedure
Once	—	  (Flashes)	The electronic key is not detected when an attempt is made to start the hybrid system.	Start the hybrid system with the electronic key present.



5-2. Steps to take in an emergency

Interior buzzer	Exterior buzzer	Warning message	Details	Correction procedure
Once	3 times	  (Flashes)	<p>The electronic key was carried outside the vehicle and the driver's door was opened and closed while the shift lever was in P without turning off the "POWER" switch.</p>	<p>Turn the "POWER" switch off or bring the electronic key back into the vehicle.</p>
			<p>The electronic key was carried outside the vehicle and a door other than the driver's door was opened and closed while the "POWER" switch was in a mode other than off.</p>	<p>Bring the electronic key back into the vehicle.</p>

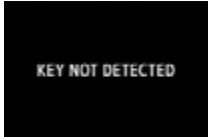

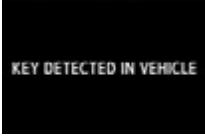

Interior buzzer	Exterior buzzer	Warning message	Details	Correction procedure
Once	Continuous (For 5 seconds)	  (Displayed alternately)  (Flashes)	An attempt was made to lock the doors using the entry function after the electronic key was carried outside the vehicle without turning off the "POWER" switch.	Turn the "POWER" switch off and lock the doors again.
9 times	—	  (Flashes)	An attempt was made to start the hybrid system without the electronic key being present, or the electronic key was not functioning normally. An attempt was made to drive when the regular key was not inside the vehicle.	Confirm that the electronic key is inside the vehicle.



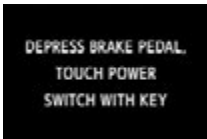

5-2. Steps to take in an emergency

Interior buzzer	Exterior buzzer	Warning message	Details	Correction procedure
Continuous	—	  (Flashes)	<p>The driver's door was opened while a shift lever position other than P was selected without turning off the "POWER" switch.</p>	<p>Shift the shift lever to P.</p>
Continuous	Continuous	  (Displayed alternately)  (Flashes)	<p>The electronic key was carried outside the vehicle and the driver's door was opened and closed while a shift lever position other than P was selected without turning off the "POWER" switch.</p>	<ul style="list-style-type: none"> • Shift the shift lever to P. • Bring the electronic key back into the vehicle.







Interior buzzer	Exterior buzzer	Warning message	Details	Correction procedure
Once	Continuous	  (Flashes)	<p>An attempt was made to lock the doors using the smart key system while the electronic key was still inside the vehicle.</p> <p>An attempt was made to lock either front door by opening a door and putting the inside door lock button into the lock position, and then closing the door while pulling on the outside door handle with the electronic key still inside the vehicle.</p>	<p>Retrieve the electronic key from the vehicle and lock the doors again.</p>

5-2. Steps to take in an emergency

Interior buzzer	Exterior buzzer	Warning message	Details	Correction procedure
Once	—	  (Flashes)	<ul style="list-style-type: none"> • The electronic key could not be detected when the “POWER” switch was pressed after the doors were unlocked with the mechanical key. • The electronic key could not be detected two consecutive times when the “POWER” switch was pressed. 	Touch the electronic key to the “POWER” switch while depressing the brake pedal.
Once	—	  (Flashes)	An attempt was made to start the hybrid system with the shift lever in a position other than P.	Shift the shift lever to P and start the hybrid system.
—	—		Power was turned off due to the automatic power off function.	Next time when starting the hybrid system, increase the engine speed slightly and maintain that level for approximately 5 minutes to recharge the 12-volt-battery.

Interior buzzer	Exterior buzzer	Warning message	Details	Correction procedure
Once	—	 	The electronic key has a low battery.	Replace the electronic key battery. (→P. 401)
Once	—		The driver's door was opened and closed with the "POWER" switch turned off and then the "POWER" switch was put in ACCESSORY mode twice without the hybrid system being started.	Press the "POWER" switch while depressing the brake pedal.
		 (Flashes)	During a hybrid system starting procedure in the event that the electronic key was not functioning properly (→P. 479), the "POWER" switch was touched with the electronic key.	Press the "POWER" switch within 10 seconds of the buzzer sounding.

5-2. Steps to take in an emergency

Interior buzzer	Exterior buzzer	Warning message	Details	Correction procedure
Once	—	  (Flashes)	The steering lock could not be released within 3 seconds of the “POWER” switch being pressed.	Press the “POWER” switch while depressing the brake pedal and moving the steering wheel left and right.
Once	—	  (Flashes)	The “POWER” switch has been turned off with the shift lever in a position other than P.	Shift the shift lever to P.
Once	—	  (Flashes)	After the “POWER” switch has been turned off with the shift lever in a position other than P, the shift lever has been shifted to P.	Turn the “POWER” switch off.

5-2. Steps to take in an emergency If you have a flat tire

Your vehicle is equipped with a spare tire. The flat tire can be replaced with the spare tire.

■ Before jacking up the vehicle

- Stop the vehicle on a hard, flat surface.
- Set the parking brake.
- Shift the shift lever to P.
- Stop the hybrid system.
- Turn on the emergency flashers.

■ Location of the spare tire, jack and tools

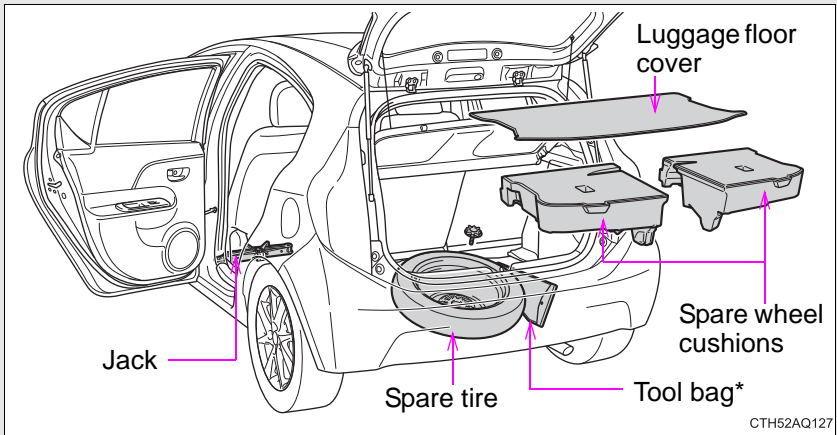

Taking out the jack

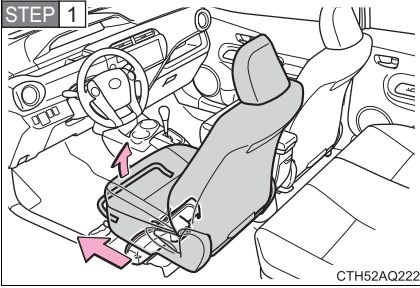

Move the driver seat to the front most position.

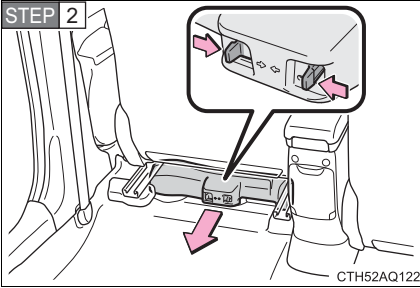

Push the tabs in and remove the cover by pulling it towards you.

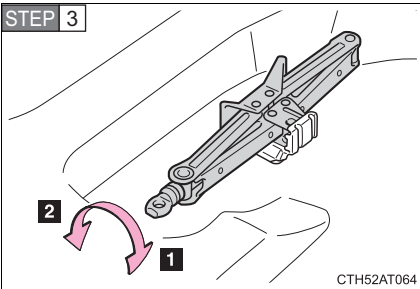

1 For tightening

2 For loosening

Taking out the compact spare tire

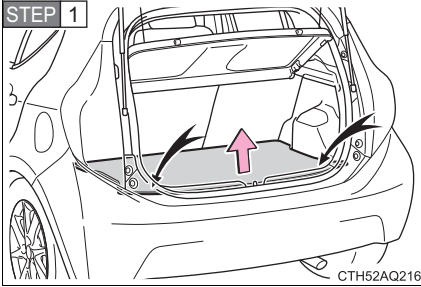

Remove the luggage floor cover by lifting up the points indicated by the arrows.

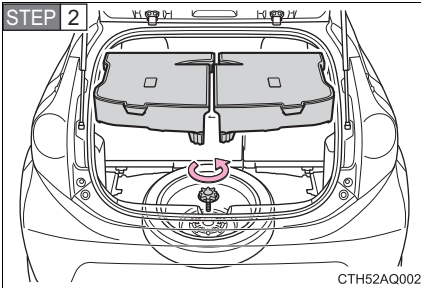

Remove the spare wheel cushions, then loosen the center fastener that secures the spare tire.

Replacing a flat tire

STEP 1

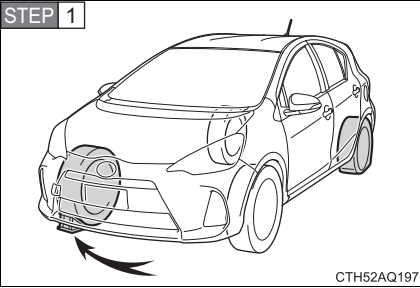

Chock the tires.

Flat tire		Wheel chock positions
Front	Left-hand side	Behind the rear right-hand side tire
	Right-hand side	Behind the rear left-hand side tire
Rear	Left-hand side	In front of the front right-hand side tire
	Right-hand side	In front of the front left-hand side tire

STEP 2

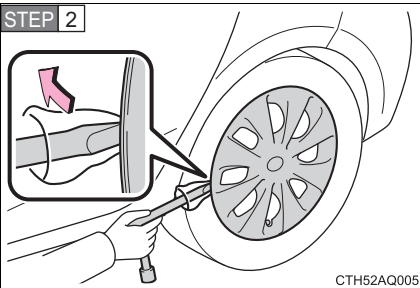

For vehicles with steel wheels, remove the wheel ornament using the wrench.

To protect the wheel ornament, place a rag between the wrench and the wheel ornament.

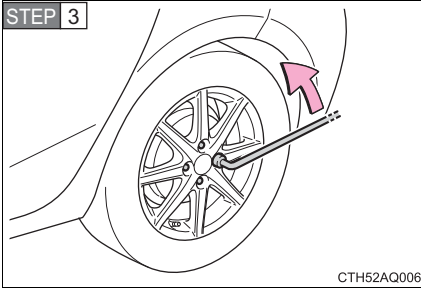

Slightly loosen the wheel nuts (one turn).

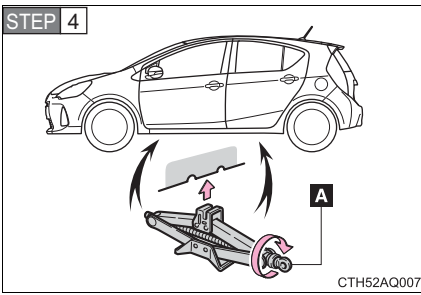

Turn the tire jack portion “A” by hand until the notch of the jack is in contact with the jack point.

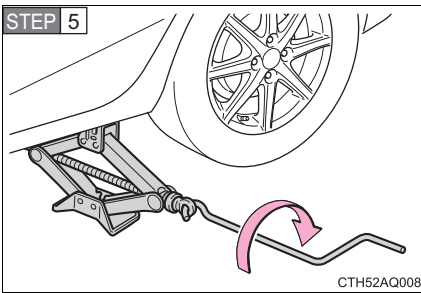

Raise the vehicle until the tire is slightly raised off the ground.

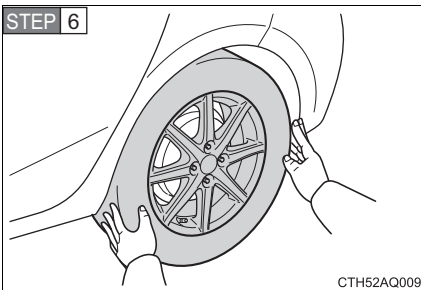

Remove all the wheel nuts and the tire.

When resting the tire on the ground, place the tire so that the wheel design faces up to avoid scratching the wheel surface.

Installing the compact spare tire

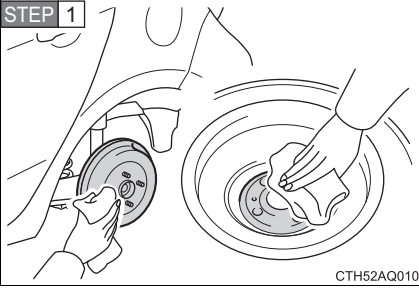

Remove any dirt or foreign matter from the wheel contact surface.

If foreign matter is on the wheel contact surface, the wheel nuts may loosen while the vehicle is in motion, causing the tire to come off.

STEP 2 Install the spare tire and loosely tighten each wheel nut by hand by approximately the same amount.

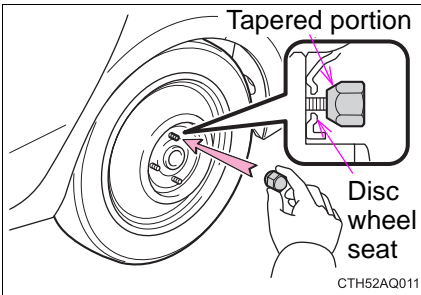

When replacing a steel wheel with a compact spare tire, tighten the wheel nuts until the tapered portion comes into loose contact with the disc wheel seat.

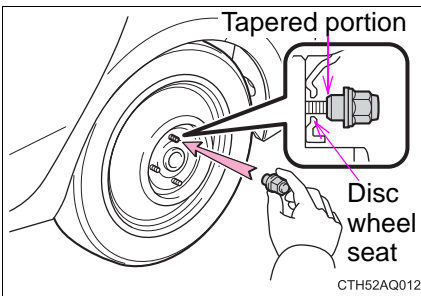

When replacing an aluminum wheel with a compact spare tire, tighten the wheel nuts until the tapered portion comes into loose contact with the disc wheel seat.

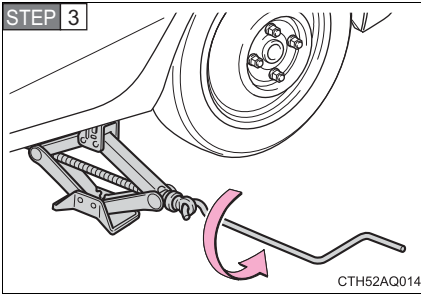

Lower the vehicle.

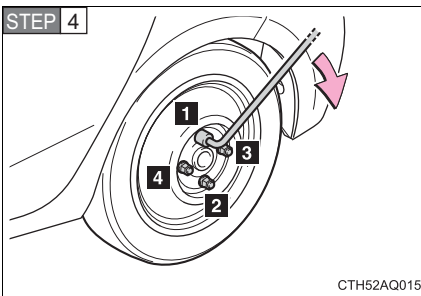

Firmly tighten each wheel nut two or three times in the order shown in the illustration.

Tightening torque:
76 ft•lbf (103 N•m, 10.5 kgf•m)

STEP 5 Stow the tire jack and all tools.

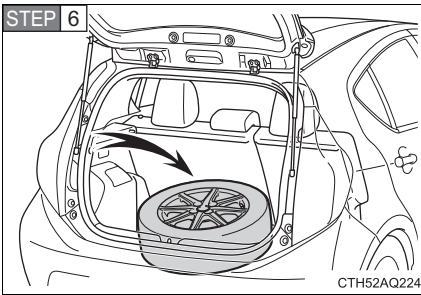

Stow the flat tire in the luggage compartment as shown in the illustration.

STEP 7 Stow the spare wheel cushions and luggage floor cover in the luggage compartment.

■ **The compact spare tire**

- The compact spare tire is identified by the label “TEMPORARY USE ONLY” on the tire sidewall.
Use the compact spare tire temporarily, and only in an emergency.
- Make sure to check the tire inflation pressure of the compact spare tire. (→P. 504)

■ **After completing the tire change**

The tire pressure warning system must be reset. (→P. 385)

■ **When using the compact spare tire**

As the compact spare tire is not equipped with a tire pressure warning valve and transmitter, low inflation pressure of the spare tire will not be indicated by the tire pressure warning system. Also, if you replace the compact spare tire after the tire pressure warning light comes on, the light remains on.

■ **If you have a flat front tire on a road covered with snow or ice**

Install the compact spare tire on one of the rear wheels of the vehicle. Perform the following steps and fit tire chains to the front tires:

STEP 1 Replace a rear tire with the compact spare tire.

STEP 2 Replace the flat front tire with the tire removed from the rear of the vehicle.

STEP 3 Fit tire chains to the front tires.

 CAUTION**■ When using the compact spare tire**

- Remember that the compact spare tire provided is specifically designed for use with your vehicle. Do not use your compact spare tire on another vehicle.
- Do not use more than one compact spare tire simultaneously.
- Replace the compact spare tire with a standard tire as soon as possible.
- Avoid sudden acceleration, deceleration and braking, as well as sharp cornering.

■ When storing the compact spare tire

Be careful not to catch fingers or other body parts between the compact spare tire and the body of the vehicle.

■ When the compact spare tire is attached

The vehicle speed may not be correctly detected, and the following systems may not operate correctly:

- ABS & Brake assist
- VSC
- TRAC
- EPS
- Cruise control (if equipped)

■ Speed limit when using the compact spare tire

Do not drive at speeds in excess of 50 mph (80 km/h) when a compact spare tire is installed on the vehicle.

The compact spare tire is not designed for driving at high speeds. Failure to observe this precaution may lead to an accident causing death or serious injury.

 CAUTION

■ **Using the tire jack**

Improper use of the tire jack may cause the vehicle to suddenly fall off the jack, leading to death or serious injury.

- Do not use the tire jack for any purpose other than replacing tires or installing and removing tire chains.
- Only use the tire jack that comes with this vehicle for replacing a flat tire.
Do not use it on other vehicles, and do not use other tire jacks for replacing tires on this vehicle.
- Always check that the tire jack is securely set to the jack point.
- Do not put any part of your body under the vehicle while it is supported by the jack.
- Do not start or run the hybrid system while your vehicle is supported by the jack.
- Do not raise the vehicle while someone is inside.
- When raising the vehicle, do not put an object on or under the jack.
- Do not raise the vehicle to a height greater than that required to replace the tire.
- Use a jack stand if it is necessary to get under the vehicle.

Take particular care when lowering the vehicle to ensure that no one working on or near the vehicle may be injured.

 CAUTION**■ Replacing a flat tire**

- Do not touch the disc wheels or the area around the brakes immediately after the vehicle has been driven.
After the vehicle has been driven the disc wheels and the area around the brakes will be extremely hot. Touching these areas with hands, feet or other body parts while changing a tire, etc. may result in burns.
- Do not attach a heavily damaged wheel ornament, as it may fly off the wheel while the vehicle is moving.
- Failure to follow these precautions could cause the wheel nuts to loosen and the tire to fall off, resulting in death or serious injury.
 - Have the wheel nuts tightened with a torque wrench to 76 ft•lbf (103 N•m, 10.5 kgf•m) as soon as possible after changing wheels.
 - When installing a tire, only use wheel nuts that have been specifically designed for that wheel.
 - If there are any cracks or deformations in the bolt screws, nut threads or bolt holes of the wheel, have the vehicle inspected by your Toyota dealer.
 - When installing the wheel nuts, be sure to install them with the tapered ends facing inward. (→P. 397)

 NOTICE

■ **Do not drive the vehicle with a flat tire.**

Do not continue driving with a flat tire.

Driving even a short distance with a flat tire can damage the tire and the wheel beyond repair.

■ **Be careful when driving over bumps with the compact spare tire installed on the vehicle.**

The vehicle becomes lower when driving with the compact spare tire compared to when driving with standard tires. Be careful when driving over uneven road surfaces.

■ **Driving with tire chains and the compact spare tire**

Do not fit tire chains to the compact spare tire.

Tire chains may damage the vehicle body and adversely affect driving performance.

■ **When replacing the tires**

When removing or fitting the wheels, tires or the tire pressure warning valve and transmitter, contact your Toyota dealer as the tire pressure warning valve and transmitter may be damaged if not handled correctly.

■ **To avoid damage to the tire pressure warning valves and transmitters**

When a tire is repaired with liquid sealants, the tire pressure warning valve and transmitter may not operate properly. If a liquid sealant is used, contact your Toyota dealer or other qualified service shop as soon as possible. Make sure to replace the tire pressure warning valve and transmitter when replacing the tire. (→P. 385)

If the hybrid system will not start

Reasons for the hybrid system not starting vary depending on the situation. Check the following and perform the appropriate procedure:

■ **The hybrid system will not start even though the correct starting procedure is being followed. (→P. 160, 164)**

One of the following may be the cause of the problem:

- Vehicles with a smart key system: The electronic key may not be functioning properly. (→P. 479)
- There may not be sufficient fuel in the vehicle's tank. Refuel the vehicle. (→P. 105)
- Vehicles with immobilizer system: There may be a malfunction in the immobilizer system. (→P. 110)
- There may be a malfunction in the steering lock system.
- Vehicles with a smart key system: The hybrid system may be malfunctioning due to an electrical problem such as an open circuit or a blown fuse. However, depending on the type of malfunction, an interim measure is available to start the hybrid system. (→P. 476)

■ **The interior lights and headlights are dim, or the horn does not sound or sounds at a low volume.**

One of the following may be the cause of the problem:

- The 12-volt battery may be discharged. (→P. 481)
- The 12-volt battery terminal connections may be loose or corroded.

■ **The interior lights and headlights do not turn on, or the horn does not sound.**

One of the following may be the cause of the problem:

- One or both of the 12-volt battery terminals may be disconnected.
- The 12-volt battery may be discharged. (→P. 481)

Contact your Toyota dealer if the problem cannot be repaired, or if repair procedures are unknown.

Emergency start function (vehicles with a smart key system)

When the hybrid system does not start, the following steps can be used as an interim measure to start the hybrid system if the “POWER” switch is functioning normally:

STEP 1 Shift the shift lever to P.

STEP 2 Set the parking brake.

STEP 3 Turn the “POWER” switch to ACCESSORY mode.

STEP 4 Press and hold the “POWER” switch for about 15 seconds while depressing the brake pedal firmly.

Even if the hybrid system can be started using the above steps, the system may be malfunctioning. Have the vehicle inspected by your Toyota dealer.

If the shift lever cannot be shifted from P

If the shift lever cannot be shifted with your foot on the brake pedal, there may be a problem with the shift lock system (a system to prevent accidental operation of the shift lever). Have the vehicle inspected by your Toyota dealer immediately.

The following steps may be used as an emergency measure to ensure that the shift lever can be shifted:

STEP 1 Set the parking brake.

STEP 2 **Vehicles without a smart key system**

Turn the engine switch to the “ACC” position.

Vehicles with a smart key system

Turn the “POWER” switch to ACCESSORY mode.

STEP 3 Depress the brake pedal.

STEP 4

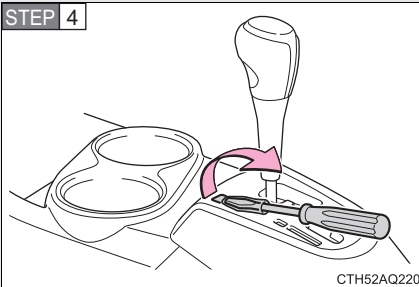

Pry the cover up with a flat-head screwdriver or equivalent tool.

To prevent damage to the cover, cover the tip of the screwdriver with a rag.

STEP 5

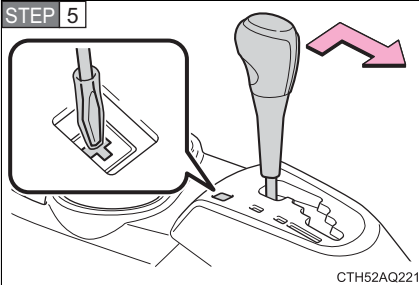

Press the shift lock override button.

The shift lever can be shifted while the button is pressed.

If you lose your keys

New genuine keys can be made by your Toyota dealer. For vehicles without a smart key system, bring a master key and the key number stamped on the key number plate. For vehicles with a smart key system, bring the other key and the key number stamped on the key number plate.

5-2. Steps to take in an emergency

If the electronic key does not operate properly (vehicles with a smart key system)

If communication between the electronic key and vehicle is interrupted (→P. 55) or the electronic key cannot be used because the battery is depleted, the smart key system and wireless remote control cannot be used. In such cases, the doors can be opened and the hybrid system can be started by following the procedure below.

Locking and unlocking the doors

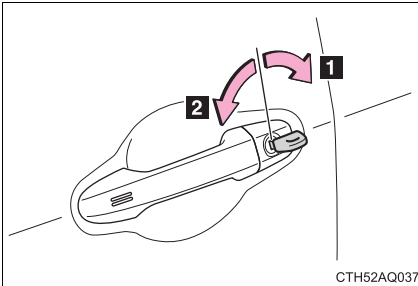

Use the mechanical key (→P. 44) in order to perform the following operations (driver's door only):

- 1** Unlocks the doors
- 2** Locks all the doors

Turning the key rearward unlocks the driver's door. Turning the key once again within 5 seconds unlocks the other doors.

Starting the hybrid system

STEP 1 Ensure that the shift lever is in P and depress the brake pedal.

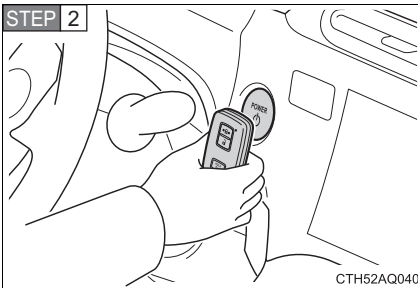

Touch the Toyota emblem side of the electronic key to the "POWER" switch.

When the electronic key is detected, a buzzer sounds and the "POWER" switch will turn to ON mode.

STEP 3 Firmly depress the brake pedal and check that  is displayed on the multi-information display.

STEP 4 Press the “POWER” switch.

In the event that the “POWER” switch still cannot be operated, contact your Toyota dealer.

■ Stopping the hybrid system

Shift the shift lever to P and press the “POWER” switch as you normally do when stopping the hybrid system.

■ Replacing the key battery

As the above procedure is a temporary measure, it is recommended that the electronic key battery be replaced immediately when the battery is depleted. (→P. 401)

■ Changing “POWER” switch modes

Release the brake pedal and press the “POWER” switch in **STEP 3** above. The hybrid system does not start and modes will be changed each time the switch is pressed. (→P. 166)

■ If the doors cannot be locked or unlocked by the smart key system

Lock and unlock the doors by the mechanical key or wireless remote control.

■ When the electronic key does not work properly

Check if battery-saving mode is set. If it is set, cancel the function. (→P. 54)

5-2. Steps to take in an emergency

If the vehicle 12-volt battery is discharged

The following procedures may be used to start the hybrid system if the vehicle's 12-volt battery is discharged.

You can also call your Toyota dealer or a qualified repair shop.

If you have a set of jumper (or booster) cables and a second vehicle with a 12-volt battery, you can jump start your vehicle by following the steps below.

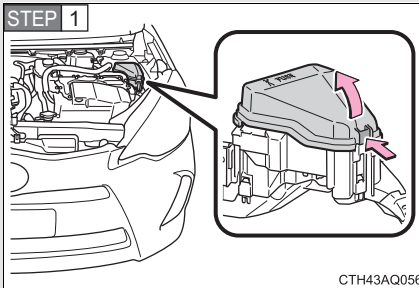

Open the hood and remove the fuse box cover.

Push the tab in and lift the cover off.

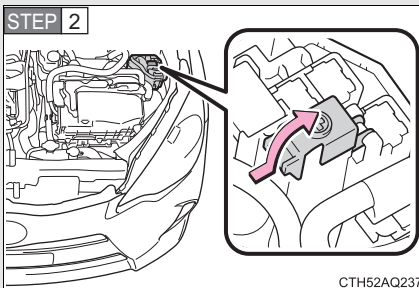

Open the exclusive jump starting terminal cover.

Push the tab in and open the cover.

STEP 3

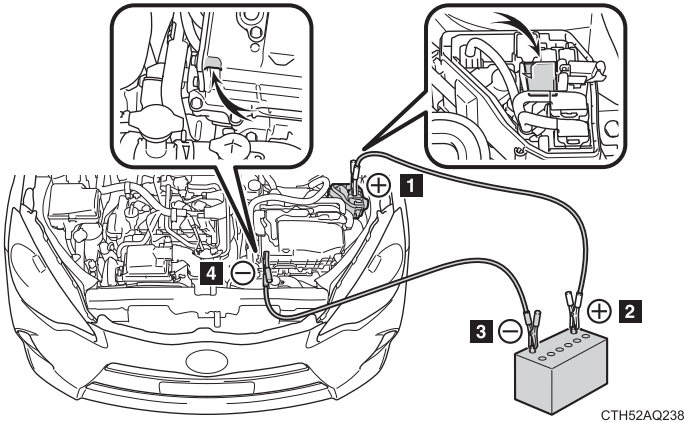

Connect the jumper cables according to the following procedure:

- 1** Connect a positive jumper cable clamp to the exclusive jump starting terminal on your vehicle.
- 2** Connect the clamp on the other end of the positive cable to the positive (+) battery terminal on the second vehicle.
- 3** Connect a negative cable clamp to the negative (-) battery terminal on the second vehicle.
- 4** Connect the clamp at the other end of the negative cable to a solid, stationary, unpainted metallic point away from the exclusive jump starting terminal and any moving parts, as shown in the illustration.

STEP 4 Start the engine of the second vehicle. Increase the engine speed slightly and maintain that level for approximately 5 minutes to recharge the 12-volt battery of your vehicle.

STEP 5 Vehicles with a smart key system only: Open and close any of the doors of your vehicle with the “POWER” switch off.

STEP 6 **Vehicles without a smart key system**

Maintain the engine speed of the second vehicle and start the hybrid system of your vehicle by turning the engine switch to the “ON” position.

Vehicles with a smart key system

Maintain the engine speed of the second vehicle and start the hybrid system of your vehicle by turning the “POWER” switch to ON mode.

STEP 7 Make sure the “READY” indicator comes on. If the indicator does not come on, contact your Toyota dealer.

STEP 8 Once the hybrid system has started, remove the jumper cables in the exact reverse order from which they were connected.

STEP 9 Close the exclusive jump starting terminal cover, and reinstall the fuse box cover to its original position.

When installing, first hook the fuse box cover onto the two rear tabs.

Once the hybrid system starts, have the vehicle inspected at your Toyota dealer as soon as possible.

■ Starting the hybrid system when the 12-volt battery is discharged

The hybrid system cannot be started by push-starting.

■ To prevent 12-volt battery discharge

- Turn off the headlights and the audio system while the hybrid system is off.
- Turn off any unnecessary electrical components when the vehicle is running at a low speed for an extended period, such as in heavy traffic.

■ Precautions when the 12-volt battery is discharged (vehicles with a smart key system)

- In some cases, it may not be possible to unlock the doors using the smart key system immediately after the 12-volt battery has been disconnected and reconnected. Use the wireless remote control or the mechanical key to lock or unlock the doors.
- The hybrid system may not start on the first attempt after the 12-volt battery has recharged but will start normally after the second attempt. This is not a malfunction.
- The “POWER” switch mode is memorized by the vehicle. When the 12-volt battery is reconnected, the system will return to the mode it was in before the 12-volt battery was discharged. Before disconnecting the 12-volt battery, turn the “POWER” switch off.
If the “POWER” switch was in ACCESSORY or ON mode before the 12-volt battery was discharged, the audio system and/or air conditioning system may operate when the 12-volt battery is reconnected.

■ Charging the 12-volt battery

The electricity stored in the 12-volt battery will discharge gradually even when the vehicle is not in use, due to natural discharge and the draining effects of certain electrical appliances. If the vehicle is left for a long time, the 12-volt battery may discharge, and the hybrid system may be unable to start. (The 12-volt battery recharges automatically while the hybrid system is operating.)

 **CAUTION****■ Avoiding 12-volt battery fires or explosions**

Observe the following precautions to prevent accidentally igniting the flammable gas that may be emitted from the 12-volt battery:

- Make sure each jumper cable is connected to the correct terminal and that it is not unintentionally in contact with anything other than the intended terminal.
- Do not allow the other end of the jumper cable connected to the “+” terminal to come into contact with any other parts or metal surfaces in the area, such as brackets or unpainted metal.
- Do not allow the + and - clamps of the jumper cables to come into contact with each other.
- Do not smoke, use matches, cigarette lighters or allow open flame near the 12-volt battery.

■ After recharging the 12-volt battery

Have the 12-volt battery inspected at your Toyota dealer as soon as possible.

If the 12-volt battery is deteriorating, continued use may cause the 12-volt battery to emit a malodorous gas, which may be detrimental to the health of passengers.

■ When replacing the 12-volt battery

→P. 383

 **CAUTION**

■ **12-volt battery precautions**

The 12-volt battery contains poisonous and corrosive acidic electrolyte, while related parts contain lead and lead compounds. Observe the following precautions when handling the 12-volt battery:

- When working with the 12-volt battery, always wear safety glasses and take care not to allow any battery fluids (acid) to come into contact with skin, clothing or the vehicle body.
- Do not lean over the 12-volt battery.
- In the event that battery fluid comes into contact with the skin or eyes, immediately wash the affected area with water and seek medical attention. Place a wet sponge or cloth over the affected area until medical attention can be received.
- Always wash your hands after handling the battery support, terminals, and other battery-related parts.
- Do not allow children near the 12-volt battery.

 **NOTICE**

■ **When handling jumper cables**

When connecting the jumper cables, ensure that they do not become entangled in the cooling fan or belt.

■ **Exclusive jump starting terminal**

The exclusive jump starting terminal is to be used when charging the 12-volt battery from another vehicle in an emergency. It cannot be used to jump start another vehicle.

5-2. Steps to take in an emergency If your vehicle overheats

The following may indicate that your vehicle is overheating.

-  (→P. 448) is shown on the multi-information display.
- The hybrid system overheat warning message (→P. 452) is shown on the multi-information display.
- Steam comes out from under the hood.

Correction procedures

■ If  is shown on the multi-information display

STEP 1 Stop the vehicle in a safe place and turn off the air conditioning system, and then stop the hybrid system.

STEP 2 If you see steam:

Carefully lift the hood after the steam subsides.

If you do not see steam:

Carefully lift the hood.

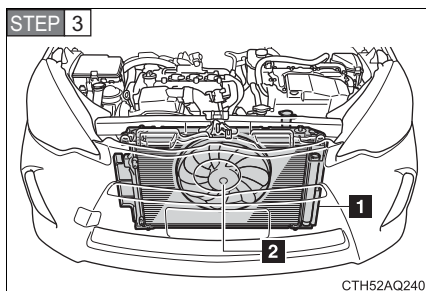

After the hybrid system has cooled down sufficiently, inspect the hoses and radiator core (radiator) for any leaks.

- 1** Radiator
- 2** Cooling fan

If a large amount of coolant leaks, immediately contact your Toyota dealer.

5-2. Steps to take in an emergency

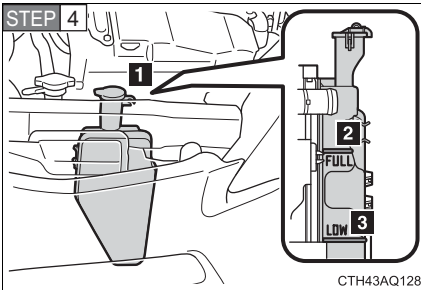

The coolant level is satisfactory if it is between the “FULL” and “LOW” lines on the reservoir.

- 1** Reservoir
- 2** “FULL”
- 3** “LOW”

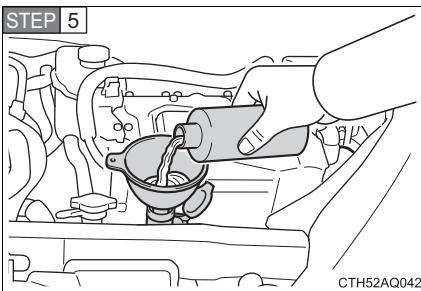

Add coolant if necessary.

Water can be used in an emergency if coolant is unavailable.

STEP 6 Start the hybrid system and turn the air conditioning system on to check that the radiator cooling fan operates and to check for coolant leaks from the radiator or hoses.

The fan operates when the air conditioning system is turned on immediately after a cold start. Confirm that the fan is operating by checking the fan sound and air flow. If it is difficult to check these, turn the air conditioning system on and off repeatedly. (The fan may not operate in freezing temperatures.)

STEP 7 If the fan is not operating:

Stop the hybrid system immediately and contact your Toyota dealer.

If the fan is operating:

Have the vehicle inspected at the nearest Toyota dealer.

■ **If the hybrid system overheat warning message is shown on the multi-information display**

STEP 1 Stop the vehicle in a safe place.

STEP 2 Stop the hybrid system and carefully lift the hood.

STEP 3

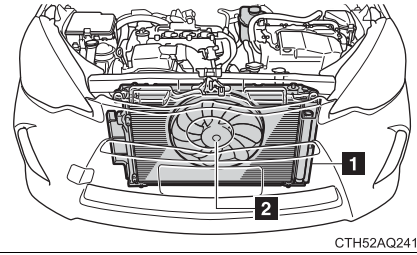

CTH52AQ241

After the hybrid system has cooled down, inspect the hoses and radiator core (radiator) for any leaks.

1 Radiator

2 Cooling fan

If a large amount of coolant leaks, immediately contact your Toyota dealer.

STEP 4

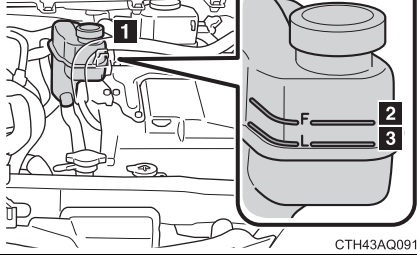

CTH43AQ091

The coolant level is satisfactory if it is between the “F” and “L” lines on the reservoir.

1 Reservoir

2 “F”

3 “L”

STEP 5

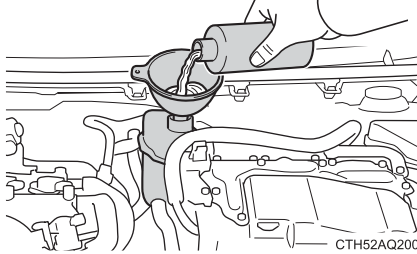

CTH52AQ200

Add coolant if necessary.

Water can be used in an emergency if coolant is unavailable.

STEP 6 Start the hybrid system and check for the multi-information display.

If the message does not disappear:

Stop the hybrid system and contact your Toyota dealer.

If the message is not displayed:

Have the vehicle inspected at the nearest Toyota dealer.

 **CAUTION**

■ To prevent an accident or injury when inspecting under the hood of your vehicle

- If steam is seen coming from under the hood, do not open the hood until the steam has subsided. The engine compartment may be very hot, causing serious injuries such as burns.
- After the hybrid system has been turned off, check that  on the multi-information display and the “READY” indicator are off. When the hybrid system is operating, the gasoline engine may automatically start, or the cooling fan may suddenly operate even if the gasoline engine stops. Do not touch or approach rotating parts such as the fan, which may lead to fingers or clothing (especially a tie, a scarf or a muffler) getting caught, resulting in serious injury.
- Do not loosen the radiator cap while the hybrid system and radiator are hot. Serious injuries, such as burns, may result from hot coolant and steam released under pressure.

**NOTICE****■ When adding engine/power control unit coolant**

Wait until the hybrid system has cooled down before adding engine/power control unit coolant.

When adding coolant, do so slowly. Adding cool coolant to a hot hybrid system too quickly can cause damage to the hybrid system.

■ To prevent damage to the cooling system

Observe the following precautions:

- Avoid contaminating the coolant with foreign matter (such as sand or dust etc.).
- Do not use any coolant additive.

5-2. Steps to take in an emergency If the vehicle becomes stuck

Carry out the following procedures if the tires spin or the vehicle becomes stuck in mud, dirt or snow:

STEP 1 Shift the shift lever to P and set the parking brake. Stop the hybrid system.

STEP 2 Remove the mud, snow or sand from around the stuck tire.

STEP 3 Place wood, stones or some other material under the tires to help provide traction.

STEP 4 Restart the hybrid system.

STEP 5 Shift the shift lever to the D or R position and carefully apply the accelerator to free the vehicle.

CAUTION

■ **When attempting to free a stuck vehicle**

If you choose to push the vehicle back and forth to free it, make sure the surrounding area is clear to avoid striking other vehicles, objects or people. The vehicle may also lunge forward or lunge back suddenly as it becomes free. Use extreme caution.

■ **When shifting the shift lever**

Be careful not to shift the shift lever with the accelerator pedal depressed. This may lead to unexpected rapid acceleration of the vehicle that may cause an accident resulting in death or serious injury.

NOTICE

■ **To avoid damage to the transmission and other components**

- Avoid spinning the wheels and depressing the accelerator pedal more than necessary.
- If the vehicle remains stuck even after these procedures are performed, the vehicle may require towing to be freed.

5-2. Steps to take in an emergency

If your vehicle has to be stopped in an emergency

Only in an emergency, such as if it becomes impossible to stop the vehicle in the normal way, stop the vehicle using the following procedure:

STEP 1 Steadily step on the brake pedal with both feet and firmly depress it.

Do not pump the brake pedal repeatedly as this will increase the effort required to slow the vehicle.

STEP 2 Shift the shift lever to N.

If the shift lever is shifted to N

STEP 3 After slowing down, stop the vehicle in a safe place by the road.

STEP 4 Stop the hybrid system.

If the shift lever cannot be shifted to N

STEP 3 Keep depressing the brake pedal with both feet to reduce vehicle speed as much as possible.

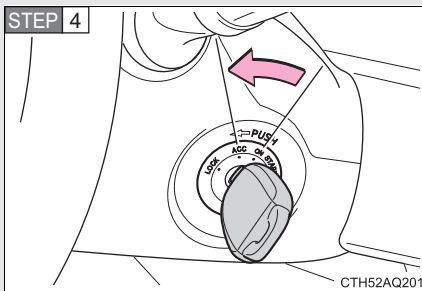

Vehicles without a smart key system: Stop the hybrid system by turning the engine switch to the "ACC" position.

STEP 4

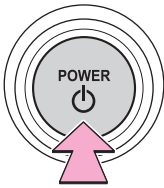

Press and hold for 2 seconds or more,
or press briefly 3 times or more

CTH52AQ043

Vehicles with a smart key system: To stop the hybrid system, press and hold the “POWER” switch for 2 consecutive seconds or more, or press it briefly 3 times or more in succession.

STEP 5

Stop the vehicle in a safe place by the road.



CAUTION

■ If the hybrid system has to be turned off while driving

Power assist for the steering wheel will be lost, making the steering wheel heavier to turn. Decelerate as much as possible before turning off the hybrid system.

- Vehicles without a smart key system: Never attempt to remove the key, as doing so will lock the steering wheel.

6-1. Specifications

Maintenance data (fuel, oil level, etc.)	496
Fuel information	506
Tire information	509

6-2. Customization

Customizable features	522
Items to initialize	528

6-1. Specifications

Maintenance data (fuel, oil level, etc.)

Dimensions and weights

Overall length		157.3 in. (3995 mm)
Overall width		66.7 in. (1695 mm)
Overall height* ¹		Without moon roof 56.9 in. (1445 mm) With moon roof 57.7 in. (1465 mm)
Wheelbase		100.4 in. (2550 mm)
Tread	Front	58.3 in. (1480 mm) ^{*2} 57.5 in. (1460 mm) ^{*3}
	Rear	58.1 in. (1475 mm) ^{*2} 57.1 in. (1450 mm) ^{*3}
Vehicle capacity weight (Occupants + luggage)		845 lb. (380 kg)

*1: Unladen vehicles

*2: P175/65R15 tires

*3: P195/50R16 tires

Vehicle identification

■ Vehicle identification number

The vehicle identification number (VIN) is the legal identifier for your vehicle. This is the primary identification number for your Toyota. It is used in registering the ownership of your vehicle.

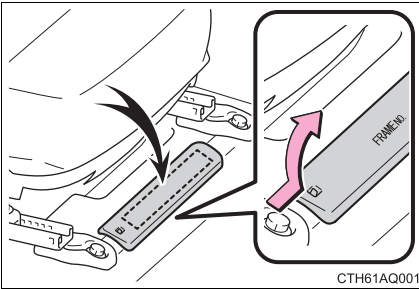

This number is stamped under the front passenger's seat.

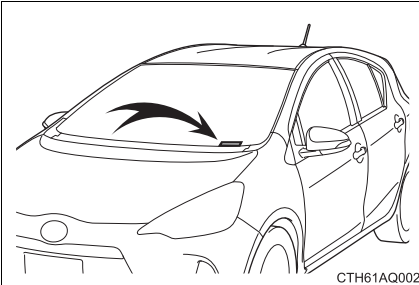

This number is stamped on the top left of the instrument panel.

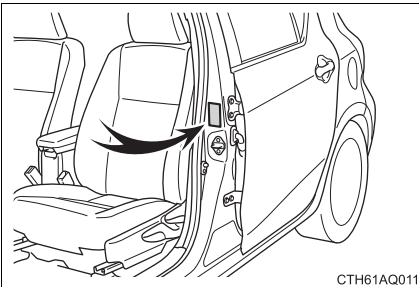

This number is also on the Certification Label.

■ Engine number

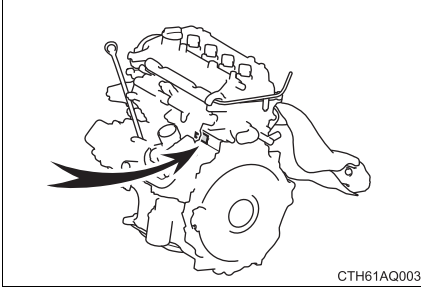

The engine number is stamped on the engine block as shown.

Engine

Model	1NZ-FXE
Type	4-cylinder in line, 4-cycle, gasoline
Bore and stroke	2.95 × 3.33 in. (75.0 × 84.7 mm)
Displacement	91.3 cu.in. (1497 cm ³)
Valve clearance (engine cold)	Intake: 0.006 — 0.010 in. (0.15 — 0.25 mm) Exhaust: 0.010 — 0.014 in. (0.25 — 0.35 mm)

Fuel

Fuel type	Unleaded gasoline only
Octane rating	87 (Research octane number 91) or higher
Fuel tank capacity (Reference)	9.5 gal. (36 L, 7.9 Imp. gal.)

Electric motor (Traction motor)

Type	Permanent magnet synchronous motor
Maximum output	45 kW
Maximum torque	125 ft•lbf (169 N•m, 17.2 kgf•m)

Hybrid battery (Traction battery)

Type	Nickel-metal hydride battery
Voltage	7.2 V/module
Capacity	6.5 Ah (3HR)
Quantity	20 modules
Overall voltage	144 V

Lubrication system

Oil capacity (Drain and refill — reference*)	
With filter	3.9 qt. (3.7 L, 3.3 Imp. qt.)
Without filter	3.6 qt. (3.4 L, 3.0 Imp. qt.)

*: The engine oil capacity is a reference quantity to be used when changing the engine oil. Warm up the engine and turn off the hybrid system, wait more than 5 minutes, and check the oil level on the dipstick.

■ Engine oil selection

“Toyota Genuine Motor Oil” is used in your Toyota vehicle. Use Toyota approved “Toyota Genuine Motor Oil” or equivalent to satisfy the following grade and viscosity.

Oil grade: ILSAC GF-5 multigrade engine oil

Recommended viscosity: SAE 0W-20

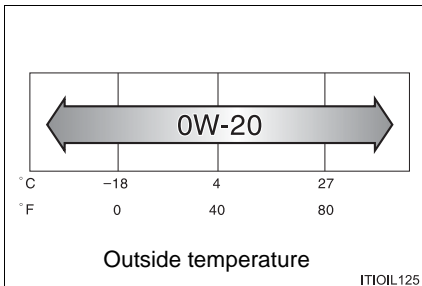

SAE 0W-20 is the best choice for good fuel economy and good starting in cold weather.

If SAE 0W-20 is not available, SAE 5W-20 oil may be used. However, it must be replaced with SAE 0W-20 at the next oil change.

Oil viscosity (0W-20 is explained here as an example):

- The 0W in 0W-20 indicates the characteristic of the oil which allows cold startability. Oils with a lower value before the W allow for easier starting of the engine in cold weather.
- The 20 in 0W-20 indicates the viscosity characteristic of the oil when the oil is at high temperature. An oil with a higher viscosity (one with a higher value) may be better suited if the vehicle is operated at high speeds, or under extreme load conditions.

How to read oil container label:

The International Lubricant Specification Advisory Committee (ILSAC) Certification Mark is added to some oil containers to help you select the oil you should use.

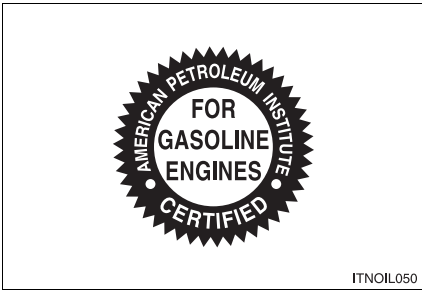

Cooling system

Capacity Gasoline engine Power control unit	5.6 qt. (5.3 L, 4.7 Imp. qt.) 1.7 qt. (1.6 L, 1.4 Imp. qt.)
Coolant type	Use either of the following: <ul style="list-style-type: none"> • “Toyota Super Long Life Coolant” • A similar high-quality ethylene glycol-based non-silicate, non-amine, non-nitrite, and non-borate coolant with long-life hybrid organic acid technology Do not use plain water alone.

Ignition system

Spark plug	
Make	DENSO FK16R-A8
Gap	0.03 in. (0.8 mm)

NOTICE

■ Iridium-tipped spark plugs

Use only iridium-tipped spark plugs. Do not adjust the spark plug gap.

Electrical system

12-volt battery	
Open voltage* at 68°F (20°C):	
Fully charged	12.5 V or over
Half charged	11.0 — 12.5 V
Discharged	Under 11.0 V
	(*: Voltage checked 20 minutes after the hybrid system and all the lights are turned off)
Charging rates	3.5 A or less (Recharge within 10 hours)

Hybrid transmission

Fluid capacity*	3.5 qt. (3.3 L, 2.9 Imp. qt.)
Fluid type	Toyota Genuine ATF WS

*: The fluid capacity is a reference quantity. If replacement is necessary, contact your Toyota dealer.



NOTICE

■ Transmission fluid type

Using transmission fluid other than “Toyota Genuine ATF WS” may cause deterioration in shift quality, locking up of the transmission accompanied by vibration and, ultimately, damage to the vehicle’s transmission.

Brakes

Pedal clearance ^{*1}	2.8 in. (70 mm) Min.
Pedal free play	0.04 — 0.24 in. (1.0 — 6.0 mm)
Brake pad wear limit	0.04 in. (1.0 mm)
Brake lining wear limit	0.04 in. (1.0 mm)
Parking brake lever travel ^{*2}	8 — 11 clicks
Fluid type	SAE J1703 or FMVSS No.116 DOT 3

*1: Minimum pedal clearance when depressed with a force of 66 lbf (294 N, 30 kgf) while the hybrid system is operating

*2: Parking brake lever travel when pulled up with a force of 45 lbf (200 N, 20 kgf)

Steering

Free play	Less than 1.2 in. (30 mm)
-----------	---------------------------

Tires and wheels

15-inch tires

Tire size	P175/65R15 84H, T125/70D16 96M (spare)
Tire inflation pressure (recommended cold tire inflation pressure)	Front: 35 psi (240 kPa, 2.4 kgf/cm ² or bar) Rear: 33 psi (230 kPa, 2.3 kgf/cm ² or bar) Spare: 60 psi (420 kPa, 4.2 kgf/cm ² or bar) Never exceed the maximum cold tire inflation pressure indicated on the tire sidewall.
Wheel size	15 × 5J, 16 × 4T (spare)
Wheel nut torque	76 ft•lbf (103 N•m, 10.5 kgf•m)

16-inch tires

Tire size	P195/50R16 83V, T125/70D16 96M (spare)
Front and rear tire inflation pressure (recommended cold tire inflation pressure)	Front: 32 psi (220 kPa, 2.2 kgf/cm ² or bar) Rear: 29 psi (200 kPa, 2.0 kgf/cm ² or bar) Spare: 60 psi (420 kPa, 4.2 kgf/cm ² or bar) Never exceed the maximum cold tire inflation pressure indicated on the tire sidewall.
Wheel size	16 × 6J, 16 × 4T (spare)
Wheel nut torque	76 ft•lbf (103 N•m, 10.5 kgf•m)

Light bulbs

	Light bulbs	Bulb No	W	Type
Exterior	Headlights Low beam	9704	55	A
	High beam	9005	60	B
	Parking lights	—	5	D
	Front turn signal lights	—	21	E
	Front fog lights* ¹	—	19	C
	Tail and rear side marker lights	—	5	D
	License plate lights	—	5	D
	Back-up lights	—	16	D
	Side turn signal lights	—	5	E* ²
	Front side marker lights	—	5	D
Rear turn signal lights	—	21	E	
Interior	Interior lights/personal lights	—	5	D
	Luggage compartment light* ¹	—	5	D

*1: If equipped

*2: Side turn signal lights should be replaced as an assembly.

A: H11 halogen bulbs

B: HB3 halogen bulbs

C: H16 halogen bulbs

D: Wedge base bulbs (clear)

E: Wedge base bulbs (amber)

6-1. Specifications

Fuel information

You must only use unleaded gasoline in your vehicle.

Select octane rating 87 (Research Octane Number 91) or higher. Use of unleaded gasoline with an octane rating lower than 87 may result in engine knocking. Persistent knocking can lead to engine damage.

At minimum, the gasoline you use should meet the specifications of ASTM D4814 in the U.S.A. and CGSB3.5-M93 in Canada.

■ Fuel tank opening for unleaded gasoline

To help prevent incorrect fueling, your vehicle has a fuel tank opening that only accommodates the special nozzle on unleaded fuel pumps.

■ Gasoline quality

In very few cases, driveability problems may be caused by the brand of gasoline you are using. If driveability problems persist, try changing the brand of gasoline. If this does not correct the problem, consult your Toyota dealer.

■ Gasoline quality standards

- Automotive manufacturers in the U.S.A., Europe and Japan have developed a specification for fuel quality called the World-Wide Fuel Charter (WWFC), which is expected to be applied worldwide.
- The WWFC consists of four categories that are based on required emission levels. In the U.S., category 4 has been adopted.
- The WWFC improves air quality by lowering emissions in vehicle fleets, and improves customer satisfaction through better performance.

■ Recommendation of the use of gasoline containing detergent additives

- Toyota recommends the use of gasoline that contains detergent additives to avoid the build-up of engine deposits.
- All gasoline sold in the U.S.A. contains minimum detergent additives to clean and/or keep clean intake systems, per EPA's lowest additives concentration program.
- Toyota strongly recommends the use of Top Tier Detergent Gasoline. For more information on Top Tier Detergent Gasoline and a list of marketers, please go to the official website www.toptiergas.com.

■ Recommendation of the use of cleaner burning gasoline

Cleaner burning gasoline, including reformulated gasoline that contains oxygenates such as ethanol or MTBE (Methyl Tertiary Butyl Ether) is available in many areas.

Toyota recommends the use of cleaner burning gasoline and appropriately blended reformulated gasoline. These types of gasoline provide excellent vehicle performance, reduce vehicle emissions and improve air quality.

■ Non-recommendation of the use of blended gasoline

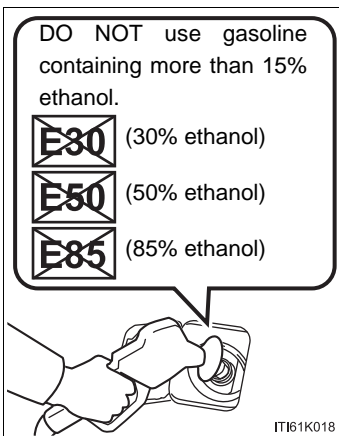

- Use only gasoline containing up to 15% ethanol.

DO NOT use any flex-fuel or gasoline that could contain more than 15% ethanol, including from any pump labeled E30, E50, E85 (which are only some examples of fuel containing more than 15% ethanol).

- If you use gasohol in your vehicle, be sure that it has an octane rating no lower than 87.
- Toyota does not recommend the use of gasoline containing methanol.

■ Non-recommendation of the use of gasoline containing MMT

Some gasoline contains an octane enhancing additive called MMT (Methylcyclopentadienyl Manganese Tricarbonyl).

Toyota does not recommend the use of gasoline that contains MMT. If fuel containing MMT is used, your emission control system may be adversely affected.

The malfunction indicator lamp on the instrument cluster may come on. If this happens, contact your Toyota dealer for service.

■ **If your engine knocks**

- Consult your Toyota dealer.
- You may occasionally notice light knocking for a short time while accelerating or driving uphill. This is normal and there is no need for concern.

 **NOTICE**

■ **Notice on fuel quality**

- Do not use improper fuels. If improper fuels are used, the engine will be damaged.
- Do not use leaded gasoline.
Leaded gasoline can cause damage to your vehicle's three-way catalytic converters causing the emission control system to malfunction.
- Do not use gasohol other than the type previously stated.
Other gasohol may cause fuel system damage or vehicle performance problems.
- Using unleaded gasoline with an octane number or rating lower than the level previously stated will cause persistent heavy knocking.
At worst, this will lead to engine damage.

■ **Fuel-related poor driveability**

If poor driveability is encountered after using a different type of fuel (poor hot starting, vaporization, engine knocking, etc.), discontinue the use of that type of fuel.

■ **When refueling with gasohol**

Take care not to spill gasohol. It can damage your vehicle's paint.

6-1. Specifications

Tire information

Typical tire symbols

Full-size tire

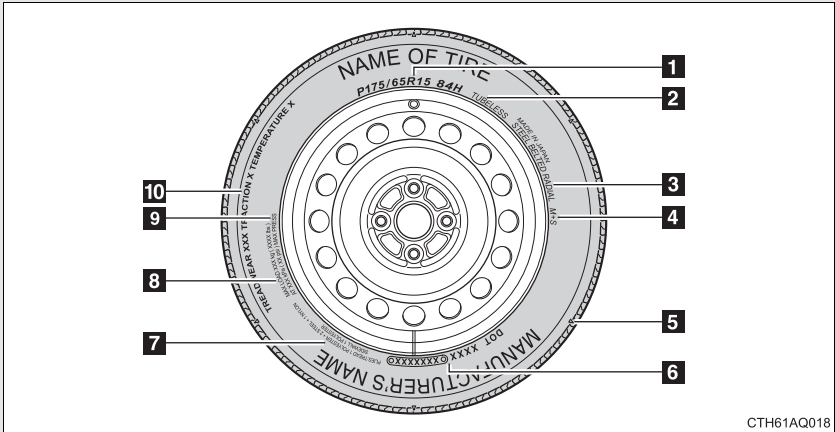

Compact spare tire

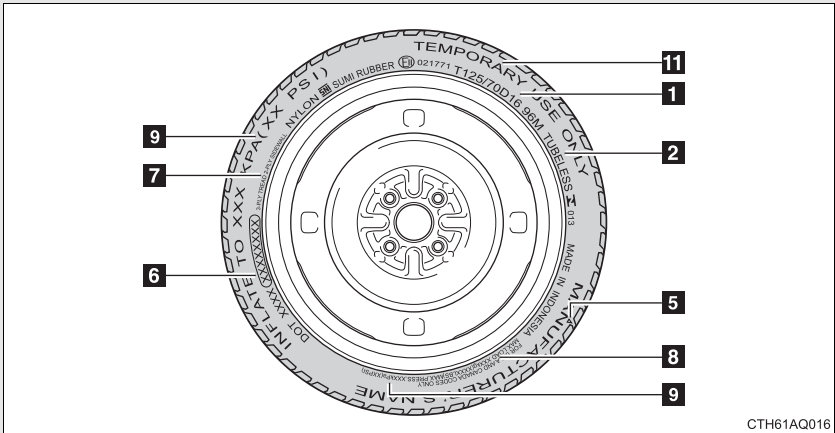

1 Tire size (→P. 512)

2 TUBELESS or TUBE TYPE

A tubeless tire does not have a tube and air is directly put into the tire. A tube type tire has a tube inside the tire and the tube maintains the air pressure.

3 Radial tires or bias-ply tires

A radial tire has “RADIAL” on the sidewall. A tire not marked “RADIAL” is a bias-ply tire.

4 Summer tires or all season tires (→P. 388)

An all season tire has “M+S” on the sidewall. A tire not marked “M+S” is a summer tire.

5 Location of treadwear indicators (→P. 384)

6 DOT and Tire Identification Number (TIN) (→P. 511)

7 Tire ply composition and materials

Plies are layers of rubber-coated parallel cords. Cords are the strands which form the plies in a tire.

8 Load limit at maximum cold tire inflation pressure (→P. 387)

9 Maximum cold tire inflation pressure (→P. 504)

This means the pressure to which a tire may be inflated.

10 Uniform tire quality grading

For details, see “Uniform Tire Quality Grading” that follows.

11 “TEMPORARY USE ONLY” (→P. 470)

A compact spare tire is identified by the phrase “TEMPORARY USE ONLY” molded on its sidewall. This tire is designed for temporary emergency use only.

Typical DOT and Tire Identification Number (TIN)

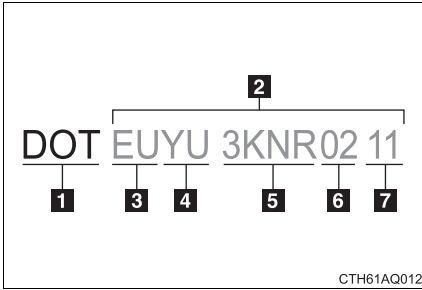

- 1** DOT symbol*
- 2** Tire Identification Number (TIN)
- 3** Tire manufacturer's identification mark
- 4** Tire size code
- 5** Manufacturer's optional tire type code (3 or 4 letters)
- 6** Manufacturing week
- 7** Manufacturing year

*: The DOT symbol certifies that the tire conforms to applicable Federal Motor Vehicle Safety Standards.

Tire size

■ Typical tire size information

The illustration indicates typical tire size.

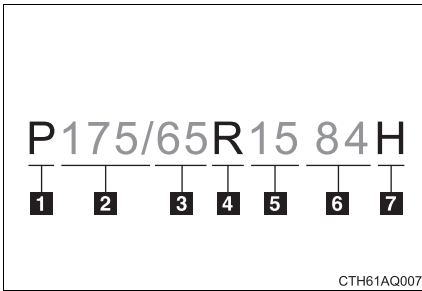

- 1** Tire use
(P = Passenger car,
T = Temporary use)
- 2** Section width (millimeters)
- 3** Aspect ratio
(tire height to section width)
- 4** Tire construction code
(R = Radial, D = Diagonal)
- 5** Wheel diameter (inches)
- 6** Load index (2 digits or 3 digits)
- 7** Speed symbol
(alphabet with one letter)

■ Tire dimensions

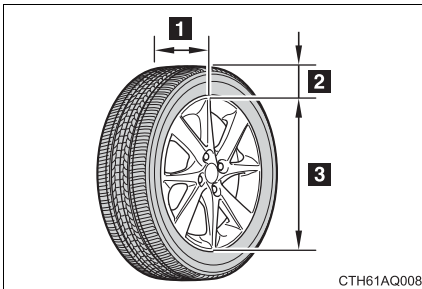

- 1** Section width
- 2** Tire height
- 3** Wheel diameter

Tire section names

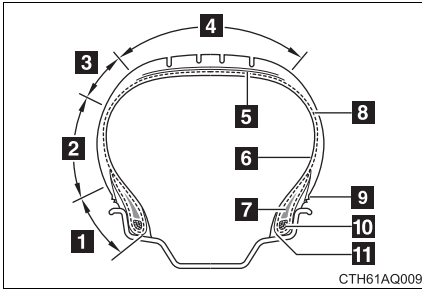

- 1** Bead
- 2** Sidewall
- 3** Shoulder
- 4** Tread
- 5** Belt
- 6** Inner liner
- 7** Reinforcing rubber
- 8** Carcass
- 9** Rim lines
- 10** Bead wires
- 11** Chafer

Uniform Tire Quality Grading

This information has been prepared in accordance with regulations issued by the National Highway Traffic Safety Administration of the U.S. Department of Transportation.

It provides the purchasers and/or prospective purchasers of Toyota vehicles with information on uniform tire quality grading.

Your Toyota dealer will help answer any questions you may have as you read this information.

■ DOT quality grades

All passenger vehicle tires must conform to Federal Safety Requirements in addition to these grades. Quality grades can be found where applicable on the tire sidewall between tread shoulder and maximum section width.

For example: Treadwear 200 Traction AA Temperature A

■ Treadwear

The treadwear grade is a comparative rating based on the wear rate of the tire when tested under controlled conditions on a specified government test course.

For example, a tire graded 150 would wear one and a half (1 - 1/2) times as well on the government course as a tire graded 100.

The relative performance of tires depends upon the actual conditions of their use. Performance may differ significantly from the norm due to variations in driving habits, service practices and differences in road characteristics and climate.

■ Traction AA, A, B, C

The traction grades, from highest to lowest, are AA, A, B and C, and they represent the tire's ability to stop on wet pavement as measured under controlled conditions on specified government test surfaces of asphalt and concrete.

A tire marked C may have poor traction performance.

Warning: The traction grade assigned to this tire is based on braking (straight ahead) traction tests and does not include cornering (turning) traction.

■ Temperature A, B, C

The temperature grades are A (the highest), B, and C, representing the tire's resistance to the generation of heat and its ability to dissipate heat when tested under controlled conditions on a specified indoor laboratory test wheel.

Sustained high temperature can cause the material of the tire to degenerate and reduce tire life, and excessive temperature can lead to sudden tire failure.

Grade C corresponds to a level of performance which all passenger car tires must meet under the Federal Motor Vehicle Safety Standard No. 109.

Grades B and A represent higher levels of performance on the laboratory test wheel than the minimum required by law.

Warning: The temperature grades of a tire assume that it is properly inflated and not overloaded.

Excessive speed, underinflation, or excessive loading, either separately or in combination, can cause heat buildup and possible tire failure.

Glossary of tire terminology

Tire related term	Meaning
Cold tire inflation pressure	Tire pressure when the vehicle has been parked for three hours or more, or has not been driven more than 1 mile or 1.5 km under that condition
Maximum inflation pressure	The maximum cold inflated pressure to which a tire may be inflated, shown on the sidewall of the tire
Recommended inflation pressure	Cold tire inflation pressure recommended by a manufacturer
Accessory weight	The combined weight (in excess of those standard items which may be replaced) of hybrid transmission, power steering, power brakes, power windows, power seats, radio and heater, to the extent that these items are available as factory-installed equipment (whether installed or not)
Curb weight	The weight of a motor vehicle with standard equipment, including the maximum capacity of fuel, oil and coolant, and if so equipped, air conditioning and additional weight optional engine
Maximum loaded vehicle weight	The sum of: (a) Curb weight (b) Accessory weight (c) Vehicle capacity weight (d) Production options weight
Normal occupant weight	150 lb. (68 kg) times the number of occupants specified in the second column of Table 1* that follows
Occupant distribution	Distribution of occupants in a vehicle as specified in the third column of Table 1* below

Tire related term	Meaning
Production options weight	The combined weight of installed regular production options weighing over 5 lb. (2.3 kg) in excess of the standard items which they replace, not previously considered in curb weight or accessory weight, including heavy duty brakes, ride levelers, roof rack, heavy duty battery, and special trim
Rim	A metal support for a tire or a tire and tube assembly upon which the tire beads are seated
Rim diameter (Wheel diameter)	Nominal diameter of the bead seat
Rim size designation	Rim diameter and width
Rim type designation	The industry manufacturer's designation for a rim by style or code
Rim width	Nominal distance between rim flanges
Vehicle capacity weight (Total load capacity)	The rated cargo and luggage load plus 150 lb. (68 kg) times the vehicle's designated seating capacity
Vehicle maximum load on the tire	The load on an individual tire that is determined by distributing to each axle its share of the maximum loaded vehicle weight, and dividing by two
Vehicle normal load on the tire	The load on an individual tire that is determined by distributing to each axle its share of curb weight, accessory weight, and normal occupant weight (distributed in accordance with Table 1* below), and dividing by two
Weather side	The surface area of the rim not covered by the inflated tire
Bead	The part of the tire that is made of steel wires, wrapped or reinforced by ply cords and that is shaped to fit the rim

Tire related term	Meaning
Bead separation	A breakdown of the bond between components in the bead
Bias ply tire	A pneumatic tire in which the ply cords that extend to the beads are laid at alternate angles substantially less than 90 degrees to the centerline of the tread
Carcass	The tire structure, except tread and sidewall rubber which, when inflated, bears the load
Chunking	The breaking away of pieces of the tread or sidewall
Cord	The strands forming the plies in the tire
Cord separation	The parting of cords from adjacent rubber compounds
Cracking	Any parting within the tread, sidewall, or innerliner of the tire extending to cord material
CT	A pneumatic tire with an inverted flange tire and rim system in which the rim is designed with rim flanges pointed radially inward and the tire is designed to fit on the underside of the rim in a manner that encloses the rim flanges inside the air cavity of the tire
Extra load tire	A tire designed to operate at higher loads and at higher inflation pressures than the corresponding standard tire
Groove	The space between two adjacent tread ribs
Innerliner	The layer(s) forming the inside surface of a tubeless tire that contains the inflating medium within the tire
Innerliner separation	The parting of the innerliner from cord material in the carcass

Tire related term	Meaning
Intended outboard sidewall	(a) The sidewall that contains a whitewall, bears white lettering, or bears manufacturer, brand, and/or model name molding that is higher or deeper than the same molding on the other sidewall of the tire, or (b) The outward facing sidewall of an asymmetrical tire that has a particular side that must always face outward when mounted on a vehicle
Light truck (LT) tire	A tire designated by its manufacturer as primarily intended for use on lightweight trucks or multipurpose passenger vehicles
Load rating	The maximum load that a tire is rated to carry for a given inflation pressure
Maximum load rating	The load rating for a tire at the maximum permissible inflation pressure for that tire
Maximum permissible inflation pressure	The maximum cold inflation pressure to which a tire may be inflated
Measuring rim	The rim on which a tire is fitted for physical dimension requirements
Open splice	Any parting at any junction of tread, sidewall, or innerliner that extends to cord material
Outer diameter	The overall diameter of an inflated new tire
Overall width	The linear distance between the exteriors of the sidewalls of an inflated tire, including elevations due to labeling, decorations, or protective bands or ribs
Passenger car tire	A tire intended for use on passenger cars, multipurpose passenger vehicles, and trucks, that have a gross vehicle weight rating (GVWR) of 10,000 lb. or less.
Ply	A layer of rubber-coated parallel cords

Tire related term	Meaning
Ply separation	A parting of rubber compound between adjacent plies
Pneumatic tire	A mechanical device made of rubber, chemicals, fabric and steel or other materials, that, when mounted on an automotive wheel, provides the traction and contains the gas or fluid that sustains the load
Radial ply tire	A pneumatic tire in which the ply cords that extend to the beads are laid at substantially 90 degrees to the centerline of the tread
Reinforced tire	A tire designed to operate at higher loads and at higher inflation pressures than the corresponding standard tire
Section width	The linear distance between the exteriors of the sidewalls of an inflated tire, excluding elevations due to labeling, decoration, or protective bands
Sidewall	That portion of a tire between the tread and bead
Sidewall separation	The parting of the rubber compound from the cord material in the sidewall
Snow tire	A tire that attains a traction index equal to or greater than 110, compared to the ASTM E-1136 Standard Reference Test Tire, when using the snow traction test as described in ASTM F-1805-00, Standard Test Method for Single Wheel Driving Traction in a Straight Line on Snow-and Ice-Covered Surfaces, and which is marked with an Alpine Symbol () on at least one sidewall
Test rim	The rim on which a tire is fitted for testing, and may be any rim listed as appropriate for use with that tire

Tire related term	Meaning
Tread	That portion of a tire that comes into contact with the road
Tread rib	A tread section running circumferentially around a tire
Tread separation	Pulling away of the tread from the tire carcass
Treadwear indicators (TWI)	The projections within the principal grooves designed to give a visual indication of the degrees of wear of the tread
Wheel-holding fixture	The fixture used to hold the wheel and tire assembly securely during testing

*:Table 1 — Occupant loading and distribution for vehicle normal load for various designated seating capacities

Designated seating capacity, Number of occupants	Vehicle normal load, Number of occupants	Occupant distribution in a normally loaded vehicle
2 through 4	2	2 in front
5 through 10	3	2 in front, 1 in second seat
11 through 15	5	2 in front, 1 in second seat, 1 in third seat, 1 in fourth seat
16 through 20	7	2 in front, 2 in second seat, 2 in third seat, 1 in fourth seat

Customizable features

Your vehicle includes a variety of electronic features that can be personalized to suit your preferences. Programming these preferences requires specialized equipment and may be performed by your Toyota dealer.

Some function settings are changed simultaneously with other functions being customized. Contact your Toyota dealer for further details.

Customizable Features

1 Vehicles with a Display Audio system: Settings that can be changed using the Display Audio system
(For further information on customizing settings using the Display Audio system, refer to the “Display Audio System Owner’s Manual”.)

2 Settings that can be changed by your Toyota dealer

Definition of symbols: O = Available, — = Not available

Item	Function	Default setting	Customized setting	1	2
Vehicle Proximity Notification System (→P. 25)	The volume of Vehicle Proximity Notification System sound	Level 1	Level 2	—	O
			Level 3	—	O
Smart key system* ¹ and wireless remote control (→P. 47, 61)	Operation signal (Emergency flashers)	On	Off	—	O
	Operation signal (Buzzer)	On	Off	—	O
	Operation buzzer volume	Level 7	Off to level 7	O	O
	Time elapsed before automatic door lock function is activated if door is not opened after being unlocked	60 seconds	30 seconds	—	O
			120 seconds	—	O
	Open door warning buzzer	On	Off	—	O
Automatic door lock function to be activated if door is not opened after being unlocked	On	Off	—	O	

Item	Function	Default setting	Customized setting	1	2
Smart key system* ¹ (→P. 47)	Smart key system	On	Off	—	O
	Number of permissible times of continuous smart lock	Twice	Unlimited	—	O
Wireless remote control (→P. 61)	Wireless remote control	On	Off	—	O
	Unlocking operation	Driver's door unlocked in one step, all doors unlocked in two steps	All doors unlocked in one step.	O	O
	Panic function	On	Off	—	O

Item	Function	Default setting	Customized setting	1	2
Door lock (→P. 65)	Unlocking using a key	Driver's door unlocked in one step, all doors unlocked in two steps	All doors unlocked in one step.	—	O
	Speed-detecting automatic door lock function*2	Off	On	O	O
	Opening driver's door unlocks all doors	Off	On	—	O
	Shifting gears to P unlocks all doors.	On	Off	O	O
	Shifting gears to position other than P locks all doors.	On	Off	O	O
Lights (→P. 204)	Daytime running light system (except Canada)	On	Off	O	O

Item	Function	Default setting	Customized setting	1	2
Illumination (→P. 321)	Time elapsed before lights turn off	15 seconds	7.5 seconds	—	○
			30 seconds	—	○
	Operation when the doors are unlocked	On	Off	—	○
	Operation after the engine switch is turned to the “LOCK” position*3	On	Off	—	○
	Operation after the “POWER” switch is turned off*2	On	Off	—	○
	Operation when you approach the vehicle with the electronic key on your person*2	On	Off	—	○
Seat belt reminder (→P. 439)	Vehicle speed linked seat belt reminder buzzer	On	Off	—	○

Item	Function	Default setting	Customized setting	1	2
Automatic air conditioning system (→P. 238)	Air conditioning control of Eco drive mode	On	Off	—	O

*1: If equipped

*2: Vehicles with a smart key system

*3: Vehicles without a smart key system

Items to initialize

The following items must be initialized for normal system operation after such cases as the 12-volt battery being reconnected, or maintenance being performed on the vehicle:

Item	When to initialize	Reference
Maintenance data (except Canada)	After the maintenance is performed	P. 353
Tire pressure warning system	<ul style="list-style-type: none"> • When rotating the tires on vehicles with differing front and rear tire inflation pressures • When changing tire pressure (such as when changing traveling speed, load weight, etc.) • When changing the tire size 	P. 385

Reporting safety defects for U.S. owners	530
Seat belt instructions for Canadian owners (in French)	531
SRS airbag instructions for Canadian owners (in French)	533

Reporting safety defects for U.S. owners

If you believe that your vehicle has a defect which could cause a crash or could cause injury or death, you should immediately inform the National Highway Traffic Safety Administration (NHTSA) in addition to notifying Toyota Motor Sales, U.S.A., Inc. (Toll-free: 1-800-331-4331).

If NHTSA receives similar complaints, it may open an investigation, and if it finds that a safety defect exists in a group of vehicles, it may order a recall and remedy campaign. However, NHTSA cannot become involved in individual problems between you, your dealer, or Toyota Motor Sales, U.S.A., Inc.

To contact NHTSA, you may call the Vehicle Safety Hotline toll-free at 1-888-327-4236 (TTY: 1-800-424-9153); go to <http://www.safercar.gov>; or write to: Administrator, NHTSA, 1200 New Jersey Ave, S.E., Washington, DC 20590. You can also obtain other information about motor vehicle safety from <http://www.safercar.gov>.

Seat belt instructions for Canadian owners (in French)

The following is a French explanation of seat belt instructions extracted from the seat belt section in this manual.

See the seat belt section for more detailed seat belt instructions in English.

Utilisation correcte des ceintures de sécurité

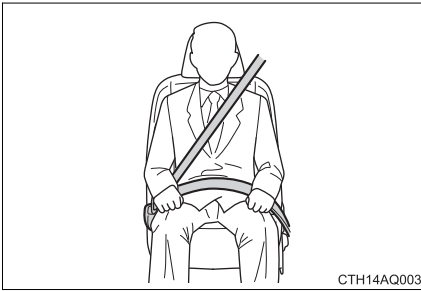

- Déroulez la sangle diagonale de telle sorte qu'elle passe bien sur l'épaule, sans pour autant être en contact avec le cou ou glisser de l'épaule.
- Placez la sangle abdominale le plus bas possible sur les hanches.
- Réglez la position du dossier de siège. Asseyez-vous le dos le plus droit possible et calez-vous bien dans le siège.
- Ne vrillez pas la ceinture de sécurité.

ATTENTION

■ Lorsque vous utilisez ou rangez la ceinture de sécurité du siège central arrière



- N'utilisez pas la ceinture de sécurité du siège arrière central lorsque l'une des boucles est détachée.

Si vous n'attachez qu'une des boucles, il y a risque de blessures graves voire mortelles en cas de freinage brusque ou de collision.

Entretien et soin

■ Ceintures de sécurité

Nettoyez avec un chiffon ou une éponge humectée d'eau savonneuse tiède. Profitez de l'occasion pour vérifier régulièrement que les ceintures ne sont pas effilochées, entaillées, ou ne paraissent pas exagérément usées.

ATTENTION

■ Détérioration et usure des ceintures de sécurité

Inspectez les ceintures de sécurité périodiquement. Contrôlez qu'elles ne sont pas entaillées, effilochées, et que leurs ancrages ne sont pas desserrés. N'utilisez pas une ceinture de sécurité défectueuse avant qu'elle ne soit remplacée. Une ceinture de sécurité défectueuse n'apporte aucune garantie de protection de l'occupant en cas d'accident.

The following is a French explanation of SRS airbag instructions extracted from the SRS airbag section in this manual.

See the SRS airbag section for more detailed SRS airbag instructions in English.

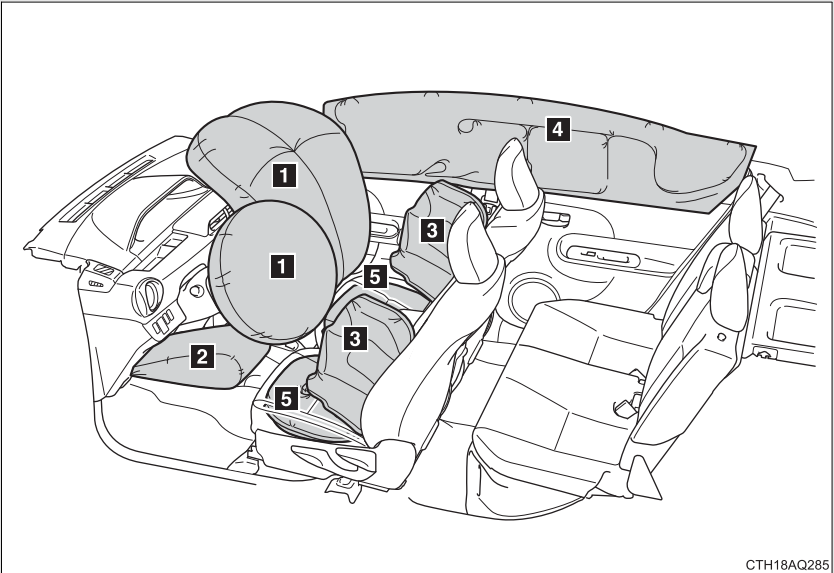

Coussins gonflables frontaux SRS

- 1** Le coussin gonflable conducteur/le coussin gonflable passager avant SRS

Participant à la protection de la tête et du thorax du conducteur et du passager avant contre les chocs contre les éléments de l'habitacle.

- 2** Coussin gonflable SRS de genoux du conducteur

Participant à la protection du conducteur.

Coussins gonflables latéraux et rideau SRS

3 Coussins gonflables latéraux SRS

Participent à la protection du torse des passagers avant.

4 Coussins gonflables rideau SRS

Participent principalement à la protection de la tête des occupants assis aux places extérieures.

Autres coussins gonflables SRS

5 Coussins gonflables d'assise SRS

Participent à la protection du conducteur et du passager avant.

Composants du système de coussins gonflables SRS

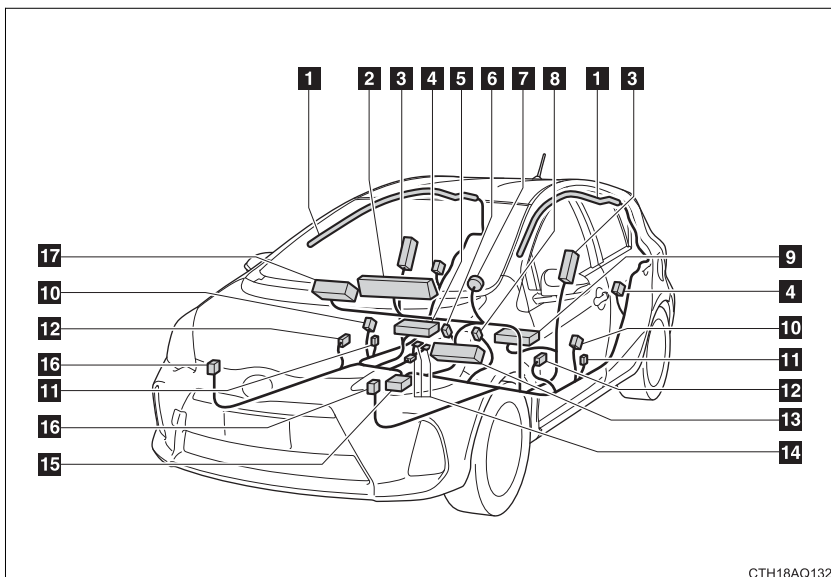

CTH18AQ132

- | | |
|---|--|
| 1 Coussins gonflables rideau | 7 Coussin gonflable conducteur |
| 2 Témoin d'alerte SRS et témoins indicateurs "AIR BAG ON" et "AIR BAG OFF" | 8 Contacteur de boucle de ceinture de sécurité conducteur |
| 3 Coussins gonflables latéraux | 9 Coussin gonflable d'assise conducteur |
| 4 Capteurs d'impact latéral (arrière) | 10 Capteurs d'impact latéral (avant) |
| 5 Coussin gonflable d'assise passager avant | 11 Prétensionneurs de ceintures de sécurité et limiteurs de force |
| 6 Contacteur de boucle de ceinture de sécurité du siège passager avant | 12 Capteurs d'impact latéral (porte avant) |

13 Coussin gonflable de genoux du conducteur

14 Système de classification de l'occupant du siège passager avant (ECU et capteurs)

15 Boîtier électronique de coussins gonflables

16 Capteurs d'impact avant

17 Coussin gonflable passager avant

Votre véhicule est équipé de COUSSINS GONFLABLES INTELLIGENTS conçus selon les normes de sécurité américaines applicables aux véhicules à moteur (FMVSS208). Le boîtier électronique (ECU) des coussins gonflables régule le déploiement des coussins gonflables sur la base des informations qu'il reçoit des capteurs, etc., indiqués ci-dessus dans le schéma illustrant les composants du système. Parmi ces informations figurent la gravité du choc et l'occupation du véhicule par les passagers. Le déploiement rapide des coussins gonflables est obtenu au moyen d'une réaction chimique dans les dispositifs pyrotechniques, qui produit un gaz inoffensif permettant d'amortir le mouvement des occupants.



ATTENTION

■ Précautions concernant les coussins gonflables SRS

Respectez les précautions suivantes concernant les coussins gonflables SRS.

Autrement, des blessures graves, voire mortelles, pourraient s'ensuivre.

● Le conducteur et tous les passagers du véhicule doivent porter correctement leur ceinture de sécurité.

Les coussins gonflables SRS sont des dispositifs supplémentaires à utiliser avec les ceintures de sécurité.

● Le coussin gonflable SRS conducteur se déploie avec une violence considérable, qui peut causer des blessures graves, voire mortelles, si le conducteur se trouve très près du coussin gonflable. L'autorité fédérale chargée de la sécurité routière aux États-Unis (NHTSA) conseille:

Sachant que la zone de danger pour le coussin gonflable conducteur se trouve dans les premiers 2 à 3 in. (50 - 75 mm) de déploiement, vous placer à 10 in. (250 mm) de votre coussin gonflable conducteur vous garantit une marge de sécurité suffisante. Cette distance est à mesurer entre le centre du volant et le sternum. Si vous êtes assis à moins de 10 in. (250 mm), vous pouvez changer votre position de conduite de plusieurs façons:

- Reculez votre siège le plus possible, de manière à pouvoir encore atteindre confortablement les pédales.
- Inclinez légèrement le dossier du siège. Bien que les véhicules puissent être différents les uns des autres, la plupart des conducteurs peuvent s'asseoir à une distance de 10 in. (250 mm), même avec le siège conducteur complètement avancé, simplement en inclinant un peu le dossier de siège. Si vous avez des difficultés à voir la route après avoir incliné votre siège, utilisez un coussin ferme et antidérapant pour vous rehausser ou, si votre véhicule est équipé du réglage en hauteur du siège, remontez-le.
- Si votre volant est réglable, inclinez-le vers le bas. Cela a pour effet d'orienter le coussin gonflable en direction de votre poitrine plutôt que de votre tête et de votre cou.

Régalez votre siège selon ces recommandations de la NHTSA, tout en conservant le contrôle des pédales, du volant et la vue des commandes du tableau de bord.

ATTENTION

■ Précautions concernant les coussins gonflables SRS

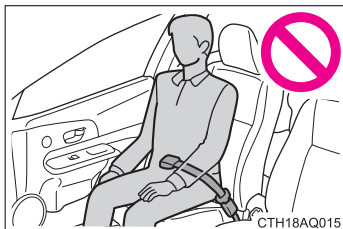

- Si vous attachez une rallonge de ceinture de sécurité aux boucles de ceinture de sécurité avant, mais pas au pêne de la ceinture de sécurité, les coussins gonflables avant SRS détectent que le conducteur et le passager avant ont attaché leur ceinture de sécurité, alors même que ce n'est pas le cas. Dans ce cas, il se peut que les coussins gonflables avant SRS ne se déploient pas correctement en cas de collision et vous risquez d'être tué ou grièvement blessé. Veillez à porter la ceinture de sécurité avec la rallonge de ceinture de sécurité.
- Le coussin gonflable SRS passager avant se déploie également avec une violence considérable, qui peut causer des blessures graves, voire mortelles, si le passager avant se trouve très près du coussin gonflable. Éloignez le siège du passager avant au maximum du coussin gonflable et réglez le dossier de siège de façon à être assis bien droit dans le siège.
- Les nourrissons et les enfants qui ne sont pas correctement assis et/ou protégés peuvent être grièvement blessés ou tués par le déploiement d'un coussin gonflable. Installez dans un siège de sécurité enfant les nourrissons et les enfants trop petits pour pouvoir utiliser la ceinture de sécurité. Toyota recommande vivement que les nourrissons et les jeunes enfants soient installés sur les sièges arrière du véhicule et convenablement attachés. Les sièges arrière sont plus sûrs pour les nourrissons et les enfants que le siège du passager avant.
- N'installez jamais un siège de sécurité enfant type dos à la route sur le siège du passager avant, même si le témoin indicateur "AIR BAG OFF" est allumé. En cas d'accident, le déploiement du coussin gonflable passager avant et du coussin gonflable d'assise passager avant est si rapide et violent que l'enfant risquerait d'être blessé grièvement, voire mortellement, si le siège de sécurité enfant type dos à la route est installé sur le siège passager avant.

! ATTENTION

■ Précautions concernant les coussins gonflables SRS

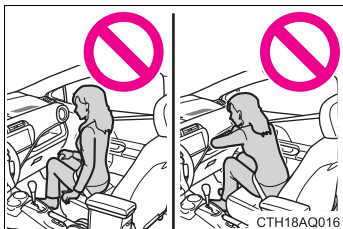

- Ne pas s'asseoir sur le bord du siège et ne pas s'appuyer contre la planche de bord.

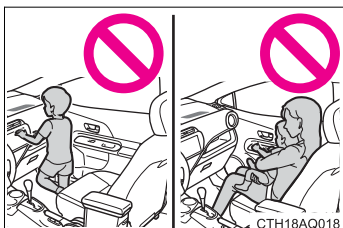

- Ne laissez pas un enfant rester debout devant le coussin gonflable SRS passager avant ou bien s'asseoir sur les genoux du passager avant.
- Ne laissez pas les occupants des sièges avant voyager avec un objet sur les genoux.



- Ne vous appuyez pas contre la porte, contre le rail latéral de toit ou contre les montants avant, latéraux et arrière.

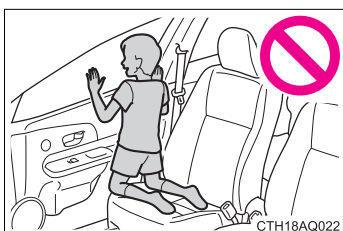

- Interdisez à quiconque de s'agenouiller sur le siège passager en appui contre la porte ou de sortir la tête ou les mains à l'extérieur du véhicule.

ATTENTION

■ Précautions concernant les coussins gonflables SRS

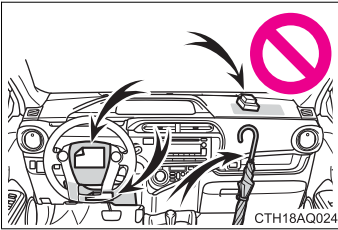

- Ne fixez ni ne posez aucun objet sur le tableau de bord, la garniture du volant de direction et la partie inférieure du tableau de bord.

Au déploiement des coussins gonflables SRS conducteur, passager avant et de genoux du conducteur, ces objets risquent de se transformer en projectiles.

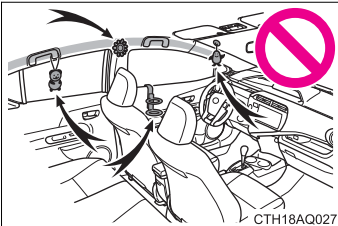

- Ne rien fixer aux portes, à la vitre de pare-brise, aux vitres latérales, aux montants avant et arrière, au rail latéral de toit et à la poignée de maintien.

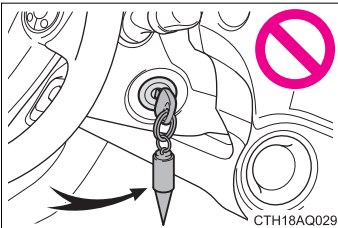

- Véhicules dépourvus de système d'accès et de démarrage "mains libres": N'attachez pas à la clé d'objets lourds, pointus ou très durs, comme d'autres clés et accessoires. Ces objets risquent d'entraver le déploiement du coussin gonflable de genoux SRS du conducteur ou d'être projetés vers le siège conducteur par la force de déploiement, constituant ainsi un danger potentiel.

- Ne suspendez aucun cintre ou objets durs aux crochets à vêtements. En cas de déploiement des coussins gonflables rideau SRS, tous ces objets pourraient se transformer en projectiles et causer des blessures graves, voire mortelles.
- Si un cache en vinyle recouvre la partie où le coussin gonflable SRS de genoux du conducteur se déploie, veuillez à l'enlever.

ATTENTION

■ Précautions concernant les coussins gonflables SRS

- N'utilisez aucun accessoire de siège venant recouvrir les zones de déploiement des coussins gonflables latéraux SRS et des coussins gonflables d'assise SRS, car il risquerait d'en gêner le déploiement. De tels accessoires peuvent empêcher les coussins gonflables latéraux et coussins gonflables d'assise de fonctionner correctement, désactiver le dispositif ou entraîner le déploiement accidentel des coussins gonflables latéraux et d'assise, entraînant la mort ou des blessures graves.
- Ne faites pas subir de chocs ou de pressions excessives à la zone renfermant les composants de coussin gonflable SRS.
En effet, cela pourrait entraîner un fonctionnement anormal des coussins gonflables SRS.
- Ne touchez aucun composant du système immédiatement après le déploiement (gonflage) des coussins gonflables SRS, car ils peuvent être chauds.
- Si vous avez des difficultés à respirer après le déploiement des coussins gonflables SRS, ouvrez une porte ou une vitre pour faire entrer de l'air frais, ou bien descendez du véhicule si cela ne présente pas de danger. Essayez tout résidu dès que possible afin d'éviter d'éventuelles irritations de la peau.
- Si les parties renfermant les coussins gonflables SRS, telles que la garniture du volant et les garnitures de montants avant et arrière, sont abîmées ou craquelées, faites-les remplacer par votre concessionnaire Toyota.
- Ne disposez rien sur le siège du passager avant, comme par exemple un coussin. Cela aurait pour conséquence de répartir le poids du passager sur toute la surface du siège, ce qui empêche le capteur de détecter correctement le poids du passager. Il en résulte que les coussins gonflables avant SRS du passager avant risquent de ne pas se déployer en cas de collision.

ATTENTION

■ **Modification et mise au rebut des éléments du système de coussins gonflables SRS**

Consultez votre concessionnaire Toyota avant de mettre votre véhicule au rebut ou de procéder à l'une des modifications suivantes. Les coussins gonflables SRS peuvent être défaillants ou se déployer (se gonfler) accidentellement, provoquant la mort ou de graves blessures.

- Installation, dépose, démontage et réparations des coussins gonflables SRS.
- Réparations, modifications, démontage ou remplacement du volant, du tableau de bord, de la planche de bord, des sièges ou de leur garniture, des montants avant, latéraux et arrière ou des rails latéraux de toit.
- Réparations ou modifications des ailes avant, du pare-choc avant ou des flancs de l'habitacle.
- Installation d'un protège-calandre (pare-buffle, pare-kangourou, etc.), de chasse-neiges ou de treuils.
- Modification du système de suspension du véhicule.
- Installation d'appareils électroniques, tels qu'un radioémetteur/récepteur ou d'un lecteur CD.
- Aménagements du véhicule visant à permettre sa conduite par une personne atteinte d'un handicap physique.

Index

Abbreviation list	544
Alphabetical index.....	546
What to do if...	558

Abbreviation/Acronym list

ABBREVIATIONS	MEANING
A/C	Air Conditioning
ABS	Anti-lock Brake System
ACC	Accessory
ALR	Automatic Locking Retractor
CRS	Child Restraint System
DISP	Display
ECU	Electronic Control Unit
EDR	Event Data Recorder
ELR	Emergency Locking Retractor
EPS	Electric Power Steering
EV	Electric Vehicle
GAWR	Gross Axle Weight Ratings
GVWR	Gross Vehicle Weight Rating
I/M	Emission inspection and maintenance
LATCH	Lower Anchors and Tethers for Children
LED	Light Emitting Diode
M + S	Mud + Snow
MMT	Methylcyclopentadienyl Manganese Tricarbonyl
MTBE	Methyl Tertiary Butyl Ether
OBD	On Board Diagnostics
SRS	Supplemental Restraint System

ABBREVIATIONS	MEANING
TIN	Tire Identification Number
TPMS	Tire Pressure Warning System
TRAC	Traction Control
TWI	Treadwear Indicators
VIN	Vehicle Identification Number
VSC	Vehicle Stability Control

A	A/C	238	Antenna	255
	ABS	221	Anti-lock brake system	221
	Air conditioning filter	399	Assist grips	340
	Air conditioning system		Audio input	268, 276, 287
	Air conditioning filter.....	399	Audio system	
	Automatic air conditioning		Antenna.....	255
	system	238	Audio input	268, 276, 287
	Airbags		AUX port	287
	Airbag operating		CD player	256
	conditions.....	120	Cord hook	272
	Airbag precautions for		iPod.....	268
	your child	125	MP3/WMA disc	261
	Airbag warning light.....	438	Optimal use.....	284
	Curtain shield airbag		Portable music	
	operating conditions.....	121	player.....	268, 276, 287
	Curtain shield airbag		Radio.....	254
	precautions	125	Steering wheel audio	
	Front passenger occupant		switch.....	288
	classification system	130	Type	248
	General airbag		USB memory.....	276
	precautions	125	USB port	276
	Indicators.....	130	Automatic air conditioning	
	Knee airbag precautions	125	system	
	Locations of airbags.....	116	Air conditioning filter.....	399
	Modification and		Automatic air conditioning	
	disposal of airbags.....	129	system	238
	Proper driving		AUX port	287
	posture.....	114, 125	Auxiliary boxes	327
	Seat cushion airbag			
	precautions	125		
	Side airbag operating			
	conditions.....	121		
	Side airbag precautions	125		
	SRS airbags	116		

B	Back door	71
	Back-up lights	
	Replacing light bulbs	415
	Wattage	505
	Battery	
	Checking	379
	Hybrid battery (traction battery).....	29
	If the vehicle 12-volt battery is discharged.....	481
	Preparing and checking before winter	231
	Bluetooth® audio	
	Bluetooth® audio	291
	Portable player	300
	Set up	308
	Using the Bluetooth® audio	295
	Bluetooth® phone	
	Making a phone call	303
	Set up	314
	Bottle holders	330
	Brake	
	Fluid.....	503
	Parking brake	179
	Brake assist	221
	Break-in tips	151

C	Care	
	Exterior.....	346
	Interior	349
	Seat belts	349
	Cargo capacity	226
	CD player	256
	Chains	231
	Child-protectors	67
	Child restraint system	
	Booster seats, definition.....	136
	Booster seats, installation	140
	Convertible seats, definition	136
	Convertible seats, installation.....	140
	Front passenger occupant classification system.....	130
	Infant seat, definition.....	136
	Infant seats, installation.....	140
	Installing CRS with LATCH system.....	141
	Installing CRS with seat belts	142
	Installing CRS with top tether straps.....	146

Child safety

Airbag precautions 125
 Child-protectors 67
 Child restraint system 136
 How your child should
 wear the seat belt 88
 Installing child restraints 140
 Moon roof precautions 104
 Power window lock switch 98
 Power window precautions ... 100
 Removed key battery
 precautions 403
 Seat belt extender
 precautions 92
 Seat belt precautions 89
 Seat heater precautions 338
 12-volt battery
 precautions 381, 486
Cleaning
 Exterior 346
 Interior 349
 Seat belts 349
Clock 189
Coat hooks 339
Condenser 375
Console box 325

Cooling system

 Hybrid system overheating ... 487
Cord hook 272
Cruise control 217
Cup holders 329
Curtain shield airbags 116
Customizable features 522

D **Daytime running light**

system 206
Defogger
 Rear window 247
 Side mirrors 247
Dimension 496
Dinghy towing 236
Display
 Energy flow 35
 Multi-information display 187
 Trip information 187
 Warning message 447
Do-it-yourself maintenance 360

Doors

- Back door 71
- Door lock 47, 61, 65
- Door windows 98
- Rear door child protector 67
- Side doors 65
- Side mirrors 96

Driver's seat belt reminder

- light 439

Driving

- Break-in tips 151
- Correct posture 114
- Procedures 150
- Winter driving tips 231

E

- Eco drive mode 176**

- Electric power steering 221**

Electronic key

- If the electronic key does not operate properly 479

Emergency flashers

- Switch 428

Emergency, in case of

- If a warning buzzer sounds 437
- If a warning light turns on 437
- If a warning message is displayed 447
- If the electronic key does not operate properly 479
- If the hybrid system will not start 475
- If the shift lever cannot be shifted from P 477
- If the vehicle becomes stuck 492
- If the vehicle 12-volt battery is discharged 481

- If you have a flat tire 463

- If you lose your keys 478

- If you think something is wrong 436

- If your vehicle has to be stopped in an emergency 493

- If your vehicle needs to be towed 429

- If your vehicle overheats 487

Engine

- Compartment 368

- Engine switch 160, 164

- Hood 364

How to start the hybrid

- system 160, 164

- Identification number 497

If the hybrid system will

- not start 475

- Ignition switch 160, 164

- Overheating 487

- "POWER" switch 164

Engine coolant

- Capacity 500

- Checking 373

Preparing and checking

- before winter 231

Engine oil
 Capacity499
 Checking369
 Preparing and checking
 before winter231

**Engine/power control unit
 coolant**
 Capacity500
 Checking373
 Preparing and checking
 before winter231

Engine switch.....160, 164

EPS.....221

EV drive mode.....172

Event data recorder18

**Exclusive jump
 starting terminal481**

F Floor mat.....341

Fluid
 Brake503
 Washer378

Fog lights
 Replacing light bulbs415
 Switch.....208
 Wattage.....505

Front fog lights
 Replacing light bulbs415
 Switch.....208
 Wattage.....505

**Front passenger occupant
 classification system130**

**Front passenger's seat
 belt reminder light439**

Front seats
 Adjustment76

Front side marker lights
 Replacing light bulbs415
 Switch204
 Wattage.....505

Front turn signal lights
 Replacing light bulbs415
 Switch178
 Wattage.....505

Fuel
 Capacity498
 Fuel gauge181
 Gas station information560
 Information506
 Refueling105
 Type498

Fuel door105

Fuel filler door105

Fuses404

G Gas station information560

Gauges.....181

Glove box325

H Hazard lights
 Switch428

Head restraints
 Adjusting81

Headlights
 Replacing light bulbs415
 Switch204
 Wattage.....505

Heaters
 Seat heaters 337
 Side mirrors 247
Hill-start assist control 221
Hood 364
Horn 180
Hybrid system
 Emergency shut off system 30
 Energy monitor/
 consumption screen 35
 High voltage components 29
 Hybrid system indicator 197
 "POWER" switch 164
 Vehicle Proximity
 Notification System 25

I **I/M test** 359

Identification
 Engine 498
 Tire 509
 Vehicle 497

Ignition switch 160, 164

Illuminated entry system 323

Immobilizer system 110

Indicator lights 184

Initialization
 Items to initialize 528

Inside rear view mirror 94

Interior lights
 Switch 322
 Wattage 505

iPod 268

J **Jack**

Positioning a floor jack 366
 Vehicle-equipped jack 463

Jack handle 463

K **Keyless entry** 61

Keys
 Electronic key 44
 Engine switch 160, 164
 If the electronic key does
 not operate properly 479
 If you lose your keys 478
 Ignition switch 160, 164
 Key battery 401
 Key number 44
 Keyless entry 61
 Keys 44
 Mechanical key 44
 "POWER" switch 164
 Wireless remote control
 key 61

Knee airbag 116

L **License plate lights**

Replacing light bulbs 415
 Wattage 505

Light bulbs
 Replacing 415
 Wattage 505

Lights
 Emergency flasher switch 428
 Fog light switch 208
 Hazard light switch 428
 Headlight switch 204
 Instrument panel light
 switch 204
 Interior lights switch 322
 Parking light switch 204
 Personal light switch 322
 Replacing light bulbs 415
 Side marker light switch 204
 Tail light switch 204
 Turn signal lever 178
 Wattage 505

Load capacity 230

Lock steering column 162, 168

Luggage compartment light
 Wattage.....505
Luggage cover343

M

Maintenance
 Do-it-yourself
 maintenance360
 Emission inspection and
 maintenance (I/M)
 programs.....359
 General maintenance.....355
 Maintenance data.....496
 Maintenance requirements.....352

Meter

Instrument panel light
 control.....182
 Meters181

Microphone.....296

Mirrors

Inside rear view mirror.....94
 Outside rear view mirror
 defogger.....247
 Outside rear view mirrors.....96
 Vanity mirrors333

Moon roof101

MP3 disc261

Multi-information display187

N

Noise from under vehicle16

O

Odometer.....189

Oil

Engine oil369

Opener

Back door.....71
 Fuel filler door105
 Hood364

Outside rear view mirrors

Adjusting and folding.....96
 Defogger247

Outside temperature

display334

Overheating, Hybrid

system487

P

Parking brake179

Parking lights

Replacing light bulbs.....415
 Switch204
 Wattage.....505

Personal lights

Switch322
 Wattage.....505

Power outlet336

“POWER” switch164

Power windows.....98

R	Radiator	375
	Radio	254
	Rear seat	
	Folding down.....	77
	Rear turn signal lights	
	Replacing light bulbs	415
	Wattage.....	505
	Rear window defogger	247
	Rear window wiper	214
	Reset the maintenance data ...	353
	Replacing	
	Fuses.....	404
	Key battery	401
	Light bulbs	415
	Tires	463
	Reporting safety defects	
	for U.S. owners	530

S	Seat belts	
	Adjusting the seat belt.....	84
	Automatic Locking	
	Retractor (ALR).....	88
	Child restraint system	
	installation.....	140
	Cleaning and maintaining	
	the seat belts	349
	Emergency Locking	
	Retractor (ELR).....	88
	How to wear your seat belt.....	84
	How your child should	
	wear the seat belt	88
	Pregnant women,	
	proper seat belt use.....	90
	Reminder light	439
	Seat belt extenders	89
	Seat belt pretensioners	88
	Seat cushion airbag	116
	Seat heaters	337
	Seating capacity	230

Seats

Adjustment76
 Adjustment precautions.....76
 Child seats/child restraint system installation..... 140
 Cleaning349
 Front seat adjustment76
 Front seat adjustment precautions 76
 Head restraint.....81
 Properly sitting in the seat.... 114
 Seat heaters.....337

Service reminder

indicators 184

Shift lever

If the shift lever cannot be shifted from P.....477
 Transmission..... 175

Shift lock system477

Side airbags.....116

Side marker lights

Replacing light bulbs415
 Wattage.....505

Side mirror

Adjusting and folding.....96
 Defogger247

Smart key system

Entry function 47
 Starting the hybrid system 160, 164

Spare tire

Inflation pressure 504
 Storage location463

Spark plug 501

Specifications 496

Speedometer 181

Steering

Column lock release 162, 168

Steering wheel

Adjustment93
 Audio switches288

Stop lights

Replacing light bulbs.....415
 Wattage.....505

Storage feature324

Storage precautions 228

Stuck

If the vehicle becomes stuck492

Sun visors 332

Switch

Cruise control 217
 “ECO MODE” switch 176
 Emergency flasher switch 428
 EV drive mode switch 172
 Engine switch 160, 164
 Fog light switch 208
 Hazard light switch 428
 Headlight switch 204
 Ignition switch 160, 164
 Light switches 204
 Power door lock switch 65
 “POWER” switch 164
 Power window switch 98
 Rear window wiper and
 washer switch 214
 Steering wheel audio
 switches 288
 Window lock switch 98
 Wiper and washer 210, 214

T

Tail lights

Replacing light bulbs 415
 Switch 204
 Wattage 505

Theft deterrent system

Immobilizer system 110
 Theft prevention labels 113

Theft prevention labels 113

Tire inflation pressure 392

Tire information

Glossary 516
 Size 512
 Tire identification number 511
 Uniform tire quality
 grading 513

Tires

Chains 231
 Checking 384
 If you have a flat tire 463
 Inflation pressure 392
 Inflation pressure sensor 385
 Information 509
 Replacing 463
 Rotating tires 384
 Size 504
 Snow tires 231
 Spare tire 463
 Tire pressure warning
 system 384, 439

Tools 463

Total load capacity 230

Towing

Dinghy towing 236
 Emergency towing 431
 Trailer towing 235

TRAC 221

Traction control 221

Transmission

Hybrid transmission 175
 If the shift lever cannot
 be shifted from P 477

Trip information 187

Trip meter 181

Turn signal lights

Replacing light bulbs 415
 Switch 178
 Wattage 505

U

USB memory 268, 276

V

- Vanity mirrors.....333
- Vehicle data recordings 18
- Vehicle identification
 - number497
- Vehicle Proximity Notification
 - System25
- Vehicle stability control.....221
- VSC.....221

W

- Warning buzzers
 - Brake system437
 - Electric power steering
 - system438
 - Key reminder.....455
 - Master warning.....439
 - Seat belt reminder.....439
- Warning lights
 - Anti-lock brake system.....438
 - Brake assist system438
 - Brake system437
 - Charging system438
 - Electric power steering
 - system438
 - Front passenger occupant
 - classification system438
 - Low brake fluid437
 - Low fuel level439
 - Low tire inflation pressure439
 - Malfunction indicator lamp438
 - Master warning light.....439

- Pretensioners438
- Seat belt reminder light439
- Slip indicator light.....438
- SRS airbag system438
- Tire pressure.....439
- Tire pressure warning
 - system439

Warning messages

- Back door.....450
- Cruise control.....449
- EV drive mode450
- Hybrid system448
- Hybrid system overheat450
- Maintenance450
- Moon roof.....450
- N position.....450
- Open door.....450
- P position450
- Parking brake.....450
- Smart key system449, 455
- Traction battery.....450

Washer

- Checking378
- Preparing and checking
 - before winter.....231
- Switch210, 214

Washing and waxing346

Weight

- Cargo capacity226
- Load limits.....230
- Weight.....496

Wheels396

Window lock switch.....98

Windows

Power windows 98

Rear window defogger 247

Washer 210, 214

Windshield wipers..... 210**Wireless remote control key**

Replacing the key battery..... 401

Wireless remote control..... 61

WMA disc 261

What to do if...

What to do if...

A tire punctures	P. 463	If you have a flat tire
The hybrid system does not start	P. 475	If the hybrid system will not start
	P. 110	Immobilizer system
	P. 481	If the vehicle 12-volt battery is discharged
The shift lever cannot be moved out	P. 477	If the shift lever cannot be shifted from P
The engine coolant temperature warning light flashes or comes on	P. 487	If your vehicle overheats
Steam can be seen coming from under the hood		
The key is lost	P. 478	If you lose your keys
The 12-volt battery runs out	P. 481	If the vehicle 12-volt battery is discharged
The doors cannot be locked	P. 65	Side doors
	P. 71	Back door
The vehicle is stuck in mud or sand	P. 492	If the vehicle becomes stuck
A warning light or indicator light comes on	P. 437	If a warning light turns on or a warning buzzer sounds

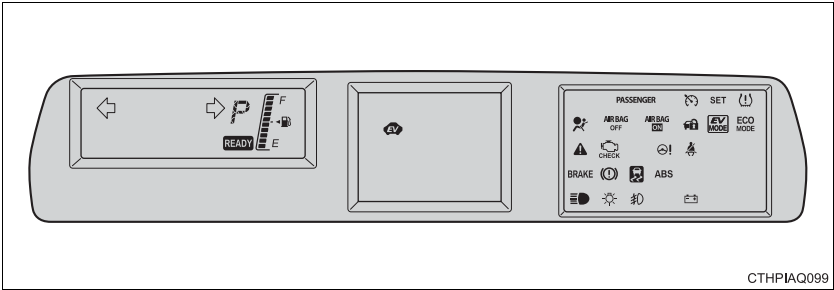

CTHPIAQ099

■ Warning lights

BRAKE Brake system warning light
(red indicator)

or



P. 437

 Charging system warning light
P. 438

 Malfunction indicator lamp

or



P. 438

 SRS warning light
P. 438

ABS ABS warning light

or





P. 438

 Electric power steering system warning light
P. 438

 Slip indicator light*
P. 438

 Brake system warning light
(yellow indicator) P. 438

 Low fuel level warning light
P. 439

 Driver's and front passenger's seat belt reminder light
P. 439

 Master warning light
P. 439

 Tire pressure warning light
P. 439

*: Slip indicator comes on.

GAS STATION INFORMATION

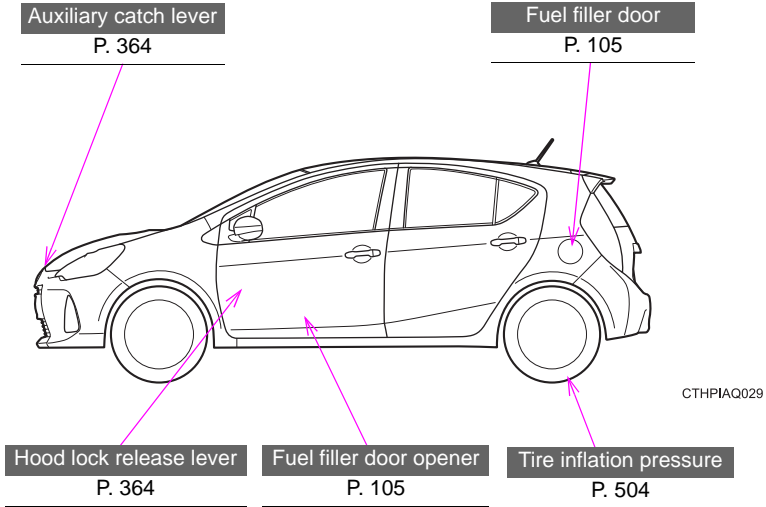

Fuel tank capacity (Reference)	9.5 gal. (36 L, 7.9 Imp. gal.)	
Fuel type	Unleaded gasoline, Octane Rating 87 (Research Octane Number 91) or higher	
Cold tire inflation pressure	P. 504	
Engine oil capacity (Drain and refill — reference)	With filter Without filter	qt. (L, Imp. qt.) 3.9 (3.7, 3.3) 3.6 (3.4, 3.0)
Engine oil type	Toyota Genuine Motor Oil or equivalent Oil grade: ILSAC GF-5 multigrade engine oil Recommended oil viscosity: SAE 0W-20 P. 499	